

QST

devoted entirely to
**amateur
radio**



February
1934
25 cents

1934
ELEVENTH
EDITION

The
**RADIO
AMATEUR'S
HANDBOOK**

Our Technical Department has spent more time on the Eleventh Edition than on any other edition except the first. So great have been the changes in technique during 1933 that almost all of the technical material has had to be re-written and re-illustrated. Several of the chapters are brand new from stem to stern. Nothing was left in the new edition unless it could lay claim to being the last word in technique or operating practice.

Chapter I outlines the story of Amateur Radio — its start, its difficulties, its accomplishments; of the formation of the League to protect and preserve the rights of amateurs. Chapter II explains in detail how to get started in this finest of hobbies. Chapters III & IV, in simple language, explain electrical and radio fundamentals. Chapter V is devoted entirely to receivers. It contains circuits with complete constructional details and makes comparisons of the various circuits. It is full of constructional tips. Chapter VI recognizes monitors and frequency meters as essential parts of the equipment and tells how to make various types; how to calibrate them, and how to use them properly. Chapter VII covers transmitters, the most important part of a station. Self-excited and crystal-controlled; what ones to build, how to build them, how to tune them, and countless other helpful things, are all here. Chapter VIII, headed "Radio-telephony," covers the particular problems of phone transmitters and their operation, thoroughly and completely. Different types of modulators and amplifiers are shown and attention called to their various advantages. Chapter IX, written by pioneers in the Ultra-high Frequency field, points out the unusual circumstances to be found and gives the necessary information to build complete transmitters and receivers for use on frequencies of 30 megacycles and up. Chapter X treats of the vital subject of power supplies. Largely upon your power supply, depends the quality of your note. Here you will find power supplies designed especially to meet your particular needs. Chapter XI tells you how to prevent and cure various types of interference. It considers broadcast reception interference, and suggests the best keying methods. Chapter XII, on antennas, is packed with useful suggestions of how to best meet this frequently bothersome problem. The best of transmitters cannot make up for a poor antenna. The solution to your antenna difficulties will be found in these pages. Chapter XIII suggests various station arrangements both for the fellow who has plenty of room and the fellow whose space is limited. Chapter XIV explains the workings of the League's Communications Department. It tells of its aims and purposes; of its extensive field organization and how you may take part in all its activities. Chapter XV gives full instructions on the best operating procedure. From the calling of a station to the keeping of a log, it is all covered. Chapter XVI tells how messages should be handled, the correct form, and the restrictions governing message handling. In addition to these chapters there is an appendix full of useful data such as international prefixes, list of "Q" signals, commonly used abbreviations, and many useful charts and tables. In wealth of information (260 pages) and its 224 illustrations, the HANDBOOK is a big book.

●

AT ANY PRICE, AN AMATEUR
COULD ILL AFFORD TO BE
WITHOUT IT

New COMET "PRO"

**CRYSTAL
FILTER**

Insert
**CLEARER
'PHONE
Signals**

Study the
Diagram
and You'll
See Why



MANY a time you would like to listen to a DX 'phone signal that is hopelessly garbled by a powerful heterodyne. The new COMET "PRO" Quartz Crystal Filter actually makes this possible.

A simple panel control eliminates, or greatly attenuates, the heterodyne while still maintaining the "single-signal" peak of the filter.

The "attenuation notch" may be shifted to either side of the main peak without detuning the signal.

This is an exclusive Hammarlund feature and may be added, at moderate cost, to the Standard "PRO."

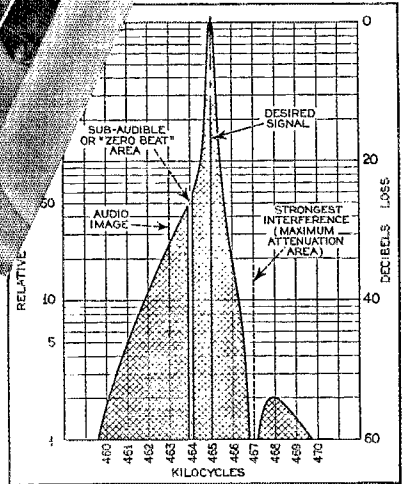

Mail Coupon for Details



HAMMARLUND MANUFACTURING CO.
424 W. 33rd St., New York

— Check here for new booklet describing the COMET "PRO" and information about adding Crystal Filter or Automatic Volume Control to the Standard "PRO."
— Check here for New General Catalog of Radio Parts.

Name.....

Address.....

.....Q-2



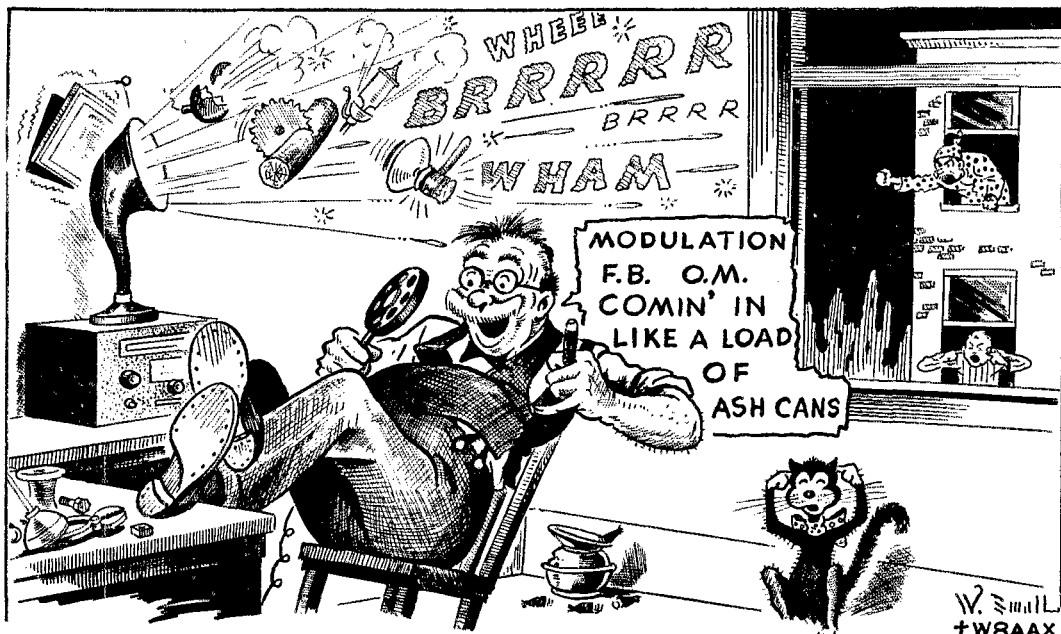

Don't let your MODULATION be "WOBBULATION." Use *Westinghouse Instruments* for accurate measurements of modulation and control

DO your phone sigs sound like a speech inverter? Do your QRK's say FB one minute and "rotten radio" the next? Remember all men are failures when it comes to guessing percentage modulation. The only way to tell definitely about modulation is by the use of accurate instruments properly applied.

This month Westinghouse offers a folder on instruments to help the phone amateur solve some of his problems. Included are discussions of measurements of modulated plate voltages across chokes, and the output of Class B transformers. The various types of indicating circuits include: Current transformer and Rectox, or thermal instrument in plate supply lead, or across line to measure exciting voltage; thermal instrument with RF pick-up; tube rectifiers with d-c. instruments; grid current indicators in Class B modulators; Rectox instruments as distortion indicators.

Every phone "bug" will want a copy of this folder. The information it gives will help you avoid being an "ether grabber" or a "hash-house echo." Send the coupon, or a post card, for your copy.

And don't forget to ask for Catalog 43-340, if you haven't already received a copy. It describes a complete line of 2¼ and 3½-inch panel-mounting instruments with latest improvements you'd expect to find only in much larger instruments.

SEND FOR INFORMATION

Westinghouse Electric & Manufacturing Company
Dept. 118, Room 2-N—East Pittsburgh, Pa.

Gentlemen: Please send the booklets checked below:

F. 8325—The Use of Rectox and Thermal Instruments in Modulation Measurements and Control.

Catalog 43-340—Types MX and NX Instruments.

Name

Address

CityState.....T 79846

Call Letters..... QST 2-34

Westinghouse

QST

Published monthly, as its official organ, by the American Radio Relay League, Inc., at West Hartford, Conn., U. S. A.; Official Organ of the International Amateur Radio Union

devoted entirely to

AMATEUR RADIO

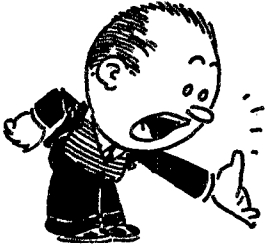

Editorials	9
Modernizing the Three-Tube Transmitter <i>George Grammer</i>	10
A Universal Antenna Coupling System for Modern Transmitters <i>Arthur A. Collins, W9CXX</i>	15
How's Your Fist? <i>F. H. Schnell, W9UZ</i>	18
Clearing Up the Note with a Bridge Rectifier <i>Dean C. Swan, Jr., WIBXC</i>	20
The M. I. T. 56-Mc. Airplane Tests	21
The Sixth International Relay Competition <i>F. E. Handy</i>	22
The Operation of R. F. Power Supplies <i>Part I. H. A. Robinson, W3LW</i>	25
Taming the Phone Transmitter <i>Temple V. Ehmsen, W7VS</i>	29
Hamdom	34
The Bandsetter <i>G. F. Lampkin, W8ALK</i>	35
Navy Day—1933 <i>E. L. Battey</i>	38
The 830-B—A New Tube for Class B Service	39
A Stable General Purpose Test Oscillator <i>Richard F. Shea</i>	40
Amateur Radio Stations <i>W6ERT, W3MG</i>	42
For the Experimenter AN INEXPENSIVE TEMPERATURE-CONTROL OVEN—A VOLT- AGE-FED ANTENNA SYSTEM WITH TWISTED PAIR FEEDERS— UNIVERSAL JOINT FOR ZEPPEL ANTENNAS	43
Calls Heard	46
I. A. R. U. News	47
Communications Department	49
License Danger	65
Election Results	65
Correspondence Department	66
Commission Tightens Enforcement of Regulations	72
Silent Keys	72
Standard Frequency Transmissions	74
Delta Division Convention	74
New Code Practice Oscillator	82
Southeastern Division Convention	84
Hamads	90
QST's Index of Advertisers	94

FEBRUARY
1934

VOLUME XVIII
NUMBER 2

Kenneth B. Warner (Secretary, A.R.R.L.), Editor-in-Chief and Business Manager; Ross A. Hull, Associate Editor; James J. Lamb, Technical Editor; George Grammer, Assistant Technical Editor; Clark C. Rodimon, Managing Editor; David H. Houghton, Circulation Manager; F. Cheyney Beckley, Advertising Manager; Ursula M. Chamberlain, Assistant Advertising Manager.

Editorial and Advertising Offices
38 La Salle Road, West Hartford, Conn.

Subscription rate in United States and Possessions and Canada, \$2.50 per year, postpaid; all other countries, \$3.00 per year, postpaid. Single copies, 25 cents. Foreign remittances should be by international postal or express money order or bank draft negotiable in the U. S. and for an equivalent amount in U. S. funds.

Entered as second-class matter May 29, 1919, at the post office at Hartford, Connecticut, under the Act of March 3, 1879. Acceptance for mailing at special rate of postage provided for in section 1103, Act of October 3, 1917, authorized September 9, 1922. Additional entry at Concord, N. H., authorized February 21, 1929, under the Act of February 28, 1925.

Copyright 1934 by the American Radio Relay League, Inc.
Title registered at United States Patent Office.

Modernize Your Transmitter!

Discard Neutralization!

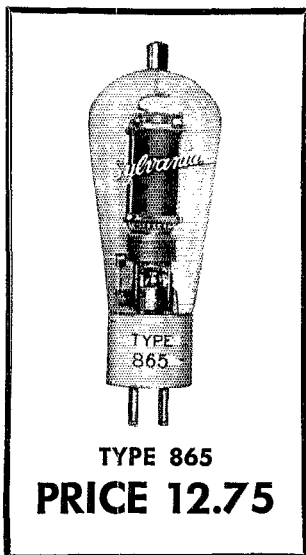

Sylvania TYPE 865

... eliminates the bother of neutralizing intermediate stages in transmitters. The amateur's dream transmitter is one where all he has to do is set the oscillator circuit to a given frequency and then simply tune the tank condensers of the intermediate amplifiers and the final amplifier to the oscillator's frequency... Some of the fellows are using this type of transmitter at the present time. They are more than pleased with the ease of operation.

Sylvania has made an 865 tube that has earned national acceptance. The efficiency of this tube is due to the graphite anode. Sylvania transmitting tubes, of the air cooled type, all use graphite anode construction. This means that Sylvania tubes will give more power output without showing any signs of strain.

The type 825 is excellent for ultra high frequency work, and don't forget the he-man output of 55 watts that the 830 will deliver in class "C" operation. In order to have a completely screen grid transmitter with no neutralizing, we suggest this tube line-up. 47osc., 865 doubler, 865 buffer, 282-A amp. class "C". The 282-A is a 70 watt screen grid tube and sells for \$31.00. For more detailed information, write to:



HYGRADE SYLVANIA CORPORATION
ELECTRONICS DEPARTMENT **AMATEUR RADIO DIVISION**
CLIFTON, NEW JERSEY

FACTORIES:

Salem, Mass.

Emporium, Pa.

St. Marys, Pa.

Clifton, N. J.

Section Communications Managers of the A.R.R.L. Communications Department

All appointments in the League's field organization are made by the proper S.C.M., elected by members in each Section listed. Mail your S.C.M. (on the 16th of each month) a postal covering your radio activities for the previous 30 days. Tell him your DX, plans for experimenting, results in 'phone and traffic. He is interested, whether you are an A.R.R.L. member or get your *OST* at the news stands; he wants a report from every active ham. If interested and qualified for O.R.S., O.P.S. or other appointments he can tell you about them, too.

Eastern Pennsylvania	W3GS	ATLANTIC DIVISION Jack Wagenseller	24 South Fairview Ave.	Highland Park, Upper Darby
Maryland-Delaware-District of Columbia	W3BAK	Edgar L. Hudson		Laurel, Delaware
Southern New Jersey	W3QL	Gedney Rigor	412 2nd Ave.	Haddon Heights
Western New York	W8DSP	Don Farrell	213 Hickok Ave.	Syracuse
Western Pennsylvania	W8CUG	C. H. Grossarth	R. F. D. 3, Eicher Rd.	Ensworth, Bellevue, Pa.
ILLINOIS	W9WR	GENERAL DIVISION Fred J. Hinds	6618 West 34th St.	Berwyn
Indiana	W9TE	Arthur L. Braun	911 Rejser St.	Indianapolis
Kentucky	W9OX	Carl L. Pfumm	P. O. Box 359	Louisville
Michigan	W8DYH	Kenneth F. Conroy	7538 E. Robinwood Ave.	Detroit
Ohio	W8BAH	Harry A. Jumbo	2073 West 85th St.	Cleveland
Wisconsin	W9FSS	Harold H. Kurth	2550 N. 8th St.	Milwaukee
NORTH DAKOTA	W9DGS-IFW	DAKOTA DIVISION Wm. Langer	313 First Ave., S.	Jamestown
South Dakota	W9DKL	C. B. Miller	449 N. 5th St.	Redfield
Northern Minnesota	W9JIE	Robert C. Harshberger	1200 Fauquier St.	St. Paul
Southern Minnesota	W9EJ	Norman Beck	415 Grand St.	Winona
ARKANSAS	W5ABI	DELTA DIVISION H. E. Velte	2918 West 15th St.	Little Rock
Louisiana	W5DWW	W. J. Wilkinson, Jr.	1624 Allen Ave.	Shreveport
Mississippi*	W5VT	W. Wren	P. O. Box 66	Jackson
Tennessee	W4AFM	F. F. Purdy	P. O. Box 173	Kingsport
EASTERN NEW YORK	W2LU	HUDSON DIVISION Robert E. Haight	1080 Heiderberg Ave.	Schenectady
N. Y. C. & Long Island	W2AZV	E. L. Baunach	7823 10th Ave.	Brooklyn
Northern New Jersey	W2CO	Walter A. Cobb	28 Ampere Parkway	East Orange
IOWA	W9FFD	MIDWEST DIVISION George D. Hansen	3734 Summit St.	Sioux City
Kansas	W9FLG	O. J. Spetter	305 Western Ave.	Topeka
Missouri	W9EVG-HCP	C. R. Cannady	300 Sixth St.	Monett
Nebraska	W9FAM	Samuel C. Wallace	Green St.	Clarks
CONNECTICUT	W1CTI	NEW ENGLAND DIVISION Richard J. Fox	19 Merrill Rd.	Norwalk
Maine	W1CDX	John W. Singleton	10 High Street	Wilton
Eastern Massachusetts	W1ASI	Joseph A. Mullen	16 Mercer St.	Ashmont
Western Massachusetts	W1ASY-WIRB	Earl G. Hewinson	33 Cortland St.	Springfield
New Hampshire	W1APK	Basil Cutting		Pembroke
Rhode Island	W1AFO	Stanley Atkinson	186 Magnolia St.	Auburn
Vermont	W1ATF	Harry Page	R. 1	Hinesburg
ALASKA	K7PO	NORTHWESTERN DIVISION Richard J. Fox	Box 301	Ketchikan
Idaho	W7A VP	Don E. Oberbillig	P. O. Box 1271	Armadia
Montana	W7AAT-7QT	O. W. Viers		Boise
Oregon	W7ABZ	Raymond W. Cummins	4835 N. Amherst St.	Red Lodge
Washington	W7AYO	Stanley J. Belliveau	Route 7, Box 387	Portland
HAWAII	K6COG	PACIFIC DIVISION C. D. Slaten	Pearl City	Yakima
Nevada	W6EAD	Keston L. Ramsay	1151 Buena Vista Ave.	Oahu
Los Angeles	W6AAN	Francis C. Martin	738 W. Huntington Drive	Reno
Santa Clara Valley*	W6DBB	Barton A. Wood	R. 1, Box 722	Arcadia
East Bay*	W6ZX	P. W. Dann	1821 Chestnut St.	Campbell
San Francisco	W6CAL	Byron Goodman	141 Alton Ave.	Berkeley
Sacramento Valley	W6DVE	Geo. L. Woodington	716 Redwood Ave.	San Francisco
Arizona	W6BJF-W6QC	Ernest Mendoza	1434 East Madison St.	North Sacramento
Philippines*	KA1XA	Newton D. Thompson	714 Tennessee	Phoenix
San Diego	W6EOP	Harry A. Ambler	401 Hamilton St.	Manila, P. I.
San Joaquin Valley*	W6AOZ	Alfred H. Green	723 North Orange St.	San Diego
NORTH CAROLINA	W4AVT	ROANOKE DIVISION G. H. Wright, Jr.	2817 Montrose Ave.	Wendell
Virginia	W3AAJ	R. N. Eubank	100 20th St.	Richmond
West Virginia	W8HD	C. S. Hoffmann, Jr.		Warwood, Wheeling
COLORADO	W9BTO	ROCKY MOUNTAIN DIVISION T. R. Becker	1176 Gaylord St.	Denver
Utah-Wyoming*	W6GQC-IDM	Arty W. Clark	260 So. 9th West	Salt Lake City, Utah
ALABAMA	W4KP	SOUTHEASTERN DIVISION L. D. Elwell	1066 Waverly St.	Tarrant
Eastern Florida	W4NN	Ray Atkinson	4524 College St.	Jacksonville
Western Florida	W4MS	Edward J. Collins	1517 East Brainard St.	Pensacola
Georgia-So. Carolina-Cuba- Isle-of-Pines-Porto Rico- Virgin Islands	W4UT	George A. Love	1202 NE Springdale Rd.	Atlanta
NORTHERN TEXAS	W5AUL	WEST GULF DIVISION Glen E. Falbutt	1902 South 11th St.	Abilene
Oklahoma*	W5BQA	Sgt. R. P. Hince	1st Ballou Co.	Fort Sill
Southern Texas	W5BFO	David H. Calk	6726 Ave. Q	Houston
New Mexico	W5DUI	Dan W. De Lay	400 North Ash St.	Albuquerque
MARITIME	VE1DQ	MARITIME DIVISION A. M. Crowell	69 Dublin St.	Halifax, N. S.
ONTARIO	VE3GT	ONTARIO DIVISION S. B. Trainer, Jr.	4 Shorncliffe Ave.	Toronto
QUEBEC	VE2AP	QUEBEC DIVISION J. C. Stadler	4334 Westmount Ave.	Westmount, P. Q.
ALBERTA	VE4HM	VALDIA DIVISION C. H. Harris	10806 125th St.	Edmonton
British Columbia	VE5AC	R. K. Town	1754 Gravelly St.	Vancouver
MANITOBA	VE4GC	PRAIRIE DIVISION Reg. Strong	284 Marion St.	Winnipeg
Saskatchewan	VE4EL	Wilfred Skafte	2040 McTavish St.	Regina

* Officials appointed to act until the membership of the Section choose permanent SCM's by nomination and election.

THE NEW GROSS 25-30 WATT STATION

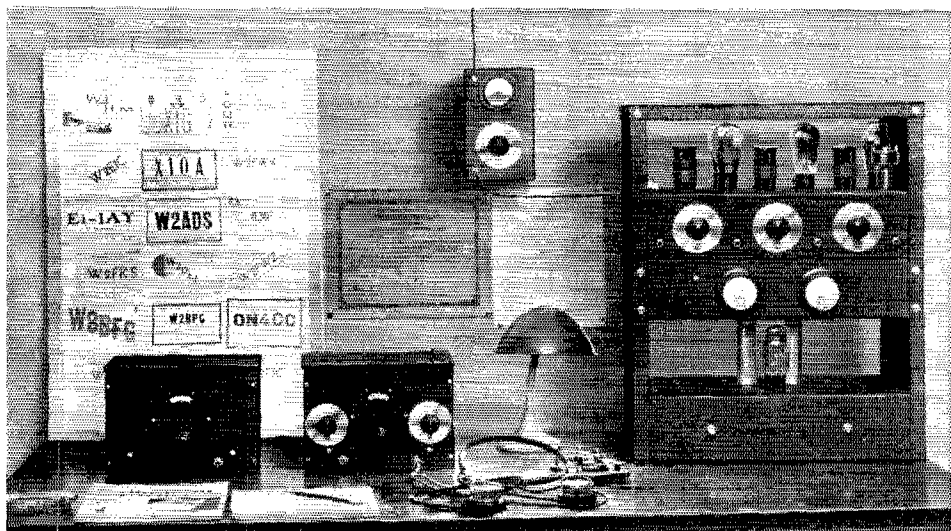

A STATION YOU WILL BE PROUD TO OWN

Complete GROSS Crystal Control Station

CW-25 Transmitter Kit.....	\$13.50
Power Supply Kit.....	8.75
Panel Rack and Meter Panel.....	8.00
Two Moving Coil Surface Type Milliammeters.....	7.00
Eagle S.W. Receiver.....	11.95
X cut 80 or 160-meter Crystal.....	2.75
Hoyt Hot Wire Antenna Meter.....	2.95
Antenna Tuning Condenser.....	1.25

The GROSS "CW-25" Crystal Control Transmitter Kit . . . \$13.95

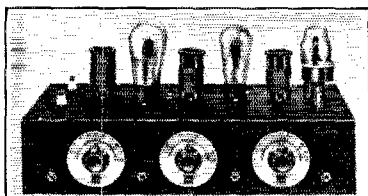

The "CW-25" transmitter kit due to its low cost makes it possible for anyone to own a modern crystal controlled station. A schematic hook-up and parts layout sheet as well as tuning instructions are furnished, thus enabling the most inexperienced operator to wire and put the set on the air, for real results. The "CW-25" is supplied with a shrivel finished sturdy metal chassis under which all parts are mounted, making the wiring and components dustproof. A plug-in crystal holder is furnished with the kit. Only one milliammeter is required for tuning the transmitter and each stage is provided with a jack for this purpose. The "CW-25" uses one '47 as crystal oscillator, one '46 as buffer or

doubler and two '46's in the amplifier stage. One set of three coils is supplied with the kit for 20, 40, 80 or 160 meter band. Any additional coils are 75 cents each.

The GROSS "CW-25" Power Supply Kit . . . \$8.75

Mounted on shrivel finished metal chassis which matches the "CW-25" transmitter. Heavy duty power transformer, chokes, condensers, bleeder, etc. supplied. Uses one '83 rectifier. This unit and the transmitter make a neat combination as well as an efficient one.

The "EAGLE" Three-Tube Short Wave Receiver

"Band Spread" over any portion of the tuning range — only finest material used thruout. Employs one '32 R.F., one '32 detector and one '33 Pentode Audio — 15 to 200 meters — four coils supplied. The "EAGLE" is economical — two dry cells will operate the filaments. See March or April *QST* for full description of this most excellent value in short wave receivers.

"Eagle" completely wired and tested. \$11.95 Three tubes tested in your receiver. \$3.00

GROSS Band Spread Monitor \$9.95

Completely wired and tested, with full size dry cells, 22.5V. C battery and type '30 tube

GROSS RADIO, INC. / **51 VESEY STREET** / **NEW YORK CITY**

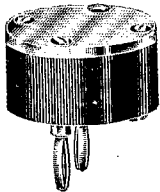

GROSS CRYSTAL HOLDER ONLY
\$1.00

A commercial type crystal holder for half the price you have to pay for ordinary holders. New type pressure springs, square inside to prevent movement of crystal, one piece molded body — dust-proof — will take crystals up to 1 1/8" square or round. Plugs standard 3/4" spacing. This holder must be seen to be appreciated for the extraordinary value offered.

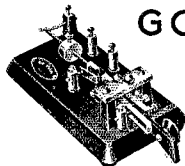

GO-DEVIL

The new Mechanical Key Sensation. Has many features — will do anything the highest priced key will — come in and try it. Price, \$6.00

NEW!

WARD LEONARD OVERLOAD RELAYS

Safeguard your tubes and meters — two types — for breaking at 250 or 500 MA.....\$5.00

TRANSPON

- Transposition Insulators.....\$0.09
- Airplane Strain Insulators......05
- 12" Antenna Insulators......45
- Tiny-mite 1/2" and 1" stand-off Ins....05
- White or Brown Beehive Ins., doz....50
- Insulantite spreaders 3" long, 10 for...35
- Pyrex 7 1/2" antenna insulators......68

TRIMM 24,000 ohm impedance Feather-weight phones. Special.....\$5.85

NEW! UNIVERSAL S.B. Microphone
GOLD Button. Special.....\$1.79

PIEZO-ASTATIC Crystal Microphone

Type D-104. Special.....\$12.25

- Thord. 30 H 75 MA choke.....\$.69
- Thord. 15 H 950 MA...... 2.95
- Thord. 30 Henry 500 MA chokes..... 9.95
- Thord. No. T-2458 double 18 H 950 MA...... 6.50
- Gross-cased 30 H 200 MA choke.... 2.25
- 500 H plate chokes for Screen Grid detectors (cased)......95

GROSS SPECIAL TRANSFORMER

600 volts each side of C.T. 200 MA
2 1/2 V. 10 amps., 5 V. 3 amps.,
7 1/2 V. 3 amps.....\$3.95

GUARANTEED TUBES

- 866 Heavy Duty Insulantite top.....\$2.15
- 888 or 871.....1.15
- 83, 47's and 46's......70
- 481......90
- 210's.....1.30
- 1/4, 1/2 and 1 watt neon bulbs......40

SOLID ENAMELED ANTENNA WIRE

- No. 14 (any length) per 100 ft.....\$.35
- No. 12 (any length) per 100 ft......55
- No. 10 (any length) per 100 ft......90
- No. 8 (any length) per 100 ft.....1.30

HAMMARLUND CRYSTAL "PRO"

Transportation prepaid anywhere in U. S. A..... \$111.72

JOHNSON

JOHNSON TYPE "Q" ANTENNA SYSTEM

A Practical Transmission-Line System for the Doublet Antenna

(for full description see article by Johnson & Glover in January 1934 QST)

- Type 5Q complete 5 M antenna.....\$2.65
- Type 10Q complete 10 M antenna... 3.67
- Type 20Q complete 20 M antenna... 5.82
- Type 40Q complete 40 M antenna...10.29
- Type 80 Q complete 80 M antenna...19.25
- Type 160Q complete 160 M antenna37.48

GROSS CASED POWER TRANSFORMERS

- 850-1350-1500 V. each side of C.T.
400 watts.....\$8.95
(the ideal job to give 750-1000-1250 V.D.C. with choke input)
- For use with '83 tube will give an output of 500 volts D.C. at 350 MA with choke input. Run your entire R.F. and Class B of this transformer. The regulation for the class B is about 5%, filaments are two 7 1/2v. and one 5v. Special.....\$5.75
- A transformer having the same filament windings as above — at 300 MA having 750 volts each side of C.T.
Special.....\$6.00
- 750-1000 V. each side of C.T.
300 watts. Extra special.....\$6.80
- 1500-2000 V. each side of C.T.
800 Watts.....\$11.95

NEW!

STAND-OFF INSULATORS

Very convenient where R.F. leads are brought thru metal chassis, etc. Ideal for low power lead-in insulators.

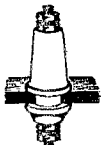

- (Type illustrated.)
- 5/8" high.....\$0.06
- 3/4" high......10
- 1 1/4" high......13
- JACK TYPE**
- 3/8" high.....\$1.12
- 1 1/4" high......15

Ward Leonard Vitreous Resistors 200-Watt 8 1/2" Long with Variable Sliders.

- 1000 ohms.....\$.99
- 2500 ohms.....1.05
- 5000 ohms.....1.05
- 10000 ohms.....1.11
- 15000 ohms.....1.20
- 25000 ohms.....1.29
- 35000 ohms.....1.35
- 50000 ohms.....1.44
- 60000 ohms.....1.49
- 80000 ohms.....1.59
- 100000 ohms.....1.65

NEW!

510 Type TUBE ISOLANTITE BASE

Lava bar insulation — Thoriated filament — the kind of tube we like to sell. Will take 750 volts on the plate. Extra Special.....\$2.85

INSULEX Low Loss Coil Forms

- 4 prongs.....29c
- 6 prongs.....34c
- 5 prongs.....32c
- 7 prongs.....37c

WIRE-WOUND Volume Controls

- 10 ohm to 75,000 ohm any size.....49c
- HOYT moving coil 3" 0-1 MA meters. Special.....\$3.95

COMBINATION

FILAMENT TRANSFORMER \$3.65

- 2 1/2 V. C.T. 10 amps for 866's
- 10 V. C.T. 7 amps. for '50's or '52's. 10,000 volt insulation.
- Cased 6.3 V. 2 amp. transf.....\$1.25
- 2.5 V. 6 amp. C.T. (midget)......80
- 5 V. 3 amp. C.T. for '83 (midget).... .80
- 2 1/2 — 2 1/2 and 5 Volt C.T.....1.45
- 2 1/2 — 7 1/2 and 7 1/2 Volt C.T.....1.45
- 2 1/2 — 5 and 7 1/2 Volt C.T.....1.45
- 5 — 5 and 5 Volt C.T.....1.45
- 5 — 7 1/2 and 7 1/2 Volt C.T.....1.45

GROSS CASED CLASS "B" TRANSFORMERS \$4.94

A pair of cased high grade transformers for 46's.

Filament Transformers shielded in metal cases, center tapped secondaries.

- 2.5 Volt 10 amperes for 866's.....\$2.50
- 10 to 12 Volts at 8 amperes..... 2.50
- Special 10-12 Volt 7.5 ampere filament transformer, extra special.... 1.10

MIDGET DOUBLE SPACED NEUTRALIZING CONDENSERS 35 mmf.

- a real buy.....\$.69
- Oil impregnated cased condensers
- 1400 volts D.C. 2-2 mfd..... 1.85
- Pilot J-23 100 mmf. condensers......60
- CARDWELL 123-B .0005 mmf..... 2.35
- CARDWELL 164-B .00022 mmf..... 2.35
- Single or Double button mike transformer......99



Hoyt Antenna Meter

Hot wire antenna meters. 2 1/4" mounting hole, flange 3" diameter, supplied in 1 1/2, 3 and 5 ampere ranges. Why work without antenna meters when you can buy them at this special price?.....\$2.95

Hoyt Milliammeters and Voltmeters

Perfectly damped meters at a price. These are not to be confused with the usual inexpensive meters. 2" mounting hole, flange 2 3/8" diameter, supplied in the following sizes: 10 ma, 25 ma, 50 ma, 100 ma, 150 ma, 250 ma, 300 ma, 4 V. AC, 10 V. AC, 15 V. AC, 10 V. DC. Price each \$1.50, 3 for \$4.25

20% deposit with all C.O.D. orders. Remit by M.O. Include postage. Prices subject to change without notice.

GROSS RADIO, INC. 51 VESEY STREET NEW YORK CITY

The American Radio Relay League



• **T**HE AMERICAN RADIO RELAY LEAGUE, INC., is a non-commercial association of radio amateurs, bonded for the promotion of interest in amateur radio communication and experimentation, for the relaying of messages by radio, for the advancement of the radio art and of the public welfare, for the representation of the radio amateur in legislative matters, and for the maintenance of fraternalism and a high standard of conduct.

It is an incorporated association without capital stock, chartered under the laws of Connecticut. Its affairs are governed by a Board of Directors, elected every two years by the general membership. The officers are elected or appointed by the Directors. The League is non-commercial and no one commercially engaged in the manufacture, sale or rental of radio apparatus is eligible to membership on its board.

"Of, by and for the amateur," it numbers within its ranks practically every worth-while amateur in the world and has a history of glorious achievement as the standard-bearer in amateur affairs.

Inquiries regarding membership are solicited. A bona fide interest in amateur radio is the only essential qualification; ownership of a transmitting station and knowledge of the code are not prerequisite. Correspondence should be addressed to the Secretary.

DIRECTORS

President
HIRAM PERCY MAXIM.....W1AW
Box 216, Hartford, Conn.

Vice-President
CHARLES H. STEWART.....W3ZS
St. David's, Pa.

Canadian General Manager
ALEX. REID.....VE2BE
169 Logan Ave., St. Lambert, P. Q.

Atlantic Division
EUGENE C. WOODRUFF.....W8CMP
234 W. Fairmount Ave., State College, Pa.

Central Division
LOREN G. WINDOM.....W8GZ-W8ZG
1375 Franklin Ave., Columbus, Ohio

Dakota Division
CARL L. JABS.....W9BVH
1822 James St., St. Paul, Minn.

Delta Division
M. M. HILL.....W5EB
P.O. Box 274, Natchitoches, La.

Hudson Division
BERNARD J. FULD.....W2BEG
280 Broadway, New York City

Midwest Division
H. W. KERR.....W9DZW-W9GP
Little Sioux, Iowa

New England Division
G. W. BAILEY.....W1KH
74 Webster Road, Weston, Mass.

Northwestern Division
RALPH J. GIBBONS.....W7KV-W7BIX
3134 N. E. 25th Ave., Portland, Ore.

Pacific Division
S. G. CULVER.....W6AN
2962 Russell St., Berkeley, Calif.

Roanoke Division
H. L. CAVENESS.....W4DW
State College Station, Raleigh, N. C.

Rocky Mountain Division
RUSSELL J. ANDREWS.....W9AAB
1867 So. Lafayette St., Denver, Colo.

Southeastern Division
J. C. HAGLER, JR.....W4SS
2424 McDowell St., Augusta, Ga.

West Gulf Division
FRANK M. CORLETT.....WSZC
2515 Catherine St., Dallas, Tex.

OFFICERS

President.....HIRAM PERCY MAXIM, W1AW
Hartford, Connecticut

Vice-President.....CHARLES H. STEWART, W3ZS
St. David's, Pennsylvania

Secretary.....KENNETH B. WARNER, W1EH
West Hartford, Connecticut

Treasurer.....ARTHUR A. HEBERT, W1ES
West Hartford, Connecticut

Communications Mgr....F. EDWARD HANDY, W1BDI
West Hartford, Connecticut

General Counsel.....PAUL M. SEGAL, W3EEA
1010 Shoreham Building, Washington, D. C.

Address all general correspondence to the executive headquarters at West Hartford, Connecticut



THE EDITOR'S MILL

THIS journal's recent dissecting of some of the intricacies of 'phone operation was hailed by the voice brethren as a very helpful diagnosis of some of their operating ills. We now want to attract the attention of the keypounding fraternity to an available object-lesson that affords helpful opportunity for self-analysis and improvement in code work. In brief, we suggest a humble comparing of our fists and operating styles with the tape transmission that is used at a number of amateur stations.

For a couple of years the official broadcasts from W1MK have been sent by tape. Several amateurs having access to commercial perforating equipment have used it for ham traffic-handling, punching out their messages in advance of schedules and putting them across with maximum ease. Amongst these we recall particularly W2NV, W2AYN, W3AHQ, W3CXL and W9DDE. It has remained for W9UZ in Chicago to apply automatic transmission to all his communication, and it is the operating of this station on 7005 kc. that we particularly have in mind as offering a nice lesson. A paper tape is punched on a Kleinschmidt perforator and run through a home-made Creed-type head to key the transmitter. The operator writes on an ordinary typewriter keyboard; everything else is automatic. We commonly think of tape transmitters only in connection with the automatic reception of meaningless high-speed blurs, far removed from the world of amateur radio. This is not like that. It is amateur stuff, at amateur speeds, used for the normal operation of the station. In a typical transmission the auto starts promptly with the usual call and sign, followed by acknowledgment of the correspondent's preceding transmission, then picking up the thread of the conversation and carrying it on, of course terminating with the usual sort of sign-off—just the same as in manual operation. Only its utter perfection identifies it as automatic.

Let us here assert with emphasis that we are not suggesting the general adoption of automatic transmission. Not that we find it coldly impersonal, since the qualities of personality reside largely in what is said rather than in the manner; but we do realize that manipulating the key is, for most of us, one of the chief pleasures of amateur operating. Moreover, the necessary gear is expensive and complex, and Messrs. Underwood, Remington, Royal, Corona, *et al.*, haven't yet brought out ten-buck tape-puncher attachments for their mills.

What we do believe is that all of us can take a lesson from the machine. It is because most of us will always prefer to use hand-sending that these transmissions, particularly those of W9UZ, are worth listening to. Here is the ultimate, it seems to us, in amateur communicating by the aid of O. M. Morse's code. Marvelously beautiful stuff, it sets a standard at which to shoot. It makes our own deficiencies glaringly apparent. Anyone who thinks that lack of "individuality" in machine-sending makes for difficulty of reading should try some of this through 40-meter QRM. Because every character is perfectly formed there is maximum ease of copying. Leisurely typing, the operator readily keeps ahead of the machine. The output speed is uniform, free from those temperamental changes of pace that so often characterize hand-sending. It starts at the beginning and moves with complete precision to the very sign-off. Nothing could be better calculated to put over the business in sure-fire fashion. Since not the space of a single dot is wasted, maximum intelligence is conveyed at minimum speed in words per minute. Perhaps best of all, the machine doesn't know how to disfigure its transmissions by hemming and hawing with breaks, periods and V's while the operator conjures up another thought. The real proof of its excellence comes when the copying operator realizes that, although the speed is easily within his capabilities, his pencil has been gliding right along at a good fast clip and that in the course of five minutes at twenty words a minute he has actually copied a hundred words.

This is exactly the kind of sending we all want to be able to do. The standard we keypounders set for ourselves is maximum intelligibility per minute per mile per watt. It is therefore illuminating to compare ourselves with the perfection of the machine. While few of us will want a tape sender, all of us want to be able to send by hand with the closest possible approach to its beauty, clarity and dispatch. By studying the automatic we can perceive our defects. We will see that we form our characters unskillfully, often carelessly; that we change pace in disconcerting fashion; and how we hem and haw! Anyone who will study the effortless perfection of these transmissions and endeavor to emulate them will make a better operator of himself.

K. B. W.

Modernizing the Three-Tube Transmitter

An Improved Version of One of QST's Most Popular Designs

By George Grammer, Assistant Technical Editor

TWO years is a long time in amateur radio, especially when new apparatus and new circuits follow on one another's heels at the dizzy pace attained in the past two twelve-months. Yet, despite new tubes and special circuits, a few fundamentals have carried through unchanged. The basic design of the three-tube three-band transmitter first described in November, 1931, *QST*,¹ is a case in point; notwithstanding the fact that it antedates most of the new tubes, Class-B audio and single-signal reception—all of them so familiar now that they seem like old-timers—a recent overhauling of the old set indicated that few changes need be made to bring it up-to-date while still retaining the features which made it popular—good power output and efficient operation on three bands, economy of apparatus, and above all, simplicity and convenience in changing bands. The changes now to be suggested will not, perhaps, greatly increase the output of the transmitter; they will, however, increase the ease of operation and give the crystal a little less work to do. Both these features represent worth-while improvements.

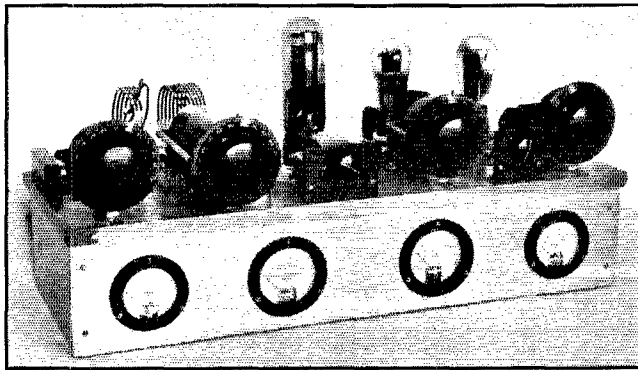

THE REVAMPED THREE-TUBE TRANSMITTER

Electrical changes include the installation of a pentode oscillator and a new tank circuit in the final stage. The meter panel, also a recent addition, is convenient but not necessary to the operation of the set.

The changes recommended are quite simple—substitution of a 47 for the 10 originally used in the crystal oscillator circuit, and revamping the

¹ "More About Economical Crystal Control," November, 1931, *QST*.

² "Which Tube for the Crystal Oscillator?," February, 1932, *QST*.

³ "Improving the Performance of the Neutralized Power Amplifier," January, 1934, *QST*.

final amplifier tank circuit to use split-stator condenser. Both these necessitate a few minor modifications in the wiring, and a new set of amplifier tank coils may be required. We shall not go into the reasons for either of these substitutions here; the pentode oscillator was covered in February, 1932, *QST*,² and the benefits to be derived from rearranging the amplifier tank circuit were discussed in January of this year.³ The transmitter also has been dressed up a bit to include a few meters, but it's still the same set.

OSCILLATOR CHANGES

The use of the 47 in the crystal oscillator circuit makes it necessary to install a 5-prong tube socket. The old bakelite sockets in vogue at the time the set was built are now unavailable, so one of the newer Isolantite ones was used. For the sake of appearance a similar socket was also installed in the doubler stage. Because of the change in sockets, blocking condensers of the type that can be fastened directly to the base-board were substituted for the old ones at C_3 and C_4 , Fig. 1. At the same time the capacity of the oscillator plate blocking condenser, C_3 , was changed to 100 $\mu\text{fd.}$, chiefly because one of that size happened to be on hand, although the use of a low-capacity condenser in the pentode circuit is often advisable. The below-deck changes to the oscillator circuit include the addition of the screen dropping resistor R_4 and by-pass condenser C_{11} . The gridleak, R_1 , was reduced from 20,000 to 5000 ohms, the latter value being more suitable for the 47, and a choke put in series with it to do away with r.f. losses in the resistor. Simultaneously, new chokes of the mid-get honeycomb type (National Type 100) were installed in

both the oscillator and doubler plate circuits to replace the home-made chokes previously used. This step is largely for the benefit of those who may now be tempted to build the set for the first time, since the discarded chokes sometimes were ineffective in preventing feedback when the oscillator and doubler were operated from the same power supply, unless by-passed at the

power-supply ends. This effect, mentioned in the original article,¹ happily is not present with the honeycomb chokes. As inspection of the bottom-view photograph will show, the chokes are

With 350 volts on the plate of the oscillator, the grid current in the buffer-doubler stage should be about 6 milliamperes, with no plate voltage on the doubler. Since this current flows through the

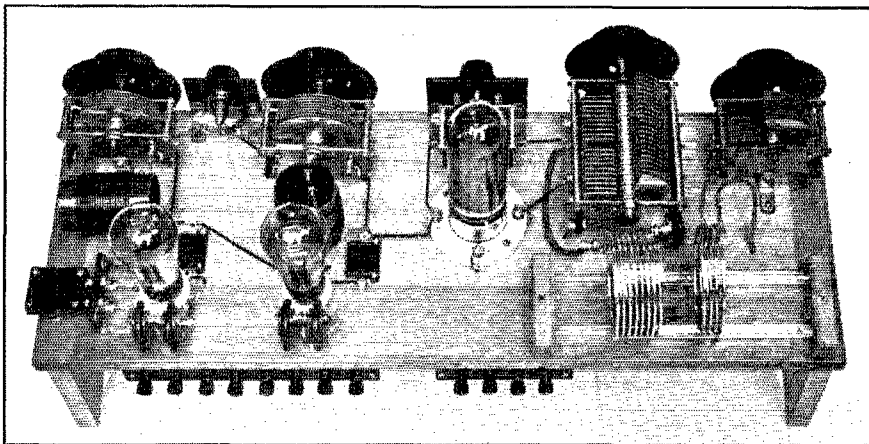

A TOP VIEW SHOWING THE NEW TANK CONDENSER AND COILS
Otherwise the layout is unchanged, the oscillator being at the left, buffer-doubler to its right, followed by the 203-A final amplifier.

mounted on some of the midget standoffs now being made by a number of manufacturers.

Before testing out the pentode oscillator it was expected that maximum excitation would be secured with the doubler grid tapped down on the coil L_1 . Actually, however, a trial of the setup showed that maximum excitation was secured with the doubler grid tap taken directly from the end of the coil, so it was left that way. The 47 is a great deal superior to the 10 formerly used because it is possible to use higher plate voltage on it with negligible crystal heating. This in turn means greater oscillator output. In this connection, to forestall repetitions of the suggestions that have been made many times by letter and in other magazines, perhaps we should say that we are fully aware of the fact that shifting the grid connections of the pentode around a bit will result in greater output. The catch is that doing it simply converts the pentode into a triode of sorts and the really good feature of the tube as a crystal oscillator—high output with little strain on the crystal—is thereby sacrificed. The only reason for using the pentode is to make life easier and longer for the crystal; otherwise one might as well use 350 volts on a 10 or 45, get plenty of output, and buy new crystals now and then.

Any of the power-pentode types, such as the 2A5 or 59, may be substituted for the 47, but it happens that the original layout of the set suits a filament-type tube. The fact that the 47 is ready for action almost immediately after the filament power is turned on often makes it preferable to the indirectly-heated types for transmitter work.

50,000-ohm resistor R_2 , the bias on this stage is approximately 300 volts plus the battery bias, or nearly 400 volts in all. Under operating conditions, with the doubler exciting the final amplifier, the grid current drops to about 4 ma., representing a total bias of about 300 volts. Because of the high bias as well as the circuit used, the doubler efficiency is high. The plate and screen current to the 47 should total about 30 milliamperes under operating conditions.

THE FINAL AMPLIFIER

With the oscillator circuit taken care of, the scene shifts to the final amplifier. The buffer-doubler circuit may be left just as it was originally, except for the choke substitution mentioned above.

A split-stator condenser at C_7 replaces the original single-section tank condenser, a change particularly beneficial in this set from the convenience standpoint because with proper handling the amplifier will stay neutralized on all three bands with a single setting of the neutralizing condenser. A secondary, but nonetheless real, benefit is that the input capacity of the final stage is reduced with this type of circuit³ so that it is no longer necessary to compromise on the position of the excitation tap on the doubler tank coil, L_2 . It works best right on the "hot" end of the coil. The revised circuit is given in Fig. 1. It will be noted that there is no longer a tap on the final amplifier tank coil, nor is there any blocking or by-pass condenser in the plate circuit. Eliminating the tap makes coil changing a quite simple matter. No blocking condenser

will be needed if the tank condenser has sufficient plate spacing to hold the d.c. plate voltage plus the r.f. plate voltage. The particular condenser used, a Cardwell Type 157-B, has not yet arced over with voltages up to 1500 on the plate of the 203-A.

Some consideration was given to the use of parallel vs. series feed in the amplifier plate circuit, the former being preferred from the standpoint of convenience, since a centertap on the

NEW COILS

A new set of tank coils to fit the amplifier tuning condenser had to be wound in this case because of the smaller capacity of the new condenser. Split-stator transmitting condensers of more than 100 μfd . maximum capacity (sections in series) run to unreasonable lengths—unreasonable for this particular layout, that is—while the coils for the old circuit were based on a maximum condenser capacity of 220 μfd . Because of the low capacity the 3.5-mc. coil has a large number of turns, so 1/8-inch tubing was secured in preference to the 3/16-inch size used for the old coils, and the coil diameter was increased to 3 1/2 inches. Soft 1/8-inch tubing is easy to wind, but results in a “floppy” coil unless some method is used to strengthen it; accordingly a scheme suggested by WIFRQ was tried out and found to work splendidly. The turns, properly spaced, are cemented to celluloid strips after the fashion of the old low-loss receiving coils.

To strengthen coils by this method, first slide the loose turns on a form just large enough to distend them somewhat so they will set firmly. The form on which they were wound will do quite well if a “filler” is put on to occupy the space left by the natural springing of the coil after it is wound. The filler may be a piece of corrugated cardboard wound around the tube or form. Then three half-inch-wide celluloid strips, slightly longer than the finished coil is to be, should be slid under the turns longitudinally, spaced equidistantly around the circumference of the coil. The next step is to straighten out the turns so that they are evenly spaced, and then fill in the spaces between the turns along the celluloid strips with Duco Household Cement.

The coil should then be left alone for an hour or so until the cement sets; then another coat can be applied and similar celluloid strips cemented on top of the coil over the first ones. These top strips give the bracing a finished appearance, as well as increasing its strength. The cement should be given plenty of time to dry—overnight if possible—after which the coil may be removed from the form. The bracing will have ample strength to withstand ordinary usage—with 1/8-inch tubing it is possible, in fact, to bend the turns in relation to each other without loosening them from the strips.

The new coils have been fitted out with small G. R. plugs as terminals, mounted parallel to the coil axis. These plug into G. R. sockets which are soldered to pieces of heavy flexible cable connecting to the stationary plates of C_7 . This flexible

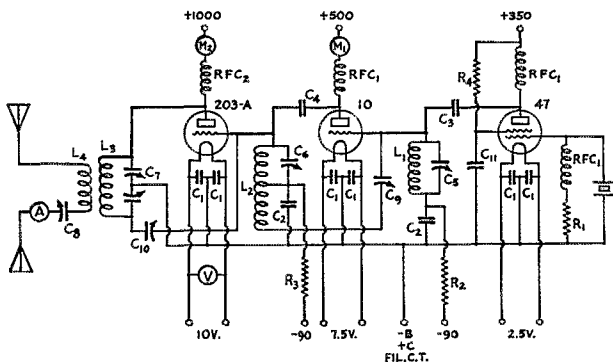

FIG. 1—MODERNIZED CIRCUIT OF THE THREE-TUBE TRANSMITTER

- C_1 —0.004 μfd . (not critical).
- C_2 —0.002 μfd .
- C_3 —100 μfd .
- C_4 —250 μfd .
- C_5 —250- μfd . variable.
- C_6 —350- μfd . variable.
- C_7 —Split-stator transmitting condenser; total capacity, sections in series, 100 μfd .
- C_8 —500- μfd . variable.
- C_9 —50- μfd . midget variable.
- C_{10} —50- μfd . transmitting variable (Cardwell 410-B).
- C_{11} —0.002 μfd .
- L_1 —21 turns of No. 12 enamelled wire on 2-inch form, close-wound.
- L_2 —10 turns of No. 12 enamelled wire on 2-inch form, spaced slightly less than diameter of wire. Neutralizing winding consists of 6 turns, close-wound, 1/2-inch from tank coil.
- L_3 —3.5 mc.: 20 turns of 1/2-inch copper tubing, coil diameter 3 1/2 inches, spaced to make coil length 4 inches.
7 mc.: 9 turns of 1/2-inch copper tubing, coil diameter 3 1/2 inches, spaced to make coil length 1 3/4 inches.
14 mc.: 4 turns of 1/2-inch copper tubing, coil diameter 3 1/2 inches, spaced to make coil length 1 inch.
- L_4 —4 turns, construction similar to L_3 .
- R_1 —5000 ohms, 2-watt rating.
- R_2 —50,000 ohms, 2-watt rating.
- R_3 —20,000 ohms, 10-watt rating.
- R_4 —50,000 ohms, 2-watt rating.
- M_1 —0-200 d.c. milliammeter.
- M_2 —0-300 d.c. milliammeter.
- V —0-15 a.c. voltmeter.
- A —0-2.5 r.f. ammeter.

tank coil L_2 would be needed with series feed. Since the choke is usually the weak spot in parallel-fed circuits, tests were carried out to determine whether or not parallel feed would result in a loss of efficiency. These did not progress beyond trying the choke originally used in the old circuit, however, because the output and efficiency turned out to be exactly the same with either parallel or series feed on all three bands. So parallel feed it is.

mounting, which is visible in the top-view photograph, is much easier to make than a fixed type of mounting, and permits the coil to rest properly in the glass-rod supports.

The antenna coil, the size of which will of course be determined by the antenna tuning system used, is of the same construction as the tank coils. The coupling coil shown is kept from tumbling over by short pieces of No. 14 wire soldered to two of the turns and hooked around the supporting glass rods. When the flexible leads are clipped on the coil, it will sit nicely in one position with no tendency to move out of place under ordinary jars and vibration. The antenna leads are brought out to a pair of stand-off insulators mounted underneath the baseboard at the rear edge.

Further additions to the set include plate milliammeters for the doubler and final amplifier stages, a filament voltmeter for the 203-A, and an antenna ammeter. They are all mounted on a 5-inch wide strip of plywood running the length of the baseboard. It is convenient to have the meters installed as shown because it is easy to see the effect of each adjustment. This method of mounting also keeps the meters at a reasonable distance from the r.f. circuits.

It should be noted that the amplifier grid resistor, R_3 , is specified as 20,000 ohms. This is a compromise value, designed to insure plenty of bias so the tube will operate with fair efficiency when doubling to 14 mc. Slightly greater output can be secured on the 7- and 3.5-mc. bands by

TUNING

Tuning and neutralizing are much the same as with the old layout, except that less of it is required when changing bands. We shall run through the procedure for the benefit of those who may be making their first acquaintance with the transmitter.

For 3.5 mc.: With plate voltage disconnected from 10 and 203-A, but with all filaments running and bias batteries connected, apply plate voltage to the oscillator and set C_5 for oscillation. This setting will be found near the minimum-capacity end of the scale. The plate current should be 25 to 30 milliamperes. Oscillation can be checked by the familiar dip in plate current or by a neon bulb or tuning lamp. Temporarily insert a milliammeter in buffer grid bias lead and readjust C_5 for maximum grid current.

With the oscillator working properly, tune C_6 to resonance (resonance will be found near the maximum-capacity end of the scale) and then find the setting of neutralizing condenser C_7 for which no indication of r.f. can be obtained in the buffer tank circuit when C_6 is swung through resonance. Adjustments to C_7 will affect the tuning of the oscillator tank circuit, so C_6 should be readjusted to keep the oscillator running each time the setting of C_7 is changed. When the 10 is properly neutralized C_6 may be swung through resonance without affecting the reading of the milliammeter in the grid circuit. After neutralizing, plate voltage should be ap-

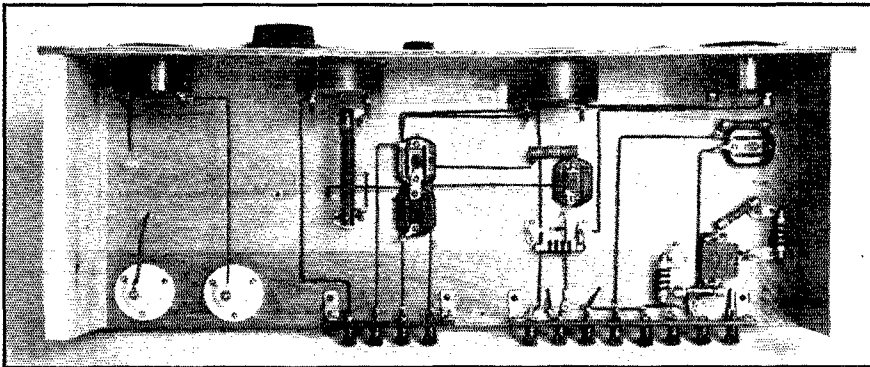

THE SUB-BASE CONNECTIONS

The buffer-doubler and final amplifier grid bias leads are now brought out to separate terminals so that grid current can be measured conveniently in each and also so that the bias on each stage can be individually adjusted. The screen dropping resistor and by-pass condenser for the 47 oscillator are near the terminal strip in the lower right-hand corner. The new r.f. chokes for the two low-power stages are mounted near the plates of the tubes. The choke for the final stage is mounted with its "hot" end away from the meter which it faces in the photograph. The two porcelain standoffs in the lower left corner are for the antenna or feeder terminals.

reducing this resistance to the old value of 5000 ohms, in which case it is desirable to insert more resistance or increase the fixed bias when working on 14 mc. For all-round work the use of the 20,000-ohm resistor is preferable.

plied and C_6 adjusted to resonance, indicated by minimum buffer plate current. The minimum current should be about 40 milliamperes if the filament of the 203-A is lighted.

The milliammeter should now be shifted to the

amplifier grid-bias lead and C_6 adjusted for maximum grid current, which should be between 15 and 20 milliamperes. Neutralize the amplifier, following the same procedure as in the case of the doubler; that is, find the setting of C_{10} which permits swinging C_7 through resonance without showing an indication of r.f. in the amplifier tank circuit (on a neon bulb or tuning lamp) and without causing a sharp change in the amplifier grid current. After neutralizing, the amplifier plate voltage may be connected and C_7 adjusted to resonance, again indicated by minimum plate current. Without the antenna load, minimum plate current should be about 20 milliamperes. With the antenna connected and tuned to resonance, the coupling between L_3 and L_4 should be adjusted to make the 203-A draw rated plate current—about 150 milliamperes. Both C_7 and C_8 should be readjusted to resonance each time a change is made in the coupling between L_3 and L_4 .

For 7 mc.: Tune oscillator and buffer as before, then set doubler plate tank for second harmonic; resonance on the second harmonic will be found near the minimum-capacity end of the C_6 scale. Grid current to the final amplifier should be the same as before—15 to 20 milliamperes—and the doubler plate current should be about 50 milliamperes. If the final amplifier has been neutralized previously on 3.5 mc., it should be neutralized on 7 mc. as well, provided both tank coils (L_3) are designed so that resonance is reached with C_7 set at half capacity or more. If the amplifier has not been previously neutralized follow the procedure given above for 3.5 mc. Minimum amplifier plate current, when the plate voltage is applied after neutralizing has been checked, should be about 20 milliamperes without the antenna.

For 14 mc.: Tune oscillator and doubler as in 7-mc. operation. Amplifier should have been previously neutralized on 7 mc. With 14-mc. coil inserted at L_3 , apply plate voltage and adjust C_7 to resonance as indicated by a minimum plate current of about 60 milliamperes. Do not change the setting of C_{10} .

AMPLIFIER TUNING NOTES

The permanence of neutralizing will depend considerably on the capacity balance in the two sections of C_7 ; if the two sections are not exactly identical the neutralizing may be slightly off when coils are changed. This is one reason for recommending that the amplifier tank coils be made so that C_7 will always be set at half capacity or

more at resonance, because the capacity balance at the higher-capacity end of the condenser is likely to be more nearly exact. If the condenser is not perfectly balanced, tuning C_7 very far off resonance will cause the grid current to change slightly during the neutralizing process, if the grid milliammeter is being used as an indicator of neutralization. In such a case the aim should be to find the setting of C_{10} which results in practically constant grid current as C_7 is varied a little on each side of resonance, with a gradual—not jerky—change in the reading as the condenser is tuned farther away from the resonance point. It is also desirable that both sections of the condenser have the same capacity to ground or other objects; in other words, the condenser should not be mounted too close to other parts of the set.

In tuning both the buffer-doubler and amplifier stages, take care that the tank circuits are off resonance for the very minimum of time when the plate power is applied. Both tubes will take rather husky plate currents when the tank circuits are detuned, and such treatment is ruinous to a thoriated filament. It is a good idea to have a key in the filament center-tap of the stage being tuned so that the plate power can be applied momentarily until the correct settings have been determined. If the plate supply to the last stage is connected and the rectifier filaments are lighted, but with the plate transformer shut off, a current of the order of 10 to 20 milliamperes generally will flow in the plate circuit if C_7 is off resonance. At resonance this current will drop to zero if the tube is properly neutralized. This indication is useful in determining the resonance setting before plate voltage is applied. It is particularly helpful in finding the 14-mc. setting of C_7 , in which case the 203-A is operating as a doubler and hence cannot be neutralized in the normal fashion.

In connection with tuning the antenna to the final amplifier, one point which many amateurs seem to overlook is that a change in coupling or antenna tuning will affect the setting of the amplifier tank condenser. The amplifier tank condenser always should be reset for minimum plate current as the last step in the antenna tuning process. When the coupling is correct, the minimum plate current will be approximately the rated plate current of the tube, although a higher minimum plate current can be drawn if the additional loading produces a corresponding increase in antenna current.

KEYING

From the standpoint of maximum stability,

(Continued on page 88)



A Universal Antenna Coupling System for Modern Transmitters

All-Band Operation with any Antenna—Improved Efficiency—
Reduced Harmonic Output

By Arthur A. Collins, W9CXX*

THERE is a very much more efficient and reliable way of transferring energy from the final tank circuit of a transmitter to the antenna than the customary arrangement using an antenna pick-up coil placed in an inductive relation to the plate coil in the transmitter. Almost every user of high frequency transmitting equipment has had the exasperating experience of getting the transmitter itself tuned up properly and developing lots of energy in the final tuned circuit and then finding that the antenna refuses to draw the power from the transmitter. This problem has become much more complicated in recent years because most high frequency transmitters are operated on several bands of frequencies, and it is usually desirable in amateur installations to use a single antenna on all bands.

Very few antennas with their associated feeder systems will resonate on all the desired frequencies without using some sort of complicated tuning arrangement at the transmitter end. It is the purpose of this article to describe an impedance matching network which greatly simplifies this problem and assures that the energy from the transmitter is properly coupled into the radiating system, with the additional feature that all harmonics are very effectively suppressed.¹ The system also makes possible the use of a single antenna and a single antenna coupling unit on all frequencies.

Fig. 1 shows the basic circuit involved. It will be observed that two capacitors and an inductance are connected in a low-pass filter circuit resembling that used in plate supply systems. The input side of the filter is connected across the output of the transmitter and the output side of the filter is connected to the radiating system. By using variable condensers and inductors, it is possible to match the output impedance of the transmitter to any antenna input impedance which will be met with in practice. This means that the transmitter can be coupled to any sort of an antenna whether it is a piece of wire 20 or 200 feet long. First we shall consider the case of an antenna having a single lead-in wire (Marconi

type or single-wire transmission line) and later show how the same system can be applied to an antenna with two lead-in or feeder wires. These are rather broad claims for an antenna coupling circuit and the amateur will be immediately interested in how he can apply this system to his transmitter without wading through a lot of theory. Therefore we shall explain the practical operation of the system first and let the theory ride until the last paragraph.

PRACTICAL ASPECTS

The two condensers C_1 and C_2 should have a fairly high maximum capacity, about 300 $\mu\text{fd.}$,

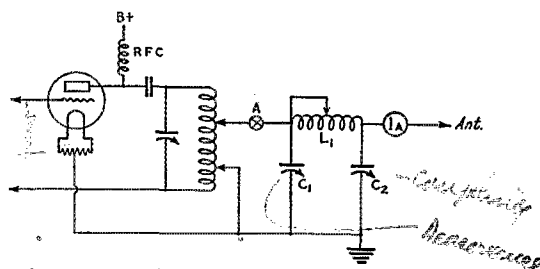

FIG. 1—THE BASIC IMPEDANCE-MATCHING CIRCUIT ARRANGED FOR COUPLING TO A SINGLE-WIRE FEED SYSTEM

See text for constants.

and the variable inductance can be 30 turns, $2\frac{1}{2}$ inches in diameter, $5\frac{1}{2}$ inches long, tapped every five turns. For transmitters with powers up to twenty-five or thirty watts, condensers of the receiving or small transmitting size can be used. Of course, both the condenser and the inductance must be of low-loss design. Let us assume, first of all, that we want to couple a transmitter tuned to, say, 3600 kc. to a single-wire Marconi type antenna and the antenna is of any size which conveniently fits the back yard. If the antenna happens to be an odd multiple of a quarter wave length long, it will have an input impedance of several thousand ohms. In both cases, it will be purely resistive. On the other hand, if the antenna is not a multiple of a quarter wave length long, its input impedance will be intermediate between these values and it will be

*Collins Radio Co., Cedar Rapids, Ia.

¹Everitt, "Output Networks for Power Amplifiers," *Proc. I.R.E.*, May, 1931. — *Editor.*

reactive; that is, it will require the addition of an inductance or a capacity to obtain resonance. The problem is effectively to match this antenna input impedance to the plate circuit of the final amplifier so that the tubes look into a pure resistance of exactly the right value for normal plate current.

Adjustment is accomplished as follows: Disconnect the matching network from the transmitter at "A" and tune the transmitter plate circuit in the ordinary way so that minimum plate current is obtained in the final amplifier,

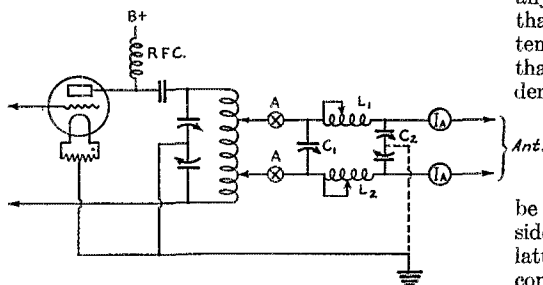

FIG. 2—THE BALANCED ARRANGEMENT FOR TWO-WIRE ANTENNA FEED

indicating resonance. After the plate tank condenser is adjusted for resonance with the output circuit disconnected, it should not be touched again during the tuning procedure. Next, adjust the tap on L_1 to a point where resonance at the transmitter frequency is likely to be obtained. The approximate settings are 30 turns for 160 meters, 15 turns for 80, 8 turns for 40 and 5 turns for 20. Set C_2 at mid-scale, connect the output circuit to the transmitter at "A" and apply plate voltage to the final amplifier. C_1 should then be rotated rapidly until a dip is obtained in the power amplifier plate current. Resonance in the output circuit occurs at this point. The value of minimum plate current obtained may be higher or lower than that desired for satisfactory operation of the output stage. If the plate current is not correct, rotate C_2 slightly and then readjust C_1 to restore resonance. This procedure can be repeated using C_2 to adjust the degree of coupling and C_1 to restore the circuit to resonance until the correct plate current is drawn in the power amplifier. An antenna ammeter placed in the antenna lead-in will indicate antenna current when C_2 is adjusted to resonance. The circuit is now properly adjusted and, after the signals are checked in the monitor, the arrangement is ready for use. It sounds very simple, doesn't it? As a matter of fact, this system is much easier to adjust than many of the conventional arrangements using a coupling coil. Volumes of equations have been written about filter networks, but in practice there is nothing so very complicated about their use even at radio frequencies.

One or two details of adjustment should be discussed, however. It will be found that the adjustment of L_1 is not critical. As more inductance is cut into the circuit, the same results can be obtained up to a certain point beyond which the insertion of more inductance will make it impossible to obtain an impedance match. Of course, C_1 and C_2 will have different settings when L_1 is changed. In general, L_1 should be kept as large as possible consistent with obtaining proper impedance match. This is the condition for lowest loss in the filter but these losses are negligible anyway if the apparatus is well constructed, so that it is not necessary to pay a great deal of attention to the adjustment of L_1 . It will be found that if the antenna impedance is low, as evidenced by relatively high antenna current, a fairly large value of capacity will be used in C_2 and there will be very little voltage across this condenser. On the other hand, if the antenna input impedance is high, C_2 will be set at very low capacity and there will be considerable voltage across this condenser. In the latter case it may be necessary to substitute a condenser with lower maximum capacity and wider spacing to prevent flash-over.

The question may arise as to how the antenna circuit gets tuned to resonance during the tuning operation described above. This may be explained by saying that, if the antenna is too long for the transmitter frequency, it will appear to the filter circuit as a resistance and a capacity and the effective input capacitance of the antenna will be in parallel with C_2 so that C_2 will be set at a lower value than if the antenna were exactly the right length for resonance. Likewise, if the antenna is too short, it appears to the filter as being a resistance and an inductance and a somewhat larger setting of C_2 will be used.

The exact position of tap "A" on the plate inductance in Fig. 1 is not critical. It is desirable that this tap correspond to an output termination of the transmitter of about 600 ohms; that is, it may be adjusted so that, if a pure resistance of 600 ohms were connected between tap "A" and the filament tap, the tube would draw normal plate current. Unless a 600-ohm lamp bank or some equivalent device is available for making this adjustment, it usually is sufficient to connect "A" at a point on the inductance halfway between the filament tap and the plate end. This approximation will be correct for practically all Class-C amplifiers. In the case of two Type 46's in parallel in the final amplifier, it is permissible to connect "A" direct to the plate end to the coil. Fig. 1 shows a shunt-fed amplifier circuit. If series feed is used, it is necessary to insert a high-capacity high-voltage fixed condenser at "A" so that the plate voltage does not appear across the condensers C_1 and C_2 and in the antenna circuit.

So far we have considered merely the problem of transferring the energy from the transmitter to

the antenna. Of course, the effectiveness of the antenna as a radiator depends upon the design of the antenna itself, and all of the principles of good antenna design which have been discussed in previous *QST* articles and in the *Handbook* still hold good. The antenna should be constructed with due regard to them. However, when it is impossible because of constructional difficulties and space limitations to put up a good antenna, the use of an impedance matching network will make it possible to put power into whatever form of sky wire is available.

The adjustments described above for 3600-kc. operation apply to other bands as well. The transmitter and the matching network are adjusted in exactly the same way except that appropriate values of C_1 , C_2 and L_1 are used to obtain resonance and proper impedance match on the particular frequency used. For instance, if the antenna is of the horizontal doublet type 67 feet long with a single-wire feeder tapped 9 feet, $4\frac{1}{2}$ inches off center and connected to the circuit of Fig. 1, the system will work as a "T" Marconi type antenna against ground on 80 and 160 meters, but on 7100 kc. and 14,200 kc. the lead-in will act as a matched impedance feeder and only the horizontal part will radiate. This system would appear to be the long-sought-for all-band antenna.

COUPLING TO TWO-WIRE SYSTEMS

At this point it is well to discuss how this system can be applied to the antennas of the "Zepp," "current-feed Hertz" and "two-feeder matched impedance" types where not one, but two lead-in wires must receive power from the transmitter. A similar impedance matching network can be used for coupling to these antennas. The arrangement as shown in Fig. 2 is similar to Fig. 1 except that the inductance is split and approximately equal values of L are inserted in each of the series arms of the network. C_2 can be the same kind of condenser as described for Fig. 1, although an alternative arrangement is to use a split-stator condenser grounding the rotor; or to place two ordinary variable condensers in series with the rotors connected together and grounded. The latter arrangement will permit individual adjustment of the coupling to each antenna lead-in. The circuit is adjusted exactly as described for Fig. 1. L_1 and L_2 should be kept approximately equal in value, although slight differential adjustments of L_1 and L_2 and of the two sections of C_2 (in case two condensers are used in series) will permit accurate balancing in the antenna lines and also accurate balancing of the load on the two tubes in the final stage of the transmitter if it is a push-pull stage. The "A" taps in Fig. 2 should be equi-distant from the center of the plate coil, and they also should be spaced for a termination of about 600 ohms. The circuit of Fig. 2 is correct for both a push-pull final amplifier or a neutralized single-ended amplifier.

HARMONIC ATTENUATION

The usual method of coupling the antenna inductively does not in itself provide any attenua-

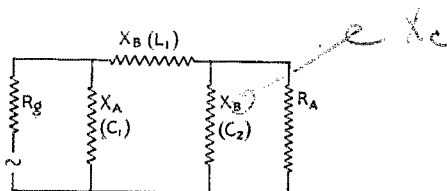

FIG. 3—EQUIVALENT CIRCUIT OF THE IMPEDANCE-MATCHING NETWORK

tion whatever of the harmonics which may be present in the plate tank circuit of the final amplifier. Such harmonic reduction as is obtained is due entirely to the effect of the plate tank condenser, and if a sufficiently high- C is used to obtain satisfactory harmonic reduction, the efficiency of the output circuit will be very materially reduced. The tendency in the design of modern crystal-controlled transmitters is toward the use of very low values of tuning capacities in the tank circuit in order to obtain the best possible efficiency. At the same time, the problem of harmonic suppression is becoming more serious every day. The amateur bands are not harmonically related and stations operating on the high frequency part of the 80- and 40-meter bands have harmonics falling in channels assigned to other services. Complaints are being made daily against amateurs who are permitting their harmonics to interfere with channels outside of the amateur bands, and it is imperative that drastic and effective measures be made to correct this situation. The use of high- C circuits in the output stage of amateur transmitters would bring some relief, but it certainly is not desirable to impair the efficiency of the transmitter by this procedure.

The low-pass impedance-matching network, described herein, is the logical step towards complete elimination of harmonic difficulties without reducing the output on the fundamental. A graphic illustration of the effectiveness of the impedance matching network in eliminating harmonics in one particular instance was obtained by listening to the second harmonic in a near-by receiver using, first, the conventional output system in the transmitter. The harmonic was of such high intensity as to block the receiver. After connecting and adjusting the filter, the second harmonic pick-up in the receiver was reduced to about the same amplitude as the harmonic being generated by the 47 crystal oscillator alone, and it could not be heard at all on a very sensitive receiver at a distance of about a mile. And this effect was accompanied by an actual increase in the power delivered to the antenna.

(Continued on page 86)

How's Your Fist?

Some Notes on "Bug" Adjustment and the Improvement of Sending

By F. H. Schnell, W9UZ*

THE goodness or badness of somebody's fist is a matter which must be handled rather gently. It is a delicate subject. The human ear reproduces faithfully everything it hears and passes it along to the brain. But brains seldom agree. By using something entirely mechanical, therefore, we remove the greatest error-making device involved. The mechanical visual recorder provides a record that can be seen, measured and inspected. Armed with this sort of checking device it becomes merely a matter of tuning around in the amateur band to find our "kill." By the way, there is plenty of game at all times.

First we pick out a commercial automatic transmitter as a standard of mechanical perfection in sending. At 60 to 65 words a minute, the recorder very clearly shows this mechanical perfection. This is more evident because words are being sent twice and each repeated word is exactly the same as the first one. This sort of sending is rather difficult of attainment by the average ham unless he is endowed with an abundance of patience. There are some amateurs who come very close to it; W2BG is one and W8DOE operating at W8AXZ is another. In fact, one evening I asked W8AXZ what kind of automatic transmitter he was using—his sending was that good. Both of these are straight key senders. You'd be surprised how much faster you can copy their stuff than the average hand sending. W8PL is a good example of a "bug" sender, approaching that mechanical perfection in making characters and in good sending.

You'll hear some of the fellows with traces of that famous "Lake Erie Swing" which was so popular in the spark days—a sort of weaving in and out of characters, very often making the dots

choppy. Then you'll hear the Navy operators once in a while with their draggy dots, very pronounced when sending NPG or NPM. The only correction for this is to put the operator to work sawing wood. One of the most general imperfections is the habit of dragging the last dash of the figure "8"—many amateurs do it. It looks and sounds like this: DAH DAH DAAAH DIT DIT. Just listen to some ham signing an eight call or to some one calling an eight and you'll notice it. Two of the most exasperating examples of brain error happen when some bird starts in with a CQ which sounds like "NN GT." Try that on your key and you'll understand how awful it can sound. Another is "TEST" which so often sounds like "NV." These are human errors or habits, the correction of which remains entirely up to the individual.

Now look at the records of the amateur sending

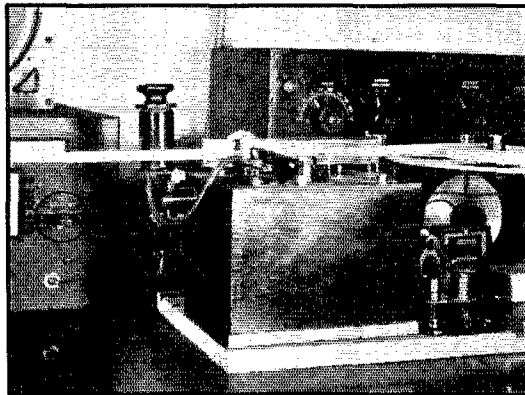

THE RECORDER RESPONSIBLE FOR THE TAPE RECORDS

This outfit is now in use at W9DEE. It was built by W2DK.

—made at random in the 3.5-mc. band. Some of the sending is very good but the defects show a poorly adjusted "bug." Inspect each character, paying attention to the length of the dots by comparison with the dashes. Notice the spacing between letters and between words and you'll see exactly what is wrong—a poorly adjusted "bug." The dot contacts are too light and the dots are not in keeping with the length of the dashes.

This is no effort to condemn. It is in the direction of pointing out the mechanical errors which can be corrected with a little care. So much for the evidence as a basis of proof that there are some bum senders in our ranks. Now to go after the "bug" and adjust it properly.

The diagram shows a circuit which answers very well for adjusting a "bug." The meter, M, is connected in series with a suitable battery and resistor. In these experiments, the battery was $22\frac{1}{2}$ volts; the resistor a 1000-ohm variable and the meter, 0-100 milliamperes. Connect the re-

* 4915 N. Sawyer Ave., Chicago, Ill.

sistor so that all resistance is in the circuit before you close the contacts. Otherwise you may burn out the meter. Now close the key and decrease the amount of resistance until the meter reads exactly 100 ma. Leave the resistor at that adjustment. Then waggle the dots and watch the meter. Adjust the dot contacts of the "bug" until the meter reads 50 ma. The needle pointer of the meter will, or should, hover at 50 ma. At high speed, around 15 dots per second, the needle will hover between 47 and 53 ma. if the contacts are properly adjusted. For heavier dots, if you want them, adjust the "bug" contacts until the meter reads 55 to 60 ma. Forget about making lighter dots—there are thousands too many of them already.

Any combination of meter, battery and resistor can be used, just so the dot adjustment is one-half of the closed circuit adjustment. Unless I have forgotten entirely (and Western Union Telegraph Company will be the first to set this right), their "bugs" are adjusted to make 11 dots per second and they solder the bug weights in that place. This is for sounder work and they have a definite standard of speed to take care of the relay lag, etc.

Practically every operator who uses a "bug," also uses a relay in the keying circuit of his transmitter. To make complete and proper adjustments, it is necessary to adjust the "dot" contact of the "bug," first by connecting the battery, resistor and milliammeter across the terminals of the "bug" in the manner just de-

scribed. Then the battery, resistor and meter are connected to the keying side of the relay and the meter is set to 100 ma. as before. Still using the dot side of the "bug," the relay contacts and tension are adjusted until the meter again hovers at 50 ma. Merely adjusting the "bug" and not the relay will not correct short and choppy dots. Both instruments have to be adjusted.

Now comes the big rub. If you've been one to take the weights off your "bug" just to make dots faster and dashes longer, you may profit by this.

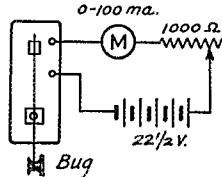

THE CIRCUIT USED FOR BUG ADJUSTMENT

For continental or international Morse, a modern Morkrum-Klein-schmidt perforator perforates tape so that the dash is equivalent to two dots, including the space between the two dots. It represents mechanical perfection in sending. No less an authority than W2AYN, Operating Engineer for R.C.A., points out that one five-letter word is equivalent to 24 space holes on the perforator and that a typical test word consists of the two words "IS NOW." In the perforator tape of 24 holes, the first hole is not counted until the second one shows up. So, by breaking "IS NOW" up into dots, dashes and spaces, we have 7 actual dots, but we don't count the first one, since no time has elapsed on the count before that dot was made. We have then, 6 dots and 6 dashes; 6 dashes are the equivalent of 12 dots. The space between each letter is the equivalent of 1 dot; between words, the equivalent of 3 dots; making 6 more dots. Altogether there are 6 plus 12 plus 6, or a total of 24 dots which is the equivalent of one five-letter word.

It is important to know the number of dots in a word if we want to adjust the "bug" for a certain speed, since this is the mechanical side of the bug and the human side is that which has to do with dashes and proper spacing. One word, as we determined, consists of the equivalent of 24 dots; 15 words per minute would be 15×24 , or 360 dots in one minute or 6 dots per second. Therefore, if your "bug" is adjusted to make 6 dots per second, you ought to be able to send perfectly at a speed of 15 w.p.m. Speed of dots for the generally-used and much-abused speeds in amateur radio are as follows:

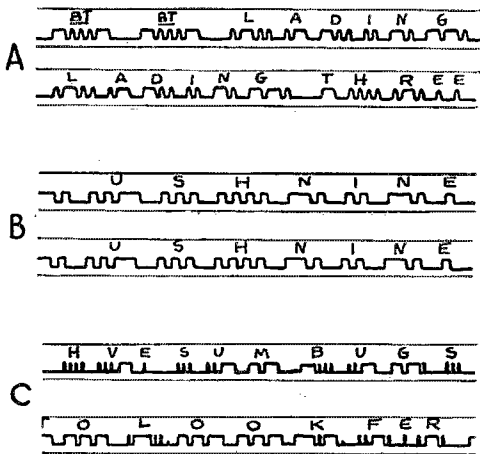

SOME REPRESENTATIVE TAPES MADE ON THE RECORDER ILLUSTRATED

- A—Commercial automatic transmitter at 60 to 65 w.p.m. sending words twice. The tape is being pulled through slowly.
- B—The same commercial automatic transmitter. Tape puller is speeded up to show characters clearly. An example of mechanical precision—note that the characters are exactly alike.
- C—A glowing example of dots that are too fast and too light and dashes are out of proportion. The tape was running at a speed that would have recorded 28 to 30 w.p.m., with a record similar to the commercial transmission.

W.P.M.	Total dots per minute	Dots per second
15	360	6
20	480	8
25	600	10
30	720	12
35	840	14
40	960	16
45	1080	18
50	1200	20

(Continued on page 84)

Clearing Up the Note With a Bridge Rectifier

By Dean C. Swan, Jr., WIBXC*

SOME months ago the writer became convinced that a single-phase bridge rectifier, employing four Type 66's was, both from a standpoint of economy and that of convenience, a very practical and satisfactory means of obtaining plate supply of the order of 4000 volts or so. A transformer with 2000 volts each side of center-tap could thus be made to furnish 4000 volts. The only additional expense of any importance involved on the rectifier side of the filter system, providing two half-wave 66's were

fiers. The signal then heard in the station monitor was pure d.c.!

This could mean only one thing—the fault was to be found in the 66 bridge rectifier. A number of people were consulted as to why the bridge should act in such a fashion. Dr. F. S. Dellenbaugh, Jr., whose valuable power supply articles have appeared in several issues of *QST*, gave expert advice, as did W9CLH, an old spark-days' friend, via 14-mc. 'phone. These gentlemen were of the opinion that the trouble was to be found in the

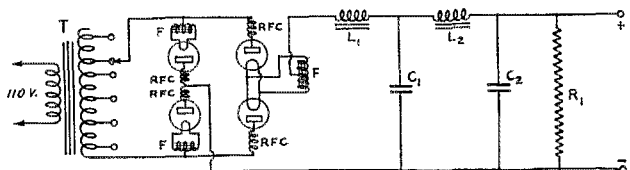

FIG. 1—CIRCUIT OF THE FULL-WAVE BRIDGE RECTIFIER USING TYPE 66 TUBES

RFC—7-mc. chokes wound on half-inch form.

L_1 —Swinging input choke.

L_2 —Smoothing choke.

C_1 —2- μ fd.

C_2 —2- to 9- μ fd., depending on type transmitter.

R_1 —Resistor to bleed 1/10th full-load current.

T—Plate transformer (1-kv. tapped 500 to 4000 volts).

F—Separate filament windings for rectifiers.

already in use, was two more 66's and two more filament windings for these. The tubes and filament windings, of course, are obtainable at a figure much below the cost of an elaborate mercury arc system or one involving any of the larger sized rectifiers which would be necessary at a 4000-volt potential. Despite what is to follow, the writer is still at a loss to understand why the bridge rectifier is so seldom used by amateurs, especially for obtaining high voltages.

As so often happens when one has a thing figured so that it looks "just right," the bridge rectifier, having been built, was found far short of expectations. Nothing but an r.a.c. note could be obtained although a proven, trustworthy and efficient filter system was used. Investigation finally revealed that none of the one hundred and one things which could be tried, such as different frequency bands, tuning and the like, were of any avail. Accordingly, two of the 66's were pulled out of their sockets, several wires changed and the remaining two were used as half-wave recti-

66's themselves, since these tubes are prone to break into oscillations of their own accord and thus modulate the transmitter signal.¹ Buffer condensers from anodes to cathodes, such as Raytheon engineers once used to cure a similar trouble in receiver power packs, were suggested. These were tried on the bridge, but helped not at all. The next endeavor was to use parasitic chokes in each anode lead. These, also, proved valueless. Inasmuch as the transmitter was tuned to the 14-mc. band at that particular time, 14-mc. chokes were tried. These made a noticeable improvement, although

r.a.c. still predominated. 7-mc. chokes were then tried and the note became pure d.c.—within a shade of being just as good as with a two-tube rectifier! Curiosity then getting the best of the writer, four extremely large chokes were wound and tried on the theory that as the choke inductance was increased the note had improved. These, however, failed miserably, being no better than none at all. Since the 7-mc. chokes performed satisfactorily, it was decided to use them permanently.

The next problem arose when it was decided to substitute a correctly designed swinging input choke for the more or less fixed inductance choke then in use. One was designed for the power supply and to suit the input to the transmitter, in this case a Type 52 t.p.t.g. The swinging choke, when tried, certainly did perform wonders. Regulation (bleeder load to full load) changed from 20 to 8 percent. The 66's became capable of handling all the current anyone would be apt to use normally in an amateur transmitter. In an effort to find how the note was being affected, the fixed inductance input choke was again tried with a

* 246 Everett St., Wollaston, Mass.

¹ Dellenbaugh, "Tunable Hum," *QST*, Jan., 1933.

very small filter so that r.a.c. was very much in evidence, the swinging choke being then substituted with a resultant change to pure d.c. Much higher plate voltages could be and were then used without endangering the filter condensers, 66's and associated power equipment. All these and other benefits accrued by this single substitution. Unfortunately, however, an entirely unforeseen and unexpected bug presented itself. Each time the key was pressed the signal "blooped." Upon closer examination of the signal with the monitor, this "bloop," or call it what you will, was found to be a rise in frequency on one side of zero beat and a fall in frequency on the other side, which lasted just long enough after the key was pressed to spoil the keying and note. This, of course, was very unsatisfactory, especially since this same self-excited rig, when working normally, had hitherto been invariably reported "xtal pdc."

When tried in the power supply to another self-excited rig—that at W1JO—the swinging choke "blooped" in exactly the same manner, although all of the above beneficial results were again noted. Discussion with others developed the theory that the drain of the 52 when starting to

oscillate and before building up to full plate impedance was proving too much for the terminal filter capacity, which was 2 μ f. With large inductance in the filter it would seem that all the initial current surge must be provided by the terminal condenser. Accordingly the terminal capacity was increased to 9 μ f.—and the "bloop" disappeared. It was then found that this capacity could be cut in half without bringing the "bloop" back to any marked degree, although the 9 μ f. were somewhat smoother under keying. Tests made since with this choke substituted in the power supply of the final amplifier at W1CGN show that this difficulty does not arise in the power supply of an amplifier. The tests at W1CGN gave definite strength to the above theory as to the cause of this "blooping."

The possibilities of such a combination as has been described (bridge plus swinging input choke) are especially worth serious consideration by the amateur who is thinking of inputs on the order of $\frac{1}{2}$ to 1 kw. Personally, the writer is going to investigate the matter further in that 4500-volt 1-kw. rig which he intends building some sweet day.

The M.I.T. 56-Mc. Airplane Tests

AFTER many delays in the receipt of logs, reports and confirmations we are now able to present a complete list of 56-mc. sta-

tions contacted from the M.I.T. meteorological plane during the tests announced in November, 1933 *QST*. The plane, flown each morning by Lt. Henry B. Harris, serves as a variable-altitude laboratory for the Meteorological Department of the Massachusetts Institute of Technology. Carrying all manner of meteorological instruments, the plane is taken up to about 18,000 feet every day for the express purpose of making observations of atmospheric conditions at various levels. The installation of 56-mc. equipment was the outcome of a desire on the part of the meteorological department personnel for continuous contact with

the plane as a safety measure in bad flying weather and as the means of obtaining technical data from the plane with the least possible delay. Professor Rossby and Dr. Carl O. Lange of M.I.T., at the League's request, agreed to expand the scope of the work in order to provide a daily

test with New England amateurs during the month of November.

Preliminary experiment with three transmitters

and a pair of receivers resulted in the selection of a Harvey transceiver as the main radio equipment in the plane. It was used almost exclusively during the test period. A variety of antenna systems was employed. During the early days of the test, a 12-foot horizontal wire running from the cabin to a wing strut was operated against a 4-foot wire inside the cabin. Later, this system was displaced by vertical rods—a quarter-wave rod operating against the ship's steel fuselage and a half-wave affair. Further study of reception reports may possibly change the present view that the grounded quarter-wave rod was the superior

antenna.

Displaying limitless enthusiasm and quite extraordinary operating ability, Lieutenant Harris, M.I.T.'s research pilot, carried through the program in splendid fashion despite much

(Continued on page 46)



LT. HARRIS, THE PLANE AND THE TRANSCEIVER

The Sixth International Relay Competition

March 10th¹-18th

Exchange Self-Assigned Serial Numbers in Two-Way DX QSOs—
Contest for All Parts of the World (with U. S. A./Canada)—
Advance Entry Not Required—Certificates for Winners

By F. E. Handy, Communications Manager

THE contest is for most DX QSOs. It is world wide! All parts of the world—with U. S. A./Canada. Get on the air . . . any amateur frequency band . . . March 10th¹-18th inclusive 1934. The American Radio Relay League invites you to take part with amateur operators everywhere in . . . THE SIXTH INTERNATIONAL RELAY COMPETITION.

GENERAL PLAN OF CONTEST

Amateurs with the prefixes W and VE will be taking part in a QSO Party with stations in all parts of the world. When they effect DX QSOs, self-assigned serial numbers will be exchanged and jotted down in the contest report. From this record each station will submit its



THE CERTIFICATE TO BE AWARDED CLUB WINNERS IN THE INTERNATIONAL DX COMPETITION

Besides the Section Award, in each club group where three or more hams take part, the local A.R.R.L.-affiliated radio club may make a certificate award. This certificate will be presented endorsed by the national organization, and also signed by the club president or club activities manager. It will be awarded by the club as a permanent trophy.

score, as explained later in this announcement. From the scores (which the Contest Committee will verify by cross-examination of all logs submitted) the winners will be determined for each locality, and certificates awarded.

Stations outside² the U. S. and Canada will try to work as many W and VE stations as possible during the

¹ 6 p.m., C.S.T., March nine—see discussion under "the contest period."

² Alaska, Hawaii, Philippine Islands, Cuba, Porto Rico, and Newfoundland, in fact, all localities using PREFIXES other than W or VE will receive QST mention and awards based on their work with W/VE stations.

ble to exchange serial numbers. Stations in all localities need only take part on the dates announced and report results at the end of the tests in the form explained herein, to receive credit in QST, and be eligible for awards.

The main competition each operator must consider comes from operators in his immediate A.R.R.L. Section in the case of W and VE stations,³ and in the case of all other amateurs it comes from the individual operators in their country or locality using the same prefix.⁴ The awards are primarily for the operator running up the best record for each Section.

THE CONTEST PERIOD

To avoid misunderstanding and possible confusion the exact local starting and ending time for our DX competition is given in the following table. These times are based on "Greenwich" and should be computed for any part of the world from the Greenwich meridian. The contest runs from Saturday, March 10th, through Sunday, March 18th (until early Monday, March 19th).

Time	Starts	Ends
Greenwich	March 10th 0000	March 18th 2400 (Mar. 19th 0000)
A.S.T.	March 9th 8:00 p.m.	March 18th 8:00 p.m.
E.S.T.	March 9th 7:00 p.m.	March 18th 7:00 p.m.
C.S.T.	March 9th 6:00 p.m.	March 18th 6:00 p.m.
M.S.T.	March 9th 5:00 p.m.	March 18th 5:00 p.m.
P.S.T.	March 9th 4:00 p.m.	March 18th 4:00 p.m.

AWARDS

Brown-bordered certificates, a high class lithographed job of striking appearance, will be awarded⁵: (1) one in each remotely located country or territory—all hams using the same prefix compete for an award, and (2) in each of

³ Page 5 of this QST carries a complete list of the Sections of the A.R.R.L. Field Organization.

⁴ Consult the A.R.R.L. booklet *Operating an Amateur Radio Station* (sent free on request) or the list of call-prefixes for different countries of the world as given in the Eleventh Edition of the *Radio Amateur's Handbook*.

⁵ A ruling of the A.R.R.L. Board of Directors permits stations of A.R.R.L.-QST staff members to participate in contests with the provision that the operators of such stations shall be ineligible to receive any League awards.

64 A.R.R.L. Sections, *mainland* U. S. A. and Canada (see page 5 *QST*).

Since the certificate awards will be made to the operator of the highest scoring station in each country, this puts all operators using the same prefix in competition with each other—and similarly each A.R.R.L. section-boundary circumscribes a competing group. DX-transmission characteristics being the same for all operators in each award-area, the chances of being a winner depend on operating ability and stations and are equally fair to all. Shall we reserve one of these certificates for *your* station?

AFFILIATED CLUB PARTICIPATION

To encourage local participation, *additional certificate awards* (besides the A.R.R.L. Section awards) will be made through each club where *three or more* individual club members, or new local hams *invited* by such a club, take part. Reports must be made either direct to A.R.R.L., West Hartford, or through the club secretary, *mentioning the name of the club*, to be eligible for the affiliated-club-award. There is nothing more fascinating than to plan local competitions and swap results in a friendly way with the ham-across-town as the operating goes along. Entrants who mention their club will be eligible for *both* club and Section certificate awards.

While no awards for "national high" DX-man are made, scores are often compared and we hope to let the contest itself determine a fair factor of comparison nationally,⁶ this year.

SCORING

Both the W/VE station, and the station in the remote locality receive *one point* when the W or VE serial number is acknowledged by the station in the remote locality. Each operator, simi-

larly, may add *two points* further when a six-figure number (*to* U. S. A./Canada) is acknowledged or OKed by a W/VE station.

After all the individual scores have been added together, this sum, in the case of W or VE participants, is to be *multiplied by the number of countries or localities (prefixes) worked to give the total score*. In the same way, those taking part in other different countries (remote), *multiply their total of points by the number of U. S. and Canadian districts (licensing areas) they have succeeded in contacting*, to give the total score. There are nine U. S. and five Canadian licensing areas making a possible multiplier of fourteen!

All competitors are requested to submit their lists, even if they only show a small score. In so doing they are supporting claims made in logs from other stations, and they will receive full credit for their work in *QST*.

The *highest* individually-attained score of any *one* of the operators of amateur stations having more than one operator is the *official score* for such a station. The summary of score must show *all* stations worked by *all* operators, however, underlining or circling the entries of stations that cannot count in the "official" total. Awards will be based on the official total and will be made to the individual operator accredited with this total. To show the possible scores that can be built up by several operators at one station, such scores (*all* countries (prefixes) or W/VE districts listed times all points listed) may be shown parenthetically after the "official" score that counts toward a possible award.

THE SELF-ASSIGNED SERIAL NUMBERS

Any amateur station, anywhere, can take part without advance entry. Each operator taking part will assign himself a distinctive three-

⁶ In the last contest, the leading western station worked 28 countries and the leading eastern station worked 42, or 1 1/2 times as many. Averaging the ten highest scores in each time zone in our DX test of last March (to give a true index of the maximum possible score for each time zone) confirms this factor, as a possible multiplier to apply to PST-, MST-, and CST-scores to place them on an equal basis with EST-scores. In the results in *QST* we shall be glad to list the leading score for each *time zone*, as well

as for each *Section*, and to show (in addition to the "ordinary" scores) the score of these leaders corrected by a factor determined by the high-low-averages which will be part of the results of the 1934 competition itself. The contest idea is based around *64 separate Section competitions* for certificate awards for "best DX." Since national comparisons are sometimes made, we suggest the introduction of this equalizing factor to facilitate *fair* comparisons.

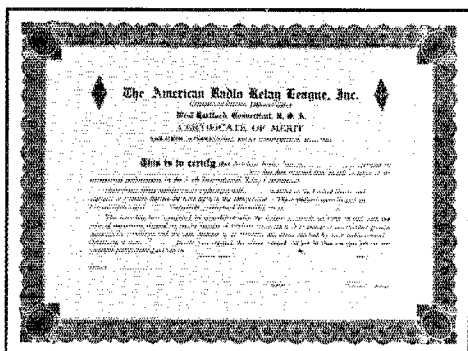
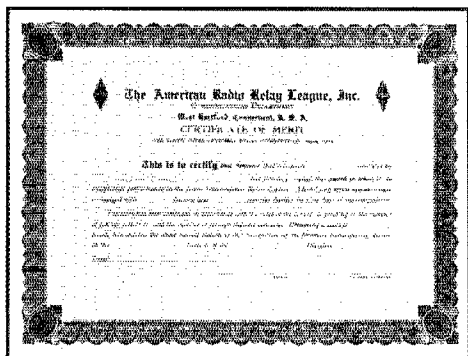

THE CERTIFICATES TO BE AWARDED WINNING HAMS IN EACH SECTION AND FOREIGN COUNTRY

numeral group and use this throughout the contest as the *first part* of each number exchanged. Numbers exchanged will have *six* figures, the latter three taken from the first half of each number-combination *received*. To confirm your first contact, since no numbers will then have been received, the six-figure group sent will consist of the three numbers which identify you in each log, followed by three "naughts."

"Handling" a serial number includes the transmission and receipt of radio acknowledgment (QSL) of same, and the entry of date, time and station call, and numbers as handled, for purposes of record. There is no object in working the *same* station more than once in the contest

period *if* three points have been earned by a full exchange during a QSO. If but one (or two) point(s) result(s) from a first contact with a station, you can complete the three points (maximum that *can* be secured with any *one* station) by working this amateur later in the contest period, and handling a serial number in the opposite direction.

REPORTING

Reports or summaries from participating stations must be received at A.R.R.L. Hdq. from all W/VE stations on or before noon April 24, 1934, to be counted in the results or to be con-

(Continued on page 80)

LOG, SIXTH INTERNATIONAL RELAY COMPETITION

Name..... Call signal.....
 Address..... Transmitter.....
 A.R.R.L. Section..... Plate watts (input last stage).....
 (If W or VE call, otherwise leave blank) Type signal (xdc, pdc, rac, etc.).....

Date	Time (local)	Station Worked	Country	Continent	Frequency	Serial Number		Points (1) or (2)
						Sent	Received	

"Total" multiplied by number of { (1) countries or localities (prefixes) OR (2) U. S. and Canadian licensing areas } TOTAL....
 worked equals the GRAND TOTAL or FINAL SCORE.....

I hereby state that in this contest, to the best of my knowledge and belief, I have not operated my transmitter outside any of the frequency bands specified in, or in any manner contrary to, the regulations my country has established for amateur radio stations; also that the score and points as set forth in the above log and summary of my contest work are correct and true.

Signature of operator (s)

(1) For W/VE entries. In computing points, each "received" serial number group counts 2. Each serial "sent" and properly QSL-ed counts 1.

(2) For entries from stations using any prefixes other than W or VE. In computing points, each 6-figure number "received" counts 1 point, and each number "sent" (with proper acknowledgment) counts 2 points.

EXAMPLE OF CONTEST LOG

STATION W6ZXY Serial Number 543

Date and Time	Station Worked	Country	Continent	Frequency	Serial Nr.		Points
					Sent	Received	
March 9th							
6:01 p.m., C.S.T. (or 0001 G.C.T., March 10th)	G5ZZ	G. B.	Europe	7 mc.	543,000	765,000	3
6:38 p.m.	VK2LL	Aust.	Oceania	7 mc.	543,765	856,287	3
9:50 p.m.	ZLIEE	N. Z.	Oceania	7 mc.	543,856	398,657	3
11:50 p.m.	AC6UU	China	Asia	14 mc.	543,398	395,984	3
March 10th							
12:05 a.m., C.S.T.	PY1WW	Brazil	So. America	7 mc.	543,395	777,000	3
3:10 a.m., C.S.T.	VK5YY	Aust.	Oceania	7 mc.	543,777		1

18
 Countries (prefixes) X 5
 GRAND TOTAL 80

The Operation of R.F. Power Amplifiers

The How and Why of Tuning Procedure

In Two Parts—Part I*

By H. A. Robinson, W3LW**

WHEN the radio amateur, be he an old-timer with a new transmitter arrangement or a beginner with his first low-power outfit, is confronted by the problem of adjusting his transmitter he follows a more or less standardized procedure.¹ One after the other the tank circuits are tuned, here for the minimum dip of the milliammeter, there for a maximum rise; and finally, when by dint of good fortune or favor of the gods the antenna or feeder ammeter shows an often all too feeble tendency to read, he wipes his fevered brow and heaves a sigh of relief.

Perhaps many an amateur after such a procedure has wondered why all these milliammeter dips and rises occurred and how he could be certain that his transmitter was adjusted for optimum performance. It is the purpose of this article to explain the underlying principles of this procedure as universally employed in tuning the transmitter, particularly the r.f. power amplifier, and to consider the limitations and the means of checking the various adjustments.

In general, the transmitting system as a whole, including the antenna or radiator, can logically and conveniently be divided into three major units (Fig. 1):

1. The exciter unit (comprising the lower-power stages).
2. The final r.f. power amplifier unit.
3. The radiator unit or antenna system.

Any radio telegraph transmitter includes these units while a telephone transmitter would have an additional modulator unit. In the case of a self-excited transmitter the functions of both the first and second units are combined. However,

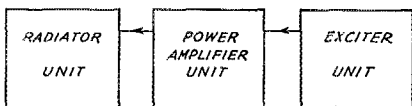

FIG. 1—THE THREE ESSENTIAL ELEMENTS OF A TRANSMITTER

along with the present trend in improvement in amateur receiver selectivity and stability, the self-excited transmitter, with its inherent limita-

tions and compromises between power output and frequency stability, is being rapidly displaced by the oscillator-amplifier type of transmitter. The adjustment of the oscillator, self-controlled or crystal, has been considered in numerous articles in past issues of *QST*, so we shall center our consideration upon the r.f. power amplifier and its adjustment with but a brief review of the function of the other units.

THE EXCITER UNIT

The exciter unit, as we have implied, comprises all the tubes and associated circuits that function

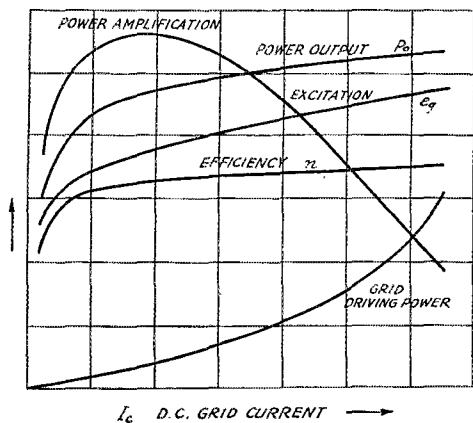

FIG. 2—THE EFFECT OF GRID EXCITATION ON POWER AMPLIFIER PERFORMANCE

primarily to provide the necessary amplitude of grid excitation to the final r.f. power amplifier unit at the desired frequency. Thus we have grouped the master oscillator, crystal or self-controlled, and the various buffer amplifier and frequency multiplier stages.

It would be well to emphasize this commonly neglected fact, that there is a maximum grid swing of the power amplifier for optimum performance when the grid driving power is considered. This grid driving power, representing the useful output of the exciter unit, is expended in supplying the grid losses of the final r.f. amplifier unit. These losses include the heat dissipation on the grid itself and the losses in the grid leak and bias supply. The results of an experimental

* Part II will appear in an early issue.
** Silver Lake Farm, Willow Grove, Pa.
¹ *The Radio Amateur's Handbook*, Chapter Seven.

study of the grid losses in an r.f. amplifier² show a relationship similar to that of Fig. 2, which is typical of the tubes available for amateur use. The power output, voltage swing, plate efficiency and grid losses are plotted against the

THE R.F. POWER AMPLIFIER—TUBE LIMITATIONS

In Fig. 3 a series of plate and grid current curves are plotted as functions of the grid voltage, for several values of plate voltage. This family of curves is typical of the triode tubes employed in amateur practice and is commonly known as the *static characteristics*. This, however, is somewhat of a misnomer; for these curves, though they can be obtained by applying the proper d.c. voltages to the various tube elements, represent the relationship between the various electrode currents and voltages *at any instant*, irrespective of whether the tube is functioning at audio or radio frequencies and with or without an external impedance of any nature. The portions of the curves to the left of the vertical axis in the region of negative grid bias are those most commonly published and are all that one requires when considering the functioning of the tube as a Class-A amplifier. For operation as a Class-B or -C amplifier the characteristics extended into the region of positive grid bias serve to determine the tube limitations.

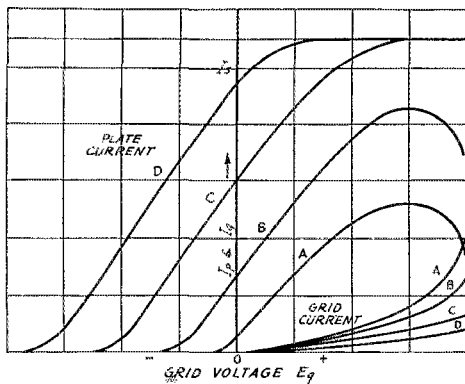

FIG. 3—TYPICAL GRID CHARACTERISTICS

d.c. component of the grid current for a normal operating value of plate circuit impedance and grid bias, the d.c. grid current being taken for the abscissa because of the convenience in reading the same in a given amplifier circuit. It will be noted that for an increasing grid swing the curve of plate efficiency of the power amplifier rapidly flattens off to a nearly constant value, the power output rises but slightly and the grid losses, which must be supplied by the exciter unit, increase very rapidly. The curve of power amplification, or the ratio of power output to grid losses, shows a distinct maximum falling less rapidly on the side of higher excitation. A similar relation obtains for each straight amplifier stage in the exciter unit since each stage, considered individually, operates as an r.f. amplifier.

Although there is an optimum value of the amplitude of the grid voltage swing, it is better to err on the side of over-excitation than to under-excite the grid of the following amplifier stage. In the case of the grid swing and grid losses of the frequency multiplier stages there are but little definite data. Theoretical and experimental practice indicate that grid voltage swings of the order of 50 to 80 per cent of the plate voltage are not excessive in the case of the triode doubler.³ Recourse to the experimental (cut-and-try) method is necessary in both amateur and commercial practice and we will do well to consider the fundamental tuning relations and tube limitations, as well as simplified methods of checking the performance of each stage, oscillator, buffer or multiplier.

Referring again to Fig. 3, the curves are marked alphabetically, the plate voltages under which the curves were taken increasing as the sequence of these letters. The limiting value of the plate current is known as the *saturation current* (I_s) and is a function of the filament or cathode emission, which latter is directly related to the filament temperature and thermionic activity of the filament or cathode material. The saturation current is thus one of the inherent limitations of the particular type of tube under consideration. The maximum allowable plate dissipation and

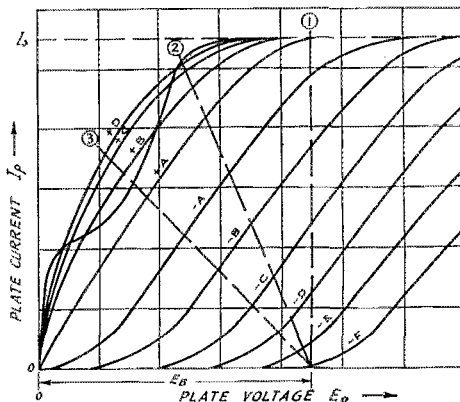

FIG. 4—TYPICAL PLATE CHARACTERISTICS

maximum safe interelectrode voltages (or currents) are the other determining factors. In Fig. 3 the curves for the higher values of plate voltage reach the limit of saturation current for lower grid potentials than those for lower plate voltages. The curves for relatively low plate voltages never reach the limit of saturation plate current but

² Spitzer, "Grid Losses in R.F. Power Amplifier," *Proc. I.R.E.*, June, 1929.

³ Smith, "Frequency Doubling in a Triode Vacuum Tube Circuit," *Proc. I.R.E.*, Jan., 1933.

indicate a drooping characteristic for higher positive grid potentials. This is a result of the familiar phenomenon of *secondary emission*, in this case from the plate, and is clearly evidenced by the sharp rise in grid current for the corresponding grid characteristics.

In Fig. 4 we have the plate current curves of Fig. 3 replotted as functions of the plate voltage giving the familiarly known *static plate characteristics*. These are also mis-named, since they express the relations between the electrode voltages and plate current at any instant, independently of the frequency at which the tube is working until frequencies of 100 mc. or so are reached. The letters on the series of curves of Fig. 4 indicate the grid voltages at which the curves were taken, the magnitude of the grid potential increasing with the sequence of the letters. The familiar published characteristics comprise but the lower half of this figure. However, it is the upper portion which largely determines the tube limitations under consideration. The peculiar crossing of the curves for the higher positive grid potentials and low plate voltages is again the result of secondary emission.

TUNING BY THE PLATE MILLIAMMETER DIP

Since the tube does not work alone, let us temporarily divert our attention from the tube characteristics to the properties of a parallel tuned circuit, commonly referred to as a tank circuit. In Fig. 5 we have represented the usual tank circuit comprising a capacitive branch (condenser) and an inductive branch (coil), the resistance being considered as lumped in the inductive branch. Such a parallel tank circuit can be conveniently represented by an equivalent series circuit composed of a resistance (R_o) and a reactance (X_o) which vary with the frequency as shown in the curves of Fig. 5. The resulting impedance of the tank circuit (Z_o) reaches a sharp maximum at resonance (f_r) at which frequency the tank circuit represents (to a very close approximation) a pure resistance ($R_o \text{ max}$) of magnitude depending on the circuit elements (L, C, r). At frequencies either side of resonance the tuned tank circuit impedance decreases very rapidly. A similar variation of impedance takes place if the impressed frequency remains constant and the tank tuning capacitor (C) is varied as indicated in Fig. 5.

Consider now the tank circuit connected in the plate circuit of a triode r.f. power amplifier supplied with a reasonable degree of grid excitation (e_g) of a fixed frequency, as shown schematically on Fig. 6. The neutralizing arrangement is omitted here for simplicity, since its addition in no way affects the tuning principles here considered.

When the plate tank is very greatly off tune

with respect to the frequency of the impressed grid excitation the resulting equivalent series impedance is very low. Tuning the tank by means of the tank capacitor, the impedance increases rapidly to a maximum at resonance. This adjustment is accompanied by the familiar dip of the plate current as we shall now demonstrate.

Returning to Fig. 4, let us select the point corresponding to zero plate current and our operating d.c. plate voltage (E_b) as an origin, and draw load lines with slopes equal respectively to the inverse of several probable values of tank circuit impedance. To a close approximation the vertical line (1) corresponds to the condition of a tank

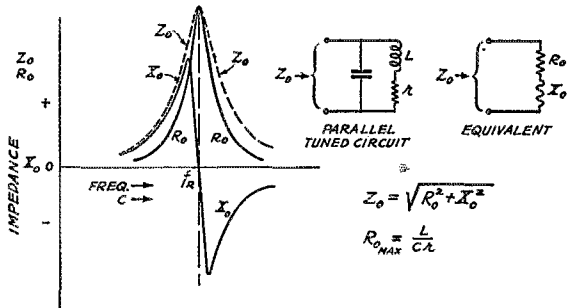

FIG. 5—PROPERTIES OF A PARALLEL TUNED CIRCUIT

circuit considerably off tune; (2) corresponds to a resonant tank circuit moderately loaded by the grid of the following tube or output load; while (3) is representative of a high L/C resonant tank circuit without a load. It should be noted that in general these load lines represent only resistive loads which are equivalent to the plate tuned circuits only when the latter are tuned to resonance, or are so far off resonance as to represent a negligible impedance. The higher the tuned circuit impedance (R_o), corresponding to a high L/C ratio and low tank resistance (r), the more nearly the load lines approach the horizontal plate voltage axis.

By selecting points along these load lines for various values of grid voltage and replotting these data as a function of grid potential, we obtain the curves of Fig. 7, commonly referred to as *dynamic characteristics*. In this figure the three curves correspond to the three representative tuned circuit adjustments previously discussed.

Applying graphically our sinusoidal grid excitation (e_g) after selecting a suitable value of bias (E_b) and projecting the corresponding points on the plate and grid curves, the three conditions of operation obtained are shown graphically to the right of Fig. 7. The short impulses of plate current, characteristic of Class-B and -C amplifier operation, are apparent; but the effect of the tuned circuit impedance on the resulting wave shape is somewhat surprising. For curve (1) cor-

responding to a zero or very low tuned circuit impedance (tank considerably off tune), the plate current rises rapidly to its saturation value (for the magnitude of grid excitation here employed),

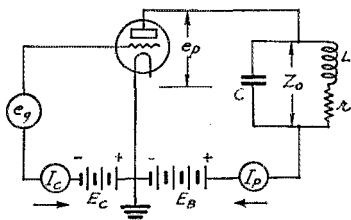

FIG. 6—THE R.F. POWER AMPLIFIER CIRCUIT UNDER CONSIDERATION

giving a flat-topped current wave shape. Since the tuned circuit impedance is very low, the resulting instantaneous voltage drop across the tank is negligible and there is no plate voltage variation, hence no useful power output, and the total plate power input is dissipated in heating the tube. The average value of the plate current pulses, read on the d.c. plate milliammeter, is relatively high.

When the unloaded tank circuit is brought into tune the relations corresponding to curve (3) result, with the accompanying great decrease in the average value of the plate current, and resulting minimum dip of the plate milliammeter. The plate current pulses build up a considerable voltage across the tank circuit (e_p) representing power output in the tank. The double hump in the plate current wave shape results from the drooping form of the characteristic curve due, as noted above, to the presence of secondary emission. Increasing the magnitude of the grid excitation will exaggerate this double hump, resulting in a loss of efficiency unless the grid bias is increased proportionately.

When a load is coupled to the tuned plate tank, either directly (as the grid of another amplifier stage), or indirectly (as an antenna or output circuit), the effective resistance of the tank increases (increased r , Fig. 5) and the resultant tuned circuit impedance R_0 decreases. This corresponds to the conditions for curve (2) with the resulting representative plate current and voltage wave shapes as shown. Here the average value of the plate current pulses increases over that of (3) and the plate milliammeter reading rises in proportion as the tank circuit is loaded (still tuned to resonance). During the negative half-cycle of the grid voltage swing the plate current is cut off for all three cases. However, the inertia or fly-wheel effect of the tank's stored energy produces a nearly sinusoidal variation of the plate voltage in cases (2) and (3).

POWER INPUT AND OUTPUT

Considering the relation of power output and input, the product of the average values of the plate current and plate voltage is the measure of the average plate input power. The useful r.f. power output to the tank circuit can be determined graphically by analyzing the plate current wave form for the fundamental frequency component (r.m.s. value) and taking the product of the square of this value by the equivalent tuned circuit impedance. Thus it is seen that the wave form of the plate current is of great importance. The double-hump effects resulting from too great a degree of grid excitation, without a corresponding increase of bias, may evidence inefficient adjustment.

By means of the cathode ray oscillograph all of these wave forms and operating relations have been observed, although usually at lower frequencies. This same graphical analysis can be applied to the screen grid power amplifier with

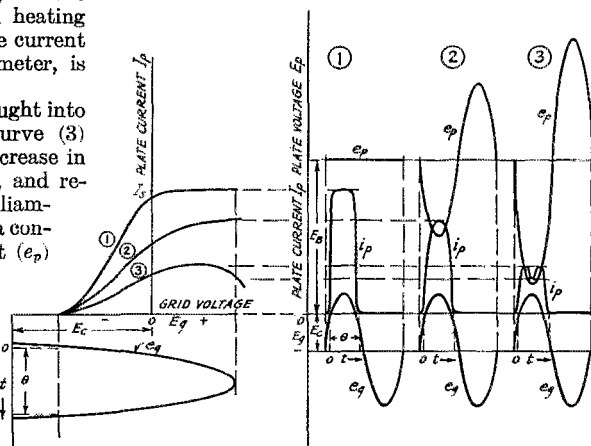

FIG. 7—TYPICAL DYNAMIC CHARACTERISTICS AND RESULTANT PLATE CURRENT AND VOLTAGE RELATIONS

- (1) Tank circuit greatly off tune.
- (2) Tank circuit tuned with moderate load.
- (3) Tank circuit tuned with no load.

similar results. In the case of the frequency doubler a more extensive treatment is necessary, though following similar principles.

W3LW's analysis will be continued in an early issue with discussion of excitation checking and output circuit considerations.—EDITOR.

Strays

Even speech amplifiers are dangerous. An unexpected jolt while W8EPY was working at his s.a. caused him to jerk his hand out in such a hurry that he gave himself a black eye!

Taming the 'Phone Transmitter

The Details of a Modern Low-Power 3.5- and 14-mc. Installation

By Temple V. Ehmsen, W7VS*

HAVING operated what was apparently a smooth 3.5-mc. 'phone for a couple of years, a whirl was taken at 14-mc. 'phone. But, alas, the docile r.f. of 3.5 mc. became a wild and uncontrolled creature on the higher frequency. Transformers squealed in the Class-B modulator, current meters suddenly went off scale and tubes flashed over. The plate current of the Class-C amplifier would show improper increase under modulation and the feeder meter would swing downward—or start blithely upward only to act as though it had struck a stone wall. R.f. skipped nonchalantly through the grid chokes; and if one were to come within a foot of the mike, modulation occurred without a word being spoken. All this was too much for any operator, so experiments were run to stabilize performance on 14 mc. The transmitter shown in the photographs is the outcome.

The rack-and-panel setup grosses 44 inches high by 24 inches wide by 24 inches deep. The rack is made of 2-by-2 fir, the 24-inch square shelves of 3-ply $\frac{1}{4}$ -inch veneer, and the panels of $\frac{1}{4}$ -inch maple. The panels were boiled in paraffin until they sank and the outside then was washed with boiling water to cut away the surface paraffin. Then about four coats of black Duco were sprayed on lightly and the surface was brushed horizontally with steel wool to give a grained effect. The finished appearance smacks strongly of grained bakelite.

All power supplies are placed underneath the table at least two feet from the modulator unit. The speech amplifier and the Class-B modulator with Type 46 tubes take up the bottom shelf. Twelve inches above the modulator is the crystal-controlled oscillator with its plate coil placed at right angles to the buffer coils above. Eight inches above the oscillator is the shelf carrying the two 46 doublers with a single plate meter which may be switched to give the plate current of each stage or the total. Another eight inches up and we have the Class-C amplifier of two 46's in push-pull with a grid and a plate milliammeter switched from one tube to the other to aid in obtaining an electrical balance.

Except for the mike and gain control cables, no

shielding is used, although the modulator could be shielded without expecting anything but improvement. Just turning the mike transformer through a right angle effectively killed a persistent 60-cycle modulation. Automatic bias is used throughout, and the action of the Class-C amplifier is essentially linear. So much for the general description; now to consideration of the transmitter's individual units.

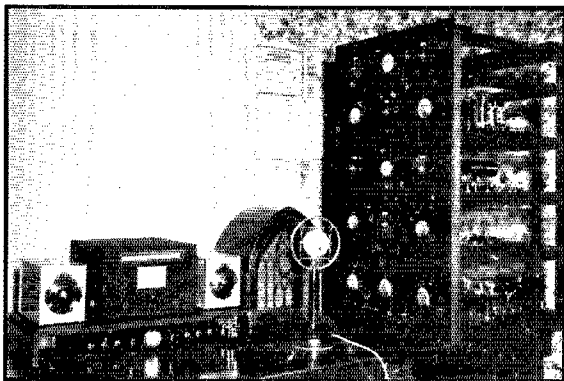

GENERAL VIEW OF W7VS, SHOWING THE TRANSMITTER AT THE RIGHT, FACING THE OPERATING POSITION, WITH THE CONTROL PANEL LOCATED DIRECTLY UNDER THE E.C. FREQUENCY METER, RECEIVER, AND THE DOUBLE ANTENNA TUNER

POWER SUPPLIES

Getting down to the essential details we might as well begin with the power supplies, and progress from there. Separate plate supplies are used for the Class-B audio and Class-C r.f. stages. For straight 'phone work the regulation of the final amplifier's separate plate supply is not important, compared to that of the Class-B modulator supply, since the r.f. load is constant; but the filtering is important. An 83 rectifier tube with a filter having choke input and about 4 μ f. at the output is used. For the Class-B modulator supply a Thordarson type T5140 transformer is used with an 83 tube and 2 μ f. This particular circuit happens to be the recommended one of the Thordarson people except that an 83 is used in place of two 866's. The regulation is excellent and on the peak swings of about 125 mils the voltage swing is only 15 to 20 volts.

A separate power supply is used for the speech amplifier and another for the oscillator and

* 4332 S. E. Madison St., Portland, Oregon.

doublers. The speech amplifier supply can be any good d.c. "B" supply that will give 250 volts at 35 or 40 ma. But the low-power r.f. supply had better be built for the job, since the current required is about 125 mils and the voltage under load should be 350 to 400 volts. Past issues of *QST* and the *Handbook* describe such supplies.

THE SPEECH AMPLIFIER AND MODULATOR

The speech amplifier and modulator of Fig. 1 are quite conventional. A double-button "Ameri-

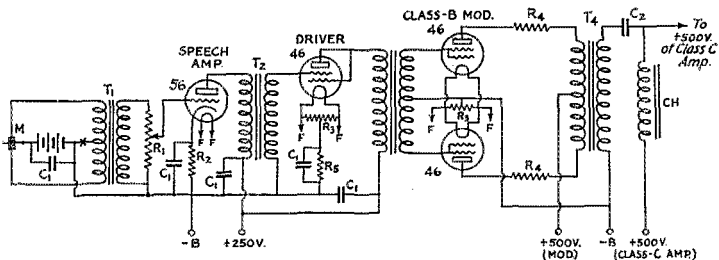

FIG. 1—CIRCUIT OF THE SPEECH AMPLIFIER AND CLASS-B MODULATOR

- M—200-ohm per button American mike.
- C₁—1- μ fd. 400-volt by-pass condensers.
- C₂—2- μ fd. 1000-volt by-pass condenser.
- R₁—500,000-ohm variable.
- R₂—2,750-ohm 1-watt.
- R₃—20-ohm center-tapped.
- R₄—100-ohm 25-watt resistors (surge suppressors).
- R₅—1500-ohm 2-watt.
- T₁—Thordarson T-3020 mike transformer.
- T₂—Silver Marshall 220 audio transformer.
- T₃—Thordarson T-5100 input transformer.
- T₄—Thordarson T-5101 output.
- CH—40-henry 400-mil choke.

can" mike drawing 8 mils on each button at 3 volts works into a transformer with the output controlled by a 500,000-ohm pot. A single 56 stage of speech is transformer coupled to a 46 Class-A driver, which, through a Thordarson input transformer (Type T5100 designed for 210's), excites the Class-B 46's. These in turn work into a Thordarson output transformer (Type T5101, also designed for 210's) which is coupled

by a 2- μ fd. condenser and a 40-henry 400-ma. choke to the final r.f. stage. This choke is home-made from *Handbook* specifications and in the photograph of the power supply is the large double-winding choke that sits toward the back of the shelf on the right-hand side. The 40-henry inductance value is estimated. This method of coupling prevents d.c. saturation of the core of the output transformer but should be used with a 2- μ fd. or larger coupling condenser, of 1000 volts rating, to give low audio impedance. In Fig. 2

will be noticed a couple of 100-ohm resistors which act to protect the output transformer against breakdown from high-voltage audio peaks that are likely if the load should be accidentally removed.

THE OSCILLATOR

The crystal-controlled oscillator of Fig. 2 also is conventional in every way. Low capacity and light loading are the desirable features. The condenser is a National Type DX 300-volt 150- μ fd., set about 30% "in" for a 3550-kc. crystal (see coil table). The excitation tap is taken from the center of the coil, since this seems to

give sufficient output and still only loads the oscillator to about 6 watts input (18 mils at 350 volts). A 46 tube seems to work about the same as the '47 except the crystal current runs higher; therefore the use of the '47. The tri-tet oscillator, described in October and November *QST*, could be adapted and should give more excitation to the final, with the two buffers to amplify any harmonic. And of course anything serving to increase stability at 14 mc. is always worth while.

Table I—Coil Data

Coil	Freq. Kc.	Total Turns	Turns Between Plugs	Coil Diameter (Inches)	Distance Between Plug Centers (Inches)	Approximate Distance Between Turn Centers (Inch)
L ₁	3,550	30	15	2 1/4	2 5/8	1/8
L ₂	7,100	18	9	2 1/4	2 5/8	1/4
L ₃	14,200	10	5	2 1/4	2 5/8	3/8
L ₄	14,200	12	6	2 1/4	3 1/4	3/8
L ₄	3,900	38	19	3 1/4	3 1/4	1/8
L ₅	14,200	5		2 1/4		1/4
L ₅	3,900	9		2 1/4		1/4

All coils except L₄ are wound with No. 12 enameled wire, L₄ being wound with 1/4-inch copper tubing.

Two L₅ coils are required for each band.

THE DOUBLERS

The first amplifier working on 7000-kc. employs a 46, and since this is a doubler, distortion of the wave form to enrichen the harmonic content is very desirable. This is accomplished by the use of a 20,000-ohm automatic bias resistor in the grid circuit. Here again low-C will be found helpful in maintaining the distortion and allowing the tube to run at a higher efficiency. High-C tends to iron out the harmonics. While neutralization is not necessary when doubling, it is used here as the transmitter is run on 3.9 mc. also, and it does not seem to bother anything when the tube is doubling. A 47 has been used in place of the 46 and works well enough, although it does not neutralize completely for straight amplification. The 46 also gives a flexible system for the

interchange of tubes to choose the best doublers— but more of this under the operating pointers.

The excitation coupling condensers are made variable to give freedom from d.c. leakage and the consequent upsetting of the working of the automatic bias. Again, when the intermediate stages are used as straight amplifiers it may be advisable to reduce excitation, and the variable condensers do this easily. The second doubler is similar to the first except for tank constants and the method of taking off excitation for the push-pull Class-C amplifier A grid resistor of 20,000 ohms is again used, and the tank circuit should have even a more favorable ratio of L/C as an increase of inductance has aided the excitation to the final in every case, and at the same time the 46 tube was cooler. Since push-pull grids are fed from the 14-mc. tank the excitation is taken from both ends of the tank circuit with the plate voltage tapped in at the center of the coil. Neutralization of this last doubler lowered the excitation to the final. The oscillator and both buffers run off of the same plate supply but have different filament supplies.

THE FINAL AMPLIFIER

This brings us down to the final amplifier where in a large measure we are able to determine the effectiveness of our transmitter. After trying both 210's and 46's in this stage it was found the 46's were just as effective as the desired input of 50 watts (100 ma. at 500 volts). The price of the 46's cinched the argument. With everything else working properly, the remaining variable is the electrical and mechanical setup.

From the photographs it can be seen the physical arrangement has been kept fairly symmetrical. A high impedance tank circuit (low C to L) allows the tubes to run perfectly cool at the 50 watts input. The tuning condenser is a rebuilt National Type DX 3000-volt 150- μ fd. The stator is split by removing the center stator plate and cutting the bolts at the point the plate is removed. They are then threaded and the remaining sections connected to either side of the plate coil with the rotor grounded. The grounding or tying of the rotor to the filaments by way of the negative line theoretically reduces some of the harmonic content, and practically reduces hand capacity effect in tuning. And at 14 mc. hand

capacity is certainly noticeable unless steps are taken to reduce such effects.

From the diagram it will be noticed that by the use of chokes and by-pass condensers the r.f. is fairly well tied into the filament return. R.f. tube filaments are on separate transformer cores from the audio tube filament supplies. The mercury-vapor rectifier filaments are also on separate transformers as they introduced bad hum into the audio system when tried on the same core, even with separate windings.

The grid meter has been found to be as important as the plate meter in getting smooth and consistent performance. In practical operation of the transmitter the grid and plate meters are simultaneously switched from one tube to the other to obtain a balanced condition in the circuit. The grid bias resistor of 1000 ohms was an arbitrary value taken from a *QST* article, but was found to allow the 46's to give Class-C operation.

The r.f. chokes *must be good*. National Type 100 chokes were used in this job throughout, and have worked splendidly. In fact, the substitution of these little chokes for the home-made ones cleared up most of the erratic operation at 14 mc. The neon globe shows no leakage of r.f. and their performance has been uniformly good at both 3.5 mc. and 14 mc.

This brings us to the antenna. While the writer realizes there are several types of antennas and methods of coupling suitable for a push-pull final, a series-tuned Zepp has given satisfactory results and an understandable

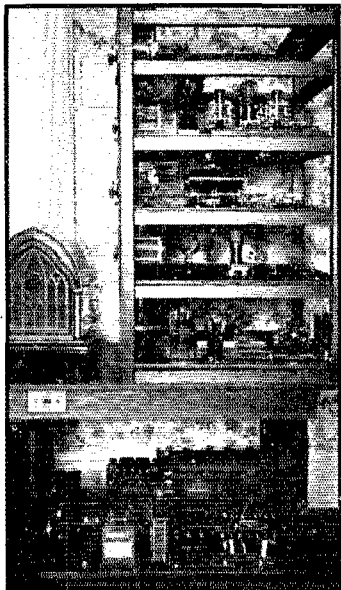

THE SIDE VIEW OF THE TRANSMITTER, SHOWING ALL POWER SUPPLIES LOCATED ON A SHELF AT THE BOTTOM, WITH THE MODULATOR SHELF ABOVE

Progressing upward are the crystal oscillator, the two doublers and the push-pull final amplifier.

Table II—Tube Operating Data

Tube	Stage	Condenser Reading	Plate Voltage	Plate Current (Mils)	Grid Current (Mils)
56	Speech Amplifier		250	5	0
46	Driver		250	20	0
46	Modulator Class-B—2 tubes		500	20-125	0-35
47	Oscillator	50	350	18	...
46	First Doubler	80	350	25	7
46	Second Doubler	10	350	60	10
46	Final Amplifier—2 tubes	70	500	100	10-15

With the antenna described the feeder r.f. current is 1.25 amp., modulating to 1.5 amp.

Values are approximately the same for 14.2 and 3.9 mc.

performance with this job. Where parallel tuning of a feeder system is used it seems to add a tank circuit with additional losses, and there is always some doubt as to whether the tank or the antenna is taking the load. Split antenna pick-up is used

TUNING UP

We come now to the tuning up process which is straight forward enough if no "bugs" are present. Table II gives the actual voltages and currents under load for this particular transmitter under

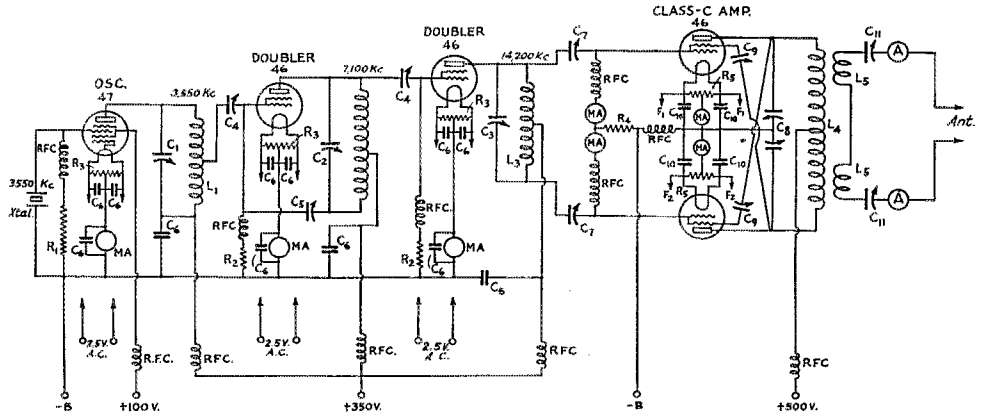

FIG. 2—CIRCUIT OF R.F. UNIT

- L₁, L₂, L₃, L₄, L₅—See Table I and text.
- C₁—150- μ fd. National type DX 3000-volt condenser.
- C₂, C₃—Split-stator condenser having a maximum of 75- μ fd. net, a total of 13 plates in each section. (See text.)
- C₄—100- μ fd. variable excitation condensers.
- C₅—25- μ fd. variable condensers.
- C₆—0.002- μ fd. Sangamo fixed condensers.
- C₇—100- μ fd. Midway Cardwells.
- C₈—150- μ fd. 3000-volt National type DX. (See text.)
- C₉—25- μ fd. Midway Cardwells.

- C₁₀—0.005- μ fd. fixed Sangamos.
 - C₁₁—500- μ fd.
 - R₁—15,000-ohm 10-watt resistor.
 - R₂—20,000-ohm 5-watt resistor.
 - R₃—20-ohm center-tapped resistor.
 - R₄—1000-ohm 10-watt resistor.
 - R₅—20-ohm center-tapped resistor.
 - RFC—National type 100 chokes.
- Meter ranges according to Table II.
Tubes have separate 2½-volt filament supplies.

to give uniform r.f. distribution to the feeders. Of course the antenna meter shows equal currents in both feeders and the current loop can be traced out uniformly along the 16-foot feeders (or the 60-foot ones at 3.9 mc. with a neon globe until the voltage loop begins to show up.

Another type of feed system that works nicely with this transmitter is the untuned low-impedance line suggested by George Grammer in July, 1933, *QST*. Having a receiving doublet cut for the 14-mc. band and a two-wire lead-in with bakelite transposition blocks every 15 inches, it was a small job to couple it to the push-pull tank through the regular 500- μ fd. variable condensers used for tuning the Zepp. The tubes took full load at about ½ turn at either side of the center tap and reports justified the continued use of this system. Changing the setting of the coupling condensers only acted to shift the load. That is, as they were increased from zero capacity setting the plate mils increased and the clips on the coil had to be moved in to reduce the load. There was no indication that this was a tuning process as the effect of increased load at increased capacity was uniform for the full condenser swing with no tuning humps noticeable. In this case the feeder happens to be about 80 feet long and each leg of the flat top was made 16 feet 5 inches in length.

normal operation, although they may vary with different crystals or individual tubes. The oscillator should have only the one dip, and can be run on the stable or "long side" of the dip for smoothest operation.

The first buffer does not load heavily (about one-third of the plate current of the next buffer or doubler). It is a good idea to keep succeeding tubes out of their sockets until each stage is working properly. And by all means use your absorption wavemeter to check the frequency of the doublers. The best of monitors will fool one badly because of the large number of strong harmonics, but at this low power the old wavemeter is practically fool-proof as it lights up on only the tank circuits fundamental.

We do not hear as much about tight coupling as we did in the old spark days when we worried about spurious waves, but the writer believes that proper coupling is just as important with our present-day amateur transmitters. The coupling between the first and second doublers should be no tighter than necessary to give sufficient excitation. Furthermore, it will usually be found that at the point where the grid mils commence to drop off and the reaction from mutual inductance is less pronounced on the tuning is the ideal condition under which to run the intermediate amplifiers. Under this condition the tubes

will run cool and stable, and every time the operator "bottoms" a circuit there is a negligible effect on the others. The way to obtain this ideal tuning setup is to set the coupling condensers all the way in and gradually decrease their capacity while watching the effects on tuning and grid and plate currents (excitation). Table II indicates grid currents of 7 ma. and 10 ma. for the first and second doublers respectively. For experiment these values could be increased to a point where the succeeding stage shows over-excitation. After a little cut-and-try practice the operator will arrive at an ideal condition.

The second doubler has the job of exciting the final amplifier and carries somewhat more of a load. The output is at 14 mc. and some tubes will be found to double better and give more output than others. The 14-mc. doubler tube is perhaps the most important tube of all. In the first place a first-grade make is necessary if reasonably long life, consistent output and sufficient excitation are to be expected. Some 46's in this last show signs of grid emission, as they gradually heat up with the plate current steadily climbing. There are many good tubes on the market and in this particular transmitter the tubes have been on the job about a year. It will pay the operator to try each tube in the last doubler stage; one will usually be found to give slightly better output and consequently higher grid excitation to the final as evidenced by the grid mills. While the grid current value is a function of several things such as bias, load, etc., this transmitter has given better operation with the grid current running 25 to 30 per cent of the plate current. Again the use of an absorption wavemeter in tuning up this stage is stressed, as the writer has found several pronounced dips of the plate current very near the 14-mc. "bottom."

When the final amplifier is neutralized with plate voltage off, the grid current will be found somewhat higher than when under load. Also, neutralizing becomes tricky unless the grid currents are about equal. If tubes are about the same and the circuit layout fairly symmetrical the grid currents will stay about equal under load, though they drop off in value. If the grid values are very different the grid meter will swing downward on one tube and upward on the other under modulation. From numerous experiments at W7VS it has been found that it takes at least a 20% grid-to-plate-current ratio to give sufficient excitation to the 46's to fill up the envelope properly under 100% modulation. Still better for the stability of the meters is a ratio of 30% (15 grid mills to 50 plate mills on each tube). With some tube combinations it is possible to get balanced plate mills but unbalanced and swinging grid mills, in which case the trouble can be remedied by adjusting the variable excitation condensers. By cut-and-try adjustment of the grid excitation condensers, a setting will be found that gives maximum grid

mills for a given load, in both the doubler and the final stage. At this optimum setting the efficiency is apparently the highest and the grid meter shows greatest stability under modulation. There is no question that the load and coupling to the final amplifier have a decided effect on the action and value of the grid current. Also, neutralization should be as exact as possible. With a nicely balanced circuit the tendency

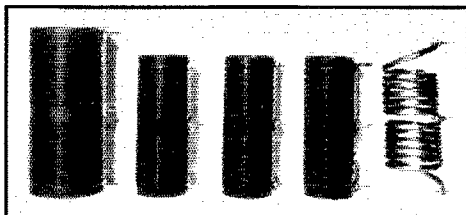

THE FINAL AMPLIFIER TANK COIL FOR 3.9 MC., THE 3.0- OR 3.5-MC. OSCILLATOR OR BUFFER TANK COIL, THE 7-MC. DOUBLER TANK COIL, THE 14-MC. DOUBLER TANK COIL, AND THE FINAL AMPLIFIER TANK COIL FOR 14 MC.

toward any feedback from the final is considerably lessened, but if one tube carries more load, with the rotor of the tank circuit condenser showing some r.f., there may be trouble from r.f. feeding back to the modulator.

When we couple to the antenna, the *Handbook* tells us not to pay too much attention to the antenna current, but to watch our impedance matching to the modulator by means of the plate current. True enough; but, harking back to the tightness of coupling again, the writer has found that a point can be reached that is optimum in every way. The first thing to do is to back the coupling off slowly until a position is reached where the antenna series condensers can be tuned through resonance with the plate mills reaching maximum at resonance, but dropping back to a no-load minimum without resetting of the tank condenser. The plate mills will drop off slower on the side of high capacity (using series-tuned Zepp), but very little upsetting is experienced from mutual inductance reacting on the amplifier. It was found also that for the proper Class-C stage input of 50 watts, the feeder current reached maximum value as the antenna circuit was brought into dead resonance. The feeder meter was much "freer" under modulation with this optimum value of coupling. Repeated experiments along the same line with this particular transmitter and antenna setup always led to the same conclusion.

Tests for parasitic oscillations have been negative, and after about six months operation on 14 mc. no particular trouble has developed. The final amplifier runs perfectly cool, and when the antenna is taking load there is very little r.f.

(Continued on page 78)

H A M D O M



Citizens of Hamdom:

A new feature in *QST* must stand on its own merits. It lives or dies as a direct result of the interest it creates and the response it arouses. "Hamdom", we are happy to say, will continue to live—for a time, at least. It is fitting therefore that, since it is to be with you regularly along with all the other *QST* departments each month, we should outline its purpose.

"Hamdom" is a cross-section of amateur radio. Not a Who's Who, not a Hall of Fame, not a Rogue's Gallery . . . but a humanized version of all three. It's a presentation, each month, of a group of figures currently newsworthy, *interesting* to us amateurs as amateurs. Neither the great nor the small, but both; neither the mighty nor the mediocre, but simply those about whom we think you'd like to read. We invite you to suggest an amateur of your acquaintance whom you think sufficiently interesting to merit a place in "Hamdom".

Speaking to those who have been and will be presented on this page . . . we're glad to have you with us! 73 and cuagn.

—THE EDITOR

BACK in '17 Army fliers sometimes flew across Long Island Sound from Mineola over Pelham in Westchester County, New York. They were mightily interesting to a young lad of 10 by the name of Henry Harris, who lived in the town at that time; so interesting, in fact, that 1928-29 found him taking the course at the Air Corps Flying Schools at Brooks and Kelly Fields, following four years of military training. After four years in the 101st Observation Squadron, Mass. N. G., we find him a 1st Lieutenant taking the M.I.T. weather plane aloft every morning to an altitude of 18,000 feet and working amateurs on 56-mc. en flight. Lieutenant Harris is a born operator. Flying his weather ship "blind" in way-below-zero temperatures, he has no difficulty in manipulating a receiver, miscellaneous transmitters, his weather instruments, and carrying on rapid-fire QSO's



PILOT

with any and all ground stations available. That's operating!

THE Key System, Ltd., of San Francisco, operates boats and ferrys across famed San Francisco Bay, short-circuiting the Bay to Oakland. An engineering job, if ever there was one. Engineer for the Key System, Ltd., is S. G. Culver, director of the Pacific Division, W6AN. He has had wide experience in the world of civil engineering, beginning with his graduation from the College of Engineering of the University of California. He was secretary-treasurer of the



ENGINEER

1928 Pacific Division Convention, and secretary-treasurer of the East Bay section from 1928 to 1932. On March 1, 1933, he became director by a special election; at the end of the year he was reelected without opposition. Amateur radio shares place with photography as his hobby. Of his family of three girls and one boy, one is a senior and one a sophomore in the University of California.



CHAMPION

TENNIS is no problem to him, but that African QSO has him stopped. Wilmer Allison, W5VV, second ranking tennis player in the U. S., member of the Davis Cup team for six years and captain in American Zone play for 1933, was national intercollegiate singles champion in 1927, national mixed doubles champion with Edith Cross in 1930, national men's doubles championship with John Van Ryn in 1930, with whom he also won the doubles at Wimbledon and the world's doubles championship in 1929 and 1930, and captain of the U. S. team to Australia last fall. An O.R.S., he enjoys chewing the rag and handling traffic, but his biggest kick is meeting in person hams all over the world with whom he has QSO'd. He's a real old-timer; started in 1919. Biggest thrill: being one of the first to contact 6ZAC in Honolulu. Biggest disappointment: failure of his kw. spark to get across to Paul Godley in Scotland in 1922. The really important thing, he insists, however, is that he still hasn't got Africa for his WAC.

The Bandsetter

How to Build and Use an Oscillator-Multivibrator Unit of Wide Utility

By G. F. Lampkin, W8ALK*

IF ON each of our amateur bands there were marker stations, always on, steady R8 or R9 d.c. carriers, at exactly the band limits, then each and every user of that band would almost automatically become frequency conscious. The limits would be there, set out so that there could be no mistaking them. Each signal heard would be either in the band or out of it. There would be no guessing as to changeable limits on a hand-spread dial, or as to how far from a commercial marker station the frequency lay. There would be no trotting out the freqmeter and measuring each questionable signal. There would be simply the procedure of the industrial inspection department—"Go," or "No Go."

Suppose, in addition, that all the even 100-kilocycle points in the band were similarly marked. The bands would be split up into definite numerical segments, giving a perspective useful in operation and an approximate frequency designation that could be had in no other way. Suppose also that the strength of these marker stations could be set to R0 or R9+, or whatever was desired, that they could be made to appear on the 50-kc. points or even be brought in every 10 kilocycles. Well, they can.

What we shall call a "bandsetter" will do all this and then some. The full name of the instrument is, a 100-kc. electron-coupled harmonic oscillator with variable-frequency multivibrator. Which is reason enough for almost any other name. The 100-kc. oscillator creates strong harmonics every 100 kilocycles all the way to as high as 30,000 kc. When listening on a receiver on the 7000-kc. band, for instance, there will be a steady carrier where the stations thin out at the top of the band, two markers in the band, and one at the bottom. If the oscillator is accurately on 100 kc. these markers are necessarily on exactly 7000 kc., 7100, 7200 and the 7300-kc. upper limit.

The same is true for all the other bands, save one. There will be definite accurate markers at the band limits, and markers every 100 kc. throughout the band. The exception is the one band that begins at 1715 kc.

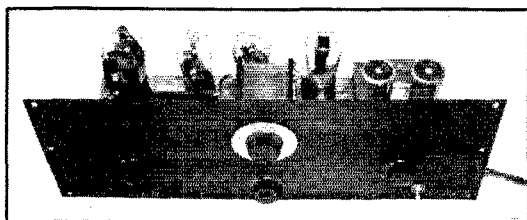

THE BANDSETTER IS A SELF-CONTAINED OSCILLATOR AND MULTIVIBRATOR UNIT THAT CAN BE CHECKED AGAINST STANDARD-FREQUENCY SIGNALS AND USED TO FURNISH ACCURATE CALIBRATION FREQUENCIES THROUGHOUT THE RADIO RANGE AT INTERVALS AS SMALL AS 10 KILOCYCLES

Panel controls are for adjusting r.f. input voltage, for varying multivibrator frequency and for tuning the electron-coupled oscillator.

The multivibrator was described by Hull and Clapp in the *Proceedings of the I.R. E.* for February, 1929.¹ The name of the instrument is imposing, but nothing could be simpler. It operates as a frequency divider. Fewer parts and less time actually are required for it than for the electron-coupled oscillator. It consists of only two tubes, two fixed condensers and four resistors—and almost any values

work. The function of the multivibrator is to create, between the 100-kc. points, any desired number of equally spaced marker points. For instance, if the 100-kc. gap is split in two, there will be points at 7000, 7050, 7100, 7150, 7200, 7250, and 7300 kc. in that band. Or the division may be made by any other whole number up to as high as 50. In the table of Fig. 1 the arithmetic is performed, showing the frequencies intermediate between any two 100-kc. points, for divisions from 2 to 10.

THE MULTIVIBRATOR

The multivibrator functions somewhat as follows: The circuit is a two-stage resistance-coupled amplifier whose output feeds back into its own input; by virtue of this direct feedback connection the multivibrator goes into sustained oscillation ("motor-boats") at a wobbly frequency very approximately determined by the grid condenser and resistor values. By varying one or more of the latter elements, a harmonic of the wobbly frequency may be made to approach the frequency of the controlling oscillator. When this

¹ Multivibrators have been described in several *QST* articles: Clapp and Crawford, "Frequency Standardization," March, 1930; and Chinn, "Standard Frequency Station W1XP," Jan., 1931 (with correction, p. 24, March, 1931).

* 146 W. McMillan St., Cincinnati, Ohio.

happens the multivibrator falls in step at *exactly an integral fraction of the controlling frequency*. The multivibrator note clears up and becomes as steady and pure as that of the control oscillator. The output is even richer in harmonics than that

oscillator was on exactly 100 kc. Methods of assuring that the oscillator is on approximately 100 kc. were outlined in the m.f.m. article. Then it is necessary to pick up on a receiver only one suitable accurately known frequency, adjust the bandsetter to zero beat, and all the other marker points automatically become correct. By "suitable frequency" is meant any frequency between 100 and 30,000 kc. that is a multiple of 100, or of the frequency to which the multivibrator is set.

The most prolific source of accurately known frequencies is the broadcast band. The 50-cycle deviation limit imposed on these stations necessitates an accuracy within .009 percent at 550 kc. and .003 percent at 1500 kc. In practically all sections of the country there is a local or near-local broadcast station on one of the even 100-kc. channels that can be used for checking the bandsetter. As a rule the high-powered clear and regional channel assignments are closely adhered to.

In Cincinnati, for instance, there is WLW on 700 kc. and WFBE on 1200 kc. These stations are picked up either on the short-wave receiver using broadcast coils, or on a regular broadcast receiver. The bandsetter

oscillator is turned on after having been approximated at 100 kc. On both of the stations there appears an audio beat, and the vernier frequency control of the bandsetter is tuned to give zero beat. If the bandsetter is started out with the multivibrator set for 50 kc., not only WLW and WFBE, but also WKRC on 550 kc., have an audio beat on the carrier. Once the bandsetter is calibrated at exactly 100 kc. by this method it is ready for use on all frequencies throughout its range.

ready for use on all frequencies throughout its range.

In using the A.R.R.L. standard frequency transmissions, if only one transmission is picked up on any of the schedules, it can be used at once with equal accuracy by means of the bandsetter on any and all of the other bands. Last and most important, there are the

weekly 5000-kc. transmissions of WWV, which are ideal for the bandsetter adjustment. Using this transmission as a standard and a multivibrator setting at 10 kc., frequencies of the broadcast stations themselves can be checked!

Most broadcasting stations use a piezo-electric monitor, running at practically no load and under accurately controlled conditions, to check the

MULTIVIBRATOR CONTROL ORDER								
2	3	4	5	6	7	8	9	10
00.0	00.00	00.0	00.0	00.00	00.00	00.00	00.00	00.0
				16.67	14.29	12.50	11.11	10.0
		25.0	20.0		28.58	25.00	22.22	20.0
	33.33			33.33		37.50	33.33	30.0
			40.0		42.87		44.44	40.0
50.0		50.0		50.00	57.16	50.00	55.55	50.0
	66.67		60.0	66.67		62.50	66.67	60.0
		75.0			71.44	75.00	77.78	70.0
			80.0	83.34	85.73	87.50	88.89	80.0
								90.0
00.0	00.00	00.0	00.0	00.00	00.00	00.00	00.00	00.0

FIG. 1—TABLE OF FREQUENCY POINTS OBTAINED AT 100-KC. INTERVALS WHEN USING DIFFERENT MULTIVIBRATOR SETTINGS

of the electron-coupled oscillator. Since the multivibrator is controlled by the 100-kc. oscillator, and is controlled at an exact fraction of this frequency, some of its harmonics must necessarily coincide exactly with the 100-kc. harmonics. The net effect noticed in a receiver when the multivibrator is cut in is that while any two consecutive 100-kc. points remain undisturbed, a given number of equally spaced carriers are created between them.

Practically, on the amateur bands, divisions much closer than 25 kc. are confusing. Fifty-kilocycle divisions can be used to show the 14,150 to 14,250-kc. 'phone band. The nearest safe approach to the one odd amateur-band limit of 1715 kc. is obtained by a division of 6, yielding a marker at 1716.67 kc. For freqmeter calibration the use of points every 20 kilocycles will eliminate practically all errors in plotting calibration curves. In fact, this whole business of the bandsetter is an outgrowth of a study of calibration methods for the micro-meter freqmeter.²

So far the assumption has been made that the

² Described by the author in *QST*, July and Oct., 1933.



REAR VIEW OF THE UNIT, SHOWING POWER PACK AND RECTIFIER TUBE AT THE LEFT, MULTIVIBRATOR AND SCREEN-GRID OSCILLATOR TUBES TO THE RIGHT

Oscillator tuning condenser and coil are between the tubes and the panel.

transmitter frequency. However, equipment of this sort even when carefully engineered and carefully used, shows discrepancies when checked with the radio inspector's office. Through WWV s.f. transmissions (schedules given in every issue of *QST*), the bandsetter can be used to adjust broadcast-station frequency indicators and monitoring equipment directly in terms of the National Standard of Frequency at the Bureau of Standards — which standard is also the basis of the radio inspector's measurements. If the multivibrator on the bandsetter is put at 10 kc. and the 50th harmonic of the oscillator set on exactly zero beat with WWV, then on every U. S. broadcasting channel there will be a marker carrier. If the output of the bandsetter, through an amplifier if necessary, is connected to the broadcast-station frequency indicator in place of the transmitter, the deviation meter should read zero. If not, proper steps should be taken to correct the error.

BANDSETTER CONSTRUCTION

In Fig. 2 is drawn the schematic diagram of the bandsetter. It is completely a.c. operated. It uses a 24-A as the oscillator, two 56 tubes in the multivibrator, and an 82 rectifier. With power-transformer secondary voltages as shown, the resistance-capacity filter delivers 15 milliamperes at 200 volts d.c. This is applied to the plates of the oscillator and multivibrator tubes through a common 10-mh. universal-wound choke. The choke serves to introduce 100-kc. control voltage in the multivibrator circuit. The 10-mh. value is optimum; if smaller, the control ranges are not well defined, and if larger they are compressed together. The frequency of the multivibrator is adjusted by means of the one variable grid leak. With resistor-condenser values shown the range is from 50 to about 6 kc., or division orders of 2 to 16 or 17.

The 100,000-ohm variable grid leak used for multivibrator control should be tapered, with the low resistance values spread out. If a linear resistor be used, the lower divisions of 2 and 3 will be very hard to find or set. When the grid leak is set at zero resistance the multivibrator is effectively cut out and only the 100-kc. harmonics from the oscillator are had.

The output control is a real aid in operation of the bandsetter. It is useful to equalize the strengths of the higher and lower harmonics, to set the markers on any one band at a level to suit the individual taste, or to cut them to practically

zero without turning the bandsetter off. If the output potentiometer resistance is 100,000 ohms, the intermediate markers from the multivibrator will be somewhat weaker than the even 100-kc. harmonics. This feature is sometimes useful in harmonic identification. If the potentiometer be

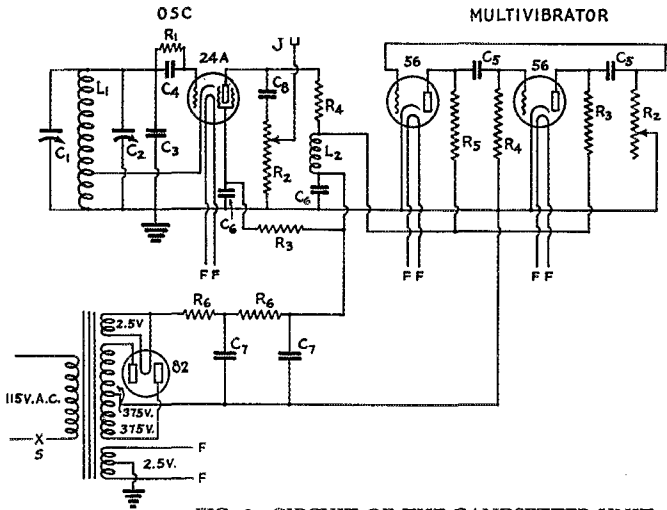

FIG. 2—CIRCUIT OF THE BANDSETTER UNIT

- C₁—Hammarlund 20- μ fd. midget condenser.
- C₂—Cardwell midway 350- μ fd. receiving condenser.
- C₃—0.002- μ fd. fixed mica condenser.
- C₄—250- μ fd. fixed mica condenser.
- C₅—500- μ fd. fixed mica condenser.
- C₆—0.25- μ fd. non-inductive by-pass condenser.
- C₇—8- μ fd. dry electrolytic filter condenser.
- C₈—Insulated hookup wire twisted 6 inches long.
- L₁—360 turns No. 34 d.s.c. wire close-wound on 1 1/4-inch diameter form; tapped at 120 turns from ground end.
- L₂—Universal (lattice-wound) 10-mh. r.f. choke.
- R₁—50,000-ohm 1-watt metallized resistor.
- R₂—100,000-ohm potentiometer, Frost No. 891.
- R₃—20,000-ohm 1-watt metallized resistor.
- R₄—100,000-ohm 1-watt metallized resistor.
- R₅—250,000-ohm 1-watt metallized resistor.
- R₆—6,000-ohm 2-watt wire-wound resistor.
- J—Yaxley insulated tip jack (output connection).
- S—"On-Off" switch.

made 250,000 ohms total, all harmonics will be of approximately equal strength.

The oscillator is provided with two variable condensers in the tank circuit. The larger is used to take up differences in the circuit constants. The smaller is used for fine frequency adjustment, and has a small dial. The dial is fixed to the condenser so that increase of reading corresponds to increase of frequency. When using the bandsetter some stations will be heard which give a heterodyne with one or the other of the marker carriers at the band limits. By turning the vernier dial on one of these stations the heterodyne can be brought to zero. If the reading must be increased to do this, the station is out of the band if at 7300 kc., or in the band at 7000 kc.; and vice versa for a decreased reading. Don't forget to return the vernier to the calibrated point.

(Continued on page 88)

Navy Day—1933

By E. L. Battey, Assistant Communications Manager

RADIO Amateurs of the United States on October 27, 1933, participated in the ninth annual A.R.R.L. Navy Day receiving competition. This yearly activity affords amateur radio operators a part in the celebration of Navy Day.

Secretary of the Navy C. A. Swanson through the facilities of Naval stations NAA (Arlington) and NPG (San Francisco) directed a message to "All Amateur Radio Operators of the United States and Insular Possessions." The text of his message appears elsewhere in this report.

A total of 556 copies of NAA and NPG were submitted by 396 amateurs; 160 operators copied both stations, 173 copied NAA only, and 63 copied NPG only, making 333 copies of NAA and 223 copies of NPG.

The 1933 Navy Day message reached the ears of radio amateurs in 45 states, the District of Columbia, and Hawaii. The three missing states were Louisiana, Mississippi and South Carolina. R. M. Hansen, ex-W6DTZ, radio operator on the S. S. *Nebraskan*, copied the message from NPG while enroute to the Panama Canal at a point approximately 2032 miles southeast of San Francisco. A. J. Gironda, W2JE, made his letter-perfect copies of both NAA and NPG aboard the S. S. *Panaman* off Point Lucas, near the Gulf of California.

It is not possible to go into detail regarding receiving conditions in all localities. Generally speaking, conditions were rather poor. Skip effects were very bad in practically every locality, and static crashes in many quarters added to the difficulties. It is hardly necessary to add that the many forms of man-made QRM were also not lacking. In a number of cases participants reported errors made by the transmitting stations. An inspection of the tapes used by NAA and NPG in sending the messages, and an inspection of a tape recording in the case of the NAA transmission, failed to show but one error at the transmitting end. This was in the case of NPG when the zeros in the number "5000" slurred and ran together. In the case of other errors reported by contestants, when such errors were reported by several operators, it was assumed that static crashes or other receiving difficulties caused the discrepancies and full credit was allowed.

The letters of commendation offered by the Secretary of the Navy to the twenty-five operators submitting the best copies of the messages, have been distributed throughout the various Naval Districts in approximate proportion to the number of participants in each District. The twenty-five high are listed first on the Honor Roll

in order of rating as compared to each other. All contestants other than the twenty-five high are listed by Naval Districts in order of their accomplishments as compared to other contestants *in their district only*. Only seven operators made perfect copy of *both* stations: W9SU, W8AXV, W4RO, W5BMI, W9EOP, W2JE and W6CLY.

The number of operators submitting copies in each Naval District may be of interest. In the First Naval District, 19; Third, 30; Fourth, 21; Fifth, 16; Sixth, 8; Seventh, 16; Eighth, 23; Ninth, 196; Eleventh, 29; Twelfth, 18; Thirteenth, 20. It will be noted that very nearly 50% of all copies came from the Ninth Naval District!

Receiving competitions may seem a "cinch" to the old-timer, but many an experienced operator "breaks down" when copying under pressure, that is, when he *must* get the message 100% perfect the first time. This Annual Navy Day Competition affords an opportunity to see if you "can take it." As one operator puts it, "It's a queer feeling to know that at the same time you are copying the message, hundreds of others are also pushing a stick or batting away on a mill, recording the same message. It makes this Navy Day Competition that much more interesting."

1933 Navy Day Message

To All Amateur Radio Operators of the United States and Insular Possessions:

Once again on Navy Day the Navy Department is pleased to extend its best wishes to all American radio amateurs in the United States and its possessions. A marked gain has again been achieved in the development of the Naval Communication Reserve which consists of 5000 officers and men. During the past year our Naval Communication Reservists have taken a very prominent part in emergency communication in connection with the California earthquake, the loss of the Akron, Ohio River flood, and during storms and hurricanes occurring recently. The service so performed has been voluntary and in accordance with the best traditions of the Naval Service and has clearly demonstrated the value of this reserve organization during short periods of time when regular commercial communication channels have been rendered inoperative. It is a pleasure to be able to reach so many of you by radio and to take this opportunity of sending you all good wishes.

C. A. SWANSON, Secretary of the Navy

(This message transmitted from NAA; the message from NPG was a paraphrase of NAA's text. The above is not for checking purposes.)

1933 Navy Day Honor Roll

The Twenty-Five High

W9SU, Louis R. Huber, Tipton, Iowa (9th Naval District)

W8AXV, Joseph H. Pitzer, Cleveland, Ohio (9th Naval District)
 W4RO, R. F. King, Morristown, Tennessee (8th Naval District)
 W5BMM, E. F. Henning, Little Rock, Arkansas (8th Naval District)
 W9EOP, Paul E. Smay, Merrill, Iowa (9th Naval District)
 W2JE, A. J. Gironda, on board S. S. *Panaman* (Att. to 11th Naval District)
 W6CLY, P. Bertelli, San Pedro, California (11th Naval District)
 W9ERU, Eugene A. Hubbell, Rockford, Illinois (9th Naval District)
 W9DXY, Porter H. Quinby, Omaha, Nebraska (9th Naval District)
 W9EYH, Walter W. Wallace, Milwaukee, Wisconsin (9th Naval District)
 W8PK, E. O. Seiler, East Bloomfield, New York (3rd Naval District)
 W9GBN, Alfred Monkkonen, Crosby, Minnesota (9th Naval District)
 W8EGX, Clayton F. Howe, Alamo, Michigan (9th Naval District)
 W9CFL, A. W. Hodge, Kansas City, Missouri (9th Naval District)
 W9GAD, R. C. Hunt, Kansas City, Missouri (9th Naval District)
 W1CU, Ralph J. Renton, Quincy, Massachusetts (1st Naval District)
 W4BG/EZ, C. F. Clark, Jacksonville, Florida (7th Naval District)
 W7ANU, Boyd Wolf, Oakridge, Oregon (13th Naval District)
 W3ZD, Roy C. Corderman, Chevy Chase, Maryland (5th Naval District)
 W3ADE, Lewis E. Elicker, Jr., Penbrook, Pennsylvania (4th Naval District)
 W7JY, Warren L. Green, Grangeville, Idaho (13th Naval District)
 W4BRG, Robert C. Check, Savannah, Georgia (6th Naval District)
 W2EWG, Frederick Best, Dunellen, New Jersey (3rd Naval District)
 —, Frank J. Czenkus, Inverness, California (12th Naval District)
 W3QP, Jack Morgan, Philadelphia, Pennsylvania (4th Naval District)

The remaining 371 participants on the Honor Roll follow. They are classified by Naval Districts and are listed under their respective districts in the order of rating. Where calls are connected by dashes, it indicates that those participants have equal ratings and are listed in a group, alphabetically:

First Naval District: W1QX W1DVJ W1APK W3CBF/W1OR W1DFQ W1AXS-W1ZI W1ATF W1BVR W1BOF W1BEU-W1EWP W1DGH W1FDS W1WV W1GHB W1EMR-W1HR. *Third Naval District:* W8ABX W1AVS W8DMJ W2FNG W2AUP W2BJX W8AOZ W8BGN W1DOV-W2DFU W2GAK W2BYO W2APO-W2DIJ W2FIS W2CBN W8HB W2EJK W2DBQ W8BAL-W8FU W2AIQ Harry E. Seales W2CUH W2AA W2EQL W3KA W2BII. *Fourth Naval District:* W3UT W8ETQ W3AR

W8KPG W8FKU W8EJG W3DRO W3ANZ W3DIA W3AKB W3QL W3BOP W3BPN W3CL W3CAP W3AKC W3AAV W3BGD W3CIM. *Fifth Naval District:* W3CTD W1ART/ZZAR W4GW W3BTJ-W3CYV W4BLT W3CDG W3AWS W8JM W3CJT Donald McClenon W4DW W4CGH W4AMK W4BRT. *Sixth Naval District:* W4DL-W4WQ W4AAR W4CFD W4AAV W4BBR W4CMA. *Seventh Naval District:* Joseph B. Kuehl W4HC Julian T. Webber W4APY W4AEM W4AKV W4HZ W4BSJ W4DZ W4CCC W4AGR Donald H. Reed W4OY W4BUR W4AZV. *Eighth Naval District:* W5TR W5RF W5IQ W5PF W5JA W5CT W5NO/W4UW W4AIL W4AAU W4CV W5ADH W4AII-W4ASV-James M. McCoy-W5AAD-W5ARZ W5DAL W5CY W2ERX/WYB W5BOE W5CVO. *Ninth Naval District:* W9BLG W9BIS-W9GHI-W9GSF-Clifford I. Melloch W9DXV-W9GGB-W9IPF E. J. Jacobson W9AHH-W9DGS-W9FNG W9KJE W9BCA-W9CER-W9CGP-W9GMQ-W9XK W9SO W9JDN-W9JSG-C. M. Howard-John V. Nyderek W9DFA-W9DUO-W9KC-W9PB W9DOE-W9FFD-Delmar Sage W8EBY W8DED W9FYX-W9JAF-W9LZ-R. J. McMahon/W9YB W9DI W8BDH W9EQV W9BFD-W9HKL W8AND-W8CMY-W9BNL-W9BXT-W9DAI-W9DEA-W9FBX-W9GFS-W9LNI-W9UZ W9HUX W9FCO W9AQL-J. R. Cadge W9IQZ W9OMW G. Lloyd Tucker W9FOQ W9DTK-Ray L. Martin W9EVQ W8HGF-W8SS-W9CCQ-W9IWJ W9FYB-W9FCQ W9PCC W9LEO W9DRM W9LGA W9EFH-W9EMN W9CZC W9LLD W9LGR W9HBK Marion R. Longworth W8DYS W8BAH-W9KQF W9FZX W9DGR W9AUH W8HS W9GEN W9IKE W9GJH W9NSX/W9HEZ W9DEB W9CWG W9COA W8CJZ W9AIR W9KDO W9ANB W9ZJZ W8KHY W9GPL Frank Gouednik W8BKM Anton J. Repesh W8DTF-W8KMT W9ENQ-W9JAR W8JUQ W9ANV-W9CWM-W9IEP-W9ANT W9ECE-W9GJU W8BGY/Babcock W9ETM-W9KJY W9IHO W8BTT-W9ACU-W9AON-W9LIV W9AET-W9RFW W9DAE-W9LHV-L. J. Larkin-John C. Mead W9DKL-W9HPP-W9HUV W9CTZ W9DJA W8UW-W9DNY W8AYO-W8NDM-W8EJ-Roy S. Skaggs-W9BHH W9EIV W9AFZ-W9IMI-H. A. Penhollow W8GTN-W9BCP W9AM-W9ILH-W9MXN-H. E. Wilcox W8CGP-W9LHQ-W9UU W9EDK-W9ESE-W9CJK W9IQW W8FYP-W9AND-W9LLV-Roy S. Herald W9MTO W8KC W8ASL Wilbur J. Tabor W9OSZ W9EWO W9DBO-W9FKI Bernard T. Wilkens W9AYO W9HNV W9JSO-W9KUT W8EDY W9FCF W9FKH W9LQW W9KMU W8GSP W9AIJ W9KCK Joe Selk W8IFQ W8BON. *Eleventh Naval District:* W6BP W6ERC W6EZL W6CBK W6FGT W6CBE W6FXL W5AAX-W6WQ-W6WV W6FJK W6BXV W6AHP-W6FTV-R. M. Hansen aboard S. S. *Nebraskan* W6GZU W6DBF

(Continued on page 46)

The 830-B—A New Tube for Class-B Service

DIFFERING from other triode tubes of the "50-watt" class in that it has been developed specifically for Class-B audio, the Sylvania 830-B particularly recognizes the special conditions met with in this work: the need of ample emission, adequate insulation, an approximately straight-line relation of plate current to grid voltage, and the somewhat contradictory requirements of moderate plate impedance and high voltage amplification constant. Like all other air-cooled Sylvania transmitting tubes it has a graphite anode.

Except for the plate connection on top, the tube is identical with the 830 in appearance. The base is of the usual medium 4-pin type, made of Isolantite. The plate lead is brought out at the

(Continued on page 79)

The four main windings are wound on 1-inch tubing $3\frac{1}{2}$ inches long, each winding separated $\frac{1}{4}$ -inch from the next. The tickler winding is in three sections. Between the two smallest tuning windings there is a tickler winding of 3 turns, 5 more between the second and third sections, and

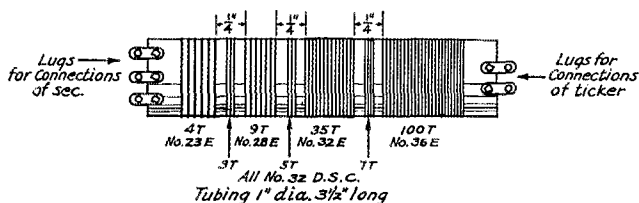

FIG. 2.

7 between the third and fourth, all ticklers being connected in series. Likewise the main coil windings are series-connected. The band selector switch picks out the proper inductance by adding up the various sections, and likewise cuts in the proper amount of tickler for each band.

There is one distinct difference in coil design as between the electron-coupled type of oscillator and the more conventional plate-tickler type. In the latter it would be possible to use one winding for the tickler, placed between the two smallest windings of the main coil, with possibly a few more turns between the last two sections in series with it. This tickler would make the oscillator work over all the bands, without switching the tickler. However, with electron-coupling the tickler is in the filament or cathode lead, and hence is common to the screen-grid and plate circuits. If this tickler is large the degeneration produced by this common coupling will overbalance the regeneration from magnetic coupling, and the tube will not oscillate. On the other hand, if the tickler is too small the tube will not oscillate at the lower frequencies. This consideration limits the range available with a variable electron-coupled oscillator, as there is a definite maximum over which the tickler cannot go if oscillation is to be maintained at the high frequency end; and there is a definite limit in frequency below which this amount of tickler will not keep the tube oscillating. Thus, in this particular circuit, the first band will oscillate only from 0 to 70 degrees, or from 12 to 26 meters. If more tickler is used it stops at 12 and goes above 26. On the other three bands the tube oscillates nicely over the whole scale, and, by making Band 2 take up at 25 meters, there is a continuous range from 12 to 550 meters.

It will be noted from the circuit that a three-section switch is necessary. One cuts in the proper secondary inductance, another cuts in the proper tickler, and the third is used to short the two larger sections of the secondary winding when the oscillator is on its two lower ranges. This

latter provision is to avoid "dead spots" due to the unused sections of the coil resonating at the higher frequencies and, because it is coupled fairly closely to the section in use, either detuning it or even stopping oscillation. The low end of the secondary is always grounded, preventing dead-end effects, but it is still possible to get resonance of the two large sections in series when one has much less inductance than the other; hence the need for this extra section of the switch.

This switch should be one of the type used in "all-wave" sets. Contact must be always positive, capacity to ground and between contacts a minimum, and the design preferably should be a self-cleaning one, where the contacts are scraped by the brush rather than merely wiped. Among the makes available are Soreng-Manegold, Best, Yaxley and Oak.

The unit is mounted in an all-metal container, aluminum or brass preferably, 10 inches long, 5 inches wide and 6 inches high. All the parts are mounted on the removable top, with the controls on it, too, so that the whole unit can be readily taken from the box. A large 4-inch dial is used. A knob controls the range desired, giving in turn 12 to 26 m., 24 to 75 m., 70 to 210 m., and 200 to 560 m. Another knob controls the output resistor. In addition, there is a switch which shorts the output terminals; by the use of this switch it is possible to obtain a very low output voltage.

In wiring up this outfit, care must be taken to get all the radio frequency leads from the coil to the switch and to the variable condenser as short as possible. Another point to remember is that, if the case is directly connected to the electric light line, it is possible to get a nice kick if one touches both the case and a ground wire. There are two ways to overcome this. One, as illustrated in the circuit of Fig. 1, is to insulate the variable condenser from the panel and return all leads from the coil and switch directly to the condenser, with a small fixed condenser of .005 μ f. connected to the case from this point. The other method is to ground the condenser by mounting it on the panel as normally, but to return the coil and switch leads to it through a fixed condenser of about $\frac{1}{10}$ μ f. The condenser must be that large, since it is in the tuned circuit. If a smaller size is used there may be some difficulty in producing oscillations at 12 meters. This latter method is OK with d.c., but will still give you a slight kick on a.c. The first method is preferable, but entails more mechanical work, as the shaft of the variable condenser must be coupled to an insulated shaft, to which the dial is fastened, to avoid radiation from the dial. If the user is careful

(Continued on page 48)



Amateur Radio STATIONS



W6ERT, San Pedro, Calif.

W6ERT is the property of Al Goodyear, 1917 S. Mesa St., San Pedro, Calif. The location is such that the station overlooks the Los Angeles Harbor.

The transmitter, at the left in the photograph, is crystal-controlled and has four stages, a '47 crystal oscillator, 10 doubler, 10 second buffer, and a final amplifier using a W.E. 242-A. Transmission-line coupling is used between the 10 driver and the final. Normal input to the 242-A is 250 watts on c.w. and 120 watts on 'phone.

Speech equipment includes a condenser mike with two 30's in the head amplifier, a 56 speech amplifier which works into a pair of 45's in push-pull, and a Class-B modulator using a pair of 10's.

Five plate supplies, the largest delivering 1500 volts from a pair of 866 rectifiers, take care of the plate power requirements of the transmitter. Bias is obtained from batteries on all stages except the crystal oscillator.

W6ERT's receiver is a single-signal superhet, used in conjunction with a doublet antenna.



An electron-coupled frequency meter is visible above the receiver in the photograph.

This station operates chiefly in the 7-mc. band, sixteen countries in all continents having been worked on either 7254 or 7094 kc.

W3MG, New Cumberland, Pa.

A FAMILIAR signal along the East Coast on 3.5-mc. c.w. is that of W3MG, owned by Paul S. LeVan, formerly of Carlisle, Pa., but now located at 318 N. 8th St., New Cumberland. The ever-popular rack-and-panel construction has been adopted for the transmitter, which is

crystal-controlled and works on 3.5, 7 and 14 mc. The frame is 6½ feet high and 20 inches square, containing seven shelves. Except for the lower-

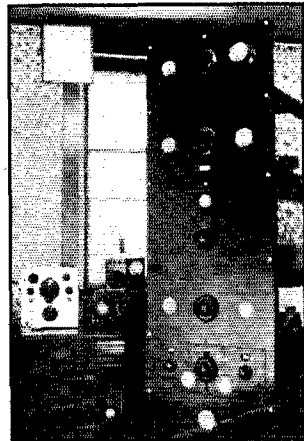

most shelf, which contains filament transformers and a trickle charger, the rack is used only for radio-frequency equipment, the power supplies being in a separate cabinet which does not appear in the photograph. The transmitter line-up is as follows: '47 crystal oscillator; '47 buffer-doubler; 20-meter doubler with a '47, a single-ended 203-A amplifier and a push-pull amplifier using a pair of 203-A's. Inductive coupling is used between all stages except the oscillator and first buffer, so that any of the following amplifiers may be connected to the antenna at will. Ordinarily the push-pull stage is used on 3.5 mc., and the single 203-A on 7 and 14 mc.

The transmitting antenna is a 40-meter Zepp with 45-foot feeders. For 80-meter work a 75-foot counterpoise replaces the dead-end feeder.

The receiver uses a 36 detector and 38 audio with "B"-battery plate supply. A harmonic monitor with a 37 tube is built in the same shield. To the right of the receiver are a dynatron frequency meter using a Type 32 tube and a field meter consisting of a fixed crystal detector and a 0-1 milliammeter. This gadget is also used as an audio level indicator in conjunction with an audio transformer, and has been calibrated in db.

A portable transmitter signing W3ZZAF is also used on occasion.

for the EXPERIMENTER



An Inexpensive Temperature-Control Oven

By C. T. Read, W9AA *

THE temperature-control oven shown in the accompanying photographs has been in use at W9AA for more than eight months and has proven satisfactory in every respect. The entire cost, excluding the crystal holders and the three-way switch, was under six dollars.

The outer case of the oven is a black crystal-line-finish metal tool box which can be purchased for about a dollar. Remove the leather handle and inner tool tray and line the box with three layers of half-inch insulating Masonite Presdwood or similar soft fibrous composition which can be secured from any good lumber dealer. Cut pieces of the lining to fit the bottom and sides snugly and force them into place. They will need no other fastening. Arrange the top pieces so they can be removed without too much trouble. After lining the box the metal tool tray can be cut with a hacksaw to fit in the bottom and make a base for the apparatus inside.

The thermostat and heater unit can be bought from any dealer in tropical fish and

* 711 E. 81st St., Chicago, Ill.

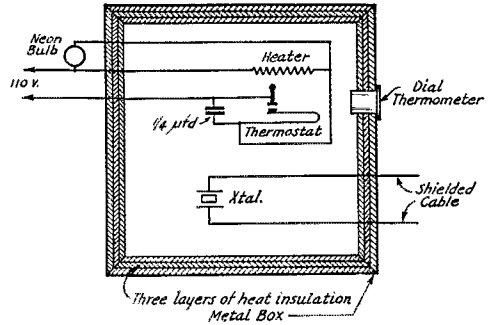
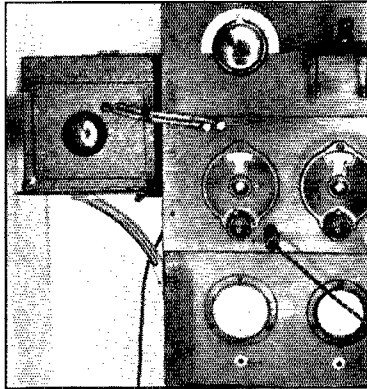

FIG. 1 — WIRING OF THE TEMPERATURE-CONTROL OVEN

The selector switch and additional crystals used by W9AA are not shown. The switch is desirable if more than one crystal is to be used.



THE CRYSTAL OVEN MOUNTED IN PLACE ON THE TRANSMITTER

The selector-switch knob and the crystal leads come through the front.

aquarium supplies. The heater unit is encased in a glass tube filled with sand and can be placed directly on the bottom of the tray. Remove the glass tube from the thermostat and mount it upright so that the adjusting screw can be reached by a screw driver through a small hole in the inner top insulation.

A cheap dial type thermometer can be mounted in a hole in the inner top insulating piece. The intermediate insulating piece should have a small hole cut over the thermometer dial and a hole should also be cut over the thermostat screw, so that in reading and adjusting the temperature it is only necessary to open the cover and lift out the top layer of insulation.

This oven contains three crystals mounted in standard plug-in holders, selected by a Yaxley two-pole three-position switch. The switch is mounted inside with an extension handle through the front of the oven. Leads to the switch and crystals are made of auto ignition cable, also run through the front.

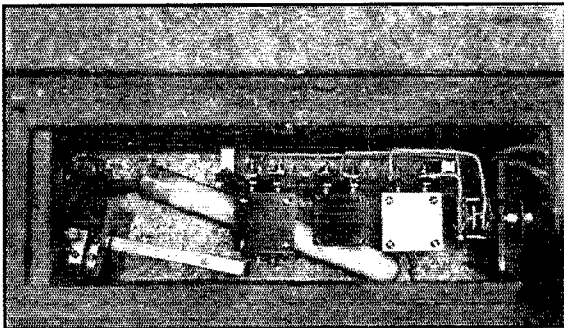

INTERIOR VIEW OF THE CRYSTAL OVEN.

Three crystals plug into a terminal strip connected with the selector switch at the right. The thermostat and heater element also are visible.

Be sure to include the $\frac{1}{4}$ - μ fd. (or larger) condenser shown in the diagram, Fig. 1, to prevent sparking at the contacts, or you will be unable to hear anything less than an R9 signal. A neon bulb connected across the heater is a convenience to show that the oven is working properly. A temperature of 100 degrees Fahrenheit can be maintained continuously and economically as the heater costs only a few cents per month to operate.

Voltage-Fed Antenna with Twisted-Pair Feeders

The antenna feed system of Fig. 2 is suggested by Thomas J. Campbell, W8IEH, for combining a voltage-fed antenna with the twisted-pair type of feeder so that the antenna can be worked on even harmonics, which cannot be done efficiently when the antenna is center-fed as described in July, 1933, *QST*. The method requires attaching a tank circuit, tuned to the transmitter frequency, to one end of the antenna. Although this may be inconvenient in a great many cases, since the antenna tank circuit has to be retuned

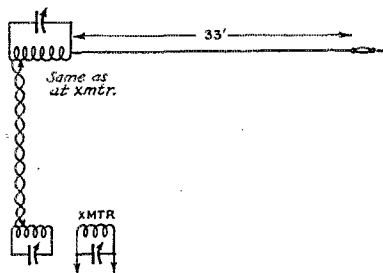

FIG. 2—TWISTED-PAIR TRANSMISSION LINE COUPLED TO A VOLTAGE-FED ANTENNA

The arrangement is useful when one end of the antenna is accessible but is not brought into the operating room itself. The twisted line may be any convenient length; when the system is properly adjusted the line losses will be small in lengths up to 100 feet or so.

each time the transmitter is shifted to a different band, nevertheless the idea can be applied with benefit when the operator is confronted by an antenna problem similar to that at W8IEH. In Campbell's case the construction of an outdoor antenna was not feasible, and the only location which offered reasonable clearance between the antenna and nearby power wires was the attic. Furthermore, it was undesirable to install the transmitter itself in the attic because of the temperature extremes characteristic of attics. Tuned feeders were considered impractical because part of the path they would have to follow in going from the transmitting room to the attic involved rather close association with water and heating pipes. The twisted-pair feeders are unobtrusive and require very little space.

Operating the system requires tuning the coupling tank circuit to the same frequency as the transmitter, adjusting the number of turns across which the feed line is connected, and making similar adjustments at the antenna tank

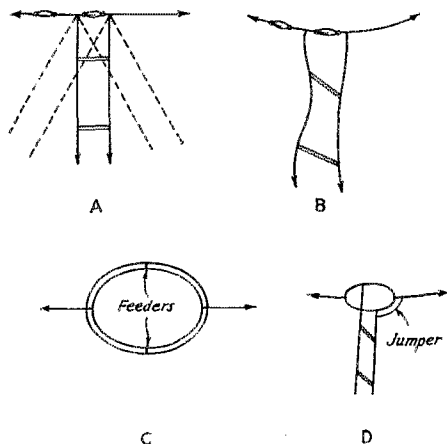

FIG. 3

circuit. W8IEH did all his tuning with only a neon lamp, the object of adjustment being to get maximum glow when the lamp was touched to the end of the antenna. The adjusting procedure can be simplified somewhat by omitting the coupling tank at the transmitter and connecting the feeders directly to the transmitter tank circuit through insulating condensers of about 0.002 μ fd.

The antenna should be cut for the lowest-frequency band on which operation is desired. The 33-foot antenna at W8IEH was all the attic length would permit, and the system is therefore best at 14 mc. and higher frequencies. It has been successfully operated on 7 mc., however, the antenna tank circuit acting as end loading to lower the frequency of the system.

Universal Joint for Zepp Antennas

The construction of a Zeppelin feeder system is, on paper, a perfectly simple matter. With a tightly stretched horizontal antenna and feeders suspended straight downwards, the antenna, the feeders and the spacers make a perfect aggregation of right angles, as may be seen from A of Fig. 3. The feeders do not need to run straight down; they can be displaced to either side of the antenna without disturbing the symmetry of the system. But even this ideal condition does not permit raking the feeders fore or aft along the antenna to the attitudes shown by the dotted line, in the endeavor to lead them into the shack.

In practice it is always a different matter. The antenna is never perfectly tight, the insulators

always sag and the general theory goes all to pot as shown in *B* of Fig. 3. There is one attitude in which the feeders can be put and kept evenly tight—if one can find it—but as every amateur knows from bitter experience the feeders are then invariably running in the wrong direction, frequently directly away from the waiting lead-

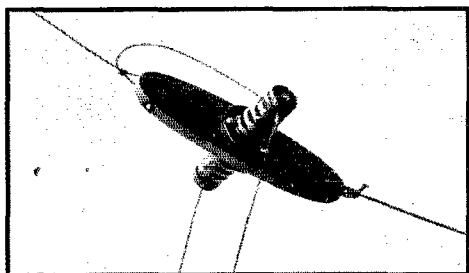

HOME-MADE UNIVERSAL JOINT FOR THE ZEPPELIN

in insulators. It takes a civil engineer and all his working tools to design such a rig so that the feeders may be under even tension and yet terminate at the desired point. And even then the result will change with the tension on the antenna.

Fed up with this sort of thing, I bethought me of the arrangement shown in Fig. 3-C. It is in effect a species of universal joint for Zepp feeders. What we need is an elliptical ring insulator, the width of the ellipse dictated by the desired separation between feeders, its length sufficient to provide adequate insulation. Antenna and halyard would connect to the "ends," the feeders to the "sides," with a jumper from one side to the antenna. With such an arrangement the antenna may terminate wherever it need be and the feeders may be brought to wherever they have to go, yet remaining evenly taut. By reference to *D* of Fig. 3 it is plain that if the feeders are placed thus side by side they may be displaced fore or aft to any desired degree. They may similarly be displaced to either side, the entire elliptical ring assuming a slight rotation, simply by twisting the antenna wire a few degrees. Any desired combination of the two movements is possible. You don't worry about it—you just stretch the feeders from here to there and the gadget does it.

No such device is commercially available. I hereby present the idea to Mr. Pyrex and Mr. Isolantite. I like my feeders about 5 inches apart and so would suggest dimensions of 5 inches by 10 inches by no greater cross-section than necessary. Others may want greater dimensions. Corrugations might help, particularly grooves for the four wires.

Meanwhile I have made me one, along a different pattern. It does not have the long leakage path between feeders but it works. The photo-

graph shows the construction. A piece of half-inch hard maple thoroughly boiled in paraffin acts as the antenna insulator and carries two G.R. stand-off insulators which support the feeders. The feeders are twisted around the neck of the insulators. The planes of movement are the same as for the ellipse.

—K. B. Warner, W1EH

The M.I.T. 56-Mc. Airplane Tests

(Continued from page 21)

wretched flying weather. Running the plane "blind" in heavy fog, attending to his meteorological instruments, manipulating several 56-mc. transmitters and a "beacon" receiver appeared to be more child's play to Harris.

No unusual DX was accomplished during the test, no records were broken. The work, however, provided the most convincing proof possible of the practicability, reliability and extreme usefulness of simple 56-mc. equipment for communication between plane and ground over distances up to about 100 miles under routine conditions. It provided, in addition, a healthy wad of reports and measurements of signal strength vs. altitude—to be given close study. A total of 108 different First District stations were contacted in several hundred QSO's. We present the complete list: AAL ACC ACH AEF AFC AFF AGH AGX AKE AKS AL ALY AND ANY AOH APQ AQW ATD AWA BBA BEF BEU BGA BGK BPH BQ BX CCX CDY CE CEA CFD CJF CK CLA COO CSR CU CVI CVK DBE DEH DEK DKM DOO DOX DPP DPW DRI DSY DXK EAE EAQ EAU EEW EHC EHZ EIL EKN ELP ELT EPH ERA ESJ EUZ EXT EY EZA FCU FFH FGA FHY FIK FJW FPR FPX FSK FSO FTB FWW GFW GHB HGJ HDQ HGR HHU HJ HMA RMQ HOH HOM HQM HSF IS HQW HTO NW RQ SE SL TY UI VIP VT VW VX XW ZW .

Professor Rossby and Dr. Carl O. Lange of M.I.T. have our sincere thanks for making the tests possible. Lieutenant Harris has the credit for all the work done. Also deserving of mention is Herbert Wetmore, W1EXT, whose report of the tests was the finest thing of the kind we've seen in years—including, as it did, a complete and carefully drawn curve of signal strength vs. altitude for every single flight.

—R. A. H.

Navy Day

(Continued from page 39)

W6IAH W6FBE W6ALU-W6BSV W6ALR W6DTS-W6JRZ W6CVV K6DSF Mrs. E. H. Burgman/W5AAX. *Twelfth Naval District:* E. G. Roberts, Jr. W6CIQ W6GQC W9LZA W9CDE W6ABB-W9GJQ W6AJP W6IY W6GQM W6NM W6SM W6DEM W6GQR W6FCX Chas. J. Piccone W6BNQ. *Thirteenth Naval District:* W7BBZ W7LD W7CNC W7BVJ-W7CAB-W7DLN W7BWD W7ANX-W7CYW-W7WY W7ALE-W7BWK W7TK W7NO W7ATN W7BMX W7DWQ W7AFC.



CALLS HEARD



J1FP, Masaharu Okochi, 17 Shimizu-Cho Yanaka, Shitaya, Tokyo, Japan

(7-mc. band)
wlch w2dod w2drj w2mr w5aax w5atf w5adz w5auc w5aui
w5chn w5ctw w5p1 w5ty w8fpu w8lx w9gmx ear228 ear108
f8xl lu1ab lu4dj lu4dd lu5bl lu8ba lu8en lu9ax nylab
ti2re vifl x1aa x1am x120 py2ak

W9GBP, Ronald Pickett, 511 N. 14th St., Manhattan, Kansas

(3.5-mc. band)
z12fa z13fj vk2wa vk4ju k7czm k6vg
(3.9-mc. 'phones)

x1g z14gs

K5AC, Fred T. Willett, Radio School, Corozal, Canal Zone

(3.9-mc. 'phone stations)
wlid w3is w4aad w4aaq w4ls w4qs
(3.5-mc. band)
wladr wlasu wlemf wifoj w1fub wiglo w3bya w3zx w4rf
w5bmi w8eoh w8fz w8iug w9fuh

J1FF, M. Oshima, 19 Nihon-Enoki, Kanagawa, Yokohama, Japan

(7000-ke. band)
wlmk wldau wizz w3cbk w5bzt w5cen w5ms w8bti w8jgx
w9cml w9mnx w9clq w9do w9hwf oh2pp sp3dq cn8mh zslc

Donald W. Morgan, 15 Grange Rd., Kenton, Middlesex, England

(14-mc. 'phone stations)
k4sa ve2ax ve2bg w1cab w1chi w1def w1uh w9bht

OK1AW, Al. Weirauch, Mestec Kralové, 9, Czechoslovakia

(7-mc. band)
j5zn vs6aq z55x z12cv z12jc z13fg z13fl z13bj z14ai z14ao
(14-mc. band)
j1ec j5cc lu1ch lu2fc cx1cg cx1az pk5aq py2qa vk2hw
vk2nr vk4bb vk4el vk4gk w6cuh w6dio w6grl w6jbe zd2c
zs4m zs5a zslh zsla

G6YL, Miss B. Dunn, Felton, Northumberland, England

(14-mc. band)
w6bvc w6cuh w6dio w6gat w6gdj w6grl w6grx w6qd
pk1bo pk4bo py4ac

Vic Bortow and George Nye, aboard S.S. Minnegoa

(Heard between Finland and Norway)
(1715-ke. band)
w1bfw w2fkj w2cew w2bjj w2akx w2ald w4atl
(3500-ke. band)
w1yu w1bap w1bij w1bxs w1ced w1lco w2vm w2wp w2bss
w2cdr w2ekv w2cvc w2eko w2emm w3brz w5bgb w7awh
w8af w8azt w8eca w8fla ve3ih ve3jz
(7000-ke. band)
k7bnv w6ccy w6ccd

G6ZU, R. H. Jackson, 54 Princess St., Stockport, England

ve4mr ve5eh w6grl w7px w7vy

W6CUH, Chas. Perrine and W6QD, Herb. Decker, Manhattan Beach, Calif.

(Heard since July 1, 1933)
(14-mc. band)
on4au on4fe on4bs f8pz f8hr f8fe f8eo g6vp g5bj g5vb g5qa
oh3na pa0xf pa0ll d4bar okiaw oklax g6wy g5by g5yh
g5hb vu2lj

(7-mc. band)
zs2a zs6b zs4m zs5a zs4t zs6af zs2f zs5f zs6ah zt2l
zt6d zt1f zt5w ztir zt5r zt5v zt2h zt5z zt5e zt2e zt6x zt1x
zt1t zulp zu5g zu5n zu5y zulx zeljf zeljh zeljn zeda cr7ad
vu2ls

K8BAZ, Kenneth L. King, 1317 S. Beretania St., Honolulu, T. H.

(1750-ke. 'phone)
w6abf
(3900-ke. 'phones)
w1bes w2tp w2go w3art w3blz k7aac z12af
(3500-ke. 'phones)
vk2ns vk7ck z11bq z12be z12pd z13af
(7000-ke. 'phones)
j1do vk2js
(14,000-ke. 'phones)
oa1b x1g vk2lz w1ccz w21p ve3wa j1eg

ZL2HR, Arthur Stevens, 75 Wilson St., Hawera, New Zealand

(Phone and c.w. stations on 3500-4000-ke. band)
x1ai x1g k6cig k6baz k6vg k6acw k6cib k7pq k7pb k7aal
k7aoc k7ahk k7acz k6az ve1bc ve1bc ve1bo ve2bg ve2dx
ve3nx ve4ip ve4cn ve5er ve9al ve1oby w1asy w1abz w1aj
w1ad w1axa w1al w1az w1aud w1bbo w1bri w1bvg w1zaz
w1bep w1bes w1bu w1ebt w1bz w1egt w1efu w1efi w1eof w1erx
w1id w1mk w1ns w1uz w2afv w2alo w2bnx w2bly w2egf
w2eth w2fst w2go w2hy w2il w2lf w2ls w2oj w2ul w3aqi
w3aty w3auy w3bms w3bdl w3bre w3ckd w3cbq w3cj
w3ems w3tn w3un w4aja w4adx w4acz w4aad w4bti w4bam
w4bgf w4bbt w4cek w4cw w4eva w4fl w4ll w4pr w4pw
w4rs w4tc w4vl w5bds w5bel w5bci w5cwc w5ckp w5chx
w5cmu w5eds w5ddl w5hr w5ix w5mn w5px w5qa w5yh
w6aht w6azc w6abs w6acq w6akw w6aer w6axq w6azm
w6acm w6axe w6am w6adj w6abb w6abf w6art w6bon
w6boh w6bxi w6bry w6byf w6bha w6bdd w6bnh w6bsv
w6bwo w6bvs w6bkf w6bvr w6cwu w6cab w6ciz w6cwo
w6cuj w6coj w6cxh w6cxz w6oqm w6cbf w6can w6dda
w6diq w6da w6dgi w6dio w6dit w6dzn w6dzt w6dyj w6dng
w6dte w6dxv w6dyg w6dyq w6ddo w6den w6evd w6exh
w6exb w6etm w6evl w6ehl w6eyo w6era w6egq w6eml
w6eqj w6ezy w6fdn w6fdo w6fex w6fyf w6fii w6fju w6fjh
w6fbh w6fey w6fdq w6fw w6fom w6fkm w6gsn w6gwt
w6gnp w6gwo w6gdf w6hex w6hfc w6ho w6hm w6hah
w6iwc w6iqo w6irs w6jgj w6jdr w6ky w6ni w6nt w6qr
w6rf w6ts w6te w6yl w6zg w6zs w7awh w7aiu w7aau
w7alp w7ezy w7auq w7ao w7acy w7ais w7aru w7arm
w7avm w7afs w7axq w7aus w7aqx w7atz w7buf w7ber
w7bjz w7bud w7bsn w7bon w7bni w7bfl w7beq w6buf
(Continued on page 70)

• I. A. R. U. NEWS •

Devoted to the interests and activities of the

INTERNATIONAL AMATEUR RADIO UNION

President: H. P. MAXIM

Vice-President: C. H. STEWART

Secretary: K. B. WARNER

Headquarters Society: THE AMERICAN RADIO RELAY LEAGUE, West Hartford, Conn.

MEMBER SOCIETIES

American Radio Relay League
Associazione Radiotecnica Italiana
Canadian Section, A.R.R.L.
Ceskoslovenski Amatér Vysilaci
Deutscher Amateur Sende-und-Empfangs
Dienst
Experimenterende Danske Radioamatører
Liga Mexicana de Radio Experimentadores

Nederlandsche Vereeniging voor Internationaal Radioamateurisme
Nederlandsch-Indische Vereeniging Voor Internationaal Radioamateurisme
New Zealand Association of Radio Transmitters
Norsk Radio Relæ Liga
Polski Zwiasek Krotkofalowcow
Radio Society of Great Britain
Rede dos Emissores Portugueses

Reseau Belge
Reseau Emetteurs Français
South African Radio Relay League
Suomen Radioamatööriyhdistys
Sveriges Sandareamatörer
Unión de Radioemisores Españoles
Union Schweiz Kurzwellen Amateur
Wireless Institute of Australia
Wireless Society of Ireland

Conducted by Clinton B. DeSoto

Current:

Austrian amateurs have formed their own organization, under the leadership of Willy Blaschek, UO3WB. The new society is called the *Oesterreichischer Versuchssenderverband*, with headquarters, apparently, at Bahngasse 29, Klosterneuburg, Austria. QSL cards can be sent to this address. The first issue of the O.V.S.V.'s official organ, dated January, is a mimeographed bulletin of 12 pages. It is titled *OEM*, edited by Carl Martin, OU1CM.

I. Niculescu, CV5EV, recently had the thrill of talking with royalty, when he worked H.I.H. the Archduke Anton de Habsburg, who was operating from his 'plane with the call letters YPAAI. The contact was particularly fortunate, in that it may lead to the formation of a strong Roumanian amateur organization under high patronage.

W. E. Lane, VQ4CRH, is now issuing monthly B.E.R.U. Zone Circulars from Nairobi for those amateurs in Dark Africa who at present have no society affiliations. *QSO*, official organ of the I.A.R.A.C., which suspended publication with the May-June, 1933 issue, now has a successor in the *QSO Monthly Letter* issued by I. Poliakoff, secretary, the first letter being dated Shanghai, Oct. 23rd.

The ranks of the WAC-on-'phoner's are slowly being augmented. On Sept. 6th the special 'phone certificate was issued to J. S. Owner, G6XQ. On Oct. 31st Jacques Mahieu, ON4AU, claimed his certificate. Finally, on Dec. 15th, Fumion Horiguchi, J5CC, was issued the first Asiatic 'phone WAC. The input to J5CC's final amplifier, by the way, did not exceed 25 watts.

The R.S.G.B.'s new handbook is enjoying a remarkable sale, several thousand copies having been distributed. Special rates are obtainable

by overseas organizations which may desire them for distribution. Write the R.S.G.B., 53 Victoria St., London, S.W. 1.

Lots of 10-meter interest in Japan these days. Several Japanese stations are on each Sunday from 0100 to 0200 G.T., CQing for five minutes, and then listening. K. Kasahara, J1EZ, is using crystal control with 35 watts input to the final, he writes Ed. Hayes, W6BC. He has been reported in Australia on this band. The technical laboratory of Japan's broadcasting system is transmitting 'phone on 37.5 mc. with 200 watts every day except Sunday at 0200-0300 and 0700-0800 G.T. The antenna is a half-wave Zepp on an iron tower 40 meters high. Best DX thus far is 1000 km. on a two-tube super-regenerative receiver. All QSL's through the J.A.R.L., Box F-77, Tokyo.

Expedition radio is achieving increasing importance in Australia. Of recent months numerous commercial and explorative expeditions have penetrated central Australia carrying radio equipment with which to work amateurs. The situation is complicated by the fact that Australian amateurs are not permitted to handle traffic, but nonetheless some excellent work has been done.

A 56-mc. relay chain is being organized between all the principal towns of Holland, according to W. Metzlaar, PAOMM, traffic manager of the N.V.I.R. Use of this band for all local communications is being strenuously encouraged, to alleviate the crowded condition existing throughout Europe on the lower frequency bands.

East coast W stations wanting to QSO Japan take note: J1EE has been coming through regularly on 7002 kc. (end of December) at 1300 G.T., numerous stations, especially 4's, working

him. This is in line with the excellent reception hereabouts of KA1NA on his Sunday morning 1100 skeds. Incidentally, WIZI now transmits traffic blind to KA1NA on 2200, Saturdays, because his signals are much better there at that time. QRM is too heavy then for him to get Redgrave, so 'NA QSL's the following morning.



THE D.A.S.D.'S EXHIBIT AT THE GERMAN NATIONAL RADIO EXHIBITION, 1933

Five o'clock seems to be the magic hour for that region on 7 mc., whether a.m. or p.m. W4FT QSO'd KA1NA at 5 p.m. for first East Coast contact.

QSL:

The annual listing of QSL bureaus incorporates a considerable number of changes this year. Undoubtedly, further corrections and changes will appear after publication of this list, and these will be given in this department as soon as they are known. Cards for countries not listed can be sent to the A.R.R.L., West Hartford, Conn., U. S. A. Delivery obviously cannot be assured, but every effort will be made.

- Argentine:** Radio Club del Argentina, Rividavia 2170, Buenos Aires.
Australia: W.I.A., Box 284d, G.P.O., Adelaide, S. A.
Austria: O.V.S.V., Willy Blaschek, Bahngasse 29, Klosterneuberg.
Belgium: Reseau Belge, 33 rue Alphonse Renard XL, Brussels.
Brazil: L.A.B.R.E., Rua Annita Garibaldi, 7-6°, Caixa Postal 26, São Paulo.
British West Indies: Ian C. Morgan, "Southlands," Warwick East, Bermuda.
Canada: A.R.R.L., West Hartford, Conn., U. S. A.
Ceylon: A. M. Rahim, "Rillington," Wellawatte, Colombo.
Chile: Luis M. Desmaris, Casilla 761, Santiago de Chile.
China: I.A.R.A.C., Box 685, Shanghai.
Cuba: Pedro Madiedo, calle Santa Rosa, Buen Retiro, Mariano, Habana.
Czechoslovakia: C.A.V., Post Box 69, Praha II.
Denmark: E.D.R., Postbox 79, Copenhagen K.
Dominican Republic: Bull Insular Line, San Domingo City.
Dutch East Indies: N.I.V.I.R.A., J. M. van Heusden Ir., Burg., Coopweg 28, Bandoeng.
England: R.S.G.B., 52 Victoria St., London, S.W. 1.
Estonia: V. Suigussaar, Hobe t. 4, Parnau.
Finland: S.R.A.L., Pohjola, Box 42, Helsinki.
France: R.E.F., 17 Rue Mayet, Paris 6°.
Germany: D.A.S.D., Blumenthalstrasse 19, Berlin W. 57.
Guam: Foster D. Brunton, Box 45, Agana.

- Haiti:** Signal Co. 1st Brigade U. S. Marine Corps, c/o U. S. Naval Radio Station NSC, Port-au-Prince.
Hong Kong: H.A.R.T.S., Box 651.
Hungary: M.R.A.E., I Zirken Janka, Utea 14/B, Budapest.
India: R. N. Fox, c/o Messrs. Lyons (India) Ltc., 11 British Indian St., Calcutta.
Iraq: L.A.C. Hamblin, Y16HT, Wireless Section R.A.F., Shaibah, Basra.
Irish Free State: R. V. Sadleir, Esq., Lonsdale, Roebuck, Clonskeagh, Dublin.

(Cards for Northern Ireland go to R.S.G.B., England.)

- Italy:** A.R.I., Viale Bianca Maria 24, Milan.
Jamaica: Cyril M. Lyons, 2-B North St., Kingston.
Japan: J.A.R.L., Box F-77, Tokyo.
Java: Th. F. Leyzers (vis), Van Heutz Boulevard 2, Batavia, Centuz.
Jugoslavia: Stephen Liebermann, Meduluceva 9, Zagreb.
Kenya: George F. K. Ball, Box 721, Nairobi.
Latvia: A. Karklin, 2 Lenca dz. 8, Riga.
Lithuania: L.R.M., Post Box 100, Kaunas.
Luxembourg: J. Wolf, 67 Avenue du Bois.
Malaya: Thos. G. Laver, Supt. Gov't Electrical Power Station, Johore Bharu, Johore.
Mexico: L.M.R.E., Sinaloa 33, Mexico City.
Morocco: R.E.F., 17 rue Mayet, Paris 6°, France.
Netherlands: N.V.I.R., Post Box 400, Rotterdam.
New Zealand: N.Z.A.R.T., P. O. Box 517, Dunedin.
Norway: N.R.R.L., P. O. Box 2253, Oslo.
Palestine: K.S.J. Rancombe, Rafi Rambleh.
Peru: Radio Club Peruano, Apartado 538, Lima.
Poland: P.Z.K., Bielowskiego 6, Lwow.
Porto Rico: Francis M. McCown, Family Court No. 7, Santurce.
Portugal: R.E.P., 93 Rua Senhora da Floria, Lisboa.
Roumania: Lt. C. Bratescu, Str. Ciru Ilescu 6, Bucarest 6.
Salvador: J. Frederico Mejia, 7a Calle Poniente 76, San Salvador City.
South Africa: S.A.R.R.L., P. O. Box 7028, Johannesburg.
Spain: U.R.E., Apartado 262, Madrid.
Sweden: S.S.A.-QSL, Stockholm 8.
Switzerland: U.S.K.A.A., Postfach, Zurich 22.
Uruguay: Montevideo Radio Club, Palacio Salvo 4-Piso, Montevideo.
U.S.S.R.: S.K.W., Ipatievsky per 14, Varvarka, Moscow.

A Stable General Purpose Test Oscillator

(Continued from page 41)

not to touch a ground and the case at the same time, these precautions are not necessary; but they are strongly recommended. One can't always remember.

If proper precautions are taken in the building of this oscillator the user will have an instrument which will be of a great many uses, both in amateur and service work; and by slight variations in the above design any particular amateur need can readily be met.

PARTS REQUIRED

- 1 Case and panel (panel 5 by 10 inches, case 6 inches deep).
 1 Type 32 tube.
 1 4-prong socket.
 1 250- μ fd. variable condenser.
 2 0.1- μ fd. tubular condensers.
 1 200- μ fd. mica condenser.
 1 0.005- μ fd. mica condenser.
 1 1900-ohm 5-watt resistor.
 1 100-ohm potentiometer with line switch.
 1 20,000-ohm 1/2-watt carbon resistor.
 1 3-section 4-position short-wave switch.
 3 1- or 2-mh. chokes.
 1 Line cord and plug.
 2 Binding posts.
 1 Vernier 4-inch dial.
 1 Coil assembly (See text and diagram).
 1 On-off switch for low output.

THE COMMUNICATIONS DEPARTMENT



F. E. Handy, Communications Manager
E. L. Battey, Assistant Communications Manager



Improving Traffic Handling and Speed

By Harold H. Kurth, W9FSS*

MORSE and radio operators handle large amounts of traffic in a much shorter time than the average amateur does. I have tried to acquire some of the little habits or "tricks" they employ. These do much to speed up amateur work. We should use some of the discoveries that these commercial operators have made to further our hobby, in our particular line, traffic handling, and increase our general operating proficiency.

First of all, try to copy a few words behind. By doing this you save correcting and erasing mistakes which the sending operator may make. It is also less nerve-racking than copying "right on top" of the other fellow. Copying behind is a habit that must be practiced to become proficient. It is well worth the time and trouble.

Another little trick that most commercial operators can do is to write the filing data (station to which sent, time, date, and "oprs sine") on the message just sent or received with the left hand while sending the next message with the right hand. First attempts at this produce weird results. Time and practice will enable you to cultivate this ability. The increased efficiency and pleasure resulting are well worth the effort of learning to write with the left hand.

Many operators decline to use a typewriter for traffic work because they think they cannot copy fast enough or think they will become confused when using it. However, three or four weeks of study at home will produce speeds of 25 to 30 w.p.m., when using the touch system. There is no excuse for using the "hunt and peck" or two-finger method, since the touch system can be learned as easily and is a better foundation for increased speed. After the operator is able to copy 25 or abouts he will begin to experience the "kick" that copying on a typewriter produces. He will find that he is able to copy 30 per easier than he could 20 with a pencil.

It is good wire practice to send a comma after the name, and address too, in the heading of a message. The receiving operator does not write this comma down, but when he hears it he knows he is to drop down one space on his typewriter. Most amateurs do not give any indication of this. I therefore propose that the Morse comma, A.A. be used in all amateur traffic handling. In this way the name, address and city can be placed one under the other in a neat orderly fashion instead of all on the same line.

Some amateurs who do not copy traffic on the typewriter do not attempt to cooperate with the man using a "mill" even when they know he uses it. Granting that the group using typewriters, appreciating the convenience and neatness, do not care to give up the use of this machine, then it is up to them to improve their receiving habits to be able to copy on a typewriter under almost all conditions from almost any traffic man. This can be done; it is my aim to show how it can.

It is wise to use double spacing on the typewriter when

copying messages so that in case a mistake is made, an insertion can be made between lines.

Commercial operators do not include operators' signs ("Hr msg fm," "Nr," "to," "A.A," "BT," "Sig") on the typewritten copy. They are sent only for the information of the receiving operator and have no significance to the addressee. The message form I use is abbreviated standard practice: "Hr Milwaukee Wis. W9FSS 555 Dec 12 John Blank A.A 444 E 4 ST A.A St John Wis BT (text) BT Mrs Doe A.R." I have found this the most effective of several different forms.

Many operators when copying on a typewriter have to spend much time in putting a new blank in the typewriter for each new message. Time can be saved here by having two or three blanks laying behind the rubber roller and placed so that when one message is about completed the next blank is right in place. A little practice will soon show the theory of this. Use of the procedure signs and operators abbreviations as given in *QST* and the Handbook is a great advantage.

A separate table for the typewriter or a thick rubber mat under both the "mill" and receiver will absorb the jar of the keys. If the operator likes to construct, a typewriter "well" can be built in about the center of the front edge of the table so that the typewriter will be lower than the rest of the table and so that the keys of the "mill" will come on a parallel to the elbows of one's arms. This is the best position conducive to typing speed. A new machine without a shift, all capital letters, and with a standard keyboard is now on the market.

My sincere belief is that we amateurs should always strive to increase our abilities and to become better operators. If we would study certain methods we might become a better class of communication men and of more service to mankind. The unemployed ham can use his time to advantage if he studies his operating and strives to improve it in every way possible.

The contributions by Mr. H. H. Kurth, W9FSS and Mr. Thomas B. Hedges, W8BKE, won the C.D. article contest prizes for this month. Your articles on any and all phases of amateur communication activity are likewise solicited, and may win you a bound Handbook, or equivalent credit applied toward League emblems, log books or other A.R.R.L. supplies. See announcement March, 1933, *QST* (page 56)—F. E. H.

On Learning the Code

By Thomas B. Hedges, W8BKE*

IT'S about this time of the year that everyone gets the radio bug. Lots and lots of would-be hams get that peculiar hankering to start toward an amateur license, but now the same as ever, their first big worry is the code exam. Everyone who knows the code admits that it is very easy. It really only takes a few weeks of concentrated study to master it but just like learning lots of other things the first few steps are by far the hardest.

*SCM Wisconsin, 2550 N. 8th St., Milwaukee, Wis.

*128 N. Pickaway St., Circleville, Ohio.

Every winter there are plenty of 160-meter fone men who render a very valuable service by sending code lessons and countless hams owe their ability to pass the "ten per" to the work of these fellows. The really hard part about learning the code is to master the memorizing of the alphabet and then work up the first few words per minute. It only

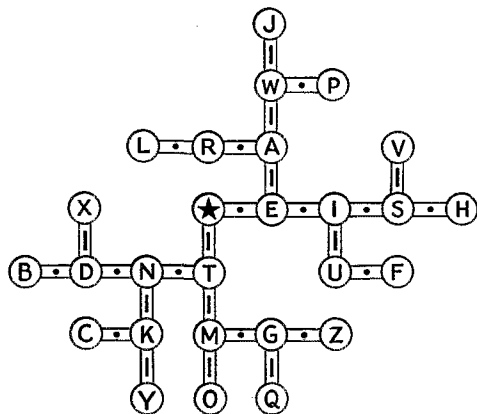

Starting Point for all characters.
All horizontal movements denote one dot.
All vertical movements denote one dash.

takes time, concentration and practice to gather speed after the code has once been memorized. Until each character is indelibly impressed on the student's mind little headway has been made.

After trying for over a year, in a slipshod manner, to learn the code I was about ready to give it all up when I happened to run across a system devised by an old operator who evidently knew beginners' troubles very well. By means of a simple diagram I was able to memorize in a few hours that which I had spent months on before without success. The beginner need only draw this diagram and fill in the letters a few times until he can do it subconsciously and has a mental picture of the relation of the letters to each other.

In the diagram all characters are indicated by starting at the starting point. All horizontal movements from the starting point denote one dot and all vertical movements denote a dash. After the position of all the letters is firmly impressed on the student's mind he can actually follow transmission up to a few words a minute by mentally referring back to the diagram. As speed is gradually worked up the student will tend to write the letters automatically and all of a sudden he will wonder how he learned the code so quickly. I know from my own experience that if the student will take the time to draw the diagram a few times and fill in all the letters it will only be a short while until the hardest step about mastering the code has been accomplished.

Traffic Briefs

RADIO OPERATOR EXAMS

Examinations for all classes of radio operator licenses will be held on February 3rd at Winston-Salem, North Carolina, in the Civil Service Room, Federal Building. The examination will be held in two sessions beginning at 1:00 p.m. and 7:00 p.m. All applicants for Amateur Class A, Commercial and Radiotelephone examinations must appear at 1:00 p.m.

Amateur radio station W4CI will be in operation at the fair grounds, Tampa, Florida, during the period of the South Florida Fair, January 30th to February 10th, inclusive. The majority of the 58 amateurs of the city will take part in the erection and operation of W4CI. Those

who will do most of the operating will be W4AJX, W4BNR, W4AKJ, W4TZ W4CDX and W4ALP. W4CI will be in operation daily from 8:00 a.m. until midnight E.S.T. on the 7- and 3.5-mc. bands. All amateurs are requested to cooperate in the efficient handling of all traffic originating at W4CI.

WCFZ

A. D. Mayo, Jr., ex-NU5DF, is radio operator on the 84-foot schooner yacht *The Buccaneer*, WCFZ, scheduled to sail from New Orleans January 1st for a seven months' cruise to Mexico, South and Central America and the many islands in the South Atlantic. *The Buccaneer* will carry a group of eleven young men and seven leaders. WCFZ uses a 30-watt rig crystal controlled on 6170, 6210, 8280, 8290, 11025 and 11040-kes. Communication with as many amateurs as possible is desired, and WCFZ will be on the look-out for 7-mc. amateurs each night, using 8280 kes. for calling, and 8290 kes. for working. Please report any work with WCFZ to A.R.R.L.

At 12:30 a.m. January 1, 1934, W6FFP, made his 230th QSO with ZL1AR.

On December 31st W8JK worked JIEE, and on January 1st he worked J1DO, both QSOs on 7 mc. That alone would be most DX hounds' idea of ending and starting a year right. But W8JK went further and worked all continents on January 1st and 2nd! "All of which," says W8JK, "brings to mind that Wacker Drive, Chicago, ought to be a good place for the 6-continent hams to live. Hi."

ONACSL, Carroll Stegall in Lubondai, Belgian Congo, is desirous of scheduling a W4 in Tennessee or North Carolina. He is on nearly every day from 2 to 4 p.m. E.S.T. on about 14130 kes. This information comes from W8JK.

Effective January 1st several of the "Q" signals took on a new meaning. Several of the changes were mentioned on page 55, December QST. In addition, QRH? (previously meaning, "What is your exact wavelength . . . ?") now becomes, "Does my frequency vary?" and the reply, "Your frequency varies."

The "Emergency Equipment Route Manager" for Michigan, Mr. O. B. Slocum, W8JO, is organizing the amateurs of Michigan into a special emergency organization for Forest Fire Suppression Work under the Michigan State Conservation Dept., in which he is acting head of the Forest Fire Radio Project. A questionnaire has been made up and from information obtained he plans to form an emergency net. The Red Cross, National Guard, State Organizations, Police and other Civil authorities will be served in case of a Michigan emergency.

The following stations were active in the Milwaukee Radio Amateurs' Club December 10th 28-mc tests: W9ANA, BVR, BYE, DIJ, EIH, ESE, EYH, GHN, GIL, GVL, IH, ITZ, LAD, LFK, LRB, NKP, NPS, NSC and NY. 28 mc. DX heard in Milwaukee on Dec. 10th included: W2AFT, W4CLC, W6BXV, W6CAL, W6CVZ, W6ENV, W6IDF, W6VQ. W9NY worked W6CAL and W6VQ. W9IH worked W6CAL. W9EIH worked W6VQ. W9GHN and W9NY made fourteen local 28 mc. QSOs each. West coast 28 mc. signals were heard between 2 and 3:45 p.m. C.S.T. with sky overcast.

The TEN-METER GANG is reminded that special announcements and results of 28-mc. tests are sent to the gang via W1MK on Thursday and Friday nights following the "QST" (3825 & 7015-kes. on Thurs., 3825 & 7150-kes. on Fri.) at 7:30 p.m. and 11:00 p.m. C.S.T. Thursday, and at 7:30 p.m. and 9:30 p.m. C.S.T. Friday. Send in any 28 mc. dope to A.R.R.L. for these transmissions.

Mr. Robert B. Parmenter, formerly "RP" of W1MK, is now located at Louisville, Kentucky, where he operates

at WHAS . . . but don't let that make you conclude he has lost the itch for pounding brass at a ham station. His new ham call is W9PLM, and for a while before he got that he kept up ham contacts through W9OX (SCM Plumm's station). Headquarters' loss of a good operator will be Kentucky's gain.

What is believed to be the first KA-W1 QSO was established by W1ZI and KA1NA at 2209 GCT December 30. A second contact was made at 1130 GCT December 31, at which time KA1NA was QSA4 R4 for over half an hour. KA1NA has been heard regularly at W1ZI on Sunday morning tests. This was all accomplished on the 7 mc. band.

Through the cooperation of the University of Virginia Radio Club, W3UVA, Pres., and W3BKC, Baltimore, a "chess match by radio" was held by the University Chess Team and the Johns Hopkins University Chess Team (Baltimore, Md.). On November 19, W3BSY, University, Va., contacted W3BKC and a trial match was conducted. Final arrangements were made as to time limit of moves, chess notations, and the like. W3BSY hooked W3BKC at 1:30 p.m. Saturday, November 25th. The match started at 2:00 p.m. W3AVR, W3BSY and W3UVA did the operating at the Va. end. Four matches were played simultaneously, concluding at 6:15 p.m. The final score was Virginia 3, Johns Hopkins 1. The Virginia Chess Team will accept challenges from other college teams for radio matches.

An emergency route, "Trunk Line NP," maintained for the Northern Pacific R. R., extends from Seattle, Wash., to Minneapolis, following the railroad, and including the following amateurs: W7LD, Seattle, W7AYO, Yakima; W7BJZ, Missoula, Mont.; W7AAT, Red Lodge, Mont.; W7BCE, Miles City, Mont.; W9HJL, Fargo, No. Dak.; W9BN, Minneapolis.

These stations "make" the B.P.L. with totals of 500 or over. Many "rate" extra credit for one hundred or more deliveries. The following one-operator stations make the B.P.L. for deliveries 100 or more messages; the number of deliveries is as follows: Deliveries count!

W6GHD, 379	VE5HP, 143	W9LLN, 118
W6BIP, 231	W1AVJ, 140	W1WV, 116
W5ASG, 225	W8CVS, 139	W9KJR, 115
W9EYH, 218	W8FYF, 139	W9FFD, 113
W6CKX, 213	W7AGE, 139	W6DBB, 113
W8EUT, 214	W6GFC, 137	W1BEF, 112
W2DBQ, 204	VE5HG, 136	W9IWP, 112
W4AG, 197	W8CUG, 134	W6CLP, 112
W6DJI, 184	W7BVE, 134	W7HD, 111
W6AZU, 184	W1CPT, 133	W5BSG, 111
W1BTW, 184	W7ABH, 133	W8CJJ, 110
W8BON, 181	W2LUP, 130	W5CCW, 110
W8FLA, 172	W9RH, 130	W9EMM, 110
W6AEP, 170	W1AVL, 130	W1ETC, 107
W9GBJ, 165	W9FQQ, 129	W6GNM, 106
W9GIL, 165	W6BAM, 129	W9EVI, 106
W4DW, 164	W7MFP, 128	W1BDI, 105
W9JRK, 160	W1AFY, 127	W7EHL, 104
W6CUIZ, 160	W8APQ, 127	W9IOW, 103
W8AXD, 158	W9FZX, 125	W5BDX, 103
W2CBB, 155	W2BGO, 125	W5BUI, 103
W1EVJ, 154	W9FXE, 125	W5BXM, 103
W8AHR, 151	VE3JT, 125	W9BEH, 103
W9OCQ, 150	W2AHL, 122	W2EHC, 103
W8DHU, 150	W1ABG, 122	W8TI, 103
W6ALU, 149	W6ENM, 122	W8JTT, 102
W6TC, 148	W6NF, 121	W4BOU, 101
W9GNK, 148	W4MR, 121	W2AFK, 101
W9ADT, 147	W1UE, 120	More-than-one-opr.
W8FDY, 146	W6CIS, 120	W3BSY, 138
W4APU, 146	W5BUX, 119	W1MK, 122
W4AKH, 145	W7DBR, 119	W7LD, 118

A total of 500 or more, or just 100 or more deliveries will put you in line for a place in the B.P.L. Make more schedules with reliable stations. Take steps to handle the traffic that will qualify you for B.P.L. membership also.

BRASS POUNDERS' LEAGUE

(November 16th-December 15th)

Call	Orig.	Del.	Rel.	Total
W6ETL	486	512	1204	2202
W8HJL	2154	—	—	2154
W2DIU	197	396	1556	2149
W8ACOM	31	68	2043	2142
W6PQ	896	358	670	1924
W6BMC	19	21	1478	1518
W2BCX	313	247	758	1318
W9ESA	36	69	1093	1198
W2EKM	324	275	553	1152
W9KEH	310	89	666	1065
W9KG	52	441	358	1051
W7CZY	57	147	650	854
W5BMI	48	42	738	828
W8FTW	60	30	733	828
W8HGG	257	192	362	811
W9JZY	77	107	627	811
W9KZY	18	114	670	802
W9ADH	378	390	32	800
KA1RC	76	43	677	796
W1BLV	224	23	532	779
W9IYA	247	278	250	775
W3ALX	256	107	357	720
W4CZ	160	126	426	712
W9KNZ	60	81	561	702
W9GWK	214	212	234	660
W1ERQ	156	108	394	658
W9BLG	238	395	24	657
W4AFM	60	50	543	654
W8GUF	260	222	156	638
W9FUT	207	210	220	637
W7WY	55	56	516	627
OM1TB	207	134	280	621
W9BWB	247	239	134	620
W9IHL	59	81	475	615
W1FO	32	146	436	614
W8DXE	3	3	607	612
W9IFE	116	110	380	606
W6ASH	24	257	322	603
W6GQC	99	92	412	603
W1VS	99	146	392	597
W4AS	496	1	100	597
W6CUU	51	310	234	595
VE3GT	236	244	114	594
W3CL	114	189	275	578
W4NN	15	20	540	575
W4PL	159	150	262	571
W1AMG	66	103	400	569
W4MG	74	76	418	568
W9NMR	151	328	88	567
W9FLG	138	147	280	565
W8BGY	236	248	76	560
KA1NA	261	32	214	557
KA1CM	286	48	256	554
W2DPB	183	2	366	551
W9DRO	157	152	238	547
W3AZF	30	117	391	538
W7AAT	214	221	101	536
W9DMV	175	131	230	536
W1DMD	234	10	260	534
W2BZZ	240	240	54	534
W2EYQ	88	121	324	533
W9BKX	20	31	482	533
W6CXW	266	262	1	529
W3BWT	36	109	331	526
K6JPT	451	50	22	523
W4AAQ	212	228	82	522
W8GZ	67	67	386	520
W9DI	80	80	357	517
W9AZR	45	76	306	517
W6TKM	65	145	306	516
W9DOU	70	195	349	515
W6AFN	43	37	428	508
W9MZF	214	197	96	507
W2EGD	58	31	418	507
W9EVT	62	64	380	506
W6IT*	12	6	488	506
W9RSS	213	147	142	504
W9DGS	125	144	265	504

MORE-THAN-ONE-OPERATOR STATIONS

W3CXL	596	935	1851	3382
W9BNT	284	557	1595	2436
NY1AB	271	142	1996	2409
KA1HR	244	216	1614	2074
K6BWO	363	306	1562	1562
W5OW	239	173	1072	1484
NY1AB**	181	153	672	1005
W2BSC	410	334	152	896
W9YB	278	181	354	813
W9BMA	343	357	10	710
AC3RT	274	138	254	666
W3BKQ	13	37	400	500

* Listing for this station for September-October.
** Listing for this station for October-November.

1750-kc. Tests

Midnight to 2 A.M. EST each Saturday and Sunday

EACH week-end, Saturday and Sunday mornings throughout January, February, and March, 160-meter tests will be in progress, on the following schedules:

W/VE Stations Transmit (EST)	Listen for G's
0000-0015	0015-0030
0030-0045	0045-0100
0100-0115	0115-0130
0130-0145	0145-0200

These tests have been arranged by G5UM and W1DBM. Be sure your clock is correct, and adhere strictly to the above schedule, please! Any calling in the listening period will ruin the possibilities of results for all.

Traffic Briefs

1715-KC. CODE PRACTICE

Since the publication in December QST of a list of 1715-kc. stations sending code practice, several other amateurs have volunteered their services in the A.R.R.L. Code Practice Program on this band. W2FHY, Ocean Gate, N. J., sends code practice on 1970-kc. each Tuesday at 8:00 p.m.; VE2CG, Scotstown, P. Q., Canada, 1812-kc., Mondays 7:00-8:00 p.m., Wednesdays 8:00-9:00 a.m., Fridays 6:00-8:00 p.m. W3AKN, Newport News, Va., 1753-kc. Mon., Wed., Fri., 9:00 to 10:00 p.m.; W6FFU, Modesto, Calif., 1790-kc. each Wednesday, 7:00 to 7:30 p.m.; W9NJJF (W9OEH operating), Milwaukee, Wisconsin, 1805-kc., Mon., Wed., 8:00 to 9:00 p.m. All times mentioned are "local." W1GMIJ, Medford, Mass., and W9NTW, Decorah, Iowa, have also signified their intention of sending code practice. Their schedule will be announced soon. Amateurs operating on the 1715-kc. band interested in sending code practice for beginning amateurs should drop a postal to Communications Department, A.R.R.L., stating frequency and schedule, and requesting suggestions for this work.

On December 9th, a severe sleet and snow storm in the Northwest brought down about 70 telephone-telegraph poles in the state of Washington, completely cutting off communication between Tacoma and Yakima, and practically cutting Yakima off from the entire west side. W7AYO at Yakima, was called upon to get rush traffic to Tacoma. After trying for about two and one-half hours W7AAX, Tacoma, was contacted. W7AAX also contacted W7DM, Tacoma, and since neither AAX nor DM had a telephone, the traffic was taken to DM's neighbor, that being the closest phone, and delivered from there. Later in the day W7CYS, Tacoma, was lined up, and he cleared the balance of the traffic. W7BIW (3.9-mc. phone), W7BGH and W7UM assisted W7AYO in contacting Tacoma.

Relative Standings of the Ten Highest Sections—November-December

Messages Per Station (25%)	Stations Reporting Traffic (25%)	Gain or Loss (Traffic Reports) (25%)	Traffic Total (25%)	Standing Based on Average of All Four Ratings %	Section Communications Manager
P. I. 350.8	Los Ang. (680)* 96	Ont. +22	Ill. 9609	Illinois 50.	Hinds, W9APY-WR
M.-D.-D.C. 317.5	Mich. (624)* 88	Conn. +18	W. N. Y. 9165	Michigan 45.	Conroy, W8DYH
Hawaii 300.5	N.Y.C.-L.I. (151)* 79	N. C. +18	N. N. J. 8068	Los Angeles 42.5	Martin, W6AAN
Colo. 298.8	Ill. (890)* 75	E. Pa. +12	Los Ang. 8052	No. New Jersey 35.	Cobb, W2CO
N. N. J. 244.4	Wash. (374)* 74	E. Fla. +11	E. Pa. 6460	Connecticut 32.5	Ells, W1CTI
Okl. 224.	Va. (150)* 60	E. Bay +11	Mich. 6258	E. Penna. 32.5	Wagenseller, W3GS
Nebr. 219.4	Ohio (868)* 53	Mich. +10	Nebr. 6144	Philippines 32.5	Thompson, KA1XA
W. N. Y. 208.2	Oregon (260)* 52	Ill. +10	F. I. 5613	W. New York 30.	Farrell, W8DSP
So. Tex. 193.6	Conn. (370)* 48	Oregon +10	Conn. 5388	Ontario 25.	Trainer, W6JGT
Wisc. 188.9	N. C. (140)* 47	W. Mass. +10	Wisc. 5290	No. Carolina 22.5	Wright, W4AVT



ILLINOIS "makes" the top of the list this month, with Michigan and Los Angeles in 2nd and 3rd positions. November-December was an active month in A.R.R.L. message-handling with 1802 stations reporting a total of 188,242! The following Sections lead all other Sections in their Divisions, order of listing showing relative standing of their different Divisions: E. Pa.-W. N. Y. tied; Ill.; E. Bay-S. P. tied; Conn.; Nebr.; N. N. J.-E. N. Y.-N. Y. C. L. I. tied; Wash.; Ont.; So. Minn.; N. C.; Colo.-U. Wyo. tied; So. Tex.; E. Fla.; Ark. During the November 16th-December 15th month, 1802 stations Originated 56,768; Delivered 49,984; Relayed 81,490; Total 188,242. (88.5% Delivery) (104.4 m.p.s.)

* The Section A.R.R.L. membership (approx.) is shown parenthetically, so that the degree of traffic reporting activity may be indicated by comparison.

O. B. S.

The following is a supplement to the list of A.R.R.L. Official Broadcasting Stations in September QST* (page 44): W3AEJ, W4CDH, W5CCB, W6AHJ, W9HPA.

During the latter part of October, '33, VE5FG, Prince George, B. C., was the only means of communication for nearly a week between two weather-bound planes in Prince George and their home base in Fairbanks, Alaska. He also collected weather reports for them from northern stations in B. C., Yukon and Alaska.

The Army Amateur Radio System

By Richard E. Nebel, W2DBQ*

THIS article is written with the intention of interesting active radio amateurs in the Army Amateur Radio System and at the same time describing the interesting work being done by this marvelous nationwide network of amateur radio stations affiliated with the Signal Corps, United States Army.

Every Monday night during the winter, A.A.R.S. drills are in progress. The United States is divided into nine Corps Areas, not to be confused with the F.R.C. call-sign areas. The Second Corps Area, for example, comprises New York, New Jersey, Delaware and Porto Rico. The entire system is based on dividing sections, districts and states into nets with a net control station (N.C.S.) at the head of each. The N.C.S. of each Corps Area is usually a station located at a fort or Army Base and manned by an Army operator who, of course, is also an amateur operator.

The Army net is at the top of the system, its net control station being that of the Chief Signal Officer at Washington, D. C. The stations in the Army Net are the N.C.S. of the Corps Area Nets. In each Corps Area Net are the N.C.S. of the different state nets and in each state net are the N.C.S. of the district nets. Each district net is comprised of local stations. When a new member joins the A.A.R.S. he is put in one of the district nets, depending on his location.

To be a member of this great network it is necessary to have one year of operating experience and also to be familiar with traffic handling. Of course, it is necessary to have a station in operation. This should be capable of operation on the eighty meter band. The minimum receiving code speed is fifteen words per minute. The transmitting equipment should be preferably crystal-controlled but non-crystal will be permitted provided the note is

* A.A.R.S. Net Control Station, New York City District, 1104 Lincoln Place, Brooklyn, New York.

consistently D.C. It might be well to add a word here that this requirement does not only pertain to the A.A.R.S. but to all amateurs under the new regulations of the Federal Radio Commission.

On Monday nights, for the system to function properly it is only necessary for each station in a net to contact the N.C.S. If it is impossible for a station to contact its N.C.S. the whole system is not rendered inoperative; only the one inoperative branch is affected.

If you are an active amateur and interested in joining the A.A.R.S. please get in touch with your Radio Aide¹ and make application for A.A.R.S. appointment. Let me emphasize that joining is entirely voluntary and there is no signing up of any kind to be done. The Army Amateur Radio System was organized to provide emergency communication in time of disaster and to help the American Red Cross. It has proven its worth time and time again in such major catastrophes as the California Earthquake, Florida Hurricane, etc.

Being a member of the A.A.R.S. will insure any operator great pleasure and operating satisfaction. Every moment in this wonderful work will be repaid a hundred-fold. If you should be forced to give up the work it is just necessary to send in your resignation.

¹ All amateurs interested in joining the Army Amateur Radio System please communicate with your Radio Aide and request application forms:

Radio Aide	Corps Area—Territory
Fred C. Bigelow, WIPI, 148 Arlington St., Hyde Park, Mass.	First: Maine, N. H., Vt., R. I., Mass., Conn.
Capt. David Talley, W2PF-WLNA, 222 1/2 Ave. O, Brooklyn, N. Y.	Second: N. Y., N. J., Delaware.
Cpl. Fox, c/o Signal Office, Ft. George G. Meade, Md.	Third: Penna., Md., Va., D. C.
Myrl F. Jones, c/o Signal Office, Fort McPherson, Ga.	Fourth: N. C., S. C., Ga., Fla., Ala., Tenn., Miss., La.
1st Lt. Loren G. Windom, WSZG-WLH, 1375 Franklin Ave., Columbus, Ohio	Fifth: Ohio, W. Va., Ind., Ky.
1st Lt. C. W. Roth, W9DOU, 329 So. Cuyler Ave., Oak Park, Ill.	Sixth: Ill., Mich., Wisc., the post of Jefferson Barracks, Mo., and Arcadia Target Range, near Arcadia, Mo.
H. W. Kerr, W9DZW, Mulberry St., Little Sioux Iowa.	Seventh: Mo., except the post of Jefferson Barracks and Arcadia Target Range, near Arcadia, Mo., Kansas, Ark., Iowa, Nebr., Minn., No. Dak., So. Dak.
1st Lt. L. J. Tatom, WLJ, Fort Sam Houston, Texas	Eighth: Texas, Okla., Colo., New Mexico, the post of Fort Francis E. Warren, Wyo.
Capt. R. B. Woolverton, Presidio of San Francisco, Calif.	Ninth: Wash., Oregon, Idaho, Mont., Wyo., except the post of Fort Francis E. Warren.

ELECTION RESULTS

Valid petitions nominating a single candidate as Section Manager were filed in a number of Sections on or before the closing dates that had been announced for receipt of such petitions. As provided by our Constitution and By-Laws, when but one candidate is named in one or more valid nominating petitions this candidate shall be declared elected. Accordingly election certificates have been mailed to the following officials, the term of office starting on the date given.

Connecticut	Frederick Ellis, Jr., W1CTI	Dec. 4, 1933
Cal.-S. C.-Cuba	George A. Love, W4UT	Dec. 15, 1933
L. of P.-P. R.-V. I.		
New Mexico	Dan W. De Lay, W5DUI	Dec. 15, 1933

In the British Columbia Section of the Vanaluta Division, Mr. R. K. Town, VE5AC, and Mr. James T. Hepburn, Jr., VE5HP, were nominated. Mr. Town received 32 votes and Mr. Hepburn received 24 votes. Mr. Town's term of office began November 20, 1933.

ELECTION NOTICES

To all A.R.R.L. Members residing in the Sections listed below: (The list gives the Sections, closing date for receipt of nominating petitions for Section Manager, the name of the present incumbent and the date of expiration of his term of office.) This notice supersedes previous notices.

In cases where no valid nominating petitions have been received from A.R.R.L. members residing in the different Sections in response to our previous notices, the closing dates for receipt of nominating petitions are set ahead to the dates given herewith. In the absence of nominating petitions from Members of a Section, the present incumbent continues to hold his official position and carry on the work of the Section subject, of course, to the filing of proper nominating petitions and the holding of an election by ballot or as may be necessary. Petitions must be in Hartford on or before noon of the dates specified.

Due to resignations in the Santa Clara Valley, Rhode Island and Oklahoma Sections nominating petitions are hereby solicited for the office of Section Communications Manager in these sections and the closing date for receipt of nominations at A.R.R.L. Headquarters is herewith specified as noon, February 15, 1934.

Section	Closing Date	Present SCM	Present Term of Office Ends
Santa Clara Valley	Feb. 15, 1934	Bruce Stone (resigned)	
Rhode Island	Feb. 15, 1934	Stanley Atkinson (resigned)	
Oklahoma	Feb. 15, 1934	Emil Gisel (resigned)	
Mississippi	Feb. 15, 1934	Wm. G. Bodker	Jan. 15, 1933
Virginia	Feb. 15, 1934	R. N. Eubank	Dec. 15, 1933
Eastern Florida	Feb. 15, 1934	Ray L. Atkinson	Dec. 15, 1933
Alaska	Feb. 15, 1934	Richard J. Fox	Feb. 16, 1934
Montana	Feb. 15, 1934	O. W. Viers	Feb. 18, 1934
Alberta*	Feb. 15, 1934	C. H. Harris	Feb. 18, 1934
Hawaii	Mar. 15, 1934	C. D. Slaten	Mar. 15, 1934
Alabama	Mar. 15, 1934	I. D. Elwell	Mar. 15, 1934
North Dakota	May 1, 1934	Wm. Langer	May 10, 1934
Saskatchewan*	June 1, 1934	Wilfred Skafte	June 15, 1934

* In Canadian Sections nominating petitions for Section Managers must be addressed to Canadian General Manager, Alex Reid, 169 Logan Ave., St. Lambert, Quebec. To be valid such petitions must be filed with him on or before the closing dates named.

1. You are hereby notified that an election for an A.R.R.L. Section Communications Manager for the next two-year term of office is about to be held in each of these Sections in accordance with the provisions of By-laws 6, 6, 7, and 8.

2. The elections will take place in the different Sections immediately after the closing date for receipt of nominating petitions as given opposite the different Sections. The ballots mailed from Headquarters will list the names of all eligible candidates nominated for the position by A.R.R.L. members residing in the Sections concerned. Ballots will be mailed to members as of the closing dates specified above, for receipt of nominating petitions.

3. Nominating petitions from the Sections named are hereby solicited. Five or more A.R.R.L. members residing in any Section have the privilege of nominating any member of the League as candidate for Section Manager. The following form for nomination is suggested:

(Place and date)

Communications Manager, A.R.R.L.

38 La Salle Road, West Hartford, Conn.

We, the undersigned members of the A.R.R.L. residing in the Section of the Division hereby nominate as candidate for Section Communications Manager for this Section for the next two-year term of office.

(Five or more signatures of A.R.R.L. members are required.)

The candidates and five or more signers must be League members in good standing or the petition will be thrown out as invalid. The complete name, address, and station call of the candidate should be included. All such petitions must be filed at the headquarters office of the League in West Hartford, Conn., by noon of the closing date given for receipt of nominating petitions. There is no limit to the number of petitions that may be filed, but no member shall sign more than one such petition.

4. Members are urged to take initiative immediately, filing petitions for the officials for each Section listed above. This is your opportunity to put the man of your choice in office to carry on the work of the organization in your Section.

—F. E. Handy, Communications Manager

ATLANTIC DIVISION

EASTERN PENNSYLVANIA—SCM, Jack Wagenseiler, W3GS—W8CVS wins Eastern Penna. Sect. QSO Contest with 308 points. W3VR is second with 250, W3CL third with 229. W3BKQ, ALX, W8CVS, FLA and W3CL BPL. W8BEV is new President of Shamokin Radio Club. W3ABT, Univ. of Penna. station sent play by description of Army-Navy game on c.w. W3AXM sent opening address on 'phone, which was received before two thousand people gathered at a meeting in South Phila. High School. W1GHF from Mass. joins us. W8DIG is new O.O. W3ATR, CNP, CMW, CQP, BZC, CNO and GS are active on 56 mc. RM W3MC has new transmitter. W3CWU got a ball and chain. W3AAV is QRL Navy traffic. RM W3ALX arranged a trunk to Florida. W3BUI is operating portable in 8th call area. W8IWT is in line for ORS. Following were in SS contest: W8I2S, W3BKQ, ALX, W8CVS, FLA, W3AGR, DWZ, GS, AMR, ADE, CIQ and CHL. W3OK schedules Holland on 3.5 mc. W8ASW has BCL trouble. W3AQN wants traffic for York. W8EOH is QRL A.A.R.S. W3BLG, W8I2S and FLA have new receivers. W3ECD, CNO and EDB (YL) report for first time. W3ABZ has new car.

Traffic: W3ALX 720 CL 578 AZF 533 BKQ 500 ADM 391 AQN 358 AKB 321 OK 319 EZ 185 ADE 178 AAV 167 ANZ 156 MC 138 DWZ 93 AMR 79 DXQ 67 CB 64 CHL 60 GS 50 CIQ 45 AGR-ATR 34 ECD 30 EER 23

CGD 16 DYL 13 BUI 12 BGD 10 EDB 9 CNO 6 AAD-BLG 4 BUK 2. W8CVS 466 FLA 402 IZS 174 EOH 96 IWT 81 DIG 21 ASW 11 CMF 3. WIGHD 2.

MARYLAND-DELAWARE-DISTRICT OF COLUMBIA—SCM, E. L. Hudson, W3BAK—RMs, W3CXL, W3CQS, W3CJS. Chief RM, W3BWT. The Delaware Amateur Radio Club is planning a HAMFEST for February 24, at the duPont Hotel in Wilmington, Del. W3CXL and BWT BPL with plenty of margin. W3VJ reports. W3DRE has new Collins transmitter. W3CQS is getting Collins 150B. W3CXL keeps daily schedule with Byrd Expedition. W3DWF is new station. W3ASO wants good Southern schedule.

Traffic: W3CXL 3382 BWT 526 ASO 120 WU 100 BND 96 BAK 95 CJS 51 CDG 46 ZD 12 CQS 6 CWE 7 DPA 10 CIZ 175 CTD 123 DWF 5.

SOUTHERN NEW JERSEY—SCM, Gedney M. Rigor, W3QL—Welcome to ex 3XM, now W3EFM, and ex 3AQW, now W3EDP. W3AVJ reports 7 mc. DX FB. W3ZX had a beautiful but sad experience; a "hams" mother spoke to her son via 14 mc. Thanksgiving time; on her return to her home she was accidentally killed; amateur radio afforded the means of a "last talk between this mother and son." W3BIR went to 28 mc. W3ABW uses 1924 chemical rectifier and gets p.d.c. sigs. W3DAH, OPS, says traffic picking up on 'phone. Welcome to W3KA from the Roanoke Division. W3BDO handles CZ messages direct. W3DRP reports shack so cold his key froze. W3CWL has thirty some schedules per week. The D.V.R.A. meets at 112th Field Artillery Armory. W3DSC works all Districts on 3.5 mc. with 20 watts input. W3APV handled missing person report to Phila. Police. W3DH will be new OO. W3DOE sends first report. The Cumberland Valley Radio Club is building new transmitter. W3BAY finally got A.R.R.L. membership. The Ultra High Freq. Exp. Club was formed with W3VX Acting Chairman, 3CWR secy. The S.J.R.A. elected W3QL Pres., W3AN Vice-Pres., W3BEI Secy., W3ZX Rec. Secy. and Birch, Treas. Every ham in So. Jersey is invited to attend third Thurs. meeting at Am. Legion Home, Audubon, N. J. W3SM is back again.

Traffic: W3DH 263 APV 112 BPT 17 QL 5 DSC 51 ZI 44 ATJ 10 CXV 4 CWF 98 DRP 21 BDO 19 KA 52 DAI 2 EDP 67 AVJ 6 EWL 7 BGP 2 BEI 16 ZX 12 DPE 3.

WESTERN NEW YORK—SCM, Don Farrell, W8DSP—The gang in Rome formed new club, "Fort Stanwix Amateur Radio Club." W2BIN and DQK are handling traffic at Cornell. W8GWL has appendicitis. W8FUG works west coast on 3.5 mc. W8EJS likes Oswego Normal. W8AON works DX. W8DSA is building 56 mc. rig. W3CCR is portable at Saranac Lake. W8ELU is in Army Net. W8GQ built new transmitter. W8EWP worked KJTY. W8DEJ won filament transformer at Schenectady hamfest. W8AKX threatens to hold a funeral for 7 mc. W8JAK and BAI operate at WPGJ, Utica Police. W8ERU reports Rochester gang attended Buffalo club meeting. W8DSS is working overtime. W8DME uses pair of '04As P.P. High "C" on 7 mc. W8BJO-GIJ is going strong on trunk line "G." W8GPS had bakelite insulation go on transmitting condensers. W8FMX is A.A.R.S. W8BGN listens in a lot on 500 kc. W8CDB's mast came down during SS. W4BTC spent Christmas with W8FTB. W8AFM made several improvements in AGSX receiver. The Radio Assn. of Western New York is going stronger than ever. W8GWZ sticks to 14 mc. 'phone. W8DBX is back on trunk "G." W8JLG is on 1.7 mc. 'phone. W8LEN is new call in Greece, N. Y. W8AOM, DXE, DSB did nice traffic work at Better Homes Exhibit at Buffalo. W8KYR is new YL op in Buffalo. W8ECF has new tritrit. W8DSP finished new transmitter for W8FMH. Rebuilding: W8GPX, DEQ. New crystal rigs: W8CUP, AXE and portable W3BVV. Those most active in SS Contest: W8EMW, GWY, JTT, BHK, DHU, EUY, CJJ, FYP, FDY and AQE. Following report: W8JJJ, GWT, DMJ, BQJ, BWY, GPT, BR and W8NW.

Traffic: W8EMW 232 JAK 294 JTT 240 HNJ 2154 AOM 2142 DXE 612 DSB 127 DHU 310 EUY 439 BJO 183 CDB 137 CJJ 242 FYP 287 FDY 421 AWX 101 AQE 353 FUG 42 KMC 87 GWY 52 DME 18 BOL 16 FMX 27 DMJ 14 BQJ 29 DBX 67 GPT 57 DHQ 48 DSS 81 BHK

68 DSA 14 AXC 8 EWP 17 DEJ 19 JTH-ERU 7 DSP-FTB 5 GWT 4 GWZ 16 BWY 20 BR 24 JLG 6. W2BIN 86 DQK 47.

WESTERN PENNSYLVANIA—SCM, C. H. Grosarth, W8CUG—W8HGG gets plenty of traffic from students at school. W8GUF lost lot of sleep in SS. W8YA is active in PSP. W8AXD turns in swell total. W8APQ returns to air. W8IQB has new 14 mc. rig. W8DYY handles VCR traffic. W8KWA uses tritrit. W8FZG keeps good schedules. W8DYY blew final amplifier. W8KQQ is collecting parts for high power rig. W8GJM is first OPS in the Section. W8KRQ worked all U. S. districts on 3.5 mc. using pair of 29 cent '45s! W8CMP is still originating traffic. W8HUL and BWL have new c.c. rigs. W8INE and HOF are on 7 mc. W8IOH has National SW-3. W8JZR bagged an eight point buck. W8CQA, FRA, GRY, and GRZ report by radio. W8KSG and KTP are working on new outfits. W8CDD, KOB, and HUI are QRL 56 mc. W8CDD is building c.c. oscillator. W8ESR reports new ham, KYW. W8IPL had amplified trouble. W8EDM is on 1.75 mc. 'phone. W8IRK has high power. W8KBJ has Collins transmitter. W8CKO is recuperating from severe illness. W8KUA is a fish hound. W8DFT went hunting in wilds of Pa. W8CUG was on for SS.

Traffic: W8HGG 811 GUF 638 YA 473 CUG 370 AXD 334 APQ 257 IQB 120 DYY 110 FZG 94 KWA 106 GRZ 44 GRY 81 DYV 48 FRA 44 KQJ 31 BWL 22 KRZ 21 KOB 19 CMP 16 CQA 14 HUL 9 KSG 8 HMJ 7 JCV-KUI-IPL 4 INE 2 ESR 13.

CENTRAL DIVISION

ILLINOIS—SCM, F. J. Hinds, W9APY-WR—RMs W9DDE, W9ERU, W9VS, W9CRT. New transmitter at W9DJG. W9CGV handled Red Cross Call reports. Superhet works fine at W9ERU. W9FO works DX on 14 mc. Rebuilding 'phone at W9RO. W9NTU has luck on 14 mc. W9MIN was called by FRC for 14 mc. harmonic. W9MCK is building c.c. 211. 3.9 mc. 'phone at W9HMB. W9NQW eliminated RAC. W9IWP says 7 mc. single wire feed on 3.5 is the Nertz. W9AD burned his hands in a fire but is OK now again. High power for W9KHD. Honduras is W9KA's 37th country. W9KSB is coming on with Kilowatt. W9KXE has an FB super. W9LQG rebuilt. W9BYZ passed first class commercial telephone. W9AVB is on 28 mc. 'phone. W9GDI is working on c.c. W9DGD, BSR, HPK, GET and CGT are on 1.7 mc. 'phone. W9MW uses pair '45s. W9HPG has new rig he and DXZ built up. W9IYA is getting A.A.R.S. to report totals. W9FWD worked VK5GR. W9FYZ is important cog in State Nets. W9KIM, KIT and BPU have FBXAs. W9PEX doesn't smoke or kiss women—he says. W9CBW and NDO have YLitis. Rig at W9PPX works better on Zepp. W9MJJ has an American flag with a QSL from each of 31 states around it. W9LZU and NUF says traffic handling is the berries. W9EVJ, LZU, OQJ and OQK work traffic schedules in a pool at Elgin. Rebuilding: W9AAR, W5DFE, W9IZP. W9MKS helped NNH build new 1.7 mc. rig. W9KJY works hard on Illinois State Nets. W9BRX has an XYL now. W9IUF has taken over job of Laboratory Technician at school. New reporters: W9OQJ, OQK, PHX, PIO, JNB, IVU and AGQ. A.A.R.S. reporting: W9LZU, KJY, IYA, HFK, CGV, DOU, GSB, MLH and MKK. New ORS: W9EVJ, LZU and LIV. New c.c.: W9MTO, PCR, IEP.

Traffic: W9KEH 1065 KJY 802 JZY 811 IYA 775 ILH 615 DDU 515 EVJ 506 LZU 285 IWP 267 FXE 262 MDL 229 EMN 219 MKK 213 FYZ 187 LIV 174 FOC 172 CUH 162 CGV 157 IEP 148 EZQ 130 MLH 113 CEO 82 HQH 80 GSB 71 BPU 76 NIU 68 AD 61 NUF 57 HPG 54 CKC 51 DJG 50 KJX-MNB-OVV 49 KA 45 HMB-HPK-NGG 44 DBO-IZP 41 IBC 29 HUX 27 ICN 34 MIN 26 WR 25 ODR 23 DZU 22 GYP-PPX 16 SG 14 AGQ-FO 12 MTO 11 MIM 10 FTX-MKS 9 KXD-OQJ 8 KHD 7 IUF-NPW 6 AVB-IVU 5 BRX-KIM-RO 4 FWD-GDI-OQK-ORT 3 AAY 54 FCW 97 HCK 211 CZL 18. W5DFE 2.

INDIANA—SCM, Arthur L. Braun, W9TE—BPLers: W9AUT, IOW, JRK. W9BKJ has 100 kc. osc. W9BTR has low power rig. W9DET is working hard on local club.

W9DJJ has 211E final 'phone. W9DJU has a 50 watter. W9EGQ has 50 ft. masts at new QRA. W9FRY has new rig. Active A.A.R.S.: W9AET, FYB, FQ, W9HSF has portable rig ready for air at Ft. Wayne. Active in the SS: W9DPL, FUT, KFJ, QRY YL: W9AEA, CNG. Would-be ORS: W9GZB, HUO, BCP. W9HBQ keeps several schedules. W9HUV ran up nice traffic score this month. W9LQE has 100 watts output. W9LVO reports for first time. W9LSB has '47-'46-800 rig. W9MQQ raises ZLs. W9OEC is Treas. of Goshen Amateur Radio Club. W9TE is awaiting Patterson Receiver. W9YB has one KW 'phone. W9DQC uses '47-'46-'46-'10s PP. DXers: W9KGU, NGB, KDD, CKG, JHY, KQE, EPT, W9FJG sports new receiver. QRL school: W9JRR. GFS. On 1.7 mc. 'phone. W9MIG, HIU. Now c.c.: W9HTJ, LKI, OXM. W9MWL, FWQ and IKX are active. W9NEE visited W6DBJ, DFG, HIF, CPS, GLA, while in Calif. W9LLV is glad to see the local club going well. W9JOQ and HML want schedules. W9JJI will be c.c. soon. W9OLP has new antenna. QRL work: W9OFA, BZZ, CKB, MBG, AKJ. W9PGT is getting out with '45s. W9LWK promises to have nice score in Jan. ORS party and will donate 3.5 mc. crystal to the winner. W9MQ works 'phone and CW. W9OKX got an '03A for Christmas. W9FXM has 50 watt MOPA. New stations: W9PLW, PAO, PKK, PIR. W9PKE has class in "ZZZ" modulation idea. W9HKZ has a few key clicks scattered around town. W9IOB is going to put on 1780 kc. code practice. W9CMQ has new freq. meter. W9DEJ got married. Rebuilding: W9DAN, AAL, LSZ, MPR, KJD, AEB. In the future send all reports to 911 Reiser St., Indianapolis, the new QRA of the SCM.

Traffic: W9YB 813 FUT 637 AUT 316 AET 221 JRK 335 IOW 307 QG 148 EGV 143 BKJ 106 DJU 105 HUO 104 MBG 124 MQQ 93 HUV 78 BCP 115 FYB 45 LLV 78 GZB 36 JOQ 120 JRY 23 LSB 28 HPJ 25 DGC 14 FQ 23 FRY-HML 20 JHY 11 TE 16 DJJ-HTP 12 DPL 10 HSF 9 EPT 8 DET-LVO 6 GFS 4 OBG 2 AEB-KFU 1 OXM 3 MPR 4 DHJ 9.

KENTUCKY—SCM, Carl L. Pflumm, W9OX—W9AUH worked 495 stations in 63 sections during SS! W9BWJ is awaiting 800 tubes. W9FQJ is looking for Comet Pro. W9EYW and HCD help keep schedules working at JYO. W9CWM is moving to Mt. Sterling. W9HAX takes all Ohio traffic. New "press talk system" goes over big at W9HCO. Prohibition repeal keeps W9BAZ QRL. "Ky. QSO Party just as good as a Bing," says W9CDA. W9HBQ is using s.s. receiver. W9LH and YL meet, and okey OXBAZ. W9ETD is moving to Florida for winter. Work QRM's W9FZV. W9KCY is on 1.7 mc. 'phone. "RP" drew call of W9PLM from FRC! W9MWR and DPW will accept donation of FBXA. W9NBD admits he's lazy. W9OFF, EOM, IBX are new ORS. W9KOX is moving. W9NEP is coming on 3.5 mc. for Ky. parties. W9OZO and BZS are experimenting with antennae. W9AEN, NMQ, EDQ, ELL, KKG, DLZ and OMW are rebuilding. W9ETT and GNV raise rumpus at Tenn. hamfest. W9IXN applies for OPS. W9HNV breaks the silence at Ashland. W9ACD visits Louisville hams. W9BAN was drawn into SS contest unwillingly. W9ARU completes dynamic mike. W9CSO is looking for good transmitter builder who wants to spend some time in the hills where duck-hunting and fishing is good. Correspondence keeps W9OX QRL. W9FGK is taking hold of traffic work. W9EQO succeeds CNE as President of A.R.T.S. W9ERH had to leave DEC. Ky. QSO party early. All stations not reporting on 16th have been cut off Ether Clippings' mailing list. All Ky. hams get in on our monthly QSP parties—It's fun and there are PRIZES.

Traffic: W9AUH 800 BWJ 620 FQJ 264 OX 233 JYO 156 CNE 132 HAX 129 HCO 123 BAZ 124 OMW 113 IXN 98 KKG 80 FGK 70 LBX 61 OFE 59 CDA 56 ERFH 52 BAN 48 ARU 44 OZO 30 ELL 21 ETT 34 ACD 26 HBQ 22 EOM 21 EQO 19 CIM 16 LH 14 BZS 12 AQV 9 ETD 8 ELW-FZV 7 KCZ-CKH 6 HNV-MWR 4 EDQ 3 DPW-EDV-GNV-NMQ 2 NEP 1.

MICHIGAN—SCM, K. F. Conroy, W8DYH—W8FTW RM Detroit—W8EGI RM E. Michigan—W9HK RM U.P.—W8BMG RM W. Mich. W8JO Emergency Equipment Mgr. Wanted: At once, Phone RM, Official Phone

MICHIGAN "UP-LP QSO PARTY-CONTEST"

A two-day "Upper Peninsula-Lower Peninsula QSO Party" will be held on the week-end of February 17th and 18th from 6:00 a.m. Saturday to 12:00 midnight Sunday, EST. This Party is being sponsored by W8JO, Emergency Equipment Route Manager of the Michigan Section.

In making contacts, stations in the lower part of the state will call CQ UP de W8—, and stations in the upper portion about the Straits will call CQ LP de W9—. The idea of this Party is not only to see how many contacts can be made, but more to find out how well and consistently signals can get back and forth between the upper and lower peninsulas. Any and all frequency bands may be used! Each fellow should exchange at least a 5 word message in A.R.R.L. form to prove the contact. Messages do not have to be kept on file. Every fellow is acting on his honor. A copy of the log should be sent to W8JO, O. B. Slocum, Cedar Bend Heights, Okemos, Mich. Indication should be given of how well the QSO was accomplished. All possible comments are requested in regard to all QSOs and any noticeable peculiar conditions such as severe fading, etc. should be noted. The frequency used should be listed in the log to ascertain the more suitable frequencies for UP-LP contacts.

The winner of the greatest number of contacts will be announced for each portion of the state, and a full list of entries with interesting information will be mailed to each ham taking an active part in this QSO Party. W8DED will donate 100 QSL cards to the amateur working the most stations.

Stations, ORS and O.O., apply SCM Conroy, W8DYH. W8FTW is filling shoes W8PP left empty. W8DED will donate QSLs in UP-LP Party. W8CFZ, W9NEZ and W9EGF report new Jr. ops. Congrats! W8FVP's snozzle is healed and ready for bigger trees! W8HSH takes hat off to W8BJ for poem in Bull. W8AYO and AFH keep Owosso going. The W8SH gang put 'em out. Jackson A.R.A. meet second Friday each month S-D Coal Co. N Jackson St. Nice new Saginaw Club—W8EVQ Pres., ENL, Vice-Pres., JXM, Secy., ESA, Treas. 20 members says W8LJS. W8SS is plugging on 28 mc. W8JNK is working on twisted antenna feeders. W8KSY puts in 2 hours a night. W8CM attempts exciting '03A with tritet. W8PP is coming back. W8IWM holds the fort. W8BRP wants schedules. W8IFE and KLR want ORS. W8EDO hitchhikes aided by ham-radio. W8CU handles long-haul. W8BRs claims SS can stand for other things. W8AIJ received B.O. '03A as Christmas "gift." W8DSQ helps BGY keep Lansing alive. Squeals. W8LFD: "W8BKX marries but isn't going to let that QRM his being a ham!" W8JK reports U. of M. Radio Club: W8QS, Pres., W1BJW, Vice-Pres., W8IXV, Secy., W8GSZ, Treas. W8ADU is QRL winding transformers. W8BMG has large plans. W8FAV reports a Jr. hamfest at HPF's. Ex8DCW is now W8KPL. W8KQT is ex8CRL. W8EHD is big service man. W8JVT's 50 watt south-west. W8DVC would handle 1000 if the SCM would fix the WX. W8QT finds things moving. W8IOR is our latest ORS. W8EMC awaits the QSLs for his WAC! When heat is low, W8DNM's total goes down. W8HA wins D.A.R.A. QSO-party. W8CEU answers to the name "Hot-pants-Pete." W8COQ and LFG consolidated. W8KOS and JTV are first reporters. REPORTS FROM THE MICHIGAN NINES: W9HK keeps the majority of schedules. W9EVI took advantage of the SS! W9NEZ's bouncing Opr. is giving very little QRM. W9ADY wants to contact L.P. gang. W9CWR is fed up on low-power radio and high-power YLs and seeks a hermitage in the woods! W9IQC works a 50 to death. W9CE adds his to the big jump. W9MXN reports LUU back. W9MJW says life would be grand if it wasn't for filter.

W9CGP squeals that EGF is a "poor Pa-Pa" now. W9FBC, ANT and MJW cut themselves some forty ft. plus trees for masts. W9CWD puts a nice drop in the bucket. W9BBP claims ham-activity flaggin' out. Do you boys want reports this manner or mixed in the "one-big-happy-family" manner? We need more ORS and other CD appointees up there. How about you? 73 & CU—Ken.

Traffic: W8FTW 823 BGY 560 DZ 307 CEU 303 DNM 244 EMC 193 IOR 171 SH 159 QT 145 DVC 124 FX 122 JVI 120 QQB 118 ??? 100 EHD 90 KQT 82 FAV 79 COQ 76 KPL 75 BHH 64 EGI 52 WG 51 BMG 44 IYN 41 DED 37 ADU 34 AFH 33 JK 32 IFD 30 HA-ICX 29 FQD 26 KOS 25 AIJ-GDR 24 DSQ-KLR 22 CFM 21 BRS 20 CU-EDD-LFE 18 EVC 16 AYO 13 BRP-IWM 12 GRB 10 BJ 9 GBB 8 DCQ 7 HFU 6 CM 5 FRW-JTV-SS 4 FGU-GSP-HBZ-HSH-IKY-JNK-KSY 3 FXB-WR-FWG-MV 2 BKU-OSL 1 COW 19 ARR 9 CPY 59 KMT 2. W9HFK 347 EVI 318 CGP 128 ADY 127 CWR 97 CWD 61 IQC 56 CE 50 BBP 22 NEZ 18 MXN 10 MJW 8 EEM 7 FBC 5 LKJ 1.

OHIO—SCM, Harry A. Tummonds, W8BAH—Chief RM W8PO Eldon Heck, Shelby, Ohio. Director Windom, W8GZ, leads the State again. Dist. No. 1: Among Ye faithful reporters this month: W8NGG, KIV, COX, CLA, BFL. W8DI entertains C.A.T.A. W8EBI is completing transmitter for OPS. New Wellington hams: W8KYP, IAJ. W8ACZ's XYL renewed his A.R.R.L. membership for Christmas. W8CIO reports again. New autodyne at W8RN. W8FNX says IOE is pre-war ham. W8EEW says RM BON is going nuts from SS. Five schedules at W8EPP. W8DAT won ACSW3 at Lakewood Radio Club raffle. Two '52s at W8BAC. W8EBY won't count SS traffic in totals. W8FFK and HC apply for OPS. Watch for W8GUL on 1.7 mc. 'phone. W8FGC applies for ORS. Dist. No. 5: W8BDG applies for OO. RM W8FGV and ICC are QRL school. Sweepstakes at W8BSR and HCS. W8KWJ is Ex W8BPD, Los Angeles. W8AMF made a same-day fast delivery of DX message. Message to girl in hospital delivered by W8KLP. District No. 2 W8BKM RM Coneaut, Ohio. SCM attended FB hamfest at Youngstown, Ohio; 165 attended. Prizes were won by W8HGS, AQO, EZB, GGS, AEE, CGG, HSP and E. Matt. W8BKM conducts Dog drills for U.S.N.R. W8DDM has c.c. on 3.5 mc. W8UX wants schedules. W8EEZ getting c.c. reports. W8LAF is new Fairport ham. Dist. No. 4 (no RM): W8JGZ wants schedules. W8WE has power leak. W8MHM is located at office of Central Utilities Service Co., Dresden. W8AFU is on 3850 kc. W8ONO reports JEA on air. W8PO is the man that Ohio RMs should send reports to on tenth of each month. Dist. No. 6: RM W8BBH. W8ISK sends map of all schedules. W8HWC has new rack. W8GZ has schedules daily with Washn., D. C., Cleveland, Akron, Ft. Wayne, and Bloomington, Ind. and Owensboro, Bowling Green, Ky., Huntington and Bluefield, W. Va. W8JBI received 9 cards from Australia in two days. W8GDC is now OPS RM. W8KQO gets his 100% four ways. W8EQC is having a vacation. Radiotelegraph 2nd at W8GSO. W8IZQ is QRL school. W8AEL renews certificates. Dist. No. 3: RM W8APC is "requested." Six schedules at W8GDO. W8CMY applies for OPS. W8AEW says he ran screw driver through '24A. W8ESN attended Detroit hamfest. W8JJK wants schedules south. W8DIIH was in SS contest. Dist. No. 7: W8EQB is only reporter! Dist. No. 9: RM W8DUV has trouble with transmitter. Dis. No. 8 (no RM): W8BRQ is QRL Univ. Cin. EE. W8PV will be new RM this district. W2FSK uses Link coupling. W8BKE was busy with SS. W8EJW introduces W8LCK, Hamersville and W8KZT, Williamsburg. W8LCO is now at Dayton.

Traffic: W8GZ 520 BON 379 RN 368 CIO 279 HWC 229 HCS 194 GDO 169 ISK 162 APC 155 PO 133 EQB 115 LCO 113 FGC 86 FGV 74 GSO 58 BSR 54 GUL 53 FJN 49 BMK 41 DIH 37 JJK 36 BAH 33 KWJ 32 FFK 29 WE 28 BKM-PV 27 FSK 26 AMFF 38 EBY 25 BAC 24 ICC 22 ESN-DAT-HMH 20 BKE 17 AFU 15 EQC-EPP 14 ARW-AEW 12 KQO-GDC 10 KLP 9 ONO 8 DDM 7 EEW 6 JBL-EJW 5 FNX 4 DUV 3 UX-BRQ 2.

WISCONSIN—SCM, Harold H. Kurth, W9FSS—W9GWK leads in traffic. W9FSS has '66s. W9HGF says,

"Let's skin the gophers." That's the slogan for Wisc.-So. Munn. traffic contest. W9LFK is QRL mail. All cylinders working at W9OKS. W9HTZ is awaiting better weather. W9IWQ has 5 good schedules. W9HMX is QRL tax rolls. W9GVL was in 28 mc. party. W9JCH's super works FB. W9AKT writes at last. W9ESZ uses 250 watts. W9IQQ has FBX. W9IH worked So. Africa in daylight. W9OTL is interested in 7 mc. W9IZY increased power. W9DJQ likes autodyne. W9KKE is active. W9JWV and JNU are rebuilding. W9BIO built super. W9ELQ is DX man. W9KGE gets c.c. report without c.c. W9ENP and FAW are on 4 mc. 'phone. W9PJS is new ham. W9OME, FSQ, AKT, HMS are on 1.7 mc. 'phone. W9ZY has SW3. W9FTX has different YL. W9FDI runs radio shop. W9DKA is on C.W.A. W9DNU is QRL teaching. W9NSM is in traffic now. Following were in SS. W9DRO, EYH, GIL, KJR, RH, ETM, LRB and GWK.

Traffic: W9GWK 660 DRO 547 FSS 504 GFC 453 EYH 435 HGF 390 GIL 334 KJR 279 RH 274 LFK 237 JDP 227 OKS 196 HTZ 187 ETM 122 IQW 102 HMX 80 GVL 73 JCH 41 HSK 35 AKT 25 ESZ 23 NSM 18 IQQ-LRB 14 IH-EXH 8 OTL 3 FAW 1.

DAKOTA DIVISION

NORTH DAKOTA—SCM, Wm. A. Langer, W9DGS—W9EJC resumed schedules. W9DYA uses a megger on a '33. W9JAR uses a '30 in transmitter. Newcomers include W9PAI, PGO, PDC, and OEL. W9KZL and PJT received Class C licenses. W9BTJ has '52 in final. W9MZE is c.c. on 3.5 mc. Ex-W9BVF is now W1HCOM with 900 watts on 14 mc.

Traffic: W9DGS 504 HJC 39 IGR 26 DYA 23 JAR-PAI 6 PJT 5 PGO 4.

SOUTH DAKOTA—SCM, C. B. Miller, W9DKL—W9AZR has a nice BPL total. W9DNS is going c.c. W9PFT has a fifty watt c.c. rig. W9BLZ worked day and night in SS. W9AJP's receiver is all A. C. W9DES is starting up again. Sioux Falls Radio Club is having a banquet at the Tip Top next month. W9GYG increased power to 50 watts. W9IQD has new frequency meter. W9CFU is back on the air. W9FLO plans to work 7 mc. New amateurs in Huron: W9PJU and PLB. The SCM plans meeting of South Dakota Radio Club by hamfest at Huron, S. Dak. next spring. W9TY plans to try 1.7 mc. for A.A.R.S. W9GTG changed from spark coils to rotary converter. W9IZQ is rebuilding. W9FOQ lost a '10. W9DGR was elected Pres. of Huron Club and W9DKL Pres. of Redfield Club.

Traffic: W9AZR 517 IQZ 160 GTG 98 DGR 38 TY 32 DNS 17 FOQ 71 GYG 6.

NORTHERN MINNESOTA—SCM, Robert C. Harshberger, W9JIE—W9BBL is first OPS in Section. W9HRB installed a Federal bottle. W9OMI and OOO are rebuilding. W9PAN was visitor to W9USA. W9PFR is new Melrose ham. W9HDN and JID worked SS hard. W9HNS delivers Isle Royale news to local paper for PCU. W9LFO is Alternate Corps Area NCS. A.A.R.S. W9NVU is home from Calif. for holidays. W9JIE is enjoying 14 mc. 'phone. W9IPR, BCT, HXR, JPR, JIE attend U. of M. radio class under W9JT.

Traffic: W9HDN 292 BHH 212 JID 268 JIE 181 HIE 195 IPN 174 HNS 23 IPA 40 IAY 9 OOO 6 LFO 125 KKQ 81 BVX 30 PAN 5 OBE 13.

SOUTHERN MINNESOTA—SCM, Norman Beck, W9EPI-EMQ—After making BPL for 4th consecutive time, W9BLG leaves us for New York State. W9BKX is now on 3580 kc. W9BKK, HCW report via radio. W9EPJ is moving place of business. W9BN renews ORS. W9CSU rebuilt to rack and panel. W9DOP reports no ORS in Luverne. W9EYL worked hard in SS. W9DEI boasts of six corn cob pipes in shack. W9YC reports formation of new club: Campus Radio Club with W9EQU Pres., HOT Vice-Pres., and JHG Secy.-Treas. W9DGE is on shore again. W9JEQ got new fifty watt. W9FNK promises activity in DX contest. W9LDQ is making changes around the studio! W9EGG completed SS receiver. W9CSJ lost two nights sleep trying to get his large traffic total—hi! W9AIR is back ashore and rarin' to go. W9GLE reports Rochester Radio Club going hot. W9OEV is building tri-

tet. W9JQA is coming on with '10s. Dec. 3rd at Winona the S.M.R.A. held annual meeting and election of officers: W9EGG Pres., DEI Vice-Pres., EGG Secy.-Treas.

Traffic: W9BLG 657 BKX 533 BKK 424 EPJ 301 BN 153 CSU 130 DOP 106 EYL 81 DEI 42 YC 27 DGE 24 DH 22 BNN19 FNK 14 LDQ 12 EGG 10 CSJ 2.

DELTA DIVISION

ARKANSAS—SCM, Henry E. Velte, W5ABI—W5BMI leads in traffic. Now c.c.: W5DSW, DFZ, DHG. Made BPL: W5BMI, BXM, CCW, BSG, BUX. Rebuilding: W5CVO, FK, DFZ. Active in U.S.N.R.: W5BUX, SI, BZK, AYH. New stations: W5DVJ, DVY, DVM. New antennas: W5CGW, DGL, W5BED has new a.c. Generator. New receivers: W5BMV, CPV, CNK. On Phone: W5BBS, BRW. New A.A.R.S.: W5DHN. New ORS: W5BUX. W5JK handled Red Cross messages. W5ABL is troubled with burning crystals. The SCM would like to hear from the gang as to how they like the new condensed reports.

Traffic: W5BMI 738 BUX 275 BXM 247 CCW 230 BSG 233 ASG 450 IQ 218 SI 156 DHG 41 BZK 30 ABL 24 JK-DFZ 18 DSW 15 DHN 13 DGL 10 CVO 6 CPV 5 BED 1.

LOUISIANA—SCM, W. J. Wilkinson, Jr., W5DWW—W5KC has reported regularly for years. W5BYJ joined A.A.R.S. W5BPL is one of our most consistent 'phones. W5HR is handling traffic on 'phone. W5DMP had QRM from SS contest. W5DAW is in Baton Rouge. W5VX is back after long absence. W5DMF received discrepancy report. W4BEX is studying at Tulane. W5AXU has new receiver coming. W5BSM completed new rig. W5DPM and DRC are new hams. W5DKR is Secretary of N.O.R.C. W5AEH is Pres. and W5JW Vice-Pres. W5BID has four good schedules. W5AQC got receiver working. W5CMQ is c.c. on 7070 kc. W5BBW is operating in movie. W5BZR entered SS contest. W5DWW is SCM's new call.

Traffic: W5DMF 6 DAW 10 DMP 18 BID 50 KC-DKR 7 BYJ 15 BSM 6 BZR 326 HR 17 BPL 3 AYZ 23. **MISSISSIPPI**—Acting SCM, W. P. Allen, W5VJ—W5CWQ is new ORS. W5DEJ applies for ORS. W5BUI wants to renew ORS. W5CLD will be new R.M. W5CO and BQX visited Jackson and carried W5ANI back home with them. W5AZV changed QRA. ORS applications are solicited! W5VJ wants to bring this ole state to the front!!

Traffic: W5BUI 249 DEJ 124 UM 55 CWQ 29 CLD 38 VJ 15.

TENNESSEE—SCM, F. F. Purdy, W4AFM—W4PL made over 21,000 points in SS. W5ACY is in C.C.C. camp near Norris Dam site. W4LN is operator of WPI, Federal Barge Lines. W4BMH is operator of Airways Radio station at Donelson. W4BOZ (WLRJ) is S.N.C.S. Tennessee A.A.R.S. W4RO (WLRJ) is Alternate N.C.S. W4AFM is Radio Aide for Operations, A.A.R.S. Fourth Corps Area. East Tenn. Radio Amateur Association's hamfest held in Johnson City Nov. 25th went over with a bang with 109 present. W4AAD is first Tenn. OPS. W4AYE reports activities in and around Nashville. W4BM schedules W9ZZP in Wyoming C.C.C. camp. W4ACU, "Major," is back on the air. W4BMC is nephew of W4AYE. W4ZP is busy with studies at Vandy. W4BEG is W3M operator. W4CDU is on 14 mc. W4LU has fine A.A.R.S. 'Phone Net going. W4EX is back on the air. W4AAD is going to junk his five kw. 'phone. Reports are that W4AXN is commuting between California and Tennessee. W4OI-CLN handles a dandy Naval Reserve net on Tues. and Thurs.

Traffic: W4AFM 654 PL 571 RO 220 BOZ 51 BVP 45 AYU 29 BTQ 24 EX 15 ACU-BM 10 AYE 6.

HUDSON DIVISION

EASTERN NEW YORK—SCM, R. E. Haight, W2LU —W2BZZ and EGF make BPL. W2BLU on 80 3750 MOPA. W2DEG had QSO with Lt. Comdr. Frank Hawks. W2FPH reports SS gave much QRM locally. W2CVL reports for TRI-STATES Radio Club, 5 members: W2BLU-FPH-FRU-CVL and W3AC. Active in SS: W2BZZ, BRS, EQC, DYC, ATM, DC. W2BJA is keeping TLG covered. W2ETH schedules PAQASD weekly on 3.5 mc. W2ACY is back on 3.5 mc. W2BKM schedules were

cut by power leak. W2GLI and BIA visited NYC. W2FEQ tells gang to try Doublet receiving antenna. W2GNI and FPH are lining up traffic net. W2EFU reports GSB, Union College, on air. W2Extra Special Operators, Gene and Dick. W2CJS was QSO W6LVN on 3.5 mc. W2GFH is FBX owner. W2BLI is QRL school. W2UL built new rig. W2FXC got FB7. New ORS: W2CLL, W2GFD reports for Kingston. W2DIN reports Crystal Radio Club new officers: W2ECC Pres., DIB Vice-Pres., DIY Secy.-Treas. W2QY spent Christmas rebuilding. W2CC is first 1934 ORS. W2DQT was home for Christmas. W2CBN is building a.c. receiver. W2APO went to NYC for Christmas. W2CJP is editor of S.A.R.A. news.

Traffic: W2EGF 507 BLU 321 LU 167 DEG 161 FPH 136 CVL-BRS 102 EQD 100 BJA 83 DYC 71 ETH 61 ACY 60 BKM 50 ATM 45 GLI 36 FEQ 23 GNI 22 DC 18 EFU 13 ESO-CJS 11 GFH 9 BLL-UL-FXC 7 CLL 6 CFD 4 FRU 2 DIB-DMC-CSC 1 BZZ 534 CC 8 DDW 172 ENY 9.

NEW YORK CITY AND LONG ISLAND—SCM, F. L. Baunach, W2AZV—New ORS: W2EKD, W2BGO is RM for the Bronx. New reporters: W2FAH, FCQ, FPJ, GLJ, GMI, GEL. Among the SS enthusiasts: W2EYS, FTS, FIP, DJP, CBB. W2OQ erected 45 foot 4 x 4 mast unaided. W2BTF is operating portable EPP at American Museum of Natural History. W2EEN helped FBE get on 7200 kc. W2BNL is at new QRA in Staten Island. W2AEN has 350 watts on 7 mc. W2FF, EGA and EPJ are working on rack jobs. W2DUP discovered an old timer a block away, W2AKF. W2GMP is heard plenty. W2CAC is working on supers. W2BRB and FLG are on 28 mc. W2ELK is on 3570 kc. W2GPR gets out FB with 220 on plates of '10s. W2A00 and EYQ have ACSW3s. W2EYB has plenty of condenser in his filter. W2FDQ, QX, and FYZ are going high power. W2DBE insists on self-excited transmitters. W2CEH has trouble with FB7 crystal filter. W2EWS missed getting a two button mike. W2EQA is thinking of learning the code again. W2DTT's transmitter was one year old Dec. 25th. W2PT schedules his YL, W2FBL, on 56 mc. daily. W2CUE was heard in Sweden. W2ETT reports from Rensselaer Poly. Tech. W2CJI is back from C.C.C. in Montana. W2FFN has DeForest 511. W2DOG says rack job is improvement over breadboard outfit. W2CUE has two rigs one on 7, one on 3.5 mc. W2CLM is using the buffer of his regular xmitter as the output stage. W2CHK and DBQ keep trunk lines going full speed. W2AGC enjoys building speech amplifiers. W2EVA says BBA gets out FB. W2BKP and AA are heard regularly on N.C.R. drills. W2AZV's 'phone is too expensive with class B transformers going west every week. W2AGC and AOB get out on 56 mc. with antennae in cellar. W2KR's 'phone is being heard by local BCL's. W2BPJ joined N.C.R. W2DWW and FO are on 3550 kc. The Sunrise Radio Club elected following officers: W2HN Pres., BNE Vice-Pres., DCG Secy., FAE Treas. The new officers were installed at the first dinner dance which was attended by 65 members and guests. W2GBQ and NI have reorganized the Wireless Society of N. Y. U. W2BEG is looking for a super sensitive super het in a 2 by 2 inch can.

Traffic: W2EYQ 533 DBQ 460 DBE 432 CBB 398 BGO 323 EYS 190 CUH 121 ELK 119 DUP 293 DOG 114 DJP 110 EGA 96 CHK 83 ETT 74 EYB 60 EKD 55 FF 52 DRG-DQW 45 DWW 34 BII 30 BTF-FIP 29 AZV 25 AEN 22 PF-OQ-QM-LB-GPR 20 GEI-GMP 19 BNJ-BAS-AA-FLG 18 PT-BKP 17 KR 16 CYX-FIS 15 CEH-BIK 12 GMJ-AOV-DJD-ATU-CIT-DPF-AGT-FFL-ATZ-FAR-FO-ADO 10 EGA 8 EVA 6 DTT-FDQ 5 BVT-AGC-EPJ-CPY-ASG 4 FFN-FCQ-BYL-EAF-CUE 3 GLJ-FPJ-BNL-HY 2 BRB-CAC-FAH-KJ-BMH-AOO 1.

NORTHERN NEW JERSEY—SCM, Walter A. Cobb, W2CO—Following eight fellows make the BPL this month: W2DIU, EKMI, BCX, BSC, DPB, AHL, AFK, EIC. W2SN reports 85,000 DX cards given out with about 5000 yet on file awaiting claimants. W2GPG is new in Orange. Santa brought W2CGG new receiver power supply. W2CTT won crystal at TRI-COUNTY RADIO ASSN. W2CIM is battling 'em out. W2BAI reports FBXA going great. W2DPA obtained ORS. W2DAC was hot after

traffic. W2GLB finds ham radio interesting. W2BWZ sent his semi-annual report. W2CIZ's power transformer let loose in flames. W2FJF is ORS applicant. Traffic takes all W2GAK's time. W2EIP joined League. W2BPY divides his money between college and Jersey Bell System. W2ENZ attends Junior College. W2FXE is a first reporter. W2DGU has QS0ed all W districts. W2FQR blew his rectifiers. ExW2CP breaks out of his shell. W2GCC is moving from Ramsey to Weehawken. W2CTV wants to find a nice home for his receiver hum! W2CSM is moving back to N. Y. C. W2FXZ is c.c. on 3.5 mc. W2EDJ is on 7 mc. W2BLQ reports KJTY R7. W2CFW reports 14 mc. DX. W2ECO is advertising his c.c. note on 3.5 mc. W2AIF is rebuilding for 77th time. W2FMI has new super. W2DOZ is proud papa of Class A license. W2CPA knocks them over with high quality 14 mc. 'phone. W2GNT is publicity manager for Memorial Radio Club of Englewood. W2FDK will be control op for club station. W2BYW's whole family was sick at once. W2BPV suffers from YLitis. W2GEG wants a White Plains, N. Y. schedule. W2BXM has a new emergency set all ready for use, which incidentally, is a good tip for some of the other boys to heed. W2EIC schedules PY9HC. W2ESB has code class of 2 YL members, with 7 hams as helpers. W2BJK obtained new super from W2FL. W2EOH hooked three new countries. W2CZP and FUY are plugging 1.7 mc. 'phone. W2CLM wants to know, "Who's afraid of the big, bad Wouff-Hong?" W2EYN's transmitter works fine up to final stage. W2FOP wants ORS. Annual election of Bloomfield Radio Club made W2NB Pres., W2PP Vice-Pres. W2FD, after 5 years of threatening, actually expects to get on the air. The SCM thanks all those who sent holiday greetings.

Traffic: W2DIU 2149 EKM 1152 BCX 1318 DPB 551 EIC 208 ENZ 198 CIM 153 DPA 36 BPY 14 CIZ-CJX 12 CTT 11 CGG 9 BSC 896 AHL 383 AFK 309 DVN 111 CTY 104 FJF 69 GGW 68 EIP 54 DAC 47 BAI 42 BJK 40 FDD 35 CLM 30 BWZ 21 FQR-FOP 9 FXE-GEG-BLQ 5 GCC 3.

MIDWEST DIVISION

IOWA—SCM, George D. Hansen, W9FFD—RM, W9ABE; RM, W9HPA—W9BWF returns and leads the list. RM W9ABE has depression troubles. W9LCX and FYX have fine schedules. W9EIV is still at it with the Army. W9JSO is chief op at N.C.R. station. W9ERY, FZO, NTY, had swell time in SS. Anyone desiring schedules and routing get in touch with W9HPA. W9LFF is on 14 and 3.5 mc. W9MHV lists new stations in C.B.; W9PDM, PDI, PJF, and PGG. W9LEZ acts as DNC of A.A.R.S. W9HMM revives. W9CWG is QRL AARS. W9JMB plans on 'phone. W9DZW-GP is busier than the proverbial cat. W9GWT says a schedule a day. W9DUN says the YL is fine. W9AYC is on 1.7 mc. W9FYC loans the portable to KOY. W9BFL cracks the crystal. W9DMX reports a few. W9GSY reports a new key filter. W9NVF heard the Stratosphere balloon of Settles and Fordney. W9DIB is working at WOC-WHO.

Traffic: W9BWF 422 ABE 321 LCX 264 EIV 254 JSO 182 ERY 176 HPA 155 LFF 137 MHV 127 FZO 111 FYX 100 LEZ 87 HMM 82 CWG 74 JMB 68 GP 67 GWT 65 DUN 55 AYC 21 FYC 35 BFL 19 DMX 13 GSY-NVF-NTY 6 DIB 4 FFD 11.

KANSAS—SCM, O. J. Spetter, W9FLG—W9KG and W9CFN, CW RMs. W9ESL Phone RM. W9KG reports Trunk Lines keep him plenty QRL. W9NMR schedules NY1AB handling Byrd traffic. W9OQC and JMS are rebuilding to c.c. New calls: W9PMA, PIW. W9ODV says job looming in office. W9APF, AWB and FMX are trying 56 mc. W9IXE is visiting in Louisiana. W9DMF and AWP worked hard in SS. W9BEZ is again active. W9BSX is knocking 'em cold. W9LFB has new portable receiver. W9ABJ built Micrometer freq. meter a la QST. W9OZN joins KNG. W9BDB is talking 'phone. W9FRC says "what a lot of power it takes to have a decent 'phone." W9KQJ is new ORS and OBS. W9OFR tried 7 mc. W9BYV had transmitter trouble. W9FKD uses pair 211s. W9NI handles lot of traffic on 'phone. W9LGR walks floor all night with Jr. op. W9JUT is new OO. W9VRC held Hamfest Dec. 14th. W9FWW won the grand prize. The



MISS OPAL SISK, W9CMV, ONE OF KANSAS' YL OPERATORS

29 NI 28 HL-OFR 24 LRR 17 BYV-CMV 16 LWP-KFD 15 EYI 8 LGR 7 BSK 4 AWB 3 DVQ 2 KM 28.

MISSOURI—SCM, C. R. Cannady, W9EYG-HCP—The Missouri Bulletin continues with but two objections. Write today for your copy. The St. L.A.R.C. and A.R.F. of St. Louis, the H.A.R.C. of Kansas City, and the S.M.A.R.A. are the leading clubs reporting radio activities on the increase. W9BMA again led the state, followed closely by W9MZD—a new one in big traffic totals. Both stations together with W9GBJ and LLN made BPL. W9JAP and NNZ get ORS. Operators interested in Official Phone Station (or in ORS, or OBS.) appointments should get in touch with the SCM at once. Those interested, let us have your suggestions and ideas. We will try to please every active man. The standings of the activity CUP RACE for this year will be released soon.

Traffic: W9BMA 710 MZO 507 GBJ 338 ASV 301 ALJ 286 LLN 214 LJE 143 NNZ 133 GTK 117 ENF 106 CJR 98 EDK 93 ECE 69 LBA 66 AQX 60 CRM 53 CVP 50 DIC 48 KVN 37 NAQ 29 HUZ 20 HUG 19 LJO 18 AEQ 17 JAP 16 EYG 15 FNO-AAN 14 AME 13 OMG 12 AUC-DPJ 10 DUD-OLC 9 JPT 8 HNM 5 JEH 4 KEP-MLR 3 HVC-JWI-DPF-FZJ-I.VA-DGI 2 EOW 1.

NEBRASKA—SCM, Samuel C. Wallace, W9FAM—W9BNT says work at WVU prevented more Amateur work, but look at that total! W9DI is trying to help the boys get schedules. W9DMY is all c.c. now. W9FAM has two West Coast schedules. W9EWO is winding transformers. Good reports from W9JLP, DCC, JEE. W9FXP is rebuilding to c.c. W9DGL is still DXing. W9EEW says W9EYE got his license fixed up. W9DFE is back from Indiana. W9IFE is knocking 'em stiff. W9FZX has a bunch of FB schedules. W9KPA has FB West Coast schedules. W9FGS is working a North and South schedule. W9UCY says last month was the best traffic month for him. W9CWM says if Clyde Wright, Port Quinby, and Jack Frost would lay off he might get time to work a little. W9PHF can handle traffic for Ellis, Diller, Harbine, Janzen, Plymouth, Beatrice, and Steel City; he has free phone to all these places. W9KJP reports for Omaha gang. W9EDY says all the Auburn gang is sporting new a.c. receivers. W9OPP cracked his crystal. W9DHO saved a postage stamp by having W9OPP report for him. W9PEX and KVB send first reports. W9DLK is back.

Traffic: W9BNT 2436 DI 517 DMY 536 FAM 181 EWO 129 DGL 4 EEW 3 FXP 21 IFE 606 FZX 475 KPA 301 FGS 260 CUY 214 CWM 56 JEE 53 PHF 47 KJP 34 EDY 22 JED 15 DLK 17 PEX 16 KVB 11 OPP 18 DHO 6 BQR 2 EHW 105 JLP 22 DC 37.

NEW ENGLAND DIVISION

CONNECTICUT—SCM, Fred A. Ells, Jr., W1CTI—W1FO leads the Section with a bang-up total. Following BPL: W1FIO, AMG, CJD, MK, UE, BYW, BDI. W1BEM ran up big SS score. Through kind help of W1DPK, DOV was loaned an FB7 for SS. DX at W1EWD was Germany on 14 mc. W1GC can QSP to most any point. W1APW clears traffic within 24 hours. W1GGM offers telephone delivery to Greenwich and Stamford. W1BMP works West Coast consistently on 3.5 mc. W1CNU delivered a message 26 minutes after it was filed. W1SZ reports many stations showing active interest in

becoming OPS and cleaning up phones generally. WIAVB is working on tritet. WIBQS was only able to listen on SS. Wallingford Radio Club elected following new officers: WICRK Pres., WIFDU Secy., WIEKD Chief Radio Operator, D. Mac Treasurer, O. Lacroix Activities Manager. WIEFW is cooperating with WIQP on 28 mc. 'phone tests. WIDOW says Waterbury gang visited Bristol Club and WIBHV gave a fine exhibition of magic. High winds nearly snapped mast at WIBFS. WIQV is the proud papa of a girl, "Nancy Jean." A detailed Conn. report is printed in "Hamonics," which is published by Conn. Brass Pounders Association. Drop a line to CBA, Box 502, Norwalk, Conn. for your copy.

Traffic: WIFIO 614 AMG 569 CJD 568 MK 439 UE 404 BYW 284 BDI 270 RHM 242 DOV 194 EWD 193 EEL 188 DOW 151 DFZ 139 GC 138 CTI 132 DGG 112 APW 111 AUK 77 GGX 76 QV 66 DCI 64 BIX 59 GUC 53 EFW 50 AFB 44 BWM-ES-GKM 41 BSS 35 DBU 24 BMP-BIQ-NE 21 CNU 20 GKM 17 ESD 11 BNB-SZ-GTV-GKQ 6 EAO 5 FUY 4 HJW-GUK 3 CUH 2 HOP-AVB 1 BFS 12.

MAINE—SCM, J. W. Singleton, WICDX—WIEF is working hard on trunk lines. WIFL, located at Portland Exposition, was operated by WICRP, CPT, DEO, DIJ and CHF. WICHF has seven good schedules. Send WIBOF dope on your schedules. WIBTG enjoyed SS contest. WIAQW renewed ORS. WIGBM is in line for ORS. WIDFQ uses 'phone and c.w. WIEBM is new ORS. WIDHH uses pair of '50s in final. WICDX was on more this month. WIBNC reports Waterville Club going fine. WIEFA has 59 tritet osc. WIEPJ is working steady. WIFNG applied for ORS. WIEZR is back on 3.5 mc. WIBTA wants schedules. WIAPX visited CRP and CPT. WICRP and FA contacted on 56 mc. 'phone. WIDUJ of Biddeford is now at Warren. Hamfest in Lewiston Saturday, Feb. 17, at De Witt Hotel; cost is one buck. WIAQB is recovering from illness. WIGEK looks like ORS material.

Traffic: WICPT 352 EF 292 FIL 248 CHF 231 BOF 228 BTG 176 AQW 110 GBM 91 DFQ 88 EBM 82 DHH 48 CRP 61 CDX 53 BNC 35 EFA 26 BLI 18 FJP 12 FNG-EZR 11 BTA 5 AGL 2 HIL 1.

EASTERN MASSACHUSETTS—SCM, Joseph A. Mullen, WIASI—The XRM, WIVS, reports with his chops dripping to the total of 597. Close behind is EVJ and CRA. WIASI gets on at intervals. WIABG is praying for second place in SS. WIKH is QRL hamfest activities. WIWV handled WX with Mt. Washington. WILM is ready to give up his ghost due to schedule failures. WIBBY has new antennae system. WIEVJ's neighbors are planning a lynching party with him in the leading role on 1.7 mc. WIBMW keeps daily schedules with the RM. WIJL reports annual banquet of Middlesex Club late February. WIRE is going big on 1.7 mc. traffic. WIVS is handling Byrd traffic. WIBZO is reappointed ORS. WICRA and CHR are after ORS renewals. WIVX celebrated his 8th anniversary on the air December 10th. WIAKY has tritet job. WICFU holds four schedules. WICNA worked G6NP on 3.5 mc. WIZO has two fifty wattors on 7 mc. WIEVE has his rig working FB. WIEBF is hoping for top place in SS. WIACH has a rack job under way. WIGEC is confined to hospital. WIGEN has MOPA on 7 mc. WIFRO is building up her totals. Old WIFBR reports his activities as 163. WICLE reports for first time. WIBSF is ex CCP. WICGM, AKN, SB and ZK are QRL plans for greater Boston hamfest to be held late in January. It will be sponsored by South Shore and Eastern Mass. amateur radio clubs. WIAQI is working as orderly in hospital with GEC. WIBJN, scribe for M.A.R.A., sends following dope: WIEMG works DX on 3.5 mc. WIFSK is building 56 mc. WIDAI has new 14 mc. rig. WIDEV took some of the rough edges off that buzz-saw. WICTW is getting along fine with 28 mc. rig. WIEMF installed new 50 watter on 1.7 mc. 'phone. WIBJN is attempting to give EMF competition. WICKV gets fine reports on 7 mc.

Traffic: WIVS 597 EVJ 389 CRA 375 BEF 286 ABG 280 WV 209 BFR 163 KH 107 AGA 102 PRO 91 BSF 81 GEN 62 BMW 56 BBY 50 EVE 46 CHR-ACH 45 ASI-CFU 32 RE 20 LM 12 CLE 11 GEC-CNA 2.

WESTERN MASSACHUSETTS—SCM, Earl G. Hewinson, WIASY-WIRB—WIASY and ETC BPL on deliveries. WIIHR is QRL college. WIDUZ is second W. Mass. OPS. 'Phone men are invited to apply for OPS. WIEAX reports "Watchusett Air Relay" has 22 members. The Springfield Radio Assn. is looking forward to 1934 Convention. WIZB puts in his spare moments at the factory. WIBNL has tritet osc. WIHOD has Collins transmitter. WIBKG should write WIVBR for schedules. WIVBR is now WLE as NCS for A.A.R.S. WIDCH is conducting code class for 11 C.C.C. boys. WIDVW gets R9 plus in Detroit on 3.5 mc. WIECT BPLs for first time. WIASY worked PAØAS on 3.5 mc. Active in SS: WIBKQ, EOB, COI, FAJ.

Traffic: WIASY 313 ETC 289 CCH 177 FAJ 171 COI 164 EOB 152 DVW 118 DCH 94 BVR 77 CPU 50 BZA 73 DIE 46 ARH 43 BKG 39 BKQ 28 HOD 27 AJD 20 BNL 10 ZB-BWY 6 OF 4 EAX-DUZ 3 HHR 1 DTA 48.

NEW HAMPSHIRE—SCM, Basil F. Cutting, WIAPK—WIUN is handling traffic with WIFEX. WIBMM is QRL railway mail job. WIGDE is ORS applicant. WIFCI renewed ORS. WIDMD's SS score is around 30,000 points! WIERQ and DMD BPL. WIGWY works DX on 14 mc. WIGXI likes single tube operation. WIHJM has SW-3. WIDUB is working in Capitol city. WICBB has FB-7. WIAYA has 50 watter in final stage. WIFJT and BII and BEJ are rebuilding. WIEFL is active A.A.R.S. WIGEK did good work in SS. WIAVJ is on 3.5 mc. WIAGO and FGC held a contest of their own in SS. WIIHO is new Nashua ham. WIANS operates 1.7 mc. 'phone. WIAFD moved to new QRA. WIIHQV is on 56 mc. WIBAB, MB and BFY are back with us. WIAUY is looking for over-modulation as per Jim Lamb's article. WIEHO enjoyed the SS. WIIP is on 14 and 7 mc. WIBJF and FFZ are new ORS. Our Super 'phone station at Glenciff Sanitarium is doing a fine job with WICCM as chief opr. WIGKE uses e.c. oscillator MOPA. WICUN is interested in 28 mc. work. The St. Paul's School Radio Club is awaiting antenna insulators. WIET of Dartmouth College is building new high power rigs. The north country sends a fine report from Berlin: WIAP, TP and FGM. WIAPK has been QRL Radio Service Lab.

Traffic: WIERQ 658 DMD 534 AVJ 292 AVL 250 BAF-UN 124 FFL 68 BAB 86 CEY 59 CUN 54 GDE 52 FFZ 16 FCI 26 CCM 2 APK 54.

RHODE ISLAND—SCM, Stanley Atkinson, WIAFO—WIGTN has new super almost under control. WICAB's new Jr. op. can say "dah dah." WIGOG is devoting much time to R.I.N.G. WICPV has new e.c. rig perking FB. WIASZ is back at old QRA. WIDDY is rebuilding for 14 mc. WIBLV BPLs; he worked 18 west coast stations on 3.5 mc. in seven days.

Traffic: WIBLV 779 GTN 75 CAB 68 GOG 53 CPV 22 ASZ-DDY 12.

VERMONT—SCM, Harry H. Page, WIATF—The "Green Mountain Rattler," A.A.R.S. Journal edited by WIDB, is gaining a national reputation. WIDQK handled important traffic between Port Ethan Allen and Washington. WIAAXN and CGV ran neck and neck in SS. WIFPS grinds out his "QST" regularly on 1884 kc. WIBJP is outstanding "Unlimited Phone" licensee in Vt.

Traffic: WIATF 174 CCF 166 DQK 109 AXN 89 BD 76 CGV 63 BJP 39 GGT 37 GAE 32 FPS 23 EBF 14.

NORTHWESTERN DIVISION

IDAHO—SCM, Don Oberbillig, W7AVP—BOISE—Gem State Amateur Radio with 40 members held first annual feed. W7DQC was drowned while duck hunting. W7GU installs forest service transmitter. W7DAW is building hearing aids for deaf. W7DBP orders new '10s. W7DLS will be e.c. W7BMF schedules AIG. New A.A.R.S.: W7CUG, DKM. 23 mc. 'phones: W7CSP, CKO, CZO, CP, DAW, BRU, BAR, DEB, IY. W7BRY serves state on Police radio committee. W7ABK hears KJTY. W7DEQ and EAY work on Radio Club Banquet. W7BRU and CHT worked in SS with flea-power. W7AVP, CFX, BLT test radio conditions for all-day reception from Boise to Twin Falls to demonstrate feasibility of police radio. W7AXY is playing checkers. W7ASA works

14 mc. W7BCU has new PR10. W7ATN puts 500-watts into two '03As. W7BEN is back on air. W7KI is at WUBJ. W7AYP lost his appendix. W7ACP is QRL YL. W7NHI and AVZ are getting ready for busy season. W7GL paid San Francisco visit. 3.9 mc. 'phones: W7KJ, JY. W7CAP likes 7 mc. W7BAA is QRL A.A.R.S. and Red Cross traffic. W7CSW has flea-power 1.7 mc. 'phone. The SCM wants a post card from every ham in Idaho next month reporting activity. Let's put Idaho on the A.R.R.L. map.

Traffic: W7AVP 309 CHT 81 CAP 4 BAA 62 IY 12 BRU 71 CSW 21.

MONTANA—SCM, O. W. Viers, W7AAT—SS participants: W7BVE, CREH, CEG, BSU, BEB, BJZ. W7BJZ is new ORS. W7BDC is first OPS in Section. W7FL is still on. W7BDJ says skip is wrecking A.A.R.S. schedules. W7CCR was headed for BPL. W7ASQ reports three new Helena stations. W7BMX is putting on new class A station. W7BSU has '60 in final. W7BDS, BYE, CPY, CBY, BHS and EDJ, all of Roundup, reported. W7AFS, quit the farm. W7CJT has nice 'phone. W7AOD has swell 3.5 mc. signal. W7CRH, BVE and AAT made BPL.

Traffic: W7AAT 536 FL 13 CCR 296 BHB 28 BJZ 67 AOD 76 BDJ 81 ASQ 91 BVE 286 BMX 18 BDC 11 BSU 104 BDS 5 CPY 10 CEG 12 CRH 490.

OREGON—SCM, Ray Cummins, W7ABZ—W7HD, ABH, DBR and MF make BPL. W7BET is now at St. Helens. W7AMF illustrates his FB letters. New poles at W7AZJ. W7WL has complete link-coupled rig. 120 footer at W7ABZ came down in big wind. W7MQ, BEE, AIP, and KR purchased whole layout at ex-W7PL. W7BKD, AIP, and BDN are active on 7 mc. W7BZS is active A.A.R.S. W7DP is new prexy of Pendleton Club. W7CFM, BUB, and BDU are putting in '03As. W7KL is "Moresin" W. U. traffic from Olympia. W7AYN, CVL, ALB are new ops at WUBH. W7ANB is building new shack. W7BGF has automatic switch for QSY from 7 to 3.5 mc. W7QW "ash-canned" the '46s. W7AHZ and ABZ shelved the '52s. 212D modulator at W7BEK. W9FQK, ex-college prof., is new member of V.R.C. W7UJ can work only W8's. W7BRH has new transmitter and receiver. W7DEA reports on Coos Bay gang. W7DQW's antenna came down six times in our storms. Severe storms in Oregon and Washington gave W7COU, WR, AYW, and AXJ the opportunity for nice emergency work. New Medford Club officers: Pres., W7CRN; Vice-Pres., DEZ; CIE, Secy.-Treas., and MF, reporter. W7LI schedules KAIME. W7BWD, AVB, and DEA are dodging the rain, and sea waves. W7DVX possesses crystal 1/4 inch square. W7CWH is getting gurgle out of his note. New C.B.A.R.C. members: W7DMK, and CTR. W7CMK and CSQ visited the SCM. W7BLN has c.c. rig perking. W7DP gave up schedules because of QRN. W7BKL keeps in touch with home through schedule with W7BOO. W7DBR handled traffic from KAINE and AC2RT. W7DPX is ex-W9JDU now living at Newberg. W7CHB has long hop 14 mc. schedules. W7DJI is QRL school. W7QY is rebuilding to 100 watts c.e. W7AXJ handled Alaskan SCM report. W7ANX is going to build c.c. super. W7AIG has SW3. W7CXX worked W1BLV on 3.5 mc. with single '45. W7AOL lost one of his pet DX '10s. Nice traffic reports received from W7CEJ, DCI, DGR, SY, and DXC. Our goal is 150 traffic reports on March 16, 1934.

Traffic: W7HD 401 ABH 302 DBR 271 MF 272 AYW 246 AXJ 240 DP 124 CEJ 112 ABZ 56 ECO 55 BRO 54 BLN 52 BWD 49 AXO 47 AVV-DUE 46 AIG 43 BOO-COU 40 CHB-CVL 33 AMF 32 DXC 26 BRH 29 WR 24 BUB 23 LI 22 DCR 21 BMA 20 DCI-BKL 18 SY 16 BNK 15 AOL-DWQ 12 CXK-CIK 8 AVB 5 BBO 14 ANX-ALM-DVX 4 AZJ-BGF 3 AHZ-QY 2 CMK 4 BZS 7 BXO-EBQ-AYN-DJ1 1.

WASHINGTON—SCM, Stanley J. Belliveau, W7AYO --W7CZY leads the Section. W7LD is doing very nicely with traffic. W7WY says his total not due to SS. W7AYO, AAX, CYS, and DM handled emergency traffic for N.P.R.R. W7BYB has '03A. W7CAM has new jr. op. W7IG is QRL A.A.R.S. W7BHH is still listed in a YLs date book. W7DLG reports traffic but doesn't say how much. W7AVM heard KJTY and WHEW. W7APR and CND

were active in SS. W7DVP send first report. W7AFC is new OBS. W7DZX needs Europe for WAC. New reporters: W7CQK, GZ, APO, DRD, CDD, CWN, W7AGE makes BPL. W7DRY applies for ORS. W7AZI clicked H2D. FBXA at W7CQL. W7ABU rebuilt. W7DPU works Southern Calif. on 1.7 mc. 'phone—5 watts input. W7AHT ops at Airways Station. W7BEV uses twisted feeder system. W7CHU handles lotsa traffic. W7BBK and AWY keep the air hot at Ritzville. W7DGY worked a new state. W7APS doesn't think much of skip. W7AEG is always first station to report. ExSCM, W7RT is back on the air. W7QI sent a '66 to the land of sky "blew" waters. W7DET is building MOPA. Following report by radio: W7CWL, RG, CGO, AMN, BUW, ECM, DMN, EAW, BTW, ALH, AWF, CZY, CSK, BLX, AJ, CKH, DGN, DJJ, YH, CFK, AWQ, LD, AIT, CPF, CCO, ASZ, and AHM. DON'T FORGET THE BIG SEATTLE CONVENTION THIS SUMMER.

Traffic: W7CZY 854 WY 627 LD 468 AGE 274 AYO 206 DVY 175 CQI 170 AWF 132 ALH 129 BLX 120 RT 93 DPU 89 DRY-BHH 73 DLN 70 ABU 69 CHU 65 IG 64 CND 58 BYB 51 APR 50 QI 49 AJ 45 AAX 42 CPF 41 DGN 40 CFR 38 APS-DJ1 35 CSK-ASZ 32 CYS 30 AMN 27 EAW 23 DGY 22 BG 17 AZI-AHQ 16 DET-CWN 13 OWL 12 BBY-CXC 10 AIT-DZX 9 DWC 8 CKH-DRD-AWY-KO 7 BTW-CCT-CAM-BUW 6 AHM-ECM-DM-BBK-AVM 5 CQK-AWQ-AUP 4 CDC-GZ 3 AHT-BUB-YH-OS-BUX 2 DMN-CDD-CFY-BEV 1 CGO 46.

PACIFIC DIVISION

HAWAII—SCM, C. D. Slaten, K6COG—K6GZI has portable TPTG. K6AUG is putting '04A in final. K6GUA is getting new call. K6EWW uses pair of '04As in c.c. rig. K6JPT makes BPL for first time.

Traffic: K6EWW 1562 JPT 523 GUA 280 FAB 180 AUQ 67 GQF 49 CIB 24 GZI 18 EDH 2.

NEVADA—SCM, Keston L. Ramsey, W6EAD—W6GYX uses '46s in final. W6HOB's sister is W6KAB. W6AJP uses link coupling. W6FUO has new super het.

Traffic: W6GYX 99 UO 94 HGL 57 AJP 25 FUO 11 HOB 3.

LOS ANGELES—SCM, Francis C. Martin, W6AAN --The gang came through with nice increase this time. Federation Hamfest at Bell Club went over in big way with attendance of 215. This same Bell Club wins the new Section Banner donated by Chief Route Manager W6BPU. W6JTF sets good example in reporting—old timers please note. W6AZU has fun with skip-cold WX. W6DWH reports via W. U. W6AKW was down from desert several times during month. Bad power noises at W6FZL. W6COF has shielded rig—500 watts input. W6EZF is building low power 'phone as auxiliary. W6GNM continues FB line of schedules. Reports from W6MA-W6AM indicate excellent results with directional beam. W6CLY goes domestic and totals suffer. SW3 at W6PD. Traffic bug bites W6EK again. W6RZ gets new Class A ticket. Don and Mac at W6GXM and CII are rolling up the old totals. W6IHK reports plenty trouble. W6ANN routes Byrd traffic through New Zealand. The old portable at W6EYE is in the field again. W6DZR blows filter. Red Cross Roll Call kept W6DQZ busy. New antennae at W6IRD. Most of traffic at W6AHP now on 14 mc. 'phone. W6TN pushes '52 final with '52 buffer. W6DIX at March Field reports ignition QRN from Planes. SS Contest brings out W6HHG. W6AGF moves away from power leak. W6EFH gets new Junior Op and First Class Radiophone ticket same month. Hal Nahmens is building 'phone rig. W6DOK was heard in ZL at 9:35 a.m. PST 3.5 mc. The inter club contest is bringing out bunch of new reporters—here are some: W6AXQ-COF-CHU-CCT-DZI-EFH-EJZ-FDO-FMO-GVI-HT-IZX-HTF-WT.

Traffic: W6ETL 2202 CBU 595 CXW 529 GXM 516 CII 353 AHP 347 GNM 340 NF 337 AZU 311 ETJ 272 BPU 207 FIT 169 DZR 154 EGJ 130 FXL 105 FTV 90 AKW-FQZ-FZL 80 HEW 65 AM 64 CVV 60 GEX 57 PD 47 EQW 46 IRD 45 AIF 42 BGF-DJC 34 EUV 33 CNO 32 CPM-DYJ 31 GFG 29 IIK 28 DJS 26 TN 23

HAH 22 DWH 21 AAN-DQZ-HHG 20 XHU-ITN 19 EK 18 GTR 17 BPP-HJW 15 DCJ 14 GNZ 10 EZF-IFC 9 ANN-DUX-HTO-HZB-IDU 8 BQF-BVZ-FNG-GMA-JCU-LC 7 AGF-DOK-DYQ-FXC 6 CEM-EBJ-MA 5 FPN-RZ 4 DEH-FEX-GOX-JJU-ON 3 FSE-FVD-FYW-IPX-IXH-JOB-JOJ 2 CLY-CUY-DGH-DLX-DVV-DZI-EGC-HUM-JMJ-JA 1 FGT 6 WT 5.

SANTA CLARA VALLEY—Acting SCM, Barton Wood, W6DBB—W6CUZ received card from G5HB. W6FQY routes Canal Zone traffic through K6 schedules. W6DBB received ZS and PY cards. W6BMW is stuck on his FBXA. W6HCQ's brother is KBA. W6GOZ entered SS. W6YX has possible source of 3000 originations and deliveries! W6JUQ is new Hollister reporter. W6AMM obtained Radiotelegraph second. New ORS: W6CUZ, YX, BCF; OPS: W6QR; OO: W6QR. Renewed ORS: W6CEO W6CEH's 400 watt 1.7 mc. 'phone is well started. W6IUZ uses single-wire fed antenna. W6IUW brought portable to this Section from Bakersfield. W6IKJ found key-click filter causing chirp. Peninsula Radio Assn. enjoyed talk on super-hets by E. M. Sargent, designer of Sargent 9-33. W6BHX is organizing code practice class. W6FBF is one of YG's chief ops. W6GFW has been cleaning up sigs. W6BSO has to re-erect whole station for every transmission. W6HZW expects to use 'phone exclusively. W6HJF is building c.c. rig.

Traffic: W6CUZ 319 FQY 276 DBB 235 YG 75 BMW 53 HCQ 36 GOZ 31 FBW 26 YX 26 JUQ 14 IUZ 2. (W6FQY 93 Oct.—Nov.)

EAST BAY—Acting SCM, P. W. Dann, W6ZX (Phone Thornwall 6412)—Whoopie! That's the way the SCM feels over the GREAT reports from all the East Bay Section gang. Boy, keep it up! Non A.R.R.L. members as well as members are urged to report. We need more ORS! (East Bay Secn. takes in Alameda-Contra Costa-Solano-Napa and Lake Cos.) W6AUT forwarded report on Napa gang. W6APB has fifty watt c.c. rig. W6BYS' antenna pulled down a ladies clothes line. W6CZN gets afflicted with "codditis" in his shack. W6JNX has an FB7A. W6BPC QSOed ZS2A. W6FAC and CYX are on low power 'phone and c.w. W6IKK and GYA are on 1.7 mc. 'phone. W6AUT is QRL W. U. Tel. Co. W6PB schedules OMITB. W6BUY is on 14 mc. 'phone. W6PS and WP are rebuilding. W6VS built a super. W6AF is working on the Railroad. W6IY and FII are QRL A.A.R.S. drills. W6RF, CTX and EDO are busy with NR work. W6GHD's traffic was all from KA1NA, AC2RT and K6GUQ, and was all mailed to destination. W6RJ has new 4-stage rack and panel job. W6TG (Ex-7KG) is new ORS. W6CBS, OPS, worked ZL1BQ on 'phone three nights straight and handled emergency traffic for K6CTB. Our OO, W6CIZ, built oven for crystal oscillator. W6EJA says KROW moved to Oakland. W6FIL says WX in Philippines NG. Active in SS: W6HRN, ATR, ZX, AF. W6ASH knocks 'em all dead with 603 messages. W6IT is building transmitter for AOU.

Traffic: W6ASH 603 TG 370 JR 366 ZX 266 FII 127 EDO 112 ATR 107 HRN 97 YM 74 TT 48 1Y 39 CIZ 35 PB 30 AF-CBH 25 FIL 20 DHS 13 CBS 12 EJA 5 PS-HB 4 RF 97 GHD 379.

SAN FRANCISCO—SCM, Byron Goodman, W6CAL—Thank you, gang, for biggest report in history of the Section. W6PQ, BIP, DJI, ENM, and CIS BPL. Tritet at W6JAL. W6CWU schedules OMITB. In SS were: W6BIP, ENM, DJI, CIS, AZX, GWW, ABB, AZK. W6PW has noise eliminator gadget. Three new states for QRP 3.5 mc. rig of W6DQH. W6CAL is QSO W9's on 28 mc. W6GIS handles China and P. I. traffic. First report from W6HJP, JQJ. W6IDN schedules BPP. W6ATP is 100% YL station since Chuck joined Navy. W6JVV handled C.C.C. traffic. W6JMR is DXing with QRP 3.5 mc. rig. PP 45s kicking out fine for W6JZB. W6AWA is experimenting. W6 HSA likes HAMFLASHES, which comes gratis to all reporters. W6JDG at Fort Bragg has three schedules. W6IU and BVL have YLitis. W6BAY, OS, BIM are rebuilding. W6DDO schedules K7DOF, W6WC likes e.c. osc. in MOPA. New receiver at W6GQA. W6UL is c.c. on 7 mc.

Traffic: W6PQ 1924 BIP 466 JAL 416 DJI 375 ENM 250 CIS 248 AZX 184 ABB 235 CWU 162 PW 140 NK

117 DQH 79 CAL 84 AZK 66 GIS 54 HJP 50 IDN 40 DTR 37 ATP-JVU 33 JMR 22 JZB 19 AWA 11 GWW-HSA 9 JDG 8 IU 6 JQJ-BAY-OS-DDO-BIM 5 BVL 4 WC-GQA 2 UL 1.

SACRAMENTO VALLEY—SCM, George L. Woodington, W6DVE—W6GAC is high traffic man. W6JNB is new traffic man. W6GHP is rebuilding. W6JDD is only active ham in Weed. W6IZE got tag from FRC for RAC! W6IQH has BCL trouble. W6JPI and FLR are making 56 mc. rig. W6GUK bought AIM's outfit. W6GSP is trying to make MOPA work. W6FEJ and FYY are still with C.C.C. W6GCM has been running down power leaks. W6EFM has rig inclosed in glass case. W6DVE received new license. W6HVM is on with c.c. MOPA. W6FOD blew transformer. W6CKV was home for Christmas. W6JOR is coming on with pair of fifties. W6DFT built new receiver.

Traffic: W6GAC 87 DVE 71 CGJ 14 DFT 4 JNB-GVM 3 JDD-ENC 2.

ARIZONA—SCM, Ernest Mendoza, W6BJF—W6DKF has been appointed Phone RM. See him about test for OPS appointment. W6ALU makes BPL in 12 days. New receivers: W6GZU, IJR, HKX, JIW, GBN. W6IQY has '52 final. W6ILF and HVY are on A.A.R.S. drills. W6CQF is at KVOA. W6HUZ blew final. 1.7 mc. 'phones: W6FOH, FPF, HBR, FKX. W6BPV uses condenser mike. W6DHR is gunning for DX. W6HCX has 63-foot poles. W6JRK had BJF revamp his PP heap. W6FRW is second op at JRK. W6GGS is designing portable transceiver. W6DKF keeps busy grinding crystals. W6CKW alternates betwixt 3.9 mc. 'phone and 7 mc. c.w. W6HQQ is new operator at Ajo. W6ILL, puts Glendale on the map. W6IZU wished for a new 825 for Christmas. W6IOG has bigger power supply. W6BJF returned his call to FRC in favor of W6QC. W6GUQ has '11 final. W6CVW has pair of '04s. Flagstaff visited radio clubhouse with 100% attendance. W6EAN brags DCQ. W6EGI is looking for a place to hang his commercial ticket. W6DPS uses self-excited 211 TPTG. W6BYD plans a radio store at Tempe. W6GFK covers the state for an oil firm. W6ZZBC is making noises on 7 mc. In Phoenix we have their majesties, the "King" (JYQ) and the "Queen" (IXC). We extend our sympathies to W6HAX in the loss of his mother-in-law. W6DVJ has a "for sale" sign on his junk. W6AND discovered how to scorch holes in 7 mc. with a 211! W6BCD likes PP e.c. MOPA. W6HG adds ZL to DX. W6GZ is a radio "pleeceman." W6FEA is interested in television. W6HEU tries contacting his dad, W8JDW, in Ohio. W6CKF plans ship job. W6EKU uses 212Ds for modulators. W6DSQ is interested in motorbikes.

Traffic: W6ALU 424 IQY 13 GBN 17 IIF 9 GZU 7 IJR 6 CQF 5 HUZ-DOW 4.

PHILIPPINES—Acting SCM, Newton E. Thompson, KA1XA—KA1PS is leaving for States Dec. 21, also KA3AA on Dec. 28. Seasons Greetings from the Philippines.

Traffic: KA1HR 2074 RC 796 NA 557 CM 554 LG 261 ME 149 OR 108 CS 87 CO 95 XA 36 TS 26 SX 20. KA3AA 105 KA4GR 11 KA9WX 113 OMITB 621.

SAN DIEGO—SCM, Harry Ambler, W6EOP—RMs W6QA, W6FQU, W6IBK, W6BMC and BAM make BPL. W6DQN has FB total. W6EFFK schedules Guam. W6FQU says local del. net FB. W6FWJ has five schedules. W6ITP has vertical ant. W6JHC is new ham. W6CNB and IQX are QRL YLs. W6IBK, 'phone RM, has three schedules. W6BOW worked KA. W6FQM is new reporter. W6AKY handled traffic for Byrd. W6GTM and AXN are going c.c. W6DWA has 14 mc. 'phone. W6GNT is attending college. W6BCF is at Stanford Univ. W6GNP is taking out OPS. W6LD has new 'phone. W6FKT is now ORS. W6BHV made fine score in SS. W6EOP has new rig.

Traffic: W6BMC 1518 DQN 417 BAM 254 EFK 205 FQU 193 FWJ 123 BHF 59 IBK-BOW 19 EOP-FQM 18 AKY 17 AXN-GTM 16 DWA 9 GNT 8 GNP-LD 5 FKT 3 BHV 1.

SAN JOAQUIN VALLEY—Acting SCM, A. H. Green, W6AOZ—W6CXX (ex6BHQ) and CLP make BPL. W6CGM is adding '52. W6WA is on 1.7 and 3.5 mc. W6AEW has gone to 'phone. W6EJU-FKV combination has new a.c. receiver. W6GEI is pouring 200 watts into

5fty. W6HPZ puts on code practise nightly except Sun. and Mon. on 3505 kc. at 7 p.m. PST. W6FFU likes Link Coupling. W6CRF and GZH are Fresno newcomers. W6AME attends U.S.N.R. meet at Fresno. W6GKE leaves Section for LA School. W6EPQ says KA and VK schedules good. W6AGV is handling A.A.R.S. traffic. W6FYM has new job. W6CLP is trying for Europe schedule. W6DTJ is working over MOPA. W6BLB resigned as President S.A.R.R. W6CCW and GUZ have FB7s. W6BIJ is rebuilding. W6GFZ's new QRA: Delano. W6BXB has he-man rig under way. Stockton Radio Club elects new officers: W6BXB Pres. It is with regret I report Gus Cates (W6GAI) for "Silent Keys."

Traffic: W6CXX 352 HBZ 269 CLP 235 EXH 117 FYM 88 AGV 72 EPQ 71 AOZ 68 GEG 44 ENH 40 GKE-FFU 34 WA 27 AME-IRG 24 CGM 22 BIL 19 CRF 16 FYN-JNL 15 AOA 12 BBC 7 GQZ-AEW-EQI 4 BRP-DQV-DTJ 2 GJO-SF-DZN 1.

ROANOKE DIVISION

NORTH CAROLINA—SCM, G. H. Wright, Jr., W4AVT—All N. C. hams are urged to attend State Club Hamfest in Winston-Salem on Feb. 4th; to read QST and "The Tar Heel Ham"; and to be on the air for NC-QSO party each Sunday afternoon. An early Sunday morning NC-Phone party is led by Phone RM W4PW. A suggestion is being made that 1.7 mc. 'phones form a net. The SCM would like to hear from 1.7 mc. 'phone operators who are interested. W4CCH worked all districts on 3.5 mc. W4CJP says R. I. and SCM are human (?). W4BVD worked a "PA." W4TP, DW, MR and CGH liked the SS. W4BEK is radio operator, linotype operator, and movie operator. W4RE worked "G" on 3.5 mc. W4UB has c.c. on 7 and 3.5 mc. Active again: W4QL, AAE, W4RV likes new NC-Phone net. W4BST is building c.c. rig. W4BHR doesn't think much of "junk" traffic in SS. W4QN is now in Salisbury, N. C. W4ALK has extended trunk line "C" into Florida. This line has N.C. connections through W4BRK, BAH, DW, AVT, BOH. W4IF worked a "VE3" 'phone. W4OG rebuilt from stem to stern. W4CAY is adding 800 tube. W4RA turned DX. W4NC is completing 500 watt rig. W4BAT is very QRL! W4COK is building rig with pair of '52s final. On 1.7 mc. 'phone: W4CDQ, VW, AHH. New N.C. hams: W4CLY, CPT, CQB, CPV. New c.c. rigs at W4AEH, BAH, CP. W4CLB is building frequency meter. W4BX has new rig going FB. W4AIS is back in Forest City, N. C. and made BPL this month. W4ATS received QSL from JIEC and is now "WAC." W4DQ gets out FB with rig using '46s PP. W4ATY resigned as RM. W4EC is appointed to succeed him. REMEMBER—free copy of "Tar Heel Ham" to each N.C. station reporting traffic to the SCM. Please get reports in by 20th.

Traffic: W4AIS 597 DW 429 MR 242 ZH 173 TP 138 QN 119 CGE 100 EG-AVT 68 BRK 54 BAH 42 ALK 38 CJP 37 ANZ 34 AAE 28 UB-CP 18 BST-BLN 14 TJ 12 IF-ATY 10 BHR 8 BX 7 CFL-AEN 6 BVD-AEH-BYA 5 RE-PW-CLB-AHH 4 DQ-ATS-VW-BSS-CAY 3 CQB-WX-CCH-RX-ALD-ABT 2 RV-QI-CLY 1.

VIRGINIA—SCM, R. N. Eubank, W3AAJ—Chief Route Manager, Dave C. Woods, W3GE. New A.R.R.L. member: W3DZW. W3DEH, CSI, CMJ operated at Kiwanis Bazaar. W3BSY played chess game by radio. New reporters: W3ALF, EGO, DEH, CYU, EBD, DFU, BSW, ECQ, EGU, AIJ, BPA, BTM, BAN, 8KCB. New traffic handlers: W3ALF, EGO, DEH, BSY, EBK, EBD, BPA, BTR, AVR, AEI, BPI, CNY, DRK, DFU, 8KCB. New calls in Section: W3EGO, AKJ, ECQ, EGU, 4CLH (Port. at VMI). Rebuilding: W3HV, CNY, AAF, BEP, BZ, BSW, CKM, AGY, APU, AG, CVQ, CPN. New transmitters: W3DZW, CYU, AEI, AVR, ASK, BPI, CEY, EBD, AVR, DAM, BNH, AIJ, AAJ, AG, BYA. New receivers: W3AAF, QN, AII, ECQ, BAD, CA, EBD, AJA, BGS. New antennas: W3CYU, EBK, EBD, CCU. New freq. equipment: W3DAM, EBK, AAJ. New field appointments: OPS-W3AEI, BIG, CNY, RM-W3GY (phone). W3BUY was married. W3FJ is Control for A.A.R.S. Net. Working DX: W3AUG, DEH, FJ, CMJ, AEI, BSY, EBK, BTR, DAM, GY, ADD, BWA, AG,

CVQ, BAN, AAD, 8KCB. W3AKN conducts code class at Norfolk Club. Experimenting: W3BZE, CYU, HV, AEI, ASK, CEY, GY, AZU, CVQ, BYA, CPN. Phone stations: W3GY, CNY, BIG, ASK, FJ, AHC, AEI, ASK. Rag choppers: W3AHQ, BIW, CYU, AEI, EBK, ASK, BPI, EBD, BTR, CKM, DFU, BSW, DAM, ECQ, AVR, AZU, DNR. Traffic stations: W3CSI, CMJ, CFV, BSY, BRY, CKM, CYV, CFL, MQ, FJ, DCU, DVO, CXM, BJX. Added crystal control: W3BZE, DZW, BSW, BPI, BSY, 8KCB. Club news: Peninsula Club held big Oyster Roast. Roanoke Club is working on 1934 Roanoke Div. Convention for Nov. 150 were at Tidewater Norfolk Hamfest Nov. 25-26. New Lynchburg Club. Staunton Hamfest was held in Jan. New club at U. of Va. Petersburg Club has station on. Active in SS: W3AZU, MQ, BTR, CSI, FJ, BTM, DCU. Va. Contest winners: (1) W3BJX; (2) W3CVQ; (3) W3BZE; (4) W3FJ; (5) W3BIW; (6) W3AUG. W3CFL is back at Ohio U. Orth, W3GY, is giving OPS exams. W3BUR is back at Roanoke. W3CVQ is collecting Roanoke reports. W3TJ got bug. W3TJ, BKG want SW 3. W3BAN is helping hams into bands. W3BJX wants schedules from 6:30-7:30 p.m.

Traffic: W3HV 22 CNY 13 ALF 3 DZW-MT 1 CSI 49 BZE 22 AHC 21 DEH 13 BIG 3 CMJ 132 BAD 68 AEI 23 BSY 277 FBK 13 ASK 9 BRY 6 BPI-CEY-EBD-5 BPA 4 BTR-CKM-DFU 2 AVR 1 CFL 97 GY 18 MQ 12 DNR 9 CYV 5 DRK 4 AZU 2 FJ 407 AHC 15 CCU 14 ADD 2 BIW 25 BGS 12 CVQ 8 DCU 105 BTM 74 BYA 48 AUG 22 CYK 16 BAN 5 AG 3 AAJ 2 BJX 203 DVO 54 CXM 44 BAI 39 CFV 16 AKN 1 DGT 14 CWS 142 DDG 33 GE 5 CDW 24 CLJ 12. W8KCB 5.

WEST VIRGINIA—SCM, C. S. Hoffmann, Jr., W8ED-WLHF-W8EIK has been pounding brass for 30 years, radio and Morse! W8EWM has new zep. W8DFC worked west coast with 7½ watts input. W8CZ is back to Charleston. W8HI and LS rebuilding. W8JCB is building 1.7-mc. 'phone. W8KWU schedules JM and KQT. W8KEC worked 34 states. W8SCHM is 'phone OBS on 3990 kc. Ex-W8SCLI is W8KEY. W8JWL is building RK18 amp. for trit. W8BDD is building new rectifier. W8ESQ reports someone bootlegging his call. W8FQB, BTV and BOW were home for holidays. W8DZW, HRO and JBY are active in Morgantown. Monongahela Valley hams formed the Mountaineer Amateur Radio Assn., with headquarters at Fairmont. Officers: W8JMJ, Pres.; BOK, Vice-Pres.; FQA/ILY, Secy.; EGS, Treas. On 1.7-mc. 'phone: W8GAD, HSA, ESQ, JM, KWI, EP, BOK, ILY. W8GBF erected new tower. W8TI worked VE5 on 3.5 mc. W8HD worked west coast regularly on 3.5 mc. New reporters: W8LBE, Sistersville, W8LBI, Moundsville. W8JKG applies for A.A.R.S. Skip is hard on W8ELO's Pennsylvania schedules. Ohio Valley Amateur Radio Club is planning tri-state Hamfest to be held in Wheeling during late spring or early summer. W8KSSJ is doing good work on 3.5 mc. W8DFC, DPO, ISB, JM, JWJ, JCB and KSJ participated in SS. W8HUK moved to Welch. W8KLO and KTO attend Marshall College in Huntington. Northfork, a town of 2000, boasts of 9 SWLs, and at one time five hams, reports W8KLO. W8OK visited W8ZG-WLH. W8ADI plans rebuilding U.S.N.R. station, W8DOB. The W. Va. Bulletin has again made its appearance, and is sent to all reporting stations by the SCM.

Traffic: W8EIK 229 TI 207 KWU 104 OK 93 JCB 77 ELJ 56 HD 39 KSJ 65 DNN/GQD 26 DMF 25 ELO 18 BDD-JKG 17 DFC 13 CMJ 48 EWM 6 JWJ 2 LS 2 JM 155.

ROCKY MOUNTAIN DIVISION

COLORADO—SCM, T. R. Becker, W9BTO—W9RX, Ex-9DQG, is back after 7½ year absence. W9GCM and AYP have nice traffic totals. W9GJQ is now ORS. W9CDE holds up the A.A.R.S. in his part of Colorado. W9ECY reports from new QRA. W9ESA sends usual FB report. W9EYN broadcast from top of Pikes Peak New Years. W9NIT reports from Loveland. W9KRV of Co. "F." C.N.G. at Boulder is operated by W9JFQ, FNR, KZG and PZB. W9KNZ is leaving the game for a while on account of his health. W9BYY is trying to get a bottle from LYE. W9EMU is getting new mike. W9AAB can be

heard on 3.5 mc. W9IPH has 750 watt bottle. W9MOF has trouble with FB7A. W9DNP is active. W9BTO uses 50 watters. W9CKO is on 56 mc. 'phone. W9RJ will be on 1.7 mc. W9OAF uses ten in final. W9HQV uses '47 in final. W9FYY is going to build 90 ft. tower. W9HRI is going to school in Boulder. W9AUJ is operating from LYE. W9LNB pounds out on 1.7 mc. 'phone. W9CND is getting an FBXA. W9FRP will be on with '03As Class B. W9GHL is QRL school. W9BCW uses a '10. W9GVN dropped his crystal! W9JB services BCL sets. Anyone wishing pictures of the Convention may get them by sending 75 cents to W9KNZ, 1708 N. Royer St., Colo. Springs. W9KKY has YLitis. W9JFD is installing '30s. W9MVI joined the Navy. W9NIT and IFD were in SS. W9TX was a loveland visitor. W9EHC joined A.A.R.S. W9GNK is back from his ranch. Four stations make BPL: W9ESA, KNZ, IFD, GNK. 3.9 mc. 'phones: W9BYK, HIR, GHY.

Traffic: W9EYN 348 ESA 1198 ECV 9 AYP 47 GJQ 240 GCM 172 CDE 76 RX 218 KNZ 702 IFD 236 EHC 33 GNK 302.

UTAH-WYOMING—Acting SCM, Arty W. Clark, W6GQC—W7COH, Midwest, Wyoming, is newly appointed RM. Fellows, "Rig" will need cooperation on this. Please help establish a Wyoming traffic net. W7AEC installed FBXA. W7ARK worked on 'phone in SS. W7AOU lacks Asia for WAC. W7AMU reports for Casper. W7NY has c.c. W7ADF is puzzled with operation of '52. W7CHR will trade rig for "buzz saw." W7CBL is tuning up. W7BXS is going home to "ma" in Houston, Texas. W7ACG has new '11 bottles. W7CJR is trying to locate stray rig. W7CYN has gone back to 'OAs. W7CMN still holds lead over his OW. W7DES is building rig. W7EDC is new Casper station. W7EDI is new Parco station. W6AFN makes BPL. W6JVB, how do you do it!!! W6DTB worked VP 5PZ on 14 mc. and UX1A and VK7BC on 7 mc. W6DGR had 276A go soft. W6JVA takes WX from W6AHD for Airways. W6FYR says most of his schedules went "hunting." W6GQC is "regusted" with QSB. W6EWW is 3.9 mc. 'phone OBS Mon. and Thurs. 7 p.m. W7COH is c.w. OBS Tues., Thurs., Sat., 7 p.m. W6FRN was active in SS. W6DEM finds it difficult to keep schedules because of working hours. W6HIE solved antenna troubles. UARC enjoyed merry Christmas party with successful and very interesting demonstration of two way 56 mc. 'phone by W6DWH, IOF and AFN.

Traffic: W6GQC 603 AFN 508 FRN 155 FYR 139 GQR 82 DGR 68 AHD 55 JVB 24 JVA 13 DEM 11 DTB 3 EWW 2 EYS 1. W7COH 87 AOU 82 ARK 36 EDI 26 AMU 23 AEC 3.

SOUTHEASTERN DIVISION

ALABAMA—SCM, L. D. Elwell, W4KP—W4AAQ has the largest traffic total. W4AG has the next highest, closely followed by BOU and APU. W4AJY made a great stab at the SS contest. W4GL reports for Mobile. W4CQM is a ham from the old spark days. W4COU is working plenty foreign DX. W4BLL is Tech. Ed. Mobile Club. W4BXV is rebuilding for c.c. 'phone. W4GP is on 'phone. W4CPC was injured in motorcycle wreck. W4NU is QRL A.A.R.S. W4CBI has new type sky wire. W4BRA and GL are on 14 mc. W4AP gets out FB on 14 mc. W4CIQ, Mobile Club station made a fine start in traffic work. W4QA gets Q5R8 from EAR164. W4DD schedules W6CNE on 14 mc. 'phone. W4SN made 635 QSOs from Oct. 1st to Dec. 15th. W4BJA handled important traffic. W4CCP is having FB time on 1.7 mc. 'phone. W4CEH had a wreck with the livver. W4BTA is putting in 50 watter. W4BBO has new shack. W4BMM reports BDH is getting married. W4BZG, Secy. of B'ham Club, gave an FB party, which was attended by 35 hams and their XYLs and OWs.

Traffic: W4AAQ 522 AG 398 BOU 320 APU 296 AJY 208 DD 92 BJA 72 CIQ 47 GL 28 BMM 22 AP 17 OA 11 KP 118 SN 52.

EASTERN FLORIDA—SCM, Ray Atkinson, W4NN—RMs: W4ALP (CW), W4WS (Phone), W4AGB (Phone and CW). Florida 'phones handed the c.w. men a surprise by handling the bulk of the traffic. W4WS, NN, AKH, TZ and BGL make "100 total club." W4NN relayed 510 by 'phone. W4AZB is putting up new antenna. W4HY has

new c.c. rig. W4AWE has new Class "B" modulator. W4ANY keeps schedules. W4UX is at sea. W4CFO reports CCR building 50 watt c.c. job. W4AYO ditto. W4AXY says "What about that Florida Hamfest?" W4BRI is new ORS. W4PT is rebuilding 'phone. W4AH is trying to contact Tampa hams from G2TT, Liverpool. W4AIW was busy with SS contest. W4CPL is new Tampa ham. W4BOT says traffic slow. W4BNR goes to 1.7 mc. 'phone. W4BBX wants reliable schedules. W4CBK reports "Central Fla. Radio Club" is being revived. W4COW is c.c. W4CJR built new receiver. W4BUM is active traffic station. W4VP is moving to Miami. W4TK is back. W4BNI is warming up a 3.9 mc. 'phone. W4MM is building a super. W4KM likes 'phone traffic. W4CJ uses 3 watts input on 'phone. W4AQU increased power. W4AOK worked VK on 3.9 mc. 'phone. W4COV is new St. Petersburg ham. W4CMN holds commercial first 'phone ticket. Don't forget to renew your ORS.

Traffic: W4NN 575 WS 223 AQU 53 DU 45 KM 24 MM 22 AOK 20 AGB 17 ANY 3 CJ 10 AKH 325 TZ 188 BGL 117 AGY 66 AJX 64 CMN 46 BUM 37 VP 25 HY-BNI 16 BBX-ALP 14 AKJ 13 AZB 10 TK 12 UX 4 BRI-DZ-COV 3 CBK 2.

WESTERN FLORIDA—SCM, Eddie Collins, W4MS—RMs W4ACB, W4AUW. W4KB worked ZL on 3.9 mc. 'phone. W4BGA is a proud father. W4BFD plans on 'phone. W4CMJ is almost ready for 56 mc. test via airplane from 20,000 ft. All stations interested, write W4MS. W4BMJ puts out p.d.c. sig. with spark coils. W4CQP is in Crestview. W4CQP is new Pensa station. W4ARV passed Commercial 2nd exam. W4KQ is going to QRO. W5ZZR was here for Christmas holidays. W4ALJ and QU are working at U.S.N.R. station NDD. W4ASV wants commercial ticket. W4AUV, BOW, AQY, and CMB work 1.7 mc. 'phone. W4AXP is experimenting. W4AQA and ABK report. W4AUW ran up over 8000 points in SS. W4COG operated W4MS in SS. K6BHG is going to get a W4 call. W4QR is active in Midway. W4ACB was swamped in Christmas Postal rush. W4BKD has FB 28 mc. 'phone. Santa Claus gave W4BSJ a 50 watter. W4CLN is new ham. W4BPI wants an SW3. W4CDE is ruling the 3.5 mc. band. W4VR says, "FB7A soon." W4MS made WAC on 7 mc.

Traffic: W4MS 173 CDE 13 BKD 44 AUW 71 AXP 2 KB 40.

GEORGIA-SOUTH CAROLINA-CUBA-ISLE OF PINES-PORTO RICO-VIRGIN ISLANDS—SCM, George A. Love, W4UT—Our sympathy to the family of CM2OP, officer in the Cuban Army who met death in the National Hotel battle. CM2RA, FA, MG, DO, AN, OR, all use c.c. CM28V is back on air. CM2WW has trouble with m.g. CM8YB is now ORS. W4MO has swell super. W4CFJ is building one. W4CDE is OBS. W9CPD visited W4WC. W4WZ is on with new c.c. rig. W4ACQ has pair of tens. W4BRG is working FB DX. W4COD has Collins 'phone rig. W4ALW is on 7 and 3.5 mc. At the Dec. meeting of Atlanta Radio Club W4WC was elected Pres., W4CBY Vice-Pres. and W4RM, Secy. W4APG has tens TPTG. W4CCJ uses MOPA on 7 mc. W4UT handles diplomatic traffic with NY1AA, Canal Zone. W4CMA is on 3853 kc. W4SS gets 250 watts from lonely '52! W4CE reports following S.C. news: Palmetto Amateur Radio Club, Columbia, S. C., meets at U. of S. C. every other Wed. W4BCN and CE are on 1.7 mc. 'phone. W4BNN is on 3.5 mc. New S. C. stations: At Gaffney—W9HJD (port.), W4CNK, CPZ. At CCC, Awendaw—W2FLB.

Traffic: W4IR 238 UT 150 KV 78 CDE 44 CQO-BO 38 CM 30 CGT 27 SS 21 CFJ 17 DL 15 MO 7 RM 2 BW 1 AZT 50 CE 46 AAY 34 CM8YB 21.

WEST GULF DIVISION

NORTHERN TEXAS—SCM, Glen E. Talbutt, W5AUL—W5BII Chief RM; W5BAY Phone RM. W5SP is new OPS. Several good Official Observers are needed badly. And we want more OPS. New hams reporting: W5DUW Lubbock; W5AQS Palmer; W5DVV and DFU Fort Worth; W5ATI Sulphur Springs; W5DQW Abilene. W5AW worked EA, ZL, VP, J, OM and HR. W5ARV located a lost relative for someone. W5DAA

reports new radio club at Terrell. Other reporting stations: W5BTS, IA, AJG, CJE, DJL, CYU, IT, DMD, CPT, CPB, CHJ, CIJ, ANU, BII, ARS, BKH, AUL. Please send the SCM information on club activities. All stations in this Section are invited to report on the 16th of each month.

Traffic: W5BII 302 CIJ 253 ATI 192 DQW 183 ANU 121 AW 115 BKH 105 ARS-AUL 87 BTS 79 ARV 70 IA 57 AJG 28 AQS 22 CJE-DJL-DFU 19 CYU 14 DAA 12 IT 6 DMD 3 CPB-SP 2.

SOUTHERN TEXAS—SCM, D. H. Calk, W5BHO—W5OW reports traffic picking up. W5MN works A.A.R.S. schedules. W5BKE is now DNCS for A.A.R.S. W5VV schedules K6BOE. W5BB handled two messages from A.C. W5AFQ added another stage to transmitter. W5CVW's new c.e. rig is FB. W5ADZ says SS ran him nutty. W5DBN and BKW report new receivers. W5BEF and BKG report. W5BWM reported from Thibodaux, La. W5ABH built new shack. W5CCI is QRL Navy in San Diego, Calif. W5DUQ and DUO are new hams. W5DVQ and CFK are building 1.7 mc. 'phones. W5DPA, Houston Amateur Club, is being rebuilt. W5CA is selling out. W5APM rebuilt. On 14 mc. 'phone: W5AHK, BKV, ANW.

Traffic: W5OW 1484 MN 303 BKL 125 BKE 92 VV 45 BB 16 CVW 23 AFQ 12 BEF 17 ADZ 11 BKG 2.

NEW MEXICO—Acting SCM, J. M. Eldott, W5CGJ—New hams: W5DVX, Lovington; W5DVU, Albuquerque. W5DVH reported for first time. W5DLG will soon be c.e. W5ZM spent holidays in Phoenix. W5AVE moved to Arizona. W5BNT is holding Albuquerque down. W5CJP reports that new Police Dept. station in Santa Fe successfully blocks all reception—at least during tests. We understand W5AIC will be in charge of this station. Let's have more reports, gang!

Traffic: W5CGJ 144 ZM 86 CJP 30 BNT 26 DVH 2 CXP 4.

OKLAHOMA—Acting SCM, St. Sgt. R. F. Hinck, W5BQA—W5BAR is new ORS. W5BQA is awaiting new license. W5PP was QSO W5VQ at March Field, Calif. Applications are invited for Official Phone Station appointment. Warning to ORS!! If you don't report regularly, your ticket will be cancelled.

Traffic: W5CEZ 712 BDX 271 CUX 221 CNC 88 AA 33 BAR 19.

CANADA

May I through the medium of QST thank the many hams throughout the width and breadth of Canada who were responsible for my reelection to the office of Canadian General Manager. I had a very worthy opponent in Mr. Hunt of Sandwich, Ont., who like myself refrained from campaigning to any extent. Considering the fact that this was Mr. Hunt's first nomination for office it is to be considered that he polled a splendid vote for which he has to be congratulated.

—A. Reid,
Canadian General Manager

MARITIME DIVISION

NOVA SCOTIA—SCM, A. M. Crowell, VE1DQ—1EP leads with 132. 1ET went strong in SS. RM 1ER has daily schedule with VE2CX for trans-Canada route. 1GL works VOBZ on 3.6 mc. 1EX says poor deliveries bad for ORS. 1DE is getting high power ready. 1EA schedules 2BT for "trans-Canada." 1AS is QRL steady. 1GH is new Lunenburg man. 1BW is active on 3.9 mc. New Brunswick news via VE1CL: Very active on 1.7 mc. 'phone are: 1DY, 1AO, 1GM, 1GN, 1AJ, 1CL. 1DG annexed a YF. 1AY has class B 'phone. 1AK shot a '60. 1BA has a Collins on 14 mc.

Traffic: VE1EP 129 ET 100 ER 58 GL 37 EX 34 DE 21 EA 11 DQ 11 AS 4.

ONTARIO DIVISION

ONTARIO—SCM, S. B. Trainer, Jr., VE3GT—The SCM and several other Toronto lads enjoyed the Hamilton A.R.C. social night Dec. 12. 3DU, RK, WB, NS, GT, JT, HP and NO enjoyed the SS. Welcome to 3WC, WE, 3PT, FZ, XD, JU, TG, HT, QH, QE and QT are pounding away on 7 mc. 3TM will be on regularly. 3QB has new set of "B's." 3TY applied for ORS. 3SG, WK, NB, DJ are after traffic. 3JO is rebuilding. 3NZ is on 3.9 mc. 'phone. 3EU, RR, QJ and KM are looking for DX on 1.7 mc. 'phone. 3CX has gone c.e. 3FW and GS are still at it. 3RA has new receiver. 3DX is on with his power leak. 3LY is out of town. Glad to have 3PY and PN on again. 9BE and 3MX have new 28 mc. rigs. The grief continues at 9AL. 3YY is QRL work. RM 3WX reported via radio. New ORS: 3IQ, SG. The H.A.R.C. is applying for OPS, and OBS. 3TO, TG, OB and SP are on 3.5 mc. An all time high was reached this month for stations reporting traffic. Let's keep up the good work. Don't forget the Ontario contest, Jan. QST!

Traffic: VE3DU 160 RK 184 DW 52 NJ 17 TM 3 WB 30 TO-IQ 3 DJ 103 EM 4 SG 39 WK 85 LZ 7 HA 19 GH 8 LI 53 MX 4 MS 22 NB 15 VL 3 NL 2 JI 52 JT 247 HP 55 TQ 2 NO 34 GT 594 UU 15 BC 2 IX 7 CE 52 WX 361 RO 20 BZ-VJ 6 OE 12 WA 6 OC 12 VF 9 GP 3 OM 12 OH 4 GO 118. VE9AL 17.

QUEBEC DIVISION

QUEBEC—SCM, John C. Stadler, VE2AP—2DQ schedules 2HQ on Anticosti. 2DR worked W7 on 3.5 mc. 2GO is after 14 mc. DX. 2HP has new 1.7 mc. 'phone. 2HK is consistent in DX. 2AB got an FBX. 2DW is planning 3.5 mc. 'phone. 2EC is adding speech to 3.5 mc. c.e. job. Welcome to 2HY (ex 3HO)—2II and 1A use '46s. 2CT at Michigan University pounds from W8AXZ. 2IC is moving to Oskelanea. 2AP is rebuilding. 2AL is visiting in town. 2HT, HM and EE handle club broadcasts. 2CX gives code practice on 1.7 mc. 'phone. 2BB has new filter. 2CA does mostly 14 mc. 'phone. 2BE had his roof-mast pulled down during storm. 2CG is on 7 mc. 2EE, AC, DR are new ORS. The Montreal Amateur Radio Club had FB hamfest.

Traffic: VE2AC 29 DR 125 HK 55 FE 56 CA 20 BB 138 AP 30 CO 139 CX 161.

VALNATA DIVISION

ALBERTA—SCM, C. H. Harris, VE4HM—4DX's QRA is under C.F.A.C. 4GD is on 14 mc. 'phone. 4AW has QRM from 4DX. 4DQ blows 50 watters. 4PH gets FB results with '45s. 4BZ is QRL "talkies." 4HQ and JX are building 14 mc. 'phone. 4NC QSOd VE1 on 3.5 mc. 'phone. 4KQ and JJ are building 3.5 mc. 'phone. 4DC worked VE1 on 1.7 mc. 'phone. 4ID is building new rig. 4OG and OF QRM EO. 4EC and BJ went north together. 4MG is on again. 4EA wants an 800. 4BV is talking high power. 4BW says 1.7 mc. band great. 4EZ puts out FB signals on 1.7 mc. c.w. 4NB and PH hope to be ORS.

Traffic: VE4DC 60 ID 52 LX 44 PH 29 BZ 17 MG 16 HM 4.

BRITISH COLUMBIA—SCM, R. K. Town, VE5AC—Rebuilders this month: 5EW, GF, CL, FH, FI, AC. 5AM hears KJTY 'phone very QSA. B.C.A.R.A. had reorganization; 5AN was elected Pres., 5GF Vice-Pres., 5BJ Secy. 5EP, DF, JA apply for ORS. 5HI has OPS in mind. 5FQ was a recent visitor to Vancouver. 5AG is QRL commercial operating. 1.7 mc. 'phones: 5FN, AO, HI. 5FP has YLitis. Let's have more reports, gang.

Traffic: VE5AC 92 AL 30 HP 326 AG 25 CA 171 DF 79 ED 59 EE 12 EO 141 FH 7 GS 126 HC 15 HQ 287.

PRAIRIE DIVISION

MANITOBA—SCM, Reg. Strong, VE4GC—The M.W.E.A. started an active New Year. 4MW picks up traffic from locals for the trunk. 4BB was visitor for couple of weeks. Active SS contestants: 4MV, DK, DZ and GC. 4AG and CD have triet. Rebuilding: 4BG, AC, FT, DY, KX and LH. New stations: 4QA and QD. 4GB has multi stage rig. 4DJ and DU worked good DX. On

7 mc.: 4CI, KU, OX, IU, NM, KW, LL, OB and CP. 4GL and KX are on 14 mc. 'phone. 4MY has rack and panel job completed. 4NW added 14 mc. doubler. 4FP, LT, CS and IP are QRL. 4NT has axe cut crystal. 4NI pounds plenty of brass.

Traffic: VE4MV 134 DK 70 DZ 52 GC 28 MW 17 AG 11 DJ 3.

SASKATCHEWAN—SCM, Wilfred Skaife, VE4EL—4KJ schedules daily 4ES, MD and LU. 4NU is in hospital. 4GA holds No. 1 OPS for this Section. 4LU is rebuilding in rack and panel. 4MD built SGFB receiver. 4KE is building MOPA. 4KJ is building speech amplifier. 4HU has new c.c. rig. 4FA had visits from 4OW and PA. 4BN reports noise level down 100% using doublet antenna. 4IE has nice 1.7 mc. 'phone. 4MN changed QRA to Sovereign. 4ML, EL and KM are on 28 mcs. 4KB is trying MOPA. 4JH works another ZL.

Traffic: VE4GA 100 NU 24 MH 22 AI 20 JH 14 MD 12 EL-HU 9 KJ-LU 8 FA 4 ML 3 KV 2 EB 12 OO 1.

LATE AND ADDITIONAL REPORTS

909 of NY1AB's relays for the Nov.-Dec. month were from the Byrd Expedition. NY1AB maintains twice-daily schedule with both WHEW and KJTY. W3CXL, W9BLG and W9NMR each schedule NY1AB and take care of the delivery of Byrd traffic. CM6XJ is starting tests on crystal controlled 'phone on 15,948 kc. every Saturday and Sunday 10:00-10:15 a.m. E.S.T. and is interested in schedules and reports. W3EHE, Washn., D. C., operated a 1-kw. rotary spark in early 1920. W7EDI, Parco, Wyo., pounds brass for an oil company on the pipe line 35 miles out of Parco; he worked LU5FV on 14 mc. using an '01A with 135 volts of plate.

License Danger

WE'VE heard of several cases recently where a fellow moves his station to a new address and postpones applying for the necessary modification because of other things to think about—thinking he'll do that when he is ready to get back on the air. When he does get ready he finds himself out of luck because he can't cite "minimum activity" in the previous three months as required by F.R.C. Rule 402—the months have just slipped away.

The remedy is simple: apply for modification immediately upon moving, whether or not you expect to be delayed in getting on the air at the new location. It is almost always possible to show minimum activity if modification is applied for immediately.

If about to move, and you haven't recently been operating, the tip is to do some operating at the old address before you move, so that you can prove use of your licenses. Present F.R.C. policies concentrate the service on active stations, penalize the inactive.

Election Results

ELECTIONS were held in late 1933 in Canada and six United States divisions of A.R.R.L. to choose seven members of the League's Board of Directors for the 1934-1935 term. Six of the seven old directors were returned to office, the change being in the Dakota Division where Mr. Carl L. Jabs, W9BVH, of St. Paul, succeeded Mr. L. E. Lindesmith, W9GKO, Duluth.

The new director, Mr. Jabs, is by profession the manager of the experimental department of Allied Motors Corporation at Minneapolis. He has been in amateur radio for twelve years, served as S.C.M. for Northern Minnesota from 1928 to 1930, and in 1931 was president of the St. Paul Radio Club.

In the Pacific Division Mr. Culver, the incumbent, was the only candidate and his term of office was renewed without balloting. In Canada, Alex Reid, present Canadian General Manager and director, won handily over Robert C. Hunt, 327 to 122. For the United States divisions that balloted the figures are as follows:

<i>Atlantic Division</i>	
Eugene C. Woodruff	701
Walter Bradley Martin	329
<i>Dakota Division</i>	
Carl L. Jabs	129
Lawrence E. Lindesmith	122
<i>Delta Division</i>	
M. M. Hill	66
E. Ray Arledge	62
F. Fremont Purdy	50
<i>Midwest Division</i>	
Harry Wallas Kerr	318
Frank J. Sadilek	91
<i>Southeastern Division</i>	
J. C. Hagler, Jr.	101
Bennett R. Adams, Jr.	92
Ralph Coady	35

It is interesting to note in passing that this season's elections were won by very narrow margins in three divisions, with pluralities for the victors of but 7, 4 and 9 votes, respectively. That is, if only a dozen members, distributed in these three divisions, had voted differently, the results would have changed. Such close margins are exceptional in A.R.R.L. elections.

It may also be of interest to report that the percentage of licensed amateurs casting votes varied between 75 and 85% in the different divisions. Although possession of amateur licenses is not a prerequisite to A.R.R.L. membership, most League members are amateurs, present, near-past or near-future. The percentage of those possessing calls habitually averages 80% in our elections.

—K. B. W.

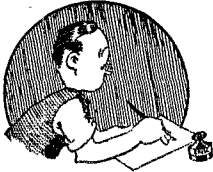

CORRESPONDENCE

The Publishers of QST assume no responsibility for statements made herein by correspondents

Readability and Audibility

Stratford, Ont.

Editor, QST:

Concerning Mr. William W. McLain's suggestions on interpretation of the QSA signals:

Of what benefit is it to indicate receivability in percentage of words missed or copied? I do not see where this is of value, and anyway such a loss of text might not be due to signal strength. Further, it is not wise to have the proposed definition of "QSA1" read "20% of what is sent is received," when the official meaning is "zero % of what is sent is received."

The proper use of QSA as I see it is this: "5," "4" and "3" should not be used unless there appears a reasonable chance of copying every word; "2" means that for one reason or another it is only possible to read the weak signal in spots; "1" means that signals can't be read at all. "QSA" does not refer to absolute signal level; a "QSA4" signal may be rendered QSA1 by a steady QSA5 signal on top of it, or by other interference.

Why alter the official meanings? "QSA" is a traffic signal, not an experimenter's signal, and as such seems quite adequate, as it provides a description of every condition from unreadable to perfectly readable. Amateurs, to whom the loudness of signals is of interest, have the "R" system, which appears to fill the bill where accuracy is not needed.

While on the subject of signal intensity, is there a better plan than to use a G.R. or equivalent output meter, and make reports in "db. above noise level at this station"? Such a report could be accurate, it would be representative of the signal's effect on the ears, and would indicate its suitability for communication. It would mean something!

—H. S. Gowan, VE3MQ

Re: Madrid

Washington, D. C., Dec. 19, 1933

Col. Clair Foster,
Amateur Radio Station W6HM,
Carmel, Calif.

My dear Clair:

I am sorry that we have been so out of touch recently. I have been much occupied and am afraid I have neglected my personal corre-

spondence. I do hope you will not mind my intruding with a suggestion.

It has come to my attention that in association with a group of amateurs in your vicinity you are conducting a campaign looking toward a Senate reservation to the Madrid treaty having as a purpose the elimination of the provision in Article 8, section 2, paragraph 1 of the annexed radio regulations, prohibiting the transmission by amateur licensees of international communications emanating from third persons.

Has it been called to your attention that such a general reservation cannot be made? Putting it otherwise, if our Government wishes to accept the Madrid treaty and its benefits, and attaches a reservation, *the reservation will be effective only with such countries as agree to it or accept it.*

The acceptance of our reservation by any country would then constitute a special arrangement between that country and ours, eliminating—as between themselves—the restriction in question.

But there is already, in paragraph 2 of the section referred to, a provision for the orderly making of such special arrangements. I know that the executive staff of the American Radio Relay League has long since taken steps to institute the negotiation of such arrangements.

It would appear to me, therefore, that the "reservation" idea is at best a mere duplication of work already being done by the headquarters staff in a more effective manner and that your efforts would be better and more efficiently expended in supporting the League's orderly campaign for these special arrangements.

Yours cordially and with vy 73,

—Paul M. Segal

Overmodulation

Fanwood, N. J.

Editor, QST:

A much needed lesson, this "The Overmodulation Racket" by Jim Lamb. What ninnies we hams are to stick our elbows out and crowd each other in these limited amateur bands! We don't realize that thereby we are crowding ourselves.

Why, from his own selfish point of view, should the amateur avoid overmodulation? I mention a few reasons:

1. The power used in wide sidebands is useless energy, wasted power.

RELIABILITY • EFFICIENCY • FLEXIBILITY

RELIABILITY — Proven reliability is assured in National midget condensers. Rigid, compact, precision-built, they are backed not only by years of experience as a manufacturer of condensers, but by years of experience as a user of high quality condensers in National Receivers.

EFFICIENCY — Isolantite insulation, thick aluminum plates, constant impedance rotor connections, insulated bearings — every feature contributing to high electrical efficiency is found in National High Frequency Condenser design.

FLEXIBILITY — A wide variety of special types for special purposes, as well as general purpose designs of great versatility contribute unusual completeness to the National condenser Line; but, equally important, National designs permit the experimenter to remove or shift plates to adjust them to the exact value desired.

NATIONAL COMPANY, INC., MALDEN, MASS.

Catalog Type No.	Capacity in Mmf.	Air Gap	Plate Shape	Rotor Plates	Stator Plates	Depth behind Panel	List Price
ST-35	35	.026		5	4	2 1/4"	\$1.50
50	50	.026		6	5	2 1/4"	1.80
75	75	.026		8	7	"	2.00
100	100	.026		10	10	"	2.25
140	140	.026		14	14	2 3/4"	2.50
150	150	.026		15	14	2 3/4"	2.50
STH-200	200	.0175		14	13	2 1/4"	2.75
250	250	.0175		16	16	2 3/4"	3.00
300	300	.0175		20	19	2 3/4"	3.25
335	335	.0175		22	21	2 3/4"	3.50
STN-18	18	.065	180° SLW	4	3	1 5/8"	2.00
STHS-15	15	.0175		2	1	1 3/16"	1.40
25	25	.0175		2	2	"	1.50
50	50	.0175		4	3	"	1.60
STD-50	50	.026		6	5	2 3/4"	3.50
STHD-100	100	.0175		7	7	"	4.50

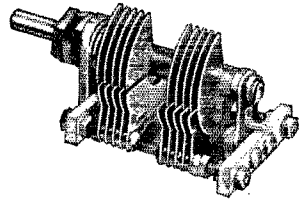

Catalog Type No.	Capacity in Mmf.	Air Gap	Plate Shape	Rotor Plates	Stator Plates	Depth behind Panel	List Price	
SS-50	50	.026		5	4	2 1/4"	\$1.80	
75	75	.026		7	6	"	2.00	
100	100	.026		9	8	"	2.25	
150	150	.026		12	12	2 3/4"	2.50	
SSH-200	200	.0175		11	10	2 1/4"	2.75	
250	250	.0175		13	13	"	3.00	
300	300	.0175		16	15	2 3/4"	3.25	
350	350	.0175		18	18	2 3/4"	3.50	
SSN-18	18	.065		180° SLC	3	3	1 3/16"	2.00
SSS-20	20	.0175			1	2	"	1.40
30	30	.0175	2		2	"	1.50	
50	50	.0175	3		3	"	1.60	
SSD-50	50	.026	5		4	2 3/4"	3.50	
SSHD-100	100	.0175	5		5	2 3/4"	4.50	
150	150	.0175	8		8	"	5.00	

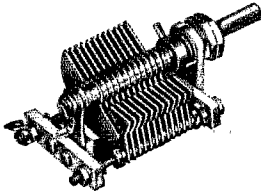

Catalog Type No.	Capacity in Mmf.	Air Gap	Plate Shape	Rotor Plates	Stator Plates	Depth behind Panel	List Price	
SE-50	50	.026		6	5	2 1/2"	\$3.00	
75	75	.026		8	7	"	3.25	
100	100	.026		10	10	"	3.50	
150	150	.026		15	14	2 3/4"	3.75	
SEH-200	200	.0175		14	13	2 1/2"	3.75	
250	250	.0175		16	16	2 3/4"	4.00	
300	300	.0175		20	19	2 3/4"	4.00	
335	335	.0175		22	21	2 1/2"	4.25	
SEU-15	15	.055		270° SFL	3	3	"	2.50
20	20	.055			4	4	"	2.75
25	25	.055	5		4	"	2.75	
2SE-100	100	.026	10		10	5"	5.50	
2SEH-200	200	.0175	14		13	"	6.50	

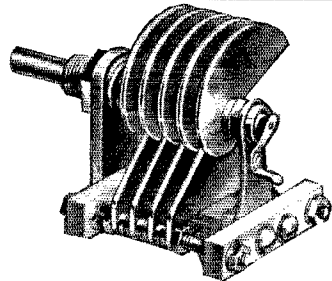

A discount of 40% applies to the above List Prices, when purchases are made from authorized Distributors

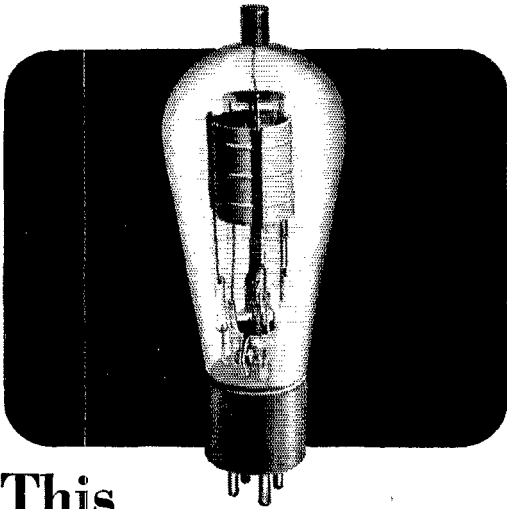

This high frequency tube meets the amateur's severest test

The Western Electric 254B is a screen-grid tube for use as a radio-frequency power-amplifier and as a harmonic-generator at intermediate power levels at high frequencies. The thoriated tungsten filament is of spiral design to keep internal impedance low and constant during the life of the tube. The mechanical structure of the 254B has adequate strength to meet severe usages.

This tube will prove more satisfactory than other tubes of comparable size which have been available and which are usually used in present circuits by amateurs.

The following are the characteristics of the 254B:

Filament Voltage.....	7.5
Filament Current, Amperes.....	3.25
Maximum Plate Voltage.....	750
Maximum Plate Current, Ampere.....	0.075
Maximum Plate Dissipation, Watts.....	25
Screen-Grid Potential, Volts.....	150
Average Amplification Factor.....	100
Average Plate Resistance, Ohms.....	75,000
Average Mutual Conductance, Micromhos.....	1,330
Approximate Direct Interelectrode Capacities:	
Plate to Control-Grid.....	0.085 Mmf.
Plate to Filament and Screen-Grid.....	5.4 Mmf.
Control-Grid to Filament and Screen-Grid.....	11.2 Mmf.
Maximum Overall Length.....	6-15/16"
Diameter of Bulb.....	2-7/16"

For booklet describing this and 25 other Western Electric tubes for use by licensed amateurs, write to Graybar Electric Co., Graybar Building, New York, N. Y.



Western Electric
 RADIO TELEPHONE BROADCASTING EQUIPMENT
 Distributed by **GRAYBAR Electric Co.**

2. If there is an abundance of modulator power, causing overmodulation, the carrier power could be increased, and still at 100% modulation, thus giving greater range.

3. Another fault, akin to overmodulation in results, is overexcitation of the modulator, causing harmonics of speech frequencies. This causes the worried-over "quality" to be distorted and reduces effective readability, thus reducing effective range.

From these points, I draw the conclusion that the amateur encourages inefficiency when he overexcites modulators or overmodulates. . . .

—R. S. Sutcliffe, W2DKA

Right You Are!

1822 Battery, Little Rock, Ark.

Editor, *QST*:

What a hobby!! What a hobby!!!

When a man like Frank Hawks puts it down in black and white that he was "thrilled beyond words" it is really something.

Not even the setting of his numerous air speed records evoked such an exclamation.

Guess I had better quit wishing I were an aviator and hit the old key a little harder.

—Bill Stewart, W6MU

Strays

One of our contemporaries describes a dynatron oscillator tube with two electrons. One primary and one secondary, we suppose, bouncing back and forth between plate and grid to produce oscillation.

Tube Base Chart Available

If you are perplexed by what socket connections go with which of any of the numerous gadgety tubes that now afflict us, you will have use for a handy chart that shows the elements and prong connections for all types. The chart is of the wall type and includes two tables for reference. One lists the base arrangements by tube types, the other the tube types by base arrangements. The chart may be obtained free by writing Hygrade Sylvania Corp., Emporium, Pa

The Bandsetter

(Continued from page 57)

Ordinarily, simply twisting the insulated coupling wire from the bandsetter around the receiver antenna lead will give more than sufficient signal. However, if for any reason greater strength is desired, a coupling condenser of 3 to 5 $\mu\text{f}.$ capacitance should be made and one electrode connected to the high side of the r.f. or detector tuned input circuit. The other electrode is connected to the coupling wire. About two inches of twisted hookup wire, or a two-plate condenser of brass angle such as used for antenna coupling on the old receiver, will be correct.

Ask Yourself

when planning to make a variable condenser purchase

Is it electrically efficient?

The CARDWELL is chiefly famous for its efficiency.

Is it compact? The CARDWELL design (large or small) is compact to an unusual degree yet sturdy enough for the roughest service.

Is it mechanically strong? The CARDWELL design is, in many respects, stronger mechanically than any other.

Is it long lived? Old timers will tell you that their CARDWELLS are good as new after many years of service.

Workmanship? No condenser is more painstakingly assembled than the CARDWELL—yet the CARDWELL costs no more.

All of these qualities in combination have made the CARDWELL the Standard of Comparison by which other condensers have long been judged!

THE CARDWELL "TRIM-AIR" CONDENSER

The CARDWELL "Trim-Air", an all-purpose quality midget condenser, and unique in several respects, has recently been added to the CARDWELL line. A full description appeared in January 1934 "QST". The "Trim-Air" is well worth your attention if considering midget condensers.

Any reliable supplier should cooperate with you to enable you to get what you want. He can get CARDWELLS for you if he does not keep them in stock. Get what you want — insist on CARDWELLS. Order direct from us if your dealer will not supply you, or let us tell you where you may buy.



Is it News to you that CARDWELL

has successfully developed for a client and made commercially practicable a new musical instrument, an electronic organ utilizing a revolutionary yet basically sound method of tone generation, capable of producing an infinite number of tonal qualities and opening up a hitherto unexplored field in musical art.

This is but one of the many developments satisfactorily concluded by the CARDWELL organization, demonstrating versatility and resourcefulness gained through years of fruitful experience.

Have you a designing or manufacturing problem? Put it up to CARDWELL.

CARDWELL "TRIM-AIR" MIDGET CONDENSERS
 CARDWELL MIDWAY "FEATHERWEIGHT" CONDENSERS,
 RECEIVING and TRANSMITTING
 CARDWELL "STANDARD" MODELS FOR RECEIVERS
 and MEDIUM POWER TRANSMITTERS
 CARDWELL 16-8 TRANSMITTING CONDENSERS
 FOR LARGER TRANSMITTERS
 CARDWELL HIGH VOLTAGE CONDENSERS
 FOR COMMERCIAL RADIO-TELEGRAPH and
 BROADCASTING STATIONS
 CARDWELL S-3244 OIL DIELECTRIC FIXED CONDENSERS
 FOR HIGH FREQUENCY FURNACES
 and TUBE BOMBARDERS
 THERE'S A CARDWELL FOR EVERY TUBE,
 PURPOSE and POCKETBOOK

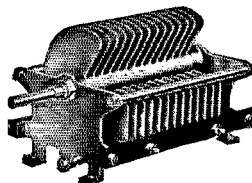

The ALLEN D. CARDWELL MFG. CORP'N.
 83 Prospect Street, Brooklyn, N. Y.

"THE STANDARD OF COMPARISON"

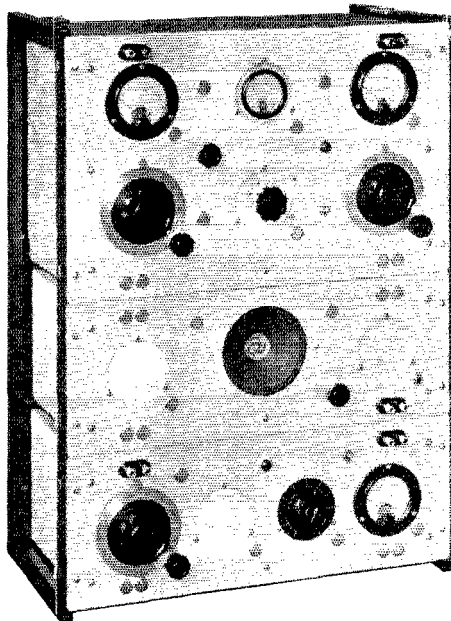

WHY GNAW OUT METER HOLES



when GR unit-panel construction gives you a completely laid out panel with all holes neatly cut. All that costs you but little more than finished stock of comparable surface and quality.

But it isn't the low first cost of GR unit-panel construction that's the important thing. It's their neatness, their clean finish, their interchangeability that make these panels the biggest thing in amateur construction practice.

The photograph above shows something of what can be done, but

Send for Bulletin 934-Q2 NOW

It contains complete layout drawings of both panels and accessories, clearly shows how all parts fit together.

GENERAL RADIO CO.
CAMBRIDGE, MASSACHUSETTS

MADE BY THE MAKERS OF
"GR" PLUGS AND JACKS

It is sufficient that the bandsetter be highly stable in frequency over short periods of time, only. Provision is made and the procedure is simple for periodic recalibration of its frequency over longer periods of time. The major cause of frequency change is the multivibrator control. Changing the grid leak on one of the tubes from zero to a finite value changes the total multivibrator plate current, which in turn reacts on the plate supply voltage. The maximum effect on the oscillator frequency is 100 cycles per million. For this reason it is advisable to set the multivibrator on the frequency desired before checking the oscillator frequency. Rotating the output control from zero to maximum decreases the frequency 20 cycles per million. A change in a.c. line voltage from 110 to 120 shifts the frequency 20 parts per million. Temperature increases cause the frequency to increase about 15 cycles per megacycle for each degree Centigrade.

Chiefly due to the use of a fixed mica condenser in the oscillator tank circuit, the frequency of the bandsetter changes with time. This occurs in the model shown at the rate of about 200 cycles per megacycle, per day. The new General Radio precision mica condensers might be used to obviate this drift. The bandsetter can be used two or three minutes after turning on, since the frequency change thereafter due to warming up is about 20 cycles per million. To sum up the effects of the major frequency changes over short periods of time, assuming that the multivibrator is set before calibration:

Temperature	± 5° C.	± 75 parts per million
Line a.c.	± 5 volts	± 10 " " "
Output control		20 " " "
Aging	(6 hours)	50 " " "
Total		185 parts per million

The total is equivalent to about .015 percent accuracy. Over a period of a week the bandsetter will hold within about 0.1 percent. Preferably, then, it should be checked every day or so while in use.

Calls Heard

(Continued from page 46)

w7coi w7cbx w7ckz w7cju w7djj w7im w7kl w7oy w7szk
w8ede w8ckq w8gdr w8idj w8je w8kg w8mx w8wr w9ajs
w9aws w9afm w9btg w9bwg w9bnt w9bym w9bnu w9cou
w9dxi w9dgy w9dhi w9efe w9fau w9geg w9gxy w9hsh
w9hsv w9hjc w9hmk w9hfa w9iqa w9ifw w9ieb w9iho
w9jns w9jie w9jcw w9kef w9kja w9kto w9lfw w9mvs
w9mst w9nic w9usa w9yb

Horace D. Simonsen, Box 72, Blenheim, New Zealand

(3.5-mc. band)

w1cdd w1ju w3asw w3cxl w3dmb w3mc w4aaq w4bpb
w4edl w4hw w4ll w5ddm w5ws w8baj w8bcc w8fzm w8ijh
w9auh w9dxi w9fnq w9euc w9ghi w9gli w9grt w9gyb
w9hsh w9kpt w9ljk w9mme w9mir w9nfq w9ojx w9ni
w9ya

(3.9-mc. 'phones)

w3cgt w3dms w4aab w6abf w6alg w6dda w6eah w6eqj
w6fen w6goy w6hkc w6jhn k6baz w7aqx w7bde w7buf
w9edw w9gxi w9jai



KENYON now offers you Commercial Radio Equipment

FOR years past KENYON has supplied iron-core devices for Army, Navy, Coast Guard and other Government radio services; to broadcasters and commercial radio organizations; and to laboratories and research workers. Built to such rigid specifications, this equipment has heretofore been unknown to the radio ham.



But today, with a matured appreciation of commercial grade equipment generally prevalent among advanced radio amateurs, the KENYON organization now makes available for ham activities its best grade products. The line will be known as the KENYON DREADNOUGHT LINE.



Power, filament and plate transformers; input and output transformers; modulation transformers; reactors and other items, complete the KENYON DREADNOUGHT LINE. Units are available in all standard ratings and voltages, featuring: *Sturdiness* — generous design and construction for reliable, steady, long service. *End Plate Castings* — neat appearance combined with ruggedness. *Heavy Insulation* — an insurance against breakdown. *Vacuum Impregnation* — a positive guarantee of thorough protection of the windings from climatic conditions and particularly moisture. *Porcelain Bushed Terminals* — eliminating leakage. In a word, you can now enjoy Navy Specification products.



Watch this page for forthcoming detailed specifications covering the various units of the KENYON DREADNOUGHT LINE. Meanwhile, ask your nearest amateur radio supply house about these products which will soon be on display and in stock for inspection and prompt delivery.

KENYON TRANSFORMER Co., Inc.

122-124 Cypress Avenue :: :: New York City

TO JOBBERS AND DEALERS: The KENYON DREADNOUGHT LINE is being sold through a select group of merchandisers in exclusive territories. Certain territories are still open. If interested, write for our proposition.

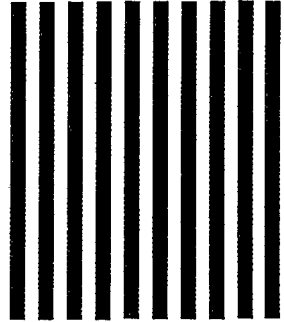

K E N Y O N

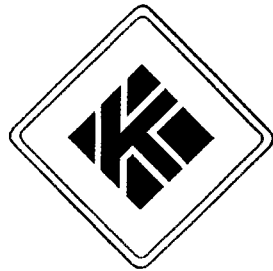

P R O D U C T S

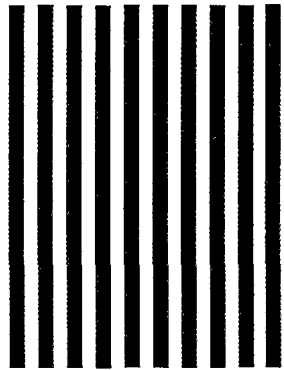

Due to Popular Demand, We Repeat This Sale

We need more customers! To build up good will, we have arranged with a reputable manufacturer to make for us a line of tubes to fit the depression pocket-book of the amateur fraternity. These tubes are first class products and carry our absolute guarantee for 90 days.

210 — 15 w... \$1.15 866 — H.D. \$1.50
28190 211 7.75
250 1.15 203A 8.95

**POWER SUPPLY — 1200 v. — 250 ma and
600 v. — 250 ma**

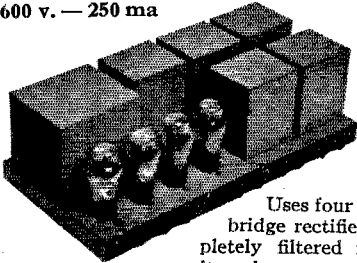

Uses four 83's in a
bridge rectifier—com-
pletely filtered in both
voltage legs.

\$35.00

WESTON 476 AC VOLTMETERS

Reconditioned like new —
guaranteed. 0 to 5 v. **\$3.50**

SYLVANIA Graphite { ... 210 — \$4.75
Anode { ... 830 — 8.75
 { ... 825 — 10.00

**PLATE TRANSFORMER — two 7½
and two 2½-volt fil. windings — 750-
750 v.—160 mils. \$3.50**

GE PLATE TRANSFORMER
750 v. each side c. t.—280 mils—fully
mounted in steel housing— **\$5.00**
original list price, \$35.00....

EXTRA SPECIAL

Filament Transformer—110 v. pri.—2
separate 7½ v. center tapped
windings—3 amps., each. **\$1.35**

Double-Button Microphone. \$2.95 } *Comb-*
Microphone Ring with 8 } *inat-*
springs. 1.75 } *tion*
Two-Button Mike Trans- } *for*
former. 1.65 } **\$5.50**

Baldwin Type C (new model) Phones... \$3.35
No. 10 H.D. Enamel— any length — per
ft.01
Neon Bulbs— ½ and 1 watt.45
No. 18 Solid push back wire — per 100 ft. .45

Johnson 50-watt sockets. \$1.20
Bliley X cut 160 — 80 — 40 m. Crystals. . 3.90
Bliley Xtal holders. 1.50

Open Evenings — 7 to 9.30 p.m.

KALTMAN & ROMANDER
62 Court Street Newark, New Jersey

Commission Tightens Enforcement of Regulations

AS WE reported recently, ten of the Federal Radio Commission's monitoring stations have been equipped with National AGS receivers for the more rapid monitoring of amateur signals and are actually spending a minimum of two hours per day in policing our bands. Amateur stations observed to be operating in violation of regulations are served with a "discrepancy report" by the monitoring station that logs them, and are obliged to make an immediate statement to the Commission at Washington concerning the occurrence.

The most common violations noted are operating outside of the authorized frequency bands or the use of plate supplies other than filtered direct current. Cases are now accumulating where the same amateur has been cited two or more times for the same violation. That is to say, the Commission is finding out now, as amateurs have long known, that the great majority of amateurs are capable and desirous of complying with regulations, but that there is a small minority who do not pay enough attention to the need for complying with reasonable regulations, and who therefore require more vigorous policing.

The Commission has now moved to stop these violations. A violator will now receive a list of questions to answer under oath, the replies to which will enable the Commission to pass upon the case. For successive violation of the same regulation definite punishment is to be meted out, including closing down the station.

It must now be said that, after some years of no visible enforcement of regulations, the Commission is undertaking a vigorous policy of enforcement. We think that this is as it should be and that it will find widespread approval. Our regulations are moderate and easily complied with. We are just passing along the word now that the F.R.C. means business and that every-body should comply with the regulations.

Silent Keys

It is with deep regret that we record the passing of these amateurs:

Weiden W. Cone, W8EGB, Jasper, Mich.
Andrew C. Dreier, W8SU, Rochester,
N. Y.

Philip T. Elliot, W9EBS, Cicero, Ill.

Earl W. Filz, W9EVH, Warsaw, Ill.

Dr. A. G. Friedline, Jr., W7DQC, Boise,
Idaho

E. C. Hamilton, Jr., W9BAU, Sedalia, Mo.
William L. Harmon, W8DSL, Saxonburg,
Pa.

Mertz Jones, W8ANS, Bellaire, Ohio

F. W. King, W9AGB, Ferguson, Mo.

Edwin Valentine, W2EMD, Rockville
Center, N. Y.

Round Out Your Station Equipment

WITH These Supplies

Here are the essential accessories to the operating equipment of a well-run and efficient amateur station. Buy them ahead of your actual needs—don't wait until you run out—check up now—how's your supply?

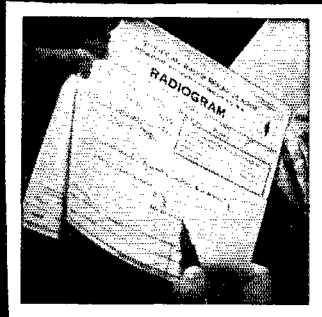
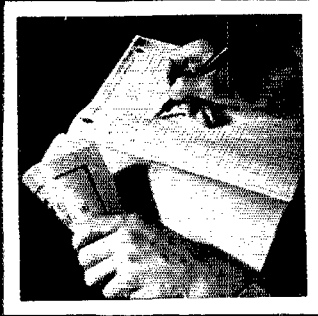

The LOG BOOK, bound in heavy paper covers, $8\frac{1}{2}$ by $10\frac{3}{4}$, contains 39 log pages and the same number of blank pages for miscellaneous notes. Also there is a list of Q signals, a message number sheet and a sheet of cross-section paper. Price, 40¢ each or 3 for \$1. The neatest and simplest way to deliver a message by mail is to use a standard MESSAGE DELIVERY CARD. It explains what it is and how it got there. Quick and convenient and easy to use. Price, 2¢ each on U. S. stamped postal cards or 1¢ each on plain cards.

The MESSAGE BLANKS are the most convenient form for handling and delivering messages. Designed by the Communications Department for maximum ease and efficiency. Well printed on good bond paper. Size $8\frac{1}{2}$ by $7\frac{1}{4}$. Price, 35¢ per pad of 100 sheets, three pads for \$1. You should write your radio letters on the official League MEMBER'S STATIONERY. It identifies you instantly and is good-looking and convenient. Lithographed on heavy $8\frac{1}{2}$ by 11 bond paper. Price, 100 sheets for 50¢, 250 sheets for \$1, 500 sheets for \$1.75.

All above prices are postpaid. Please do not remit in postage stamps. Stock up now with these various supplies for a flying start into the new year.

AMERICAN RADIO RELAY LEAGUE, WEST HARTFORD, CONNECTICUT

To Our Readers who are not A.R.R.L. members

YOU should become a member of the League! That you are interested in amateur radio is shown by your reading of *QST*. From it you have gained a knowledge of the nature of the League and what it does, and you have read its purposes as set forth on the page opposite the editorial page of this issue. We should like to have you become a full-fledged member and add your strength to ours in the things we are undertaking for Amateur Radio. You will have *QST* delivered at your door each month. A convenient application form is printed below — clip it out and mail it today.

A bona fide interest in amateur radio is the only essential qualification for membership

AMERICAN RADIO RELAY LEAGUE
West Hartford, Conn., U. S. A.

I hereby apply for membership in the American Radio Relay League, and enclose \$2.50 (\$3.00 outside of the United States and its Possessions, and Canada) in payment of one year's dues, \$1.25 of which is for a subscription to *QST* for the same period. Please begin my subscription with the issue. Mail my Certificate of Membership and send *QST* to the following name and address.

.....
.....
.....

Do you know a friend who is also interested in Amateur Radio, whose name you might give us so we may send him a sample copy of *QST*?

.....
Thanks

Standard Frequency Transmissions

STANDARD frequency transmissions from W1XP have been suspended temporarily for changes and repairs in the frequency standard equipment at the Round Hill Station. Schedules of the S. F. System's Midwest and Pacific Coast stations, W9XAN and W6XK, continue as usual, according to the following schedule:

Date	Schedule	Station	Date	Schedule	Station
Feb. 2	A	W6XK	Mar. 2	A	W6XK
Feb. 9	B	W9XAN	Mar. 9	B	W9XAN
	B	W6XK		B	W6XK
Feb. 14	C	W9XAN	Mar. 14	C	W9XAN
Feb. 16	B	W9XAN	Mar. 16	B	W9XAN
	A	W6XK		A	W6XK
Feb. 21	BB	W9XAN	Mar. 21	BB	W9XAN
Feb. 23	BB	W6XK	Mar. 23	BB	W6XK
	A	W9XAN		A	W9XAN
Feb. 24	BX	W6XK	Mar. 24	BX	W6XK
Feb. 25	C	W6XK	Mar. 25	C	W6XK

STANDARD FREQUENCY SCHEDULES

Time (p.m.)	Sched. and Freq. (kc.)		Time (p.m.)	Sched. and Freq. (kc.)	
	A	B		BB	C
8:00	3500	7000	4:00	7000	14,000
8:08	3600	7100	4:08	7100	14,100
8:16	3700	7200	4:16	7200	14,200
8:24	3800	7300	4:24	7300	14,300
8:32	3900		4:32		14,400
8:40	4000				

Time (a.m.)	Sched. & Freq. (kc.)	
	BX	
6:00	7000	
6:08	7100	
6:16	7200	
6:24	7300	

The time specified in the schedules is local standard time at the transmitting station. W9XAN uses Central Standard Time and W6XK, Pacific Standard Time.

TRANSMITTING PROCEDURE

The time allotted to each transmission is 8 minutes divided as follows:

- 2 minutes — *QST QST QST de* (station call letters).
- 3 minutes — Characteristic letter of station followed by call letters and statement of frequency. The characteristic letter of W1XP is "G"; that of W9XAN is "O"; and that of W6XK is "M."

1 minute — Statement of frequency in kilocycles and announcement of next frequency.

2 minutes — Time allowed to change to next frequency.

W9XAN: Elgin Observatory, Elgin National Watch Company, Elgin, Ill., Frank D. Urie in charge.

W6XK: Don Lee Broadcasting System, Los Angeles, Calif., Harold Peery in charge.

WWV 5000-Kc. Transmissions

The 5000-kc. transmissions of the Bureau of Standards' station, WWV, are given every Tuesday continuously from 12:00 noon to 2:00 p.m., and from 10:00 p.m. to midnight, E.S.T. The accuracy of these transmissions is to better than 1 cycle (one in five million).

— J. J. L.

The Delta Division Convention

WITH entertainment as the key-note the convention opened auspiciously at the Hotel Gayoso, Memphis, Tenn., October 20th-21st. The convention committee of the Memphis Amateur Radio Club, sponsoring the affair, saw to

A.C. RELAYS

Made by

Allen-Bradley

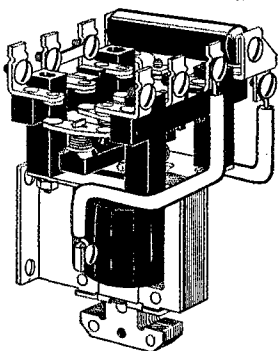
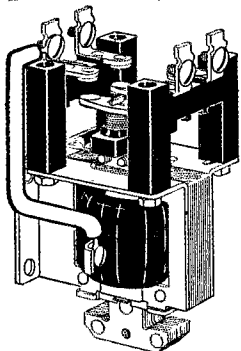

These A. C. solenoid relays are ideal for remote control of transmitters, for control of crystal ovens, and for any general remote control application except for keying. **THESE RELAYS WILL NOT OPERATE IN KEYING SERVICE.** Silver-to-silver double break contacts are used throughout.

The maximum contact rating is 10 amperes at 220 volts. The relay coils are wound for 115 volts 60 cycle alternating current. Relays for other voltages can be supplied on special order. Use coupon below when ordering.

Type No.	Poles	Nor- mally	Circuit Diagram	Price		Type No.	Poles	Nor- mally	Circuit Diagram	Price	
				Open	In Cab.					Open	In Cab.
A107	1	Open		\$3.00	\$4.00	A177	1	Closed		\$5.00	\$6.00
A117	1	Closed		3.00	4.00	A207	2	Open		3.50	4.50
A127	1	Open and Closed		3.50	4.50	A217	2	Closed		3.50	4.50
A137	1	Open		3.50	4.50	A227	2	Open and Closed		4.50	5.50
A147	1	Closed		3.50	4.50	A237	2	Open		4.00	5.00
A157	1	Open and Closed		4.00	5.00	A247	2	Closed		4.00	5.00
A167	1	Open		5.00	6.00	<p>Radiostat—A stepless graphite compression rheostat for primary of 550 watt filament or plate supply transformer. Range 4 to 150 ohms. Price \$6.50</p>					

ORDER BLANK—MAIL WITH REMITTANCE TO

Allen-Bradley Co., 108 W. Greenfield Ave., Milwaukee, Wis.

Enclosed find money order for \$..... for which please send me, shipping charges prepaid, the following items:

Name

Address

"HAMS" Are Improving the Efficiency of Their Transmitters and Receivers by the Use of LYNCH Antenna Systems

EVERGREEN 2756

HARRY A. TUMMONDS

NORTHERN OHIO LABORATORIES

Wholesale Distributors of
RADIO TRANSMITTING AND RECEIVING
EQUIPMENT
2073 West 85th Street
CLEVELAND, OHIO

14th November, 1933
51 Vesey Street, New York, N. Y.
Attention: Mr. Arthur H. Lynch, President.
(W2DKJ)

Dear Mr. Lynch:

After the introduction of your original transposition blocks, we were bewildered by claims made by makers of glazed porcelain units.

To satisfy ourselves, we made the following simple test for moisture penetration.

Three of your blocks and three of your competitors' products were soaked in a penetrating dye for 48 hours. Then they were allowed to dry thoroughly. Then they were broken.

Not a single glazed block came through without showing marked absorption. The interiors of the three Lynch blocks were as clean as a hound's tooth.

Use of your units has improved the efficiency of both our transmitting and receiving antennas. You have made a real contribution to "ham" radio. Thanks.

Yours for more and better QSO's,
NORTHERN OHIO LABORATORIES
HARRY A. TUMMONDS, President.
(signed) Harry A. Tummonds

HAT-LMO
W5BAH

FULL DOPE ON REQUEST

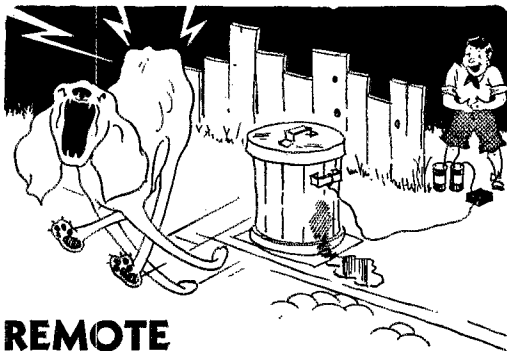

REMOTE CONTROL...

WARD LEONARD MIDGET RELAYS permit sending and receiving from any spot without reference to location of working equipment. They are made single and double pole, single and double throw for both A.C. and D.C. Send for the FREE booklet 507. It includes relays and other important equipment.

WARD LEONARD ELECTRIC COMPANY

41 South Street, Mount Vernon, N. Y.

Please send me free copy of booklet 507.

Name

Street

City and State

Call Signal

76

Say You Saw It in QST — It Identifies You and Helps QST

it that every delegate was made to feel at home. An unusually large number of ladies was present and the committee had a special program for them, enabling all to become better acquainted. The principal guest present, Lieut. John L. Reinartz, the well-known amateur, did not disappoint the delegates. As consultant on amateur matters for R.C.A. Radiotron his technical information on the several new tubes was enlightening and moreover his lecture on his trip to Etah with Captain McMillan made many envious. Sickness in Director Hill's family prevented him from attending the convention for which everyone was sorry. On the shoulders of J. C. Flippin, W4VT, E. C. Frase, W4FK and J. H. Viser rested the responsibility of the convention. Our congratulations go to them for preparing such a fine program. Dave Veazey, W4OI, pinch-hit when one of the technical speakers failed to arrive and we all know more about crystals. Geo. Bidwell, W9FIS, representing Walter Ashe Co., St. Louis, brought over a fine display board of transmitting parts and was the center of attraction many times during the convention. Fieldman Hebert, representing A.R.R.L. Headquarters, was kept busy talking organization, answering questions and discussing the many problems with which A.R.R.L. is faced. Miss Janet Parnell and the WMC trio carried the honors with their very fine music, although the dancing talent from the Mary Lee studio proved very entertaining.

Radio Inspector du Treil of the New Orleans office made a surprise visit on the last day just to meet the many friends he has and gave words of advice on the new regulations. The person who has not heard of Rush, W4TM (the old Horse Fly), does not know radio. It is too bad that thousands of those hams, who are disturbed in their night operating by Junior insisting on receiving attention, were not present to look in wonder on the gadget invented, described and demonstrated by TM. You have all heard that the "hand that rocks the cradle" governs the world. Well, Rush does it with a microphone. We hope to see a description in QST some day.

W4PL, being the oldest amateur present, won a prize; E. C. Holland, an embryonic ham, 14, was also awarded a prize. The most distant prize went to Oscar Fortune, XER, Via Acuna, Mexico. The most contested event was the spelling contest and the judges had to resort to all kinds of manuals and books and Louis Bustler was declared the winner over some 50 participants. W5UI, Geo. Harvey, knows his "Q" signals so well it landed him a prize. He also brought a haywire receiver that won in the receiver contest. W5DHG was a close second. The speed artist was McCoy, one of the ops. at W4OI.

Only one SCM, Henry Vette of Little Rock, Ark., was present, and to him fell the responsibility of giving advice to those interested in the C.D. The introduction of "dutch" luncheons kept the many groups together during the convention. When the big bell struck for the final

(Continued on page 78)

1934 BRINGS

New Ideas

New Apparatus

and New Low Prices

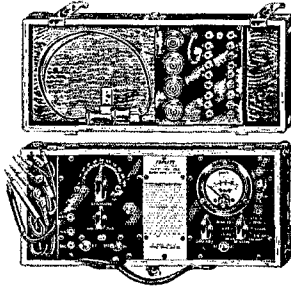

Amateurs everywhere are taking to TRIPLET METERS like a duck takes to water. A complete line of quality service equipment is also available at low prices. Take the 1179 perpetual tester for example. For the first time a complete service laboratory in one oak case. All necessary voltage current and resistance measurements, shielded two range oscillator, output meter and a complete selective analyzer panel. Absolutely nothing else to buy at..... **\$33.98**

Write for that bulletin today

Announcing a new LEEDS DEVELOPMENT

in frequency meter calibration. Dozens of calibration points available 24 hours a day with an accuracy of .01% or better. Send us 10c in stamps, to cover cost of mailing the hottest dope ever released on frequency meter checking. A \$10,000 frequency service for less than \$10.

Leichner Condensers

are the best units we have yet seen for blocking and bypassing at high frequencies. Just compare the prices.

Effective working voltage 3500 — not flash test

Type B-3	Type F-2	
75 mmf.	500 mmf.	} \$1.10
100 mmf.	1000 mmf.	
150 mmf.	2000 mmf.	
200 mmf.		
250 mmf.		
500 mmf.		

SPEAKER SPECIALS

Wright Decoster 6" dynamic speaker, with 2500 w. field and pentode output transformer..... **\$2.75**

Wright Decoster 5" midjet dynamics with 3000 w. field and pentode output transformer..... **\$2.25**

Genuine Baldwin Phones

Type C — Mica diaphragm. Limited quantity — only 2 pair to a customer. Special..... **\$3.75**

Western Electric Phones

Type P-11 Signal Corps. phones. These would ordinarily sell at \$7.50. All new — all perfect. Here's a genuine bargain at..... **\$3.95**

Special RELAY Bargain

Operates on one dry cell, two pole. One pole make and break, the other break only. Contacts will handle 250 MA. A BUY at, each..... **\$2.29**

Extra Special until February 25th only. FLECTHEIM 2 mfd.

1000 volt condensers, **\$1.95**
\$6.00 list; our price

JEWELL METERS No. 190 A.C. Meters

Just a few more left. Better order now, tomorrow may be too late.

0-8 v. } each
0-10 v. } **\$3.50**
0-15 v. }
No. 165 Thermo-ammeters 0-1 amp., and 0-2 amp., each..... **\$4.95**
The new Western-Jewell dealers' bulletin is now available.

READRITE flush mounting meters; range from 0 to 15 to 0 to 400 M.A. D.C..... **59c**

LEEDS' precision crystal holder... **\$1.25**
Y cut crystal 10 KC 80 or 160 meters **2.50**
With crystal holder..... **3.50**
Y cut xtal .1 of 1% accuracy..... **3.00**
With crystal holder..... **4.00**
X cut crystals .1%..... **3.75**

Navy Type Telegraph Key

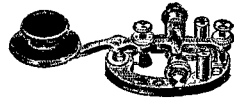

List \$3.60.
Navy knob — 1/8" Tungsten contacts. Only a few left at **\$1.15**

With regular knob..... **\$1.95**
Leeds transmitting key, spec..... **\$6.50**

Carter 20000 w. wire wound potentiometers 3" diameter..... **\$2.25**
Dubilier, 3 mfd. 400 v. paper condensers, each..... **\$4.9**
R.G.A. chokes; 18 H, 125 M.A. 200 ohm, each..... **\$7.99**
Aerovox electrolytics 12 v. 1500 mfd. **\$6.99**
DeForest Audio Trans. 3:1, each... **\$4.99**
R.G.A. UV712 peaked audio transformers 9:1, each..... **\$9.95**
DeForest tubes, 481-450 only; each, **\$9.95**
Kenyon KC 350; 30 H, 75 mils; 350 ohms..... **\$7.50**

NATIONAL

F.B. pre-selector unit in stock; complete with coil for one band... **\$15**

FBXA..... **\$47.70**
FB7A..... **34.20**
All FB coil ranges..... **6.00**
SW 3 receivers..... **17.70**
Short wave coil ranges, each... **3.00**

All the new National Insulator products as advertised last month now available. **40% discount from list.**

The WING 5 Meter Transceiver

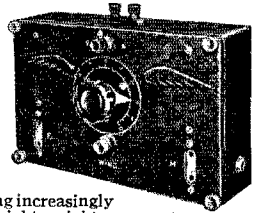

is becoming increasingly popular. Light weight, compact size and simplicity make it ideal for portable or automotive use. With tubes..... **\$18.25**

Picard type matched impedance antenna for 5 meters complete..... **\$2.50**

GENERAL RADIO

We carry a complete stock of all the latest parts for immediate shipment. We can also supply all of the parts advertised last month at the same special prices.

All Wave Receivers

We have been watching the trend of the broadcast field toward this type of receiver and after thorough investigation heartily recommend the ZENITH No. 288 to our non amateur short wave friends. List price \$78, complete. Write for descriptive folder.

LEEDS does not publish a catalog. We will be glad to furnish manufacturers bulletins on any apparatus advertised by us if you will specify those you are interested in. We will be glad to quote our lowest prices on any equipment by return mail.



45 Vesey Street, New York City

New York Headquarters for Transmitting Apparatus

Êtes-vous intéressé dans l'appareil American? Notre annonce dans le QST de Novembre, page 68, vous informe comment l'obtenir dans la manière la plus vite et moins chère. Vous remportez de grands avantages de requérir une translation de notre plan.

THE TRITET UNIVERSAL EXCITER UNIT

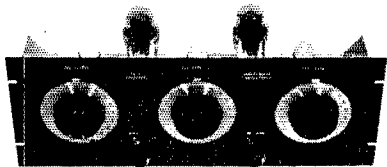

Retaining all the basic circuit features of the original Tritet as developed by J. J. Lamb, the Harvey Tritet has all plug-in coils, crystal and output posts in the rear, and provisions for connecting plate current meters without disturbing the circuit wiring. With an 80-meter crystal, the output on 20 meters is ample to excite a 210 or an RK-18. Built for relay rack mounting, of highest quality parts, fully wired and tested, complete with two Raytheon 59 tubes. **\$52.00**

56 MC. TRANSCEIVERS

The identical transceiver taken with the Byrd Antarctic Expedition. Only 3½ pounds in weight, it uses one 30 and one 33 tube, and operates from the smallest B batteries. Truly portable, it has worked 95 miles from a mountain top. Six-volt model also available for automobile or aeroplane installation. Shown with microphone to give an idea of its size. Fully wired. **\$19.50**

Send stamp for literature on Tritet, companion RK-18 amplifier and accessories.



HARVEY RADIO LABORATORIES

12 Boylston Street, Brookline, Massachusetts

The Delta Division Convention

(Continued from page 76)

events, the banquet and the award of prizes, there was 100% representation.

With a few final words from Reinartz, Hebert and du Treil the curtain came down on a successful ham convention. Memphis again next year.

— A. A. H.

Taming the 'Phone Transmitter

(Continued from page 33)

voltage indication about the tank circuit or any other part for that matter. The plate currents of the r.f. tubes remain solid under 100% modulation with sometimes a 1 or 2 mil grid current variation on the final.

PROPER MODULATION

A word about loading the modulator system is in order at this time. After running the final r.f. amplifier at a 500-volt and 100-ma. input for several months with uniformly good quality reports, a doubt arose as to this 5000-ohm load value. Upon writing the manufacturers of the Class-B transformers, information was received that the load should be 3700 ohms. This called for an increase to 135-ma. input to the final amplifier. But after tightening the antenna coupling and easily getting the 135-ma. load with a nice increase in feeder current (necessitating shunting the 1.5-amp. thermocouple meter), the reports from reliable DX stations were not conclusive. Some times the signal strength reports favored the 5000-ohm load and again others favored the 3700-ohm load. In no case did the quality reports change. Since the 5000-ohm load for practical purposes gives the same signal effectiveness as a 3700-ohm load, the former is preferred, not only because of its lighter input on both the modulator and Class-C stage, but also because the plate current to the final amplifier shows a dip under modulation peaks at 135 ma., indicating overloading of the modulator and "downward modulation," whereas with the 100-ma. input the plate current is absolutely stable and the r.f. meter whips more freely.

As evidence of what can be gained by attention to details, after the series of experiments and changes the feeder current has been gradually worked up from 0.7 amp. to 1.25 amp. with cooler tubes, less r.f. straying around the tank coil, and better reports on both volume and quality. The tuning holds true from day to day with the possible exception of the Zepp antenna circuit, which is affected somewhat by the weather. While the tubes in the modulator and Class-C stage are being pushed a little hard, so far they have given an excellent account of themselves. On the present market any tube in the whole setup could be replaced for less than a dollar at amateur prices. And as for results—well, the old saying that "you can work what you hear" has held essentially true.

Are You "Stuck"? LEARN CODE QUICKLY AND EASILY and become a Skilled Amateur or Radio Operator . . . AT HOME

Watson, WIBGL, op Bear of Oakland, Byrd Expedition, says: "Candler training enabled me to pass rigid competitive tests for this position."

Many Instructors and ops in U. S. Army, Navy and Aviation are Candler trained.

The FASTEST and most SKILLED Amateurs and Commercial ops during the past 22 years were Candler trained. 9 year old girl wins championship in Class "E" 2 months after beginning our Code Course for Beginners.

If you're wise you'll get your SPEED where the champions got theirs and prepare for that Amateur or Commercial Ticket the CANDLER SCIENTIFIC WAY. It's EASY and INTERESTING.

CANDLER STUDENTS NEVER FLUNK. Tell us what ticket you're preparing for and we'll show you how easy it is to get.

SEND FOR BOOK OF FACTS for Radio Ops, Amateurs and Beginners. Your questions answered promptly. No obligation.

CANDLER SYSTEM CO.

Dept. Q-1 6343 S. Kedzie Avenue, Chicago

Candler System Code Guild

An organization of CANDLER trained ops sending practice programs daily from their stations all over the U. S.

Become a CSCG Member. We furnish Schedules listing all CSCG stations, time on the air, speed 8 to 45 wpm.

You can bring in CSCG Practice Programs with your S.W. Receiver. This is REAL practice that costs you nothing. There is no substitute for it. CANDLER trained ops will help you develop your code technique.



The 830-B—A New Tube for Class-B Service

(Continued from page 89)

top, the grid and filament through the base. The simple internal structure is based on substantial lavite insulators. A clear bulb is used because of the choice of materials and their treatment during manufacture. This facilitates inspection, also observation during operation.

Preliminary ratings for Class-B amplifier or modulator operation are as follows:

Filament: 2.15 amperes at 10 volts.

Plate: 1000 volts normal. Average plate current per pair at max. (190 watts) output, 280-ma. Maximum efficiency under proper conditions, 68%. Max. plate dissipation, approximately 60 watts per tube.

Grid: Bias voltage, —33. Rectified grid current per pair at full load, 36 ma. 8 driver watts required per pair (225 volts r.m.s. a.c. between grids).

Optimum load resistance: 10,000 ohms, plate to plate, for two tubes.

Plate resistance, 8000 ohms. Amplification factor (μ), 30.

The following driver and input transformer combination are suggested:

<i>Class-A Push-Pull Tubes (#)</i>	<i>Class-B Input Trans. Turns Ratio</i>
2A3 (recommended)	1/1.4
45	1/1.4
10	1/1
59 (recommended)	2/1 or 3/1

The outstanding operating feature of the 830-B is ability to furnish 190 watts of audio output per pair, with modest requirements as to tube cost, bias voltage and driving power. While 1000-volt operation has been stressed, the tube may be operated to advantage at lower voltages, the 600-volt performance being proportionate. At the lower voltage it may be compared with the Type 10 and will be found to have advantages over it, from every viewpoint.

Since the use of a graphite plate removes plate-color as a criterion of overloading, an amplifier or modulator using 830-B tubes must be operated with proper conditions as shown by the associated d.c. meters indicating plate and grid current, and preferably also by a high-resistance a.c. grid-to-grid voltmeter (0-300 rectifier type), all of which should be left permanently in circuit.

—J. J. L.

Strays

Bakelite caps from toothpaste and similar tubes make good insulating bushings for metal panels. Just bore a hole in the center large enough to pass the wire.

—W3AAJ

Alden Products Company has a new catalog which gives a very complete socket layout chart and contains useful information on modernizing obsolete tube checkers and set analyzers. Copies will be sent on request if addressed to the firm at 715 Center St., Brockton, Mass.

W1AMG focuses a 50-watt desk lamp on his right hand to keep it warmed up for DX these cold mornings!

THE FLORIST SAYS "SAY IT WITH FLOWERS"—AND IF QST HAD A SWEETIE IT WOULD YELL

"SAY IT WITH BINDERS!"

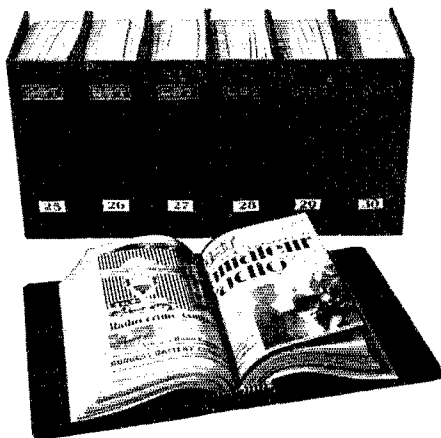

QST BINDERS

Priced at

\$1.50 postpaid

AMERICAN RADIO RELAY LEAGUE
WEST HARTFORD, CONN.

NEW PRESELECTOR AMPLIFIER — FOR S.W. SUPERHETS

We have in stock the new National Preselector Amplifier for FB7A, FBXA, Hammarlund Pro and other similar types of Amateur Receivers, following design by James Lamb and F. E. Handy in QST, December 1933. Net Price complete (less tubes and coils) \$11.40. Coils, each, \$3.60.

RCA - 800's

Also available for immediate delivery from stock, the new RCA 800's. Net Price \$10.00 each.

It will pay you to have your name on our mailing list

H. JAPPE COMPANY
46 CORNHILL BOSTON, MASS.

RCA-DEFOREST • TUBES •

CONNECTICUT DISTRIBUTORS

203A—\$17.50		800 —\$10.00
211 —\$17.50	ETC.	852 —\$23.80
845 —\$20.00		866-A —\$5.00

NATIONAL CONNECTICUT DISTRIBUTORS

RCA-CUNNINGHAM RECEIVING TUBES

ACME-DELTA BLILEY CRYSTALS

HATRY & YOUNG
203 ANN STREET, HARTFORD, CONN.

The Sixth International Relay Competition

(Continued from page 24)

sidered in the awards. From all outlying localities, reports must be received on or before May 29, 1934. Play safe . . . mail your report immediately at the end of the contest period to avoid delay and insure that your results are credited. Show your "official" claimed-score in full, following a tabulation of points in the log form indicated with this announcement.

CONTEST NOTES

You can't help but work a new bunch of stations, run up some new DX records for your station, get a new bunch of QSL-cards, have a whale of a lot of fun, and perhaps rate an A.R.R.L. award at the conclusion. Any neatly kept tabulation in the form given with this announcement will be an acceptable and welcome report. Any operator you work that doesn't know "what it's all about" can be referred to these pages of QST.

Results in previous Relay Competitions indicate that the majority of stations worked were raised, not by sending CQ, or testing on a half-dozen frequencies—but by first listening and locating foreign amateur stations, then going after them. No excuse for ten minute CQ's. The stations in remote localities, not W/VE stations, are the ones using CQ most effectively in previous international-DX affairs. The planning of best use of frequencies and operating hours for most effective participation and real operating skill are necessary to successful DX-work.

Operators of all stations have equal opportunity insofar as this can be arranged in this contest. Much depends on the judgment of the individual operators in determining the times and frequencies of operation of each station as well as on operating ability itself. Low power apparatus succeeds as often as high power on 14,000 kc., as was clearly demonstrated in our last international competition.

The contest offers a special incentive to W/VE amateurs to qualify for membership in the WAC Club. We wonder how many W/VE's will work all continents in the nine days of our contest? Of course many more will complete QSO's with continents most difficult to work, which operation supplementing present achievements will put them in line for "WAC"!

Stations using 14 mc. for the first time are cautioned to use care to keep in the band—slight tuning capacity changes, antenna changes, etc., can change frequency over very wide limits—interference with A.T. and T's 14,440-kc. channel (GBW) from off-frequency amateur operation will be decidedly out of order. We don't want to be obliged to make disqualifications again on these grounds this year!

Also W/VE hams are being heard across the water regularly on 3500 kc. this season. QSA5 reports from D, F, G, ZL and VK are being forwarded through Hq.

Both public opinion and government regulations have ruled against "prehistoric" signals, "ac" and unduly broad notes, so we hope there will be "none such." Good notes and stable frequencies should make your work in this contest more successful and enjoyable. A.R.R.L. Official Observers are requested to put in all time possible notifying amateur stations observed off-frequency or with improper-type signals, operating during the contest period. Observers' reports should be sent in through S.C.M.s at the conclusion of the contest.

Stations with good d.c. notes and real frequency stability will have the "edge" over those with poorly adjusted or otherwise inadequate equipment. But more than station equipment will be required to win! Most effective use of the available operating hours, intelligent choice of the different amateur bands, and a high degree of operating proficiency will take one a long way toward superlative results in this contest—or in any amateur radio work for that matter. The best equipment is only as useful for communicating as the man behind the key or "mike" can make it. Use any amateur frequency band, more than one if you wish. Take your pick of operating hours, 'phone or c.w. equipment. All active ham stations are invited to take part and report.

EXAMPLE OF CONTEST WORK

Every operator taking part in the contest assigns himself a distinctive three-numeral group, used by him throughout

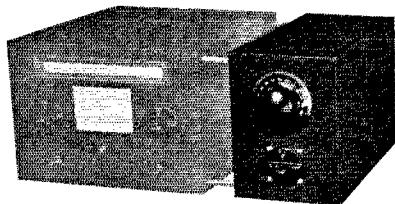

PRESELECTION

A preselector unit is now offered by National for use in conjunction with superheterodyne receivers. Though designed for FB receivers, it is well suited for use with receivers of other makes.

The virtues of preselection are so well known as to scarcely require comment. Image frequency suppression, improved weak signal response, improved signal-to-noise ratio, and increased sensitivity are but a few of the advantages conferred by its use.

The new unit is housed in a metal cabinet similar to, and matching, the cabinet of the FB-7A or FBXA. Its use does not interfere with the Single Signal Controls of the latter.

The preselector is designated as type PSK. Its List Price is \$25.00, including one plug-in coil. Additional coils are available to match all the FB-7 ranges, at a list price of \$6.00 per coil. A discount of 40% applies, when purchases are made through an authorized distributor.

NATIONAL COMPANY, INC., MALDEN, MASS.

METAL-WORKING LATHE

Precision equipment for the small shop. New designs and manufacturing processes make this amazing bargain possible. Complete metal working lathe with compound slide-rest, combination face-plate and independent chuck and tail center, 5 7/8" swing; 24 1/2" length, 20 pounds. Send \$1.00, balance plus postage C.O.D. Lathe for wood-turning alone, \$4. Attachments for milling, grinding, sanding, saw-table, etc., available at low prices. Order from ad at once and have a complete machine shop.



AMERICAN MACHINE & TOOL CO., Dept. Q-8 200 BROADWAY
NEW YORK

ALUMINUM BOX SHIELDS

Genuine "ALCOA" stock, silverdip finish, 5 x 9 x 6, \$1.65. 10 x 6 x 7, \$2.65. Any Size to Order. SOMETHING NEW! Your call letters, or any marking for your panel, on BLACK aluminum ribbon. Looks like engraving on bakelite. Sc up to 2 inches, 5c each additional inch. Sample 8c. U.S. Army V.T. 1 tubes 35c, 10 for \$2.50. Foil for condenser or velocity mike 1/2 mil., 25c ft.



New Master Teleplex on demonstration.
BLAN, the Radio Man, Inc. 177 Greenwich St.
New York City

*Technical
Training Station*

Phone C. W.

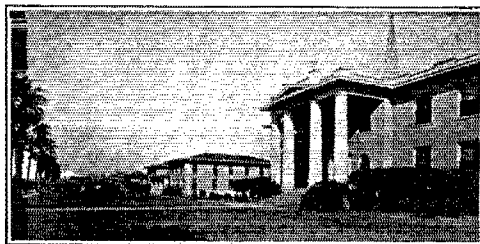

*Studio Technique
Guaranteed*

KFDL

1000-Watt 560
W. E. Kilocycles

IN 3 to 7 months we train you to secure Amateur, Commercial Telegraph Second-class, and Radiotelephone First-class government licenses. Course consists of Wireless Code, Radiophone, Microphone-Studio Technique, Television, Service, Police, and Aeronautical Radio. We are authorized to teach RCA Institutes, Inc., texts. At completion of your course you receive practical studio technique experience in broadcast studios located in our administration building, and operating experience on KFDL (1000-Watt W. E. Commercial Broadcast Station), and WPA, 4000-Watt Commercial Wireless Station. Return coupon for details.

PORT ARTHUR COLLEGE

Port Arthur (world-known port) Texas

Name

Street or Box

City and State

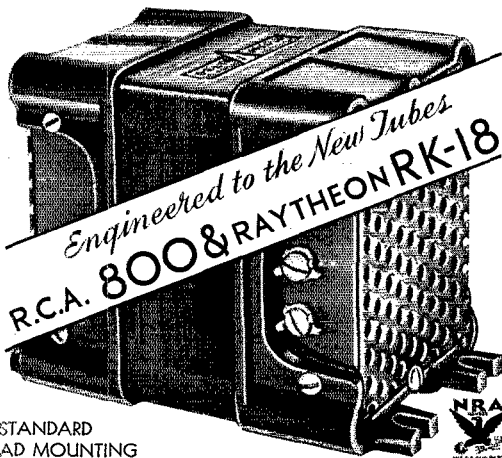

STANDARD
AD MOUNTING

ACME-DELTA

POWER SUPPLY EQUIPMENT

New Acme-Delta Power and Filament Transformer and new Swinging and Smoothing Chokes, especially and specifically designed for use with the Raytheon RK-18, R.C.A. 800, and the Hygrade-Sylvania 825 and 830 tubes, are now ready. See the complete catalogue in QST for December, 1933. Extra copies will be gladly sent you on request.

F. B. Dellenbaugh, Jr.
Pres. &
Chief Engr.



G. E. M. Bertram
Treas. &
Gen. Mgr.



Who's Afraid OF THE BIG BAD WOLF?

No wonder CENTRALAB Resistors defy abuses that would make the average resistor fail to function.

Your jobber has the new 1934 Volume Control Guide. Ask for it!

CENTRAL RADIO LABORATORIES
Milwaukee, Wisconsin

The "huffs" and "puffs" of vibration, excessive heat and overloads mean nothing to a Centralab resistor, safely housed in its protective ceramic cover (an integral part of the resistor itself).

the contest as the first part of each number exchanged (sent). All numbers exchanged are SIX figure groups. The last three digits of the serial number sent are always taken from the first half of the number group just received (the one from the last participating operator with whom a two-way exchange in the contest has taken place).

Since no exchanges have taken place at the start of the contest (and whenever a "partial" or incomplete exchange has been made so no "foreign" identifying number is available), the FIRST (or next) foreign or remote station worked will receive from you a six figure group made up of YOUR three-figure identification plus three zeros, constituting the six figure group.

Assume that these are some self-assigned identifying numbers: W6ZXY 543, G5ZZ 765, VK2LL 856 (he has already QSO W8ZXY 237), ZLLEE 398 (he has just received a number from VE3YY 657), AC6UU 395 (who last worked W1YXZ 984), PY1WW 777 and just starting his contest work, also VK5YY 852.

At the beginning of the contest W6ZXY contacts G5ZZ. He works all the other stations we have named above, and exchanges numbers with each during the contest period. W6ZXY's log (page 24) will show (by italic figures) just how the "first half" of numbers received are used as the "last half" of subsequent transmitter serial number groups.

New Code-Practice Oscillator

AT ONE time or another nearly every requirement of the beginner has been filled by the product of some manufacturer, but it is only recently that an audio oscillator of the type described in the Handbook has been made available. Such an oscillator is shown in the accompanying photograph.

Using the familiar circuit employing the windings of an audio transformer to produce oscillation, this unit is furnished equipped with

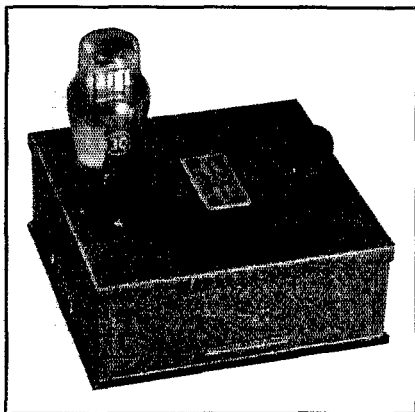

four flashlight cells which fit inside the case to furnish all the needed filament and plate current. A filament rheostat, with knob projecting from the top of the case, serves the double purpose of regulating the filament current and changing the tone of the oscillator. Tip jacks for headphones are visible on the near side, together with the on-off switch. Terminals for the key are brought out to the opposite side. The oscillator uses a Type 30 tube.

The new oscillator is a product of the National Company, Malden, Mass.

**• The Favorite •
National FB7-A**

with New Improved Air-tuned
I. F.

TRANSFORMERS

\$34.20

New pre-selector Kit for above
set, less coils....
Coils, \$3.60 each **\$11.70**

REAL NEWS!!

We Have Just Been Appointed
Distributors for the Famous

RCA Transmitting Tubes

The Long-Desired **\$3.25**

841 Tube Now,

A high Mu '10 Tube requires less excitation and less bias for a given output. Has wonderful possibilities.

- 203A (100 Watts, carbon plate)..... \$17.50
- 211 — (carbon plate)..... 17.50
- 800 — (35 Watts — Low Int. cap.).... 10.00
- 845 — (Modulator or A.F. Amp.).... 20.00
- 852 — (100 Watts, R.F. Amp. osc.)... 23.80
- 860 — (100 Watts, Screen Grid)..... 35.00
- 865 — (15 Watts, Screen Grid)..... 12.75
- 866A (10,000 Volt Rect., half-wave)... 5.00

New 1934 M. & H. Radio Catalog Ready

Another Bargain

**M. & H.
Power Pack**

Developed in our Laboratory
especially for

THE NATIONAL FB7-A

SPECIAL

THIS MONTH \$9.95

Rectifier Tube 40c extra

**Another Hard-to-Get
TRANSFORMER**

M. & H. Plate & Filament
Transformer, 750 volts each side,
C.T., 200 mls. 7½ volts, 4
amps., C.T., 5 volts, 3 amps.,
C.T. Cased and mounted.

Special \$8.25

Designed especially for 841 or
210 osc.—amp. Combination
with Type 83 Rectifier.

**A Hard-to-Get
TRANSFORMER**

**M. & H. Plate and Filament
TRANSFORMER**

450 volts, each side C.T., 150
mls., 2¼ volts, 3 amps. C.T.,
5 volts, 3 amps., C.T., com-
pletely mounted.

Special \$6.75

Designed especially for 47 xtal,
46 amp. 83 Rect. combination.

512 Market St. **M. & H.** Philadelphia, Pa.

Sporting Goods Co.

TELESKETCH An ex-navy operator has worked out a simple cypher by which diagrams, cartoons, recognizable faces, etc., can be telegraphed or 'phoned. Receiving operator draws straight from point to point on transparent paper placed over the cypher chart. 5,120 points in 5½ inch square allow good detail. Each point instantly selected. 50 cents, with instructions.

MICK-MACK Cypher, Box 45, Wollaston, Mass.

GRID LEAK BIAS

may be used with complete safety in even the largest ham transmitter equipped with the—
SENTINEL MAGNETIC OVERLOAD BREAKER
Most efficient, lowest priced instantaneous automatic protective device on the market. Model A50 to 400 m.a. Model B 100 to 800 m.a. Either \$5.85 plus 3 lbs. postage. Cash or C.O.D.

Write for free circular
DON. H. MIX & CO. Box 403, Bristol, Conn.

PANELS — BAKELITE — RUBBER — ALUMINUM

All Sizes Cut to Order **BAKELITE TUBING & RODS**

Drilling, Engraving & Special Work
ALUMINUM GANS—Stock sizes. Special sizes, made to order.
ALUMINUM CHASSIS—Threaded brass studs for 6/32 screws.
Length from ¼" to 6"—price 5c to 30c.

Insulating bushings for all size shafts 75c to \$1.90 per dozen  Couplings in brass or bakelite —15c 

UNITED RADIO MFG. CO. *Transmitting frames and racks.*
Est. 1923 191 Greenwich St., New York



Aluminum or electralloy panels, sheets, cans, shields, chassis — high gloss or silver finish — electralloy, very easy to machine, is non-magnetic — and low priced. Also bakelite, hard rubber panels and tubing machined, drilled and engraved at low prices: Send sketch for estimate.



**INSULINE CORP.
OF AMERICA**

25 Park Place
N. Y. C.

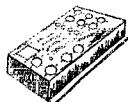

READ AND SEND CODE

Learn Easily at Home this Quicker Way:

No experience needed. Beginners read code quickly, copy accurately. If already an op, speed up your wpm this *approved* way and make better money. "Almost human!" experts call the amazing New Master Telex. Only instrument ever produced which records your sending in visible dots and dashes — then *sends back* to you audibly through headphones. Fascinating, fool-proof, gets results because you learn by HEARING as well as seeing. Has taught code to more students in past few years than all other systems combined. Used by U. S. Army and Navy, R. C. A., A. T. & T., and others. We furnish Complete Course, lend you the New Master Telex, and give you personal instruction with a **MONEY-BACK GUARANTEE**. Low cost, easy terms. Write today for folder Q2; no obligation.

TELEPLEX CO.

76 Cortlandt Street
NEW YORK, N. Y.



How's Your Fist?

(Continued from page 19)

Now you may understand why you hear some fellows sending dots at a rate of speed of 50 w.p.m. and making dashes and spaces about 20 w.p.m., and when you see that sort of sending on a recorder—sawful. There may be many who disagree with this method of determining speed, but it must be kept in mind that radio amateurs do not have the expensive instruments which are available in commercial telegraph organizations. This, therefore, is a simple, practical way out for those of us who have to make use of the best we have. It may be the means of teaching some skillful operator how to adjust his "bug" and thereby perfecting sending which now may be subject to criticism. After all, aren't we striving for cleaner and better sending? When we find that we can copy on paper with a brush and a pot of paint, at 35 per, improvements will have been made.

The Southeastern Division Convention

RUMOR has it that the reason for the interesting and successful convention held at Birmingham, Ala., October 27th-28th, under the auspices of the Birmingham Amateur Radio Club, was the presence of three of the leading liars in amateur radio. While the presence of these leading men helped, credit goes to Jeff Baynes, W4AAQ, and his convention committee for a well-balanced program.

With a stirring address of welcome by Mr. Ralph E. Parker, assistant city attorney, representing the president of the city commission, the convention opened auspiciously. The get-together meeting with remarks by SCM L. D. Elwell, W4KP; Ray Atkinson, W4NN, SCM, Florida; Bennett Adams, W4APU, activities manager for the club, and A. A. Hebert, A.R.R.L. fieldman who brought the greetings of headquarters, put every one in the proper mood for other events.

Following the "ham luncheon" the delegates boarded two large busses for the sightseeing trip. Broadcasting station WAPI tendered a fine reception to the visitors. Mr. Bell of Station WBRC took pleasure in explaining some of the new gadgets in use at his station. The trip ended at the police broadcast station WPFM.

I. J. Jones, W4JY, chairman of meetings, supervised the contests, which brought out plenty of competition. The event of the first evening was the introduction of Lieut. John Reinartz, W1QP, who described his trip to the North Pole region, while operator on WNP.

The technical session on Saturday was started by L. B. Hallman, Jr., chief engineer WSFA. Others who gave valuable information were: John C. Candler, W4AW, of General Radio Laboratories, Atlanta, and Lieut. J. L. Reinartz, consultant for R.C.A. Radiotron Co. Lieut. K. P. Maley, U. S. Coast Guard, spoke for their emergency net along the gulf region. Capt.

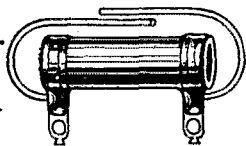

A TEN-WATTER That Can "Take It"

COMPACT, wire-wound, vitreous-enameled — a low-priced, efficient ten-watter that will be welcomed wherever *quality with economy* is a factor.

Non-corrosive Monel Metal contact bands and lugs, plus pigtails for convenience.

Same type made in three sizes, three ratings and 67 values.

Write Dept. Q-2 for FREE General Catalog and Vest Pocket Volume Control Guide

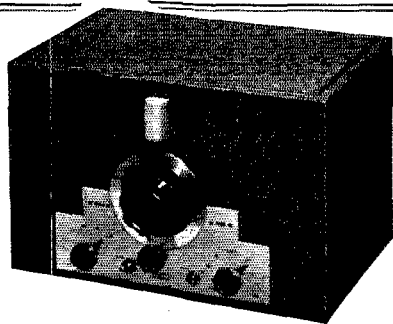

HERE'S THE SET YOU'VE BEEN WAITING FOR!

GIVES YOU 4 AMATEUR BANDS BY
TURNING A SWITCH — No Coils to Plug
In — No Coils or Other Extras to Buy.

Be from Missouri! See for yourself! Write today for fully illustrated folder giving all the dope on this outstanding amateur receiver development. Study its many features — note the money-back guarantee behind it. Then you'll quickly realize why the NEW Ross Jupiter Model is the handiest, most efficient set for amateur use — and at the lowest price (only \$59.50 net, complete with permanently attached coils and dynamic speaker but less tubes).

A. H. ROSS AND COMPANY

Keswick Ave. and Waverly Rd., Glenside, Pa.
(Suburb of Philadelphia)



"How's the new examination?"

"Tough, m'lad, tough. You gotta get down and dig, if you want to pass it. Them transmitter questions — wow!"

■ We'll bet our 1933 auto license plates that a minimum of 10,000 conversations such as the above have occurred since October the 1st, that day of renown on which the new regs took over. But, happily, that isn't the end of the story. Listen to this: ■

"Yuh don't say! And me what ain't yet been able to see one itty-bitty electron climbing from filament to plate. Ain't there nothin' I can do about it?"

"Sure. Get a copy of

THE RADIO AMATEUR'S LICENSE MANUAL

from good ol' A.R.R.L. It's got all the dope—questions 'n' answers—technical info—the new regs—everything."

"Yeah? How much is it? — that's the burning query these days."

"Just two bits, postpaid. And it tells the whole story on the Class A license for unlimited 'phone, too, and all that complicated stuff on renewals and modifications."

Get your copy today, 25c, postpaid, no stamps, please

THE AMERICAN RADIO RELAY LEAGUE, West Hartford, Conn.

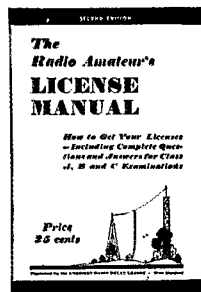

The Radio Amateur's License Manual (No. 9 in the series entitled The Radio Amateur's Library).

LEARN RADIO

New Classes Now Forming! Send for 40-page catalog, explains fully. 180 licensed graduates placed in past 2 1/2 years in broadcasting, shipping, police radio, aviation, etc. We teach all branches. Oldest, largest and best equipped school in New England. Equipped with Western Electric sound and broadcasting equipment and RCA marine transmitter. Course prepares for United States Government telegraph or telephone license.

MASS. RADIO SCHOOL, 18 Boylston Street, BOSTON

MICROMETER FREQMETER

Users of the MFM say "SF stations could set their frequency with it." Whether you buy or build your freqmeter get the superb performance of the MFM.

G. F. LAMPKIN LABORATORIES
146 W. McMillan Street CINCINNATI, OHIO

Attention, Hams!!

Bakelite Navy Key Knobs

1 3/4" outside diameter — 8-32 screw in back

25c each

POSTPAID

No C.O.D. Orders

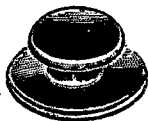

ORDER
DIRECT
FROM

RADIO SHACK 428 South State Street
Chicago, Illinois
or your local jobber

JOBBERS — Write for Quantity Prices

LOW RANGE FUSES

- Littelfuses for Instruments: Amps.: 1/100, 1/32, 1/16—20c ea. 1/8, 1/4, 3/8, 1/2—15c ea. 1, 2—10c ea. For milliammeters, ham rectifiers, etc. Use 1/8 for radio B circuits. High Voltage
- Littelfuses: 1000, 5000, 10,000 volt ranges in 1/16, 1/8, 1/4, 3/8, 1/2, 3/4, 1, 1 1/2, 2 amps. Renewable. Price 35c to \$1.25 ea.
- NOW—\$100 PROTECTION GUARANTY. Get New Cat. #5.

"Quicker than a Short circuit"

LITTELFUSES

XMITTING PARTS

RCA — RADIOTRON

203-A	\$17.50	852	\$23.80
300	10.00	860	35.00
845	20.00	866-A	5.00

SYLVANIA

210	\$4.75	825	\$10.00
866-A M.V. Rec.	9.00	203-A	17.50
830	8.75	852	23.80
RAYTHEON type RK-18 Oscil.-Ampl. tube			10.95
RAYTHEON types: RK-15-16-17		each	5.00
RAYTHEON 866-A M.V. Rectifier			9.00
HOYT Milliammeters: d.c. 12-15-25-50-100-150-200-250-300 m.a.			1.50
HOYT Voltmeters: 4v. a.c., 10v. a.c., 15v. a.c., 5v. d.c., 10v. d.c.			1.50
HOYT hot wire antenna meters: 1 3/4, 3, and 5 amp. ranges		each	2.95
HAMMARLUND "STAR" Midget Condensers: 15 mmf. 50c, 25 mmf. 50c, 50 mmf. 55c, 100 rpmf. 60c, and 140 mmf. 75c.			
HAMMARLUND Midget 35 mmf. double spaced			60c
HAMMARLUND Comet "PROS" in stock.			

Carry a complete stock of National S. W. Receivers and parts. Prompt service. 20% deposit with all C.O.D. orders. Remit by M.O. Include postage. FREE bulletin.

MAURICE SCHWARTZ & SON
710-712 Broadway, Schenectady, N. Y.

QST Oscillating Crystals

All "Scientific Radio Service Crystals" are accurately ground to an accuracy better than .03% on equipment tested regularly by the U. S. Bureau of Standards standard frequency signals."

SUPERIOR BY COMPARISON

● New Low Prices Are Now in Effect ●

BROADCAST and COMMERCIAL BANDS
Broadcast Band Crystals mounted in our Standard Holder and ground to our usual high degree of accuracy now \$35.00 each. Other bands similarly reduced. Prices quoted upon application.

AMATEUR BAND

Scientific Radio Service Crystals ground to within FIVE Kilo-cycles of your specified frequency in either 80 or 160 meter bands \$10.00 each. Mounted in our Standard Holder \$5.00 additional. Accurate calibration with each crystal.

PROMPT SHIPMENTS ASSURED

Scientific Radio Service



"The Crystal Specialists" Since 1925
124 Jackson Ave., University Park
Hyattsville, Maryland Dept. Q-2

When Seeking a Radio School

Consider RCA Institutes . . . an institution recognized as an important factor in the radio industry.

The beginner or the experienced man who seeks instruction in any branch of radio will find courses designed for him . . . either at the Resident Schools in New York and Chicago or the RCA Institutes Home Study courses.

Resident Schools are fully equipped — conveniently located — low weekly tuition rates.

FEATURES OF HOME STUDY COURSES

Extension courses for home study on convenient "no obligation" plan. Examination and lecturial advisory services. Free post-graduate practical training at resident school with modern equipment under instructing engineers.

Illustrated Catalog on Request



RCA INSTITUTES, INC.
Dept. ST-2

75 Varick Street, New York
1154 Merchandise Mart, Chicago

AMATEURS OF THE WEST

We carry in stock at all times all **NATIONALLY ADVERTISED** parts and kits of all **STANDARD MANUFACTURERS** for **TRANSMITTING** and **RECEIVING**

Prices are advancing
Write for latest quotations

Amateur's Headquarters of the West

RADIO SUPPLY CO.

H. A. Demarest, President

912-14 So. Broadway Los Angeles, California
(W6FBI located in building)

Myrl Jones, of the Squinch Owl fame, brought out the interesting points of the army-amateur net. Many matters of importance were discussed under the leadership of fieldman Hebert at the open meeting.

Dr. H. O. Phillips, W4BZG, as toastmaster; talks by Major Van Nostrand of Atlanta; Mr. Perkins Prewett, chamber of commerce; Hebert and Reinartz, plus a fine entertainment from the broadcasting studios under the direction of John Connelly left nothing to be desired.

The convention closed with the distribution of prizes and a dance. Onward to Mobile, Alabama, in 1934, and thanks of the delegates to the committee for a great convention.

—A. A. H.

Modernizing the Three-Tube Transmitter

(Continued from page 14)

center-tap keying in the final stage is recommended. For key-click elimination, however, it is more desirable to key in the center-tap of the buffer-doubler stage. This puts a variable load on the oscillator which may result in a slight change in frequency as the set is keyed, particularly if the oscillator is worked right at the critical setting of C_5 . In such a case a slight detuning of C_5 on the high-frequency side will be beneficial. The 90-volt fixed bias specified for the final amplifier will be sufficient to cut off the plate current of that tube during keying spaces if the buffer-doubler tube is keyed.

A Universal Antenna Coupling System for Modern Transmitters

(Continued from page 17)

NETWORK EFFICIENCY

Small diameter inductances have come very much in vogue in high frequency transmitters within the last year or so. Their use is well justified in multi-stage transmitters because they have very small external fields and eddy current losses in shielding, etc., are reduced to a minimum. A well-designed small coil will usually have a much higher Q than a large coil of heavy copper tubing. But it is very difficult to couple inductively to one of these small inductances because of their small field and because of mechanical difficulties and losses in the pick-up coil form. Repeated measurements have shown that the power in the antenna is usually increased from 20% to 30% when an impedance-matching network is substituted for a pick-up coil. This increase is accounted for by the inherent high-efficiency of the network and by the elimination of the losses which might have been introduced by the pick-up coil. Another reason for the better output is the fact that the antenna impedance can be precisely matched to the plate of the final amplifier tube, obtaining exactly the right relationship for optimum output with true resonance so that the voltage neither leads nor lags the cur-

HEY, YOU YOUNG SQUIRTS!

Think you'll ever know as much about radio as Jim Lamb?

Well, you've got to learn, if you ever expect to get there. You can go to school — but the best school is experience. Whatever school you go to, you've got to have the proper kind of textbooks.

There are a lot of grades in radio school. If you're a young lad in junior high you've got a

lot of them to pass before you get in the class of J.J.L., R.A.H., G.G. and the rest of 'em. It won't be so hard, though, if you study the Handbook carefully, and then tackle some of the books in the Amateur's Bookshelf. You'll get there — and we'll be glad to help.

But maybe you aren't even in the Handbook class, yet. Then there's only one answer — the League's famous beginner's booklet.



HOW TO BECOME A RADIO AMATEUR

Although No. 8 in the series entitled *The Radio Amateur's Library*, it's the primary text of amateur radio. Deals with elementary things, told in clear, simple language. Tells how to build a complete, efficient, yet inexpensive amateur station — receiver, monitor, transmitter. Tells how to operate it, too — in fact, it's the complete beginner's guide to amateur radio. And the price is only 25c, postpaid. (No stamps, please.)

Order your copy today, and join our school right now

THE AMERICAN RADIO RELAY LEAGUE, WEST HARTFORD, CONNECTICUT

GULF RADIO SCHOOL

Radiotelegraphy Radiotelephony
Radio Servicing

SECOND PORT } 1007 Carondelet Street
U. S. A. } NEW ORLEANS, LA.

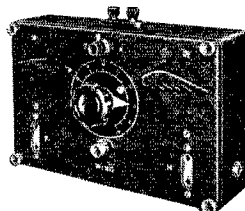

WING'S TRANSCIVER and Antenna Outfit

Make the ideal 5-meter outfit for your auto.

Why not equip your car with a 5-meter job that is attractive, efficient and sturdy? This transceiver is designed especially for auto use. A cast aluminum case and front panel insure strength, dependability and ease of installation. The black wrinkle finish makes a show piece suitable for any car. Transceiver uses a special 76 and 41 tube and costs \$16.50, less tubes. A clamp for your steering post sells for \$1.50 extra. Transformer and rods are \$2.50. See it at your dealers or at

LEEDS, 45 Vesey Street, New York City

CHAUNCEY WING'S SONS, Manufacturers
Greenfield, Mass.



THE INSTRUCTOGRAPH (Code Teacher)

The Scientific, easy and quick way to learn the code. Send a post card today for literature.

Machines, tapes and complete instructions for sale or rent. Terms as low as \$2.00 per month.

Rental may be applied on purchase price if desired. Rent for a month. If the Instructograph meets every requirement, buy it. If not, send it back.

INSTRUCTOGRAPH CO., 912 Lakeside Place, Chicago

PERFORMANCE!

International enthusiasm has been voiced for the remarkable performance of the D-104 microphone, low in price — high in quality, ruggedness and dependability. Equip your transmitter now and enjoy the benefits of this exceptional new instrument.

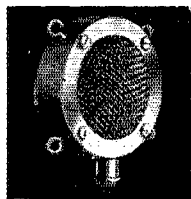

Piezo-Astatic MICROPHONE

Licensed under Brush Development Co. patents

Astatic Microphone Laboratory, Inc.
Youngstown, Ohio



SANGAMO ACCURATE CONDENSERS

Available in 5000 volt construction for use in short wave transmitters

Write for catalog sheet

SANGAMO ELECTRIC CO.
SPRINGFIELD, ILLINOIS

PROFIT BY THE EXPERIENCE OF OTHERS—Thousands of Amateurs Have Read **HINTS AND KINKS**

If you haven't yet gotten a copy of this indispensable compilation of the money-saving ideas of 189 experimenters, you'll be glad to know that the original supply, exhausted in less than six months, has been replenished by a second printing. You'll find in it hundreds of good ideas which amateurs have found helpful. It will return its cost many times in money savings — and it will save hours of time. Many of these little dodges would probably never occur to you. Order your copy at once.

HINTS AND KINKS FOR THE RADIO AMATEUR

No. 10 in the A.R.R.L. series entitled The Radio Amateur's Library

EIGHTY PAGES IN ATTRACTIVE PAPER COVERS
50 cents, postpaid anywhere (no stamps, please)

THE AMERICAN RADIO RELAY LEAGUE
West Hartford, Connecticut

PRECISION CRYSTALS

FOR ACCURATE FREQUENCY CONTROL



Crystal Holder

bands—\$4.50 ea. 7000 kc. band—\$5.50, Crystal holder (illustrated)
holder into—15c pair.

FREE Plug-in, dust-proof holder with each amateur band crystal purchased.
PRECISION Crystals are of the highest quality obtainable. These crystals are X cut, one inch square, accurately ground for maximum output, thoroughly tested and fully guaranteed. They are accurately calibrated and will be supplied within 0.1% of your specified frequency. It will pay you to buy these quality crystals. 1750 and 3500 kc. —\$1.50 (Holder free with each crystal purchased). Jacks to plug holder into—15c pair.

Crystals and ovens for commercial use quoted on at your request. When ordering our product you are assured of the finest obtainable. Now in our 5th year of business.

PRECISION PIEZO SERVICE

427 ASIA STREET

BATON ROUGE, LA.

BIRNBACH

Standoffs

QUALITY insulators for careful amateurs. Compact; rugged; efficient. Pure porcelain, highly glazed. Nickel-plated brass hardware.

All standard types—also new feed-through models (plain or jack) with porcelain insulating collar for metal-panel mounting. Write for Bulletin "A."

BIRNBACH
RADIO CO., INC.
145 Hudson St., N.Y. C.



rent. Substitution of the network system of coupling will usually result in a considerable increase of antenna current in an amateur installation with the same power input to the final amplifier.

NETWORK DESIGN

Usually neither the antenna input impedance nor the desired plate load impedance is accurately known in amateur installations, and so it is impractical to attempt quantitative design of a coupling network. The experimental method of adjustment outlined above for obtaining the proper relationships is entirely satisfactory when the shunt and series arms are adjustable over wide ranges. When the input and output impedances have been measured or can be calculated, it may be desirable to calculate the values of the filter elements. Of course, conventional network theorems are employed, but two or three relations will be listed here for ready reference.¹ Referring to Fig. 3, when the input and output impedances are pure resistances, the filter elements must satisfy the resonance equation:

$$\frac{L_1 C_1 C_2}{C_1 + C_2} = 4\pi^2 f^2. \quad (1)$$

Impedance match is expressed thus:

$$X_A = \frac{-R_0 X_B}{R_0 \pm \sqrt{R_0 R_A - X^2_B}} \quad (2a)$$

$$X_C = \frac{-R_A X_B}{R_A \pm \sqrt{R_0 R_A - X^2_B}} \quad (2b)$$

X_B has a maximum value beyond which there is insufficient coupling for impedance match. For sufficient coupling

$$X_B < \sqrt{R_0 R_A}. \quad (3)$$

The degree of harmonic attenuation can be determined from the known values of $L_1 C_1 C_2$ by determining their reactance at the harmonic frequency and solving for power loss using conventional network theorems.

The author claims no particular novelty for this method of antenna coupling, since low-pass networks have been associated with vacuum tube output circuits for many years. The particular system outlined above, however, has advantages over arrangements in which the plate is connected directly to the filter input, in that the system can be applied to existing transmitters with conventional tank circuits, and, also, because it is permissible to have the antenna reactance appear as a series arm in the output circuit, which is not desirable when a single π section is used between the tube and the antenna. The arrangement described above is so simple in construction and adjustment that it deserves widespread application, especially in the high frequency field.

¹ Everitt, "Output Networks for Power Amplifiers," *Proc. I.R.E. May, 1931*—Error.



Get Started Right!

YOU wouldn't hunt quail with an air gun . . . it hasn't the range. And so with radio transmission . . . you cannot expect distance with inferior equipment.

Start right! Begin with crystals . . . *the best crystals*, for results are far more certain and in the long run cost much less.

Bliley Crystals cost very little more to buy, and much less to run because they are more efficient . . . give greater power output . . . and keep you LOCKED on one chosen frequency.

For Bliley Crystals see your nearest distributor. If he does not have your choice in stock, he can get it for you BY RETURN MAIL.

Get our 1934 illustrated folder, and large 3-color frequency chart from your distributor . . . or write us direct.



BLILEY CRYSTALS AND HOLDERS						
Type	Mc Band	Substid	Pre- cision	Fur- nished	Price	
BCX	1.7, 3.5, 7.0	25Kc*	0.05%	Umtd.	\$3.90	
BC3	1.7, 3.5, 7.0	25Kc*	0.03%	Mtd.	4.95	
BC3	1.7, 3.5, 7.0	5Kc	0.03%	Mtd.	5.75	
BC3	1.7, 3.5, 7.0	0.5Kc	0.03%	Mtd.	6.85	
BC5	100Kc	Exact	0.05%**	Mtd.	9.50	
BC2	1.7-3.5Mc, or 7Mc holder for BCX					1.50
BC6	1.7, 3.5 or 7Mc holder-oven for BCX					7.50
SSF	465, 500, or 525 Kc S.S. Qtz filter, Mtd.					5.90

* Or your choice from distributor's stock.
** Adjustment by purchaser will greatly reduce this.

Announcing the new

BLILEY CRYSTAL OVEN

A scientifically designed constant-temperature holder-oven; compact, holds within one degree C., plugs into standard 5-prong socket. Operating on 7.5 V. For inch sq. 40, 80 or 160 M crystals. Type BC6, \$7.50 each, complete.

BLILEY PIEZO-ELECTRIC CO.

226 Union Station Bldg. Erie, Pa.

Special Crystals also manufactured between 20 Kcs and 15 Mcs

Notice to All Hams and Operators!

We have just been appointed official distributors for DeForest Amateur Radio Division of the R.C.A. Radiotron Company.

Now the "House of Service" is ready with a complete line of Radiotron Amateur Transmitting Tubes.

SPECIAL: We will gladly send you a copy of the new 1934 R.C.A. Cunningham Reference Book, together with the latest data on the Amateur Transmitting Tubes. Free of All Cost. Just drop us a line and we will do the rest.

ROYAL-EASTERN ELECTRICAL SUPPLY CO., INC.
16-18 West 22nd Street New York City, N. Y.



New!
UNIVERSAL
Stretched Diaphragm Type
1934 MODEL "X"

Here is microphone value without precedent! A brand new 1934 model, *stretched diaphragm* type. Full Diaphragm Protection 2-button microphone, listing at only \$10.00! Exceeds every reasonable requirement for quality performance.

UNIVERSAL MICROPHONE CO., Ltd.
424 Warren Lane Inglewood, Calif., U. S. A.

Send for this

New
METER BULLETIN
— all bargains —

Just issued, lists many types — all new meters — big selection: Ammeters, Radio Frequency Ammeters, Thermo-ammeters, Volt-meters, Milliammeters, A.C.-D.C. Universal Meters, D.B. Power Level Meters and Volt-meters, Volt-Ohm Milliammeter Circuits, Resistor Kits, Shunts, Resistors — every item a real bargain and guaranteed. Send postal *now* for free bulletin.

Universal Meter Works
410 N. Leavitt St., Chicago, Ill.

Radio Operating Radio Servicing—

Prepare for the new Government Radio Operating license examinations; Radio Operator, Marine and Broadcasting. Also Radio Amateur Telegraph and Telephone. Resident courses. Write for booklet "Opportunities in Radio."



West Side YMCA Trade & Technical Schools
4 West 63rd Street, New York City

HAM-ADS

(1) Advertising shall pertain to radio and shall be of nature of interest to radio amateurs or experimenters in their pursuit of the art.

(2) No display of any character will be accepted, nor can any special typographical arrangement, such as all or part capital letters be used which would tend to make one advertisement stand out from the others.

(3) The Ham-Ad rate is 15¢ per word, except as noted in paragraph (6) below.

(4) Remittance in full must accompany copy. No cash or contract discount or agency commission will be allowed.

(5) Closing date for Ham-Ads is the 25th of the second month preceding publication date.

(6) A special rate of 7¢ per word will apply to advertising which, in our judgment, is obviously non-commercial in nature and is placed and signed by a member of the American Radio Relay League. Thus, advertising of bona fide surplus equipment owned, used and for sale by an individual or apparatus offered for exchange or advertising inquiring for special equipment, if by a member of the American Radio Relay League takes the 7¢ rate. An attempt to deal in apparatus in quantity for profit, even if by an individual, is commercial and takes the 15¢ rate. Provisions of paragraph (1), (2), (4) and (5) apply to all advertising in this column regardless of which rate may apply.

Having made no investigation of the advertisers in the classified columns, the publishers of *QST* are unable to vouch for their integrity or for the grade or character of the products advertised.

OVER six pounds radio data, circuits, bulletins, 50¢ postpaid. Beyond Rockies 75¢. Kladag, Kent, Ohio.

MICROPHONE and meter repairs. Low prices. Quick service. Sound Engineering Corp., 416 N. Leavitt St., Chicago, Ill.

RADIO engineering, broadcasting, aviation and police radio, servicing, marine and Morse telegraphy taught thoroughly. All expenses low. Catalog free. Dodge's Institute, Byrd St., Valparaiso, Ind.

GENERAL Electric 24/1500 volt Dynamotors \$35; 24/750 volt \$25. Westinghouse 27½/350 volt \$10. Mounted pair \$15. 6-15 volt 500 watt Aircraft with propeller \$10. 500 cycle 500 watt with exciter 110-220 volts \$7.50. Dynamotors give pure DC outputs. Perfect results from battery plants. Henry Kienzle, 501 East 84th Street, New York.

QUARTZ—Direct importers from Brazil of best quality pure quartz suitable for making piezo-electric crystals. Diamond Drill Carbon Co., 719 Piezoe Bldg., New York.

TWO color QSLs, 50¢ up. W9GOF.

QSLs, SWLs, W6DQU, Hayward, Calif.

SOCKETS—50 watt, front panel, universal mounting, aluminum, mirror finish, \$4; pair, \$7.50 postpaid. Satisfaction guaranteed. Cantonwine, 414 N. First, Rockford, Ill.

CALLBOOKS—new Winter 1933-34 Radio Amateur Call Book, many pages of the new W calls and hundreds of new DX stations, is yours for \$1.10. Next four issues for \$3.65 (Foreign \$1.20 and \$3.75). W9FO—610 S. Dearborn, Chicago.

QSL cards, two color, cartoons, message blanks, stationery, snappy service. Write for free samples to-day. WIBEF, 16 Stockbridge Ave., Lowell, Mass.

QSLs! Your QSL is your station's representative! Be well represented! Free samples! W8DED, Holland, Mich.

CRYSTALS guaranteed accurate 160-80 meters, \$1.65 postpaid. Blanks, 50¢. W9DEQ, Wishek, No. Dak.

TRADE: meters and miscellaneous parts for shotguns. State model, gauge and condition. James Coe, Wright Field, Dayton, Ohio.

FOR sale: Fifty watt \$15, and ten watt xmtr \$5, with tubes. K7ABQ. Details answered.

TRADE—849 modulating tube. Good condition. What have you? WIEMV, 351 Main St., East Hartford, Conn.

SELL or swap dynamotor, cheap. W2BZB.

HIGHEST price takes short wave converters. Commercial jobs, two to six tubes. Write for photos. R. F. Shea, 8718 77th St., Woodhaven, L. I., N. Y.

CRYSTALS, \$1.35. Hipower oscillators 3500-1700-kc. bands close to your specified frequency. 7000-kc. band \$4.25. Plug-in holders with mounting, \$1. Blanks 65¢. Immediate delivery. Send for latest bulletin. Hipower Crystal Co., 3807 N. Luna Ave., Chicago, Ill.

ROTARY converters, 110 a.c., d.c. or vice versa, 200 watt, \$20. A-6 Edison cells \$4. each. Box 1116, San Antonio, Texas.

CRYSTALS, holders, prices free. W9ECI.

QSLs, 50¢ per 100. Samples, 2143 Indiana Ave., Columbus, Ohio.

WONDERFUL bargain—Complete 100 watt fone and cw station. Xtal controlled (3xtals) 242-A output, completely metered, 1500 volt 500 watt supply, 750 volt 200 watt supply, 2-300 volt 100 watt supplies, vibroplex, high gain speech amplifier. 20-40-80 ss superhet (with xtal), power supply, fones and speaker. Conventional 5-meter transmitter and receiver. Also large cabinet of valuable tubes and parts. \$150 takes everything. Photographs, lists. Tom McCann, 95 N. Walnut St., East Orange, N. J.

866A Duovac Mercury Vapor Rectifiers. First grade original cartons. Characteristics: Filament 2.5 volts; 5 amps; max. peak plate current, 0.8 amps; Max. Peak Inverse Voltage, 10,000; standard 4 prong U. X. Base \$2.95 ea. Terms 20% deposit with order, Balance C. O. D. W2AGC, 567 78th St., Brooklyn, N. Y.

PHONES—Eliminate BCL troubles with Detlab 75 or 160 meter filters. One dollar postpaid. Specify Band used. Send us your BCL problems. Delta Laboratories, 3455 Chicago Blvd., Detroit, Michigan.

WANTED—to trade: New type '03A receiving tubes and transmitting equipment, cash. For high power binoculars, camera. Also want portable receiver. W4AG, M. H. Gravice, Kennedy, Ala.

CLASS B transformers—for 46s, \$1.95 pair. Universal transformers for two or four 46s, 210s, 800s, RK18s, etc. \$7.75 pair. 70 watts of audio from 46s. Write for details. W8UD, Douglas, Mich.

QSLs. Get our free samples before you buy. Maleco, 1512 Eastern Parkway, Brooklyn, N. Y.

RECEIVER complete with '24 and '47 tubes; coils for 20, 40, 80. No power supply. First money order for \$8 takes it prepaid. W3ASP.

FB7s, Omnigraphs, Teleplexes, Vibroplexes, meters, receivers, converters. Bought, sold, traded. Ryan Radio Co., Hannibal, Mo.

QSLs, two color, stationary. Send for samples. Printer, Corwith, Iowa.

LOW emission transmitting tubes restored normal. Write Mims Radio, Texarkana.

SELL 400 watt pure crystal d.c. fone and c.w. transmitter 100% modulated. Very complete and highly efficient outfit with established reputation. C. H. Vincent, W8RD, Utica, Mich.

NEW 15 and 200 watt RCA talking picture amplifiers. Sell or trade for xmtr or lab. equipment. Mattlin, 2037 Euclid Ave., Cleveland, O.

FOR sale—1932 Hammarlund Pro complete with tubes and 6 pair coils. Best offer over \$50. W8DMJ.

QSLs, two color! 50¢ up! Snappy service! W9ECI, Clayton, Mo.

CRYSTALS 95¢. Your approximate frequency in 80 or 160 meter band and calibrated to within 0.05%. 40 meter crystals at \$2.00. Blanks 3 for \$1.00. The only guaranteed crystals in the world selling at these low prices. White Radio Laboratory, Sandpoint, Idaho.

OLD QSTs. 1920-1930, 50¢ each. 1930-1934, 15¢ each. 1905 Encyclopedia Britannica, \$15. Everything perfect condition. Box 16, Station Y, Brooklyn, N. Y.

SPECIALS: G.E. 5 mf condensers, 800V test, 75¢; soft heavy-rubber-covered No. 16 stranded tinned wire, 1¢ per foot; magazines, thousands of all kinds, many recent, very cheap. Box 16, Station Y, Brooklyn, N. Y.

AMATEURS—condenser microphones, 2-stage \$31; velocity 3-stage \$35; carbons repaired \$6; guaranteed crystals \$5; rectifiers, 1000V 200W \$50, 1500V 300W \$70. We build transmitting equipment to order. Radio Engineering Co., 103 Willis, Columbus, Mo.

BARGAINS—brand new Teleplex with tapes, \$9. High quality 600 volt power supply kit, \$5. Monitor \$4. Kellogg mike and transformer, \$3. Robert Brown, Sullivan St., Dolgeville, N. Y.

\$1.35 Hipower crystals see other hamads. Send for bulletin.

XTALS, 1", x or y, approximate frequency, 80, 160. Guaranteed excellent oscillators, \$1.35. W9HWE.

CRYSTALS. See last month's *QST* hamad for special. Wm. Threm, W8FN, 4021 Davis Ave., Cheviot, Ohio.

SELL—Brand new Del'orest 504-A in original carton, never used—\$50. Used RCA 204-A, perfect condition, \$20. Class B Modulation transformers couple 203-A's into one 204-A, \$17. National triple spaced transmitting condensers. Heavy duty Cardwell. Fred Manion, 905 West First Street, Oil City, Penna.

SELL two "P" tubes, wartime General Electric tungsten-filament transmitting tubes, predecessors of the UV-204, used, at \$5 each, express collect from Hartford, Conn. F. H. Schnell, 4915 No. Sawyer Ave., Chicago.

SEE January hamads. Catalog free. Mid-Con, 3007 Main, Kansas City.

NEARLY new FB7, \$40, includes two sets coils and tubes. Write W7BGC, Terry, Montana.

WANT: 250 or 500 watt, used. Must be cheap. W3BBV, York, Penna.

BARGAIN! complete station for sale at great loss to owner. SW5AC receiver with coils, and 100 watt xmitter with power supply. A real buy. For dope write A. Newton, 34 Hill Dorm, Princeton, N. J.

OUTBOARD motors wanted. Trade transmitting equipment or pay cash. Give description. Lowell Ecker, Sedan, Kansas. QST Superheterodyne pre-selector, \$10.00. Universal five-band exciter unit, \$22.50. T.R.F. Autodyne receiver, \$19.95: Monitor-Frequency meter, \$15.95: Beginners crystal transmitter, with power supply, \$20.00: Write for new catalogue. We build to order. Precision Radio Laboratories, 109 East 94 Street, Brooklyn, N. Y.

IN stock—lowest prices: All National, Hammarlund, Patterson receivers. Trade in your receiver. Immediate shipment all Sylvania, Triplett, National, Hammarlund, Cardwell, Thordarson, Weston, Universal, Johnson, Bliley. Teleplex rented. Henry's Radio Shop, Butler, Mo.

WANT MIK-I. Sell Comet Pro; complete highest quality 100 watt crystal transmitter; much used amateur apparatus. W9ARA.

STEEL racks with panel and shelves. 50 watt size, \$6. W8JMH, 1239 Glenmore Dr., Springfield, O.

SOCKETS—front panel mounting, aluminum mirror finish. 50 watt \$4, pair \$3.75. UX, UY base, \$2.25. Postpaid. Satisfaction guaranteed. Cantonwine, 414 N. First, Rockford, Ill.

QSL 75¢ a 100, two colors. W9DGH, 1816 5th Ave. N., Minneapolis, Minn.

CRYSTALS: guaranteed 1", 160, 80 meters, approximate frequency, \$1. W8EBV.

CRYSTALS: Guaranteed excellent oscillators, 160 or 80 meters, your approximate frequency \$1.35 postpaid. Crystal Maker's blanks 1" 65¢—dozen \$6.00. Irregular shapes 25¢. Improved dust-proof Bakelite Holders, 1 1/8" silvered electrodes increases efficiency. Plugs into G.R. or tube socket mounting, any position. No exposed electrodes. 75¢—dozen \$5.40. Fisher Laboratory, 1200 E. Nevada, El Paso, Texas.

REL 278 receiver, 7 coils, tubes, \$15.00; d.c. superwasp, \$7.50; QST 1926 minus January, February, 1927—1933 complete, make offer. Henri Griner, 121 Harrison Avenue, Baldwin, L. I., New York.

GET my QSL proposition first. Jake, Specialty Printer, Franklin, Penna.

HEAVY duty mesh filament 866s, \$2.50; 872s, \$7.50. Meters. 212Ds, \$13. Universal S-G quarters, \$15. 849s, 204As, etc. Reconditioned WE387 mikes, \$15. Cathode ray tubes and special thyratrons built to specifications. Ewing, 1057 Pratt Blvd., Chicago.

\$1.35 Hipower crystals. See other hamads. Send for bulletin.

ENGINEERING and Manufacturing. Holmes C. Miller, Box 105, Palo Alto, California.

QSL, January 1924 to December 1933 complete except October 1931. Make offer. K. M. Taylor, Bernola Apts., Ardmore, Penna.

TRANSFORMERS—600 volts each side center, 125 milliamperes, one 7½ and one 5 volt filament winding, both center tapped, mounted, heavy construction. Made for transmitting, \$5.75. Remit \$2. with c.o.d. orders. Amateur Equipment Co., Myrtle, Miss.

QSLs first class! Silver! W6FZQ, Box 1804, Phoenix, Arizona.

SELL—custom built, Grammer's autodyne t.r.f. three tube receiver, January '33 QST, \$25. Bill, 529 Eubanks, Oklahoma City, Okla.

QSLs of the better kind. W2AEY, 338 Elmora, Elizabeth, N. J.

SELL—complete 50 watt ce. cw transmitter, description, photos furnished. Four G.E. filter condensers, ½ mf. 18000 volts. Joe DuPre, Beachwood, N. J.

TRANSFORMERS—quotations given. W9CES, Frank Greben, Accurate Radio Service, 2920 W. Cermak Road, Chicago, Ill. Phone Crawford 2050.

866s, 1000 hour guarantee, \$1.49; 825s fifty-watters 7½ volt filament \$4.95; 203-A plate-filament transformers, \$3.50; panels, milliammeters; holders; transformers; chokes, etc. See December hamad. Custom-built transmitters. Howard Radio, 314 Pine Ave., Chicago.

PLATE transformers—any normal voltages. 1/2 KVA \$10.50; 3/4 KVA, \$12.50. Full specifications upon request. Baker Engineering Labs., Fort Wayne, Ind.

POWER equipment that agitates the antenna more than the watt meter. Relay racks for that prized commercial touch. Edison batteries. See January display. Rectifier Engineering Service.

QUALITY QSLs. Samples? T. Vachovetz, Elmsford, N. Y.

ESCO 1,000-volt motor-generator; 2-horse motor, 110-220 volt. Cost over \$400 new; used about 50 hours. Swap for FB7-X, AGS receiver, what have you or sell outright. A FB mg for someone. W9BNC, 167 Carter Lake club, Omaha, Neb.

SELLING out. Large list of parts. W2AEB.

CRYSTALS: 1" quality x cut power type, within 2-ke, \$2. Bliley BC2 holders, \$1.50. W8DLM, Rochester, Mich.

VBROPLEXES, all models. Rebuilds \$7. up. Speed X bugs, new, \$10. Lydeard, 28 Circuit, Roxbury, Mass.

\$1.35 Hipower crystals. See other hamads. Send for bulletin.

RADIO

ENGINEERING, broadcasting, aviation and radio telegraphy and telephony, police radio, servicing, marine accounting taught thoroughly. Morse telegraphy and railway work. School established 1874. All expenses low. Catalog free. **DODGE'S INSTITUTE**, Day Street, Valparaiso, Indiana



Within the covers of the new 1934 C-D Catalog will be found the only complete condenser line covering every receiving, transmitting, laboratory, servicing and other electronic requirement.

Send for your copy—**TODAY**



CORNELL-DUBILIER CORP.
4377 Bronx Blvd. New York City

Highest Quality

QUARTZ CRYSTALS

Made from the finest Brazilian quartz unconditionally guaranteed:

160-80 meter Amateur bands —	
Within 10.0 KC selected by you.....	\$3.50
Within 5.0 KC selected by you.....	4.50
Within 0.5 KC selected by you.....	5.50
40 meter Amateur band —	
Within 10.0 KC selected by you.....	\$4.00
Within 5.0 KC selected by you.....	5.50
Within 0.5 KC selected by you.....	6.50
Blanks — 1-inch square to finish in the 160-80- or 40-meter Amateur bands.....	1.50
465-500 or 525 KC, S. S. Quartz filters.....	5.00
100 KC bars.....	10.00
50 KC bars.....	20.00

Special cuts or Commercial and Broadcast crystal prices furnished upon request. Shipments are made C.O.D. unless accompanied by cash. Watch for our announcement on a new plug-in adjustable air gap holder.

BELLEFONTE RADIO ENG. LAB.

BELLEFONTE, PENNSYLVANIA

Member N.R.A.

Your Nearest Dealer

Your nearest dealer is entitled to your patronage. You can trust him. He is equipped with a knowledge and understanding of amateur radio. He is your logical and safe source of advice and counsel on what equipment

Patronize the dealer nearest you—

<p>ALLENTOWN, PENNSYLVANIA Radio Electric Service Co. 1024 Hamilton Street Complete stocks transmitting equipment</p>	<p>DETROIT, MICHIGAN Radio Specialties Company 171 E. Jefferson Avenue Ham Supplies — National & Hammarlund Sets and Parts</p>
<p>BALTIMORE, MARYLAND Radio Electric Service Co. 303 W. Baltimore Street Everything for the amateur</p>	<p>ERIE, PENNSYLVANIA Jordan Radio Laboratory 1019 East Fifth Street Amateur, service parts, including Bliley, National, Raytheon. WBCXG</p>
<p>BOSTON, MASSACHUSETTS Nutter & Cross, Inc. 99A Milk Street All OMs, OWs, and YLs welcome — W1HRF</p>	<p>HARTFORD, CONNECTICUT Radio Inspection Service Company 227 Asylum Street Complete line of guaranteed parts</p>
<p>BROCKTON, MASSACHUSETTS Ware Radio Supply Company 913 Centre Street Everything in parts. Comet Pro in stock with crystal filter</p>	<p>KANSAS CITY, MISSOURI Burstein-Applebee Company 1012-14 McGee Street "Specialists" in supplies for the Amateur and Serviceman</p>
<p>BUFFALO, NEW YORK Kronson Service Company 143 East Genesee Street Western New York's largest wholesale distributors—W8EHF</p>	<p>KANSAS CITY, MISSOURI Radio Laboratories 1515 Grand Avenue Amateur Headquarters — Complete Stock — Quality Parts</p>
<p>CHICAGO, ILLINOIS Chicago Radio Apparatus Company 415 South Dearborn Street Dependable Radio Equipment. Established 1921. All Standard Lines</p>	<p>LOS ANGELES, CALIFORNIA Radio Manufacturers Supply Co., Inc. 1000 S. Broadway Amateur Headquarters of the Pacific Coast</p>
<p>CHICAGO, ILLINOIS Mid-West Radio Mart 520 S. State Street All standard lines carried in stock</p>	<p>MANCHESTER, NEW HAMPSHIRE Radio Service Lab. of N. H. 1008 Elm Street—Tel. 218-W Northern New England Suppliers of Amateurs and Servicemen</p>
<p>CLEVELAND, OHIO Northern Ohio Laboratories 2073 West 85 Street Wholesale Distr. for National, Hammarlund, Thordarson, Cardwell</p>	<p>MILWAUKEE, WISCONSIN Radio Parts Company, Inc. 332 West State Street Complete stock Nationally Known products</p>
<p>CLEVELAND, OHIO Radio Servicemen's Supply Co. 206 Prospect Street Wholesale Distributors catering to Amateurs, Dealers, Servicemen</p>	<p>NEWARK, NEW JERSEY Kaltman & Romander 62 Court Street Drop in for an over-counter QSO</p>
<p>DENVER, COLORADO Inter-State Radio & Supply Co. 1639 Tremont Place Amateur Radio Headquarters in the Rocky Mountain Region</p>	<p>NEW ORLEANS, LOUISIANA Rose for Radio 129 Camp Street Complete stock quality radio parts</p>
<p>DETROIT, MICHIGAN Radio Equipment Sales Co. 14036 Woodward Avenue, Highland Park A complete stock of amateur, shortwave and service parts</p>	<p>PHILADELPHIA, PENNSYLVANIA Freeland Radio Supply Co. 5 N. 7th Street "If it's radio we have it"</p>
<p>DETROIT, MICHIGAN Radio Electric Service Co., Inc. N. E. Cor. Seventh & Arch Sts. All nationally advertised lines in stock</p>	<p>PHILADELPHIA, PENNSYLVANIA Radio Electric Service Co., Inc. N. E. Cor. Seventh & Arch Sts. All nationally advertised lines in stock</p>

This advertisement is paid for by the firms listed above. Qualified dealers

Is Your Best Friend

you should buy. His stock is complete. He can supply your needs without delay. His prices are fair and consistent with the high quality of the goods he carries. He is responsible to you and interested in you.

You can have confidence in him

<p>PHILADELPHIA, PENNSYLVANIA</p> <p>Eugene G. Wile 10 S. Tenth Street</p> <p>Complete Stock of Quality Merchandise</p>	<p>SHANGHAI, CHINA</p> <p>Amateur's Home, Ltd. 323 Kiangse Road The Radio Store of the East</p>
<p>PITTSBURGH, PENNSYLVANIA</p> <p>Cameradio Company 603 Grant Street</p> <p>Tri-State "Ham" Headquarters Standard Apparatus Standard Discounts</p>	<p>SPRINGFIELD, MASSACHUSETTS</p> <p>T. F. Cushing 345 Worthington Street</p> <p>An amateur, endeavoring to sell good parts</p>
<p>PORTLAND, OREGON</p> <p>Wedel Company, Inc. 443 Washington Street</p> <p>"The Ham's Paradise." Transmitting and receiving parts and tubes</p>	<p>SYRACUSE, NEW YORK</p> <p>Roy C. Stage, W8IGF</p> <p>Complete stock of standard Ham & BCL parts</p> <p>Standard Discounts. Free technical service</p>
<p>PROVIDENCE, RHODE ISLAND</p> <p>W. H. Edwards & Company 32 Broadway, Room 23</p> <p>A full line of reliable Amateur Equipment & Supplies</p>	<p>TORONTO, CANADA</p> <p>A & A Radio Service Supply 101 Queen Street West</p> <p>Largest wholesale stock of Amateur supplies in Canada</p>
<p>ST. LOUIS, MISSOURI</p> <p>Walter Ashe Radio Company 1100 Pine Street</p> <p>W9FIS in charge of the oldest and largest parts store in St. Louis</p>	<p>TORONTO, CANADA</p> <p>Wholesale Radio Company, Limited 355 Danforth Avenue</p> <p>Canada's Largest Amateur Supply House</p>
<p>ST. PAUL, MINNESOTA</p> <p>Lew Bonn Company 2484 University Avenue</p> <p>Rex L. Munger, W9LIP, Sales Engineer</p> <p>Radio Wholesaler Complete Stock</p>	<p>TRENTON, NEW JERSEY</p> <p>American Radio Co. 5 N. Broad Street</p> <p>Central Jersey's leading radio parts store</p>
<p>SAN FRANCISCO, CALIFORNIA</p> <p>Offenbach Electric Company, Ltd. 1452 Market Street</p> <p>"The House of a Million Radio Parts"</p>	<p>UTICA, NEW YORK</p> <p>Vaeth Electric Company 701 Varick Street</p> <p>Wholesale Distributors of Radio Parts and Supplies</p>
<p>SEATTLE, WASHINGTON</p> <p>Wedel Company, Inc. 520 Second Avenue</p> <p>"The Ham's Paradise." Transmitting and receiving parts and tubes</p>	<p>WASHINGTON, D. C.</p> <p>George's Radio Co. 816 F Street, N.W.</p> <p>Washington's largest distributor of radio parts</p>
<p><i>are invited to apply for rates, etc., to Advertising Department, QST</i></p>	<p>WILMINGTON, DELAWARE</p> <p>Wilmington Electric Specialty Co., Inc. 405 Delaware Avenue</p> <p>Amateur headquarters — Collins, Hammarlund, National, etc.</p>
<p><i>Say You Saw It in QST — It Identifies You and Helps QST</i></p>	<p>WINNIPEG, MANITOBA</p> <p>Electrical Supplies, Ltd. 310 Ross Avenue</p> <p>A complete parts service for amateur and servicemen</p>
<p><i>are invited to apply for rates, etc., to Advertising Department, QST</i></p>	<p>ZANESVILLE, OHIO</p> <p>Thompson Battery & Radio Service 393 West Main Street</p> <p>Distributor radio equipment for amateurs and servicemen</p>

Say You Saw It in QST — It Identifies You and Helps QST

You Are Protected When You Buy From QST Advertisers

¶ "Advertising for QST is accepted only from firms who, in the publisher's opinion, are of established integrity and whose products secure the approval of the technical staff of the American Radio Relay League."

Quoted from QST's advertising rate card.

Every conceivable need of a radio amateur can be supplied by the advertisers in QST. And you will know the product has the approval of the League's technical staff.

● See Editorial April issue of QST

For Your Convenience QST'S INDEX OF ADVERTISERS IN THIS ISSUE

Allen-Bradley Company	75
American Machine & Tool Co.	81
Astatic Microphone Lab.	87
A.R.R.L. Application Blank	74
Binder	79
Handbook	Cov. <i>II</i>
Hints & Kinks	88
How to Become a Radio Amateur	87
License Manual	85
Supplies	73
Bellefonte Radio Engineering Labs.	91
Birnbach Radio Company	88
Blan, The Radio Man, Inc.	81
Billey Piezo-Electric Co.	89
Burgess Battery Company	Cov. <i>IV</i>
Candler System Company	78
Cardwell Mfg. Corp., Allen D.	69
Central Radio Labs.	82
Collins Radio Company	96
Cornell Dubilier Corp.	91
Delta Mfg. Company	82
Dodge's Institute	91
Electrad, Inc.	84
General Radio Company	70
Gross Radio Company	6, 7
Gulf Radio School	87
Hammarlund Mfg. Company	1
Harvey Radio Labs.	78
Hatry & Young	80
Hygrade Sylvania Corp.	4
Instructograph Company	87
Insuline Corp. of America	83
Jappe Co., H.	80
Kaltman and Romander	72
Kenyon Transformer Co.	71
Lampkin, G. F.	85
Leeds	77
Littelfuse Laboratories	85
Lynch Mfg. Company	76
M & H Sporting Goods Co.	83
Massachusetts Radio School	85
Mick-Mack Cypher	83
Mix & Co., Don H.	83
National Company, Inc.	67, 81, Cov. <i>III</i>
Port Arthur College	81
Precision Piezo Service	88
RCA Institutes, Inc.	86
RCA Radiotron Company, Inc.	95
Radio Shack	85
Radio Supply Co.	86
Ross & Co., A. H.	84
Royal Eastern Electric Co.	89
Sangamo Electric Co.	87
Schwartz & Son, Maurice	85
Scientific Radio Service	86
Teleplex Company	83
United Radio Mfg. Co.	83
Universal Meter Works	89
Universal Microphone Co.	89
Ward Leonard Electric Co.	76
Western Electric Company	68
Westinghouse Elec. & Mfg. Co.	2
West Side Y.M.C.A.	89
Wing's Sons, Chauncey	87

RCA de Forest **AMATEUR TYPES**

AMATEUR TRANSMITTING TYPES

Type	Description	Elec- trodes	Max. Plate Dissipation Watts	Cathode Type	Cath- ode Volts
203-A	Oscillator, R-F Power Amplifier, Class B Modulator	3	100	Filament	10.0
503-A	Oscillator, R-F Power Amplifier, Modulator	3	100	Filament	10.0
800	Oscillator, R-F Power Amplifier, Class B Modulator	3	35	Filament	7.5
841	Voltage Amplifier, R-F Power Amplifier, Oscillator	3	15	Filament	7.5
842	A-F Power Amplifier, Modulator	3	15	Filament	7.5
843	Oscillator, A-F and R-F Power Amplifier	3	15	Heater	2.5
844	A-F and R-F Power Amplifier, Oscillator	4	15	Heater	2.5
845-545	Modulator, A-F Power Amplifier	3	100	Filament	10.0
850	R-F Power Amplifier, Oscillator	4	100	Filament	10.0
852-552	Oscillator, R-F Power Amplifier	3	100	Filament	10.0
860-560	R-F Power Amplifier, Oscillator	4	100	Filament	10.0
865-565	R-F Power Amplifier, Oscillator	4	15	Filament	7.5

RECTIFIERS

Type	Description	Elec- trodes	Max. Peak Inverse Volts	Cathode Type	Cath- ode Volts
866-A	Half-Wave Mercury Vapor	2	10,000	Filament	2.5
872-572	Half-Wave Mercury Vapor Heavy Duty	2	7,500	Filament	5.0
872-A-572-A	Half-Wave Mercury Vapor Heavy Duty	2	10,000	Filament	5.0
878	Vacuum Type for Cathode-Ray Tubes	2	20,000	Heater	2.5
885	Gaseous-type triode for cathode-ray sweep-circuit control	3	300	Heater	2.5

CATHODE RAY TUBES

Type	Description	Elec- trodes	Max. Anode No. 2 Volts	Cathode Type	Cath- ode Volts
904	5 in., Electro-static-magnetic deflection, high-vacuum, hot-cathode	5	4,600	Heater	2.5
905	5 in., Electro-static deflection, high-vacuum, hot-cathode	4	2,000	Heater	2.5
906	3 in., Electro-static deflection, high-vacuum, hot-cathode	4	1,000	Heater	2.5

HIGH-POWER TYPES

Type	Description	Elec- trodes	Max. Plate Dissipation Watts	Cathode Type	Cath- ode Volts
204-A	Oscillator, R-F Power Amplifier	3	250	Filament	11.0
504-A	Oscillator, R-F Power Amplifier	3	400	Filament	11.0
849-549	A-F and R-F Power Amplifier, Oscillator	3	400	Filament	11.0
851-551	A-F and R-F Power Amplifier, Oscillator	3	750	Filament	11.0
861-561	R-F Power Amplifier, Oscillator	4	400	Filament	11.0

RCA de Forest amateur types are sold through authorized distributors of the RCA de Forest Amateur Radio Division. If your amateur distributor is unable to supply you, please write to us, giving his name and address, and we will advise you where RCA de Forest tubes may be obtained.

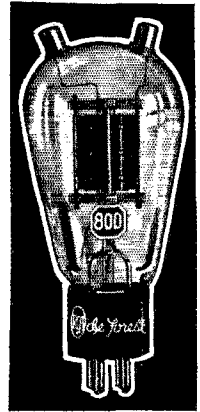

RCA-800

List Price

\$10.00

Now available through authorized distributors of
RCA de Forest Amateur Radio Division

Fill out this coupon if you wish the following: RCA de Forest Price List Technical Data on RCA de Forest types. Address Dept. T.

Name Call

Street

City State

RCA de Forest **AMATEUR RADIO DIVISION**

RCA RADIOTRON CO., INC.

CAMDEN NEW JERSEY

Say You Saw It in QST — It Identifies You and Helps QST

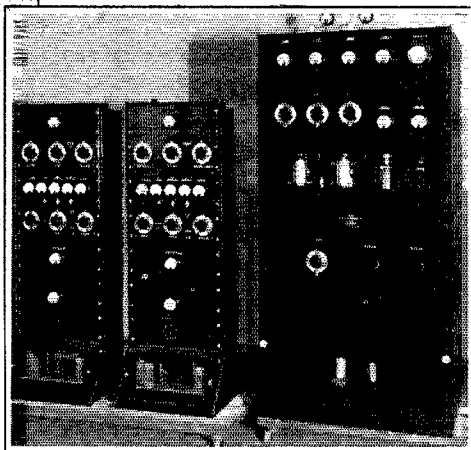

The Collins Equipment which is bringing the news of Little America back to civilization

The Collins 30DXB Transmitter

POWER OUTPUT, RADIOPHONE: 55 watts (100% modulation)
POWER OUTPUT, CW: 55 watts with 830 power amplifier; 100 watts with 203A.

FREQUENCY RANGE: 1500-15,000 kc. (Provision for operation on higher and lower frequencies on special order at slight additional charge.) Coils for one band furnished with transmitter.

TUBE ARRANGEMENT: 47 crystal oscillator, 2-46's buffer, 830 or 203A power amplifier. Modulated by 2-210's or 830's class B.

DUAL POWER SUPPLY: One 83 and two 866's, 80 keying rectifier.

AUDIO FREQUENCY RANGE: 70 to 10,000 cycles within plus or minus 1.5 DB. when used with either COLLINS 7A or 7C speech amplifiers.

POWER SOURCE: 110 volts, 60 cycles, A.C. standard. Provision for other voltages upon special order.

The 30DX CW Transmitter has the same general specifications but no modulator unit is furnished.

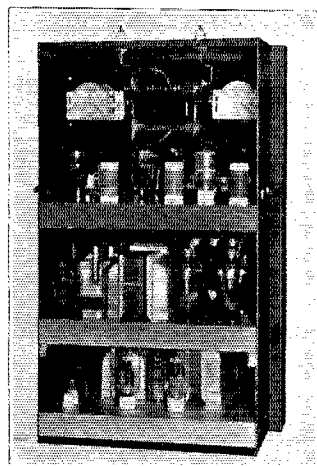

Collins 30DXB

The present-day user of radio equipment wants the very best apparatus obtainable. Makeshift equipment just won't do. Every COLLINS transmitter is designed and built with the assistance of precision equipment and laboratory standards. Assembling and wiring is done by real craftsmen and every unit must pass a rigid series of tests, including exact determination of power output and actual measurement of audio fidelity. A record is made of dial settings and meter readings observed under actual operation. Each transmitter is operated under full load for several hours. All the data obtained by these measurements accompanies the operating manual. This painstaking care in building the transmitters and the continued assistance given the purchaser has proved its value by the widespread acceptance of COLLINS equipment by the amateur and other discriminating users, such as, the Byrd Antarctic Expedition.

Your letter of inquiry will receive personal attention

COLLINS RADIO COMPANY

CEDAR RAPIDS  IOWA, U. S. A.

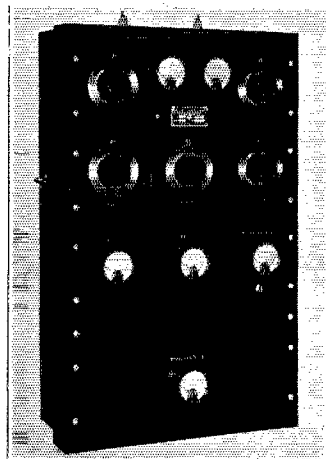

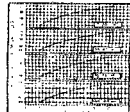
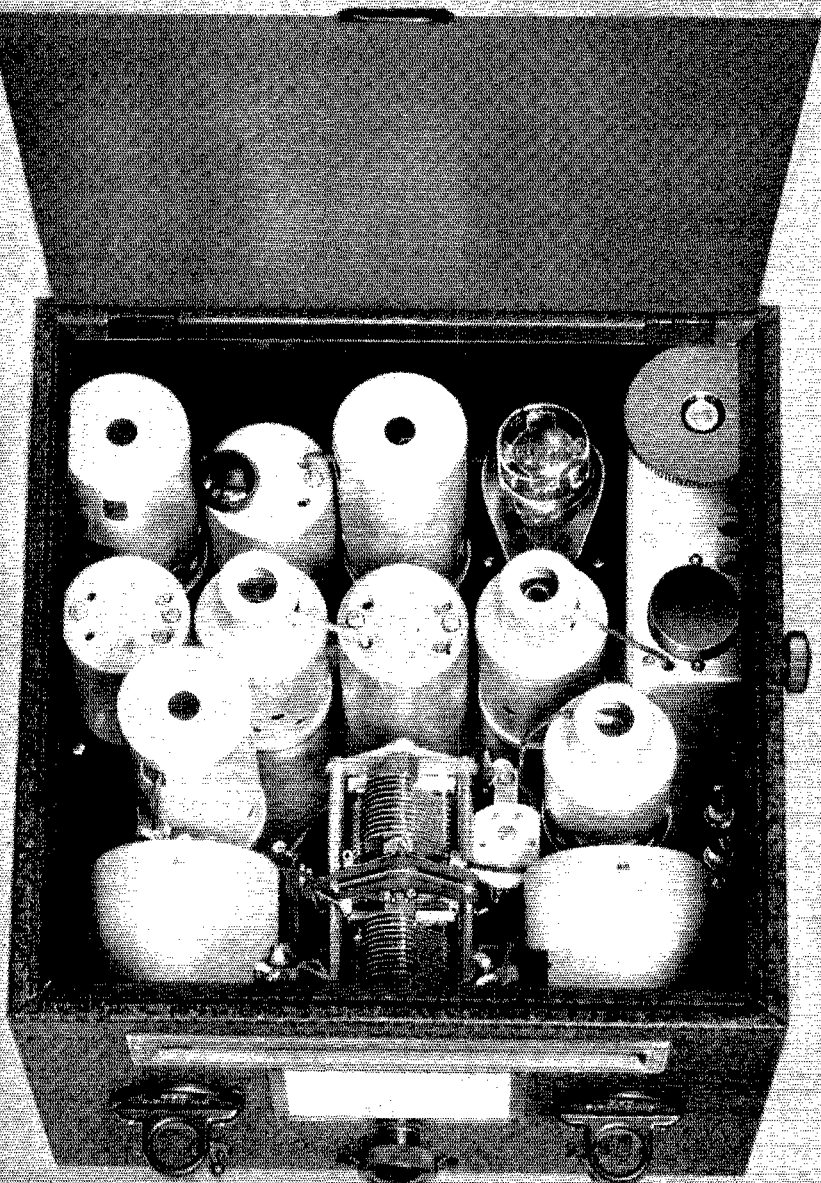

PERMANENT LOGGING

Single-control, one-dial logging; Fixed Band Spread; True Tracking — these make permanent, accurate calibration possible.

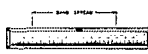

FIXED BAND SPREAD

On each of the amateur bands, the special band-spread coils give a fixed uniform 100 division tuning range, no receiver adjustments being required.



PANEL COIL CHANGE

All coil changes are made through the panel of the receiver, swiftly, easily and without lifting the cover or disturbing any shielding.



NO CROSS MODULATION

In addition to being a type of superheterodyne inherently free from cross modulation, all FB receivers employ a type 57 detector, which the most thorough laboratory tests show to be superior to any other tube for this purpose.

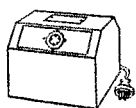

EXTERNAL POWER PACK

Saving valuable space on the operating table as well as providing an equipment flexibility that often results in tangible savings to the amateur, the external power pack is a much-prized feature of National SW receivers.

C. W. Selectivity measured in cycles rather than kilocycles and phone selectivity instantly adjustable to operation conditions, built into a receiver remarkable for sensitivity, stability and compactness. The Single-Signal FBX. National Company, Inc., Malden, Mass.

FBX

To the Bottom of the World

WITH **BYRD**
again!



Once more BURGESS Batteries are going to Little America with Byrd! Way down there at the bottom of the world his men must have batteries that give maximum power, the finest performance, batteries with the very longest life!

In the photo above, you see part of the one and a half tons of BURGESS Radio, Ignition and Flashlight Batteries being loaded on the "Jacob Ruppert." The man in the center is Clay Baily, Chief Radio Operator of the BYRD Antarctic Expedition. With him are two of his assistants, Stanley Pierce (left) and Guy Hutchinson (right). The photograph below shows Clay Baily in his shack on the "Jacob Ruppert" with the BURGESS Batteries he uses.

Great explorers, who can't afford to take chances, use BURGESS Batteries. Hams who don't want to take chances on performance use BURGESS Batteries. And, because the "Chrome Formula" makes BURGESS Batteries last longer, both get more for their money.



BURGESS BATTERIES