

QST



devoted entirely to

amateur radio



January
1934
25 cents

1933

Troubles



CAN BE

OVERCOME

IN

1934

With

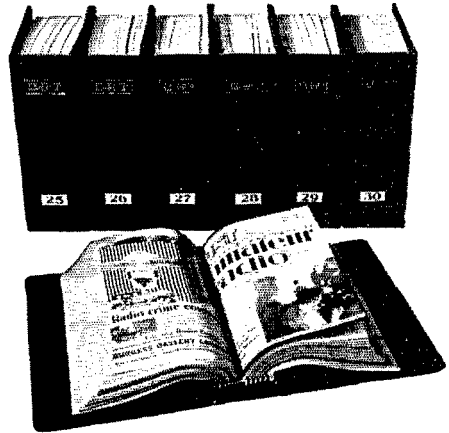

QST

BINDERS

priced at

\$1.50

postpaid

American Radio Relay League
West Hartford, Connecticut

A NEW CRYSTAL FILTER

Further Improves

The

COMET "PRO" RECEIVER

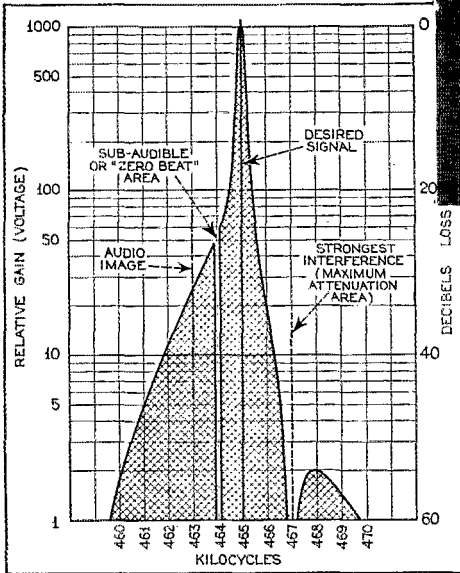
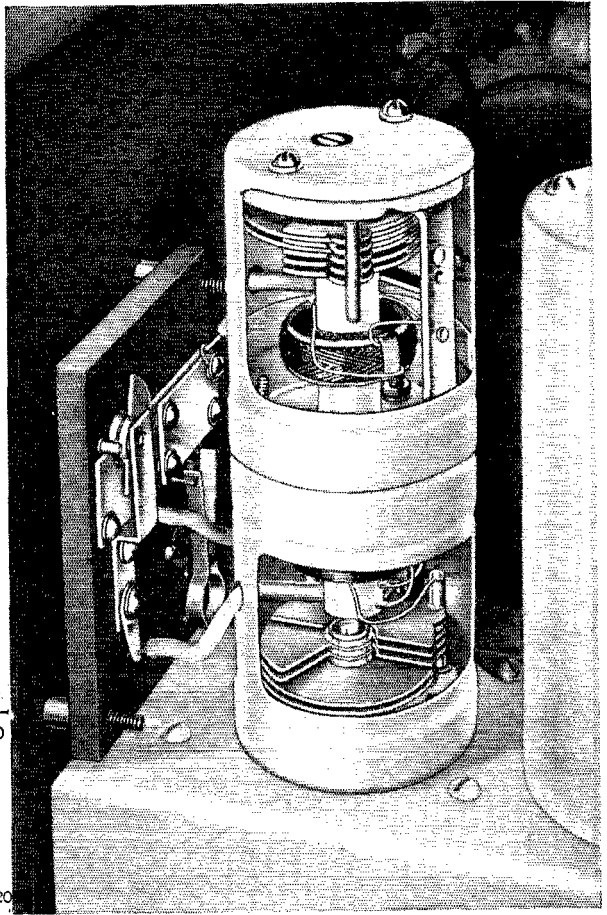

The diagram illustrates the elimination of a strong heterodyne while still maintaining the "single-signal" peak of the Quartz Crystal Filter.

By means of a panel control, this "elimination notch" may be shifted to either side of the main peak to greatly attenuate exceptionally troublesome interference.

The Crystal Filter, also Automatic Volume Control, may be added at moderate cost to the Standard Model "PRO."

Mail Coupon for Details



HAMMARLUND MANUFACTURING CO.
424 W. 33rd St., New York

—Check here for new booklet describing the COMET "PRO" and information about adding Crystal Filter or Automatic Volume Control to the Standard "PRO." —Check here for New General Catalog of Radio Parts.

Name.....

Address.....

.....Q-1



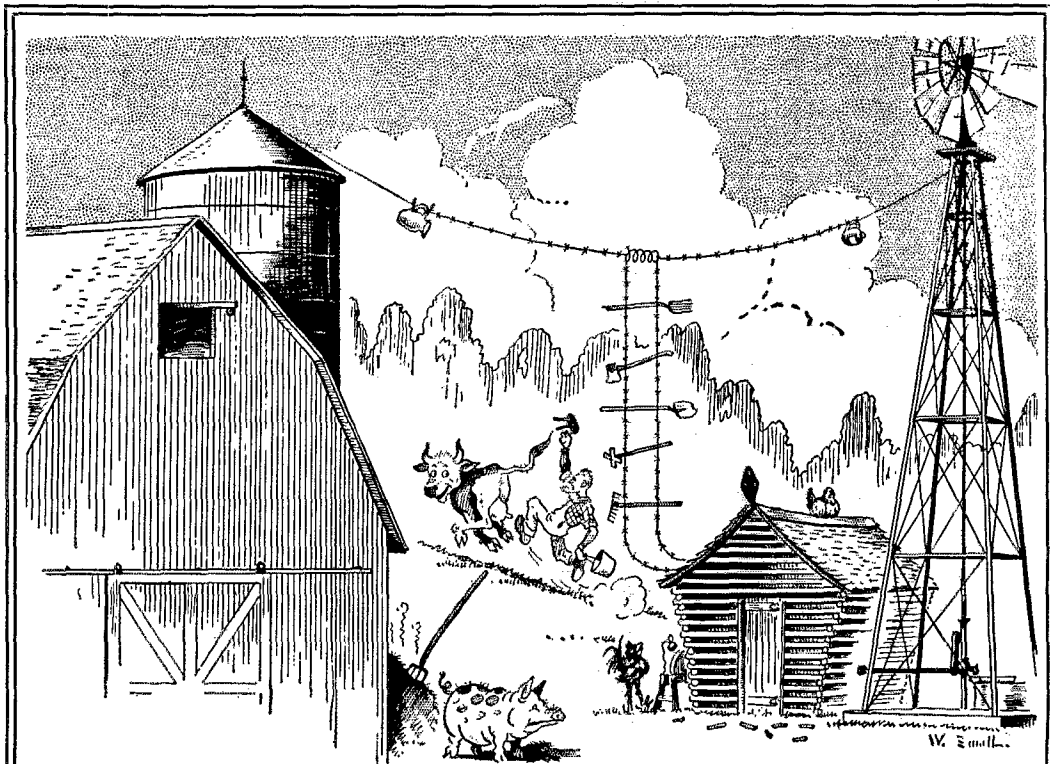

Put Watts in your Skywire with Westinghouse Instruments

DO you want to know whether the watts pumped out of your shack are "rolling down to Rio" or crawling around in your neighbors' broadcast sets? Or if your X-mission line is feeding the antenna or broadcasting on its own account? Or why DX cards poured in when you changed your feeder coupling? Want an easy way to calculate the surge impedance of your feeders? Or to determine the value of antenna coupling coil? And some hints on methods of coupling the feeders to the X-mitter tank coil?

Start the new year right by tuning up the radiating system to get maximum efficiency. Westinghouse MX and NX instruments will do the trick.

Westinghouse

Since 1888, manufacturers of highest quality instruments, now available at standard prices. There is no longer any reason for accepting lower standards.



Territory is still open for dealers.

And here's news. Another Westinghouse folder is just off the press giving data on the construction and the determination of the impedance of two-wire transmission lines; on the construction of an antenna coupling coil; on the method of final coupling of line to tank coil; and the proper procedure for tuning up the system.

The information in this folder will help the "ham" put his watts in the antenna, keep feeder oscillations out of circulation, and put more DX cards on the walls of the shack. Send the coupon for your copy.

If you haven't received Catalog 43-340, MX and NX instruments, ask for it, too.

SEND FOR INFORMATION

Westinghouse Electric & Manufacturing Company
Dept. 113, Room 2-N—East Pittsburgh, Pa.

Please send me the booklets checked below:

- E. 8322 Two-Wire Untuned Transmission Lines.
 Catalog 43-340—Types MX and NX Instruments.

Name

Address

City State T 79839

Call Letters QST 1-34

QST

Published monthly, as its official organ, by the American Radio Relay League, Inc., at West Hartford, Conn., U. S. A.; Official Organ of the International Amateur Radio Union

devoted entirely to

AMATEUR RADIO

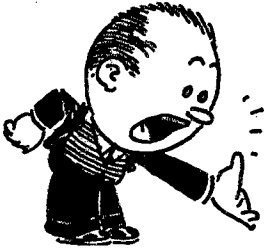

Editorials	9
The Tenth Anniversary of Transocean Work	10
An Efficient C. W. and 'Phone Transmitter Using the New Tubes and Circuits Part II. L. C. Waller, W2BRO	11
Oklahoma State Convention (Announcement)	16
A Practical Transmission-Line System for the Doublet Antenna E. F. Johnson and Ralph P. Glover	17
A New Handbook	21
A Convertible Push-Pull Oscillator or Amplifier R. B. Parmenter, W9PLM	22
It's in the Blood! J. C. (Felix) Johnson, W5LS	25
Improving the Performance of the Neutralized Power Amplifier George Grammer	27
Crashing Page One William H. Graham, W9BNC	32
Hamdom	33
The Amateur and Police Radio Robert S. Kruse	34
How to Get a Class-C License K. B. Warner	38
Tri-Tet Tricks M. P. Mims, W5DB	41
Amateur Radio Stations W6AXN, W9BUY	42
Experimenters' Section	
A. C. FROM D. C. GENERATORS — 'PHONE MONITOR USING A 55 — NOTES ON THE LOCKED P. A. — WIPING OUT THE HARMONIC	43
Strays	46
I. A. R. U. News	47
Communications Department	50
Correspondence Department	66
Financial Statement	74
The West Gulf Division (Report)	76
The Pacific Division Convention (Report)	78
Standard Frequency Transmissions	80
Club Directory Available	88
Hamads	90
QST's Index of Advertisers	94

JANUARY
1934

VOLUME XVIII
NUMBER 1

Kenneth B. Warner (Secretary, A.R.R.L.), Editor-in-Chief and Business Manager; Ross A. Hull, Associate Editor; James J. Lamb, Technical Editor; George Grammer, Assistant Technical Editor; Clark C. Rodimon, Managing Editor; David H. Houghton, Circulation Manager; F. Cheyne Beekley, Advertising Manager; Ursula M. Chamberlain, Assistant Advertising Manager.

Editorial and Advertising Offices
38 La Salle Road, West Hartford, Conn.

Subscription rate in United States and Possessions and Canada, \$2.50 per year, postpaid; all other countries, \$3.00 per year, postpaid. Single copies, 25 cents. Foreign remittances should be by international postal or express money order or bank draft negotiable in the U. S. and for an equivalent amount in U. S. funds.

Entered as second-class matter May 29, 1919, at the post office at Hartford, Connecticut, under the Act of March 3, 1879. Acceptance for mailing at special rate of postage provided for in section 1103, Act of October 3, 1917, authorized September 9, 1922. Additional entry at Concord, N. H., authorized February 21, 1929, under the Act of February 28, 1925.

Copyright 1933 by the American Radio Relay League, Inc.
Title registered at United States Patent Office.

SIGNS of an EFFICIENT STATION

LOG BOOK



Log Books. Bound with heavy paper covers. $8\frac{1}{2} \times 10\frac{3}{4}$. Contains 39 log pages, and same number of blank pages for miscellaneous notes. Also list of Q sigs, message number sheet and sheet of cross-section paper. 40c each or 3 for \$1.00. Postpaid.

MESSAGE BLANKS

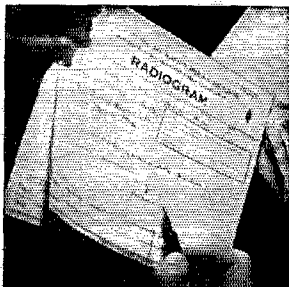

Message Blanks. Most convenient form. Designed by the Communications Department of the A.R.R.L. Well printed on good bond paper. Size $8\frac{1}{2} \times 7\frac{1}{4}$. Put up in pads of 100 sheets. One pad postpaid for 35c or 3 pads for \$1.00.

STATIONERY



A.R.R.L. Letterheads. Write your radio letters on League stationery — it identifies you. Lithographed on $8\frac{1}{2} \times 11$ heavy bond paper. Postpaid. 100 sheets, 50c; 250 sheets, \$1.00; 500 sheets, \$1.75.

MESSAGE DELIVERY CARDS

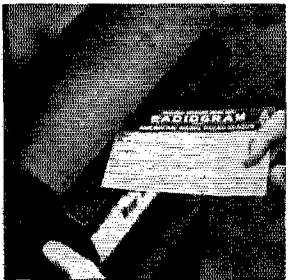

Message Delivery Cards. Neatest, simplest way to deliver a message to a near-by town. On U. S. stamped postals 2c each. On plain cards (for Canada, etc.) 1c each postpaid.

THE AMERICAN RADIO RELAY LEAGUE — WEST HARTFORD, CONN.

Section Communications Managers of the A.R.R.L. Communications Department

All appointments in the League's field organization are made by the proper S.C.M., elected by members in each Section listed. Mail your S.C.M. (on the 16th of each month) a postal covering your radio activities for the previous 30 days. Tell him your DX, plans for experimenting, results in 'phone and traffic. He is interested, whether you are an A.R.R.L. member or get your QST at the news stands; he wants a report from every active ham. If interested and qualified for O.R.S., O.P.S. or other appointments he can tell you about them, too.

Eastern Pennsylvania Maryland-Delaware-District of Columbia Southern New Jersey Western New York Western Pennsylvania	W3GS W3BAK W3QL W8DSP W8CUG	ATLANTIC DIVISION Jack Wagenseller Edgar L. Hudson Gedney Rigor Don Farrell C. H. Grossarth	24 South Fairview Ave. 412 2nd Ave. 213 Hickok Ave. R. F. D. 3, Elcher Rd.	Highland Park, Upper Darby Laurel, Delaware Haddon Heights Syracuse Emmorth, Bellevue, Pa.
Illinois Indiana Kentucky Michigan Ohio Wisconsin	W9WR W9TE W9OX W8YVH W8BAH W9FSS	CENTRAL DIVISION Fred J. Hinds Arthur L. Braun Carl L. Pfumm Kenneth F. Conroy Harry A. Tummonds Harold H. Kurth	6618 West 34th St. 911 Reiser P. O. Box 359 7538 E. Robinwood Ave. 2073 West 85th St. 2550 N. 8th St.	Berwyn Indianapolis Louisville Detroit Cleveland Milwaukee
North Dakota South Dakota Northern Minnesota Southern Minnesota	W9DGS-IFW W9DKL W9JIE W9EPJ	DAKOTA DIVISION Wm. Langer C. B. Miller Robert C. Harshberger Norman Beck	313 First Ave., S. 449 N. 5th St. 1200 Fauquier St. 415 Grand St.	Jamestown Redfield St. Paul Winona
Arkansas Louisiana Mississippi* Tennessee	W5ABI W5VT W5VJ W4AFM	DELTA DIVISION H. E. Velte W. J. Wilkinson, Jr. W. P. Allen F. F. Purdy	2918 West 15th St. 1624 Allen Ave. P. O. Box 66 P. O. Box 173	Little Rock Shreveport Jackson Kingsport
Eastern New York N. Y. C. & Long Island Northern New Jersey	W2LU W2AZV W2CO	HUDSON DIVISION Robert E. Haight E. L. Baunach Walter A. Cobb	1080 Helderberg Ave. 7823 10th Ave. 28 Ampere Parkway	Schenectady Brooklyn East Orange
Iowa Kansas Missouri Nebraska	W9FFD W9FLG W9EYG-HCP W9FAM	MIDWEST DIVISION George D. Hansen O. J. Spetter C. R. Cannady Samuel C. Wallace	3734 Summit St. 305 Western Ave. 300 Sixth St. Green St.	Sioux City Topeka Monett Clarks
Connecticut Maine Eastern Massachusetts Western Massachusetts New Hampshire Rhode Island Vermont	W1CTI W1CDX W1AST W1ASY-W1RB W1APK W1AFO W1ATF	NEW ENGLAND DIVISION Frederick Ellis, Jr. John W. Singleton Joseph A. Millen Earl G. Hewinson Basil Cutting Stanley Atkinson Harry Page	19 Merrill Rd. 10 High Street 16 Mercer St. 33 Corland St. 186 Magnolia St. R. 1	Norwalk Wilton Ashmont Springfield Pembroke Auburn Hinesburg
Alaska Idaho Montana Oregon Washington	K7PQ W7APV W7AAT-7QT W7ABZ W7AYO	NORTHWESTERN DIVISION Richard J. Fox Don D. Oberbillig O. W. Viers Raymond W. Cummins Stanley J. Belliveau	Box 301 P. O. Box 1271 4835 N. Amherst St. Route 7, Box 387	Ketchikan Boise Red Lodge Portland Yakima
Hawaii Nevada Los Angeles Santa Clara Valley East Bay* San Francisco Sacramento Valley Arizona Philippines* San Diego San Joaquin Valley*	K6COG W6EAD W6AAN W6DBB W6ZX W6CAL W6DVE W6BJF-W6QC K6IXA W6EOP W6AOZ	PACIFIC DIVISION C. D. Slaten Keston L. Ramsay Francis C. Martin Barry A. Wood P. W. Dann Byron Goodman Geo. L. Woodington Ernest Mendoza Newton E. Thompson Harry A. Ambler Alfred H. Green	Pearl City 1151 Buena Vista Ave. 738 W. Huntington Drive R. 1, Box 722 1821 Chestnut St. 141 Alton Ave. 716 Redwood Ave. 1434 East Madison St. 714 Tennessee 4101 Hamilton St. 723 North Orange St.	Oahu Reno Arcadia Campbell Berkeley San Francisco North Sacramento Phoenix Manila, P. I. San Diego Stockton
North Carolina Virginia West Virginia	W4AVT W3AAJ W8HD	ROANOKE DIVISION G. H. Wright, Jr. R. N. Eubank C. S. Hoffmann, Jr.	2817 Montrose Ave. 100 20th St.	Wendell Richmond Warwood, Wheeling
Colorado Utah-Wyoming*	W9BTO W6GQC-IDM	ROCKY MOUNTAIN DIVISION T. R. Becker Arty W. Clark	1176 Gaylord St. 260 So. 9th West	Denver Salt Lake City, Utah
Alabama Eastern Florida Western Florida Georgia-So. Carolina-Cuba* Isle-of-Pines-Porto Rico- Virgin Islands	W4KP W4NN W4MS W4UT	SOUTHEASTERN DIVISION L. D. Elwell Ray Atkinson Edward J. Collins George A. Love	1066 Waverly St. 4524 College St. 1517 East Brainard St. 1202 NE Springdale Rd.	Tarrant Jacksonville. Pensacola Atlanta
Northern Texas Oklahoma* Southern Texas New Mexico*	W5AUL W5BOA W5BHO W5CGJ	WEST GULF DIVISION Glen E. Tabbutt Sgt. R. F. Hinc David H. Calk J. M. Eldodt	1902 South 11th St. 1st Balloun Co. 6726 Ave. Q	Abilene Fort Sill Houston Chamita
Maritime	VE1DQ	MARITIME DIVISION A. M. Crowell	69 Dublin St.	Halifax, N. S.
Ontario	VE3GT	ONTARIO DIVISION S. B. Trainer, Jr.	4 Shorncliffe Ave.	Toronto
Quebec	VE2AP	QUEBEC DIVISION J. C. Stadler	4334 Westmount Ave.	Westmount, P. Q.
Alberta British Columbia	VE4HM VE5AC	VANALTA DIVISION C. H. Harris R. K. Town	10806 125th St. 1754 Graveley St.	Edmonton Vancouver
Manitoba Saskatchewan	VE4GC VE4EL	PRAIRIE DIVISION Reg. Strong Wilfred Skaife	284 Marion St. 2040 McTavish St.	Winnipeg Regina

* Officials appointed to act until the membership of the Section choose permanent SCM's by nomination and election.

Immediate Sylvania

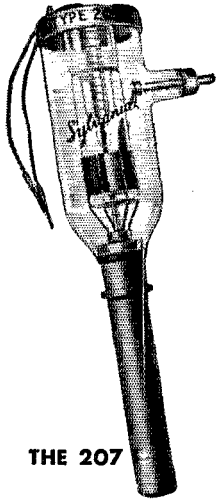

THE 207

THE 849



THE 204A



THE 852

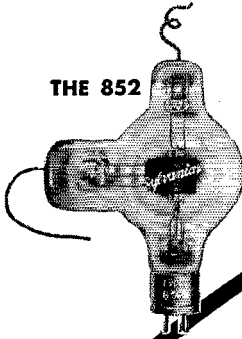

THE 866

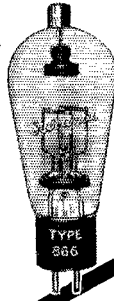

THE 203A

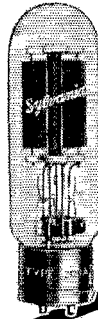

THE 865

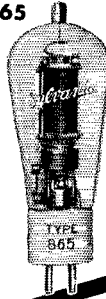

THE 242A



THE 830

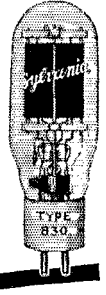

**ALL SYLVANIA AIR-COOLED
TYPES USE GRAPHITE ANODES**

FACTORIES: SALEM, MASS. EMPORIUM, PA. ST. MARYS, PA.
CLIFTON N. J.

*Hygrade Lamps
Sylvania Tubes*

Deliveries

MODERN TRANSMITTING TUBES

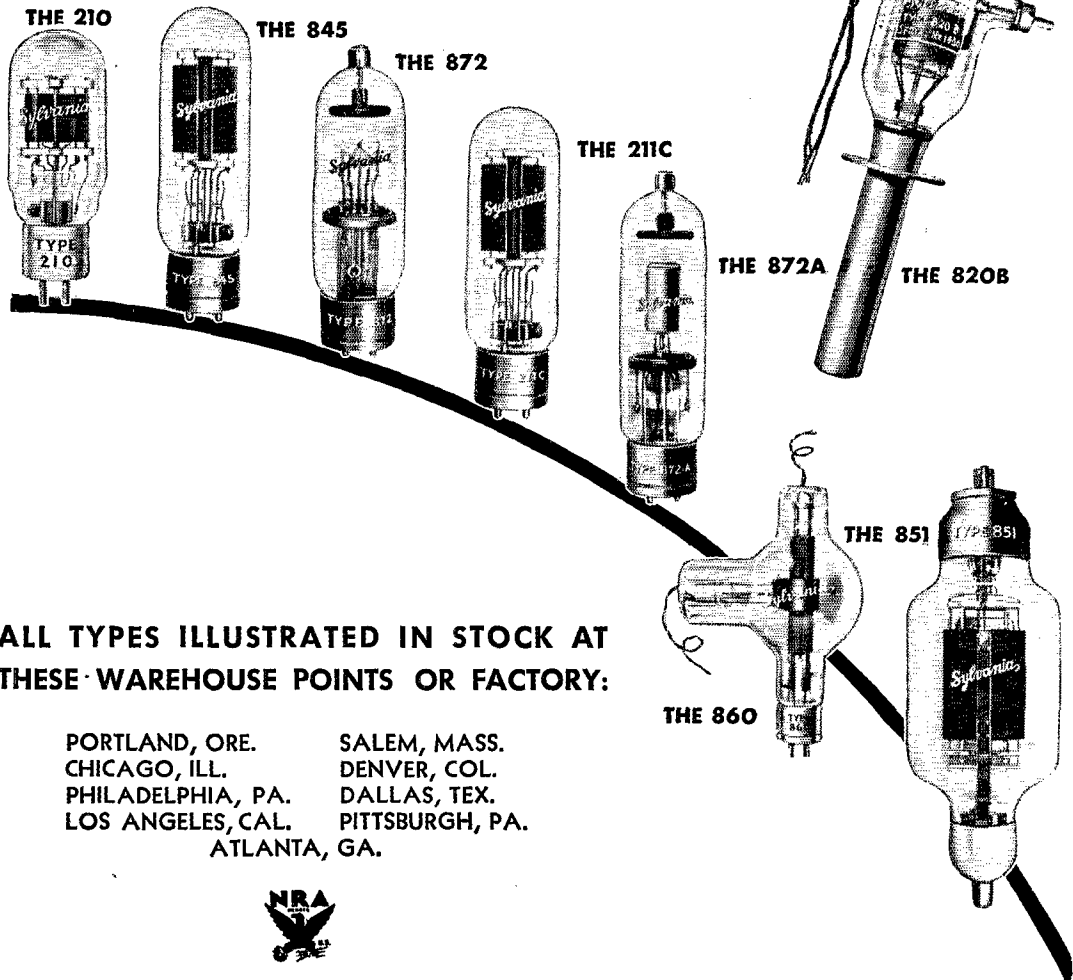

ALL TYPES ILLUSTRATED IN STOCK AT THESE WAREHOUSE POINTS OR FACTORY:

- | | |
|-------------------|-----------------|
| PORTLAND, ORE. | SALEM, MASS. |
| CHICAGO, ILL. | DENVER, COL. |
| PHILADELPHIA, PA. | DALLAS, TEX. |
| LOS ANGELES, CAL. | PITTSBURGH, PA. |
| ATLANTA, GA. | |



HYGRADE SYLVANIA CORPORATION

ELECTRONICS DEPARTMENT

CLIFTON, NEW JERSEY

Say You Saw It in QST — It Identifies You and Helps QST

The American Radio Relay League



• **T**HE AMERICAN RADIO RELAY LEAGUE, INC., is a non-commercial association of radio amateurs, bonded for the promotion of interest in amateur radio communication and experimentation, for the relaying of messages by radio, for the advancement of the radio art and of the public welfare, for the representation of the radio amateur in legislative matters, and for the maintenance of fraternalism and a high standard of conduct.

It is an incorporated association without capital stock, chartered under the laws of Connecticut. Its affairs are governed by a Board of Directors, elected every two years by the general membership. The officers are elected or appointed by the Directors. The League is non-commercial and no one commercially engaged in the manufacture, sale or rental of radio apparatus is eligible to membership on its board.

"Of, by and for the amateur," it numbers within its ranks practically every worth-while amateur in the world and has a history of glorious achievement as the standard-bearer in amateur affairs.

Inquiries regarding membership are solicited. A bona fide interest in amateur radio is the only essential qualification; ownership of a transmitting station and knowledge of the code are not prerequisite. Correspondence should be addressed to the Secretary.

DIRECTORS

<i>President</i>	HIRAM PERCY MAXIM.....W1AW
	Box 216, Hartford, Conn.
<i>Vice-President</i>	CHARLES H. STEWART.....W3ZS
	St. David's, Pa.
<i>Canadian General Manager</i>	ALEX. REID.....VE2BE
	169 Logan Ave., St. Lambert, P. Q.
<i>Atlantic Division</i>	EUGENE C. WOODRUFF.....W8CMP
	234 W. Fairmount Ave., State College, Pa.
<i>Central Division</i>	LOREN G. WINDOM.....W8GZ-W8ZG
	1375 Franklin Ave., Columbus, Ohio
<i>Dakota Division</i>	LAWRENCE E. LINDESMITH.....W9GKO
	1055-85th Ave. W., Duluth, Minn.
<i>Delta Division</i>	M. M. HILL.....W5EB
	P.O. Box 214, Natchitoches, La.
<i>Hudson Division</i>	BERNARD J. FULD.....W2BEG
	280 Broadway, New York City
<i>Midwest Division</i>	H. W. KERR.....W9DZW-W9GP
	Little Sioux, Iowa
<i>New England Division</i>	G. W. BAILEY.....W1KH
	74 Webster Road, Weston, Mass.
<i>Northwestern Division</i>	RALPH J. GIBBONS.....W7KV-W7BIX
	3134 N. E. 25th Ave., Portland, Ore.
<i>Pacific Division</i>	S. G. CULVER.....W6AN
	2962 Russell St., Berkeley, Calif.
<i>Roanoke Division</i>	H. L. CAVENESS.....W4DW
	State College Station, Raleigh, N. C.
<i>Rocky Mountain Division</i>	RUSSELL J. ANDREWS.....W9AAB
	1867 So. Lafayette St., Denver, Colo.
<i>Southeastern Division</i>	J. C. HAGLER, JR.....W4SS
	2424 McDowell St., Augusta, Ga.
<i>West Gulf Division</i>	FRANK M. CORLETT.....W5ZC
	2515 Catherine St., Dallas, Tex.

OFFICERS

<i>President</i>	HIRAM PERCY MAXIM, W1AW
	Hartford, Connecticut
<i>Vice-President</i>	CHARLES H. STEWART, W3ZS
	St. David's, Pennsylvania
<i>Secretary</i>	KENNETH B. WARNER, W1EH
	West Hartford, Connecticut
<i>Treasurer</i>	ARTHUR A. HEBERT, W1ES
	West Hartford, Connecticut
<i>Communications Mgr.</i>	F. EDWARD HANDY, W1BDI
	West Hartford, Connecticut
<i>General Counsel</i>	PAUL M. SEGAL, W3EEA
	1010 Shoreham Building, Washington, D. C.

Address all general correspondence to the executive headquarters at West Hartford, Connecticut



THE EDITOR'S MILL

ONE of the valuable services that A.R.R.L. has arranged for amateur radio is the transmission of standard frequency signals. Three specially-equipped stations, W1XP on the Atlantic, W6XK on the Pacific and W9XAN in the middle west, afford the entire country a highly accurate calibration service at frequent intervals. Prearranged schedules are announced in each issue of *QST*. Week after week, year after year, the highly skilled personnel of these stations is doing a painstaking job to help amateur radio. Thousands of reports from amateurs prove that the service is used and appreciated.

Any amateur anywhere in the country can receive the signals for the calibration of frequency meter, monitor or receiver — that is, when QRM is not too bad. Many of the reports received show calibration points missed because of intense interference from amateur signals and we have received numerous letters protesting the discourtesy of transmitting during these short periods. Remedies are suggested ranging all the way from pleas for coöperation to the suggestion that the Federal Radio Commission declare a compulsory silent period during the transmissions. While not believing in the latter suggestion, we are strong for coöperation, and indeed it does seem a shame that the value of these signals should frequently be lost through transmissions that might just as well be postponed a few minutes. We have often remarked that ham radio consists of people with every conceivable interest in amateur radio and we know that not everyone is interested in calibration signals, and that even those interested do not check their calibrations at every s. f. transmission. Nor is there necessity for all of amateur radio to pipe down during these transmissions. Stations on frequencies well removed from the standard frequencies are not likely to cause interference. But stations operating on or near the transmitted frequencies (round hundreds of kilocycles) are certain to cause serious interference. If the amateur operators of such stations desire to do the courteous thing by the rest of the fraternity, they will watch the schedules of transmission and forego operating their own transmitters during that period. Not during the whole schedule; it is important only during those few minutes that that particular standard frequency is being sent. That isn't too much to do, is it?

It is remarkable how much interference the standard-frequency transmissions will stand without completely losing their value. The reasonably skillful amateur should not abandon a calibration party as hopeless in the face of intense interference. There is small likelihood of a transmission being found completely useless through interference, since only a small part of the total transmission is necessary to make a calibration. During the three-minute transmission there is almost always a lull sufficiently long to identify the signal and tune it in accurately. The transmissions can frequently be identified only by their timing, so that sometimes a calibration point can be got through interference so tough that not a letter of the transmission is actually readable. But under those difficulties how one does wish that the several hundred hams who seem to be squatting on that particular frequency would be kind enough to fold up for just a few minutes!

It isn't always possible to receive the particular s. f. station you set out to get, on the band you have in mind. Transmission conditions vary too. It is for the very reason of as-

sureing service that there are three stations. For instance, at the moment of writing WIXP's performance is curtailed because of trouble with its primary frequency standard, but W9XAN still supplies eastern needs. It is more difficult, though, and the circumstances make coöperation in minimizing interference even more important.

To you fellows on or near a transmitted frequency: considering the desires of your brother amateurs to receive calibration signals, and considering the thankless grind of service being performed by these three stations to help all of us, how about resolving to consult the schedules and stay off the air those few minutes? It will make a swell New Year's Resolution!

K. B. W.

The Tenth Anniversary of Transocean Work

January 1-15, 1934—Work and Report European DX—Renew DX Friendships—
Celebrate Individual Tenth Anniversaries in Informal Tests

THE headlines of ten years ago!! "1MO and 1XAM Work French 8AB. Transatlantic Amateur Communication Accomplished; One Hundred Meters Does the Trick on November 27, 1923."

A decade ago we reached an important milestone in amateur history. Those were glamorous days. Transocean work was a striking, unknown, feat. It marked the discovery and exploitation of the high frequencies, making "spark sets" and "above 200-meter" operation definitely obsolete. The drift to c.w. became a stampede. There was a rush to make new high frequency records, a rush to higher and higher frequencies. On and on it went to new countries, new bands. Commercial "heavy" equipment was made obsolete overnight; 7-mc. band frequencies were popularized; 14-mc. daylight transcontinental work came into its own. All oceans were spanned. On and on, a decade of progress and development in amateur radio has now been completed. It started with A.R.R.L. Tests and the startling news of the first high frequency successes of 1923-1924.

Important tenth anniversaries:

U.S.A.-France,	Nov. 27, 1923 u1MO-1XAM-8AB
U.S.A.-England,	Dec. 8, 1923 u1MO-g2KF
Italy-England,	Dec. 9, 1923 i1MT-g2HF
U.S.A.-Netherlands,	Dec. 27, 1923 u2AGB-PCII
Canada-England,	Dec. 28, 1923 c1BQ-g5BV
U.S.A.-Italy,	Jan. 25, 1924 u2AGB-u1XW-iACD
U.S.A.-NZ.,	Sept. 21, 1924 u6CGW-u6BCP-z4AA

We started to list anniversaries, but the list is a long one. In the early months of '24 literally hundreds of transatlantic contacts were made. Schedules were kept night after night, friendships started, traffic handled. It is our suggestion that every individual who had any part in this work, and many are active in amateur radio

to-day, attempt to renew these international friendships on the tenth anniversary of their inception, or in the first half of January which has been set aside for general and informal transocean DX work.

We wish every old timer who keeps active would inform us what success he has in renewing his European amateur friendships. A.R.R.L. Headquarters is attempting to notify individuals prominent in this early work, so that letters may be written and formal duplication of the early contacts made on to-day's frequency bands. We are also writing representative European amateur societies to the effect that this announcement will appear in *QST*. It is hoped that a revival of interesting two-way DX work between W/VE and European hams may take place during this tenth-anniversary season.

It is an opportunity for old timers to stage a *real Old Timers DX Party* (January 13-15) and we hope many can arrange to take advantage of this occasion. With the coöperation of foreign sister societies, new amateurs in North America and Europe alike may also take advantage of these January tests to reproduce a reincarnation of the days of '23 '24. The eleven-year sunspot cycle brings us ideal DX conditions. Let us reestablish old bonds and weld new ones by establishing new trans-ocean friendships in this period. As the old year passes out and brings in the new let us work some interesting international DX to "start the new year right." Don't forget to send the A.R.R.L. Communications Department your QSL with a brief note of the DX calls you worked, with comments on how you celebrated the tenth Anniversary of Two-Way International DX.

— F. E. H.

An Efficient C.W. and 'Phone Transmitter Using the New Tubes and Circuits

The Speech Amplifier and Class-B Modulator Unit

Part II*

By L. C. Waller, W2BRO**

TWO 800's in Class B constitute a suitable combination to modulate the 200-watt input Class-C stage, since they are capable of delivering approximately 90 useful watts of audio power. Two of the new 2A3's in push-pull are admirably suited for the driver stage and are used in this modulator.

Among the more important considerations for any Class B modulator are the input and output

transformer should be as low as possible. Because leakage inductance is proportional to the inductance of the primary, the latter inductance should not be made greater than necessary to obtain good low-frequency response as outlined above.

If low distortion is to be obtained, the driver tubes should be worked into a load resistance higher than the normal value (approximately

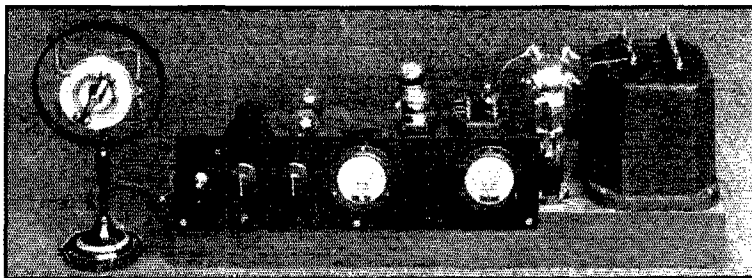

THE AUDIO UNIT OF THE TRANSMITTER
The r.f. section was described in the Dec., 1933, issue of QST

transformers. If these transformers are incorrectly designed, a high-quality speech amplifier and a good power supply will be of no avail as far as good quality is concerned. In the tube data sheet accompanying the 800 we read, "The input transformer should be designed to give good frequency response when operated into an open circuit, such as that represented by the grid circuit of the Class-B stage when the signal amplitude is small, and also to handle the required input power for a strong signal." The first stipulation means, in effect, that the inductance of the input-transformer primary should be large enough to provide an inductive reactance at low frequencies equal to not less than twice the plate-to-plate resistance (in this case $4 \times 800 = 3200$ ohms) of the driver stage; also, since it is difficult to compensate for leakage reactance of the input transformer without excessive loss of high-frequency response, the leakage inductance of the

twice) recommended for optimum power output as a Class-A amplifier, since distortion produced by the driver stage as well as that by the power stage will be present in the output. The input transformer, since it must handle power when the Class-B grids are swung positive, should have a reasonably high peak-power efficiency. The input transformer used in the modulator has a turns ratio, total primary to $\frac{1}{2}$ secondary, of 2:1 and has a rated total primary inductance of 30 henrys at full signal (higher at low signals). Therefore, the primary's inductive reactance at 60 cycles is $X_L = 2\pi fL = 2 \times 3.14 \times 60 \times 30 = 11,304$ ohms. Before purchasing Class-B transformers it would be well to check their ratings, since a skimpily designed unit, either input or output, may impair quality and reduce output.

Reading further in the 800 data sheet, "The output transformer should be so designed that the resistance load presented by the modulated Class-C amplifier is reflected as a plate-to-plate load of 12,500 ohms in the Class-B stage for the 1000-volt conditions. The ratio of the output

* Part I, describing the companion r.f. unit, appeared in Dec., 1933, QST.

** RCA Radiotron Co., Inc., Harrison, N. J.

transformer is then 1.59 to 1, step-down (total primary to total secondary). The transformer should be designed with a core sufficiently large to avoid saturation effects, which would impair the quality of the output. If the secondary is to carry the d.c. plate current of the modulated

modulator. A single weak link in the chain may ruin results.

Now for the more cheerful side of the picture: A Class-B modulator using properly designed parts can be made to give excellent quality (5 to 7% total harmonic distortion). In addition,

as has been explained in previous articles in *QST*, Class-B systems are far more economical than comparable Class-A systems. Compare the size and cost of the modulator shown in the photograph to any Class-A system that will deliver 90 to 100 watts of audio output!

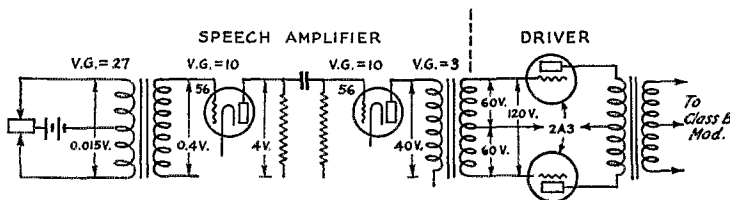

FIG. 1—SKELETON DIAGRAM OF SPEECH-AMPLIFIER AND DRIVER STAGES, SHOWING APPROXIMATE VOLTAGE GAIN AND PEAK VOLTAGE PER STAGE

amplifier, the core should be made larger and include an air-gap to compensate for the d.c. magnetization current."

The output transformer used in this modulator was designed to meet these specifications. An idea of its size may be gained from the photograph by comparing it to a 2A3 or an 800. It is obviously much larger than a power transformer of equal rating (approximately 100-watt)—a rough way, incidentally, of checking up on Class-B output transformer design.

It is small wonder, when the more important considerations of high-quality Class-B audio amplification are reviewed, that many Class-B modulated 'phones are noted for fuzzy, rattly and generally poor quality. The trouble is not with the

Class-B system itself, except that it may be more critical than Class-A systems as regards the correlation of the various parts. Almost anyone can rig up a tube with any old transformer or choke and get "good" to "fair" quality from a Class-A system. This is fortunate because of the fact that, although many of our fraternity know what to use for a given type of apparatus, they frequently find it necessary to use the parts on hand. As one amateur has put it, "If I haven't got what I want, I'll want what I have." Such philosophy, however, doesn't work with Class-B systems of modulation. Each part, from the driver stage to the high-voltage power supply, is not only important, but its correct functioning depends upon some or all of the other components. Therefore, unless all of the necessary parts are available, it is not a good plan to start building a Class-B

THE SPEECH AMPLIFIER

The next important consideration is the speech amplifier required to furnish the voltage gain necessary from the microphone to the grids of the 2A3 driver stage. The amplifier, because of varying voice input levels and to allow for a variation in microphone sensitivity, should have from 30

to 100 per cent more gain than the maximum value determined by calculation. It is always an easy matter to reduce the gain with the volume control, but when the control is wide open and the gain is still insufficient, a new speech amplifier may have to be constructed. On the other hand, an amplifier which has 5 to 10 times as much gain as necessary may cause trouble

due to a.f. and r.f. feed-back, with attendant motor-boating and "peanut whistles."

The following procedure for determining the necessary voltage gain is quite simple and is typical regardless of what types of tubes, or how many of them, are used. The microphone used with this amplifier at W2BRO is the W.E. 600-A, which is similar to, and the successor of, the Type 387. The obtainable voltage output of the 600-A, as given by an authority believed to be competent, is approximately 0.015 volts. The microphone transformer has a turns ratio of 1:27, which may be assumed to be the voltage step-up of the transformer. Therefore, the voltage at the secondary is $0.015 \times 27 = 0.4$ volt. This is the input voltage used in the amplifier calculations.

The 2A3's in push-pull require a bias of -45 volts and likewise a peak grid voltage of approxi-

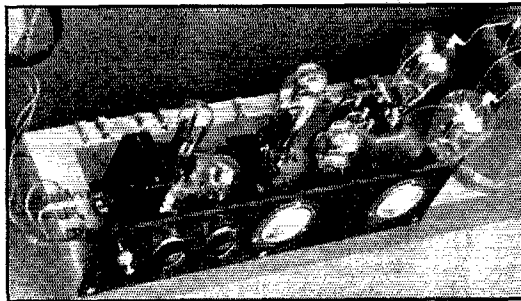

PLAN VIEW OF THE SPEECH AMPLIFIER AND MODULATOR UNIT

Placement of the parts is described in the text.

mately 45 (slightly less than 45, because their filaments are a.c. operated). This is 45 volts *per grid*, or 90 volts from grid to grid across the total secondary of the push-pull-2A3 input transformer. The overall voltage gain necessary in the amplifier is, therefore, 90/0.4 or 225. A Type 57 as a screen-grid a.f. amplifier is easily capable of a gain of 100.¹ This is too little; adding a Type 27

tied together, providing a high- μ triode. A plate load resistance of 15,000 to 30,000 ohms will prove satisfactory, the exact value depending on the plate-supply voltage and the amplifier requirements.

Fig. 2 shows the complete speech amplifier and modulator circuit. Grid and plate circuit decoupling filters are used in both of the 56 stages—

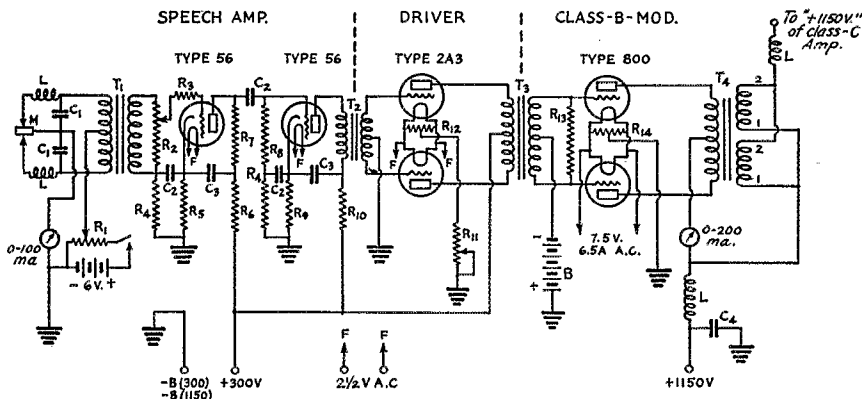

FIG. 2—CIRCUIT OF THE SPEECH AMPLIFIER AND MODULATOR UNIT

- T₁—Double-button microphone transformer (Thordarson Type T-3180).
- T₂—Push-pull input transformer.
- T₃—Class-B input transformer (Hilet Type IB-100).
- T₄—Class-B output transformer (Hilet Type OB-101).
- M—Type 600-A double-button microphone.
- B—Medium-size 63-volt "B" battery (45 and 18 volts in series).
- L—8-mh. r.f. choke (General Radio Type 379-T).
- R₁—400-ohm potentiometer, wire-wound.
- R₂—500,000-ohm potentiometer, volume control.
- R₃—75,000-ohm 1-watt resistor.
- R₄—200,000-ohm 1-watt resistor.
- R₅—2800-ohm 1-watt resistor.

- R₆—25,000-ohm 1-watt resistor.
 - R₇—50,000-ohm 1-watt resistor.
 - R₈—500,000-ohm 1-watt resistor.
 - R₉—2700-ohm 1-watt resistor.
 - R₁₀—7500-ohm 1-watt resistor.
 - R₁₁—500-ohm 10-watt adjustable wire-wound resistor.
 - R₁₂—20-ohm center-tapped wire-wound resistor.
 - R₁₃—40,000-ohm 2-watt resistor.
 - R₁₄—50-ohm center-tapped wire-wound resistor.
 - C₁—0.002- μ fd. fixed mica.
 - C₂—0.1- μ fd. 300-volt.
 - C₃—2.0- μ fd. 400-volt.
 - C₄—0.002- μ fd. 5000-volt.
- "Grounds" indicate connections soldered to copper base-sheet.

resistance-coupled will give approximately 7×100 ; this is too much. Two 56's resistance-coupled are capable of giving a gain of 100, that is, 10 per stage. Now, if the second 56 is transformer-coupled to the 2A3's with a 1:3 input transformer, the overall gain will be approximately 100×3 , or 300; this gain proves satisfactory. A glance at the voltage gain and voltage output diagram in Fig. 1 shows how the 0.015-volt output of the mike is built up to 60 volts per grid at the 2A3 stage. Since only 45 volts are needed, the gain control may be adjusted to approximately 45/60 or $\frac{3}{4}$ of maximum setting, for normal voice levels.

If a gain of 750 had been desired, the first 56 could have been replaced by a Type 53, which is capable of giving a gain of approximately 25. Thus, $25 \times 10 \times 3 = 750$. Two 53's would give $25 \times 25 \times 3$ or 1875. For this class of service, the 53 is operated with the grids of the two triode units tied together and with the two plates also

an important "ounce of prevention" against a.f. and r.f. feed-back. In addition, a grid suppressor resistor is used in the grid lead of the first 56. This filter resistor should be placed close to the socket terminal. As mentioned previously, the microphone transformer (Thordarson Type T-3180) has a turns ratio of 1:27 and the 2A3 input transformer has a turns ratio of 1:3. Transformers having a somewhat higher ratio can be used, but transformers with a lower ratio may not give sufficient gain.

THE LAYOUT

The complete speech amplifier and modulator unit is built in breadboard fashion, similar to the r.f. unit. A general idea of the arrangement of the parts can be obtained from the photograph. Trouble from a.f. feed-back due to the proximity of the output transformer to the low-power a.f. stages was half-expected, but fortunately failed to materialize when the apparatus was put in operation. If trouble from this source does occur, the output transformer should be rotated to a

¹ Waller, "The New 57 as a High-Gain Audio Amplifier," QST, July, 1932.

position which eliminates inductive feed-back, or moved further away from the speech amplifier.

The base-board is a piece of dry white pine of $\frac{3}{4}$ -inch stock measuring $7\frac{1}{2}$ inches by 26 inches. The Bakelite panel is $4\frac{1}{2}$ by 17 inches. A lower panel strip 2 by 26 inches placed under the in-

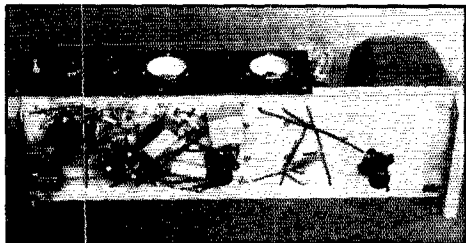

CONDENSERS, RESISTORS AND R.F. CHOKES ARE MOUNTED UNDER THE BASEBOARD ACCORDING TO CONVENIENCE

strument panel hides the wiring of the various r.f. chokes, by-pass condensers, and resistors underneath. As shown in the bottom view, no attempt was made to place these miscellaneous parts in an orderly manner. Each component part is placed in the position where it is most convenient for connections. Every lead is made as short as practicable. In the microphone and first-stage circuits, all important leads (microphone, grid and plate) are shielded wire, the shield of each lead being grounded. This detail is very important in order to prevent r.f. feedback.

A piece of heavy sheet copper $6\frac{1}{4}$ by 24 inches is mounted on top of the baseboard, flush with the front and the output-transformer end. This method of mounting leaves a space at the rear and at the left end of the baseboard in which to mount the Fahnestock clips for external connections. The copper plate is valuable as an r.f. shield, as a common ground point for all stages and as an effective ground for the three transformer cases. The bottoms of the transformers were scraped clean in order to make good contact with the copper plate. The apparatus was wired originally without the copper plate but gave unsatisfactory results. Considerable care should be exercised in making the socket connections, inasmuch as a small length of insulation must be left protruding through the holes where the socket wires come up, in order to prevent shorting to the copper base-plate.

Looking at the front of the modulator unit, from left to right the parts are: microphone transformer; the 56's; the push-pull 2A3 input transformer; the 2A3's; the Class B input transformer, the 800's and the Class-B output transformer. On the panel, from left to right are the microphone battery switch, microphone button-current potentiometer, the volume control potentiometer, the 0-100 microphone button-current d.c. mil-

liammeter and the 0-200 modulator plate-current d.c. milliammeter. The modulator milliammeter serves as an excellent voice-level indicator. If one speaks too low into the mike, this meter may swing to less than 160 ma. (or so) as it should when the 800 grids are receiving their full signal voltage swing. A twist of the a.f. gain control should remedy this condition.

It should be noted that this layout brings the 1000-volt plate potential up close to the operator. This is a convenient arrangement for prudent operators who do not mind dodging high plate voltages in the r.f. power amplifier. However, a fool-proof layout comprising enclosures and automatic power-circuit interlocks should *by all means* be adopted for those stations where equipment is exposed to children and non-technical visitors. Also, it is well for the operator himself to keep his fingers off the little zero-reset screw on the front of the modulator plate-current meter—one of those little things sometimes apt to be forgotten.

A 40,000-ohm resistor is connected across the grid terminals of the Class-B input transformer. This "audio-bleeder" helps to stabilize the load reflected from the modulator grid circuit into the plate circuit of the 2A3's. The resistor reduces the gain slightly, but improves the frequency characteristic, more or less, depending upon the design of the input transformer.

ADJUSTING THE MODULATOR

After the modulator unit is wired up, the filament and the 300-volt plate supplies are connected. The plate current, plate voltage and grid bias voltage of each Class-A stage are then checked individually. The voltage at the plate of the first 56 should be nearly 125 volts; the grid bias is about -6.5 volts and the plate current is approximately 2.3 ma. The voltage at the plate of the second 56 is 250 volts (measured between plate and cathode) and the plate current about 5.0 ma. This current provides the necessary -13.5-volt grid bias across the 2700-ohm self-bias resistor, R_2 . The self-bias resistor R_{11} in the filament return circuit of the 2A3's should be adjusted until the IR drop across it provides the necessary -45-volt bias for the driver stage. The total plate current of the two 2A3's may be approximately 120 ma., though this value is likely to vary considerably with different tubes. Individual tubes may differ plus or minus 15 ma. This difference can usually be expected in tubes having a very large mutual conductance (like the 2A3), because in such tubes a small change in grid bias will produce a relatively large change in plate current. The voltage at the plate of the 2A3's is about 250 volts, measured to the center-tapped filament resistor.

After these adjustments are made, the microphone and microphone battery are connected. The amplifier can now be checked for "quality" and a.c. hum (insofar as listening to the output is

a check!). In the first test of the speech amplifier, hum was objectionable. Two 8- μ fd. electrolytic condensers added to the 300-volt-supply filter system corrected this difficulty. The circuit of the 300-volt supply is given in Fig. 3. A magnetic speaker or a pair of headphones may be connected to the Class-B input-transformer secondary, since the impedance match is fair, and the gain control set at minimum. Headphones are better for this test than a speaker, however, because acoustic feed-back to the microphone is probable with the connection it may be of interest to note that the turns ratio of the input transformer is about right for use in grid-bias modulation circuits. With two 2A3 drivers, a grid-modulated 'phone of fairly good quality can be arranged with almost any good c.w. transmitter of the type employing 'Type '03-A, 52 or '04-A r.f. amplifier tubes.²

If the quality sounds reasonably good at the output of the 2A3's, the Class-B stage may now be checked. For the initial test it is well to substitute a 5000-ohm 100-watt resistor as load across the paralleled secondaries of the output transformer. The two secondaries are marked 1-2 and 1-2; they must be connected 1 to 1 and 2 to 2 (aiding) for a 5000-ohm load, as shown in Fig. 2. The grid bias battery of 63 volts should next be connected and the bias voltage measured between each grid and ground. The 1150-volt supply is then applied to the plate. The no-signal (static) d.c. plate current is about 30 ma. When the gain control is advanced, a reasonable voice signal should swing the d.c. plate current over 160 ma. The secondary load resistor should show signs of dissipating about 100 watts—approximately 140 ma. (0.14 amp.) a.c. through the load circuit, as measured by a thermo-couple ammeter, with steady sound input.

TUNING UP THE CLASS-C STAGE

The Class-C amplifier is next put in operation. Further tests with the 841 buffer show that while it delivers ample r.f. excitation to the final amplifier for c.w. work, it has to be cajoled somewhat to furnish enough for plate-modulated telephony. The 841 is used successfully at W2BRO, but an 800 substituted in its place with 70 watts input delivers the necessary excitation without cajoling! Tests indicate that at least 20 ma. d.c. grid current per tube (40 ma. in the common grid return of the 800's) is necessary for

² Isberg, "Making Practical Use of Grid-Bias Modulation," *QST*, August, 1932.

Class-C plate modulation. If the excitation is insufficient, unsymmetrical modulation and poor quality are sure to result in addition to the emission of a broad, interfering signal.

While the modulator and Class-C amplifier adjustments are being made, the antenna coil should be connected to a 100-watt lamp as a dummy antenna, instead of to the antenna feeders. Remember the Golden Rule! A lot of needless

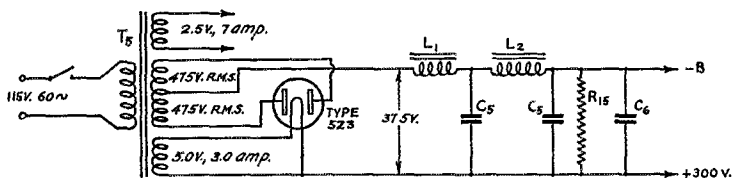

FIG. 3—THE SPEECH AMPLIFIER AND DRIVER POWER SUPPLY
Use of a separate supply minimizes troubles from r.f. and audio feedback.

- T_2 —100-watt power transformer with windings as shown.
- L_1 —Filter input choke, 10-henry at 125 ma. d.c., resistance 200 ohms.
- L_2 —Smoothing choke, 30-henry at 125 ma. d.c., resistance 400 ohms.
- C_5 —8- μ fd. 500-volt electrolytic filter condensers.
- C_6 —0.01- μ fd. mica r.f. by-pass condenser.
- R_{15} —60,000-ohm 2-watt bleeder resistor.

QRM in our crowded 'phone bands can be eliminated in this manner, as has been emphasized many times before in *QST*. The lamp can be clipped across about two turns of the antenna coil; on modulation, the bulb becomes "dangerously" bright.

It should be remembered that the Class-C radio-frequency amplifier in this case is supposed to present a resistive load of 5000 ohms to the modulator; but a Class-C amplifier does not behave like a resistive load unless it is operating truly Class-C. This means sufficient excitation, as indicated by d.c. grid current, with proper bias. Increasing the grid current by reducing the bias is not generally conducive to satisfactory results. If the grid current is too low at rated bias and rated d.c. plate input, the power output of the buffer stage must be increased. The 800's with 1000 volts on their plates, require -135 volts bias. A little more rather than a little less bias is desirable. The 1150-volt supply recommended provides 150 volts for the bias drop through the self-bias resistor and leaves about 1000 volts for the plate. To provide a 5000-ohm load for the modulator, the Class-C stage output load ought to be adjusted to make the plate current,

$$I = \frac{E}{R} = \frac{1000}{5000} = 0.2 \text{ ampere, or } 200 \text{ ma.}$$

Since the maximum rating of the 800 is 80 ma. per tube, or 160 ma. for two tubes, it is preferable to adjust the amplifier to that value. This makes the equivalent resistance (or "modulation impedance") of the Class-C stage somewhat higher than 5000 ohms, but it is not sufficiently different to impair results.

The output transformer is also designed to take

care of 2000-volt r.f. amplifiers. In that case, the two secondaries are connected in series aiding (1-2-1-2) and the Class-C amplifier is operated to present a 20,000-ohm load (2000 volts at 100 ma.). The series connection of course provides a turns ratio twice that of the parallel connection; since impedance varies as the square of turns ratio, twice as many turns means four times as much impedance; that is, $4 \times 5000 = 20,000$. If a value of impedance between 5000 and 20,000 ohms is desired, a special transformer with a tapped secondary can be obtained.

It will be found that juggling the d.c. plate current slightly, by means of both grid bias and antenna loading, will give the optimum set of conditions for complete and symmetrical modulation of the carrier. When steady sound of good wave form is supplied to the microphone, the feeder current should increase about 23 percent above its normal value. The non-modulated feeder current is 1.5 ampere at W2BRO. In no case should the amplifier be modulated above the level where its average plate current (d.c.) begins to vary noticeably. Although doubling the antenna current on modulation may seem nice, such a condition decidedly does *not* indicate proper modulation.

An incident which occurred during the operation of W2BRO some time ago may partly explain why so many amateur 'phones are from 150 to 300 percent modulated. A certain well-known second-district amateur who was being worked offered to give a rough check on W2BRO'S percentage modulation. This particular amateur watched the cathode milliammeter in his second detector, and reported that the modulation percentage was very low, because, although the carrier increased the meter reading, the meter "kicked" up but very little on modulation! In other words, W2BRO was *over-modulating* slightly, and was being criticized for not over-modulating more! With a carrier symmetrically modulated 100 percent or less, the meter would, of course, have remained perfectly steady. The obvious thing for a 'phone operator to do is to build some form of modulation monitor, which is essentially a simple linear detector.³

OPERATING CHECKS

In case others who build a 'phone similar to this rig have trouble in getting it to work properly, they may find the following comments helpful. The d.c. plate current of the Class-C stage should remain steady (within 5%) when modulation is applied. A small dip may be due to the regulation of the power supply when the Class-B modulator is drawing power. If separate power supplies for the modulator and the r.f. power amplifier are used, no variation should be observed. An r.f. amplifier d.c. plate current that fluctuates violently when

³ Lamb, "A Modulation Monitor," *QST*, April, 1933; and note concerning, page 11, May, 1933.

the microphone is spoken into is a sure sign of lop-sided modulation and poor quality.

If the antenna current "modulates down" (rare occurrence, these days), there may be insufficient r.f. excitation or too little grid bias on the Class-C stage; or the antenna may be drawing too much power. Loosening the antenna coupling and reducing the feeder current may help. If the excitation on the Class-C stage is ample, an increase in grid bias and the corresponding decrease in plate current may give better results.

All r.f. circuits should be accurately tuned to resonance. The neutralization of the Class-C amplifier should be as nearly perfect as possible. In any event, trouble is more likely to be encountered in the r.f. portion of the transmitter than in the modulator, especially if the d.c. plate current of the latter is swinging to its proper maximum value. If the circuit of the modulator is followed and the parts are properly correlated, little trouble is likely with that unit. As a matter of fact, when correctly designed parts (especially transformers) are at hand, it is as easy, or easier, to get a Class-B modulator to work properly than one operated Class-A.

The complete 'phone transmitter as described is exceedingly light and movable, considering its power output capabilities. When conditions on the 14-mc. band are reasonably good, daylight coast-to-coast 'phone contacts with good signal strength at the other end are nothing out of the ordinary. The quality obtained with this rig is good even beyond expectations. All reports received have been highly pleasing. The best one, however, came from our old friend W2JN (Charles Atwater, of N. B. C.) of ten-meter fame. Said Charlie, "Your quality is excellent"—and with that from Charlie, little is left to be desired!

Oklahoma State Convention (West Gulf Division)

PLACE: Ponca City, Okla.

HEADQUARTERS: Jens Marie Hotel.

DATE: January 20th-21st.

AUSPICES: Key Clickers.

R. O. Miles, Convention Manager, 1402 South Fifth St., Ponca City, Okla., will give you further information if you write him.



QST Index (1933)

The annual index to *QST* for 1933 (Volume XVII) was published as part of the December issue, and sent to every member of the League. News stand readers may obtain a copy of this index for 6 cents in stamps.

A Practical Transmission-Line System for the Doublet Antenna

A Different Solution of the Impedance-Matching Problem

By E. F. Johnson* and Ralph P. Glover**

EFFICIENT operation of any transmitting antenna system requires that the radiator be hung in free space. But it is probably a matter of universal experience that free space and transmitter location seldom coincide; the amateur is rarely able to base his selection of a home site on suitability for radio transmission. The solution is to put the antenna in the best approximation of free space within a reasonable distance of the transmitter, and then connect antenna and transmitter in the most efficient manner possible. The receiving antenna system comes in for similar treatment.

The connecting link between antenna and transmitter or receiver is most logically a transmission line of some sort, whose function is purely to transfer power without forming a portion of the radiating or collecting system. This article is concerned mainly with practical designs for use with the popular half-wave Hertz antenna (doublet) in transmitting applications.

TYPES OF LINES

Transmission lines in which two conductors are employed fall into two general classifications. The first is the open-wire type, which may consist either of spaced bare wires, either straight or transposed, or of insulated twisted pair. The second type is the concentric tube line, in which the outer conductor is a tube which encloses the concentric inner conductor. Such a line is really a single-conductor cable with a sheath used for a return path. In both types the insulation between conductors may be either solid dielectric, or, what is better for r.f. work, air. Both open wire and concentric lines have well-defined places in radio communication. The open-wire type, however, works out to be the more practicable type in amateur communication.

Let us consider the various forms of open-wire lines. We want the line to be balanced to ground, to radiate as little as possible, and to have minimum electrical losses. Some means for impedance-matching to the antenna—preferably a simple means—must be provided.

TRANSPOSSED LINES

Most amateur feed lines, probably through sheer habit, are non-transposed lines with about

* E. F. Johnson Company, Waseca, Minn.

** Electrical Engineer, 215 West Huron St., Chicago, Ill.

6-inch conductor separation. For end-fed Zepelin systems, where there is a standing wave on the line, this method is entirely suitable and may possibly have advantages over the transposed line. The wide spacing is conducive to peace of mind, especially in high-power transmitters where voltage maxima attain husky proportions.

Transposed lines, however, have several advantages over straight non-transposed lines for

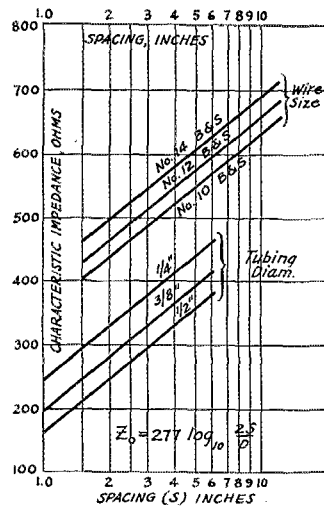

FIG. 1.—GRAPHICAL TABLE OF CHARACTERISTIC IMPEDANCES OF TYPICAL OPEN-WIRE TRANSMISSION LINES

feeding symmetrical radiators such as the doublet. Theoretically, frequent transposition makes the capacitance between each side of the line and ground approximately the same, a factor which becomes more and more important as the operating frequency increases. Currents flow not only along the transmission line, but also to a certain extent from the transmission line to ground through capacitance paths. If the capacitance between each side of the line and ground is not the same, differential currents will flow. Then, the transmission line radiation goes up, because the unequal line currents produce unequal fields which do not cancel out. Such unbalances are more likely to exist with non-transposed lines than with transposed lines, especially if the line

takes an indirect path to the transmitter, or if one of the conductors is appreciably closer to earth or to earthed objects than the other.

Transposition is accomplished by means of insulators, spaced at regular intervals along the line, so that the conductors cross over at each

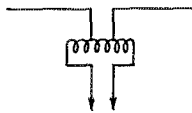

FIG. 2—SIMPLE TRANSFORMER COUPLING

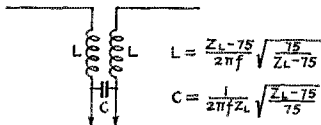

FIG. 3—TUNED CIRCUIT COUPLING, ADAPTED FROM ROBERTS, QST, JAN., 1928

point of transposition. Thus each conductor occupies alternate sides of the line in successive sections. The usual block type transposition insulators have necessitated rather sharp bends in the wires where they pass through the slots, thereby introducing stresses which all too often have resulted in broken conductors after a short period of service. A newer type skeletonized transposition insulator eliminates sharp bends and keeps the wires in a continuous line throughout their length. The skeleton-type construction reduces weight and affords a long surface-leakage path. The conductors are spaced two inches and the line impedance for any particular wire size can be determined from data to be given.

The close spacing of wires with insulators of this type reduces line radiation considerably. Since line radiation is proportional to the square of the spacing, conductors spaced two inches will radiate only one-ninth as much as those spaced six inches.

LINE IMPEDANCES

Any uniform transmission line whose length is appreciable, compared to a wavelength, has a definite surge impedance or characteristic impedance whose value is mainly determined by the ratio of inductance to capacity per unit length of the line. The subject of line impedance has been discussed in a number of previous articles in *QST* and the reader who wishes to review the subject should consult these references. The important point is, that for best efficiency the terminal equipment must be arranged to match the line impedance. In other words, there must be an impedance match at the junction of the antenna and the line and again where the line connects to the transmitter output circuit. If impedance matching is not provided, not only will the antenna-feeder system be unable to

absorb the maximum amount of power from the output stage, but standing waves will appear on the line and run up the losses and disturb the radiation pattern. Of course, impedance-matching can be dodged entirely at the junction of antenna and line if we make the line exactly a half-wavelength long (current feed), but this length may not be convenient for the particular installation and the line losses will be greater. There are no restrictions on the length of the line when impedances are carefully matched all the way through.

Impedance matching can be accomplished experimentally (which is actually what we do when we adjust coupling at the transmitter end of the line). Or we can calculate the line impedance and then figure out some means of matching the line to the antenna. A few calculations will save a great deal of wasted time. The radiation resistance of a conventional half-wave antenna doublet, plus ohmic and loss resistances, is known to be about 75 ohms. At radio frequencies the impedance of a parallel-conductor two-wire line using round conductors can be computed from the diameter of the wire and center-to-center spacing by means of the well known formula:

$$Z_0 = 277 \log_{10} \frac{2S}{D}$$

where *S* is the separation of wire centers and *D* is the conductor diameter, both *S* and *D* being

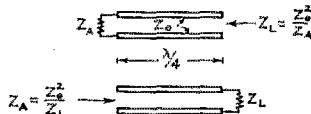

FIG. 4—IMPEDANCE RELATIONSHIPS FOR A QUARTER-WAVE LINE

expressed in the same units (inches, millimeters, etc.). This formula holds only where the dielectric is air and hence cannot be used for twisted pair lines with solid insulation. The results, however, are quite close for the usual types of lines employing feeder spreaders or transposition insulators.

The chart of Fig. 1 shows computed line impedances for practical sizes of wire and copper tubing, plotted against spacing in inches, thus making calculations unnecessary. For example, suppose the feeder spreader spaces the wires 6 inches and the conductors are No. 12 B & S. The ordinate of the curve for No. 12 wire with 6-inch spacing is 600 ohms, which is the line impedance. The curves show that the line impedance goes down as we reduce the spacing or increase the conductor diameter. Now to prevent mismatching loss, we ought to have a 75-ohm line to connect to our 75-ohm doublet; but the curves indicate that we are to be disappointed in this respect. Half-inch copper tubing will bring the

impedance down to a minimum of 160 ohms. If No. 10 wire is used and the spacing made 2 inches, which is about the practical minimum for small wire sizes, the line impedance is 440 ohms or nearly 6 times the value sought! If such a line were connected directly to the doublet there would be a reflection loss of approximately 3 db due to mismatching at the junction of feeder and antenna. This corresponds to a power loss of 50 per cent, which certainly should not be taken without a struggle. And this reflection loss isn't the whole story, by any means, for the actual transmission losses in the line due to standing waves will be higher (for the same amount of transmitted power) than for the properly matched line.

There are three possible lines of attack on the problem of eliminating this reflection loss. First, by using twisted pair with solid dielectric between conductors the line impedance actually can be brought down to 75 ohms or thereabouts. Solid dielectric lines, however, are not very inviting because of inevitable losses in the dielectric, and certainly some of the gain acquired in matching at the antenna will be offset by increased line loss.

Secondly, the feeder length might be made exactly one-half wavelength or some multiple of a half wave, which, due to the standing wave on the line, would make the input impedance of the line appear to be 75 ohms regardless of the actual characteristic impedance. This type of line, however, is not working at best efficiency and the actual power lost in the line is considerably higher than would be the case if matching to the characteristic impedance was carried out at the terminals. The necessity for making the line length an integral multiple of a half wavelength is a serious disadvantage, for if the physical distance between antenna and transmitter should happen to require only a few feet more than a half-wave multiple, there will be nearly a half-wavelength of feeder, or equivalent loading, serving no useful purpose except to build up the line to the proper electrical length.

Last—but by no means least—we can perform some sort of impedance transformation which will allow us to work the line at best efficiency, with impedances matched throughout and no limitations on line length. What is wanted, in effect, is a sort of impedance-matching transformer to couple a line of 500 ohms or so to an antenna impedance of 75 ohms. The problem is something like that of designing a transformer to couple the output of an audio line to a loud-speaker load, except that the use of radio frequency complicates the task, especially when it is considered that the coupling device will be hanging up in the air at the end of the transmission line.

A simple inductive form of r.f. transformer, or autotransformer, has been used for this purpose,

but it is a practical impossibility to attain anything like the ideal coupling which is essential to efficient transformer action. Fig. 2 shows the idea. A tuned circuit arrangement is considerably better, as in Fig. 3, but adjustments are rather critical and the construction and suspension of

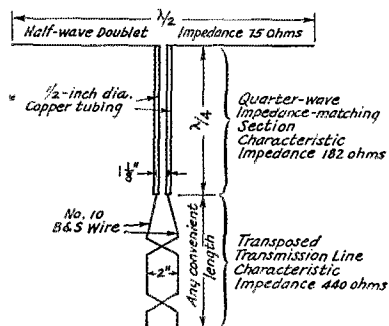

FIG. 5—A TYPICAL FEEDER SYSTEM USING A QUARTER-WAVE MATCHING SECTION
The dimensions hold only for a 440-ohm line.

efficient inductances capable of carrying high currents is not particularly simple. Then too, the circuit elements must be protected against adverse weather conditions, which likewise presents some difficulties. At high frequencies, the efficiency of both coupling schemes is very low.

Let us digress for a moment and consider just what we mean by *impedance*. Impedance is nothing more or less than the ratio of voltage to current in the circuit. If the impedance at the center of the doublet is 75 ohms, then the ratio of voltage to current here is 75. Stated another way, the voltage is 75 times the current in magnitude. But at other points on the antenna, the voltage-current relations are different due to the presence of standing waves, and hence there is a point-to-point variation in impedance along the antenna. By attaching the feeder wires to other points on the antenna it should be possible to locate an impedance which matches that of the line. This is the case and a method of designing the "Y" connection was described in *QST* for December, 1930. It should be noted that the dimensions given therein are intended only for 600-ohm transmission lines, although the location of the tapping points for lines of other impedances can be determined experimentally; the points will probably lie rather close to those determined by the method in the above article. An interesting point in connection with this method is the fact that the impedance of the feed wires where they are connected to the antenna is considerably greater than that of the transmission line, due to the greater spacing of the conductors. However, since the spacing of the branched wires is the same as that of the transmission line at the junction point, the impedances are perfectly matched throughout. A *gradual* change of line spacing is perfectly per-

missible and such lines have different characteristic impedances at the two ends.

The branched wires of the "Y" system are too widely separated for complete cancellation to occur in the "Y" and hence these branched wires may be responsible for appreciable radiation. The antenna radiation pattern may be somewhat modified. The system, however, has the advantage of simplicity.

THE QUARTER-WAVE SECTION TRANSFORMER

A section of line a quarter-wavelength long acts as a transformer and such quarter-wave sections have been used for some time by the Bell Telephone Laboratories to match antenna arrays to the main transmission line. No one, however, seems to have described its application to the feeder system of the center-fed doublet, where it

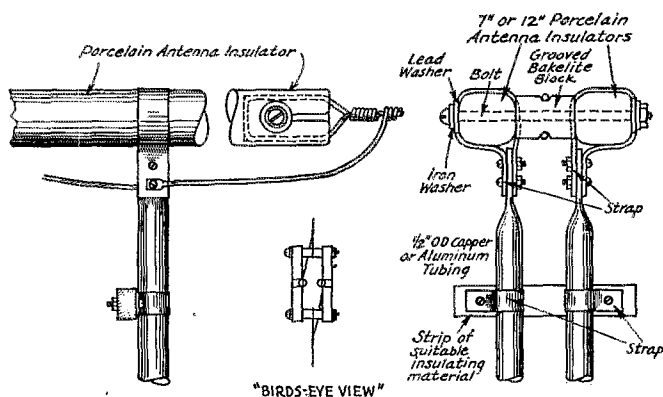

FIG. 6—MECHANICAL ARRANGEMENT FOR THE ANTENNA TERMINAL OF THE QUARTER-WAVE SECTION

admirably fulfills the requirements of an ideal antenna-transmission line system. The antenna performs in true doublet fashion; there is practically no radiation from the line which operates near maximum efficiency; the line can be any length whatever just as long as it is more than a quarter wavelength (and any good horizontal antenna should be at least that high above ground in the higher-frequency amateur bands); impedances are matched throughout and there are no standing waves on the orthodox part of the line.

The theory involved is very brief. Referring to Fig. 4, the impedance Z_L looking into a quarter wave line of characteristic impedance Z_0 when terminated by an impedance Z_A is:

$$Z_L = \frac{Z_0^2}{Z_A}$$

Similarly, the impedance at the other end when

terminated by Z_L is:

$$Z_A = \frac{Z_0^2}{Z_L}$$

Thus, to match two impedances Z_A and Z_L , it is only necessary to insert a quarter-wave section of characteristic impedance, $Z_0 = \sqrt{Z_A Z_L}$. Now, the impedance Z_A can be the antenna impedance, which is approximately 75 ohms for the half-wave doublet, and Z_L can be the characteristic impedance of a transmission line connecting the quarter-wave section to the transmitter.

The success of the idea depends on the feasibility of building a quarter-wave section of the required characteristic impedance. Since it is somewhat more difficult to construct very low impedance lines, because of the close spacing and large conductor diameter necessary, the scheme should be examined for the lowest practicable line impedance which is to be matched to the antenna.

No. 10 B & S wire, spaced two inches, results in a transmission line impedance of 440 ohms. The characteristic impedance of the quarter-wave section to match the 75-ohm antenna will be:

$$Z_0 = \sqrt{75 \times 440} = 182 \text{ ohms.}$$

A glance at Fig. 1 shows that we cannot hope to make a 182-ohm line of ordinary size wire.

And since the quarter-wave section will be up in the air, it ought to be reasonably light in weight. Still, we know that the way to get low line-impedance is through the use of large diameter conductors. Copper tubing will probably answer both size and weight requirements, with aluminum having less weight, and the curve for half-inch tubing shows the desired impedance with about $1\frac{3}{8}$ -inch spacing.

The line-impedance formula probably isn't highly accurate for close spacing because the proximity of the conductors will tend to crowd the current to one side of the conductor and this changes the line constants somewhat. The difference, however, will not seriously affect the practical working of the system. The final result of our calculations is the system shown in Fig. 5.

The reader should bear in mind that the conductor separation of $1\frac{3}{8}$ inches for the q.-w. section holds only for use with 440-ohm transmission lines. To save the labor of computations on the reader's part, Table I has been prepared (on the

assumption that half-inch tubing will be used in the quarter-wave section), indicating the proper center-to-center spacing of the tubing to match main transmission lines of common sizes of wire with either 2-inch or 6-inch spacing. For example, suppose that the main transmission line connecting the quarter-wave section with the transmitter is of No. 14 wire with 2-inch spacing. The table

TABLE I		
Antenna Wire Size (B & S)	Center-to-center Separation of Quarter-wave Section (1/2-in. tubing)	
	Line Spacing 2"	Line spacing 6"
No. 10	1 1/8"	1 3/4"
No. 12	1 3/8"	1 7/8"
No. 14	1 1/2"	1 3/4"

Length in feet of the quarter-wave tubing section will be nearly an actual quarter-wavelength for the frequency of operation.

Length in feet = $\frac{3.28\lambda}{4}$, λ being the wavelength in meters, or,

length in feet = $\frac{246}{f_{mc}}$, where f_{mc} is the frequency in megacycles (thousands of kilocycles).

For a 60-mc. (5-meter) system the tubing section would be $\frac{246}{60} = 4.1$ feet long.

The doublet antenna length (half-wave) would be calculated by the usual formulas, as given in the Handbook.

shows that the quarter-wave tubing should be 1 1/4 inches between centers.

MECHANICAL CONSTRUCTION

Undoubtedly by this time the reader is wondering by what miracle the quarter-wave section is to be suspended from the center of the doublet. It's not as difficult as might appear at first blush. Fig. 6 shows one practical method and modifications will unquestionably occur to the mechanically-minded amateur. The method shown involves flattening the ends of the tubing which are bolted to straps or clamps supported on 7-inch porcelain insulators of high tensile strength. The tubes are clamped firmly to insulating strips located at about two-foot intervals. The strips may be made of impregnated wood or Bakelite and tubing separation would be according to the data in Table I. In the higher frequency bands (5 and 10 meters), the weight of the entire feeder system probably can be carried by the antenna wires themselves. Other arrangements for relieving the antenna of the weight would be advisable at lower frequencies. A short mast, running to the bottom of the quarter-wave section, would answer the purpose.

At 5 meters the quarter-wave system is ideal, for the doublet antenna can be formed by simply bending the tubing at right angles. The whole system could be self-supporting and would require no antenna insulators. For portable work, the structure could be joined so as to occupy small space when out of commission. The transmitting end of the quarter wave feeder might well be arranged to plug into suitable receptacles in the top of the case which houses the equipment.

It is believed that the suggestions outlined in this article open up new fields for the transmitting experimenter, and the writers feel confident that activity along these lines will more than repay the effort expended.

Bibliography

- "Matching the Transmission Line to the Antenna," Roberts, *QST*, Jan., 1928.
- "The Doublet Antenna," Houldson, *QST*, December, 1930.
- "Transmission Line Feed for Short-Wave Antennas," McLean, *QST*, October, 1932.
- "Twisted Pair Feeders for the Transmitting Antenna," Grammer, *QST*, July, 1933.
- "The Tool-Box 56-mc. Transceiver," Leonard and Hadlock, *QST*, August, 1933.
- The Radio Amateur's Handbook*, 10th Edition, Chapter Twelve.
- "The Conduction of High-Frequency Oscillatory Energy," Roosenstein, *Proc. I. R. E.*, October, 1931.
- "Transmission Lines for Short-Wave Radio Systems," Sterba and Feldman, *Proc. I. R. E.*, July, 1932.

A New Handbook

We feel like celebrating!

As we write this we are just about completing the job of producing an eleventh edition of the *Handbook*. For three months or more the Headquarters staff has been doing work on it—in as much time as could be spared from other duties. For the past month the pressure has been increasing because we had to have the book ready by January 1st. Now, with a final soaking of midnight oil and a final spurt on the part of all concerned, it's ready for the printer.

It seems to us that the new edition will be a hot number. Probably more time has been spent on it than on any other edition except the first. So great have been the changes in technique during 1933 that almost all the technical material has had to be re-written and re-illustrated. Several of the chapters are brand new from stem to stern. Nothing was left in the book unless it could lay claim to being the last word in technique or operating practice.

Anyway, the eleventh edition is off the hook. We hope you'll like it.

A Convertible Push-Pull Oscillator or Amplifier

By R. B. Parmenter, W9PLM*

IN THIS day of high-power multi-stage amateur transmitters there is still need for a comparatively simple, inexpensive and medium-power unit; one which can be put in service in a few minutes' time and used as an auxiliary transmitter when the high-power rig is off the air. High-power transmitters in general are more inclined to fail than their little brothers, and the up-to-date station should be equipped to get on the air quickly in such cases. The ham with the lean pocketbook also finds an inexpensive and simple oscillator unit useful — and particularly so when this same oscillator may be later converted to a neutralized amplifier without making any circuit changes other than supplying r.f. to the grids and going through the neutralizing process.

All of the various oscillator circuits are capable of giving good note and there is but little to choose between them. But when a set is to be used both as a self-excited oscillator and a neutralized amplifier there is some basis for calling one circuit better than another — especially if the minimum number of parts is to be used. For example, the old reliable tuned-grid tuned-plate oscillator is not very well suited for this job because the neutralizing condensers with which it would have to be equipped could not “double” as something else for self-excited operation. On the other hand, a push-pull Hartley oscillator may be used to better advantage as it requires but one coil and the same variable condensers may serve the double purpose of neutralizing and as grid condensers. And there is an additional advantage — by making the grid condensers variable the bothersome taps on the coil may be done away with. By varying the capacity of these condensers it is possible to control the excitation when the circuit is used as an oscillator; and by merely supplying the grids with r.f. and using the same condensers for neutralizing we have a neutralized amplifier.

With these considerations in mind, the Hartley

**W. E. H. A. S., the Courier-Journal and Louisville Times, Louisville, Ky.*

circuit was used originally in the combination amplifier-oscillator unit described here. Power output was good, but it was difficult to keep the signal free from modulation on the 14-mc. band, and after some experimenting the circuit was changed to Colpitts. The difference between the two circuits is simply in the center-tap connections to the tank condenser and coil. In the original set-up, the rotor of the split-stator tuning condenser was left free and the plate-feed tap at

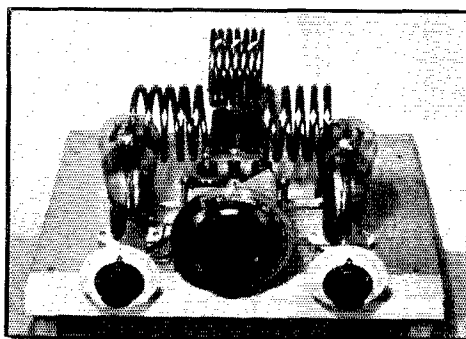

FRONT VIEW OF COMBINATION AMPLIFIER OSCILLATOR SHOWING THE SCALES ON THE GRID CONDENSERS AND THE POSITION OF THE SOCKETS AND COILS

the center of the coil was grounded to the filaments through a by-pass condenser. Since the feedback in this case is magnetic the circuit is a push-pull Hartley. Now if the rotor plates are grounded to the filament center-tap and the plates fed at the same tap on the tank coil through an r.f. choke, the feedback is capacitive and we have a Colpitts oscillator. This circuit arrangement is preferable to the first because grounding the rotor plates provides

a low-impedance by-pass for even harmonic voltages developed at the plates, and the even harmonic output is therefore reduced considerably. Using this arrangement it was possible to get rid of all a.c. modulation on all three bands.

One other feature of the layout described here worth consideration is the method of coupling to the antenna or feeders. This is done by splitting the tank coil at the center — thus making it into two similar coils — and spacing them so that the antenna coil may be coupled between them. This is a decided advantage over coupling at the two ends of a push-pull circuit, because the voltage is high at the ends and this results in capacitive as well as magnetic coupling. Although this may perhaps be tolerated in an amplifier (except for harmonic radiation) where swinging feeders do not affect the frequency, unwanted capacity coupling to an oscillator may destroy its stability. If capacity coupling is absent, the antenna may be coupled more closely — result, more output. Even when the feeders swing badly it is possible to get much more output and still have the frequency stay put. By coupling at a point of low

r.f. voltage less reaction takes place and better efficiency results. The same is true of an amplifier — one should always couple to the cold end of the circuit. Instead of less output there will actually be more — and with less input to the tubes. The same type of coupling could be secured by using a single tank coil and putting a coupling coil of larger diameter around it at the center. The difficulty with this arrangement is that only one

antenna coupling coil are mounted $1\frac{1}{2}$ inches apart and are fitted with two brass "L" pieces to which the ends of the coupling coil are bolted. Elastic stop nuts are used on the bolts to give enough tension to hold the coupling coil in any position. In addition a piece of felt should be pulled between the turns of the coupling coil to prevent it from vibrating and thus modulating the note. Two pieces of Bakelite might also be fastened across the two leads of the coupling coil to give additional strength and prevent movement.

The stand-off insulators which carry each section of the tank coil are mounted $2\frac{1}{2}$ inches apart, the two inside insulators being placed two inches apart to allow room for the coupling coil to fit between them. A short length of $\frac{1}{2}$ -inch copper strip is used to connect the two halves of the tank coil; a heavy connector should be used here because it is part of the tank circuit. The plate r.f. choke is mounted underneath this connecting strip. All by-pass condensers are under the base, as is most of the wiring. Since the wiring under the base is only a few inches from the tank coils, care should be taken not to run any long leads where they would be likely to pick up r.f. The wiring from the variable grid condensers should be as short and as direct as possible and should be kept clear of the a.c. filament wiring or some modulation may be picked up from this source.

The tank coils must all be wound in the same direction, otherwise their fields will buck each other. The direction of winding of the antenna coil does not matter.

TUNING CONSIDERATIONS

So much has been said on the subject of stabilizing self-excited oscillators that the subject probably is more than familiar to most amateurs. However, we repeat again — plenty of tank capacity is necessary. Probably the easiest way is to use just enough capacity to keep the drift down to whatever is considered workable. If the tank circuit has too much C there will be some drift caused by heating of the coil itself which will offset to some extent the good effects of the high C tank in the circuit. Also, the efficiency is better with lower C , particularly on the higher frequency bands. A monitor is still the only sure means of knowing what is going on while working on a transmitter, and it should be consulted whenever the adjustments are changed. When testing for frequency drift it is desirable to use a dummy load, because the drift will always be less with a load than with the oscillator running without load.

The input of a self-excited oscillator should be kept down to reasonable limits. Never operate the set with the tube plates showing color, as heating of such magnitude always causes a rapid drift in frequency. Plenty of bias (obtained with a high-resistance grid leak) should be used and the tubes kept cool.

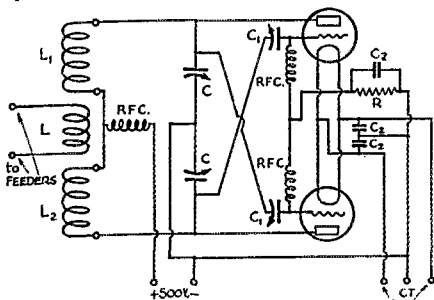

FIG. 1 — THE OSCILLATOR CIRCUIT

C — 1000- μ fd. split stator two 500- μ fd. sections in series making 250 μ fd. as used (Cardwell 156B).

C_1 — 50- μ fd. grid condensers (National SE-50).

C_2 — 0.01- μ fd by-pass condensers.

L — Antenna coupling coil; 7 turns 3/16-inch copper tubing $2\frac{1}{2}$ inches in diameter.

L_1 and L_2 — Tank coils, both identical and wound in the same direction. 3.5-mc. coils each 10 turns of 3/16" copper tubing; 7-mc. coils each 5 turns of 1/4-inch tubing; 14-mc. coils each 3 turns of 1/4-inch tubing. All tank coils are $2\frac{1}{2}$ inches long and $2\frac{1}{2}$ inches in diameter.

R — 7000-ohm grid leak, 25-watt size.

degree of coupling can be had unless the coupling coil is tapped, in which case it becomes rather awkward to vary the coupling smoothly and in small steps.

CIRCUIT DETAILS

The final circuit of the combination oscillator and amplifier is shown in Fig. 1. Following the usual procedure, all parts are mounted on a $11\frac{1}{2}$ -inch by 14-inch baseboard, on the bottom of which are $1\frac{1}{2}$ -inch-high cross pieces which make room for parts fastened beneath the base. The tube sockets are placed at each side of the tuning condenser with the grid and plate terminals facing the condenser terminals; this permits short leads and at the same time crosses the filament wiring, a device which is helpful in preventing a.c. modulation from this source.

The two variable grid condensers are mounted immediately in front of each tube. Instead of crossing the plate leads from the tube sockets to opposite ends of the tank coil, the grids are crossed right at the terminals of the tuning condenser (terminals are available on both sides of the condenser). This makes all wiring short and direct. The tank circuit is arranged symmetrically behind the tuning condenser and is wired to the condenser with 3/16-inch copper tubing.

The two stand-off insulators which hold the

To get a smooth d.c. note and one which keys properly the power supply should be well filtered and have an input choke before the filter to improve the voltage regulation. Poor regulation or insufficient excitation are the chief causes of poor keying. Too tight coupling to the antenna will also give poor keying characteristics, as a little experimenting will easily prove.

To avoid the possibility of a.c. modulation the power supply should not be placed too near the oscillator. Not only mechanical vibration but a.c. picked up by the grids of the oscillator from

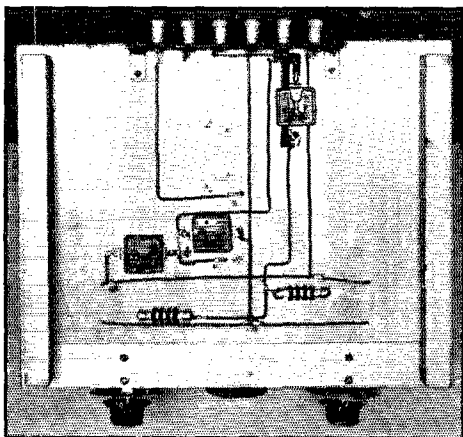

VIEW OF SUB-BASE WIRING SHOWING THE FILAMENT BY-PASS CONDENSERS, GRID LEAK AND BY-PASS CONDENSER AND THE TWO SMALL SECTIONAL WOUND GRID R.F. CHOKES

The terminals are at the back of the set, one being a spare for the key connections.

stray fields will put a decided ripple on the note. In our particular case the power supply was moved from the immediate vicinity of the transmitter to a distance of about three feet and an annoying modulation stopped at once, well illustrating this point. Some modulation even may be picked up by the grids from house wiring which is not in BX cable. This may be compared to a receiver which is built in the open and is unshielded — even though it may be entirely battery-operated there can still be some a.c. hum due to stray fields. Consequently, keep the grid circuit wiring as short as possible and away from any points where modulation might be picked up.

Another source of modulation on an otherwise pure d.c. note is a.c. picked up from the antenna through the feed line. If the feeders or wiring of the antenna circuit are run near the grids, plenty of hum can be picked up. Keep the antenna leads on the other side of the rig. In a test, running one feeder wire on each side of the transmitter near the grid condensers and then back to the antenna coupling coil introduced enough hum to ruin the note. On bringing the feeders in from the back of the set the note was d.c. once more. Evidently the

feeders themselves can be a source of a.c. sufficient to spoil an otherwise good note.

In some cases filament by-pass condensers do more harm than good. Different sizes should be tried because such troubles as they may cause generally are due to resonance effects when the wiring and some particular size of by-pass form a tuned loop.

TUNING STATISTICS

After the transmitter is all wired, the coils made and ready to be used, the first necessity is to tune it inside the band. With the particular tank capacity used and the coil sizes given, the 3.5-mc. band is covered with the condenser almost to maximum capacity, the 7-mc. band with the condenser approximately three-quarters of the way in, and the 14-mc. band with the condenser set at one-third capacity. The variable grid condensers then may be adjusted to get the proper excitation. Scales made from white cardboard are fastened to the lock nuts on the condenser shafts and make it possible to return accurately to previous settings. The scales are marked from one to ten, with ten falling at the maximum-capacity end. About 5 on this scale gave the proper excitation for all of the bands. By running more excitation slightly more output is obtained with some sacrifice in the quality of the note. This adjustment should be made carefully with each particular transmitter because correct adjustment makes the difference between a poor note or a good one.

With a 550-volt power supply, slightly more than 30 watts output can be obtained on the 3.5- and 7-mc. bands and about 30 watts on the 14-mc. band — with a steady d.c. note on all of them.

AS AN AMPLIFIER

To convert the unit to a neutralized push-pull amplifier a pair of 100- μ fd. condensers should be connected to the grids of the tubes and the r.f. excitation fed in the usual way. The variable grid condensers now act as neutralizing capacities, with complete neutralization being obtained with the condensers almost all the way out. This point corresponds to the point at which the unit stops oscillating when it is used as an oscillator. Used as an amplifier, the unit makes a good final stage for a transmitter of moderate power. It may be advisable to use 45 or 90 volts of battery bias in series with the grid leak, R, when the unit is separately excited.

Strays

M.I.T. Airplane Tests

Delay in the receipt of confirmation of many QSO's has prevented the completion of the M.I.T. test report in time for publication in this issue. It is hoped that the story will appear in the February number.

It's in the Blood!

By J. C. (Felix) Johnson, W5LS*

IT ALL started when I was a collitch-boy learnin' to be an English prof. I had a coupla fifties perking along nice as you please and everything was rosy. Even had a QSA5 YL that was so interested in ham radio that she learned the code, or started to. But about the time she got down to C the storm broke; she started resonatin' with some competition named Thomas who wrote poetry and spent his extra dough on red ties and nut sundaes instead of filter condensers and so the YL ups and reads the Riot Act to li'l Felix in seven different languages, includin' English. It seemed 'twas either her or radio for me, but not both. . . .

Well, I kinda missed 'er at that, but, thinks I, what's a mere YL when there's always a chance of puttin' a sig into the cans of an Aussie and Zedder, so fer long weeks I poured the soup into the fifties, but no luck at all. And then one day Soupy Groves—W5NW to you—comes breezin' over and with his customary shyness gently breaks the news that he's wk'd a coupla Zedders and an Aussie with his 202.

That was the last straw! I was through with radio!

Some several years later finds me as far from radio as it's possible to get, bein' hired by the United Rubber to operate a half kw. sync shore station stuck up the Amazon about three inches further than the map goes. But bein' one-third of the white population of Acapulpa ain't so bad, as I'm quite the hot potater as a representative of the U. S. and am also a full-fledged U. S. consul, which means I've gotta bail out the U. S. sailors that get judged for bein' off-frequency with some of the *Jefe's* (Mayor's) OW's, which are about as numerous as clothes-line harmonics on 28 mc. Not a bad life, until . . .

One a.m. I'm sweatin' over some quenched gaps that my noble assistant Juan Jose Alvarez Gomez de Vacua y Nollo has poured some coffee into when I hears a raspy voice I'd heard somewhere before:

"That third-rate sawmill sounds exactly like it looks; lousy, spelled with two 'z's'."

"Yeah?" says I, placin' the voice without even lookin' up.

"Yeah! Reminds me of your manners, Felix me lad."

I looked up. Sure 'nuf it was Soupy himself, only he looked scrawnier'n ever with a duffle bag in one hand, a SW receiver under one arm, and a parrot perched on his operator's cap.

"Meet the Modulator," he says, pointin' in the direction of the bird. In response the bird

flaps his wings and squawks out a coupla CQ's, every other one of which is punctuated with some Spanish word you can't find in the dictionary.

"Well, here we are," sez Soupy, tossin' Modu-



lator up on the loadin' coils, puttin' both his receiver and his feet on top of the operatin' table, and carefully fishin' a 50-watt jug outta his coat pocket. "Garçon, take my luggage down to El Senor's house (pointin' at me), get somebody up here with a long tall one for me, a beer for the parrot . . . and oh yes, what'll you have?" he asks, turning to me.

"A meat axe," I tell him gently.

"Bring El Senor some milk of magnesia," he translates.

"Now that you've kinda taken charge," says I, "please tell me some of the dope. I suppose you're the Sparks from that crummy hooker that pulled out this a.m. for Trinidad, and that you got left ashore account of the tub's pullin' out ahead of sked. Seems I've heard that story before. . . ."

"If you'll kick that circuit-breaker that operates your leathery tongue, I'll tell you. To begin with, you're all wrong."

"I've heard that one before, too," I admits.

"I was op on WQOE. The past tense, son—"

"Oh! So you're the lid who told me my sendin' sounded like Hebrew punctuation marks!"

"Let it pass—let it pass. As I was sayin' I got tired of gettin' compass bearings for the skipper after bankin' hours and stealin' press from WNU, so I decides that you and I are gonna build us a ham station that'll knock your eyes out."

"And I spose you intend to goldbrick on me in the meantime."

"Harsh words, son, but they convey the

* 215B Humble Bldg., Houston, Texas.

meanin' . . . an' lookit this fifty-watter! The other one in WQOE was kinda soft, or I'd've hauled it along, too. Ain't it a dilly?"

So it came to pass that Soupy was installed as second op, first assistant consul, and chief worry for the *Jefe*—it not doin' the *Jefe* much good to jug Soupy as he was now on the consul staff and could get himself outta jail. And pretty soon we had station "FX" working strong—mebbe you've heard us—sure sounded FB, so we've been told. 'Course it was a bit irregular to work SW, but when the local Chief Shot of Radio Com-

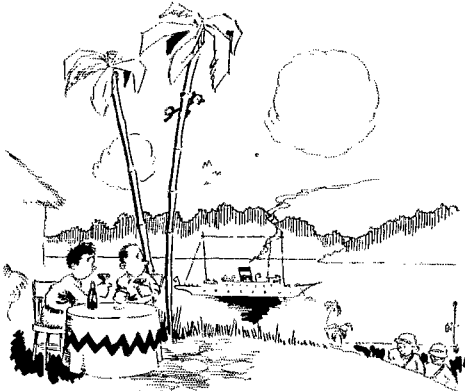

"YOU'D KNOW THAT THIS IS SOME CRUMMY RESEARCH OUTFIT GOIN' UP THE RIVER TO STUDY BUGS—"

munications would come around we'd explain it was a new invention to distill *Ron Veijo*, an' then he'd take off his shoes an' all hands, including the parrot, would hoist a few and everybody'd go home happy.

One day when Soupy and I was down on the *Avenita* gassin' at the gals through the bottoms of bottles (they look better that way) a spiffy white boat came up the river and anchored in front of us, and a small boat is lowered and puts out for shore.

"Looks like a yacht," says I, idly.

"If you'd 'a read the news from WNU last week, you'd know. . . ."

"Oh, do you read the radio code?" I asks him.

". . . you'd know," continues Soupy, ignorin' me as usual, "that this is some crummy research outfit goin' up the river to study bugs, and to explore some untamed upriver stuff where the foot of white man has never touched, and that they gotta hot radio on board with regular skeds to be fixed up with some outfit in the U.S.A. to keep the home papers fulla news right outta the jungle."

About this time two geezers breeze up to us from the small boat which has landed. These guys are dressed like all sure-enough tropical explorers are supposed to be dressed if you believe what you see in the Satevepost: cork "lion-

tamers" hats, khaki shirts, shorts (the kind skeeters and flies adore) and, of course, cameras across their backs. One of these eggs—a tall, jib-nosed, fan-eared jobbie—sidles up and pokes his duke out.

"I'm Jasper Q. Sideband, radioman for this expedition, and this (pointin' to a fat pinkish mug who hasn't got his breath yet from climbin' the hill) is Dr. Schwabstein. We're from the M.S. *Palooka*; you have doubtless been informed of our expected arrival. We are in search of the American consul, for whom we have several letters."

"I'm the consul," says I, aimin' to be cordial. "Welcome to our fair city."

"Sure," says Soupy, "squat and bathe your whiskers in some of this Bacchus brew."

But Jasper kinda sniffs and declines sorta haughty-like and says they have important work to do and if we'll kindly accompany 'em aboard they'll outline their projeck and tell us where we can assist 'em in matters of native aid, etc. I looks at Soupy and he looks at me, and we both sorta sigh, but fellow-Americans is fellow-Americans, so we go out to the boat. On the way our new boyfriend mentions this 'n' that about life in the tropics, etc., but the general thought through the whole gab is that a certain Mr. Jasper Sideband and the word "radio" are synonymous terms and should be mentioned in the same breath.

"By the way," says he, "do you know much about short-wave radio?"

"Not much," I answers, truthfully.

It turns out this rig of his looks like it mighta been a good ham set once 'til somebody sprung the boobyhatch bolts 'n' let this Napoleon of the Heavysides scramble a few patented cabbage-peelin' machines and doorknob displays with it. But according to him it'll do everything but answer your wedding invitations 'n' scratch your back when you take a bath (if and when). He was still in the throes of explaining how you changed frequency when Soupy and I drifted back to the *Avenita* to gargle a few and restore our good opinion of the locality.

It took 'em about four days to get three lousy little outboard boats started upriver with the radio junk and such other truck as we couldn't persuade 'em to feed the goats. And when the last boatload of cork helmets and patented cook-stoves hove outta sight, Soupy and I heaved a sigh of relief and worked a coupla G's just to sort of get the taste outta our mouths.

Well, we forgot 'em and supposed they were firing lurid bulletins from the jungles straight to the States when one mornin' we hear KXXX just above the 40-meter band callin' his head off for our friends and from the sound of things they'd been doin' it without results for about three-four days. They might just as well have put it on a tape and gone to visit their Aunt Hattie in

(Continued on page 65)

Improving the Performance of the Neutralized Power Amplifier

Permanent Neutralization—Higher Efficiency—Harmonic Suppression

By George Grammer, Assistant Technical Editor

EVER since those early days when "short waves" meant 100 meters, stray capacities, especially those inherent in tubes themselves, have been something to battle with. In the light of our present technique, however, such old-time capacity-reducing tactics as taking the bases off tubes and soldering the tuned-circuit right to the lead wires seem absurdities of the highest order. In these days we treat such stray capacities with utter nonchalance even in 56-mc. sets. Yet unwanted capacities, disregarded in oscillators where we intentionally shunt the coils with large condensers to get the stabilizing effect of high- C , present a considerable problem in the operation of multistage transmitters at frequencies as low as 14 mc. Especially is this true when tubes such as those in the "50-watter" class are used. Deservedly popular despite the fact that their basic design dates back to the 200-meter era, tubes of this type probably cause their owners more grief than any others when used as neutralized amplifiers in conventional circuits on 14 megacycles. Many of the troubles can be traced directly to high inter-electrode capacities; most of the others come from the same source, although sometimes through devious routes.

There seems to be a sharp dividing line somewhere between the 7- and 14-mc. bands that keeps a tube from doing as good a job at 14 mc. in ordinary circuits as it does at 7 mc. and lower. One reason is the fact that the losses become greater as the frequency is raised. But another and just as important part can be attributed to poorer circuits—small L/C ratios when we need them high—which are directly chargeable to those neglected stray capacities.

Consider for a moment the garden variety of amplifier coupling circuit shown in Fig. 1-A. Here we have a driver tube, V_1 , coupled through a condenser to the grid of an amplifier tube, V_2 . The equivalent of that circuit, insofar as it affects the $L-C$ combination in the plate circuit of V_1 , is shown at the right. In addition to the actual tuning capacity, C , the tank is shunted by the plate-filament capacity of V_1 , the grid-filament capacity of V_2 , and an unknown capacity X which includes the shunting effect of the neutralizing condenser plus all the other stray ca-

pacities in the circuit. The total of all these is far from negligible; 50 $\mu\text{fd.}$ is a low minimum, and 100 $\mu\text{fd.}$ or more is not unusual. In the face of such conditions as these, the mere use of a tank condenser C of low maximum capacity does not guarantee a high $L-C$ ratio. Such a high minimum capacity may pass unnoticed on 3.5 or 7 mc., but it becomes of importance at 14 mc. and is intolerable at anything higher.

INTERSTAGE COUPLING

A step in the right direction is to drop the capacity coupling between stages and use induc-

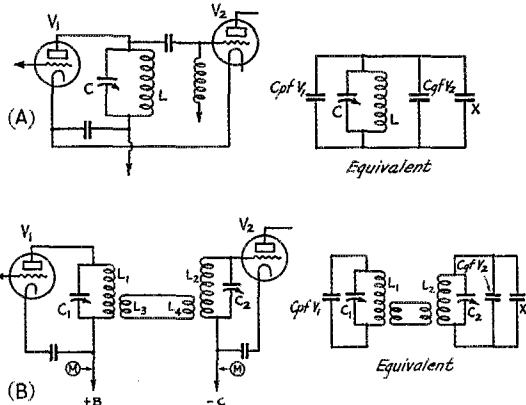

FIG. 1—CAPACITIVE AND LINK COUPLING BETWEEN DRIVER AND AMPLIFIER, WITH THEIR EQUIVALENT CIRCUITS TO SHOW STRAY CAPACITIES SHUNTING THE TANK

tive coupling. This confines the stray capacities associated with each tube to its own circuit, and does not add them all up across one diminutive coil. Of course an extra coil and tuning condenser are needed, but the advantages of the arrangement far outweigh the slight inconvenience resulting from the addition of another control. Straight inductive coupling is somewhat messy to handle, however, because it is necessary to provide a means for varying the coupling between the two coils to control excitation and loading. A logical step, therefore, is to use link coupling, as shown in Fig. 1-B, which not only accomplishes the same result but also gives more flexibility.¹ When this scheme has been adopted

¹ Experimenters' Section, May and June, 1933, *QST*'s.

we secure these desirable results: The shunting capacities are reduced; the two stages may be separated by a considerable distance, since the line coupling the two circuits may be of any reasonable length; and the relations—or impedances—between the output circuit of the driver and the input circuit of the amplifier can be adjusted correctly for maximum power transfer. This latter point is one of considerable importance. Proper coupling between tubes of different char-

acteristics is something of a problem, at its worst when a tube of high plate impedance is to be coupled to an amplifier tube of low grid impedance. The theoretical solution (with capacitive coupling) is to tap the grid lead at some point on the coil which gives the proper match; in practice it is more than likely that doing this will give rise to parasitic oscillation in the amplifier.² This can be circumvented by the compromise of using a small grid-coupling condenser with the tap taken directly from the hot end of the coil—but a loss of efficiency. The job can be done in A-1 shape by link coupling.

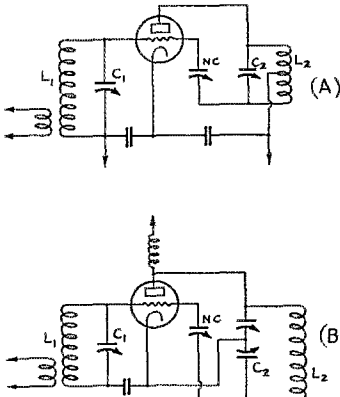

FIG. 2.—TWO WAYS OF OBTAINING NEUTRALIZING VOLTAGE FOR THE AMPLIFIER

The split-condenser circuit shown at B has certain advantages which are discussed in the text.

acteristics is something of a problem, at its worst when a tube of high plate impedance is to be coupled to an amplifier tube of low grid impedance. The theoretical solution (with capacitive coupling) is to tap the grid lead at some point on the coil which gives the proper match; in practice it is more than likely that doing this will give rise to parasitic oscillation in the amplifier.² This can be circumvented by the compromise of using a small grid-coupling condenser with the tap taken directly from the hot end of the coil—but a loss of efficiency. The job can be done in A-1 shape by link coupling.

ADJUSTING THE LINK CIRCUIT

It may be worth while to take a moment to explain how the coupling is adjusted in the arrangement shown at Fig. 1-B. The driver tank circuit, L_1C_1 , is first proportioned so that it tunes to the operating frequency, preferably with a low value of C_1 . The coupling coil should be wound on the same form as L_1 at the end opposite the plate terminal, using tight coupling. Three or four turns will be sufficient. Next, the tank circuit L_2C_2 should be made up, using the same dimensions as at L_1C_1 for a starter if nothing definite is known about the characteristics of the amplifier input circuit. Use three or four turns also for L_4 , which should be tightly coupled to the fila-

ment end of L_2 . Light the filament of the amplifier tube and connect in the "C" battery or grid leak, but leave off the plate voltage. Start up the driver and tune L_1C_1 to resonance, noting the driver plate current. Now tune C_2 , at the same time watching for a change in driver plate current; if L_2C_2 can be tuned to resonance the driver plate current will rise and then fall again as the tuning passes through the resonance point. If it is impossible to strike resonance on C_2 the stray shunting capacity is too high and the inductance of L_2 should be decreased, assuming that the two tank circuits were identical in the first place. The amplifier neutralizing condenser should be set at the proper point for neutralization if the amplifier has been operated previously; if not, it should be set at about the point which neutralization is to be expected; or if this is too speculative, at minimum capacity. A little juggling with the size of L_2 eventually will result in hitting resonance on C_2 . When this is done, neutralize the tube in the regular way, readjusting C_2 for resonance if the setting of the neutralizing condenser has to be changed. Should the neutralizing capacity increase considerably from its value during the first cut-and-try, it may be necessary to make further alterations to L_2 to keep the circuit L_2C_2 in resonance.

Once the tube is neutralized the coupling between the two stages can be adjusted for maximum transfer of power from the plate circuit of the driver to the grid circuit of the amplifier. To do this it is necessary to measure the rectified grid current in the amplifier stage. A milliammeter of suitable range (100 milliamperes full scale is convenient for nearly all tubes) should be connected in the bias lead. Adjust both C_1 and C_2 —the tuning of these two circuits is nearly independent—to obtain maximum grid current; then note the driver plate current. If the plate current is lower than normal, the two circuits are not coupled tightly enough; the remedy for this is to add a turn or two to L_4 . Conversely, if the plate current is too high, the coupling is too tight and a turn or two should be taken off L_4 . Adjust the coupling to obtain maximum amplifier grid current (for a given "C" voltage or grid leak resistor) consistent with the allowable plate input on the driver tube. For driver tubes operating at 500 volts or less the tanks L_1C_1 and L_2C_2 can be wound with fairly small wire—No. 22 or larger—on ordinary receiving coil forms; the losses will be low when the grid of the amplifier is taking power. The plug-in feature is handy if bands are to be changed frequently.

We should emphasize here that in adjusting excitation a grid meter is just as indispensable as a plate meter. The same meter, fitted out with plugs and jacks, can be made to do both jobs.

A BETTER NEUTRALIZING CIRCUIT

Isolating the driver and amplifier circuits is

² Grammer, "Circuits Within Circuits," June, 1933, QST.

certain to go a long way toward increasing the ease of handling the set and eradicating inter-stage parasitic oscillations, as well as decreasing stray capacities shunting the tuned circuit. Still more can be done, however.

In casting about for an amplifier circuit which could be neutralized once and then would stay neutralized even though different coils were put in when changing bands, the idea of tapping the tank tuning condenser instead of the coil presented itself. This arrangement should maintain a constant voltage ratio between the "plate" and "neutralizing" portions of the tank circuit regardless of the dimensions of the tank coil. Then by using parallel plate feed on the amplifier, the feed tap on the tank coil could be eliminated and only two coil connections would be required. To try out the scheme an experimental bread-board amplifier using the circuit of Fig. 2-B was rigged up. Fig. 2-A shows the ordinary neutralizing circuit for purposes of comparison. The connections in this particular layout could be changed readily from one circuit to the other to see what differences in performance, if any, were to be observed. The tube was a 203-A.

Several interesting things developed. The first effect was a very considerable decrease in the stray capacity shunting the grid tuned circuit, L_1C_1 , when the circuit of Fig. 2-B was used. A combination at L_1C_1 which would tune to resonance using Fig. 2-A was much too small when the circuit was shifted to 2-B; actually it was necessary to use twice as much inductance at L_1 to hit resonance, with the same setting of C_1 , when the circuit was changed to 2-B. That this reduction in shunting capacity was of some benefit was proved by the fact that the use of the larger inductance at L_1 increased the grid excitation and, in turn, the output of the amplifier. Of course in shifting between the two circuits the plate tank circuit, L_2C_2 , was left unchanged; the split-stator condenser, C_2 , simply served as a single-section affair in 2-A. The tap on L_2 in 2-A was adjusted so that neutralization was reached with practically the same setting of NC as with the split condenser in 2-B.

A second feature of interest was the comparative stability of the two circuits. Both gave all the indications of satisfactory neutralization—no r.f. in the tank circuit at resonance and no tendency to oscillate when in operation—yet when the excitation was shut off and the bias decreased so that the tube drew a plate current of 30 or 40 milliamperes, the circuit at 2-A would oscillate readily while that at 2-B could not be made to oscillate under any conditions. That this was no peculiarity of the particular tube used was proved by the fact that four other types of tubes behaved in exactly the same way. The amplifier was later converted to push-pull using a pair of 10's and the same thing happened; the tapped-coil circuit would oscillate while the split-con-

denser circuit would not. This was not entirely unexpected; previous experiments with a push-pull 2S-mc. amplifier had shown that an amplifier having a grounded-rotor split-stator condenser, with the plate voltage fed to the center of the tank coil through an r.f. choke, had much greater stability than the more common arrangement with the center of the coil grounded through a bypass condenser and the condenser rotor left floating. This, incidentally, does not apply alone to amplifiers; it has been found invariably that oscillators—especially push-pull oscillators—are considerably more stable, at the higher frequencies at least, with a grounded-rotor split-stator condenser than with grounded coil taps. Probably the reason is that it is much easier to get a good balance with a split condenser, which not only can be made accurately but is symmetrical with respect to both the circuit and ground. The advantages of this arrangement in oscillator circuits were pointed out in *QST* more than three years ago;³ that similar advantages were to be obtained in amplifier circuits does not seem to have been generally realized.

BETTER EFFICIENCY

Reduction of input capacity and increased stability were not the only effects observed, however. An entirely unforeseen development was a considerable increase in power output using the circuit of Fig. 2-B. Comparisons between 2-A and 2-B, keeping the same plate input on the amplifier tube and the same driver power, always resulted in a higher antenna current with the latter circuit, the increase being as much as 20 percent in some cases. Since a 20-percent increase in antenna current is a *power* increase of over 40%, evidently there is something here worth considering! Rechecking with several different types of tubes, some of them being designed especially for very high frequency work, invariably gave the same result.

A possible explanation of the increased power output resulting from the use of circuit 2-B can be found in the fact that harmonics are more effectively shorted out in this circuit than in 2-A. In the latter circuit, the harmonic components in the r.f. plate current must flow through the upper portion of L_2 to get back to the filament; since inductive reactance is proportional to frequency, this part of the coil offers twice as much reactance to the second harmonic as to the fundamental, three times as much to the third harmonic, and so on. This means, simply, that a fair load impedance is offered for developing harmonic power—useless power except insofar as it is radiated and causes interference on other frequencies, which makes it worse than useless. On the other hand, the reactance of the upper half of condenser C_2 in circuit 2-B is inversely propor-

³Lamb, "Advanced Transmitter Design," June, 1930, *QST*.

tional to the frequency, so that its reactance at the second harmonic is only half the reactance at the fundamental, the reactances at other harmonic frequencies decreasing in proportion to their numbers. As a result, the load impedance for harmonics is very low and little harmonic power is developed. This sort of tank circuit is, in fact, often used in high-power push-pull amplifiers—for instance, in transmitters in the broadcast band—when it is necessary to reduce harmonic radiation to the absolute minimum. Since power wasted in harmonics detracts from the total power output available from a given input, it seems reasonable to believe that harmonic suppression is the explanation of the increased efficiency. This is further borne out by the fact that in a push-pull amplifier the difference in power output between the two methods of splitting the tank circuit is almost negligible—in one representative amplifier the split-condenser circuit showed a power increase of three or four percent over the tapped-coil circuit. In the push-pull amplifier the second harmonic cancels out in both systems, so any improvement would have to result from elimination of the third and higher odd harmonics. Since the effects of these harmonics are small, the differences in performance between the two circuits also are small. But the split-condenser circuit for push-pull has plenty in its favor in the way of increased stability at very high frequencies.

As intimated at the beginning, these tests were carried out in the 14-mc. band, using a 203-A for most of the work and including several other types of tubes for comparative purposes. To make sure that the effects weren't wholly tied up with the frequency, the scene of operations was shifted to 7 mc. and the same procedure gone through once more—with the same results. Using the circuit suggested, a 203-A is just as easy to handle at 14 mc. as any other type of tube.

One interesting sidelight has been a comparison between the old reliable Type 10 and the other tubes used, these including the 203-A and the new 800, 830 and RK-18 types. Of course a single 10 will not handle as much power as any of the others, but a pair of them in push pull at 600 volts and 120 ma. can be compared directly to single tubes of the other types operating at the same plate voltage and current. The striking thing about such a comparison has been that in every single instance the other tubes have given more output than the 10's. A 203-A, for instance, gives 20 percent more output at that input, and requires less driving power to do it. One reason, at least, for the poor showing of the Type 10 tubes is the dielectric loss in the base; every one of several tubes tried showed blisters in the bakelite between the grid and plate pins after a little use. On the other hand, the 830, which has the same pin connections as the 10, was a good performer in the test circuit—but it has a ceramic base.

The operation of the 10 probably would be improved to an appreciable extent at high frequencies by substitution of a ceramic base for the commonly-used bakelite.

OPERATING CONSIDERATIONS

The split-condenser circuit has been found to do what originally was intended—the neutralization stays put when various plate tank coils are connected in for work on different bands. There is a possibility of loss of balance if stray capacity between the tank coil and various parts of the circuit is allowed to enter into the picture, however, so it is well to keep the coil a few inches away from other apparatus. Also, since the capacity ratio between the two condenser sections is likely to vary from its normal value when the condenser is set near minimum, the size of the tank coil should be adjusted so that resonance will be obtained with the tank condenser set at at least 30% of full capacity. If these two precautions are observed the neutralizing condenser can be set once and then forgotten.

The fixed-neutralization feature is also valuable when the amplifier is to be used as a doubler. One type of neutralization greatly improves the efficiency of a doubler⁴ because it adds regeneration at the second harmonic without going beyond the critical point at which the doubler would oscillate of its own accord. This circuit has been found to operate in a highly satisfactory manner doubling from 14 to 28 mc.—even when using a 203-A, supposedly inefficient at such high frequencies.

The efficiency of the amplifier with parallel feed will depend considerably upon the effectiveness of the r.f. choke. The small universal-wound chokes such as the National Type 100 introduce no apparent losses, and stand up well at plate voltages of 1000 or less. At higher voltages, where a choke of higher power-handling capabilities will be needed, special attention should be given to its construction. It will pay to experiment with different choke sizes at higher power. On the other hand, series feed may be used to do away with choke worries, in which case it will be necessary to introduce the plate voltage through a tap at the center of the tank coil. Do *not* ground the center of the coil through a by-pass condenser, and be sure that an r.f. choke of some sort is used in the plate supply lead.

PRACTICAL CIRCUITS

So far we have been talking generalities, principally for the benefit of those who already have transmitters which are susceptible to improvement. If a concrete amplifier circuit is wanted, Fig. 3 should give the necessary information. These circuits will be good for any type of three-element tube, and for all bands with suitable

⁴ Grammer, "More About Economical Crystal Control," November, 1931, *QST*.

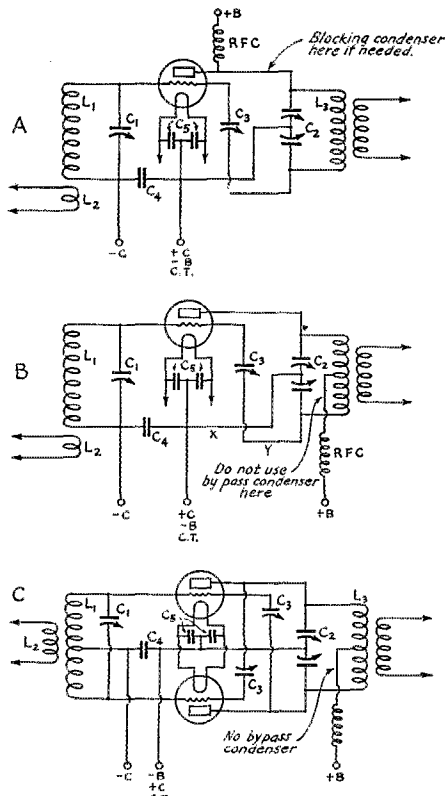

FIG. 3—THREE CIRCUITS USING A SPLIT-STATOR TANK CONDENSER FOR PERMANENT NEUTRALIZATION

The circuit at A represents the ultimate simplification; no plate blocking or by-pass condensers and only two connections to the coil. The tank and neutralizing condensers must have good insulation if high plate voltages are used. A blocking condenser inserted as shown will keep the d.c. voltage off the condensers.

Circuit B will avoid possible difficulties with the r.f. choke, which must be good in the parallel feed arrangement shown at A. In B almost any choke will do; its purpose is to avoid grounding the center of the tank coil through a low-impedance path and thus splitting the tank circuit into two parts. The plate lead should be clipped on the tank coil at about the center; its position is not critical nor will it affect the neutralization. In this circuit the d.c. voltage is again across the tuning and neutralizing condensers; the plate-spacing of these condensers must be adequate. Alternatively, blocking condensers may be inserted at X and Y to keep the d.c. off the condensers. The blocking condenser capacities should be large compared to the tuning and neutralizing capacities; 0.001 μ fd. or higher will be satisfactory.

The push-pull circuit at C has the same voltage limitations as B. To avoid the necessity for three blocking condensers it is advisable to use tuning and neutralizing condensers with adequate voltage ratings (at least twice the d.c. plate voltage).

Optimum values in the three circuits will depend upon the type of tube and the frequency. For 7 mc. and higher, C_2 should have a total capacity (both sections in series) of 50 or 100 μ fd. On lower frequencies a condenser with a total capacity of 250 μ fd. will permit the use of coils of reasonable size at L_1 . The grid tuning condenser, C_1 , can be 50 μ fd. maximum in almost all cases, since coils of large inductance can be wound conveniently with small wire and forms to work at L_1 . The grid by-pass condenser, C_4 , and the filament by-pass condensers, C_6 , should be 0.002 μ fd. or more. The neutralizing condenser requirements are discussed in the text. Coils must be adjusted according to the tuning capacity available.

choice of values. Regardless of the type of tube used, the only circuit element which is at all critical is the neutralizing condenser, C_3 ; its capacity must be right. For the 10 and 830 tubes, the neutralizing condenser should have a range from 5 to 15 μ fd. approximately; tubes of the 302-A, 211 and similar types, will require a neutralizing condenser having a maximum capacity of 25 μ fd.; the 852, RK-18, 800 and 825 types will take a condenser having a minimum of 2 μ fd. and a maximum of approximately 5 μ fd. Necessarily, the various condensers used must be capable of handling the voltages to be applied. It will be noticed that no plate blocking condenser is shown in Fig. 3-A, the plate spacing in the tuning condenser, C_2 , and neutralizing condenser, C_3 , being depended upon to withstand without breakdown the d.c. plate voltage plus the developed r.f. voltage. This will be satisfactory at voltages up to 1000 if transmitting or double-spaced condensers are used. In high-voltage circuits it would be safer to insert a good blocking condenser (500 μ fd. or more) in the lead between the tube plate and the tank circuit. The other condensers in the circuit are unlikely to have high voltages on them.

The by-pass condensers should be large enough to do a good job at the frequencies to be used. It is advisable to keep the $L-C$ ratio in the grid tank circuit high, as previously pointed out. The plate tank tuning condenser, C_2 , may be any ordinary split-stator condenser; fairly high capacity (250 μ fd. with both sections in series) is desirable if the amplifier is to be worked on frequencies lower than 7 mc. because the tank coils become unwieldy when the condenser capacity is low. On the other hand, a low-capacity condenser is desirable for operation on the higher frequencies. After all there is a considerable difference between 1.75 and 23 megacycles, and it is not wholly reasonable to expect that the same apparatus will do a top-notch job over such a large frequency range.

Neutralizing, plate tuning and other routine adjustments are the same as with any other amplifier. Plenty of information on these has been published in past *QST*'s, and also is to be found in the *Handbook*.

Strays

W2DGU suggests the following method for removing paint from aluminum taken from old auto bodies: Lay the aluminum on a flat surface and cover the entire piece with cloth, preferably wool. Mix equal parts of boiling water and ammonia and add a small handful of washing soda. Soak the cloth with the mixture and let it stand for about an hour. The paint will soften and can be scraped off with a fine-edged tool. Be careful not to apply too much pressure, as the tool will dig into the piece and make unsightly scratches.

Crashing Page One

Helpful Hints for Hunters of Publicity for Ham Radio

By William H. Graham, W9BNC*

YES, crashing page one. It's easier said than done, brother! But it can be done.

Nearly every amateur radioman and YL, secretly perhaps, has cherished the desire at some time or another of crashing page one of his local newspaper with a picture of himself 'n' everything. As a matter of fact, who hasn't cached away at least one good photo of himself in some secluded spot in the old ham shack, ready to be yanked forth at a moment's notice when the city editor calls, to go into page one alongside some astounding radio feat?

It gathers dust, gets big earthquakish cracks in it and in due time gets younger as we grow older until it doesn't even look like us any more. So we give up in disgust and resolve if it's necessary to go out and bite a dog, we'll stay off page one.

There is no set of rules, no accurate yardstick by which the best newspaperman in the world can measure a news item. What might be of tremendous interest to the individual radioman or his comparatively small circle of friends wouldn't interest one one-thousandth of a metropolitan newspaper's readers. That's what the city editor goes by—what will make a vast majority of his paid subscribers perk up their ears and read. If you can produce it and the city editor hears about it, you'll find yourself and the old rock crusher bursting forth on page one whether you like it or not.

Oftimes it happens that the amateur radioman will do or hear something that will seem trifling and uninteresting to him, something utterly dull and unworthy of even mentioning, according to his standard of news, yet this may be the very item for which the city editor and his pack of news wolves are constantly on the hunt to brighten up their pages.

Take the word of a seasoned newsman for it, one who has served not one but several "hitches" as a news hound before he graduated (?) into the

so-called editor class. Believe me when I say that a real, honest-to-goodness, genuine, dyed-in-the-wool news item seldom, if ever, walks into the editor's office and lays itself down on his desk. The city editor has long since learned that he has to scratch for the real live interesting news of the day, and scratch hard.

At the risk of having my ears filed down by some of my brethren of the press should they see this, I am going to endeavor to dissect the elusive news item, as it pertains to the amateur radioman, and see what makes the wheels go round. Let us see if we can't find some way, by hook or crook, by which the amateur radioman can trod that elusive trail that leads right down (or up) to the pinnacle page one.

Club news, election of officers, etc.: That's out! Nine hundred and ninety-nine out of a thousand metropolitan newspapers don't give a tinker's darn about it. Small-town papers (cities of 25,000 and less population) and country weeklies will give fairly good space to it.

New inventions: Not so hot unless the invention is a whiz that will command world-wide interest, such as a static eliminator. Hi! (Don't try to fool the city editor with some trick "invention," for while neither he nor his reporters probably will know anything about the intricacies of radio, they'll send someone who does. I recall one instance of a fellow who claimed to have a new-fangled radio receiver which worked without tubes and gave the volume of a 7-tube receiver. The city editor assigned a radio expert—not me—to the story and he readily found the hidden tubes.)

DX: Null and void unless you work Santa Claus! Of course, if you should get in touch with Stalin or the Prince of Wales while DX-ing, that would be news in anybody's newspaper. Measure your DX news this way, fellows: Ask yourself this question, "Does this DX interest the druggist on the corner, the fellow who works in the broker's office, the day laborer, the school child, the lady



*% The World Herald, Omaha, Neb.

(Continued on page 88)

H A M D O M



AT THE southwest end of the island of Montreal lies the village of Ste. Anne de Bellevue. If we take a stroll down the main street we reach a grocery store bearing the name, "Chas. J. Dawes". On entering, we are greeted by a white-haired man with warm blue eyes and a kindly smile. It is none other than that philosopher and true ham, VE2BB, whose letter back in the November, 1929, issue of *QST* headed, "As We Sow—" still ranks with the finest expositions of the true amateur spirit. That spirit pervades VE2BB. It appears in the thousands of cards which cover the walls and ceiling. It is



manifested by the numerous visitors who each year visit the shack—many of whom contribute their bit in adjusting and building the station. We chat awhile about DX, about the station, about the respectable monthly traffic totals. We have a cup of tea, and then we drive off again down the winding road along the lake back to the city, feeling that during our visit we have glimpsed the real spirit of amateur radio.

CAREER of a radio amateur: Built a telegraph line with three schoolmates in 1910. First saw a broadcast receiver in 1920. In 1922 duplicated a breadboard receiver seen at Columbia University summer school, paying \$7.50 for headphones, \$7.50 for a variable condenser, \$5.00 for a 201, and \$1.25 for a six-ohm rheostat. Learned the code with the aid of a Ford spark coil and buzzer, ruining neighbors' broadcast reception unknowingly for three years. First saw an amateur transmitter in 1928. Obtained a temporary in 1929. S.C.M. in 1930, O.R.S., A.A.R.S., U.S.N.R., member of four radio clubs. That's the ham record of Hugh Lynn Caveness, W4DW, director of the Roanoke division, who, in 1925, following an A.B. at Trinity and an M.A. at Duke, joined North Carolina State College as Assistant Professor of Chemistry, the position he still occupies.



AT THE mystic hour of midnight sixty men foregathered deep in the bowels of the earth. Down a narrow, treacherous trail, past bottomless pits, through the Needle's Eye—an aperture almost too small for the largest of them to pass—they had come, until finally they entered the mysterious grotto, the Bandit's Hall. This natural subterranean cavern 300 feet below ground already had a romantic history as a robber's stronghold. And now . . . the Young Squirt, his candle's feeble light making weird shadows of the stalactites and stalagmites, pursued his "uncertain journey across mountains of hopelessness, o'er rocks of despair, through rivers of doubt, and along paths beset with enemies" . . . the most impressive performance of the ritual of the Royal Order of the Wouff Hong ever witnessed, staged by Joseph Rohrer, W9EYN-W9EOV, president of the Pike's Peak Amateur Radio Association, in the Cave of the Winds at Colorado National Park during this year's Rocky Mountain Division Convention.



H'E'S a man of the air—aviation, his vocation; radio, his avocation. Nowadays, Ralph J. Gibbons pilots a United Airways' plane along the air lane between Portland, Oregon and Salt Lake City, Utah. Before that, he managed the Walla Walla airport for a year, after having spent sixteen months on active duty with the Third Attack Group of the U. S. Army Air Service, at Fort Crockett, Texas. His aviation career started when he left Whitman College in 1929 to enter the Army Flying School. His radio career started during senior year in high school, with the call 7EE, followed by W7ABY at Whitman. In Galveston, he organized W5AUX and held W5AAR. W7BIX and W7KV were acquired on the return to Walla Walla. Married, Gib has two children. These, with radio, comprise his hobbies. Basketball is his sport. But the air is, and probably always will be, his domain.



The Amateur and Police Radio

By Robert S. Kruse*

WHO started this police radio business? Trace it down as you wish, you will find a radio amateur at the bottom of it; one of that hopeful crew that is always insisting that a new idea will work—and then working it.

Yes, amateur radio has a good right to take pride in police radio. That would be enough reason for telling the story of a fine police radio system; but there are other reasons, too.

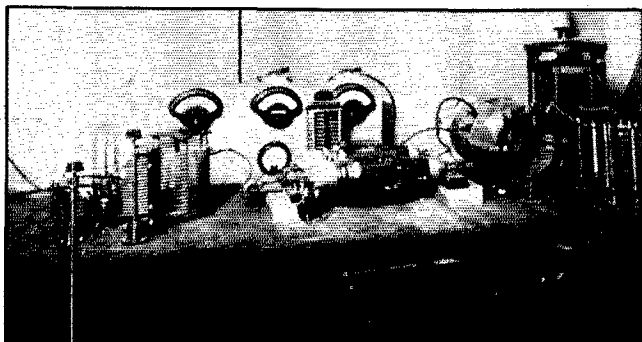

AN EXPERIMENTAL BREADBOARD LAYOUT, REMINISCENT OF FAMILIAR AMATEUR GEAR, FROM WHICH ONE OF WCK'S EFFECTIVE TRANSMITTERS WAS DEVELOPED

The system described here not only illustrates the best in police radio, but also sets standards for operation of any sort of station, 'phone or c.w. As you read the story remember that the operating staff owns the amateur calls W8HP, W8ARR, W8FWU and W8BJ, besides having a number of spark alumini from old 8KJ, 8ASY and 9ZN. We are not dead sure of Milo Mainville who operates on the motorship "Benson Ford," working the land stations; but quite probably one could pull his commercial ticket out of its frame and find a faded amateur ticket underneath.

You have now guessed, of course, that I refer to Detroit's police radio system. The story as told here is partly from the writer's observations, while the remaining facts and the illustrations are due to the courtesy of Lt. E. C. Denstaedt, in charge of both WCK and WPD. Now to our story itself.

Surely no radio station, 'phone or c.w., is more smartly operated than WCK of the Detroit Police Department. WCK's carrier is never wasted. The instant it appears the dispatcher speaks crisply, the operator repeats and finishes with ". . . WCK"; . . . and that channel is clear. The carrier stopped with the voice. It was done 1,000,000 times in one year. It will be done many

* Consulting Engineer, North Guilford, Conn.

more times than that in 1934. And every transmission means that the starting relays operate, the filaments come up, the operator checks readings, the message is sent twice, is recorded in the station log, and the station shut down. Such a schedule demands alertness of the best sort, and even the distant listener soon feels the brisk capability behind the station and its teammates. This is as it should be, for no station has done more for police radio; and, quite literally, scores of police chiefs have in one day at Detroit become stout and permanent converts to police radio, not as something magical, but as a strong auxiliary to other police tools and methods.

Of course radio alone will not make over a police system. In Detroit the radio system was preceded by a highly organized system of "minute cars" and "booth cars," sent out from precinct houses and scattered police booths by telephone. The system was the pride of the department—and it still is to-day. Radio's best work is done when it is used *with*

other means, precisely as wire, radio and messenger work cooperate in other phases of our existence. Detroit's high position in police radio comes as much as anything from the ability to organize personnel and equipment to obtain such cooperation.

This is no attempt to belittle the work of other police radio services, but on a historical basis WCK and its Detroit forerunners make an impressive story. The story begins over 12 years ago when plans were made and apparatus prepared—a 50-watt 'phone built and operated by Officer Bernard D. Fitzgerald, under the amateur call 8BNE. In the next year a 500-watt Western Electric 1-A transmitter was added and for several years worked at 200 meters as 8BNE, at 375 meters as 8XAS and as KOP at 360, 286 and 277.8 meters—and finally as WCK. So long transmission had mainly been to fixed points, other police departments, precinct houses and the like, but there had been continuous experimenting in reception in automobiles. The hope was that there could be developed a radio-controlled patrol fleet, capable of such speed as would at last permit the police to strike from the criminal's hand his strongest weapon, surprise. That development was pressed forward constantly and by 1929 there existed the swift-acting

WCK system, in instant touch with 27 "scouts" and 8 "cruisers," as well as with other police departments.

There were difficulties of a serious sort, however. The apparatus, then in charge of Lt. Cox, was largely home-made; for the 1-A transmitter had been outgrown and there were no commercial police receivers. It was a staggering job to build new equipment, to make some 50,000 transmissions per year, to service the existing equipment and to build ahead. This period saw shifts of WCK to 144.8 and 154 meters (as 8F50), to 175.23 (quite worthless because of interference at that time), then to 94.7 and—but in *QST* we are supposed to talk kilocycles—to 2410 kc. and finally 2414 kc. There were also licensing difficulties; but finally a better understanding was obtained and the station allowed to work in peace.

The work for the last several years has largely been under the direction of E. C. Denstaedt, to whom I am indebted for the illustrations herewith, as well as for much of the factual material in this story. The present system can be well presented by information from a report made by him, which may be familiar to some readers as it appeared in an article by Lt. Jett, Assistant Chief Engineer of the Federal Radio Commission, in *Broadcast News*:

"The information broadcast by the police transmitter can be roughly put into three classes:

"1. Runs. Orders to a police car to proceed to the scene of a crime, fire or accident are termed 'a run,' and given precedence over other broadcasts.

"2. Station Calls. Cars are often wanted by the precinct station, or perhaps by the police dispatcher. In this case the cars are either told to go into their stations or given whatever other information there may be. This type of message is classified as a station call.

"3. Teletypes. The Detroit Police Department uses the teletype to disseminate information from Headquarters to its precinct stations. The radio station is equipped with one of these teletype machines and the teletypes received are broadcast by the operator. They contain information regarding holdups, descriptions of men wanted by the police, missing person reports, stolen car reports, etc.

"The transmitted information is obtained from, (1) citizens by means of the Bell telephone; and (2) precinct stations and the several divisions of the Police Department.

"All sources of information converge in one room in which both the police 'phone board and the Bell 'phone board of the department are located. In this room are the police dispatchers. These dispatchers—two in number—are trained men with long experience in their work. These men and no others dispatch police cars on runs. One of these men supervises cars on the East

Side, while the other has the West Side. They have at their fingertips all the resources of the Police Department. Patrol wagons, detective bureau flyers, emergency wagons, booth cars, minute cars and ambulances can be reached by the police telephone system. The radio-equipped scout cars and cruisers patrolling the streets are available instantly by means of regular broadcasting microphones which stand before the two dispatchers; they merely plug in on a 'phone line, the transmitting equipment starts automatically

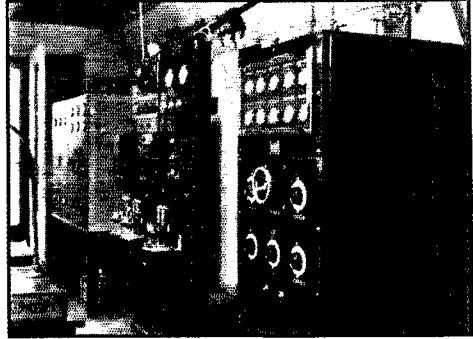

PART OF THE EQUIPMENT AT WCK

In the foreground (right) is the transmitter developed by the staff from a breadboard original. Much of the Detroit system's equipment has been designed and built by its amateur and ex-amateur personnel. In the background (left) is a W.E. 9-A set.

and their voices can be put on the air almost instantly."

Here we interrupt Lt. Denstaedt and make explanation purely of interest to the radio man. This is not a "station description," but as the business of a radio system is to transmit and receive signals we can hardly keep the apparatus out of the story altogether.

WCK is located on Belle Isle, which lies in the Detroit River and is thus at one edge of town. Dwellers in cramped cities can ill imagine the territory covered by Detroit—and most of them hardly suspect that it is fast approaching the 2,000,000 population mark. The 139 square miles within the city limits must be overlaid with a signal that out-shouts the trolley noises; and Detroit depends on surface transit, which isn't all rubber-tired by any means. The problem is complicated by the curious shape of the town, for it has grown around the independent cities of Grosse Point, Highland Park and Hamtramik (if that's the way to spell it!).

Omitting the story of the past experiments, we finally come to a four-station system in which there are four police stations on the same frequency, serving five cities in the same neighborhood. Detroit has WCK outside the city on Belle Isle, using a reflector antenna to spray the signals into the East Side steel-building territory, and also has WPDX in the heart of the West Side,

servicing that territory and Hamtramik. These are 500-watt stations, working sometimes together to cover the city with one alarm, sometimes independently and simultaneously. The latter is made possible by careful adjustment of the power levels so that there is overlapping only in a region which is fortunately fairly free of police work. When that region is to be reached one station

trict. The patrol districts are chosen with the following five points in mind: Density of population; the crime record of the district; the traffic problem; other police protection present; and records of the radio station as to runs made there.

CRUISERS

"The cruisers are heavy, high-powered cars (special Lincoln touring cars or sedans) and carry four or five men, two plain-clothes patrolmen, one driver in uniform, one detective and sometimes an additional man. These cruisers are equipped with riot guns, tear gas bombs, etc. Also, they have bullet-proof windshields. A cruiser patrols through an entire precinct and covers territory which is also covered by scout cars, so that in any serious trouble the two policemen in the scout car may be reinforced by the cruiser crew.

TRAFFIC

"A citizen calls the Police Department on the 'phone. This call comes into the dispatching room. The police dispatcher plugs in on the radio station and talks into the microphone. His voice is on the air and at the same time is audible to the operator at the radio station, who writes the message down, signals that it is OK or in some cases makes the dispatcher spell out words on which he considers that there might be a mistake. He then cuts in his own microphone and repeats the message until he considers that all possibility of the car missing the run is eliminated." (There is a follow-up system whereby any failure of a prompt report from the car called results in another transmission, and if conditions warrant in a follow-up by another scout or a cruiser. If a car or cars must be gone on a run for any length of time, other cars move in and "cover up" as in a fire department.)

"While most of the publicity given the Detroit system has been written around the spectacular split-minute captures, we believe that many of the writers have overlooked other points:

"1. The large mobile force, available to combat serious outbreaks.

"2. A commanding officer who need not waste time to get in touch with men out on patrol duty.

"3. The many duties that fall to the lot of a police department which are not strictly police work, nor are they emergencies; but that none the less require men and cars. Men in radio cars can do these jobs and still be available for emergencies.

"4. The patrol car that is at all times in possession of the very latest information on stolen cars, holdup descriptions, etc., and thus is able to work to better advantage than patrolmen."

SAFETY DEVICES

Thus we have a general outline of the system. How well the system works depends on the men

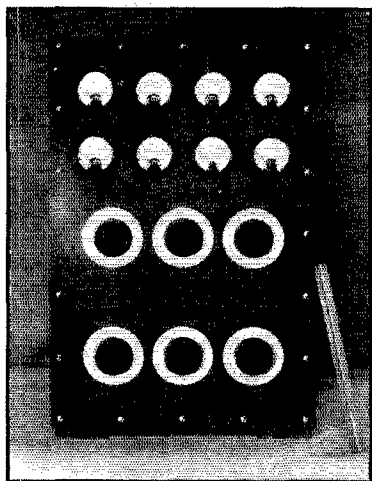

RIGHT DOWN THE HAM'S ALLEY
A 100-watt transmitter in the shack of WPDX.

works alone, or the two are tied-in. This takes high-grade dispatching.

In addition there are two 50-watt stations, WRDR of the Grosse Pointe Police Department and WMO of the Highland Park Police Department. All four stations are tied together with an interlocking relay system so that other stations are warned by lamp-signals whenever any one of the four is transmitting. It is the invariable rule that if a "run" is to be sent the other stations are asked to suspend any secondary messages. It is done by blinking the lamps and is obeyed instantly! If you don't believe it, just *listen* on that wave and observe how a teletype or station call will stop *in the middle of a word* while one of the other three stations snaps out a "run"; and then how the first station goes ahead after repeating only the one lost word. Clearly the men in the cars must be alert, too.

Now for the cars and a resumption of the report:

"The radio-equipped cars are of two types, termed 'scout cars' and 'cruisers.' The scouts are light cars (Ford roadsters or coaches) and are manned by two uniformed policemen. It is these cars that are assigned to the patrol districts, into which the regular police precincts have been split. A radio car is assigned to each district and is constantly on watch while patrolling that dis-

at the dispatcher's office, at the stations and in the cars, and also, on the forethought against emergencies. *Espirit de corps* cannot be described; but you can assume that it is there in good measure. Now for the forethought.

We have said that WCK is on an island, easily defensible. It has two power lines and an automatic transfer switch to throw to the other line if one goes dead. It has enough power so that if WPDX goes out the city can be covered by simply raising the level from WCK. In addition there is a complete duplicate transmitter at WCK.

At WPDX there are also two power supplies, and two transmitters. There is a 500-watt amplifier feeding the antenna and this may be fed from a master crystal-controlled set of low power, or by a 100-watt set which can itself be put on the air directly if the 500-watt rig fails. There is also another crystal rig, and a complete failure seems remote. The various 'phone lines are duplicated throughout to both WCK and WPDX.

The radiation systems have been made as good as possible so that the stations can operate with reduced power normally; and if an emergency antenna must ever be used spare power will be available to compensate. At WCK there is a 103-foot vertical antenna, halfway between two 117-foot poles. At one of the poles is a 103-foot nearly-vertical one-wire reflector. Both antenna and reflector go to ground through tuning devices. The antenna current is 2.8 amps and the reflector current 1 ampere. The grounding system consists of rods and wires in earth whose surface is only 3 feet above permanent water level. The two wires are spaced $\frac{1}{4}$ -wave apart.

Since it is possible that a car receiver may fail it is standing practice for any car to call in and ask for a test when it does not hear signals. Ordinarily the four stations provide ample signals for tests, but extra ones will be sent on request. After midnight time signals are sent occasionally, by voice, for this purpose and to keep the men's watches OK as well.

Should a car miss a run, reports are made out by the car crew, radio operator and dispatcher, so that periodical analysis may expose any weak spots. Do not think, however, that this is a report-writing organization. That comes later. At the moment the main thing is to get the car back into service. If the car misses a run or fails to hear a test it is reached by radio, or by another car, and the receiver is serviced. The service and battery cars are busy—and fast. They carry spare batteries and sets. Things that can't be repaired at once are exchanged and taken in for bench service. A Michigan winter night is not fitted for circuit analysis.

As a result of this less than $\frac{1}{8}$ of 1% of the runs are missed, and the record is equally good on messages and teletypes.

THE SPIRIT OF THE SERVICE

Having just abandoned the attempt to define the spirit of the organization I may yet say that the men at the stations and in the cars seem thoroughly to believe in the thing they work at. The car work is hard, but it may lead to sergencies, though the cruisers are sometimes commanded by lieutenants. In passing it seems noteworthy that the orders may come from a dis-

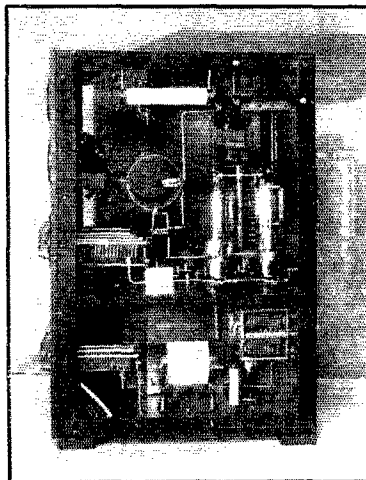

SIDE VIEW OF THE WPDX 100-WATT SET

In size and construction it is not unlike the better-type amateur equipment.

patcher of lower rank; but the fact that the orders are executed willingly none the less is good evidence that there is a proper appreciation of the necessity for a cog which is radio-trained rather than police-trained.

RESULTS

It has been found that the radio system materially improves the percentage of arrests in which it is necessary to catch the offender on the spot. This applies to holdups, housebreakings and sex crimes especially. The number of holdups has not greatly decreased; partly they are often "amateur crimes" caused by hunger or other acute distress and the times have been such as to encourage such things. But Detroit holdups have not increased as in almost all other major cities.

The "professional" or "habitual" crimes, such as housebreaking, banditry and sex crimes have decreased for several reasons. Partly this has followed because a professional criminal leaves a town that is made bad for his business. The supply of such men is not unlimited and many of them have been caught. Finally, the threat of the thing may deter a few; courts seem more inclined to convict the criminal who is caught quickly.

(Continued on page 65)

How to Get a Class-C License

By K. B. Warner, Secretary, A.R.R.L.

THE new amateur licensing procedure is so intricate that it is going to be some time before we all settle down into a full understanding of it. When we at headquarters ourselves are puzzled over some new angle and have to engage in research and deduction for the answer, we appreciate that it must be pretty tough for the ordinary ham. This article is intended to help that situation. While it is a reliable guide for a new amateur going after his Class-C ticket, that is by no means its primary purpose. Its intention is to illustrate and explain the case of a new Class-C application because that is the basic case of which all the more complex forms of application are derivative. Understand the simple Class-C situation thoroughly and you understand most of the others.

The operator portion of amateur licenses is now either Class A, Class B or Class C. Class A carries every amateur privilege; that is, it is the same as the old "unlimited 'phone." Unless otherwise qualifying under F.R.C. Rule 405, an applicant for it must have held an amateur license at least a year and must appear before an inspector for personal examination. Class B carries every right except 'phone in the 80-meter and 20-meter bands. To get it, the applicant must appear before an inspector for personal examination; and either this class or Class A is compulsory if the applicant lives within 125 miles airline of any of the 32 examining cities named in Rule 30. In both these cases the applicant writes for forms to the inspector of the district in which he lives, files the forms, and later appears for examination. Under such circumstances he has the assistance of the inspector in getting things straight. If the applicant lives more than 125 miles airline from all the 32 examining cities, he does not have to appear for examination. He can get a new license by mail. It carries the same operating privileges as the Class-B but is known as Class C. This applicant will have no contact with the inspector except by mail, and one particular purpose of this article is

to help him to proceed correctly. A very great deal of the procedure applies in the other classes of license too, but a Class-B applicant of course should follow the printed instructions he receives even when they deviate from this article, which is primarily to help the fellow who must go it alone.

Old amateur station licenses run at least until early 1935. Your operator license, if you have one now, probably expires sooner. When it does, you come up for the new class ticket. *If it is of a grade other than the Temporary, you are eligible, if active, to Class B—see the licensing notes in November QST.* In fact, if your present license authorized unlimited 'phone you are entitled, if active, to Class A. If it is a Temporary it is not subject to renewal and you must be reexamined. Not every Temporary holder, however, is eligible to relicense by mail. If a TA lives within 125 miles of any examining city, he is eligible only for Class B (or possibly A) and must appear in person.

Let us imagine that you are going up for your first amateur license or have an existing Temporary operator license which is about to expire, and you think you're eligible for Class C. We're now going to determine just how you go about it.

First is the question of actual eligibility. Get a reliable map of large scale and, by careful reference to the scale of miles, draw a circle of 125 miles radius with your town as its center. Then examine the area inside this circle and see if it contains any of the 32 examining cities: Washington, Boston, New York, Philadelphia, Baltimore, Norfolk, Atlanta, Miami, New Orleans, Galveston, Dallas, Los Angeles, San Francisco, Portland (Ore.), Seattle, Denver, St. Paul, Kansas City (Mo.), Chicago, Detroit, Buffalo, Schenectady, Winston-Salem, Nashville, San Antonio, Oklahoma City, Des Moines, St. Louis, Pittsburgh, Cleveland, Cincinnati, Columbus (Ohio). If it does, you are not eligible for Class C. You must apply for Class B and appear in person.

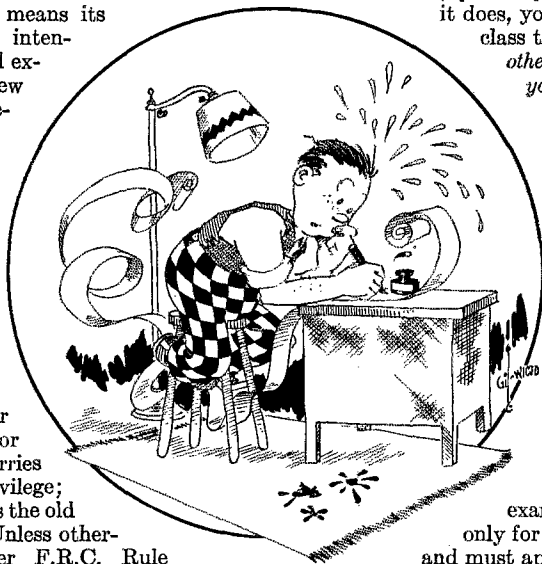

As an additional guide to you, F.R.C. has published a limited number of maps showing 125-mile circles around the 32 cities, and a copy of this map and of the new regs is going to every A.R.R.L. director and S.C.M. and to every club affiliated with A.R.R.L. Ask your S.C.M. or club where the "official circle" hits if it is a close shave.

But let us say there is no examining city within your radius and that you're therefore eligible for Class C. The next step is to write to the U. S. Radio Inspector in Charge of the district *in which you live*. *QST* for last December, the A.R.R.L. *Handbook* and the *License Manual* and Rule 30 of the new F.R.C. regs all contain this list of districts and inspectors' addresses. You write to yours and request the necessary papers for taking out a Class-C license. You then receive from him an application form called Form 610, an instruction sheet, a return envelope addressed to the Commission at Washington, and a sealed envelope containing a set of examination questions. Read the instruction sheet carefully.

As part of the Class-C examination you have to have yourself examined in code by some licensed operator with whom you make an arrangement to that effect. He must hold a license to operate radio-telegraph stations and the license must be of a grade higher than Class C or the former temporary amateur class. (Specifically, the classes acceptable for this code examining are commercial extra first class; radiotelegraph operator first, second and third class; commercial operator first and second class; amateur extra first class; amateur class; amateur Class B.) You also have to provide yourself with a witness who will open the envelope of questions and certify that you wrote the answers without assistance. There is no reason why the code examiner and the examination witness may not be the same person. If you do not know a licensed operator in your vicinity, communicate with the nearest radio club or write your A.R.R.L. Section Communications Manager (directory in front of every *QST*). You must know the name or names of your examiner and witness before filling out the application. There is, in fact, a specified sequence: First you fill out the form, which includes the data on examiner and witness, and then you swear to it before a notary. Next you get your

code examiner to give you the code test and to fill out and swear to a statement of your code speed, for which a space is provided on the application form. Then, and only then, are you ready for the written examination. If you do not pass the code test, you must return the examination envelope unopened, and wait 90 days before trying again. But if your *examiner* swears that you did at least 10 words per minute, your *witness* may then open the examination envelope. He examines it and sees that it consists of five sheets of paper, each bearing a printed question at the top of each side, ten questions in all. He hands these to you. You proceed to the answering of the questions, using the space below each question.

You must write with ink, not typewriter or pencil, although you may draw any necessary diagrams with pencil. Your witness must remain constantly present, and at the conclusion sign and swear to a statement that he opened the envelope and that you wrote out the answers in his presence and without assistance from any source. There is space for this also on the application form. Then you put both the application form and the examination sheets in the envelope provided, and mail them direct to the Federal Radio Commission. If you have passed, your license will come to you in about three weeks.

If you have failed, don't be too discouraged—study some more for the examination and after 90 days try it again.

(An applicant for Class B or Class A uses the same application form but fills it in only through the place where his affidavit occurs. He does not provide himself with code examiner or examination witness, since the inspector performs these functions when the applicant appears in person, and in these cases, too, the application is returned to the inspector, not to the Commission.)

The application form is a double sheet of four pages. The first page, 16 questions, relates to an operator application, while questions 17 to 39 on the next page and a half relate to the station application. The remainder of the space is taken up by the affidavits or jurats. You may apply for an operator license, on the first part, even though you have no station—in which case you leave the second part all blank. You may not apply for a station license unless you have or are also applying for an operator license.

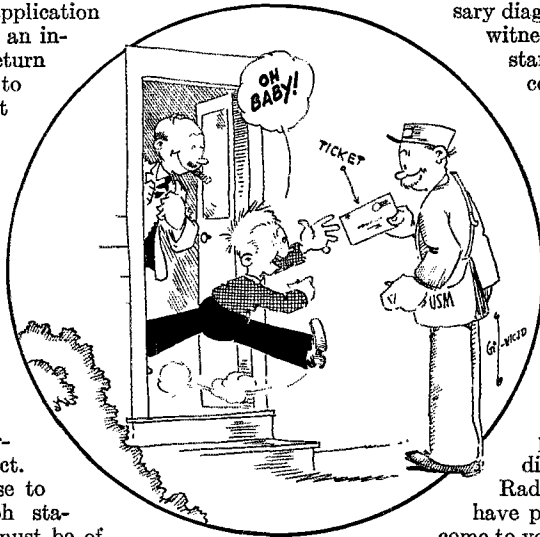

The application form may be filled out at your leisure, and you may refer to *QST* articles to help you. It is the written operator examination itself, for which you receive the questions in the sealed envelope, that you must do without assistance, in one sitting, in the presence of a witness who has opened the envelope. The application form, as already stated, must be filled out and the code test completed before the envelope containing the examination questions is opened.

(Not only does this application form cover both operator and station; it is used for new applications or for securing renewal, modification or duplicate of either or both licenses. In any application relating to renewal or modification of any existing license except Temporary operator, both the existing station license and the existing operator license must accompany the application, since a new combined license is to result.)

On the first line of the application form you state whether this request is for a new operator license or a renewal of an old one, etc. You, as a Class-C applicant, either have no license now in force, or only a Temporary, which is not capable of renewal. You therefore request a "new" operator license with Class C privileges.

The next succeeding questions relate to your name, address, age, citizenship, whether recently examined or not, until we come to Item 12. Here you list all operator licenses held in the past five years. Item 13 requires you to supply data concerning three amateur stations with whom you have been in radio communication during the past three months. If you haven't had a license, obviously you haven't communicated, so you leave this blank. It relates particularly to applications for modification or renewal. In Item 14 you give the name, address and license data of your code examiner, and in Item 15 the name and address of your examination witness—which is why you must determine upon these people in advance. Item 16 relates only to duplicates. So much for the operator application.

Part II, about the station license, starts off in identical fashion, the first questions being easy. Item 27 is a legal question that must be asked, since the law forbids licenses to those convicted of monopoly. Items 28 and 29 list the calls you now hold and those previously held but expired, respectively. Item 30 is similar to Item 13 but with this distinction: to obtain renewal of an operator license it is merely necessary to show activity as an operator, using anybody's station over which to transmit; but in this Item 30 you must show the activity of *your own* amateur station (as operated by you) if you want renewal of

your station license. Renewals will not be granted inactive stations. You have to wait 90 days and then apply for a "new" station license. If you are a new applicant, obviously you leave this item blank. Item 31 again relates only to duplicates.

Item 32 calls for simple data on whether the station has ever before been licensed. Partly this is to bar attempts to get a new license merely to shift call letters, and partly it is to avoid confusion between applications for new and for modified licenses. The beginner wants a "new" license, and so does the old-timer who let his previous license expire.

Item 33 shows whether the existing equipment

FEDERAL RADIO COMMISSION	CAUTION - DO NOT OPEN!	CLASS C
<p>THIS ENVELOPE MAY BE OPENED ONLY BY THE PERSON SELECTED BY THE APPLICANT TO SUPERVISE HIS WRITTEN EXAMINATION, AND THEN ONLY AFTER THE APPLICANT HAS COMPLETED THE APPLICATION AND RECEIVED HIS ADMIT AND CODE TEST REQUIREMENTS AND SATISFIED. ANY ATTEMPT TO OBTAIN AN OPERATOR'S LICENSE BY FRAUDULENT MEANS OR BY ATTEMPTING TO IMPERSONATE ANOTHER, OR BY COPYING OR DIVULGING QUESTIONS USED IN EXAMINATIONS, WILL CONSTITUTE A VIOLATION OF THE REGULATIONS, FOR WHICH PENALTIES ARE PROVIDED.</p> <p>BEFORE THIS ENVELOPE IS OPENED THE FOLLOWING INSTRUCTIONS, AS WELL AS THE SPECIFIC INSTRUCTIONS WITH THE REPLICATION FORM, SHOULD BE READ CAREFULLY AND OBSERVED BY THE APPLICANT.</p> <p>1. BEFORE THIS ENVELOPE IS OPENED THE APPLICANT IS REQUIRED TO PASS A CODE TEST IN ACCORDANCE WITH RULES 407 AND 413 AND A CODE TEST (CODE RULE 408).</p> <p>2. IF THE APPLICANT FAILS TO PASS THE CODE TEST OR FAILS TO COMPLETE THE APPLICATION WITHIN THE TIME ALLOWED, THIS ENVELOPE, UNOPENED, TOGETHER WITH THE COMPLETED APPLICATION FORM, SHALL BE SENT BACK TO THE FEDERAL RADIO COMMISSION AT WASHINGTON, D. C. OTHERWISE, THE APPLICANT MAY BE BARRED FROM EXAMINATION FOR AN UNLIMITED PERIOD.</p> <p>3. THE ENVELOPE CONTAINS FIVE SHEETS OF PAPER STAPLED TOGETHER WITH AN EXAMINATION QUESTION PRINTED ON EACH SIDE OF EACH SHEET. AFTER THE SERVICE IS RENDERED BY THE WITNESS THE APPLICANT SHALL SEPARATE EACH SHEET BY CAREFULLY REMOVING THE STAPLS, AND PLACE THE SAME IN THE UPPER RIGHT-HAND CORNER OF EACH SIDE OF EACH SHEET BEFORE STARTING THE EXAMINATION. THE ANSWERS SHALL BE WRITTEN BY THE APPLICANT IN INK IN THE SPACES PROVIDED AFTER EACH QUESTION. CRAPIONS MAY BE DRAWN WITH PENCIL. THE PENALTY FOR THIS SHALL BE OBTAINED IN A SEPARATE PART IN EACH EXAMINATION IS 75 PER CENT. EACH QUESTION CARRIES 100 PER CENT. IF THE APPLICANT IS THE HOLDER OF A RECENTLY ISSUED LICENSE IN ACCORDANCE WITH RULE 408 OR 409, HE IS REQUIRED TO ANSWER ONLY THE FIVE QUESTIONS WHICH RELATE TO NAME, ADDRESS, AND REGISTRATION (NAME BEARING EXEMPTIONS, IN WHICH CASE OTHER QUESTIONS CARRY 200 PER CENT).</p> <p>4. WHEN THE APPLICANT IS READY TO PRECEED THE WITNESS SHALL OPEN THE ENVELOPE, CHECK THE CONTENTS, AND HAND THEM TO THE APPLICANT, WHO SHALL IMMEDIATELY COMPLETE THE EXAMINATION, WITHOUT INTERMISSION, IN THE PRESENCE OF THE WITNESS.</p> <p>5. IMMEDIATELY UPON COMPLETION OF THE EXAMINATION THE WITNESS SHALL EXECUTE THE PROPER PARTS APPEARING ON THE APPLICATION. THE APPLICANT SHALL THEN SEND THE COMPLETED APPLICATION AND EXAMINATION DONE BY THE FEDERAL RADIO COMMISSION, WASHINGTON, D. C. IN THE ENVELOPE PROVIDED FOR THIS PURPOSE.</p>		

THE SEALED CLASS-C ENVELOPE

Containing questions for the mail examination and bearing on its face detailed instructions for its handling.

is or has been under previous license. This item is not to be understood as referring to second-hand equipment which you bought from another amateur who once used it at a different address. Its purpose is to check up on evasions and "ringers."

Licenses must control their equipment. If they do not own it, they must submit a statement from the owner showing that the applicant has control, so that he is lawfully able to assume responsibility for its performance. Item 34 covers this.

Item 35: Apparatus must be designed to prevent changes other than in amplitude. Filtered d.c. plate supply must be used below 14,400 kc. The applicant must state by what means he proposes to keep his frequency within an amateur band, as by heterodyne frequency meter, monitor calibrated against standard-frequency signals, crystal, etc.

Item 36: The station must not be on premises controlled by an alien. The station location is that of its radiating antenna.

Item 37 relates to distant-control, a subject that will hardly interest the new applicant. Those interested should carefully consult Rule 213 and arrange their station to comply, if one-man operation is desired.

Item 38 relates to applications from a trustee on behalf of an amateur club. The applicant must be an individual, himself a licensed operator. He

(Continued on page 38)

Tri-Tet Tricks

By M. P. Mims, W5BDB*

INASMUCH as the cathode circuit of the tri-tet oscillator works best at high L - C values (although with small L for the fundamental frequency), it was reasoned that the old idea so familiar in the TNT grid-coil should perform just as well here, the distributed capacity of the coil itself furnishing the needed balance for the oscillatory circuit. A coil was inserted in place of the coil-condenser combination and, with a minimum of turn shifting, all was well. Thus the tuning was reduced to the selection of the desired harmonic in the plate tank. Various crystals work equally well.

Keying at W5BDB is done in the negative plate supply to the crystal stage. With the insertion of an old broadcast 30-henry choke shunted by a variable carbon-pile resistance, it gives no interference in several broadcast receivers operated in the same room with the transmitter, which has 250 watts input to the final stage. Hence it was desired to maintain this freedom from interference in the new unit. The key was inserted and a check made, with results as in the old unit. Next the bug was tried. Here the results were more pleasing than ever. With the weights off and the bug going full speed the response was all that could be desired, which had not been true in the older unit.

Our experimenting had been from the standpoint of producing a crystal unit capable of delivering frequencies for the commonly used bands and the elimination of doubler stages which never have appeared desirable. The 59 tube had been selected for the use and all had gone very well—with the exception of a tendency for double resonance dip when the plate tank was tuned to the fundamental frequency. One dip was considerably more pronounced than the other. First, this was greatly reduced by placing the two coils with their axes at right angles and fairly well separated. Another trick later on eliminated any tendency for the double dip. (This should not be mistaken where a crystal with two frequencies also gives this double dip.)

Plate and screen milliammeters had been inserted as well as a hot-wire galvanometer in the low side of the crystal circuit. The current-squared galvanometer would have been much more useful had not its thermocouple expired in a previous experiment. The work so far had been done at plate voltages of 400 and screen of 200 volts. The power delivered was not all that could be desired and so the plate voltage was raised to 550 while the screen was held at 200:

Attention was returned to the screening action

of the tube and the tendency for double-dip when the plate was at the fundamental frequency. It was decided to try and make the 59 into a full-fledged screen-grid tube—if it might be so called. This was done by applying a good heavy coat of aluminum airplane dope, containing plenty of

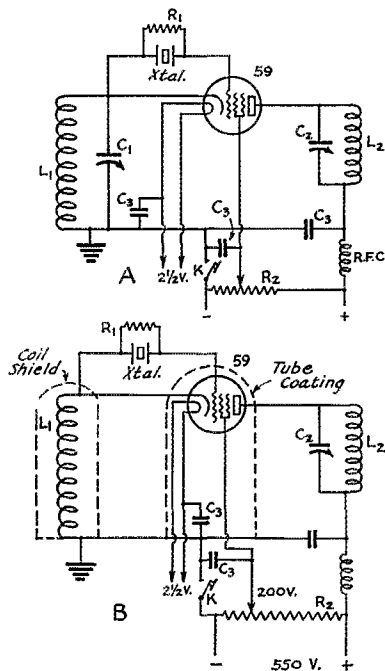

FIG. 1—A, THE CONVENTIONAL TRI-TET OSCILLATOR CIRCUIT WITH TUNED CATHODE TANK; B, THE MODIFIED CIRCUIT USING TNT CATHODE TANK, AND SHIELDED COIL AND TUBE

L_1 —Usual for the crystal used (See Oct. and Nov., 1933, QST), when tuned. TNT coil for 3500-kc. band crystal, 30 turns No. 22 d.c.c. close-wound on $1\frac{1}{4}$ -inch diameter form. Adjust number of turns to give best output and stability.

L_2 —For 3.5 and 7 mc., 10 turns No. 20 d.c.c. spaced diameter of wire on 2-inch form; for 14 mc., 5 turns No. 20 d.c.c. spaced diameter of wire on 2-inch form.

C_1 —50- μ fd. midget variable.

C_2 —250- μ fd. variable.

C_3 —0.01 μ fd.

R_1 —50,000- to 250,000-ohm 1-watt (not critical).

R_2 —50,000-ohm 50-watt tapped resistor (Ohmite).

Coil shield—3-inch diameter.

See text for information on shielding the tube.

aluminum, to the envelope of the tube except for the flat portion of the dome. A couple of turns of bare No. 26 copper wire had been placed around the bottom of the envelope with a lead to the

(Continued on page 84)



Amateur Radio STATIONS



W6AXN, Calexico, Calif.

THIS station, a typical example of the type of equipment to be found in amateur stations all over the country, is owned by D. C. Strawn, of Calexico, Calif., who got his start in radio in the Service during the war. Dropping out of the game about the time when the rotary gaps and DeForest unit-panel receivers were in their heyday, a long period of retirement ended when W6AXN was issued in May, 1931—proving once again that old saw, "They always come back."

Left to right in the photograph are a dynatron frequency meter, a three-tube a.c. receiver, and a monitor. The latter is fitted out with a switch that controls the transmitter power supply, the receiver "B" supply, and connects the 'phones in the monitor whenever the transmitter goes on so that all transmissions are monitored.

The transmitter, a push-pull tuned-plate tuned-grid outfit, is operated in the 7- and 14-mc. bands. The power supply has mercury-vapor rec-

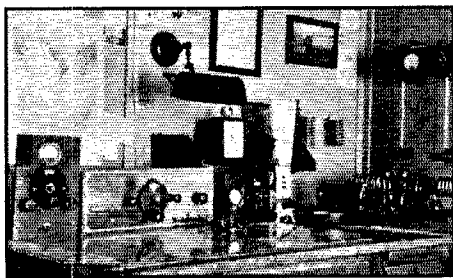

W6AXN

tifiers and the usual brute-force filter. Reports are always p.d.c. or "xtal."

The transmitting antenna is a 7-mc. Zepp. A cage is used for receiving. All continents except Europe have been worked.

W9BUY, Independence, Kans.

W9BUY, owned by Clifford W. Johnson, 1305 North 8th St., Independence, Kans., has been on the air since 1920. Having passed through all the usual phases associated with amateur activity over a period of thirteen years, the station is now equipped for c.w. operation in all bands

and for 'phone on those frequencies on which 'phone operation is permitted.

The transmitter is crystal-controlled, starting with a 10 oscillator, 10 doubler, 865 buffer, and a

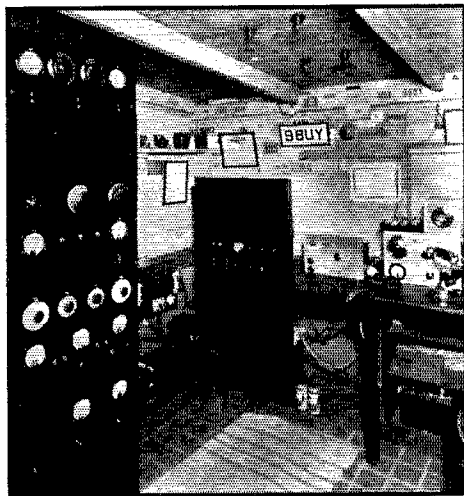

W9BUY

final Class-C amplifier using a 211. The modulator is a 212-D, fed by a three-stage speech amplifier ending up in a pair of 45's in push-pull. Separate power supplies are used for the high- and low-power stages, the former having a Thor transformer and 86G rectifiers and the latter an Acme transformer with a pair of "S" tubes which are still going strong after many years of service.

A three-tube a.c. receiver modelled after the one described in January, 1933, *QST*, takes care of the receiving end. A monitor and electron-coupled frequency meter handle the frequency and signal checking. Both carbon and condenser type microphones are available for 'phone.

W9BUY served four years in the U.S.N.R., is an O.R.S., and also belongs to the R.O.W.H. and R.C.C.

The fellows who own the two stations shown here this month and those shown last month all confess to an interest in amateur radio dating back before 1920. Nothing less than an old-timers' reunion!

for the

EXPERIMENTER



A.C. from D.C. Generators

By Wilbur Jackson, W4AVR

AMATEURS who are isolated from a.c. or might like to have an auxiliary a.c. power supply for portable or emergency use may be interested in the system used at W4AVR for obtaining a.c. from a d.c. generator.

The only source of power here is a 750-watt 32-volt Delco farm-lighting plant. By a slight alteration of the generator, however, enough a.c. power is obtained to run all filaments and supply plate power for all but the final stage of a crystal controlled 'phone-c.w. transmitter ending up with a 75-watt tube. Dynamotors supply the plate voltage for the final stage, since I was already in possession of them and saved the trouble of building an a.c. power supply for this stage.

It is possible to obtain 350 watts of 60-cycle a.c. from a four-brush 750-watt d.c. generator (25-cycle if it is a two-brush job), and at the same time get d.c. at the rated voltage of the generator.

To accomplish this a pair of slip rings and a brush rigging must be added to the commutator end of the armature. An extension shaft, 5 inches long and $\frac{1}{2}$ -inch in diameter, threaded at the free end, was attached to carry the rings. The shaft here was made from an old Chevrolet fan shaft.

A number of discs, $2\frac{1}{4}$ inches in diameter, with $\frac{1}{8}$ -inch holes in the center, were cut from old bakelite panels and slipped over the extension shaft. They are held securely in place by the nut on the end of the shaft. The slip rings were made from brass tubing of 2-inch inside diameter with $\frac{1}{8}$ -inch walls. The rings are $1\frac{1}{2}$ inches wide.

The group of bakelite discs, or drum, was turned down while the generator was running so that the slip rings would fit tightly on the insulated shaft. The rings are separated about $\frac{1}{4}$ -inch so that there is no danger of a short circuit. A $\frac{1}{8}$ -inch hole is drilled through the insulation parallel to the shaft to carry the wire from the commutator to the outside slip-ring. A 1-16-inch hole is drilled $\frac{1}{4}$ -inch deep in one of the commutator bars near the hole in the insulation. No. 14 copper wire is used to make the connection between the commutator segment and the outside slip-ring; it is threaded through the insulation and the connections well soldered. The connection to the other ring is made to a commutator bar exactly one-fourth the way around the commutator from the other segment.

The brush rigging here is made from old automobile generator brush holders, two regular auto-generator brushes being used to each slip-ring. The brush rigging must be insulated from the frame of the generator.

The d.c. voltage taken from the armature is of the order of 38 volts at a speed of 1800 r.p.m. The r.m.s. value of the a.c. voltage (which must be used in making calculations for winding transformers) is, therefore, approximately 27 volts. As there is some loss in the windings the transformer primaries are designed for 25 volts. Wire of sufficient size to carry the current must be used, No. 14 being about right for the primary of a 300-watt transformer.

If the d.c. generator is a two-brush job, the slip-ring connections should be made to commutator segments exactly opposite each other on the commutator. The a.c. taken from such a generator will be of the order of 25 cycles at a speed of 1500 r.p.m. The transformers will, of course, have to be designed for 25 cycles. Additional dope on transformer winding may be found in *The Radio Amateur's Handbook*.

About 75 watts of 60-cycle a.c. may be taken from a Ford power-house type auto generator, which is of the four-brush variety. This is about the only four-brush automobile generator available. The a.c. r.m.s. voltage from such a generator is about 5.6 volts, so the transformer primary should be designed for 5 volts. The current will be about 12 amperes, so the wire used in winding the primary should be No. 12 enameled. A transformer with a core cross-section of one square inch is large enough to handle the output of a 6-volt auto-generator, and if standard core material is used 7 turns per volt will be about right for the windings. The primary should consist of 35 turns and the number of turns on the secondary would be the desired voltage multiplied by 7. The size wire used in winding the secondary is, of course, determined by the amount of current taken from the secondary winding; No. 30 is OK for 300 volts each side of the center tap.

If the generator is left running all the time while on the air it will be found necessary to use some means of suppressing the interference caused by the brushes. At W4AVR a 1- μ f. condenser is used across the d.c. brushes; the frame of the generator also is well grounded. Two $\frac{1}{2}$ - μ f. condensers are connected in series across the a.c. brushes and the center tap is run to a separate ground. If severe interference is

encountered it may be necessary to use heavy r.f. chokes, consisting of 150 turns of No. 10 wire on a 2-inch form, in series with each of the leads carrying the output of the generator.

'Phone Monitor Using a 55

The circuit shown in Fig. 1 has been found to be very satisfactory for audio monitoring of an amateur 'phone transmitter. It utilizes a Type 55 duplex-diode-triode tube. The diode is used as a rectifier or detector and the triode as an audio amplifier. The diodes may be connected either for half- or full-wave rectification; the necessity for carrier frequency filtering can be eliminated

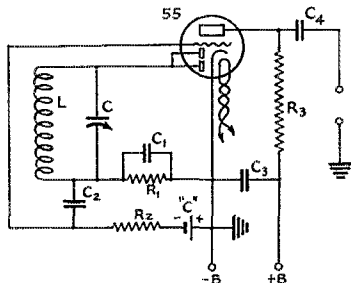

FIG. 1 — MODULATION MONITOR USING A TYPE 55 TUBE

- | | |
|------------------------|---------------------|
| C_1 — 250 μ fd. | C_4 — 1 μ fd. |
| C_2 — .01 μ fd. | R_1 — .5 megohm |
| C_3 — .002 μ fd. | R_2 — 2 megohms. |
| | R_3 — .1 megohm. |

by the use of full-wave rectification, the circuit being balanced so that the carrier frequency is not applied to the grid of the triode. When the diode is used as a half-wave rectifier (diode plates in parallel) the output will be approximately twice that of the full-wave rectifier, but theoretically carrier-frequency filtering will be required. Experiments carried out here indicate a decided increase in signal level when the half-wave rectifier is used, with no noticeable differences in other respects between the two systems. Methods of output coupling other than that shown may be used; for instance, an output transformer can be coupled to a 200- or 500-ohm line for remote monitoring, etc. The pickup coil is placed in inductive relation to the tank inductance of the modulated amplifier or the antenna inductance, the degree of coupling depending on the signal level desired.

A simple monitor of this type together with a dummy antenna will provide an adequate means of monitoring the modulation quality as well as indicating the character of the carrier. Hum, ripple and other extraneous noises due to improper filtering in the various r.f. and a.f. stages of the transmitter or other causes may be discerned readily and can be remedied without the usual interminable testing while the transmitter is on

the air. The component parts of the monitor are shown below the diagram. The values of C and L will depend on the operating frequency. For the 75-meter 'phone band, 12 turns of No. 18 d.c.c. on a three-inch form, tuned by a 50 μ fd. condenser, have been found satisfactory.

— S. E. Newman, W3HN

Notes on the Locked P.A.

The following letter from Yardley Beers, W3AWH, will be of interest to those who have been experimenting with the "Goyder Lock" system described in the Experimenters' Section in August, 1933, *QST*:

"I was very glad to see the paragraph on the Goyder Lock in the Experimenters' Section. . . . I have used this circuit occasionally and have gathered a few facts which I should like to add to those published.

"The version shown to me in England is slightly different in that the coupling between the C.O. or last F.D. and the final oscillator (known in England as a 'locked P.A.')

is done by a different method, as shown in Fig. 2. The advantage of this method is that the two parts of the transmitter can be separated by several feet. The fact is that in the stations I visited this separation was about six or eight feet, probably to minimize the back-wave, or spacer as it is called by the British. The size of the coupling coil is not critical.

"The method of tuning is exactly the same as described except that the clip on the plate tank of the exciter tube must be adjusted for normal plate current. I might make, however, a few remarks on the tuning. One who had never used this circuit will probably wonder what happens if through tube heating the natural frequency of

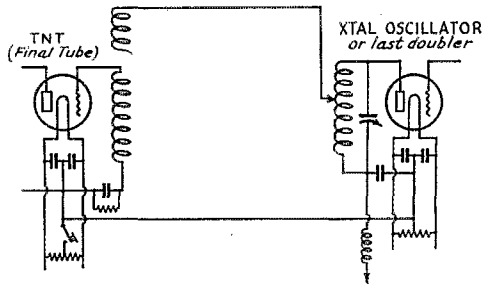

FIG. 2 — A METHOD OF COUPLING THE CRYSTAL TUBE TO THE OSCILLATING AMPLIFIER

the output oscillator differs slightly from that of the crystal. The fact is that if the two differ only by a slight amount, dependent on the strength of the lock, the frequency of the output oscillator will be attracted by the other, and the lock will take place as well as ever. On one occasion I had the two so far apart that with no

coupling between them I was unable to hear them both at the same time on the monitor; yet when the lock was applied, there was only one frequency audible.

"Though the plate supply to a t.n.t. oscillator may have a good filter, it may when tuned for maximum output have a very rough r.a.c. note. Usually when a Goyder lock is applied to such an oscillator, the note will be cleared up to p.d.c. Thus it is possible to get a little more out of a t.n.t. when locked than alone, for one does not have to pay much attention to the note until the lock is applied. However, if the t.n.t. is overloaded too much, it may jump out of lock. Another thing to be noted is that when the lock is applied, the antenna current will rise slightly.

"In England this circuit is very popular. I was told that in South London, where are located many of the leading stations, nearly everyone was using this type of crystal control. However, the 'driven' (the kind generally used in America) also has a large following. Consequently this question is of frequent debate over there. Each has its advantages, nearly all of which are obvious. However, it must be pointed out that there is one very important advantage to the Goyder lock: that is, it is possible to work crystal control on a frequency *lower* than that of the fundamental of the crystal. For example, one can use a 3.5-mc. crystal to work 1.7-mc. crystal control. The method is exactly the same except that the t.n.t. is tuned to one half the frequency of the crystal instead of to the same frequency. In this arrangement every cycle of the t.n.t. locks with every other cycle of the crystal oscillator. As a general rule, I personally prefer the driven method, but in this one case, of course, the Goyder lock is the only one which will work.

"My British friends tell me that the locked p.a. has to be a t.n.t. or t.p.t.g. However, I coupled a locking coil to one side of p.p. unity-coupled oscillator and found it would lock. I did not, though, try it on the air."

Wiping Out the Harmonic

Operating r.f. amplifiers at high efficiency means plenty of harmonic content in the output, usually. R.f. harmonics from the output stage do nobody good and can bring plenty of trouble down on unsuspecting heads. Many signals heard off-frequency are actually from transmitters whose intended output is on some lower-frequency band—which is really no valid excuse for off-frequency operation because it's up to the operator of the station to see that harmonics are suppressed. The following excerpt from a letter from B. P. Hansen, W9KNZ, outlines an inexpensive and satisfyingly simple method of wiping out the harmonic:

"One result of all this going over to crystal control is that the gang are using fairly efficient final amplifiers—high bias and excitation, low-*C*

tanks and high plate voltage—with the result that harmonics have been raising the old merry heck. The stunt shown in Fig. 3 is simple and wipes 'em out.

"The idea is simply to feed the harmonic into a trap circuit and let it do the old merry-go-round there instead of going up the flue and blocking somebody's receiver on the harmonic frequency—or getting into some nice AGSX in one of Uncle Samuel's monitoring stations. It works every time, and while in some cases it won't *completely* eliminate the harmonic, it will reduce its strength so much that it no longer bothers anyone. So far as I've been able to determine, low-*C* is better than high-*C* in the trap, probably due to better *Q* or something. An extension insulating handle about a foot long should be put on the trap condenser shaft to get away from body capacity. Also, the trap should be pretty close to the transmitter to prevent radiation of the harmonic from the feeder. Tune in the harmonic

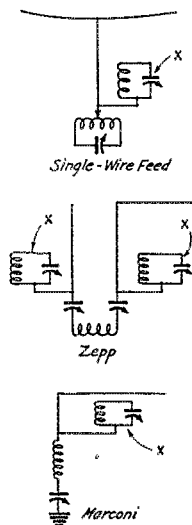

FIG. 3

on the monitor and, listening closely (with key down of course), tune the trap over the scale. As it passes through resonance, POOF! out goes the harmonic, and out it goes at the other fellow's receiver. That's all there is to it.

"Yes, I've heard of traps in series with the feeders and all that, but they invariably introduce losses and most fellows won't stand for that even though it means giving others something of a break. But so far as I've been able to see, this stunt doesn't react on the final amplifier at all—and even if it does the loss is so slight as to be negligible. I've tried tests time after time, while working all bands, with both local and distant stations, and the reports are invariably the same—no change in strength of fundamental signal and complete obliteration of the harmonic. I had a 20-meter harmonic from my 40-meter rig strong enough to get R-7 reports from the east coast, and could wipe it out 100% with this stunt."

While you're about it, it might be a good idea to pay some attention to the third as well as the second harmonic, especially if the output stage is a push-pull affair.



W9K—wants to know who plays the music on the Official Organ at W1MK.



STRAYS



The color coating on the neon Christmas tree lamps (no need to point out what a ham can use these lamps for) can be removed by dipping the lamp in acetone for half a minute. When the coloring is wiped off it is much easier to see the neon glow.

—W8CMW

A new edition of the RCA Radiotron-Cunningham Tube Manual, Technical Series RC-11, is just off the press. Besides giving complete operating conditions and characteristics, including the most important characteristic curves, on all standard types of receiving tubes, this 154-page book contains much interesting and valuable information of a general nature. There are chapters on vacuum-tube fundamentals—excellent reading and highly informative; on tube applications, including methods for securing automatic volume control and automatic noise suppression; on tube characteristics, in which the methods of calculating power output and other uses of the curves are explained; on tube testing; and there is also a section giving a considerable number of receiver circuits for all sorts of tubes, r.f. and audio systems.

The tube data in the book will be up-to-date for a considerable time, since a year's moratorium has been declared on the production of new receiving types. The new edition carries the same price as last year's, twenty-five cents. It is obtainable from RCA Radiotron-Cunningham at Harrison, N. J.

W5PY says that a pair of surgeon's forceps makes a most useful addition to the ham's tool kit. Besides being long and thin enough to get into those almost-inaccessible places, the forceps are provided with a locking catch on the handle by which they can be clamped on the nuts and screws which are forever slipping out of ordinary pliers. Your family doctor probably has an old pair which are rusted and of no value to him.

In a hidden transmitter hunt held in Philadelphia, W3QV located the transmitter, which was on 3.5 mc., in exactly forty minutes by taking four bearings and plotting the intersections on a large map. Second place was won by W3CTB, who arrived at the right spot in 55 minutes. The excellent work of these two fellows proves that it is not at all impossible for hams to locate those outlaws who appropriate other people's calls, provided they set about doing it.

Vibration in a copper-tubing coil can be squeelched by stuffing a rubber bath sponge inside it. The sponge should make a snug fit, of course.

—W7CTN

Those fancy "tune for greatest swing" meters which have a moving shadow for an indicator and sell for about six bits really set off the small transmitter whose owner cannot afford a flock of Westons. They can be used to measure relative amounts of excitation when put in series with the grid bias of each amplifier stage. Several different full-scale deflections are available. They can be adapted to tubes drawing heavy grid current by providing them with shunts.

—W6BCX

Here we have none other than W3JZ, well-known to ham conventions in the East as expositor of the deeper principles of things in general



and stuff in particular, in costume for delivery of enlightenment on the finer art of street cleaning before a civic club of his home town, Philadelphia. Woody is the figure at the left of the vehicle, his apostle in cleanliness being the dope at the right.

CORRECTION

An unneeded (and unwanted) connection between one tube plate of the 7-mc. transmitter and the junction of the antenna coupling coils appears in Fig. 1, page 22, October *QST*, in the article "Inexpensive Individual-Band Transmitters." The coupling between the tank circuit and the antenna should be purely inductive.

Northwestern Division Director Gibbons reports a Jr. op at W7KV.

• I. A. R. U. NEWS •

Devoted to the interests and activities of the
INTERNATIONAL AMATEUR RADIO UNION

President: H. P. MAXIM

Vice-President: C. H. STEWART

Secretary: K. B. WARNER

Headquarters Society: THE AMERICAN RADIO RELAY LEAGUE, West Hartford, Conn.

MEMBER SOCIETIES

American Radio Relay League
Associazione Radiotecnica Italiana
Canadian Section, A.R.R.L.
Ceskoslovenski Amatérí Vysilací
Deutscher Amateur Sende-und-Empfangs
Dienst
Experimenterende Danske Radioamatorer
Liga Mexicana de Radio Experimentadores

Nederlandsche Vereeniging voor Internationaal Radioamateurisme
Nederlandsch-Indische Vereeniging Voor Internationaal Radioamateurisme
New Zealand Association of Radio Transmitters
Norsk Radio Relæ Liga
Polski Związek Krotkofalowcow
Radio Society of Great Britain
Rede dos Emissores Portugueses

Reseau Belge
Reseau Emetteurs Français
South African Radio Relay League
Suomen Radioamatööritto r.y.
Sveriges Sändareamatorer
Unión de Radioemisores Españoles
Union Schweiz Kurzwellen Amateur
Wireless Institute of Australia
Wireless Society of Ireland

Conducted by Clinton B. DeSoto

Spain:

On January first a new call system goes into effect in Spain. No longer will we hear the familiar EAR followed by a numeral of two or three. Instead, the prefix will consist of two letters, EA, a district numeral, and two identifying letters, as has become common practice in other countries. Nine districts have been arranged, in conformity with the district representation in the U.R.E., as follows:

- EA1 Northwest region (Galicia and Asturias) and Castilla-León
- EA2 Basque region (Viscaya, Guipuzcoa) and Aragón
- EA3 Cataluna
- EA4 Central region (Castilla la Nueva and Estremadura)
- EA5 Levante region (Valencia, Castellón, Alicante, Murcia Albacete)
- EA6 Balear region (Mallorca, Menorca, Ibiza)
- EA7 Andaluza region (East and West)
- EA8 Canaria region (all of the Canary Islands)
- EA9 Marroqui region and all African possessions

Existing Spanish calls are to be converted into the new two-letter identifications by a definite system. The two letters following the district numeral in the new calls will be letters representing the same place in the alphabet that the old numeral formerly indicated, starting AA to AZ, VA to BZ, CA to CZ, etc. Thus EAR12 in Madrid will become EA4AL, Madrid being in the 4th call area and AL being the 12th two-letter indication. Other calls can be worked out in the same way.

TBTOC:

New members of this order are stepping up regularly and taking their bows. First came Henry J. Walsh, W1CPB, whose qualifying QSO's were with F. W. Miles, G5ML.

Nicholas C. Stavrou, W3AWB-W2DFN, worked across the Atlantic on three bands with Maxwell Whyte, G6WY. Mr. Whyte has also been in contact with W2CUQ on the three intermediate frequency bands.

The next two applications bring us up against an interpretation of the rule requiring that the qualifying QSO's be across an ocean. Does this mean that one of the major oceans must be entirely spanned, from continent to continent? Presumably it does. Yet the following instances are undeniably deserving insofar as the distance covered and the work done are concerned, even though they do not strictly follow this rule, and we therefore make mention of them as well.

Everett W. Mayer, K4KD, worked on three bands with J. H. Reynolds, VE3DA, more than two years ago.

The contacts between R. W. Collins, W8EUY, and Otis Hill, K6AJA, are equally interesting. Both a continent and an ocean were spanned and the greatest bedlam of interference on this earth pierced during these QSO's.

General:

New WAC record! On November 2d Charlie Perrine and Herb Becker, W6CUH-W6QD, worked the six continents in 1 hour and 58 minutes. The stations QSO'd were J1FF, ZS2A, VK6FO, W6MJ, G5YH, and OA4J. This feat climaxed three days of WAC activity. Inci-

dentally, Africa has been visiting Manhattan Beach regularly this year—108 QSO's with 27 stations so far, and the end not yet in sight . . . The R.S.G.B. has organized a Contact Bureau Group to deal with the problems of television, especially in connection with ultra-high-



MISS CHIYONO SUGITA, SISTER OF THE LATE J1DN, IS JAPAN'S FIRST LICENSED YL
As a special concession she was granted the call sign of her brother, who passed on recently. She will be on 7 mc. chiefly.

frequency work. Overseas amateurs interested in this problem are cordially invited to cooperate; write the R.S.G.B., 53 Victoria St., London, S.W. 1 We have just learned from Dr. J. M. Cruikshank, formerly VP2NA, of Nassau, that word has been received from the Secretary of State for the Colonies advising that the prefix for amateurs in the Bahamas henceforth will be VP7. Dr. Cruikshank's official call now is VP7NA. The VP2, which is replaced, was only a temporary assignment pending the final decision which has now been given A number of amateur prefixes will of necessity be changed when the governments of their countries ratify the Madrid convention, which reassigned several blocks of call signals. We urgently request that amateurs in these countries advise us as soon as any change is made, in order that the information can be passed on for the benefit of all The licenses of two Czechoslovakian amateurs, OK1KX and OK1FX, were cancelled for the relaying of a third party message recently, which action conflicts with the state telegraph monopoly. No warnings are issued in such cases, according to reports; violation of the regulations results in instantaneous revocation of the license

Amateur Radio in Poland

By Adam Gac, Hon. Sec'y, PZK

AFTER regaining its independence and after a successful war with Soviet Russia in 1920, Poland obtained a proper place amongst the great European powers. Although in some re-

spects we were much behind the great Western European states, as regards the latest scientific and technical research and achievements, however, we could from the start favorably compete with other nations, as equal with equal.

The first Polish scientists to study radio technique came from the Polish Army, in which an early interest in radio developed. Among these pioneers can be mentioned Lieutenant Engineer Machcewicz, prematurely deceased in Paris in 1923, and Lieutenant Engineer Groszkowski, at present the professor of radiotechnics at the Warsaw Polytechnic. His works on the cathode tube have appeared in a large volume which has been translated into many foreign languages.

In 1924 the first Polish broadcasting station was founded and in 1925 was established the first Polish factory for the manufacture of cathode tubes and all component parts for transmitting and receiving stations. From that time on we could look bravely ahead of us.

Progress in radio was followed by growing numbers of radio amateurs. The majority of them were demobilized soldiers of the radio-technical army corps, and boy scouts. In 1921 the first Polish amateur transmitting stations were established using long waves only. In 1922 and 1933 the number of radio transmitters increased to about a hundred, and short wave experimentation had begun. Such names as Trembinski, Hattowski, Piotrowski, the Danilewicz brothers, Lieutenant Göralski Heftman, Kruczkowski, Engineer Lubinski, Morzycki, Wysocki, Ziemiński, Ziembinski and many others, perhaps less known but also well deserving pioneers of Polish amateur radio transmitting, belong already to the history of our movement. Many of them participated in the First General Polish Radio Exhibition, in May of 1926, and exhibited their own creations. The jury of the exhibition awarded gold medals to the Danilewicz brothers and Messrs. Heftman and Wysocki, and the Ministry of War awarded them bronze medals.

At this time the first radio relay organization was being founded in Warsaw under the name of the "Polish Wireless Transmitters Club," and in 1927 was also founded the "Polish Radio Transmitters Club" in Poznan. At the beginning the whole movement developed very well; later, however, it was handicapped by the lack of proper governmental regulations. The laws of 1924 did not take into consideration the possibility of such a splendid development of the amateur radio transmitting movement and thus the activity of amateur transmitters was greatly handicapped, as the Ministry of Posts and Telegraphs, basing themselves upon this regulation, refused to issue licenses to the extended circles of amateurs, so that many of them worked in secrecy and illegally. In 1928 was founded the Polish Short Wave Amateur Radio Club, District Lwow; and in 1929, the Polish Short Wave Amateur Radio

Club, District Wilno; and also the Polish Short Wave Amateur Radio Club, District Krakow.

Although radio amateurs were associated in five clubs, their work was nevertheless haphazard, without proper assistance on the part of people and institutions which should and could have contributed towards the proper development and regulation of this movement, which had great importance both for the progress of Polish radio and for the interests of the Polish State. Left to itself as it was, the movement developed mostly in an illegal way and could not overcome all the difficulties of internal and external nature. The particular clubs did not coordinate their activity and they even competed between themselves because of an unhealthy local patriotism which, during a period of about two years, put obstacles in the way of the Polish transmitting movement.

It was only in 1929 that the Vice-Director of the Radiotechnical Institute founded in 1929, Professor Engineer D. Sokolcow, started to reorganize the movement on his own initiative and began concrete work in this direction. With assistance from the Ministry of War there was created a "Commission for Short Waves" which consisted of Colonel Engineer Zygmunt Karaffa-Kraeuterkraft, a special delegate of the Ministry of War, Major Engineer Goebel Kazimierz, the chief of connecting lines of the Ministry of War, and Professor Sokolcow Dymitr, a representative of the Radiotechnical Institute. This commission worked out the general organization of Polish short wave transmitting, adopted a plan of modification of the regulations to permit amateur radio stations, and also initiated the first general Congress of Polish Short Wave Amateurs, in Warsaw, on the 22nd and 23rd of February, 1930. To this Congress came the official delegates of all the existing amateur clubs, and all the problems of the movement were discussed.

At this Congress there was organized the *Polski Zwiasek Krotkofalowcow* (P.Z.K.) or Polish Radio Relay League, with headquarters in Warsaw. The Constitution stipulated that all existing clubs would automatically form branches of the P.Z.K. Officers were elected, including Prof. Dr. Eng. Janusz Groszkowski, director of the Radiotechnical Institute, president; Engineer K. Siennicki, vice-president; W. Cichowicz, secretary; and Prof. Dymitr Sokolcow, member of the board. The most important problems put before the newly elected board of the P.Z.K. were, first of all, the question of drawing up a list of the amateurs which were not associated with the new organization, and further, the question of modification of the regulations according to the suggestions of the "Commission for Short Waves." These matters were successfully settled after removing many difficulties.

In the constitution it was stated that the Polish

short wave movement would be represented before the central state authorities and abroad by the Headquarters of the P.Z.K. However, in 1929, the Lwow Club of amateur transmitters had applied to the I.A.R.U. to become its membership society from Poland, and thus a situation was created whereby the Lwow Club, although only a branch organization of the P.Z.K., represented Polish amateurs before the foreign organizations.

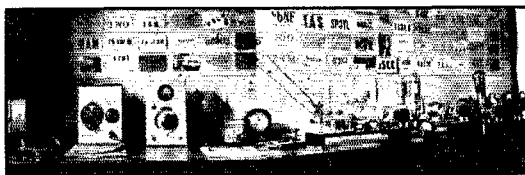

ZLIAR, FOUR-BAND TRANSOCEAN STATION OF L. M. MELLARS, AUCKLAND, WITH W6FFF

Contact has been established across the Pacific on the four lower-frequency bands. An attempt is now being made to QSO on 28 mc.

This was changed in 1932 and at present the member society of the I.A.R.U. is the P.Z.K.

Polish radio amateurs were represented in 1932 at the International Radiotelegraph Conference in Madrid by the present president of the P.Z.K., Colonel Engineer Karaffa-Kraeuterkraft, who during the Congress held several conversations with Mr. Warner and Mr. Segal, the delegates of the I.A.R.U., to whom he described the existing situation of the Polish relay movement and presented its future program.

In 1932 it was found necessary to reorganize our Union. With this aim in view, several meetings of the Constitution Commission were held, and at last a new Constitution was submitted to the General Meeting in 1933, which was accepted. This Constitution stipulates that the organization of the P.Z.K. be that of a federation of independent Clubs. The number of members has been increased to eight:

The Polish Radio Transmitters Club, Warsaw
The Lodz Radio Transmitters Club, Lodz
The Lwow Radio Transmitters Club, Lwow
The Krakow Radio Transmitters Club, Krakow
The Wilno Radio Transmitters Club, Wilno
The Czestochowa Radio Transmitters Club, Czestochowa
The Bydgoszcz Radio Transmitters Club, Bydgoszcz
The Poznan Radio Transmitters, Poznan.

Each member-club has its allotted territory, and the amateurs residing in each district must belong to its club. The clubs have their own statutes, under the terms of the P.Z.K. Constitution. This permits the development of the individual clubs, and at the same time makes it possible for the Headquarters of the P.Z.K. to look after the whole organization.

(Continued on page 32)

THE COMMUNICATIONS DEPARTMENT



F. E. Handy, Communications Manager
E. L. Battey, Assistant Communications Manager

Suggesting Further Interpretation of Signal Strength Scale

By William W. McLain, W8BOW-W8EXP*

SOME amateurs are dissatisfied with the present way of reporting signals, if *QST* articles are any indication. Most agree that many reports are meaningless. If one receiver is better than the next, or conditions permit better reception, the QSO with the ham who has the best receiver and the ideal conditions will bring in the most favorable reports. The copyability or readability of signals is, after all, the issue of greatest importance in carrying on communication. The present scale of QSA-definitions stipulated in the international regulations for indicating

QSA "The strength of your signal is . . ."

- QSA1 Hardly perceptible; unreadable.
- QSA2 Weak; readable now and then.
- QSA3 Fairly good; readable but with difficulty.
- QSA4 Good; readable.
- QSA5 Very good; perfectly readable.

signal strength might well be supplemented and given additional meanings based on an estimate of just *how much* of what is sent can be understood or copied. Such ratings of course would not apply to lid operators, but would apply strictly from the standpoint of *readability of signal* by the theoretically 100% capable operator.

A supplemental definition of the QSA-code for amateur work will clear up mistaken ideas and difficulties such as

*Official Relay Station, A.R.R.L., 100 Maple Tree Lane, Wheeling, W. Va.

Announcement to O.P.S.

THE first QSO Party for Official Phone Station appointees is also announced for dates of January 20th and January 21st. The Official 'Phone Station field organization appointment is now available to qualified 'phone station operators. See details page 37, November, 1933, *QST*. If interested write your Section Manager (address on page 5, *QST*) for application forms.

As of December first, about 40 'phone appointments had been made, reports on this received from only 18 of the League's 69 Sections. This is a remarkably good showing in view of the short time the application forms and certificates have been available, and augurs well for a good number of contacts, and an enjoyable activity in our first Phone QSO Party test in January. Many additional applications for O.P.S. appointment have been received and are being handled currently by S.C.M.s.

The first bulletin to those stations that have received Official Phone Station appointment will be sent from League Headquarters in January. This will include the complete list of phone appointees for use in the January operating activity. Copies of this bulletin will be sent to

arise when two different amateurs disagree (on the report they might make on the same signal at the same time on the same receiver), as is the case now and then. At the right of the following regulation definitions is a proposed supplemental interpretation of each. Thus used, "QSA3" loses the vague meaning, "fairly good, readable but with difficulty," or if it retains this, it in addition tells the fact that, under the existing conditions, "3/5 of what you sent, I received."

Use of such interpretation would save much unnecessary transmission. I have heard hams use "Most OK" in addition to a QSA-report. If there is much trouble from QRN-M it would be more understandable to come back at the start of the transmission with QSA3. With suitable interpretation, a better general understanding will be made possible, and superfluous words and conversation actually eliminated. This same idea of supplementing our

Interpretation

- 1/5 of what is sent is received. (20% or less)
- 2/5 of what is sent is received. (approx. 40%)
- 3/5 of what is sent is received. (approx. 60%)
- 4/5 of what is sent is received. (approx. 80%)
- 5/5 of what is sent is received. (100%)

QSA Code might also be used to substitute for or replace the R-system of indicating audibility. In this case a signal which is *the loudest one can possibly receive* should receive the report R9, and all other reports for any given receiver will mean that the signal is in some ratio to this "ultimate" response of which the receiver is capable. Thus, when a signal is 1/9 as loud as possible, it will receive the report R1; when it is 2/9 as loud as possible it will receive the report R2, and so on. Try this plan, and see if you don't receive more satisfaction from truly accurate reports.

new appointees as rapidly as their addresses are received from Section Managers.

January 20th—21st—Announcement for O.R.S.

THE next quarterly QSO contest for O.R.S. only is the Tenth O.R.S. QSO Party, and will be held January 20th/21st. The official and up-to-date list of O.R.S. and stations eligible to take part will be mailed all appointees just before the dates of each contest period. Non-O.R.S. may make application for appointment by writing the proper S.C.M. (See address page 5 this *QST*.) The qualifications for O.R.S. appointment are indicated in the new *Handbook* and in the "Rules and Regulations of the A.R.R.L. Communications Department," the 1934 (new) edition of which will be sent to any A.R.R.L. member requesting same on a postal.

In the January O.R.S. Party the Fort Wayne Radio Club, W9LWK, announces that it will present the winner of the contest with a 3.5-mc. band crystal, ground by W9BKJ.

Highest Scores—October O.R.S. QSO Party

This get-together of all O.R.S. was the second largest since radio activities of this nature were announced. Forty Transcon messages were started, about twenty from each coast, and added to the "doings," several making excellent time. Typical of the comments received were: "One of best times in three years ham radio. Can hardly wait until Jan. for next party.—W7AYV." "Will give the winner a run for his money next time." "Enjoyment beyond words . . . the thrill of the contest . . . working one skilled operator after another.—W6JAL." "W7BVE worked 3 ORS in last ten minutes." "Handled 1000 words with KA1XA during ORS Party.—W6AM." "Renewed old and added new acquaintances at W7QY." "Will bet a stack of 1919 QST's I win the next contest.—D.R. W9—" "Had a heck of a fine time. W8FTW, W8CEU and W8DYH also at W8DZ." "Parties are getting FB. Was called by at least seven non-ORS to unload traffic, because I signed ORS.—W9AUH." "Couldn't let a good old party go by with me not in it. Win, lose or draw, let's have more of 'em." W9AUH led, working 133 stations in 42 Sections, and logging 52 other O.R.S. The highest scores, of the several hundred participating stations:

W9AUH	24,528	W1MK	8070	W8GBC	6100
			(ev)		
W1YU	11,028	W8BGY	7742	W3ADE	5742
	(bob)				
W3ZD	9960	W9IYA	7656	W2DQK	5720
				(& W2BIN op.)	
W3SN	9660	W8EUY	7650	W8KD	5600
W9ETT	8850	W9ICN	7632	W9AET	5439
W9YB	8808	W8DZ	7475	W1BFT	5360
	(dr)				
VE3GT	8736	W9KKG	6500	W6BHV	5258
W1AFO	8658	W9KJR/OOS	6123	W2EKM	5103

Byrd Antarctic Expedition—KJTY-WHEW

NY1AB, Darien, C. Z., maintains a twice-daily schedule with KJTY, the *Jacob Ruppert*, and daily schedule with WHEW, the *Bear of Oakland*, and handles about 30 to 50 messages daily with them. This information comes via W9BLG. We are also advised that all amateur traffic from the Byrd Expedition for the states is now coming through NY1AB. W9BLG, W9NMR and W3CXL have regular schedules with NY1AB and clear the traffic from him. When KJTY and WHEW have difficulty in making contact, NY1AB acts as an intermediate, or relay point between the two ships. A. H. Waite, Jr., W1DTL, is now Chief Operator of the *Bear of Oakland*, and he and Dick Watson, W1BGL, keep WHEW humming. Latest word received from Operator Waite states: "We shall try to test with all hams calling us on 7-mc. band between 10:30 and 11:30 p.m. on Mondays and Tuesdays. We will be on about 8280 kcs. . . . about half way between CKS and WCC on the 36-meter channel."

Traffic Briefs

W6CUH-QD says conditions were unusual on Oct. 31st. Nov. 1st and Nov. 2nd, days on which he was trying for a WAC record. Also, "the times for each day were 7½ hrs., 6 hrs. 20 min., and finally 1 hr. 58 min., breaking G5BJ's 2 hr. 5 min. record—the best world record to our knowledge. Best U.S.A. was W6FYT 2 hrs. 25 min. Those worked for the record were J1FF, ZS2A, VK6FO on 7 mc., and W6MJ, G5YH and OA4J on 14 mc., from 6.55 to 8.53 a.m. PST."

KAINA has been heard regularly on several Sunday

morning tests at W2BSR, Riverhead, L. I., N. Y. QSA4 R4 on Nov. 5th, 7 mc.

ON4CSL is an American and the only active ham in the Belgian Congo. W2BSR schedules him Saturdays. VE3GT and W2BSR both report South Africans rolling in FB on 14 mc. starting right after noon daily. W2BSR mentions ZS4M, ON4CSL and ZS1H as particularly outstanding.

W1BLV, Woonsocket, R. I., reports hearing ZL2FR and ZL2NY at about 2:30 a.m. E.S.T. for three consecutive mornings on 3900 kcs. during late November. PA0ASD works 'phone and c.w. on 3770 kcs. and is attempting two-way work with W and VE hams at 0400 Greenwich every Sunday morning. He reports hearing dozens of W/VE stations on the 3.5-mc. band.

KHEVE-VE3GT QSO

After obtaining special permission to use 36.2 meters, VE3GT on July 25th maintained successful communication with Commander Frank Hawks' plane, NR-12265, radio call KHEVE, over 250 miles of the Commander's non-stop flight from New York City to Regina, Sask. KHEVE was flying at 10,000 feet! VE3GT-KHEVE established two-way contact soon after 2:40 E.D.S.T., and constant communication was held until 3:58 p.m. when Comdr. Hawks advised that he was averaging 193 m.p.h. and was over Lake Huron. BE3GT transmitted weather reports and other data through the cooperation of the Meteorological Service of Toronto. W1FGV advises that Comdr. Hawks is a radio amateur, and that W1EMV schedules KHEVE.

With the arrival of 1934 don't forget to start a new series of numbers on your originated messages. The systematic operator uses a "number sheet" crossing off each number as used.

"Q Code" changes effective January 1, 1934 (with the Madrid Convention), were run on page 55, December QST. A complete Q Code list appears in the 11th edition of the Radio Amateur's Handbook, the 1934 edition.

The Lancaster Short Wave Club, A.R.R.L. affiliated club at Lancaster, Pa., held a QSL Contest from October 1 to October 15, 1933. The object was to see which club member could receive the greatest number of QSLs confirming two-way communications during that period. W3CHV was first prize winner (a year's A.R.R.L. membership) with 75 cards to his credit. W3DVH with 74 cards, and W3AAI, with 58 cards were in second and third place. An "SWL" Contest for unlicensed members held in conjunction with the QSL Contest was won by Richard Ford.

RADIO OPERATOR EXAMS

Cleveland, Ohio, December 28, 29, 30, 1933—Examinations for radio operator licenses will be conducted in the Civil Service Examining Room, Federal Building, Cleveland, on each of these dates beginning at 9 a.m. and again at 2 p.m. The morning of December 28 is reserved for commercial operator examinations.

Kansas City, Missouri.—Examinations are given in the Federal Building, K. C. the first and third Friday and Saturday of each month. If examination is desired at any other time write the Radio Inspector in regard to specific dates.

St. Louis, Missouri—1934 Examination days: January 26, 27; April 27, 28; July 27, 28; October 26, 27.

Des Moines, Iowa—1934 Examination days: February 23, 24; May 25, 26; August 24, 25; November 23, 24.

The dates given for each month fall on Friday and Saturday. In each case commercial and amateur examinations will be given on Friday, but only amateur examinations will be given on Saturday. All examinations begin at 9 a.m.

BRASS POUNDERS' LEAGUE

(October 18th–November 15th)

Call	Orig.	Del.	Rel.	Total
W9BMA	39	210	2844	3093
W6PQ	942	420	532	1894
W2DIU	326	218	1324	1868
W6ETL	266	312	858	1436
W9KG	28	335	864	1227
W9ZZAF	167	90	940	1197
W2BCX	102	54	1006	1162
W6BMC	19	27	1086	1132
W9ESA	19	63	985	1067
W9KJY	66	100	850	1016
W5BMI	7	138	864	1009
W8GXM	91	204	668	963
W6GUF	16	47	838	901
W7WJ	81	129	618	828
W9JZY	56	60	682	798
W4AFM	33	25	722	780
W9ERS	342	175	230	747
K6FAB	75	10	662	747
W5AYZ	40	17	600	657
OM1TB	214	114	310	638
W3ALX	221	106	307	634
W6DQN	21	27	546	594
W8GZ	36	100	446	582
KAINA	226	69	280	575
K6AUQ	91	58	426	575
W2EKM	41	102	417	560
W9KEH	129	23	406	558
W2BLU	50	50	450	550
W9BKX	51	48	450	549
W8JAK	104	38	377	519
W8FJN	63	60	394	517
W6GQC	106	89	318	513
W9BLG	129	346	36	511
W6GNM	116	60	330	506
W9KNZ	33	51	417	501

MORE-THAN-ONE-OPERATOR STATIONS

W9BNT	363	503	2206	3072
W3CXL	420	464	1686	2570
KAIHR	242	230	998	1470
W5BYY	2	3	1146	1151
K6EWQ	257	229	608	1094
W9USA	894	33	66	993
W5VT	905	2	—	907
W5OW	153	153	600	906
W3BKQ	150	130	450	730

These stations "make" the B.P.L. with totals of 500 or over. Many "rate" extra credit for one hundred or more deliveries. The following one-operator stations make the BPL for delivering 100 or more messages: the number of deliveries is as follows: Deliveries count!

W7WY, 349	W6AZU, 176	W1YU, 112
W9NMR, 220	W1AMG, 122	W3CL, 109
W2ELB, 187	W3BWT, 118	W6BWF, 104
K6AJA, 178	W1CAB, 117	More-than-one-opr.
W6ALU, 177	W8BIN, 116	W1MK, 114
	W9NP, 115	

A total of 500 or more, or just 100 or more deliveries will put you in line for a place in the B.P.L. Make more schedules with reliable stations. Take steps to handle the traffic that will qualify you for B.P.L. membership also.

O. B. S.

The following is a supplement to the list of A.R.R.L. Official Broadcasting Stations in September QST (page 44): W1ASY, W1DQK, W2DIU, W2EIC, W2LU, W3AE1, W5ADZ, W5BZT, W7AFC, W8IWT, W9CJR, W9GFC, W9HRB, W9IQZ.

Traffic Briefs

The Federal Radio Commission is cancelling licenses for failure to acknowledge "discrepancy reports" and for failure to correct whatever discrepancy is reported. Upon receipt of discrepancy reports it is necessary to make reply to same in accordance with F.R.C. rule 24 on the forms provided for this purpose, stating what corrective steps have been taken. Immediate correction will prevent further embarrassment and possible cancellation of licenses.

An Illinois Traffic Net has been organized under the leadership of ORS W9KJY, Glen Ellyn. At this writing 36 stations are included, representing nearly as many Illinois cities. Outside schedules and Trunk Line connections hook this net into the national network.

Raymond Goodrich, W1BWK, is laid up in the hospital with a broken back. It is suggested that the gang send him a word of cheer. A QSL card or letter from any of the gang would be much appreciated. Address Raymond Goodrich, W1BWK, Care of North Adams Hospital, North Adams, Mass.

Late evening November 22d W8ZY gave W1SZ a message originating in Jamaica. It was dated the same day and its nature made it imperative that it be put into New York City as soon as possible. The next morning it was given to W2CHK on 3.9 mc. phone, but the addressee could not be located at the address given. The message referred to relatives in Buffalo, N. Y., so W8ADR in Medina, N. Y., was recruited to help out at that end. Within an hour W8AWK at Buffalo had been given the information, and the Police Department in Buffalo put out a broadcast to the relatives. This was all accomplished in less than three hours from the time the message started that morning; delivery was effected one day after origination!

During the last week in October, 1933, the University of Colorado Radio Club, Boulder, Colo., gave a demonstration of a complete amateur radio station operating under the call W9NRA. The equipment, installed in a store window of the J. C. Penney Co. in the center of the town, was in operation for about 18 hours daily. Over 60 messages were handled and several foreign countries contacted. The local paper, *The Boulder Daily Camera*, cooperated in giving publicity.

The Houston Amateur Radio Club had a booth at the South Texas Exposition October 27 to November 5, 1933. On the night of October 27 the club transmitter was put on 7 mc. and was dedicated by Mr. J. H. B. House, Mayor protem of Houston and by Mr. Laird of the C. of C. over station KXYZ. The time for this broadcast was donated by Frank Smith, W5VA, chief engineer at KXYZ.

OK1AW works a 30 watt c.c. rig on 14,098-kc. almost daily between 1300–1500 and 1700–1800 Greenwich, and would appreciate reports from DX points.

"CQ TFC" is the general call used in the GENERAL TRAFFIC PERIOD—6:30–8:00 p.m. (local time). Use this period to move your traffic through reliable stations. Operators who sign "ORS," "TLS," "RM" or "SCM" after their call are sure to be "reliable." The very use of "CQ TFC" by any operator indicates an interest in reliable traffic work. Cooperate with the stations using the TRAFFIC HOUR!

Relative Standings of the Ten Highest Sections—October-November

Messages Per Station (25%)	Stations Reporting Traffic (25%)	Gain or Loss (Traffic Reports) (25%)	Traffic Total (25%)	Standing Based on Average of All Four Ratings %	Section Communications Manager
M.-D.-D. C. 309.3	Los Ang. (680)* 96	N. V. C.-L. I. +40	Ill. 6055	Missouri 50.	Cannady, W9EYG
Hawaii 266.2	Mich. (624)* 78	Kansas +21	Los Ang. 5562	Los Angeles 47.5	Martin, W6AAN
P. I. 257.7	N. Y. C.-L. I. (1511)* 76	N. N. J. +14	Mo. 5392	N. Y. C.-L. I. 45.	Baunach, W2AZV
Nebr. 225.8	Wash. (374)* 68	Mo. +12	Nebr. 4510	No. New Jersey 42.5	Cobb, W2CO
La. 195.7	Ill. (890)* 65	Mich. +9	N. N. J. 4348	Illinois 42.5	Hinds, W9APV-WR
San Dle 181.1	Mo. (324)* 61	N. Texas +7	P. I. 4124	Michigan 37.5	Conroy, W8DYH
Colo. 164.9	Va. (150)* 60	Iowa +7	E. Pa. 4071	Nebraska 35.	Wallace, W9FAM
N. N. J. 144.9	Ohio (868)* 63	W. Va. +7	M.-D.-D. C. 4021	Philippines 32.5	Thompson, KAIXA
E. Pa. 135.7	Oregon (260)* 42	Alabama +7	Hawaii 3994	M.-D.-D. C. 32.5	Hudson, W3BAK
Ark. 130.1	W. N. Y. (563)* 41	Illinois +6	Kansas 3611	Hawaii 27.5	Slaten, K6COG



MISSOURI climbs up into the Banner position this round, closely followed by L. A.; N. Y. C.-L. I. places a good third. For the October-November month we can report a gain of 125 in "stations reporting traffic." The following Sections lead all other Sections in their Divisions, order of listing showing relative standing of their different Divisions: Mo., Ill., P. I., N. N. J., E. Pa., La., N. Tex., Conn., Ore., Colo., S. Minn., B. C., Ala., Va. During the October 16th-November 15th month 1617 stations Originated 21,970; Delivered 19,660; Relayed 72,038; Total 113,668. (89.9% Delivery.) (70.3 m.p.s.)

* The Section A.R.R.L. membership (approx.) is shown parenthetically, so that the degree of traffic reporting activity may be indicated by comparison.

Traffic Briefs

W1FIL, installed and operated by W1CRP and W1CPT, was in operation the latter part of November, 1933, at the Maine Progress Exposition, Portland. The transmitter was a breadboard rig using a '24 e.c. oscillator and '46 final. With only 15 watts input stations were contacted all over New England, New York, New Jersey, Penna., and in Canada. 247 messages were started on their way. Local Portland amateurs, W1CHF, W1CPT, W1DIJ and W1DEO, took some of this traffic to their own stations and handled it from there. W1VS, West Medford, Mass., took over 75 messages direct from W1FIL, and handled many more which he picked up from other N. E. amateurs. W1BLV, W1ERQ and W1BE also helped by taking a string.

While Cecil B. DeMille, well-known movie director, and a company of 87 people were in Hilo, Hawaii, filming "Four Frightened People," K6AJA maintained a schedule with W6BWF, Hollywood, handling several hundred messages.

On November 4, 1933, the Hannibal (Mo.) Amateur Radio Club honored its secretary, W9FGJ, on the occasion of his leaving for Nashville, Tenn., at a farewell party in the form of an "all-night QSO party." The eighteen amateurs present were: W9CWG, FNT, ECZ, DZF, OAB, FAU, AEX, FLD, EET, CCU, EFZ, FSZ, HSZ, FSB, GBC, HBJ, IRR, and the guest of honor W9FGJ.

The Los Angeles Section Quarterly Banquet will be held January 20, 1934 starting at Noon at the Masonic Temple, 200 S. Euclid Ave., Pasadena, Calif. The ladies are particularly invited, and provisions will be made to entertain them. Technical talks, door prizes, raffle and plenty to eat will round the program. This Banquet is sponsored by the Federation of Radio Clubs Southern California and is being given under the auspices of the Pasadena Short Wave Club.

The Ogle County Radio Traffic Association (Oregon, Mt. Morris, and Polo, Illinois) lists among its members a doctor, a druggist, and an undertaker. One member has a station license issued on Valentine's Day, another issued on April Fool's Day, and his operator's license issued on St. Patrick's Day! Further, a member has a 7 mc. Zepp, 50 ft. high with both 65 ft. top and 35 ft. feeders of 1/4 inch copper tubing. What a club!!

ATLANTIC DIVISION

EASTERN PENNSYLVANIA—SCM, Jack Wagenseller, W3GS—W3ALX has been appointed RM to assist MC. W3ADM and EZ are new ORS. W3ADX and W3FKO report for first time. W3ABT, Univ. of Penna., has five new ops. W3CHU reports in person. Over 200 hams attended FB Hamfest held by Chester Radio Club, W3BKQ. W3CPV has MOPA. W3CFF has first-class BC ticket. W3EOH is Army NCS. Skip spoiled schedules for W3CL and AQN. W8IWT got R3 in Richmond; found ant. on roof! W8FLA visited W8VD. W3AKB visited Washn. and was taken through WAR and NAA by W3CXL. W3DXQ has pair '03As in final. W3MC has new 50-watt rig. W8CVS is ready for ORS. W3AGK rebuilt. W8CMF is putting c.c. '52s on 7 mc. W3OK is QRL Army Net. W3DWZ joined Army Net. W3ERA is at Lafayette College. W3ECM has SS Super. A new radio club, the Allentown Amateur Radio League, has been formed; W3CNZ pres., W3EYV vice-pres., W3DOV secy.-treas. Club has 13 members to start. Results of contest not until next issue QST. Heartiest greetings to the gang.

Traffic: W3BKQ 730 ALX 634 OK 371 CL 334 AKB 242 ADM 213 ABT 161 EZ 151 AAV 142 AQN 127 ADX 118 ADE 56 MC 55 AZF 50 GS 47 EDA 26 DIJ 25 DXQ 20 DWZ 10 CPV 7 AGE 4 CHU 3. W8FLA 168 CVS 115 VD 103 EOH 77 FKO 44 IWT 22 CFF 14 CMF 2.

MARYLAND—DELAWARE—DISTRICT OF COLUMBIA—SCM, E. L. Hudson, W3BAK—RMS, W3SN—W3CJS—W3CQS. Chief RM, W3BWT. Reports are welcomed from all stations in the Section. District of Columbia: W3CXL and BWT make BPL. W3BWT is being heard in Russia, France, ZL and VK on 3.5-mc. rig. W3DML is doing fine work. W3CWE is QRL college. Maryland: W3BGI is putting up new sky wire. W3CGK is building new 1.7-mc. 'phone. W3SN is QRL Red Cross work. W3BND burned up a crystal. W3CDG is getting fine list of schedules working. W3CQS and ADP attended Washn. Hamfest. Delaware: W3DPA has fine 'phone. W3BAK has 50-watter in final.

Traffic: W3CXL 2570 BWT 488 SN 395 BND 181 ASO 111 BAK 59 CDG 54 BGI 40 BHE 8 IL 2 CTD 69 CIZ 25 DML 19.

SOUTHERN NEW JERSEY—SCM, Gedney M. Rigor, W3QL—W3DSC fell off roof and broke his right arm putting up a zepp. W3APV is new RM. W3UT is on 56 mc. W3ATJ is getting out well. W3BYR went to "Chi," sent a message to the SCM, which was delivered next night, less than 24-hour service! W3BEI is DXing. W3AWL had new frequency meter. W3BDO reports Atlantic Radio Club has 37 members. W3DRP put a good choke in by order of FRC. W3AEJ handles his usual total. W3AVJ handled transcon ORS message. W3CWL joined A.A.R.S. W3ZI reports gang of hams en-

listing in Trenton in 112th Field Artillery. W3CQO is our first OPS. W3ZX and BGP also get OPS. W3BGP is chief opr. at WCAM. W3AYA reports Cape May County Club getting under full swing. W3PC has gone to Fla. W3DNU and CLW want ORS.

Traffic: W8AVJ 5 AOV 34 CQO-ATJ 2 CWL 73 AEJ 16 DRP 5 BDO 4 ZI 22 APV 55 AWL 8 KW 12 BEI 4 DNU 8 QL 14 BYR 3.

WESTERN NEW YORK—SCM, Don Farrell, W8DSP—W8GZM is new ORS. W2BIN and W2DQK are QRL at Cornell. W8BGO reports his '03A is over ten years old. The Mohawk Valley Brasspounders purchased an FB-7. W8ENZ resolves to use nothing but split stator condensers in P.P. r.f. amplifiers. W8AWX is on for OBS schedules. W8SU (Andrew C. Dreier) was drowned while fishing in Sodus Bay, Nov. 11th. His loss will be greatly felt in the Section. W8AXE says skip is terrible. W8GPU is working all hands. W8ETH uses a pair of '10s P.P. W8EDA has 211 final. W8JUO has a '46 rig on 1.7-mc. 'phone. W8GBK has stopped 56-mc. experiments for time being. The Rochester Club had a booth at Electrical Show. New hams in Rochester: JNE, KMQ, KXW. W8SF is working at WHEC. W8CID passed radiophone exam. W8BSL is at WPDR. W8ERU is handling traffic on 'phone. W8EBK has new SW-3. W8BWW QTA'ed all schedules account of sickness. W8FDY is back at Waterville. W8FSY is high 'phone traffic man. W8AFM secured first OPS in the Section. W8BR is getting the rig dusted off. W8FTB is a member of Boy Scout Amateur Radio Net. W8GWY is interested in RM appointment. W8BQJ shot a nice black bear on a hunting trip. W8EET has FB-7. W8BEN is all set for Sweepstakes contest. W8DMJ is busy fixing up all the aches and pains common to this time of year. W8FYF is QRL school. W8DHU has new c.c. rig. W8EMW has pair of 50-watters. The S.T.T.A. had a fine hamfest with attendance of 61. Talks were given by Karl Brandt (Veteran Operator), W8AJ and the SCM. W8GWT has nice schedules. W8GWZ is going strong on 14-mc. 'phone. W8FUG reports regular amount of traffic. W8CJJ wants Florida traffic. W8EUY is building a tri-tet. W8BOL has good Canadian schedules. W8FMX has a new pole. W8DBX purchased a new house. W8GPT reports traffic. W8JTT handled traffic with K6AUG. W8JAK is high traffic man. W8HVS is handling a lot of traffic. W8BFG is on 14 mc. The S.T.T.A. is having winter meet and feed at W8BHK's place on Lake Keuka. W8DSS now has more time for radio. W8AGS' FR-7 stopped perking. W8DME spent the summer at his Owassa Lake camp. W8DHQ has new impedance coupled transmission line to his antenna. W8IDJ is on 7 mc. W8BJO is at new QRA at Fulton. W8CQW turns in nice traffic report. W8FHL is on in the "woe" hours. W8ACK has FR-7. W8BDC is on with pair of '10s. W8DES is at CC Camp in Alabama. W8SER is working nights and sleeping days. W8DSP is building a 200-watt rack and panel 'phone for W8FMH. Starting Feb. 1st the SCM will be on every Sunday a.m. from 9 a.m. to 11 a.m. for the purpose of working any stations who are interested in obtaining A.R.R.L. appointments. Frequency 3826 kc. Want ORS: W8KMC, GPR. First reporters: W8GHQ, DXO.

Traffic: W8JAK 519 DSS 71 BWY 52 IDJ 60 FSY 112 HVS 100 EBK 32 GWY 27 BQJ-DMJ 10 FFF 13 DHU 44 FMW 60 GWT 32 FDY 47 FUG 36 CJJ 46 EUY 13 BOL-DBX 11 GPT 21 KMC 22 JTT 12 GZM 54 BAL-CQW 34 GPR 13 DME 28 BHK 16 AFM 7 FTB 5 GWZ 2 DXO-BGO-ERU 5 DSP 3 BFG 7 DHQ 11 AGS 6. W2BIN 14 DQK 2.

WESTERN PENNSYLVANIA—SCM, C. H. Grosarth, W8CUG—W8GUF's schedule with W9USA puts him on top. W8YA is troubled with skip. RM W8GBC is giving 1.7 mc. a workout. A.A.R.S. keeps W8DYV busy. W8FZG is new ORS. W8IPL landed a job in a brewery! W8CCD finds it harder to get the bugs out of his second-hand car. W8GRZ says things going better in Uniontown. W8CQA joined NCR. W8CGX gives good account of himself. W8IQB pounded lot of brass during QSO contest. W8KWA tells us about Midnight Fat Chewers Assn., a swell gang of Sewickley and Coraopolis boys. "Still re-

building," says W8CMP. W8KQQ changed to c.c. W8HMJ made a lot of new friends during the contest. W8FRA, AEG, GRY and FPD report by radio. W8FTP says there were too few stations in QSO contest. W8GXU finds "Comet Pro" an improvement over his old receiver! W8DLG will be on by Xmas. W8CMT likes FB-7. W8FSZ has been after 14-mc. D.X. W8KXP is new ham in St. Mary's. W8IOH visited W9USA. W8IFY is working 7 mc. W8IOI is rebuilding for 1.7 mc. W8HGG reports football activity. W8GJM and ABS applied for OPS. W8CUG has been busy with contest reports; next issue of QST will show the winners.

Traffic: W8GUF 901 YA 348 CUG 202 GBC 192 DYV 116 FRA 92 FZG 88 CCD 80 GRZ 63 CQA 48 CGX 32 IQB 26 KVA-CMP-GRY 24 KQJ 17 HMJ 9 AEG 7 GXU-FPD 4 HGG 300.

CENTRAL DIVISION

ILLINOIS—SCM, F. J. Hinds, W9APY-WR—RMs: Chief W9DDE, W9CRT, W9ERU. W9KJY and DDE have organized an FB Illinois Net. W9KEH's trunk lines are well greased. W9AVB wants to be OPS. W9AAJ is new ORS. W9NRV finds 3.5 mc. FB for traffic. W9MAJ keeps excellent schedules. W9MKS says "three cheers for high power." W9SG gave up his ISG call. W9IXN of Greenville, Ky. wants a good 'phone for the Chicago end of his Florida to Chicago 'phone relay trunk line. W9HPG states the C.R.T.A. is going strong. W5DFE has his rig on at Peoria—thanks to W9LF. The Lewis Radio Club has membership of W9AOT, AGF, GJC, GGV, GPF, HUS. W9IYA's schedules work like clockwork. W9LZU says KJY has started him to work on traffic. W9LOJ has new superhet. W9FYZ, CGV, KJX and GSB are doing fine A.A.R.S. work. W9EVJ has six excellent schedules daily. W9NWJ is recovering from a broken arm. W9VH has 1.7 mc. 'phone under call NKC. W9DOU/WLT says we need some good A.A.R.S. stations between Chicago and Mississippi River. The Egyptian Radio Club has W9AIU going in new clubhouse. W9LEP and LNI visited HUX, ACU, LQQ, AOV, OOO and FXE. W9RO is playing with 'phone. W9KUM is back on the air. W9FVJ and DNA are YLing. W9MKK is good ORS. W9JCG wants to be chief reporter for his section. W9JQM has 211s in PP. W9ICN takes off antenna for local QSOs. W9BXL was heard in England on 3.5 mc. W9HHQ is on 1.7 mc. 'phone. W9OJX has private line for the transmitter. W9GVQ and IUU left for Reforestation Camp. W9IBC has new receiver. W9PFX is a new reporter. W9GSB received Marconi's autograph while he was in Chicago. W9HUX increased power. W9ASZ has '10 final. W9ACU is working 14 mc. and 4 mc. 'phone with his '12A. W9AAK's receiver needs new tubes. W9EXB has a steel racked affair. W9KOQ is building 56 mc. rig. W9KHD is putting in 50 watt crystal. W9ERU says NCR enlistments will be held in Rockford soon. W9EWW is moving to new quarters at Gen'l Del., Lewisburg, Penna. W9FOC has good schedules. W9FXE is still grinding crystals. New 211 P.P. rig at W9MRH. Boy—have you heard W9MYH's new 'phone? W9MPLY, MDL and OVV are doing fine traffic work. W9MNB has new c.c. rig. W9MIM blew his '02s. W9MTO has parasitic oscillations. W9MCK says he will make the BPL yet. W9MBQ and MIN want traffic. W9CKC says QSB is bad on 3.5 mc. W9DJG was pleased to have KAISL visit him on his way to West Coast. W9CZL reports DX and traffic picking up. Rebuilding: W9JQ, BPP, W9PCJ is building 1.7 mc. 'phone.

Traffic: W9KJY 1016 USA 993 JZY 798 KEH 558 DOU 432 ILH 360 EVJ 202 IYA 179 LZU 163 MCK 154 MDL 119 FYZ 112 FCW 97 MLH 89 IEP 88 FOC 65 CGV 47 ICN 37 GSB 36 DJG 33 CZL 32 MAJ 31 MRH 25 70 24 CUH 23 DXZ 22 HMB-HPK 19 DBO 18 MIN-MKS 17 OVV 16 JCG 15 ISG 14 EMN-IWP-KHD-LOJ-LZF 13 NRV 11 AAY 10 MNB-MTO 9 AVB-KJX 8 CKC 7 DZU-GYP-WR 6 FXE-KOQ 5 AAK-FO-MBQ 4 FTX-FWD 3 HPG-HUU-IBC-KA-LNI 2 ASZ-HUX-PFX-VH 1.

INDIANA—SCM, Arthur L. Braun, W9TE—W9AEB is working 14, 7, 3.5 and 1.7 mc. W9AKJ is returning

from Mich. W9AXH has a WE203B modulation indicator. W9BTR uses low power on 815 mc. W9CHA is arranging schedules. W9DET is trying to get local club in full swing. W9DJJ has new 'phone rig. W9DJU joined A.A.R.S. W9DPL of Huxley, Iowa is on air at Valparaiso. W9EGV says skip getting the best of schedules. W9EPT departed to 7 mc. W9GFS is getting ready to send code practice on 1948 kc. W9HPQ has a new pole. W9HML keeps plenty of schedules. W9HSF will use portable at Ind. Tech. College. W9HTX is coming on with pair of '46s. W9HUV is doing FB job as OO. W9JJA has FB7A. W9JOQ is c.c. W9KDK reports for first time. W9MQQ has street car QRN. W9MPR rewired his rig. W9OMS blew a transformer. W9QG likes his 5-band receiver. W9JHY wants OPS. W9GGY is QRL Purdue. W9KYM has new ant. and new rig. W9LLV lost his job. W9JKK got a job. W9JYV has new receiver. W9KKZ is getting 1.7 mc. 'phone ready. W9GNY has buffer trouble. W9MQ has c.w. rig on the air. W9HTP is QRL work. W9OFA wants c.c. rig. W9OLP is coming on with pair of '45s. DXers: W9HIU, KDD, KPD, JTU, IKX, MNL, MBZ, TE. Rebuilding: W9FQ, RS, DAN. W9LWK blew a '10. W9NCT needs parts. W9DGC reports for first time in 7 years! W9FJG is building new receiver. W9KDW moved to St. Louis. W9CNG is moving rig into the house. New stations: W9PIJ, PGT. W9FYB is going strong in A.A.R.S. W9LMD is on regularly. W9BDE says business is getting better. W9AHL is experimenting with photo work. W9ARK gets out FB with new rig.

Traffic: W9YB 236 EGV 251 MBG 201 AET 141 MQQ 95 JJA 50 MMY 63 HML 53 HBK 38 JRR 40 HSF 23 TE 14 HTP 12 LLV 16 HIU 8 NCT 2 MPR 7 OMS 2 KDD 1 DGC 7 QG 6 KDK-JOQ 7 HUV 12 HPQ 7 DJJ-DJU 21 NCC 5 EPT 15 EGQ 8 DPL 6 AXH 8 DET 5 GFS 4 CHA 2 AEB-FQ 1.

KENTUCKY—SCM, Carl L. Pfumm, W9OX—W9AUH cops high honors in 3-month KY QSO contest. W9CNE consoles himself with second prize of one quart OXBZ. "Down but not out" with diphtheria reports W9CIM. W9KKG uses 1KW input. W9BVJ dreamt he won KY QSO Contest! W9OPV, ex-WSEL, is new ORS. W9BAN copies 204 word message and then can't find addressee! W9HAX schedules WLH daily. W9BAZ handled message from Dawes to Admiral Byrd. W9JYO's heart is broke because she never won the OXBZ. W9CDA's total surprises himself. W9FQQ throws away buffer stages. W9IXN and 8YW celebrated at Indianapolis hamfest. W9ETT is RM for third Ky. district. W9JVK is sporting c.c. rig. W9OMW's total gets bigger. W9ERH and NBD have AC SW-3 receivers. Service work keeps W9EQO on hop. School work forces W9IFM off air. W9HCD takes to c.w. W9EDQ fights antennas. W9ARU is open for early morning schedules. W9OFE (Oh Effie!) is ex-W9BFC and WIZZI. W9KOX is moving to Middletown for winter. W9ZZQ snagged a few in last Ky. QSO party. W9EDV increased power to 40 watts. W9ACD wants a party every Sunday. W9KTO is in dutch with his neighbors (clicks). Local QRM has W9MWR worried. W9AQV is building 1.7 mc. rig. J3EI hears W9FZL's 4 mc. 'phone! W9ABV lacks a sky wire. W9HCO is Ky's first OPS. Work QRMs W9FZV. W9OZO is lining up good schedules. W9DGN is all set for future QSO events. W9KZC is adding 'phone on 1.7 mc. Bowling takes W9BOF's time. W9NEP, NMY and HBQ report. Get your monthly copy of Bluegrass Ether Clippings. The price?—your report on the 15th.

Traffic: W9OX 209 CIM-KKG 140 BWJ 134 OPV 122 BAN 116 HAX 110 BAZ 103 JYO 100 CDA 85 FQ 62 CNE 55 IXN 45 ETT 41 FZV 37 OMW 31 ERH 27 ERQ 26 AUE-DGN 20 OZO 16 HCD 13 EDQ-IFM 12 ARU-ELL 11 HBQ-OFE 10 KOX 9 ZZQ 7 NMQ 6 FGK 5 DPW 3 EDV-ACD-KTO 2 MWR-AQV 1.

MICHIGAN—SCM, K. F. Conroy, W8DYH—W8FTW will soon be one of Detroit's R.M.s. Mr. & Mrs. W8DYH wish our many friends a Happy New Year. We are sorry to have W8EVC's resignation as RM. "Pop," W8EVJ popped power transformer. Flint Club meets 2nd Friday each month, Detroit 2nd Thursday, M.S.C. Lansing, 1st & 3rd Tuesdays, Owosso every two weeks, and all invite vis-

itors. D.A.R.A. gives door prizes now! W8BRS says W8DPE put message-box at C.C.C. camp. W8AYO settles down. W9EGF means it this time. He's on the air. W8IXM's YL lost her grip on 'im. W9IAO and HIS QYL. Yes, W8HSH, you'll be the first Ann Arbor station in the BPL—when you make it! W8DZ pounding W8BIN BPLs on deliveries. W9IOV hooks G2MA! W9EEM and W8IFE hope they believe in Santa! W8CSL is after "semi-DX." W9MJW reports W9LJK back. W8SS hooked African CNSMA on 14 mc. W8INF sends 1st report. W8GSP, AKN, BIU & DZ have Tri-tets. W9CGP complains of '45s balking at 700 volts! W8JYH is ex-8AS. W8ALJ has e.c. going FB. W8JK knocks 'em off. W8KOX reports Jackson Hamfest a success. W8GRN has P.P. antenna—when wind blows one tree pulls one way and another pushes! W8FVP & HSH incorporate. W8GRB uses flea-power in his gas-station. W9MXM handled urgent sick message. W8JO is lining up the gang for emergency work. W8LXJ says a BCL hooked his antenna on BKU's Zepp! W8FDX is all set! W8CU handles 'em—long DX ones at that. W9NEZ expects a Jr. opr. soon. W8HA wins RCA '59 QSO party prize. W8FAV boasts a Comm! ticket. W8HXT boasts two new members. W8CET and AFL report for Down River Radio Club. W9HK piles W8GDR full of traffic. W8DVC and IOR sport ORS tags. W8CEU got 30 shupers for his four-bits at D.A.R.A. party! W8DWB wants QT to marry the girl! W8DLX wonders why QT is putting in so-ooo much wine! Lookie that Kazoo gang—W8BMG, GUC, IPD, FWG and the rest! Our apologies, W8CPY, didn't know it was Venus' sister you worked! W9ADY keeps a flock of nice schedules. W9BBP is going on a hunting trip. W9CWR claims the miserable weather makes boys pound brass. W8BGY uses e.c. W8COQ is a two-op station. W8DNM is going strong. W8GUC sports A.A.R.S. call WLTC on 3497.5 kc. W9FSK is NCS for A.A.R.S. 5th district. W8AEG keeps a few schedules to help Michigang. W8EGI will declare war if license doesn't get back soon! Applications invited for ORS and OPS. Reports welcome from stations member of A.R.R.L. or not.

Traffic: W8FTW 432 DVC 278 BIN 236 CEU 224 QT 166 BMG 135 AEQ 126 DNM 124 GUC 101 BGY 97 CPY 67 EGI 61 FX 49 IOR 44 COQ 43 GDR-JYH 39 CET-DLX 34 HXT 33 FAV 32 HA-IYN 30 COW 29 IFQ 22 CU 21 FDX 18 CFM 16 AFL 15 BHH-IXJ 11 RJ-JO 10 DWB 29 BKU 9 GRB-HRC 8 FVP-GRN-KOX-JK 7 CFZ-BRS-DED-EHD-HUD-JXO 6 AIJ-HBZ-IFE 5 CTD-IFD-SH-WR 4 DYH-GQS-GSP-INF-KLR-SS 3 CSL-KMT 2 BNK-FWG-HSH-INQ 1. W9HK 363 CWR 76 BBP 73 ADY 69 FSK 57 NEZ 30 MXM 10 CGP 5 MJW 3 EEM-IOV 2 IAO 1.

OHIO—SCM, Harry A. Tummonds, W8BAH—Chief RM W8PO. The station having best total each month will receive copy of this report from the SCM. Director Windom, W8GZ, leads the state! District No. 6: W8ARW is on 3908 kc. W8GDC passed OPS exam. Welcome W8KQO in Columbus. W8HWC wants IIL schedules. W8IZQ says all priority traffic. W8GSO wants good Cleveland schedule. W8ISK sends list of live schedules. RM W8BBH almost made BPL. W8FJN crashes BPL. W8JBI reports for first time. District No. 8 (RM needed): W8BRQ worked ZT1R. W8ESW uses '45 TNT. Crystal filter in W8FSK receiver. W8BKE is QRL Class A exams. W8PV will test new WLW transmitter, 500 KW! W8YX QSO'd CM8PQ. District No. 7: RM W8VP opened brand new restaurant. District No. 9: RM W8DUV reports by radio. District No. 3: RM W8APC sends real schedule map. W8ESN applies for OPS. W8GOD is showing fight. District No. 2: W8EEZ is rebuilding. RM W8BKM is on 3600 kc. District No. 5 RM W8FGV: W8KLP joined NCR with JNQ, AOU, BLV. W8DDM is taking PG course. W8HCS is QRL school. W8FGV has been on 7 mc. W8ISB Bellaire, Ohio reports by radio. District No. 4: New c.c. rig at W8ANZ. Seven schedules at W8UW, RM. RM W8PO leads the district. New a.c. receiver at W8ICC. New '24 e.c. osc. at W8GVX. W8JKK burned out '10. QRM power leak at W8WE and HMH. W8AFU joined A.A.R.S. Welcome first report in five years from W8ONO. W8JEA is new

ham. District No. 1: W8BON is new RM. W8HPW goes way down to Baltimore. W8RN is on land for winter. W8DVL says, "Army schedules." W8BAH reports many OPS applications. W8BMX rebuilt. W8EBY and AOA are QRL A.A.R.S. W8EPP is burning midnight oil. W8GUL is president Lakewood Radio Club. W8BAC spends 80% of time ragchewing. "Higher power to give BCLs a thrill," reports W8DAT. W8BRB has new QSL cards. W8DIH, GME, IOG, HBI, ZZZ, FGP, EFW, and ITR report. FB7A at W8FNX. Single '45 TNT at W8KFG. Why not be an ORS or OPS? Write SCM for application blanks.

Traffic: W8GZ 582 FJN 517 BBE 426 PO 183 RN-DVL 125 BAH 95 ISK 83 BON 66 APC 64 GSO 63 ISB 51 UW 43 FGV 42 BMX-IQZ 38 EBY-BKM 34 ANZ 30 EPP 28 GUL-AFU 26 FFK-HWC-KQO 24 WE 22 HMH-BAC 20 JJK 19 ESN 15 GVX-BMK 14 BWA-GDC 13 FVL 12 ARW 11 DAT 9 HCS-PV-YX 8 AOA-DDM 6 BKE-ITR-EFW-IOC 3 KFQ-FNX 4 GOD-ZZB 2 IOG-DIH-BRB 1.

WISCONSIN—SCM, Harold H. Kurth, W9FSS—W9ERS was operated by GYQ and DJH during radio week. W9HGF wants to be ORS. W9HSH QRL La Crosse Teachers College. W9DRO reports on La Crosse club. W9HMS is studying fiddle. W9FSS visited W9BCF, HMS, ERS. W9JDP is active in traffic. W9LTK is new ORS. W9GFC says AMB looks FB behind tavern counter. W9OKS has three schedules. W9JCH is building super. W9GWK had most blown down. W9DNU keeps tab on father's condition by ham radio. W9KJR reports and reports. W9HMX is awaiting schedules. W9MBX sends first report. W9HRM visited in Penna. W9GFC was appointed RM. W9LBK was heard in Berlin on 3.5 mc. W9IQQ has 500 watts. W9PAQ reports club news. W9JNU finally woke up. W9DNE has rig on. W9EXH coaching two new hams. W9IFS is on with 50 wattor. W9CTH is working on football reporting. W9HFY is QRL public address work. W9HGF, IQW, ETM are prospective ORS. On phone: W9IFV, EOX, ONF, PJ. YLitis: W9DIT, EWY. Milwaukee Radio Amateurs Club held 56 and 7 mc. QSO Parties. Northern Wisconsin Radio Club held meeting at W9FBU.

Traffic: W9ERS 747 HGF 158 DRO 138 HMS 127 FSS 115 HSK 142 JDP 76 LFK 74 GFC 70 OKS 60 JCH-IQW 48 ETM 42 GWK 32 DNU 20 KJR 16 HMX 9 MBX 5 HRM-EXH 3.

DAKOTA DIVISION

NORTH DAKOTA—SCM, Wm. A. Langer, W9DGS—W9HJC is Alt. SNCS A.A.R.S. W9DYA is plugging away. W9IGR reports new rig FB. Treetops are antenna supports at W9JAR. W9BTJ is building new power supply. W9JZJ's rig is '47-'46-'46-'10. W9KBE is QRL school. W9DGS is putting in 'phone. W9EGE is building 5-tube super. W9KZL has Class C license. W9PAI and PGO are new Bismarck hams.

Traffic: W9DGS 64 HJC 51 DYA 36 IGR 23 JAR 13 BTJ 4.

SOUTH DAKOTA—SCM, C. B. Miller, W9DKL—W9AZR is Chief RM. New Hams: W9PHD, PFI and PHE. W9FLO pulls throttle on C. & N. W. locomotives. W9TY finds lots of hams in R.R. game. W9DNS has power supply troubles. W9BLZ has new Super. W9DIY is on the air. W9DRB is setting up rig. Sioux Falls Radio Club is starting radio course. W9HAT blew power supply. W9GQH makes OPS application. W9KPF is on 7 mc. W9GPB will soon be on 1.7 mc. W9CDW asks SCM for quality report on KUSD. W9DGR reports Griffith celebrated arrival of new junior op. W9IQZ is located at 20 W. 7th Ave., Redfield. W9FOQ lost feeder system in South Dakota's biggest dust storm in history. W9FDD turns poet.

Traffic: W9AZR 252 IQZ 112 DGR 57 DNS 42 TY 36 FQO 29.

NORTHERN MINNESOTA—SCM, Robert C. Harshberger, W9JIE—W9OOO, FTJ and OMI are building 1.7-mc. 'phones. W9OML is at CCC camp at Coleraine. W9HDN built S.S. super. W9HNS put '47 in place of '10

as c.c. osc. W9LFO handles AA traffic. W9LAY uses 140 volts B Bat. on '33. W9SV is building e.c. freq. meter. W9JIE is on 3.9-mc. 'phone and will look for gang on 15th and 16th for reports. W9GBG is on 'phone. W9JID is trying 28-mc. 'phone. W9BVH is on 3.5-mc. c.w. and 'phone.

Traffic: W9IPL 157 JIE 185 KKJ 11 IMI 18 GBG 30 IPA 23 LAY 4 HDN 7 HNS 21 LFO 61 OOO 6.

SOUTHERN MINNESOTA—SCM, Norman Beck, W9EJP-EMQ—W9BKK promises big totals. W9BKK wants to hear from those who want schedules. W9BLG makes BPL third consecutive time. W9CSY is building Class B modulator. W9EJP visited Rochester gang. W9NBQ is new reporter. W9LDQ claims Lambertson QRM situation under control! W9GNU sent traffic report! W9FNK reports new Radio Club at Rochester; W9GLE, pres.; W9FNK, vice-pres.; W9MXW, secy. W9HCW is making changes in rig. W9KAV is one of ops at W9NBQ. W9DEI is DX-minded. W9KDI worked VPSMK. W9JUJ hopes to have 50-wattor. W9CSJ tried spark coil power supply. W9YC is getting all set. W9AIR is oping on River. W9LN resigns RM job. W9GLE reports three new Rochester hams: W9OZX, FEV, PDL. New Minneapolis ham: W9PBC.

Traffic: W9BKK 549 BLG 511 BKK 250 CSY 205 BN 102 EPJ 81 NBQ 50 LDQ 36 GNU 28 FNK 23 DH 15 HCW 13 KAV 22 DEI 13 KDI 6 JUZ 4 BNN 5 CSJ 2. (Sept.-Oct. W9LN 16.)

DELTA DIVISION

ARKANSAS—SCM, H. E. Velte, W5ABI—W5BMI has been busy with A.A.R.S. work. W5BED is planning a larger transmitter. W5IQ keeps A.A.R.S. schedules. W5CLQ worked his first VK. W5DGL wants a schedule with an ORS or TLS within 9 AM-7 mc. range on 7190 kc. W5JK has low power c.c. rig. Ex-W5BU is doing radio service work. W5NJ joined the ranks of the benedicts. W5PX has been working DX. W5CVO is in charge of radio work at John E. Brown College. W5DHN is trying for A.A.R.S. appointment. W5DER reports things picking up. W5BDD and BIA got a nice write-up in local paper. W5KKB is selling out. W5CIU gets good reports. W5CR is QRL U. of A. W5SI is running for Director of this Division. The SCM has on hand some nice-looking certificates for phone hams who want appointment as Official Phone Station. See page 37 November QST. Crystal controllers: W5ABI, UI, ABL.

Traffic: W5BBI 1009 IQ 186 PX 34 DHN 20 ABI 18 CLQ 13 BED 10 JK 6 DRY 3 CVO 2.

LOUISIANA—SCM, W. J. Wilkinson, Jr., W5VT—W5AYZ, BYY and VT made the BPL State Fair traffic helped totals. W5AOZ has about finished 1.7-mc. phone. W5BID has reliable schedules. W5BPL wants OPS. W5HR reports via W5BPL. W5AFW keeps schedules all directions. W5BI says the gang in N.O. La. are trying to build club house. W5KC is moving transmitter. W5DKR is going to build phone. W5BFB was heard from via W5CFG. W5YV reports via his sister, W5AYZ. W5CEN gets his WAC. W5PY is still laid up. The New Orleans Radio Club is giving Lotto Party to raise funds for club house. Let's get going, LOUISIANA. Active: W5ZK, AGM, QH, CXQ. Shoreport visitors: W5CMQ, DMP, EE.

Traffic: W5BYV 1151 VT 907 AYZ 657 AFW 179 BZR 230 AOZ 1 BI 10 KC 4 BID 41 BPL-HR 4 YW 36 ZK 23 DKR 4 CXQ 1.

MISSISSIPPI—Acting SCM, W. P. Allen, W5VJ—W5CWQ leads with traffic. W5GQ has commercial ticket. W5DEJ gets crystal reports. W5DNN is on 1.7-mc. 'phone. W5AZV changed QRA. W5BQX has '03s in Class B. W5AWU is back from his honeymoon. Coming on 3.9-mc. 'phone: W5BNW, CO.

Traffic: W5CWQ 59 VJ 14.
TENNESSEE—F. F. Purdy, W4AFM—W4AFM is busy meeting schedules, etc. W4RO and PL report over the hundred mark as usual. W4RO, PL and AFM are working hard on establishing trunk line "J." Eight stations of Tennessee A.A.R.S. are equipped with 3737-kcs.

crystals. They are W4AFM, BOZ, RO, OV, AFI, AEP, BQK and BTQ. W4BAO is a Boy Scout Netter. W4BCA is active in NCR. W4OI had meter stick stunt pulled on him during Memphis Convention! East. Tenn. Amateur Club elected officers for forthcoming year: W4ADX, pres.; W4AAD, vice-pres., W4BQK, secy.; W4BZO, treas.; Eugene Jones, Activities Mgr. W4BYI and EX are ops at WROL. W4BUD installed rig at East Tenn. Fair, Knoxville. W4ADX handles traffic on 14 mc. W4BOZ made a long trip through middle Tenn. and acted as chief pianer player for a nifty widow's fan dance. W4AAD is using automatic phone break-in. W4LU organized a fine A.A.R.S. 'phone net. Chattanooga Radio Club witnessed a demonstration of a 3.6-meter transmitter at University of Chattanooga. W4MU will transfer his 'phone activities to 14 mc. W4CAP is our big hamburger ham. W4AM purchased new home. W4ACU "Major" is back on active 'phone list.

Traffic: W4AFM 780 PL 109 RO 106 BUD 102 AAD 52 CBS 40 MU 32 CIA 28 BOZ 21 BTQ 14 BQK 19 AYU 8 BAO 4 ADX 3 BBT 2 BCA 1.

HUDSON DIVISION

EASTERN NEW YORK—SCM, R. E. Haight, W2LU—W2BLU BPLs. FB results at W2EGF. W2BKM visited W1MK. W2EQD is recruiting for A.A.R.S. W1EFM/2 is pushing out in hockey. W2FEQ reports FVL new Scarsdale ham. W2CNF operates EZI Wed. nights. W2UL breezes to Schenectady for week-ends. W2FPH is out for WAC. W2FRU tackles traffic. W2GNI reports DNN revamping for c.c. W2BWB is QRL NCR. W2BRS is organizing 3.5 mc. Q80 party for S.A.R.A. W2GLI, CLL, FXC, DEG and CC qualified for ORS. W2EFU is vice-pres. of Union College Radio Club. W2BJA is lining up stations for A.A.R.S. Red Cross Annual Roll Call to Wash. W2EZO reports FB deliveries. W2DYC is Editor in Chief S.A.R.A. NEWS: W2CJS getting DX on 80. W2GFD reports Kingston hams going strong. W2ENY is pounding from FAM. W2FUM (the host), EQC, EQD and FKL gave ESO send-off party. W2KW and YF are honeymooning in Mediterranean. W2DDW is secretary of Mid Hudson Radio Club. W2BYR reports blowing for a living up in Maine. W2BZZ comments on ENY Bulletin. W2QY sends code practise on 1.7 mc. 3 days week at 5 p.m. W2CC totals 666 contacts with VK5HG up to November 13th. W2CL reports W2FSD is ex-9ASI. W2CBN received Class A ticket. W2BLL keeps Troy well covered. W2GRJ and GGC visited SCM. Report and receive a copy of ENY Bulletin. Your SCM extends Seasons Greetings to all.

Traffic: W2BLU 550 EGF 307 LU 141 BKM 178 EQD 34 FEQ-CNF 29 FPH 28 UL 24 GNI 14 BRS 10 FXC 9 EFU-CC 8 GLI-BJA-EZO 6 DYC 5 CJS 4 GFD 3 CLL-FAM-ATM-DEG-BLL 2. W1EFM-2 34.

NEW YORK CITY AND LONG ISLAND—SCM, Ed L. Baunach, W2AZV—W2BTF is now ORS. W2FF has a commercial-looking transmitter! W2ADO and BCK are trying to teach DUP Morse. W2EYQ, DOG, CHK, and DBQ have L.I. net going 100% daily. W2FDQ has hard luck with new rig. W2EGA and EPJ are building rack job. W2CEH is a service man. W2AXN's '48s cry for help. W2DBE sends his highest report. W2EWS, FEB, OL and US are on 3.5 mc. W2CYM, ECL and GOW send first reports. W2AFT and QM are experimenting with 75 cm. W2DJP freezes in his shack. W2OQ uses low power e.c. osc. W2PF is at new QRA, 188 Linden Blvd., Brooklyn. W2FIS, KJ and GAC report 7 mc. punk. W2EKD is A.A.R.S. W2DDW is out to become ORS. W2BRV and ECJ applied for OPS. W2FFN has an '03A. W2AIQ is taking exam to become N. Y. C. cop. W2HAS is on 7 mc. beside 3.5 mc. W2EVA is trying to work DX. W2ELB BPLs. W2AYE now has a YF! For west coast traffic work W2BGO. W2BRB has been experimenting on a U. S. Destroyer. W2CYX is recruiting for NCR. W2BHL is chief control op at Hotel Montclair. W2EAF is trying c.c. W2EXO gets xpcd reports. W2DIT is taking course at Nassau C.C. W2DNW is building "Tritet." W2DRG keeps Sunday morning schedules. W2BMH handles long hop schedules. W2FIP is proud of his A.R.R.L. membership. W2BII uses new SW3. W2DTT has a spare transmitter for sale. W2EYS has transmitter trouble.

W2ELK reports BYL moved to new QRA. Two ops at W2CYA. W2CLM is leaving for Montclair, N. J. W2AA, BKP and LB boost totals with NCR traffic. W2ASG is doing FB work on the air correcting poorly operated stations. W2KR schedules KJTY (9500 kc.) the Byrd Expedition. W2AWT has unlimited 'phone. W2CYP is rebuilding. W2GMP is conducting tests with a '12 in Hartley. W2EDZ reports for ERH and EQH. W2FRK visited the gang in the section. W2TI is working on s.s. receivers. W2BVT is breaking the junior op in 56 mc. W2BNJ and AGC are deeply divulged in radio business. W2GIM is on 1.7 mc. W2GBQ is trying to outdistance GEZ, his cousin. W2AEN after 10 years of operating is now an ORS. W2ETG reports new man, GAO. W2AZV has been conducting successful 56 mc. tests between an aeroplane and an automobile. W2BEG swapped his car radio for a heater.

Traffic: W2ELB 263 CHK 203 EYQ 174 DUP 148 ELK 129 QM 124 DBQ 121 DBE 140 FF 76 DJP 51 BGO 50 PF 45 DRG 32 CYX 31 LB 35 35A 22 FIP-EGA-OQ 20 BTF 15 DOG 14 KR 65 EYS 14 CAC-CYA 13 AZV 45 BAS 11 EKD 10 AXN 7 BKP-AA 8 BII-BNJ-BRB-GMP-EDZ 4 ERE-EQH 8 BMH 2 CHH 4 FDQ-CLM-CYM-DTT 1 EAF 6 BHL 1 ECL 5 EPJ-EXO 2 FIS 1 FFN 3 TI 2 COO-DFS 5 GIM 1 CAU 2 AWT-BVT-CPY-US 1 EYB 33 BSR-AEN 2 FRK 3 ETG 1 ASG 15 GMP 2 AIQ 1 KJ 10 DW 4 BRV 3 BYL-DIT-DNW-CRL-DQW 2.

NORTHERN NEW JERSEY—SCM, Walter A. Cobb, W2CO—This is greatest traffic month since the SCM took over the job, with 30 stations reporting 4348 messages handled, and W2DIU, BCX and EKM all making the BPL. Congratulations! New stations reporting: W2GGW, GNM, GPU, GCC and GPS. DX at W2FDK, DJE, AHL, CLM, EOH and BYK. W2EEN and FMI sport new receivers. W2CIZ and CZP held antenna parties. New transmitters at W2CPA, GNT, FBS, CJX, DPB and AIW. W2DNG, GMR, DPA and ARS have been improving their old jobs. W2EWA, ELJ, BPY, BXM, and DZA are rebuilding. New ORS: W2DPA, BCX, CTT and ENZ. W2DIU and EIC are new OBS. W2EJU has been made our Official Observer. W2ALO and CIM passed unlimited 'phone exam. W2ZC is back from Florida. W2TP obtained blanks for OPS. All schedules went haywire for W2CGG. Rutherford Radio Club is going well. The Stevens Radio Club at the Institute in Hoboken has an active station, W2BSC. Red Bank Amateur Radio Club had several interesting speakers. W2DPA is desirous of morning schedules. W2DVN was QSO CM2MG on 3.5 mc. W2BAI delivers NYC messages by commuting daily to the big town. W2DGU complains his shack is not so hot any more. W2CTV found that it pays to QSP personally, especially if the addressee happens to be young, good-looking and of the feminine sex! The Memorial Radio Club of Englewood is growing steadily. W2ADP is waiting for his WAC confirmation. W2DOZ suffers from antenna trouble. W2AIF was QSO for 30 minutes with KA1YA at 7 p.m. EST on 14 mc. W2BYW has charge of construction of club station at Englewood. The Tri-County Radio Assn. at Rahway is applicant for A.R.R.L. affiliation. W2FRF erected forty footer. W3GHL, down at Fort Monmouth, is organizing a club composed of hams who are now stationed at the post. W2DIU is the third appointee as Route Manager for the Section, with BPY and EKM. W2FOR got a recipe for making goulash from HAF3BZ, in Hungary. W2DFB has gone on 1.7 mc. 'phone. The November meeting of North Jersey Clubs at Newark Evening News auditorium was well attended with a lecture on the "IONOSPHERE" by Mr. Richey, chief transatlantic operator for AT&T. W2FL has fallen in love with new crystal Comet. W2AFB is proud daddy of new 7 mc. rig. Somebody has proposed the Z31 Operators Club with W2AFQ, GG, AOE and AOG as charter members. The finest talk given in ten years was delivered before the Bloomfield Radio Club by Comdr. Frank Hawks, W2GKL, accompanied by David Grimes, W2GKM, recently.

Traffic: W2DIU 1868 EKM 560 TP 31 EIC 15 CJX 14 CIZ-CGG 9 DPB-ELJ 5 BPY 4 BXM 2 CIM 1 BDX 1162 AFK 183 BSC 121 ENY 83 BPV 81 EWA 57 FDD 38 DPA 32 CPU 17 DVN-BAI 8 DGU 7 CTV 6 CTT 3 ECW 2 FBS-AHL 1. W3CGU 15.

MIDWEST DIVISION

IOWA—SCM, George D. Hansen, W9FFD—RM, W9ABE; RM, W9HPA. The Rover, W9ZZAF, leads this time. RM W9ABE turns in a fine total. W9BFL has a nice bunch of schedules. W9EIV has a special assignment from A.A.R.S. W9LEZ will have 200 watt rig. W9AHX works W6ZZBL occasionally. W9LXC is cooperating with trunk lines and C.C.C. camp in Minn. W9JSO is chief op at NCR station W9NS. W9NUC is building c.e. job. RM W9HPA reports activities at W9JDV, NWX, AS, FOP, and NYN. W9GP is still putting out the SHEET. W9DPO has a steady job. W9CWG, OO, says off-freq. logging is getting slimmer. W9IO is resuming activity. W9FFD is QRL work and NCR. W9NTY reports for W9CZY. W9ERY is fishing for DX. W9GSY vacationed around N.Y.C. W9NDN reports in person. W9GXU is QRL picking ole ioway-nubbins. W9CYL says business picking up. W9DEA is QRL W9NS, and "STATIC." W9NVF and OZA are first reporters. W9DFE is cooperating with FRC by installing new keying circuit. The TSARC held annual Founders Day Banquet; 43 attended.

Traffic: W9ZZAF 1197 ABE 335 BFL 317 EIV 214 LEZ 192 AHX 174 LCX 151 JSO 136 NUC 103 HPA 80 GP 76 DPO 63 CWG 57 GWT 49 FYX 41 IO 38 FYC 35 FFD 22 FLI 19 NTY-ERY 13 GSY 22 NDN 7 GXU 6 CYL 5 DEA 2 NVF 2 DFE 4 CZY 6. W6ZZBL 28.

KANSAS—SCM, O. J. Spetter, W9FLG—W9KG and W9CFN CW Rms. W9ESL 'phone RM. W9KG leads the state with a grand total. W9LGV is licensed to operate at State Sanitarium. W9GHI is operator at WREN. W9KQJ stimulates traffic with pads in hotels and drug stores with much luck. W9CSK is YL-ing. W9EHA gave a talk on radio at Iowa Junior College. Dick West of Hartford, Kansas, has gone into the ministry. W9IGQ goes to Radio school at Port Arthur. W9EHA worked one "G" and a "CE." W9IQV is QRL school. W9LOG is in C.C.C. W9GJU is QRL store. W9GOZ says '45s can't be beat. W9EKA is new WARC member. W9BSX is putting up new sky wire. W9OHY and OZN have a contest on. W9ABJ, DMF and OHY built new station at North High. W9CCO is instructor in Radio at East High. Stations heard on the air in Wichita: W9BSX, GNO, PGL and LVZ. W9PGL worked several states on 'phone. Wichita Club is now affiliated with A.R.R.L. W9ODV put up new Zepp. W9EMT has new SW3. W9OPR is building MOPA. W9ODJ is new at Ellsworth. W9IQI uses '47 crystal osc. W9PB is responsible for a family reunion on the air. W9NMR, ex-CZW, reports on A.R.R.L. card so old we are going to frame it. W9CRU has new 20 watt rig. W9LGR reports new Junior op arrived November 6th. Ex-FMZ is now at Moran, Kas. W9CWW proves his mettle with death message. W9OBV is moving to Quenemo. W9MWM passed Radiotelephone First. Imperial Radio Club is in full swing. Code practice every Monday night. Osage County Amateur Radio Club is affiliated with A.R.R.L. They meet every Monday night. W9LFN has new relay rack 100 watt 'phone and c.w. rig. W9FLG lost high voltage filter and rectifiers. The Sunday Morning ORS schedule is now in effect. Get in. W9IOL is new ORS. Re-building: W9AWP, ABG, BKN, BEZ, OKA, KUO, OUU, KDR. New rigs at: W9NLZ, GDS.

Traffic: W9KG 1227 NMR 413 FLG 366 IOL 242 ODV 106 NJS 103 CKV 97 KFQ 77 AWP 76 CNW 68 BYM 66 FRC 64 PB-KCR 62 EFE 54 FMY 50 IEL 48 CFN-IRE 40 BQW 39 MUY 38 OFR 33 KDO 28 OQC 25 KQJ-BYZ 22 HSN 17 AHR-GRA 15 HJF 14 DMF 12 CWW 11 EYY 10 LGR 8 CMV 6 COA 3 ICV 30 LV 2.

MISSOURI—SCM, C. R. Cannady, W9EYG—W9FTA, W9BMA and W9CJR, RMs. The "Bull" seems to be doing the work! A bigger report for this month and thus far not a single complaint on this system of handling our report. In fact, the gang seem to like this system best—it allows more space for each man in his personal column! REMEMBER, AN ACTIVITY REPORT BRINGS YOUR COPY OF THE "BULL." ASK FOR IT NOW AND SEND YOUR COMMENTS ON THIS REPORT AND THE "BULL." Let's hear from everyone next month!

Traffic: W9BMA 3093 CJR 270 ASV 247 HON 235 AIJ 176 NP 167 MZD 128 ENF-NNZ 119 NAQ 113 GBJ 67 ECE 61 IGX 42 LLN 39 HUZ 38 IYT 34 DPJ 32 BDX-

KVN 31 LXO 26 CRM-LBA 25 KNM 24 HUG 23 GTK 20 EDT 17 LBB 15 HVW-EYG 13 DUD-FHV 12 BGE 11 EDK 10 IJW 9 FYM 8 MYO-HVC-IPT 6 AEQ-KEP-RR 5 GNQ-LWG-AUC 4 AHH-GXT-FEH-LLJ-DLC-FZJ-HCP-EHS 3 ZZ-MAK-BYN-KJK 2 DIC-OKR-EWT-LTN-ENK 1.

NEBRASKA—SCM, Samuel C. Wallace, W9FAM—W9BNT comes through with an FB total. W9DMY stands in second place. RM W9DI is keeping a nice bunch of schedules and reports new stations, W9PEX at Jansen and W9PHF at Ellis. New officers of Cornhusker Radio Club, Lincoln: W9CWM, pres., W9FWL, vice-pres., W9DZK, secy & treas. W9EHW schedules W9BQR, DI, BNT, FWL, DZK, DMY, CUY, LSI, FZX, EDI, and HYR. RM W9DHA wants to hear from any of the gang especially in the western part of the state. W9FAM is on low power on 3574 kc. in evening about 5 p.m. until the trouble is found in last stage. The new Ham Paper has been named and rearing to go; send in all your dope, gang, and let's make this one of the finest ham papers in the U. S. A. W9LFE is keeping daily schedule with W9IFE. W9PDG is new Omaha ham. W9BCX is craving excitement. W9FWW is trying to get up on 3.5 mc. W9DGL is building new c.e. rig. W9MQY, EEW and DHO report. W9FGS is working hard to boost Nebraska's totals. W9CUY says the '46s sure work FB. W9KPA is doing some nice traffic work. W9DLK says W9CUY induced him to report his traffic. W9DHO reminded W9OPP to report. W9KJP moved his outfit into the house. New officers of A.R.O.C.: W9KJP pres., W9DHS vice-pres., W9JQJ secy., W9EW treas., W9HGO sergeant at arms. W9JQJ is busy getting new HAM PAPER ready for print; he says the issue first to come out will be the SUNFLOWER STATE ISSUE as Kansas leads the number of subscriptions. W9HGO sent some good dope. W9IEQ says W9CTJ is setting his rig up again.

Traffic: W9BNT 3072 DMY 311 DI 219 EHW 129 DHA 54 FAM-IFZ 22 AFD 14 BCX 13 FWW 5 FGS 155 CUY 143 KPA 134 LFE 105 MQY 15 CWM 44 HNG 30 DLK 23 OPP 4 KJP 2.

NEW ENGLAND DIVISION

CONNECTICUT—SCM, Fred A. Ells, Jr., W1CTI—W1AMG, YU and MK make BPL on deliveries. W1FIO keeps long hop schedules. W1BDI says traffic routes perking OK. W1CTI hooks into Trunk "C" via W3AKB. W1DGG reports by long distance 'phone. W1BHM reports lot of new stations in New Haven. W1CJD now has remote control from the house to the shack. W1GC has good schedules lined up. W1APW changed to a '47 for crystal osc. W1FGV worked England. W1BFS and EBY say shacks very cold. W1BMP is with 176th Co. C.C.C. W1ES pounds brass at W1MK Monday evenings. W1BNP works on 7 mc. week days. W1EWD improved his filter. W1GGM is looking for schedules. W1SZ holds Number 1 OPS. Who is next? W1GKM rebuilt to T.N.T. W1GUC looks for a "B" eliminator. The Bulkeley Radio Club appreciated W1CBD's lecture on Nov. 7th. W1HJW is doing detective work on his transmitter. The Torrington Amateur Radio Club has W1DTV as pres. and W1BLQ as secy.-treas. Meetings are held every Thursday. Litchfield County hams are urged to get in touch with W1BLQ and join a live club. The November 4th-5th QSO Contest was highly successful with W1SZ on fone leading in number of points and W1AQU on c.w. a close second. Full reports will appear in an early issue of "Hamonics." Special items of interest to all Conn. operators are broadcast every Sunday morning by W1CJD at 9:30 and W1CTI at 10:30. Send in any information you wish included in these broadcasts to the Conn. gang.

Traffic: W1AMG 474 YU 335 MK 324 FIO 307 CJD 241 DOW 138 BDI 126 CTI 115 DGG 93 UR 90 GGX 88 BIX 72 BHM 71 GC 49 APW 41 FGV 38 BFS 32 AUK 21 UZ 18 EEI-GTO 17 BMP 10 ES-EAO 8 CNU 6 BNP 3 EWD 2 EBY-GGM 1 BWM 8.

MAINE—SCM, John W. Singleton, W1CDX—All hands are requested to mail a list of their schedules to Chief R. M. Kenneth V. White, W1BOF, W1EF and

W1GSC were married Oct. 15th. Congratulations from the gang. W1CHF's schedules are working again. W1EBM is A.A.R.S. SCS. W1OR is putting in "tritet" exciter. W1EFA has been hunting. W1TO is also a newly-wed. Congrats, OM. W1BNC wants a Bangor schedule. W1APX shot a nine point deer. W1FJP is QRL work. W1DFQ and EOP are in line for O.P.S. W1HNU is new S. Portland ham. W1AQW is going to Bates. W1CRP is engaged. W1DHH, DHD, DRZ, BTA, CBU, CPT and AQL are active. W1EZW, Hoxst, R. I. and W1ETC, Mt. Hermon, Mass., want a Maine schedule. W1ABQ has been on the sick list.

Traffic: W1BOF 121 EF 85 EBM 58 CHF-OR 50 EFA 36 BYP 33 DHH 18 CDX-BNC 16 APX 10 FJP-DFQ 9 AQW-BTG 8 BTA 6 CRP 4.

EASTERN MASSACHUSETTS—SCM, Joseph A. Mullen, W1ASI—W1ASI attended a meeting of Framingham Radio Club. W1ABG has been QRL. W1KH is agitating more activity on 28 mc. W1WV says DX conditions poor. W1AGA has trouble with schedules due to skip. W1LM finds his schedules working rather poorly. W1BBX is hanging on tight to his VE schedules. W1EVJ says any stations interested in joining Atlantic Seaboard net please write him for schedules. W1ABF is awaiting license renewal. W1DFS is editor of NCR paper, "The Intercept." W1BZO has 'phone going on 1.7-mc., thanks to DNL. W1RE heard the East Boston plane on 56 mc. with excellent sigs. W1CNA is building new modulator unit. W1GEC reports his antenna down. W1FRO has aspects of becoming an ORS. W1DOF is among the first to apply for OPS. Old man Harrison, W1VS, is at it again and leads the Section his first month on. W1FLZ has pair of '10s in PA. W1EVE has been experimenting on 7 mc. W1EXT is using MOPA. W1GX has a new Jr. op. Congrats, OM. W1HHG has a pair of '03As. W1BZN is working all bands. W1DUA is on 3.5 mc. every noon. W1BER is due on with e.c. job. W1GWA has sacrificed his power supply to the God of Radio. W1DFF is on the Yacht *Atlantis*. W1DQN is running school busses. W1AF is battling out all kinds of DX. Miss Sullivan of the "Globe" Radio Editor's office has her ticket and license. W1HRB. W1ZK is handling Army Net drills in his quarter. Check your ORS certificate and see if it has expired yet. Happy New Year, gang.

Traffic: W1VS 111 BBY 105 AGA 81 ABG 71 EVJ 68 KH 67 EVE 59 FRO 58 BEF 43 EXT 38 BZO 32 BMW 23 RE 19 DFS 12 ASI 11 LM-WV 10 DOF 6 FLZ-EUW 5.

WESTERN MASSACHUSETTS—SCM, Earl G. Hewinson, W1ASY—W1ASY sends official broadcast 6 p.m. daily except Sunday. W1BPT is interested in 1.7-mc. 'phone. W1DVV is QRL school. W1EOB is new ORS. W1CCH rejoined ORS ranks. W1AJD is keeping schedules. W1COI has novel keying monitor. W1BYR looks like Springfield Radio Assn. 1934 president. W1FAJ leads traffic scores. The Berkshire Brass Pounders had a very successful hamfest on Nov. 18th. OPS appointments are now in order. New hams: W1HPQ, GBZ.

Traffic: W1FAJ 93 BVR 74 COI 68 AJD 63 CCH 55 EOB 47 DVV 46 APL 44 HHR 32 APP 28 ARH 24 EAX 8 BPT 12 ASY 4 OF 1.

NEW HAMPSHIRE—SCM, Basil F. Cutting, W1APK—W1FEX operates daily on Mt. Washington on 56 mc. The elevation is over a mile. We think we have the altitude record for a 56-mc. permanent 2-year station. W1BFT's call is changed to W1DMD. W1BFT and IP resigned as RMs. W1GDE called on the SCM. W1GPN applies for ORS. W1HFO is going to radio school in Boston. W1GWY is the smallest ham in Manchester. W1BDN is the YL of the Queen City. W1HJM is having trouble with rig. W1CME has p.d.c. note. W1FFL schedules ARW. W1ERQ is new RM for Southern N. H. Get schedules with him. W1AFD has 55-foot mast. W1FGC has new 56-mc. receiver. W1BHJ and HQE are on 56 mc. W1CVK has a new job. W1FTJ pounds a typewriter days and a key nights. W1BII is in the north country for Tel. Co. W1DMI has a new "tritet." W1UN is White Mt. master control station for

Appalachian Mt. Club. On 1.7-mc. phone: W1HFO, AGO, HET, GHT, EZT. W1DSX is building a Super. W1CUN is new ORS. W1ATJ has the bug again. W1AXL is RM of Northern N. H. W1CBB is Radio Aide for A.A.R.S. for N. H. W1BEO is active in Berlin. W1BJF is a farmer-ham. W1DUK is looking for a "J." W1AQX is building new super 2-mfd. condenser. W1BLA has RF everywhere except in his antenna. W1EUH is building e.c. rig. W1BRT changed to "tritet." W1BCP is going to have Class "B" 'phone. W1AEF has a very high mast. The So. N. H. and So. Maine Radio Assn. meets the 2nd and 4th Friday each month. W1EES is working 14 mc. ragged. The St. Paul's School Radio Club is on with an '03A and an FBXA. W1CFG showed the SCM the WFEA transmitter at Merrimack. OPS for N. H.: W1AUY, EAW, FEX and APK. W1AUY holds OPS Number 1. W1AVJ is an expert bridge player. W1AVL is DXing. W1GKE is on 7 mc. W1HOV plays in an orchestra with W1DMD as leader. W1CDT is a radio service man. Actives: W1FFZ. W1HQS is new Manchester ham.

Traffic: W1ERQ 317 BFT 165 UN 150 DMI 80 FFL 58 BFF 56 FEX 63 APK 29 CUN 19 EZT 16 FFZ-FTJ 8 CBB 18 EES 5 GDE 19.

RHODE ISLAND—SCM, Stanley Atkinson, W1AFO—W1CAB is the proud father of a new Jr. op. Congratulations, OM. W1EOF resumes schedules with new transmitter. W1AXS is building e.c. job. W1GTN has superhet bug. W1GPE has been appointed A.A.R.S. DCS. W1DJX works VK consistently. W1GOG sends code practice on 3.5 mc. W1DDY has a 212 on 14 mc. W1GTS sticks to 7 mc. W1CPV has a 5-stage e.c. rig. W1GV is learning radio service business. W1EZW reports his rig FB on 3.5 mc. W1ASZ applies for O.P.S.

Traffic: W1CAB 244 EOF 98 AXS 52 AFO 42 GTN 19 GPE-DJX 16 GOG-DDY 13 GTS 12 CPV-GV 9 EZW-ASZ 7.

VERMONT—SCM, Harry Page, W1ATF—W1BD is c.w. OBS. W1DQK and FPS are 'phone OBS. Vt. OBC include last-minute Vt. ham news in their regular transmissions. W1DAJ is building e.c. rig. W1BJP, RM, is liaison station for c.w. and 'phone lines. W1AXN has new "tritet" rig. W1EZ reports action on 7 mc. Reports are solicited from every Vt. ham.

Traffic: W1DQK 154 ATF 100 BJP 49 CCF 48 BD 29 GGT 31 FPS 12 CGV 10 AXN-GAE 9.

NORTHWESTERN DIVISION

ALASKA—SCM, Richard J. Fox, K7PQ—K7CCL has gone to Fairbanks to college. K7BND is back on the air. K7DVF left for Stanford. K7CF and AOC have gone south. K7PQ put porcelain spreaders on his zepp feeders. K7BOF has 50-wattter on 3712 kc. K7GF will be heard from Ross Inlet during the winter. K7BAQ has FB7. K7VH has Collins 32. K7AVU gets good results on 7 mc. K7BND is on his way to States. K7BMY is now at Lovelock, Nevada.

Traffic: K7VH 16 BZX 19 BNW 22 BWA 30 PQ 81 BND 144.

IDAHO—SCM, Don Oberbillig, W7AVP—Boise—Gem State Amateur Radio Club is busy with Grange Convention traffic. Members active: W7BRU, DEQ, YA, AXY, DKY, CUG, ASA, AVP and members Boise Hi Radio Club. W7BAR has '52. W7AYH, CSP, BAR are on 28-mc. 'phone. W7GU is QRL radio service and pheasants. W7CMD burned out transformer. W7BHN has 3.9-mc. 'phone. W7BLT and CFX attended police radio meeting at Boise. W7GL, DZO, BAA, AAJ, AXY do fine work in Police broadcast. W7BZJ is working A.A.R.S. W7AVZ and NH hold open house for hams. W7DD has new rig. W7CHV is ready for winter. W7CSW reports for first time. W7AFT receives police broadcast. W7DCM, Moscow, reports. W7CDJ, W7CRL got married. W7CCT, CQX and AVD attend U. of I. W7BPM reports football game at Walla Walla to CZG at Moscow. W7AGD DCM have SW3s. W7DJM worked K6. W7AYQ is holding panhandle down at Bonners Ferry. W7KJ is QRL refig-

erators. W7BMF applies for ORS. W7EAY is QRL Debate team. New c.c. rigs at: W7DQC, CHT, CAT.

Traffic: W7AVP 189 BAA 21 IY 4 CAP 2 CHT 18 CSW 5.

MONTANA—SCM, O. W. Viers, W7AAT—W7CCR takes traffic honors. W7AOD, ASQ and CRH have nice schedules. W7BVE is working bugs out of his rig. W7BDJ wants early morning traffic schedules. W7CCR keeps 38 schedules each week! W7CEG is rebuilding receiver. W7AFS is herding the YL—cows (on farm). W7AHF gets more time in at KGEZ. W7CDK will soon be on near Kalispell. W7ABT is on again. W7OW will soon be on 3½ mc. W7CRU is using a '30 crystal oscillator. W7AOH moved to new shack. W7AFU is building c.c. rig. W7BCA blew transmitter tubes. W7CME is working lots of W9s and W6s. W7CUK is on 1.7-mc. 'phone. W7DST has dead receiver batteries. W7AFU, CME, AOH and CUK are going to take unlimited 'phone exam. W7AAT finished new c.c. job. W7COX may boom forth soon with a 50-watter in final. QRL: W7BYR, CTP, BTL.

Traffic: W7CCR 222 AOD 43 BDJ 25 BYR 20 BVE 70 ASQ 29 AAT 2 CEG 3 CRH 137 CRU 5.

OREGON—SCM, Raymond W. Cummins, W7ABZ—Nov. 18th, the Valley Radio Club was host to about 50 hams from all over Oregon. W7PK, BTS, QY, HD, CEJ, ABZ, AMF, CVL, and ALB made the trip to Eugene to attend the first of these semi-annual hamfests. W7WJ turns in largest total of the year. W7BCK is Airways operator at Siskiyou Summit. YLs are claiming W7BEK and BAX. W7BDE has pair of '10s. W7BQK is hunting good receiver. W7BRH is vacationing. Astoria Club is reporting traffic 100% of membership. W7EBQ is getting clicks out of rig. W7BBO has new rig. W7BUF works ZLs and K6s with 3.9-mc. 'phone. W7DCR is AOI's brother. W7BKL is operating portable at college. W7BNX is back again. W7DKI and DHZ are new Central Point hams. W7CRN handles traffic. W7CIK is A.A.R.S. W7GK has 800 volts B batts on a Ten. W7MF is in possession of an '03A. W7LT and CXX got together at Seaside. W7AHJ and AJX are now in Carmel, Calif. W7DAY is in CCC. W7DXC is new Astoria ham. W7CHB paid SCM a call. W7BWD worries about getting reports in on time. W7AMF is building a super. W7WR had to take vacation from radio. W7DP claims world's worst radio location. W7AQX made trip to altar. W7AIP, KR, BDN, BKD, and BZS are going strong. W7ZB is going to 1.7 mc. W7AXJ is also WLVP. W7HD wants to know how to keep the cat out of transmitter. W7AYV is a live wire ORS. W7KL's shack was turned into a hotel during hamfest. W7KH is experimenting with 56 mc. W7LI got R8 from a KA3, at 9:30 a.m. W7KP is servicing radios. W7CUV's receiver pulls in DX. W7DWQ is going MOPA. W7AVB and CMK are working lots of DX. W7CWH and WL are rebuilding. W7BLN is in U.S.C.G. W7APG gets on with '52. Nov. 1, 1933, the Rose City Amateur Radio Club was laid to rest, and a new organization named the "Portland Sevens," with only A.R.R.L. members, took its place. High price of filter is keeping power curtailed at W7ABZ. Our goal is a report from every traffic handling station!

Traffic: W7WJ 828 AXJ 301 HD 319 AYV 161 DP 152 KL 143 CEJ 87 MF 54 QY 41 WR 39 AMF 24 AHJ 32 DCR 28 SY-BUF 23 BLN-ABZ 20 BKL 18 BNK-BWD 15 CUV-BMA-AVB 14 COU 13 AIG 12 CIK-LT 8 CRN-AOI 5 ALM-CBA-BOO 3 DEA-AXO-DAV-DXC 2 DVX-EBQ-LI-BNX-DWQ 1 CXX 8.

WASHINGTON—SCM, Stanley J. Belliveau, W7AYO—W7CZY leads Section. W7UE and CQI report by radio. W7BXT burned out plate transformer. W7APS reports skip affecting Trunk Line "F." W7IG and DLN report on same card. 7 mc. is picking up, says W7APR. W7QI schedules K7. W7BEX has homemade "Collins" perking. W7DWB worked his first DX. W7DJJ has new c.c. rig. W7CCN applies for ORS. New reporters: W7JT, CMO, DSZ and EAH. W7DRY is on daily. W7DGX is DGY till next summer. W7ABU did nice traffic work. W7BCS worked 4 new states. W7DWF is one of the Section's

newest YL additions and sister to W7BCS. W7CXC is trying 1.7-mc. 'phone. W7CND is planning new receiver. W7AFC and W7AIT report. W7AG/SL, AAN, ARN apply for OPS. W7BUW gets



Miss W7DWF, sister of W7BCS, and one of Washington's YL operators.

more r.f. in his antenna when AKS is on than when his own rig is going! W7BKE is now ALH. W7CRP has station at CCC Camp near Eatonville. W7DPU has good luck on low-power 1.7-mc. 'phone. W7AJ5 is now in Seattle. W7CHH changed QRAs. W7BMU has bad case of YLitis. W7BHH has been seen at Radio Club and other places with a certain Miss "B . . ." . . . or is it Mrs. Beach? . . . W7RT will have to buy a ticket to Abyssinia when BHH reads that. W7AVM is busy making Xmas presents. W7DZX gets out FB on 7 mc. W7EBK, ANZ, and DZR report via W7WY. W7WY makes BFL with plenty deliveries. W7LD is president of Rho Alpha Radio Frat. at U. of W. W7AYO got back on the air Armistice Day.

Traffic: W7CZY 465 WY 403 LD 377 ABU 145 ALH 139 CQI 110 BHH 92 CHH 86 AWG 81 IG 76 DRY 54 CMO 52 CCN 51 CRK-APS 42 AHF 41 DSZ 38 DPU 37 EK 32 CQA 30 BFL 28 AYO 27 AJS 23 ASZ 21 BUW-BOF-DET 20 ACY-BEX 19 CXG-APR 18 DJJ 17 AWP 15 CZK-QI 14 CHU 12 AG-BCS-DLN 11 AIT 10 BBY-AFC-DUJ 8 JT-BXT 7 AHT-DWB 6 ANZ-DGY-UE 5 BLX-KO-AVM 4 BUQ-EBK-DZX-AKL-CCT-BEV 3 DRF-CND-CRY-EAH-BYT 2 DZR-BUB-AHO-BUX 1.

PACIFIC DIVISION

HAWAII—SCM, C. D. Slaten, K6COG—K6BDC is on with single '10. K6CRT is pounding. K6HOO is rebuilding. K6COG is taking up fishing with GGF.

Traffic: K6EWQ 1094 FAB 747 AUQ 575 AJA 375 GUA 348 JPT 319 COG 293 GGF 99 CIB 61 GZI 34 HOO 22 EDH 14 DSF 5 JRN-CRU 4.

NEVADA—SCM, Keston L. Ramsey, W6EAD—W6UO is c.c. W6YAR at U. of N. handled traffic on Homecoming Day. W6BYR handled all his with 'phone! W6BTJ is experimenting on 28 mc. W6AJP has two daily schedules.

Traffic: W6BYR 158 UO 89 YAR 82 AJP 70 BTJ 17 HGL 10 GYX 6.

LOS ANGELES—SCM, Francis C. Martin, W6AAN—The Federated Clubs put over well-attended hamfest at San Bernardino. Joint station of W6CUH-QD made WAC 22 times in 1933 and 110 QSOs with South Africa in 10 months! W6EUV is QRL school. W6FKF is back from trip to rough section of Sierra Nevada Mountains. DX is principal diversion at W6HCR. New '10 at W6CUQ as result U.S.C.—St. Mary's football game. W6IUO is proud daddy of FB 7-lb. boy. New transmitter at W6CYV. New ham, W6JJU, reports on 14-mc. work. W6FKD and BQS are rebuilding. Ex-W6ALL is now on as W6IOX. W6FEW is giving series of lectures on technical subject. W6CQG is finally on 'phone with help from W6CRY. New rig at W6EQJ covers all bands. W6ALR passed Radiotelephone Second Class exam. Remodelling at W6BWF. W6ANN moved three times since the "quake." New call at San Pedro is W6JXE, he is old Commercial. W6EPZ moved to South Gate—leaving all bands in Maywood to W6BPP. W6EK is now in Navy Net—in addition to A.A.R.S.—whatta gal! W6ETJ is active again with nice schedules. W6CUU changes QRA. Portable W6EYE reports fine results on mountain trip. W6CEM and GNZ are two blocks apart! W6CVV blows '65. Here's a record—no changes at W6CZZ for over two years. W6HEW is rebuilding 'phone job for 175 watts output. Radio school keep totals at W6GLZ low. W6ALQ reports from C.C.C. Camp. WAC at W6BVZ twice dur-

ing past month. We are indebted to the following who took time to report: W6ALQ-ALR-ANN-CQG-DIX-EGC-HT-WT and SN.

Traffic: W6ETL 1436 GXM 963 GNM 506 CVF 285 AZU 251 BPU 241 BGN 223 ETJ 189 CII 143 FSE 119 BWF 118 CUI 115 BPP 78 EDW 74 BZF 62 CZZ 49 FGT-GFG 41 DZC 33 AIF 29 HEW 27 DYJ-EUV 26 DWP 24 FTV.25 EAR-ERC 20 AAN 18 GLZ 17 CNO-DQZ 16 DJS-ITN 15 HXU-LC 13 DYQ 12 CLY-CVV 10 CEM-DEH-DJC-DOK-ICM-IGO-TN 8 FIT-FWN-GMA-GTE-MA 7 DGH-EBO-FDM-FNG-GEX 6 DOP-DRQ-FEW-FOZ-FYW-IVL 5 BQF-BXG-CHU-CXW-HAH-HJW 4 AGF-CDM-CPM-DCJ-EK-FEX-GNZ-HAE-IFC-JJU-JMJ 3 BGF-BOB-BVZ-FVD-HTO-IRD-IVT-IXH 2 DZI-EBJ-ERM-FQG-GH-IIK-IWO-PD-EMY 1 CUH/QD 5.

SANTA CLARA VALLEY—Acting SCM, Barton Wood, W6DBB—Much credit goes to W6AMM for the help he has given his Section while SCM. We regret that he is unable to continue due to pressure from other work. Mail all reports now to W6DBB, Rt. 1, Box 722, Campbell, Calif. W6YG again leads the Section. W6FBW schedules north, south, and east. More TP traffic from W6AMM. W6BMW has FBXA. W6DBB rebuilt 1.7-mc. 'phone. W6GOZ is using c.c. rig. W6CDX has been appointed PRA activities reporter for the bulletin. W6QR renews ORS. W6BDR is now AUC. W6YL finally acquired a new shack. W6HZW built new 1.7-mc. 'phone.

Traffic: W6YG 138 FBW 107 AMM 38 BMW 25 DBB 17 GOZ 12.

EAST BAY—Acting SCM, P. W. Dann, W6ZX—Please mail reports to W6ZX by the 16th, or phone Thornwall 6412. Your cooperation will be greatly appreciated, gang. W6IT-TT-AGQ-CBF and CGU are our first OPS. W6CTX-GHD are new ORS. W6GHD is East Bay outlet for consistent traffic to Orient. W6RJ is now Radio Aide to Signal Officer 9th Corps Area, A.A.R.S. W6ZX is now A.A.R.S. W6EJA had hours of work changed. W6AF says railroad keeps him busy. W6RF is QRL NCR. W6ATR blew 7 electrolytics. W6CDA had to cancel schedules due to illness. W6CIZ kept schedules with W6FWJ, 9LOK, 9GIC. W6ZX is busy keeping schedules with W6BPU and W7KL on Trunk Line F. Don't forget the Section meetings at Oakland Trade School—Room 205—second and fourth Fridays. These meetings open to ALL HAMS. W6CIZ turned in FB OO report. HAPPY NEW YEAR from ME to YOU. "Pop" Dann.

Traffic: W6AF 23 RF 92 RJ 339 TT 20 ZX 180 ATR 16 CDA 82 CIZ 45 CTX 20 DHS 13 EJA 37 GHD 132.

SAN FRANCISCO—SCM, Byron Goodman, W6CAL—W6PQ tops them all with a grand total. W6JAL and AWA find conditions poor for schedules. W6NK is hitting his stride. First report from W6TA in 8 years. W6BTZ was visited by W6FS and JPW. W6HFR likes link coupling. Congrats to W6AZK, now WAC. W6ATP is beginning to coast. W6MV stalking mallards. 3.9-mc. portable 'phone at W6AAR. W6DTR says bye-bye to 50-watter. 3.5-mc. DX for W6DQH. PP '45s reaching out for W6JBZ. W6JDG schedules W7EX. All China traffic for W6GIS. W6LDN is saving pennies for '10s. YLs R9 at W6BIP. W6GPB is putting in ACSW3. W6JKN, Ex-HTI, swears by screen-grid modulation. W6CAL is QRL college and 28 mc. Four messages at W6DDO totaled 530 words! W6HSA wants HAMFLASHES. W6IU blew his pet '10. Super's working at W6BVL. W6JPA is second op at W6UL. C.C. rig perking at W6AZX. W6COC has antenna ideas. W6DJI reports W6YA on 1.7-mc. 'phone. W6WC deserts briny deep for 3.5 mc. W6GWW is after DX. New 1.7-mc. 'phone at W6DZQ. 7020 crystals at W6GQA. W6GXV is QRL bubble water. W6EKC blew transformer and '52. W6CIS is lining up schedules. New reporters from Sonoma: W6FAJ and HKA. W6DXT is rebuilding speech amplifier.

Traffic: W6PQ 1894 JAL 371 AWA 262 NK 147 TA 81 BTZ-HFR 35 AZK 29 ATP-MV 26 AAR 19 DTR 16 DQH 15 JBZ-JDG-GIS 14 IDN 13 BIP 12 GPB-JKN-CAL-DDO 10 HSA-IU 8 BVL 7 UL 5 AZX 4 COC-DJI 3 WC-GWW 2 DZQ-GQA-GXV 1 CIS 15.

SACRAMENTO VALLEY—SCM, George L. Woodington, W6DVE—W6GAC is new Route Manager. The

SCM urges all traffic men to give him their whole-hearted support. W6GCM is looking for an '01A. W6AIM offers all equipment in the shack for 100 bucks. W6GUK is making hay while the DX lasts. W6FYY and FEJ are bottled up with C.C.C. W6IQH and JPI lost antenna masts in wind storm. W6IQH worked a W9 and a VE5 on 1.7-mc. 'phone. W6GVM worked his second country on 3.5 mc. W6LXE has a new '45. W6FLR, GSP, and JPI are playing with 56 mc. W6HVM has FB c.c. rig. W6FND is in servicing game. W6GGB is crashing the 7-mc. band. W6FOD has RAC Hair-monkeys (harmonics) all over town. W6DFT has trouble getting 14-mc. sigs to bounce off his 3.5-mc. zepp with a d.c. ring. W6JOR had visit from W7BHN. W6GUR moved to Sacramento from Reno, Nevada. W6ADS is new traffic reporter.

Traffic: W6CGJ 27 DVE-GAC 21 EWB 12 ADS 9 DFT 4 DYF 2.

ARIZONA—SCM, Ernesto Mendoza, W6BJF—A.S.W.R.C. meetings are held every other Wednesday at Phoenix Armory Bldg. There are over 230 licensed amateurs in Arizona according to the R.I. Where are all the reports? W6CQF visited W6DDX-GXM-CII-QD and CUI on the coast. W6HBR put up higher masts. W6IIG (age 12) is coaching his mother (age 50) for license. W6IIF is contemplating an s.s. super. W6BLP and BJF operated portable QC from San Francisco Peaks (12,000 feet) and had to leave the antenna behind next morning because 2 inches of ice encircled it! W6HEU is new secy.-treas. of ASWR. W6FGG is driving '52s PP with '52 buffer. W6CPX is chief engineer at KUMA. W6GGW is one of the two ops at Yuma BC station. W6COI deserted BC job for U. of A. W6HAX works in a smelter all night and at his dry goods and notions store all day! W6IZU wants a schedule with Phoenix. W6IQY is youngest ham in Flagstaff. New A.A.R.S.: W6HVY, ILL, HUZ, HGD, FGO, GDF. W6BPV wants OPS appointment. W6GFK is back with us. W6GZU has 9-tube super. W6GGS is building portable to take on power house shift! W6JYQ is a new 50-watt TPTG. W6CUS is nearing completion. W6FKX lives next door to W6HUZ. W6JRK worked Conn. and N. J. Actives: W6HGX, GBN, AND, DCQ, JIL, DOW. W6LXC attends night-school class conducted by GZU. W6DPS will go to Los Angeles Radio School in January. W6EKU duplexes 3.9/1.7-mc. 'phones for 2-band contacts between outside stations! W6EFC has his eye on new 35-watter. W6GDD reports new one tube converters work mighty well. W6IUY the "OW" is on the air. W6FZQ is going 1.7 mc. W6DIE has job with KGAR. W6GJC has carpenter work with C.C.C. camps. W6ANO is looking for commercial ops. job. W6HKX will have super-het in Tempe Armory station.

Traffic: W6ALU 415 CQF 9 HBR 6 JHF 5 BRI 2 IIG-QC 1.

PHILIPPINES—Acting SCM, Newton E. Thompson. KA1XA—KA3AA is back with us again.

Traffic: KA1HR 1470 NA 575 RC 405 FS 223 LG 211 CM 136 CO 128 OR 75 KA 38 EE 30 TS 26 SX 25. KA3AA 41. KA4GR 13. KA9WX 90. OM1TB 638.

SAN DIEGO—SCM, Harry Ambler, W6EOP—RMs. W6FQU, W6QA, 'Phone W6IBK. W6BMC makes BPL and then some! W6DQN also BPLs. W6FWJ has six schedules. W6FQU says city delivery net works FB. W6EFK says trunk line "F" going well. W6BHF is ORS and OPS. W6IBK is RM for OPS. W6BHV made 5358 points in ORS contest. W6AXN worked PK and VK. W6BAM reports W6IGC and FUU opening a ham supply store in Santa Ana. W6GWW handled a message for Byrd Expedition. W6GNP is on 3.9-mc. 'phone. W6FKT says Fallbrook is organizing a radio club. W6DWA is back home. Following are A.R.R.L. members: W6JEC, JRM, FMJ, HAO, FJR, GIQ, GOF, GSN, JRW, FAT, IUG, GNP, HJB. San Diego Radio Club is progressing in fine shape. W6BOW has new 'phone rig.

Traffic: W6BMC 1132 DQN 594 FWJ 422 FQU 245 EFK 216 BHF 54 IBK 16 BHV 13 AXN 9 BAM-GWY-GNP-EOP 3 FKT-DWA 2.

SAN JOAQUIN VALLEY—Acting SCM, A. H. Green. W6AOZ—RM 6GEG is working hard on southern end of Section. W6BCR is our first OPS. W6BHQ makes BPL.

with all Trans-Pacific traffic. W6GXL is on 1.7 mc. W6AME has c.c. W6FFU worked 33 miles on 56 mc. W6GEI keeps schedules on 7 mc. W6EXH's new QRA: Ripon. W6EPQ schedules KAIEM. W6DQV reports Bakersfield Club (6HPZ) operators on air with code broadcast 7 to 7:30 daily except Sat. and Sun. W6EIQ worked Zedder on 3.9-mc. 'phone. W6AEW has gone 'phone. W6AOA blew tens. W6BRP is dolling up 'phone rig. W6JIC is newcomer to Fresno. W6IKG is new ORS. W6DXL has Patterson Super. W6FLS is home after year in China. W6SF built new Super. W6GJO is QRL NCR. W6JNL is confined to bed. W6AKR is fighting bugs in super. Rebuilding: W6BXX, FYM, DZN. Active: W6WA, AGV, SCM wishes you all a Happy New Year. Traffic: W6BHQ 220 EXH 95 IKG 32 A0Z 27 JHY 24 GEG 23 GKE-YB-DQV 18 AGV 12 EPQ 11 JNL 10 GEI-GQZ 6 SF-BTF 4 CVA 3 JIN 2 BBC-AME-FFU-FYM-DZN-GXL-JIC-FRH 1.

ROANOKE DIVISION

NORTH CAROLINA—SCM, G. H. Wright, Jr., W4AVT—W4ABT Chief RM. W4PW Phone RM. A large number of N. C. Fellows attended the big Virginia Hamfest in Norfolk on November 25th-26th. "Big Feet" Hege lost his title to Mr. Kimbril of Charlotte! W4MR and EG are vying for DX honors. W4CJP is going strong on 3.5 mc. W4CDQ worked a VK. W4CP copies the QST from W1MK eleven times during month. W4RE says 14-mc. band is NG. W4CGL is burning down pair of '10s with 1000 volts. W4RV gets OPS appointment. W4IF and BRK send nice traffic reports. W4BST is using '45 TNT. W4CFL is subscriber and booster of "Tar Heel Ham." Sample copy of same will be forwarded to any ham in the United States upon receipt of 3-cent stamp for postage. W4CGH worked a W6. W4BVD, ZH, and TU are ready for winter. W4ALK blew filter condensers. W4ALT says the OW wants to become a ham. W4CJM is building c.c. rig. W4ATY has transmitter to tune to both 7 and 3.5 mc. W4CPA is new Wilmington ham. W4VW joins A.R.R.L. after 10 years on the air. W4BKs has an '03A. W4AAK and AAH have new mast poles. W4BHR is giving code practice on 1.7 mc. W4BV has transmitter with plug in coils for 14, 7, and 3.5 mc., also 1.7-mc. 'phone. W4PW reports organization of NC-Phone Net. Phone operators, please get in touch with him. W4ANZ closed schedule with W9USA. W4BX reports Charlotte Club still active. W4DW has 3.9-mc. 'phone going FB. W4EG has A.A.R.S. State Net going very nicely. W4ATS is keeping up interest in Greensboro. W4JR is QRL WSOX. W4BDU is building c.c. rig. All North Carolina stations are requested to be on the air each Sunday afternoon for the regular NC QSO party.

Traffic: W4BRK 87 DW-RG 33 IF 31 CGL-ANZ 30 ZH 25 CFL 21 BLN 17 RE-ALT 11 BST-TP 10 CJP 9 CP 8 BHR 7 CDQ-CJM-BRT 5 ALK 4 CGH-ATY-AVT 3 RV 2 CLB-TU-BVD-BV-BSS 1.

VIRGINIA—SCM, R. N. Eubank, W3AAJ—Chief R. M., David Woods, W3GE, DXers: W3WM, CZJ, AZU, BTR, BWA, DNR, CHE, DCU, CCU, AAF, CMJ, BGS, BSY. New stations: W3ECT, ECQ, CYW, DQB, EBM, EFZ. Active: W3BPI, MQ, BAD, DDG, AVR. Rebuilding: W3AAJ, CDW, AEL. Active in A.A.R.S.: W3FJ, CYV, BIW, APT. W3ASK's QRA 315 2nd St., Shenandoah. W3DGT QSO'd 22 states in 2 months. W3BZ has new antenna. W3BRE needs tubes. W3GY wants OPS. W3DRK welcomes hams. W3AKN is on 1753 and 3621 kc. W3AOT on 3875 kc. wants schedules. W3CSI QSP'd message from Hawaii. W3DAM has SW3. W3AGW has been in hospital. W3MT is secy. Peninsula Club. W3DXO has 150 watts input. W3CEY is getting publicity for hams. W3CVF is on S.S. York. W3DBI, Petersburg Club, 3875-kc. c.c., Thursdays. W3CEB is at sea. W3CFV is ORS. W3NE's antenna down. W3HV has new Freq.-Monitor. W3BSB went back to '45s. W3CKM is no longer A.A.R.S. officer. W3ADJ has new rig. W3AJA wants SW3. W3BJX has FB schedules. W3AUG is adding '03A 'phone. W3CYK is building 'phone-c.w. rig. W3COJ likes duplex 'phone. W3AHQ is on 3527, 3991, 7054 kcs. W3BEB: 70% 'phone, 25% c.w. W3CKM says c.c. FB. W3BRA QSP'd Byrd ship. W3CPN's Collins rig arrived. W3BRY formed new club. W3CEY reports KJTY R7-R9.

W3DQD rag chews 99.99% time. W3COO is on 3600 kc. W3BNH was heard in Germany on 3.5 mc. W3BAN, HC1FG, W9UM, had 3-way QSO. W3BZA is QRL work. W3AII will be on after Christmas at VML. W3AGY has FB club. W3BYA visited Richmond. W3BXP is QRL CCC. W3BIG has new 110 W. 'phone. W3CA and N. & W. mea are forming Net. Write W3CA. W3CWS is QRL. W3ADD is pres. of FB. club. W3CUR is traveling. W3DVP is on 3551 kc. W3IQ is c.c. 3638 kc. W3BLE worked NYI. W3CFL is on Trunk Lines "C" and "E." W3DDD is W3JNZ at VPT. 125 attended Norfolk Hamfest Nov. 25th! FB. W3DVO is now ORS. VIRGINIA FLOATING CLUB HOLDS FIRST MEETING JANUARY. MORE DOPE LATER. W3AAJ WELCOMES REPORTS FROM ANY LICENSED VIRGINIA STATION. MAIL ON 16TH.

Traffic: W3FJ 132 AAJ 27 CSI 22 ASK-AGW-DGT-WM 8 GY 7 CYW 5 CEY-DAM 3 DXO-MT 2 AKN-ECQ 1 CXM 92 BAD 20 DNR 19 BIW 15 CHE-HV 10 CPV 6 ADJ-CZJ 4 CYV 3 AZU 2 BSB 1 BJX 283 AUG 76 DCU 52 CYK 49 APT 30 AHC 23 CMJ 22 COJ 19 AHQ 18 CCU 12 DDG 11 BEB-CKM 10 BGS 9 BSY 8 BRA 6 CPN 5 BRY-CEY-DGD 3 COO 1 BYA 36 BXP 18 BIG 10 CWS 8 ADD 6 AAF 4 MQ 2 DVO 15 DVP 6 AG 1 CFL 52 BZE 53.

WEST VIRGINIA—SCM, C. S. Hoffmann, Jr., W8HD—RMs W8EIK and JM have organized a State traffic Net which functions each night at 7 p.m. on 3700 kc. The Net is composed of W8EIK, JM, HD, ELJ, DMF, EZR and GQD. Write to your respective RM if interested in joining. W8GEG operates at WMMN. W8HCL worked Spain. W8KSJ worked all districts. W8KDP had 180 QSOs first 2 months' operation. W8ELO schedules W8YA, W8GBC, W9KXC and W4BTU. W8EKK, HVY, KSS, HD visited Chicago. W8HBQ worked VK. W8DAS is teaching school. W8JBP was operated at Marshall County Fair in Moundsville. W8JWL built "Tritet." W8AHF, CHM and DSO desire OPS. W8EZR and BDD are running class at Y.M.C.A., teaching 10 will-be hams. W8OK is constructing PA. W8EWM is building permanent rig. W8CMJ schedules W8CCD, W8FZG, W4DW, W3SN. W8FQB/JCX will handle traffic from WVU. They desire schedules with W. Va. stations. W8TI got R-9 from AC2BHEH on 28 mc. W8HWI is new Morgantown 'phone. W8ILY desires 1.7-mc. 'phone schedules. W8DMF is QRL hunting season. New stations reported: W8KWL, JKG, KWV, KXB, KXC, KDP. W8EL is operating W9OPV at college. New ORS: W8ELJ; New OBS (phone) W8CHM. "The W. Va." has made its appearance again. The next issue will be previous to Christmas holidays, and will be mailed to all reporting stations.

Traffic: W8EIK 195 EOR 60 JM 52 OK 51 JBP 35 HD 33 ASI 28 ELJ 25 CMJ 22 ELO 18 KWU 16 KDP 12 HCL 11 BDD-KSJ 9 DMF 8 ILY 7 DFC-EWM 4 AFB 2 FQB 1.

ROCKY MOUNTAIN DIVISION

COLORADO—SCM, T. R. Becker, W9BTO—The Denver Radio Club is off to a good start. W9GJQ reports fine total. W9CDE is building MOPA. W9NRA is club station in Boulder. W9IUH, ELE, LIP and HKN report. W9JGF found a job. W9GCM joined A.A.R.S. W9LEK changed QRA. W9BRZ is "part on the air." W9KNZ makes the BPL. The Springs gang report FB results with the "tritet." Take a look at W9ESA's total. W9APZ's flea power is working FB. W9YL handled a few. W9EHC is building "tritet." W9FYY worked three Britishers. W9IPH is now O.O. W9LYE has new operator-station license. W9BTO will be on 3.5 mc. soon. W9BYK and EMU are on 'phone. W9FRP is installing Class B '03A modulator. W9AAB has new sky sticks. W9GVN is working in Alma. W9CND has FBXA. W9BCW uses a ten in final.

Traffic: W9EHC 4 YL 23 NRA 83 IUH 6 LLP 7 HKN 6 CDE 58 GJQ 327 GCM 17 KNZ 501 ELH 43 ESA 1067 APZ 2.

UTAH-WYOMING—Acting SCM, Arty W. Clark, W8GQC—RM W6EXL. Members of Utah Traffic Net are to be commended on reliability and efficiency. W6AFN S.L.C. is Control Station; other members: W6AHD, Cedar City; W6FYR, Ogden; W6GQR, Park City. Join

up, gang, and get in on the fun. W6FPJ built new shack. W6CRS has 1 KW 3.9-mc. 'phone. W6CUD and CRX are on 'phone. W6DEM and AWV have c.c. W6DGR visited W6FBW and YF W6DEV, San Jose. W6GQM is active in NCR. New stations: W6ITW, Murray; W6JYL, Salt Lake. W6GPJ is looking for schedules. W6HHI handles traffic on 14 mc. W6EWW is 'phone OBS on 3.9 mc. W6EXL applies for OPS. W6GQC slips into BPL. W7BJS is on 3.9-mc. 'phone. W7BVJ is QRL school in Seattle. W7COH keeps FB schedules with '01As P.P. W7AMU took portable to Cheyenne. W7AOU built 50-watt c.c. rig. W7NY is working on new rig.

Traffic: W6GQC 513 AFN 337 GQR 80 AHD 73 HH 63 EXL 33 FYR 23 DGR 18 BTX 13 GPJ 7 DEM 5 GQM-JVB 2 BAE-JVA 1. W7COH 39 BJS 6 AOH 5.

SOUTHEASTERN DIVISION

ALABAMA—SCM, L. D. Elwell, W4KP—W4BOU leads the state! W4DS, the RM, is next. Close on his heels comes W4AAQ. W4ASM wants OPS appointment. W4APU built SS super. W4AP says 15-mc. 'phone FB. W4BSL won a crystal at convention. W4SN, 'phone station at Auburn, has FB traffic total. W4RS handles both 'phone and c.w. W4BZG worked seven W1's in a row. W4BJA moved to 3645 kc. W4CHJ reported fine total. W4DD is QRL work. W4AJJ's antenna is 3 feet from the ground. W4AJY built TRF receiver. W4BAI reported via radio. W4AKX reports new station in town. W4BCU is back on after a fire. W4GL is starting 50-watt rig. W4BXV worked his first ZL. W4BSA is op at WODX. W4FB is renewing op license. W4OA put more juice on the modulators. W4CBI has new rig. W4CNI is thinking of 'phone. W4CPC is a newcomer. W4BLI reported. WINJ was a visitor to Mobile Radio Club. W4CCP and COA consolidated. New member: W4CPE. W4BMM is 'phone Trunk Liner. W4BDH is winding new transformer. W4AEZ is on 'phone and c.w. W4BBO visited Montgomery gang. W4BLY moved to Amarillo, Texas. W4CIG is Mobile Club station. W4COU is new addition. Ex-W4BFP is in Fort Sam Houston, Texas. W4ADL, the OO, reports. W4KP is handling traffic on All 'Phone Trunk Line from Chicago to Miami.

Traffic: W4BOU 352 DS 129 AAQ 125 SN 65 CEJ 56 RS 41 BJA 38 CCP/COA 37 GL 17 ASM 18 AP-BZG 12 BMM 7 BAI 6 DD 4 AJY 3 KP 33.

EASTERN FLORIDA—SCM, Ray Atkinson, W4NN—The 'phones handled the bulk of the traffic this month. W4WS is new Route Manager. W4ALP, RM, will help line up reliable c.w. schedules. 'Phone news: W4NN is first to make the "100 total club" this season. W4ACZ says 'phone DX FB. W4COS wound all transformers for his new 'phone. W4AQU is a new 'phone-traffic man. W4MM at Winter Haven has improved his quality. W4KM and AOK report traffic. W4AGB handled messages on 14-mc. 'phone. W4AXY is on 1.7-mc. 'phone. W4CGW is planning 1.7-mc. job. W4AKA is rebuilding 3.9-mc. 'phone. C.W. news: W4BDM wants schedule with North Florida. W4BNI hooked HC1JW. W4VP is QRL moving. W4CGV is newest traffic hound. W4AIO has new rig. W4ABV has new power supply. W4CAR is looking for traffic. W4HY has Class "A" license. W4AEM sends nice total. W4AZB did nice OO work.

Traffic: W4NN 172 BGL 50 WS 43 AOK 36 AEM 32 KM-CGV 13 ACZ-AZB-AGB 10 MM-BDM 7 BNI 13 HY-COS 4 VP-BRI-AQU-CN 3.

WESTERN FLORIDA—SCM, Eddie Collins, W4MS—RMs.: W4ACB, W4AUW. W4AQY and AUV are on 1.7-mc. 'phone. W4KB applied for OPS. W4AGS is on 14 mc. W4QK attended Birmingham Convention. W4CV is operating from NDD. W4CBD is going on seven months' cruise. W4COG has been sick. W4CMJ is on 56 mc. W4CDE will run airplane tests. W4BFD has our best c.c. signal. W4AUW uses c.c. Osc. W4BMJ turns in FB total. W4QR is on all freqs. W4BSJ reports DX. W4ACB is moving into house for winter. W4AUA has been transferred to N. Carolina. W4BPI has a partner now. W4CNL. W4ARV is on for U.S.N.R. drill with storage batteries. W4BGA lost an '03A. W4AQA and ABK are QRL school. W4CFF has been transferred. Ex-W4ABJ returned to Columbia. W4UW is in Texas. W4BGA and MS worked Africa. W4FV is in Harvard. W4BOW is renewing op

license. W4ASG may go to Guam in the Marines. The SCM would like to hear from prospective ORS, OPS and OBS. W4BGA makes WACJ on 7 mc. with '10s!!

Traffic: W4BSJ 10 BMJ 43 KB 30 BFD 6 COG 8 BGA 10 ACB 12 AQY 16 MS 27 BPI-ARV 4 AUW 6 CDE 7 AXP 5 QR 3.

GEORGIA-SOUTH CAROLINA-CUBA-PORTO RICO-VIRGIN ISLANDS-ISLE OF PINES—Acting SCM, G. A. Love, W4UT—W4IR leads the Section. W4CBY worked Africa five times in a week! W4AW gave a "swelegant" talk on crystals at convention. W4UT copped an RK-18 tube for prize. At regular meeting of Atlanta Radio Club, J. Gardberg of local IRE contingent gave an excellent talk on volume controls. All Georgia hams are urged to attend these monthly meetings. The annual old-timers' get-together and banquet will be held by the club some time in January. For information write W4MO. CM2RA says QRM from bombs and guns makes communication impossible in Habana. W4CGT is operating Naval Net (NDJ) tri-weekly on 3510 kc. The Palmetto Amateur Radio Club of Columbia, S. C., held a hamfest with Augusta, Ga., club in Columbia. W4CE is Comms. Officer, 4th Fleet Div., Georgetown, S. C. W4CIR will soon be on with '12A in Hartley.

Traffic: W4CMZ 24 BO 13 CDH 7 CM 6 BOJ 3 CFJ 2 CBY-AEI 1 R 161. W9LMS 34. W4CE 47.

WEST GULF DIVISION

NORTHERN TEXAS—SCM, Glen E. Talbutt, W5AUL—W5BII, C.R.M. District 1: W5BII is DNCS is A.A.R.S. Mrs. W5NW is W5DUR. W5ASU reports new club at Athens. W5BTJ wants 1.7-mc. schedules. W5YL is on at Palestine. W5AHC is on 1.7-mc. 'phone. W5BZT WAC last month. "Felix" of South American fame is on at Jacksonville signing W5AJ. W5ANU, RM, has c.c. freq. meter. W5DAA has nice traffic. District 2: W5AMK reports by radio. W5CMS wants ORS. W5DFU is on 1.7-mc. 'phone. W5CHJ is building new super. W5CCD sends big DX list. W5CAV visited San Antonio. W5IA, RM, has MOPA. W5BKJ says new club starting in Ennis. District 3: W5IT worked K6 on 3.5 mc. W5BCW is building c.c. rig. W5CY is using '03A. W5CPB fell off antenna pole. W5CPT "says" 5520 M.P.W. this month. W5CNU is rebuilding. W5OJ is on at Wichita Falls. W5ARS, RM, has 6 schedules. District 4: W5AUJ worked Hong-Kong. W5CYU and SP are on 3.9-mc. 'phone. W5BAY is building new rig. W5AW erects new antennas daily. W5BNS finally reported. W5DKF burns lots of midnite oil DX'ing. W5BVF has new crystal. W5DST is new Abilene ham. W5BKH is busy RM'ing. Thanks, gang, for reports this month; we broke the record with 38 traffic reports. The SCM invites all stations to report monthly, and is especially interested in getting dope on all clubs. W5BKH offers an RK-18 tube to the station handling the most traffic in 1934 contest closing November 15th. W5BAY has been appointed 'Phone Route Manager and wants applications for OPS from all good 'phone stations.

Traffic: W5BII 354 ARS 151 ANU 122 AUL 117 DAA 111 CCD 93 AW 77 AJG 71 IA 66 CAV 60 AUJ 55 BKH 47 CYU 34 CJE 32 CPX 29 IT 27 AHC 28 AYD-BKJ 26 AMK 20 BCW 18 CY 17 DKF 16 OJ 11 CMS 10 AVA-BYM-BNS 8 JA 7 TR 6 BAY 4 DFU-DJL 3 BKC 2 BWM-ARV-CHJ-CEE 1.

OKLAHOMA—Acting SCM, R. F. Hinck, W5BQA—Our SCM, W5VQ, has been transferred to 9th Bombardment Squadron, March Field, Riverside, Calif. Sorry to see you go, OM. Best of luck. W5CEZ heads the list again this month. While on vacation he visited W9DMY, W9IGF and Grand Island monitoring station. W5AKX has new QRA. W5BDX says the gang at Enid has organized the Enid Amateur Radio Club, W5CEB pres., W5BJT vice-pres., W5CWL secy. W5CON is with the CCC, Co. 1810, Binger, Okla. W5BOE is using 100-watt c.c. rig. W5CJZ says BMT is putting up new sky poles. The Oklahoma State Convention is to be held at Ponca City on January 20 and 21, 1934. Registration fee is only one buck. W5BQA's temporary ticket expired. Please send your reports to St. Sgt. R. F. Hinck, 1st Balloon Squadron, Fort Sill, Okla., until further notice.

Traffic: W5CEZ 283 BDX 112 CNC 106 BOE 30 CJZ 26 CBY 16 CUX 6.

SOUTHERN TEXAS—SCM, D. H. Calk, W5BHO—W50W sends nice report. W5MN keeps A.A.R.S. schedules. W5BKE reports for Kerrville. W5BKZ has portable on 3.9-mc. 'phone. W5VV schedules K6BOE. W5CVW visited in Maine. W5PF reports two new hams, W5AXI and DQN. W5ADZ is new O.B.S. W5AJW handled traffic for lost Army plane from W9BSE. W5AJW keeps 12 schedules per month with W9ESE, his Dad. W5AFQ delivered traffic for man to come after his sick wife and baby. W5BEF is working DX. W5BEF works his son, W5BFY, every other day on schedule. W5BKY visited W9USA and South Town Am. Assn. in Chicago. W5YL handled Red Cross traffic. W5DTL-W9LNU wants schedule in Mo. and Ill. W5JB's c.c. rig perks FB. W5CDV has new receiver. W5AKN plans 50-watt rig. W5CET is rebuilding c.c. rig. W5EXX reports deer hunting FB. W5CKK moved to San Benito. W5CMY and CNA are on 1.7-mc. 'phone. W5AGG moved to Pharr. W5BFS is going in for high power. W5CSL spends most of time on 1.7-mc. 'phone. W5PM is building 1.7-mc. 'phone. W5ALJ works all bands. W5BBR works lots of DX. W5DUH is new ham. W5CFK has trouble with transformers. W5ZG is building new c.w. rig. W5BB is new ORS. W5DPA, the Houston Amateur Radio Club, had a transmitter on 7 mc. at South Texas Exposition. W5ON plans on higher power to compete with W5BHO. W5ANW is on with low power 3.9-mc. 'phone. W5BGG reports 1.7-mc. 'phone FB. W5BFA reports 14 and 3.9-mc. 'phone. W5DSP schedules Mo. 5DSP is X-W9IGC. We will welcome applications for OPS appointment; also need a Route Manager. W5DBN and AMV report.

Traffic: W50W 906 MN 295 BKE 59 CVW 57 VV 47 PF 7 ADZ-AFQ-AMV 5 AJW 4 BEF-BKY 3 YL 1.

NEW MEXICO—Acting SCM, J. M. Eldodt, W5CGJ—W5CGJ, ZM, AOP, CJP and BNT joined A.A.R.S. W5AIC has rig perking.

Traffic: W5AAX 32 BNT 22 ZM 45 CGJ 36.

CANADA

MARITIME DIVISION

NOVA SCOTIA—SCM, A. M. Crowell, VE1DQ—1BV heads the traffic list. 1ER, RM, schedule with 2CX completes Canada T.L. 1EP is a two-op station. 1EA schedules 2BT. 1DE schedules 2HK. 1FB, QSL Mgr., sends fine report. 1DO is SW3 owner. 1FD is new YL ham. 1BO is building shielded c.c. job. 1FS has new power transformer. 1AJ had hard job getting up sky-wire. 1FJ blew his '10. 1DY has QRM from trucking business. 1DC has '52 in final. 1AG applied for OPS. Active 3.9-mc. 'phones: 1EL, BA, BW, MOPA on 1.7 mc.; 1AO, CL.

Traffic: VE1BV 31 ER 28 EP 5 EA 14 DE 3 FB 1 DC 8.

ONTARIO DIVISION

ONTARIO—SCM, S. B. Trainer, Jr., VE3GT—Many thanks, fellows, for electing me as your new SCM. I hope, with your help, I may continue the good work. VE3QB, Ont. QSL Mgr., requests that all stations that have worked DX in the past year send him stamped envelopes for their QSLs. 3HH reports good club at Palmerston. 3RI visited OD. 3TM and JT operated at W9USA. 3UX wants schedules. 3RK, LI and WK are new ORS. With much regret I must report the resignation of 3HA as RM. 3RT has a crazy buffer. 3YY and KM want test schedules on 28 mc. 3MX says it is "the berries." Mr. and Mrs. 3DW went to London hamfest. 9AL battles 'phone bugs. 3GO will have a '61 on 7 mc. 3QD, OB, JU, PG, RR, QE, VJ, HT, QU reported via RM 3HP. 3DC's cheery sig is missed. Prospective ORS: 3DJ, SG, IQ, RT, QH. 3OJ is QRL "U." 3IE, AD and NB will be on soon. New reporters: 3RE, XD, TG, TQ, SP. Don't forget the Ontario QSO parties every Sunday morning on 3.5 mc. New officers Ottawa Amateur Radio Transmitting Assn.: pres., VE2GP; vice-pres., 3MX; secy.-treas., 3SA; tech. adviser, 3JW. Meetings held every other Friday night. All hams welcome.

Traffic: VE3GT 269 JI 164 GO 83 DJ 78 HA 57 RK 54 WK 38 HP 26 SG 15 DW 11 RT 10 QB 9 MX 7 GI-1I 4 QH 3 LZ 2 NB 1 GA 14 CA 19 SA 3. VE9AL 21.

WINTER CONTEST FOR ALL ONTARIO AMATEURS

Contest starts Jan. 16th, 12:01 a.m., ends March 15th, 11:59 p.m. Simply report to your SCM on Feb. 16th and March 16th: 1. Your traffic handled. 2. Copy of your log of: (a) all VEs worked outside of 25-mile radius; (b) all stations worked off the continent; (c) all W/VE ORS worked; (d) all W/VE RMs and SCMs worked. Points to be based on your standing in each of the five groups. Five useful prizes for which your own RMs and SCM are not eligible.

QUEBEC DIVISION

QUEBEC—SCM, John C. Stadler, VE2AP—2BT schedules his brother VE1EA. 2EE has 39 countries. 2GO worked his first CM. 2AC has bugs in his 'phone. 2HP is getting his shack fixed up. 2DG is on daily. 2FE has YL QRM. 2BB returned to previous shack. 2HM gets out better with new sky-wire. Many masts went down in that storm. 2BG had W1MF and W1BES visiting him. 2EM wants 56-mc. enthusiasts. The "Sky-Wire" is available to all VE2—if you do not get it, send me your QRA. DXers: 2CA, EX, DR, HK, GH.

Traffic: VE2CO 6 BT 24 AP 32 CA 1 BG 95 BB 146 CX 101 DG 8 AC 19 HK 36.

VANALTA DIVISION

ALBERTA—SCM, C. H. Harris, VE4HM—4GT lost his mast. 4HM and EA supers working well. 4EW is back in Edmonton. 4EC is going north. 4OS has transmitter at varsity. 4EA has 50-watter. 4EO is trying crystal. 4NB uses pair '46s c.c. 4AB rebuilt. 4LX contemplates higher power. 4DX, ID, DC, JK and NC are on 'phone. 4KT sends first report. 4JP is going to 1.7-mc. 'phone. 4GM gets better results with linear amplifier. 4KN has nice signal. The A.R.E.A. in Calgary are putting on QSO-QSL contest. Edmonton and district gang had a FB hamfest on Nov. 11th and 12th; about 35 present. Active: 4GY, EX, CX, BV, MG, DQ, GD, HQ.

Traffic: VE4LX 21 HM 11 NB 7 DX 6 EO 5 KT 3 DQ 2.

BRITISH COLUMBIA—SCM, J. K. Cavalsky, VE5AL—The B.C.A.R.A. operated a station at Vancouver Radio Gala. 5BN's two ops keep station on the air. 5BY is coming on 'phone. 5GJ plays chess by radio. New officers of Victoria Club: 5DF, pres.; 5IE, vice-pres.; 5DY, secy. 5IR is active. 5FE moved to Victoria. 5EC increased power. 5EF has been on sick list. 5CV wants more power.

Traffic: VE5EH 16 GI 8 AC 58 JD 6 AG 48 AL 24 FG 42 DF 36 HR 19 JA 19 JC 13 HP 134 EO 31 EU 62 HI 200. VE9AJ 103.

PRAIRIE DIVISION

MANITOBA—SCM, Reg. Strong, VE4G—4AG is MWEA president. 4BG is building rack and panel. 4KU completed MOPA. 4AE has '10 TPTG. 4CI has 50-watter. 4BQ schedules Great Bear Lake. 4DU is using "tritrit." 4GC has TPTG. 4CD is MWEA secretary. 4DK schedules are working OK. 4FP is looking for station using his call. 4IP is looking for new QRA. 4MW is looking for good schedules. 4GL is considering an FBX. 4NF is on 1.7-mc. 'phone. 4MY is building MOPA. 4JF is honorary president of MWEA. 4NY and MV are building c.c. rigs. 4KX is pushing 'phone out on 14 mc. 4LT is QRL. 4LN is awaiting new transformer. The MWEA held a banquet at the St. Charles, and a good time was had by all. Rebuilding: 4LH, HP, DXers: 4NW, DJ.

Active: 4CP, FT, OB, NM, DZ, OX, IU, NI.

Traffic: VE4MW 31 LN 15 MV 9 AE 6 DJ 4.

SASKATCHEWAN—SCM, Wilfred Skaife, VE4EL—Your SCM visited 4EU, 'phone, and had FB QSO party with 4GA, CE, ID, DC, GI, FA and KJ. 4GA handles raft of traffic from Van. to Chi. 4KJ works ID 100% with 183 volts. 4EH and GA apply for OPS. 4JH worked his first ZL. 4BF is QSO PY. 4JV is building 50-watter. 4GR handled traffic with QRM from 7 locals. 4IM is on nightly. 4EM is trying a.c. receiver. 4BB visited 4JS, JV, KX, EM and CN. 4MH changed to P.P. 4FF is transferred to Ontario. 4EL is coupling his P.P. 28 mc. Osc. to final AMP. 4ML built dandy cabinet to take both

transmitter and receiver. 4DB is completing rig with c.c. osc. 4CN visited 4AZ, IJ, and GW. 4OE works all W. districts with 4 watts.

Traffic: VE4BB 53 MH 31 GR 23 GA 22 BF 13 KJ 10 EL 8 JH-KV-AV 3 OE 35.

LATE AND ADDITIONAL REPORTS

W5DMP wants all traffic possible. W5CLV is c.c. W5DAW increased power. W5CYI has 200-watt rig. W5BMM is on regularly. W5DLD, LaPlace Radio Club, schedules W3CL and W4BOU.

Traffic: W5DLD 65, W5DMP 10.

Traffic Briefs

W2BSR worked XW4PDA on Oct. 17th on 14 mc. XW4PDA is the ship *Ripple* of the Hammond Research Expedition, at the time 70 miles from Ciudad Bolivar, in the Orinoco River, Venezuela.

For *poor fists*, use QSD . . . your keying is bad, signals unreadable. Of course the signal QSD is equally appropriate for the signal in difficulty due to trouble with cold rectifiers, sluggish keying relays, wrong grid bias for keying, defunct relay batteries etc. too. Irrespective of the cause, QSD will inform an operator of keying difficulties.

The Amateur and Police Radio

(Continued from page 37)

All this is machinery and men, from which may be built drama. It is unfortunate that you have the wrong writer for that purpose. I will make a feeble stab at it by a few examples and then send you elsewhere—for it has been done by more exciting pens than mine.

One night we left WCK with an experimental receiver. Soon the speaker warned two scouts that a pair of drunks was endangering traffic by their handling of a car at a corner just six blocks ahead of us. We gave the Packard its head; but when we had come the six blocks two scouts had the offenders jammed against the curb!

That night there were four cases of the sort which the ponderous Connecticut law would call "breaking and entering." Three of them were caught *in the houses*. The fourth man saw the scout coming and jumped out of a back window, ran to the end of the alley—and met another scout.

With such results, the number of cruisers and scouts seems well justified; and appropriations for more warranted. Other city administrations seem to agree with this estimate, and while a bit of listening will show that some stations are woefully mishandled, the majority are growing up in a fine tradition of clean operation—and for that WCK may well take a share of credit.

But I promised you drama. Very well—remember the *Saturday Evening Post* stories by Mary Roberts Rinehart, especially the one under the title, "That Is All?" I think she has been in Detroit. But no WCK operator ever said, "That is all." For by saying, "That's all," he can speed up the service a fraction of a second; and lately he says only "WCK." That's an honorable finish for any radio transmission.

It's in the Blood!

(Continued from page 26)

Hoboken for all the good it did 'em; but they needn't have felt hurt, 'cause we listened and cudn't find Jasper either. However, Soupy manages to hook him one a.m.; he was twaddlin' around in the 7000-ke. band with a sig that sounded like the ghost harmonic of a goober-tube long since gathered to its fathers, and a note about as stable as a YL's mind. When Soupy tells him he's in the ham band and that we are hearin' KXXX and can work him and handle all their traffic he tells Soupy he can't be in the 7000-band because his crystal is ground to 6826 kc. and what's more we are QRMing him and he doesn't need any help and will we please get off the air. So we tell him he can go places on a one-way ticket, and go back to our business of snaggin' Zedders in the early mornin' hours and don't bother with him for the next coupla weeks.

By this time the crew of the M.S. *Palooka* was tearin' their hair wonderin' where the outfit could be upriver and WNU's press was gettin' full of the missin' expedition—none of which caused Soupy and me to miss our Cafe Royal every a.m. So it goes for a coupla more days until one day about the time you can work K7's I hears a scratchin' on the window. Thinkin' maybe that one of the native gals I'd been teachin' English to had forgotten a word and come to the ole maestro to review her lesson I gets up for a looksee, and who is it but J. Q. Sideband in person—none other.

"Listen," says he, "maybe I was a bit hasty when I worked FX that last time; the mosquitoes, you know, were nearly driving me insane." He points to his swollen dogs. "Could you chappies help me with my set?" says he. "I can't seem to make it work."

Well, after I'd booted Soupy into as near consciousness as he ever gets we have a parley and it seems the idea is we should muck among the mangroves with this egg and scam upriver to get his set working without lettin' the guys on the M.S. *Palooka* know about it, thus keepin' Jasper's name unsullied so's he could go back to the U. S. A. and endorse poney static-eliminators and cigar-box antennas. Why we agreed to do it I dunno; guess we were (and still are) screwy. But we did. Just before we sneak out, Jasper points to our rig.

"Shouldn't we take that set along, as a sort of auxiliary rig?" he asks, pointin' at FX all nicely haywired up. "Of course I know there's nothing fundamentally wrong with my set . . . some mere trick feed-over from the last stage to the second doubler, but . . ."

"You will NOT!" yells Soupy. "You may get me to lose a qt. of blood to the flies, an ear to the 'gators, and several days' drinkin' time, but you don't get your dukes on this rig!"

When we come up to the expedition some days later they didn't look quite so natty as when

(Continued on page 72)

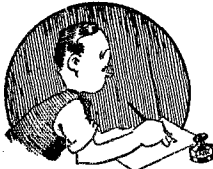

CORRESPONDENCE

The Publishers of *QST* assume no responsibility for statements made herein by correspondents

Hawks Enters Hamdom

The Texas Company,
135 E. 42d St., New York, N. Y.

Editor, *QST*:

I have hesitated to write any comments on my entry into the ham fraternity, but it might perhaps be amusing and interesting, and, possibly, of some constructive value.

I was thrilled beyond words in passing the examination and receiving certificate and station license. I could not wait until I could finish my flea-power transmitter. I say flea-power because my good friend W2GKM and I both agreed that we would start in with very low powered outfits until we have gained experience in the field of both construction and operation of the equipment.

All hams have experienced the thrill of constructing their outfit and the first night of trial. That anticipation of an answer to continued calls can last just so long and then there is bound to be a bit of disappointment and even resentment. Personally, I spent my first three nights between careful observation of A.R.R.L. recommendations, sent very few CQ's, twiddled the dials religiously to pick up others. I was not in the least optimistic of my own outfit, so I called only stations within my immediate district. Needless to say I was very disappointed on the third night that I had raised nobody.

Finally, to make sure of the signal's strength, I enlisted the aid of W2GKM to operate my rig while I climbed into my airplane and worked with him. KHEVE, which is in the 'plane, is a decidedly proven outfit. I circled my home until I picked up my own station and then flew in radiating circles about the house for a distance of some 50 miles in all directions, keeping in constant contact with home.

With this information I was fired again to go after the boys in my own district, knowing that I was actually getting out and that surely somebody would answer.

Time has elapsed and I have had the pleasure of a few QSO's (very few). I have talked with several prominent amateurs who have been at it a long time and find that it is rather difficult to QSO with a ham in your own district; most of them pay no attention to local calls as they are after DX. Now, I cannot blame them for their eagerness to get distance, but I do think that

when some weak and perhaps modulated signals are discerned, some of the hams should feel a spirit of charity and answer those calls with a definite intention of giving a thrill to the other fellow who is so eager for an answer, plus helpful suggestions regarding tone or any other defect that might be noted on the signals.

W9ZZAF wrote a very helpful article in October *QST* along these same lines, and I am merely elaborating on it. My giving specific instances is just a more concrete manner of helping rid the air of thoughtless and inconsiderate hams. I would not be so bold as to mention specific calls. In working one chap I was hampered with considerable QRM plus his none-too-good signals. He was going a little faster than I could take it under the circumstances, yet each time I managed to catch enough to come back and give an intelligent reply along with which I asked him — five times — to QRS. He paid no attention whatever to my request and the completion of the QSO was rather disappointing. I worked another chap to whom I asked for a slight repeat due to QRM and he never answered me at all and never even signed off. The next thing I heard was his CQ and I was decidedly at a loss to know just what could possibly be in his mind by treating me in that manner.

Of course, they have not all been that way. I have had the pleasure of contact with a few very courteous hams who have been most helpful. I am new, eager to learn and eager to cooperate.

I was impressed with the article by W6ZI on the classification of pests, in November *QST*. It would not hurt any ham in the world to peruse that article and take inventory of his own station and the operation of it.

I am extremely interested in amateur radio and will only increase the power of my outfit as I gain in experience and ability to operate it effectively with as little hindrance to others as possible and to the satisfaction of those in the fraternity with whom I may have the pleasure of coming in contact, and to the best interests of the A.R.R.L., with which I am proud to be affiliated.

—Frank M. Hawks, W2GKL

Hot Cat

City Hall, Lake Worth, Fla.

Editor, *QST*:

It was a nice quiet night in a certain commer-

(Continued on page 70)

PRECISION CONTROL

There is a NATIONAL Velvet-Vernier Dial for every application in Amateur radio where consistently smooth and fine operation, precision control and precision logging are requisites.

NATIONAL Velvet-Vernier DIALS

FULL VISION DIAL

U. S. Pat. Nos. 1,656,532 and 1,713,146

The Amateur can note instantly just what part of a band he is working, when he uses this dial on his receiver. The ample 7" illuminated scale permits a high degree of accuracy in reading and logging. Mechanically this dial has all the fine quality that has always been found in NATIONAL Velvet-Vernier Dials. The drive is smooth and positive. The pointer is vertical on all parts of the scale. Escutcheon is finished in antique bronze.

TYPE "NW" DIAL

U. S. Pat. Nos. 1,744,675; 1,653,875; 1,656,532; 1,713,146

Outstanding precision-vernier instrument dial for monitors, frequency meters, oscillators and a wide range of other uses where extreme accuracy of control and reading are necessary. Its polished German-silver machine divided dial and parallax-eliminating flush vernier read directly to 1/10 division and may be estimated to 1/20 division. Equipped with Standard Velvet-Vernier drive, of the type used in the NATIONAL Type "B" dial, with three-point variable-ratio. No finer dial is made, either in accuracy or appearance.

TYPE "N" DIAL

U. S. Pat. Nos. 1,744,675; 1,653,875; 1,656,532; 1,713,146

This 4" instrument dial of solid German silver is equipped with unexcelled NATIONAL Velvet-Vernier, Type A mechanism. This is the dial used on the AGS Receiver. It has 5-1 ratio and vernier index, reading to 1/10th dial division. Here is a precision control mechanism fully suitable for many uses for which as large a dial as the "NW" would be unnecessary or impracticable.

TYPE "A" DIAL

U. S. Pat. No. 1,744,655. Others pending

This is the original NATIONAL Velvet-Vernier Dial,—more widely used by Amateurs than any other dial ever made. Its smooth and matchless mechanism is permanently free from backlash, the drive is always even and positive. Ratio is 5-1.

TYPE "B" DIAL

U. S. Pat. Nos. 1,653,875 and 1,656,532 and 1,713,146

One of the most popular Velvet-Vernier Dials. Equipped with variable ratio of 6-1 to 20-1. Fitted with black Bakelite shell. May be equipped with dial illuminator. Also available in new midjet size, type BM.

TYPE "G" DIAL

*U. S. Pat. Nos. 1,744,655; 1,656,532; 1,713,146. Des. pat. 79,378
1,790,939; 1,789,912; 1,751,658*

Disc Projection Dial for condensers with shafts at 90° to panel. Dial numbers are projected in magnified size on dial screen. Also available as Type "H" Drum Projection Dial, for operating condensers with shafts parallel to front panel.

These and other types of NATIONAL Velvet-Vernier Dials and Dial Lever Indicators as fully described in Catalogue No. 220 (see QST, October, 1933), are also licensed under Federal Telegraph and RCA patents.

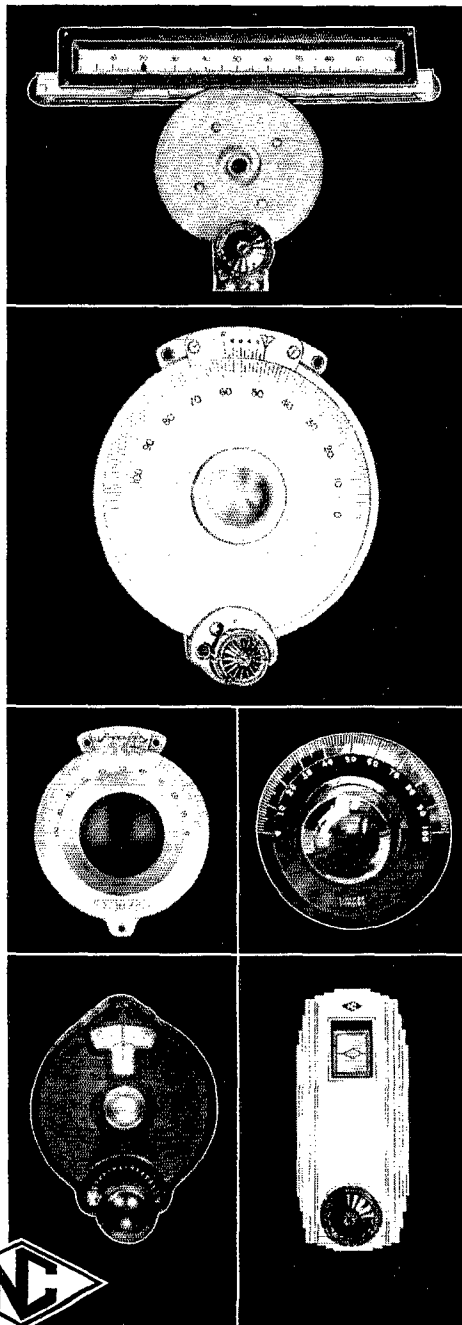

NATIONAL COMPANY, INC.,

MALDEN, MASS.



Say You Saw It in QST — It Identifies You and Helps QST

EFFICIENCY! APPEARANCE! VALUE!

The New GROSS Transmitters possess all these features

The transmitters described here were designed to fill the requirements of the most discriminating purchaser. Many novel constructional features are incorporated in this equipment.

The GROSS "CB-25" Kit

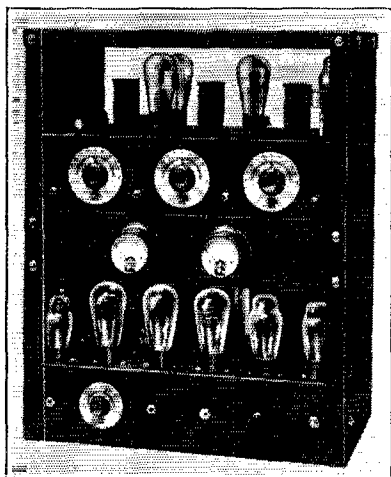

A complete class "B" Phone and C.W. Transmitter kit. Output 25 watts maximum Phone or C.W. Separate Power Supplies for Speech Amplifier and Crystal — heavy duty Supply for Class "B" and Class "C" Amplifier — Speech Amplifier is self-contained. A quality job thruout. "CB-25" \$66.00

The GROSS "CW-25" Crystal Control Transmitter Kit \$13.95

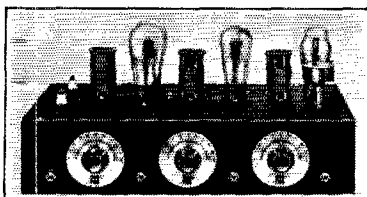

The "CW-25" transmitter kit due to its low cost makes it possible for anyone to own a modern crystal controlled station. A schematic hook-up and parts layout sheet as well as tuning instructions are furnished, thus enabling the most inexperienced operator to wire and put the set on the air, for real results. The "CW-25" is supplied with a shrivel finished sturdy metal chassis under which all parts are mounted, making the wiring and components dustproof. A plug-in crystal holder is furnished with the kit. Only one milliammeter is required for tuning the transmitter and each stage is provided with a jack for this purpose. The "CW-25" uses one '47 as crystal oscillator, one '46 as buffer or doubler and two '46's in the amplifier stage. One set of three coils is supplied with the kit for 20, 40, 80 or 160 meter band. Any additional coils are 75 cents each.

The GROSS "CW-25" Power Supply Kit \$8.75

Mounted on shrivel finished metal chassis which matches the "CW-25" transmitter. Heavy duty power transformer, chokes, condensers, bleeder, etc. supplied. Uses one '83 rectifier. This unit and the transmitter make a neat combination as well as an efficient one.

The GROSS "CP-100" Kit

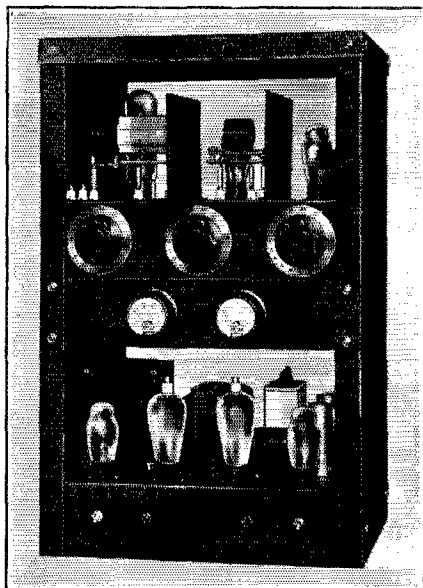

A complete crystal controlled medium high power C.W. transmitter having an output of 100 to 150 watts on all frequencies. Extra heavy duty power supplies, three separate filters are among the many features. Careful design and use of high grade components make it easy to obtain a fine signal and maximum output. "CP-100" .. \$76.00 (Note the dials illustrated on the "CP-100" can be furnished on any of the transmitters at an additional \$3.50)

The GROSS "CW 100" Kit \$24.50

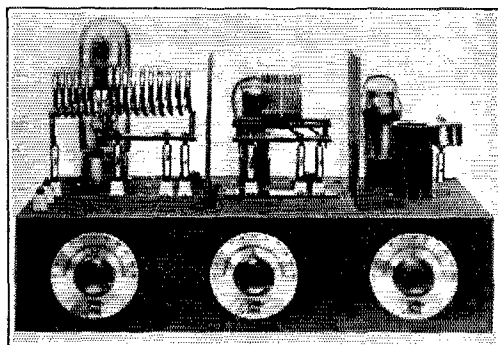

The smooth and easy handling of the "CW 100" even on 20 meters will be a revelation.

100 TO 150 WATTS OUTPUT

'47 osc. — '10 buffer or doubler — output stage choice of '03-A, RCA 800 or Raytheon RK-18.

Special jacks are provided so that entire transmitter can be tuned with one milliammeter. All parts are supplied including one set of coils for either 20, 40, or 80 meters. When ordering transmitter with 160 meter coils add \$3.00 to the price of kit.

TRIPLE POWER SUPPLY KIT on matched chassis is available at \$36. This supply furnishes all filament voltages also 400-600-1200 volts, all with separate filters.

GROSS RADIO, INC.

51 VESEY STREET

NEW YORK CITY

The "EAGLE" Three-Tube Short Wave Receiver

"Band Spread" over any portion of the tuning range — only finest material used thruout. Employs one '32 R.F., one '32 detector and one '33 Pentode Audio — 15 to 200 meters — four coils supplied. The "EAGLE" is economical — two dry cells will operate the filaments. See March or April QST for full description of this most excellent value in short wave receivers.

"Eagle" completely wired and tested. **\$11.95** Three tubes tested in your receiver. . . **\$3.00**

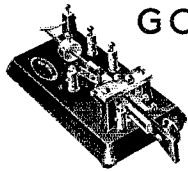
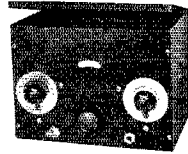

GO-DEVIL

The new Mechanical Key Sensation. Has many features — will do anything the highest priced key will — come in and try it. Price, \$6.00

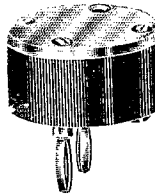

GROSS CRYSTAL HOLDER ONLY \$1.00

A commercial type crystal holder for half the price you have to pay for ordinary holders. New type pressure springs, square inside to prevent movement of crystal, one piece molded body — dust-proof — will take crystals up to 1 1/8" square or round. Plugs standard 3/4" spacing. This holder must be seen to be appreciated for the extraordinary value offered.

Johnson 12" Antenna Insulators . . . \$.50
 Tiny-mite 1/2" and 1" stand-off ins.05
 White or Brown Beehive ins. doz.50
 Isolantite spreaders 3" lons, 10 for35
 Pyrex 7 1/2" antenna insulators68

GUARANTEED TUBES

Heavy Duty Isolantite top 866 \$2.15
 888 or 871 1.15
 83, 47's and 46's 70
 210's 1.30
 DeForest 450's 1.35
 1/4, 1/2 and 1 watt neon bulbs.40

Filament transformers shielded in metal cases, center tapped secondaries.
 2.5 Volt 10 amperes for 866's \$2.50
 10 to 12 Volts at 8 amperes. 2.50
 Special 10-12 Volt 7.5 ampere filament transformer, extra special. 1.10

GROSS CLASS "B" TRANSFORMERS \$4.95

A pair of cased high grade transformers for '46's.

SILVER DIPPED ALUMINUM

cut to size specified

1/16" thick — per square inch. 7/10c
 3/32" thick — per square inch. 3/4c
 1/8" thick — per square inch. 1c

GROSS SPECIAL TRANSFORMER
 600 volts each side of C.T. 200 MA
 2 1/2 V. 10 amps., 5 V. 3 amps.,
 7 1/2 V. 3 amps. \$3.95

Multiple phone plugs take one to four pairs of phones. \$1.15
 5 slot wood choke forms.06
 Bakelite dials 5" diam., 1/4" shaft.15
 5-meter oscillator coils.65

GROSS cased double button mike transformer. \$2.35
 Single or Double button mike transformer.99

New Bliley constant temperature crystal oven. \$7.50
 Compact, efficient, inexpensive.

CARDWELL CONDENSERS

123-B.0005 mmf. \$2.35
 164-B.00022 mmf. 2.35
 147-B.00044 mmf. 4.10
 T-199.00033 mmf. 5.88
 T-183.00011 mmf. 5.30

Gross Special Power Transformer

for use with '83 tube will give an output of 500 volts D.C. at 350 MA with choke input. Run your entire R.F. and Class B off this transformer. The regulation for the class B is about 5%, filaments are two 7 1/2v. and one 5v. Special. \$5.75
 A transformer having the same filament windings as above — at 300 MA having 750 volts each side of C.T. \$6.00
 750-1000 V. each side of C.T. 300 watts. Extra special. \$6.80
 675-1350-1500 V. each side C.T. 400 MA. \$8.95
 1500-2000 V. each side of C.T. 800 Watts. \$11.95

Ward Leonard Vitreous Resistors 200-Watt 8 1/2" Long with Variable Sliders

1000 ohms \$.99
 2500 ohms 1.05
 5000 ohms 1.05
 10000 ohms 1.11
 15000 ohms 1.20
 25000 ohms 1.29
 35000 ohms 1.35
 50000 ohms 1.44
 60000 ohms 1.49
 80000 ohms 1.59
 100000 ohms 1.65

Cased 6.3 V. 2 amp. transf. \$1.25
 2.5 V. 6 amp. C.T. (midset).80
 5 V. 3 amp. C.T. for '83 (midset).80
 2 1/2 — 2 1/2 and 5 Volt C.T. 1.45
 2 1/2 — 7 1/2 and 7 1/2 Volt C.T. 1.45
 2 1/2 — 5 and 7 1/2 Volt C.T. 1.45
 5 — 5 and 5 Volt C.T. 1.45
 5 — 7 1/2 and 7 1/2 Volt C.T. 1.45

HAMMARLUND CRYSTAL "PRO"
 Transportation prepaid anywhere in U.S.A. \$111.72

BAKELITE TUBING (any length)

1" diameter — per inch. 4c
 1 1/2" diameter — per inch. 5c
 2" diameter — per inch. 6c
 2 1/2" diameter — per inch. 7c
 3" diameter — per inch. 7c

Thord. 30 H 75 MA choke. \$.69
 Thord. 15 H 250 MA. 2.95
 Thord. 30 Henry 500 MA chokes. L. H. Thord. No. T-2458 double 18 H 250 MA. 6.50
 Gross cased 30 H 200 MA choke. 2.25
 500 H. plate chokes for Screen Grid detectors (cased).95

70-WATT CLASS B MODULATOR UNIT KIT \$50.00

Uses 1-57, 1-56, 2-45's P.P. & 4-46's in P.P. Parallel Class B. All parts including power supply and metal chassis furnished — less tubes. Will fully modulate a 50 watt tube with an input of 140 watts. Parts sold separately.

SOLID ENAMELED ANTENNA WIRE

No. 14 (any length) per 100 ft. \$ 1.35
 No. 12 (any length) per 100 ft.55
 No. 10 (any length) per 100 ft.90
 No. 8 (any length) per 100 ft. 1.30

MIDGET DOUBLE SPACED NEUTRALIZING CONDENSERS 35 mmf.

— a real buy. \$.69
 Oil impregnated cased condensers
 1400 volts D.C. 2-2 mfd. 1.85
 Pilot J-23 100 mmf. condensers.60

COMBINATION FILA. TRANSFORMER \$3.65

2 1/2 V. C.T. 10 amps for 866's
 10 V. C.T. 7 amps. for '50's or '52's.
 10,000 volt insulation.

204-A type sockets. per pair \$1.85
 Porcelain base 50 watt sockets — side wiping contacts. 1.19
 110 volt Jewell pilot lights red, green24
 Jewel pilot lights, red, green.20

HOYT moving coil 3" 0-1 MA meters. Special. \$3.95



Hoyt Antenna Meter

Hot wire antenna meters. 2 1/4" mounting hole, flange 3" diameter, supplied in 1 1/2, 3 and 5 ampere ranges. Why work without antenna meters when you can buy them at this special price? \$2.95

Hoyt Milliammeters and Voltmeters

Perfectly damped meters at a price. These are not to be confused with the usual inexpensive meters. 2" mounting hole, flange 2 3/8" diameter, supplied in the following sizes: 10 ma, 25 ma, 50 ma, 100 ma, 150 ma, 250 ma, 300 ma, 4 V. AC, 10 V. AC, 15 V. AC, 10 V. DC. Price each \$1.50, 3 for \$4.25

20% deposit with all C.O.D. orders. Remit by M.O. Include postage. Prices subject to change without notice.

GROSS RADIO, INC. 51 VESEY STREET NEW YORK CITY

'RME-9' SUPER

540 KC to 22,000 KC

SINGLE SIGNAL RECEIVERS

Incorporate every known feature
desired by present operators

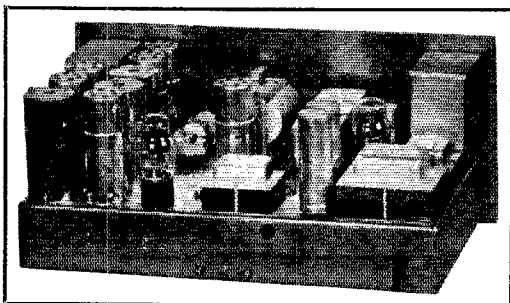

TO MENTION JUST A FEW:

Effective single control tuning with accurate logging of stations made possible.

All plug-in coils eliminated through the use of an efficient 5-position band selector switch.

Heterodyne oscillator for CW reception with variable beat note control on the panel.

High selectivity RF circuit providing high gain ahead of the first detector tube.

Automatic and manual volume control.

500 KC crystal furnished with the receiver.

NEWEST DEVELOPMENTS ADDED:

A monitor circuit — built in — to quickly determine at all times the quality of the modulated carrier.

A bridge meter — calibrated to read R values. The full scale is used, O reading indicating a carrier strength of R-O, and full scale a carrier strength of R-9. No more guessing. Every report accurate.

NO INCREASE IN PRICE

Details fully described in our pamphlet, available for 10c, which also contains other important information to amateurs relative to new RME PRODUCTS.

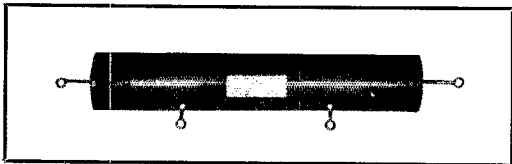

ANTENNA MATCHING NETWORKS

will give your transmitter that high percentage of radiated energy. No harmonics can get out. Easily installed. Quickly and readily adjusted. No tuning of transmission lines necessary. Low in cost. Complete data found in pamphlet.

RADIO MFG. ENGINEERS

147 Cooper Avenue

PEORIA

ILLINOIS

Hot Cat

(Continued from page 68)

cial shack, with a few hams and whatnot paying a quiet visit. They were enjoying a ragchew when there came a crash that sounded like three or four Fourth-of-July celebrations. Everybody took one look at the clouds of smoke billowing from the back of the transmitter, especially from the vicinity of the 851's, and organized a stampepe for distant parts, making doors where the contractors hadn't intended any to be.

After a period of time a few came back and cautiously peeped in the door and were assailed by clouds of smoke and an unspeakable odor that again caused their departure.

After much airing and fumigating it was possible to conduct an investigation into the mysterious explosion. It seemed a little pussy cat had gotten chilly and feeling the heat radiated by the p.a. tubes, tried to snuggle as close as it could. All would have been well had not furry tail and head connected with the high-voltage leads and caused a dandy short circuit. Results: one very much mangled cat and a bunch of sick radio ops. Hi! Shades of the electric chair!

— Floyd Hermanson, W4ASA-ZZQ

File Your Address

Grand Island, Nebr.

Editor, *QST*:

Many QSL cards are lost because the address contains neither the operator's name nor street number. The postal directory clerks cannot help because most amateurs fail to file the station call and address at their local post office. Post cards are *not* returned to writer, if undeliverable.

Address QSL's as completely as you can. File your station address with your Postmaster — there is no charge.

— Frank J. Alexander

The "X" Club

Cherokee, Kans.

Editor, *QST*:

Have given some little thought lately to the idea of organizing an "X" Club — an order for the mutual entertainment, rag chewing, etc., of the members. The membership is to be restricted to those "W" hams who have at some time held some ham call other than U. S. The idea was suggested some months ago by a QSO with W5VQ, a fellow I have worked many times when he was KA1CM, and I was KA1BD. Most of the old KA1 gang were Americans, and probably most of them are back in the States by now. I think probably many of them would be interested in finding out what the other fellow is doing now, and where he is. The same would be true with "X" hams from other countries. I know I would much like to meet old AC8NA, who was a U. S. Marine in 1928, and numerous others.

Would like to hear from any eligibles who are interested. If enough fellows interested, we will get together and do something about it.

— Harry I. Hall, W9FLQ

A Power Supply Engineered TO THE NEW TUBES

For the Amateur Who Is Hard to Suit

Acme-Delta Power Supply Equipment is designed and built for the Amateur who is not easily satisfied.

It is made for the man who wants the ultimate in ripple-free power, thus complying to the limit with the present radio law.

It is intended for the Amateur who secretly thrills to the remark that his station is as quiet and his modulation as good as a broadcast station.

And it is made for those who want to be sure of the ratings and the excellence of every component which they build into their equipment.

Purchasers of Acme-Delta Equipment do not have to return it for repairs or replacements. We know this for our factory records show less than 1% returns for any cause whatsoever.

If your standards and expectations are high . . . Acme-Delta Power Supply Equipment is offered you in full confidence that it will measure up to those standards and expectations.

A 1250 or 1000 VOLT ACME-DELTA POWER SUPPLY

Ripple .15%—Regulation 11%

- AD-15 FILAMENT TRANSFORMER.** Lights the filaments of two '66's. Output volts 2.5 CT, amps. 10, insulation 4000 volts, VA 25 Wt. 3 $\frac{3}{4}$ lbs. List price \$6.40
- AD-26 PLATE TRANSFORMER D.C.** Output from filter 1250/1000 volts @ 400 MA Output A.C. r.m.s. 1500-1250-0-1250-1500 volts @ 300 MA. Power Output 675 VA. SEC VA 900 — Ins. 7000 volts. Wt. 28 lbs. List price \$29.00
- AD-35 SWINGING CHOKE.** Inductance 5/25 Henrys — Input Choke for rectifier whose D.C. output does not exceed 1250 volts @ 400 MA. Ins. 3500 volts. Wt. 16 lbs. List price \$18.50
- AD-46 SWINGING CHOKE.** Inductance by Bridge Measurement. 8.5 Henrys @ 400 MA. D.C. Res. Ohms 50 — Energy Storage 0.68 watt Secs. Weight 16 lbs. Ins. 3500 volts. List price \$18.50

LIST PRICES ARE SUBJECT TO 40% DISCOUNT TO AMATEURS AND EXPERIMENTERS

To obtain 750 or 600 volts for Sylvania 830, 210 and 825 tubes, use Delta Auto Trans. AD82 in plate transformer primary. List price \$16.50. Ripple values given will be secured when recommended apparatus is used throughout circuit. SEE COPY ACME-DELTA CATALOGUE IN QST FOR DECEMBER, 1933, for specifications and list prices of complete Acme-Delta line. (All list prices subject to change without notice.)

F. S. Dellenbaugh, Jr.
Pres. & Chief Engr.



G. E. M. Bertram
Treas. & Gen. Mgr.

RAYTHEON
RK-18
RCA
800
HYGRADE SYLVANIA
210,825,830
ALSO RCA
'03-A&'11

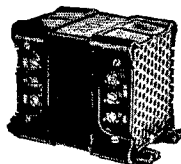

AD-15

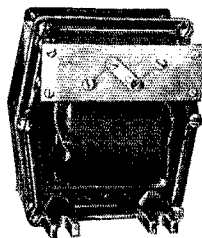

AD-26

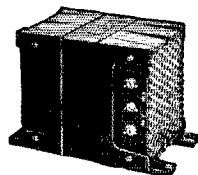

AD-35

AD-46

DISTRIBUTORS

Acme-Delta equipment is obtainable through selected distributors, through whom Amateurs and Experimenters may receive a discount of 40% from list price given in this catalogue. We recommend that you deal directly with the distributor in your territory for obvious reasons of greater convenience and service to you. If your regular distributor is not able to supply you, please write us direct.

COUPON: This coupon will bring you complete engineering data on the construction of LATEST TYPE OF CLASS "B" AMPLIFIERS, with outputs of 20, 100 & 200 watts. Enclose 5 cents to cover mailing costs and write your name and address in margin below.



WESTON PERFORMANCE

...
in a matched line

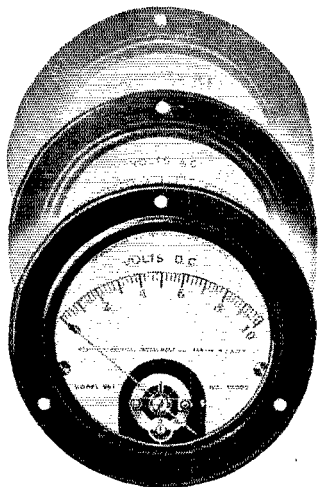

THERE is economy and satisfaction in equipping with accurate, reliable electrical measuring instruments. That's why amateurs the world over standardize on Weston Instruments in transmitting, experimental work and radio servicing.

The matched lines of Weston 2 and 3¼ inch panel meters provide Weston accuracy and dependability in a wide range of DC, AC, thermo-couple and rectifier type instruments. They are built to the high standards of design and workmanship for which Weston Instruments are known the world over, and are furnished in flush or surface type, as well as with rugged Bakelite cases if desired.

Keep your instrument costs down and improve results by equipping from the preferred Weston line. Full details on these and other Weston Instruments are yours for the asking . . . Weston Electrical Instrument Corporation, 602 Frelinghuysen Avenue, Newark, New Jersey.

WESTON·JEWELL *Radio Instruments*

Weston Electrical
Instrument Corp.
602 Frelinghuysen Ave.
Newark, N. J.

Name _____

Address _____

Please send me further
information on Weston-
Jewell Service Equipment.

It's in the Blood!

(Continued from page 65)

they'd left our station, but still you gotta hand it to those eggs; they were gettin' their dope in spite of blisters, bites and bruises. Their shorts had give way to men's britches, their lion-tamers' lids was kinda floppy and rigged with nets, their trick stoves had gone by the board and they was livin' on rice and corned willie, but they was nabbin' their bugs and photos. Except for Jasper they weren't so bad. So after we'd poured water outta the generator, cut a handful of trees from around the antenna, and chased the snakes out of the receiver Soupy started paring things offa that portable radio show. Every time he'd drop some gadget over the side or chunk some doodad to the monkeys, Jasper would make a noise like somebody was cuttin' his heart out, but then he'd take a glim at Soupy cussin' the flies and remain QRT.

In a coupla days we had him QSO KXXX on sked and movin' traffic, having got contact just in time to stop a rescue party, anyway. So then we pulls out.

About a month later the whole gang comes downriver and after throwin' a farewell brawl with us they cleared out, and when the *Palooka* finally heaves outta sight Soupy 'n I settles down to a normal existence again with the goats, palms, bottles and fleas.

Everything went on as usual until one day the mail boat blows in with a batch of newspapers.

"Would you glim this!" snorts Soupy, spillin' a perfectly good Planter's Punch on some pigs that happened to be under our table on the *Avenita*. And there blazin' forth from the magazine section of one of the NY rags was a map of our own Jasper Q. Farad, twice life size 'n three times as ugly. His mug was snapped, as I well remember, just after Soupy had sent him wadin' through slime waist-deep to chop off a few feet of counterpoise. "Listen!" invites Soupy:

HEROES OF THE HOUR

NEW YORK, N. Y.—Jasper Q. Sideband (see photo pg. 11), son of Mr. and Mrs. Otto Y. Sideband, wealthy cheese merchant, has given every reason for his parents to be proud of him.

Jasper, with his frail short-wave radio, which he designed himself, served as the only connecting link between the ——— Expedition in the heart of the South American jungle, and the outside world. His set was smashed and he was injured when the canoe he was in overturned while shooting treacherous rapids the second day after the party left the base. Although sorely wounded, young Jasper patched the pitiful fragments of his set together and finally got in communication with the outside world. Such pluck is commendable and characteristic. Imagine this frail youngster standing his lonely vigil, hovering over a few tubes, coils and batteries, while the bloodthirsty etc., etc., etc. . . .

"Well," says Soupy, "howzat for you!"

"Heck," says I, disgusted, "may I see nine-toed blue redbirds with yellow tails if I ever

Every Needed Fact, Figure, Formula—
Every Shortcut and Special Method

in the

WHOLE FIELD OF MATHEMATICS

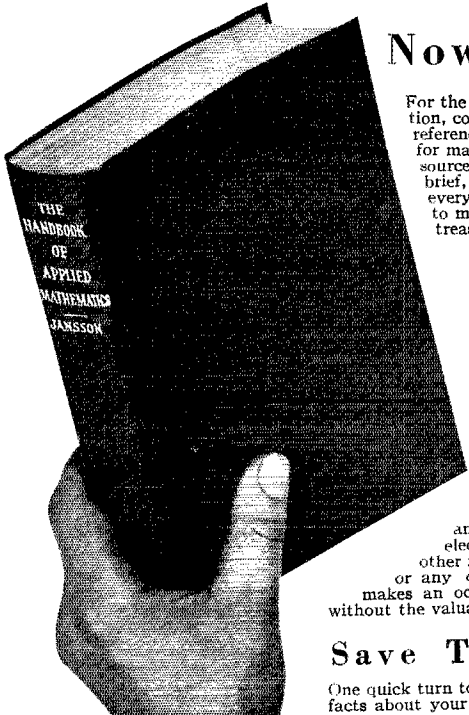

Now in ONE Handy Volume!

For the first time you can have this wealth of practical mathematical information, covering every trade and business, condensed into one handy book for quick reference. This volume puts right at your fingertips instant facts and formulas for making every kind of mathematical calculation. From hundreds of different sources, this priceless information has been gathered together, boiled down into brief, simple language, and applied to actual problems. Every man in business, every man in the mechanical trades, every man who ever uses a tool or has to make calculations or estimates in office, shop, or home, will find here a treasury of money-making, money-saving ideas.

THE HANDBOOK OF APPLIED MATHEMATICS

No previous knowledge of mathematics is needed. No study is required. The specific information you want is easy to find, by looking it up in the index. The book takes up every trade and gives you practical methods, easily-worked formulas for solving every problem. Thousands of specific examples show you just how to make your calculations. If your work involves mathematics in any way this complete reference handbook is an indispensable part of your equipment. It is an amazing time-saver for any one concerned with engineering, architecture, electricity, mechanics, construction, automobiles, machinery, printing, or any other industrial work; or with accounting, auditing, manufacturing costs, taxes, or any other business mathematics. No practical man, no house-owner who makes an occasional repair, no one who has a home work-shop can afford to be without the valuable information quickly found in this book.

Save Time—Be Sure of Your Facts

One quick turn to the index in this complete reference volume and you find at once all the facts about your subject—the best methods of doing the work, the easiest formula for making the calculations, completely worked out sample problems that show you just what to do. You avoid the expensive errors that handicap the man who merely guesses. Think what an advantage it is to have all this information gathered into one handy book that you can carry in your pocket. Act today and take advantage of your opportunity to examine this book as soon as it is published, and save 17½% off the regular price.

Save 17½%
on this
Special
Advance of
Publication
Offer

The regular price of this book will be at least \$6.00, probably more. If you reserve your copy now, you may have it for only \$4.95. Easy payments if you wish.

Over 800 Pages, 375 Illustrations, 150 Tables.
Durable Maroon
Fabrikoid Binding

Simplified, Dependable Methods by an Expert

The author of this book, Mr. Martin E. Jansson, has had the widest experience in practical work. Trained as a civil engineer, he has built tunnels and dams, roads and houses; he has had years of experience in railway and industrial construction work. He has instructed adult classes at New York University. He gives you the benefit of his wide experience in this book.

See How Thoroughly It Covers the Needs of YOUR Work

Arithmetic
(including Slide Rule)
Algebra
Geometry
Trigonometry
Weights and Measures
Mechanics
Excavations and
Foundations

Concrete
Brickwork
Carpentry and
Building
Lathing and
Plastering
Painting
Plumbing
Heating

Machine Shop
Automotive Shop
Sheet Metal Work
Electricity
(D.C. and A.C.)
Print Shop
Business
Mathematics
Accounting

EXAMINE THIS BOOK FREE SEND NO MONEY — MAIL THIS COUPON

D. VAN NOSTRAND CO.,
250 Fourth Ave., New York

Send me as soon as ready *The Handbook of Applied Mathematics*, at the Special Pre-Publication Price. Within 5 days after I receive the book, I can return it and owe nothing. If I keep it I will send you \$1.25 as first payment and I will pay \$2.00 monthly thereafter for 2 months — \$5.25 in all. (Cash with order \$4.95) Q.S.T. 1-34

Name.....

Address.....

City..... State.....

Reference.....

Address.....

To Our Readers who are not A.R.R.L. members

YOU should become a member of the League! That you are interested in amateur radio is shown by your reading of QST. From it you have gained a knowledge of the nature of the League and what it does, and you have read its purposes as set forth on the page opposite the editorial page of this issue. We should like to have you become a full-fledged member and add your strength to ours in the things we are undertaking for Amateur Radio. You will have QST delivered at your door each month. A convenient application form is printed below — clip it out and mail it today.

A bona fide interest in amateur radio is the only essential qualification for membership

AMERICAN RADIO RELAY LEAGUE
West Hartford, Conn., U. S. A.

I hereby apply for membership in the American Radio Relay League, and enclose \$2.50 (\$3.00 outside of the United States and its Possessions, and Canada) in payment of one year's dues, \$1.25 of which is for a subscription to QST for the same period. Please begin my subscription with the issue. Mail my Certificate of Membership and send QST to the following name and address.

.....

.....

.....

Do you know a friend who is also interested in Amateur Radio, whose name you might give us so we may send him a sample copy of QST?

.....

Thanks

hammer another key! Me, I'm goin' to Kansas and go in the sunflower business!"

"It's the heat," says Soupy. "I'm gonna see what's on 14 mc.; you better sit still or you'll have apoplexy."

So with a final hooker I legged it for the shack to beat him to it and get the best pair of 'phones.



W9LZY (proudly): "Yowsah, my fist sounds just like a bug."

W9NJZ (agreeably): "You said it—you should have Flit put on it."

The origin, manufacture, and applications of bakelite are covered in interesting although non-technical fashion in a pamphlet, "The Versatile Service of Bakelite Resinoid," published by the Bakelite Corporation, Bound Brook, N. J. Copies can be obtained by writing to that address.

Financial Statement

BY ORDER of the Board of Directors the following statement of the income and expenses of the American Radio Relay League, Inc., for the third quarter of 1933 is published for the information of the membership.

K. B. WARNER, Secretary

STATEMENT OF REVENUE AND EXPENSES
FOR THE THREE MONTHS ENDED
SEPTEMBER 30, 1933

REVENUE	
Advertising sales, QST	\$11,359.65
Newsdealer sales, QST	9,355.86
Handbook sales	4,759.65
Booklet sales	2,018.91
Membership dues	10,829.58
Membership supplies sales	1,488.41
Interest earned	694.34
Cash discounts earned	130.13
Bad debts recovered	20.00
	\$40,656.53
Deduct:	
Returns and allowances	\$3,370.29
Cash discounts on sales	154.00
Exchange and collection charges ..	18.51
	\$3,542.80
Less reduction of provision for newsstand returns of QST ..	202.43
	3,340.37
Net Revenue	\$37,316.16
EXPENSES	
Publication expenses, QST	\$ 8,784.48
Publication expenses, Handbook ..	2,204.73
Publication expenses, Booklets	1,144.91
Membership supplies expenses	737.34
Salaries	15,076.58
QST forwarding expenses	614.95
Telephone and telegraph	363.15
Postage	1,315.17
Office supplies and general expenses	1,209.64
Rent, light and heat	820.53
Traveling expenses	1,256.33
Depreciation of fixed assets	250.67
Communications Dept. field ex- penses	197.58
Headquarters station expenses	55.05
Bad debts charged off	90.85
Federal tax on bank checks	5.16
	\$34,187.12
Total expenses	\$34,187.12
Net Gain from Operations	\$3,129.04

an Xmitter Frame

with BC class

... surprisingly

low-priced

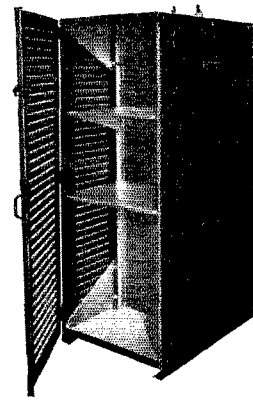

Complete frame, panels and shelves, \$20. Protective outside safety shield, \$7 additional. F.O.B. Chicopee Falls, Mass.

"HAMS" who have seen this new frame say it's FB. With four adjustable shelves, there is plenty of room for power supply, crystal control, freq doubler and amplifier stages, without crowding.

Eight 3½-in. covered instrument holes are provided in the front panel, which is finished in true BC style in black baked-crackle lacquer. The inside is aluminum lacquered. All steel parts are copper-plated under the finish, to make the losses negligible at high frequencies, and to provide a good ground.

Two RF bushings are provided in the top of the cabinet. A hole for incoming power and control leads is in the bottom plate. The entire frame is rigidly constructed of ½-in. steel, spot-welded and bolted to angles and tees. The front panel and rear shield are bolted to the frame while the two side covers are hinged to the rear shield.

The size?—19 in. deep, by 27 in. wide, by 49¾ in. high . . . exclusive of RF bushings and shield handles.

Price?—Frame, panels and shelves, only \$20. The protective safety shield, \$7 additional. F.O.B. Chicopee Falls, Mass.

Just send certified check. Your frame will be shipped promptly.

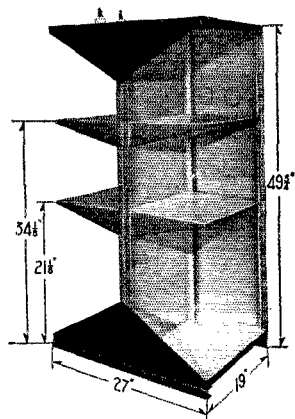

Frame with side covers and rear shield removed.

Westinghouse

*Quality workmanship
guarantees every Westinghouse product*



ATTACH CHECK TO COUPON

Radio Division, Westinghouse Elec. & Mfg. Co.
Chicopee Falls, Mass.

Gentlemen: Send the following pronto, check for \$.....enclosed: Frame only, at \$20.
Frame and protective shields, at \$27.

(Make certified check payable to H. S. Sanderson, Cashier-trustee, Westinghouse Elec. & Mfg. Co.)

Name
Address
City State T 79838
Call Letters QST 1-34

YOU CAN'T AFFORD to Pass Up This Opportunity

We need more customers! To build up good will, we have arranged with a reputable manufacturer to make for us a line of tubes to fit the depression pocket-book of the amateur fraternity. These tubes are first class products and carry our absolute guarantee for 90 days.

210 — 15 w.	\$1.15	866 — H.D.	\$1.50
28190	211	7.75
250	1.15	203A	8.95

POWER SUPPLY — 1200 v. — 250 ma and 600 v. — 250 ma

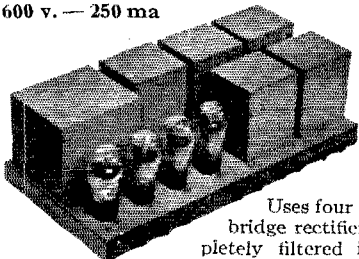

Uses four 83's in a bridge rectifier—completely filtered in both voltage legs.

\$35.00

WESTON 301 MILLIAMMETERS

Reconditioned like new — guaranteed.
0-2, 0-10, 0-150, 0-200, 0-500
mils. **\$3.75**

SYLVANIA Graphite { . . . 210 — \$4.75
Anode { . . . 830 — 8.75
. . . 825 — 10.00

PLATE TRANSFORMER — two 7½
and two 2½-volt fil. windings — 750-
750 v. — 160 mils. **\$3.50**

Double-Button Microphone . . .	\$2.95	} <i>Combi-</i> <i>nation</i> <i>for</i> <i>\$5.50</i>
Microphone Ring with 8 springs	1.25	
Two-Button Mike Trans- former	1.65	

Baldwin Type C (new model) Phones . . . **\$3.35**
No. 10 H.D. Enamel — any length — per
it. **.01**
Neon Bulbs — ½ and 1 watt. **.45**
No. 18 Solid push back wire — per 100 ft. **.45**

Johnson 50-watt sockets **\$1.20**
Bliley X cut 160 — 80 — 40 m. Crystals . . **3.90**
Bliley Xtal holders **1.50**

Open Evenings — 7 to 9.30 p.m.

KALTMAN & ROMANDER
62 Court Street Newark, New Jersey

The West Gulf Division Convention

NOTWITHSTANDING the heavy downpour the night before the opening of the convention, with many roads impassable, representatives from over ten affiliated clubs registered on the first day of the convention being held at the Hilton Hotel, San Angelo, Texas, October 13th and 14th.

Without any frills Chairman Ray Samberson, W5BFA, started the proceedings by introducing Mr. Dean Chenoweth, managing editor, *San Angelo Standard*, who gave the welcoming address. Director Frank Corlett, W5ZC, responded in well chosen words. A.R.R.L. Treasurer Hebert brought the greetings of headquarters and discussed the F.R.C. Regulations.

During the two-day convention fine instructive lectures were given. Mr. W. J. Kantenberger of Morrissey-Kantenberger, Dallas, spoke on "Photo-Electric Cells" and gave an "Infra-Red Ray" demonstration; and, moreover, a good talk on the use of Supreme Testing Instruments. Mr. Robert S. Van Cleve of General Engineers, Dallas, gave a fine demonstration on "Cathode-Ray Oscillographs" and also talked on modern and advanced testing methods. Mr. Dan Whitaker, W5BAY, West Texas Utilities Co., Abilene, was in his glory when he talked on the subject of "Interference on Amateur Frequencies and Its Elimination." During the technical talks a good address on the NRA was given by Mr. B. C. Deal. Glen Talbutt, W5AUL, and Dave Calk, W5BHO, SCM's for north and south Texas, respectively, assisted by Fieldman Herbert supervised the Traffic Meeting where many subjects came up for discussion. It showed that traffic activities are still paramount in the amateur field.

The inspection tour on Saturday morning proved of interest, especially to the ladies, and consisted of visits to the West Texas Utilities' Plant, the San Angelo Telephone Exchange and Broadcasting Station KGKL.

Bill Green, W5BKH, in the absence of Lieut. Fischer, spoke on the Naval Reserve and Glen Talbutt, Alternate Corps Area Control, did justice to the Army-Amateur network. These two organizations are becoming firmly entrenched in amateur radio and should be considered seriously by those who desire to acquire a thorough training in both army and navy procedures.

Many fine contests were held and worthwhile prizes won. The youngest ham at the convention was W5AHZ (15), the oldest, W5BSC. Director Corlett's wife and Mrs. Groves, W5NW, who has her own ticket, and that very active secretary of the Corpus Christi Club, Ethel Henderson, were among those present. We are unable to mention the names of those two fine ladies from Wichita Falls, who so well represented their radio club, because some one forgot to return the memorandum to this reporter.

The big event of the whole convention was the spirited bidding for the 1934 convention; San Antonio, Corpus Christi and Wichita Falls having strong delegations. Final vote of the dele-

Companion Publications

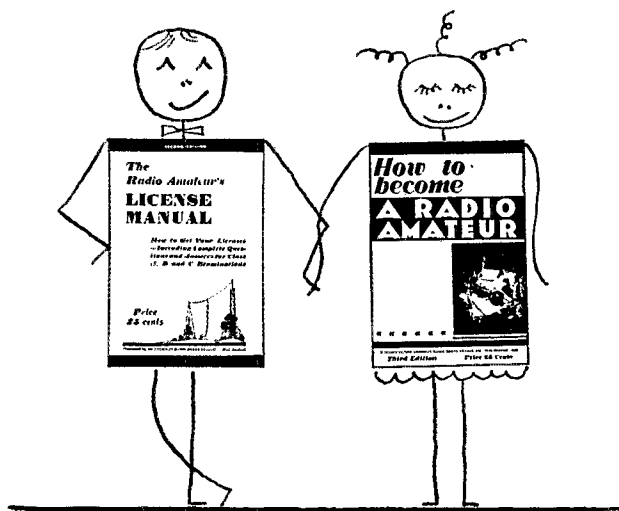

MAKING IT EASY FOR THE BEGINNER TO BEGIN

It's the elementary things that are discussed in the League's carefully prepared book for beginners, "How to Become a Radio Amateur." Now in its third edition, completely done over in 1934 style, its 32 pages are filled with concise, clearly written material telling how to build the first receiver, a simple transmitter, an inexpensive monitor — in fact, the entire beginner's station.

"How to Become a Radio Amateur" (No. 8 in the A. R. R. L. series entitled "The Radio Amateur's Library") is the standard elementary guide for the would-be amateur. 25c (no stamps, please) postpaid anywhere.

A necessity for the beginner — equally indispensable for the already licensed amateur. Going after your first ham "ticket"? You need the manual for its instructions on where to apply, how to go about it in the right way — and, most important of all, for the nearly 200 typical license exam questions and answers. Already got a license? The manual is still necessary — for its dope on renewal and modification procedure, the Class A exam (with questions and answers), portable procedure, etc.

All the dope on every phase of amateur licensing procedure, and, of course, the complete text of the new regulations and pertinent extracts from the basic radio law.

Get a copy of "The Radio Amateur's License Manual" and be sure to get your ticket.

(No. 9 in the series entitled The Radio Amateur's Library)

Order your copy today, 25c postpaid (no stamps, please)

American Radio Relay League

West Hartford, Connecticut

BACK COPIES OF QST WITH INDEXES

THE LIST given below shows many exceptions, and as time goes on each yearly list becomes more incomplete. The 1931, 1932 and 1933 sets will not be complete when next presented. You'll be sorry some day if you don't stop, look and ACT now—Right Now!

HERE THEY ARE

1923 — Only May and November issues.....	\$1.50
1924 — Only November and December issues.....	.50
1925 copies (except January, March, May and July).....	2.00
1926 copies — complete.....	2.50
1927 copies (except January).....	2.50
1928 copies (except January, February and August).....	2.25
1929 copies (except February, March, April and May).....	2.00
1930 copies (except January, February and July).....	2.25
1931 copies — complete.....	2.50
1932 copies — complete.....	2.50
1933 copies — complete.....	2.50

Complete Set of Copies as Listed \$15.00
SINGLE COPIES 25c EACH

ALL PRICES INCLUDE POSTAGE

New binders to keep these files in order are \$1.50 each, postpaid. Each binder holds 12 issues of QST and index, and does not mutilate the copies.

AMERICAN RADIO RELAY LEAGUE

West Hartford Connecticut

gates awarded the honor to San Antonio.

The Committee's discrimination was well reflected in the fine menu served, the inspirational talks, awarding of prizes, and dancing. The convention formally closed with everyone expressing appreciation to the convention committee. See you in San Antonio.

—A. A. H.

The Pacific Division Convention

FROM the mountains, valleys, deserts — from the large metropolitan areas of three western states, nearly 500 amateurs gathered in San Jose, Calif., at the Hotel Sainte Claire, on September 2d, 3d and 4th for the Pacific Division's largest convention to date.

General Chairman Eugene R. Booker and his assistant, Harry Engwicht, president of the Santa Clara County Amateur Radio Association, had obtained a number of authoritative technical speakers for the three days. They were: Milton A. Ausman (Audio Amplifiers); Earl R. Meissner (Velocity Microphones); Frank C. Jones (Ultra-Short Waves); Norris Hawkins (Electron-Coupled Oscillators); Dr. F. E. Terman (Directional Antennae); Ralph Heintz (Development of the Gamatron); Arthur Halloran and A. H. Brolly (Television) and D. B. McGown (New Tubes).

Looming largest in the minds of those present, however, was the open forum, set for the afternoon and evening of the second day. Labeled by Chairman Booker as "the time and place for constructive action," it was to offer every one an opportunity to help in shaping the future of the Pacific Division. Many subjects were discussed and recommendations made to be transmitted to A.R.R.L. Headquarters.

Other features of the convention included a smoker under the chairmanship of George Call, W6BHY; ladies' entertainment arranged by Mae Amarantes, W6DHV; a 'phone meeting headed by Charles Holdiman, W6AGJ; a Naval Reserve meeting under Lieut. Frank Quement, W6NX; a bus trip to Moffett Field, home of the Macon, and Ryan High-Voltage Laboratory at Stanford University, and code contests under supervision of Elbert Amarantes, W6FBW.

More than \$1200.00 worth of prizes were distributed at the closing banquet. Chairman Booker approached manufacturers and dealers with a "new deal"—a pro rata share of convention receipts after all expenses were paid. (This turned out to be \$330.00 which was divided among prize donors in proportion to prize value.—Editor.)

Visitors had the use of the official station at convention headquarters, where five-meter equipment was used to remote-control the half-kilowatt transmitter at W6HTB about three miles away. A leased wire was installed as a stand-by and was used part of the time for the same purpose. This phase of the convention was under the supervision of Terry Hansen, W6KG, one-time ship operator and widely known California amateur.



BIRNBACH STANDOFFS

A NEW insulator — with NEW features — practical in every respect — just what you would want in a first class insulator.

One hole for panel mounting, secure connections easily made on bottom of subpanel. Ideal for mounting all kinds of high voltage, receiving and transmitting apparatus.

Birnbach makes a complete line of quality insulators in various sizes and styles from 3/8" to 1 1/2" high.

Write for Bulletin "A" today — it will pay you to keep it on file.

BIRNBACH RADIO CO., INC.

145 Hudson St.

New York City



Adding New Pages to Radio History

PIEZO-ASTATIC

CRYSTAL

INSTRUMENTS

Microphone

You've heard about it! Here it is! The D-104 microphone is a highly perfected general purpose instrument of the generator type having exceptional fidelity. Output level approximately -60 D.B. It is rugged in construction and beautifully finished in chromium. No button current, polarizing voltage or field current required. Cannot "freeze" or "pack"! No internal noise!

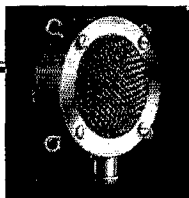

D-104
Suspension or
stand mounting
\$17.50

The Piezo-Astatic pickup represents a distinctive achievement in transcription instruments, light in weight and freely damped. The

Transcription Unit



S-8
LIST
PRICE
\$15.00

Your job-
ber can
supply you

greatest single advancement since electrical recording. Rising low frequency response makes practical for the first time, constant amplitude recording.

LICENSED UNDER BRUSH DEVELOPMENT CO. PATENTS

ASTATIC MICROPHONE LABORATORY, INC.

YOUNGSTOWN, OHIO

MORE WATTS PER DOLLAR

Transmitter power equipment specifically designed for converting 60 cycles AC into an R9 signal. Puts its kick into the antenna without heating the shack. Relay racks, too, to give the station that NBC air, Edison B batteries work the world on A210. Stretch-proof, storm-proof hard drawn enameled aerial wire. Everything to put your station among the top-notchers.

RECTIFIER ENGINEERING SERVICE

4837 Rockwood Road

Cleveland, Ohio

TRANSFORMERS FOR CLASS B 800'S

PHONE MEN! 100 watts of audio with Class B 800's— BUT — properly designed input and output transformers are necessary.

Type IB-100 2-2A3's to 2-800's \$7.00 net
Type OB-101 2-800's to 5000/20000 ohms \$18.00 net
(Note: OB-101 for 1000/2000-ohm r-f amp. Sec. for 200/100 MA d.c. Response flat + or - 2.5 DB, 40-10,000 cycles.)
Prices f.o.b. Newark, N. J. 15% cash with C.O.D. orders.
HILET ENGINEERING CO., P. O. Box 35, Newark, N. J.
Send stamped envelope for folder describing above transformers

Technical Training Station

Phone C. W.

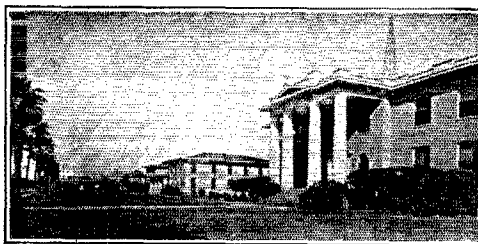

Studio Technique Guaranteed

KFDm

1000-Watt 560
W. E. Kilocycles

IN 3 to 7 months we train you to secure Amateur, Commercial Telegraph Second-class, and Radiotelephone First-class government licenses. Course consists of Wireless Code, Radiophone, Microphone-Studio Technique, Television, Service, Police, and Aeronautical Radio. We are authorized to teach RCA Institutes, Inc., texts. At completion of your course you receive practical studio technique experience in broadcast studios located in our administration building, and operating experience on KFDm (1000-Watt W. E. Commercial Broadcast Station), and WPA, 4000-Watt Commercial Wireless Station. Return coupon for details.

PORT ARTHUR COLLEGE

Port Arthur (world-known port) Texas

Name

Street or Box

City and State

NEW! THE RECEIVER AMATEURS HAVE BEEN WAITING FOR

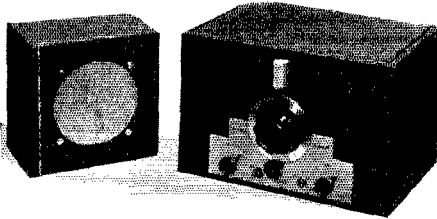

4 AMATEUR BANDS BY TURNING A SWITCH

NO COILS TO PLUG IN — NO COILS OR OTHER EXTRAS TO BUY

Never before have amateurs been offered such a fine, precision receiver at such a low price. Think of it! No more plug-in coils. Instead, coils are permanently attached and adjusted. You flit from band to band with the flick of a panel switch. Complete with high grade dynamic loud speaker. Whether you are an amateur of broad experience or a beginner you'll find the new Ross Jupiter Model unexcelled for your purpose — attractive, efficient, easy to operate. The outstanding amateur set development of 1934. Investigate at once!

\$59.50

Incl. speaker and mfr's excise tax (less tubes)

A. H. ROSS AND COMPANY
KESWICK AVE. AND WAVERLY RD., GLENSIDE, PA.
(Suburb of Philadelphia)

WRITE FOR FULL DETAILS — TODAY!

FERRANTI

TRANSFORMERS — CHOKES

Designed and built to your particular requirements.

Each unit made of twelve separate sections wound by hand.

Our engineers are experienced in the design of precision apparatus.

Transformers for all new tubes shipped at once from our New York Laboratory.

SPECIAL ITEMS

Shipped on short notice where immediate delivery is essential.

WRITE FOR OUR 1934 CATALOGUE

Order direct from New York Office

"QUALITY AND SERVICE"

FERRANTI, INC.

130 WEST 42 ST., NEW YORK CITY

Bernard H. Linden, supervisor of radio at San Francisco, was among those in attendance and made a brief address at the banquet.

Fresno was chosen as the 1934 convention city and it is reported that the gang there is planning to hold it in November.

— W6CFK

Standard Frequency Transmissions

Date	Schedule	Station	Date	Schedule	Station
Jan. 5	A	W6XK	Feb. 2	A	W6XK
Jan. 7	C	W1XP	Feb. 4	C	W1XP
Jan. 10	A	W1XP	Feb. 7	A	W1XP
Jan. 12	B	W9XAN	Feb. 9	B	W9XAN
	B	W6XK		B	W6XK
Jan. 17	BB	W1XP	Feb. 14	BB	W1XP
	C	W9XAN		C	W9XAN
Jan. 19	B	W9XAN	Feb. 16	B	W9XAN
	A	W6XK		A	W6XK
Jan. 24	B	W1XP	Feb. 21	B	W1XP
	BB	W9XAN		BB	W9XAN
Jan. 26	BB	W6XK	Feb. 23	BB	W6XK
	A	W9XAN		A	W9XAN
Jan. 27	BX	W6XK	Feb. 24	BX	W6XK
Jan. 28	C	W6XK	Feb. 25	C	W6XK

STANDARD FREQUENCY SCHEDULES

Time (p.m.)	Sched. and Freq. (kc.)		Time (p.m.)	Sched. and Freq. (kc.)	
	A	B		BB	C
8:00	3500	7000	4:00	7000	14,000
8:08	3600	7100	4:08	7100	14,100
8:16	3700	7200	4:16	7200	14,200
8:24	3800	7300	4:24	7300	14,300
8:32	3900		4:32		14,400
8:40	4000				

Time (a.m.)	Sched. & Freq. (kc.)
	BX
6:00	7000
6:08	7100
6:16	7200
6:24	7300

The time specified in the schedules is local standard time at the transmitting station. W1XP uses Eastern Standard Time. W9XAN, Central Standard Time, and W6XK, Pacific Standard Time.

TRANSMITTING PROCEDURE

The time allotted to each transmission is 8 minutes divided as follows:

2 minutes — QST QST QST de (station call letters).

3 minutes — Characteristic letter of station followed by call letters and statement of frequency. The characteristic letter of W1XP is "G"; that of W9XAN is "O"; and that of W6XK is "M."

1 minute — Statement of frequency in kilocycles and announcement of next frequency.

2 minutes — Time allowed to change to next frequency. W1XP: Massachusetts Institute of Technology, Round Hill Research, South Dartmouth, Mass., Henry G. Houghton in charge.

W9XAN: Elgin Observatory, Elgin National Watch Company, Elgin, Ill., Frank D. Urie in charge.

W6XK: Don Lee Broadcasting System, Los Angeles, Calif., Harold Peery in charge.

WWV 5000-Kc. Transmissions

The 5000-kc. transmissions of the Bureau of Standards' station, WWV, are given every Tuesday continuously from 12:00 noon to 2:00 p.m., and from 10:00 p.m. to midnight, E.S.T. The accuracy of these transmissions is to better than 1 cycle (one in five million).

— J. J. L.

ADM. BYRD TAKES BLILEY CRYSTALS INTO THE FRIGID ANTARCTIC

NEARLY 100 Bliley Crystals of standard quality are serving Admiral Byrd and his expedition in the maintenance of reliable communication on their trip to the South Pole. Some will be used in the mainland station; others on dog sleds for intercommunication.

Men's lives are at stake, and Bliley Crystals contribute to their safety and happiness by increasing the efficiency of communication thru single, accurate and dependable frequency even under these severe conditions.

Bliley Crystals are the preference of leading radio engineers and progressive radio amateurs. You, too, will find them best. And they actually cost less in the long run.

See last month's "QST" for price range of all Bliley amateur band crystals. We also manufacture to all special frequencies between 20Kcs and 15Mcs. Sold by distributors of radio amateur equipment everywhere.

BLILEY PIEZO-ELECTRIC CO.

227 Union Station Bldg.

Eric, Pa.

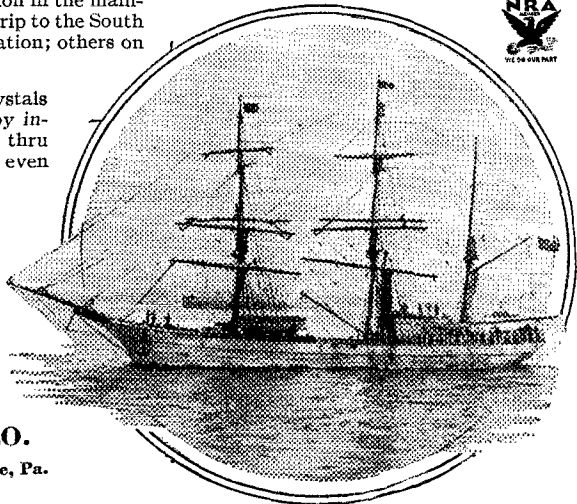

METAL-WORKING

LATHE Precision equipment for the small shop. New designs and manufacturing processes make this amazing bargain possible. Complete metal working lathe with compound slide-rest, combination face-plate and independent chuck and tail center, 6" swing; 24" length, 20 pounds. Send \$1.00, balance plus postage C.O.D. Lathe for wood-turning alone, \$4. Attachments for milling, grinding, sanding, saw-table, etc., available at low prices. Order from ad at once and have a complete machine shop.



AMERICAN MACHINE & TOOL CO., Dept. Q-7 200 BROADWAY NEW YORK

LEARN RADIO

New Classes Now Forming! Send for 40-page catalog, explains fully. 180 licensed graduates placed in past 2½ years in broadcasting, shipping, police radio, aviation, etc. We teach all branches. Oldest, largest and best equipped school in New England. Equipped with Western Electric sound and broadcasting equipment and RCA marine transmitter. Course prepares for United States Government telegraph or telephone license.

MASS. RADIO SCHOOL, 18 Boylston Street, BOSTON

2/5ths Size

ELECTROLYTICS!

Both are 8 mfd. 450 wkg. v. or 525 max. surge v. Older type, 4¾ x 1¾ in., new type, 3¾ x 1 in. A saving of 2½ times in bulk! This compact electrolytic is made possible by new C-D process. Despite extreme compactness, it stands higher peak voltages than its older and larger brother.

WRITE for details. Also, be sure to get your copy of new 1934 C-D catalog covering the complete condenser line.

CORNELL-DUBILIER CORP.

4377 Bronx Blvd.

New York City



THE TRITET UNIVERSAL EXCITER UNIT

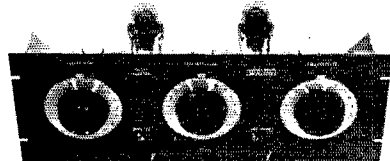

Retaining all the basic circuit features of the original Tritet as developed by J. J. Lamb, the Harvey Tritet has all plug-in coils, crystal and output posts in the rear, and provisions for connecting plate current meters without disturbing the circuit wiring. With an 80-meter crystal, the output on 20 meters is ample to excite a 210 or an Kk18. Built for relay rack mounting, of highest quality parts, fully wired and tested, \$49.50 less tubes and crystal.

56 MC. TRANSCEIVERS

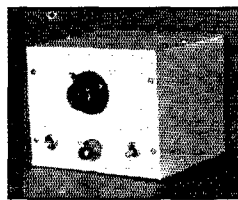

A 6-volt transceiver is now available, and is just the thing for automobile, aeroplane, or home installations. Uses one 37 and one 41 tube, and requires as plate supply 180 volts at 40 ma. from an A.C. B eliminator, auto B eliminator, or batteries. Identical in size and appearance to the 2-volt model using one 30, and one 33. Price of either 2-volt or 6-volt model, fully wired and tested..... \$19.50

Kit of all parts, including drilled case, for either model..... \$14.00

HARVEY RADIO LABORATORIES

12 Boylston Street, Brookline, Massachusetts

NEW PRE-SELECTOR AMPLIFIER — FOR NATIONAL FB-7A & FBX-A

(As featured by James J. Lamb and
F. E. Handy in *QST*, Dec. 1933)

We announce a complete set of parts for assembling the new Pre-Selector Amplifier for the NATIONAL FB-7A and FBX-A Amateur Receivers — with all the specified genuine NATIONAL parts, and including NATIONAL cabinet finished to match the FB-7A. Net price, complete (less tubes and coils)..... **\$11.70**

Coils.....each **\$3.60**

It will pay you to have your name
on our mailing list

H. JAPPE COMPANY
46 CORNHILL BOSTON, MASS.

1933 BOUND VOLUME of *QST*

WE have now a limited number of copies of Bound Volume XVII of *QST*. Vol. XVII comprises the entire 1933 series of *QST*. This year the volume is made up in one book, containing the twelve issues of *QST* and index. It is handsomely bound in red cloth and with gold imprint.

It is priced at \$5.00, postpaid.

Better act quickly — only a few copies available.

QST
38 LaSalle Road
West Hartford, Connecticut

I.A.R.U. News

(Continued from page 46)

In 1932 the Ministry of Posts and Telegraphs issued a regulation concerning private broadcasting stations, operated both for scientific and amateur research. This regulation is most liberal, as every Polish citizen and even a loyal foreigner belonging to the P.Z.K., can apply officially through the Headquarters to the Ministry of Posts and Telegraph, submitting the technical qualifications of the station and a certificate of examination passed before the authorities of his League, and on the basis of this he obtains a license.

The Headquarters works not only in this country. In 1933, wishing to assist our neighbors in the organization of the short wave movement, we initiated the organization of a Radio Short Wave Union of Poland, Czechoslovakia, Jugoslavia and Roumania. This Union, consisting of the respective national societies which act as independent organizations and are at the same time member-societies of the I.A.R.U., has as its object mutual assistance in the development of the short wave movement in the member-nations, similar to the cooperation existing between these countries in cultural, economic and even political fields. Jugoslavia and Roumania show a slow development of the radio short wave movement, as the local regulations make it difficult for amateurs to have transmitting stations. The common initiative of the Headquarters of the P.Z.K. and of the C.A.V. caused the proposed change of the existing regulations in Jugoslavia and Roumania, and thus it is hoped that in these countries the amateur movement will develop considerably.

The plan of this Union and its Constitution was discussed in detail at Cieszyn in July, 1933, by the delegates of the P.Z.K., C.A.V., and U.J.R.A., when a special organizing commission was formed, consisting of Colonel Engineer Karaffa-Krauterkraft of Poland, acting as the chairman, Col. pil. Jaroslav Skala of Czechoslovakia, and Lieutenant Adam Gac from Poland, honorary secretary of the Commission. At the end of 1933 or during the beginning of 1934, there will be called an Organizing Congress, at which the Union will be definitely formed. A report of the meeting at Cieszyn was sent to all the interested parties on August 11, 1933.

As there are many Poles and sympathizers in other countries, most of all in the A.R.R.L. and R.E.F., the Constitution of the P.Z.K. also provides for foreign members, the number of which amounts to about 400. Foreign members receive our official organ: "Krotkofalowiec Polski." Our QSL office situated at Lwow sends out the QSL cards. The number of foreign cards in 1932 was more than 50,000 thus giving an idea of our work. This year the P.Z.K. organized on several dates international and local contests and the results of them will be made known to all other national societies.

The development of the amateur movement in Poland has its future assured. Our numbers are

A Favorite with Amateurs
EVERYWHERE

**Dunco Midget
A. C. Keying
Relay**
\$3.85

Operates on 110v.-A.C. Will
Key up to 40 words per minute
and break 6 Amps. at 110v.

The Bargain of the Year
ONLY A FEW LEFT

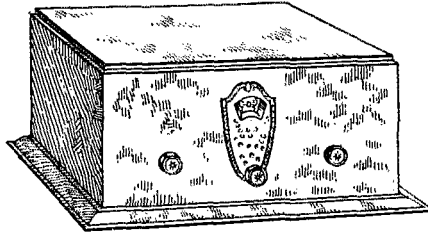

**Famous NATIONAL
SW 45 Sets \$19.75**
AT OUR SPECIAL PRICE
(less tubes and coils)

A 5-tube, Tuned R.F. Set, using two
Type 35, one 27 and two 45 Tubes
Coils available from 9 to 2000 meters. Short
Wave and Band Spread Coils, \$3 per pair

Watch for your copy. New 1934 Catalog being
sent to everyone in Call Book

**M. & H.
Power Pack**

Developed in our Laboratory
especially for

**THE NATIONAL SW 45
or SW 3**

**SPECIAL
THIS MONTH \$8.95**

Specify, when ordering
whether for SW 45 or SW 3

Those "Hard-to-Get"
Transformers

M. & H. Filament Trans-
former for two 800 or 825
tubes. 7½ volts
7 amps. **\$3.95**

**Midget
Power Transformer**
for Small Receivers

500V.-c.t.-2½V.-
5V. 2" x 2½" **\$1.35**

Mounted and Cased.
Will deliver 30 mils.

**The Latest in
Xmitting Tubes**

RCA Type 800.....\$10.00
Sylvania 830..... 8.75
Raytheon RK18.... 10.95
Sylvania 825..... 10.00
Gordos Carbon
Plate 203A..... 11.95
New Sylvania 15-watt
Carbon Plate 210 . 4.75

M. & H. Sporting Goods Co.
512 Market St., Philadelphia, Pa.

R A D I O

ENGINEERING, broadcasting, aviation and
radio telegraphy and telephony, Morse telegraphy and railway
accounting taught thoroughly. Engineering course of nine
months duration equivalent to three years of college radio
work. School est. 1874. All expenses low. Catalog free.

DODGE'S INSTITUTE Day Street Valparaiso, Indiana

THE INSTRUCTOGRAPH
(Code Teacher)



The Scientific, easy and quick way to learn
the code. Send a post card today for literature.
Machines, tapes and complete instructions
for sale or rent. Terms as low as \$2.00 per month.

Rental may be applied on purchase price if
desired. Rent for a month. If the Instructo-
graph meets every requirement, buy it. If not,
send it back.

INSTRUCTOGRAPH CO., 912 Lakeside Place, Chicago

**WING'S
5 to 10 Meter
Transceiver**

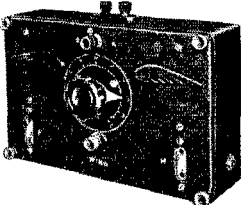

A precision, highly efficient
ultra high frequency receiver
and transmitter using a 76 and
41 tube. In cast aluminum box
6" x 9" is only 2½" thick.
Finished in black wrinkled lac-

quer. All parts mounted on cast front panel making a very solid
outfit. Latest pie wound antenna coil with micrometer screw adjust-
ment. Outfit can be mounted on auto steering column with special
clamp which is furnished extra.

Transceiver with 5 meter coils, less tubes.....\$16.50
For best results use Wing's special 5 meter antenna outfit.....\$2.50

E. R. Sharp — WIACH — West Newton, Mass.
Representative — Boston & Vicinity

Manufactured by

CHAUNCEY WING'S SONS GREENFIELD, MASS.

QST Oscillating Crystals

All "Scientific Radio Service Crystals" are accu-
rately ground to an accuracy better than .03%
on equipment tested regularly by the U. S. Bu-
reau of Standards standard frequency signals."

SUPERIOR BY COMPARISON

● **New Low Prices Are Now in Effect** ●

BROADCAST and COMMERCIAL BANDS
Broadcast Band Crystals mounted in our Standard
Holder and ground to our usual high degree of
accuracy now \$35.00 each. Other bands similarly
reduced. Prices quoted upon application.

AMATEUR BAND
Scientific Radio Service Crystals ground to within
FIVE Kilo-cycles of your specified frequency in
either 80 or 160 meter bands \$10.00 each. Mounted
in our Standard Holder \$5.00 additional. Accurate
calibration with each crystal.

PROMPT SHIPMENTS ASSURED

Scientific Radio Service

"The Crystal Specialists" Since 1925
**124 Jackson Ave., University Park
Hyattsville, Maryland Dept. Q-1**



LEARN RADIO CODE

WITH FLERON CODE PRACTICE SET . . .

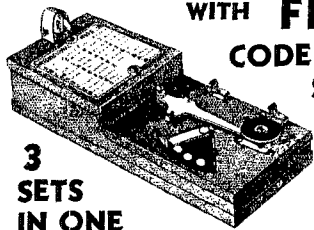

**3
SETS
IN ONE**

You need to know the Code before you can get any kind of an Amateur License. Start to learn at low cost with Fleron Code Practice Set.

Can be used as High Pitch Buzzer, Telegraph Sounder or Night Blinker. Runs on two Flashlight cells obtainable anywhere.

International-Morse Code on large etched top Plate. Key in correct practice position. Can be connected to second set and signals sent or received. \$1.50 complete with batteries. Pocket size. Lamp and reflector can be detached for carrying or packing.

Manufactured by

M. M. FLERON & SON, INC.
TRENTON, N. J., U. S. A.

Are You "Stuck"? LEARN CODE QUICKLY AND EASILY and become a Skilled Amateur or Radio Operator . . . AT HOME

Watson, W1BGL, op Bear of Oakland, Byrd Expedition, says: "Candler training enabled me to pass rigid competitive tests for this position."

Many Instructors and ops in U. S. Army, Navy and Aviation are Candler trained.

The FASTEST and most SKILLED Amateurs and Commercial ops during the past 22 years were Candler trained. 9 year old girl wins championship in Class "E" 2 months after beginning our Code Course for Beginners.

If you're wise you'll get your SPEED where the champions got theirs and prepare for that Amateur or Commercial Ticket the CANDLER SCIENTIFIC WAY. It's EASY and INTERESTING.

CANDLER STUDENTS NEVER FLUNK. Tell us what ticket you're preparing for and we'll show you how easy it is to get.

SEND FOR BOOK OF FACTS for Radio Ops, Amateurs and Beginners. Your questions answered promptly. No obligation.

CANDLER SYSTEM CO.
Dept. Q-1 6343 S. Kedzie Avenue, Chicago

Candler System Code Guild

An organization of CANDLER trained ops sending practice programs daily from their stations all over the U. S.

Become a C S C G Member. We furnish Schedules listing all C S C G stations, time on the air, speed 8 to 45 wpm.

You can bring in C S C G Practice Programs with your S.W. Receiver. This is REAL practice that costs you nothing. There is no substitute for it. CANDLER trained ops will help you develop your code technique.



growing, and the results of our work are known throughout the world. The sign "SP" has reached every corner of the earth. Following one of our slogans, "The radio short wave movement means the coöperation of the nations," we work for the glory and the welfare of our own country and at the same time for humanity as well.

Strays

Since F.R.C. publishes no list of Amateur calls expired or cancelled, the *Radio Amateur Call Book Magazine* requests that all owners of temporary or portable calls that are being cancelled coöperate in the maintenance of a reliable call-book by dropping them a card to that effect.

F.R.C. no longer writes letters to amateur licensees to serve as an extra operator license for the operation of a second station. Since the new regulations of October 1st, Rule 221 governs, and the amateur must supply himself with a photostat copy of his operator license.

Tri-Tet Tricks

(Continued from page 37)

screen pin of the tube, soldered snugly against the tube base. Due care was observed in making good contact with the turns of wire and the aluminum dope. Incidentally, this "screen-grid" tube doesn't screen you from a nice shock when you get your hand against it and the ground or plate circuits. Only one or two offenses are needed to cure this habit, however. After drying the tube thoroughly, it was returned to the circuit. There was no double dip when the plate tank was tuned to the fundamental frequency.

The unit was still in the experimental form and strung out on the bench, allowing leads to fall where they might; but a load test had to be made. A few turns were wound on the plate coil form and one end connected to a broadcast antenna about 35 feet long and 15 feet high—at the high end. The other end was connected to ground through a variable condenser. It was among the world's worst Marconi antenna systems. The outfit was tuned up to resonance and the antenna loaded on it. For a wonder the thing worked out right. A 3575-ke. crystal was used and the plate tuned to 7150, the second harmonic. The input was 40 mls or 22 watts.

To save time the regular rig in the station was used to make contact with W5BKL, who gladly agreed to stand by for the test. The crystal was switched to the little rig and transmission started with it. W5BKL came back with the report that all was FB, XPDC QSA4 R6, while on the same contact the 250-watt input and 132-foot Zepp (50 feet high) of the regular rig got QSA5 R9.

The next question is: Were we using a simple rig with our oscillator coupled to the antenna or was the little rig a full-fledged MOPA? Somebody else can answer that; for this thing must be built up into shape to go into the rack here with the rest of the station.



I DO DO! YOU?



BELONG TO THE ARRL AND WEAR THE EMBLEM

You Owe it to:—

- ▶ Yourself
- ▶ Other Amateurs
- ▶ Your League
- ▶ The Fraternal Spirit of Amateur Radio

Because:—

- ▶ You Are Proud of Amateur Radio and Your Part in It
- ▶ Amateurs Should Be Able to Recognize One Another
- ▶ The League Grows Stronger by Your Support
- ▶ The Amateur Spirit Is Maintained by Your Loyalty

The League Emblem, in heavy rolled gold and enamel, either pin or button type, \$1.00 postpaid

AMERICAN RADIO RELAY LEAGUE, WEST HARTFORD, CONNECTICUT

LOW RANGE FUSES

- *Littelfuses for Instruments:* Amps.: 1/100, 1/32, 1/16—20c ea. 1/8, 1/4, 3/8, 1/2—15c ea. 1, 2—10c ea. For milliammeters, ham rectifiers, etc. Use 1/8 for radio B circuits. *High Voltage*
 - *Littelfuses:* 1000, 5000, 10,000 volt ranges in 1/16, 1/8, 1/4, 3/8, 1/2, 3/4, 1, 1 1/2, 2 amps. Renewable. Price 35c to \$1.25 ea.
 - **NOW—\$100 PROTECTION GUARANTY.** Get New Cat. #5.
- LITTELFUSE LABS. 1784 Wilson Ave., Chicago**

“Quicker than a Short circuit” LITTELFUSES

FOR THAT NEW POWER SUPPLY

A new product now available to amateurs. Genuine General Electric Pyranol Filter Capacitors, conservatively rated, extremely compact, low priced.

Write for circular giving complete data and prices. Free consulting service on your radio problems by commercial radio engineers.

MOHAWK ELECTRIC COMPANY

1335 State Street, Schenectady, N. Y.

W2CCG—Distributors of standard radio products

When Seeking a Radio School

Consider RCA Institutes . . . an institution recognized as an important factor in the radio industry.

The beginner or the experienced man who seeks instruction in any branch of radio will find courses designed for him . . . either at the Resident Schools in New York and Chicago or the RCA Institutes Home Study courses.

Resident Schools are fully equipped—conveniently located—low weekly tuition rates.

FEATURES OF HOME STUDY COURSES

Extension courses for home study on convenient “no obligation” plan. Examination and lectural advisory services. Free post-graduate practical training at resident school with modern equipment under instructing engineers.

Illustrated Catalog on Request

RCA INSTITUTES, INC.
Dept. ST-1

75 Varick Street, New York
1154 Merchandise Mart, Chicago



PRECISION CRYSTALS

for accurate frequency control



Crystal Holder

FREE Plug-in, dust-proof holder with each amateur band crystal purchased. PRECISION Crystals are of the highest quality obtainable. These crystals are X cut, one inch square, accurately ground for maximum output, thoroughly tested and fully guaranteed. They are accurately calibrated and will be ground to within 0.1% of your specified frequency. It will pay you to buy these quality crystals. 1750 and 3500 kc. bands—\$4.50 ea. 7000 kc. band—\$5.50 ea. Crystal holder (illustrated)—\$1.50 (Free with each crystal purchased). Jacks to plug holder into—15c pair. Crystals and ovens for commercial use quoted on at your request.

When ordering a PRECISION crystal you are assured of the best obtainable. Now in our 5th year of business.

427 ASIA STREET PRECISION PIEZO SERVICE BATON ROUGE, LA.

Radio Operating Radio Servicing—

Prepare for the new Government Radio Operating license examinations; Radio Operator, Marine and Broadcasting. Also Radio Amateur Telegraph and Telephone. Resident courses. Write for booklet “Opportunities in Radio.”



West Side YMCA Trade & Technical Schools
4 West 63rd Street, New York City

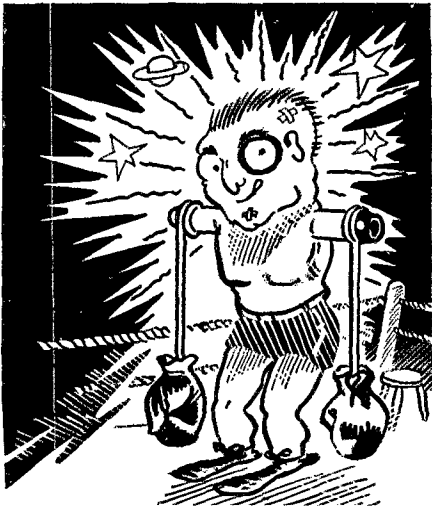

**"Can I
take
it!"**

Lefts and rights in the shape of heat, vibration, excess voltage . . . mean nothing to a Centralab Fixed Resistor. Baked at 2700 degrees it takes every abuse "on the chin" and comes up smiling. That's why we say . . . *insist on*

Centralabs
CENTRAL RADIO LABORATORIES
MILWAUKEE, WIS.

GULF RADIO SCHOOL

Radiotelegraphy Radiotelephony
Radio Servicing

SECOND FLOOR } 1007 Carondelet Street
U. S. A. } NEW ORLEANS, LA.

PANELS — BAKELITE — RUBBER — ALUMINUM

All Sizes Cut to Order BAKELITE TUBING & RODS

Drilling, Engraving & Special Work
ALUMINUM CANS—Stock sizes. Special sizes, made to order.
ALUMINUM CHASSIS—Threaded brass studs for 6/32 screws.
Length from 3/4" to 6"—price 5c to 30c.

Insulating bushings
for all size shafts
75c to \$1.90 per dozen



Couplings in
brass or bakelite
—15c

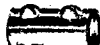

**UNITED RADIO
MFG. CO.**

Transmitting frames and racks.
Est. 1923 191 Greenwich St., New York

AMATEURS OF THE WEST

We carry in stock at all times all **NATIONALLY ADVERTISED** parts and kits of all **STANDARD MANUFACTURERS** for **TRANSMITTING and RECEIVING**

Prices are advancing
Write for latest quotations

Amateur's Headquarters of the West

RADIO SUPPLY CO.

H. A. Demarest, President
912-14 So. Broadway Los Angeles, California
(W6FBI located in building)

How to Get a Class-C License

(Continued from page 36)

must here present evidence of his authority to act for the society, preferably by a certified copy of resolution so appointing him. This relates to his authority to act as license-holder, in distinction to Item 34 which relates to his control of apparatus. Both must be evidenced in the case of club-trustee applications.

One has no option about the waiver in Item 39—the law requires it.

The examination itself consists of ten questions, five of which relate to the theory and adjustment of apparatus and five to the requirements put upon amateur licensees by radio treaty, law and regulations. The Commission has several hundred questions which are shuffled around so as to make thousands of differing sets of ten. Your examination may not remotely resemble that of another applicant next door; again it may partly coincide and partly diverge. All are supposed to be of the same stiffness. Each question counts 10 and a passing mark of 75 is required. It is impossible to suggest in this article the answers to these questions. The applicant must study, and he is properly expected to know something about radio and its regulation. The new examination is indubitably more difficult than the old. To aid old-timer and newcomer alike in passing it, the A.R.R.L. has prepared an inexpensive 32-page booklet called *The Radio Amateur's License Manual*, advertised in *QST*, which will be found of the greatest possible value both in the intricacies of procedure and, more especially, in preparing for the examination itself.

See September *QST* for the complete regulations and an interpretation.

Reference has been made to some F.R.C. Rules by number. The complete regulations and an extensive interpretation of them appeared in September *QST*.

Crashing Page One

(Continued from page 32)

who lives around the corner who doesn't even own a radio?" It may interest you, but does it interest them? If it meets this acid test, take the item to your city editor and he will print it.

Traffic and emergency work: If your station is the only one or one of a very few stations in touch with some area cut off from the world by a disaster or catastrophe, get word to your city editor as quickly as possible. That's news! On ordinary traffic work, don't bother him. He's a busy, barking, son-of-a-gun.

Visiting dignitaries to your local club: First-rate news, if the visiting dignitaries are really somebody. Oddly enough, the city editor will listen to an account of amateur radio from him quicker than he will from you. Example: If Hiram Percy Maxim pays you or your club a visit, that's news. If John Jones, president of the radio club in the next town pays you a call, that isn't.

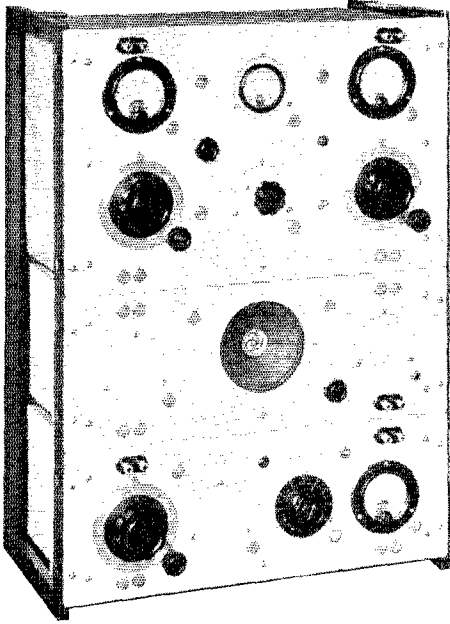

WHY GNAW OUT? METER HOLES?

when GR unit-panel construction gives you a completely laid out panel with all holes neatly cut. All that costs you but little more than finished stock of comparable surface and quality.

But it isn't the low first cost of GR unit-panel construction that's the important thing. It's their neatness, their clean finish, their interchangeability that make these panels the biggest thing in amateur construction practice.

The photograph at the left shows something of what can be done, but

Send for Bulletin 934-Q2 NOW

It contains complete layout drawings of both panels and accessories, clearly shows how all parts fit together.

**GENERAL RADIO CO.
CAMBRIDGE, MASSACHUSETTS**

MADE BY THE MAKERS OF "GR" PLUGS AND JACKS

HINTS AND KINKS FOR THE RADIO AMATEUR

(No. 10 in the A.R.R.L. series entitled The Radio Amateur's Library)

Amateurs are noted for their ingenuity in rather than buy new equipment. This overcoming by clever means the minor book is a compilation of hundreds of and major obstacles they meet in their pursuit of their chosen hobby. An amateur must be resourceful and a good tinkerer. He must be able to make a small amount of money do a great deal for him. He must frequently be able to utilize the contents of the junk box



good ideas which amateurs have found helpful. It will return its cost many times in money savings — and it will save hours of time. Why try to figure these things out for yourself? You might just as well profit by the experience of others. Order your copy today.

PRICE

80 pages in attractive paper covers. **50** (no stamps, please), postpaid anywhere

CENTS

AMERICAN RADIO RELAY LEAGUE, INC., WEST HARTFORD, CONN.

CONVERTIBLE VOLUME CONTROL

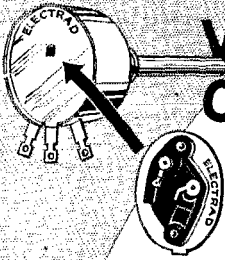

Used with
or without
Power Switch

IDEAL for replacement purposes, because of these distinctive advantages:

- 1—Interchangeable end covers, instantly convertible to use power-switch, without disturbing control connections.
- 2—Long ALUMINUM shafts, easily cut to desired length.
- 3—Only five types required to service 799 standard receiver models.

Write Dept. Q-1 for FREE Catalog and Vest-Pocket Volume Control Guide.



ALUMINUM BOX SHIELDS Genuine stock, silver-plate finish, 5 x 9 x 6, \$1.65, 10 x 6 x 7, \$2.65, Any Size to Order. **SOMETHING NEW!** Your call letters, or any marking for your panel, on BLACK aluminum ribbon. Looks like engraving on bakelite. Sc up to 2 inches, 5c each additional inch. Sample 8c, U.S. Army V.T. 1 tubes 35c, 10 for \$2.50. Fall for condenser or velocity mike 1/2 mil., 25c ft. New Master Teleplex on demonstration.

W 2GT

BLAN, the Radio Man, Inc. 177 Greenwich St. New York City

Be an Expert Radio Operator

Learn at Home
It's Easy
with The New
MASTER

Teleplex

Records and Repeats Your Own Sending

TELEPLEX trains you quickly at home. No experience necessary. We furnish Complete Code Course and lend you the New Master Teleplex. Realize the advantage and success that comes with being an **EXPERT OPERATOR** — capable of filling the highest-paid jobs. Daily practice with **TELEPLEX** develops amazing speed in short time. Teaches both sending and receiving. Makes everything simple and clear. Personal instruction. **TELEPLEX** has instructed more students in code during past ten years than all other systems combined. Used by U. S. Army and Navy, R. C. A., A. T. & T. Co. and principal schools. Whether beginner or operator lose no time in getting started with **TELEPLEX**. Others are doing it — why not you? Get started NOW! Easy terms. Write today for folder Q-13 giving full details.

TELEPLEX COMPANY
76 Cortlandt Street
New York, N. Y.



Radio and romance: Don't laugh, it's honest-to-gosh page one news, the very best kind. Here's how: Suppose Bob Smith at W9XYZ meets Sadie Blake at W5PDQ, a romance buds over the air and they get married. But nell's bells, what's the use, you'd probably want to keep that away from the city editor and then be the first to grumble that he won't print your news!

Strays

Back in the old days 5EK was one of the mightiest sparks in town. He used to adjust clips on his OT to where the cards came in the largest number. One day he called out the photographer to take a shot of his noisemaker. In opening the glass-fronted transmitting enclosure, the OT, which was held up with a string, tumbled out on the floor. It took 5EK over three months to find the old setting where the cards came in the largest number.

—Delta Division Convention Program

W2BNX worked W6BOW and shortly afterward heard W6DOG. Now he's trying to figure out why he heard the bark before the dog.

The mark of a high-power rig is the size of the arcs that can be pulled off the tank. W6DSZ says that his 52's release only a 4-inch arc against a poor conductor like a hammer, but that with a good conductor, like a soldering iron, the arc stretches out a full 8 inches. They have 5000 volts on the plates.

—Delta Division Convention Program

Club Directory Available

A directory of the local amateur radio societies affiliated with the League, showing their times and places of meetings, is available to members upon request, enclosing three cent stamp, please. Address the Communications Manager. Traveling amateurs will find this list helpful in visiting other clubs.

Send for this

New METER BULLETIN — all bargains —



Just issued, lists many types — all new meters — big selection: Ammeters, Radio Frequency Ammeters, Thermo-ammeters, Volt-meters, Milliammeters, A.C.-D.C. Universal Meters, D.B. Power Level Meters and Volt-meters, Volt-Ohm-Milliammeter Circuits, Resistor Kits, Shunts, Resistors — every item a real bargain and guaranteed. Send postal now for free bulletin.

Universal Meter Works
410 N. Leavitt St., Chicago-III.

A radically new *DX* type transmitter is now in production following months of development work. It is the first low-priced transmitter using powerful tubes. Write for new Bulletin giving full details.

COLLINS RADIO CO.

Cedar Rapids, Iowa

FEEDING THE DOUBLET

A new idea of great importance in short wave transmitting antenna construction, using a balanced, non-radi-

ating feed line of ANY convenient length, with a simple solution of the impedance problem.

Complete plans and specifications for construction of this feeder system will be mailed free on request. Get the dope on the simple parts we have developed before you build.

The heart of the system is the correct construction of the tubing section, plus the perfection of the JOHNSON Transposition Insulator. Parts will be available through all Johnson jobbers.

Your anti-noise receiving antenna will be better and easier to build with the unique JOHNSON No. 31 Transposition Insulator.

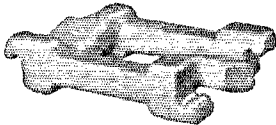

Bulletin 933 describes these and other original JOHNSON parts. Send for it

E. F. JOHNSON COMPANY
Waseca, Minnesota

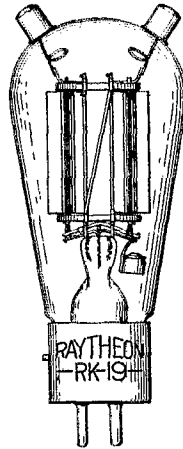

RK-19

A
VACUUM TYPE
HIGH VOLTAGE
RECTIFIER
FOR
THE AMATEUR

The RK-19 is a FULL WAVE vacuum rectifier having the advantage of low voltage drop, approaching that of the mercury vapor type, combined with freedom from RF noise generation.

The RK-19 makes possible a compact and economical power supply for tubes of the 750-1000 volt class such as the RK-18, with good voltage regulation required for Class B modulation.

RATING

Heater Voltage.....	7.5 Volts
Heater Current.....	2.5 Amperes
Maximum RMS Voltage per Anode.....	1250 Volts
Maximum Peak Inverse Voltage.....	3500 Volts
Maximum Peak Current.....	.600 Amperes
Anode Connections.....	At top of bulb
Heater Connections.....	Medium Four Prong Base
Overall Height.....	6½"
Diameter.....	2½"

Price \$7.50

Do you have technical data on the RK-15, RK-16, RK-17, RK-18 and other Raytheon tubes? If not, write the nearest office below

RAYTHEON PRODUCTION CORPORATION

New York, N. Y.....30 E. 42nd Street
Newton, Mass.....55 Chapel Street
San Francisco, Cal.....555 Howard Street
Chicago, Illinois.....445 Lake Shore Drive

HAM-ADS

(1) Advertising shall pertain to radio and shall be of nature of interest to radio amateurs or experimenters in their pursuit of the art.

(2) No display of any character will be accepted, nor can any special typographical arrangement, such as all or part capital letters be used which would tend to make one advertisement stand out from the others.

(3) The Ham-Ad rate is 15¢ per word, except as noted in paragraph (6) below.

(4) Remittance in full must accompany copy. No cash or contract discount or agency commission will be allowed.

(5) Closing date for Ham-Ads is the 25th of the second month preceding publication date.

(6) A special rate of 7¢ per word will apply to advertising which, in our judgment, is obviously non-commercial in nature and is placed and signed by a member of the American Radio Relay League. Thus, advertising of bona fide surplus equipment owned, used and for sale by an individual or apparatus offered for exchange or advertising inquiring for special equipment, if by a member of the American Radio Relay League takes the 7¢ rate. An attempt to deal in apparatus in quantity for profit, even if by an individual, is commercial and takes the 15¢ rate. Provisions of paragraph (1), (2), (4) and (5) apply to all advertising in this column regardless of which rate may apply.

Having made no investigation of the advertisers in the classified columns, the publishers of *QST* are unable to vouch for their integrity or for the grade or character of the products advertised.

OVER six pounds radio data, circuits, bulletins, 50¢ postpaid. Beyond Rockies 75¢. Kladag, Kent, Ohio.

MICROPHONE and meter repairs. Low prices. Quick service. Sound Engineering Corp., 416 N. Leavitt St., Chicago, Ill.

TRADE, sell for tools, woodworking machines, receiving transmitting equipment. Jewett body course with bells. John Olsen, 1046 Summit Ave., New York City.

PERFECT RCA 860, \$12. W2BWB, Ossining, N. Y.

SELL Esto 1600 volt generator, Rochester 3/4 h.p. 240 d.c. motor. Cheap. Write W2AOY for details.

QSLs two color. 70¢ up. Free samples. Printer, Corwith, Iowa.

QSLs! QSLs! NRA printer! Any order sent c.o.d. Free Samples! W8DED, Holland, Mich.

CABINETS—metal, chrome finish, 19 x 13 x 9 inches. Each \$1. six \$5. Cash in advance. Gates Radio & Supply Co., Quincy, Ill.

BEST offers take 1 SW3AC with 3 band spread coils and power pack, 1 G.E. 1500 watt plate transformer 115 volt primary 1150-0-1150 secondary, 1 Westinghouse 500 watt plate transformer 115 volt primary 2300-0-2300 secondary. W5AXU.

SELL—Gross Hawk, Tubes, cable, transformer, good condition, \$10. 3024 Somerton Rd., Cleveland Heights, Ohio.

CRYSTALS: 1 inch square Hipower oscillators, 3500-1700-Kc. bands. Close to your specified frequency \$1.35. 7000-Kc. band \$4.25. Exact calibration with each crystal. 1 inch blanks 65¢. Dustproof plug-in holder with mounting complete \$1.00. Broadcast stations, Radio manufacturers and Airline Companies, who require precise and accurate crystals are using Hipower crystals. Hipower is the logical place to buy yours. Our frequency standard is accurate to one cycle in five million. Prices of crystals for any use and degree of accuracy on request. Send for bulletin. Immediate delivery, no waiting. Hipower Crystal Co., 3607 N. Luna Ave., Chicago, Ill.

QSL cards, two color, cartoons, message blanks, stationery, snappy service. Write for free samples today. W1BEF, 16 Stockbridge Ave., Lowell, Mass.

QSLs? The best in the U. S. W2AEY, 338 Elmora, Elizabeth, N. J.

NEW Trans-receiver, never used. First \$15. takes same. Snyder, 9208 Frankstown Rd., Wilkingsburg, Penna.

NEW Apex all wave Superhet receiver, \$25. complete. Snyder, 9208 Frankstown Rd., Wilkingsburg, Penna.

HAMS: Get our samples and prices on printed call cards made to order as you want them. W9APY Hinds, 19 S. Wells St., Chicago, Ill.

HOW about some good headphones? Write for lowest prices. Finest available. Limited supply. Absolutely guaranteed. W9WR 6618 34th St., Berwyn, Ill.

YOU can still get those 95¢ crystals. White Radio Lab., Sandpoint, Idaho.

MAST-kits. Now you may have that vertical xmitter antenna for DX. Clear timber spruce lattice masts fifty sixty five and eighty feet, \$28. to \$55. Shipped knocked down, holes drilled, bolts and instructions for assembling. Communications Laboratories, North New Portland, Maine.

FOR sale—xtal, all bands phone and c.w. transmitter; monitor complete, \$4. Vibroplex \$5. Write W9DLC, Spruce, Mo.

KILO-watt Esco direct-connected motor-generator complete with field rheostat, Westinghouse remote control and overload relay; delivers 2500 volts purest d.c. at 1000 MA with taps at 1000 and 500 volts. Double commutator Type F22 generator; single-phase 1750 RPM motor for 110 or 220 a.c. Best offer gets it f.o.b. Garden City, L. I., New York—Dr. L. J. Dunn, 80 Hanson Place, Brooklyn, N. Y.

IMPOSSIBLE to list all parts here. Selling all short wave equipment including 100 watt crystal controlled transmitter and receivers. Also broadcast receivers and parts. Over 250 parts. Write for list and prices. W9CKU, L. W. Robson, Heron Lake, Minnesota.

LIMITED supply—Dongan cased transformers, used but guaranteed. Primary 110V, secondary 600-0-600 volts at 130 mils.—10V 1 amp.—7.5V 3 amps., 3.75V 3 amps. Wt. 10 lbs. each, shipping weight. \$3. each, plus postage. Acme parvot condensers. Used, but guaranteed. 3 sections of 4.0 mfd. each. 750 volts. \$3. each, plus postage. 5 lbs. shipping weight. Motor generators Esco, used, as is. 110V a.c. 60 cycle motor—325 volts d.c. generators. Some deliver as high as 0.5 amp. \$5. and up, plus shipping charges. Power amplifiers—class A 15 watts output, uses 1-58, 1-59, 2-250 or 2-2A3 and 1-83. \$20. each, less tubes, plus shipping charges. A few amplifiers, use 3-112As, 2-530s and 2-281s, as is, \$10. each, plus shipping charges, less tubes. W212D used, with socket, \$15, plus postage. WICKF, Middle Haddam, Conn.

TRADE—automatic 8ML arc, 5000 volt filter condenser—1 kw 2200 volt transformer, plate blocks. Want good camera. Will add cash for good Graflex or Roliflex. W9ADS.

REFRIGERATION course complete. 48 lessons. Cost \$100. Make cash or xmitter parts offer. W9KJF.

RELAY racks custom built. Standard 19" x 27" or 24" high, \$5. W9KJF, 1115 DeQuincy St., Indianapolis, Ind.

FOUR large 3.5 mc. crystals, guaranteed unusually strong oscillators, \$4. each. E. G. Watts, Chagrin Falls, Ohio.

QSLs, 50¢ per 100. Samples, 2143 Indiana Ave., Columbus, Ohio.

SMITH—Precision crystals now only \$1.95 postage, airmail. See January hamad. W6BCX.

FOR sale—large motorola car set, Scott DeLuxe, Silver all-wave, superwasp, two fifty amplifier, Phono pick-up, mike, special receiving antenna increases volume. Glenn Watt, Chanute, Kansas.

WANTED—Scott all-wave, National, Comet Pro, or similar band spread receiver. Glenn Watt, Chanute, Kans.

QST's—back issues as far as 1923 20¢ per copy prepaid. Also proceedings of IRE for past 3 yrs. 35¢ per copy. C. L. Phillips, McKinney, Tex.

QUARTZ—Direct importers from Brazil of best quality pure quartz suitable for making piezo-electric crystals. Diamond Drill Carbon Co., 719 World Bldg., New York.

WANTED: finest shortwave communication type receiver. Heinfling, 540 Rosedale Ave., Bronx, New York City.

BACK issues of QST cheap. W9BYZ.

CLASS B TRANSFORMERS—for 46's \$4.95 pair. Universal Transformers for two or four 46's, 210's, 800's, RK18's, etc. \$7.75 pair. 70 watts of audio from 46's. Write for details. W8UD, Douglas, Michigan.

VIBROPLEXES bought, sold. Rebuilds \$8. up. Speed bugs, new \$9. Lydeard, 28 Circuit, Roxbury, Mass.

QSLs—submarine prices, airplane quality. 200 one color for \$1. Jake, The Specialty Printer, Franklin, Pa.

FB7s, Teleplexes, Omnigraphs, Vibroplexes, converters, meters, receiver. Bought, sold, traded. Ryan Radio Co., Hannibal, Mo.

CRYSTALS: Guaranteed excellent oscillators, 160 or 80 meters, your approximate frequency \$1.35; no specified frequency \$1.00; postpaid. "Crystal Maker's blanks" 1" 65¢—dozen \$6.00; 3/4" 50¢—dozen \$4.80. Irregular shapes 25¢. Standard dust-proof plug-in Holders 75¢—dozen \$5.40. Fisher Laboratory, 1200 E. Nevada, El Paso, Texas.

CONDENSER microphones \$7.50, desk or suspended amplifiers. \$10. Stands, foil, literature. Microphone Labs., 345 Eighth, Ann Arbor, Mich.

NEW Jewell 5000 volt meter, list \$82.50, sell \$24. Pyrex 30" antenna insulator, \$5. Other apparatus and magazines. Want ham super. Edward Talbot, 3010 Memphis, El Paso, Texas.

CRYSTALS: x cut, power, within 2 kc. 160-80, 1", \$2. Oscillating blank, x or y cut with comp. \$1. Bliley holders, \$1.50. W8DLM, Rochester, Mich.

QSLs! New metallic surfaces! Others 200, \$1.50 up. W6FZQ, Box 1804, Phoenix, Ariz.

CALLBOOKS—new Winter 1933-34 Radio Amateur Call Book, many pages of the new W calls and hundreds of new DX stations, is yours for \$1.10. Next four issues for \$3.65 (Foreign \$1.20 and \$3.75). W9FO—610 S. Dearborn, Chicago. 866s. \$1.40; 203-A transformers \$3.50; transmitters built. R. Howard, 314 Pine Ave., Chicago.

TRANSFORMERS, 600 volts each side center, 125 milliamperes, one 5 volt and one 7½ volt center tapped filament winding, mounted, heavy construction. Made for transmitting, \$5.75. Remit \$2. with c.o.d. orders. Amateur Equipment Co., Myrtle, Miss.

OFFER, Weston d.c. voltmeter, model 301. Utah dynamic speaker, pp 45s. Potter, W9HFV.

QSLs, 75¢ a 100, two colors. W9DGH, 1816 5th Ave., N., Minneapolis, Minn.

COMPLETE engineering service. Problem solutions. Circuit diagrams. Laboratory measurements. Calibrations. Apparatus designs. Special equipment manufacture. Reliable work. Holmes C. Miller, Radio Engineer, Box 105, Palo Alto, California.

QST "Grammer" Universal Exciter Unit, \$25; T.R.F. Autodyne receiver, \$19.95; monitor \$8.50; beginner's crystal transmitter with power supply, \$20. Write for new catalog. We build to order. Precision Radio Labs., 109 E. 94 St., Brooklyn, N. Y.

QSLs? Write W8DED.

SIXTY bucks takes late FBXA, four sets coils, tubes, power pack. W8DGV, 1145 Erieview, Cleveland Heights, Ohio.

HEAVY duty mesh filament 866s, \$2.50, 872s, \$7.50, Meters. 212Ds, \$13. Universal S-G quarters, \$15. 849s, 204As, etc. 203A class B xims, \$8.50 pair. Television receiver, complete \$30. Cathode ray tubes and special thyratrons built to specifications. E. Ewing, 1057 Pruit Blvd., Chicago.

SELL R.E.L. 278 receiver or trade for portable typewriter or 852 power supply. W8FOV.

CRYSTALS—160-80 meter 1", good output, your approximate frequency \$1.35 guaranteed. Oscillating blanks, 75¢. William Threm, W8FN, 4021 Davis Ave., Cheviot, Ohio.

GUARANTEED Ham Bargains: Mid-Con.

4 TUBE TRF band spread Receiver. Complete in wrinkle cabinet with coils, latest tubes, power supply \$18.90. Mid-Con.

RECEIVERS, Transmitters \$2.00 up. Mid-Con.

FIVE-BAND Exciter Unit described Nov. QST. Kit \$16. Wired and tested \$20. Mid-Con.

TRANSMITTER Power Supplies. 500vdc \$6.90, 800vdc \$9.90, 3000vdc 600 mil \$35. Mid-Con.

RELAY Racks, \$3 up. Mid-Con.

New 210s \$1.40. Used Transmitting tubes. Mid-Con.

CRYSTALS; ¾" blanks 25¢, 1" 50¢, Finished 160 or 80 meters \$1.00. Holders 50¢. Mid-Con.

RF CHOKES 500 mil, 50¢. Mid-Con.

FREE CATALOG, 24 hour service. Money refunded unconditionally. Mid-Con Radio, 3007 Main, Kansas City, Mo.

ROSS announces mastantenna vertical steel radiators, beam transmission equipment for amateur wavelengths, stationary and rotatable reflector antennae. Ask your jobber or write direct for bulletin including all types amateur towers. Prices unbelievably low, function, construction guaranteed. A. C. Ross Company, Van Wert, Ohio.

TRANSFORMERS—1250-1000-750-0-750-1000-1250, 300 ma. Mounted, 32 lbs., \$7. Cash-trade. Spear Co., Waterville, Ohio.

IN stock: FB7As \$34.20, FBXAs \$47.70, coils \$6, 5897AB \$15.90; SW3s \$17.70, coils \$3, 5880 AB \$15.90. Comet Pros \$88.20, Crystal Pro \$111.72. Trade-in your receiver. Sylvania 210s \$4.75, 830s \$8.75, 825s \$10, 203-As \$17.50, 852s \$23.80, 860s \$35, 866s \$5. Triplet milliammeters and voltmeters \$3.75, Hoyt meters \$1.47. Vibroplexes \$16.50, Speedexes bugs \$7.35. Guaranteed 866s \$1.95. Any amateur or serviceman equipment. Write. Henry's Radio Shop, Butler, Mo.

SELL complete phone rig. Reasonable offer. James L. Raines, Perry, Kansas.

QSLs, SWLs, W6DOU, Hayward, Calif.

RADIO engineering, broadcasting, aviation and police radio, servicing, marine and Morse telegraphy taught thoroughly. All expenses low. Catalog free. Dodge's Institute, Byrd St., Valparaiso, Ind.

QSLs. Samples free. W9IHM, Escanaba, Mich.

SOCKETS—50 watt, front panel, universal mounting, aluminum, mirror finish, \$4; pair, \$7.50 postpaid. Satisfaction guaranteed. Cantonwine, 414 N. First, Rockford, Ill.

**THERE'S
ON THE BACK COVER
NEWS!**

BARGAINS!!!

National Union type 83 tubes.....	\$.85
Black Shrivel Shield Boxes, 5" x 5" x 5".....	.60
Black Shrivel Shield Boxes, 9" x 5" x 6".....	1.05
TOBE 8 mfd. dry elec. Conds. cardboard cases, 500 volts.....	.49
TOBE 8 mid. dry elec. Conds. Alum. cans, 500 volts.....	.55
NATIONAL FB-7A S.W. Receiver.....	34.20
NATIONAL FBX-A crystal filter Receiver with crystal.....	47.70
NATIONAL SW-3 AC or DC models.....	17.70
NATIONAL R.F. Choke, type No. 100.....	.45
NATIONAL air dielectric padding conds. 75 mmf. \$1.20; 100 mmf.....	1.35
NATIONAL air dielectric "I.F." transformers.....	3.00
DeForest: types 410, 450, 481.....	.95
ELECTRAD 10 watt wire wound vitreous enameled resistors, from 1 to 25,000 ohms.....	.21
ELECTRAD 10 watt, Truvolt adjustable resistors, from 1 to 25,000 ohms.....	.29
SPRAGUE 8 mfd. wet elec. condensers, metal cans, 450 V.....	.39
CARDWELL Condensers at WHOLESALE prices—write!	
Lifetime double button mike and stand (with your call letters).....	3.98
Thordarson 30 hy. choke, 150 m.a.....	.69
Franklin filament transformers: 2½ V.—6 A.; 6.3 V.—3 A.; 5 V.—3 A.; 7½ V.—3 A.; 2½ V.—9 A., each.....	.89

Write for free bulletin. 20% deposit with all C.O.D. orders. Remit by M.O. include postage. Prompt service

MAURICE SCHWARTZ & SON
710-712 Broadway, Schenectady, N. Y.

The last Round-up!

We have just 47 sets, unbound, of the complete series of 1931, 1932 and 1933 QST issues. They are available at the special price of \$6.00, postpaid. Orders sent from outside the United States and its Possessions, and Canada, should include an extra \$1.00 to cover the additional postage charge.

They won't last until the next issue of QST appears. Act now, or keep your peace for evermore.

The complete list of available QST back copies are to be found on Page 78 of this issue.

QST

38 La Salle Road West Hartford, Conn.

Your Nearest Dealer

Your nearest dealer is entitled to your patronage. You can trust him. He is equipped with a knowledge and understanding of amateur radio. He is your logical and safe source of advice and counsel on what equipment

Patronize the dealer nearest you—

ALLENTOWN, PENNSYLVANIA

Radio Electric Service Co.
1024 Hamilton Street
Complete stocks transmitting equipment

BALTIMORE, MARYLAND

Radio Electric Service Co.
303 W. Baltimore Street
Everything for the amateur

BOSTON, MASSACHUSETTS

Nutter & Cross, Inc.
99A Milk Street
All OMs, OWs, and YLs welcome — W1HRF

BROCKTON, MASSACHUSETTS

Ware Radio Supply Company
913 Centre Street
Everything in parts. Comet Pro in stock with crystal filter

CHICAGO, ILLINOIS

Chicago Radio Apparatus Company
415 South Dearborn Street

Dependable Radio Equipment. Established 1921. All Standard Lines

CHICAGO, ILLINOIS

Mid-West Radio Mart
520 S. State Street
All standard lines carried in stock

CLEVELAND, OHIO

Northern Ohio Laboratories
2073 West 85 Street
Wholesale Distr. for National, Hammarlund, Thordarson, Cardwell

CLEVELAND, OHIO

Radio Servicemen's Supply Co.
206 Prospect Street
Wholesale Distributors catering to Amateurs, Dealers, Servicemen

DENVER, COLORADO

Inter-State Radio & Supply Co.
1639 Tremont Place
Amateur Radio Headquarters in the Rocky Mountain Region

DETROIT, MICHIGAN

Radio Equipment Sales Co.
14036 Woodward Avenue, Highland Park
A complete stock of amateur, shortwave and service parts

DETROIT, MICHIGAN

Radio Specialties Company
171 E. Jefferson Avenue
Ham Supplies — National & Hammarlund Sets and Parts

ERIE, PENNSYLVANIA

Jordan Radio Laboratory
1019 East Fifth Street
Amateur, service parts, including Bliley, National, Raytheon. W8CXG

HARTFORD, CONNECTICUT

Radio Inspection Service Company
227 Asylum Street
Complete line of guaranteed parts

KANSAS CITY, MISSOURI

Burstein-Applebee Company
1012-14 McGee Street
"Specialists" in supplies for the Amateur and Serviceman

KANSAS CITY, MISSOURI

Radio Laboratories
1515 Grand Avenue
Amateur Headquarters — Complete Stock — Quality Parts

LOS ANGELES, CALIFORNIA

Radio Manufacturers Supply Co., Inc.
1000 S. Broadway
Amateur Headquarters of the Pacific Coast

MANCHESTER, NEW HAMPSHIRE

Radio Service Lab. of N. H.
Amateur Supply Headquarters for New Hampshire
Amateur discounts allowed

MILWAUKEE, WISCONSIN

Radio Parts Company, Inc.
332 West State Street
Complete stock Nationally Known products

NEWARK, NEW JERSEY

Kaltman & Romander
62 Court Street
Drop in for an over-counter QSO

NEW ORLEANS, LOUISIANA

Rose for Radio
129 Camp Street
Complete stock quality radio parts

PHILADELPHIA, PENNSYLVANIA

Freeland Radio Supply Co.
5 N. 7th Street
"If it's radio we have it"

PHILADELPHIA, PENNSYLVANIA

Radio Electric Service Co., Inc.
N. E. Cor. Seventh & Arch Sts.
All nationally advertised lines in stock

This advertisement is paid for by the firms listed above. Qualified dealers

Is Your Best Friend

you should buy. His stock is complete. He can supply your needs without delay. His prices are fair and consistent with the high quality of the goods he carries. He is responsible to you and interested in you.

You can have confidence in him

PHILADELPHIA, PENNSYLVANIA

Eugene G. Wile
10 S. Tenth Street

Complete Stock of Quality Merchandise

PITTSBURGH, PENNSYLVANIA

Cameradio Company
603 Grant Street

Tri-State "Ham" Headquarters

Standard Apparatus

Standard Discounts

PORTLAND, OREGON

Wedel Company, Inc.
443 Washington Street

"The Ham's Paradise." Transmitting and receiving parts and tubes

PROVIDENCE, RHODE ISLAND

W. H. Edwards & Company
32 Broadway, Room 23

A full line of reliable Amateur Equipment & Supplies

ST. LOUIS, MISSOURI

Walter Ashe Radio Company
1100 Pine Street

W9FIS in charge of the oldest and largest parts store in St. Louis

ST. PAUL, MINNESOTA

Lew Bonn Company
2484 University Avenue

Rex L. Munger, W9LIP, Sales Engineer

Radio Wholesaler

Complete Stock

SAN FRANCISCO, CALIFORNIA

Offenbach Electric Company, Ltd.
1452 Market Street

"The House of a Million Radio Parts"

SEATTLE, WASHINGTON

Wedel Company, Inc.
520 Second Avenue

"The Ham's Paradise." Transmitting and receiving parts and tubes

SHANGHAI, CHINA

Amateur's Home, Ltd.
323 Kiangse Road
Radio Manufacturer, Wholesaler and Retailer

SPRINGFIELD, MASSACHUSETTS

T. F. Cushing
345 Worthington Street
An amateur, endeavoring to sell good parts

SYRACUSE, NEW YORK

Roy C. Stage, W8IGF
Complete stock of standard Ham & BCL parts
Standard Discounts. Free technical service

TORONTO, CANADA

Wholesale Radio Company, Limited
355 Danforth Avenue
Canada's Largest Amateur Supply House

TRENTON, NEW JERSEY

American Radio Co.
5 N. Broad Street
Central Jersey's leading radio parts store

UTICA, NEW YORK

Vaeth Electric Company
701 Varick Street
Wholesale Distributors of Radio Parts and Supplies

WASHINGTON, D. C.

George's Radio Co.
816 F Street, N.W.
Washington's largest distributor of radio parts

WILMINGTON, DELAWARE

Wilmington Electric Specialty Co., Inc.
405 Delaware Avenue
Amateur headquarters — Collins, Hammarlund, National, etc.

WINNIPEG, MANITOBA

Electrical Supplies, Ltd.
310 Ross Avenue
A complete parts service for amateur and serviceman

ZANESVILLE, OHIO

Thompson Battery & Radio Service
393 West Main Street
Distributor radio equipment for amateurs and servicemen

are invited to apply for rates, etc., to Advertising Department, QST

Say You Saw It in QST — It Identifies You and Helps QST

You Are Protected When You Buy From QST Advertisers

¶ "Advertising for QST is accepted only from firms who, in the publisher's opinion, are of established integrity and whose products secure the approval of the technical staff of the American Radio Relay League."

Quoted from QST's advertising rate card.

Every conceivable need of a radio amateur can be supplied by the advertisers in QST. And you will know the product has the approval of the League's technical staff.

● See Editorial April issue of QST

For Your Convenience QST'S INDEX OF ADVERTISERS IN THIS ISSUE

American Machine & Tool Co.	81
Astatic Microphone Lab.	79
A.R.R.L. Application Blank	74
Back Copies	78, 91
Binder	Con. II
Booklets	77, 87
Bound Volume	82
Emblem	85
Handbook	Con. IV
Supplies	4
Birnbach Radio Company	78
Blan, The Radio Man, Inc.	88
Bliley Piezo-Electric Co.	81
Candler System Company	84
Cardwell Mfg. Corp., Allen D.	96
Central Radio Labs.	86
Collins Radio Company	89
Cornell Dubilier Corp.	89
Delta Mfg. Company	71
Dodge's Institute	83
Electrad, Inc.	88
Ferranti, Inc.	80
Fleron & Son, M. M.	84
General Radio Company	87
Gross Radio Company	68, 69
Gulf Radio School	86
Hammarlund Mfg. Company	1
Harvey Radio Lab.	81
Hilet Engineering Co.	79
Hygrade Sylvania Corp.	6, 7
Instructograph Company	83
Jappe Company, H.	82
Johnson Company, E. F.	89
Kaltman and Romander	76
Leeds	95
Littelfuse Labs.	85
M & H Sporting Goods Company	83
Mass. Radio School	81
Mohawk Electric Company	85
National Company	.67, Con. III, Insert
Port Arthur College	79
Precision Piezo Service	85
Radio Mfg. Engineers	70
Radio Supply Co.	86
Raytheon Production Corp.	89
RCA Institutes, Inc.	85
Rectifier Engineering Service	79
Ross & Company, A. H.	80
Schwartz & Son, Maurice	91
Scientific Radio Service	83
Teleplex Company	88
United Radio Mfg. Co.	86
Universal Meter Works	88
Van Nostrand Company, D.	73
Westinghouse Elec. & Mfg. Co.	2, 75
Weston Electrical Instrument Co.	72
West Side Y.M.C.A.	85
Wing's Sons, Chauncey	83

HAPPY NEW YEAR O. M.

To our large and far-flung host of friends that LEEDS has served during the past years — *Many Thanks.*

We will endeavor to express our appreciation in service of increased scope during the coming year.

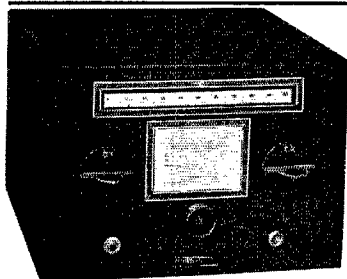

NATIONAL FB-7A \$34.20

F B X A \$47.70. All coil ranges, each \$6.00. SW-3. All models \$17.70. All band spread and short wave coil ranges \$3.00. We carry a complete stock of National parts.

Have you received **GENERAL RADIO Bulletin No. 935**. We will be glad to send you one listing the complete line of amateur apparatus. We carry a complete stock at all times.

Announcing new LEEDS transformers; 10v. 4 amp. C.T. with tapped primary. Ideal for 1-203A or 1 or 2 Sylvania 830. Special... **\$1.75**

Two 7½ v. — C.T. windings at 5 amps each for 4 R.K. 18's or 800's. Special... **\$3.95**

New cased plate transformer 1250 v. E.S.C. 400 mmf. Special... **\$16.50**

For other Leeds' transformers see Dec. issue

5-Meter Enthusiasts

2 RED HOT items by G. S. Wing. **FIRST** — The answer to the antenna problem. A complete assembly, including a Picard type matched impedance coupler and two 46" brass tubing radiator rods. Complete only... **\$2.50**



SECOND — A real transceiver, employing 176 and 141 tube. Ideal for use in auto. Self contained in heavy cast aluminum case. SIZE 3 x 6 x 9. Truly the finest 56 m.c. unit we have seen in our experience. Only... **\$16**

Special RELAY Bargain

Operates on one dry cell, two pole. One pole make and break, the other break only. Contacts will handle... **\$29**

LEEDS does not publish a catalog. We will be glad to furnish manufacturers' bulletins on any apparatus advertised by us if you will specify those you are interested in. We will be glad to quote our lowest prices on any equipment by return mail.

G.R. in radio, is like "sterling" on silver. It is the best. Here are a few G.R. products. We carry the complete line.

374-B. 125 mmf. SLF.....	\$1.25
374-N. 350 mmf. SLF.....	1.25
247-K. 250 mmf.....	.75
247-M. 250 mmf. vernier.....	.95
387-A. Speaker filter.....	.49
587. Power speaker filter.....	.95
369. Impedance 90H. 15 m.....	.49
373. Double impedance with coupling condenser.....	.95

Triplett Meters



We had a hunch that the boys would appreciate quality instruments at reasonable prices. Our sales of the new Triplett Meters have certainly proven we were right. For example — all the 3½" bakelite cased milliammeters as illustrated, from 0-5 to 0-1000 MA at only **\$3.75**. **A.C. Voltmeters** — 0-5 v. — 0-10 v. — 0-15 v. Each... **\$3.75** **Thermo coupled meter**..... **\$6.67** You are missing a bet if you don't have a Triplett bulletin handy. *Write today.*



Apparatus of Distinction — now carried in stock. See Dec. issue for their list prices. Our wholesale prices are **40% less.**

Jewell Meters

Another special buy enables us to offer a few more Jewell 2" meters.

No. 190 A.C. Meters
0-8 v. } each
0-10 v. }
0-15 v. } **\$3.50**

No. 165 Thermo-ammeters 0-1 amp., and 0-2 amp.; each... **\$4.95**

The new *Western-Jewell dealers' bulletin* is now available.



LEEDS' precision crystal holder...	\$1.25
Y cut crystal 10 KC 80 or 160 meters	2.50
with crystal holder.....	3.50
Y cut xtal. 1 of 1% accuracy.....	3.00
with crystal holder.....	4.00

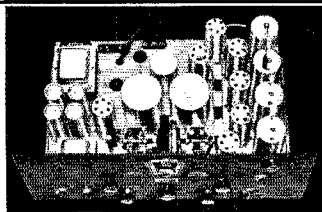

The New Hammarlund "Pro"

Standard Chassis.....	\$79.38
Metal cabinet, add.....	8.82
Crystal filter, add.....	23.52
Automatic vol. con., add.....	17.64
Complete set R C A tested tubes, add.....	7.17
Tubes for A V C model.....	8.35

830 — **\$8.75** 825 — **\$10** 210 — **\$4.75**

YES — we have the **THREE ACES!** and all the other transmitting tubes manufactured by **HYGRADE SYLVANIA**. Descriptive bulletin and complete price list furnished on request.

Birnbach Insulators

We carry the complete line

DUMONT "B" Eliminator

uses 280 rectifier, 3 taps 180 v. maximum... **\$3.95**

We are pleased to announce that we are **New York Headquarters** for the new line of **McMurdo-Silver** products.

The new Piezo Astatic Crystal Microphones in stock. Type D-104 only **\$12.25**

Western Electric Phones

Type P-11 Signal Corp. phones. These would ordinarily sell at **\$7.50**. All new — all perfect. Here's a genuine bargain at... **\$3.95**

Navy Type Telegraph Key



List \$3.60. Navy knob— ½" Tungsten contacts. Only a few left at **\$1.25**

With regular knob... **\$1.10**



45 Vesey Street, New York City

New York Headquarters for Transmitting Apparatus

Aficionados de Español

Estan Vds. interesados en el radio americano? Nuestro anuncio en *QST*, de noviembre, pagina 68 les dice como obtenerle en el modo más pronto y menos costoso. Valdrá la pena de obtener una traducción de nuestro proyecto.

THE "TRIM-AIR" MIDGET

AN ALL-PURPOSE, ISOLANTITE INSULATED *QUALITY*
CONDENSER OF UNUSUALLY SMALL DIMENSIONS.

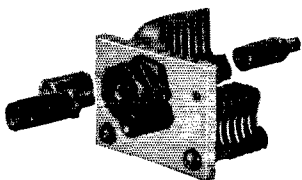

"Trim-Air" Midget receiving condenser showing possible combinations for various uses as described in text. Note tapped rotor shaft with screwdriver slot and rotor locking nut for permanent adjustment. If used for knob control, the extension shaft is screwed into the tapped hole in rotor shaft.

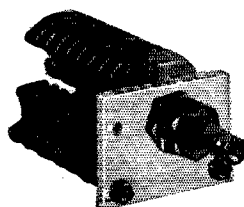

Transmitting type, fitted as "Trim-Air" condensers are regularly furnished.

SIX DISTINCTIVE FEATURES

1. May be Panel mounted by single nut, and knob-controlled by shaft extension.
2. May be Panel mounted by single nut (without shaft extension), screwdriver-adjusted, and locked.
3. May be Panel mounted by means of mounting posts, keeping screwdriver adjustment slot and locknut behind panel.
4. May be Shelf mounted by means of bracket (which can be supplied), either knob controlled or permanently adjusted and locked.
5. May be ganged and mounted for use in any of the ways suggested above.
6. May be mounted with a coil in a can or shield as small as 2" in diameter.

NOTE: When mounted in any other manner than by single hole method (as by means of mounting posts or brackets) both sides of the condenser will be completely insulated from the panel, chassis or shield.

For tuning high-frequency receivers and tuning and neutralizing low-powered high-frequency transmitters, the "Trim-Air" Midget will be found eminently satisfactory. In addition, it may be used as an air dielectric padding condenser, as an air dielectric trimmer for ganged units and for air dielectric condenser tuned I. F. transformers.

PRICES and ADDITIONAL DATA

RECEIVING TYPE (Airgap between adjacent rotor and stator plates .031", except RT-100 which has .020" airgap).

TYPE NO.	MAX. CAP.	MIN. CAP.	NO. of PLATES	DEPTH BEHIND PANEL	PANEL SPACE DIMENSIONS	LIST PRICE
RT-15	15	1.5	5	3/4"	1-7/16" x 1 1/4"	\$1.15
RT-25	25	2.0	7	7/8"	"	1.25
RT-35	35	2.5	9	1-1/16"	"	1.35
RT-50	50	2.8	13	1-3/16"	"	1.45
RT-75	75	4.0	21	2"	"	1.75
RT-100	100	3.7	19	1-1/2"	"	1.60
RT-140 Double end— 2 Bearings	140	7.0	39	2-3/4"	1 1/2" x 1 1/2"	\$2.85
TRANSMITTING TYPE (Airgap between adjacent rotor and stator plates .070").						
XT-30	30	2.0	17	2-1/4"	1-7/16" x 1 1/4"	\$1.70

Manufacturers: Quotations will be submitted on request for TRIM-AIR condensers having any desired combination of accessories. Send your requirements for our quotation and quantity discounts.

THE ALLEN D. CARDWELL M'FG. CORP'N.
83 PROSPECT STREET, BROOKLYN, N. Y.

The supplier who tries to discourage you, or attempts to substitute, or refuses to supply CARDWELLS, has not your interest at heart. He can get CARDWELLS for you if your service means as much to him as a little more profit. Get what you want—insist on CARDWELLS. Order direct from us if your dealer will not supply, or let us tell you where you may buy.

"THE STANDARD OF COMPARISON"

SPECTACULAR IN ABILITY



Outstanding Features

Tuned R. F. stage preceding first detector. (Image suppression — improved signal-to-noise ratio — improved "weak signal" response.)

Electron coupled oscillators.

No frequency drift—air padded oscillators.

Air dielectric tuning condensers in I. F. amplifier.

Single dial straight frequency line tuning (270°).

Calibration curves and station chart on panel.

Coil change from front of panel.

Automatic volume control or manual volume control, by throw of switch.

Extremely rigid mechanical construction from very heavy aluminum plate.

Relay rack or table mounting (panel size 8 $\frac{3}{4}$ " x 19").

Frequency range 1500 to 20,000 k. c. Band spread coils available.

Heterodyne oscillator for c. w. reception.

A. C. or battery operation.

Panel switch for phones or speaker.

Mechanical filter for single signal reception (in AGS-X).

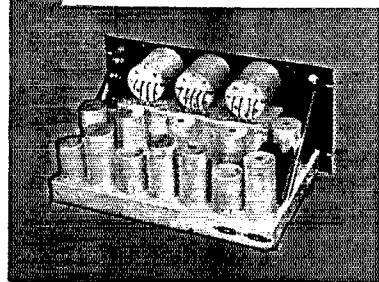

Proof of high performance is not lacking in the "AGS". Hundreds of these receivers were in full time commercial use months before the first was sold over the counter, and their impressive reputation among commercial operators was firmly established before the first amateur told his friend about the "AGS".

For the original specifications for the "AGS" were written by Government engineers, the first production receiver was tested in Washington, and Government stations have been a merciless proving ground where no flaw could escape criticism.

The "AGS" is no longer an experiment. The receiver which we offer today is the polished product of the combined experience of National and Government engineers, and no detail of design or craftsmanship has been overlooked which would improve its spectacular ability.

Whether a prospective customer or not, we cordially invite you to inspect the "AGS" at your dealers. And if you cannot conveniently do this we shall be glad to send a copy of our booklet "The National AGS Communication Type Short Wave Superheterodyne" containing fifteen pages of concise technical information on design and operation for high performance.

 NATIONAL COMPANY, INC., MALDEN, MASS.

NEW

**THE
RADIO AMATEURS**

HAND- BOOK

**ELEVENTH
EDITION**

PRICE **\$1.00**
POSTPAID

**AMERICAN
RADIO RELAY
LEAGUE
WEST HARTFORD
CONN.**



NATIONAL

H. F. DIELECTRICS

ON CHOOSING DIELECTRICS

No single dielectric universally suitable for all applications has yet been tested in National's Laboratories. Four materials have been found to have outstanding merit, however, and these four have been extensively used in National Products.

We have recently completed an agreement with the several manufacturers of these dielectrics, enabling us to design and offer the new line of insulators shown on the following pages. In this line, the selection of material has been based upon its fitness for the particular application, and upon its H.F. performance, and in no case has "special electrical porcelain" or other inferior material been used.

The properties of two of the materials chosen, Isolantite and R-39, are well known to users of National products. The two new and as yet comparatively unknown materials, Steatite and Victron, have only recently become available. Their rather remarkable properties are described on Page Six of this bulletin.

Like other National Products, the new dielectrics will be available exclusively through our authorized distributors.

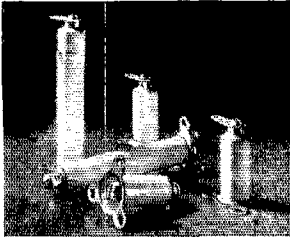

STAND-OFF INSULATOR. This well-known little insulator is now offered in two lengths. Long and slender, the larger model is shaped for extreme electrical efficiency. It is an excellent core for H.F. solenoid chokes. (Isolantite)

Type WGS-1 (L=1 $\frac{3}{8}$ "..List Price \$.25
 Type WGS-2 (L=2 $\frac{7}{8}$ "..List Price \$.35

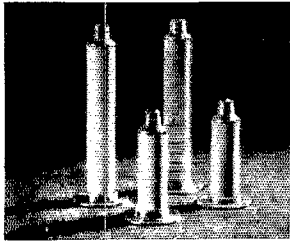
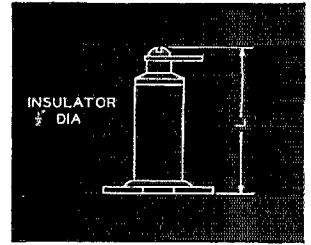

STAND-OFF INSULATOR. Metal mounted like the smaller units, these heavy Isolantite stand-offs combine electrical efficiency with strength and convenience. The insulator is $\frac{3}{4}$ " diameter and is available in two lengths.

Type WGS-3 (L=2 $\frac{7}{8}$ "..List Price \$.80
 Type WGS-4 (L=4 $\frac{7}{8}$ "..List Price \$ 1.00

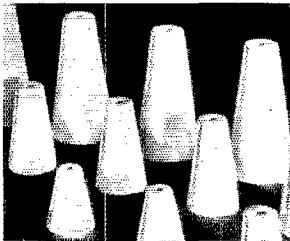
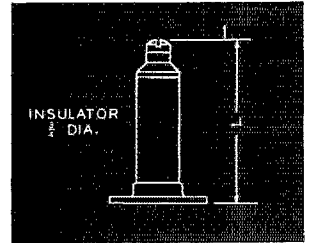

STAND-OFF INSULATOR. This popular style of insulator is offered in three sizes, all of low-loss Steatite. The smallest model is tapped 8-32 each end, the larger 10-24.

Type WGS-5 (A=1 $\frac{1}{2}$ " , B=1 $\frac{1}{4}$ " , C=1").....List Price \$.25
 Type WGS-6 (A=5 $\frac{5}{8}$ " , B=2" , C=1 $\frac{1}{8}$ ").....List Price \$.35
 Type WGS-7 (A=3 $\frac{3}{4}$ " , B=3" , C=1 $\frac{1}{2}$ ").....List Price \$.65

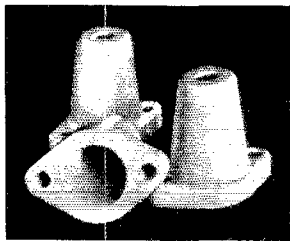
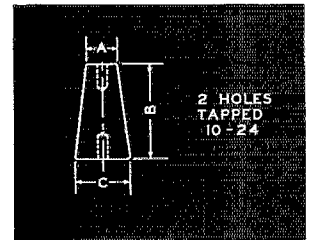

STAND-OFF INSULATOR. Another small insulator suitable for a variety of applications. Being made of Steatite, it is eminently suited for Low Loss H.F. circuits. It is available in a special model with a jack for mounting plug-in inductances.

WGS-8.....List Price \$.25
 WGS-9 (with jack).....List Price \$.35

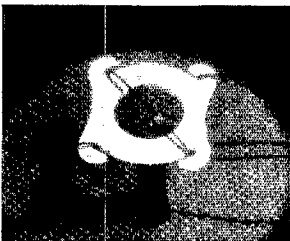
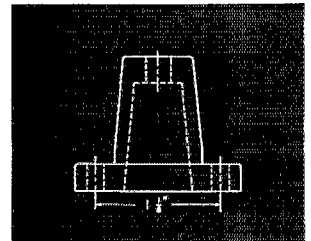

TRANSPPOSITION BLOCK. Wafer-thin, and made of Victron, these blocks have but a fraction of the weight of conventional types. They remove weight where it is most objectionable, as well as reducing losses to the minimum value.

Type AA-1.....List Price \$.30

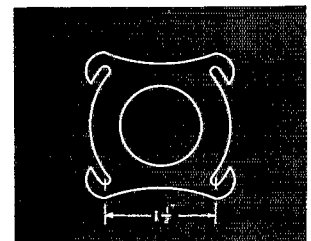

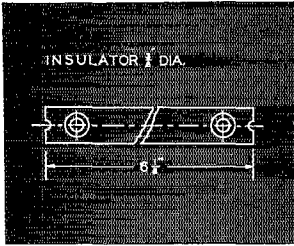

SPREADER. Conventional in design, unusual in efficiency, these Steatite spreaders will more than justify their slight extra cost. They are at present available only in the six inch length.

Type AA-3.....List Price \$.30

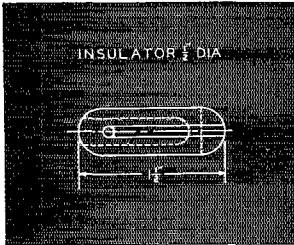
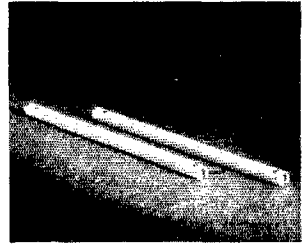

STRAIN INSULATOR. This aircraft-type insulator, in spite of its short leakage path, has a variety of uses in small portable, mobile and police installations. Being loaded in compression, the insulator provides great mechanical strength.

Type AA-5.....List Price \$.18

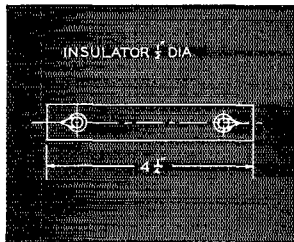
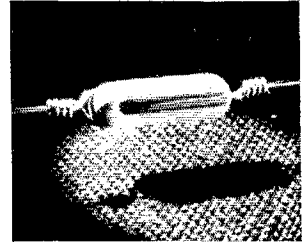

ANTENNA INSULATOR. This insulator is particularly suited for general use by the amateur. Its length provides ample leakage path, while its cross-section provides ample strength for all but the heaviest loads. The use of Steatite assures excellent electrical performance.

Type AA-6.....List Price \$.25

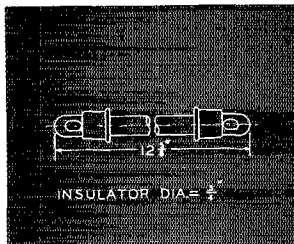
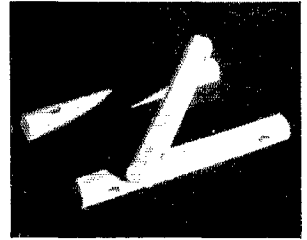

ANTENNA INSULATOR. Designed for sustaining heavy loads, this insulator combines great strength with low losses. The Steatite bar is $\frac{3}{4}$ " diameter and has a leakage path of $8\frac{1}{4}$ ". The fittings are of bronze. The weight of the complete insulator is approximately one pound.

Type AA-7.....List Price \$5.00

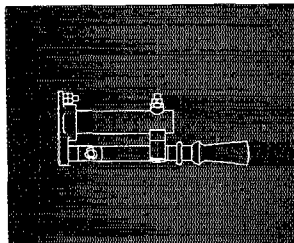
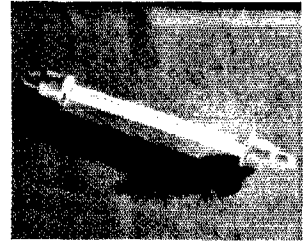

ANTENNA DRAIN SWITCH. Primarily designed for draining large antenna systems during lightning storms, and outstanding for its low loss features, contributed by Steatite insulation, this switch is suited to a variety of applications where positive contact and high insulation are necessary.

Type AA-9.....List Price \$4.50

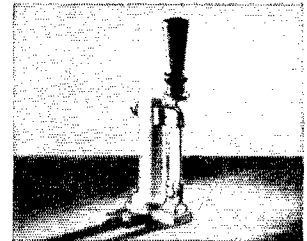

NATIONAL COMPANY, INC., MALDEN, MASS.



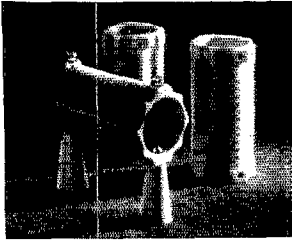

COIL FORM. Suitable for 20 and 40 meter amplifiers and 80 meter self-excited oscillators, this Steatite transmitting form is threaded for No. 10 wire or smaller and drilled for wires and supports. A similar form for 80 and 160 meter use is in preparation.

Type XR-10, form only . . . List Price \$3.75

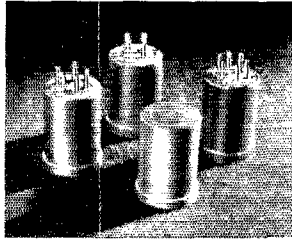
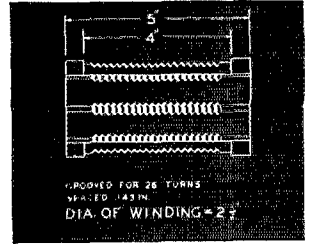

COIL FORM. These well-known R-39 coil forms are machinable, permitting the experimenter to groove and drill them to suit individual requirements. They are available in 4, 5 and 6-prong types, and plug into the sockets shown on the opposite page. A = 2 1/4", B = 1 1/2".

Type XR-4, XR-5 or XR-6. List Price \$.75

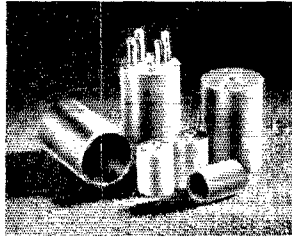
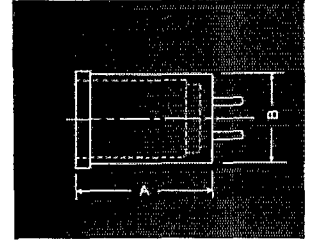

COIL FORM. National Midget coil forms are now offered in two sizes.

Type XR-1 (A = 1 1/2", B = 1", with 4 prongs) List Price \$.50

Type XR-2 (A = 1 1/2", B = 1", without prongs) List Price \$.35

Type XR-3 (A = 3/4", B = 9/16", without prongs) List Price \$.25

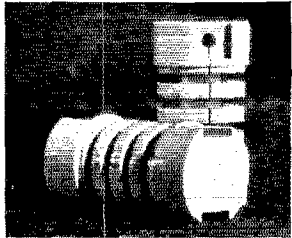
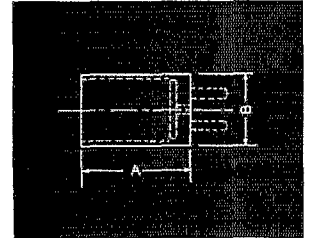

COIL FORM. This Steatite Choke Coil Form is ideally suited for small choke coils and precision resistors. The winding is divided in four sections by partitions. A slot is provided for leading the wire from section to section, and to the terminals.

Type XT-8 List Price \$.50

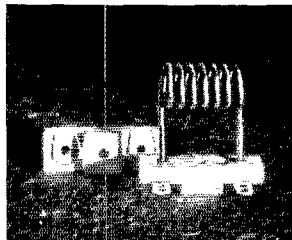
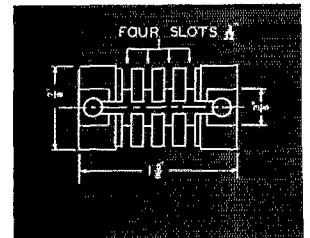

5 METER COIL. Consisting of a heavy copper air-spaced winding and mounted on a Steatite base, this coil is specifically designed for 5-meter transmitters, receivers or transceivers. They are usually used in pairs.

Type XR-9, complete, per coil
List Price \$.45

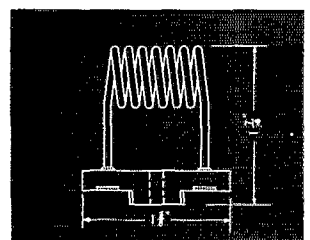

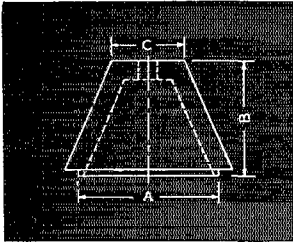

H.F. BUSHING. This small Steatite bushing has a variety of uses in transmitter construction, not only as a neat and efficient means of bringing H.F. leads through partitions, but as a support for coils, etc. Each pair of cones includes suitable metal fittings.

Type WXS-1 (A=1", B=1 1/16")
per pair.....List Price \$.60
Type WXS-2 (A=1 1/2", B=1 3/16")
per pair.....List Price \$.80

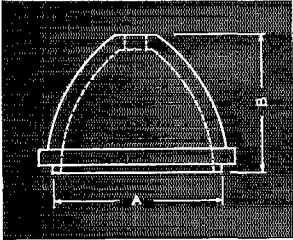
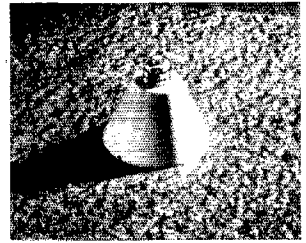

H.F. BUSHING. Larger in size than the bushings described above, and shaped to conform to the lines of electrical stress, these Steatite insulators are suitable for higher H.F. voltages. Prices are per pair, with metal fittings.

Type WSX-3 (A=2 3/4", B=2 5/16")
List Price \$3.30
Type WXS-4 (A=3 3/4", B=2 25/32")
List Price \$6.00

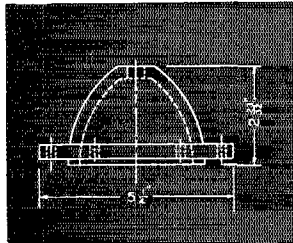
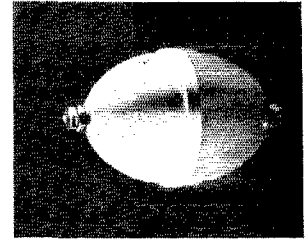

H.F. BUSHING. A heavy bowl-type lead-in, suitable for large transmitters, this Steatite insulator provides a weatherproof joint for antenna lead-in purposes. Leakage Path 3 1/4".

Type WXS-5 eachList Price \$7.50
Type WXS-5, with fittings, per pair
List Price \$15.50

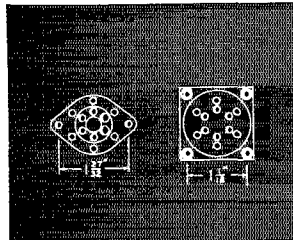
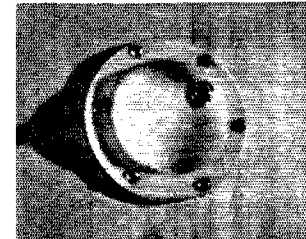

RECEIVING SOCKETS. The National Line of receiving sockets are now available in either Isolantite or Steatite. The six prong coil socket has been redesigned for four hole mounting.

Isolantite sockets, all models
List Price \$.60
Steatite sockets, all models
List Price \$.70

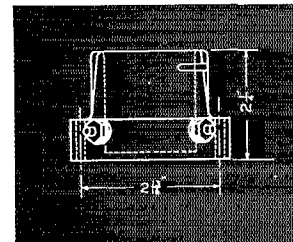
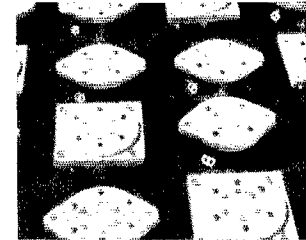

50 WATT SOCKET. An unusual socket, — it cannot break down by arcing from contacts to metal shell, for there is no shell, nor will it arc downward from tube prongs to chassis, for the socket has a solid base. One piece, all Steatite, with positive electrical contacts.

Type XC-50.....List Price \$3.50

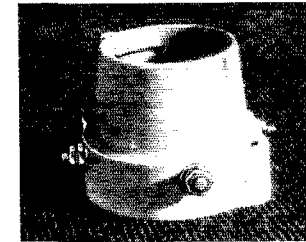

NATIONAL COMPANY, INC., MALDEN, MASS.



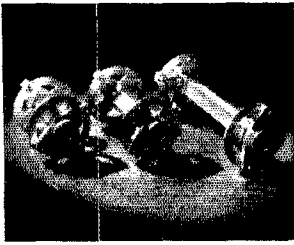

HIGH VOLTAGE SHAFT COUPLING.
Isolantite insulated, rugged, and free from backlash, this coupling is made in three lengths, bored for $\frac{3}{8}$ " or $\frac{1}{2}$ " shafts. Leakage path is $2\frac{3}{4}$ " less than over-all length.

- Type TX-3 (L = $3\frac{5}{8}$ ")... List Price \$7.00
- Type TX-5 (L = 5")... List Price \$7.75
- Type TX-7 (L = $7\frac{1}{2}$ ")... List Price \$8.50

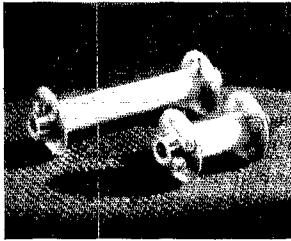
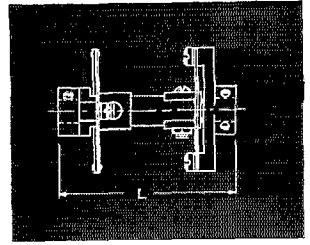

HIGH VOLTAGE SHAFT COUPLING.
Also Isolantite insulated, but smaller than the models described above, this coupling possesses their excellent design features. For $\frac{1}{4}$ " shafts only. Leakage path $\frac{3}{4}$ " less than over-all length.

- Type TX-1 (L = $1\frac{3}{4}$ ")... List Price \$1.00
- Type TX-2 (L = $3\frac{1}{4}$ ")... List Price \$1.10

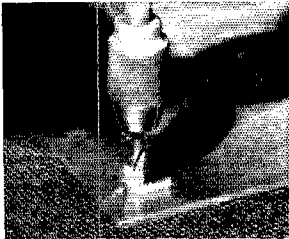
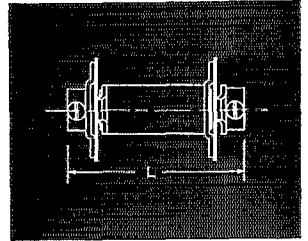

VICTRON SHEETS The ease with which Victron can be machined makes it an ideal material for experimental work. Its remarkable properties are described in detail below. Dimensions of standard sheets are shown in the blue-print, but $\frac{1}{8}$ " sheets are also available.

- Victron $\frac{3}{16}$ " thick, per sheet
List Price \$6.00
- Victron $\frac{1}{8}$ " thick, per sheet.
List Price \$5.00

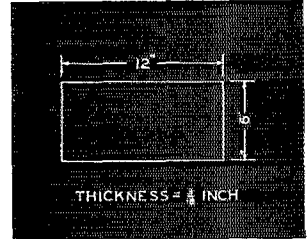

NATIONAL COIL DOPE

National Coil Dope is a special R.F. lacquer, specially prepared to give low power factor. It may be used as a cement for holding windings in position without spoiling the low-loss features of the coil support. It provides a

tough, protective film, seals surface pores, and gives a moisture-repellant surface. The Coil Dope is applied with a brush, and dries in air without baking. List Price, per can, \$1.50.

THE NEW DIELECTRICS

VICTRON, a development of the United States Rubber Company, possesses almost incredible electrical properties. Its Loss Factor (0.2) is one-eighth that of "Low Loss" Hard Rubber, and one-ninetieth of that of the usual R.F. Insulators. Its Power Factor is .06%-.08%, compared to .09%-.20% for Steatite. In color it is a transparent amber. It may be readily drilled or sawed. Being non-hydroscopic, it is suitable for outdoor use. Its Tensile Strength is about 6,500 lbs. per sq. in.

STEATITE is a white ceramic material specially developed for use in H.F. circuits. Generally speaking, it is

similar in properties and uses to Isolantite. However, materials of this class are often influenced considerably by manufacturing requirements, and pieces of different sizes and shapes often vary considerably in properties. For this reason, Steatite and Isolantite, which are manufactured by somewhat different processes, are not always equally suitable for all applications. For example, National Sockets made of Steatite have shown a considerably lower power factor than those of Isolantite, though this is by no means true of other items in our line. In every case we have chosen the material which seemed best adapted to the particular application.

NATIONAL
61 SHERMAN STREET



COMPANY
MALDEN, MASS.