

# QST

devoted entirely to

# amateur radio



november  
1933  
25 cents

# GOT YOUR COPY?

Yes, we mean *you*, Mr. Licensed Amateur—for you, as well as the beginner, need a copy of

## *The* RADIO AMATEUR'S LICENSE MANUAL

*(No. 9 in the A.R.R.L. series entitled  
The Radio Amateur's Library)*

Effective the first of this October, all our amateur regulations were revised. There are new power supply regs — new 'phone bands have been opened up — there is a new order for portable operation, dispensing with separate portable licenses, but specifying a certain operating procedure to identify your station when it is being operated as a portable — a complete revision of licensing procedure, not only for the beginner with his Class B or Class C license, but for those already licensed who want to get into Class A, and “unlimited 'phone” — there is a new procedure for license renewals.

Every already-licensed ham needs to be thoroughly familiar with the new regs — with the new order of things in ham regulation. And the subject is covered thoroughly in *The Radio Amateur's License Manual*. There is, of course, the full text of the new regs, dope on what to do and how to do it when you renew, or modify; the procedure necessary to be observed when and if you get a “discrepancy report” from the R. I. (it's covered in Rule 24, if you want to know). What to do to get that Class A ticket, with a *complete* set of representative questions and answers for its exam (as well as questions and answers for the Class B and C exams).

The License Manual should be within handy reach of every amateur's operating table. Originally conceived as a source of help for the beginner, it is, in its present form, equally indispensable to the old-timer. Order your copy today!

*25c (no stamps, please) postpaid*

*The* American Radio Relay League, Inc.

WEST HARTFORD

CONNECTICUT

*Now* **EQUIPPED** *with*

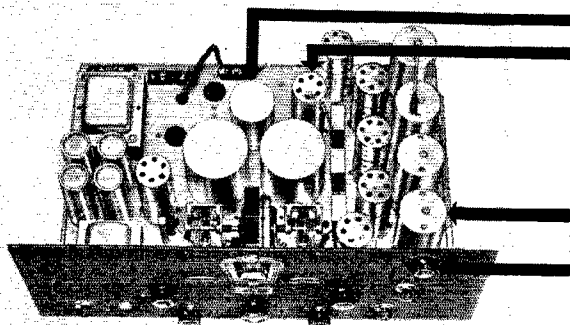

**AUTOMATIC  
VOLUME CONTROL**

*and*

**CRYSTAL  
FILTER**

# COMET "PRO"

*The Modern*

## RECEIVER

(8 to 550 Meters)



**H**AMMARLUND ever advances! More than 33 years of engineering progress is expressed in the four COMET "PRO" Receiver models.

First, the *Standard* "PRO" — the complete, sensitive and selective standard short-wave receiver.

Second, the inclusion of an improved panel-controlled Quartz Crystal Filter effects a remarkable reduction in high-frequency noise and increases selectivity amazingly — all without sacrifice of a single feature for which the *Standard* "PRO" has won international fame.

And now, Automatic Volume Control is available in either the *Standard* "PRO" or *Crystal* "PRO." This device may be used or not, at will, merely by operating a front-panel switch. It is a most useful improve-

ment for maintaining more stable volume on fading signals.

All "PRO" models are complete, with built-in power pack, band-spread tuning on all waves, and four sets of coils covering 15 to 250 meters. *Extra coils for the 8 to 16 or 250 to 550 meter bands may be had for \$5.00 a pair.*

You will be as proud to own a COMET "PRO" as we are to produce it — because it is the *modern receiver*, embodying all of the knowledge that radio engineering has mastered up to this time.

The Hammarlund Crystal Filter and Automatic Volume Control may be added, at moderate cost, to any

*Standard* "PRO" Receiver.

**Mail Coupon for Details**



**4 models**

**STANDARD  
STANDARD + A.V.C.  
CRYSTAL  
CRYSTAL + A.V.C.**

Operating on  
Battery, D.C.,  
or A.C. in all  
Voltages and Cycles



HAMMARLUND MANUFACTURING CO.  
424 W. 33rd St., New York

— Check here for detailed description of the COMET "PRO." — Check here for information about adding Crystal Filter or Automatic Volume Control to the Standard "PRO." — Check here for General Catalog of Radio Parts.

Name.....

Address.....

..... Q-11

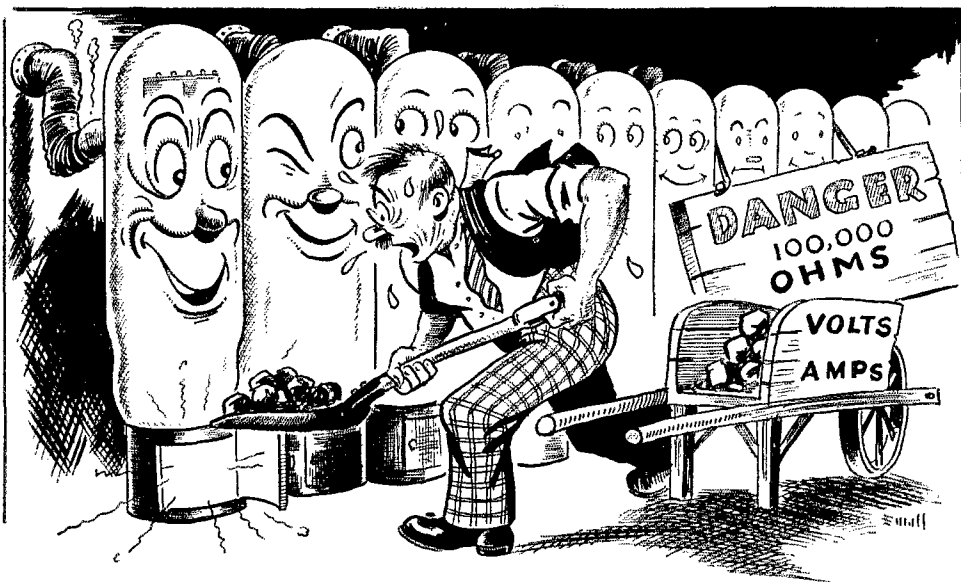

*Don't Let Your Bottles Be Stoves*  
**MAKE THEM ETHER BUSTERS**  
*with Westinghouse Instruments*

**D**O YOU want to know if your tubes are putting out more watts in heat than in power? Or why that 47 that works FB on 40 won't perk on 20? Or why the output went up when you changed the self-biasing grid leak on one stage, whereas the same change in the high freq stage made it go haywire? Or why the stage you "neuted" with the flash light lamp goes crazy when you put the juice on it?

All these questions can be answered easily by a couple of Westinghouse low-current-range types, MX or NX, d-c. instruments in the plate and grid circuits of an amplifier or doubler stage.

To help you in applying these instruments to your Xmitter, Westinghouse has printed a new folder that explains the meaning of the indications given by

instruments in the plate and grid circuits, and points out what to do to get the best possible results from your equipment.

The information in this folder will help the brasspounder keep his amplifier and doubler stages on the straight and narrow, and make the old junk pile deliver more miles per watt, with the minimum waste of power to heat the shack. Send the coupon or a post card for your copy.

If you haven't a copy of our Catalog 43-340 on MX and NX Instruments, ask for it, too. It gives description and listing of a complete line of moderately-priced radio instruments for panel mounting.

Watch future Westinghouse advertisements in QST for announcements of other instrument application folders.

# Westinghouse

Radio Instruments



## SEND FOR INFORMATION

Westinghouse Electric & Manufacturing Company  
 Dept. 109, Room 2-N—East Pittsburgh, Pa.

Please send me FREE the booklets checked below.

F. 8315. The Use of Westinghouse Instruments in Amplifier and Doubler Stages.

Catalog 43-340. Types MX and NX Instruments.

Name .....

Address .....

City ..... State ..... T 79718

Call letters ..... QST 11-33

# QST

Published monthly, as its official organ, by the American Radio Relay League, Inc., at West Hartford, Conn., U. S. A.; Official Organ of the International Amateur Radio Union

devoted entirely to

# AMATEUR RADIO

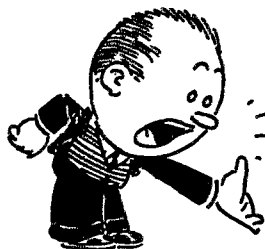

Editorials	9
A Simplified Five-Band Exciter Unit	George Grammer 10
A New Regenerative Detector Circuit for Ultra-Short Waves	Richard Hilferty, W1AFC 15
Silent Keys	17
Speech-Amplifier Economy with a 2A5	A. D. Muldoon, W1FRQ 18
The American Regional Conference	K. B. Warner 19
A Practical Crystal-Controlled Portable	20
Developments in Crystal Filters for S.S. Superhets	James J. Lamb 21
The Old Man's Son Speaks Again	25
Byrd Expedition Gets Under Way	26
Putting the Type 800 Transmitting Tube to Work	John L. Reinartz, W1QP 27
Attention, 56-Mc. Crew	30
Further Notes on Licensing Procedure	K. B. Warner 31
Automatic Gain Control for the Superhet	James J. Lamb 32
Radio vs. Bugs	Richard D. Wagner 34
C. C. C. and the Radio Amateur	Garland C. Black 36
The A.R.R.L. Official Phone Station Appointment	F. E. Handy 37
When the World's Radio Speed Title Changed Hands	I. S. Coggeshall 39
Experimenters' Section:	
METERING SEVERAL STAGES — 28-MC. BAND-SPREAD COILS — FINDING THE 28-MC. BAND — RELAY RACK FACTS — NOTES ON MACHINING ALUMINUM — A "di" SCALE FOR THE SLIDE RULE — BLOCKED-GRID KEYING TO ELIMINATE BACKWAVE	41
Standard Frequency Transmissions	44
Amateur Radio Stations	W1YU-WLE, W4MO 45
Strays	47
I. A. R. U. News	48
Calls Heard	50
Communications Department	51
Correspondence Department	66
The Kansas State Convention (Report)	74
The Oklahoma State Convention (Report)	76
The Wisconsin State Convention (Report)	78
The Dakota Division Convention (Report)	78
Forming a Club?	82
Club Directory Available	90
Hamads	91
QST's Index of Advertisers	94

NOVEMBER  
1933

VOLUME XVII  
NUMBER 11

Kenneth B. Warner (Secretary, A.R.R.L.), Editor-in-Chief and Business Manager; Ross A. Hull, Associate Editor; James J. Lamb, Technical Editor; George Grammer, Assistant Technical Editor; Clark C. Rodimon, Managing Editor; David H. Houghton, Circulation Manager; F. Cheyne Beekley, Advertising Manager; Ursula M. Chamberlain, Assistant Advertising Manager.

Editorial and Advertising Offices  
38 La Salle Road, West Hartford, Conn.

Subscription rate in United States and Possessions and Canada, \$2.50 per year, postpaid; all other countries, \$3.00 per year, postpaid. Single copies, 25 cents. Foreign remittances should be by international postal or express money order or bank draft negotiable in the U. S. and for an equivalent amount in U. S. funds.

Entered as second-class matter May 29, 1919, at the post office at Hartford, Connecticut, under the Act of March 3, 1879. Acceptance for mailing at special rate of postage provided for in section 1103, Act of October 3, 1917, authorized September 9, 1922. Additional entry at Concord, N. H., authorized February 21, 1929, under the Act of February 28, 1925.

Copyright 1933 by the American Radio Relay League, Inc.  
Title registered at United States Patent Office.

# Sylvania

REGISTERED U. S. PAT. OFF.

DEVELOPS  
A REAL

## ULTRA SHORT WAVE TUBE!

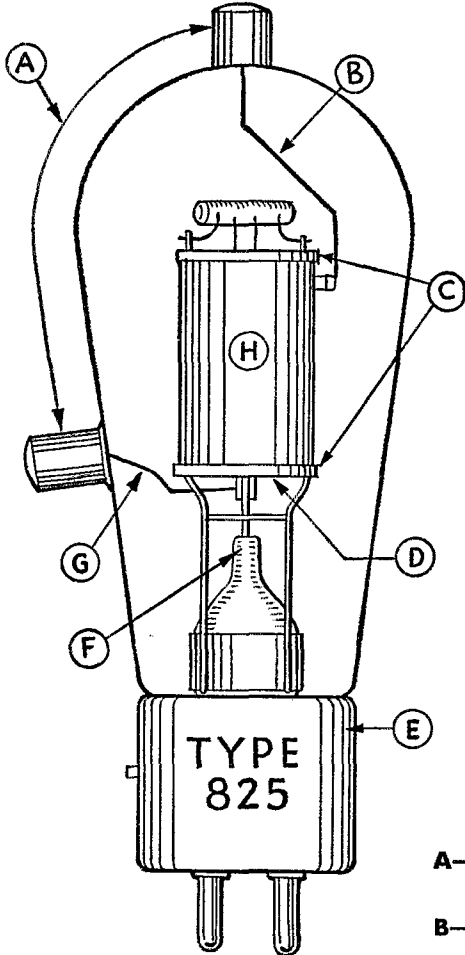

UNUSUALLY low inter-element capacity, and low inductive widely-spaced plate and grid connections . . . these two features make this new three element tube the most efficient short wave oscillator and amplifier yet produced!

This new type 825 tube is highly suited to all short wave work . . . and outstandingly superior for frequencies between 20-100 megacycles!

Seasoned research experience in the many phases of radio engineering and thorough study of high frequency phenomena by HYGRADE SYLVANIA engineers is manifested by this latest product.

### AVERAGE CHARACTERISTICS

Filament Voltage	7.5
Filament Current	3.25 Amp.
Average Characteristics at: Ep, 1000 E <sub>G</sub> , 70 E <sub>F</sub> , 7.5 DC	
Plate Current	.040 Amp.
Plate Resistance	10,000 Ohms
Voltage Amplification Factor	10
Mutual Conductance	1000 μMhos
Maximum Plate Voltage:	
Modulated DC	750
Unmodulated DC	1000
Maximum Plate Dissipation	.40 watts
Normal R. F. Output	.40 watts
Interelectrode Capacitances	
Grid to Plate	3 uu Fd.
Grid to Filament	2 uu Fd.
Plate to Filament	1 uu Fd.
Max. Overall Dimensions	
Height	6 3/4 inches
Diameter	2 7/16 inches
Bulb	S-19
Base, Medium 4-pin Ceramic	

- A**—Wide separation of input and output leads for lowest possible capacity.
- B**—Plate lead. Maximum insulation.
- C**—“Floating Anode” held only by low-loss ceramic spacers.
- D**—Thoriated tungsten carbide filament, specially designed

and processed for ultra-high frequencies.

- E**— Low-loss ceramic base
- F**— No mechanical strain on press
- G**— Grid lead. Maximum insulation.
- H**— Graphite anode

PRICE \$12.50



Write Amateur Section H

**HYGRADE SYLVANIA CORPORATION**

Hygrade Lamps

**ELECTRONICS DEPARTMENT**  
CLIFTON, NEW JERSEY

Sylvania Tubes

FACTORIES

SALEM, MASS.

EMPORIUM, PA.

ST. MARYS, PA.

CLIFTON, N. J.

## Section Communications Managers of THE COMMUNICATIONS DEPARTMENT, A. R. R. L.

Eastern Pennsylvania Maryland-Delaware-District of Columbia Southern New Jersey Western New York Western Pennsylvania	W3GS  W3BAK W3QL W8DSP W8CUG	<b>ATLANTIC DIVISION</b> Jack Wagenseller  Edgar L. Hudson Gedney Rigor Don Farrell C. H. Grossarth	24 South Fairview Ave.  412 2nd Ave. 213 Hickok Ave. R. F. D. 3, Eicher Rd.	Highland Park, Upper Darby Laurel, Delaware Haddon Heights Syracuse Emsworth, Bellevue, Pa.
Illinois Indiana Kentucky Michigan Ohio Wisconsin	9WR W9TE W9OX W8DVEH W8BAH W9FSS	<b>CENTRAL DIVISION</b> Fred J. Hinds Arthur L. Braun Carl L. Pfumm Kenneth F. Conroy Harry A. Tummonds Harold H. Kurth	6618 West 34th St. 1653 Kelly St. P. O. Box 359 7538 E. Robinwood Ave. 2073 West 85th St. 2550 N. 8th St.	Berwyn Indianapolis Louisville Detroit Cleveland Milwaukee
North Dakota South Dakota Northern Minnesota Southern Minnesota	W9DGS-IFW W9DKL W9HJE W9EPJ	<b>DAKOTA DIVISION</b> Wm. Langer C. B. Miller Robert C. Harshberger Norman Beck	313 First Ave., S. 448 N. 5th St. 1200 Fauquier St. 415 Grand St.	Jamestown Redfield St. Paul Winona
Arkansas Louisiana Mississippi Tennessee	W5ABI W5WF W5AZV W4AFM	<b>DELTA DIVISION</b> H. E. Veltz W. J. Wilkinson, Jr. William G. Bodker F. F. Purdy	2918 West 15th St. 1624 Allen Ave. 1013 Bratton St. P. O. Box 173	Little Rock Shreveport Jackson Kingsport
Eastern New York N. Y. C. & Long Island Northern New Jersey	W2LU W2AZV W2CO	<b>HUDSON DIVISION</b> Robert E. Haight E. L. Baunach Walter A. Cobb	1080 Helderberg Ave. 7823 10th Ave. 28 Ampere Parkway	Schenectady Brooklyn East Orange
Iowa Kansas Missouri Nebraska	W9FFD W9FLG W9EYG-HCP W9FAM	<b>MIDWEST DIVISION</b> George D. Hansen O. J. Spetter C. R. Cannady Samuel C. Wallace	3734 Summit St. 305 Western Ave. 300 Sixth St. Green St.	Sioux City Topeka Monett Clarks
Connecticut Maine Eastern Massachusetts Western Massachusetts New Hampshire Rhode Island Vermont	W1CTI W1CDX W1ASI W1ASV-W1RB W1APK W1AFO W1BD	<b>NEW ENGLAND DIVISION</b> Frederick Ells, Jr. John W. Singleton Joseph A. Mullen Earl G. Hewison Basil Cutting Stanley Atkinson Roy Gale	19 Merrill Rd. 10 High Street 16 Mercer St. 33 Corland St.  186 Magnolia St. 41 Beacon St.	Norwalk Wilton Ashmont Springfield Fembroke Auburn Barre
Alaska Idaho* Montana Oregon Washington	K7PO W7AVP-DKD W7AAT-7QT W7ABZ W7AYO	<b>NORTHWESTERN DIVISION</b> Richard J. Fox Don D. Oberbillig O. W. Viers Raymond W. Cummins Stanley J. Belliveau	Box 301 P. O. Box 1271  4835 N. Amherst St. Route 7, Box 387	Ketchikan Boise Red Lodge Portland Yakima
Hawaii Nevada Los Angeles Santa Clara Valley East Bay* San Francisco Sacramento Valley Arizona Philippines* San Diego San Joaquin Valley*	K6COG W6EAD W6AAN W6AMM W6RJ W6CAL W6DVE W6BJF-W6QC K4LXA W6EOP W6AOZ	<b>PACIFIC DIVISION</b> C. D. Slaten Keston L. Ramsay Francis C. Martin Bruce Stone J. H. MacLafferty Byron Goodman Geo. L. Woodington Ernest Mendoza Newton B. Thompson Harry A. Ambler Alfred H. Green	Pearl City 1151 Buena Vista Ave. 738 W. Huntington Drive R. 1, Box 311 2901 Rawson St. 141 Alton Ave. 716 Redwood Ave. 1434 East Madison St. 714 Tennessee 4101 Hamilton St. 723 North Orange St.	Oahu Reno Arcadia San Jose Oakland San Francisco North Sacramento Phoenix Manila, P. I. San Diego Stockton
North Carolina Virginia West Virginia	W4AVT W3AAJ W8HD	<b>ROANOKE DIVISION</b> G. H. Wright, Jr. R. N. Eubank C. S. Hoffmann, Jr.	2817 Montrose Ave. 100 20th St.	Wendell Richmond Warwood, Wheeling
Colorado Utah-Wyoming*	W9BTO W6GQC-IDM	<b>ROCKY MOUNTAIN DIVISION</b> F. K. Becker Arty W. Clark	1176 Gaylord St. 200 So. 9th West	Denver Salt Lake City, Utah
Alabama Eastern Florida Western Florida Georgia-So. Carolina-Cuba- Isle-of-Pines-Porto Rico- Virgin Islands	W4KP W4NN W4MS  W4PM	<b>SOUTHEASTERN DIVISION</b> L. D. Elwell Ray Atkinson Edward J. Collins  Clas. W. Davis	1066 Waverly St. 4524 College St. 1517 East Brainard St.  91 North Ave., N. W.	Tarrant Jacksonville Pensacola  Atlanta
Northern Texas Oklahoma Southern Texas New Mexico*	W5AUL W5VQ W5BHO W5CGJ	<b>WEST GULF DIVISION</b> Glen E. Talbutt Emil Gisel David H. Calk J. M. Eldodt	1902 South 11th St. 1st Balloon Co. 6726 Ave. Q	Abilene Fort Sill Houston Chamita
Maritime	VE1DQ	<b>MARITIME DIVISION</b> A. M. Crowell	69 Dublin St.	Halifax, N. S.
Ontario*	VE3AD	<b>ONTARIO DIVISION</b> W. Stephens	258 Egerton St.	London
Quebec	VE2AP	<b>QUEBEC DIVISION</b> J. C. Stadler	4334 Westmount Ave.	Westmount, P. Q.
Alberta British Columbia	VE4HM VESAL	<b>VANALTA DIVISION</b> C. H. Harris J. K. Cavalsky	10806 125th St. 4868 Blenheim St.	Edmonton Vancouver
Manitoba Saskatchewan	VE4GC VE4EL	<b>PRAIRIE DIVISION</b> Reg. Strong Wilfred Skalfe	284 Marion St. 2040 McTavish St.	Winnipeg Regina

\* Officials appointed to act until the membership of the Section choose permanent SCM's by nomination and election.

# a GROSS modern crystal controlled ham station

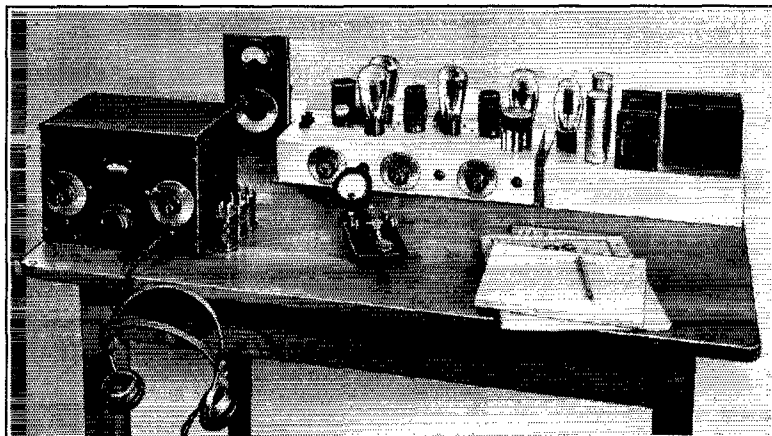

Real "DX" is yours at Low Cost!! here is the proof—  
**COMPLETE GROSS STATION**

Gross Radio Inc.,  
 51 Vesey St.,  
 New York City.

19 Public Square  
 Plymouth, Ohio.  
 Oct. 3, 1933

Dear Sirs:

Please send me one complete "20-W Jr." kit with a set of 80 Meter coils and a 0-250 MA Hoyt milliammeter.

Would like to know your price on 20 and 40 M coils for "20-W Jr."

Another amateur here has worked all United States districts, Ontario and British Columbia with his "20-W Jr." on 80 Meters, in less than a month.

PLEASE RUSH!

Very truly yours,

Thomas DeWitt  
 Radio Sta. W8ANZ

**\$39.95** "20-W Jr." transmitter kit . . . \$10.95  
 "Eagle" S.W. receiver . . . . . 11.95  
 Power supply kit . . . . . 8.45  
 X cut 80 or 160 M xtals. . . . . 2.75

Hoyt milliammeter . . . . . 1.25  
 Hoyt hot wire antenna meter . . . . . 2.85  
 Antenna tuning condenser . . . . . 1.15  
 Transmitting key . . . . . .60

Units may be purchased separately. Accessories above prices only if purchased with the "20-W Jr."

## The Gross "20-W Jr." Crystal Control Transmitter Kit, \$10.95

The "20-W Jr." transmitter kit due to its low cost makes it possible for anyone to own a crystal controlled station for greater efficiency, stability and compliance with the new rulings which require all of the above. The cost is much less than you would expect to pay for a self excited transmitter of this type. A schematic hookup and parts layout sheet as well as tuning instructions are furnished, thus enabling the most inexperienced operator to wire and put the set on the air, for real results. The "20-W Jr." is supplied with a neat metal chassis under which all the parts are mounted, making the wiring and components dustproof. The overall size of the chassis is 7" x 18" x 3". A plug-in crystal holder is furnished with the kit at no additional cost. Only one milliammeter is required for tuning the transmitter and each stage is provided with a jack for this purpose. The "20-W Jr." uses one '47 as crystal oscillator, one '46 as buffer or doubler and two '46's in the amplifier. One set of three wound coils is supplied with the kit for the 20, 40, 80 or 160 meter band. When the 160 meter coils are ordered add 50 cents extra to the price of the kit. Any additional coils can be supplied as listed below at only 75 cents for each coil.

### COILS REQUIRED FOR WORKING ON EACH BAND

	xtal. oscil. coil	doubler or buffer	doubler or amp.
	'47 tube	'46 tube	two '46 tubes
160 meters . . . . .	160	160	160
80 meters . . . . .	80	80	80
40 meters . . . . .	80	40	40
20 meters . . . . .	80	40	20

## Gross "20-W Jr." Power Supply Kit, \$8.45

Mounted on metal chassis which matches the "20-W Jr." transmitter. Heavy duty power transformer, chokes, condensers, etc., supplied. Uses one '83 as rectifier. This unit and the transmitter make a neat combination as well as an efficient one.

## The "EAGLE" Three-Tube Short Wave Receiver

"Band Spread" over any portion of the tuning range — only finest material used thruout. Employs one '32 R.F., one '32 detector and one '33 Pentode Audio — 15 to 200 meters — four coils supplied. The "EAGLE" is economical — two dry cells will operate the filaments. See March or April QST for full description of this most excellent value in short wave receivers.

"Eagle" completely wired and tested . . . . . **\$11.95**      Three tubes tested in your receiver . . . . . **\$3.00**



### Hoyt Antenna Meter

Hot wire antenna meters. 2 1/4" mounting hole, flange 3" diameter, supplied in 1 1/2, 3 and 5 ampere ranges. Why work without antenna meters when you can buy them at this special price? . . . . . **\$2.85**

### Hoyt Milliammeters and Voltmeters

Perfectly damped meters at a price. These are not to be confused with the usual inexpensive meters. 2" mounting hole, flange 2 3/8" diameter, supplied in the following sizes: 10 ma, 25 ma, 50 ma, 100 ma, 150 ma, 250 ma, 300 ma, 4 V. AC, 10 V. AC, 15 V. AC, 10 V. DC.  
 Price each . . . . . **\$1.50**, 3 for **\$4.00**

**GROSS RADIO, INC. · 51 VESEY STREET · NEW YORK CITY**



# WE stocked up when prices were lower— YOU can still take advantage of these values

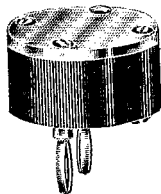

## GROSS CRYSTAL HOLDER ONLY \$1.00

A commercial type crystal holder for half the price you have to pay for ordinary holders. New type pressure spring, square inside to prevent movement of crystal, one piece molded body — dustproof — will take crystals up to 1 1/4" square or round. Plugs standard 3/8" spacing. This holder must be seen to be appreciated for the extraordinary value offered.

## USE BLILEY CRYSTALS

Same price 40-80-160 Meters

For greatest precision, power and stability, use Bliley BC3 mounted crystals. Within 25 Kcs. .... \$4.95  
BC3 mounted crystals with a frequency within 5 Kcs of specified value. .... 5.75  
Calibrated to EXACT specified frequency in Kcs. .... 6.85  
BCX — inch square crystals, unmounted 40-80-160. .... 3.90  
BC2 molded bakelite holder for BCX crystals. .... 1.50

## DEFOREST 410's 69c

Another lucky buy enables us to sell these tubes at this extraordinarily low price. Every tube oscillator tested at 650 volts.

<p><b>GROSS GC-30 CW 30 WATTS OUTPUT \$34.50</b></p> <p>'47 xtal oscillator — '10 buffer — '10 amplifier.</p>	<p><b>GROSS GC-100 CW 100 WATTS OUTPUT \$45.00</b></p> <p>'47 xtal oscillator — '10 buffer — '03-A or '11 amplifier.</p>	<p><b>70-WATT CLASS B MODULATOR UNIT KIT \$50.00</b></p> <p>Uses 1-57, 1-56, 2-45's P.P. &amp; 4-46's in P.P. Parallel Class B. All parts including power supply and metal chassis furnished — less tubes. Will fully modulate a 50 watt tube with an input of 140 watts. Parts sold separately.</p>
<p><b>GROSS SPECIAL TRANSFORMER \$3.95</b></p> <p>600 volts each side of C.T. 150 MA 2 1/2 V. 10 amps, 5 V. 3 amps, 7 1/2 V. 3 amps.</p>	<p><b>GROSS SPECIAL TRANSFORMER \$3.65</b></p> <p>10,000 volt insulation. 2 1/2 V. C.T. 10 amps for 866's. 10 V. C.T. 7 amps for '50's or '52's. Use one transformer instead of two.</p>	<p><b>GROSS CLASS "B" TRANSFORMERS \$4.95</b></p> <p>A pair of cased high grade transformers for '46's.</p>

## SANGAMO — .002 COND. — 5000V. (attention dealers) ONLY 90c

**Gross Special Power Transformer** for use with '83 tube will give an output of 500 volts D.C. at 350 MA with choke input. Run your entire R.F. and Class B off this transformer. The regulation for the Class B is about 5%, filaments are two 7 1/4 v. and one 5v. *Special*. . . \$5.75  
A transformer having the same filament windings as above — at 300 MA having 750 volts each side of C.T.  
*Special*. . . \$6.00  
750-1000 V. each side of C.T. 300 watts. Extra special. . . \$6.80  
1000-1500 V. each side C.T. 300 MA 8.50  
1500-2000 V. each side of C.T. 800 Watts. \$11.95  
Case 6.3 V. 2 amp. transf. . . 1.25  
2 1/2 V. 6 amp. C.T. (midget) . . . .80  
5 V. 3 amp. C.T. for '83 (midget) . . .80  
2 1/2 — 2 1/2 and 5 Volt C.T. . . 1.45  
2 1/2 — 7 1/2 and 7 1/2 Volt C.T. . . 1.45  
2 1/2 — 5 and 7 1/2 Volt C.T. . . 1.45  
5 — 5 and 5 Volt C.T. . . 1.45  
5 — 7 1/2 and 7 1/2 Volt C.T. . . 1.45  
Thord. 30 H 75 MA. . . 1.69  
Thord. 15 H 250 MA. . . 2.95  
Thord. No. T-2458 double 18 H 250 MA. . . 6.50  
Gross cased 30 H 200 MA choke. . . 2.25

**High Grade filament transformers shielded in metal cases, center tapped secondaries.**  
2.5 Volt 10 amperes for 866's. . . \$2.50  
10 to 12 Volts at 8 amperes. . . 2.50  
Special 10-12 Volt 7.5 ampere filament transformer, extra special. . . 1.10  
Oil Impregnated cased condensers  
1400 Volt D.C. 2-2 mfd. . . 1.85

**Ward Leonard Vitreous Resistors 200-Watt 8 3/4" Long with Variable Sliders.**  
1000 ohms. . . \$ .95  
2500 ohms. . . 1.05  
5000 ohms. . . 1.05  
10000 ohms. . . 1.11  
15000 ohms. . . 1.20  
25000 ohms. . . 1.29  
35000 ohms. . . 1.35  
50000 ohms. . . 1.35  
60000 ohms. . . 1.49  
80000 ohms. . . 1.59  
100000 ohms. . . 1.65

Raytheon RK-18 tubes in stock. Get our price.

**MORRILL 2 mfd. 3000 V. D.C. working; extra special. . . \$7.25**

**MIDGET DOUBLE SPACED NEUTRALIZING CONDENSERS**  
35 mmf — a real buy at . . . .69c

**CARDWELL CONDENSERS**  
123-B .0005 mmf. . . \$2.35  
164-B .00022 mmf. . . 2.35  
147-B .00044 mmf. . . 4.10  
T-199 .00033 mmf. . . 5.88  
T-183 .00011 mmf. . . 5.30

**BAKELITE TUBING (any length)**  
1" diameter — per inch . . . 4c  
1 1/2" diameter — per inch . . . 5c  
2" diameter — per inch . . . 6c  
2 1/2" diameter — per inch . . . 7c  
3" diameter — per inch . . . 7c

Porcelain base 50 watt sockets — side wiping contacts. . . \$1.19  
110 volt Jewell pilot lights red, green, amber. . . .24  
Multiple phone plugs take one to four pairs of phones. . . .29  
204-A type sockets. . . per pair 1.85  
Silk covered 2" inductance. . . per inch .25  
Variable .00035 condensers — high grade job. . . 1.15  
Mica .005 condensers. . . .20  
Mica .01 condensers. . . .35  
5 watt 1,000 ohm wire wound resistors. . . .20  
25 watt 10,000 ohm wire wound resistors. . . .25  
Pilot 1-23 100 mmf condensers. . . 60  
Acme featherweight 2000 ohm phones .95  
Thord. 30 Henry 500 MA chokes. . . 9.95  
GROSS cased double button mike transformer. . . 2.35

**SILVER DIPPED ALUMINUM**  
*cut to size specified*  
1/16" thick — per square inch. . . 7/10c  
3/32" thick — per square inch. . . 3/4c  
1/8" thick — per square inch. . . 1c

Polymet cased cond. 8 mfd. 1000 V. DC. . . \$1.65  
Bakelite 7/8" spreaders with set screws .16

**SOLID ENAMELED ANTENNA WIRE**  
No. 14 (any length) per 100 ft. . . \$ .35  
No. 12 (any length) per 100 ft. . . .55  
No. 10 (any length) per 100 ft. . . .90  
No. 8 (any length) per 100 ft. . . 1.30

**GUARANTEED TUBES**  
Heavy Duty Isolantite top 866. . . \$2.15  
888 or 871. . . 1.15  
83 and 47's. . . .70  
DeForest 481. . . .1.30  
210's. . . .1.30  
46's. . . .60  
DeForest 450's. . . .1.35

**BLACK SHRIVEL SHIELD BOXES**

Length	Height	Width	Price
6"	5"	5"	\$ .65
9"	6"	5"	1.15
10"	7"	9"	1.35
10"	8"	8"	1.45
14"	8"	10"	1.75
18 1/2"	9"	8"	2.85

(for 20-W Jr.)

Tiny-mite 1/4" and 1" stand-off Ins. . . \$ .05  
Egg Strain Insulators. . . .20 for .25  
Beehive stand-off ins. Per doz. . . .50  
3" Isolantite spreaders. . . .10 for .35  
Jewell Pilot lights, red, green. . . .20  
5-meter oscillator coils. . . .65  
5 slot wood choke forms. . . .06  
Bakelite dials 5" diam., 1/4" shaft. . . .15  
1/4, 3/8 and 1 watt neon bulbs. . . .40

Hoyt 0-1 M.A. moving coil meters  
2" type \$3.50

20% deposit with all C.O.D orders. Remit by M.O. Include postage. Prices subject to change without notice.

# GROSS RADIO INC. 51 VESEY ST., N. Y. C. TEL. BARCLAY 7-0161

# The American Radio Relay League



• THE AMERICAN RADIO

RELAY LEAGUE, INC., is a non-commercial association of radio amateurs, bonded for the promotion of interest in amateur radio communication and experimentation, for the relaying of messages by radio, for the advancement of the radio art and of the public welfare, for the representation of the radio amateur in legislative matters, and for the maintenance of fraternalism and a high standard of conduct.

It is an incorporated association without capital stock, chartered under the laws of Connecticut. Its affairs are governed by a Board of Directors, elected every two years by the general membership. The officers are elected or appointed by the Directors. The League is non-commercial and no one commercially engaged in the manufacture, sale or rental of radio apparatus is eligible to membership on its board.

"Of, by and for the amateur," it numbers within its ranks practically every worth-while amateur in the world and has a history of glorious achievement as the standard-bearer in amateur affairs.

Inquiries regarding membership are solicited. A bona fide interest in amateur radio is the only essential qualification; ownership of a transmitting station and knowledge of the code are not prerequisite. Correspondence should be addressed to the Secretary.

## DIRECTORS

<i>President</i>	
HIRAM PERCY MAXIM.....	W1AW Box 216, Hartford, Conn.
<i>Vice-President</i>	
CHARLES H. STEWART.....	W3ZS St. David's, Pa.
<i>Canadian General Manager</i>	
ALEX. REID.....	VE2BE 169 Logan Ave., St. Lambert, P. Q.
<i>Atlantic Division</i>	
EUGENE C. WOODRUFF.....	W8CMP 234 W. Fairmount Ave., State College, Pa.
<i>Central Division</i>	
LOREN G. WINDOM.....	W8GZ-W8ZG 1375 Franklin Ave., Columbus, Ohio
<i>Dakota Division</i>	
LAWRENCE E. LINDESMITH.....	W9GKO 1055-85th Ave. W., Duluth, Minn.
<i>Delta Division</i>	
M. M. HILL.....	W5EB P.O. Box 274, Natchitoches, La.
<i>Hudson Division</i>	
BERNARD J. FULD.....	W2BEG 280 Broadway, New York City
<i>Midwest Division</i>	
H. W. KERR.....	W9DZW-W9GPF Little Sioux, Iowa
<i>New England Division</i>	
G. W. BAILEY.....	W1KH 74 Webster Road, Weston, Mass.
<i>Northwestern Division</i>	
RALPH J. GIBBONS.....	W7KV-W7BIX 3134 N.E. 25th Ave., Portland, Ore.
<i>Pacific Division</i>	
S. G. CULVER.....	W6AN 2962 Russell St., Berkeley, Calif.
<i>Roanoke Division</i>	
H. L. CAVENESS.....	W4DW State College Station, Raleigh, N. C.
<i>Rocky Mountain Division</i>	
RUSSELL J. ANDREWS.....	W9AAB 169 So. Ogden St., Denver, Colo.
<i>Southeastern Division</i>	
J. C. HAGLER, JR.....	W4SS 2434 McDowell St., Augusta, Ga.
<i>West Gulf Division</i>	
FRANK M. CORLETT.....	W5ZC 2515 Catherine St., Dallas, Tex.

## OFFICERS

<i>President</i> .....	HIRAM PERCY MAXIM, W1AW Hartford, Connecticut
<i>Vice-President</i> .....	CHARLES H. STEWART, W3ZS St. David's, Pennsylvania
<i>Secretary</i> .....	KENNETH B. WARNER, W1EH West Hartford, Connecticut
<i>Treasurer</i> .....	ARTHUR A. HEBERT, W1ES West Hartford, Connecticut
<i>Communications Mgr.</i> ...	F. EDWARD HANDY, W1BDI West Hartford, Connecticut
<i>General Counsel</i> .....	PAUL M. SEGAL, W3EEA 1010 Shoreham Building, Washington, D. C.

Address all general correspondence to the executive headquarters at West Hartford, Connecticut



# THE EDITOR'S MILL

SOMETHING ought to be done about the interference caused by automobile ignition systems. As every worker on the ultra-high-frequencies knows from bitter experience, this is the greatest single handicap to u.h.f. communication to-day. Extremely severe on 56 mc. and still considerable at 14 mc., it is at its worst at 28 mc., in which frequency region the output of most ignition systems seems to peak. We know of one modern 28-mc. amateur installation with a directive receiving antenna, a matched-impedance transmission line, and a *QST* Single-Signal superhet utilizing the highest selectivity practicable for c.w. reception. The noise-signal ratio of this installation is reducible to a tenth of that at average stations, yet the auto QRM remains intolerable. This is just one example. Something must be done and it must be done at the source.

Amateurs aren't the only ones to suffer. In the fields of television and police radio, towards which h.f. activity is being increasingly accelerated, ignition interference is and will grow further to be the limiting factor to successful communication. What matters it that static of the atmospheric variety is absent at these frequencies if it is replaced by a more vicious variety? If a radio cop has to get a mile off the highway before he can collect the lurid details they won't do him much good. Who will want television pictures surcharged with snakes and zigzags symbolic of ignition wires and spark discharges? It may add a dash of impressionism to a drinking scene but most folks just won't appreciate it.

Radio development has reached the place where it is squarely afoul of this defect in motor-car manufacture. It is a real infringement upon "public interest, convenience and necessity." The solution, technically, is simple: equip all cars, at the factory, with suppression resistors and with adequate ignition systems so that the addition of suppressors does not impair motor performance. Cars equipped with automobile radio are regularly thus fitted. All cars should be; the small added expense would be completely justifiable.

*QST* solicits the cooperation of automobile manufacturers. It is inevitable that some day it will be unthinkable to permit roaming cars to deal wholesale destruction to u.h.f. radio communication. The live car builder, sensitive to public opinion, can increase his sales and prestige by

recognizing this problem and correcting it at once in his cars. We who use radio can advance that day by working towards the same goal whenever opportunity is offered.

THE *QST* technical staff has always made it its business to perceive amateur problems and develop new apparatus to overcome them. We're proud of the many contributions we have been able to make. For instance, there's Jim Lamb's single-signal superheterodyne, the finest receiver for its purpose that the world has ever seen, to-day's last word in ham reception. We believe that we have now hit a certain other nail squarely on the head with the "tri-tet" exciter unit for transmitters, described in our last issue. Every amateur has been annoyed to the corona point by the fact that 95% of the pieces of gear, money investment, shielding, work, soldered connections and chances for grief were in that vast array that supplied excitation to the real transmitter, the final stage. What we have needed is a sort of magic box, simple and compact, from which any desired frequency might be extracted to run an amplifier. The new device is a very pleasing approximation of that, one that is well worth every amateur's consideration. We shall have more to offer on it soon.

Speaking of apparatus, Fieldman Hebert tells us that he found, on his recent swing around the country, that only about one station in six has a monitor. That's a distressing situation, for monitoring is tremendously important. Admittedly the modern superhet lends itself so nicely to this need that a separate monitor is there unnecessary, but unfortunately most of us haven't yet achieved superhet status. So we need monitors. And they're so easy to make. By the way, one of these large-size round cracker tins that are now to be found in every grocery store makes a swell can for an inexpensive monitor. The lid is large enough to hold all the apparatus except the batteries, which can rest on the bottom. Or drop a spare receiver in a tin bread-box and there is a monitor. Or set it up on the other side of the room and do without the shielding. Anybody can arrange something adequate for monitoring in two hours after he is persuaded that it is a most necessary and desirable thing to do.

K. B. W.

# A Simplified Five-Band Exciter Unit

By George Grammer, Asst. Technical Editor

THE "universal exciter unit" idea is much too good to be allowed to rest with its first presentation in October *QST*.<sup>1</sup> The deluxe model described therein is just about the last word for the fellow who likes his transmitters dressy and arranged for the very maximum of operating convenience. But there are plenty of others who will want to know how the same result can be

The tri-tet oscillator, it will be remembered,<sup>2</sup> operates as a combination oscillator and harmonic amplifier. For further basic information, the two articles to which reference is made in the footnotes should be consulted.

In this breadboard model of the exciter unit, shifts between bands and from electron-coupled to crystal control are made by the use of plug-in

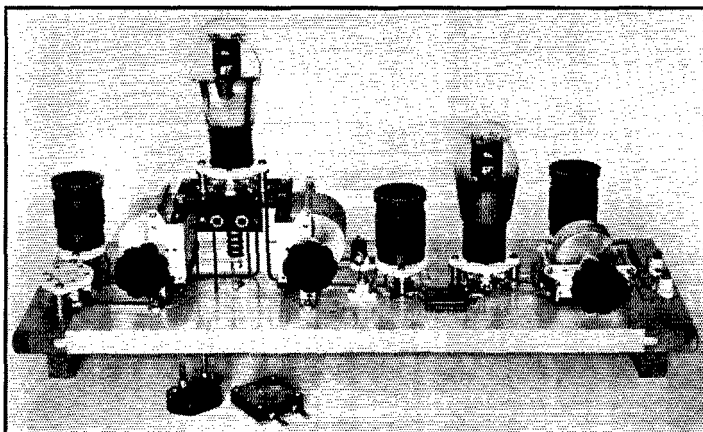

A BREADBOARD UNIVERSAL EXCITER UNIT

Two Type 59 tubes are used to give crystal or electron-coupled frequency control on five bands. This photograph shows the coils in place for 14-mc. operation with electron-coupled control. The grid condenser in the foreground, which plugs into the socket underneath the oscillator tube, has been removed so that the r.f. choke and wiring underneath the platform can be seen.

accomplished with less expensive equipment and reduced wiring complexities. To describe such a unit, and to present further operating information which should clear up some of the difficulties with Type 59 tubes, is the purpose of this article.

Before plunging into constructional details, a recapitulation of the fundamental idea of the universal exciter should be helpful. Basically the unit consists of two tubes, one a tri-tet oscillator (pronounced "try-tett," equal accent on both syllables) and the other a high efficiency doubler. Ideally, both tubes would be of the indirectly-heated screen-grid type, as a practical compromise between cost and power output (represented by the screen-grid power tubes at one end and the 24-A and similar types at the other) the Type 59 tube is the logical choice. Although the screening between control-grid and plate is not complete, these tubes can be made to do an excellent job.

<sup>1</sup>Lamb, "Tritet Multi-Band Crystal Control," *QST*, October, 1933.

coils. For convenience, standard receiving coil forms have been used throughout. Because these coil forms have small dimensions, it is necessary to wind the coils with what appears to be fine wire for transmitting circuits; actually, however, the losses seem to be smaller than in coils wound with No. 14 or larger wire on ordinary bakelite tubing. Most of the losses are in the bakelite, anyway; special low-loss bakelite or Isolantite forms cut down losses appreciably.

The baseboard on which all the parts are mounted measures 7 by 20 inches. Strips are screwed to the bottom at the ends to elevate the under surface so by-pass condensers, resistors and miscellaneous parts mounted underneath will have plenty of room. Fig. 1 gives the wiring diagram.

The two sockets at the left edge of the board are for the oscillator coil. The one toward the

<sup>2</sup>Lamb, "A More Stable Oscillator of High Harmonic Output," *QST*, June, 1933.

front is used for crystal control; that at the rear is for e.c. control. Immediately to the right of the coil sockets is the oscillator tuning condenser,  $C_1$ , a Cardwell Type 407-B which has been mounted edgewise so that the  $2\frac{1}{4}$  by  $3\frac{1}{2}$ -inch bakelite platform holding the oscillator tube socket can be bridged between the stator-plate terminals of this and the similarly-mounted Type 412-B plate tuning condenser,  $C_2$ . Suspended below the front edge of the platform by small metal angle-brackets is a bakelite strip equipped with two G.R. Type 274-J sockets spaced  $\frac{3}{4}$ -inch between centers, standard spacing for the conventional type of plug-in crystal holder. The r.f. choke in the crystal grid circuit is mounted vertically between the baseboard and the platform, held at the baseboard end by a machine screw which goes through to make connection to the grid leak,  $R_1$ , underneath. The connections to the oscillator tube socket are run directly to the socket terminals through small holes in the platform. The filament prongs face the rear edge of the board.

To the right of  $C_2$  is the socket for the oscillator plate coil,  $L_2$ . Beside it is the r.f. choke which serves as a coupling impedance on the low-frequency bands. The doubler tube socket (filament prongs to the rear) is on the other side, with the interstage coupling condenser,  $C_6$ , between. The doubler plate tuning condenser,  $C_3$ , the socket for  $L_3$ , and the output terminals at the extreme right, complete the list of parts on the upper surface of the baseboard.

The photograph of the under side of the baseboard shows the wiring in relation to the top-view photograph; that is, the left-hand edge in this photograph also is the left-hand edge in the other. The terminal strip at the lower left is a piece of bakelite measuring  $\frac{5}{8}$  by 4 inches; at regular intervals G.R. Type 738-A screw terminals have been forced into it. Just above the terminal strip is the voltage divider resistor  $R_4$ , supported a little away from the board so the heat will be readily carried off by air circulation. The other voltage divider resistor,  $R_5$ , is mounted somewhat to the right; beside it is the oscillator grid leak,  $R_1$ . The oscillator screen and plate by-pass condensers,  $C_4$  and  $C_5$ , are fastened end-to-end to the board by means of a wood screw; the connection common to the two goes to the negative "B" while appropriate leads from the tube socket and  $C_2$  drop through the board to the other terminals. The doubler cathode by-pass condenser,  $C_7$ , a Dubilier Type 9, is held in place by one of its tapped terminals, which is threaded on one of the machine screws which holds the  $L_3$  coil socket to the board. The doubler cathode resistor,  $R_3$ , is connected directly across the condenser terminals. Above these toward the upper (front) edge of the board is the r.f. choke

in the doubler grid circuit; it is mounted on a pair of Johnson miniature stand-offs like those used for the output terminals on top. Between the cold end of the choke and the ground end of  $C_7$  is the doubler grid leak,  $R_2$ . The two remaining condensers, one fastened to each of the two machine screws which hold the doubler tube socket in place, are the doubler screen and plate by-pass condensers,  $C_8$  and  $C_9$ .

This completes the list of material mounted directly on the baseboard. There should be little trouble with the wiring provided the circuit diagram is followed carefully. Keep the r.f. leads short and direct; the others are not so important, although by-pass condensers should be mounted as close as possible to their respective circuits. The wiring of the oscillator coil sockets for crystal and e.c. control is shown in Fig. 2. Six-prong coil forms and sockets will be required for greatest economy of coils; four prongs are needed for the

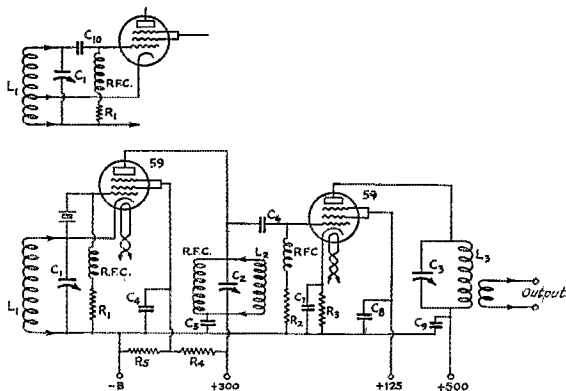

FIG. 1—EXCITER UNIT WIRING DIAGRAM

For the sake of simplicity, the alternative crystal and e.c. control circuits are shown as separate diagrams, although the choice actually is made in the unit by plugging  $L_1$  into either of two sockets and using a crystal or grid condenser as required. Wiring of the sockets is shown in Fig. 2.

Actual brands of parts used are indicated below for the convenience of builders; others of the same electrical values may be substituted, of course.

- $C_1$ —350- $\mu$ fd. variable condenser (Cardwell Midway Type 407-B).
- $C_2$ —100- $\mu$ fd. variable condenser (Cardwell Type 412-B).
- $C_3$ —50- $\mu$ fd. variable condenser (Cardwell Type 410-B).
- $C_4, C_5$ —0.05- $\mu$ fd. mica condensers (Dubilier Type 3).
- $C_6$ —100- $\mu$ fd. mica condenser (Dubilier Type 4).
- $C_7$ —100- $\mu$ fd. mica condenser (Dubilier Type 9).
- $C_8, C_9$ —0.05- $\mu$ fd. mica condensers (Dubilier Type 3).
- $C_{10}$ —250- $\mu$ fd. mica condenser (Dubilier Type 9).
- $R_1, R_2$ —50,000-ohm, 2-watt resistor (I.R.C.).
- $R_3$ —1000-ohm, 5-watt wire-wound resistor (I.R.C.).
- $R_4$ —10,000-ohm, 10-watt wire-wound resistor (Electrad).
- $R_5$ —5000-ohm, 10-watt wire-wound resistor (Electrad).
- RFC—Universal-wound high-frequency chokes (National Type 100).

Coil data is given in Tables I and II. All coils are wound on National six-prong receiving coil forms (diameter  $1\frac{1}{2}$  inches).

Coil and tube sockets are Isolantite, made by National. The knobs are G.R. Type 637-G.

The heaters of the two tubes are wired in parallel. No center-tap resistor is used in the exciter unit itself; a 20-ohm c.t. resistor should be connected across the heater winding at the power supply. The center-tap should be connected to -B.

oscillator windings and two more for the output windings. Since the same coils can be used in all three positions on different bands, the use of six-prong forms means a saving in the number of coils and forms required. Four-prong forms can be used throughout if crystal control is to be used exclusively; for the sake of greater flexibility, however, it is urged that the suggested arrangement be followed.

When e.c. frequency control is to be used it is necessary to replace the crystal by a grid con-

cealed or decreased accordingly. Coils of any type may be wound if the following points are kept in mind: The oscillator coil,  $L_1$ , always should be high- $C$  for the fundamental frequency of the oscillator. Adjust the number of turns so that the desired frequency will be obtained with  $C_1$  set at at least 75% of maximum capacity. The oscillator plate coil,  $L_2$ , should be low- $C$  for the frequency to which it is to be tuned. Proportion it so that the plate tuning condenser,  $C_2$ , is very nearly at minimum capacity at resonance. This is extremely important on the higher frequencies. In practice, it will be found that a plate coil properly adjusted will also work well in the  $L_1$  position as a high- $C$  coil in the next-lower-frequency band. It is also highly important to use very low  $C$  in the doubler plate coil,  $L_3$ , and coils for this position also should be proportioned so that resonance is reached with the condenser  $C_3$  near minimum capacity.

Because the minimum capacities across  $L_2$  and  $L_3$  differ— $L_2$  has two tubes

shunted across it—it has been found impossible to use duplicate coils for 14 mc. in both these positions, hence the two coils D and E, one of which is satisfactory for 14 mc. at  $L_3$  and the other for the same band at  $L_2$ . The latter coil is only needed for 28-mc. operation, where it is necessary to excite the doubler on 14 mc.

Where a figure appears in the "Length of Winding" column in Table I, the number of turns specified should be spaced out evenly to make that length along the form. If no length of winding is given, the turns should be close-wound to the required number, using the wire size indicated. The coupling between the tank winding and the output winding should be made as close as possible, the latter winding being placed at the bottom of the form. Naturally it will not be necessary to put output windings on the duplicate coils, nor will it be necessary to tap the windings in all cases, since a few of the coils are never used in the  $L_1$  position. If crystal control is to be used exclusively, it will not be necessary to tap any of them. It is better to make the coils uniform, however, to avoid confusion in picking out the right ones.

The jumper connecting the two upper coil-form pins in Fig. 2 is necessary to complete the cathode circuit in the crystal position when the socket arrangement shown in Fig. 2 is used.

Since 59 tubes of different makes have different inter-electrode capacities, it may be necessary to add or subtract a turn or so from the specifications given for the higher-frequency coils to obtain

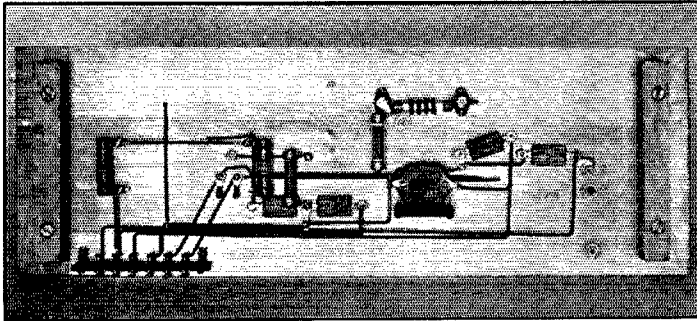

A SUB-BASE VIEW OF THE EXCITER UNIT  
Details of the wiring are given in the text.

denser. This condenser, which can be seen in one of the photographs, is supplied with a pair of G.R. plugs which fit the crystal mounting. This has been done by appropriately drilling and tapping small pieces of 1/4-inch square brass rod which are fastened to the condenser terminals.

#### COIL REQUIREMENTS

The number of coils needed will depend upon the frequency coverage desired. A maximum of eight will be required for complete coverage from 1.75 to 28 mc. For ordinary operation, i.e., 3.5, 7 and 14 mc., only four coils need be used with crystal control; one additional coil will give the same coverage with e.c. control.

Complete coil specifications are given in Table I. Only six coils are indicated; the other two needed to finish off the set are duplicates of the B and C coils. If coil forms of different diameter are to be used, the number of turns should be in-

Table I

Coil	Turns	Length of Winding	Tap*	Wire Size	Output Winding**
A	80		20	No. 28 d.s.c.	10
B	32	1 1/4"	8	No. 22 d.s.c.	5
C	15	1"	4	No. 22 d.s.c.	5
D	10	1"	3	No. 22 d.s.c.	3
E	7	1"		No. 22 d.s.c.	
F	4	3/8"		No. 22 d.s.c.	3

Coil diameter is 1 1/2 inches in all cases.

\* Number of turns from ground end of coil.

\*\* Turns close-wound.

resonance with  $C_1$  or  $C_2$  near minimum capacity.

Table II indicates the way in which the various coils are used in operating the exciter unit on different bands. Since Type 59 tubes are not completely screened, oscillation will take place if the plate and grid circuits of the same tube are tuned to the same frequency; such a possibility naturally must be avoided and for this reason an untuned coupling arrangement is used on those bands where consecutive circuits might logically be expected to work on the same frequency. The untuned coupling consists of the r.f. choke shunted across  $C_2$  together with the regular coupling condenser and choke in the grid circuit of the doubler. It is important to have good chokes if the coupling is to work at all well; the small, inexpensive universal-wound chokes are satisfactory.

#### COIL COMBINATIONS

For 1.75-mc. operation, the oscillator grid is tuned to that frequency with the high- $C$  coil, B—the same coil is used for both crystal and e.c. control; the oscillator plate coil socket is left empty, and the low- $C$  1.75-mc. coil is used in the doubler position. (The second tube is an amplifier, not a doubler, in this case, but it is more convenient to refer to it throughout as the “doubler.”) The 3.5-mc. arrangement is similar, except that the high- and low- $C$  3.5-mc. coils are used in the oscillator grid and doubler plate sockets, the oscillator plate coil socket again being left empty. For crystal control on 7 mc., the low- $C$  3.5-mc. coil, B, is plugged in the oscillator plate coil socket, and the low- $C$  7-mc. coil, C, in the doubler plate coil socket. The oscillator grid coil socket is left empty. When this socket is unused the oscillator cathode circuit is open, so it is necessary to put a jumper between the cathode and ground prongs (upper left and lower right prongs in the “xtal” socket in Fig. 2). One of the unused high-frequency coils can be used to do this—the 28-mc. coil, preferably—or a “U” of No. 12 wire can be made to fit into the socket holes. This coil combination makes the oscillator tube work as an ordinary tetrode. For e.c. control on 7 mc., the oscillator grid is tuned to 1.75 mc., oscillator plate to 3.5 mc., and doubler plate to 7 mc.

On 14 and 28 mc. the consecutive circuits operate on harmonics and no unorthodox circuit arrangements are necessary.

#### HOW TO TUNE

It is no trick at all to get the exciter unit into action—with the usual proviso, of course, that the wiring and specifications have been followed carefully. The procedure is quite simple. The easiest case is that of crystal control on 1.75 or 3.5 mc. On either band, using an appropriate crystal and the coils recommended in Table II, apply all voltages except that to the doubler plate. Set  $C_2$  at minimum capacity and tune  $C_1$  until the

oscillator starts. Oscillation will be indicated by a dip in the oscillator plate current (a meter inserted in the plus 300 lead will read the voltage-divider and screen currents as well as the oscillator plate current, the first two taking between 20 and 25 ma.) or, if no meter is used, can be detected by the usual neon bulb or flashlight-lamp-loop. Set  $C_1$  somewhat on the high-frequency side of resonance. Now apply the doubler plate voltage and adjust  $C_3$  to resonance, which will be indicated by minimum plate current. The output terminals then can be connected to a following amplifier, the tuning of which will of course depend upon its design.

The procedure is just the same when e.c. control is to be used on either of these two bands, except that the oscillator coil,  $L_1$ , is placed in the rear socket;  $C_1$  must be adjusted so that the oscillator operates on the desired frequency. This should be done with the aid of a frequency meter.

To use crystal control on 7 mc., again plug in the proper coils and apply all voltages except the doubler plate voltage. Make sure that the oscillator cathode circuit is closed by the jumper. Turn  $C_2$  down from maximum capacity; near the minimum-capacity end of the scale oscillations will start. Now apply plate voltage to the doubler and adjust for minimum plate current, and the tuning is complete.

For 7-mc. e.c. control, set the oscillator to one-fourth the desired output frequency, again having the doubler plate voltage off. Next, tune  $C_2$  for resonance at the second harmonic of the oscillation frequency; resonance will be indicated by a dip in oscillator plate current or by use of the familiar neon bulb or lamp-and-loop. Either of the latter will affect the tuning, however, so the plate current indication is best. Now apply the doubler

Table II

Crystal Control			
Band, Mc.	Coil at $L_1$	Coil at $L_2$	Coil at $L_3$
1.75	B*	None	A
3.5	C	None	B
7	Jumper	B	C
14	C	C	D
28	C	E	E
	D**	E	F

E. C. Oscillator			
Band, Mc.	Coil at $L_1$	Coil at $L_2$	Coil at $L_3$
1.75	B	None	A
3.5	C	None	B
7	B	B	C
14	C	C	D
28	D	E	F

\* 1.75-mc. crystal.

\*\* 7-mc. crystal.

plate voltage, adjust  $C_3$  for minimum plate current and, leaving  $C_3$  set, readjust  $C_2$  for maximum doubler output.

For 14-mc. crystal control, the general procedure is about the same as that just described. The oscillator condenser,  $C_1$ , should be set well on the high-frequency side of the point at which oscillations start;  $C_2$  should be set for the dip in oscillator plate current at the second harmonic (a 3.5-mc. crystal is assumed); and  $C_3$  should be set for minimum doubler plate current. When this last adjustment is completed, both  $C_1$  and  $C_2$  should be readjusted for maximum doubler output. If e.c.

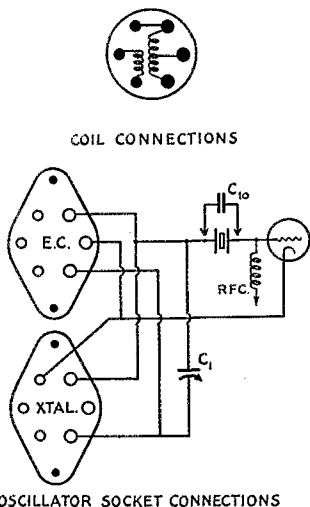

FIG. 2—COIL AND SOCKET WIRING

The upper drawing shows the internal wiring of the coils, looking down into the coil form. The wiring of the two sockets into which  $L_1$  may be plugged for either crystal or e.c. control is shown below.

control is to be used, the oscillator must be adjusted to a suitable frequency in the 3.5-mc. band with the aid of a frequency meter and thereafter let alone. The oscillator plate and doubler plate circuits are tuned just as with crystal control.

On 28 mc. the tuning is the same as for 14 mc. (with a 3.5-mc. crystal) except that the fourth harmonic instead of the second is picked off in the oscillator plate circuit. The dips in both oscillator and doubler plate current as  $C_2$  and  $C_3$  are varied probably will not be as pronounced as on the lower frequencies. If a 7-mc. crystal is used the second harmonic of the oscillator will be taken off in the oscillator plate circuit.

With e.c. control on 28 mc., the oscillator grid will be tuned to a frequency between 7 and 7.5 mc., oscillator plate to the second harmonic, and doubler plate to the 28-mc. harmonic. The same tuning procedure is used.

One caution: Be sure you have picked out the right harmonics before attempting to put the transmitter on the air. The best way to be certain

of being right is to check with an absorption wavemeter. On the very high frequencies it is easy to get the wrong beats in an oscillating frequency meter.

#### OPERATING CONSIDERATIONS

A number of readers who tried the original tri-tet circuit in June *QST* had considerable trouble with heating of the crystal. As pointed out in the October article,<sup>1</sup> to minimize heating and consequent frequency drift when the oscillator plate circuit is tuned to a harmonic it is necessary to use a high- $C$  oscillator grid circuit and tune far above the resonance frequency—into the region around 5 or 6 megacycles with a 3500-kc. crystal. We emphasize this again. The worst possible method of operating the oscillator is to use a low- $C$  cathode circuit, tuned as an ordinary crystal oscillator would be tuned. When this is done the voltage across the crystal builds up tremendously—although at the same time the harmonic output will be low. If a neon bulb is touched to the oscillator grid and the tuning condenser,  $C_1$ , is varied downwards from maximum capacity, there will be a bright glow as the oscillator starts working, accompanied by a marked dip in the oscillator plate current. As the capacity is further decreased, the neon glow will decrease, fairly rapidly at first and then more slowly, while the plate current will rise. The proper setting of the condenser is in the region beyond the bright glow of the neon bulb. If the plate circuit is tuned to the second harmonic and some sort of indicating device such as a flashlight lamp and loop is coupled to  $L_2$ , the point of maximum second-harmonic output will be found in the desirable tuning region on  $C_1$ .

#### SCREEN-GRID VOLTAGE

The r.f. on the crystal can be reduced further by paying attention to the screen voltage. The optimum screen voltage depends to some extent on the order of harmonic to be taken from the plate circuit; for minimum crystal heating and most stable operation of the oscillator tube, the screen voltage should not exceed 100 volts. Repeated tests have demonstrated that the second-harmonic output is maximum with this screen voltage; it decreases slightly if the screen voltage is lowered to 75 volts, but it drops off more if the voltage is raised to as much as 150 volts. The voltage divider recommended in Fig. 1, consisting of a 10,000- and 5,000-ohm resistor, is about right for a plate voltage of 300.

The optimum adjustments of both screen voltage and oscillator grid tank tuning for second-harmonic output are not necessarily also optimum for output on higher harmonics. The higher harmonics are best when the tank circuit is tuned nearer to resonance and when a somewhat higher screen voltage is used, both of which tend to en-

(Continued on page 86)



# A New Regenerative Detector Circuit for Ultra-Short Waves

By Richard Hilferty, WIAFC\*

**I**N LINE with the normal progression toward more stable transmitters for the very high frequencies, it is fitting to look to the development of simple receiving systems which will take advantage of transmitter carrier stability. The super-regenerative receiver, because of its modulated detector, is scarcely capable of discriminating between stable and unstable signals. The superheterodyne can, of course, be made to do so; but it is apt to require a multiplicity of stages and a considerable power supply. The regenerative autodyne receiver seems to offer something in the way of a medium between the two aforementioned types.

The selectivity of a well-constructed autodyne may be expected to be ample for some time to come and, in fact, can be made too good for many of the present-day five-meter transmitters. So, before going further into a discussion of an effective autodyne circuit, it may be well to consider briefly the justification for this move for improved receiver selectivity. They are: first, increased occupancy of our ultra-high frequency bands; and second, improved transmitters.

Now the super-regenerative receiver, most commonly used on our very high frequencies, has one highly useful characteristic. Its lack of selectivity makes possible reception at the one setting over a band of frequencies as much as several hundred kilocycles wide. This has been desirable because our transmitters have radiated precisely this sort of a band of frequencies as the result of frequency wobulation with modulation of self-controlled oscillators. In other words, the receiver has duplicated, in effect, the characteristics of the transmitter. Both are frequency-modulated oscillators. Hence there is little to be gained by stabilizing the transmitter if we are to continue using unselective receivers whose band width may be hundreds of kilocycles. But, as recent *QST* articles have shown, it is now practicable to obtain good transmitter stability. So let us proceed to improving the stability and selectivity of the receivers.

The purpose here is to describe a stable regenerative (autodyne) detector circuit that is peculiarly adapted to ultra-high-frequency operation. The highest frequency upon which it will operate is not known; but its performance in the 56- to 60-mc. band is especially good. The essential elements of the detector circuit are shown in Fig. 1, the important one being the cathode choke, *RFC*.

\* Maynard, Mass.

This choke provides impedance common to both the grid and plate circuits.<sup>1</sup> Unlike the usual regenerative circuit, it has no tickler or other obvious means of feedback. But it is highly regenerative and an excellent oscillator, especially at ultra-high frequencies.

The cathode choke need not have an especially critical value of impedance. It appears, however, that it should be of a size normally "too large" for the radio-frequency concerned, a standard 2.5-mh. short-wave type (National 100-R) being satisfactory for the 56-mc. and 28-mc. bands. A

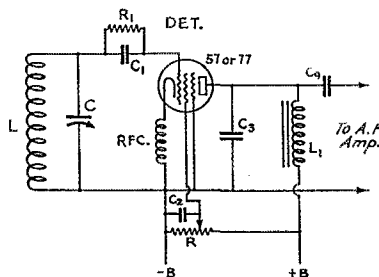

FIG. 1—THE NEW REGENERATIVE DETECTOR CIRCUIT THAT IS ESPECIALLY EFFECTIVE AT ULTRA-HIGH FREQUENCIES

It resembles a non-regenerative circuit except for the cathode choke, *RFC*, which acts as a common impedance in the grid and plate circuits, and makes the circuit regenerative. Regeneration is controlled by the variable screen-grid potentiometer *R*. Circuit constants for the 56-mc. band are given with Fig. 3.

non-inductive resistor of a few hundred ohms used in this position will, in combination with the stray capacitance, furnish the required impedance and permit the tube to oscillate normally, but in a detecting circuit would constitute an audio-frequency as well as a radio-frequency impedance and thus affect grid bias at audio-frequency rate.

The remainder of Fig. 1 is quite "according to Hoyle" and yields to the usual procedure for extracting the proper amount of "soup," "juice" or "hop" from a screen-grid detector. Heater-type triode tubes, such as the 56, oscillate as well but the s.g. tube gives the desirable sensitivity.

<sup>1</sup> Developed independently by the author, this circuit is akin to the ultraudion doubler arrangement used in the universal transmitter exciter unit described in the October issue. Both appear to depend for regeneration on a capacitive impedance that is common to the grid and plate circuits. To distinguish this particular type of circuit, the description, "cathode impedance ultraudion," is suggested. Discussion by circuit analysts is invited. — ERROR



ously erratic only when audio-frequency modulation is applied. The receiver may be made to generate an interruption frequency within the detector, and to operate as a super-regenerator, by increasing the screen voltage to the point

fine, but sometimes on 3549 kc. and again on about 3565 kc. Prohibition has its points after all!" HI.

### New Bureau of Standards Research Papers

"A 200-Kilocycle Piezo Oscillator," by E. G. Lapham (Research Paper RP576) describes the crystal-controlled oscillator used in the 5000-ke. WWV standard-frequency transmitter. This control oscillator, which is monitored against the National Frequency Standard maintained at the Bureau, is built in a unit which incorporates double temperature control of the crystal and the temperature control of the oscillator-amplifier associated

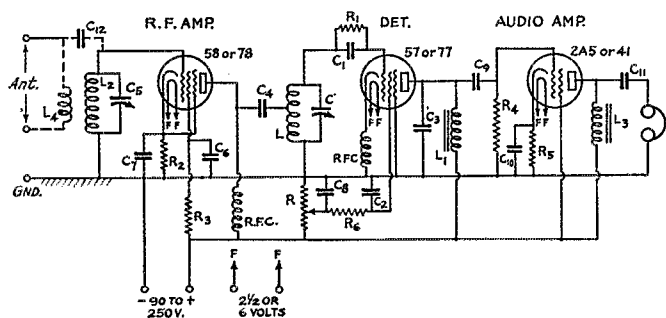

FIG. 3—COMPLETE CIRCUIT OF THE 56-MC. RECEIVER USING THE NEW REGENERATIVE DETECTOR CIRCUIT

Type 58, 57 and 2A5 tubes should be used for 2.5-volt a.c. filament supply; Type 78, 77 and 41 tubes for 6-volt a.c. or d.c. supply. Batteries or a power pack may be used for the "B" supply.

L—8 turns No. 16 enameled, 1/8-inch diameter form, turns spaced diameter of wire.

L<sub>1</sub>—500-henry audio-frequency choke.

L<sub>2</sub>—10 turns No. 16 enameled, same diameter and spacing as L.

L<sub>3</sub>—30-henry output choke or a pentode output transformer.

L<sub>4</sub>—Few turns coupled to L. Varies with antenna and should be adjusted for best operation.

RFC—National Type 100-R radio-frequency chokes (2.5-mh).

C and C<sub>5</sub>—4-plate midjet variable condensers.

C<sub>1</sub>, C<sub>2</sub>, C<sub>3</sub>, C<sub>4</sub>, C<sub>6</sub> and C<sub>7</sub>—100-μfd. or larger mica condensers.

C<sub>8</sub> and C<sub>10</sub>—0.5-μfd. paper condensers.

C<sub>9</sub>—0.05-μfd. mica condenser.

C<sub>10</sub>—2-μfd. or larger paper condenser.

C<sub>11</sub>—1 or 2 μfd., overlapped insulated wires (used for capacitive antenna coupling).

R—100,000- or 200,000-ohm potentiometer.

R<sup>1</sup>—2 to 10 megohms, preferably the higher resistance.

R<sub>2</sub>—300- or 400-ohm 1-watt resistor.

R<sub>3</sub>—50,000-ohm (or thereabouts) 1-watt resistor.

R<sub>4</sub>—0.5-megohm.

R<sub>5</sub>—750-ohm 2-watt resistor.

R<sub>6</sub>—500-ohm 1-watt (decoupling) resistor.

where "squegging" (low frequency oscillation) starts. Contrary to expectations, however, it has been found that there is little to be gained by super-regeneration excepting in the case of a badly frequency-modulated carrier. For an excellently stable carrier, straight regeneration produces the more satisfactory results. The inherent receiver noise is low and the selectivity is neither too great nor too poor.

The oscillator circuit itself has many other interesting applications, exploration of which offers promising possibilities.

### Strays

From VE2BC: "My 3549-ke. crystal wasn't oscillating well, so I took it out for cleaning. Not having any Carbona, I poured a bit of gin over it, wiped it off and replaced it. It oscillated

with it. A vernier adjustment in the crystal oscillator circuit gives fine frequency control to three parts per million and the frequency remains constant within two parts in one hundred million, when once adjusted, for periods of several hours. This paper is of interest to anyone engaged in precision frequency work.

"Phase Synchronization in Directive Antenna Arrays With Particular Application to the Radio-Range Beacon," by F. G. Kear (Research Paper RP571) describes two types of excitation systems for the "TL" antenna which eliminate variation of course indications with slight detuning of the antennas. The new type "TL" antenna was described in a previous paper, "The Cause and Elimination of Night Effects in the Radio-Range Beacon Reception," by H. Diamond (Research Paper RP513).

Copies of the above papers are obtainable from the Superintendent of Documents, Government Printing Office, Washington, D. C., at 5 cents each. Remember not to remit in postage stamps.

### Silent Keys

It is with deep regret that we record the passing of these amateurs:

Philip E. Eisenhart, W3CIK, York, Pa.  
Whitney S. Gage, W8BYD, Cleveland, Ohio.

Forrest E. Herron, W8HK, Pittsburgh, Pa.

Henry T. Phelps, Jr., W5DDB, Brownsville, Tex.

R. W. Wauchope, VK5WF, Maylands, S. A.

Lee A. Wilkinson, W5KW, Dallas, Texas.

# Speech-Amplifier Economy With a 2A5

By A. D. Muldoon, W1FRQ\*

WITH the deluge of new tubes that has flooded the market during the past year, we often hear a puzzled ham say, "What's the dope on that one?" The object of this article is to show how a 2A5 was used to simplify the audio system preceding the Class-B modulator in use at this station.

On many of the QSL cards that adorn the walls of most any shack, it is not uncommon to find a great number of stations having stage after stage of audio amplification when a double-button mike is used. We do not blush to admit that our station had such a line-up; it consisted of a double-button mike, a 24-A impedance-coupled to a 56, followed by a pair of 45's in push-pull

to answer the question in our mind, so we went to work on it with the idea of eliminating as much as possible of the original audio system.

A midget receiver chassis measuring  $7 \times 11 \times 2\frac{1}{2}$  inches was used for a base. On and under it are mounted all the parts called for in Fig. 1, the circuit diagram of the unit. A small panel across the seven-inch end holds the battery switch, microphone-current control, 110-volt line switch, a pilot light, audio gain control, and terminals for the microphone cable. Fig. 1 is self-explanatory and orthodox enough for most any of us. About all that is needed in the way of explanation is a note on the method of coupling the 2A5 to the Class-B input transformer. The center tap is

ignored, the plate of the 2A5 going to one side, and the plate voltage lead to the other. These leads were reversed several times but on the transformer used there seemed to be no difference in the results. A single  $1\frac{1}{2}$ -volt flashlight cell is used for bias on the 24-A and precludes the possibility of a noisy resistor; its use has the added advantage that no bypass condenser is needed. One of these batteries will last a long time and the replacement cost is very low.

Notice that the grid and plate leads are shielded. The really important one to shield, however, happened to be the grid lead to the 24-A. Since this unit sits on a table about three feet from the transmitter, it was deemed necessary to shield the lead from the 2A5 to the Class-B input transformer to reduce the chances of r.f. pickup.

A terminal strip along one side of the chassis provides connections for the output, microphone battery and also "B" voltages for other purposes.

When checked with headphones, the hum could scarcely be heard. The quality had not suffered to any noticeable extent, so the unit was put to work at its intended job of driving the 841 modulators. The rig was turned on and a few words spoken into the mike in the usual

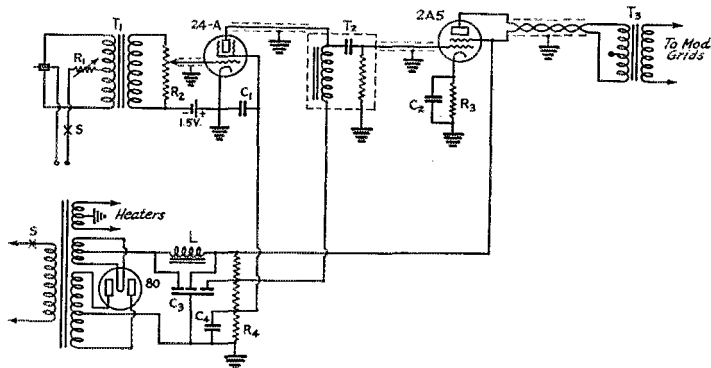

FIG. 1—HIGH-GAIN SPEECH AMPLIFIER FOR A CLASS-B MODULATOR

- T<sub>1</sub>—Double-button microphone transformer.
- T<sub>2</sub>—High-impedance audio coupler (National S-101 or equivalent).
- T<sub>3</sub>—Class-B input transformer (use whole primary winding, neglecting center tap).
- L—Filter choke, 30 henrys, about 75-ma. capacity.
- C<sub>1</sub>—25 μfd.
- C<sub>2</sub>—5-μfd. dry electrolytic, 50-volt rating.
- C<sub>3</sub>—Three-section electrolytic, 8μfd. each section.
- C<sub>4</sub>—1 μfd.
- R<sub>1</sub>—400 ohms, variable.
- R<sub>2</sub>—Gain control (250,000-ohm potentiometer).
- R<sub>3</sub>—410 ohms.
- R<sub>4</sub>—Voltage divider, total resistance about 15,000 ohms, with taps.
- S—Single-pole single-throw switch.

The power transformer is of the type made for midget b.c. receivers. D.c. operating voltages are: 250 at plate of 2A5, 180 at plate of 24-A, 70 at screen of 24-A.

driving a pair of 841's Class-B. That was too much to get on a one-and-a-half-inch line on a QSL card, so we cleared the decks for action, unlimbering the cutters, soldering iron and screw-driver.

Looking over the "output" column of a tube chart, we find that a 2A5 has an output of some 3 watts, uses 2.5 volts on the heater and draws 34 mils plate current at 250 volts. This seemed

\* 170 Laurel St., Longmeadow, Mass.

(Continued on page 86)

# The American Regional Conference

Governments of North and Central America Unanimously Continue 1715–2000 and 3500–4000 kc. Amateur Bands

By K. B. Warner, Secretary, A.R.R.L.

THE international radio convention provides that groups of adjacent nations may make regional agreements which by mutual assent modify the international treaty within that region, provided no unauthorized interference is caused the services of any country outside that region. Since 1929 there has been in effect the so-called North American Agreement, arranged at Ottawa in 1928. Amateurs are particularly interested because the Washington and Madrid regulations make both our 1715- to 2000- and 3500- to 4000-kc. bands available, at the discretion of the governments concerned, not only for amateur stations but for other services as well. It is to the regional conferences that we look for exclusive assignment of these bands to amateurs. From July 10th to August 9th a North and Central American regional conference was held at Mexico, D. F., at the invitation of the Mexican government, and there these two bands were unanimously reaffirmed as exclusively amateur.

The primary purpose of the conference was to come to some understanding over the international division of broadcasting channels in this region, a problem complicated by diplomatic questions that are of no concern to us amateurs. After a month of discussions no agreement on this subject was found possible and in this respect the conference must be considered almost a complete failure. Although it failed in this primary purpose, agreement was reached concerning the frequencies from 1600 kc. upwards, and this of course is the portion that most interests us.

This was a conference of government representatives only. Although some of the radio companies and associations sent representatives to the city, they were not permitted to attend the meetings. This constituted no worry to us, for we had assured ourselves in advance that the Canadian, Mexican and United States delegations would stand for a continuation of the amateur bands. Moreover, the International

Amateur Radio Union had requested the *Liga Mexicana de Radio Experimentadores*, the Mexican amateur society, to look after the interests of amateurs, and they had kindly accepted the responsibility. The L.M.R.E. is a strong and flourishing association and in a particularly strong position with its government. It happens that early this year the Mexican radio administration suddenly resigned and in the emergency the amateurs were called in to take charge. They did such a good job that they have been practically in control of the situation ever since, and took prominent part in this conference. Their president, Mr. Julio Prieto, X1AA, served as delegation high-frequency technical adviser, their secretary, Mr. F. Castro Herrera, X1AX, as technical adviser on broadcasting. Because of this government connection both Mr. Prieto and Mr. Castro took temporary leaves of absence from their L.M.R.E. offices, being succeeded for the duration of the conference by the vice-president and assistant secretary. In fact, four Mexican amateurs served on their delegation, including also X1K and X1C. Amongst those present, although "on his own" and not as our official representative, was Paul M. Segal, A.R.R.L. General Council, who kept in touch with the situation and worked with the L.M.R.E. in its activities.

In the agreement drafted, "the delegations from Canada, Costa Rica, Cuba, El Salvador, Guatemala, Honduras, Mexico, Nicaragua and the United States of America . . . unanimously

(Continued on page 46)



DELEGATES AND TECHNICAL ADVISERS TO THE NORTH AND CENTRAL AMERICAN REGIONAL RADIO CONFERENCE HELD IN MEXICO CITY THIS PAST SUMMER

# A Practical Crystal-Controlled Portable

THE ham who is travelling constantly wants a portable station that is reasonably compact and light-weight, yet with enough "sock" to take it out of the toy class and make daily communication over the distances covered by the average station a practical proposition. That, at least, was the problem confronting W. C. Clarke, W9DLS of Des Moines, Iowa, in the design of his portable station, W9ZZAF. That W9ZZAF does all that could be expected of it is attested by the DX worked from various temporary locations — plus the fact that it has main-

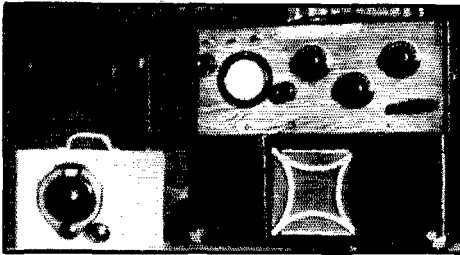

THE RECEIVER AND TRANSMITTER OF PORTABLE W9ZZAF

Part of the cover of the transmitter carrying case has been removed to show the panel and tuning controls. The power supply occupies the lower part of the case.

tained reliable schedules with W9BMA and that the signal is well known to a large number of amateurs who habitually work the 7-mc. band.

A portable transmitter that is to keep regular schedules must be capable of maintaining a fixed frequency regardless of the vicissitudes of travel and the often far-from-ideal antenna conditions — all of which points to the use of crystal control. The outstanding feature about W9ZZAF is

the elimination of non-essentials in the construction of a crystal transmitter. Not that there is anything unusual about the circuit employed; it is simply the familiar oscillator-doubler-amplifier with the parts reduced to the minimum.

The circuit diagram of the transmitter is shown in Fig. 1. The photographs indicate the construction. The carrying case, outside dimensions 14 by 10 by 14 inches, is double-decked; the r.f. part of the set occupies the upper deck and the power-supply equipment the lower. The r.f. and power supply are separate units, each with its own panel and subpanel, and can easily be slipped out for repairs or changes.

The oscillator tube is a 47 followed by a 10 doubler and a 10 amplifier. All the variable condensers are 23-plate Pilot midgets, including the neutralizing condenser for the final stage as well as the three tank tuning condensers. The coils for the oscillator and doubler are wound with No. 16 enamelled wire on tube bases, the bases being used for the sake of easy alteration and compactness. The tank coil in the final stage is wound with No. 12 enamelled wire with the turns held in place by strips of celluloid.

Bias batteries and r.f. chokes are conspicuous by their absence in the circuit diagram of Fig. 1. At the outset it was decided that batteries were too heavy and bulky to be carried along for bias so grid leaks have been used instead. Besides furnishing the bias for the various stages, the leaks also replace the customary grid chokes. Chokes are also omitted from the plate circuits, the by-pass condensers being depended upon to keep the r.f. in its place. There is no stray r.f. in the set, and since tests with chokes showed that the operation was the same with or without them, they have been discarded.

The voltages shown on the three stages in Fig. 1 are obtained from a single power supply by means of a voltage divider. The power input to the last stage is normally 60 to 75 watts. A 0-500-mil meter in the plate circuit of the last stage is the only meter in the set.

The power supply also follows out the rule of "essentials only" established in the transmitter. The output of a 700-volt Thordarson transformer is rectified by an 83 and filtered by a single 4- $\mu$ f.d. condenser section. The filament supply for the 10's is taken from the same transformer. A separate transformer handles the filaments of the 83 and 47. Separate cords are brought out from the two transformers to the 110-volt source so the rectifier and oscillator filaments can be heated before the plate voltage is put on. The key is in

(Continued on page 84)

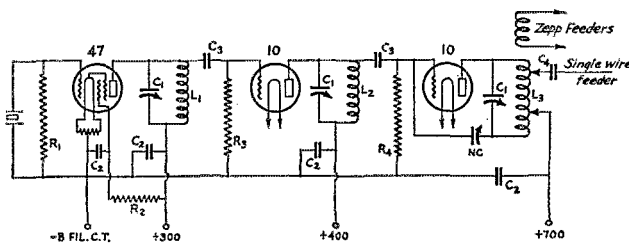

FIG. 1 — CRYSTAL-CONTROLLED PORTABLE CIRCUIT

- C<sub>1</sub> — 23-plate Pilot midget (100- $\mu$ f.d.).
- C<sub>2</sub> — .002- $\mu$ f.d. mica condenser.
- C<sub>3</sub> — 100- $\mu$ f.d. mica condenser.
- C<sub>4</sub> — 500- $\mu$ f.d. mica condenser.
- C<sub>5</sub> — 23-plate Pilot midget.
- R<sub>1</sub> — 10,000 ohms.
- R<sub>2</sub> — 50,000 ohms.
- R<sub>3</sub> — 25,000 ohms.
- R<sub>4</sub> — 10,000 ohms.
- L<sub>1</sub> — 20 turns No. 16 wound on tube base.
- L<sub>2</sub> — 10 turns No. 16 wound on tube base.
- L<sub>3</sub> — 14 turns No. 12 on 3-inch diameter form.

# Developments in Crystal Filters for S.S. Superhets

By James J. Lamb, Technical Editor

BY MODIFYING the crystal filter circuit of the single-signal type superhet it has been found that the performance of the receiver can be considerably bettered, particularly in selectivity and efficiency with the filter in the series connection. The essential feature of the modification is provision of more favorable impedance conditions for the crystal resonator, which serves as the coupling link between the filter input and output circuits and which, itself, has relatively low impedance (resistance) at its resonance frequency. The modified circuit is shown in Fig. 1 and will be recognized as unchanged from that used in the original receiver<sup>1</sup> and in the National AGSX<sup>2</sup> and FBXA, except for the output transformer.

As was shown in previous articles, this filter with the crystal in series is unusual not only in being capable of very high selectivity but also in providing variable selectivity from near the maximum of which the crystal is capable, down to about 1/10 maximum. Measurements made on the original receiver show selectivity ranging from an equivalent band-width of 18 cycles or less to a band-width of 120 cycles. This variation is obtained by adjustment of the input tuning condenser,  $C_1$ , which serves as the selectivity control, operating to vary the impedance of the parallel-tuned input circuit. To clear up some common misconceptions concerning this filter, it will be well to describe its operation briefly.

## HOW THE FILTER WORKS

Except for the output circuit, the diagram of Fig. 1 is essentially the circuit used in the original receiver. The filter input circuit consists of a transformer with a relatively large untuned primary  $L_1$  and a closely-coupled secondary  $L_2$  tuned by the balanced condenser  $C_1$ . The crystal is connected across one section of this condenser, in series with the output

element  $L_3$  across which the voltage applied to the i.f. amplifier is developed. This output element must have a broad impedance characteristic of relatively low resistance in order that it will not introduce excessive resistance in the crystal series circuit and thereby impair the maximum sharpness of resonance of the filter.<sup>3</sup> The other side of the balanced input circuit furnishes voltage more or less in opposite phase to the voltage applied to the crystal, through the phasing condenser  $C_2$ , for the purpose of modifying the effective shunt capacitance of the crystal and thereby shifting its anti-resonant frequency. This is apart from the general variable selectivity operation, however, and will be discussed later.

Since the crystal is connected across one section of the balanced tuning condenser, one quarter of the resistive impedance of the tuned

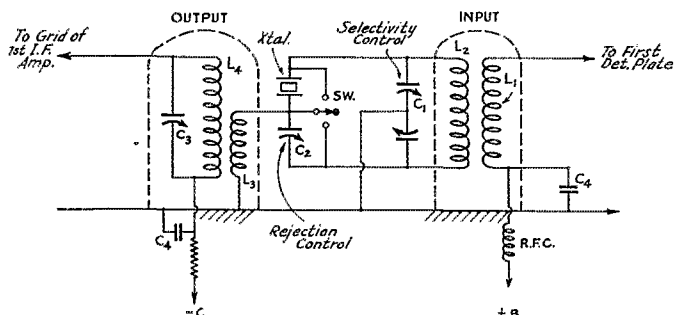

FIG. 1—VARIABLE-SELECTIVITY FILTER WITH IMPEDANCE-MATCHING OUTPUT TRANSFORMER

Except for the latter, the circuit is the same as used in the original s.s. receiver (Aug. and Sept., 1932, QST).

$L_1$ —5.5-mh. universal-wound primary.

$L_2$ —1.5-mh. universal-wound secondary, close-coupled to  $L_1$ .

$L_3$ —Low-impedance output primary, approximately 300- $\mu$ h., universal wound.

$L_4$ —1.5-mh. universal-wound secondary, close-coupled to  $L_3$ .

$C_1$ —Balanced input tuning condenser (selectivity control), 140- $\mu$ fd. per section.

$C_2$ —Phasing condenser (rejection control), 10- or 15- $\mu$ fd. max.

$C_3$ —Output secondary tuning condenser, 75- $\mu$ fd., midget.

$C_4$ —R.f. bypass condensers, 0.01- $\mu$ fd. or larger.

The crystal resonant frequency is approximately 525 kc., which is also the intermediate frequency of the receiver. The input and output transformers are in separate shields.

circuit is therefore in series with the crystal. We know that introducing resistance in a series resonant circuit broadens its resonance curve or, in other words, reduces its selectivity. Hence, with the input circuit tuned to resonance the selectivity of the crystal circuit is minimum. At the same time, the voltage across the transformer secondary, and across the condenser section in series

<sup>1</sup> QST, Aug. and Sept., 1932.

<sup>2</sup> QST, p. 26, June, 1933.

<sup>3</sup> QST, March, 1933.

with the crystal, is maximum. As the parallel circuit is tuned away from crystal resonance frequency, either inductively (to a frequency higher than resonance) or capacitively (to a frequency lower than resonance), the impedance is reduced. This impedance is the vector sum of a resistance and a reactance component. As the impedance is reduced by detuning, the resistance component decreases, of course, but does so more rapidly than does the impedance because the reactive component is increasing. Therefore, at

action is that the filter provides a range of approximately 10-to-1 in selectivity with practically constant sensitivity for a signal of resonance frequency. In actual communication the selectivity range obtainable (with crystals of around 500-kc. resonant frequency) works out to cover from the highest practicable for c.w. at 20 w.p.m. (band width of 15 to 20 cycles) to selectivity low enough for intelligible voice reception, even though the measured equivalent band-width at minimum selectivity is only 120 cycles or so.

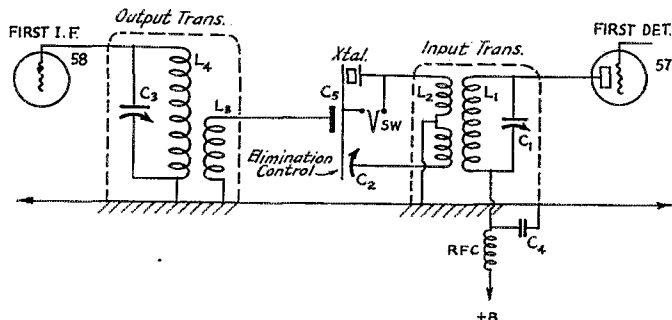

FIG. 2—THE IMPEDANCE-MATCHING FILTER USED IN THE "COMET-PRO" RECEIVER

- It is designed for resonance frequency of 465 kc.  
 $L_1$ —1.4-mh. input primary.  
 $L_2$ —Balanced low-impedance secondary, wound over  $L_1$  in two side-by-side sections.  
 $L_3$ —Low-impedance output primary, wound over output secondary.  
 $L_4$ —1.4-mh. output secondary.  
 All transformer coils are universal-wound type.  
 $C_1$  and  $C_2$ —Air-type i.f. tuning condensers (Hammarlund).  
 $C_3$ —Phasing condenser (elimination control), 6- $\mu$ fd. range, approximately 10- $\mu$ fd. max.  
 $C_4$ —R.f. bypass condenser.  
 $C_5$ —Output coupling condenser, 30- $\mu$ fd. fixed air type (see text).

first the resistance in series with the crystal decreases more rapidly than does the applied voltage, which voltage is nearly proportional to the impedance. The result is that current through the crystal increases slightly as the selectivity improves with detuning of the input circuit. Since this current also flows through the low-impedance output circuit, the voltage applied to the first i.f. amplifier behaves accordingly.

This current and the output voltage rise to a maximum approximately where the total resistance of the circuit (including that of the crystal itself) and the reactive component of the input impedance become equal. At this point the selectivity is optimum. Thereafter the selectivity continues to increase as the input circuit is further detuned but the output voltage decreases. In a typical instance, with constant voltage input of crystal resonance frequency, the output voltage varies from unity value at minimum selectivity, to 50% above this value at optimum selectivity and then to 25% below unity value at maximum selectivity, as the selectivity is varied from minimum to maximum. The resonance frequency of the crystal is but slightly affected by variation of the selectivity control. The net result of this

The other branch of the filter, comprising the lower section of the split input and the phasing condenser  $C_2$ , operates to augment in a peculiar fashion the high selectivity normally obtainable with the crystal. This branch serves to introduce a counter voltage across the crystal, not especially to neutralize the shunt capacitance of the crystal but more generally to modify the effect of this capacitance in determining the anti-resonant frequency of the mounted crystal. The crystal itself is equivalent to a circuit containing very high inductance, medium resistance and very small capacitance in series.<sup>4</sup> The frequency at which the equivalent inductive reactance and capacitive reactance are equal is the natural (series resonant) frequency of the crystal.

But the crystal is mounted between electrodes and there is ordinary capacitance between these electrodes with the quartz as the dielectric. At a frequency somewhat higher than crystal resonance the reactance of the crystal will be of the proper inductive value to equal the capacitive shunt reactance and thereby give parallel resonance. The crystal network therefore becomes anti-resonant at this higher frequency. Ordinarily the anti-resonant frequency will be between 0.3% and 0.5% higher than the series resonant frequency of the crystal. But by introducing a counter voltage in familiar neutralizing fashion the effect of the shunt capacitance can be modified to shift this anti-resonant frequency, not only over a limited range higher than crystal resonance frequency, but also through resonance frequency and over a limited range on the lower side. This

<sup>4</sup>P. 34, *QST*, March, 1933. Typical approximate values for a 525-kc. X-cut crystal with faces approximately 0.4 inch square: Equivalent inductance, 8.6 henrys; resistance, 2500 ohms; capacitance, 0.01  $\mu$ fd; sharpness of resonance or  $Q$ , 11,400. These values were obtained from the resonance curve of the crystal and indicate considerably higher selectivity than previously published data would indicate. See Terman, *Radio Engineering*, pp. 264.



is accomplished by adjustment of the phasing condenser  $C_2$ . When its capacitance is less than the crystal's shunt capacitance, "under-neutralizing" the latter, the anti-resonant frequency is *above* resonance. When it equals the shunt capacitance, the circuit is practically neutralized and the resonance curve is nearly symmetrical. When it exceeds the shunt capacitance of the crystal, "over-neutralizing" the latter, the anti-resonant frequency becomes *lower* than resonance frequency. Thus the phasing condenser adjustment operates to vary the symmetry of the resonance curve rather than to affect its sharpness of resonance or selectivity, as does the input tuning adjustment. The phasing condenser therefore is more properly the "symmetry" or "elimination control." The latter designation is especially apt, because with the desired signal on resonance frequency this control can be used to reject an undesired signal on a neighboring frequency. It is used for this purpose in the s.s. superhet, particularly to reject at the frequency of the audio-frequency image in c.w. reception.<sup>1</sup>

#### STEPPING UP THE OUTPUT VOLTAGE

To meet the requirement for low-resistance filter output, mentioned previously, a reactive r.f. choke was used in the earlier filter circuit with the grid circuit of the first r.f. amplifier connected across it. This gave low resistance in the crystal circuit but also gave low impedance and, consequently, relatively low voltage on the amplifier input. In the modified arrangement of the variable-selectivity type filter, shown in Fig. 1, a step-up transformer having a low-impedance primary and a high-impedance tuned secondary is used to couple the filter output to the amplifier grid circuit, thereby giving the desired low resistance in series with the crystal and, at the same time, increasing the voltage on the amplifier grid. There is nothing especially critical about the primary to secondary ratio, although the optimum would be that which would match the characteristic resonant impedance of the crystal to the tuned impedance of the secondary. Primary-to-secondary impedance ratios as high as 1-to-50 could be used, since measurements recently made for us show 500-kc. crystal resistances of 2500 to 3000 ohms and a good tuned secondary may have a resonant impedance of around 100,000 ohms at this frequency. Considerably lower ratios, seem to be satisfactory, however.

With the balanced tuning condenser providing an impedance step-down at the input and the transformer a step-up at the output, the crystal is given more favorable operating conditions. For straight superhet operation the low-impedance intermediate circuit serves simply as a coupling link.

#### ANOTHER FILTER DEVELOPMENT

A somewhat different arrangement, independently developed by Hammarlund and used in the

"Comet Pro" receiver, is particularly novel and interesting. The schematic diagram is given in Fig. 2 and the filter unit is illustrated in the photograph. Impedance matching transformers are used both on the input and output, the low-impedance secondary of the input transformer being center-tapped to provide the split circuit for the rejection-control operation. The impedance in the crystal circuit is not adjustable as with the split-condenser arrangement just described and the sharpness of resonance of the crystal is practically constant at selectivity that is optimum for c.w. telegraph reception. The phasing condenser is equipped with a panel control so that the anti-resonant adjustment for varying the symmetry of the resonance curve is convenient in operation.

The mechanical arrangement is particularly novel and effective, consisting of two units. An insulating panel carries the crystal in its air-gap mount, the phasing condenser (elimination control), the crystal shorting switch and the output

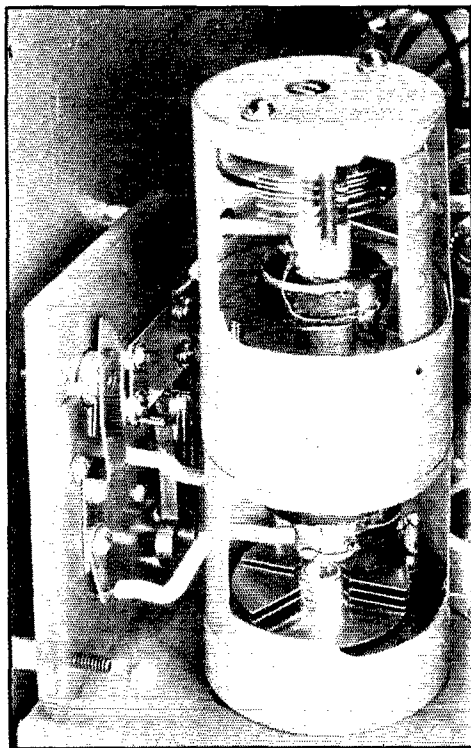

THE CRYSTAL FILTER ASSEMBLY IN THE "PRO" RECEIVER

The shielding has been cut away to show the transformer windings in the unit at the right. This unit replaces the normal first i.f. transformer of the receiver. The input transformer and tuning condenser are in the lower section, the output in the upper section. The filter panel, described in the text, is mounted behind the main receiver panel, at the left.

coupling condenser. The crystal mounts vertically in a hole cut through the panel, with its electrodes on either side. The panel thickness is made just right to give the proper air gap of approximately one-thousandth inch. As suggested in the schematic diagram, one electrode of the crystal is elongated to serve also as the fixed plate of the two-plate phasing condenser  $C_2$  and as one plate of the fixed output coupling condenser  $C_3$ . This arrangement gives very short connections in the crystal circuit and, at the same time, minimizes stray capacitance.

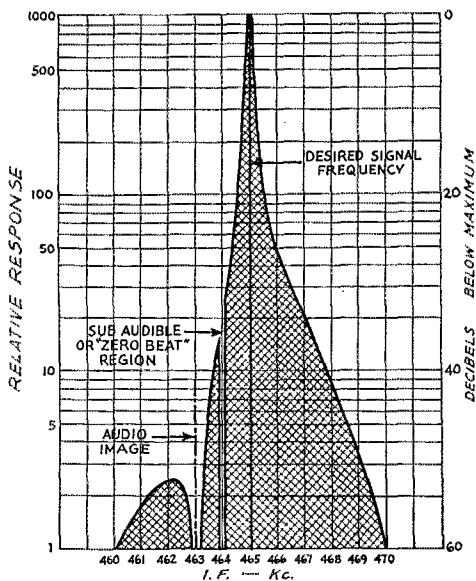

FIG. 3—AN EXCELLENT ILLUSTRATION OF SINGLE-SIGNAL SELECTIVITY

Measured selectivity characteristic of the crystal-type "Pro" receiver with the elimination control adjusted to suppress a signal 2 kc. below desired-signal frequency. The resonance frequency, to which the desired signal is tuned, is 465 kc. The local oscillator frequency is 464 kc., to give a beat note of 1000 cycles. Audio-image interference from a signal on 463 kc., also 1000 cycles different from the local oscillator frequency and 2 kc. below the desired signal frequency, is prevented by suppression at this frequency.

The primary of the input transformer is tuned, as is the secondary of the output transformer. The impedance ratios are 30-to-1 step-down on the input side and 1-to-30 step-up on the output side. The transformer coils are of the universal-wound type, the input transformer having its secondary wound over the primary in two equal sections symmetrically placed side-by-side. The low-impedance primary of the output transformer is a single-section wound over the high-impedance secondary. The respective transformers with their tuning condensers are shielded from each other and contained in separate sections of the unit shown at the right in the photograph. Both tuning condensers are of the air-dielectric type, that

of the input being adjusted from the bottom and that of the output from the top. The switch, controlled from the panel, shorts the crystal for straight superhet operation of the receiver.

A typical selectivity characteristic of the receiver operating with the crystal in circuit is shown in Fig. 3. In this instance the elimination control is set to make the circuit anti-resonant for a frequency 2 kilocycles lower than the resonance frequency. This is an especially good illustration of single-signal selectivity as applied to c.w. reception. The local oscillator frequency is 1 kc. lower than the signal (resonance) frequency, to give a 1000-cycle beat note. Ordinarily a signal 2 kc. lower than the desired-signal and 1 kc. lower than the oscillator frequency also would beat with the local oscillator to give an identical beat note, or would be the audio-frequency image of the desired signal. But in this case the filter has been made anti-resonant for this audio-image frequency and interference from a signal on that frequency is therefore practically impossible.

Although the selectivity might appear to be so high as to make 'phone reception impracticable, 'phone signals can be received intelligibly, although at considerably reduced strength, and can be cleared of heterodyne interference from one carrier by adjustment of the elimination control.

## Strays

W8BR and W1ADF keep a sked on 3.5 mc. for the purpose of checking up on the fly fishing in the Catskills and Berkshires. Fly-fishing hams interested in forming a network for the purpose are invited to get in touch with either station.

W6GXE has a unique method of smoothing out the beginning-of-oscillation "plop" that some times spoils the working of regenerative receivers. A lamp socket is put in series with the primary of the filament transformer and different sizes of electric lamps tried until one which results in smooth regeneration control is secured. The object of the lamp is simply to control the voltage on the tube heaters, of course. W6GXE's receiver operates most satisfactorily with about 1½ volts on the heaters.

In response to a number of inquiries as to the brand of copper-oxide rectifier discs used in the construction of the miniature rectifiers described in "A Sensitive Tuning Indicator" in May *QST*, W4IS writes that these were taken from a Westinghouse trickle charger. The units will be more uniform in characteristics if the soldered type of construction is used; there is some danger of cracking the copper oxide surface when the pressure-type unit is made up and differences in pressure are likely to result in different characteristics.

# The Old Man's Son Speaks Again

SAY, Warner, what's all this QRZ bunk you hear on the air lately? It nearly busted up our radio club meeting the other night!

We had a mighty fine program mapped out for the session. Final Authority was to talk on the advantages and disadvantages of molybdenum and graphite as an anode material. Radical had put enough nerve into one of the young squirts to get him to agree to tell us about how he was using some of the 2A5 tubes in rock oscillators. Pop persuaded Radical to let the young feller get his load off first.

Things came to order about seven-thirty, and right after the reading the minutes of the last meeting Radical pops up and introduces the young one. Well, this little feller was a college graduate and had been working with some of the Camden celebrities for a year or so and knew his stuff pretty well. He went into the calculus of push-pull and what not. Along towards the last of his spiel, after he had drawn all over the blackboard, he nonchalantly says that he can work all night on one CQ with his new rig. Well, I saw Pop's ears stick up and quiver and he nudges me in the ribs and says, "Pretty rotten, eh what?"

I looked over at Final and saw he was kinda squirming in his pants. I finally got Pop to breathing regular, but he didn't have much to say to anybody during the rest of the meeting. He seemed to be brooding.

Final Authority unloaded next and concluded that graphite has a great many advantages over the anode materials that the audion manufacturers heretofore have used, such as tantalum, nickel and molybdenum. Graphite has a much higher radiation emissivity which results in lower bulb temperatures which is equivalent to less danger of stain cracking and glass elec-

trolisis. Needless to say, we were all glad to learn that with proper methods of manufacturing we would have no sacrifice of tube life. Even Pop brightened up at that.

After a few routine matters and attending to some BCL trouble, the meeting ended and Pop and I headed home. Heretofore Radical, Pop,

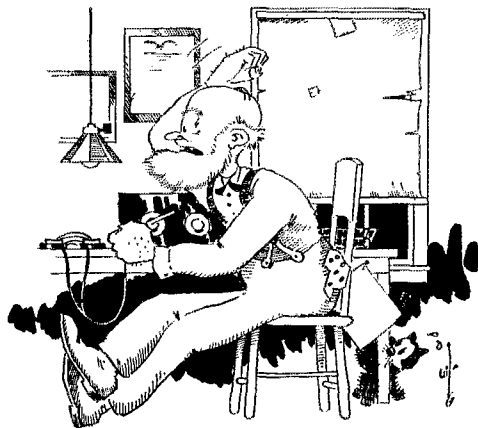

"BY GOSH, SON, I'D STILL BE WORKING SOMEBODY ON THE FIRST CQ THAT SPLIT THE ETHER OUTTA OLD BETSY IF I'D SEND A BLUE MILLION QRZ'S AFTER EVERY QSO"

Final and I had always left the club together, but Pop was in such a bad humor that there wasn't any use waiting on anybody. I had a hard time keeping up with him on the way home.

Kitty was waiting at the door, and as Pop walked in he spit right square betwixt her eyes. Pop sat down in front of the tuner and then he began!

"Yes, by gormy, work all night on one CQ, can he? By gosh, son, I'd still be working somebody on the first CQ that split the ether outta Old Betsy if I'd send a blue million QRZ's after every QSO. Son, get out the Wouff-Hong and hand me that bottle of Common-Sense Extract, because I'll be danged if I ain't gonna follow the directions on that bottle label and put a stop to all this darn foolishness."

It's not often that I can get away with telling Pop to do something, but I told him to go on to bed and I'd work the AC sked and that in the morning I'd write Warner a letter and see if something couldn't be done about this QRZ business.

See here, KB, the amateur has always juggled the Q sigs to fit his own purpose, and to good advantage. It looked like an impossible task ever to get the darn monkeys to look around over the band after they had put the SK, VA, 30, or what have you, to a fellow. They had a habit of calling

(Continued on page 80)

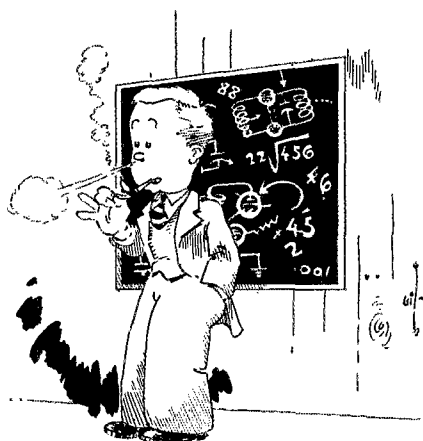

"—HE NONCHALANTLY SAYS THAT HE CAN WORK ALL NIGHT ON ONE CQ—"

# Byrd Expedition Gets Under Way

**A**MATEUR radio is again destined to play a big part in Antarctic Exploration. Most of the radiomen with the expedition are amateurs or ex-amateurs. Much of the communication will be with U. S. amateurs.

We were privileged to be able to board the *Jacob Rupert* in Boston just before she sailed. Amongst other things, a shipment of about 150 dogs had just been loaded. Their continuous CQing completed a scene of bedlam. John Dyer, WIBJD, Engineer in Charge of Radio Communication, was on hand directing the installation of the Collins thousand-watt transmitter. He had just remembered that while they had the necessary hundreds or thousands of tubes, condensers, resistors and machine screws, there wasn't a spare knob in the place. Something had to be done about it!

Under dyed-in-the-wool ham Dyer is Stanley Pierce, Assistant Communication Engineer, and the following operators: Guy Hutcheson; Clay Bailey; R. D. Watson, WIBGL, Carl O. Petersen and W. Waite. Watson is operator of the auxiliary barkentine *Bear of Oakland*, WHEW. Hutcheson is the operator on the freighter supply-ship *Jacob Rupert*, KJTY.

The *Bear* left Boston on September 25th bound for Bayonne, N. J., to take on oil and proceed southward via Panama. WHEW carries a 350-watt Federal Telegraph Transmitter, with regular ship telegraph frequencies in bands 375-500 kcs., also 5500-22,100 kcs. KJTY, with a 500-watt set works 375-500 kcs., and 2000-30,000 kcs. for commercial telegraph work, and also carried a Collins transmitter (1000 watts) which



GUY HUTCHESON, NOW OPERATING KJTY AND DESTINED TO BE ONE OF THE "ICE CREW" We'll hear plenty of this fellow's fist.

can be used on 2 to 30 mc. for telegraph, and on specific frequencies near 6660, 8840, 13,230, 17,620 or 21,600 kcs. for 'phone.

Both WHEW and KJTY are licensed to use the following high frequencies (for calling) and certain specified adjacent (working) channels, for telegraphy:

3105	6210	12,420
4140	8280	16,560
5520	11,040	22,080 kcs.

Communication will be primarily with coastal and maritime mobile stations, and secondarily,

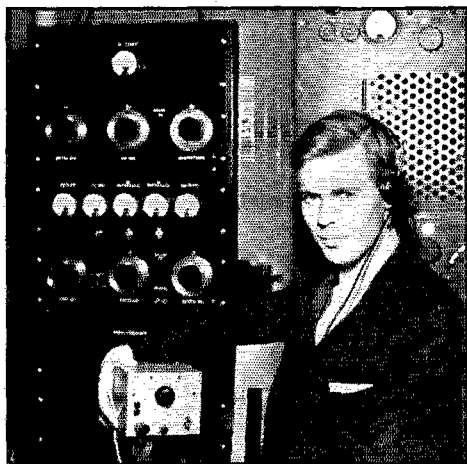

JOHN DYER, WIBJD, ENGINEER IN CHARGE OF RADIO COMMUNICATION, FORGETS HIS RESPONSIBILITIES LONG ENOUGH TO LET US SHOOT THIS LANDSCAPE OF A COLLINS TRANSMITTER, A HARVEY TRANSCEIVER AND THE HARASSED HAM HIMSELF

with amateur stations provided no pecuniary interest is involved, nor interference is caused with commercial communication.

Upon arrival at the ice barrier, most of the radio equipment will be dismantled and transported in various ways to the Main Base (several hundred miles from the barrier) and to the Forward Base (450 miles farther toward the Pole). The big Collins transmitter will be used at the Main Base, power supply being obtained by way of 5 kw. and 1½ kw. Kohler gas-electric units and a 100-volt storage battery (think of having to lug that along!). The forward base will be equipped with a Collins 150-B transmitter. All communication receiving equipment is National. The planes are to be equipped with W. E. transmitters and SW3 receivers.

This, of course, is by way of being just a preliminary announcement of the personnel and

(Continued on page 74)

# Putting the Type 800 Transmitting Tube to Work

## How To Use It In R.F. And Class-B Audio Circuits

By John L. Reinartz, W1QP\*

**D**ESIGNED particularly for amateur use, the Type 800 transmitting tube (announced in September *QST*) has characteristics fitting it admirably for r.f. operation not only on the ultra-high frequencies but also on the lower-frequency bands and for audio work as a Class B modulator as well. High insulation and low capacitances between the elements (grid and plate terminals are on top of the envelope) together with its other characteristics, permit operation at full rating on frequencies as high as 60 mc. (5 meters).

### OPERATION IN GENERAL

The general ratings and characteristics of the Type 800 are as follows:

Filament voltage (A.C.)	7.5 volts
Filament current	3.25 amperes
Amplification factor	15
Grid-plate capacitance	2.5 $\mu$ fd.
Grid-filament capacitance	2.75 $\mu$ fd.
Plate-filament capacitance	1.0 $\mu$ fd.
Maximum overall length	6 $\frac{3}{4}$ inches
Maximum diameter	2 $\frac{1}{16}$ inches
Bulb	S-21
Base	Medium 4-pin Bayonet

The base pins of the 800 fit the standard four-contact socket, which should be installed so that the tube will operate in a vertical position. The filament terminals are connected to the two large base pins; the grid lead and the plate lead are brought out to separate metal caps at the top of the bulb. Because of the heavy filament current taken by the 800, the socket should make firm, large-surface contact with the filament pins of the tube; heavy, well-soldered leads should be used for the filament-circuit wiring.

Flexible leads should be used to make connections to the grid and plate caps so that normal expansion will not place a strain on the glass at the base of the caps. Likewise, the caps should not be made to support coils, condensers, chokes, etc. Under no circumstances should anything be soldered to the caps, as the heat of soldering may crack the glass seals. Too much attention cannot be called to this precaution. Use flexible leads, heavy enough to handle the large circulating r.f. current which flows at high frequencies.

\* 176 Wadsworth St., South Manchester, Conn.

The filament of the 800 is of the thoriated-tungsten type; it is also quite husky, taking 3.25 amperes, and should be excited from an a.c. source, although a d.c. supply may be used. The filament transformer should have a power rating sufficient to supply the current necessary for the filament of the 800, at the rated voltage. A voltmeter should be connected directly across the socket terminals so that the filament voltage may be kept at 7.5 volts. Deviation from rated voltage may result in a loss of filament emission. With an a.c. source, rheostat control should be placed in the primary circuit of the filament transformer. During "standby" periods, the filament should be maintained at its rated voltage.

The rated plate dissipation of the 800 is 35 watts; at this load the plate does not show color. Under no conditions of operation should the plate be allowed to show even the faintest tinge of color. Overheating the 800 by severe overload

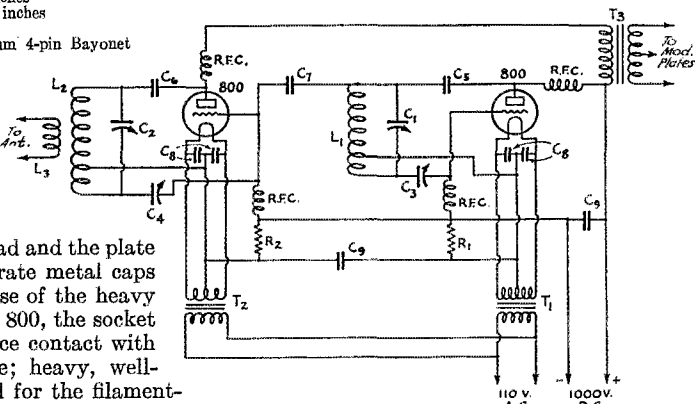

FIG. 1—CIRCUIT OF THE 28-MC. OSCILLATOR-AMPLIFIER TRANSMITTER USED AT W1QP

- $L_1$  and  $L_2$ —Oscillator and amplifier tank coils. Each 4 turns of  $\frac{1}{2}$ -inch copper tubing,  $\frac{1}{2}$ -inch diameter. Mounted on tank condenser terminals.
- $L_3$ —1 or 2 turn antenna coupling coil.
- $C_1$  and  $C_2$ —50- $\mu$ fd. variable tank condensers with Mycalex insulation and oversize terminal studs.
- $C_3$ —Oscillator grid condenser, 50- $\mu$ fd. midget variable.
- $C_4$ —Neutralizing condenser, approx. 10- $\mu$ fd. maximum.
- $C_5$  and  $C_6$ —100- $\mu$ fd. or larger fixed mica, 5000-volt type.
- $C_7$ —100- $\mu$ fd. fixed mica, receiving type.
- $C_8$ —0.001- $\mu$ fd. or larger, receiving type.
- $C_9$ —0.001- $\mu$ fd. or larger, 5000-volt type.
- $R_1$  and  $R_2$ —Each 2000-ohm 50-watt.
- RFC—Short-wave type r.f. chokes.
- $T_1$  and  $T_2$ —7.5-volt 3.25-amp. filament transformers.
- $T_3$ —Class-B output transformer.

may decrease filament emission but, unless the overload has liberated a large amount of gas, the activity of the filament may be restored by operating it at rated voltage for ten minutes or more with no voltage on the plate or grid.

In order to prevent overheating due to improper circuit adjustments or to overloading, the plate circuit should be provided with a protective device such as a relay or circuit breaker. In the long run, this is cheaper than buying new tubes.

Heavy leads and conductors should be used in all parts of the plate tank circuit, in order that the heating effects of the circulating r.f. current will be reduced. These heating effects are especially noticeable at the higher frequencies. Any insulating material, such as that employed in the

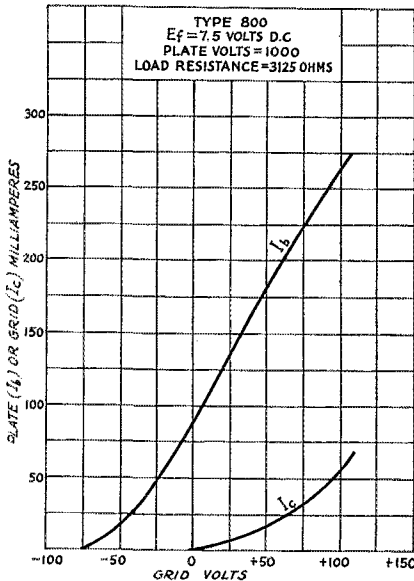

FIG. 2—TYPICAL CLASS-B CHARACTERISTICS OF THE TYPE 800

Note that there are no kinks in the grid curve.

tank condenser, should be suitable for high-frequency operation.

If more power output is required than can be obtained from a single tube, two may be used either in parallel or in push-pull. The parallel connection provides approximately twice the power output of a single tube without an increase in exciting voltage, while the push-pull connection gives twice the power output of one tube but requires twice the r.f. excitation voltage; with either connection the grid bias is the same as for a single tube. The push-pull arrangement is advantageous in reducing the shunting effect of the interelectrode capacities, inasmuch as these capacities are then in series with each other, although this is not especially important with

the 800. With parallel operation of two or more tubes, it is best to place a non-inductive resistance of from ten to one-hundred ohms in the grid lead of each tube, close to the grid cap, to prevent parasitic oscillations.

#### CLASS-C R.F. OPERATION

As an r.f. power amplifier and oscillator, Class-C telegraph service, the following ratings tell the story:

Plate voltage, d.c.	1250 (max.) volts		
Plate current, d.c.	80 (max.) milliamp.		
Plate dissipation	35 (max.) watts		
R.f. grid current	5.0 (max.) amperes		
D.c. Grid current	25 (max.) milliamp.		
Typical operation:			
Filament voltage (a.c.)	7.5 volts		
Plate voltage, d.c.	750	1000	1250 volts
Grid voltage, d.c.	-100	-135	-175 volts
Plate current, d.c.	70	70	70 milliamp.
Grid current, d.c.	15	15	15 milliamp.
Driving power, r.f.	2.0	3.0	4.0 watts
Nominal power output	35	50	65 watts

Just think, up to 65 watts tube output on frequencies as high as 60 megacycles! Because so much power is available, the boys at Headquarters advise m.o.p.a. transmitter operation on ten and five meters when these tubes are used. For full output, as little as 4 watts are required to drive one of these tubes in a good circuit. The driving power is, however, subject to wide variations depending on the impedance of the load circuit. High-impedance load circuits require more grid current and driving power to obtain the desired output. Low-impedance circuits need less grid current and driving power, but plate circuit efficiency is lowered. The driving stage should have a tank circuit of good regulation and should be capable of delivering considerably more than the required driving power. A splendid arrangement, used here at W1QP, is one 800 for the oscillator in a regular Hartley circuit to drive another 800 as an amplifier at 28 or 56 megacycles, and to modulate the p.a. stage with a pair of 10's in Class-B.<sup>1</sup> This arrangement provides sufficient audio power to modulate one 800 as an r.f. power amplifier at the allowable ratings given below:

Plate dissipation	23 (max.) watts		
R.f. grid current	5.0 (max.) amperes		
D.c. grid current	25 (max.) milliamp.		
Typical operation:			
Filament voltage (a.c.)	7.5 volts		
Plate voltage (d.c.)	750	1000	volts
Grid voltage (d.c.)	-100	-135	(approx.) volts
Plate current, d.c. (unmodulated)	70	70	milliamperes
Nominal power output	35	50	watts

#### CIRCUIT SUGGESTIONS

In both the oscillator and amplifier circuit of the transmitter used at W1QP (Fig. 1) the plate tank coils were  $2\frac{1}{2}$  inches outside diameter. As

<sup>1</sup> See "Quality Performance With Class-B Modulation," by A. A. Collins, May, 1933, *QST*, for information on Type 10 modulators and on Class-B modulator operation in general.—Editor.

the r.f. current at these high frequencies is of considerable magnitude it is necessary to see that all connections the plate coil has with the tank tuning condenser are heavy and make perfect contact. Otherwise losses will result from this source. Cardwell Type 197-B condensers are used to tune each tank circuit and Cardwell Type 201-E or Type 519 will do nicely as neutralizing and oscillator grid condensers. In the case of the plate tank condensers, Mycalex insulation is used. Also, the terminal studs are changed from 6-32 to 10-24 to be better able to handle heavy r.f. current without heating.

Grid bias is obtained through self-biasing resistors; this method allows automatic protection of the tubes, even when the r.f. excitation fails. These resistors could be variable and shunted with by-pass condensers. The value of such a resistor can readily be computed from the plate current and the grid voltage requirements and is in the region of 2000 ohms for 1 tube or 1000 ohms for two tubes. The dissipation rating in watts must be sufficient to handle the loss due to plate-current flow. To give a reasonable safety factor, the 50-watt type may be used.

R.f. chokes present no particular problem and may be of the type described many times in *QST*. Keep them in the clear so that there will be minimum capacity shunting effect. They are used in both the oscillator and the amplifier for shunt feed of the plate and grid voltage. Make the connecting leads short, of course, but do not hang chokes on the grid and plate terminals.

Inductive coupling to the antenna system is used rather than direct or capacitive coupling. Remember that you are dealing with high power and high-plate voltages, and that you cannot handle 1000 volts promiscuously. Treat it with respect and it will treat you well.

#### AS A CLASS-B MODULATOR<sup>2</sup>

The versatile 800, while having outstanding performance capabilities in radio-frequency service, is likely also to become popular with amateur 'phone enthusiasts because of its excellent performance as a Class-B modulator. Two tubes in a properly designed circuit are capable of modulating approximately 100 per cent an input of 200 watts to a Class-C r.f. amplifier. Most 'phone men will agree that a 200-watt plate-modulated

rig will do plenty in *any* band, 3900-kc. not excepted. Not the least consideration is the fact that a Class-B modulator with two 800's is an economical arrangement of delivering 100 watts of virtually undistorted audio output. The total harmonic distortion, with properly designed transformers and push-pull 2A3's for the driver, will be approximately 5 per cent.

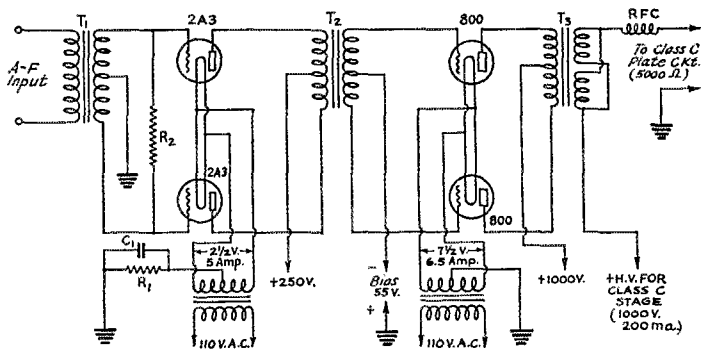

FIG. 3.—THE CLASS-B MODULATOR CIRCUIT FOR TYPE 800 TUBES

- T1—Audio coupling transformer, 3-to-1 step-up type.
- T2—Class-B input transformer. See text.
- T3—Class-B output transformer. See text.
- R1—375-ohm 10-watt resistor.
- R2—250,000-ohm 1-watt resistor.
- C1—20-µfd. 100-volt electrolytic condenser.

The question might be asked, why use 800's when a pair of 03-A's will deliver twice as much audio output? In addition to the higher cost, the 03-A's in Class-B put a peak plate-current drain of about 550 ma. on the power supply. Even with a choke-input filter this almost exceeds the peak current rating of a pair of 66's. The power transformer and filter chokes also must be quite husky to handle such high direct currents with adequate regulation. But the 800's require a peak plate current of only 200 ma. (approx.), which considerably simplifies the design of a satisfactory power supply, as well as permitting the use of less expensive parts.

#### Class B Modulator Ratings

D.c. plate voltage		1250 (max.) volts
D.c. plate input		85 (max.) watts
Plate dissipation		35 (max.) watts
Typical operation: (2 tubes)		
Filament voltage (a.c.)		7.5 volts
Plate voltage (d.c.)	750 1000	1250 volts
Grid voltage (d.c.)	-40 -55	-70 (approx.) volts
Static plate current (per tube)	13 14	15 milliamp.
Peak grid voltage	+121 +93	+77 volts
Peak grid swing	156 143	142 volts
Average grid current (per tube at full output)	17 10	9 (approx.) milliamp.
Peak grid current	77 47	37 milliamp.
Peak plate current	333 253	200 milliamp.
Average plate current (per tube) at full output	107 82	65 milliamp.
D.c. plate input (per tube)	80 80	80 watts
Load resistance (plate-to-plate)	6400 12,500 21,000	ohms
Nominal power output (2 tubes)	90 100	106 watts

<sup>2</sup> This information supplied by L. C. Waller from data prepared by the Applications Laboratory, RCA Radiotron Co., Harrison, N. J.

#### INPUT AND OUTPUT TRANSFORMERS

Two suitable driver combinations for a Class-B modulator using a pair of 800's are a pair of 45's push-pull Class-A or a pair of the newer 2A3's in push-pull Class-A. The transformer connections for either would be as shown in Fig. 3, the diagram of a Class-B modulator using 2A3's driving a pair of 800's in Class-B. The combinations would be as follows:

Two 45's to two 800's ( $E_b = 1000$  volts):

Input transformer ratio, total primary to $\frac{1}{2}$ secondary, 1.7 : 1.	
Driver plate volts, d.c.	275
Driver grid bias volts, d.c.	-56

Two 2A3's to two 800's ( $E_b = 1000$  volts):

Input transformer ratio, total primary to $\frac{1}{2}$ secondary, 2 : 1.	
Driver plate volts, d.c.	250
Driver grid bias, volts, d.c.	-45

The output transformer recommended is for coupling the Class B plates to either a 5000-ohm or 20,000-ohm load. The secondary of the transformer is in two sections, identically alike. The two are connected in parallel (aiding) for 5000-ohm load (Class-C amplifier input of 200 ma. at 1000 volts); or are connected in series (aiding) for 20,000-ohm load (Class-C amplifier plate input of 100 ma. at 2000 volts). The turns ratios of the output transformer are as follows:

5000-ohm load: $\frac{1}{2}$ primary to total secondary turns ratio, 1 : 1.29.	
20,000-ohm load: $\frac{1}{2}$ primary to total secondary turns ratio, 1 : 2.58.	

In both cases the plate-to-plate load on the 800 tubes is 12,500 ohms and the audio power output is 100 watts, when they are operated at plate voltage of 1000 and negative grid bias of 55 volts. As has been repeatedly emphasized, the matter of insulation in the output transformer is exceedingly important.

The circuit diagram shown in Fig. 3 is quite conventional and needs no special discussion. The modulator plate power supply should have voltage regulation of 10 percent or better from no-signal to peak-signal conditions. If the regulation is poor, the output will be decreased and unsymmetrical modulation will be likely, causing a broad interfering signal and impairing the quality. As a general rule it is better to have a separate plate power supply for the Class-B stage, because of these considerations.

### Strays

Here's a suggestion for a cheap lightning arrester from Lamar Allison, Emory, Va. Get a blown-out plug fuse (generally there are at least one or two around a ham station), screw into an ordinary porcelain lamp socket and mount on the window sill. Connect antenna and ground as with any other arrester. The gap in the fuse preferably should not be too great—a 64th of an inch will be about right—so pick out one that has been blown gently (!).

## Attention, 56-Mc. Crew!

ALL ultra-high frequency experimenters, in their wildest flights of imagination, must surely have thought of a radio-equipped airplane flying to some tremendous altitude and transmitting at known altitudes all the way up. We are not alone in having dreamed about such a stunt for years.

Well, dreams or no dreams, an amateur radio-equipped plane is to fly to 20,000 feet, making 56-mc. transmissions at every 500 feet. And it is to fly not just once but every day during the month of November. Mull that over fellows—an experimenter's dream coming true every morning for a month!

The plane is operated by the Meteorological Department of the Massachusetts Institute of Technology. Flown by Henry B. Harris, the ship will take off from the East Boston Airport at 7:30 a.m. EST. Transmissions will be made every 500 feet on the flight up. Contact with amateur stations will be attempted on the flight down. Each flight will terminate at approximately 9 a.m.

It need hardly be said that this will be the most interesting, the most comprehensive and certainly the most important series of tests ever attempted on the amateur ultra-high-frequency bands. Sincere experimenters will see in the program an extraordinary opportunity for ultra-high-frequency study. Because of our intention to gain the greatest possible benefit from the work we make a plea for widespread and continuous observation of the plane's signals. Logs containing the altitude of the plane, the signal strength and the time will be welcome at Headquarters, particularly if they are sent in immediately after each test. The full cooperation of the 56-mc. group is earnestly requested.

The plans for the program have been made possible by the kindness of Professor Rossby and Dr. Carl O. Lange of the M. I. T. Meteorological Department. Operators Arsenault and Murphy and Pilot Henry Harris will be in charge of the equipment.



# Further Notes on Licensing Procedure

By K. B. Warner, Secretary, A.R.R.L.

THE Federal Radio Commission in effect is recalling all portable station licenses issued to amateurs who also have "fixed" licenses. They are now unnecessary, since every "fixed"-station license now authorizes the holder to engage in portable operation. If you have only a portable license, it's still good. If you have both kinds of license, you are requested to mail the old portable license to the Commission at Washington for cancellation, and continue operation—fixed and portable—under the old fixed-station license *and call*. No application is required; you may simply mail it in and say you're surrendering it. *The Commission will not interchange old fixed and portable calls; no time, they say.*

The new application form went into effect October 1st. It is a double sheet of four pages containing 39 numbered questions. The first page relates to the operator application, the next page and a half to the station application, the remainder being devoted to the necessary affidavits or jurats. A space is provided to state whether the application is for new licenses, renewal, modification of license, or duplicate to replace a lost one. It may be used for station or operator alone, or the two in combination.

A request for modification or renewal of a station license only is sent direct to the Commission, not the inspector, regardless of where you live. But if it is accompanied by a request for modification of operator license as well, to a higher class, it goes to the district inspector. Principle: applications requiring personal appearance go to the field office; others direct to Washington.

A fellow living outside all the 125-mile circles does not have to content himself with Class C. He may go up for Class B (or for A if eligible) if he is willing to appear for personal examination. And of course he must do this to get the unlimited 'phone privileges carried by Class A.

Application forms are always to be procured from your district inspector, not from the Commission.

If you change address you may think that you need a new station license, but that isn't what the Commission calls it. You want a different license, it's true, but you should apply for a "modification of." You leave blank the operator part of the application, fill out all the spaces on the station part, and by context rather than by specific

stipulation the Commission will see what you require. Regardless of where you live, even if the same city as the inspector, you mail application for such modification alone direct to the Commission. You must accompany it with both your operator and station licenses.

If you apply for a higher class of operator license, you want a "modification of." Fill in the operator part, leave the station part blank if there is no change there. Such forms are returned to the inspector, because you must appear in person for examination. In that case you do not send in your existing licenses, but you take both of them with you when you appear for examination and then hand them over.

Any license sought to be renewed must be applied for at least 60 days before expiration, even an operator license. To escape reexamination this means that you must show activity (Rule 402) in the *one-month period* between 90-days-before-expiration and 60-days-before.

This 125-mile business applies to *any* of the 32 examining cities, even if in another call area. You must escape all of them to be eligible for Class C. But if you're not, you can go to any one you choose for your examination. Tell your own inspector which one, and if necessary he will forward the papers to the other inspector who will notify you when and where to appear.

While the active holders of First Class and Extra First Class operator licenses may renew them as they expire, the holder of a Temporary Amateur certificate does not apply for a renewal. He is not eligible, since TA's are not renewable. If you have a TA, you must take the new examination when it expires. You make application for a "new" license. Whether it is Class C by mail, or requires Class B and personal appearance, depends upon whether you are within 125 miles of an examining city.

Every active holder of an amateur operator license other than a Temporary is eligible for renewal as *Class B* without reexamination, even though residing more than 125 miles from any examining city. He must show activity and must apply 60 days before expiration.

No one not a licensed amateur operator may operate an amateur c.w. station. A commercial

(Continued on page 50)

# Automatic Gain Control for the Superhet

## An Effective System for Phone Reception

By James J. Lamb, Technical Editor

PROVISION was made for automatic gain control connection in the crystal-type s.s. receiver described in August and September, 1932, *QST*, and a number of autogain systems has been tried on the original model of this receiver. Without going into all the history involved, and without reciting the pros and cons of each system considered, we can summarize the qualifications that were found to be desirable in the a. g. c. system chosen. They are as follows:

1. Least possible complication of the receiver circuit in additional apparatus required and no impairment of its performance. The first point ruled out systems using a separate a. g. c. tube and the second eliminated the diode-type detector as the source of control voltage. The diodes took too much useful r. f. energy and spoiled the i. f. selectivity (considerations that b. c. receiver designers can neglect, perhaps, but all-important in high-frequency superhet practice).
2. Strictly linear rectification of the control voltage over the widest possible range, unaffected by a. f. modulation on the carrier.
3. Relatively small time constant in control, to take care of rapid fading.
4. Control to maintain output nearly constant over a wide range of signal strength variation, without handicapping the maximum sensitivity of the receiver for very weak signals.
5. Adaptability to switching autogain in for 'phone reception or out for c.w. telegraph, at pleasure of the operator. (Any system utilizing carrier control is worse than useless for telegraph reception.)
6. Freedom from motorboating and feedback troubles, and tolerance in adjustment.

### HOW THE SYSTEM WORKS

The system finally adopted and found to qualify highest on all these points is diagrammed in Fig. 1. This is an adaptation of the autogain system used in the diversity 'phone receivers of R.C.A. Communications at Riverhead, L. I.<sup>1</sup> The principle of its operation is simple. The d.c. component of the self-biased second detector furnishes the control voltage. This type of detector is quite linear in its rectifying action, more linear than any other in our experience. The plate d.c. increment is therefore proportional to the average amplitude of the r.f. grid voltage—which

means that the plate current variation depends on the carrier average amplitude and is independent of the modulation, at least so long as the modulation is properly symmetrical.

The plate current due to the carrier voltage flows through the resistor  $R_C$ , which is in series with the negative feed from the separate detector "B" supply. When the current increases with an increase in carrier strength, the supply side of this resistor becomes more negative and increases the bias on the r.f. tubes. To compensate for the excess minimum bias caused by the no-signal detector plate current flowing through this resistor, the grid-return lead from the r.f. tubes is brought back to a point on the potentiometer  $R_B$  which is sufficiently positive to buck out the excess negative voltage. With the set-up shown, this bucking voltage is in the neighborhood of 20 volts.

The time constant of the circuit is determined largely by the capacitance of  $C_A$ , which also serves as the a. f. plate-return by-pass. A condenser of 1- $\mu$ f. is generally satisfactory, giving a time constant of approximately 2/10 second; more capacitance can be used to improve further the bass note response but will slow down the autogain action. The small capacitance  $C_B$ , which also affects the time constant, is not absolutely necessary unless the potentiometer  $R_B$  happens to be of the noisy variety.

Trial of autogain on all four variable- $\mu$  stages, including the second i. f., indicated what seemed like over-control on the stronger signals. Application of control to only the first three stages was more satisfactory, and the latter connection is used as shown in the diagram. The grid return of the second i. f. stage may be directly to "ground," so that this tube is affected only by the manual control—which, by the way, remains operative (through  $R_C$ ) with the autogain circuit in action. The switch connects the grid returns of the controlled stages to the control circuit in the "On" position, and connects them directly to ground in the "Off" position, at the same time shorting out the control resistor  $R_C$ .

In adapting this system to the receiver, the plus-"B" connection of the second detector is brought out independent of the regular "B" supply, to the separate low-current supply required for the detector. The necessity for providing this separate supply might seem something of a hardship, but it really isn't. You can't get something for nothing. Any autogain system either requires

<sup>1</sup> Peterson, Beverage and Moore, "Diversity Telephone Receiving System of R.C.A. Communications, Inc.," *Proc. I.R.E.*, April, 1931.

that extra something in apparatus or extracts payment by handicapping receiver performance. A separate tube as a self-biased plate rectifier can use the common power supply. But it must rob voltage from other circuits, operate at skimpy plate voltage itself and extract r.f. from the detector input. The diode takes no plate voltage, but more than makes up in the r.f. energy it must

as well as it did before the changes were made. Switching the a.g.c. "On," turn the manual control,  $R_{11}$ , to maximum sensitivity and then set the bucking control  $R_B$  for maximum no-signal sensitivity, which will be at the point where background hiss is maximum (with the antenna disconnected). The plate current of the i.f. stage, indicated by  $M_2$ , will vary as the bucking control

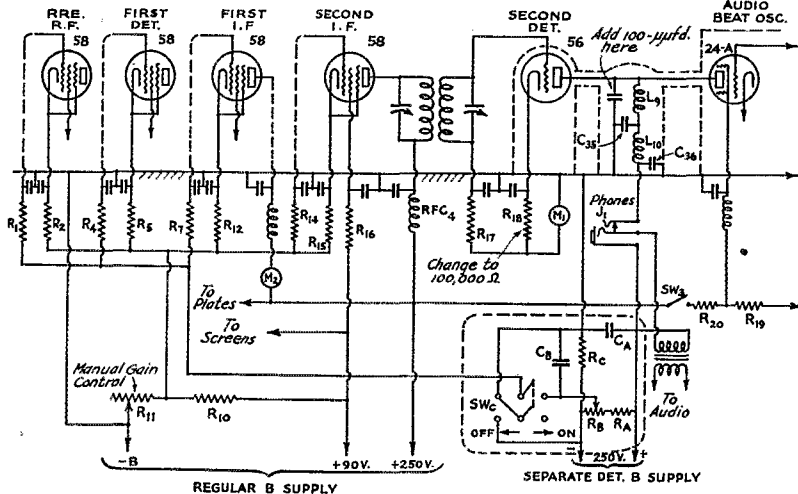

FIG. 1—CIRCUIT ESSENTIALS OF THE AUTOMATIC GAIN CONTROL SYSTEM OF THE S.S. RECEIVER

The principal elements are the ones circled by the dash line. Components other than those given below are as specified in the QST diagrams of the original receiver (Fig. 3, pp. 13, Aug., 1932; and Fig. 1, pp. 12, Sept., 1932).

$R_A$ —Bucking potentiometer bleeder resistor, 200,000-ohm 1-watt.

$R_B$ —Bucking potentiometer, 50,000-ohm variable.

$R_C$ —Control-voltage resistor, 100,000-ohm 1-watt fixed.

$C_A$ —1- $\mu$ fd. by-pass condenser.

$C_B$ —0.01- or 0.1- $\mu$ fd. by-pass (See text).

$SW_C$ —A.g.c. "On-Off" switch, d.p.d.t. jack-type or toggle.

$M_1$ —0-1 detector plate milliammeter (same as before).

$M_2$ —0-10 visual-tuning milliammeter.

be furnished. The present system calls for its own plate supply, but operates without taking anything from other circuits. The gains more than justify the small extra "B" supply required.

In addition to the 0-1 ma. detector plate-current meter  $M_1$ , a 0-10 ma. meter,  $M_2$ , is shown connected in the plate feed to the first i.f. stage. This meter serves as a visual tuning indicator, dipping to minimum reading when the receiver is tuned to resonance with the carrier, at which setting the control bias is maximum. It is not absolutely necessary but is very helpful. Comparing its variation with variation of second detector plate current shows how well the autogain is working, the detector plate current varying narrowly for wide changes in the i.f. plate current.

#### ADJUSTMENT AND CHECKING

When the wiring has been completed, including the minor changes in previous circuit components suggested in Fig. 1, switch the a.g.c. "Off" and check the operation of the receiver. It should work

is adjusted and should be approximately 8 ma. at the maximum sensitivity setting. With the antenna restored, when the receiver is tuned to a signal this current should decrease, dipping to minimum at resonance. On the strongest signals (including those from a local oscillator) the current minimum should be approximately 4 ma. Even with the very strongest signals, however, the second detector should not overload and its plate current should not increase to more than 0.4 or 0.5 ma. from its no-signal minimum of approximately 0.2 ma. (NOTE: With detector cathode resistor of 100,000 ohms). And the audio output should vary but little, even when tuning from a distant station to a strong local.

The autogain feature is most useful in ham 'phone operation, particularly with a really selective receiver in which the carrier of the desired station can be depended upon to keep control. In the less selective type of receiver autogain is not such an advantage, because strong carriers on neighboring frequencies are likely to

(Continued on page 35)



justment and efficiency when a minimum of parts is available. The only change from a straight Hartley transmitting circuit was the inclusion of two aluminum plates  $5 \times 6$  inches mounted on Isolantite and porcelain stand-off insulators to form a capacity across the tank circuit (thus forming the exposure field between the plates) in place of the usual tank condenser.

The range of the equipment was between 18 and 60 meters. Within this range a series of experiments was conducted to determine the frequency index with reference to the time of paralysis and weakness of fruit flies. It was observed that at frequencies below 6000 kc. internal heating took place without affecting the muscular and nervous systems or causing other physiological reactions. It is possible that the electrical field produced by the oscillator at frequencies lower than 6000 kc. was insufficient to produce the more acute symptoms. At frequencies higher than 6000 kc., not only internal heating, but also other physiological reactions were noted. Results showed that as the frequency is increased the time factor is decreased proportionately. This fact, however, is dependent upon the power output characteristics of the oscillator and must not be taken as proof of an absolute dependence on frequency for the time required to produce paralysis. (See Figs. 2 and 3.)

It was observed also that the number of flies in the field changed the time factor almost proportionately. (The time factor is the period in which the abnormal conditions reach a point where change may first be observed.) This result is perhaps surprising because the output circuit of the oscillator (the exposure condenser and its connections) was far from resonant at all frequencies used. The following may offer explanation of these effects; the change of effective re-

but no positive statement can be made as to the relationship of temperature to the frequency gradient.

Adult fruit flies were exposed to radio waves of the order of 15,000 kc. at 1.5 amperes for time intervals of 1, 2, 3, 5, 10, 15 and 20 minutes. From

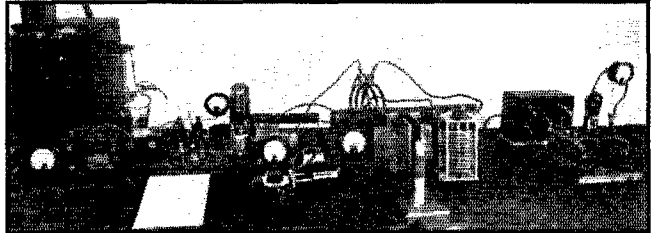

SPECIMENS ARE GIVEN RADIO-FREQUENCY TREATMENT BETWEEN THE PLATES OF THE TANK CAPACITOR ON THE PANEL OF THE 50-WATT OSCILLATOR

The low-power ultra-high frequency oscillator is at the extreme right.

a series of experiments in which 1000 specimens were used for each time interval, it was found that an exposure of from one to five minutes was sufficient to produce definite effects on the length of the various stages of development and on reproduction. Exposures exceeding five minutes proved lethal to the flies a few days after exposure. The effect of these 15,000 kc. radio waves did not show definite changes in the reproduction until the third generation. The third generation of the flies exposed for periods of 1, 2, 3 and 5 minutes all developed into males! There was no apparent increase or decrease in the number of offspring of the exposed as compared with the normal checks. When larvae (maggot stage) were exposed for from 1 to 10 minutes, they pupated (went into resting stage) but flies did not emerge. The exposure of pupa for a period of one or more minutes proved lethal. Adults exposed to ultra-high frequencies (from 1.7 to 3 meters) showed marked reactions but these reactions were not constant, probably because of the low power of the equipment.

Of course, all this is a mere beginning to what it is hoped can be accomplished. There can be endless experimentation with fruit flies alone, not to mention thousands of other insects.

### Automatic Gain Control for Superhet

(Continued from page 33)

take the control away from the desired signal and, by their fading, make the fluctuation in the desired signal worse than with no automatic control at all. This system is adaptable to other receivers of similar stage line-up, of course, provided they have a similar second detector. It also can be applied to t.r.f. receivers; but it will not be practicable in any receiver that offers less than two variable-mu r.f. tubes on which the automatically controlled grid bias can work.

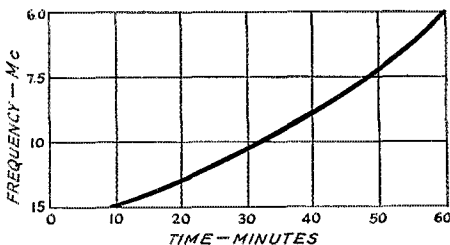

FIG. 3 — TIME-PARALYSIS CURVE FOR THIRTY SPECIMENS PER EXPOSURE

sistance (power loss), the presence of moist tissue of the flies and the shielding effect of the flies upon each other. Internal temperature is an important factor when the frequency is high or low,

# C. C. C. and the Amateur

By Garland C. Black\*

**C** C. C.—these are letters one finds in almost every newspaper to-day. It is a title now familiar to all of us. When the president established the Civilian Conservation Corps this past spring it was not foreseen that this would provide another field for the amateur to serve the populace. In some specific instances it is possible that members of our fraternity met the announcement with a welcome since it afforded an opportunity for earning a living during the then existing emergency; to work as a laborer in the nation's forests, not as a radio operator. However, radio communication is proving a large factor in making the administration of the forest camps the success it is. It is also doing a great deal toward boosting the morale of the camp personnel by affording a direct channel of communication between home and camp. Letter mail in many instances requires considerable time to get through. Some of the forest camps located in the western states are more than a hundred miles from a railroad station, and in such cases the roads are not always the best. Such is the field open to the amateur.

Just what is the complete C. C. C. picture? To begin with, the total strength of the Corps has recently been announced at 301,575 men. This number comprises 240,000 young unmarried men from civil life, 34,375 experienced foresters, 2200 veterans recruited from Bonus Marchers, and 25,000 veterans. By executive order the War Department was given the task of receiving this personnel in concentration camps in various locations throughout the United States, making the necessary physical examinations, clothing and equipping and organizing into units or companies under the administration of army personnel for transfer to and duty at the forest camps.

This was accomplished by using the existing military organization set-up which divides the United States into nine corps areas. Each corps area commander was charged initially with administration of the concentration camps within his corps area and initiating the rail movement of the organized companies to their forest camp, and then with the administration of the camps finally located within his corps area.

The total number of camps has recently been announced as 1430. Of this number 459 camps have been spotted in the 9th Corps Area which includes the states of Washington, Oregon, Idaho, Montana, Wyoming, Utah, Nevada, California and a part of Arizona. Since this territory contains numerous and large national forests it is logical that most of the camp sites are located here. The

\* Liaison Officer, Signal Corps, Washington, D. C.

remaining 971 camps have been spotted throughout the other eight corps areas.

Therefore to peruse the activity of the amateur it will best serve as a criterion to consider the situation in the 9th Corps Area. First it might be well to point out the fact that the volume of radio traffic handled by the War Department was greatly increased by the creation of the C. C. C. In many nets it doubled and trebled. This required pressing into duty all available soldier operators, leaving none available for assignment to the C. C. C. headquarters as was done in the case of company officers and enlisted clerks, cooks, and supply personnel.

The Commanding General of the 9th Corps Area upon recommendation of his Signal Officer elected to meet this situation through the services of the Army Amateur Radio System of his corps area. The initial plan provided for the 9th Corps Area Army Amateur Net to release its frequency of 3497.5 kcs. for use in a C. C. C. Net, and return to 3846 kcs.; establish twelve stations to be operated by army amateurs located at twelve C. C. C. District Headquarters at places other than radio equipped army posts. The Chief Signal Officer of the Army approved the use of 3497.5 kcs. and 6900 kcs. for this purpose and also the assignment of station calls consisting of WUB with a fourth letter added. The local representative of the Federal Radio Commission sanctioned the use of these amateurs and their equipment, provided the traffic handled be on government frequencies and with government station calls. Further assistance was given by certain C. C. C. funds being made available for tubes, crystals and antenna equipment for all stations.

The corps area commander next secured through district commanders and state representatives of the Department of Labor, the enrollment of twenty-four army amateurs. These amateurs were selected for their operating ability and the fact that they possessed suitable radio sets. Twelve of these took with them crystal-controlled transmitters of 50-watts output or better. In several cases selected men did not reside at the headquarters where they were to be employed, and were transported there by the C. C. C. The list of operators, and the headquarters where employed, follows:

*Sacramento, California*—WUBA  
Graham Van Patten ... W6CQM ... Glendale, Calif. .... with set  
S. W. Purcell. .... W6ENA ... Fresno, Calif.

*Redding, California*— WUBB  
Morris B. Spillard. .... W6BSV ... Hollywood, Calif. .... with set  
R. E. Longaker. .... W6DNA ... Lancaster, Calif.

(Continued on page 82)

# The A.R.R.L. Official Phone Station Appointment

By F. E. Handy, Communications Manager

A NEW A.R.R.L. field organization appointment, for qualified radiotelephone operators is announced herewith. The Official Phone Station Appointment somewhat parallels ORS appointment. It is for every live-wire operator of a first class phone, working any phone band. Like all other C.D. appointments, one makes application to the Section Communications Manager<sup>1</sup> for O.P.S. appointment, and receives the necessary application forms. A certificate of appointment is issued by the SCM if and when an appointment is granted. Appointments are issued good for one year, but may be kept in effect by activity and annual endorsement by the SCM.

The new appointment gives phone operators the advantages of more complete organization, readiness for systematic coöperation in emergencies, and quarterly bulletin news. Operating tests on a national scale are planned for as soon as enough O.P.S. are signed up. By mid-January we hope there will be a sufficient number of O.P.S. lined up in each Section to make a first quarterly get-together and test for all phone station appointees possible. The necessary forms and certificates are now ready. The purposes, requirements and qualifications will be covered herein. Phone men are invited to get in touch with SCMs if interested.

O.P.S. appointment does *not* stress traffic handling by voice, but rather aims to set up a voluntary acceptable "operating code" for phone men to follow. The new appointment should add to phone operating enjoyment by helping to formulate good operating practices for regular operating, at the same time not overlooking the emergency organization aspect. O.P.S. appointment should establish new ideas and standards to better phone bands, thus making voice work more enjoyable and systematic. Official Relay Stations have had quarterly tests or QSO Parties for several seasons. There is keen interest in this organized operating activity, station reports from which are returned to each appointee with the following bulletin. We now wish to extend the same benefits that ORS have in their get-togethers to a qualified group in the phone bands. It is just as much of value to phone men to work together in this fashion and should assist in maintaining regular contacts between key stations,

facilitating emergency tests at any time within a nationwide group.

Official Phone Station appointment differs from Official Relay Station appointment in that the operators are *not appointed specifically to handle traffic*. Of course when traffic is handled these stations observe the same high standards of responsible operating work; they will therefore at all times coöperate with SCMs and RMs by

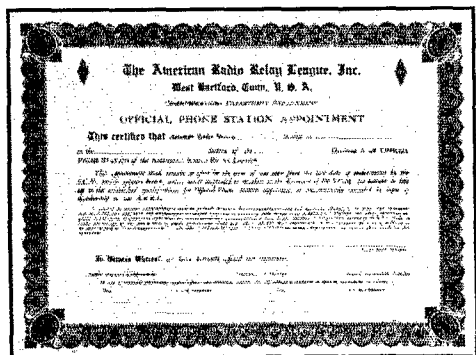

prompt dispatch or delivery of any traffic that may be sent via the phone bands. Stations holding O.P.S. appointment will, of course, insist on complete addresses, and give city of origin and number each message carefully in accordance with A.R.R.L. procedure—see pages 187–189 *Handbook*; also follow international phone procedure to insure full *accuracy* in such messages as handled. Page 183 of the 10th Edition *The Radio Amateur's Handbook* covers such procedure completely. In ordinary voice work it is hoped that supplementary helpful and common sense practices may be worked out for adoption by the O.P.S. group, to be recommended for all phone operators. Such a code of operating practices will doubtless be at least a year in the making, and will be worked out through suggestions and discussion in O.P.S. bulletins by O.P.S. themselves, to insure thoroughly practical, acceptable, and helpful voice operating technique.

Official Phone Station appointees must endeavor to live up to the Amateur's Code of good fraternalism and operating equality regardless of individual high power or low power, or what particular band is used for operation. The "race for power" should be supplanted by improvements of operating adjustment of stations and adoption

<sup>1</sup> See page 5, this QST, for complete list of A.R.R.L. Section Communications Managers which includes the address of the elected official for your A.R.R.L. Section.

of such good operating procedure that success for all concerned may result from "coöperation, coördination, and consideration"—which are results of organization.

The application for O.P.S. appointment does not require a 15-w.p.m. code speed such as prescribed in the test for O.R.S. applicants. Applicants must have had at least one year of amateur operating experience. A description of the station for which appointment is sought must be given the SCM whereupon, if the arrangement meets modern technique, if the operating experience is adequate, and if the adjustment of the station checked by inspection, or test over the air, is also approved, the A.R.R.L.-O.P.S. appointment may be granted by the SCM and Headquarters so notified at the same time the appointee receives his certificate. The station signal, and its operation too, must meet satisfactory standards. Appointments may be cancelled for inactivity, or failure to meet prescribed qualifications (like all other A.R.R.L. appointments) to make the O.P.S. appointment really stand for something worthwhile to all voice-operated amateur stations. Under the Constitution and By-Laws of the League, the provision that no person *not a member* is eligible to hold appointment, must also be observed by the SCM in granting appointments. Each Section Manager will give personal attention to applications for this new appointment, and may also appoint a qualified representative (usually known as the Phone Route Manager) who will assist him in necessary station inspection or test-over-the-air for O.P.S. applicants.

The appointment will mean that:

1. O.P.S. use circuit precautions that avoid frequency modulation and overmodulation, and employ indicators in their transmitters to assist in detecting and correcting such maladjustments, at all times.

2. O.P.S. coöperate with each other, and with all other amateurs, regardless of power, frequency band used, or whether voice or telegraph is used.

3. Major adjustment of transmitters should be performed outside of heavy operating hours.

4. Testing should be performed using dummy antennas, and radiating antennas should be used only for bona fide voice communication—not needless record playing or knob twisting performed under the guise or excuse of legitimate testing. (This increases QRM and reduces the pleasure and profit in radio work for all amateurs who use voice operation, and may be regarded as a mere exhibition of selfishness.)

5. No "monopolization" of a frequency channel by an individual operator is permissible, excepting such a situation is demanded by emergency conditions at a station in an isolated area.

6. O.P.S. will agree to report their activities monthly to the particular Section Communications Manager of the A.R.R.L. in whose jurisdiction their station may come.

7. O.P.S. will endeavor at all times to make the operation of their stations an example to be looked up to by other amateurs; they will stand ready to assist other amateurs in observing frequency bands, in complying with F.R.C. regulations, in adopting and furthering common sense, effective, voice operating procedure as formulated and codified by the group of O.P.S. for the benefit of all, and the furtherance of radiotelephone and general operating work.

With the increase in the number of licensed amateurs the need for a uniform code of operating procedure for radiotelephone operation has increased. The request of phone station operators for some such suggestions moved the League to start work on this problem some time ago. Exchange of correspondence and discussion of these matters direct with the men behind the microphones of representative phone stations has resulted in a number of suggestions and finally in the O.P.S. appointment itself. For all constructive comment on points used in the tentative code presented herewith, we give grateful acknowledgment. The O.P.S. appointment is here. We hope many amateurs who are regularly active on the different phone bands will make application for the new appointment, and that all operators who use voice will be able to make use of the suggestions codified to improve operating conditions in the phone bands. It will be up to the group of O.P.S. appointees to discuss the points involved, come forward in their bulletin with further constructive suggestions, and through their standard of operating, to benefit all amateur operating.

The Official Phone Station appointment has been approved throughout the A.R.R.L. field organization, where some of these details have been under discussion since last February. The appointment is for every qualified ham who normally uses his "mike" more than his key in his amateur station, and who takes a pride in the manner of signal he puts on the air, and aims to have his station really accomplish worthwhile communication work.

If you have a year or more of radiotelephone operating experience behind you, and a well adjusted voice station of modern technique on the air, this is a cordial invitation to you to get in touch with your Section Manager. Tell him you are interested in the Official Phone Station appointment, as explained in this *QST* announcement. Ask him for application forms to fill out and return so he can consider the matter.

## Strays

In the report on the Chicago World's Fair Convention in the October issue, well-known J. B. Wathen III of Mockingbird Valley, Kentucky, was erroneously described as RM for Virginia. Our apologies, OM; your appointment could certainly be in none other than good old Kaintuck!



# When the World's Radio Speed Title Changed Hands

Some Impressions of the World's Fair Contest

By I. S. Coggeshall\*

WHEN "Bill" Schweitzer, W9AAW, asked me to serve with Lt. A. A. Hebert, W1ES, and Lt.-Com. F. H. Schnell, W9UZ, as a judge in the speed contest at the World-Wide Amateur Convention in Chicago, I expected that there would be a fine gathering of hams present, but I hardly foresaw the size and enthusiasm of the crowd that showed up to enter the speed contests. The contest committee had gauged the situation fairly accurately by providing 200 pairs of "cans" to be put in parallel across our 1000-cycle G.R. oscillator—yet even that estimate of requirements proved inadequate and we had to run the preliminaries off in two heats. More than 250 CQ-ers showed up, either to copy or to make marks on sheets of paper, in competition for silver trophies in eight classes, beginning with 8 words a minute and ending high up in the 50's.

The preliminary classification took place on August 4th in the Minaret Room of the Mininah Michigan Avenue Club, where the banquet tables had been arranged "in series" and fitted up with a great conglomeration of pads of paper, headphones and typewriters. Tests, run from an automatic Wheatstone transmitter, began at slow speed. In spite of the fact that everyone felt he was the "champ" and was just "rarin' to go," more than half the 250 proceeded to sort themselves into the 8- and 15-word pigeonholes. Some of the copy was good—some wonderful to behold—scrawled, printed (apparently with one hand tied behind the back), or pounded out on the "typewriter" with all sorts of bizarre effects. Some of the boys listened to the 8-words-a-minute transmission, and evidently not believing a word of it, turned in their papers with nothing on them but their entry numbers. One lad, more frank, endorsed his boldly, "Too much World's Fair." But some of the amateurs were good—surprisingly good. It was not unusual to find splendid copy, in perfect "fist," turned out at 30 words a minute. One man, indeed, made the 40-word class, although it must be admitted that at that speed his handwriting had passed the stage of cracking up and his pencil was writing like a piece of chalk. Several other amateurs, using typewriters, also "made" the select group of eight men who were to fight it out to the finish in the high-speed class. Since this was to be an

"open" championship for the world's speed title, the "pro's" were also present in the A class, including T. R. McElroy, of Boston, who as a 1922 champion was presented to defend his record.

Next day came the run-off. The transmitter, fed with tape prepared and sealed in New York in the presence of Inspector Manning of the Federal Radio Commission and opened by Inspector Hayes at the scene of the contest, had a voracious appetite that grew rather than diminished with increased feeding. Here was the Machine that was going to be pitted against the skill of Man to a conclusion known in advance. A twist of the wrist and the machine would leap forward, faster and faster—one by one the men would crack, until at last the machine would still be going but the men, conquered, would be taking what consolation they could get from how long they could keep up with the transmitter's inexorable pace.

For the benefit of those who could not be present at the contest (and it is regrettable that the judges were forced by circumstances to deny admittance even to many present at the convention), I shall attempt to record my impressions of the transmission, as the tape is speeded up:

At 8 words a minute, you sit back and twiddle your thumbs, you yawn, and wish to heaven that that "lid" would get off the air. At 15, you take up your pencil and leisurely jot the stuff down on a piece of paper. At 20, you see the first signs of life. For a minute or two you sit back and copy, and then, on second thought, you hitch your chair forward a bit and straighten the paper. At 25, you quit "laying behind"; you decide to close the gap until you are about a word behind the sender. Not so bad, now. At 30, the fun begins. You can read it all right, but the pencil seems to be getting a little sluggish—better make a grab for a "mill." At 35, you begin for the first time to think about errors: "How many am I allowed on a 5-minutes' run of this?" At 40, it gets hotter, and darn suddenly, too. The last 5 words a minute have more mustard on them, it seems, than the first 30. You are holding your own with many a crack commercial radio or telegraph operator now. You quit worrying about single wrong letters and start hoping you can put a typewritten line down without leaving a word out. At 45, the jig is up. You quit, but half a

\* Western Union Telegraph Co., New York.

dozen of the champs go on. You make a grab for the transcription (if a judge), and by dint of much mental agility you may contrive to "follow" the transmission, but you are glad you are no longer trying to put it on the typewriter. At 50 words a minute, the dots and dashes get blurred and jumbled. The letter O, instead of being designated by three ordinary dashes, comes through as one dash, and that one exceptionally staccato. The common "and's" and "the's" whiz by undeciphered. At 53, it is just a lot of static—no sense now in trying to hear anything. Above 55, there is no change. Just as easy to read the QRN with the tape upside down as right side up in the transmitter.

And so the contest goes. Little Jean Hudson, just past her 9th birthday, pounds an Underwood and gazes around the room nonchalantly at 25 words a minute. Suddenly her typewriter jams under her too-enthusiastic touch; the tears stream down her cheeks as she frees the bars—but little "brick" that she is, she picks herself up to win in that class with only one word missing. Nice little girl, Jean, who told me that although she preferred copying code to doing her arithmetic, she liked playing with dolls better than either! The news photographers single her out, together with "Mac," the record-holder, and hold up the show until the flashlight powder gives out. As each group finishes its contest, the contestants file from the room, finally leaving the eight contenders for the Class A championship in almost solitary grandeur. J. C. Smyth, a Western Union cable operator from New York, and also a 1922 holder of the championship, now puts on an exhibition of receiving 5-letter solid cipher code correctly at the rate of 45 words a minute, making amateurs out of all the other contestants and thus putting them on more equal a spiritual footing for the speed grind to follow.

Half an hour sees the big event begun and ended. Transmission was for exactly five-minute intervals as read and checked on stop-watches and recorded on an undulator. From 40 words a minute the speed was boosted to 45, then to 50 and 53. After that the copy was laboriously counted, letter by letter, for accuracy of speed determination, so that it is definitely known that the next higher speeds were exactly 54.1, 57.3, and 61.6 words a minute. At each change of speed the contestants listened to some familiar tape, followed immediately by the fresh test tape, which was in plain English, containing no figures, and only the simplest of punctuation. The material had been taken from Chicago newspapers and carefully edited from a telegraphic point of view.

After the 61.6 test, all contestants were holding up the QRS sign, and agreed they wanted no more. The smoke died down, the papers were turned in unretouched, and the judges, spurred

on by the popular clamor to know the results, retired to their chambers to grade the papers and make the awards.

The rules of the contest provided that of the total number of characters transmitted in five minutes, not more than 1% might be incorrectly transcribed—added, omitted, or overtyped letters each to be counted as an error. On this basis, the 61.6 w.p.m. run was at once thrown out, as all contestants had made more than the 15 errors permissible at that speed.

The next lower run, 57.3 w.p.m., proved to be the championship, for here one candidate, known to the judges at the time simply as "No. 336," came through with only 11 errors out of an allowable 14. Count showed that 1432 characters, or 286 $\frac{2}{3}$  5-letter words had been transmitted. At the next lower speed, 54.1 w.p.m., No. 336 had only 5 errors. At this speed, the next best man, No. 374, had 8 errors, also within the allowable limit.

At the great banquet, which by the time the judges had finished grading all eight contests was at the height of its brilliance (for the food was all gone and oratory was in full flower), the results were announced. Amid wild acclaim, No. 336, the new World's Champion, was identified as Joseph W. Chaplin, radio operator of Press Wireless, Inc., New York; and No. 374, the runner-up, as Theodore R. McElroy, formerly operator of Western Union and the Associated Press, Boston. Chaplin was presented with a solid silver loving-cup, standing 22" high, to signalize his achievement of breaking McElroy's record which for 11 years had stood at 56.5 w.p.m., with 1 error on a 3 minutes' run.

The Chicago speed contest of 1933 will go down in the annals as closely fought, and was particularly happy in that it established a new high for speed. The A.R.R.L. is to be congratulated both on staging the event and in furnishing so much amateur competition of championship calibre. Who among this year's contestants, I wonder, will prove to be the Bobby Jones of amateur radio, to meet and to beat the "pro's" in open tournament and place the Big Cup where it rightfully belongs—in the midst of a flock of QSL cards in a real ham's shack?

## Strays

R.F. chokes might often do better if so much temptation was not placed behind them. At W9ADG when the plate supply was run to the transmitter in grounded conduit the chokes showed considerable soup on the wrong end. When the leads were draped haywire fashion about a foot from the floor (basement), the chokes tested OK, the plate current went down, and the output way up. Just stepping on the plus cable, thus holding a length on the concrete, raised hob with things on "20."

for the

# EXPERIMENTER



## Metering Several Stages

When economy is desirable in a multi-stage transmitter, it is common practice to use a single current-meter terminated with a plug which can be inserted in jacks connected in the circuits where one wants to read the plate or grid currents. If a common supply is used for the plate or grid voltages an alternate method suggested by the diagram, Fig. 1, may be employed. A dummy plug (metal rod or short circuited plug) is inserted

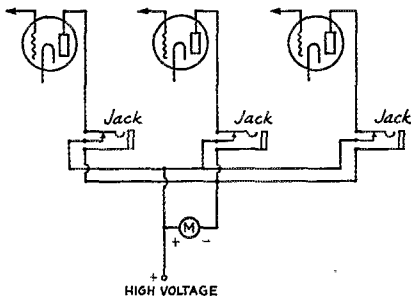

FIG. 1—A PLUG-AND-JACK METERING SYSTEM IN WHICH NO FLEXIBLE CORD IS REQUIRED  
Single closed-circuit jacks are used.

into the jack of the circuit which it is desired to read.

The necessary resistances to give the correct voltages to the different tubes may be placed in the circuit on the tube side of the jack. One meter should be used for the plate currents and, if desired, another for the grid currents. Western Electric uses this method in some of their equipment.  
—W. B. Gould, 3rd, WINP

## 28-mc. Band-Spread Coils

Though these coils were designed for the National SW3 and 5, there is no reason why they will not work in any receiver employing six-prong coil forms. The detector coil, at least, should be six-prong, unless the screen-grid feedback arrangement described in detail in "Hints and Kinks" and in the January, 1933, issue of *QST* is used. It works to advantage on the higher frequencies.

Most owners of the SW5 have the black coils lying around. These coils are practically useless for ham work, since the 14-mc. band occupies only three degrees on the tuning dial. A very

good use is now found for them. With a few alterations, they can be converted into 28-mc. band-spread coils. Here's how:

**R.f. coil:** Take one turn off the grid winding, drill a small hole and pull the loose end through. Leave the other two windings untouched. Now two turns up from the bottom of the grid coil, drill small holes on each side of the wire, being careful not to break the fine-wire winding. Scrape the wire and solder one lead of a fixed 100- $\mu$ fd. condenser (the midget kind with pigtailed) to it; the other lead goes to the prong to which the top of the grid coil formerly was connected. This hooks the condenser in series with the tuning condenser as shown in Fig. 2. Now take a small Hammarlund trimmer condenser (EC-35) and bend down the large "ear." This is the "band-locating" condenser; it should then be connected across the ends of the grid coil. The top connection is made by drilling into the top side of the coil form and fastening the bent "ear" and the loose end of the coil, together with a flexible lead that goes to the control-grid cap on the r.f. tube.

The detector coil construction is the same with one exception—instead of the upper end the grid coil going to the band-locating condenser and the flexible lead as already described, a 100- $\mu$ fd. condenser, with a  $\frac{1}{2}$ -watt 5-megohm resistor across it, is placed in series with the free end of the coil and the control grid lead, also shown in Fig. 2.

When these alterations are completed you have some efficient 28-mc. band-spread coils. Set the 28-mc. band at about 125 on the dial by adjusting the band-placing condenser on the detector coil in conjunction with a frequency meter; after this is done vary the condenser on the r.f. coil to bring the two circuits into resonance. The r.f. coil setting is not critical, but proper adjustment helps to bring the two coils in step. The spread is about 60 dial divisions.

Those who do not have National coils or the SW3 or 5 will find the following table of coil dimensions useful:

### R. F. Coil Windings

Grid—5 turns No. 20 enamel wire space-wound 3-16-inch between turns, placed well up on the coil form.

Trimmer—3 $\frac{3}{4}$  turns No. 32 wound in between grid winding.

Antenna—3 turns No. 28 at bottom of coil form.

### Detector Coil Windings

Grid—Same as r.f. grid coil

Input— $2\frac{3}{4}$  turns No. 32 wound in between grid windings.

Tickler—3 turns No. 28 at bottom of coil form.

In all other respects the construction is exactly as described above.

A word about the input winding of the detector coil. The National coil has  $3\frac{3}{4}$  turns; I had to take off one turn so that the detector would oscillate in the old plate-feedback circuit, and

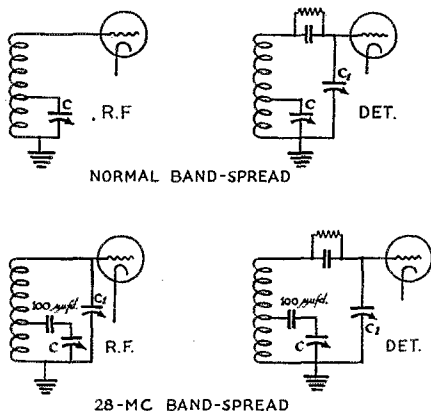

FIG. 2—WIRING OF THE 28-MC. BAND SPREAD COILS

The normal band-spread arrangement used in the National SW3 and SW5 receivers is shown above. For 28 mc., 100- $\mu$ fd. fixed condensers are connected in series with the tuning condensers (the tuning condensers have a maximum of 90  $\mu$ fd. in the National sets) and a mica trimmer is used on the r.f. as well as the detector coil.

found that it worked just as well as  $3\frac{3}{4}$  turns in the screen-grid feedback circuit so I left it that way. Five-prong coil forms will suffice for the screen-grid feedback circuit.

The trimmer winding is a big help on these coils, for it peaks the signals as well as acting as a trap for loud local QRM.

A 7-mc. doublet was found to be the best receiving antenna. The feeders go to the antenna and ground posts of the set.

—Clyde C. Anderson, W6FFP

### Finding the 28-mc. Band

That ten-meter band, where is it? Cut and try on the coils but nothing doing, no signals except harmonics from the e.c. frequency meter.

If we could only tell which harmonic we are hearing! We are hunting for 30,000 kc., which is the 15th harmonic of 2000 kc. So tune the meter to 2000 and zero-beat the receiver on the harmonic. Leaving the receiver set, tune the frequency meter—another harmonic! That looks interesting. The frequency of the fundamental of this harmonic is 1875 kc.

While tuning up the old think tank trying to zero-beat an idea, we start to play with the slide rule.

Now a slide rule is used to multiply and we do that little stunt. First we multiply 2000 by a number so as to give 30,000, the frequency needed; that number is 15. Then we try 1875—but look at that, we don't have to move the slide at all, as 16 is opposite 1875 and 16 times 1875 is 30,000.

Thus, if we wish to measure a frequency near 30,000 kc. we have only to note what two fundamental frequencies will have consecutive harmonics at that frequency; that is, as in the illustration above, the fifteenth and sixteenth harmonic of the respective fundamentals will be equal, i.e., 30,000 kc.

Run the slide along until two numbers coincide with the two fundamentals; then the end of the scale will indicate the frequency of the receiver. This stunt helped me on 14 mc. when a queer frequency jump occurred in my detector. It jumped right over the 14-mc. band, and only this method told me what was happening.

—C. E. Marsh, W6FFU

### Notes on Machining Aluminum

The increased popularity of aluminum has certainly done much to improve the appearance of amateur apparatus. However, it has often placed a severe strain upon the average amateur's ability as a machinist.

Aluminum does not seem to cut, drill or file like most metals. A drill seems to clog and merely force its way through the work, leaving a bad burr on both sides. The material is so soft that it mars and scratches easily, and though we start with a highly-polished sheet, our finished panel is apt to look like a war relic.

The first trick in avoiding these difficulties is to use a good cutting lubricant. Turpentine is best, but ordinary liquid soap is good. Use a medicine dropper or small oil can and keep plenty of lubricant in the drill hole; if the drill is sharp, the shavings will come out like steel shavings. Dip your file in turpentine and it will cut much more rapidly and will not gum up.

Aluminum's softness presents advantages as well as drawbacks. Large, or irregular shaped holes may be cut with an ordinary jig-saw, just as they might be cut in wood. Use a fine blade and do not force the work. Always use lead or leather covers for vice jaws, or else clamp the work between smooth blocks of soft wood. It is much easier to avoid dents than to remove them!

Avoid using a file on the face of a panel as file scratches are extremely hard to remove. Use a very sharp cold chisel to remove drill burrs or other irregularities.

Holes drilled in the wrong place may be easily filled with Alumweld solder. The only precau-

tions are absolute cleanliness and plenty of heat. Clean the hole with a jeweler's rat tail file and fill it with flux and chips of Alumweld, heating the panel with a blow torch. After filling the hole wash away any excess flux, as it is corrosive. Chip off excess solder with a sharp cold chisel and polish smooth with emery cloth.

The easiest and one of the most distinctive ways of finishing aluminum parts is by sand-blasting. This gives a crystalline satin finish, similar to ground glass. If some plant near you has sand blasting equipment, warn the operator to use old sand, only about 30 lb. air pressure, and to work from a considerable distance. This will largely avoid any danger of warping thin parts.

In case you wish a grained finish, start with emery cloth which is coarse enough to remove all dents and scratches. Keep the work wet with liquid soap to cut through any grease films or finger prints. Use increasingly finer grades of emery, finishing with the finest "wet or dry" paper, or with "French emery." If you have sufficient patience, the results will well justify the labor.

Screw heads and other brass parts on the front of the panel may be painted with aluminum paint. However, a much more satisfactory scheme is to have them chromium plated but not polished. Dull chromium plate gives a surprisingly close match to a grained aluminum panel and will last much better than the aluminum paint. Chromium plating of screw heads should cost less than 25 cents per hundred—less than the cost of a can of aluminum paint!

Aluminum may usually be obtained quite cheaply from a dealer in non-ferrous metals. If it is available, it would be well to consider using Duralumin. It is not prohibitively expensive and combines most of the valuable properties of aluminum and mild steel. It cuts like steel, has great strength, weighs but 8% more and costs about 50% more than aluminum. Very often panel thicknesses may be cut in half by using "Dural" with an actual saving in cost and weight.

—S. G. Lutz,  
218 Sheetz St., West Lafayette, Ind.

## A "Di" Scale for the Slide Rule

In a recent issue of *QST* it was suggested that a fixed *CI* scale engraved above the *A* scale on a slide rule would facilitate *LC* calculations. This scheme is good as far as it goes except for the unavoidable inaccuracies of amateur engraving.

A better plan and one saving much time if the slide rule already has a *CI* scale is to get either from a junk dealer or from the manufacturer of your slide rule an additional *D* scale. This is then glued on the shelf above the *A* scale with the ends opposite those of the *A* scale but in reverse order.

With this *DI* scale it is now possible to multiply and divide in reciprocals exactly as it is done on the *C* and *D* scales. The *DI* scale is upside down, but this is no inconvenience after a few minutes' use.

This plan was used recently using the *D* scale from a badly damaged slide rule of the same make and saved a great deal of time in a lengthy series of transformer calculations.

—R. L. Ives, 32 Laurel Pl.  
Upper Montclair, N. J.

## Blocked-Grid Keying to Eliminate Backwave

This keying system should be of interest to those who wish to use grid-leak bias on a medium- or high-power final amplifier stage and yet retain the advantages of keying in a low-power circuit. It is a combination of blocked-grid and center-tap keying that requires only one resistor to furnish the grid-blocking voltage. However, its development by the writer was to gain an entirely different end—to prevent the preceding amplifier from feeding through the final amplifier into the antenna, in an unshielded transmitter, by cutting down the power output of the preceding stage. The scheme shown in Fig. 3 was finally hit upon.

The transmitter in question consists of a 47 crystal oscillator, 46 buffer and 203-A final amplifier. Only enough of the apparatus to illustrate the point is shown in the diagram. A 40,000-ohm resistor,  $R_1$ , was inserted in series with the grid leak in the final stage, then the center-tap of the 46 stage was opened and the center-tap connected to the negative of the final stage. The negative of the 46 stage was connected to the grid end of the 40,000-ohm resistor. The key or relay is connected across the resistor. In this case a voltage drop of approximately 180 volts was secured across the resistor and the 46's plate current was reduced to about 4.5 mills. Therefore, we have

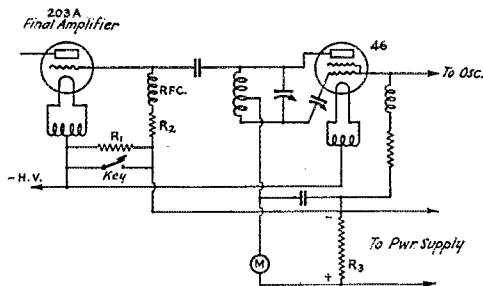

FIG. 3 — BLOCKED-GRID KEYING

The blocking voltage, which is applied to the grids of both exciter and final amplifier, is obtained by causing the plate current of the exciter stage to flow through the auxiliary resistor,  $R_1$ .

180 volts of bias on the grid of the 203-A and the power input to the 46 is reduced to about two watts with the key open. When the key is closed the circuits are normal with their negatives common.

Different setups will, of course, require different values for resistor  $R_1$ , and a variable resistor such as the Bradleyohm or its equivalent would be very convenient for adjusting to the proper value. Separate power supplies are necessary for the final and preceding amplifier stages. This system has been in use here only a short time but has proven very satisfactory so far.

— *Wm. B. Hann, W8GBC-INC*

## Standard Frequency Transmissions

Date	Schedule	Station	Date	Schedule	Station
Nov. 1	B	W1XP	Dec. 1	A	W9XAN
	BB	W9XAN	Dec. 2	BX	W6XX
Nov. 3	BB	W6XX	Dec. 3	C	W6XX
	A	W9XAN	Dec. 8	A	W6XX
Nov. 4	BX	W6XX	Dec. 10	C	W1XP
Nov. 5	C	W6XX	Dec. 13	A	W1XP
Nov. 10	A	W6XX	Dec. 15	B	W9XAN
Nov. 12	C	W1XP		B	W6XX
Nov. 15	A	W1XP	Dec. 20	BB	W1XP
Nov. 17	B	W9XAN		C	W9XAN
	B	W6XX	Dec. 22	B	W9XAN
Nov. 22	BB	W1XP		A	W6XX
	C	W9XAN	Dec. 27	B	W1XP
Nov. 24	B	W9XAN		BB	W9XAN
	A	W6XX	Dec. 29	BB	W6XX
Nov. 29	B	W1XP		A	W9XAN
	BB	W9XAN	Dec. 30	BX	W6XX
Dec. 1	BB	W6XX	Dec. 31	C	W6XX

### STANDARD FREQUENCY SCHEDULES

Friday Evenings			Friday & Sunday Afternoons		
Time	Sched. and Freq. (kc.)		Time	Sched. and Freq. (kc.)	
(p.m.)	A	B	(p.m.)	BB	C
8:00	3500	7000	4:00	7000	14,000
8:08	3600	7100	4:08	7100	14,100
8:16	3700	7200	4:16	7200	14,200
8:24	3800	7300	4:24	7300	14,300
8:32	3900		4:32		14,400
8:40	4000				
<i>Saturday Mornings</i>					
	Sched. & Freq. (kc.)				
	Time (a.m.)	BX			
	4:00	7000			
	4:08	7100			
	4:16	7200			
	4:24	7300			

The time specified in the schedules is local standard time at the transmitting station. W1XP uses Eastern Standard Time, W9XAN, Central Standard Time, and W6XX, Pacific Standard Time.

### TRANSMITTING PROCEDURE

The time allotted to each transmission is 8 minutes divided as follows:

2 minutes—QST QST QST de (station call letters).

3 minutes—Characteristic letter of station followed by call letters and statement of frequency. The characteristic

letter of W1XP is "G"; that of W9XAN is "O"; and that of W6XX is "M."

1 minute—Statement of frequency in kilocycles and announcement of next frequency.

2 minutes—Time allowed to change to next frequency.

### ACCURACY

Although the accuracy of the transmissions is not guaranteed, those of W1XP are usually dependable to 0.001 per cent and those of W9XAN and W6XX to 0.01 per cent. The transmissions are checked frequently by the Department of Commerce monitoring stations; and the frequency standards used have been checked against the national standard maintained by the Bureau of Standards at Washington.

### THE TRANSMITTING STATIONS

W1XP: Massachusetts Institute of Technology, Round Hill Research, South Dartmouth, Mass., Howard A. Chinn in charge.

W9XAN: Elgin Observatory, Elgin National Watch Company, Elgin, Ill., Frank D. Urie in charge.

W6XX: Don Lee Broadcasting System, Los Angeles, Calif., Harold Peery in charge.

### REPORT BLANKS

Blanks for reporting on the S.F. transmissions will be sent postpaid upon request. Just send a card or message to Standard Frequency System, QST, West Hartford, Conn., asking for s. f. blanks.

### WWV 5000-KC. TRANSMISSION

The 5000-kc. transmissions of the Bureau of Standards station, WWV, are given every Tuesday from 2:00 to 4:00 p.m. and from 10:00 p.m. to midnight, E.S.T. The accuracy of these transmissions is now better than 1 cycle (one in five million). Information on how to receive and utilize the signals is given in pamphlets obtainable on request from the Bureau. Communications concerning these transmissions and reports on their reception should be addressed to Bureau of Standards, Washington, D. C.

— *J. L. J.*

## Strays

W8DZU has a simple stunt for improving the "local" selectivity of tuned r.f. receivers. It is an ordinary wave-trap—made from a 140- $\mu$ fd. midget condenser and some spare plug-in coils—which is connected in the antenna lead and tunes over the band on which the receiver is set. The trap acts as a very effective r.f. input control, enabling distant stations within a few kilocycles of locals to be heard, and has negligible tuning effect on the receiver.



# Amateur Radio STATIONS

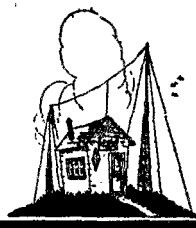

W1YU—WLE

The Yale Radio Club, New Haven, Conn.

THE Yale Radio Club was organized in January, 1931, by a small group of amateurs attending the university. There are thirty members in the club and twenty-one of these hold operator's licenses, but owing to the pressure of studies only a few can devote much time to operating. The following calls are included in the membership: W1BOD, W1FJ-SA-2EBM, W3AWH-W2CMA, W1ASD, W1AYR, W2DKT, W1FDM, W1DBP, W1COA, W2DAX, W2AMD and ex2AOF. Graduate members are W1BHM, W1DGG, W1FKQ, W1ZY, W8DR, W1BGJ, W9AK, exEF8CSR and exW6APK.

Although many kinds of experimental work are undertaken, the chief activity of the club is the operation of W1YU. Since the formation of the club, work has been done on all bands above 56 mc. except 28 mc. At the present time permanent transmitters to work on the 7- and 3.5-mc. bands are maintained. These are practically identical except for the different output frequency, each using a 47 crystal oscillator, 46 doubler, and 10 buffer exciting a pair of 852's in parallel in the last stage. In each case, the crystal is operated on the next lower frequency band so that break-in may easily be used. There is a common high-voltage power supply for both transmitters, and this apparatus is the only way in which W1YU differs from most conventional amateur outfits. Since three-phase power is available at the laboratory it is used exclusively for high-voltage supply. Three 1.5-kva. transformers with 220/2200 volt rating are used with three 866 tubes in a three-phase half-wave circuit, giving an output of 3600 volts d.c. A slight 180-cycle ripple is present, and this is easily eliminated with a 5-henry choke and 4  $\mu$ fds. of condenser. Separate low-voltage power packs are used for the low-power stages of each transmitter. A switchboard distributes the various filament and plate voltages to either transmitter or to any other piece of apparatus desired.

Separate antennas are used for each transmitter. A 132-foot Hertz with 60-foot Zepp feeders is used for the 80-meter set, and a single-wire-fed Hertz 66 feet long for 40 meters. A

horizontal wire about 75 feet long is used for receiving weak signals, although a short indoor antenna is ordinarily used.

At the receiving position are a monitor, e.c. frequency meter, and three receivers. The main receiver has one stage tuned r.f. and one or two stages a.f. amplification as desired. The other two receivers are two-tube battery sets, one of them being an experimental model built by W3AWH using British tubes. By means of a switching arrangement the 'phones may be connected to any receiver or the monitor, or the receiver may be put on the loud speaker. Two straight keys, a sideswiper and two bugs provide for the wants of any operator who may be working the set.

W1YU is a 100-percent home-made station since all of the apparatus was built by club members. The receiver and monitor were made by

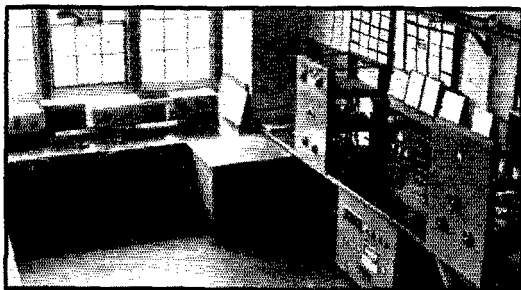

W8DR, the transmitting layout was made by Wilson, W1FJ-SA and the frequency meter was the result of the combined efforts of four members.

The station has been in operation during twenty months since the formation of the club, and in this time over 3700 contacts have been made. Most of the DX work has been done on 40 meters, and 40 countries in five continents have been contacted. As usual, Asia is the sticker. W1YU is O.R.S. and O.B.S., and has usually acquitted itself well in the various ORS QSO contests and the Sweepstakes and DX contests. W1YU is State Control Station for Connecticut in the Army Amateur Radio System, and is

acting Net Control Station for the First Corps Area. Several members of the Club are in the U. S. Naval Communication Reserve, W1BOD being Commander of Section One, Unit Five, Third Naval Dist. W1ZY, the 1932 President of the club, has an ensign's commission.

Normal operation of the station is about 75 percent in the 80-meter band and 25 percent on 40 meters. The frequencies used are 3526, 3632, 7050, and 6990 kc., using the Army Amateur call WLE on the latter frequency. On 80 meters, during 1933, D4ZUA, PAQQQ, and FMSIH were worked; 21 reports from Germany and numerous reports from England, Netherlands, Switzerland, Hungary, and New Zealand have been received on this band.

### W4MO, Atlanta, Ga.

ALTHOUGH W4MO has been on the air only since March 1931, its owner, Don G. Harmer, dates his initiation into wireless back in 1912, when a spark coil layout established a one-way communication record of the distance across the street — one-way because the other fellow didn't own a coil. From the appearance of the transmitter in the photo, the spark coil is nothing but a fond memory!

Starting out with a 47 crystal oscillator, the set includes an 865 buffer, a pair of 865's in push-pull as a modulated amplifier, and a final push-pull stage using a pair of 560's as a liner amplifier. None of these stages needs neutralization. The speech end of the set has three 27's in cascade and a pair of 50's in parallel as modulators. An Ellis double-button mike is used.

An auxiliary transmitter has a 47 crystal oscillator, 47 buffer and two 47's in push-pull as a modulated amplifier. The modulator tube is a Type 50, with a 56 driver.

A Super-Wasp receiver is used for loud-speaker reception, although the set does not appear in the

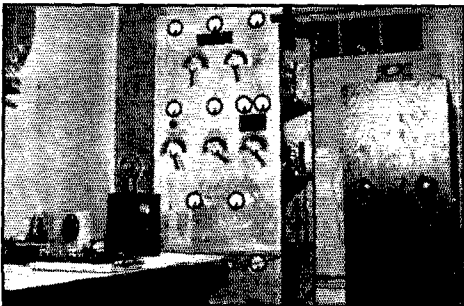

photograph. The outfit on the table is a 3-tube affair using a 24 detector, 56 first audio and 47 second audio.

Both transmitters have worked all U. S. districts and several in Canada. C.W. signals from W4MO also have been heard in Holland on 3.5 mc.

## The American Regional Conference

(Continued from page 19)

submit to their respective governments" the stated recommendations. Here is an immense improvement in the amateur position. Only Canada, Cuba, Newfoundland and the United States accepted the old Ottawa agreement, and Mexico did not sign the Madrid radio regulations. Now all of these countries have agreed (subject to ratification, of course) that the 1715- and 3500-kc. bands are assigned exclusively to amateurs throughout North and Central America. This makes for the freer encouragement of amateur radio in these countries and relieves us of the possibility that some of these countries might put fixed or mobile services in these bands. Strangely enough, the only difficulty encountered in this negotiation came from Canada who, distressed by the narrowing of a maritime mobile band important to her, endeavored to have the 1715-2000 band shifted bodily upwards. But neither Mexico nor the U. S. would accept this displacement of the amateur band, and eventually Canada was persuaded.

The agreement as signed distributes the frequencies from 1600 to 4000 kc. to various services, sometimes in minor deviation from the Madrid table and, as stated, assigns 1715-2000 and 3500-4000 exclusively to amateurs. The band 1500 to 1600 kc. is left unassigned; we understand it is generally regarded as "available for broadcasting." Above 4000 kc. the governments agree to follow the Madrid table rigidly except that 5600-5700 kc. is assigned exclusively to air mobile. Channel centers, separation between channels, tolerances and stabilities are agreed upon, none of these affecting us, and there are extensive definitions, including two amateur ones which comply with existing language. It is expected that the agreement will be ratified by the respective governments by an exchange of diplomatic notes and become effective the first of 1934.

Our thanks and congratulations are due the L.M.R.E. and its officers for their success in looking after amateur interests at the conference. This is the first time that the headquarters of the I.A.R.U. has called upon a member-society to undertake amateur protection at a conference held in its country, as is provided for in the Union's constitution. Its success causes us to look forward to the day when in every country we shall have an amateur society capable of taking care of the interests of amateurs of the whole world when an international conference is held in its country. *A su salud, L.M.R.E.!*

F. H. Rawson, Chicago, advises that he will pay telegraph charges on any messages addressed to him from Byrd Antarctic Expedition, II, when telegraphed to him collect at 1550 North State Parkway, Chicago, Illinois.





# STRAYS



A large paper map of the United States, ideal for hams who like to know just where the other fellow is, can be obtained from the National Geographic Society, Hubbard Memorial Hall, Washington, D. C., for 50¢, with an index of the names on the map for 25¢ extra. The same map on linen sells for 75¢.

— W3CA

W3CBR, starting out for a ride and finding his gas line defective, returned to the shack, tore his tank coil from its firm foundation, and made speedy repairs!

— W8IVC

An excellent cement for fastening grid terminal caps of bases which have come loose on good tubes is sold under the name of "Bond-Rite" at most hardware stores. It is FB for cementing wood, bakelite, glass, metal, etc., and is a non-conductor. It requires about two days to set firmly.

— C. Floyd Donbar, WFDL

If the OW doesn't look kindly on papering the walls with QSL cards, try a photograph album for holding them. An ordinary album usually will hold about 300 cards and keeps them in convenient form for exhibiting to a visiting ham.

— W6DIP

The Wm. B. Duck Co. of Toledo in early January wound up its affairs and discontinued business. Thus ends one of the oldest radio supply houses. Many of the old-timers in ham radio cut their eye-teeth on the catalogs of the Wm. B. and J. J. Duck companies, back in the days when radio was wireless, when there were no retail radio stores, and when every piece of gear and part had to be ordered by mail. The Duck company flourished in those days and its catalog was as well known and as indispensable to amateurs as *QST* is to-day. . . . We are reminded of a story, at one time or another told of every mail order house in the country and no more applicable to Duck than to any other. It seems that a ham received a defective Audiotron tube from Duck and wrote a letter of complaint. Back came a splendid letter of rebuttal, which left the amateur feeling that it was all his fault. Then he noticed that his own letter of complaint had also been returned to him in error, with a pencil notation across its face to the Duck stenographer: "Miss K.: Write this guy the bum-tube letter. — D." But that was away back in those dim dead days.

In the article on our revised regulations in September *QST*, in reporting that the band 400,000 to 401,000 kc. had been opened to 'phone transmission, we said, "'Phone is now OK in the 75-cm. band for everybody interested in trying it."

"75 cm." of course means 75 centimeters, or  $\frac{3}{4}$  meter. We thought everybody would understand that. But you would be surprised at the number of fellows who have misread that as referring to the 75-meter band and gathered the impression that we were telling them that the entire 75- to 85-meter band was now open to 'phone. *QST* is read, and this particular experience proves it to us beyond all doubt, but it also shows that *QST* is not read carefully, for the reference is plain enough. The only portion of the 3500- to 4000-kc. band, sometimes called the 75- to 85-meter band, that is open to 'phone is the portion 3900 kc. to 4000 kc., as before.

*QST* attempts to maintain a complete list of dealers who are interested in and able to supply amateur radio equipment. We are frequently called upon to tell prospective amateurs where to go to buy equipment. We believe our present list is pretty complete, but if any dealer has the slightest doubt of his name being on it, we should appreciate a line from him. We should like to know his complete address and any other information, such as lines carried, etc., which might be of value to us. We are, of course interested in hearing of new dealers.

W4EG makes high-voltage fixed tank condensers from old engraved copper plates and half-inch extensions for loose-leaf binders, all obtainable from engraving establishments. No bolts are needed since one extension screws into the next through a hole bored in the copper plate, and the shoulder of the extension holds each plate firmly in place. The capacity can be made anything desired simply by using enough plates, and final tuning can be done with a very small high-voltage variable condenser connected in parallel.

Fellows using bread cans from the five-and-ten stores for monitors, oscillator shields, etc., will do well to solder the seams in the cans even though they appear to make good electrical connection. A lot of noise can be generated in creaky joints and it might just as well be killed off before it starts.

— W5BSK

---

---

# • I . A . R . U . N E W S •

---

---

Devoted to the interests and activities of the

## INTERNATIONAL AMATEUR RADIO UNION

President: H. P. MAXIM

Vice-President: C. H. STEWART

Secretary: K. B. WARNER

Headquarters Society: THE AMERICAN RADIO RELAY LEAGUE, West Hartford, Conn.

### MEMBER SOCIETIES

American Radio Relay League  
Associazione Radiotecnica Italiana  
Canadian Section, A.R.R.L.  
Československí Amatéri Vysílací  
Deutscher Amateur Sende-und-Empfangs  
Dienst  
Experimenterende Danske Radioamatører  
Liga Mexicana de Radio Experimentadores

Nederlandsche Vereeniging voor Internationaal Radioamateurisme  
Nederlandsch-Indische Vereeniging voor Internationaal Radioamateurisme  
New Zealand Association of Radio Transmitters  
Norsk Radio Relæ Liga  
Polski Związek Krotkofalowcow  
Radio Society of Great Britain  
Rede dos Emissores Portugueses

Reseau Belge  
Réseau des Émetteurs Français  
South African Radio Relay League  
Suomen Radioamatööritto y.r.y.  
Sveriges Sändareamatörer  
Unión de Radioemisoros Españoles  
Unión Schwelz Kurzwellen Amateur  
Wireless Institute of Australia  
Wireless Society of Ireland

---

### Conducted by Clinton B. DeSoto

#### National:

On November 11th, the fifteenth anniversary of the Armistice of 1918, the R.E.F. proposes a special amateur ceremony to be held in memory of that momentous anniversary. The observance they have outlined for their members and are requesting of amateurs everywhere is to be conducted in the following manner: During the minute of silence which will mark the official ceremonies (at 1100 G.T. for western Europe), the French amateur transmitters will cease all traffic; operators will bow their heads; microphones will be silent; and from hundreds of antennas unkeyed and unmodulated carriers will be sent out, indicating the silent presence of the amateurs at their posts. Amateurs in all countries are asked to collaborate with their French comrades in making this same gesture and in uniting with them in thought.

The QSL Bureau of the R.E.F. not only provides QSL forwarding facilities for the French nation, but covers all the French colonies and protectorates, including all stations operating under the following prefixes: F8, F3, F4, CN8, FM8, and FM4. Amateurs in France, Algeria, Tunis, Morocco, and all the French colonies can be addressed through the R.E.F., whose headquarters address is 17, Rue Mayet, Paris 6°.

The eighth annual convention of the R.S.G.B. was attended by nearly 200 members from every part of the British Isles. The opening meeting took the form of a *conversazione*, when short papers on subjects of amateur interest were given, with films taken by G2PD and G6UN also being shown. A running buffet enabled everyone to become quickly acquainted. SU1EC, VS6AH, and VQ5NTB were among the visitors. The various meetings and the dinner which followed were

fully reported in the September issue of the "T & R Bulletin," which also contains details of practical 5 meter equipment.

Colonel Otto Fulda, for many years president of the D.A.S.D., in August announced his resignation from that office due to regard for his health. The new president is Professor Dr. Leithauser, a figure well known in German amateur radio. Col. Fulda will continue as honorary member of the society, which formally accorded him its intense gratitude for the long and useful work he has done in its development.

---

#### Dx:

If we can ever find the time, we're some day going to chart the localities in which WAC stations are located. Something informative and interesting should result, because it is becoming increasingly certain that not only do radio conditions change generally in short and long cycles as a result of varying terrestrial and etheric conditions, but that these changes occur quite differently in different sections of the country. In other words, we realize not only what has long been known—that some locations are good for DX while others aren't—but that in time the poor localities may become good, when some cycle or other in the series has changed sufficiently to enable the ionosphere to reach its proper altitude or altitudes over these regions.

Take the case of Wm. Reid, Jr., W5CWJ, in Houston, Texas. Ordinarily you'd say Houston ought to be a pretty good place for contact with South America, even on 14 mc. Yet W5CWJ has never yet heard one South American station! In fact, he hasn't heard any DX at all just recently, except an R3 EAR in Madrid—and this

during the time that we in New England were in the midst of a literal beehive of DX activity. Of course, as we remarked some time ago, W3AWH in Trenton, N. J., reported about the same luck—while over in Schenectady the DX had been pounding along in great style. Labor Day (Sept. 4th) on Long Island was the best DX day in years, culminating a recuperative period of several weeks. Elsewhere, things were rotten as could be. In Chicago in early August we collected much the same variety of opinions, comparatively slight geographic differences resulting in greatly altered conditions. Regions which had once enjoyed good DX going dead. Poor locations becoming alive with signals. . . . And we once confidently published DX charts to let you know when you were going to be able to hear that DX your soul yearned for!

**General:**

The R.S.G.B.'s new "Guide to Amateur Radio" is enjoying a remarkable sale . . . . Those interested should write direct for copies to 53 Victoria St., London, S.W. 1; the price is 6d . . . . Fiji Islanders are still using the prefix VP1, apparently, despite the fact that they are officially assigned VP2 . . . . The most active station to be heard from there is VP1FF, who



VK5GR, AND G. B. RAGLESS, ITS OWNER

[Using TPTG on 7 mc. and TNT on 14 and 28 mc., with an input never exceeding 35 watts to a single UX310, 68 countries have been worked, with WAC each year since 1928, once in less than eight hours. VK2-3-4-5-7 have been worked on 28 mc., and the station is always open for skeds on this band.]

works on 7 mc. . . . . An expedition call now to be heard on 7 mc. is XVK8BA, that of the Hannam Exploration party, operating in out-back country in Central Australia . . . . According to Eric W. Trebilcock, of Moonta, S. A., QSL's for the party can be sent via VK5BJ, Glenelg, South Australia . . . . Going through Liverpool on your European trip? Then be sure to drop in on J. Davies, G2OA, at 13 Exeter Road, Wallasey, near Liverpool . . . . Ship operators in particular are invited, whether full hams or not—pleasant evenings assured! . . . . ZC6CN tells us through W2BSR that any W's wanting to work Asia should keep an eye out for him . . . . He is on every day

with 12 watts input, from 1900 to 2200 G.T. . . . . In Europe and Great Britain 28 mc. activity continues strong, with improved conditions the past few months . . . . QSO's between England, most of Europe, North Africa and Egypt have been made recently . . . . The number of ZL YL and XYL operators continues to grow, now having reached the figure of eleven . . . . The listing follows: ZL1CN, ZL1HF, ZL3BT, ZL3DW, ZL4CL, ZL4CX, ZL4DT, ZL4FN, ZL3HC, ZL3HW, ZLAGB . . . . Since the first of the year, the total number of feminine operators in the United States possessing their own stations has increased by about 45 . . . . R.S.G.B.'s tests for the 1933-34 season are scheduled as follows: 3.5 mc., Nov. 4, 5, 11 and 12; 1.7 mc., Jan. 7, 8, 14 and 15; B.E.R.U., Feb. 3, 4, 10, 11, 17, 18, 24 and 25; Low Power, March 3, 4, 10 and 11; National Field Day, June 10, 1934 . . . .

**Special:**

Displaying a national characteristic in its thorough and careful production, "OZ", official organ of the *Experimenterende Danske Radioamatører*, is a monthly publication of 16 large pages filled with material of slightly different calibre than that contained in most ham sheets. The difference in flavor is difficult to describe, but a glance at any representative issue will show the distinctiveness in tone. Technical material is original, and often unique. Local and national notes are inimitable. Anyone capable of reading Danish will enjoy "OZ" greatly. It comes with membership in the E.D.R., the annual dues being 18 kroner, or, at the moment of writing, approximately \$3.84. The address is: E.D.R., Postboks 79, København K., Denmark.

**Strays**

W1AYG suggests connecting a .1- $\mu$ fd, condenser across the 'phones in five-meter superregen receivers to cut down the hiss. Apparently the voice signals are little affected, but the reduction in hiss makes reception much more enjoyable. This stunt is of most help on weak signals, of course, where the carrier is not strong enough to wash out the background.

At last a transmitter wrapped in Cellophane!—well, not exactly wrapped, but at least covered. W2DPP is the innovator; his breadboard-style transmitter is protected from dust by a cover made from sheets of Cellophane glued on a light wood frame slightly larger than the complete transmitter. When in place the frame sits on the table and "surrounds" the set; when adjustments are to be made the frame is simply lifted off. A good idea for keeping the transmitter free from dust.



# CALLS HEARD



**W1DF-W1SZ, 88 LaSalle Road, West  
Hartford, Conn.**

(Heard on 28-mc. band between July 15-Aug. 2)  
w4bjv w4bpa w4mr w8and w8bti w8bsf w8ccw w8enf  
w8epc w8fal w8fca w8fsk w8kdo w9agr w9clh w9dxx w9ef  
w9ffq w9fkk w9giz w9gvr w9gxe w9hbd w9isu w9kep  
w9myc nylab

**W9FFQ, Milton R. Carlson, 413 South Second  
St., Rockford, Ill.**

(28-mc. band between July 1st-30th)  
wlblv wlccz wldf wlsz w2tp w3bb w3cqn w3my w6cbq  
w8amz w8ata w8bti w8era w8dlu w8fap w8gzw w8hgr  
w9ayw w9cvn w9fiv w9lbb

**D4UAO, H. Hoffmans, Ettal, Germany**

(3.5-mc. band)  
wlafb wlaye wlbev wldcy wlcfg wldmk wlefi wlmk  
wlrp wlzh w2amb w2ear w2dyl w2jt w3aoj w3ava w3jf  
w3rj w4dw w4ert w4ins w4vc w6acv w6dyj w8api w8esy  
w8fo w8for w8gga w8fru w8hio w9fij w9gu w9kkd w9vob

(7-mc. band)  
lislbk kalcm kallg vk2oc vk3bw wk dt kx wl lz kr lq  
cq zb cw bw zb vk5gk vk7ch zala zlfz zl2kq zd2a zulc  
zulp zu6w

(14-mc. band)  
et8fa lu6lz vk3dr vk2ly vk2hx zllab

**VK5MY, Harry M. Roberts, 68 Fourth Ave.,  
Alberton, East South Australia**

(3.5-mc. band)  
w6aoz w6evd-w7aqx ('phone)  
(Many w 'phones heard but too weak to copy.)

(14-mc. band)  
k6baz k6bfi ve4jc wlsz w6ig w6dyh w6cd w6cvw w6vq  
w6cup w7bar

**Eric. W. Trebilcock, Moonta, South Australia**

(3500-kc. band)  
k7baq k7cf w6biu w6gpn zllbl zllcb zllgx zl2fe zl2fg  
zl2hy zl2kz zl2nc zl2nq zl2ns zl3ar zl3ca zl3fo zl3he

(14000-kc. band)  
g5hj g6us g6vp jleg jlft j2ce j2cf j5ce k6baz k6bvp  
k5aa ve3zb ve4jc ve5id xlaa x9a ear121

**W9BJQ, Highland Park, Upper Darby, Penna.**

(56-mc. band)  
w3abq acf ago ake ahr atr axm aiy azw ajv bay beh bg  
bly bms bpy bwp cbu cem cfg clp eno cdf cfu lv lz my  
ux vx

**PA0QQ, C. A. Gehrels, St. Geraduslann 10,  
Eindhoven, Netherlands**

(28-mc. band)  
fm8ih su6hl f8ct f8cl f8gq f8rq f8rj haf4d ok2va oklaw  
g5gy g2fn sm6wl on4dj

**W9AOG-W9KEP, Frank Lewis, 2925 Victor,  
Kansas City, Mo.**

(28-mc. band)  
wicuh wlsz w2jn w2tp w3aeh w8era w8dtn w4mr w9fg  
w9giz w9gtu

**G6YL, Miss B. Dunn, Felton, Northumberland**

(14-mc. band)  
w6gid w6qd en2fn em2mg em2rz em2wa em8fr exiaz  
hc2cv k5aa k5ae lu3de lu3oa lu5dj lu6dg lu8dj pylah  
py2qa py9am ti2rc ve2cx ve2dm ve3qs vp2nb vp2yb  
vi6ht ze6cn ze6fo zd2a xz8y xzn2e

**W6GAL, 809 E. Pine Ave., Compton, Calif.**

(7-mc. band)  
gb1m kn2 z2a z2j z5y z5b zt5v zt2l x1q (fone) ear96

(14-mc. band)  
en2no ear121 ei2bd on4fe on4dp pa0xf g2bm g6pm f8pz  
qt4

(14-mc. 'phone)  
x1g ti2db k6baz k6alm

## Further Notes on Licensing Procedure

(Continued from page 31)

radiotelegraph operator must also take out an amateur operator license if he wants to ham. This applies now even on the 5-meter band, formerly exempt from this provision. Anyone may excite an amateur microphone if a licensed amateur operator is in charge.

-----  
An operator license is renewable without re-examination if the holder can show activity during the last 90 days of its life. Since this relates to the operator's activity, the necessary operating may be done at any amateur station. But a station license is renewable only if that station is operated during the last 90 days of its license term. If the station isn't used in that period, the owner must wait until 90 days after expiration before he is permitted to apply for another station license, and then he applies for new license, not renewal, and very possibly loses his old call. Since all renewal applications must be filed at least 60 days before expiration, all of the above-mentioned activity must occur during the second-from-the-last month of the license life, that is, between 90-days-before-expiration and 60-days-before.

-----  
Reason for the above: It isn't the cost of administering active amateurs that hurts Uncle Sam's pocketbook; it's the terrible amount of deadwood. Active amateurs continue easily, but the new policy aims directly at avoiding the expense of licensing stations that are inactive.

# THE COMMUNICATIONS DEPARTMENT



F. E. Handy, Communications Manager  
E. L. Battey, Assistant Communications Manager



## Amateur Radio

YOU grasp your key or mike and the world is at your finger tips! The value of amateur radio to you is just what you yourself make it. Its usefulness to you is limited only by the breadth of your activities, the number of your friends and interests, the scope of your operating and experimenting in different amateur bands, and the degree of imaginative interest in the other individuals in the world in which you live. All these things should increase, the more you make use of amateur radio. Your station may be used to share a joke, to extend a greeting, to exchange small pleasantries, cement a friendship and make life more worth while; or it may help in more serious purposes, to avert a danger, or in emergency to aid a community. A simple message may end an anxiety or solve a difficulty. Regardless of *apparent* simple or intricate wording, the *import* of a message to the one who receives it may be great for good or ill.

Amateur radio can do all these things, and more. Then why the "formula" QSO? Let us broaden our amateur enjoyment to include something of all sides of amateur radio, whatever our special interest. Let us use imagination in our QSOs and improve our acquaintances. The full benefits from any tool are only obtainable by correct use. Study of *our* procedure and operating purpose, may yield us fruitful results. Let us consider how we use amateur radio to-day. Let us operate with *definite purpose*, always ready to assist fellow amateurs constructively. It will make a "better" amateur radio and A.R.R.L.

—F. E. H.

W9EDK, Cape Girardeau, Mo., worked VOQH September 16. The following have heard and reported VOQH: VE3EA, W3ABA/DAN, W3DKT, W3ZX, W8EBY and Richard Kardel, Burlingame, Calif. W2NV reports that Bob Moe (W2UN) returned to N. Y. C. October 7 after sailing 18,000 miles with the S.S. *Morrissey*.

NX1XL, the University of Michigan Expedition in Greenland, was worked by W3BOP (Allentown, Penna.) on September 4, 5:30 p.m. EST and a nightly schedule arranged. NX1XL was on 14,085 kcs. and we suggest that additional amateurs try to assist in working and reporting NX1XL.

The following contribution by Mr. Charles S. Mundt, W6ZI, wins the C.D. article contest prize for this month. Your articles on *any and all phases of amateur communication activity* are likewise solicited, and may win you a bound Handbook, or equivalent credit applied toward League emblems, log books or other A.R.R.L. supplies. Also see announcement March 1933 *QST* (page 56). The QRR work suggestions by Mr. S. M. Douglas, W4ACB, are also to the point, and are published with honorable mention. Your contributions are invited.—F. E. H.

## An Oldtimer Classifies Pests By Carlos S. Mundt, W6ZI \*

IN the old spark days *every* amateur was a pest. Commercials and hams alike gnashed their teeth when the nearby 1 K.W. spark (signal as broad as a barn door) came on the air. Power got out and nothing else. QRM was an enveloping mist upon all alike. You just tried to QSO and prayed while you tried. You started with a spark coil, graduated to a  $\frac{1}{2}$  K.W. transformer with a smart rotary gap and did a little better. But the acme of perfection was a 1 K.W., because it got out by brute force, to the exclusion of all others nearby. Its QRM was an accepted thing, and excused simply because the art of radio had not yet advanced far enough to make the air "open to all comers."

But to-day? We have a highly developed art, with all the assistance of modern scientific practise, allowing all to enjoy its pursuits, and giving each and every ham pleasures unknown in the olden days. Strike out "allowing all to enjoy its pursuits." For there have developed a variety of PESTS whose selfishness was and is still spoiling the game. Happily, these are a minority of the entire amateur ranks, but they deserve no mercy; their amateur sins are no longer to be condoned in this day of monitors, frequency meters, well designed outfits, splendidly made materials, soundly drawn regulations, and fine amateur fellowship. Who are these pests? Let us classify them. Then let us scrutinize the list carefully and see just where each and every one of us belongs.

1. The CQ Pest. Should not be taught the gentle art of the scientific CQ, so that the last remaining member could be so overcome with shame that he would smash his 210s?

2. The off frequency Pest. He should receive the worst punishment, since there are many ways of prevention, and many coöperative hams to assist in prevention. The finger

\* Asst. Professor of Science, San Francisco State Teachers College, Buchanan and Waller Sts., San Francisco, Calif.

of scorn should be forever pointed to him, and a collection taken to buy him a nice new S.F. transmission all for himself.

3. The deliberate QRM Pest. Selfish, of course, this one is the kind who lets old ladies stand in a street car. Sometimes his offense is of the Nth degree, as in the recent Los Angeles 'Quake, where much depended upon 100% coöperation. Boil in oil, shoot him, then drop him out of the top of the Empire State Building.

4. The ragged note Pest. This kind sometimes can be educated, as his fault is usually the result of ignorance.

5. The message garbler Pest. Simply a poor operator who is not interested in bettering himself. He should be required to read up on operating procedure. *Lack of responsibility* also cause delays and uncorrected errors. Don't be this kind of a pest. Make your operating clear cut; be reliable.

6. The no license Pest. Show him no mercy, since the law is to be respected and licenses are after all very easy to obtain. Licensing has a purpose and no man is a law unto himself.

7. The long winded Pest. He needs a set of Q abbreviations and the realization that time is precious even on the air.

8. The prehistoric Pest. This is the fellow who uses 500 cycles, buzzer modulation, a.c. note, wide carrier, etc. Such things are not only out of date, but they violate the regs and exhibit a large parcel of supreme ego and selfishness. The F.R.C. monitoring stations are now rapidly taking care of these.

9. The speed Pest. This one sends faster than the man at the other end can receive and then says, "Can't wait time wid you, OM." He feels self-important by so doing. We should help the other fellow, not hinder.

10. The sloppy sender Pest. He is the one who runs his words together or messes his call signal so that you cannot make sense out of it. *Accuracy* comes before speed. Remember it.

Ten amateur pests, and the list is of course far from complete. Do you fit somewhere in the above? Then take stock of the situation and do something about it. The game has the greatest group of good fellows you ever met. Why antagonize them? It pays to be on the best of terms with a group any one of which is willing and anxious to be your pal. Then there is the question of the greatest good for the greatest number. It is largely up to us amateurs ourselves what consideration we deserve from our government. If *all* of us were pests we would command no respect; all efforts of the A.R.R.L. could be of little avail in our behalf. Consequently we should try to correct ourselves and help correct others, but not giving way to ill feeling and bad temper. As the fine art of radio communication grows in our hands we surely should not mar it by indifference and selfishness.

Are you a pest? If *not*, help the other fellow. If you *are*, be a good sport and correct it yourself. Amateurs are aroused. "Being a pest" is unhealthy and not in good taste.

Help the other fellow; and may your '45s blossom into '10s; and may all your parasitics disappear; and may an X cut xtal be given to all who are helpers of the cause. Hear ye! An old timer has spoken!

## "QRR-QRM"

By S. M. Douglas, W4ACB \* \*

OFFICIALS in Tallahassee asked local stations to get their weather and storm conditions all along the East Coast and keep continuous watch Sept. 3rd and when communication lines had been disrupted, amateur radio was depended on for word from the storm area. Right there the fight against QRM started.

First, there were too many stations trying to reach Florida when Florida stations were trying to crawl out from under the debris and take stock of the damage and request relief if necessary. I heard no less than two W4s and one W8 calling "QRR? Fla." *QRR is in effect an SOS and should not be sent unless the station sending it needs assistance or is asking for help for someone else.* To put IMI after QRR is the height of something or other. Phone stations north of Florida were as a whole ready to coöperate except where operators decided "it was just another breeze."

When a storm or other emergency impends, *listen* a little and find out what is going on. If your help is needed there will no doubt come a call directed your way, possibly in the form of a QST. As it was with the Florida stations, power lines down and emergency rigs using low power set up, QRM was terrific. Listen around. If your help is needed you will be called. *Don't clutter up the air with useless CQs directed at the stricken area.* Sign your state or city too so you can be identified at such times and called if and when needed. Some stations will go on the air in spite of everything, but most of us will QRT, we believe, and thus cause less QRM. Remember, QRR is SOS to us. "CQ CQ CQ STORM AREA" is just some more QRM.

\* RM, W. Fla., ORS, OBS, AARS, Box 3, Tallahassee, Florida.

## Traffic Briefs

On May 20th, starting at 5:25 a.m., W5YF, 3.9 mc. radiophone at Southern Methodist University, Dallas, Texas, held an hour's QSO with K6CRW, Maui High School, Hamakua, Hawaii.

## Relative Standings of the Ten Highest Sections—August-September

Messages Per Station (25%)	Stations Reporting Traffic (25%)	Gain or Loss (Traffic Reports) (25%)	Traffic Total (25%)	Standing Based on Average of All Four Ratings %	Section Communications Manager
Hawaii 270.	Los Ang. (680)* 112	N.Y.C.-L.I. +28	Kans. 8476	Kansas 52.5	Spetter, W9FLG
P. I. 263.1	Mich. (624)* 86	E. Fla. +16	Ill. 4983	Los Angeles 45.	Martin, W6AAN
Kansas 180.3	N.Y.C.-L.I. (151)* 58	Conn. +15	Los Ang. 4771	N.Y.C.-L.I. 45.	Bautach, W2AZV
Tenn. 175.9	Va. (150)* 58	Ohio +10	E. Pa. 4622	Hawaii 40.	Slaten, K6CQG
Okla. 174.2	Ill. (890)* 57	N. H. +10	Hawaii 3241	Illinois 37.5	Hinds, W9APY-WR
M.-D.-D.C. 174.	Ohio (868)* 57	Ont. +9	M.-D.-D.C. 3132	Philippines 32.5	Thompson, KA1XA
E. Pa. 149.1	N. C. (140)* 49	W. Va. +9	P. I. 2895	M.-D.-D.C. 30.	Hudson, W3BAK
N. Minn. 139.5	Kansas (244)* 47	Sask. +9	N. Minn. 2373	Ohio 30.	Thompson, W8BAH
S. Tex. 130.7	Wash. (374)* 44	M.-D.-D.C. +8	N. Tex. 2364	E. Penna. 27.5	Wagenseller, W3GCS
Sac. V. 99.8	Mo. (324)* 41	W. Fla. +7	Mich. 2163	Michigan 25.	Conroy, W8DYH



KANSAS carries the Banner for the second consecutive month, leading the country in the volume of traffic handled. Kansas' lead is due to some degree to the operation of National Guard station, CX7, which scheduled many Kansas stations for traffic work. Los Angeles is again the only Section with over 100 traffic reports! The following Sections lead all other Sections in their Divisions, *order of listing showing relative standing of their different Divisions:* Hawaii, M.-D.-D.C., Ill., Kans., N. Tex., N. Y. C.-L. I., Va., Conn., Ont., Ore., N. Minn., Tenn., E. Fla., Colo. During the August 16th-September 15th month: 1404 stations Originated 21,575; Delivered 15,235; Relayed 45,395; Total 82,205. (70.8% Delivery) (58.5 m.p.s.)

\* The Section A.R.R.L. membership (approx.) is shown parenthetically, so that the degree of traffic reporting activity may be indicated by comparison.

## Traffic Briefs

### FRC EXAMS—WINSTON-SALEM, N. C.—NOV. 4

Examinations for all classes of radio operator licenses will be held in the Civil Service Room, Federal Building, Winston-Salem, North Carolina, on November 4, 1933. The examination will be held in two sessions, beginning at 1:00 p.m. and 7:00 p.m. All applicants desiring to take Amateur Class A, Commercial and Radiotelephone examinations must appear at 1:00 p.m.

W8JSU, instead of building the P.P. TNT and running a risk of jamming the band and adding to the QRM, decided to assemble a small two tube crystal control job, low-powered, and to work constantly with a monitor, spending most of his time getting a good, clear crystal signal which would not jam the bands. He points out that, after all, it is the good piercing signal that cuts through the QRM like a knife through cheese and gets the most responses. Why not try, fellows, to improve your signals, instead of increase your power.

Eight radio amateurs, leading their class scholastically, and making up about 13% of the class, were graduated from Wheaton (Illinois) Community High School, at the close of the 1933 term. These "hams," W9IPY, W9KJW, W9IML, W9KGP, W9IPT, W9LIF, W9IZK and W9JGS, were all in the Physics class of W9MYK, Science Department instructor, who assisted them in obtaining their "tickets."

R. C. Mitchell, R. 3, Yukon, Okla. advances the suggestion that operators of phone stations in signing might occasionally state their frequency. This would assist newcomers, who do not know the code, in the calibration of new coils and receivers.

The Southeast Radio Experimental Association (President C. M. Feay, W6EJZ) has been active at Maywood, California, in policing the bands and clearing up local operating conditions. The organization last spring handled the A.R.R.L. quarterly banquet, which drew a record-breaking attendance. The club membership has been responsible for unusual activities. One novel feature of every meeting is the raffling off at each meeting, one or two A.R.R.L. memberships. Needless to say, meetings are exceptionally well attended.

W5DO has discovered the original mathematical bird in a little wren that sits in his back yard and whistles "DB" all of the time. . . . And W1CTI inquires what makes "katy-dids" call "VVV . . ." all night long? He also notices that katy-dids have r.a.c. notes—very few Oct. 1 signals. Hi.

There are a few things still to be thankful for. One of them is that all amateur messages are not garbled in transmission like the following example: K7PQ, SCM Alaska, reports that a message filed in Ketchikan, Alaska, read:—"Continue combating age we convey compliments and celebrate with coffee Kalas (sig) The Tobins." Some two weeks later the message had meandered as far as Mitchell, Indiana from where it was mailed to the destination, Quincy, Mass. When received the message read:—"Continue corn beef and cabbage we convey compliments and celebrate with comfy (sig) Tobias." It actually happened!

## O. B. S.

The following is a supplement to the list of A.R.R.L. Official Broadcasting Stations in September QST (page 44):

W1CBB, W1YU/WLE, W4BAW, W4MS/ZZP, W6ATP, W6CBF, W6CIZ, W7KL, W8AXV, W9AND, W9IYA, VE3HA.

## BRASS POUNDERS' LEAGUE

(August 15th-September 16th)

Call	Orig.	Del.	Rel.	Total
W9JID	1260	31	216	1507
W4OI	50	50	1400	1500
W9YAB	517	848	—	1365
W6DSU	1200	—	6	1206
W8AWX	53	21	1009	1083
W3ADM	12	44	971	1027
W5AMC	—	—	1008	1008
W6PQ	645	125	186	956
W3ALX	192	252	509	953
K6FAB	291	14	626	931
W6CKO	5	35	844	884
VE3AU	69	32	624	725
W9BAU	6	64	642	712
OMITB	340	144	216	700
W6FQY	186	147	344	677
W9KJY	18	12	638	668
W9KG	8	32	567	607
W8EIK	21	18	551	590
W9ZZAF	85	61	442	588
W5BII	8	21	558	587
W3GL	53	109	374	536
W5CEZ	—	—	536	536
W2CBB	161	72	282	515
W8FFK	69	77	358	504
W2BLU	3	2	496	501

### MORE-THAN-ONE-OPERATOR STATIONS

CX7	2378	1149	—	3527
W9USA	2433	84	62	2579
W3CXL	147	191	1329	1667
KAIHR	215	210	966	1391
NYIAB	170	185	780	1135
K6EWQ	255	139	686	1080
W6OW	124	54	742	920
W6FWJ	120	84	484	688
W3BKQ	23	22	608	653

These stations "make" the BPL with totals of 500 or over. Many "rate" extra credit for one hundred or more deliveries. The following one-operator stations make the BPL for delivering 100 or more messages; the number of deliveries is as follows: Deliveries count!

W9BDB, 330	W6AZU, 164	W3ASO, 105
W9BLG, 289	W3BWT, 157	K6GUA, 103
W9FLG, 245	W1ZZAR, 150	W6BPU, 101
W7BB, 207	W6BHQ, 124	W3ZD, 101
W9BEZ, 201	W6CLE-ALU, 123	
K6GAS, 186	KAILG, 110	More-than-one-opr.

W6ZX, 174      W6HEU, 109      WIMK, 110

A total of 500 or more, or just 100 or more deliveries will put you in line for a place in the B.P.L. Make more schedules with reliable stations. Take steps to handle the traffic that will qualify you for B.P.L. membership also.

"CQ TFC" is the general call used in the GENERAL TRAFFIC PERIOD—6:30-8:00 p.m. (local time). Use this period to move your traffic through reliable stations. Operators who sign "ORS," "TLS," "RM" or "SCM" after their call are sure to be "reliable." The very use of "CQ TFC" by any operator indicates an interest in reliable traffic work. Cooperate with the stations using the TRAFFIC HOUR!

## Report

Whether one or a hundred messages are handled, whether your work is mainly of experimenting, DX, traffic, or 'phone interest, whether you are an A.R.R.L. member or just buy *QST* at the news stands, your SCM (see address page 5 each *QST*) welcomes and invites your report. Mail it on the 16th of each month for the preceding 30-days' work! Let him know your plans for amateur work and what you are doing.

## A-1 Operator Club

The following amateurs have been elected members of the "A-1 Operator Club." To become a member of the club you must be nominated by at least two operators who already "belong." See page 36, July *QST*, and page 41, Sept. *QST*, for further information.

"Alma" at W1BZI	W1BYW	W3BEY	'Phone
"Elaine" at W1BZI	W1ES	W3CL	W6ZH
W1AJB	W1UE	W4AFM	
W1AMG	W1VB	W9AUH	
W1BDI	G2BM (H & R)		
W1BMP	W2UL	W9FO	
W1BB	W3ADM		

## Radio Amateurs in a War Game

By Lieut. Charles Felstead \*

RADIO amateurs of Los Angeles, Calif., and the vicinity gave an outstanding exhibition of their worth as a vital factor in national defense during the building up of a theoretical protection against an imaginary attack by enemy airplanes in the territory adjacent to Hawthorne, Calif. 150 Reserve Officers participated in the maneuvers and were organized into machine-gun, anti-aircraft gun, and searchlight groups. The problem was to prepare their defense of the prescribed territory so well that an actual enemy aerial attack would be repulsed before it could do serious damage.

The radio amateurs furnished their own portable transmitting and receiving sets and operated their own portable amateur stations. Low transmitting power was employed because the defense problem was chiefly theoretical; and the stations of the communication network that connected all units of the brigade were located for the most part in several public buildings which had been loaned for the purpose. The amateur stations were able to establish reliable communication without employing transmitting aeriels, since the distances involved were small. Field telephone lines were strung between headquarters groups and the radio stations. The absence of regular radiating systems on the transmitters and the short distances covered made communication conditions practically the same as they would be under regular defense operations over normal distances with the usual antennas.

Groups of officers were stationed in the several civic buildings. Each group was provided with its own radio communication unit. Each unit received messages from a headquarters station of the invasion of hostile air-

\* 977th Coast Artillery Reserve Communications Officer, 2010 Sixth Ave., Los Angeles, Calif.

† Their work was done in connection with three regiments of Reserve Officers and a National Guard regiment from Los Angeles, assisted by the 63rd Coast Artillery regiment from Fort MacArthur, San Pedro. The regiments were under the command of Col. M. C. Crissey of Fort MacArthur, acting as Brigade Commander, assisted by Col. E. A. Evans, Commander of the 977th Coast Artillery Reserve regiment and organizer of the tactical program. With the exception of the National Guard, the regiments were of the anti-aircraft division of the Coast Artillery.

planes, the messages supposedly originating at anti-aircraft observation posts distributed throughout Southern California. These messages had been prepared beforehand; and were transmitted at designated intervals from the headquarters station. The officers plotted the direction from which the attack would presumably come and the probable strength of the attacking air force. Then with that information before them on their maps, they directed through the radio network the locating of the imaginary gun and searchlight batteries at the most strategic points to protect the sections assigned to them. There was not a single failure in the amateur network during the two days of the tactical problem; and at the *critique* held after the conclusion of the program to sum up the results secured, Col. Evans praised the amateur operators for their outstanding work and discussed the incalculable aid the radio amateurs as a body could lend to the government in the event of a national defense emergency.

## Traffic Briefs

Route Manager Hal Falk, W8PP, says, "Good traffic originations is the problem of individual stations. If only worthwhile messages leave the station, traffic lanes of the state will not be cluttered and operators will not be burdened to the extent of monotony or disgust." And history shows traffic will move more effectively when discrimination in originations, gained by advising the public, and personal care in making up messages if followed.

If you've enjoyed a QSO with a chap, you will invariably send "73" when signing off. W8DYH suggests "37" to be used on those tongue-tied birds who say "tks for rept cul." He says sending "37" would give you "that satisfied feeling" or something or other.

PA0JQ, Rotterdam, has a 50-watt c.c. rig working on the 7000-ke. band every Saturday from 5:40 to 7:40 p.m. E.S.T., and would appreciate reports.

Operators C. W. Muller and Charles K. Smith of W5AUC, Brooks Field, Texas, recently kept a 24-hour test watch. The following countries were worked in addition to every state in the Union: Cuba, China, Canada, Nicaragua, Mexico, Hawaii, Haiti, New Zealand, Tahiti and Porto Rico. The operators worked in four-hour shifts. Who can better this record?

W6BQB was QSO W6UO, Yerington, Nevada. Having lived there for several years while his father was a R.R. telegraph operator, W6BQB told his OM that he was QSO the old-home town. The OM took the key and held a thirty-minute rag chew with OM Newcombe at W6UO, entirely in American Morse. Both operators got a kick out of this QSO, as in the past they had often talked with each other over the Morse wires. FB.

H. Y. Sasaki, W6CXW, visited many "J" stations on his trip to Japan. He noticed the following equation on the walls of several of the shacks: "Ham plus YL equals minus DX. Ham minus YL equals plus DX." Hi, and it actually works out.

## DIVISIONAL REPORTS

### ATLANTIC DIVISION

EASTERN PENNSYLVANIA—SCM, Jack Wagenseller, W3GS—W3CL, ADM, and ALX make the BPL. W8EOH is experimenting with key click filters. W3AAD is QRL YLs and work. W3AQI reported by telephone. W3BKQ is preparing for active traffic year. W3AKB has a FB7. W3AMR is at Penn State. W3AQN is aiming at a total of 1000. W3AZF has 150 watts input. The summer loves of W8CFE are fading. W3DUQ is rebuilding. W3AHD renews QRS. W3ADM is active A.A.R.S. W3CBK is Freshman at Dickinson College.



W3CJA is Freshman at Villa Nova. W8CMF works out of town. W3CUG is coming on with c.c. W3ECM reports first time. W8ASW has new receiver and transmitter. W3AKJ reports from Mt. Vernon, N. Y. W8LXC sent long list of calls heard. W3ANA attended World's Fair. W3BPX reports from Texas. W3ATR got a job. W3BUK reports Beacon Club is A.R.R.L. affiliated. The SCM welcomes visitors at his new QRA.

Traffic: W3AAV 87 AAD 7 OK 136 AQI 478 BKQ 653 AKB 26 AMR 13 ADE 21 AQN 23 AZF 33 BEY 37 ABZ 21 DXQ 5 CJA 14 DUQ 74 CL 536 ALX 953 AHD 35 GS 38 ANZ 20 BRH 45 ADM 1027 EZ 32 CBK 13 BOL 18 BUK 15 CIQ 27. W8EOH 11 FLA 62 CFF 16 CYS 146.

### THE EASTERN PENNSYLVANIA SECTION QSO CONTEST

After considering many contests, the following was chosen as being most suited for the promotion of activities and interest in the Section. Due to the nature of the contest, it is necessary that it be limited to the 3.5 mc. band. The object of the contest is to QSO as many stations as possible in the E. Pa. Section. Attractive prizes will be awarded the three highest contestants.

#### RULES

1. Contest starts midnight November fifth. Ends midnight November eighteenth.
2. SCORING: Each QSO counts one point. However, thirty stations (23 CW and 7 fone) have been chosen as "extra point stations." These stations have been designated as counting extra points ranging from FIVE to TWENTY-FIVE when QSOed. Therefore you may work a station, thinking you earned only one point when you actually earned five, ten or perhaps twenty-five. When traffic is handled during a QSO, the score for that particular QSO is doubled.
3. The identity of all "extra point stations" is known only by the SCM. For this reason the SCM is not eligible to enter the contest.
4. Only one QSO with a particular station will count in scoring.
5. Within one week from end of contest, log, showing all stations worked and notation as to whether or not traffic was handled, must be in the hands of the SCM who will compile the final scores by adding the extra points where due.
6. When a station has more than one operator, each must submit a separate log.

—Jack Wagenseller, W3GS,  
SCM E. Pa.

MARYLAND-DELAWARE-DISTRICT OF COLUMBIA—SCM, E. L. Hudson, W3BAK—RMs, W3SN-W3CJS-W3CQS. Chief RM, W3BWT. The Baltimore Amateur Radio Association holds regular meetings at W3ADB's. The Delmarva HAMFEST, postponed one week account storm, enjoyed a large attendance. District of Columbia: W3CXL, BWT, ZD, ASO make BPL! Each did fine work in handling storm traffic on Aug. 23-24. W3WU has new c.c. rig. W3CWE applied for ORS. Maryland: W3BND and CIZ have been QRL. W3CJS is looking for schedules. W3SN, BHE and CQS handled plenty storm traffic Aug. 23-24. W3BGI is studying for Commercial. W3CDG is organizing East Coast net. Delaware: W3WI will be on soon. W3BAK divides time between QSOs and work.

Traffic: W3CXL 1667 BWT 443 ASO 338 BND 176 ZD 113 CQS 112 SN 82 BAK 47 CDG-BGI 24 BHE 8 CJS 1 ZV 2 CIZ 39 CTD 25 CPP 18 CWE 6 DML 7.

SOUTHERN NEW JERSEY—SCM, Gedney Rigor, W3QL—W3CWL comes through with fine total. W3APV handled traffic for letter carriers' convention. 3BPT handled traffic from Texas storm area. W3BHT is away at Troy, N. Y. W3ZI had successful trip to camp. W3BDO is new ORS. W3BTS is op at WPG. W3DRP is old timer. W3CLQ is returning from Delaware. W3BIR re-

ports from Trenton. W3ZX handled traffic with VOQH. W3BYR will handle traffic. W3AYA is rebuilding. The S.J.R.A. in conjunction with I.R.E. of Phila. extended to Signor Marconi an invitation to attend special joint meeting of the clubs in event he toured Phila. section on his trip to Chi. The Atlantic Radio Club reported reorganizing with W3CLW, pres.; Ed Schofield, vice pres.; treas., W3UT; secy., W3APV and chief op. W3BDO. W3ATJ is back after long lay off. W3BEI changed QRA. W3BUB moved too darn near W3QL as did BEI. W3AQC, BAY, VZ, CXO, CUA and CVE are looking up for ORS tickets.

Traffic: W8ZX 8 BIR 4 DRP 22 CLQ 3 BTS 2 BDO 31 ZI 8 OWL 179 BPT 2 APV 19 AEJ 42 ATJ 2 AKI-QL 4.

WESTERN NEW YORK—SCM, Don Farrell, W8DSP—W8AXE schedules W8DSP. W8ETH wants an 'O3A. W8GPU is trying c.c. W8EDA is back from honeymoon trip. W8AJS has new masts. W8DSP can take a few more schedules. W8GWZ says the M.V.B.P. reduced monthly dues. W8DBX is ready for winter schedules. W8FDY has been operating from WLNC and W8JE. W8JJJ, AQE, GPT, JLG, IDJ, EBR are new ORS. W8AWX turns in large total. W8FMX has nice schedules. W8GWS moved to Kansas. W8EMW took thirty-three messages from W9USA at one sitting. W8BRH, COK, DOA, DNP, EQS, JOG are new calls in Newark. W8KBS sends first report. W8GZM reports through KKR. W8DWJ is working 1.7-mc. 'phone. W8AFY is building c.c. job. W8EED was just married. W8JSD moved to Richfield Springs. The Mohawk Valley Amateur Radio Club will hold a hamfest in Waterville late in October. W8KJO, KPI, KIC are new hams in Herkimer. W8EVM reports traffic. W8CLP is changing QRA. W8JTT worked all W and VE districts in past month. W8AED and ABV visited BXY. The Elmira Radio Amateur Ass'n reorganized. W8AJ gave a fine talk on crystals at Elmira. W8DMJ is a busy M.D. examining the returning school children. W8JAK is trying to stir up 56 mc. interest in Utica. W8GQ is active. W8GPS and CQW both turn in nice totals. W8ACK's antenna is down. W8BFG is building 3.5 mc. rig. W8FUG was in auto accident. W8FYF expects lots of traffic from Colgate. W8CJJ is arranging schedules with Florida. W8BJO moved to Fulton. W8JKA is busy fishing. W8DNG was on the air at Wayne County Fair at Palmyra. W8BWW is lining up schedules. W8AQE is using low power. W8HVG and CBE are active at Sodas. W8ABX is working 28 and 56 mc. W8AGS expects an active U.S.N.R. season. W8CDB will be on with new outfit. W8BOL reports 56 mc. activity. W8FTB joined N.R.A. W8JTN will use portable W8JYK at Albany. W8IYX reports traffic. Pre-war 1UN is back on the air at Binghamton. W8CF, QP, AOW and DQE visited the SCM. W8AOW plans to take his family to Florida for the winter. W8CSE schedules W8JAK. W8JW is trying to make a golfer of W8DSS. W8FWY is on at Oneida. W8BQJ is working again.

Traffic: W8AWX 1083 DSS 110 DSP 43 EMW 91 FMX 56 FDY 84 GZM 15 IDJ 21 JJJ 26 GPS 69 CLP 48 CJJ 53 AFY 38 JAK 33 DHU 31 AED-JTT 30 EBR 48 GPT 27 FUG 30 EVM 28 DMJ 25 CQW 16 GWY 15 FYF 3 DBX 2 GWZ 4 AXE 3 BWY 4 AQE 8 AGS 9 BOL 12 FTB 10 IYX 14 JLG 19 BQJ 18.

WESTERN PENNSYLVANIA—SCM, C. H. Grosarth, W8CUG—W8GBC has been appointed RM. Bill's address is 15 N. Jared St., Dubois. W8FCO tried hard for traffic. W8CMP is home from vacation. W8DKL has returned to air. W8GUF sends first report. W8FRA has trouble making DC. W8AJE reports by radio. W8GRY sends nice total. W8FZG will be in the Nov. contest. W8DYF says W8KQX, KRO and KQH are new hams. W8KSG and KSK are working 56-mc. 'phone. W8AVY still thinks he is a fisherman. W8CQA was reported in N.Z. on 3.5 mc. W8FKU is trying to land a job. Portable W8KCS, Boys Club of St. Marys, reports many QSOs. W8IOH is interested in 7 mc. W8IOI is in the market for SW-3. W8ECH reports for W8DDU, BFZ, CAF and FFR. W8FAK has been hunting DX. W8IQB hopes to

boost his traffic total. W8FIP is working all bands. W8KQQ reports for W8KQY. W8HMJ visited Johnstown gang. W8KD is getting settled at school. W8CFR's transmitter is on the fritz! W8CUG is trying to find 23 mc. See Oct. QST for Contest rules.

Traffic: W8GBC 183 CUG 92 GRY 82 GUF 63 FZG 38 CQA-ECH 31 AVY 30 HGG 24 DYV 13 IQB 11 FIP 10 KQQ 7 HMJ 4 FAK 2 FRA 1.

#### CENTRAL DIVISION

ILLINOIS—SCM, F. J. Hinds, W9APY-W9WR—RMs, I. W9DDE, ERU, VS, CRT. W9CZL visited W9USA. W9KEH is organizing trancon route. W9ENH is moving. W9NDB has new bug. W9JZY passed Radiotelegraph Second. W9HQH and AAK work FB DX. W9AAY joined A.R.R.L. Old 9ATG is now W9HPG. W9COO is getting busy with traffic. Traffic handling is where W9MAJ gets most of his enjoyment. W9OPT is with C.C.C. at Morris, Ill. W9OMA has 50 watters in final. W9EBL has SW3. W9FOC moved back upstairs. W9BIN rigged up a voltage doubler. W9LNY is W5DTL when in Texas. W9AFN worked Tunis and Sudan. W9AVB would like to hear more local 28 mc. phones. W9CGV worked the Mizpah, KFZT, and Coast Guard Station, W8DXQ, all day to help locate missing balloonists. W9DOU has enough control switches to suit anyone. W9DCI is on after summer in Wyoming. W9LNI says new regulations FB. W9DBO sent his sister to W9USA as his representative. W9NN says some high traffic totals must be done with "Mirrors." W9EMN spent two weeks on U.S.N.R. Cruise. W9ERU is working on Rockford Police Stations, WPGD, etc. W9FXE has been visiting boys near him. W9IYA wants schedules. W9CJM has gone c.c. W9KCX is making 250 watt outfit. W9OJX was on Naval Cruise. W9IEP is watching activities around Lostant. W9NGG has '45 TNT. W9MBJ says 14 mc. picking up. W9JLK has new receiver. W9SG has SW5. W9HUX is building new receiver. W9BYZ and JO did fine work on 56 mc. at Chicago Air Races. W9ACU needs power supply. W9KOQ is building c.c. rig. W9OJO has two 50 foot sky hooks. W9LJU has 50 watter. W5DFE is new ham in Peoria. Rebuilding: W9KIM, LVQ, BPU. New ORS: W9IBC, MKK, AND. W9LZF wants ORS.

Traffic: W9USA 2579 FCY 668 JZY 360 DOU 164 JOC 141 KEH 107 ENH-KJW 90 LZU 74 ILH 50 FOC 49 AND-IWP 42 OPT 38 CZL 35 CUH 34 HMB 30 AMO 29 NDO 28 MKK 26 IEP-IBC 20 HNK 17 AFN-GYP-HPG-LZF 15 KCX 14 OGV-MAJ-SG 13 FXE-ISG 12 AAK-ICN 10 IUF-WR 9 BPU-NN 8 IYA 7 EMN 6 AVB 5 DJG-FTX-JLK-MBJ 4 DBO-DCI-ERU-HQH-NIU 3 BIN-HUX-KIT-MSV 2 DXZ-FO 1.

INDIANA—SCM, A. L. Braun, W9TE—In the future, mail reports to 1653 Kelly St., Indianapolis, new location of W9TE. On the first Sunday of each month a QSO party for Indiana hams is held. From 6 a.m. to 6 p.m. C.S.T. is time. All Indian hams should participate. W9AET is getting ready for A.A.R.S. W9AIP is going to work Oct. 1. W9BKJ claims he is going on 'phone. NRA helped W9BZF land a job. W9BTR is doing service work. W9KLA and KMI are trying 1.7-mc. 'phone. W9MVS works DX. W9GHF is making a bug. W9HTP has trouble with power supply. W9AB and CRZ are goofy about 56 mc. W9CKB moved. W9CHA replaced '81s with recto-bulbs. W9DJJ is winding his Class B transformers. W9DJU has FB7A. W9DET expects to make BPL some day. W9DKR will have 4 ops. W9EPT has been counting relays one for about a year. W9GFS entered Evansville college. W9HMI was elected to A1 op club. W9CKY works lots VKs. W9HPQ is getting A.A.R.S. lined up. W9HBK handled a death message. W9HIU met a real AC3 op at W9USA. W9JRR is at Indiana Tech. W9JQO is trying 28 mc. W9JHY tried to put up 80 ft. gutter-pipe mast. W9EEJ is trying '45s PP. W9KDD will op W9NAA at Rose Poly. W9OVR is at Terre Haute. W9LCL has rack and panel. W9LLV wants AC receiver. W9MQQ is on with a 50 watter. W9MSZ is building c.c. rig. W9RS has a new job. After ORS: W9EGV, EGQ. At W9YB: W9GYB, CKG, GVV. W9UM

will do his part as far as DX is concerned. W9CLF is on CW again. W9JKK is giving 23 mc. a try. W9JTU likes MOPA. W9JYU works plenty DX. W9JXE has a steel rack. W9KFS uses a '24. W9KPD uses a '10. W9LKI cracked his crystal. W9OFA will have DC receiver. W9OLP is at Ft. Wayne. W9JOQ is trying an a.c. rig. W9AAL-W9HLF are building 28 mc. rig. W9OFT left for Iowa. W9OCT and KDK are back at school. W9ASJ is collecting parts he loaned other hams. W9AEA gets on early in the morning. W9MPR is buying filter. W9DSC is QRL police radio station. W9HSD likes 7 mc.

Traffic: W9HML 113 EPT 105 AIP 103 MQQ 52 DET 50 EGV 47 HBK 47 HUV 28 MBG 32 GFS 19 BKJ 13 AET-CRZ-LLV 12 GYB 11 EGQ 10 HPQ 9 TE 24 AAL 40 JNH 14 RS 4 CHA 2 JRR 1 FQ 22.

KENTUCKY—SCM, Carl L. Pfumm, W9OX—The Ky. QSO Party on Sept. 10th was a big success. W9AUH copped the key used by Reinartz on Macmillan's first Arctic trip. W9FQQ decided to stay in Ky. W9GGB sprouts a bigger total. W9BAZ is installing new receiving equipment. W9EQO gives JYO an FB-7! W9ETT and OX added TRF stages to their FBX's. W9IFM returned to school. W9CDA and AEN have fine signals. W9CIM is all set for new regs. W9OFE claims to be most eastern W9. W9ERH is moving back to Frankfort. W9CIS and NKD have c.c. rigs. W9ARU is settling down to regular operation. W9IXN keeps Ky. schedules. W9KTO rebuilt to 5-stage transmitter. W9EJD is newcomer in Louisville. 3.5 mc. QRM too much for W9MWR. W9FZV doesn't like local QRM. W9JVA has receiver troubles. W9EDV is coaxing along an 18 watt transmitter. W9BEW is on for first time in many moons. New XYL keeps W9ZZQ occupied. W9AQV is waiting for gang to resume schedules. W9HAX has been transferred to Bowling Green. W9ELL spends his time building boat on river. W9BWJ completed his 25th log book in ten years' operation. W9EDQ in Ludlow is back with us. W9ABV is looking for antenna space. W9BAN is awaiting license renewal.

Traffic: W9OX 138 AUH 87 FQO 76 GGB 46 BAZ 45 ETT 42 CNE 38 IFM 36 CIM 34 CDA 24 OFE 22 ERH 18 CIS 16 JYO 14 ARU-IXN-NKD 9 HJD-MWR-KTO 6 FZV 4 JVA 2 AEN 1.

MICHIGAN—SCM, Kenneth F. Conroy, W8DYH—W9EEM very successful at Isle Royale. W8QT reports DWB ready to graduate class of code-ists. W8BGY is perking up on traffic. W8AEG leads the pack. W9LGU is another Isle Royale-er. W8DZ is pounding them at BIN along with Mr. & Mrs. SCM. W9HK promised W8FX a YL—so FX goes North. Ensign W8ARR has 56 meggie bugs. W8BJ, Editor D.A.R.A. Bulletin (copy free to reporting stations), promises real dope in future Bulletins. W8IOR bursts forth. W8COW recommends coconut oil for W8BMG's knob. W8AIN goes big for 7 megs. W8EHD goes c.c. The gang will be sorry to hear of W8CUX's illness. W9HK promises plenty activity. More traffic & less YLs for W9CWL. W8EVC is organizing an eastern Michigan net. W8CTD is on the outs with the YL. W8HBB is NRA station—"We do our part!" W8TS keeps in touch with folks in Chgo! W9IAO is back in circulation. W8GMB is looking for 70 ft. Mast. W9IOV QSOed G5YH. W9IJH & W8GDR merger—W9DQT will handle Hube's traffic to YL! W8GRN can't hear Michigan stations. W9FSK cancelled schedules. Ludington Club, W8HXT, goes forward with 50 watter. W8CPY tried to QSO Venus but N.D. W9AYT & W9EVI sport comm'l tickets. W9EQQ sends 73 to gang. W9AAM is peppering 'em up. FB. W8ECG & W8IHN are sporting new, fast bugs. W9CE says we're missing the scenes of beautiful Northern Michigan in fall. W9BBP claims it was the YL's OM that has the Base-ball bat! W8JO is Emergency Transmitter Manager for Michigan Section. W8DED reports from QSL-ville. Mike, W8FTW, is certainly "beering" down! W8EGI, BMZ, W9ADY and W8GSP are on their marks. W8BKU and IXJ look like coming BPL-ers. W8JUD, W9MXM, W8KQT, KOX, JNK are new reporters. W8BBH is ready for schedules. We are sorry to get the resignation of W8PP as Chief Route Manager.

Traffic: W8AEQ 230 BIN 166 CEU 127 FX 72 ARR 63 BJ 61 DUR 49 IOR 45 BMG 40 AIN 39 EHD 38 BGY 36 QT 35 BMZ 34 FTW 32 BKU-DDO 24 GSP-CFM-DDO-JO 22 JYU 21 GRN-IFQ 17 CPY-ECG 14 HSH-IFE 13 AIJ-JVI 12 AW-GQS-HXT 11 DCQ-HCC 10 BHH-GRB 9 DSQ 8 EGT-ETP-GDR 7 AYO-CSL-EDO-GMB-HA-NR 6 ICX-IFD-JUD-TS-WR 4 HBZ-JXR 3 CTD-EVC-GQB-FWG-SS 2 COW-CUP-INQ-JNK-NQ 1 IHN 11 HRC 17 DWB 67 DVC 151. W9LGU 199 EEM 38 CSI 27 BBP-HXB 15 CB 16 AAM-EVI 12 RQQ-FSK 11 LLD 10 IJH-KDE 8 ADY-IOV 7 IAO 5 MXM 2 CWR 1.

OHIO—SCM, Harry A. Tummonds, W8BAH—Chief RM, W8DDS, Russell Karg. District No. 1—RM W8DVL: Three times in a row W8FFK leads the state! W8BON handled a death message. More power at W8BAH. W8AOA passes ORS test. 13th VK worked by W8EFW. Low power FB at W8ITR. BCL QRM bothers W8GME. W8HGE is on 3.5 CW. W8BMX is on 3600 kc. YL can copy 13 WPM says W8FGC. Using 7 mc. zepp for 3.5 at W8DAT. W8EPP is on 3625 kc. W8GUL has a job. W8ZZB is QRL YLs. W8BAC takes his code in shorthand. W8ACZ is active OO. RM W8DVL says total going up. W8FVL has two schedules. W8EVI is back at school. W8KKQ has three schedules. School keeps W8FGP busy. W8FJE is ready for schedules. New sky hook at W8IRM. W8FJX is alternate Cleveland U.S.N.R. station. New rig at W8FFM. W8AXV got Army certificate. Old timers club meeting in Cleveland; see W8BSS. Cleveland Crystal Club very active; W8KIY secy.-treas. Brooklyn Radio Club, Cleveland, meets at 4245 West 25th St. Cleveland Amateur Traffic Assn., W8AXV, pres., Cleveland Five and Ten Meter Club; W8AES secy.-treas., Lakewood Radio Club; W8GUL secy.-treas. Lorain County Mike and Key Club announce big Ham-fest for late November. District No. 2—RM W8BKM: W8EEZ has a job. W8BKM was appointed Unit Control station U.S.N.R. District No. 3—RM W8APC: W8DIF says high school principal ordered disbandment of Norwalk Amateur Radio Assn. W8GOD is QRL work. The Maumee Valley Radio Assn. held a very FB Ham-fest at Toledo. District No. 4—RM W8EEQ: W8UW is starting A.A.R.S. tactical district net. W8HMH reports Marion Amateur Radio Club organized with 14 Chapter members: pres., W8CMI; v.-pres., W8HMH; secy., W8CPX; treas., W8BAS. W8IC is out for DX. Change of QRA at W8EEQ. W8WE is on 3590 kc. Write W8PO if interested in portable work. District No. 5—RM W8FGV: W8KLP passes ORS tests. W8BMK tried 'phone. New '52 at W8FGV. W8DVE has gone to college. District No. 6—RM W8BBH: W8GZ is still on temp. Antenna. Lots of call bootlegging going on in Columbus says W8GDC. W8FJW is QRL college. W8ISK had FB Auto horn QSO with ESV at 30 MPH. Hi. District No. 7—RM W8VP: W8HWC wants afternoon schedules. W8FRV handled state fair traffic. Antenna going up at W8VP. District No. 8—RM W8CGS: W8BRQ applies for ORS. W8BKE visited W9USA. W8FSK uses doublet receiving antenna. District No. 9—RM W8DUV: W8DTD uses 'phone. W8DUV is preparing for college. New calls: W8KPB, KTQ, KMU. First reporters: W8GPB, AEW, GVX. Rebuilding: W8BRB, DEM.

Traffic: W8FFK 504 BH 137 BN 112 DU 100 KQ 81 IZQ 71 DDM 55 EBY-FVL 50 FRV 48 RN 44 DVL 41 FGV 40 EQB 38 WE 37 GSO 32 ACZ 30 BAC 29 BKM-EEQ 28 ZZB 27 EEZ-ARW 26 ICC 24 DTD 22 HMH-KPB 20 BKE 17 BRQ-BMK 15 GUL-UW 16 ISK 13 EPP-FJW 11 GDC 10 AES-GZ 9 HWC 7 DAT-DEM-UX-AEW 6 KLP-GVX 5 FGC-BMX 3 GPB-FGP-HGE-GME-ITR-DIH-EFW 2 ZZDC-AOA 1 BAH 28.

WISCONSIN—SCM, Harold H. Kurth, W9FSS—Milwaukee Radio Amateurs' Club resumed meetings Sept. 21st. Watertown Amateurs Club holds meetings first Friday each month. W9HRM wants good schedules. W9NQG is an M.D. W9IQW is preparing for traffic season. W9FJQ has nice station. W9HTZ is QRL school marm (YL). W9JCH-MIH is working from his lake

cottage. W9LBK teaches school. W9OKS (X-W9GPQ) handled hurricane traffic. W9ATO uses remote control. W9OUF is Boy Scout station. W9HKL wants to see "QRZ" again. W9HSK is successor to W9AZN as Route Manager of District No. 4. W9LFK holds daily three way with HRM and ATO. W9HVA got radiotelegraph 1st. W9FAV was visited by IZQ. W9GFC hopes to have traffic total soon. W9OTL is new amateur. W9DRO is back home. W9BXZ is married. W9HFL is putting up silos. W9RH is selling crystals. W9ENP is on 7 mc. W9NAV has a baby boy. W9LAD, GKE, FMI, CAS are active on 56 mc. W9JVV is putting in high-powered 'phone. W9FSS has c.c. at last.

Traffic: W9HRM 99 NQG 73 IQW 43 FJQ 49 KJR 27 JCH 14 LBK 10 OKS 8 ATO 2 FSS 3 HKL 2 LFK 11 HSK 9 HTZ 27 CFP 44 RH 14.

#### DAKOTA DIVISION

NORTH DAKOTA—SCM, Wm. A. Langer, W9DGS-NIFW—W9KBE and IGR are lining up schedules. W9BTJ visited W9USA. W9FSF is lining up A.A.R.S. recruits. W9DYA-JTI rebuilt receiver. W9JAR is handicapped by low power. W9KZL reports newcomer, W9ORG, at Napoleon. The second op at W9DGS will keep the rig on the air.

Traffic: W9KBE 27 DGS 25 IGR-BTJ-FSF 2 DYA 1. SOUTH DAKOTA—SCM, Carrol B. Miller, W9DKL-CIO—Dist. Nr. 1 RM W9DGR: W9FOZ moved to Minneapolis. W9BJV moved to Wis. W9IEK lost power transformer. W9FOQ lost sky hook. W9DGR reports Fair station, W9MVQ a success. W9CFU took unto himself a wife. Congrats, Walt. W9FLO went to Montana for vacation. W9FDD is W.U. relief op. W9TY was 9BFR in 1922-23. W9CAU left for Port Arthur College. W9DKJ uses CAU's 400 watt rig. W9IQZ and DKL plan medium power rig. Dist. Nr. 2 RM W9AZR: W9ITA is on at C.C.C., Keystone, S. Dak. W9NCN is new Cottonwood ham. Stan of W9DNS is job hunting. W9AZR has fifty watt rig. W9HAT is lining up A.A.R.S. phone net.

Traffic: W9IQZ 69 DKL 63 MVQ 35 TY 28 MZJ 14. NORTHERN MINNESOTA—SCM, Robert C. Harshberger, W9JIE—ORS in this Section must handle 20 msgs. per month now until June 15th. W9IPN schedules HNS. W9BCH, portable of HZV, was at Minn. State Fair using ASW's 50 watt rig, with BVM, chief op, assisted by HZV and GQP. New hams: W9OUC, St. Paul; W9OTX-OOU-OIG, Floodwood; W9OSM-OSR, Grand Rapids; W9OPA, OMI, OML and W9OOO, White Bear. W9OBE was at Benton County Fair. W9JES has SW3. W9CTW's last month's report rec'd after SCM went on vacation. W9HEN, 4th op at W9KEE, W9DPP went to 7 mc. W9LAY works Mississippi on 3.5 mc. W9BBL is on 14-mc. 'phone. W9DJW is laid up with paralysis. W9JIE worked first ZL. W9BBH will have EC freq. meter for OO work. W9JID hit BPL hard. W9IPI is president of St. Paul Radio Club instead of W9IPN as reported Sept. QST.

Traffic: W9JID 1507 OBE 208 IPN 180 JIE 59 BCH 57 HNS 55 IMI 48 IBJ 23 HDN-IPA 24 LAY 4 GZO-HEN-JHS 2 HZV 1 DPP 4 CTW 168.

SOUTHERN MINNESOTA—SCM, Norman Beck, W9EPJ-EMQ—RMs, W9BKK and W9L.N. W9LBG BPLs on deliveries. W9BNN is ready to hit the ball. W9GCN will apply for ORS. W9BN will resume schedules. W9DH has rack and panel job. W9DEI will try 3.9-mc. 'phone. W9EPJ built April QST SS. W9BKK is QRL A.A.R.S. W9JUZ is new reporter. W9JBA is ready for winter season. W9HCC has been experimenting with new antenna system. W9GLE wants more soup in sky-wire. W9IAE is on 3.9-mc. 'phone. W9LDQ joined A.A.R.S. W9CSY is back in Mpls. W9FNK will resume traffic work. W9EYL has 56 mc. rig. W9FCS sends 73 to gang. W9KDI is on 1.7-mc. 'phone. Annual meeting of I-W-M 1.7-mc. 'phone club met at Rochester Sunday Aug. 27.

Traffic: W9BIG 428 BNN-HCW 38 GCN 30 BN 25 DEI 24 EPJ 18 BKK 16 JUZ 14 JBA 12 HCC 8 GLE 6 IAE 4 LDQ 3 CSY 2.

## DELTA DIVISION

**ARKANSAS**—SCM, Henry E. Velte, W5ABI—W5BED is responsible for many reports from his section of state. W5CUO has been experimenting with antennas. W5BXM has good traffic report. W5DHN is c.c. 3667 kc. W5DRW is new station in Siloam Springs. W5DRY got his call just as Arkansas went wet. Hi. Ex W5BU is back from Calif. after 7 years. W5GN has been off account of sickness. W5PX works lots of DX. W5BMI is c.c. W5ABL is rebuilding. W5IQ is making RF chokes for the gang. W5SI and LV visited the SCM. W5BUX took in Midwest Convention. W5DFY is looking for that K DX. W5ABI has new c.c. rig.

Traffic: W5PX 128 IQ 45 BXM 33 JK 4 DHN 2.

**LOUISIANA**—SCM, W. J. Wilkinson, Jr. W5WF—A station will be in operation at the State Fair Oct. 21-29. W5BYX gets pdc reports. W5CXQ is an FB fellow. W5AFW is laid up with infected jaw. W5BI returned to air. Rudolph Marshall (call?) is about ready to go. W5ACV is ship op. W5AKW returned to LSU. W5CMQ attended convention. W5AGM will relay traffic from fair. W5AXU has fine 14-mc. 'phone rig. W5CW-CFF-CFG-CEN-BYQ are building station for state fair. W5AYZ will handle your traffic. W5PY gave his rig to W5WL. W5BID is A.A.R.S. W5DOK is in Boyce. W5ADJ is in Hodge. W5ANQ will be on in Monroe. W5FR is cook at LTI. W5LT is on 1.7-mc. 'phone. W5ACA has trouble with DX cards. W5BN needs some traffic. W5DC is in Greenwood. W5AKI and ML sent messages to convention on 14-mc. 'phone via W2TP. W5BYQ and BYY have combined. W5BFB left for Texas A. & M. W5ZK starts A.A.R.S. net.

Traffic: W5AFW 84 BYX 50 BZR 22 AYZ 54.

**MISSISSIPPI**—SCM, William G. Bodker, W5AZV—The Meridian A.R.C. has been organized. They boast 18 members. W5DP is building c.c. MOPA. W5DEO is getting parts together for 7 mc. rig. W5LD is on 7 mc. W5CLD has National FB7X. W5ANI is Master of Ceremonies on Army Net for Mississippi every Monday night. W5DPP has '10 TNT.

Traffic: W5CLD 22 VJ 4.

**TENNESSEE**—SCM, F. F. Purdy, W4AFM—W4OI leads traffic reports this month! W4YK has returned to Purdue. W4PBV-AAO has portable on air at C.C.C. Camp in Middle Tenn. W4AAD and AFM maintained communication with Florida hams during hurricane. W4EX is operating at WROL, Knoxville. W4BGQ resigned as secretary of East Tenn. Amateur Radio Club. W4BQK was appointed to finish the term. Chattanooga hams exchanged visits with Atlanta hams. The 'Nooga hams visited Atlanta first. The U. S. Monitoring Station, Naval Armory, Fort McPherson, The Airport, WSB, W4IR and W4MO were visited after which the entire gang were treated to a lunch. Three weeks later the Atlanta hams visited 'Nooga. The gang met at Lookout Mountain Caverns where W4PL had installed his receiver. With 1500 feet of rock as a barrier, four feet of wire attached to a copper spike driven into a crevice constituting the antenna, W4LU's 'phone was heard with loudspeaker volume. W4LU acted as toastmaster and welcomed the gang to Chattanooga. A trip through the Caverns was enjoyed after which the gang adjourned to W4PL's country home where a most welcome and delicious lunch was served by Mrs. W4PL. After the lunch W4PL, W4DD and W4LU were visited. A short talk by the SCM climaxed the wonderful hamfest.

Traffic: W4OI 1500 RO 202 PL 128 BPC 78 EX 75 CBS 42 AEP 25 VK 17 BTQ-AFM 14 BBT-AYU 8.

## HUDSON DIVISION

**EASTERN NEW YORK**—SCM, Robert E. Haight, W2LU—The SCM expresses his appreciation on reelection. An ENY TFC. Bulletin will be published monthly. Only members reporting monthly to SCM will receive it. W2BLU walks away with traffic honors. W2UL, CFU and EGF are QRO. W2DC QSPs for VOQH. Doublet antennas at W2KW. W2ACD and DTB plan visit S.A.R.A. Banquet. W2FPH is looking for traffic.

W2DTS is QRL S.A.R.A. activities. W2DQT goes to school at Kent, Ct. W2ATM is 90% traffic handler. W2BRS joins traffic gang. W2BJA is lining up fall schedules. W2CJS burned up power supply. W2GPD is popular Kingston Ham. W2ESO reports for local hams. W2ENY-ENG and FAM pledge their support. W2BZZ is always at RM parties. W2DIN talks with his hands (CW). W2DMC, Crystal Rdo Club, lost both antennas in storm. W2FMI is heard on 1.7 mc. W2BGH and AUX have law abiding signals. W2DIB takes crack at unlimited. W2DXJ is gang's official tube checker. A new Chev. and SW3 at W2CSC. W2DIY tries 1.7 mc. W2FUM is putting in PP '10s. W2EQD wants 50 watter. W2EQC's power transformer went west. W2GCE is Ex2BXO. Ex War Flier. W2MA returns to Pelham. W2DDW is Treas. of Mid Hudson Club. W2DWO leaves for school in Ohio. President, W2BJX, presented Go Devil Bug, a patent of W2CVT. W2CSB and DDO were visitors at DDW. W2AXX adds '52s to final. W2DOS is on 56 mc. W2CGT has new rig. W2CDM is c.c. W2FKQ returns to Union. W2CJP revamps.

Traffic: W2BLU 501 UL 237 LU 216 EGF 93 DC 67 KW 57 ACD 31 FPH 18 DTS 17 DQT 15 ATM 7 BRS 6 BJA 4 ACY 3 CFU-CJS 2 GFD-ESO 1 FKQ 35 EFU 3.

**NEW YORK CITY AND LONG ISLAND**—SCM, Ed. L. Baunach, W2AZV—W2ELB and BTF are after ORS. W2FIP sends first report. W2ETD, GYI and CMW are at WPEF. W2ELK found a ham across the street. W2AZV, ASG, AGC, BAS, KR, PF did fine work at Electrical Exposition at Madison Square Garden, using call W2PF. W2FFN has new QRA. W2AZV, LC and AOP operate NDB. W2GND is new station. W2QX schedules XIG on 'phone. W2BSR schedules Chile. W2TI spends some time in Canada. W2DOG listens daily on 28 mc. W2FDQ and EYQ are QRL school. W2DBE is out for commercial ticket. For a good RC hook up with W2CEH. W2DBQ and DJP resume A.A.R.S. schedules. W2BGO was on for 16 hours during last coastal storm and did fine work. W2EPJ is on 1.7-mc. 'phone. W2TKD will be heard from the Bronx. W2BIN and DQK will operate portables from college. W2DRG visited W9USA. W2COH and FIS will be QRL college. W2CBB has plenty of visitors. W2BEPJ has decided to study MORSE. W2DTT has a commercial looking layout. W2BNJ sent his report from Plattekill, N. Y. W2DUP wants an early morning schedule. W2DMI is rebuilding and doubling power. DXers: W2CAC, CLM, EXO, FVU, EVA.

Traffic: W2CBB 515 SC 328 BNJ 196 BGO 134 CYX 127 ELB 118 CHK 109 EYQ 108 EKD 72 DRG 42 DBQ-ELK 31 PF 21 FIS-BAS 20 AZV 18 BIN 17 ASG 15 AIQ-CAC 11 BPJ 8 DUP 7 EXO 4 AOP-BVT-EVA-AGC 3 DQK-LB-LC-LR-QM-FIP-KR 2 ADO-BTF-CLM-DJP-COH-FPJ-ETD-GYI-CMW-FFN-QX-HY-CUD-BEG-DMI-DTT-FDQ-AXN-CEH-DBE-EGA-EWS-CEH-EW 1.

**NORTHERN NEW JERSEY**—SCM, Walter A. Cobb, W2CO—Traffic is under way for W2EXQ. W2TP maintains contact with VOQH. W2DV is back on the air. W2EIP is bearing down on rag chewing. W2GJT and GLF assisted at the funeral of AFK's '10. W2CJX threatens to burn up the air. Somebody is using W2CIZ' portable call. W2BXM went away for most of the month. W2ABT schedules K5AB. W2CTV's B eliminator consists of 90% hum! Rutherford Radio Club resuming activity, writes W2CFM. W2CWK threatens to renew A.R.R.L. membership. W2ELJ is back on 3.5 mc. W2EOH spends his time building new rig. W2CHH is off the air until Xmas. W2CZP and EAG had the first 25 mc. QSO on Jersey Shore. W2DFB sports a 100 watt c.c. job. While on vacation, W2BPY reported in at HQ in Hartford. W2EIC slid down his roof. Ouch! W2DGU walked ten miles to deliver a message! W2CGG has been traveling around. W2DSP and CTT got lost in NY looking for RI's office. W2AFQ and NB are QRL handling inquiries on their new transmitter. W2GAG is new in Plainfield. W2EKM is organizing a new traffic net. W2DIU writes from ST. LOUIS where he is on furlough. W2DSV of

Red Bank is now at WVB, Fort Sam Houston, Texas. Mrs. Margaret Wandelt, Bayonne, has call W2FPR.

Traffic: W2TP 4 CGG 41 CIZ 26 ABT 11 CJX 10 ELJ 5 BPY 4 DV 3 AFK 106 EIP 28 CWK 18 CTT 7 RXQ 6 CTV 4.

MIDWEST DIVISION

IOWA—SCM, Geo. D. Hansen, W9FFD-JXA—RMs, I W9ABE, W9HPA. W9ZZAF tops the list. W9ABE is SNCS. W9KSV, port. of BFL, did fine work at State Fair. W9NUC is new reporter. W9ERY lost part of rig in fire. W9FFD is wrapped up in new business. W9FZO wishes rig would work as well on 7 mc. as on 14 mc. W9CWG sends OO report. W9GWT is ready for A.A.R.S. W9LFF has hard luck with filter condenser. W9FLI is settled after five moves. Reports received from W9JMB, DZW, GXU, NDN, FYC, CYL, NTR, ONG, DPO, HPA. W9JXA is Unit Control U.S.N.R.

Traffic: W9ZZAF 588 ABE 341 KSV 142 GXU 62 BFL 22 NUC 21 DZW 19 ACL 18 ERY-FFD 12 FZO 11 CWG 9 GWT 6 NDN 4 LFF 3 FLI 2 JXA 13.

KANSAS—SCM, O. J. Spetter, W9FLG—W9KG and W9CFN CW RMs. W9ESL Phone RM. W9BEZ wins Kansas Wouff-Hong for 1933. Congrats, OM. Again CX7 takes the lead! W9KG BPLs on total. Following BPL on deliveries: CX7, W9YAB, BDB, FLG and BEZ. Walnut Valley Radio Club took home the bacon from convention. SEKAN Radio Club had 56 mc. field day at IOLA. W9IGY attended World's Fair. W9GUO has c.c. 3.5 mc. rig. W9ABG, LFB and AWP report swell time at N. G. Encampment. W9DAL won crystal donated by BDB at W.A.R.C. meeting. W9DMF and KTG are building 1.7-mc. 'phones. W9CKV has new c.c. rig. W9GBP lost power transformer. W9CWW worked EL. W9FET, NQE and BCY had wreck enroute to Convention. W9CGI is located near Halstead, Kans. now. W9NJS is going strong on 'phone. W9IOL congratulates the SCM for getting back on the air. W9BWP has pair '52s. W9AHR delivered a death message. W9CSK is on 3.5 mc. W9EHA uses pair '45s. W9LGV is moving to Norton, Kansas. W9LGM, port., set up at Kansas Fair in Hutchinson. W9LEL sends code practice daily except Sat. and Sun. W9OFR reports 200 QSOs in five weeks. W9OBV took unlimited 'phone. W9AWR reports Garden City Radio Club is going to operate booth station at county fair at Holcomb. W9KXN is building MOPA. W9BTG moved to Grand Rapids, Mich. W9FRC passed unlimited 'phone. W9ICV increases plate supply to 1000 volts. W9NI on air all night during convention and contacted 14 states. W9FRC reports CX7 remotely controlled at Camp with 1000 foot center tap keying circuit using no relay. W9LFN is building for 'phone and CW. W9FLG was honored with a visit from two directors at once, W9AAB and W9GP. Also had four visitors from Maine, W9GLN, DBQ, DGJ, BOC, also W9ESA during convention. W9ESL won pair Frost headphones at convention. New hams: W9OEH, OCV, W9GJU and IGQ have SW3s.

Traffic: CX7 3527 W9YAB 1365 KG 607 BDB 387 FLG 330 BEZ 242 GBP 229 IGQ 173 EFE 146 IPD 139 AHR 106 KDO 103 CYV 95 LHM-DMF 90 KCR-EIB 86 NJS-HTF 64 IOL 58 BNU 46 EHA 44 OQC 40 CKV 37 CSD 34 FET-NLZ 30 IEL 29 DFY 27 DQJ 25 BUY-FRC 22 ESL 18 LGR 16 NI 13 IFR 10 NQE 7 BWP-JBV-OPR 6 GHI-AWP 5 CMV 4 BGL 3 GWN 2 KFK-AWR 1.

MISSOURI—SCM, C. R. Cannady, W9EYG—RMs, W9FTA and W9BMA. W9BAU makes BPL. Much comment has been made relative a STATE BULL' publication. A trial issue will be made about NOV. first. If interested, make what contribution you can towards defraying its expense and it will become a Missouri fixture; otherwise it will be dropped! W9MZZD's transmitter, receiver and "B" went west in two days! W9BYN is back at Parkville with AHH. W9LBA comes up on traffic. W9LBM holds Jeff City in activity. W9LFU reports for NHW. W9BTD is back to Fulton. W9WC made World's Fair. W9AJJ is beginning work in A.A.R.S. and U.S.N.R.

W9HVW and INI were visited by BAU. "BF" of W9CRM says "BF" Jr. built new receiver. W9AAN gets ORS. W9HNM renews activity at Brookfield. W9MLR, ENT and GBJ are 7 mc. traffickers. S.M.A.R.A.: W9HUG reports Convention a dandy. W9CJR is being considered for R.M. W9IXO is back to 3.5. W9EHS is coming up! W9FYU and FVM are going to show up Arkansas. St. Louis: W9LWG makes debut at trafficker. W9KFL moved. W9LLN, NNF, KEF, ILL, and BQI are 1.7-mc. 'phones. W9CCZ is QRL YL. W9GUO is back from Great Lakes cruise. W9HVN works on boat on River. W9NBV and HUZ are getting c.c. rigs perking. W9NBE is on 7 mc. W9FPA is working DX. W9GTK-ENK are back in A.A. W9DOE has new transmitter. W9IJW lost code student when YL got in Munny Opera! OBP: W9BGE kept daily convention schedules and with EFC brings OBP ahead of St. LARC again in traffic! W9GDU and FTA are working on the river. W9RR sends K.C. lone report. QRL school: W9EDK, DHN, DIC, FZJ.

Traffic: W9BAU 712 HNM 52 CJR 48 ENF 30 GBJ 27 CRM 26 HUZ-MZD 25 EDK 22 LBA 19 BGE 13 EFC-HUG 11 AIJ-NP 10 DOE 9 MLR-LFU 7 EYG-LBM 6 LWG 5 NEW-IJW-RR 4 JPT-HCP 3 GTK-MAK 2 LTN-LLJ-FEH-DHN-NOY-JUB-BYN-AHH-ENK-DIC-OKR-IXO-EHS 1.

NEBRASKA—SCM, S. C. Wallace, W9FAM—W9DMY takes the lead. W9DFE is leaving for a job at W I N D at Gary, Ind. W9DI is all set to go. Let's cooperate with our RM, fellows. W9EWO reports JLP took exams. W9HTU left us for unlimited time operating a ROAD SHOW (???). W9BCX blew his buffer tube. W9EHW is preparing for A.A.R.S. W9IFE has c.c. rig. W9CUY turns in FB report. W9OPP sports FB7. W9DHO reports for first time. W9KJP is helping put Omaha back on the map. W9KVZ is another Omaha ham getting in line. W9FXP asks for ORS and OBS. W9CWM is campaigning for Midwest Division Convention in Nebraska next year. W9HFD had a hamfest at his shack and the following were present: W9FYP, HYS, FXF, HZR, MGV, KYD, BMK, HFD, FAM.

Traffic: W9DMY 54 DFF 33 FAM 22 DI 17 DGL 9 IFE 69 CUY 40 OPP 19 DHO 20 KJP 11 KVZ 7.

NEW ENGLAND DIVISION

CONNECTICUT—SCM, Fred A. Ells, Jr., W1CTI—W1CJD got FB Traffic Net going Sept. 11. W1MK BPLs. WIDOW schedules eight stations. W1AMG had receiver trouble. W1GGX is ORS. W1BMP is c.c. 3840 kc. W1QV sends dope on New London gang. W1BIQ pinch hits for DOW on schedules. W1CVL had school QRM. W1CTI keeps his Thursday evening schedules from CBA. W1APW used a penny in place of a fuse so he could keep a schedule one night. W1GTO reports by radio. W1YU signs WLE on 6990 and 3497.5 kc. W1BQS is building port. receiver. W1ERU has an SW3. W1TD is collecting parts for new transmitter. W1EWD moved. DXers: W1CNU, CUX, EKD. The Wallingford Radio Club meets every Thursday evening at the Town Hall. W1FRK, AVS, CER are on 56 mc. W1FDU visited W9USA. W1HKF and HKT are new hams. W1ALS is rebuilding. W1CRK says 3.5 mc. FB. W1GZG is going 1.7-mc. 'phone. W1ABN is on 7 mc. W1DCI's job keeps him off air. W1DCM is manager of Fruit Dept. for National Economy store. W1FOZ is playing with c.c. W1GUK is building A.C. receiver. W1CTO doesn't like FBXA on 14 mc. W1BDS is building new receiver. W1ANG and CTX work a noon schedule. W1GXU is on 1.7-mc. 'phone. W1DBU and ESD got back from two weeks with Uncle Sam in Vermont. W1CUH, GKQ are busy with new transmitters. W1FUY is boating. W1CTV and GTE are on 3.5 mc. C.W. W1FO keeps sure fire schedules. W1AYB bought an SW3. W1CBA had a shore dinner and hamfest with 21 hams present. W1GEX keeps the club transmitter on the air. Seventeen ORS and RMs were present at the annual ORS meeting held at A.R.R.L. Headquarters Sept. 17th. F. E. Handy acted as chairman. Traffic work was main topic of discussion. The latest in

ham receivers and transmitters was demonstrated by Jim Lamb. Several of the gang visited WIBDI and MK.

Traffic: WIMK 280 DOW 130 AMG 125 GGX 75 BMP 72 QV 56 BIQ 54 DCI 40 UE 28 CVL 26 BDI 25 CTT 23 APW-GTO 20 CTO-BQS 16 ERU 14 APZ 12 CNU-CBA 10 GKM 7 BDS 5 ANG-TD 3 ABN-HAG 2 DCM-CUX-EWD 1 GUK 1 FIO 25 CJO 36 BBS 11 AQA 4 DGG 3 YU 25.

MAINE—SCM, J. W. Singleton, WICDX—WIGKC and BEU handled traffic from Camp Keyes. Weather conditions temporarily deranged WIBOF's schedules. WIEFA's receiver works great. WIEBM will be c.c. soon. WIFJP is working on c.c. W1HMJ is new YL ham in Belfast. W1AXJ is on 3590 kc. WIDHH lost some tubes. W1BTG is on 3.5 mc. W1GGF says all hands should read QST. W1BNC is getting ready for new regulations. W1HLL is new ham in Lisbon Falls. W1VVF entertained the following visitors: Mr. & Mrs. W1BNL & children, W8CWW, W6GD and W8DRP. Old NUIALK of Hiram, Me. is active again under call W1BTY.

Traffic: WIGKC 193 BOF 174 EFA 119 CDX 49 BEU 44 EBM 40 EF 20 ABQ 30 FJP 12 AXJ 8 DHH-BTG-GGF 6 BNC 5 HLL 4 APX 2.

EASTERN MASSACHUSETTS—SCM, Joseph A. Mullen, W1ASI—WICEL has FB total. W1ABG offers two dollar bill to any ham who can rid his outfit of keyclicks. W1KH is on 28 mc. W1WV is converting his entire outfit to run on A.C. W1AGA has been reappointed R.M. W1BKY returned from vacation in Canada. W1EVJ is doing a bit of 'phone work on 1.7 mc. W1BMW says business is good. W1DFS reports a lot of missionary work along QRR lines. W1DNL has been giving BZO a lift on new rig. W1JL has a new job. W1BEF got "taken" for a shipment of QSL cards. WIRE says that EXT is looking to a big season in traffic. W1FRO says she will be QRL school from now on. W1CCF has aspirations of regaining ORS. W1EEL divides time between ham radio and the job. W1BO is getting ready for compliance with new regs. W1EEN has new 600 watt rotary converter. W1CRA is back after a year's QRT. W1HCO reports for first time. W1CGY is working portable at North Falmouth. W1DZQ has moved from the section to Portland, Maine. Your SCM has been elected for another term of office. If the gang want another traffic contest, let's see some postals to that effect. Will club secretaries please keep the SCM informed as to meetings. W1LM will keep Chelmsford on the air.

Traffic: W1EVJ 169 AGA 128 CEL 107 ABG 76 FRO 61 BEF-EHG 53 RE 40 DFS 34 CCF 28 BMW 23 JL 21 BBY 8 BZO 2.

WESTERN MASSACHUSETTS—SCM, Earl G. Hewinson, W1ASY-RB—W1EFM is leaving for school in N. Y. W1AIC reports for Hoosac Valley Radio Club, W1FTS. An old timer, Ralph Damon, reports under call W1AJ. W1AJD thanks W1APR for his help on traffic. W1EBH visited SCM. W1BNL is back on air. Depression over for W1DCH. W1GP and ASY are "on the beach" having left WBZ. W1DVV reports new ham in town, W1HOD. South Berkshire gang were up on Mt. Everest 27 for N. E. 56 mc. Field Day, says W1ADF. W1BNS is new traffic manager for W1BWY. W1AFI reports for fall traffic. W1HNP is new Greenfield ham. W1EOB has YL trouble. W1COI worked six Europeans on 7 mc.

Traffic: W1FTS 61 AJD 34 BWY 33 FAJ 34 EFM 24 BVR 19 COI-EOB 16 ARH 27 AFI 31 APL 12 ADF-DVW 11 DCH 9 EBB 6 ZB 4.

NEW HAMPSHIRE—SCM, Basil F. Cutting, W1APK—W1BGL is going with Byrd Expedition. W1BFT, RM, is starting state net. W1DMI handles Dartmouth College traffic. W1EES has FB7. W1CGJ is repairing BCL sets. W1GKE has new transmitter and receiver. W1EYT was sick for 3 weeks. W1GDE wants to put N. H. on map. W1BAB received 2nd class commercial ticket. W1FTJ (YL) is working in Radio Service Lab. W1IP has YLitis. W1UN handles WX reports from Mt. Washington. W1FEX keeps the state going on 56 mc. W1CBB has a fine looking transmitter. W1FCI is fed up on haywire receivers. W1AUY is going on 500 watts CW. W1ERQ

will get ORS if he keeps up. W1BII says his sister is a better op than he. W1AVJ will handle any foreign traffic. W1BXU is QRL gasoline station. W1AVG is putting up couple new masts. Golf kept W1AVL busy this summer. W1DSX has new job in Boston. W1CGP moved his portable 'phone to Durham. The SCM wishes to thank the gang for all the cooperation. Let's have some ORS applications.

Traffic: W1UN 66 BPT 32 FCI 24 DMI-APK 11 GKE 4 BES 6 GDE-CBB-FTJ 3 AUY-CGJ 2 ERQ 20.

RHODE ISLAND—SCM, Stanley Atkinson, W1AFO—W1EOF comes through with fine total. W1ASZ is building 1925 kc. 'phone. W1AXS returned from summer in Maine. W1DBA is in service business. W1ARK gets out 'PB on 7 mc. W1CAB has started Naval Reserve drills. W1EZW reports new location FB. W1FNE pounds away on 14 mc. W1ATX reports from North Kingston Beach. W1FAH will trade his outfit for a glider.

Traffic: W1EOF 213 AFO 39 ASZ 22 AXS 17 DBA 13 ARK-CAB 12 EZW-FNE 11 ATX 5 FAH 4.

VERMONT—SCM, Roy L. Gale, W1BD—W1BJX is new Brandon ham. W1DAJ has e.c. frequency meter. W1BAE is building new receiver. W1FPS changed QRA. W1GNT reports DHX in Maine, ERJ in New York State. W1DQK has 28-mc. 'phone. W1BNS is attending Bay Path, and has port. HGB. W1EFC adds to DX list. W1BHR visited SCM. As my appointment as SCM expires before you read this report, I wish to express my thanks for the loyalty shown during past two years. Keep the new SCM busy, gang.

Traffic: W1BJP 18 GAE-BER 4 FPS 3 EFC 1.

#### NORTHWESTERN DIVISION

ALASKA—SCM, Richard J. Fox, K7PQ—K7AID has gone to states. K7FF is canning salmon. K7VS has lots of noise. K7DEV has gone south. K7ACS visited K7PQ. K7DWO is new call of exK7MM. K7BAK handled commercial traffic at Skagway when junior commercial station was unable to clear schedules. K7CHP is new ham at St. Elias. K7DJA uses four '45s parallel p.p. K7DWF is new ham at Wrangell.

Traffic: K7PQ 68 BNW 55 CCL 43 CHP 27 VS 7 FF-DWAM 6 DJA 2.

IDAHO—Acting SCM, Don Oberbillig, W7AVP-DKD ---Active: W7BRU, DQC, CZO, CSP, AXY, BMF, ASA. W7GU has class B 'phone. W7CKO is in hills with portable. W7AFH is putting up towers. W7CAP is in hospital for two months. W7BAU keeps eastern Idaho on air. W7BAA and GL are starting A.A.R.S. season. W7BAR plans 'steen toob sooper. W7ATN, ALY, ACP, W6AAX lost sleep at convention. W7DLS may go to school. W7AQK is member NRA (Northwest Radiophone Association). W7AYP works at WUBJ. W7BRY is flying. W7BKX says NH and AVZ are still about. Rebuilding: W7ARS, AAJ, BCU. New hams: W7DBP, DAX.

Traffic: W7BRU 4 AVP 11.

MONTANA—SCM, O. W. Viers, W7AAT—W7ASQ reports new stations. W7FL worked VK3ZB. W7CT turned 'phone. W7BKB is trying 'phone. W7BDP is still building. W7CCR reports four stage c.c. rig. W7BGC reports from Century of Progress Exposition. W7BDJ wants traffic schedules. W7CSG is getting new power supply. W7BI built 1.7 mc. rig. W7BYR is building c.c. rig. W7BVE has '03A final. W7DQT is new Havre ham. W7BMX reports new shack. W7HP has FB7. W7CRH is going to school in Kalispell. W7AHF has portable at Kalispell. W7AFS is building super het. W7CEG, CRH and ABT attended Great Falls Hamfest. W7BSU moved to Great Falls. W7BOR plans 1.7-mc. 'phone. W7BDS worked X246. W7AST is night man at garage for AYG. W7AYG says W7AIR is on a ranch near Red Lodge. On Sept. 2nd W7AVL took unto himself a wife. Congrats, Leo. W7BJZ is after ORS. W5CQS and W7DXR were visitors at the SCM's.

Traffic: W7FL 9 CCR 18 BDJ 6 BYR 7 BVE 32 ASQ 26 CRH 11 BOR 26 BDS 4 BJZ 29.

OREGON—SCM, Ray Cummins, W7ABZ-CBB—W7BUB and DP apply for ORS. W7CUV has com-

pletely shielded Aluminum rig. RM W7KL visited the SCM for a conference. W7AXO won FB7 at convention. W7ZZZ and BXQ have new baby ops. W7QY visited W7AEJ-AJX. Valley Radio Club elects officers: pres., W7CFM; vice-pres., BIO; secy., BDU; treas., KL. W7AHZ is moving. W7ANB gets new op. license. W7BGF is going hi-power 'phone. W7QW has transmitter trouble. W7AYN is CCC op at WUBEL. W7BRH gathers in reports for V.R.C. W7UJ and BEK have YLitis. W7SY assists the R.M. A report arrived from W7DAV. W7CHB adds to his DX. W7WRV completes 25th month of schedule with W7WY. W7AYV and CBA dropped in on the SCM. W7ANX and DJI are starting Boy Scout net. W7BNX is busy with school. W7PL and BZS got home from convention. W7BKD gets out FB on 1.7-mc. 'phone. W7AIP has bigger and better rig. W7AQX is building a house for a YL. W7KR is going strong. W7MQ will soon be back. W7LI is grid-modulating his '52s. W7DWQ worked 93 stations in first month. W7AOL got the bugs out of his 'phone. W7APF fell in river while working on a drill barge. W7BLN is in the Coast Guard. W7CRK and AZJ have fine c.e. rigs. W7DCI is QRL box factory. Astoria is 100% crystal-controlled!

Traffic: W7KL 329 WR 311 AXJ 251 AYV 194 HD 84 WJ 65 CXK 54 ANX 53 ABZ 51 BGF 48 CUV 50 COV 36 BDV 26 BRH 20 AXO-BUB 15 AHJ 13 LI 10 LT 9 BUF 8 DP-BZS-DJI 7 AIG-ALM 4 PL-CFM 3 QY-CHB-DWQ 2 DUE 18.

WASHINGTON—SCM, Stanley J. Belliveau, W7AYO—W7BB leads with BPL total. W7WY works in a cannery. W7LD misses second place by a hair. W7CFK is heavy on del. W7CWL uses port., DJO. W7ASZ reports from Fort Worden and DGE from Richmond Beach. W7BFL is lone reporter from Bellingham. W8EGD/BWN would like gang in Illinois to know he's safe in C.C.C. at Camp Matlock, Shelton, Wash. W7BHH is QRL Army Net. W7BCV is building '52 rig. W7AHQ had a fine time at convention. W7AIB will be signing K7 soon. W7CPD gets his usual traffic. W7DLN and IG keep Eatonville on the air. W7BMT and DRY are new reporters. W7AFC and HS apply for OBS. W7KO's OO report shows all W7's but one. W7BUW is at WSC. W7AYC is at U. of W. We hear from W7CGZ again. W7ABU clicked VK. New hams: W7DXI, DXU, DXZ, DZH. W7AWF intends to do some early morning stuff. W7APS keeps FB schedules. W7CTS applies for ORS. New regs. scared W7AQB into c.e. job. W7CZY sent the SCM a picture of his shack. Monitor is newest piece of junk at W7DGX. W7AZI reports for Tacoma. W7BKE claims to be first ham to go "NRA." W7CHH is now Alternate S.N.C. . . . A.A.R.S. . . . FB. W7CQI overhauled antenna. W7DET holds State high school jump record. W7BCC was visitor at IG. W7BUQ is back getting expelled from hi-school for another year. W7BCS is ruining the code with a new bug.

Traffic: W7BB 434 WY 310 LD 309 CQI 148 BFL 94 CHH 80 APS 75 BHH 71 CZY 60 DGX 56 CFK 44 BUW 39 IG 35 BKE 31 ABU 25 BCV-DGE 19 BUQ 16 AWF-DET 15 AFC-DLN 13 AYC-BSX 12 DRY 11 CPD 9 AQB 7 AZI-AHQ-DMO 5 CGZ-CHU-DLR-ASZ 4 KO-BMT-DJO-APR-CTS-HS 3 BCS-AMA-BVB-RL 2. (W7CHH 65 June 16-July 15.)

#### PACIFIC DIVISION

HAWAII—SCM, C. D. Slaten, K6COG—This report received by radio thru K6COG-NY1AB-W9BLG. K6AIU got married. Good luck, OM. K6IOO has MOPA. K6JPT is new call in Hilo. K6FAZ is attending University of Hawaii.

Traffic: K2EWF 1080 FAB 931 GUA 378 COG 352 GAS 302 GQF 61 HOO 41 GZI 23 EDH 21 FAZ 19 CCO 18 CIB 15.

NEVADA—SCM, Keston L. Ramsey, W6EAD—W6AJP works DX on 7 mc. W6HGL rewired transmitter. W6GUR has new c.e. rig. W6FUO has new 'phone. W6GYX was heard in New Zealand on 3.5 mc. W6BTJ is experimenting on 28 mc. W6BIC and HGY have new

masts. W6BYR has new antenna. W6EEF has pair of '10s.

Traffic: W6AJP 25 UO 17 HGL 12 GUR 11 FUU 10 GYX 4 BTJ 2.

LOS ANGELES—SCM, Francis C. Martin, W6AAN—W6FDN is studying for unlimited 'phone. New secretary of El Sereno Club is W6HCR. New rig at W6CUQ. Rebuilding: W6EMY, GNS, CZT and DQZ. W6CGC has new receiver. W6PKF is one of our best news reporters. W6HXN has Zepp anchored to 80 foot Eucalyptus tree. Hal Nahmens is on job again. W6ALR says doublet FB for FB7 receiver. Pessimistic report on deliveries from W6AZU. W6CPM lost a high voltage transformer, filter choke and condensers. W6IGO works nice DX. Don Wallace was on at Chicago this summer. W6EFH is taking "com'l." Our YL, W6EK, joined A.A.R.S. Sixty-first country at W6CXW is worked with ZEIJF. W6EUV is back at USC. Portable W6DSU at Los Angeles County Fair at Pomona with W6FEW, DVV, EBJ and CQG as CW ops and W6FFN, FDM, CDM and AQD handling the mike. W6CIX is QRL school. W6GNZ makes WAC. W6CVF knocks out another good total. W6BGF took portable W6FHM to Catalina for a four day outing. W6TN has August QST super. New op at W6NF. Silent key at W6IGU—Luke MIMS killed in airplane accident August 25th. W6DOK is looking for 14 mc. schedules. Radiophone First and Telegraph Second tickets at W6GKZ. W6EBJ and CQG have Patterson receivers. Following reported: W6ADJ, AIF, BPP, CGC, CNQ, CGQ, CZT, EBJ, EJZ, EXA, FDM, FEX, FDN, GVI, HCR, HOR, IS, JOE, MA, and SN.

Traffic: W6DSU 1206 BPU 372 CVF 317 CUU 277 AZU 260 BGN 254 FRB 221 NF 183 GXM 174 EII 128 GOX 80 FGT 71 JGA 70 FTV 57 AAN 58 FKF-GKZ 53 ESK 49 GFG-GNM 48 CZZ-TN 45 GLZ 40 AKW 31 EUV 34 AM-CJZ 27 ERC-GYU 26 DWP 23 JFQ 25 FHM 20 GJA-IJK 19 DJC 18 VB 16 DCJ 14 CXW 13 DQZ-DRQ-EMY-FWN-HXP 11 ESW-DYQ-EAR 10 IRD 9 CPM-DYJ-FNG-FXF-IXH 8 BWE-CIX-FEC-FSE-HEN 7 BGF-CH-DEH-DOK-FEW-FOZ-HT 6 CDM-FFN-GEX-IGO 5 BVZ-CLY-GAL-GTE-IDW-IVT 4 CEM-CVV-DJS-FXI-GMA-HOS-HXU-PD-ZZA 3 BO-BOB-BQF-CGP-EGC-EWY-FWT-GNS-EAH-HMW-HQS-IOL-IUL-RZ-ESA 2 AGF-DUX-DYH-DZI-EK-EQD-GHX-GNZ-GOY-HMV-HZM-ILV-JMJ-SJ 1.

SANTA CLARA VALLEY—SCM, Bruce Stone, W6AMM—W6FQY is keeping the honor position. W6FBW has resumed schedules. W6DBB is working ZS and ZT stations. W6BMW is resuming K6 traffic. W6QR carries eight schedules on 'phone daily. W6IED is new reporter. W6HJT has trouble with bad crystals. W6CEO is rebuilding. W6CUZ sent fine report. W6FPL visited the Fair and W9USA. W6FMT, DSE, GOZ, HTP, and DBQ reported.

Traffic: W6FQY 677 FBW 92 DBB 71 BMW 37 QR 30 IED 17 DBQ 15 FMT 11 HJT 5 GOZ 4 DSE 2.

EAST BAY—Acting SCM, J. H. MacLafferty, Jr., W6RJ—CRM, W6AUT, W6ZXX is new TLS. W6CDA handled 135 in 8 days. W6EJA and IFO apply for ORS. W6RJ says "thanks for traffic reports, gang, and keep 'em comin'." W6FWO was QSO ZS2A. W6FMY works 28 mc. W6AIJ has c.e. W6AMI is at KYA. W6PB reports 14 mc. DX. W6BUY is on 14 mc. W6CTE steps out with PDC. W6AUT cooperates with the SCM FB. W6AGQ enjoyed S. J. Convention. W6EJA wants traffic for KA1CO. W6CIZ is new OBS. W6BPC finally gets that new rig going. W6RF has PDC all stages. W6BYS is back after acquisition of a very FB OW. W6CZN is moving. W6GYA works 1.7 mc. 'phone and 7 mc. c.w. W6FII sticks by 3500. W6JNX is newcomer. W6APB is building c.e. rig. W6AOJ controls an A.A.R.S. net. W6CIC sends official broadcast. W6IY visited W7 hams. W6ANK has new rig. W6AMC gives code lessons. W6CUG is tied up with power noise. W6BMZ keeps Piedmont on the map. Director Culver, W6AN, gave an interesting talk on the Pacific Division Convention at September Section meeting. W6DUA wants 56 mc. sched-

ules. W6ZM presented members with A.R.R.L. station cards. W6IT rebuilt. W6HH reports by 'phone. W6CAZ loaned equipment for ham station exhibit, cooperating with "Radio Week" and Pacific Radio Trade Association. East Bay Section meetings held second and fourth Fridays at Central Trades School. Newcomers and old-timers all invited.

Traffic: W6ZX 396 RF 162 CDA 135 RJ 113 EJA 69 BPC 34 AGQ 15 HH 7 AUT 5 CTE 3.

SAN FRANCISCO—SCM, Byron Goodman, W6CAL—Army W6PQ BPLs. W6ATP is new OBS, W6ABB new ORS. New FB7 at W6NK. Rebuilding: W6AWA, EKQ, SC, GXV. Southern Rhodesia new country for W6MV. W6DDO schedules K7CZM. On 28 mc.: W6AZX, FVJ, CAL. W6BFZ likes '66s. New SW3 at W6GNV. W6JAL has eye on ORS. Lamb 5-tube supper at W6BVL. "Gimme reliable 7 mc. skeds," cries W6HIR. W6OS has '04A. TL picking up at W6CIS. 1.7-mc. 'phone DX good for W6HTI. W6WB handled three messages—with three continents! PP MOPA at W6HRY. W6HPC is moving to San Jose. W6GWH suspects his fifty of going soft. W6AZK has new '52 final. W6DO is recuperating from shiner received at Convention. QRL school: W6AVX, EID, and IVN. W6IDN inquires about HAMFLASHES—sent free for your report, OM. W6BIP: "DX?" W6GPB likes 14 mc. First report from W6HSU. W6BTZ is minus power supply.

Traffic: W6PQ 956 ATP 118 ABB 114 NK 93 AWA 70 MV 66 DDO 30 AZX 22 BFZ 19 GNV 16 EKQ 15 JAL-BVL 14 HR 13 OS 12 CIS 10 HTI 8 WB-HRY-HPC 6 GWH-AZK-DO-FVJ 5 IVN-IDN 4 BAY-BIP 3 SC-CAL 2 AVX 1.

SACRAMENTO VALLEY—George L. Woodington, W6DVE—W6CKO is high traffic man. W6EUIH schedules VE5AJ. W6GHP schedules Oakland and S.F. W6GAC schedules L.A. W6FRP is at Ukiah. W6GZY installed new Zepp. W6DYF has '52 TPTG. W6BUH, FND, DFT, and BDX went to convention. W6GL and ATQ took in the state fair. It is rumored that W6BDX is married. W6BHM is busy with apples. W6FKM works all kinds of DX. W6GGD is building c.c. 1.7-mc. 'phone. W6CTV is new ham. W6GBA is QRL work. W6GUV is going to 3.5 mc. W6FBS is building 56-mc. rig. W6BEM is on 3.9-mc. 'phone. W6EDV has 400-watt 'phone on 3.9 mc. W6HLQ is working. W6NT is on 3.5 mc. c.w. W6HVM is back from vacation. W6FOD schedules GUK. W6BBB and GBB are building. W6EAG has c.c. W6AXT has high powered 'phone. W6BHE is going high power. W6GHN has a WE21E. W6GDJ worked a ZL2. W6IQH has an FB 'phone. Ex-W6LO is coming back into the game. W6FLR visited headquarters in West Hartford. W6GVM divides his time between c.w. and 'phone. W6EQU and DYF spent two weeks at N.G. camp. W6JPI is new 1.7-mc. 'phone. Following were at San Jose Convention: W6UM, GZY, AHN, John and Bill BYB, FW, EMK, EWB, CFP, EUH, IAG, CDJ, TM, FPH, DYF, AK, DFT, FND, GHP. QRL school: W6ICR, DGS, CFP, ENC. New calls: W6IZE, INB.

Traffic: W6CKO 884 EUH 34 DVE 15 GHP 9 GAC 8 FRP 2 GZY-DYF 1 EWB 21 DVD 23.

ARIZONA—SCM, Ernesto Mendoza, W6BJF—The Arizona Short Wave Radio Club is taking steps to affiliate with A.R.R.L. The N.G. Encampment at Flagstaff had daily contact with Capital City through W6CDU's portable, CLE, scheduling HEU and BRI. W6BJF's portable, QC, was at camp, contacting three Army planes. W6BLP, CVR and GBN attended San Jose Convention. W6ALU is using '04-A. W6HUZ wants c.c. W6IIF is an amateur photographer. W6CQF was visited by W6ALU and BRI. W6BLP, GFS and HAX were heard in Poland. W6GUQ is awaiting power supply. W6ISO and HCX are together until first of the year. W6FGG and FBE have FBX's. W6CLL is operator at KVOA. W6EGI, at Century of Progress, won pair of "cans" on code contest. W6BUQ is manager of Tempe "movie." W6IDR is in Prescott guard company "M." W6IVZ plans to put Winslow on map. W6HVV is on consistently. W6GGJ and IXC are new stations. W6ILM is port. of IZU. W6JIV

is port. of IQY. W6CKF is attending radio school at Los Angeles. W6DSQ gets FB reports on 14-mc. 'phone. W6AND is back on 7 mc. c.w. W6JIL, IUQ, JDO, HXK are on 1.7-mc. 'phone. W6DRE works world-wide DX. W6EKU is getting bugs out of 1.7-mc. 'phone. W6COI is operator at KUMA. WICPH-ZZX handled a few messages on way to Oakland, Calif. W6IJK is nearing completion. W6FKX and EBP own Phoenix Radio Company. W6FZQ has new printing press for QSL business. W6ZZBC was in hospital with ptomaine poisoning. W6JIW has powerful public-address system. W6CAP is QRL BC station at Bisbee. W6LEY was NCS at N.G. W6HBR wants new a.c. receiver. W6FIP sold his motor-bike. W6ILL is buying parts for the first station! W6CTI (x6EAA) is about to blossom out again. W6BCD is operator of police KGZJ! W6IIG visited several hams in Los Angeles. W6DCQ plans a 26 tubes rig! W6DRX is on staff of Tempe Teacher's College. W6GZU and DJH attend bi-monthly radio club meetings!! W6GDI makes himself well known on 3.5-mc. 'phone. W6GGW is vacationing in Yuma. W6EFC finds grid-bias modulation FB on 14-mc. 'phone. W6IUY is found at all radio club meetings. W6CEW is selling out DC SW-3. W6AYW will trade station for outboard motor! W6DUQ is "prof" at Tempe Normal. W6HBF had portable at Fort Tuthill.

Traffic: W6CLE/ALU 398 HEU 163 BRI 80 HUZ 15 HF 5 CQF 4 BLP 3 IIG-DSQ 2. W1ZZX 3.

PHILIPPINES—Acting SCM, Newton E. Thompson, KAIXA.

Traffic: KA1HR 1391 LG 237 NA 132 OR 107 CO 67 PS 124 FS 55 XA 31 TS 26. KA4GR 25. OM1TB 700.

SAN DIEGO—SCM, Harry Ambler, W6EOP—W6FWJ leads the Section. W6FQU, RM, has three schedules. W6EFK says trunk line "F" is FB. W6AXN works three bands. W6BLZ is building c.c. rig. W6BAM is WAC. W9ZZBJ and W6GTM called on the SCM. W6AKY is working DX. W6APG has new 'phone. W6DNS is QRL building transmitters. W6BOW, HVT, VQ, DEF, IQX, IXQ, CSQ, APG, HAO, DJP, IZW, LD, APG, HBK, BWU, CNB, IBK, CAV, FJR, GIQ, JLB, GOG, FGU, GNP, FMJ, GRD are local 'phones.

Traffic: W6FWJ 638 FQU 65 EFK 17 AXN 5 BLZ 10 BAM 2 GTM 11 AKY 17. W9ZZBJ 11.

SAN JOAQUIN—Acting SCM, A. H. Green, W6AOZ—W6AOZ is Acting SCM until further notice. W6DZN is back in hills. W6AHO is making plans for 1934 Pacific Convention. W6BBE rebuilding. W6BHQ traffic is all Trans Pacific. W6GEG is new RM. W6FYN has '52a PP. W6FFU is at Fire Camp with portable. W6EPQ has directive antenna pointed at P.I. W6GXL and FNV have new National receivers. W6GJO has new rig. W6GKE handled traffic for Pomona Fair. W6BIL is President Society of Amateur Radio Research at Tulare. W6CVT is lining up new Fresno hams. W6FFP completed 250th QSO with ZLIAR. W6CUL is at sea. W6EXH is new OBS. W6AGV and CVA are lining up traffic schedules. W6BTN works fine 'phone DX. W6ASV, ABJ, FYO, HJ are charter members new Tulare Radio Club. W6GIV is on air after vacation. W6BFH is on east coast. W6TKG is getting ready to entertain for Section Hamfest. W6AV is QRL U.S.N.R. W6BXX has new Comet Pro. Rebuilding, W6FYM, ABJ, FYO.

Traffic: W6AHO 9 AOZ 6 AGV 8 BBC 4 BHQ 240 CVT 24 CVA 79 EPQ 18 EXH 66 FFU 3 FYM 7 FYN 15 GKE 45 GQZ 10 IKG 4 SF 5.

#### ROANOKE DIVISION

NORTH CAROLINA—SCM, G. H. Wright, Jr., W4AVT—Next regular meeting of the Central Carolina Amateur Radio Club will be held in Greensboro on Sunday, November 5th, BE THERE!! W4MR handled a 50 word message from W8BML, who is visiting at G8BM, to W8BML's mother in Pittsburgh. W4CKT is at Wake Forest College. W4ALK wants schedules south. W4BWE, GZ and BWV are at State College. W4CJM has new rig. W4ATC, State College Amateur Radio Club, is on the air. W4ANU has about completed 3.9-mc. 'phone.



W4BMW is building 3.9-mc. 'phone with 75 watter final. W4BTC worked about 200 stations within two months. W4JB rebuilt his 'phone. W4EG has A.A.R.S. functioning smoothly. W4BVY schedules Philadelphia. W4CGL had an operation for appendicitis. W4DW and EG were on for storm emergency work. The Greensboro Club station, W4BVA, will soon be on with 50 watter. The new Wilmington Club is getting off to a nice start. W4ATY gets RM appointment. W4AAK is moving to new quarters. ORS W4ANZ wants schedules on 3000 kc. W4AYH is changing location. W4CLB returned from World's Fair. W4BXF has rack and panel job. W4CQ is QRL Naval Reserve. W4IF and BRJ are attending school at Oak Ridge. W4BYA is N. C.'s "Little Fellow." W4AHF, CFR, and CP have new SW3s. W4NC, Winston-Salem Club station, purchased auxiliary power plant capable of delivering 5 KW to be used in an emergency. W4BFV blew plate transformer. W4BCG gets out FB with c.c. W4AVT is adding a 50 watter. W4BLU is QRL service work. W4BWD is building new receiver. W4BAW has 5-stage c.c. rig. Going crystal: W4UB, AEH. Rebuilding: W4ZH, PFA, AI. Thanks for reports W4AMC, BSS, ABT, BDU, CDG. Active: W4ATS, BRK, ALD. QRL business: W4CAY, R.X. Trafficking: W4BJZ, BLN, OG.

Traffic: W4ANZ 201 BJJ 105 ABT 53 GZ 28 DW 26 CDG 23 OG 22 ALK 19 EG-ANU-AVT 15 BLN-BVY 14 AYH 11 AEH-BRJ 10 CKT-BRK 9 MR 8 BHA 7 ANX-BRT 5 BYA-CJA-BSS 4 UB-CLB-BDU-BML-BKT-WX 3 AMC-RX-CAY-IF-ZH-BTC-BXK-BPO-AIT-ALD 2 BWE-BX-CS-BHP-CGL-CJM-NC-CCF 1.

VIRGINIA—SCM, R. N. Eubank, W3AAJ—Handled emergency storm traffic: W3DCU, AEI, CYK, CZX, BAI, WIZZAR, W3GW, WO, NT, APF, CA, BDZ, BTM, AKZ, CUR, COJ, CVQ, AAJ, BNE, GE, FJ, CLV (Bill & San), AKN, NE, CDW, ATY, AJA, BZE, NO, CLX, COO, AUG, BWA, BPA, WM, CPN, BRA. W3CFV requests ORS. W3BEB schedules VE3NZ. W3AAF has FB rig. Active: W3BGS, CFL. W3BZ is listening only. Want schedules: W3BIW. DXing: W3AG, CWS, DEH, CSI, BSB, CYM. New antennas: W3AZU, BAD. New c.c. rigs: W3BWA, CZX, DRK, DVP. W3GY has new rig. W3BYA handled death message to Hawaii. W3BAN worked NY1AB. W3CYV is ex W9PF. W3BFW is in Charlottesville. W3BTR is raising plate volts. W3BJX has FB traffic system. W3BNH is adding chokes. W3BLE says contests FB. W3GE has FB7 coming. W3ADD started Norfolk club. W3AI is at VMI. W3ASK added '04A. W3BRY has lots of schedules. W3DPS will op at Maryville College. W3MQ reports Norfolk Club started. W3CZJ wants OBS. W3CUR visited SCM. W3HV got 1st ticket. W3CNY says QSP FB home. W3CPN has portable WW. W3DOG will be on at college. W3BPA helps Richmond club plenty. W3AQK is at U. of Va. W3NT off due to storm. W3AAR is operating at DDG. W3AKN is Eastern RM. W3AHW is revamping receiver to SS. New calls: W3DFU, DQB, DUG, DGH, EBD, EBK, DPV, ECQ, EBF, W3DKJ is at VPI. W3AUG has FB 3095 kc. signal. WIZZAR set up rig in Postal Bldg. for storm. W3BTM made paper for QRR work. W3FJ: 'Phone 10%, CW 90%. W3CXM has sick on vacation. W3DES is on 3694 kc. W3DVO was sick, flu. W3BPI has SW3. W3CMJ blew cond. W3BIG, CA, are working on R.R. QRR net. W3MT, Peninsula Club, starts Oct. W3BRE has new a.c. receiver. W3BXP is now EBF. W3FE is at Ga. Tech.

Traffic: W3BZE 247 CVQ 207 APF 204 BJX 164 BYA 115 BIW 104 AAJ 100 DCU 96 CLV 83 FJ 72 BTM 41 AUG 40 AEI 36 BNE 32 CA-BPA 30 BRY 24 CZX 22 CYK 19 CFV 18 BEB 16 AAF 13 WM-CSI 12 BGS-BLE 11 CXM 9 CNY-CUR-BAI 8 GE-AZU-BSB 6 BAN-CZJ-CPN 5 CWS-COO-AG 3 ASEK-HV-DFS-CYV-BWA-ADD-CFL 2 MQ 3 CMJ 27 BRA 1 AMB 14 COJ 18 MT 4 BRE 1 BDZ 22 CHE 13 NE 1 CDW 5. WIZZAR 177.

WEST VIRGINIA—SCM, C. S. Hoffmann, Jr., W8HD-W8EIK handled schedule with Army plane flight during Florida storm. W8FJS, erected at W. Va. State Fair by Ohio Valley A.R.C., handled 362 in week. Opera-

tors were: W8AAO, AZD, BHG, BWK, CDV, DPO, HCL, ISB, IQY. W8FQB plays checkers via radio with JM and TI. W8CVX schedules FQB and GPS. W8HCL worked EAR132. W8HD-WLHB, W8HI and DMF are rebuilding. W8HD received his fourth Extra First license. Ex-8VZ, former SCM, is now W8EZR. W8EZR, JM, GOD and GBF promise to join A.A.R.S. W8LS has SS receiver. W8DTL uses a pair of '52s final. Hamfest in Charleston Sept. 16 was a huge success. W8ILF passed Radiotelegraph second license. W8OK wants to sell a 500-cycle note. Hi! W8GAD reports someone using his call. W8HSA is rebuilding P.A. W8GBF is putting up a 75-foot tower. W8DSO and CXR are experimenting with 'phone. W8JRL is on 1.7-mc. 'phone. W8FEO uses port. call KLF. W8KKG uses 3603 kcs. W8JWL boasts of 161 QSOs in less than 2 months on the air. W8ASI worked EAR46 and XOH2FJ. W8CDV is experimenting with 14 mcs. W8TI has 28 mc. tests with AC2BHH, which have been heard by AC2BHH. Operators at W8CAY will install station at Forest Festival, Elkins, in October. W8DPD made 92% at Bluefield exam. W8DNN visited ADI. W8DNN is building 50-watt c.c. job. W8CHM is working splendid DX on 'phone. W8BKJ, BTW, BOW, JBU and EL (using W9OPV at college), are returning to college. W8JM/IXD is new Route Manager for Northern District. Your cooperation with him will help our state to the front. W8BKI and portable EAG have done successful portable 28 mc. work. New stations reported: Wheeling: W8KRU, KSJ; Lost Creek: W8KKG; Huntington: W8EZR (Ex-8VZ).

Traffic: W8EIK 590 FJS 362 FQB 190 CVX 95 HCL 92 HD 84 EZR 63 DMF 40 OK 33 JM/IXD 25 BOW 23 KKG 22 JWL 9 CVY 8 KEC 6 AFB-ASI-ELO 4 CDV 3 KFL 2 CMJ 1.

#### ROCKY MOUNTAIN DIVISION

COLORADO—SCM, T. R. Becker, W9BTO—W9IPH has new frequency meter. W9BYK installed c.c. W9BYY's 50 went bad. W9FYY changed QRA. W9CJJ has 212Ds as modulators. W9BTO will be on 14 and 3.5 mc. W9EMU is getting bugs out of his rig. W9CVE schedules W9USA. W9LZH reports. W9ESA plans a big year. W9AAB is getting settled at new QRA. W9EKQ is active A.A.R.S. W9LYE threatens to put in 1 KW. W9HIR has YL QRM. W9GVN will be on from ALMA. W9CWX works DX. W9JB is active. W9GHL is QRL teaching at North High. W9BCW uses low power. W9BYC has gone East. W9HRI has FBXA. W9YL has FB7. W9LLP has 50 watter final. W9IUH and FRP will be on soon. W9APZ needs new "B" batts. W9GLG rebuilt. W9OGG is a new ham. W9CDE and BRZ are rebuilding. W9LEK is on 3.9-mc. 'phone. W9GCM passed unlimited 'phone. W9HDI handled a few. The P.P.A.R.A. took their portable rig up on Pikes Peak Labor Day and transmitted the results of the races. 3.5-mc. 'phone was used. W9EYN and EHC were the operators. W9JNV has been appointed State Net Control for A.A.R.S. and signs WLJD. Recent visitors were W9FID and W5CRV. W9GHY is putting 50 watts on pair of '03As. W9MKN has FB note. W9BJN helps new fellows to get their tickets.

Traffic: W9CVE 413 BYY 40 ECV 2 GLG 1 CDE 10 GCM-HDI 6 JNV 14 BTO 46.

UTAH-WYOMING—Acting SCM, Arty W. Clark, W6QC-IDM—Until further notice send reports to Acting SCM Arty W. Clark, 260 So. 9th West, Salt Lake City. W6BSE keeps several schedules. W6GQC was only ham from Utah-Wyo. at Rky. Mtn. Div. Conv. W7COH is ready to resume schedules. W6EXL erected 65 ft. stick. W6ZZBI reports by radio. W6BUW is interested in fast traffic schedule. W6DWH, APN and GIO attended conv. at Jenny Lake. W6JEW is port. of IOF. W6GQC-IDM took semi-portable on vacation in Kansas maintaining daily schedule with W6BSE S.L.C. and W6GXM L.A. Hamfest at Jenny Lake, Moose, Wyo. big success and resulting in organizing WIMU (Wyo., Idaho, Mont., Utah) AMATEUR RADIO ASSOCIATION with W7BBA, pres.; W7GL secy.-treas.; Mrs. W7ALI in charge of women's social activities. W1ZZA bought a place

at Moose. Crystal controllers: W6FPJ, W7BJS, W6BTX, W6DGR.

Traffic: W6GQC/IDM 82 BSE 39 AFN 35 AHD 33 QQR 10 BUW 8 EWW 2 W7COH 3.

#### SOUTHEASTERN DIVISION

**ALABAMA**—SCM, L. D. Elwell, W4KP—W4BOU leads with FB total. W4BJA has c.c. rig. W4APU got married. W4GL blew a plate transformer. W4BRA has Jr. operator of 6 lbs. W4BXV is installing sky wires. W4GP promises a 50 watt 'phone. W4AAQ was busy with convention. W4DS, Chief RM, sends fine report. W4BAI will now be known as W4ZZAA at Auburn. W4BCU lost a good transmitter in fire. W4BMM, RM, is working on 'phone Trunk Line. W4DD is on 14-mc. 'phone. W4BLL has YLitis. The secretary of Mobile Club reports the club organizing an emergency net for storm relief with cooperation of Coast Guard. W4OA acted as control station during threatening storm. W4BAI named the "Bull" for us and wins the prize. W4BOE and BDE are on 'phone. W4LT worked XIG for two hours on 'phone. W4AUS built a new shack of logs. Thanks for reports W4AKX, BXA, BIW. New hams: W4CNI, CMK.

Traffic: W4BOU 170 DS 58 AAQ 24 GL 17 LT 13 BXA 8 BMM 5 BJA 2 APU 1 KP 10.

**EASTERN FLORIDA**—SCM, Ray Atkinson, W4NN —ON4HC visited W4AI aboard ship while in Antwerp. W4BGL and BIN will attend U. of Fla. W4CMN-CNJ is leaving for Gulf Radio School. W4AGB has her 200 watt Class B job on 14 mc. W4NN is building MOFA. W4BNI schedules Yacht "Ripple," W4PDA. W4CJR reports Miami Radio Club will put a station on the air. W4BRI applies for ORS. It is now Mr. and Mrs. W4AGR1 Congrats, folks. W4VP reports traffic picking up. W4CCI is using P.P. '45s. W4BDM reports power off two days during hurricane. W4DT is on 7150 kc. W4AIW replaces the old call of W4OT. W4CED and BNR are on 14 mc. W4ALP, RM, has been handling Tampa district very nicely. Crystal controllers: W4AGP, AWS, AZF. Vacationers: W4BOT, DZ. W4WS 'phone reports traffic handled during the storm. Following 'phones handled much of hurricane emergency work: W4LS, PT, AIV, QA, MM, ADB, NF, KM and ANR. Congrats, fellows. W4CA is interested in 56 mc.

Traffic: W4NN 75 LS 34 BNT 32 BGL 29 PT-BDM 25 BIN 24 AIV 19 ADB 18 QA-VP 16 AGE 14 CCI 12 WS 11 HY-AZB-CMN 8 CJR-AZF-BFR 6 BRI-AIP-AJX 5 BNR 4 BOT 1.

**WESTERN FLORIDA**—SCM, Eddie Collins, W4MS-ZPP—W4AUW is RM for western half of Section and W4ACB for eastern half. W4AGI was visitor to Pensy. W4BGA, KB and AGS moved to 14 mc. W4BFD has been ironing out c.c. rig. W4BOW applied for new ops license. W4BKD and QK have SW3s. W4CDE moved to 7 mc. W4CBD visited W9USA. W4AUW's son is W4CMB. W4AXP is getting over sick spell. W4BSV is on in California. W4ZZAO went to west coast. W4BSJ swears by PB7. W4VR is thinking about Convention. W4QK visited Memphis. W4AUA and ACB did good storm work. W4BKV has new QSLs. W4AQY is jumping on them on 14 mc. W4AQA has an FB note. W4ABK is after a good filter. W4ASV plans complete overhaul. West Fla. J.A.R.L. tests are going FB on 14 mc. W4AUW is pushing 28 mc. W4BPI is ready to enter U. of F. W4BGB has 3.5 mc. to himself. W4BMJ wants an MG. W4CMJ is on. W4MS is experimenting.

Traffic: W4AQY 8 AXP 3 KB 45 ACB 18 BGA 25 BFD 5 BMJ 8 BJS 26 CA 9 ZZAO 4 QR-QK 2 AUW 11 CDE 9 AGS 10 MS 52.

#### WEST GULF DIVISION

**NORTHERN TEXAS**—SCM, Glen E. Talbutt, W5AUL—W5BII, CRM. Dist. one. W5ANU, RM. W5BII makes BPL and wins prize. W5CMJ is our "Fly-

ing" Ham. W5BZT is minus appendix. W5DJL is in Boy Scout Net. W5BTJ reports first time. W5DAA is new traffic man. Dist. two. W5AJG, RM, is getting district lined up. W5JA "traffic 100%." W5CAM reports nice traffic. W5CFM has new "phone" ticket. W5BKJ sends 28 mc. tests every Sunday p.m., and listens for call. W5SU is off to Florida. W5AHZ school, gloom. W5CPU, CHJ, AID, AMK, ARV are active. Cen-Tex Club reports activity. Dist. three. W5ARS, RM. W5BCW schedules W9USA. W5ARS and CIJ have big totals. W5IT lost his back wheels and tires. W5CPB and CPT are getting PDC. W5IA wants to know if he is youngest ORS, age 14. W5BJX is Op' at KOMA. Dist. four. W5BKH, RM. W5BFI QSP'd lots of traffic from Gulf Storm area. W5BKH wants more traffic men. W5BVF has c.c. W5CTU is going to college. W5BXY likes 3.2. W5CCQ, DKF, CYU, AUJ, AW, DAG, SP, DOQ, QA report. Following handled traffic from Gulf Storm area: W5IT, CYU, IA, JA, CMJ, BFI, BII, CFM and AUL.

Traffic: W5BII 587 ANU 222 ARS 217 CIJ 183 BFI 176 AUL 98 BCW 94 CMJ 66 CAM 46 JA 45 BKH 42 AJG 37 DAA 36 IA 15 CYU 11 BKC-IT 10 AMK 8 CFM-BVF 5 DKF-DJL 3 AAD-NW 2 CAV-BTU 1 AVF 437 COR 2.

**OKLAHOMA**—SCM, Emil Gisel, W5VQ—W5AMC leads the Section. W5CNC applies for ORS. W5CEZ keeps FB schedules. W5BDX handled important traffic for Naval Recruiting Service. W5AND is QRL college. W5BAR worked first VE5. W5BQA took message from W9USA. W5BOE is rebuilding to c.c. W5CUX has '10 T.P.T.G. W5BRD acquired a YL. W5JP is c.c. with '03-A. W5CPI was down at Guard Camp this summer. W5ALE is QRL postal clerk. The SCM is on leave so W5BQA is pinch-hitting for him. W5CEZ handled Gulf Coast storm tlc. W5CPI has ordered a new FB7A.

Traffic: W5AMC 1008 CEZ 536 BDX 102 CNC 36 AND 13 BAR 18 BOE 10 CUX 8 BQA 6 CPI 5.

**SOUTHERN TEXAS**—SCM, D. H. Calk, W5BHO —W5OW tried to contact the valley for three days during storm. W5AUC reports one KW transmitter. W5DEE spends lots of time at AUC. W5AQK moved to San Antonio. W5DTJ reports for first time. W5HX worked LU5FV. W5BKL-5DJJA send nice letter. W5BXH is going to 28 mc. 'phone. W5DCV is back in Austin. W5DNN is in Austin. W5CT is in Little Rock, Ark. W5CTW and ATQ handled storm traffic. W5BKE attended Century of Progress. W5ADZ schedules W9USA. W5AFQ is new O.O. W5MN keeps traffic schedules. W5CWW is QRL school. W5CVW leaves for trip to Maine. W5BVG's boss is Ex-3HL. W9LNY (port. W5DTL) reports from Victoria. W5CNX and CHM are attending school. W5BSP is on 7 mc. W5BSP worked flock of DX at BZO. W5ABH will be on soon in new shack. W5BFS attended Chicago Convention. W5PM lost both masts in storm. W5GL's shack was blown down during storm. W5CSL is on 1.7 mc. 'phone. W5BBR returned from fair and convention at Chicago. W5CFK is rebuilding in rack and panel. W5BBR and AGG rigged up a TNT and using 32 volts to 110 volt converter (W5CFK supplied the batteries) they handled about 30 messages day after the storm. W5CKS raised a 110 volt light plant and had his rig on shortly after the storm. W5CA, TG and VB report working with Valley stations during storm spell.

Traffic: W5OW 920 CVW 47 CWW 5 MN 89 AFQ 19 ADZ 7 BKE 61 ATQ 42 CTW 135 BKL 112 HX 1.

#### CANADA

##### MARITIME DIVISION

**NOVA SCOTIA**—SCM, A. M. Crowell, VE1DQ—1EX has SW3. 1FB is QSL Mgr. for this section. 1EP is swatting heavy DX. Welcome to following new hams: 1FO, FN, FK, CZ, and FY. Monthly meetings M.A.R.A. at home of Secty. 1DH. Active on the 3.9 mc. band: 1CL, EI, DO, AK, BM, AX, AG. 1CY moved to Fredericton.

Traffic: VE1EX 28 FB-DO 1.

## ONTARIO DIVISION

ONTARIO—Acting SCM, W. Stephens, VE3AD—VE3EB is preparing speed boat for entry in Harmsworth race. 3SN is a new man in Galt. 3TU has a '71A with Ford coil supply. The Weston gang is going c.c. 3UA has started the ball rolling at Fort William. 3HA is trying to drown the fires in north. The London crowd operated 3LW at the London Fair. 3QM and QI pulled off some good portable work for the "Across the lake" swim at Orillia. 3LZ is taking his whirl at traffic. RM, 3DW, will soon have all the fruit shipped out of the Niagara Peninsula. The Hamilton A.R.C. put over another fine gathering with Brantford, Toronto, and Beamsville in attendance. A very prominent guest of the evening was exRM, 3CP. AD is off the air temporarily. The new SCM will be elected before the next report comes in. Give him your support, gang. 3TB reports 3TY new ham. 3SE reports for first time.

Traffic: VE3AU 725 AD 183 DJ 176 GT 131 GO 107 JI 95 NO 85 MX 73 IB 69 LI 49 HB 42 QC 35 RK 27 LY 24 QB 14 HA 11 DW 9 QY 6 HP-CD-RT 4 QH 3 SG 1 EU 35 SE 4. VE9AL 8.

## QUEBEC DIVISION

QUEBEC—SCM, J. C. Stadler, VE2AP—2FG worked 8 new countries. 2DR tried 1.7-mc. 'phone. 2DG handled traffic with W9USA. 2CO is moving. 2HT has lots of trouble. 2CM has Comet Pro. 2EU is building transmitters. Somebody is borrowing 2HG's call. 2GM is on 3.5 mc. 2AC is active. 2FE is 75% traffic man. 2BB reports bad DX conditions. 2HM is on 1.7-mc. 'phone. 2DY is getting 3.5 mc. Zepp. 2AB and DB are visiting 2BA and AU.

Traffic: VE2CX 7 FG 6 DR 5 BB 71 AP 50 FE 17.

## VANALTA DIVISION

ALBERTA—SCM, C. H. Harris, VE4HM—4EA is building receiver for BV. 4EX says, "Please do not call me OM." 4EO, AF, OG and OF are active. 4GY reports good crop. 4LQ has new rig. 4CX has Comet Pro. 4HA is on weekends. 4AH took unto himself a YF. 4FJ moved to BC under call 5JR. 4ID has FB c.c. signal. 4NB starts ham radio with 150 QSOs in ten weeks. 4LX has FB7XA. 4LA has MOPA. 4KN rebuilt. 4HM has good results on 14-mc. 'phone. 4KN, HB, JP and KC visited Edmonton.

Traffic: VE4DT 27 LX 19 HM 17 NB 2.

BRITISH COLUMBIA—SCM, J. K. Cavalsky, VE5AL—On Aug. 29th the B.C.A.R.A. staged a successful hamfest at Georgia Hotel in Vancouver. Visitors included W6HM. 5HP was a visitor in Vancouver. 5EW threatens to get going. The New Westminister boys have affiliated with the B.C.A.R.A. 5FY is president, 5IA secty. 5HU says DX is falling off.

Traffic: VE5FG 5 GI 51 HQ 6 GS 26 AM 148 AC 25 AL 15 HJ 3.

## PRAIRIE DIVISION

MANITOBA—SCM, Reg. Strong, VE4GC—4MW is building rack and panel rig. 4DU has pair of 50 watters. 4GL has fifty watt 'phone. 4GB is on 7 mc. 4KU wants more filter. 4EX and W9BLG were visitors. 4NW has pair '10s MOPA. 4NT considers erecting big mast. 4KX has 14-mc. 'phone. 4AE has '10 on 7 mc. 4MU is heard on 1.7-mc. 'phone. 4BG is going QRO. 4DK keeps reliable schedules. 4CI left everything on but the bias! 4FT is looking for Africa. 4OB moved to 7 mc. 4FP is experimenting with c.c. 4CD has c.c. 4MV has pair '10s. 4GC worked lots DX. 4LE has the best note in the section. 4NF holds out on 1.7 mc. 4NZ has pair of '45s. 4DJ has 300 watts input. The M.W.E.A. are looking forward to another get-together with the Brandon gang.

Traffic: VE4GC 9 DK 8 DJ 5 KX 2.

SASKATCHEWAN—SCM, Wilfred Skaife, VE4EL—Time we had our get-together. Make it Sunday, Nov. 5th, 10 a.m. M.S.T. All on 3.5 mc. 4BN finds 3.5 mc. FB. 4FF, CB and ED logged traffic from Captain Hawkes and heard EH QSO. 4MX changed rig to PP TPTG. 4GN

worked another G. 4AU is working on 1.7-mc. 'phone network. 4BB visited 4GN, KR, KB, KV, CN and GR. 4MH wants schedules. 4JV reports 14 mc. FB. 4BF gets out fine. 4GR has separate transmitters on 3.5, 7 and 14 mc. 4MN reports regularly. 4EH in plane and EL on ground make 3.5 mc. tests. The gang send good wishes to Bill Pickering upon the occasion of his marriage. 28 mc. experimenters: 4IG, FY, ML, EL, ED, BF, GR.

Traffic: VE4BB 24 MN 22 MH 21 AT 15 GR 12 BR 9 EL 7 BN-AV 5 BF 2.

## Strays

### AN OM SPEAKS

I got heart palpitation —  
I worked my first YL;  
I asked her for a schedule  
And she said, "All very well."

There were hours when we chatted  
And letters sent galore;  
For months we kept this up,  
Then I could wait no more.

Said I, "My dearest maiden  
What time for you is best  
For me to come a-callin'  
My eyes on you to rest?"

She quickly set the date  
And I traveled far to see  
This wondrous lovely lady  
Who QSO'd with me.

Oh, dear, is there no justice  
For hams who have such faith?  
I came into her life  
Just thirty years too late!

— W8CKH

Note from Martion of KUP on receiving antennas: "In all our experimenting we have found the vertical antenna superior to the horizontal type. Signals from such places as Australia, Japan, the Canal Zone, South Africa, when received weakly on a horizontal doublet will jump something like three points on a vertical doublet; that is, from an R3 to an R6 or R7 signal. The background-noise-to-signal ratio seems much better, something we certainly strive for. By placing reflectors a quarter wave behind the antenna the system can be made highly directive and the signal strength is raised considerably. A vertical doublet is rather simple to put up, since only one pole is necessary. Of course a doublet cut for a desired frequency is far more effective than a doublet cut at random, but even such a doublet is better than a horizontal cut for the desired frequency. We expect to install all vertical receiving antennas at KUP, doing away with every other type we now use."

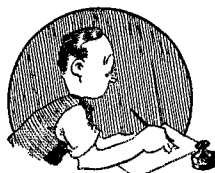

# CORRESPONDENCE

The Publishers of QST assume no responsibility for statements made herein by correspondents

## Armstrong Wins

Columbia University, New York  
September 8, 1933

Dear Mr. Hebert:

You may recall that over nine years ago on the occasion of the first decision which had been rendered in favor of deForest in the regenerative circuit litigation, you asked me for a statement of the situation. I told you then that when the truth was established about it I would be very glad to make a statement, never dreaming at the time that the road thereto lay through nine more years of litigation in six different courts.

The decisions of five of these courts have been adverse to me, including that of the Supreme Court of the United States, which passed upon certain questions of law without undertaking to review the facts, but in the sixth decision which has just been handed down by the Court of Appeals for the Second Circuit, in which the Court reaffirms its previous decision rendered over ten years ago in my favor, you will find the facts.

I am sending you herewith a copy of the opinion of this Court which has just been handed down by Judge Chase, and also copies of the decision rendered May 17, 1921, by Judge Julius Mayer, sitting as a District Judge, and of the Circuit Court of Appeals opinion written by Judge Martin T. Manton on March 13, 1922.

You will find in these opinions a most careful and accurate distinction between the howling telephone repeater and the singing multi-stage audio-frequency amplifier (which deForest had in August, 1912, and on which he based his claim to the invention) and the regenerative circuit invention. You will also find that the Court has again refused, as in its previous decision, to credit the deForest testimony that he knew that radio-frequency currents could exist in the plate circuit of an audion and that it was an obvious step to proceed from the howl on a telephone line to the radio-frequency feedback circuit. With these views I am certain that all the old timers will agree.

Sincerely yours,

*Edwin H. Armstrong*

[This is a subject of great interest to radio amateurs because Armstrong, at the time of inventing the regenerative feedback circuit, was himself a 22-years-old amateur. His work is

frequently pointed to as the outstanding example of the amateur's ability to contribute to the art. Although leading radio experts of the country have always held that Armstrong was the rightful inventor of this circuit which marks the difference between old-time and modern radio, a decision in favor of deForest in a suit in a lower court was eventually affirmed by the Supreme Court, but on points of law rather than of facts relating to conception. In a recent suit by R.C.A., A.T.&T. and deForest Radio Co. against R.E.L., based on the decision in favor of deForest, Armstrong financed an appeal by R.E.L. in which the court reviewed the question of who was the first inventor and, reaffirming its decision first handed down in 1921, declared strongly for Armstrong. Thus belated justice seems now in the offing for a persevering amateur.—EDITOR]

## Overmodulation

Ogallala, Nebr.

Editor, QST:

I . . . hesitate very much to say anything against the way some amateurs operate their transmitters. But after operating a low-power 'phone in the 75-meter band for some months, I feel that something should be said and done. I am not speaking of poor modulation, as a large percentage of the 'phones on 75 meters have good understandable quality; nor am I speaking of high power as I have nothing against a high-power 'phone properly operated. What I am kicking about is *overmodulation*. I use a super-heterodyne receiver which is fairly sharp, and have heard several 'phones whose side-bands would be heard any place in the band. I believe more QRM is caused by overmodulation than by any other thing in the 'phone band.

'Phone operators seem to have only a vague idea of the proper operating conditions of a 'phone transmitter for 100% modulation. . . . All of them seem to take great delight in seeing the hands on milliammeters and voltmeters oscillate all over the scale. Perhaps this comes from operation on c.w., where the milliammeter went from zero clear across the scale and bent the peg when the key was pressed. . . . Few operators seem to realize that the plate current and voltage on the Class-C amplifier should remain constant during modulation and that the

(Continued on page 70)

# FOR EVERY PURPOSE, IN ANY CIRCUIT NATIONAL H.F. CONDENSERS

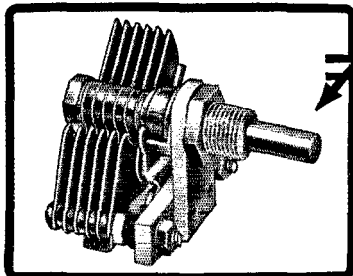

Midget condensers of the ST Series have "Straight-Line-Wavelength" Plates and are listed in capacities from 15 to 335 mmf. Type STHS is illustrated. In sizes of 50 mmf and larger, rotors have double bearings. The List Price of ST-100 (100 mmf) is \$2.25.

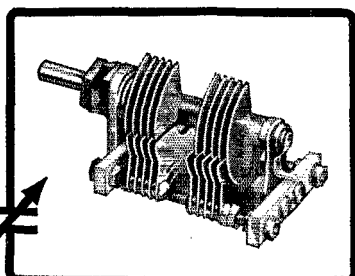

Series ST condensers are also supplied in two section ganged models, stock sizes being 50 mmf and 100 mmf per section. They incorporate all the standard features of the ST Series, including SLW Plates, Isolantite insulation and constant impedance pig-tail. List Price of STHD-100 (100 mmf per section) is \$4.50.

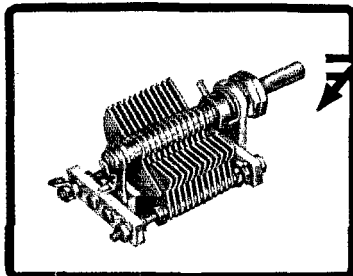

Where the circuit indicates the use of "Straight-Line-Capacity" Plates, the SS Series is available in sizes from 20 to 350 mmf, including two double section ganged rotor models, of 100 and 150 mmf (per section) respectively. List Price of SS-100 (100 mmf) is \$2.25.

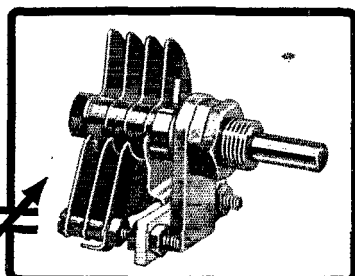

For neutralizing 245, 247, 210 and similar tubes in amplifier, buffer or doubler stages, type SSN is recommended. The maximum capacity is 18 mmf, rated at 3000 Volts breakdown, while the minimum capacity is extremely low. List Price is \$2.00.

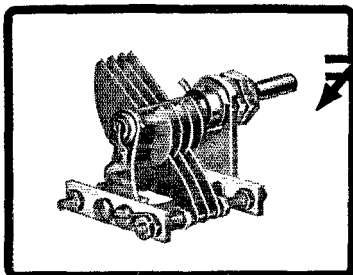

Condensers of the SE Series have 270° rotation for greater ease in tuning, the plates being of the "Straight-Frequency-Line" type, the stock sizes ranging from 15 to 335 mmf. All have double rotor bearings. The List Price is \$3.50 for the 100 mmf size (SE-100).

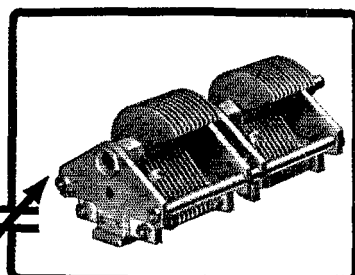

Built in 100 mmf and 200 mmf capacities, the 2 SE ganged condensers possess the unusual feature of electrically isolated rotors, to prevent interstage coupling through common rotor and frame circuits. Like the other SE condensers, plates are of the SFL type. List Prices \$5.50 and \$6.50 respectively.

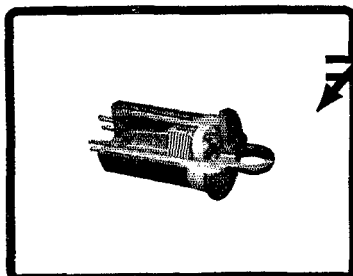

Typical of National's specific design for specific purpose, the tiny air-dielectric coil padding condenser provides stability not possible with condensers of the mica type. Sold as a complete unit, the R-39 low-loss unwound coil form, metal handle and padding condenser (as used in FB-7 receivers) list at \$3.65. Specify Type XR-39.

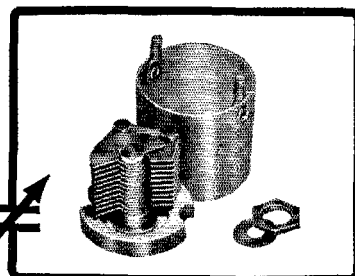

For replacing erratic mica condensers, these shielded, Isolantite-insulated, air dielectric padding condensers have innumerable uses. The 75 mmf size has a shield 1 1/4" diameter by 1 1/4", the 100 mmf size is 1 1/4" diameter by 1 1/2". List Prices \$2.00 and \$2.25 respectively.

The listing above, incomplete as it is, is representative of the National line of High Frequency Condensers. For every purpose, in any circuit, there is a National condenser designed to serve with distinction. All are of uniform high quality, all have quiet rotor connections, mechanical rigidity and high electrical efficiency. A complete listing of stock sizes and types will be found in the National General Catalog No. 220.

Usual Discounts Apply

NATIONAL COMPANY, INC.



MALDEN, MASSACHUSETTS

## FOREIGN AMATEURS ATTENTION

We know that American radio gear has a universal appeal because for many years we have been sending it all over the world. Because much apparatus comparable in construction, quality and price, cannot be obtained elsewhere, amateurs overseas in increasing numbers are purchasing American apparatus.

We are fully aware of the obstacles in the way of such transactions. High tariffs, mountains of red tape and delay in delivery for periods up to three or four months must be exasperating to our overseas friends both amateur and commercial.

Trouble is not confined to the purchaser alone. Our experience with export shipments has also been unsatisfactory. Variations in prices and exchange rates, the difficulty in arriving at terms that are mutually satisfactory and the amount of detail necessary with this type of order make the handling cost excessive.

Frankly, we feel that export business does not necessarily have to be carried on in the usual manner and that we can greatly increase our foreign trade if the methods are changed.

## A NEW LEEDS SERVICE

has been developed to eliminate these difficulties insofar as possible. This is the way it works. Send us, by air mail, a list of the equipment you need, with complete technical specifications and ratings. Include in your letter your cable address or that of a local business house. On all orders valued at \$100 or more, we will send a free cablegram to your cable address. This will inform you of the total cost of your order in American dollars, including all charges except import duty, delivered to the place designated by you. For identification our cable address is "Radleeds Newyork." If our quotation is satisfactory send us a three word cablegram — "Radleeds accept", with your cable address. Transmit the necessary funds through your bank to the Corn Exchange Bank, Terminal Branch, New York, and we will do the rest. Shipment will be made by American Railway Express unless otherwise specified by you.

LEEDS USUAL LOW PRICES IN EFFECT  
YOU PAY NO MORE THAN AMERICAN  
AMATEURS DO

## A SENSATIONAL OFFER TO RADIO DEALERS

Seventy JEWELL Tube Checkers in a Final Close Out

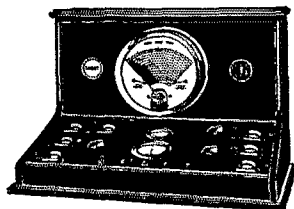

No. 538  
Regular  
dealer's  
price,  
\$112.50.  
3 Meters

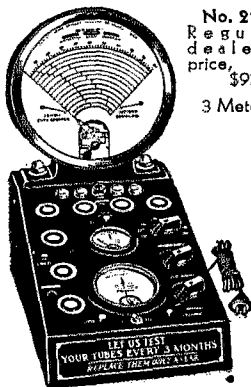

No. 214  
Regular  
dealer's  
price,  
\$93.75  
3 Meters

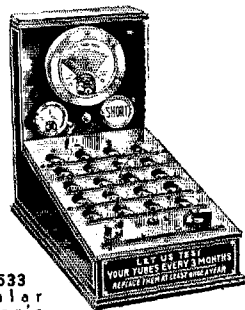

No. 533  
Regular  
dealer's  
price,  
\$69.75  
2 Meters

These imposing tube checkers cannot help but impress your customers and increase your tube sales. With a year's moratorium on new tubes, you are assured of satisfactory performance with no additional expense. Each checker is furnished with the Na-Aid 950XYL — 950TR and 975AB7 adapters and complete instructions. You can test every tube now manufactured without trouble at one-half the cost of a more recent one meter model. All instruments are brand new carrying the regular factory guarantee.

Only  
**\$33**  
COMPLETE  
F.O.B. Our Store

Take your pick and order immediately, such a remarkable offer CANNOT last very long

### A Satisfied Florida Customer Writes:

"I sent four orders to different radio supply houses the same day. Three of them delivered the goods ordered in three weeks. The largest and most complex order was sent to Leeds. Your shipment was received FOUR DAYS after the order was mailed." Leeds "Same Day Service" is an actuality, not a meaningless catch phrase. Try it OM.



45 Vesey Street, New York City  
New York Headquarters for Transmitting Apparatus

# Plenty of Room for Bargains—But No Room for Ballyhoo

## National Receivers

Have a world wide reputation for performance richly deserved.

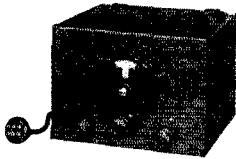

The popular SW-3 TRF receiver, in 3 models—2 v. D.C., 2½ v. A.C. and 6 v. A.C.-D.C. operation. **\$17.70**

All band spread and short wave coil ranges. **\$3.00**

The new FB-7A superheterodyne **\$34.20**

FBXA Crystal Filter model. **\$47.70**

All coil ranges. **\$6.00**

For Ultra High Frequencies

HFC converter. **\$23.70**

SRR Super regenerator. **\$17.70**

We carry the complete line of National apparatus as advertised last month.

## November Special FLECHTHEIM TC 200

Condensers: 2 mfd. 1000 v. **\$2.50**  
List \$5.50. Your cost.....

## SYLVANIA TUBES

With Graphite Anodes create a new standard of performance

New 210. **\$4.75** 203A. **\$17.50**

No. 830. **\$12.50** 852. **\$23.80**

Bulletin

## Special RELAY Bargain

Operates on one dry cell, two pole. One pole make and break, the other break only. Contacts will handle 250 MA. A BUY at. **\$2.29**

## FEDERAL F10A

175-watt RF amplifier, ideal for high frequency use. **\$34.50**

New 366-A shielded mercury vapor rectifier, 10,000v. inverse peak. **\$5.65**

Bulletins on request

## It's the Nertz!

G.R. 637P knob. **\$0.40**

HUBBELL 3-way flush mount receptacle with brass plate and plug. **\$0.95**

## Centralab "Elf" Potentiometers

All sizes from 1000 to 500000 ohms. **\$4.9**

GENERAL RADIO No. 677U ribbed porcelain coil forms. **\$3.35**

Pin base for above. **\$0.70**

Jack base for above. **\$0.65**

We carry a complete stock of Weston meters, analyzers, tube checkers, at wholesale prices.

## Leeds Transformers

For Every Amateur Need

### Mounted Filament Transformers

2½ v. 6 amp. 2000 v. ins. **\$0.95**

2½ v. 10 amp. 2000 v. ins. **1.25**

5 v. 3 amp. 2000 v. ins. **.95**

6.3 v. 2½ amp. 2000 v. ins. **.95**

7½ v. 2½ amp. 2000 v. ins. **1.25**

Two 2½ v. 5 amp., one 5 v. 3 amp. **2.25**

Two 7½ v. 3 amp., one 2½ v. 5 amp. **2.50**

Two 7½ v. 3 amp., one 5 v. 3 amp. **2.50**

Three 5 v. 3 amp. for 83 Bridge Rectifier. **2.50**

2½ v. 5 amp.; 5 v. 3 amp.; 7½ v. 3 amp. **2.50**

2½ v. C.T. 10 amp. 10,000 v. insulation. **\$2.75**

10 v. C.T. 7 amp. with tap primary. **\$3.95**

### Mounted Plate Transformers

1100v. C.T. 150 M.A. 7½ v. 3 amp.; 5 v. 3 amp.; 2½ v. 5 amp. **\$4.75**

950v. C.T. 200 M.A. two 2½ v. 5 amp., one 5v. 3 amp. **3.75**

Universal cased plate transformer with standoff insulator terminals, 300 w. capacity; 750-1000-1500v. **\$10.95**

each side C.T.

Leeds uncased class B transformer for 46 and 59 tubes, pair **\$3.50**

## SHIELDED CABLE

Rubber covered, with tin copper shield over all

No. 20 25 ft. **\$0.35** 50 ft. **\$0.55** 100 ft. **\$1.00**

No. 16 .45 .80 1.75

No. 14 .55 .95 1.85

Double conductor No. 18 rubber covered, with tin copper shield over all, per foot. **.4c**

Triple conductor No. 18, per foot. **.5c**

## 3-Wire Microphone Cables

Copper shielded, brown cotton over all, finished with spade ends.

12 ft. **\$.65**, 25 ft. **\$1.25**, 50 ft. **\$2.25**

5-wire shielded, per ft. **.7c**, 75-ft. **\$4.50**

## LEEDS GLASS INSULATORS

5" long, each. **\$.15**; 2 for **\$.25**

## All Cardwell Condensers at Wholesale Prices

Here are a few sample items

164B double spaced 220 mmf. **\$.236**

T199 double spaced 330 mmf. **5.83**

T183 triple spaced 110 mmf. **5.30**

Lifetime double button microphone, with gold spot diaphragm. **\$2.50**

Special.

S.M. CHOKES—150 H. 15 mil. **\$.49**

THORDARSON—Screen Grid Detector impedance 800 H. 8 mils. **\$.75**

## Western Electric Phones

Type P-11 Signal Corp phones. These would ordinarily sell at **\$7.50**. All new—**all perfect**. Here's a genuine bargain at. **\$3.95**

## Navy Type Telegraph Key

List **\$3.60**. Navy knob—**¼"** tungsten contacts. Only a few left at. **\$1.25** with Regular knob. **1.10**

## All Parts for Lamb's Universal Exciter Unit in Stock

### GENERAL RADIO PARTS

334N Condenser. **\$3.00**

274K Binding Post strips. **.60**

503A Vernier doubler. **2.00**

339B Switch. **2.00**

### NATIONAL PARTS

Isolantite sockets. **\$3.36**

Midget coil form. **.30**

No. 100 choke. **.45**

ST50 cond. **\$1.08**

Aerovox Condensers and Resistors at lowest prices

### SHIELD CANS

Black Crystalline finish on durable steel. These sturdy boxes must be seen to be appreciated.

5" x 5" x 5½" high. **\$ .65**

5" x 9" x 6" high. **\$1.25**

8" x 10" x 7" high. **\$1.45**

11" x 12" x 8" high. **\$1.85**

Large undrilled chassis 13" x 18½" x 1½", ideal for modulator units etc. **\$7.75**

## A New Line — TRIPLETT METERS

There is one for every purpose

These flush mounting precision instruments (accuracy 2%) with Sapphire jewel bearings and white enamelled dials, are of particular interest to amateurs.

3½" instruments, bakelite case — 2" metal case.

D.C. Mil. Ammeter Model 321 223

3½" **\$4.67** 2" **\$3.83**

0 to 1-2 or 3 mil

all standard sizes from 5

to 1000 mil 3.83 3.00

A.C. Volt Meters Model 331 233

0 to 5-10-15-50-100 mil 3.83 3.00

Write for descriptive folder on the complete line. All prices are correspondingly low.

This won't last forever

DeFoster 410—481—450. **\$.95c**

R.C.A. 2 stage amplifier, as advertised last month. **\$1.50**

READRITE flush mounting meters;

range from 0 to 15 to 0 to 400 M.A.

D.C. **\$.59c**

Bruno velocity microphone kit. **\$5.88**

Condenser microphone kit. **2.95**

R.C.A. type 712—peaked audio transformer 10 to 1 ratio. **\$.95c**

Sangamo audio transformer 3 to 1 ratio. **\$.85c**

Lock switch with two keys. **\$.29c**

Ohmite — Brand new — Red Devil wire wound resistors with pigtail leads.

10 watt units — 60 types from 1 to 25000 ohms; each. **\$.25c**

20 watt units — 30000 to 70000 ohms, in 5000 ohm steps. **\$.45c**

75000 to 100000 ohms, each. **\$.50c**

The new Sprague line of 600 v. working tubular paper condensers — all standard capacities from .0001 to .01. **15c** .02. **18c**

.05. **18c** .1. **21c**

.25. **27c** .5. **36c**

LEEDS' precision crystal holder. **\$1.25**

Y cut crystal 10KC 80 or 160 meters. **2.50**

with crystal holder. **3.50**

Y cut xtal. 1 of 1% accuracy. **3.00**

with crystal holder. **4.00**

# LEEDS—45 Vesey Street, New York City—LEEDS

Say You Saw It in QST—It Identifies You and Helps QST

# ACME~DELTA NOW 100 WATTS Audio Power with 2-RK 18 RAYTHEON TUBES

AD 75 CLASS "B" INPUT  
TRANSFORMER . . . . . \$7.50  
AD 76 CLASS "B" OUTPUT  
TRANSFORMER . . . . . \$15.50

Plus—

Your Present Voice-Amplifier  
or a New and Modern Amplifier using  
AD 90 MICROPHONE  
TRANSFORMER . . . . . \$7.50  
AD 91 INTERSTAGE  
TRANSFORMER . . . . . \$7.50  
AD 91 INTERSTAGE  
TRANSFORMER . . . . . \$7.50

Tubes required:

Audio Input Tube Type 56  
Audio Interstage Tube Type 56  
Driver Tubes 2 Type 45

Class "B" Audio—2 Raytheon RK-18

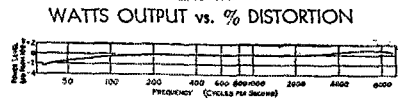
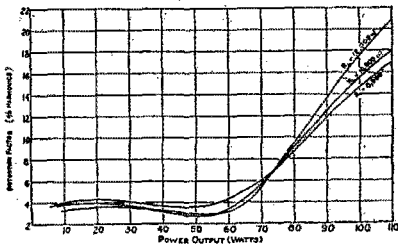

FREQUENCY RESPONSE CURVE

FOR BEST RESULTS, and hum-free carrier, the above should be used with Delta Power-Supply Equipment.  
LIST PRICES above are subject to the usual 40% discount to Amateurs and Experimenters. If your regular dealer has not yet received his stock, we shall be glad to supply you direct.

F. S. Dellenbaugh, Jr.  
President and  
Chief-Engineer

G. E. M. Bertram  
Treasurer and  
General Manager



Mail this Coupon Today

DELTA MANUFACTURING COMPANY  
39 Osborne Street, Cambridge, Mass.

Gentlemen: Please send me complete circuit drawing, instructions and set of performance curves, of new Acme-Delta 100 watt Equipment. I enclose 5c to cover mailing costs.

Name .....

Address .....

QST-11-33

## Correspondence Dept.

(Continued from page 66)

same thing applies to Class-A modulators. 'Phones using Class-B modulation do not seem to be troubled so much with excessive modulation; perhaps this is explained by the fact that the craving for action on the meters is supplied by this system of modulation.

"But how are we to tell when we have 100% modulation?" is asked by many operators. Most systems of measuring modulation percentage are too expensive for the average ham, who would do well to read the articles on Class-B modulation in the November and December, 1931, issues of *QST*, in which it is stated that 100% modulation is obtained when: The modulated amplifier plate input power is twice the modulator's audio output power, the load impedance offered by the Class-C amplifier (plate voltage divided by plate current) is correct for the modulator tube being used, and an increase in antenna power of 50% of the unmodulated carrier power is obtained. . . . In all cases the Class-C amplifier plate current and voltage must remain constant. . . .

*QST* has done its part, and it's up to the hams to digest the articles in *QST* and adjust their 'phones according to Hoyle (or *QST*). . . .

—Laurence Smith, W9EIZ

## Lampcord Feeders

North Guilford, Connecticut

Editor, *QST*:

Mr. Grammer's able discussion of the twisted-pair r.f. feeder of the untuned type has brought forth several claimants for the idea—some in print, others on the air.

When short-wave "firsts" are discussed it is seldom well to overlook my good friend John L. Reinartz. In this case he was at least an early user of the idea at a time when all stations at waves below 100 meters could have been counted on one hand—with fingers left over. He introduced us to the scheme while we were potting around with NSF in pursuit of the skip-distance and day-night-reversal effects. At 1XAQ we worked a 50-foot length of lampcord as a feeder between a Hartley oscillator and an antenna-counterpoise system—that is to say a Hertz antenna. In the process it came to light that the fireworks stopped when one "fanned" the far end of the lampcord apart. Incidentally, if this is tried in wet weather and with enough power there will still be fireworks unless the "fanning" is more or less logarithmic. The triangular fanning does not give a good enough gradation of the *C* and *L* distributions for mere lampcord at powers above 300 watts—not in wet weather.

—Robert S. Kruse

## Goofy Language

2805 Baker St., Baltimore, Md.

Editor, *QST*:

Inasmuch as you have started the ball rolling regarding the incorrect application and usage of



# STANDARDS of ACCURACY

There is no logical reason for using instruments below proved Weston standards—since Weston instruments are available at standard prices. Weston Electrical Instrument Corporation, 602 Frelinghuysen Ave., Newark, N. J.

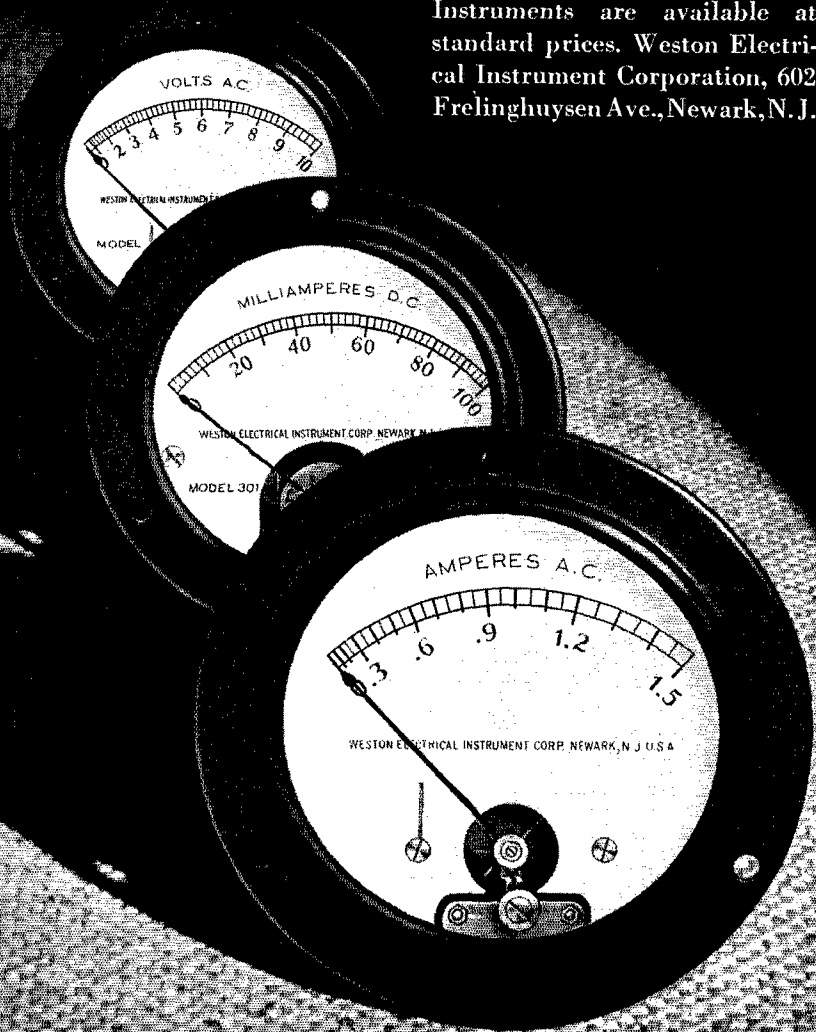

# WESTON

*Radio Instruments*

Say You Saw It in QST — It Identifies You and Helps QST

# NEW STANDARDIZED CONSTRUCTION UNITS

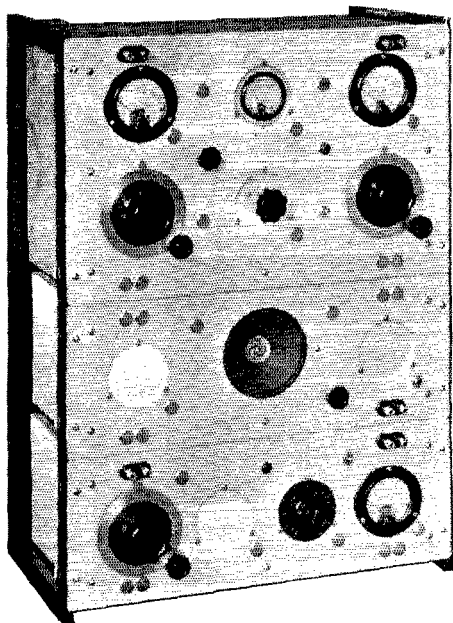

## PANELS AND ACCESSORIES RACK BASE PLATES END PANS DUST COVERS

Here is a thoroughly practical development of the unit construction idea. We do all the layout and drilling; all you do is assemble your parts to produce an attractive, workmanlike job. Then, when that new circuit must be tried out, you strip down the old set and rebuild without scrapping your investment in panels, base plates, etc.

Panels, bases, end plates, and dust covers are made of Eraydo, the new non-magnetic panel material. Holes are cut for standard navy-type meters with a liberal supply of 1/4 inch holes for rheostats, jacks, terminals, toggle switches, and whatnot. Covers of the same material are furnished for mounting condensers, coils, and other gear; also adapter rings for 2-inch meters. Push-in buttons cover the small holes that are not in use, and bushings are supplied so that parts mounting in holes smaller than 1/2-inch can be utilized.

We haven't room for more details, except that the prices are lower than you expect. *Example:* \$4.00 for the 7 x 19 inch panel shown at the bottom of the above illustration. That includes the accessories.



Complete prices, with parts lists and dimensioned drawings, are contained in a booklet now ready. Your name, address, and a request for Bulletin 661-Q sent to the General Radio Company, Cambridge, Massachusetts, will bring you a copy by return mail.

# GENERAL RADIO

"es" and "sk" in ham work, why not continue and put the bee on the eggs that make such goofy use of "hi" in 'phone work? Doesn't it gripe you to hear a bunch of grown-ups chortling back and forth in that famous ham 'phone monotone, "high, high"?

If you can't make some impression why not inaugurate the use of the practically unknown symbols of radio. Think of the possibilities of expression in the various punctuation marks!! Just look at all the combinations possible in the question mark. For instance, there's "eati" "imi" "iz" "uti" "ud." The comma (.-.-.), I think, has already been widely applied, judging by the number of ahhs and errs in the average 'phone ragchew.

Well OM errr what do you think immy immy high high kay?

—A. C. Goldbach, W3VD

## The D.C. Regs.

Box 245, Flagstaff, Ariz.

Editor, *QST*:

. . . Let me congratulate the League and *QST* on the wonderful work that has been done in the last two months. As a result we have an FB new set of regulations and the finest issue of *QST* in some time, although ever since this young squirt has been allowed to read anything so mature as *QST* it has been the finest magazine in the field.

Most amateurs seem to agree that the new regulations were needed. Now the thing to do is for all amateurs to get together and see that they are enforced. R.a.c., wobbly notes, and frequency-modulated 'phones must be relegated to five and ten where they are still useful for the present. More power to the F.R.C. and its new shipment of AGSX single-signal receivers. They are liable to have to make examples of a few of the gang even before October 1, unless my FB-7 is haywire for it makes some of the present crop of r.a.c. signals unreadable as c.w. although they may be QSA 5, R6 without the beat oscillator. . . .

One more thing and I shall QRT. I should like to see if I will stir up another hornet's nest by suggesting that something be done to lessen c.w. operation in the 14-mc. 'phone band. This band is very crowded with 'phones at present, and it seems a shame to have so many QSO's spoiled by QRM. I honestly believe that both c.w. and 'phone men would be better off if the c.w. stations would stay in their exclusive part of the band. What say gang, let's see some argument on both sides of this question?

—Roger Wilson, W6EGI-GZG

## Receivers and Power

Ashland, Ohio

Editor, *QST*:

"Receivers vs. High Power" in the Correspondence Department of July *QST* by W9FRV, certainly strikes a responsive chord here. . . .



## RK-18

**ONE OF A NEW LINE OF TUBES  
DESIGNED SPECIFICALLY  
FOR AMATEUR USE**

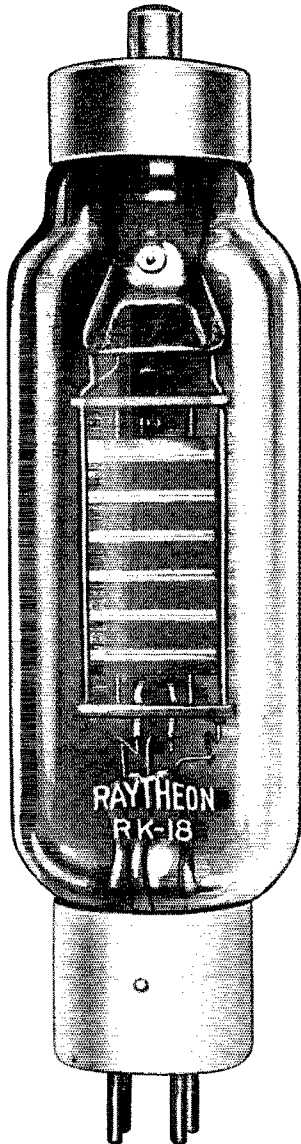

**LIST PRICE \$10.95**

The RK-18 is a high- $\mu$  triode with characteristics that adapt it for operation as self excited oscillator, RF amplifier or Class B modulator. Every feature of design covers specific amateur needs: Power output, low internal capacitances, thoriated filament, molybdenum plate, plate connection at top of bulb, Isolantite bridge spacers and base, appearance to match the finest apparatus.

### RATING

	Class A	Class B	Class C
Filament Voltage.....	7.5		
Filament Amps.....	2.5		
Maximum Plate Volts.....	1000	1000	900
Grid Bias Volts.....	-40	-50	-150
Amplification Factor.....	18		
Mutual Conductance.....	3000		
Max. Watts Plate Dissipation....	35	35	35
Nominal Watts Output per Tube..	8.5	35	35

*If your dealer cannot supply, order direct from us*

## RAYTHEON PRODUCTION CORPORATION

GENERAL SALES OFFICE, NEW YORK, N. Y.

NEW YORK, N. Y.  
30 EAST 42nd ST.

NEWTON, MASS.  
55 CHAPEL ST.

SAN FRANCISCO, CAL.  
555 HOWARD ST.

CHICAGO, ILL.  
445 LAKE SHORE DRIVE

# To Our Readers who are not A.R.R.L. members

**Y**OU should become a member of the League! That you are interested in amateur radio is shown by your reading of *QST*. From it you have gained a knowledge of the nature of the League and what it does, and you have read its purposes as set forth on the page opposite the editorial page of this issue. We should like to have you become a full-fledged member and add your strength to ours in the things we are undertaking for Amateur Radio. You will have *QST* delivered at your door each month. A convenient application form is printed below — clip it out and mail it today.

*A bona fide interest in amateur radio is the only essential qualification for membership*

AMERICAN RADIO RELAY LEAGUE  
West Hartford, Conn., U. S. A.

I hereby apply for membership in the American Radio Relay League, and enclose \$2.50 (\$3.00 outside of the United States and its Possessions, and Canada) in payment of one year's dues, \$1.25 of which is for a subscription to *QST* for the same period. Please begin my subscription with the ..... issue. Mail my Certificate of Membership and send *QST* to the following name and address.

.....  
.....  
.....

Do you know a friend who is also interested in Amateur Radio, whose name you might give us so we may send him a sample copy of *QST*?

.....

Thanks

About everything in the detector line has been used here, down through coherer, electrolytic, crystals, cylindrical audiotron and the flock of newer tubes, and the conviction has steadily grown that the solution of bettering DX was in reducing rather than increasing transmitter power.

After being off the air for about seven years, some old parts were soldered up into a little c.w. and 'phone transmitter with one poor little 210 with 25 watts input in the Class-C stage instead of the pair of 100-watt bottles which had been used before, and due to the vast improvement in receivers and tubes, this little tube steps out just as well as the big boys did.

So what is the use of causing a lot of grief for the other fellows for a hundred miles or more around, whose perfectly good little signals can be received over what a short time ago was considered unbelievable distances, when given half a chance and not blanketed by some high-powered bird who may be only working a station in the next town?

—I. W. Copeland, W8GGD, ex8JM

## Byrd Expedition Gets Under Way

*(Continued from page 28)*

plans of the radio section of the expedition. Further details of operating frequencies and schedules will appear in future issues of *QST*.

John Dyer asks us to tell the Ham World that every possible opportunity will be made for amateur contacts with the expedition. He admits that it will be utterly impossible to attempt to QSO every station heard, however, and explains that they will be obliged to restrict their schedules to well-established ham stations able to withstand the terrific strain such schedules mean. It is Dyer's secret ambition to take a special expedition to the Pole one of these days for the sole purpose of having a QSO with every ham extant.

## The Kansas State Convention

**S**ECOND only to the late Lt. Col. W. F. McFarland, W9EVT, of Topeka, who passed August 3rd to the realm of silent keys, William C. Obrist, W9BEZ, Wichita, is the winner of the 1933 competition for the Kansas Wouff-Hong, awarded annually to the state's best amateur.

Announcement of the award was made at the closing banquet on the roof garden of the Hotel Jayhawk, of the seventh annual Kansas State amateur radio convention, held in Topeka, September 9th and 10th. The 1933 winner is a chief radioman in the U. S. Naval Communication Reserve, and is acting commander of Unit 4, Wichita.

An attendance of 135 was chalked up for the convention, which drew from far away Waterville, Maine, Raoul Vigue, W1DBQ, his brother

# PURE DC



## EVERY INCH A BATTERY

NATIONAL CARBON COMPANY, INC.

GENERAL OFFICES: NEW YORK, N. Y.

UNIT OF UNION CARBIDE  AND CARBON CORPORATION

Say You Saw It in QST — It Identifies You and Helps QST



242A mounted  
in No. T-6  
Coast Guard  
transmitter.

## Used in more sockets!

The Western Electric 242A general purpose tube—one of the most widely used transmitting tubes—is now available to amateurs for use as an oscillator, audio or radio frequency amplifier. This tube meets U. S. Government standards for the most severe communication conditions. It assures *more dependable transmission*.

First developed for service in U. S. Coast Guard equipment, the 242A is widely used in Western Electric sound reproducing systems, broadcasting equipment, airplane transmitters, trans-atlantic telephone apparatus. Dependability, uniformity, ruggedness and long life are built into every tube.

Filament Voltage.....	10
Filament Current, Amperes.....	3.25
Average Plate Resistance, Ohms.....	3500
Average Mutual Conductance, Micromhos.....	3500
Average Amplification Factor.....	12.5
Approximate Direct Inter-electrode Capacities:	
Plate to Grid.....	13.0 mmf.
Plate to Filament.....	4.0 mmf.
Grid to Filament.....	6.5 mmf.
Maximum Plate Voltage, DC.....	1250
Maximum Plate Current, DC, Amperes.....	0.150
Maximum Plate Dissipation, Watts.....	100
Maximum Overall Length.....	7-15/16"
Maximum Diameter.....	2-5/16"

For booklet describing this and 25 other Western Electric tubes for amateur use, write to Graybar Electric Co., Graybar Building, New York, N. Y.

# Western Electric

RADIO TELEPHONE BROADCASTING EQUIPMENT

Distributed by GRAYBAR Electric Co.

Leo, W1BOC, Waldo H. Edmonds, W1GLN, and Phil Allen, W1DGJ.

Kansas fellowship expanded to maximum in the Saturday night entertainment at the Kansas National Guard Armory—and W1DBQ, as spokesman for the Maine four, promised with enthusiasm to return next year if it were necessary to walk. Even the world amateur convention at Chicago was a stop-over for them, on their 4000-mile jaunt.

Two division directors honored us with their presence—our own H. W. Kerr, W9GP, Little Sioux, Iowa, and the Rocky Mountain head, R. J. Andrews, W9AAB, of Denver, Colo., accompanied by his O. W. Speakers included Prof. L. C. Pasley, Kansas State College, Manhattan; Capt. W. A. Beasley, W9FRC; C. H. Annis, Kansas City, Hygrade-Sylvania representative; E. A. Roche, W9FLT; Guy Wilson, W9EL; Clifford W. Johnson, W9BUY; E. Earl Harden, W9FMX, and Ens. Harry E. Legler, C-V (S) U.S.N.R., W9PB. Conferences of the O.R.S., led by O. J. Spetter, W9FLG, SCM for Kansas; of the A.A.R.S., led by Director Kerr, radio aide, seventh corps area; of the USN Communication Reserve, led by Ens. A. W. Hodge, C-V (S), W9CFL, and the CX7 association led by Captain Beasley, preceded the special entertainment Saturday night.

C. W. Loeber, acting inspector-in-charge of the F.R.C. Kansas City office, conducted examinations for amateur licenses, and was featured speaker Sunday at the banquet, explaining new regulations and prescribing the routine through which recipients of the green and pink QSL's can preserve their precious tickets.

— F. K. T.

## The Oklahoma State Convention

(The West Gulf Div.)

THE Red Lacquer Room of the Alvin Hotel in Tulsa, June 16th and 17th, was busy as a bee hive when the Tulsa Amateur Radio Club staged a real convention. Guests from all over the state were cordially greeted by President John Douglas.

Howard Hamilton, convention manager, showed his versatility by giving the delegates three musical selections on the xylophone. Such contests as needle threading, radio word spelling-bee, won by W5CCV and W5CSU respectively, helped relieve the seriousness of speeches. Director Frank Corlett gave a 25-minute talk on A.R.R.L. and I.A.R.U. Director Corlett is the Dean of Divisional Directors and last May presented his seventeenth annual report at the annual meeting, so his talk was based on actual knowledge of conditions and progress made by the organization over so many years. Jim Pitcher spoke interestingly on photo-cells and demonstrated their application in a talking moving picture machine. Visits were made to Dept. of Commerce airways station, the Municipal airport and Bell Telephone Building. The Army and Navy were well represented by Carter Simpson and Charles Dunn respectively. Liars, pie-

# THE Amateur's BOOKSHELF

A balanced selection of good technical books, additional to the A.R.R.L. publications, should be on every amateur's bookshelf. We have arranged, for the convenience of our readers, to handle through the QST Book Department those works which we believe to be most useful. Make your selection from the following, add to it from time to time and acquire the habit of study for improvement. *Prices quoted include postage.* Please remit with order.

## RADIO THEORY AND ENGINEERING

**COMMUNICATION ENGINEERING**, by *W. L. Everitt*. A general text for both first year and advanced courses. 567 pp., 335 illustrations. . . . . **\$5.00**

**RADIO ENGINEERING**, by *F. E. Terman*. A comprehensive treatment covering all phases of radio communication. A good all around book for students and engineers. 688 pp., 418 illustrations. . . . . **\$5.00**

**MANUAL OF RADIO TELEGRAPHY AND TELEPHONY**, by *Commander (now Admiral) S. S. Robinson, U.S.N.*. Published by the Naval Institute. Covers both the theoretical and practical fields. 791 pp., 6 $\frac{1}{2}$  x 9. . . . . **\$4.00**

**ELEMENTS OF RADIO COMMUNICATION**, by *Prof. J. H. Morecroft*. This is a new book by the author of the "Principles" listed below. It is about half the size of the larger work, and the subject is treated in more elementary fashion. Simple algebra is sufficient. An excellent book for the "first-year" student. 269 pp., 170 illustrations. . . . . **\$3.00**

**PRINCIPLES OF RADIO COMMUNICATION**, by *Prof. J. H. Morecroft*. An elaborate general textbook, and one of the recognized standards on theory for the engineering student. A working knowledge of mathematics is desirable for the reader who expects to get the greatest benefit from this work. 1001 pp., 5 $\frac{1}{4}$  x 9. . . . . **\$7.50**

**PRINCIPLES OF RADIO**, by *Keith Henney*. This book is chock-full of meat for the experimenter. The subjects treated range from the fundamentals of electricity to the modern concepts of modulation and detection. 477 pp., 306 illustrations. . . . . **\$3.50**

**THEORY OF THERMIONIC VACUUM TUBES**, by *E. L. Chaffee*. Based on Dr. Chaffee's research and study at Harvard University, this book offers much new material and many new presentations, especially in connection with regeneration. Recommended particularly for advanced study. 652 pp., 360 illustrations. . . . . **\$6.00**

## RADIO EXPERIMENTS AND MEASUREMENTS

**RADIO FREQUENCY ELECTRICAL MEASUREMENTS**, by *H. A. Brown*. A thoroughly practical book for the experienced amateur, the experimenter or engineer who has knowledge of the elementary principles of radio communication and of alternating currents. . . . . **\$4.00**

**HIGH-FREQUENCY MEASUREMENTS**, by *August Hand*. A thorough, modern book, especially useful in ad-

vanced laboratory work. Includes a chapter on piezo-electric determinations. 491 pp., 373 illustrations. . . . . **\$5.00**

**EXPERIMENTAL RADIO**, by *Prof. R. R. Ramsey*. Revised Edition. A splendid book for the experimenter. This is a laboratory manual, describing 128 excellent experiments designed to bring out the principles of radio theory, instruments and measurements. 150 illustrations, 229 pp., 5 $\frac{1}{4}$  x 7. . . . . **\$2.75**

## COMMERCIAL EQUIPMENT AND OPERATING

**RADIO THEORY AND OPERATING**, by *Mary Texanna Loomis*. Although giving a moderate amount of theory, it is essentially a practical handbook for commercial and broadcast operators, and as such ranks among the foremost publications of this sort. Used as a textbook by many radio schools. A good book for any amateur. 1000 pp., 800 illustrations. . . . . **\$4.25**

**THE RADIO MANUAL**, by *George E. Sterling*. Another excellent practical handbook, especially valuable to the commercial and broadcast operator, and covering the principles, methods and apparatus of all phases of radio activity. Over 900 pp. . . . . **\$6.00**

**RADIO TELEGRAPHY AND TELEPHONY**, by *Duncan and Drew*. Still another work along the lines of a general practical handbook. In size it is approximately the same as the two listed just previously, and the subject matter generally follows along the same lines. A good book in this class. 950 pp., 468 illustrations. . . . . **\$7.50**

**HOW TO PASS U. S. GOVERNMENT RADIO LICENSE EXAMINATIONS**, by *Duncan and Drew*. Intended as a companion volume to "Radio Telegraphy and Telephony" by the same authors, as a guide to the applicant for commercial

licenses. It is not a text in itself. The chapter arrangement follows that of the sections of the commercial theoretical examination, each being made up of typical examination questions and their answers. 169 pp., 92 illustrations. . . . . **\$2.00**

**RADIO TRAFFIC MANUAL AND OPERATING REGULATIONS**, by *Duncan and Drew*. A book for students, amateurs or radio operators who contemplate entering the commercial field; it will enable you to learn quickly and easily all the government and commercial traffic rules and operating regulations. 181 pp. . . . . **\$2.00**

**PRACTICAL RADIO TELEGRAPHY**, by *Nilson and Hornung*. Written particularly for the student training for a commercial license, and covering theory and apparatus. A practical handbook. 380 pp., 223 illustrations. . . . . **\$3.00**

**RADIO OPERATING QUESTIONS AND ANSWERS**, by *Nilson and Hornung*. A companion volume to "Practical Radio Telegraphy" by the same authors. The 1933 Revised Fifth Edition is very complete, covering Commercial and Broadcasting, Amateur, Aeronautical and Police Radio, Beacons, Airways, Meteorology, and Teletype Operating. 356 pp., 5 $\frac{1}{4}$  x 8. . . . . **\$2.50**

## MISCELLANEOUS

**THE RADIO AMATEUR CALL BOOK**. Lists all U. S. and foreign amateur radio stations, s.w. commercials and broadcasters. . . . . **\$1.00**

**BELOW TEN METERS**, by *James Millen and R. S. Kruse*. Ultra-high-frequency oscillators, radiating systems, receivers, theories, measurements, television reception, etc. Abundant photographs and diagrams. 64 pp. . . . . **\$5.50**

**ELECTRICITY, WHAT IT IS AND HOW IT ACTS**, by *A. W. Kramer*. A modern treatment with the electron as its basis. It deals only with accepted theories, presenting them

simply and straightforwardly so that those not mathematically minded can understand them. Two volumes, 592 pp., 242 illustrations. . . . . **\$4.00**

**RADIO DATA CHARTS**, by *R. T. Beatty*. A series of graphic charts for solving, without the use of mathematics, most of the problems involved in receiver design. 82 pp., 8 $\frac{1}{2}$  x 11. . . . . **\$1.50**

**SERVICING RECEIVERS BY MEANS OF RESISTANCE MEASUREMENTS**, by *J. F. Rider*. 203 pp., 94 illustrations. An excellent book for the service man and amateur constructor. . . . . **\$1.00**

# AMERICAN RADIO RELAY LEAGUE, INC.

WEST HARTFORD, CONNECTICUT

**Amateur Headquarters**

**Save Money on These M. & H. Specials**

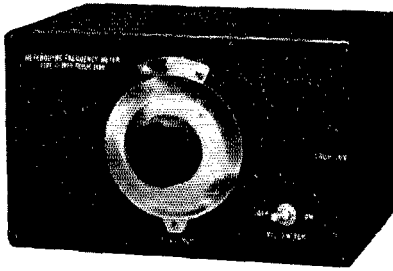

**Precision Frequency Meters**

The new M. & H. Electron Coupled Frequency Meter is an outstanding development of the year. Housed in a one-piece cast aluminum box with heavy aluminum front panel suitably engraved. Finished in a beautiful "crinkle" black lacquer. Uses one type 24 tube, two 22½ volt portable type "B" batteries, A.C. operated filaments. Supplied completely calibrated with all batteries and tube.

M. & H. Special Price ..... **\$30**

**New Hammarlund "Pro"**

With Crystal Filter

Special Amateur Price.

Less Tubes .....

**\$111.72**

**Sylvania Tubes**

The New 830 ..... **\$12.50**

New Carbon Plate, 210 ..... **\$4.75**

Carbon Plate 203A ..... **\$17.50**

**Thordarson-Special**

**Ham Transformer**

800 Volts Each Side of C. T.

160 Milliamperes

Weight Eleven Pounds

Special **\$3.95**

**The New Gordos Tubes**

203A (Carbon Plate) ..... **\$11.75**

866 ..... **2.45**

210 ..... **2.45**

*We are now distributors for the famous Collins Transmitters and Westinghouse Meters*

**M. & H. SPORTING GOODS CO.**

512 MARKET ST., PHILADELPHIA

eating, tallest and youngest ham contests took place during the convention and proper prizes awarded. All convention activities came to a close with one "swell" banquet and the thanks of all go to the Ponca City and the Tulsa Clubs for this joint affair. Looks as though the 1934 official West Gulf Division convention may be held in Tulsa. Let's root for it.

— A. A. H.

**The Wisconsin State Convention**

(Central Division)

THE combined 1933 convention and hamfest held at the Hotel Wausau, Wausau, under the auspices of the Northern Wisconsin Radio Club is a thing of the past, but Saturday, June 10th and Sunday, June 11th will be long remembered by the delegates.

With a cordial welcome by Mayor Otto Muenchow, President Fear started things going. Talks were given by R. C. Judd, W9IFV; Roy Bushland, W9GIT; Clarence Stellow, W9BRJ and Rex A. Munger, W9LIP.

The excellent banquet was held Saturday evening and was followed by motion pictures. Director Windom was unable to attend the convention because of an auto accident and the delegates missed the opportunity of meeting their director but are glad to know that no personal injury was sustained.

Sunday was to be a day for stunts and it looked like a big disappointment as the day started out wet, raining very hard until about 9:00 a.m., but cleared up nicely after that. Portable stations W9HFX, MCO and LST were brought out of their shelter and put in operation on 80 meters and had successful QSO's. In the afternoon a picnic was held in Marathon Park. After the "eats" a kittenball game was held between the c.w.'s and 'phones, the winner to take a cup put up last year at the annual picnic by the N.W.R.C. Floyd Smith, W9FAW, was captain for the c.w., and Roy Bushland, W9GIT, captain for the 'phones. The c.w.'s won the cup which is permanent now as they also won last year. A Tug-of-War between the c.w. and 'phones was won by the c.w. crowd and proved quite exciting. Like all good things there must be an end and so after a few more stunts, late in the afternoon 73 and SK closed the events of two pleasant days.

— Bob & A. A. H.

**The Dakota Division Convention**

THE Dakota Division conventions are not held very often but when one takes place it makes up for lost time. With an attendance of over 300 this year's convention held at the Oxford Ballroom, St. Paul, Minn., under the auspices of the St. Paul Radio Club, assisted by Minneapolis Radio Club, April 21st and 22nd, proved an outstanding affair. Rex Munger, general chairman,



# Have You These Supplies On Hand?

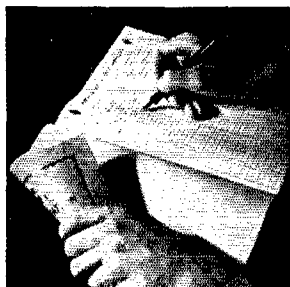

## THE LOG BOOK

Bound with heavy paper covers.  $8\frac{1}{2} \times 10\frac{3}{4}$ . Contains 39 log pages, and same number of blank pages for miscellaneous notes. Also list of Q sigs, message number sheet and sheet of cross-section paper. 40c each or 3 for \$1.00. Postpaid.

## THE MESSAGE BLANKS

Most convenient form. Designed by the Communications Department of the A.R.R.L. Well printed on good bond paper. Size  $8\frac{1}{2} \times 7\frac{1}{4}$ . Put up in pads of 100 sheets. One pad postpaid for 35c or 3 pads for \$1.00.

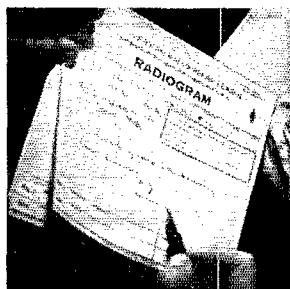

## MEMBER'S STATIONERY

Write your radio letters on League stationery—it identifies you. Lithographed on  $8\frac{1}{2} \times 11$  heavy bond paper. Postpaid. 100 sheets, 50c; 250 sheets, \$1.00; 500 sheets, \$1.75.

## MESSAGE DELIVERY CARDS

Neatest, simplest way to deliver a message to a near-by town. On U. S. stamped postals 2c each. On plain cards (for Canada, etc.) 1c each postpaid.

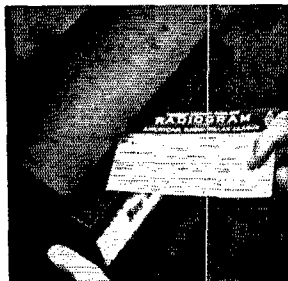

THE AMERICAN RADIO RELAY LEAGUE—WEST HARTFORD, CONN.

## GUARANTEED Amateur Equipment

A complete stock of NATIONAL Radio Products is always carried . . . a discount of 40% from list prices quoted.

SW-3, National Short Wave Receiver (AC or DC)	\$17.70
HAMMARLUND Comet "PRO" — latest model, in cabinet with tubes and coils . . .	\$95.49
Hammarlund 8 m.h. Choke, 125 m.a., type CH-8	65c
Hammarlund H. D. Xmitting Choke 5.3 m.h., type CH-500 . . . . .	\$1.03
Hammarlund Midget Condensers	
20 mmf. . . . . \$ .82	200 mmf. . . . . \$1.61
35 mmf. . . . . .88	260 mmf. . . . . 1.76
50 mmf. . . . . .94	320 mmf. . . . . 2.06
80 mmf. . . . . 1.18	35 mmf. . . . .
100 mmf. . . . . 1.32	double spaced . . . 1.32
140 mmf. . . . . 1.47	50 mmf. . . . .
	double spaced . . . 1.61
De Forest 210's and 281's . . . . . each	\$1.19
De Forest type 510 (15-watter) . . . . .	3.95
Bliley X-cut Crystals . . . . .	3.90
Bliley Crystal Holders . . . . .	1.50
Crystal Blanks (X-cut) . . . . .	1.00
Universal model "E" Condenser Mike . . . . .	52.92
Universal NEW model "BB" 2-button Mike . . . . .	14.70
Universal NEW model "X" 2-button Mike . . . . .	5.88
REL . . . 50-watt Sockets . . . . .	1.60
Johnson 50-watt type Sockets . . . . .	1.20
Johnson "Micro Mite" Stand-off Insulators — 13/16" high . . . . .	5c
Johnson Stand-off Insulators — 1 1/8" high . . . . .	8c
Porcelain Stand-off Insulators — standard size . . . . .	9c

25% deposit with all C. O. D. orders. Remit by M. O. Include postage. Prices are changing rapidly, therefore, we cannot guarantee them indefinitely. **BUY NOW and SAVE!**

We are authorized distributors of nationally known radio equipment, and can supply you with any part of the following manufacturers: Thordarson, Kenyon, Eby, Centralab, Cardwell, Electrad, Universal, Ward-Leonard, Hammarlund, National, Ohmite, IRC, Littelfuse, Jefferson, Readrite, etc. Write for our FREE bulletin.

**Maurice Schwartz & Son**  
710-712 Broadway, Schenectady, N. Y.

### GOTYOURLICENSEMANUALYET?

*See inside front cover*

### Radio Operating Radio Servicing—

Prepare for the new Government Radio Operating license examinations; Radio Operator, Marine and Broadcasting. Also Radio Amateur Telegraph and Telephone. Resident courses. Write for booklet "Opportunities in Radio."



West Side YMCA Trade & Technical Schools  
4 West 63rd Street, New York City

with his committee of 25, kept busy every minute to see that the program was carried out as it should be. Talks were given by Prof. Todd and Carl Swanson of the U. of M. and Mr. Skifter, Western Radio Eng. Co. Our old friends "Beep" Phelps and Al. Kahn of Electro Voice spoke on subjects interesting to hams. Traffic meetings under the direction of the SCM's. Army-Amateur and Naval Reserve meetings took place during the convention. Arthur Collins of Collins Radio, Mr. Engel, Engineer, RCA Radiotron were the principal speakers on Saturday. The banquet was a real "feed" and good addresses were made by Director Lindesmith and Radio Inspector Sherman. Our only regret is we were not there and have to write this story as a "ghost" writer on second-hand information. Well done St. Paul-Minneapolis!

— A. A. H.

### The Old Man's Son Speaks Again

(Continued from page 25)

an Aussie or any other DX after *his* SK but they never stopped to think somebody might call them after *their own* SK.

To correct this, somebody advanced this QRZ theory, which was all well and proper when used right. But I'll be horn-soggled if in two weeks time all you could hear wasn't QRZ? QRZ? (10 times) de LID. Pop said CQ was doomed for a hasty death, and I took sides with him. And this young feller at the radio club who sed he could work all night on one CQ had been doing just that. Pop had been riled up over this business for quite a while, so no wonder he nearly blew up when he heard one of 'em brag about it.

Who couldn't CQ at 5 p.m., work a fellow, and when finished with him crank out QRZ? *eight or ten times* and get another answer? But listen, young feller, it would have saved watts and time to have sent another CQ right after your SK, even if Handy would have paced the floor when he heard it.

And then the other evil that has crept in with it: One of you squirts calls a CQ and gets an answer buried in a mess of hogwash and QRM and can't get what he signs and you come back with a QRZ? QRZ? de whoever ye be. Then some monkey hears you squeal that out and gives you a call away down in the other end of the band. Of course you don't find him because you are still trying to drag that other fellow through by his head. More foolish QRM. Some of the fellows solve a case like that by coming back with QRZ? DC 7040 KC de W—. That's not half bad.

I don't know anything Pop hates worse than these CQ hounds, and I hate 'em worse than he does. But I'll be danged if I wouldn't rather hear a squirt CQ twenty-five times and sign once than hear some of you birds pull off this QRZ business ten and fifteen times. Wake up and listen to what a silly thing you're doing!

*The Old Man's Son*

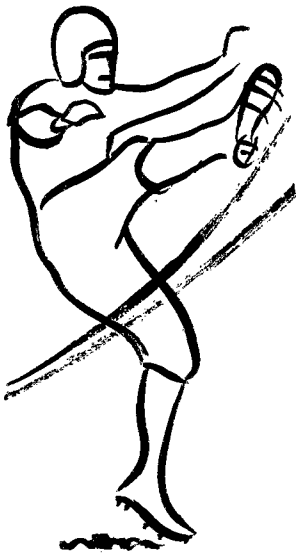

## Kicked Around Like a Football or Neat and Orderly in a QST Binder

THE rough treatment that a football gets is nothing compared to what your QSTs get if they are not kept in a QST BINDER.

This is the eleventh issue of QST for 1933. CAN YOU READILY FIND ANY ONE OF THE OTHER TEN ISSUES? You can if it's in a binder but you'll sure need help if it isn't.

The QST Binder is covered in deep maroon cloth. It is cleverly designed to take each issue as received and hold it firmly without mutilation. It permits the removal of any desired issue without disturbing the rest of the file.

To enhance the appearance of your station, to facilitate your reference work, and to preserve the records of the advancement of the radio art, you need a BINDER. You need one for this year's issues and one for each of the accumulated year's issues that you have. It will accommodate twelve issues of QST and a yearly index. You will find it an investment

*at \$1.50 each, postpaid*

**The American Radio Relay League, Inc., West Hartford, Conn.**

### CLASS B 800'S!

The introduction of the new type 800 undoubtedly marks a new era for phone enthusiasts. It is now possible to build an *inespensis* modulator that will deliver 100 watts of virtually undistorted output. No more expensive 851s, 849s or 203As! Two type 800s in Class B will modulate 100 per cent an input of 200 watts to the Class C stage!

Foreseeing the demand for properly designed transformers for these tubes, HILET is pleased to announce the following Class B input and output transformers — each completely mounted in a cast aluminum shell with a terminal panel:

Type	Purpose	Net Price
IB-100	2-2A3s to 2-800s	\$7.00
OB-101	2-800s to 5000/20000 ohms	18.00

(Note: Type OB-101 has two secondaries, designed to carry 100 MA d. c. in series and 200 MA d. c. in parallel.)

Prices are net, f. o. b. Newark, N. J.

C. O. D. orders must be accompanied by 15% of order amount.

#### HILET ENGINEERING CO.

Phone — Orange 4-3871      P. O. Box 35, Newark, N. J.  
*Class B Transformers a Specialty*

### Fleron Insulators

*Complete line of new sizes and shapes for Amateur use*

**NEW FLERON-WALLACE ALL GLAZED** Transposition Block for S-W Doublet Antenna. List Price 20c. ea.

**NEW FLERON-WALLACE S-W** Doublet Antenna outfit contains 200 ft. No. 14 Solid Enameled Copper Aerial Wire; 3 Tugite Glass Insulators; 20 Fleron-Wallace All Glazed Transposition Blocks; 2 No. 82 Terminal Insulators; 32-page Don Wallace S-W Instruction Book. List Price \$4.95. Catalog Q-653 Free.

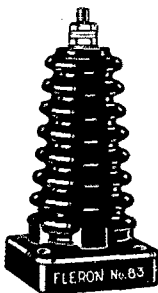

**M. M. Fleron & Son, Inc. Trenton, N. J.**

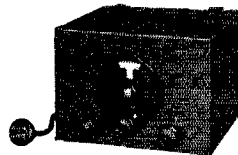

### "TEN METER" COILS

Two new coils for operation of the SW-3 on Ten Meters have recently become available: Number 60, a General Coverage Coil having a range of 9 to 15 Meters, and Number 60A, a Band Spread Coil for the 10 Meter Band.

These recent coils, together with those for the FB-7 announced in August QST, and others previously available, make all National Receivers available for 10 Meter use.

*The above coils are all listed in our new number 220 catalogue, which appeared in the pages of the October issue of QST.*

**NATIONAL COMPANY, INC.  
MALDEN, MASS.**





**WESTON # 301**  
Metal Case Type  
**MILLIAMMETERS**



Reconditioned — like new **\$3.75**  
— guaranteed

*This offer is limited to licensed amateurs — orders must be placed before November 30.*

Complete kit for 1200 volt — 600 volt—500 m.a. "83 bridge" rectifier— will supply 1200v @250 m.a. and 600v @250 m.a. — all units fully mounted in steel cases. Including Power Transformer—1350v—with c.t.....\$8.50  
Filament Transformer for 4-83's, \$3.85  
250 m.a. Swinging Choke... \$5.00  
250 m.a. Smoothing Choke... \$5.00  
Sold as a kit for.....\$20.30  
Completely built including steel base — filters — bleeders, etc.....\$34.50

**KALTMAN & ROMANDER**  
62 Court St. Tel. MArket 3-2020 Newark, N. J.

## Strays

The usual method of mounting QSL cards on the wall with tacks often results in loud howls from the OW concerning the many perforations and resulting damage to the wall-paper. We place our cards in vertical rows, woven into two tightly-stretched loops of enamelled wire (sizes 22 to 30). This requires only four tacks for each row, one at the top of each loop and one in each lower corner of the bottom card. The loops of wire and the bottom card are fastened up first and the other cards then inserted. The result is a neat layout which has the advantage of being easily re-arranged to keep each country and district separate.

— W1BTA

### Forming a Club?

**I**F YOUR organization is new, or just in the formative stages, and you need information on how to organize, or a sample constitution, drop a postal to our Communications Department asking for these club helps. The paper on clubs by Mr. Corderman of W3ZD, presented before the New England Division A.R.R.L. Convention this year, is also now available on request in mimeographed form. This covers club problems of every description, club property, the club station—everything from sky wire to ground. If you need these helps, just ask. Already-organized clubs, interested in establishing an affiliation with the American Radio Relay League, are invited to write for the suggested resolution to be considered by their organizations as a first step in bringing the subject before the A.R.R.L.'s Executive Committee for action.

— F. E. H.

### C. C. C. and the Amateur

(Continued from page 36)

Marysville, California— WUBC  
Edwin H. Staar ..... W6ETM ... Glendale, Calif. .... with set  
Joseph Henderson ..... W6HHM ... Oakland, Calif.

Fresno, California— WUBD  
G. M. Luchessa ..... W6BRV ... Modesto, Calif. .... with set  
W. Milligan ..... W6DQR ... Fresno, Calif.

Eureka, California— WUBE  
E. P. Stropole ..... W6AUB ... Pasadena, Calif. .... with set  
F. L. Zerlong ..... W6DHE ... Eureka, Calif.

Baker, Oregon— WUBF  
Earl L. Pickett ..... W7ZZZ ... North Bend, Oregon ... with set  
Charles H. Buhman ..... W7CVL ... Forest Groves, Oregon

Medford, Oregon— WUBG  
Donald Shugg ..... W6BTJ ... Huntington Park, Calif. with set  
Edwin Grimsted ..... W7AWO ... North Bend, Oregon

Eugene, Oregon— WUBH  
Bradley Thompson ..... W7CFM ... Eugene, Oregon. .... with set  
H. H. Gates ..... W7AYN ... Lebanon, Oregon

Lewiston, Idaho— WUBI  
John Brus ..... W6EBK ... Baldwin Park, Calif. ... with set  
J. M. McCampbell ..... W7KI ... Caldwell, Idaho

Boise, Idaho— WUBJ  
Robert Lambert ..... W7AYP ... Boise, Idaho. .... with set  
Marvin Johnston ..... W7ACP ... Parma, Idaho

Pocatello, Idaho— WUBK  
Waldo G. Hodson ..... W6DPO ... Provo, Utah. .... with set  
John Thatcher ..... W7AAJ ... Pocatello, Idaho



### BUY AT BEN'S

Buy your National SW3—AC OR DC, FB7A, FB7, FB7X, FB7XA, and all other National sets, kits, parts, and coils, for immediate delivery at BEN'S

'NATIONAL EQUIPMENT IS THE BEST IN EVERY TEST'  
Hoyt DC Peep Hole Meters, either 10V — 4 amp — 1.5 amps — 3 amps.....\$ .75

PILOT GANG CONDENSERS { Pilot 2 — Gang .000365 ..... \$1.00  
Pilot 3 — Gang .000365 ..... 1.60  
Pilot 4 — Gang .000365 ..... 1.90

GR Condensers .00025 . \$ .75 Wafer Sockets 4 and 5 . . . . . .05  
Hoyt 2" 75 Mill Meters . . . . . 2.50 4 Shortwave Plug-in Coils 1.45  
Mike Case Kits — Unptrd. .75 Billey BCX Crystals . . . . . 3.90  
30 Henry 80 Mill Chokes . . . . . .90 Billey BC2 Holders . . . . . 1.50  
1-Lb. Spool 31 SCC. . . . . 1.00 Bruno Microphone Con- denser Head Kit. . . . . 2.94  
990 and 1440 Honeycomb Coils, unmtd. . . . . 1.00 Velocity or Ribbon Kit. . . . . 5.88  
3 1/4" Porc. Spreaders . . . . . .10 Billey Crystals, Weston & Jewell RCA, Cunningham, Deforest, Billey Crystals, Weston & Jewell Meters, National Company Equipment and all ARRL Books. Write for Ben's Special Prices. Amateurs and Experimenters, send for our Special Discount Card. Surprise Package with every order. Mail Orders — Postage extra.

BEN'S RADIO, 228 Tremont Street, Boston, Mass

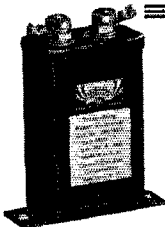

**1/6th Size**



with better  
**Operating Characteristics!**

Special impregnating compound and carefully selected materials spell C-D Pyranol Transmitting Condensers. Superior characteristics. Longer life. Conservative rating. Surprisingly compact. For example: 1 mfd. 1600 v. int. or 1000 v. con., D.C., only 1 1/4 x 1 x 2 1/4 in. Any capacity. All standard voltages.

Write for new 1933 Cornell-Dubilier Catalog describing the complete condenser line

**CORNELL-DUBILIER CORPORATION**

4377 Bronx Blvd. New York City



There IS Something New Under the Sun

IT'S THE

# PIEZO-ASTATIC Crystal Microphone

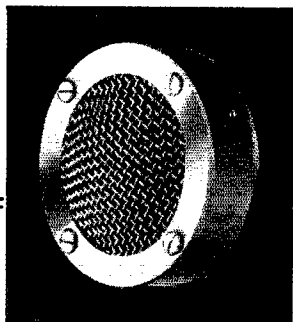

TYPE D-104

SUSPENSION OR  
STAND MOUNTING

LIST PRICE **\$17<sup>50</sup>**

See Your Dealer or Order Direct

A highly developed general purpose microphone ruggedly constructed having excellent frequency response. Cannot be overloaded acoustically. No adjustments required. No carbon rush or internal noise. No blasting or freezing; no button or field current; no polarizing voltage. Connects direct to grid or may be used with matching transformer. Chrome plated, 3" diameter, 1" thick, with 6 ft. shielded cord.

THE MOST PRACTICAL MICROPHONE EVER OFFERED

LICENSED UNDER BRUSH DEVELOPMENT CO. PATENTS

ASTATIC MICROPHONE LABORATORY, INC.  
YOUNGSTOWN, OHIO

## GULF RADIO SCHOOL

Radiotelegraphy

Radiotelephony

Radio Servicing

SECOND PORT } 1007 Carondelet Street  
U. S. A. } NEW ORLEANS, LA.

## GO-DEVIL

THE MECHANICAL FIST

The New Design Twin-Pivot  
Automatic Transmitting Key

A FEW FEATURES  
FOUND ONLY IN THE  
GO-DEVIL

Single or double ratio  
lever action doubles the in-  
tensity of the dots and makes  
operating a pleasure.

Eleven adjustments instead of  
half as many to eliminate difficult  
setting.

All contacts close squarely, regard-  
less of throw between them, thereby pro-  
longing their life, adding to the quality of  
your signals.

Ten to fifty words per minute with one single  
weight. Suitable for beginners or experienced operators.

Husky contacts, no higher priced model necessary for high voltage.

Simple stop is noiseless while operating.

Rugged fool-proof construction. 3 pound non-skid base.

Black crystallized base, all other parts brass, fibre handle.

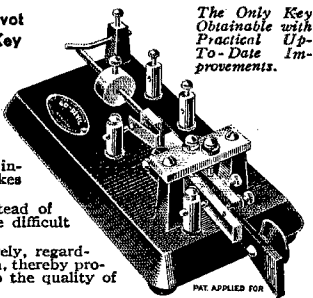

The Only Key  
Obtainable with  
Practical Up-  
To-Date Im-  
provements.

**\$6.00** VERY BEAUTIFUL APPEARANCE **\$6.00**

Absolutely guaranteed to be more than satisfactory

A. H. EMERY, 263 Mill St., Poughkeepsie, N. Y.

## OCTOCOILS WITH BYRD IN THE ANTARCTIC

Commander Byrd will use  
Octocoils at the South Pole  
because of their dependabil-  
ity. You should use Octo-  
coils, too.

Actual size of these coils is  
3 $\frac{5}{8}$  inches high and 1 $\frac{7}{8}$   
inches in diameter.

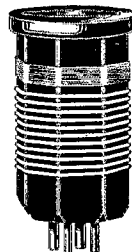

29 to 58  
Meters

Octocoils are moulded in genuine bakelite in  
four distinctive colors, green, brown, blue and red,  
and are wound with Nos. 12, 14, 16 and 25 en-  
ameled wire. They plug into the ordinary tube  
socket and have a rugged rim to grasp coils so they  
will not break.

Wave length range, 16 to 225 meters.

These coils will also cover the 10 to 80 meter  
amateur band if used with .00005 mfd. Midget  
Condenser.

Price, per set of 4, \$2.25

Broadcast coil also furnished, price, \$.75

Short Wave and Television Corporation

70 Brookline Avenue

Boston, Mass.

Division of General Electronics Corporation

## A COMPLETE

High-grade Amateur  
SUPERHETERODYNE

at the modest

price of

**\$42.**

plus \$2.10  
Federal tax

including a  
**DYNAMIC  
SPEAKER** in  
attractive metal  
cabinet.

A SUPERHETERODYNE  
RECEIVER WHICH PRO-  
VIDES INSTANT SWITCH-  
ING BETWEEN TWO PRE-DETERMINED BANDS  
DOES NOT USE PLUG-IN COILS

It employs two 2A7's, two 58's, one 47 and one 80 tube. These provide two stages of high gain high selectivity I.F. amplification—a C.W. beat oscillator and ample audio output for the dynamic speaker.

The receiver, with a built-in power supply, and the speaker are housed in metal cabinets having an attractive crinkle lacquer finish.

A description of the original of these receivers appeared in QST, August, 1933, Page 12.

**A. H. ROSS & COMPANY**

5839 Germantown Ave.

Philadelphia, Pa.

# FERRANTI

"The Standard of Quality"

WRITE FOR OUR 1934 CATALOGUE

STANDARD — Input, Interstage, Output, Microphone, Mixing and Class B Transformers.

SPECIAL — Transformers, Chokes, Inductors, etc. engineered and designed to suit your requirements on particularly short notice.

WE BUILD — Anything with an iron core where **QUALITY** and **SERVICE** are essential.

Let us quote on your requirements, large or small, without obligation.

**FERRANTI, INC.**

130 WEST 42 ST., NEW YORK CITY

Missoula, Montana— WUBL  
C. R. Miller.....W6DPJ.....Provo, Utah.....with set  
Arlie Madsen.....W6APM.....Provo, Utah

The above account covers the establishment of the net in May. Since that time expansion has occurred. Similar accounts of the C. C. C.-Amateur activities in the other eight corps areas could be given. But in each case the situation would be the same in one particular, namely, that the amateur is meeting the emergency and proving his value to his country. Any list of total stations operated by amateurs in connection with C. C. C. activities would soon be out of date as the number continues to increase, for not only is the government installing more stations, but more individual amateurs are coming on the air. Some took their outfits along with them, and others who are at camp are getting in outfits to operate while there.

## A Practical Crystal-Controlled Portable

(Continued from page 80)

the center-tap of the 10's and is kept open after the plate transformer is started up to permit the filaments to reach operating temperature. Although the filter consists of but a single condenser d.c. reports are invariably received.

The antenna used with the set is a portable Zepp, 67 feet long, with 15 foot feeders, also tuned with a 23-plate midget condenser. Occasionally a 67-foot end-fed wire is used instead. The antenna usually is dropped outside the hotel windows.

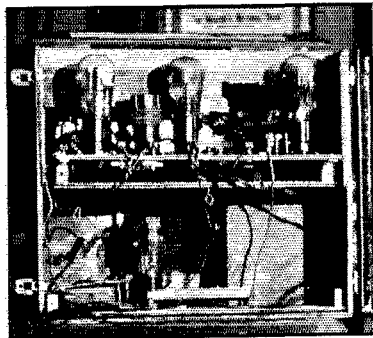

AN INSIDE VIEW

Oscillator at the left, doubler in the center, and final amplifier at the right. All the tuning condensers are midgets, and the coils for the oscillator and doubler stages are wound on tube bases.

The receiver is practically a duplicate of the one described by W9CH in August, 1931, QST — incidentally a very popular outfit by all accounts — using a pair of Type 30 tubes. Signals from all continents have been heard frequently.

As an example of what can be done with a portable station of moderate power, W9ZZAF has QSO'd VK, ZL, CM, X, EAR, LU, K5, K6 and K7 stations from various temporary locations, proving that the operation of a portable station is entirely practical providing the transmitter is stable and has a moderate amount of power output.

# HINTS AND KINKS FOR THE RADIO AMATEUR

(No. 10 in the A.R.R.L. series entitled *The Radio Amateur's Library*)

Amateurs are noted for their ingenuity in rather than buy new equipment. This overcoming by clever means the minor book is a compilation of hundreds of and major obstacles they meet in their pursuit of their chosen hobby. An amateur must be resourceful and a good tinkerer. He must be able to make a small amount of money do a great deal for him. He must frequently be able to utilize the contents of the junk box

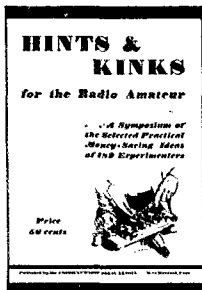

good ideas which amateurs have found helpful. It will return its cost many times in money savings — and it will save hours of time. Why try to figure these things out for yourself? You might just as well profit by the experience of others. Order your copy today.

PRICE

80 pages in attractive paper covers. **50** (no stamps, please), postpaid anywhere

CENTS

AMERICAN RADIO RELAY LEAGUE, INC., WEST HARTFORD, CONN.

## LEARN RADIO

Fall Term begins September 11. Send for 40-page catalog, explains fully. 180 licensed graduates placed in past 2½ years in broadcasting, shipping, police radio, aviation, etc. We teach all branches. Oldest, largest and best equipped school in New England. Equipped with Western Electric sound and broadcasting equipment and RCA marine transmitter. Course prepares for United States Government telegraph or telephone license.

MASS. RADIO SCHOOL, 18 Boylston Street, BOSTON

There is **NO DEPRESSION** in the activities of the transmitter protected by a **SENTINEL MAGNETIC OVERLOAD BREAKER**. Most efficient, lowest priced instantaneous automatic protective device on the market. Model A 50 to 400 m.a. Model B 100 to 800 m.a. Either \$5.85 plus 3 lbs. postage. Cash or C.O.D.

Write for free circular  
DON. H. MIX & CO. Box 403, Bristol, Conn.

## We've taken the "bugs" out of TRANSPOSITION INSULATORS



These two views show the unique shape of our new No. 31 Transposition Insulator. It eliminates sharp kinks in the wires, reducing strain on leads and insulators. Skeleton shape for light weight and greater insulation. Easiest to install, and glazed



all over. Use them in transmitting and receiving antennas.

List price **20c**

A new midget Airplane Type Strain Insulator!

List price **10c**



At most good jobbers—usual discounts. Bulletin 933 FREE, describing these and numerous other JOHNSON products.

E. F. JOHNSON CO., Waseca, Minn.

Be an Expert Radio Operator



Learn at Home  
*It's Easy*

with The New  
**MASTER**

**Teleplex**

Records and Repeats Your Own Sending

TELEPLEX trains you quickly at home. No experience necessary. We furnish Complete Code Course and lend you the New Master Teleplex. Realize the advantage and success that comes with being an **EXPERT OPERATOR** — capable of filling the highest-paid jobs. Daily practice with TELEPLEX develops amazing speed in short time. Teaches both sending and receiving. Makes everything simple and clear. Personal instruction. Teleplex has instructed more students in code during past ten years than all other systems combined. Used by U. S. Army and Navy, R. C. A., A. T. & T. Co. and principal schools. Whether beginner or operator lose no time in getting started with TELEPLEX. Others are doing it — why not you? Get started NOW! Easy terms. Write to-day for folder Q-11 giving full details.

**TELEPLEX COMPANY**  
76 Cortlandt Street  
New York, N. Y.

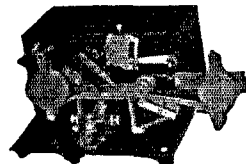

# FIXED

better with ...

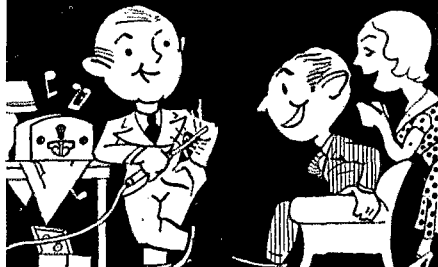

## Centralab FIXED RESISTORS



More and more servicemen are being "wised up" to the fact that they can do a better job with CENTRALAB Fixed Resistors.

For these sturdy, dependable resistors will stand up under strains and abuses that would make the average resistor give up and quit.

CENTRAL RADIO LABORATORIES  
MILWAUKEE, WISCONSIN

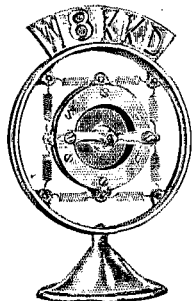

Model 8

A NEW DEAL  
in Microphone Values

\$20.00 DOUBLE  
BUTTON  
MICROPHONE



At Our Introductory Price

Postpaid on receipt of remittance  
or C.O.D. plus postage and charges

\$5.95

Model 8 is Lifetime's newest contribution to an unbeatable value for Amateurs and public Address Men.

A beautifully chrome plated microphone of 3 1/4" diameter — 1 1/4" thick overall — having a stretched duralumin gold spotted diaphragm — gold contact buttons 200 ohms each — a frequency of between 40 and 5,000 giving remarkable reproduction of voice and music.

Unconditionally guaranteed to more than please you!  
A handsome chrome plated stand to match — with your call letters if desired at only ..... \$1.95  
Matching transformer—shielded \$1.45—unshielded 95c.  
8 Feet 3 conductor cable..... 45c  
Write for our literature of Electro-dynamic speakers, aluminum trumpets, etc. at the lowest prices in America.

The LIFETIME CORP. 1302 DORR ST.  
TOLEDO, OHIO

## Speech-Amplifier Economy With a 2A5

(Continued from page 18)

manner, with no thought given to treating the outfit with any favors that it was not accustomed to getting. The results were all that could be asked for—and to our surprise we discovered that less vocal effort was expended on the mike to make the 841's do their part. In other words, the revamped system contained two less tubes, one stage and its transformer, but still produced the same amount of power. The next step was to get reports from stations worked consistently. Again, we were pleased to find that we had "never been any better." The quality apparently had not suffered enough to be noticed.

It must not be forgotten that this is not an engineering report and that the more technically-minded probably will find more faults than fine points, but it works well, is simple, eliminates one stage—and the description takes up less room on the QSL.

## A Simplified Five-Band Exciter Unit

(Continued from page 14)

courage crystal heating. Since the second harmonic of the oscillator ordinarily is the most useful, it has been judged best in this particular exciter unit to employ the screen voltage which gives maximum second-harmonic output and least r.f. voltage on the crystal. That this is successful is proved by the fact that a neon bulb touched to the oscillator grid shows less glow when used in the tri tet circuit than when the oscillator is converted to the tetrode circuit—far less than the glow that would be gotten at the grid of a triode crystal oscillator at the same plate voltage. After long operation the crystal shows no appreciable rise in temperature, and there is, for practical purposes, no frequency creep.

Too much stress cannot be laid on the importance of correct screen voltage in the operation of Type 59 tubes not only as oscillators, but also as amplifiers. These tubes, in common with all other small power-tubes having oxide-coated cathodes, often will be unstable if operated continuously at 400 volts or more. The grid loses its bias, takes on a positive potential, and the plate current starts to climb. When the all-too-familiar danger signal of climbing plate current appears there is nothing to be done except to shut off the set and let the tube get cold again. Too much of this sort of treatment will cause the cathode to lose its emission.

The screen-grid—by screen grid we mean the Nos. 2 and 3 grids tied together—in the 59 can be used to make the tube immune from this sort of ailment. Usually the "blocking" results when the plate current is higher than it should be—when the tube is working inefficiently and therefore



# Quality is of first importance

IN THE MANUFACTURE

of

**BLILEY  
CRYSTALS**



**M**EN whose skill and training qualify them for the most accurate workmanship . . . a plant and its equipment ideally suited to specialty manufacture . . . hours and pay in strict keeping with the spirit and letter of the N R A . . . and the use of Brazilian quartz as the accepted standard for finest crystals—the it is the co-ordination of these vital factors in manufacture which make Bliley Crystals of the highest quality.

● Increased demand and production enable us to sell Bliley Crystals at the lowest possible price consistent with their fine quality. They are sold only by dependable distributors of amateur radio equipment.

Write for name of your nearest distributor

**BLILEY  
PIEZO-ELECTRIC CO.**

227 Union Station Bldg.

Erie, Pa.

Special Crystals also manufactured between 20 Kcs and 15 Mcs

Type	Mc Band	Supplied	Pre- cision	Fur- nished	Price
BCX	1.7, 3.5	±25Kc*	0.05%	Unmtd.	\$3.90
BCX	7.0	±50Kc*	0.05%	Unmtd.	3.90
BC3	1.7, 3.5, 7	±25Kc*	0.03%	Mtd.	4.95
BC3	1.7, 3.5, 7	±5Kc	0.03%	Mtd.	5.75
BC3	1.7, 3.5, 7	±0.5Kc	0.03%	Mtd.	6.85
BC3	14.0	±50Kc	0.03%	Mtd.	9.85
BC2	7.0	Special mount. for 7Mc BCX			1.50
BC2	1.7, 3.5	Standard mount. for BCX			1.50
SSF	465, 500, or 525 Kc S.S. Qtz filter, Mtd.				5.90

\* Or your choice from distributor's stock.

## LOW RANGE FUSES

- Littelfuses for Instruments: Amps.: 1/100, 1/32, 1/16—20c ea. 1/8, 1/4, 3/8, 1/2—15c ea. 1, 2—10c ea. For milliammeters, ham rectifiers, etc. Use 1/8 for radio B circuits. High Voltage
- Littelfuses: 1000, 5000, 10,000 volt ranges in 1/16, 1/8, 1/4, 3/8, 1/2, 3/4, 1, 2 amp. Renewable. Price 35c to \$1.25 ea.
- NOW—\$100 PROTECTION GUARANTY. Get New Cat. \*5.

LITTELFUSE LABS.

1784 Wilson Ave., Chicago

*"Quicker than a Short circuit"* **LITTELFUSES**

## TRANSMITTER COIL WINDING

*Without Figuring!*

A NEW book of charts by Edward M. Shiepe, B.S., M.E.E., Massachusetts Institute of Technology, dispenses with all computation. Knowing frequency and capacity, the required inductance is read from one chart, the number of turns to attain that inductance from one of the other charts. All popular wire sizes and winding diameters. Accuracy 1 per cent.

Not only are the amateur frequencies covered but also all radio frequencies, from audio frequencies to ultra-high frequencies!

Sent prepaid on receipt of \$2.00

### UNIVERSAL TEST OSCILLATOR

The Bernard Modulated Test Oscillator, in a steel cabinet, with superimposed bakelite panel, gives direct reading of frequencies for broadcast band and commercial intermediate frequencies, and can be used for short waves by harmonics. Constantly modulated. Works on 90-120 volts, a.c., d.c. or B batteries. Instruction sheet furnished. Shipping weight, 5 lbs. Sent express collect on receipt of \$6.50 (30 tube included).

**HERMAN BERNARD**

135-Q Liberty Street

New York, N. Y.

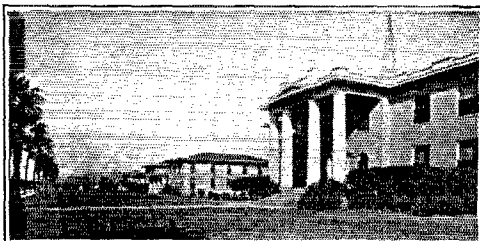

In 3 to 7 months we train you to secure Amateur, Commercial Telegraph Second-class, and Radiotelephone First-class government licenses. Course consists of Wireless Code, Radiophone, Microphone-Studio Technique, Television, Service, Police, and Aeronautical Radio. We are authorized to teach RCA Institutes, Inc., texts. At completion of your course you receive practical studio technique experience in broadcast studios located in our administration building, and operating experience on KFDM (1000-Watt W. E. Commercial Broadcast Station), and WPA, 4000-Watt Commercial Wireless Station. Return coupon for details.

Name .....

Street or Box .....

City and State .....

**PORT ARTHUR COLLEGE**  
PORT ARTHUR, TEXAS

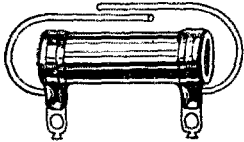

## Ten Watts of RESISTOR PERFECTION

**A** WIRE-WOUND, vitreous-enameled ten-watt that is compact, beautifully made, long-lived and remains constant in resistance value.

The price is so low there is no longer any excuse for using non-wire-wound resistors of low wattage, when you can have the extra safety factor without extra cost.

The electrical industry has recognized vitreous enameling as the finest type of insulation for more than fifty years.

Monel Metal contact bands and lugs resist oxidation and eliminate expansion strains. Equipped also with pigtailed.

Same type made in three sizes, three ratings and 67 values.

Write Dept. Q-11 for FREE General Catalog and Vest-Pocket Volume Control Guide

175 Varick St., New York, N.Y.  
**ELECTRAD**

runs hot. In the 59, the screen voltage can be used to control the plate current to a considerable extent. The effect of screen voltage on the output is not very marked except when the voltage is very low; investigation has shown that "saturation" takes place at about 150 volts, a further increase in screen voltage producing no increase—in fact, in many cases, resulting in a reduction—in output. In this respect it is very similar to a genuine screen-grid power tube, to which it corresponds, even though its screening is not complete. For all-around operation, the optimum screen voltage is about 125 volts when the tube is used as an ordinary amplifier or doubler.

### HIGHER PLATE VOLTAGE

If the screen voltage is maintained at about 125 volts, the plate voltage can be raised considerably with little danger to the tube. In fact, "blocking" and the disastrously-high plate currents resulting can nearly always be traced to too-high screen voltage and its corollary, too-high plate current. Some ten Type 59 tubes of different makes were tried in the doubler position of the exciter unit pictured, operating with 125 volts on the screen and between 500 and 600 volts on the plate, and all of them were perfectly stable with plate currents of 35 to 40 milliamperes on 14 megacycles—running continuously over periods far in excess of the time ordinarily occupied by normal transmissions. As a result of this, we are of the opinion that it is possible to operate the tubes at 600 volts, providing the screen voltage is less than 150 and the plate current is not more than 40 milliamperes. This hardly puts the tube in the high-power class, but at least an input of 24 watts is enough for a stage driving a medium-power tube, providing the efficiency is reasonable. At any rate, it is far enough beyond the ordinary rating on the tube to make it worth while for that type of ham who thinks of tubes only in terms of how much overload they will take.

For ordinary work—14 mc. and lower—there seems to be no advantage in using more than 125 volts on the screen of the doubler; raising the screen voltage increases the plate current but does not affect the output, except that if the screen voltage goes too high the output decreases. When doubling to 28 mc., slightly greater output can be secured by using 150 volts on the screen.

### OUTPUT

The measured outputs of the doubler operated as previously described are as follows: 1.75 and 3.5 mc., 3.5 watts; 7 mc., 8 watts; 14 mc., 5 watts. The corresponding inputs are 9, 16 and 20 watts, respectively. The output figures are conservative. The reason for the lower output on 1.75 and 3.5 mc. lies in the coupling method adopted to avoid neutralization; the excitation is lower on these two bands so that neither the input nor output are as high as on 7 and 14 mc. These amounts of power are quite sufficient to excite a pair of 10's or one of the newer intermediate-power tubes; they are, in fact, quite enough to excite a tube of the

# BEGINNERS! OPERATORS!!

Over 45,000 of World's Best Operators say there is Nothing like

## CANDLER TRAINING

If you want to learn to do balanced work and copy behind at 30 to 45 wpm — write Candler. The Candler High Speed Method of Radio Telegraphing trains your brain, muscles and nerves to co-ordinate in doing fast work easily and accurately. It is the only scientific method of telegraphing and is recommended by more than 45,000 successful Radio and Morse Operators whom it has developed.

Telegraph Touch Typewriting — only method especially for operators. Trains you to use mill in receiving.

Beginners who want to learn code easily and quickly need Junior Course. Save three-fourths of your time and more than half of the cost. FREE ADVICE. Beginners and others. If you want to become a fast and capable operator — write Candler. Get the benefit of his 20 years' experience in developing experts. Your questions answered promptly and personally. No obligation.

Two Candler students do remarkable receiving feats at World's Fair Code Contest. Jean Hudson, W3BAR, 9 years old, wins championship in Class "E." McElroy, inactive as operator for 11 years, copies 57 wpm in Class "A," beating his former record of 56 1/4 wpm.



Walter H. Candler  
President  
CANDLER  
SYSTEM CO.  
6343 S. Kedzie  
Ave., Dept. 57  
Chicago

答告白時寫QST有助QST業知汝

**NOW AVAILABLE!** . . . *A NEW*

# How to Become a Radio Amateur

(No. 8 in the A.R.R.L. series entitled *The Radio Amateur's Library*)

completely done over in 1934 style  
telling all about amateur radio  
describing the latest equipment

- push-pull transmitter
- bandspread pentode receiver
- simplest of monitors

giving modern operating instructions

The third edition of "How to Become a Radio Amateur" marks another milestone in amateur development.

Still the standard elementary guide for the would-be amateur, the simple, inexpensive station described incorporates features which in the past have been confined to the more advanced layouts. The designs have been made flexible, so that parts out of the junk box can be readily substituted. The performance of the completed station is such that any amateur can own and operate it with satisfaction and pleasure. It's a real amateur station, with construction and operation described in clear, understandable language. References to sources of detailed information on licensing procedure are given, as well as a highly absorbing narrative account of just what amateur radio is and does.

25c (no stamps, please) postpaid anywhere

**THE AMERICAN RADIO  
RELAY LEAGUE, INC.**

**WEST HARTFORD, CONNECTICUT**

## RADIO ENGINEERING

RCA Institutes offers a combined course of high standard embracing all phases of Radio. Practical training with modern equipment at New York and Chicago schools. Also specialized courses and Home Study Courses under new "No obligation" plan. Illustrated catalog on request

**RCA INSTITUTES, INC. Dept. ST-11**  
75 Varick St., New York. 1154 Merchandise Mart, Chicago  
Recognized Standard in Radio Instruction Since 1909



### PANELS — BAKELITE — RUBBER — ALUMINUM All Sizes Cut to Order BAKELITE TUBING & RODS

Drilling, Engraving & Special Work  
ALUMINUM CANS — Stock sizes. Special sizes, made to order.  
ALUMINUM CHASSIS — Threaded brass studs for 6/32 screws.  
Length from 1/2" to 6" — price 5c to 30c.

Insulating bushings  
for all size shafts  
75c to \$1.90 per dozen



Couplings in  
brass or bakelite  
—15c



Mail orders filled same day.

Transmitting frames and racks.

**United Radio Mfg. Co., Est. 1923, 191 Greenwich St., New York**

## PRECISION CRYSTALS

for accurate frequency control



Crystal Holder

PRECISION crystals are of the highest quality obtainable. They give more power output and better frequency control. X cut, accurately ground to oscillate on a single frequency at maximum power output and thoroughly tested. They are accurately calibrated and will be supplied to your specified frequency in the 1750 or 3500 kc. band—\$3.90 each. 7000 kc.—\$4.75. Furnished complete with bakelite, plug-in holder—1750 or 3500 kc.—\$4.50. 7000 kc.—\$5.50. G.R. jacks to plug holder into—15c per pair. Crystals and ovens for commercial use quoted on at your request. When ordering a PRECISION crystal you are assured of the best obtainable. Your satisfaction guaranteed. Now in our 5th year of business.

### PRECISION PIEZO SERVICE

427 ASIA STREET

BATON ROUGE, LA.

## MID-WEST SPECIAL BARGAINS

Distributors for All Nationally Known Parts

THORDARSON — 2 1/2V at 10 A. 7 1/2V at 1 1/4V. 1200-Volt insulation. Limited quantity. . . . . \$1.95

THORDARSON — T1998 — 30 H-200 Mill Choke. 2200-Volt insulation. . . . . \$1.50

THORDARSON — T3956-A 2H-200 Mill Input or key thump filter choke. . . . . \$1.95

THORDARSON — 210 Power Transformer. Two 7 1/2-Volt at 2 1/2 amp. windings. One 3 volts at 7 amps. 1100 Volts CT at 140 mills. . . . . \$1.95  
150 mill 30H Choke for that intermediate power supply. . . . . \$1.95

POTTER — 2mfd. 600-volt condensers in metal can. . . . \$1.49

MERSON Electrolytic Filter Condensers —  
400V DC 7 and 8 mfd. upright and inverted. . . . . \$2.99  
400V DC 16 mfd. . . . . \$4.99

FULL LINE OF NATIONAL SETS AND PARTS  
ALWAYS IN STOCK

Write for our free special Bulletin  
Your order shipped the day it is received

## MID-WEST RADIO MART

Builders of W9USA

520 South State Street

CHICAGO, ILLINOIS

# QST OSCILLATING CRYSTALS

"Superior by  
Comparison"

NEW LOW PRICES

NOTE: These NEW LOW PRICES will be in effect up to November first, 1933. At any time after that date, we reserve the right to increase prices without notice.

SCIENTIFIC RADIO SERVICE CRYSTALS are now available to Amateurs at the LOWEST PRICE IN THEIR HISTORY. Crystals ground to within FIVE KILOCYCLES of your specified frequency in either 80 or 160 meter bands \$10.00 each. Mounted in our Standard Holder \$5.00 additional. Accurate calibration with each crystal.

## BROADCAST AND COMMERCIAL SHORT WAVE BANDS

BROADCAST BAND CRYSTALS mounted and ground to our usual high degree of accuracy now \$35.00 each. Other bands similarly reduced. Prices quoted upon application. Usual prompt deliveries.

## SCIENTIFIC RADIO SERVICE

"The Crystal Specialists"  
124 Jackson Avenue, University Park  
Hyattsville, Maryland



203-A type run at normal input (150 watts). There is hardly enough to handle an overloaded 100-watt tube efficiently, however, so a third stage would be desirable if one expects to excite a "100-watt" tube operating at 500 watts plate input.

For maximum carrier stability it is desirable to key the following amplifier stage, whatever its type, and allow both tubes in the exciter unit to run continuously. Several types of keying were tried in the doubler stage, but none proved to be entirely satisfactory. Those that left the oscillator frequency unaffected did not cut off the output completely, and vice versa. Since the tubes showed no signs of getting hot grids when operated continuously, it was deemed best to let them work that way and key the following amplifier.

The power output on the various bands is practically the same with either crystal or e.c. control. So, for that matter, is the note; both give characteristic "crystal" signals. The one defect of the e.c. oscillator is its susceptibility to mechanical vibration and jars and to body capacity. The latter could, of course, be obviated by shielding, but this elaboration is not necessary so long as the oscillator is kept at least a foot away from waving hands. On 28 mc., e.c. control with the oscillator grid on 7 mc. is preferable to 3.5-mc. crystal control because the output is higher; with the latter arrangement the 28 mc. output is rather low compared to the highly satisfactory outputs on the lower-frequency bands. There is enough, however, to excite a 10 or two.

## AMATEURS OF THE WEST

We carry in stock at all times all NATIONALLY ADVERTISED parts and kits of all STANDARD MANUFACTURERS for TRANSMITTING and RECEIVING

Prices are advancing  
Write for latest quotations

Amateur's Headquarters of the West

## RADIO SUPPLY CO.

H. A. Demarest, President  
912-14 So. Broadway Los Angeles, California  
(W&FBI located in building)

## Club Directory Available

A directory of the local amateur radio societies affiliated with the League, showing their times and places of meetings, is available to members upon request, enclosing three cent stamp, please. Address the Communications Manager. Traveling amateurs will find this list helpful in visiting other clubs.

## The New and Improved VELOCITY MICROPHONE KIT

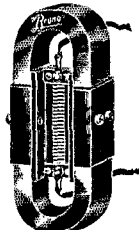

Excellent fidelity characteristics. Frequency response 30 to 14000 cycles per second. Not subject to variations with humidity and temperature. Substantially free from resonance peaks. Easy to assemble. \$5.88 Net not critical in adjustment.

### TRANSFORMERS TO MATCH

R. L. Ribbon to 200-500 ohm line \$4.41 Net  
R. G. Ribbon to Grid Ea.

L. G. 200 ohm Line to Grid  
Model R. V. 2-Velocity Microphone assembled with extra sensitive dural ribbon. Factory tested and guaranteed. \$11.76 Net

BRUNO LABORATORIES  
20 West 22nd Street NEW YORK

Send for this

## New METER BULLETIN

— all bargains —



Just issued, lists many types — all new meters — big selection: Ammeters, Radio Frequency Ammeters, Thermo-ammeters Volt-meters, Milliammeters, AC DC Universal Meters, D.B. Power Level Meters and Voltmeters, Volt-Ohm Milliammeter Circuits, Resistor Kits, Shunts, Resistors — every item a real bargain and guaranteed. Send postal now for free bulletin.

Universal Meter Works  
410 N. Leavitt St., Chicago, Ill.

# HAM-ADS

(1) Advertising shall pertain to radio and shall be of nature of interest to radio amateurs or experimenters in their pursuit of the art.  
 (2) No display of any character will be accepted, nor can any special typographical arrangement, such as all or part capital letters be used which would tend to make one advertisement stand out from the others.

(3) The Ham-Ad rate is 15¢ per word, except as noted in paragraph (6) below.

(4) Remittance in full must accompany copy. No cash or contract discount or agency commission will be allowed.

(5) Closing date for Ham-Ads is the 25th of the second month preceding publication date.

(6) A special rate of 7¢ per word will apply to advertising which, in our judgment, is obviously non-commercial in nature and is placed and signed by a member of the American Radio Relay League. Thus, advertising of bona fide surplus equipment owned, used and for sale by an individual or apparatus offered for exchange or advertising inquiring for special equipment, if by a member of the American Radio Relay League takes the 7¢ rate. An attempt to deal in apparatus in quantity for profit, even if by an individual, is commercial and takes the 15¢ rate. Provisions of paragraph (1), (2), (4) and (5) apply to all advertising in this column regardless of which rate may apply.

**Having made no investigation of the advertisers in the classified columns, the publishers of QST are unable to vouch for their integrity or for the grade or character of the products advertised.**

OVER six pounds radio data, circuits, bulletins, 50¢ postpaid. Beyond Rockies 75¢. Kladag, Kent, Ohio.

MICROPHONE and meter repairs. Low prices. Quick Service. Sound Engineering Corp., 416 N. Leavitt St., Chicago, Ill.

CALLBOOKS—new fall 1933 Radio Amateur Call Book with many new DX calls, several thousand more W calls than summer issue, is yours for \$1. Next four issues for \$3.25. WFO—610 S. Dearborn, Chicago.

NEW callbooks \$1. W9FO—610 S. Dearborn, Chicago.

FOR sale or trade. 2000 volt, half ampere double commutator motor-generator, excellent condition. Need mikes, dynamic speakers, converters. Bob Gleason, Van Wert, Ohio.

QSLs. Write for samples and prices. Box 116, Corwith, Iowa.

WANTED used but complete standard radio correspondence course. Lessons for serviceman. Quote. W1BEW.

\$38. takes a complete ten watt transmitter and a.c. receiver. DX guaranteed. W9DCN, Gladstone, Michigan.

GUARANTEED crystals, 95¢. Going strong. X-cut 40 meters, \$2. Blanks, 3¢ for \$1. Special prices on round crystals. White Radio Lab., Sandpoint, Idaho.

HAM supplies cheap. Joe's Exchange, W8GPA, Route 1, Johnstown, N. Y.

TWO complete stations sell, trade for car, camp-trailer, truck or most anything. Also have new receivers, crystals, tubes, etc. W9DOQ, Route One, Duluth, Minn.

HAVE 50 watt transmitter complete, meters, etc. Also include 100 watt motor-generator set. Wanted: Late model Ford. Meade, W2VE, 2937 Far Rockaway Blvd., Far Rockaway, N. Y.

QSLs! SWLs! World's finest! Be proud of your QSL card! Stamp for samples. W8DED, Holland, Mich.

VIBROPLEX, trade for SW3. W5BNT.

CRYSTALS: \$1.35 Hipower oscillators, close to your specified frequency, 35-1700 bands, 1 inch square. Round \$1.60. Exact calibration furnished. 7000-ko. band, \$4.25. 1" blanks, 65¢. Dust-proof plug-in holder with mountings, \$1. S. S. I. F. crystals 525-400-ko. your desired frequency set tested, mounted in air-gap holder, \$5.25. We have specialized in crystals for broadcast station use for five years. Our frequency standard is accurate to 1 cycle in five million. Immediate shipment, no delays, no waiting. Hipower Crystal Co., 3607 N. Luna Ave., Chicago, Ill.

TRANSMITTING and receiving equipment manufactured to order. Holmes C. Miller, Radio Engineer, Box 105, Palo Alto, California.

SWAP: Hardly used Remington. Noiseless portable typewriter, original ribbon. Cost \$65. Want: Motor-generator, transmitter, precision meters. Cuthright, 309 57th St., New York City.

TRADE: Practically new Underwood portable typewriter for FB7. Also Rectobulb for what have you? W5LW.

SELL xtal controlled transmitter, UV861, final stage. W2EGT.

RELAY racks, 60 inch, \$7.50, cans, panels, chassis. Write! Commercial Radio, Sycamore, Ill.

CABINETS—metal, chrome finish, 19x13x9 inches. Each \$1. six \$5. Cash in advance. Gates Radio & Supply Co., Quincy, Ill.

MARINE, broadcast, amateur, transmitters, radiophone, e.w. receivers, four to ten tubes. Frequency meters. Makers various apparatus. Also construction to order. Quotations on request. Enssall Radio Lab., 1527 Grandview St., S. E., Warren, Ohio.

SELL, Acremeter, A1 condition for best offer. W9DNJ. Details on request.

CRYSTALS: 1", approximate frequency, prompt service. Guaranteed, \$1.35. W9HWE.

SELL complete station: 150 watt xmtr, FB7, Electron coupled, power, etc. for best offer. Or trade for complete portable and cash. Maurice Ross, 1023 Hyde Park, Chicago, Ill.

WANTED: motor generators, 500 volts, 200 mills and 1000 volts, 300 mills motors to be 110 volts, 60 cycle. Name best cash price, condition and ratings. W3AAO, Wilbur E. Gemmill, 112 N. Queen St., York, Penn.

QSLs, 75¢ a 100, two colors. W9DGH, 1816 5th Ave., N., Minneapolis, Minn.

CRYSTALS, 95¢. 80 or 160 meters, or 525-kc. filter. Special prices on round plates, 40 meters, \$2. Fully guaranteed. White Radio Lab., Sandpoint, Idaho.

QSLs. Get our samples and prices before ordering. Maleco, 1512 Eastern Parkway, Brooklyn, N. Y.

QSLs, samples, prices. W2AEY, 338 Elmora, Elizabeth, N. J. CRYSTAL control Class B one with power supplies, \$46. Crystal control c.w. transmitter, \$15. W9KQO, Topeka, Kans.

CRYSTALS: Second to none—except in price. Husky, full-sized, single-frequency oscillators. Unconditionally guaranteed. Zero calibration error. Close to frequency 1750-4000 kilocycles \$2.51. 7000-7500 kilocycles \$4.01. Exact frequency 1750-4000 kilocycles \$3.01. Single-signal filters. X cut, excellent response, \$3.01. All postpaid by airmail. Immediate deliveries. 2400 sold. Smith-Precision, W6BCX.

RIBBON microphone with transformer. Bruno. Cheap. W6BCX.

QUALITY QSLs. T. Vachovetz, Elmsford, N. Y.

OMNIGRAPHs, Teleplexes, receivers, meters, Vibroplexes. Bought, sold, traded. Ryan Radio Co., Hannibal, Mo.

CRYSTALS: Guaranteed excellent oscillators, 160 or 80 meters, your approximate frequency \$1.35; no specified frequency \$1.00; Postpaid. "Crystal Maker's" blanks, 1" 65¢—dozen \$6.00; 3/4" 50¢—dozen \$4.80. Irregular shapes 25¢. Standard dust-proof plug-in Holders 75¢—dozen \$7.20. Fisher Laboratory, 1200 E. Nevada, El Paso, Texas.

WILL sell or trade brand new Teleplex complete with 3 tapes to the best offer. W8GOC, 11 Sherman Ave., Washington, Penna.

QSLs, modern, different. Samples? W8DDS, 2155 West 81st St., Cleveland.

TRANSFORMERS—1200-1000-750-0-750-1000-1200. 300 ma. Mica insulation, mounted, terminal board, \$6.75; 10V, 6 1/2 A, mica insulation, \$2. Spear Co., Waterville, Ohio.

CLASS A. Prime modulation equipment as built by Ross, finest quality, great driving power, inexpensive. Transformers, ready for all tube combinations. Ask your jobber, or write direct for bulletin and copy of general catalog. A. C. Ross Co., Van Wert, Ohio.

NEW Jewell milliammeters. Triple-range, 0 to 40-80-200. Also 0 to 50-100-250. Self contained instant-switch, beats plugs. Save money—buy one meter—not three. \$4. Engineering Service Company, 3720 A St., Lincoln, Nebr.

VIBROPLEXES bought, sold. Rebuilds \$7. up. Tradins accepted. Lydeard, 28 Circuit, Roxbury, Mass.

ADD \$1,000,000 to the appearance, performance, accessibility of your station. A relay rack gives it that prized-commercial touch. See September display, March hamad. Edison batteries. Rectifier Engineering Service.

WANTED: DeForest Audion Detector cabinet, 1913-1917 model, Clapp-Eastham tuner. C. Leonhardt, Norwalk, Ohio.

QSLs, SWLs, wall cards, etc. Satisfaction guaranteed. W3BHG.

QSLs, 50¢ per hundred. Samples. 2143 Indiana Ave., Columbus, Ohio.

QSLs, only \$1, 200 two colors, till code. W6FZQ, Box 1804, Phoenix, Ariz.

QUARTZ—Direct importers from Brazil of best quality pure quartz suitable for making piezoelectric crystals. Diamond Drill Carbon Co., 719 World Building, New York.

FOR sale: Complete broadcasting equipment including 50 watt transmitter. Wonderful outfit for shortwave. Sell reasonably. Write Box 215, Macon, Mo.

QSL stationery. Samples. W9ECI, R3, Clayton, Mo.

CRYSTALS, \$1.75. Blanks, 60¢. W9ECI.

NEW Ross amateur band superheterodyne, dynamic speaker, \$42, delivered (USA). Lowest prices on all ham equipment. L. I. Marine & Elec. Co., Laurel, N. Y.

QSLs, 2 colors, 75¢-100; \$1.50-300. Samples. W8BTP.

**RADIO BILL**—has some more real specials for you this month! Shoot in your order now! Tubes: Heavy duty 15 watt 210s, large plate, heavy filament—\$1.40; DeForest tubes: 410—\$1.29, 450—\$1.19, 46—\$9¢, 31—60¢, 32—76¢, 33—85¢, X99—35¢, 864—95¢, 481—\$1.15; New type heavy duty 866s, special—\$1.55; transformers: Thordarson power transformers, 600—0—600 at 200 mills, 7½¢, —\$3.75; Metal cased filament transformers, 2½ volts at 10 amperes to binding posts on bakelite panel, 110 volt primary to AC cord and plug, 2000 volt insulation, special—95¢; Special transformers, double bell cased, 7½ volt 4 amps—\$1.10, 5 volts at 3 amps—\$1.05, 10 volts at 4 amps—\$1.80, 2½ volts at 10 amps and 2½ at 4—\$1.60, 2½ at 12 amps—\$1.30; condensers: Faradon filter condensers, fibre case—2 mfd, 1000 volts DC working—55¢; 1 mfd, 1500 volts DC working—65¢; Aerovox—2 mfd 1500 and 4 mfd 1250 in single case—\$3.75; 600 volt by-pass block, containing six ¾ mfd condensers in metal case—special—42¢ each, 3 for \$1.10; Chokes: Heavy duty power chokes, 20 Henry 2500 mills, —\$2.85; Thordarson 20 Henry, 150 mill—\$1.20; Brunswick wax-dip 15 Henry 100 Mill—33¢; Jefferson 700 Henry plate coupling impedances—85¢; resistors: Hardwick-Hindle 20,000 ohm, 60 watts, with 4 taps,—45¢ each, two for 77¢; 100 watt (9"x1") bleeders, any size up to 25,000 ohms—\$1.25; any size from 25,000 to 100,000—\$1.40; same but with 6 sliding taps—add 40¢ to price; microphones: single button, 200 ohm, good response,—95¢; add 30¢ for small desk stand or suspension ring; See previous Ham-Ads for more bargains. Buy Now! Shoot your order in to—Bill Green, 698 West End Ave., NYC.

SELL two 204's, \$22.50 each. Trade for FB7 with 40 meter coils. W4MS, Pensacola, Fla.

IN stock: FB7As, \$34.20, FBXAs, \$47.70, coils \$5.88; SW3s, \$17.70, coils \$2.79; Comet Pros. \$88 complete. Trade your receiver on latest model. Guaranteed 866s, \$1.95; Bliley mounted crystals, \$4.95, 40-2% off all National, Hammarlund, Cardwell, Thordarson, Johnson, Universal. Teleplexes, Omnigraphs rented 75¢ week, \$10. deposit. All types RCA, WE tubes. Sell, trade used apparatus. Write. Henry's Radio Shop, W9ARA, Butler, Mo.

NEW condition Cardwell 166Bs, \$20. Heavy duty mesh filament 866s, \$2.50, 872s, \$7.50. New RCA UX250s, \$1.50. 1000 mill. Weston type 301s, \$3.75. Late production RCA 204As, \$30. 212Ds, \$15. 6000V oil condensers, 2.75mf. R1A. Class B transformers. Want Western carbon mikes in any condition. E. Ewing, 1057 Pratt Blvd., Chicago.

**CRYSTALS:** X cut, accurately and neatly finished, 1" sq. \$2. Oscillating blanks with comp., \$1. W8DLM, Rochester, Mich.

204A, \$28; 204, \$19; WE50, \$7; 212D, \$18; 600V PDC complete \$7. Want 8ML MA rectifier tube. W9CP.

**CLASS B transformers**—for 46's \$4.95 pair. Universal transformers for 2 or 4 46's, 210's, etc. \$7.75 pair. 70 watts of audio from 46's. Write for details. W8UD, Douglas, Mich. QSL's, 75¢ up. Samples. W6IID, 5462 Olive, Longbeach, Calif.

**TRANSMITTERS** built to order; Stamp for descriptions and lists of miscellaneous parts. Transformers—Silver-Marshall 866 filament \$2.85; plate and filament for 203A, \$3.50. Guaranteed tubes, 866, \$1.75; 210, \$1.50. Howard, 314 Pine Ave., Chicago.

**WANTED:** complete phone transmitter for 160 band. Also receiver. Either FB-7, Comet Pro, Silver or standard make. W9QLR, 218-20th S. E., Mason City, Iowa.

**FREE** bargain sheet sent upon request. Edbern Radio Co., 2156 Cruiger Ave., New York City.

**CRYSTALS**, guaranteed, 1750 to 2000, 3500 to 4000 kc. ¾ to 1", X or Y, within ten kilocycles \$2.00, 1", within five kilocycles \$2.50. Oscillating blanks, 1" \$1.50. 7000 to 7300 kc, ¾ to 1", within 20 kc, \$4.50. Plug-in holders, \$1.25. Grinding instructions 25¢. This month's extra special offer. One oscillating blank, one dust-proof plug-in holder, grinding compound and grinding instructions, all for \$2.75. Wm. Threm, W8FN, 4021 Davis Ave., Chevy, Ohio.

**FOR sale**—entire equipment of W9NQP, Manchester, Wisconsin. Estate must be settled. 50 watt xtal xmitter and several receivers. All A1 equipment.

A.C. generator, 120 W, 110V, 60. Constant voltage, variable speed. Drives from fan belt, fits any auto complete with V pulley less mounting bracket, \$22.50. F. O. B. Elmhurst. Write for complete list, broadcast transformers and constant velocity microphones. Air-Ad Sound, 417 Evergreen Ave., Elmhurst, Ill.

203As, \$9.75; new, first quality and guaranteed. Amateur Service, Ridgefield, N. J.

W8RD, Utica, Michigan offers for sale—modern 400 watt pure d.c. 100% modulated fone and c.w. transmitter. Special price if called for.

**GENERAL Electric** 24/1500 volt Dynamotors \$35; 24/750 volt \$25. Westinghouse 27½/350 volt \$10. Mounted pair \$15. 6-15 volt 500 watt Aircraft with propeller \$10. 500 cycle 500 watt with exciter 110-220 volts \$7.50. Dynamotors give pure DC outputs. Perfect results from battery plants. Henry Kienzle, 501 East 84th Street, New York.

**WOODWORK.** Rack and panels with highest grade furniture finish. Years experience. Specializing in panels for transmitters. Cut and drilled to your specifications. Prices reasonable. Prompt quotations. W4CJH, Hickory, N. C.

QSL cards, two color, cartoons, message blanks, stationery, snappy service. Write for free samples today. W1BEF, 16 Stockbridge Ave., Lowell, Mass.

QSLs—SWLs, W6DOU, Hayward, Calif.

BUM QSLs? You are the judge. Samples. W6DYL, Exchange, P. O. Box 607, El Monte, Calif.

SELLING meters cheap. W9ANZ.

## ALUMINUM BOX SHIELDS

"ALCOA" stock, silverdip finish, 5 x 9 x 6, \$1.65. 10 x 6 x 7, \$2.65. Any Size to Order. **SOMETHING NEW!** Your call letters, or any marking for your panel, on BLACK aluminum ribbon. Looks like engraving on bakelite. 5c each, sample, 8c.

Foil for condenser or section mike ¼ mil., 25¢ ft. 2½ MFI 4 velocity r.f. choke, 55¢. ¼ watt Neon lamp, 35¢.

New Master Teleplex on demonstration.



BLAN, the Radio Man, Inc. 177 Greenwich St. New York City

IMMEDIATE DELIVERY

## NEW RAYTHEON TUBES

RK18. Fifty watter ..... \$10.95

RK17. Screen grid electron coupled oscillator ..... \$5.00

New Silver RK18 power transformer for two RK18s, center tapped 2000 volt, 170 m.a. secondary, 7.5 volt, 3 ampa. filament supply ..... \$10.80

Silver 25 H, 175 m.a. type 1485 filter choke ..... \$3.90

Headquarters for New Raytheon Tubes, Hammarlund, National and Silver Parts and Sets

"ASK W2DB"

## HAYNES-GRIFFIN

373 Madison Avenue New York, N. Y.

## TRANSCIEVERS

On the Byrd Expedition! Five of these 5 meter transcievers are being taken to the Antarctic by the Byrd Expedition to furnish an important link between isolated parties. Ideal from the portable standpoint the weight of one unit is but 3½ pounds, its dimensions but 4½ x 5½ x 6 inches. Tubes used are one 30, one 33. One of these transcievers has worked over 50 miles with but 90 volts

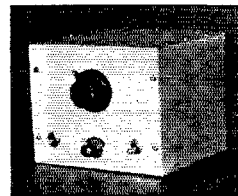

of plate battery. Completely enclosed in an attractive aluminum case, comes complete with instruction sheet, and circuit diagram. TRANSCIEVER, less tubes ..... \$19.50

Radio equipment for all frequencies custom built to QST or your own specifications

## HARVEY RADIO LABORATORIES

12 Boylston Street Brookline, Massachusetts

## CRYSTAL OSCILLATORS

X Cut Power-Type Super-Crystals



160 Meter Band within 5 Kcs. .... \$4.00  
160 Meter Band within 50 cycles ..... 4.50  
80 Meter Band within 10 Kcs. .... 4.00  
80 Meter Band within 100 cycles ..... 4.50  
Beautiful plug-in holder ..... 1.50  
Crystal mounted with frequency engraved on holder, add to cost ..... 1.00

We specialize in amateur band crystals . . . laboratory crystals for test oscillators . . . and "single signal receivers."

W8OK MURRILL & MURRILL W8EL

P. O. Box 298, Huntington, West Va.

# Your Nearest Dealer Is Your Best Friend

Your nearest dealer is entitled to your patronage. You can trust him. He is equipped with a knowledge and understanding of amateur radio. He is your logical and safe source of advice and counsel on what equipment you should buy. His stock is complete. He can supply your needs without delay. His prices are fair and consistent with the high quality of the goods he carries. He is responsible to you and interested in you.

Patronize the dealer nearest you — You can have confidence in him

<p><b>CHICAGO, ILLINOIS</b> Chicago Radio Apparatus Company 415 South Dearborn Street Dependable Radio Equipment Established 1921</p>	<p><b>NEW ORLEANS, LOUISIANA</b> Rose for Radio 129 Camp Street Complete stock quality radio parts</p>
<p><b>CHICAGO, ILLINOIS</b> Mid-West Radio Mart 520 S. State Street All standard lines carried in stock</p>	<p><b>PHILADELPHIA, PENNSYLVANIA</b> Eugene G. Wile 10 S. Tenth Street Complete Stock of Quality Merchandise</p>
<p><b>CLEVELAND, OHIO</b> Northern Ohio Laboratories 2073 West 85 Street Wholesale Distr. for National, Hammarlund, Thordarson, Cardwell</p>	<p><b>PITTSBURGH, PENNSYLVANIA</b> Cameradio Company 603 Grant Street Tri-State "Ham" Headquarters Standard Apparatus                      Standard Discounts</p>
<p><b>CLEVELAND, OHIO</b> Radio Servicemen's Supply Co. 206 Prospect Street Wholesale Distributors catering to Amateurs, Dealers, Servicemen</p>	<p><b>PROVIDENCE, RHODE ISLAND</b> W. H. Edwards &amp; Company 32 Broadway, Room 23 A full line of reliable Amateur Equipment &amp; Supplies</p>
<p><b>DENVER, COLORADO</b> Inter-State Radio &amp; Supply Co. 1639 Tremont Place Amateur Radio Headquarters in the Rocky Mountain Region</p>	<p><b>ST. LOUIS, MISSOURI</b> Walter Ashe Radio Company 1100 Pine Street W9FIS in charge of the oldest and largest parts store in St. Louis</p>
<p><b>DETROIT, MICHIGAN</b> Radio Specialties Company 171 E. Jefferson Avenue Ham Supplies — National &amp; Hammarlund Sets and Parts</p>	<p><b>ST. PAUL, MINNESOTA</b> Lew Bonn Company 2484 University Avenue Rex L. Munger, W9LIP, Sales Engineer Radio Wholesaler                      Complete Stock</p>
<p><b>HARTFORD, CONNECTICUT</b> Radio Inspection Service Company 227 Asylum Street Complete line of guaranteed parts</p>	<p><b>SAN FRANCISCO, CALIFORNIA</b> Offenbach Electric Company, Ltd. 1452 Market Street "The House of a Million Radio Parts"</p>
<p><b>KANSAS CITY, MISSOURI</b> Burstein-Applebee Company 1012-14 McGee Street "Specialists" in supplies for the Amateur and Serviceman</p>	<p><b>SPRINGFIELD, MASSACHUSETTS</b> T. F. Cushing 345 Worthington Street An amateur, endeavoring to sell good parts</p>
<p><b>KANSAS CITY, MISSOURI</b> Radio Laboratories 1515 Grand Avenue Amateur Headquarters — Complete Stock — Quality Parts</p>	<p><b>SYRACUSE, NEW YORK</b> Roy C. Stage, W8IGF Complete stock of standard Ham &amp; BCL parts Standard Discounts. Free technical service</p>
<p><b>MANCHESTER, NEW HAMPSHIRE</b> Radio Service Lab. of N. H. Amateur Supply Headquarters for New Hampshire Amateur discounts allowed</p>	<p><b>UTICA, NEW YORK</b> Vaeth Electric Company 701 Varick Street Wholesale Distributors of Radio Parts and Supplies</p>
<p><b>MILWAUKEE, WISCONSIN</b> Radio Parts Company, Inc. 332 West State Street Complete stock Nationally Known products</p>	
<p><b>NEWARK, NEW JERSEY</b> Kaltman &amp; Romander 62 Court Street Drop in for an over-counter QSO</p>	

This advertisement is paid for by the firms listed above. Qualified dealers are invited to apply for rates, etc., to Advertising Department, QST

Say You Saw It in QST — It Identifies You and Helps QST

# You Are Protected When You Buy From QST Advertisers

¶ "Advertising for QST is accepted only from firms who, in the publisher's opinion, are of established integrity and whose products secure the approval of the technical staff of the American Radio Relay League."

Quoted from QST's advertising rate card.

Every conceivable need of a radio amateur can be supplied by the advertisers in QST. And you will know the product has the approval of the League's technical staff.

● See Editorial April issue of QST

## For Your Convenience QST'S INDEX OF ADVERTISERS IN THIS ISSUE

Astatic Microphone Lab. ....	83
A.R.R.L. Application Blank .....	74
Binder .....	81
Bookshelf .....	77
Handbook .....	Cov. IV
"Hints and Kinks" .....	85
"How to Become a Radio Amateur" .....	89
"License Manual" .....	Cov. II
Supplies .....	79
Ben's Radio .....	82
Bernard, Herman .....	87
Blair, The Radio Man, Inc. ....	92
Bliley Piezo-Electric Co. ....	37
Bruno Labs. ....	90
Candler System Co. ....	88
Cardwell Mfg. Corp., Allen D. ....	95
Central Radio Labs. ....	86
Collins Radio Co. ....	96
Cornell-Dubilier Corp. ....	82
Delta Mfg. Co. ....	70
Electrad, Inc. ....	88
Emery, A. H. ....	83
Ferranti, Inc. ....	84
Fleron & Son, M. M. ....	81
General Radio Company .....	72
Gross Radio Company .....	6, 7
Gulf Radio School .....	83
Hammarlund Mfg. Co. ....	1
Harvey Radio Labs. ....	92
Haynes-Griffin .....	92
Hilet Engineering Co. ....	81
Hygrade Sylvania Corp. ....	4
Johnson Company, E. F. ....	85
Kaltman and Roimander .....	82
Leeds .....	68, 69
Lifetime Corp. ....	86
Littelfuse Labs. ....	87
M & H Sporting Goods Co. ....	78
Massachusetts Radio School .....	85
Mid-West Radio Mart .....	89
Mix & Co., Don H. ....	85
Murrill & Murrill .....	92
National Carbon Company .....	75
National Company, Inc. ....	67, 81, Cov. III
Port Arthur College .....	87
Precision Piezo Service .....	89
Radio Supply Company .....	90
Raytheon Production Corp. ....	73
RCA Institutes, Inc. ....	89
Ross & Co., A. H. ....	84
Schwartz & Son, Maurice .....	80
Scientific Radio Service .....	90
Shortwave & Television Corp. ....	83
Teleplex Company .....	85
United Radio Mfg. Co. ....	89
Universal Meter Works .....	90
Western Electric Co. ....	76
Westinghouse Elec. & Mfg. Co. ....	2
Weston Electrical Instrument Corp. ....	71
West Side Y.M.C.A. ....	80



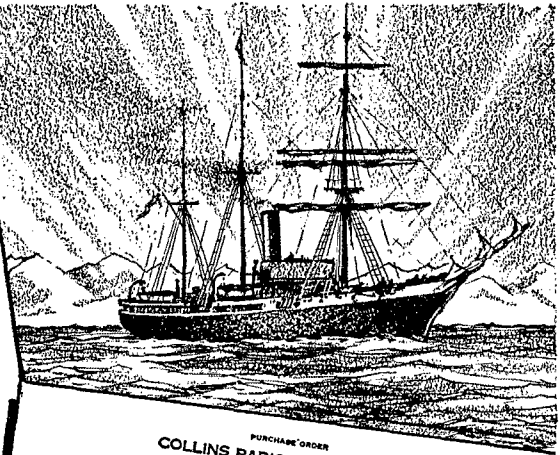

BYRD ANTARCTIC EXPEDITION II

ORDER BY DELIVERY OR  
PREPAYMENT TO BE MADE IN  
THE AMOUNT OF \$100.00

BE PLEASED TO FURNISH DATE  
OF THIS LETTER

BYRD ANTARCTIC EXPEDITION II  
U. S. NAVY YARD  
BOSTON, MASS.

Cardwell Equipment

Transmitting Condensers

- 4---T-183
- 4---164-B
- 4---T-189
- 1 design 16-B # 2578

Midway Condensers

- 2---413-B Transmitting
- 4---404-B Receiving
- 4---406-B

Taper plate

- 4---168E Receiving

PURCHASE ORDER

**COLLINS RADIO TRANSMITTERS**

CEDAR RAPIDS, IOWA

No. 1901

To: The Allen D. Cardwell Mfg. Co.  
81 Prospect St.  
Brooklyn, N. Y.

Date of Order July 25, 1938  
Date to Ship Delivery before Aug. 8, 1938.  
How to Ship

Please send the following goods:

Quantity	Number	Description	No. 1901
8	415 B	135 wfd. special midway	
1	162-3276	Condensers	
2		40 mafd. series capacity .296 inch spacing	
		each section on	
		Neutralizing condensers, suitable for use	
		with Federal P1004 tubes in pushpull	
		bulletin.	
		Ample safety factor should be provided.	
		Plate voltage will be 3000.	

# Trust in Providence

but keep your powder dry"

—Cromwell is reputed to have cautioned his mighty Roundheads.

Byrd sails for Antarctica; Ellsworth departed some weeks ago, each having unbounded faith in Providence but nevertheless prudently fortified against disaster by employment of the *most dependable* equipment procurable.

For the third time **CARDWELL** condensers go with Byrd on Polar ventures and, as they have gone many times before with other expeditions, they go now with Ellsworth.

**CARDWELLS** are good, honest condensers; no glitter, no gadgets but how efficient and dependable when the going gets tough and hope lies only in the radio and—Providence!

**COLLINS RADIO COMPANY**  
Designers and Manufacturers of  
Transmitters, Transformers and Speech Equipment

CEDAR RAPIDS, IOWA.

July 25, 1938

The Allen D. Cardwell Mfg. Corp.  
81 Prospect Street  
Brooklyn, New York

Gentlemen:

ATTENTION: Mr. R. L. Wrenhouse

We are building two 100-watt transmitters (Type 1908) and one 1000-watt transmitter (Type 2001) for the Byrd Antarctic Expedition II which plans to sail September 16.

As you know, we have been using Grinnell Condensers for the Expedition. Mr. T. S. McCalla, Communications Engineer of this equipment very carefully and he has heretofore approved or the use of Cardwell Condensers.

The enclosed purchase Order covers the special equipment which will be required, exclusive of what we already have in stock. We are again calling on your engineering department to assist us in building these special lines which, of course, will be routed on to stand up under very rigorous conditions.

Thanking you in advance for your valued assistance, we are

Yours very truly,

*Arthur D. Collins*  
Arthur D. Collins  
President

"THE STANDARD OF COMPARISON"

**THE ALLEN D. CARDWELL M'F'G. CORP.**  
83 PROSPECT STREET, BROOKLYN, N. Y.

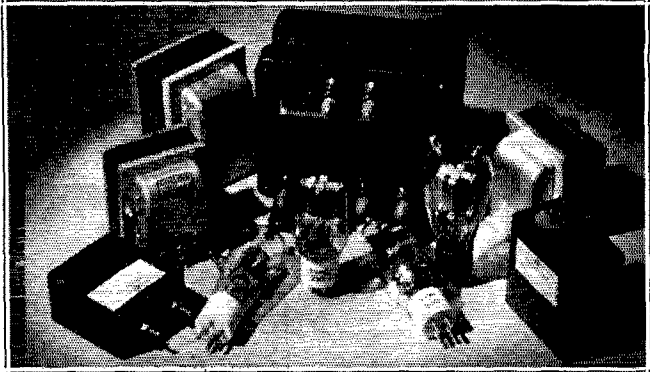

# POWER with the new tubes—

THE new "50-watt" tubes are the answer to the amateur's prayer for an overgrown 210 that will really "take it." To complete the picture, COLLINS announces modulation transformers and power transformers which are so skillfully designed that they can be used with any of the new tubes and also with old reliable, like the 46 and 203A. The new transformers are just as important as the tubes.

Sylvania 830, 210, 825  
RCA Victor 800  
Raytheon RK18

**MODULATION TRANSFORMERS:** The two Class B modulation transformers of a new heavy duty design can be used with either 46's, 59's, 210's, 800's, 830's or 18's. Special secondary connections permit a wide range of load impedances with high efficiency and fidelity.

No.	Output impedance range	Sec. D.C.	Wt.	Net Price
No. 781	3300-7000 ohms	.150A	6 lb.	\$6.00
No. 782	8000-14300 ohms	.085A	6 lb.	6.50

Class B input transformers are \$4.00 each. Specify tube arrangement when ordering.

**PLATE TRANSFORMERS:** Modern choke-input filters require correct secondary voltages. These new plate transformers are real brutes and the two sizes will handle anything from 210's to a 203A and will take care of the modulators as well as the Class C stage.

No.	Primary	Sec. Volts Rms. Each Side of Center	D.C. Volts from Filter (Choke Input)	D.C. Amps. from Filter		KVA.	Wt. Pounds	Net Price
				Continuous	Intermittent			
912	110V 60 cycle	620-740-929	500-603-750	.250	.350	.305	28	\$16.50
913	110V 60 cycle	900-1240-1500	750-1000-1250	.150	.210	.305	28	16.50

Both types are mounted in cast frames with pressed steel covers and porcelain insulated terminals

**FILAMENT TRANSFORMERS:** Some of the new tubes have 7½-volt filaments and some have 10-volt filaments. The 1032C will handle four 7½-volt tubes or four 830's or 203A's as well as two 866 rectifiers.

1032C Primary: 105v 60 cycle  
Secondaries: 7.5-10v, 12A, C.T.; 2.5v, 10A, C.T.

Insulation 5000 volts. Fully encased with insulated leads out base. Weight 9¼ pounds. Net Price \$6.50

**FILTER CHOKES:** The following chokes are companion pieces to the 912 and 913 transformers.

No.	L. hys.*	D.C. Amps.	D.C. Volts	R ohms	Ins.	Wt.
808	8	.300	750	100	1500v	9¼ lb.
809	20	.200	1250	250	2500v	9¼ lb.

\*Values of inductance shown are with air gap adjusted for smoothing. The gap is adjustable to obtain "swinging" inductance when used as input choke. Fully encased with insulated leads out base. Net Price both types \$5.50

**FILTER CONDENSERS:** Pyranol treated condensers are unexcelled for modern high voltage filters. They are compact, reliable and inexpensive.

No.	Capacity	Voltage Rating	Dimensions	Net Price
1801	6mf.	1000v	1¼" x 3¼" x 3¼"	\$4.50
1809	4mf.	2000v	2¼" x 3¼" x 4"	6.00

## GROUP 1. Use 781, 808, 912 transformers and chokes, 1801 condenser

	Nominal Carrier Output Watts	Class C Tube(s)	Class C Plate Voltage	Modulator Tubes	Modulator Plate Voltage	Required Modulator Power Watts	Modulation Impedance Ohms	Class C Plate Current Amps.	Modulator Plate Current Amps. (100%)	Total Plate Current on Modulation Peaks Amps.	RL Ohms	Tap
M	20	1-210	500	46's or 59's	400	20	6250	.080	.095	....	1750	(B)
N	25	2-46's	400	46's or 59's	400	24	3300	.120	.112	.232	1500	(A)
O	40	2-10's	500	210's	500	37.5	3300	.150	.140	.290	1500	(A)
P	55	1-830	750	210's	750	41	6800	.110	.130	.240	1900	(B)
Q	70	2-800's	750	800's or 830's	750	50	5350	.140	.126	.266	2440	(B)
R	76	2-18's	750	18's or 830's	750	64	4400	.170	.158	.328	2000	(A)

## GROUP 2. Use 782, 809, 913 transformers and chokes, 1809 condenser

	Nominal Carrier Output Watts	Class C Tube(s)	Class C Plate Voltage	Modulator Tubes	Modulator Plate Voltage	Required Modulator Power Watts	Modulation Impedance Ohms	Class C Plate Current Amps.	Modulator Plate Current Amps. (100%)	Total Plate Current on Modulation Peaks Amps.	RL Ohms	Tap
S	35	1-800	750	10's	750	26w	10700	.070	.091	.161	2460	(C)
T	35	1-800	750	46's	400	26w	10700	.070	.106	....	1820	(D)
U	38	1-18	750	10's	750	32w	8800	.085	.110	.195	2000	(C)
V	50	1-18	1000	18's	1000	43w	11800	.085	.130	.215	2000	(D)
W	50	1-800	1000	800's	1000	35w	14300	.070	.105	.175	2430	(D)

Order direct from this advertisement or from authorized COLLINS distributors

# COLLINS RADIO COMPANY, Cedar Rapids, Iowa

# WHEN NOTHING LESS WILL DO

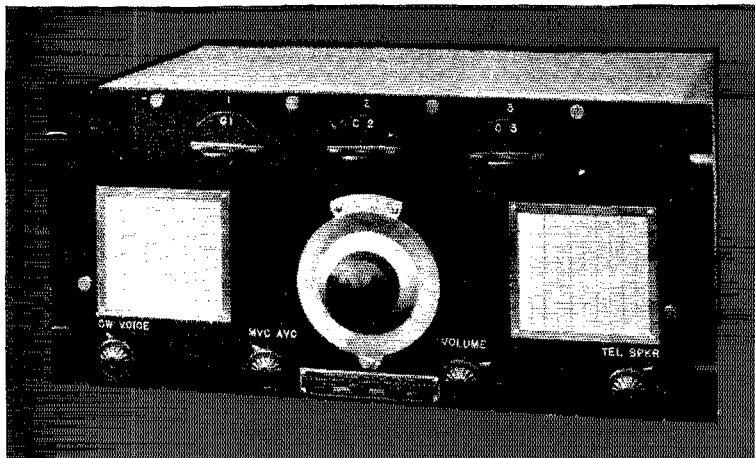

To the fortunate amateur who can select his station equipment without regard to cost, as well as to the commercial operator to whom nothing less than the best is adequate, to these the National AGS is an overwhelming choice. For in the evolution of this remarkable receiver, there has been no omission of even the slightest detail of design or of craftsmanship that the combined experience of National and Government Engineers showed desirable.

For the performance of the AGS is as unique as its convenience. Such details as Tuned R. F. Preselection — for high Image Suppression, Signal-to-Noise Ratio, and Weak Signal Response — and such conveniences as Automatic Volume Control and strictly Single Control Tuning are too universally valued to require comment on this page. But the equally important, and almost innumerable small refinements that make this receiver so outstanding, become obvious only upon actual operation under adverse conditions.

Whether a prospective customer or not, we cordially invite you to inspect the AGS at your dealers. And if you cannot conveniently do this we shall be glad to send a copy of our booklet "The National AGS Communications Type Short Wave Superheterodyne," containing fifteen pages of concise technical information on design and operation for high performance.

## Outstanding Features

Tuned R. F. stage preceding first detector. (Image suppression — improved signal-to-noise ratio — improved "weak signal" response.)

Electron coupled oscillators.

No frequency drift — air padded oscillators.

Air dielectric tuning condensers in I. F. amplifier.

Single dial straight frequency line tuning ( $270^\circ$ ).

Calibration curves and station chart on panel.

Coil change from front of panel.

Automatic volume control or manual volume control, by throw of switch.

Extremely rigid mechanical construction from very heavy aluminum plate.

Relay rack or table mounting (panel size  $8\frac{3}{4}'' \times 19''$ ).

Frequency range 1500 to 20,000 k. c. Band spread coils available.

Heterodyne oscillator for c. w. reception.

A. C. or battery operation.

Panel switch for phones or speaker.

Mechanical filter for single signal reception (in AGS-X).

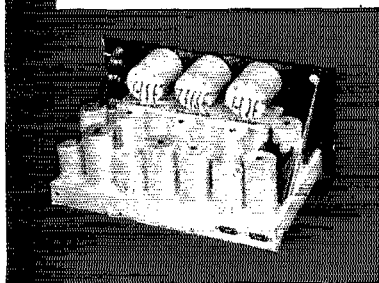

 NATIONAL COMPANY, INC., MALDEN, MASS.

