

QST

DEVOTED ENTIRELY TO

AMATEUR RADIO

PUBLISHED SINCE 1915 BY THE AMERICAN RADIO RELAY LEAGUE INC.

*Receiving Short-Wave Phones
on your Broadcast Receiver*

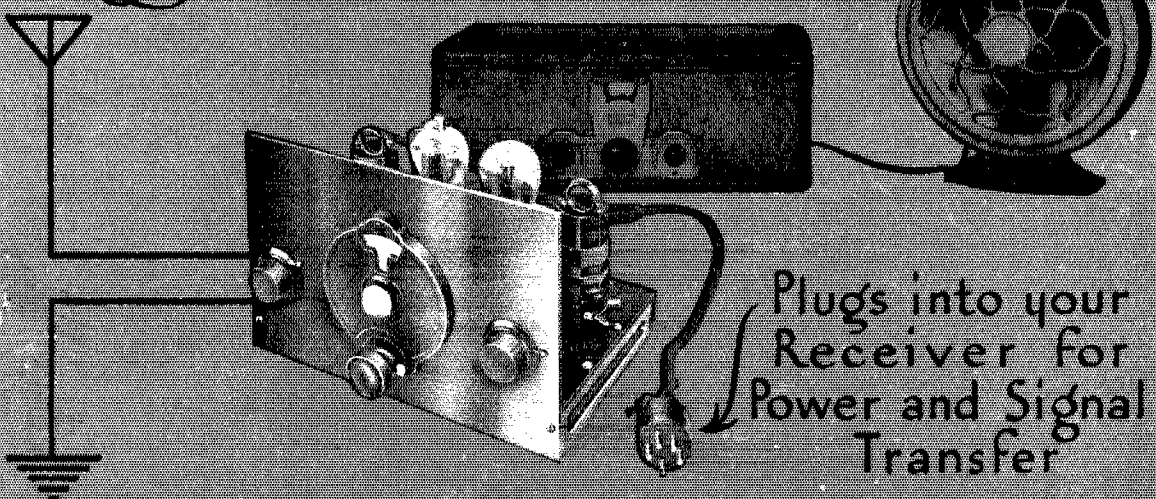

Plugs into your
Receiver for
Power and Signal
Transfer

JULY, 1930

25^c

The Radio Amateur's HANDBOOK

Sixth Edition

(Second Printing)

By HANDY and HULL

For Newcomers In The Game

THE Handbook is an eminently practical manual of amateur radio in all its phases, published by the American Radio Relay League, the amateur's own organization. It starts at the beginning and tells the whole story: What amateur radio is, How to be a radio amateur, How to obtain your licenses, How to build the simple apparatus of a simple station, How to build the best known equipment for the most modern station, How to operate your station. Enough information to keep you fascinated for five years.

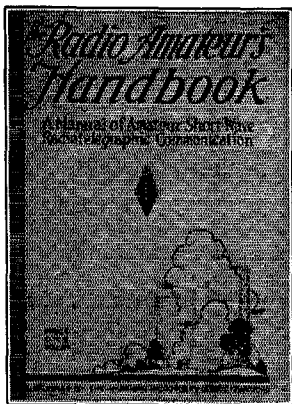

For Practical Amateurs

THE Handbook is the daily working guide of successful amateurs the world over. Technical and operating matters treated in every form, from the simplest to the most elusive and complex. Not only all sorts of modern transmitters and receivers but solid chapters on power supplies, antenna systems, keying methods, frequency measurement and monitoring, crystal control, radiotelephony. Not only apparatus but operating procedure, traffic handling, reports, how the Communications Department works.

[EVERYTHING YOU
WANT TO KNOW]

NOW IN ITS SEVENTY-NINTH THOUSAND

240 Pages

6½ × 9½

196 Illustrations

The Handbook is the biggest dollar's worth in the radio world. If it were printed like an ordinary textbook it would gross 500 pages and have to sell for about \$4, but it is printed like *QST*, got into a handy 240 pages, and so is available at ridiculously small cost. Constantly revised, the Sixth Edition

is the best ever distributed, a record-breaker in radio literature, for it has had enthusiastic reception by both novice and skilled amateur in every quarter of the globe. It contains everything the League can think of to help you as an amateur. You can't afford to be without it.

Blue-and-Gold Paper Cover, \$1.00

Stiff Buckram Binding, \$2.00

POSTPAID ANYWHERE IN THE WORLD

AMERICAN RADIO RELAY LEAGUE

Hartford, Connecticut, U. S. A.

The popular 566 Vapor Rectifier at a *new* NET PRICE

Its popularity, which is due to its special cathode construction, enables us to lower the price to meet the demand of the average amateur.

TYPE 566
VAPOR RECTIFIER
NOW \$9.00

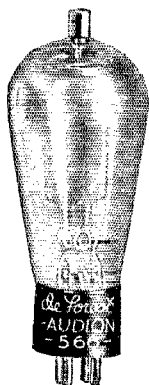

A HALF-WAVE
mercury
vapor rectifier
of special hot
cathode construction, emitting a wave form easy to filter. Raises flash-over breakdown point to 7500 volts inverse peak. A low and practically constant voltage drop. The special

oxide coated filament insures ample emission, and the low temperature of this filament makes for long life.

THE NEW NET PRICES ON DE FOREST TRANSMITTING TUBES:

| | |
|---|---------|
| 510- 15 Watt Oscillator..... | \$ 9.00 |
| 503A- 50 Watt Oscillator and R. F. Power Amplifier..... | 30.00 |
| 511- 50 Watt Oscillator, R. F. Amplifier, modulator or R. F. Power Amplifier..... | 30.00 |
| 545- 50 Watt A. F. Amplifier and Modulator..... | 33.75 |
| 552- 75 Watt Oscillator and R. F. Amplifier..... | 24.25 |
| 504A- 250 Watt Oscillator Modulator or R. F. Power Amplifier.. | 105.00 |
| 500- 500 Watt Special Oscillator.. | 97.50 |
| 520B- 5000 Watt Oscillator water cooled..... | 187.50 |
| 565- 7 1/2 Watt Screen Grid R. F. Amplifier..... | 16.50 |
| 560- 75 Watt Screen Grid R. F. Amplifier..... | 37.50 |
| 561- 500 Watt Screen Grid R. F. Amplifier..... | 292.50 |
| 566- "Half wave" hot cathode mercury vapor rectifier..... | 9.00 |
| 572- "Half wave" hot cathode mercury vapor rectifier..... | 22.50 |

DE FOREST Radio Tubes, in both receiving and transmitting types, are designed by engineers whose skill and experience are a valid guarantee of precision and rugged construction.

DE FOREST RADIO COMPANY, PASSAIC, N. J.
Export Department, 304 E. 45th Street, New York City, N. Y., U. S. A.

de Forest
(AUDIONS)

RECEIVING
AND
TRANSMITTING TUBES

THE NEW TYPE 334-Z VARIABLE CONDENSER

Maximum Capacitance, 500 μf

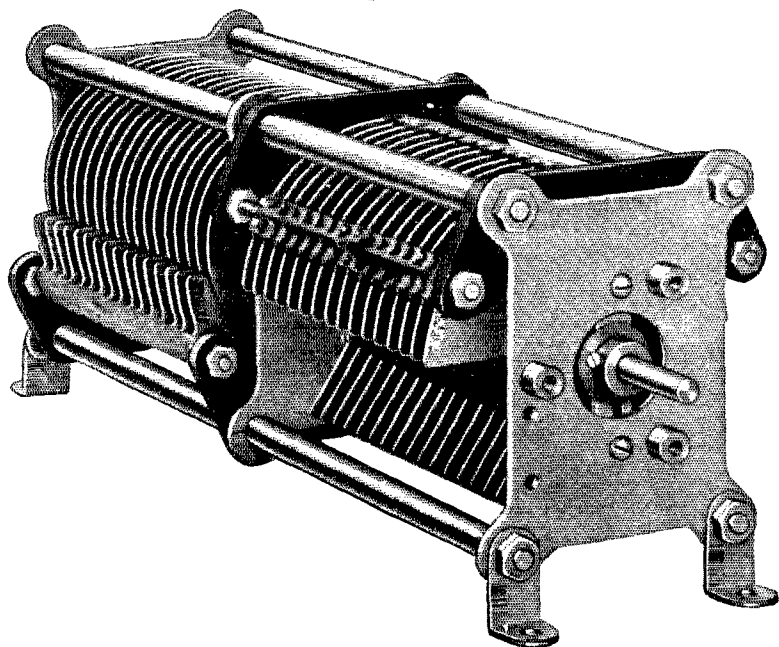

SPECIFICATIONS

THIS condenser is made in two sections so placed that the rotor is balanced without requiring a counterweight. Both rotors are connected, but the stators are isolated from each other.

Breakdown Voltage: 3500 volts, peak. Condensers are built in jigs so that the 0.088 inch spacing between rotor and stator plates is accurately maintained.

Mounting: For panel or table mounting. Four feet supplied with each unit. Drilling template furnished.

Dielectric Suspension: First-quality hard rubber.

| Type Number | Capacitance | | Overall Dimensions | Weight | Price |
|----------------|-------------------|------------------|---|---------------------|---------|
| | Max. | Min. | | | |
| 334-Z | 500 μf | 35 μf | 3 $\frac{3}{4}$ x 3 $\frac{3}{4}$ x 11 in. | 3 $\frac{1}{4}$ lb. | \$10.00 |
| *334-R | 250 μf | 30 μf | 3 $\frac{3}{4}$ x 3 $\frac{3}{4}$ x 6 $\frac{1}{2}$ in. | 2 lb. | 5.50 |
| *334-T | 100 μf | 15 μf | 3 $\frac{3}{4}$ x 3 $\frac{3}{4}$ x 4 in. | 1 $\frac{1}{8}$ lb. | 2.75 |
| *334-V | 50 μf | 10 μf | 3 $\frac{3}{4}$ x 3 $\frac{3}{4}$ x 3 $\frac{1}{4}$ in. | $\frac{5}{8}$ lb. | 2.50 |

* Single section models, with counterweight.

Order from this ad and if cash accompanies it we will pay the transportation charges anywhere in the United States or Canada. We ship within twenty-four hours after we get your order.

GENERAL RADIO COMPANY
CAMBRIDGE A MASSACHUSETTS
274 BRANNAN STREET, SAN FRANCISCO

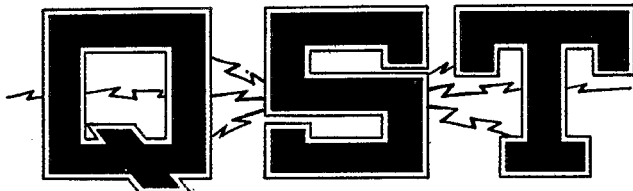

The Official Organ of the A.R.R.L.

VOLUME XIV

JULY, 1930

NUMBER 7

| | |
|---|----|
| Editorials | 7 |
| Your Broadcast Receiver as a Shortwave Superhet <i>Geo. Grammer</i> | 8 |
| A Compact and Inexpensive Chemical Rectifier <i>George S. Parsons</i> | 15 |
| Annual Meeting of The A.R.R.L. Board <i>K. B. Warner</i> | 20 |
| New Two-Volt Tubes | 22 |
| Official Frequency System Progress | 23 |
| New DeForest Tubes | 24 |
| Naval Reserve Holds Its First National Emergency Drill <i>Wm. Justice Lee</i> | 25 |
| Hamming With a Portable in Africa <i>Clyde DeVinna</i> | 27 |
| Correction | 32 |
| VE2CA | 33 |
| New England Division Convention | 38 |
| Experimenters' Section | 39 |
| I.A.R.U. News | 45 |
| Communications Department | 47 |
| Calls Heard | 59 |
| Correspondence Department | 60 |
| Correction | 86 |
| Silent Keys | 86 |
| Charles S. Taylor | 90 |
| Ham-ads and QRA's | 92 |
| QST's Index of Advertisers | 94 |

QST is published monthly by The American Radio Relay League, Inc., at Hartford, Conn., U. S. A. Official Organ of the A.R.R.L. and the International Amateur Radio Union

Kenneth B. Warner (Secretary, A.R.R.L.), *Editor-in-Chief and Business Manager*

James J. Lamb
Technical Editor

George Grammer
Assistant Technical Editor

Clark C. Rodimon
Managing Editor

David H. Houghton
Circulation Manager

G. Donald Meserve
Advertising Manager

Advertising Offices 55 West 42d Street, New York City
Editorial Offices 1711 Park Street, Hartford

Subscription rate in United States and Possessions, Canada, and all countries in the American Postal Union, \$2.50 per year, postpaid. Single copies, 25 cents. Foreign countries not in American Postal Union, \$3.00 per year, postpaid. Remittances should be by international postal or express money order or bank draft negotiable in the U. S. and for an equivalent amount in U. S. funds.

Entered as second-class matter May 29, 1919, at the post office at Hartford, Connecticut, under the Act of March 3, 1879. Acceptance for mailing at special rate of postage provided for in section 1103, Act of October 3, 1917, authorized September 9, 1922. Additional entry at Concord, N. H., authorized February 21, 1929, under the Act of February 28, 1925.

Copyright 1930 by the American Radio Relay League, Inc. Title registered at United States Patent Office.

A SAFE GUIDE

in the selection
of insulation for
Radio Transmitting
and Receiving Sets

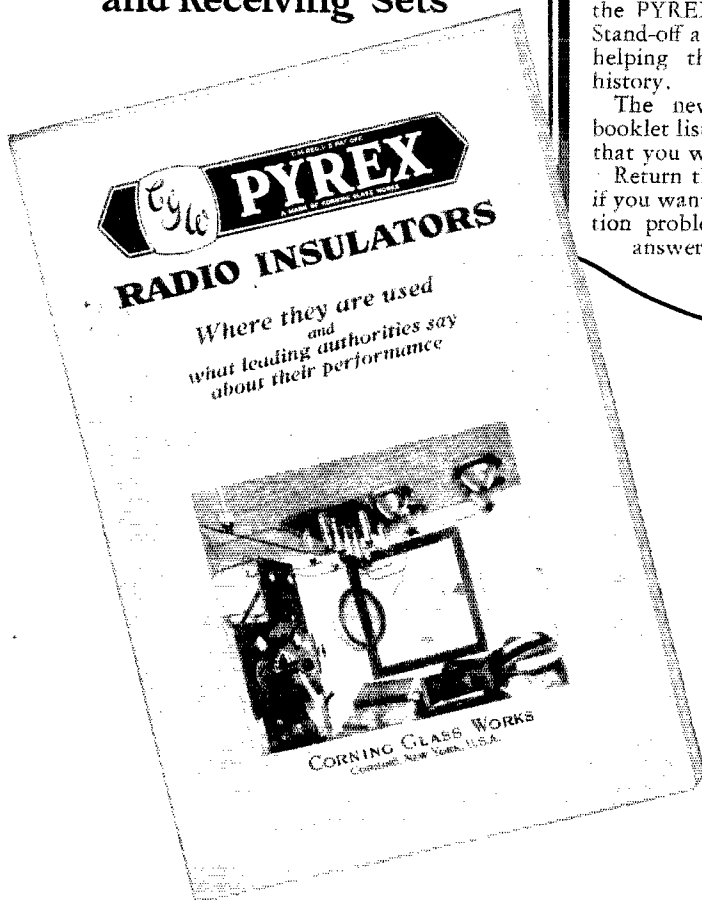

OVER 300 broadcasting stations, leading radio telegraph systems, the United States Army, Navy, Air Mail, Coast Guard and Ice Patrol Services, explorers like Commander Byrd, and exacting amateurs everywhere have utilized PYREX Insulators in many spectacular achievements.

Regardless of whether you are sending or receiving — on land, sea or airplane — you should be thoroughly familiar with the PYREX Antenna, Strain, Entering, Stand-off and Bus-bar Insulators that are helping these leaders to make radio history.

The new PYREX Radio Insulator booklet lists all types and sizes with data that you will want for ready reference.

Return the coupon for your copy, and if you want further advice on any insulation problem, our Technical Staff will answer your questions promptly.

Send
the coupon
for your copy

CORNING GLASS WORKS
Corning, N. Y.

Gentlemen:

Please send me copy of your new
bulletin on Radio Insulators.

Name

Address

QST 7-30

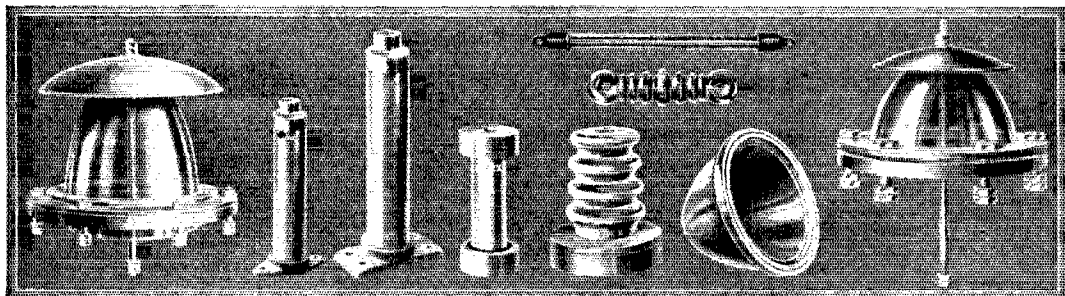

Section Communications Managers of THE COMMUNICATIONS DEPARTMENT, A. R. R. L.

| | | | | |
|--|--|---|--|---|
| Eastern Pennsylvania of Columbia Maryland-Delaware-District | W3ZF | ATLANTIC DIVISION Don Lusk | 116 West Wyoming Ave. | Germantown, Phila. |
| Southern New Jersey Western New York Western Pennsylvania | W3BHW W3ATJ W8CKC W8CEO | Forrest Calhoun John R. Blum A. W. McAuly | 1636 Thomas Ave. 146 Mount View Ave. 44 Seward St. 309 Third St. | Baltimore, Md. Huron, N. J. Danville, N. Y. Oakmont |
| Illinois Indiana Kentucky Michigan* Ohio Wisconsin | W9APV W9CVO W9RAZ W8DVB W8BYN W9VD | CENTRAL DIVISION Fred J. Hinds D. J. Angus J. B. Wathen, III Ken Conroy H. C. Storck C. N. Crapo | 3337 Oak Park Blvd. 310 N. Illinois St. Mockingbird Valley 7553 E. Robinwood Ave. 694 Carpenter St. 443 Newton Ave. | Berwyn Indianapolis Louisville Detroit Columbus Milwaukee |
| North Dakota South Dakota Northern Minnesota Southern Minnesota | W9BVF W9DGR W9BVB W9EPK | DAKOTA DIVISION Guy L. Ottinger D. M. Pasek Carl L. Jabs J. C. Pshoushek | 326 6th Ave., So. 780 Illinois St. 1823 James St. 60 Melbourne Ave., S. E. | Jamestown Huron St. Paul Minneapolis |
| Arkansas Louisiana Mississippi Tennessee | W5ABI W5WF W5AKP W4SF | DELTA DIVISION H. E. Velte F. M. Watts, Jr. J. W. Gillett James B. Witt | 315 No. Jackson St. 1716 Park Ave. 1708 23rd Ave. 832 N. Fifth Ave. | Little Rock Shreveport Meridian Knoxville |
| Eastern New York N. Y. C. & Long Island* Northern New Jersey | W2QU W2BGO W2WR | HUDSON DIVISION H. J. Rosenthal V. T. Kenney A. G. Wester, Jr. | Box 740 1836 Hone Ave. 50 Princeton St. | New Rochelle Bronx Maplewood |
| Iowa Kansas Missouri Nebraska | W9DZW W9CET W9RR W9BYG | MIDWEST DIVISION H. W. Kerr J. H. Anis L. B. Laizure C. B. Diehl | 8010 Mercier St. 915 Lincoln Ave. 8010 Mercier St. 5605 Cedar St. | Little Sioux Topeka Kansas City Omaha |
| Connecticut Maine Eastern Massachusetts Western Massachusetts New Hampshire Rhode Island Vermont | W1CTI W1AQL W1WV W1UM W1AII W1BCR W1IT | NEW ENGLAND DIVISION Frederick Ellis, Jr. C. P. Brown M. W. Weeks Dr. John A. Tessmer V. W. Hodge C. N. Kraus Clayton Paulette | 7 Union Ave. 269 N. Main St. 40 Norfolk Rd. 8 Schaffner St. 227 Main St. 92 Keene St. | Norwalk Brewster Chestnut Hill Worcester Claremont Providence North Troy |
| Alaska Idaho Montana Oregon Washington | WWDN W7ACN-JL W7AA1-7QT W7UN W7ACS | NORTHWESTERN DIVISION W. B. Wilson James L. Young O. W. Viers Wilbur S. Claypool Eugene A. Piety | U. S. LHT Fern 303 13th Ave., So. 1059 Greenwood Ave. 912 No. Ainsworth St. | Ketchikan Nampa Red Lodge Portland Tacoma |
| Hawaii Nevada Los Angeles Santa Clara Valley East Bay San Francisco Sacramento Valley Arizona Philippines San Diego | K6CJB W6EAD W6EQF W6NX W6CZR W6WB W6DON W6BWS KA1CY W6EOP | PACIFIC DIVISION L. A. Walworth Keston L. Ramsay B. E. Sandham F. J. Quement J. Walter Frates C. F. Hane Everett Davies Russ Shortman S. M. Mathes Harry A. Ambler | 2737 Ferdinand Ave. 1151 Buena Vista Ave. 4508 8th Ave. 1348 Hanchett Ave. 439 62nd St. 262 Castro St. Rt. 5, Box 380 519 W. Madison St. Army-Navy Club 4101 Hamilton St. | Honolulu Reno Los Angeles San Jose Oakland San Francisco Sacramento Phoenix Manila San Diego |
| North Carolina* Virginia* West Virginia | W4AEW W3CA W8JM | ROANOKE DIVISION J. F. Bivins J. F. Wohlford D. B. Morris | 512 Worth Drive 118 Cambridge Ave. 703 Maryland St. | High Point Roanoke Fairmont |
| Colorado Utah-Wyoming* | W9CAA W6DFJ | ROCKY MOUNTAIN DIVISION C. R. Stedman C. R. Miller | 429 Pearl St. 134 E. 2nd North St. | Denver Provo, Utah |
| Alabama Florida Georgia-Sos. Carolina-Cuba- Isle-of-Pines Porto Rico-Virgin Islands | W4AHP W4AII W4RZ K4KD | SOUTHEASTERN DIVISION Robt. E. Troy, Jr. Harvey Chain M. S. Alexander B. W. Mayer | 516 Cloverdale Rd. 6002 Suwanee Ave. 79 Rogers St., S. E. Box 193 | Montgomery Tampa Atlanta Ensenada, P. R. |
| Northern Texas Oklahoma Southern Texas New Mexico | W5RJ W5GF W5OX W5AHI | WEST GULF DIVISION Roy Lee Taylor W. J. Gentry R. E. Franklin Leavenworth Wheeler, Jr. | 1500 St. Louis St. 538 N. Pottenger St. 1806 Valentine St. Box 33 | Ft. Worth Shawnee Houston Valmore |
| Martime* | VE1DQ | MARITIME DIVISION A. M. Crowell | 69 Dublin St. | Halifax, N. S. |
| Ontario | VE3FC | ONTARIO DIVISION E. C. Thompson | 266 Queensdale Ave. | Toronto, 6 |
| Quebec | VE2AC | QUEBEC DIVISION Alphy Blais | Box 221 | Thetford Mines |
| Alberta British Columbia | VE4FC VE5AL | VANALTA DIVISION Fred Barron J. K. Cavalsky | Warwick Apts., 95th St. 4868 Blenheim St. | Edmonton Vancouver |
| Manitoba Saskatchewan | VE4HR VE4FC | PRAIRIE DIVISION A. V. Chase W. J. Pickering | 109 Lanark St. 514 19th St. W. | Winnipeg Prince Albert |

*Officials appointed to act until the membership of the Section choose permanent SCMs by nomination and election.

The American Radio Relay League

The American Radio Relay League, Inc., is a non-commercial association of radio amateurs, bonded for the promotion of interest in amateur radio communication and experimentation, for the relaying of messages by radio, for the advancement of the radio art and of the public welfare, for the representation of the radio amateur in legislative matters, and for the maintenance of fraternalism and a high standard of conduct.

It is an incorporated association without capital stock, chartered under the laws of Connecticut. Its affairs are governed by a Board of Directors, elected every two years by the general membership. The officers are elected or appointed by the Directors. The League is non-commercial and no one commercially engaged in the manufacture, sale or rental of radio apparatus is eligible to membership on its board.

"Of, by and for the amateur," it numbers within its ranks practically every worth-while amateur in the world and has a history of glorious achievement as the standard-bearer in amateur affairs.

Inquiries regarding membership are solicited. A bona fide interest in amateur radio is the only essential qualification; ownership of a transmitting station and knowledge of the code are not prerequisite. Correspondence should be addressed to the Secretary.

DIRECTORS

President
HIRAM PERCY MAXIM
W1AW
Drawer 2102,
Hartford, Conn.

Vice-President
CHARLES H. STEWART
W3ZS
St. David's, Pa.

Canadian General Manager
ALEX. REID
VE2BE
169 Logan Ave.,
St. Lambert, P. Q.

Atlantic Division
EUGENE C. WOODRUFF
W8CMP
234 W. Fairmount Ave.,
State College, Pa.

Central Division
D. J. ANGUS
W9CYQ
P. O. Box 596
Indianapolis, Ind.

Dakota Division
CY. L. BARKER
W9EGU
Henning, Minn.

Delta Division
M. M. HILL
W5EB

P. O. Box 274,
Natchitoches, La.

Hudson Division
A. LAFAYETTE WALSH
W2BW

220 West 42d St.,
New York City

Midwest Division
LOUIS R. HUBER
W9DOA

517 East 4th St.,
Tipton, Iowa

New England Division
FREDERICK BEST
W1BIG

13 East Crescent St.,
Augusta, Maine

Northwestern Division
K. W. WEINGARTEN
W7BG

3219 No. 24th St.,
Tacoma, Wash.

Pacific Division
ALLEN H. BABCOCK
W6ZD
65 Market St.,
Southern Pacific Co.,
San Francisco

Roanoke Division
W. TREDWAY GRAVELY
W3BZ
Box 245,
Danville, Va.

Rocky Mountain Division
PAUL M. SEGAL
W9EEA
Box 1771,
Denver, Colo.

Southeastern Division
HARRY F. DOBBS
W4ZA
292 Spring St., N. W.
Atlanta, Ga.

West Gulf Division
FRANK M. CORLETT
W5ZC
2515 Catherine St.,
Dallas, Tex.

OFFICERS

President HIRAM PERCY MAXIM, Hartford, Conn.
Vice-President CHARLES H. STEWART, St. David's, Pa.
Secretary KENNETH B. WARNER, Hartford, Conn.
Treasurer ARTHUR A. HEBERT, Hartford, Conn.
Communications Manager F. EDWARD HANDY, Hartford, Conn.

GENERAL COUNSEL

PAUL M. SEGAL, 1010 Shoreham Bldg., Washington, D. C.

ADDRESS ALL GENERAL CORRESPONDENCE TO THE EXECUTIVE HEADQUARTERS AT HARTFORD, CONN.

EDITORIALS

A SIGNIFICANT feature at the recent meeting of our Board of Directors was the very lively advance interest which had been shown by members in the important topics which were to come up for discussion. Helped somewhat by the preparation of a list of topics some weeks in advance of the meeting, and by the usual call in *QST* urging members to communicate their views to their directors, the meeting had the advantage of an unusually complete expression of amateur opinion and desire. It is a sign of good health in an organization when its members actively interest themselves in its affairs and when, as this year, they so well unite in viewpoint and general sanity of comment.

This was very well shown in the study of out-of-band operating. There was little question that when the Board met the directors would feel that the Government ought to be asked to undertake better enforcement of allocations, but what would the members think of such a course? The answer was clear, because the members of every division had expressed themselves in advance, voluntarily to their directors, and in emphatic language. That, we say, is a good sign.

This lively interest was particularly evident in the 'phone question. Many points of view had been expressed. There were, of course, some requests to widen the 3500-3550 'phone band, many to keep it as it is, some to shift it to the other end of that band; suggestions to make the use of oscillator-amplifier transmitters compulsory; and many suggestions concerning the desirability of increasing the qualifications required of the 'phone operator. Experienced 'phone men in particular joined in sponsoring this last suggestion. The Board's job in deciding upon a course that represented "the greatest good to the greatest number" was a difficult one, but nothing like as difficult as it would have been without the very extensive expression of opinion which had been made by members everywhere.

The Board's eventual decision, as reported elsewhere in this issue, was to seek no change in the size or location of the 3500-kc. 'phone band, to frown upon any specifications of apparatus, but to sponsor a new grade of operator's license to be required for all 'phone operating, the basic requirements of which would be the possession of special technical qualifications and at least a year's C.W. experience. 'Phone transmission must be recognized as an advanced form of communication, the fundamental requirement for which is the possession of a very high-grade C.W. station. To operate it intelligently the amateur must first be a skilled and experienced C.W. operator. The 'phone bands are badly congested today, but not with good 'phones. The 'phone amateurs consist of a small number who are well-versed technically and seriously interested in doing a good job in a very difficult field, and a large number of "punks" who make the night hideous with unintelligent efforts directed at inadequate equipment. The League's present plan for 'phone thus proposes a big improvement for the legitimate 'phone operators by the eventual removal of the poor 'phones. The elimination of amateurs without the qualifications or the enterprise to learn the code, and of C.W. amateurs who are just "messing around" temporarily with 'phone, is the biggest favor that could be done the 'phone man. The good 'phone man deserves protection and the right to adequate operating facilities. The Board's action will clear the air for him, and the good 'phone man will be well pleased with the change.

K. B. W.

Your Broadcast Receiver as a Short-Wave Superhet

A "Converter" Which Actually Converts

By George Grammer, Assistant Technical Editor

The development of a satisfactory S/W converter was undertaken by the QST technical staff because of a real demand, as evidenced by letters received by the Technical Information Service, for a "short-wave converter" to be used in conjunction with the usual broadcast receiver, particularly the types which are a.c. operated. The converter is applicable to the amateur field, notably in amateur radio-telephony, as well as to high-frequency broadcast reception. — Editor.

THE possibility of adapting a broadcast receiver to short-wave reception has always been attractive but the evolution of a satisfactory converter has not been so easy. Most attempts at converter design have aimed at using only the audio amplifier of the broadcast receiver with an autodyne detector for the high-frequency end, although a few have made a stab at the superhet idea, using the r.f. amplifier as the intermediate amplifier for an oscillating first detector. Either of these systems has a number of disadvantages. The regenerative detector (working into the receiver's audio amplifier) is not sufficiently selective for 'phone reception and entirely ignores the excellent r.f. amplifier with which the modern broadcast receiver is equipped. The autodyne superhet uses the r.f. amplifier of the receiver but does not give it much opportunity to do its stuff, because the detector circuit must be tuned off the incoming frequency by the beat frequency (intermediate frequency) and both sensitivity and selectivity are sacrificed.

It is obvious, therefore, that the ideal converter should be one which utilizes to the utmost all the features of the broadcast receiver. This requirement indicates a superhet converter for the high-frequency end. For the realization of maximum selectivity and sensitivity, the converter must have separately tuned oscillator and

first detector circuits. The problem of using the broadcast receiver simply resolves itself into the design of a detector and oscillator for high-frequency work.

The advantages of a high intermediate frequency for short-wave reception have previously been pointed out in *QST*.¹ With the broadcast receiver it is possible to choose any frequency between 500 and 1500 kc. at will — a considerable advantage, since a slight shift in the i.f. will often mean the disappearance of unwanted interference. A further desirable result of this freedom of choice is that small differences in the short-wave coils in the oscillator and first detector can be compensated for in the tuning of the broadcast receiver itself, thus to some extent obviating the necessity for cutting the coils to the

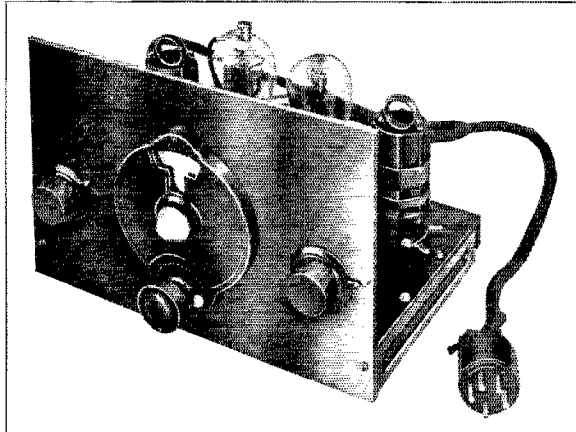

FRONT VIEW OF COMPLETE CONVERTER

last quarter turn — the bugaboo of all short-wave receiver coil construction. Finally — and in some respects this is the most important advantage of all — it is possible to cover a 1000-kc. band at any portion of the high-frequency spectrum by doing all tuning *on the broadcast receiver itself*. A preliminary adjustment of the controls on the converter to the proper setting, which need only be determined *once* by experiment, is all that is necessary. This means that tuning at 20,000 kc. is as easy as at 600 kc. in the regular broadcast

¹ "Improving Short Wave 'Phone Reception," *QST*, March, 1929.

band—and anyone who has tuned the usual type of short-wave regenerative receiver doesn't require further explanation! Essentially, the usual superhet procedure is reversed, and instead of using a variable oscillator frequency and a fixed i.f., the intermediate frequency is varied and the oscillator frequency is fixed.

There are many ways in which such a converter (and this really is a converter, because it serves as a medium for converting a high frequency into a lower one) can be constructed. The fundamental requirements are a high-frequency detector, an oscillator which will produce a 500- to 1500-ke. beat with the incoming signal, and a means of mixing the two and feeding the result into the broadcast set. Although any of the many varieties of detector and oscillator circuits may be employed and their coupling may be effected by several different means, it is desirable to have an arrangement in which the tuning of the first detector and oscillator is independent (insofar as such a thing is possible) to avoid interlocking of controls and resultant tuning difficulties. In this respect some circuits are better than others; the one shown in the diagrams avoids such obstacles to a large extent.

SOME IMPORTANT CONSIDERATIONS

Before taking up the constructional details of the converter, it is well to consider how it is to be used. It can be combined with any broadcast receiver which has a good r.f. amplifier, even a regular super-heterodyne, but it cannot always be connected to obtain plate and filament voltages from the receiver itself. If the receiver has three or more stages of radio-frequency amplification with heater-type a.c. tubes, the first r.f. tube can be removed from its socket and the converter plug inserted in place of it, providing the remaining two stages have sufficient gain to make satisfactory reception possible. This of course depends entirely on the construction of the broadcast receiver itself, and a trial will probably be necessary to determine whether or not it will work out satisfactorily. A receiver which has only two r.f. stages, even though screen grid tubes are used in them, is not adaptable to such use of the converter, because only a single i.f. stage remains if the first tube is removed. Although some of the more powerful stations come through weakly, the results are not gratifying.

When separate plate and filament supplies are provided for the converter, however, these drawbacks are overcome, and its use is not restricted to sets using any particular type of tube or number of r.f. amplifier stages. This does not necessarily mean that the power supply in the broadcast receiver cannot be used; the objection is simply to taking the supply through a socket from which a tube must be removed. Many broadcast receivers, including d.c. sets which have been modernized with a.c. power supplies, have power-

packs which are readily accessible; in such a case it is only necessary to tap off the requisite voltages and connect to the proper posts on the converter. In the extreme case, however, where the set has been put together with rivets, or the owner does not care to "take chances" the only extra equipment necessary is a 90-volt battery or eliminator and a 2½-volt transformer for filament supply, neither of which is very expensive.

In fact, it is recommended that wherever possible the plate and filament supplies for the

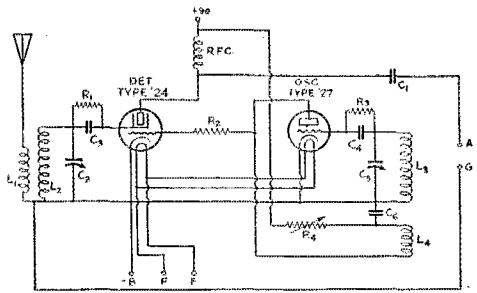

FIG. 1.—WIRING OF THE CONVERTER WHEN USED WITH SEPARATE PLATE AND FILAMENT SUPPLIES

- C₁—500 μfd.
- C₂—50-μfd. midget condenser.
- C₃—100 μfd.
- C₄—100 μfd.
- C₅—50-μfd. midget condenser.
- C₆—2000 μfd.
- R₁—75 megohm.
- R₂—50,000 ohms.
- R₃—5 megohm.
- R₄—50,000-ohm variable resistor.
- RFC—Radio-frequency choke suitable for broadcast band.
- Coil Data:

| Approximate Range | Detector | | Oscillator | |
|------------------------|----------|----|------------|----|
| | L1 | L2 | L3 | L4 |
| 5000-7000 kc. | 12 | 16 | 20 | 9 |
| 8000-13,000 kc. | 7 | 8 | 9 | 4 |
| 13,000-19,000 kc. | 5 | 5 | 5 | 3 |
| 3500-ke. band. | 15 | 30 | 30 | 10 |
| 7000-ke. band. | 7 | 12 | 13 | 6 |

All wound with No. 22 d.s.c. on forms 1 ½ inches in diameter.

converter be obtained by means other than through a plug which replaces one of the r.f. tubes.

CONSTRUCTION OF THE CONVERTER

Referring now to Fig. 1, it will be seen that a Type '24 screen-grid tube is used as the first detector. This type of tube is a more sensitive detector than the regular three-electrode tube, and in addition the extra grid is advantageous in that it provides a good means of coupling between the detector and oscillator, when used as shown in Fig. 1, without causing annoying interlocking between the two tuning controls. A Type '27 is used as the oscillator.

L₁ and C₂ comprise the tuned grid circuit of the first detector, and this circuit is adjusted to the frequency of the incoming signal. The oscillator employs the very common tickler circuit,

the resistor R_4 serving as a regeneration control. Coupling between the oscillator and first detector is provided by the resistor R_2 , connected between the plate of the oscillator and the inner grid of the detector. Once again, lest there be any misunderstanding, the inner grid is connected to the cap which comes through the top of the tube. In this case the '24 is acting as a space-charge detector, the grid leak and condenser being con-

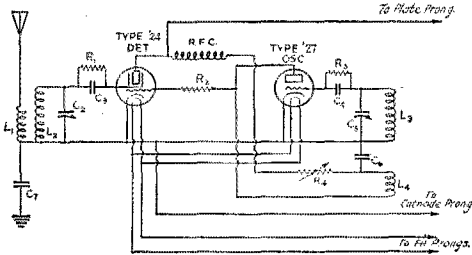

FIG. 2. — WIRING DIAGRAM WHEN PLUG IS USED
 $C_7 = .000 \mu\text{fd.}$

All other constants same as in Fig. 1.

nected to the screen grid. In addition to serving as a coupling link between oscillator and detector, R_2 also drops the plate voltage down to the proper value of inner-grid bias for space charge detection.

The connections in Fig. 1 are used when separate plate and filament supplies are available, or when the proper voltages can be taken from the regular receiver power-pack without recourse to a plug which necessitates the removal of one r.f. tube. This arrangement is much to be preferred to the plug method because, as mentioned above, the amplification is greater, and it is unnecessary to remove or replace a tube every time a change is made from the regular broadcast band to short waves and *vice versa*.

All connections to the converter except one may be permanent, and the single connection which must be changed is the antenna. The post marked "G" in Fig. 1 is connected permanently to the ground post on the receiver, and the post marked "A" is connected to the antenna post, the antenna itself being transferred to L_1 . A switch can be installed to make this change, and the transfer from regular broadcasting to short-wave reception accomplished by throwing the switch. It is well also to include an "on-off" switch in the filament supply to the converter.

If, in spite of the recommendations above, the builder prefers to remove the first r.f. tube in the receiver and obtain the "A" and "B" supplies for the converter through a plug, the connections shown in Fig. 2 should be used. The constants are the same in either case, the difference being in the method of transferring the signal from the converter to the broadcast set.

With d.c. operated broadcast receivers, the connections in Fig. 3 may be used. In this case there is nothing to be gained and much to be

sacrificed by using a plug, because it is an easy matter to get at the "A" and "B" batteries or eliminators, and consequently the full amplification of the set can be realized. The constants are again the same as those in Fig. 1, with the exception of the extra resistors listed. Care should be taken to see whether either side of the "A" battery is connected to ground in the broadcast receiver, and if so, the "G" post on the converter should be left unused.

Pilot coil forms were chosen as the winding forms. Any other type of form of the same diameter ($1\frac{1}{2}$ "') can of course be used without change in the coil specifications. The Pilot forms are easily identified in pairs, however, because it is possible to use differently colored rings for each set of coils. Moreover, the first detector and oscillator coils can be differentiated by removing the unused pins from the forms; the method of making connections allows this since only three pins are required for the detector coil and four for the oscillator.

The arrangement of the connections on the coil sockets used in the converter shown in the photograph is given in Fig. 4. While other combinations may be used just as readily, those depicted will result in no harm to the tubes or batteries if a coil is inadvertently put in the wrong socket. The coils should never be placed in the sockets intended for the tubes, however! The turns of both windings on each form should be wound in the same direction; this is particularly important with the oscillator coils because if the connections and direction of windings are not correct, no oscillations will be set up and no signals will be heard.

As is usual with any short-wave receiver, it is advisable to keep all wires carrying r.f. separated as much as possible from other wires, and avoid closely paralleling them.

OPERATION

On this particular model the large dial in the center is the control for the oscillator tuning condenser; the small knob on the left is the first detector tuning condenser, and the similar knob on the right is the oscillator regeneration control.

If one has had no experience in operating a superhet when the various controls were not ganged together, it may take a little time to get the "feel" of the set. When all adjustments are properly made the first detector will not oscillate, and neither will the broadcast receiver itself (some sets will when the volume control is turned too high); therefore the "background," the hissing noise accompanying the operation of a heterodyne or autodyne receiver, will be comparatively low in volume. It may be necessary to provide a home-made background for preliminary tuning and an ordinary buzzer may be used for this purpose. It should be connected to a battery, and a single wire run from one of the

buzzer terminals to the antenna post on the converter. Some locations, particularly in city districts, are very noisy, and there is often enough electrical racket from street cars, automobiles, machinery, fans, etc., to provide all the background one wants — oftentimes a great deal too much of it.

A pair of coils should now be placed in the proper sockets. Be sure the detector and oscillator coils are not interchanged. Set the dial on the broadcast receiver to about 650 kilocycles; this is a convenient setting and ordinarily not so many regular broadcasting stations will be picked up directly at the low frequency end of the band. Also, *tuning is more spread out at this end of the scale on many broadcast receivers.* If a local station is near this frequency it may be impossible to cut it out completely, even though the antenna is transferred to the converter and is not connected to the receiver itself. The object is to pick out a quiet section of the band where the possibilities of direct pick-up are minimum, and set the dial in about the middle of it.

Now set the dial on the converter (oscillator tuning) to about the center of the scale. The right-hand knob (regeneration) should be set so that about half the resistance is in the circuit. Now turn the left-hand knob (detector) slowly from zero to full capacity and note whether the background noise comes up to a maximum at any point. In the event that there is no response with the background supplied, several things may be wrong; but to avoid interrupting the tuning story, possible sources of trouble will be considered later on.

For the present we will assume that a definite point of maximum background has been noted on the detector tuning.

The right-hand knob (regeneration control) should now be advanced until the volume is maximum. It probably will be necessary to make a slight readjustment on the oscillator dial as this control is varied; a little experimenting will readily indicate which setting gives the best results. It may be found that as the setting is advanced a point will be reached where there will be a loud roaring noise set up; this is the result of too much regeneration, and the knob should be set below this point.

The next step is to begin a search for signals. The oscillator dial should now be turned very slowly, the first detector knob being varied at the same time. The importance of doing this searching very slowly cannot be stressed too greatly, because it is easily possible to miss even a very loud station entirely by too rapid tuning. A dial with a high vernier ratio is useful on the oscillator condenser. The other two controls are not at all critical.

The oscillator tuning condenser covers a considerable range of frequency, and it may be possible to pick up the same station at two different

points on the dial, depending upon the intermediate frequency to which the broadcast receiver is adjusted. In such a case the setting of the oscillator condenser which gives the best volume should be chosen. The first detector setting will be the same in either case.

Now turn the attention to the broadcast receiver. If, as most of them are, it is a single-dial affair, it will be very easy to cover a 1000-ke.

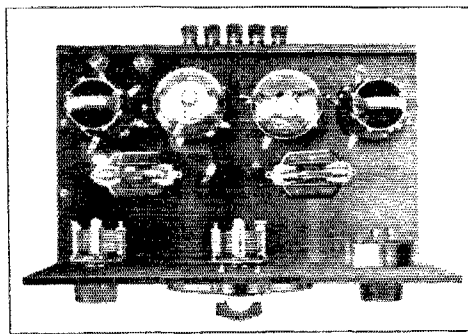

LOOKING DOWN ON THE CONVERTER

band by simply turning the dial as if tuning in ordinary broadcast stations. If a group of stations has been heard previously when searching as described above, that same group will appear on the receiver dial just the same as they did on the converter dial but they will not be nearly so crowded, and tuning them in will be much easier. Although it is possible to listen with perfect satisfaction without again touching the converter after preliminary adjustments have been made, it is sometimes advantageous to reset the first-detector knob slightly in order to bring the volume up to the very maximum.

Once set up correctly and adjusted, the converter and broadcast receiver form a really sensitive short-wave super-herodyne, and the results are just as good as would be obtained from a short-wave super built especially for the job and using a comparable number of tubes. In spite of the fact that the time for trying out the device has been limited, the preliminary results convince us that, with proper handling and reasonably decent receiving conditions, it should be possible to pull in distant stations with ease.

The set used in the tests was an Atwater-Kent Model 55 chassis, with the A-K dynamic speaker. This particular model has two screen-grid r.f. amplifiers, and although it has plenty of gain, it is possible that a receiver with a well-designed three-stage r.f. end would be more sensitive. Separate plate and filament supplies were used on the converter, because only the stronger stations would come through when the first r.f. tube was removed from the receiver to allow a plug to be used. The converter has since been given a trial on other popular models of receivers with uniformly better success when the plug is

not used. As expected, however, the plug works out fairly well with sets which have more than two stages of r.f. amplification.

AMATEUR WORK

The set had a real kick on short-wave amateur and commercial signals. Since beat-note reception was impossible without a separate heterodyne, all signals were received at first on their modulation only and how some of those raw a.c. and rough r.a.c. signals did show up! We got a big

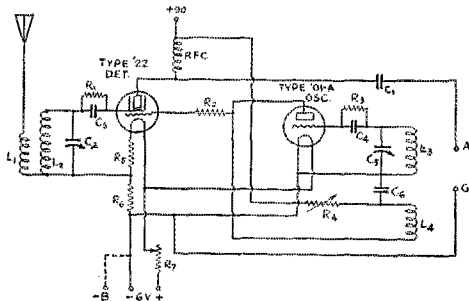

FIG. 3.— THESE CONNECTIONS ARE USED WITH D.C. TUBES

R_6 — 10 ohms.
 R_5 — 5 ohms.
 R_7 — 30-ohm rheostat.
 All other constants same as in Fig. 1.

— B post not used in most cases as this connection has already been made in most B/C receivers.

kick out of watching the diaphragm of the speaker do tricks when some high-powered commercial station was tuned in "on the nose." Both domestic and foreign commercials had so much pep that the signal could actually be "felt" by holding the hand in front of the speaker, because the piston was moving almost a quarter inch and produced a considerable blast of air. It was impossible to be heard in the lab while speaking in an ordinary tone of voice when such a signal was on — we had to shout in each other's ears. (Some of the Directors, who were in Hartford for the annual meeting at the time, will attest to this.)

Although it is possible to get some extremely loud signals and the selectivity is all that could be desired, there are a few difficulties attendant upon the use of such a receiver as a telegraph outfit. In order to get beat note reception it is necessary to use a separate heterodyne, and to use the tuning system outlined above would mean the addition of another variable tuning control. Of course it is possible to do all tuning with the oscillator, and use a fixed intermediate frequency with a fixed heterodyne to set the beat note. In such a case the usual band-spreading tactics would have to be applied to the coil and condenser in the oscillator circuit. The beauty of the variable intermediate frequency is that the speed of tuning is exactly the same no matter what frequency the converter may be tuned to, and therefore all amateur bands can be spread on the dial in pro-

portion to the actual number of kilocycles each band covers. A three-circuit broadcast tuner hooked up in a single-tube regenerative circuit with a wire run from the antenna post on the tuner to the ground post on the broadcast receiver will provide a satisfactory separate heterodyne. The pick-up will be sufficient to give a good beat note on c.w. signals.

The combination is a mighty good amateur 'phone receiver, possessing the selectivity required for operation in a crowded band, and providing a real audio amplifier for ham 'phone signals. With an outfit of this sort it is easy enough to find out whether a 'phone really "sounds like a broadcast station," because it is possible to compare the two directly. It is axiomatic that anything which can be heard on the 'phones with an ordinary short-wave receiver can be heard on the speaker with a super because of the greater amplification, and it really works out that way. Maybe if the neighbors can hear both sides of the conversation they won't think friend ham has gone daft and talks to himself constantly.

This, we think, is the most pertinent application of the converter to amateur radio, aside from the pleasure which many of us get from listening to short-wave broadcasts and DX hunting now and then. The operation of such a receiver is quite in contrast to the usual short-wave receiver, in respect to both selectivity and quality of reproduction.

SHORT-WAVE BROADCASTING

Naturally the converter is eminently suited for short-wave broadcast reception. If the same values of condensers have been used as specified in Fig. 1 and the coils are also exactly as per specifications, the tuning should be fairly close to the dial settings which have been logged on the set shown in the photographs.

With the pair of coils for the 6000-ke. band, a station should appear somewhere between 40 and 55 on the center dial if the broadcast receiver is set to 650 ke. The left-hand knob will be set at about half capacity. If such a station is heard, pass by it for the time being and see if there are any more near it. This particular band is 150 kilocycles wide, and it is usually possible to hear three or four stations working in it in the evening. If several stations are picked up, select the one nearest the center of the group, and then make a record of the oscillator dial setting for that station. This dial setting becomes the key setting for the band, and no further tuning is done on the converter itself except perhaps to make a small adjustment on the left-hand knob now and then as different stations are tuned in.

The other sets of coils are treated in just the same manner. The other broadcast bands are not always as well populated as the 6000-ke. band, but it is usually possible to hear some stations on 9500 and 11,800 ke. The 15,100- and 17,750-ke.

bands seem to be used mostly for daytime broadcasting, and at times it is impossible to find any signs of activity on them. The four bands last named are the ones on which foreign stations are most likely to be heard, the first for night reception, the second for afternoon and early evening, and the last two for daytime or late night transmission over great distances.

One of the great disadvantages of short-wave broadcast reception is rapid and drastic fading. The newer broadcast receivers with automatic volume control are therefore particularly suited to this work, because the intensity will be maintained at approximately the same level.

Receiving conditions at A.R.R.L. Headquarters are far from ideal, with two car-lines and an electrical manufacturing plant within a few hundred feet of the "lab," to say nothing of small machinery which is constantly running in various parts of the same building. The street on which the offices are located is likewise a well-travelled one, and at high frequencies the noise from ignition systems of trucks and automobiles is particularly bothersome. For this reason a good part of the time available for experimenting was taken up with simply waiting for some especially virulent machine to let up so something besides noise could be heard. In addition, the broadcast receiver with which the experiments were made was ours for only three days, being borrowed from one of the local radio stores. Therefore, it is not possible to say with any certainty just what can be expected in the way of distant reception.

However, in the moments when it was possible to listen with some degree of comfort, a number of broadcast stations within a thousand miles or so on the 6000-ke. band were picked up in the afternoon and early evening with volume which was considerably more than ample—in some cases it was impossible to turn the volume control fully on without overloading the audio system. On 9500 ke. PCJ was picked up in late afternoon with fairly good volume, increasing in intensity later in the evening, and except for fading was as loud as stations are ordinarily allowed to become in a home. The following morning a foreign station was heard on the 17,750-ke. band with fair intensity. One or two other stations were also heard on the higher-frequency bands, but lack of time or recurrence of noise prevented identification. Several of the transatlantic telephone stations, both English and American, were picked up on various frequencies at different times of the day. Reception was of course all on the loud-speaker. We would hesitate to put a pair of 'phones on the output of a modern broadcast receiver.

HUNTING TROUBLE

During the cut-and-try period of construction, a number of things happened which weren't quite as they should have been. Uncarthy shrieks and

howls, roars and grunts frequently rent the air, much to the disgust of persons nearby who were trying to keep their minds on their work. Bursts of music and the machine-gun rattle of tape transmitters rewarded the efforts of the experimenters now and then, but added nothing to the enjoyment of the unwilling audience.

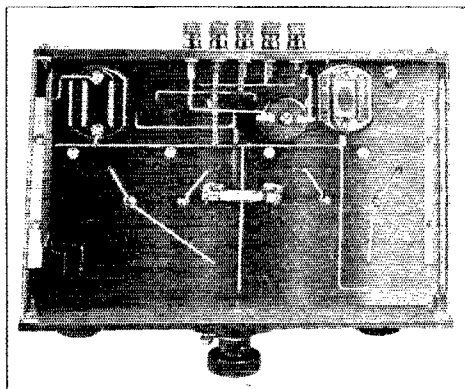

UNDERSIDE OF CONVERTER

However, a number of things were learned, and since others are quite likely to have the same troubles a few hints as to cures will be given. We are quite certain that the possibilities of the device as a noise-creator have not been fully probed, but a number of sources of trouble have been analyzed.

The commonest source of trouble is too much regeneration on the oscillator, which has been mentioned previously. As the regeneration control is advanced a point will often be found where a loud mushy roar starts, which is simply an audio frequency oscillation caused by too high plate voltage on the oscillator tube with that particular coil. The remedy is quite obvious, but there is a tendency for the howl to lag so far as settings on the knob are concerned. In other words, the roar stops when the regeneration control setting is considerably lower than the point at which it started. It may happen, particularly when the plates of the oscillator condenser are very nearly completely unmeshed, that it will be impossible to keep the howl from breaking out at inopportune moments. This indicates that the tickler winding, L_4 , on the oscillator coil, is too large, and removing one turn will probably help a great deal. It is well to be cautious in removing tickler turns, because the operation of the oscillator at the upper end of the condenser scale may be adversely affected.

If nothing can be heard at any setting of the converter dials and knobs, any one of a number of things may be wrong. The chances are ten to one that some mistake has been made in the wiring or some connection has been omitted. One or both

of the tubes may be defective. All connections should be checked carefully, and then everything should be scrutinized very critically with the idea of showing up poor workmanship, joints in wiring which only apparently make connections, and poor judgment in laying out the r.f. parts of the circuit. The latter point is probably one of

in the same direction and the connections brought out as shown if the oscillator is to work. Other grid leaks and coupling resistors should be tried if all else fails. Finally, if nothing is found wrong with the coils or leaks, it may be that the oscillator tube or the layout is such as to require a few more turns on the tickler winding, L_4 .

A series of chirps as either the oscillator dial or detector knob is turned indicates that the first detector is oscillating. This point can easily be settled by touching the grid leak on the first detector with the finger, and no further chirps will be heard as long as the finger is held on the leak. The detector seems most likely to break into oscillation when its tuning condenser is at about minimum capacity, and so long as it does not oscillate near where the desired stations are heard, there is no particular harm done. However, it may be aggravating at times, and can usually be stopped by either reducing the setting on the oscillator regeneration control or by decreasing the coupling between the two tubes, which requires a higher value of resistance at R_2 . Increasing the value of R_2 may also decrease the signal strength on the higher-capacity settings of the oscillator and detector tuning condensers; all these factors should be taken into account in making a permanent adjustment.

With the receiver used in the tests, it was found that a particularly strong signal would cause a howl to build up if the volume control on the broadcast receiver were advanced too far. This howl did not seem to be assignable to the receiver or the converter separately, but was probably a result of interaction between them. Setting the volume control at a lower value or a slight readjustment of the detector tuning or both, will nearly always cure it.

Hum is likely to be non-existent or bad, depending upon individual tubes. Ordinarily no trouble of this kind is encountered with the first detector, because hum does not become bothersome until a tube is oscillating. Since the first detector is not allowed to oscillate it was not anticipated that any trouble would be had with hum from it, and such has proved to be the case. The oscillator, however, cannot be so lightly pushed out of the picture. Some tubes will work with perfect satisfaction, introducing no more hum than is already present in the broadcast receiver itself; others are not so considerate. Out of some eleven tubes tested, nearly all of different makes, three were perfectly humless, five had a noticeable hum only when the volume control on the receiver was near maximum, with two the hum was somewhat more noticeable than with the other five, and one out of the eleven had a really bad hum. Grounding the filament transformer, either through a resistor or condenser, seemed to have no effect whatever, so that the conclusion naturally presented itself

(Continued on page 80)

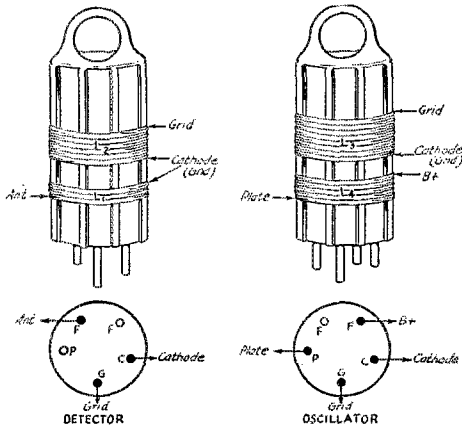

FIG. 4. — ARRANGEMENT OF THE COILS AND COIL SOCKETS

Only the connections on the sockets marked with the solid black circles are used.

the most important. We have seen any number of attempts at set construction which were enough to disgust an experienced radio constructor, and yet the builders seemed to be sincerely laboring under the impression that it was "exactly like the one in QST." At least they said so. If you are inexperienced in such matters, follow the photographs carefully.

If, after checking as suggested above, there is still no sign of activity, and other tubes have failed to give results, it is probable that the oscillator is not functioning. In order to test for oscillation, a milliammeter should be connected in series with the negative "B" lead to the converter, and the oscillator grid leak touched with the finger. If the oscillator is working the plate current will increase when the grid is touched; if it is not, nothing will happen. If a milliammeter is not handy a pair of 'phones may be connected in series with the plus B lead and the same test applied, in which case a healthy click will be heard both when the grid leak is touched and when the finger is removed. Touching the side of the leak which is farthest from the grid of the tube will give the most positive results.

If the test shows the oscillator is not working, the coils should be looked over carefully to make sure that the connections have been made as in Fig. 4, and that all coils have been wound in the same direction. This latter point is probably the cause of non-oscillation. The coils must be wound

A Compact and Inexpensive Chemical Rectifier

Applying New Ideas to Electrolytic Rectifier Design

By George S. Parsons*

THERE is a widespread belief among amateurs of to-day that the chemical or electrolytic rectifier, as applied to high-voltage rectification, is greatly inferior to other types. There is a number of reasons for this belief, among them the fact that the usual amateur set-up is very messy, occupies a considerable space, and requires a transformer of generous proportions for successful operation. It must be admitted that a set-up of twenty-four pint Mason jars, coated with a greasy scum, is not beautiful to look upon, especially when it is compared to the compact and neat-appearing tube rectifiers. It is the purpose of this article to describe a chemical rectifier which meets these objections; it is highly compact, neat in appearance, and reasonably efficient.

In the April, 1929, issue of *QST* there appeared the first part of an article on rectifiers by R. J. Kryter.¹ Lest it appear that I am attempting to parade the ideas of others as my own, I wish to state that it was this article which gave me the fundamentals with which to work. Mr. Kryter reviewed in detail both the theory and the design of rectifiers, and gave an excellent discussion of the needs of the chemical rectifier. A brief review of his findings is therefore in order.

Kryter states that if an electrolytic rectifier is to function properly, certain conditions must be fulfilled. These conditions deal with purity of electrode material, current density, shape and size of electrodes, and types of solutions.

It appears that one of the most important of these conditions (and one which is least often properly taken care of) is the matter of current density. For an active electrode of pure aluminum, Kryter states that the current density should be *not less* than fifty milliamperes per square inch of active aluminum surface. Thus if a sheet of aluminum having an area of one square inch on one side is totally immersed in the solution, the current density should be *at least one hundred milliamperes*. The total active area of the above plate is two square inches, and a load of one hundred milliamperes would give the required current density of fifty milliam-

peres per square inch. With special cooling methods much higher current densities may be used, densities as high as 2500 milliamperes per square inch being permissible. At this point I should like to bring to attention this fact: Practically all the articles which have appeared in *QST* specify that the current density should be *kept below* forty milliamperes per square inch,

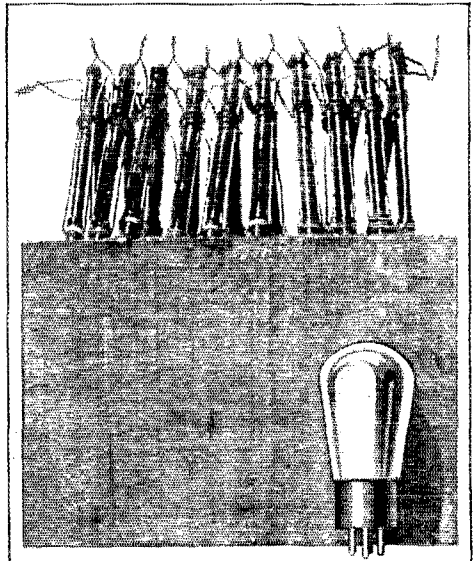

THE CELLS AND CONTAINER FROM ONE SIDE
The small size of the complete rectifier can be judged by comparing it with the receiving tube.

and this figure is given in the *Handbook* as well. In view of the later work which has been done on the aluminum rectifier, however, the current density specification should be made *at least* fifty milliamperes per square inch of active surface.

Other conditions of considerable importance are as follows: The aluminum electrode should be constructed of the purest metal obtainable; it should have a polished and well rounded surface in order that the potential gradient be uniform over the entire electrode. The solution

* 2717 Derby St., Berkeley, Calif.

¹ "Alternating Current Rectification as Applied to Radio," *QST*, April and May, 1929 (in two parts).

should consist of certain organic acids and their salts dissolved in pure water. Sodium bicarbonate or borax may be used but will not give the excellent results obtainable with an organic solution.

Let us now consider the theory of design of a small chemical rectifier. Assuming that the rectifier will be used to supply one or two Type '10 tubes, we may draw the following conclusions.

If one tube is used, the plate current will be sixty to eighty milliamperes, depending on the

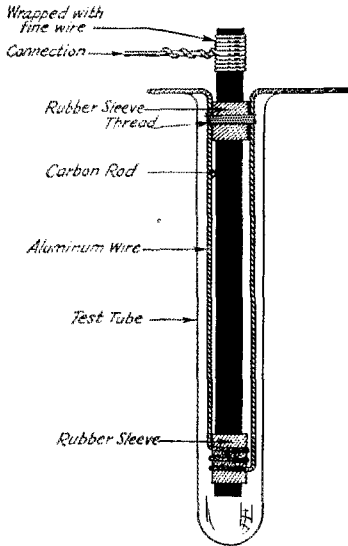

FIG. 1.—ONE OF THE NEW TYPE RECTIFIER CELLS

The active electrode is No. 14 pure aluminum wire and the inert electrode is the carbon rod from an old "B" battery cell. Twenty-four of these cells in a bridge will rectify 750 volts a.c. (r.m.s.) and deliver at least 100 ma. for a pair of Type '10 tubes.

adjustment of the circuit and the voltage applied to the tube. The transformer voltage will probably be anything from five hundred to eight hundred volts, depending on the transformer available. Aluminum, used as the active electrode, has a definite operating voltage which should not be exceeded. If an organic solution of the proper type is used, an operating voltage of 160 volts per cell is permissible. In the bridge type of connection, one-fourth of the cells must withstand the entire secondary voltage when in the closed valve position; thus a bridge-connected rectifier consisting of twenty-four cells will operate without danger of overload at a voltage as high as 960 volts (r.m.s.).

It has been stated that the aluminum electrode should have a polished and rounded surface and that sharp corners should be avoided. Perhaps the easiest way to realize this is to use aluminum

wire as the active electrode. Aluminum wire of No. 14 gauge has a diameter of 0.064 inches. The area of the surface of the wire is given by the expression πDL , where D is the diameter of the wire and L the length. πD is 0.201 inch: The wire has a surface area of 0.201 square inch per linear inch. Since the current density must be not less than fifty milliamperes per square inch, not more than 1.8 square inches of aluminum should be exposed to the solution. If the rectifier is to be used on very light loads (60 milliamperes or less) the area should be even less, about one square inch being suitable. Assuming that a load of at least one hundred milliamperes will be drawn, the value of 1.8 square inch should be used, and may be obtained by immersing at least nine inches of the aluminum wire in the solution. Allowing three inches for connections, the wire should be cut in twelve-inch lengths.

Since organic solutions are to be used, carbon is probably the best suited for use as the inert electrode, and may be easily obtained from an old "B" battery. Carbon rods obtained from this source should be carefully cleaned in boiling water. This will remove the ammonium chloride and other impurities which may be present on the rods.

It is always desirable, in a cell of this sort, to reduce the resistance to a minimum. To do this the electrodes should be mounted as close to each other as is possible. Five millimeters (about 0.2 inch) is a convenient distance. It is not advisable to mount the electrodes closer than this, since with changing temperature some of the organic salts present in the solution may crystallize out around the electrodes and cause erratic performance.

In place of the usual pint Mason jars or drinking glasses, test tubes were used as containers. Test tubes are small, cheap, easy to obtain, and may be mounted in a small box, thus providing a very compact and neat arrangement. Following this design the rectifier described below was built.

The rectifier network consists of twenty-four cells. The containers are test tubes, six inches in length and seven-eighths inch in diameter. The tubes are mounted in two rows in a wooden box, twelve inches long, two inches wide, and sufficiently deep so that only the rims of the test tubes are above the top of the box. The tubes are held in place by pouring molten paraffin around them.

The electrodes were made as follows: Carbon rods of approximately four-inch length were obtained from an old "B" battery. These rods were thoroughly cleaned in boiling water and dried. Short pieces of rubber tubing of sufficient diameter to fit snugly to the carbon rod were pushed over each end. At the top, sufficient carbon was left exposed to make a connection. A piece of aluminum wire of No. 14 gauge was then led down the side of each rod: two and one half

turns were made about the lower rubber sleeve, and the wire led back up along the opposite side of the rod.² The aluminum wire was then secured to the upper rubber sleeve by means of a few turns of a thin twine. Connections to the carbon rods were made by wrapping the ends of the rods with several turns of bare copper wire of No. 24 gauge, and soldering a short piece of No. 16 bare copper wire to the wrapping of No. 24 wire. The drawing, Fig. 1, illustrates the design.

The electrodes were placed in the tubes and connected in the usual bridge form. An organic solution³ was poured into the cells and the rectifier was connected to the secondary of a transformer of five hundred watts input, the secondary voltage being 750 volts (r.m.s.). The time required for forming was approximately one minute and the leakage after this time but a few milliamperes.

As Kryter states, the performance of the usual chemical rectifier is limited by the heat developed in the solution. As the solution undergoes a rise in temperature, the working voltage decreases. More explicitly, the leakage effects increase with increasing temperature, finally reaching a point where the rectifier ceases to operate and acts as a dead short on the high-voltage supply line. Assuming that the rectifier will always be operated at or below the rated working voltage, the point at which the rectifier suffers complete break-down depends upon the ratio of heat developed to heat radiated. If the rectifier is capable of radiating heat as rapidly as heat is produced, regardless of current, exceedingly high currents could be drawn without overloading the rectifier. In actual practice any rectifier has a definite current rating which may not be exceeded without overheating. This limit is set by the construction of the rectifier. For example, the one described in this paper has the cells imbedded in paraffin, which is a rather poor radiator of heat. Thus the maximum permissible load is not large — probably not over 250 milliamperes for short periods.

In any electrolytic cell through which an electric current is flowing, energy is being dissipated in the form of heat and in electrolysis of the solution. The electrolysis may be accompanied by certain chemical reactions which may either liberate or absorb heat, depending on the exact nature of the reactions. In order to determine the relation between these two values, the following experiment was carried out.

A direct current was sent through a single cell consisting of one of the electrodes described above immersed in 600 ccs. of the solution in a large Dewar flask. Knowing the specific heat of the solution, the amount and duration of current

flow, and the resistance of the cell, the heat developed due to the resistance of the solution could be calculated from the expression, $H = I^2 R/4.187$. Measuring the rise in temperature by means of a Beckman thermometer and calculating the total heat developed, it was found that for a given current flow the experimental value

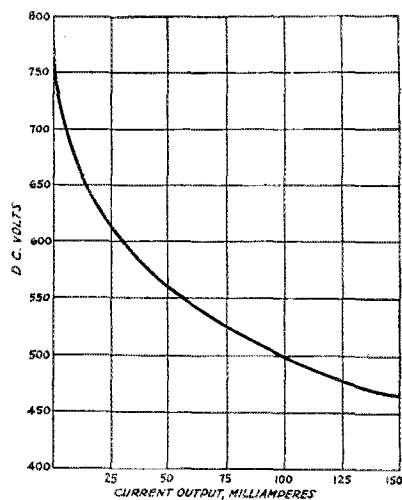

FIG. 2. — VOLTAGE REGULATION CURVE OF THE RECTIFIER

The transformer secondary voltage is 750 (r.m.s.) and the load is a pure resistance.

corresponded very closely to that calculated. This means, of course, that whatever heat may be absorbed or given out by the chemical reaction going on within the cell is small in comparison to the heat developed by the resistance of the cell to the current flow. If we calculate (on the basis of the above data) the heat developed in the rectifier network described above, with a load of 200 milliamperes, it will be found that a rise in temperature of 0.115 deg. C. might be expected. It will be shown that this value is very much too low.

Let us now consider the rectifier under actual operating conditions. Suppose the output to be 500 volts at a load of 100 milliamperes. Assuming an overall efficiency of 50%, the total input to the rectifier is 50 watts and the loss in the rectifier must be 25 watts. With about 20 cc. of a solution having a specific heat of 0.85, this would cause a rise in temperature of about two degrees C. per minute. However, since a great amount of this energy lost in the rectifier is spent in causing chemical action within the cells, the heat actually developed is much less than the value given above. It was found by experiment that the rise in temperature under the above conditions was not two degrees but was slightly less than one degree, the exact value depending somewhat on the room temperature. Inasmuch as the

² If shorter rods are used, more turns of aluminum wire should be wound around the lower rubber sleeve. — *Editor*.

³ The formula for the electrolyte is given at the end of this article. — *Editor*.

load on a chemical rectifier being used to supply a small high frequency transmitter is usually intermittent rather than steady, and since a certain amount of heat will be radiated from the cells, the rise in temperature will vary considerably for different set-ups. The reason for the error in the value for rise in temperature, calculated

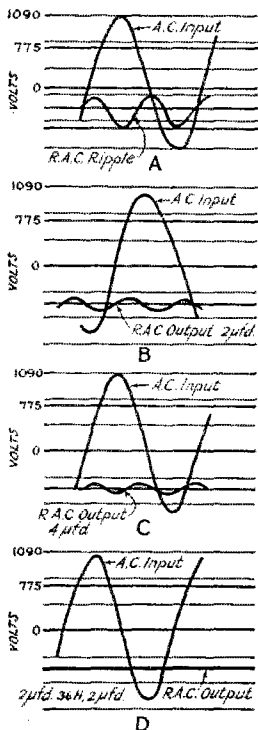

FIG. 3.—OSCILLOGRAPH RECORDS OF THE RECTIFIER'S PERFORMANCE

"A" is without any filter in the output; "B" is with 2 μ fd. across the output; "C" is with 4 μ fd; and "D" is with a filter of 2 μ fd., 36 H. and 2 μ fd.

from the d.c. values for a single cell and applied to the network, is probably that the formation and breaking of the film by the alternating current involves losses which are not encountered with a steady current flow. The particular network with which the above tests were made has been used to supply an intermittent load of 100 milliamperes at an input voltage of 750 volts, for several hours. No appreciable heating could be observed.

The efficiency of the rectifier was found to vary with the conditions of the test and the load drawn. It appears that temperature has a great deal to do with the efficiency, it being advisable to operate at a low rather than a high temperature. Although the cells will operate at temperatures above 35 degree C., it is much better to keep the temperature below 20 deg. C. A room

temperature of 68 deg. F. corresponds to a temperature of 20 deg. C., hence room temperature is a convenient point for satisfactory operation. As a matter of fact, the rectifier will probably not show a rise in temperature of more than three to five degrees above the temperature of the room, assuming a normal load of 100 milliamperes and intermittent operation. The power efficiency usually will vary from 40% to 50% and at light loads the efficiency probably will not be more than 40% of the input. Although this may seem to be low efficiency, it should be kept in mind that the maximum over-all effi-

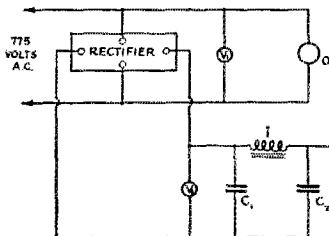

FIG. 4.—THE CIRCUIT USED IN MAKING THE OSCILLOGRAPH RECORDS

V_1 —A.c. voltmeter, 0-1000 volts.

V_2 —D.c. voltmeter, 0-1000 volts.

L —36-henry choke.

C_1 and C_2 —2- μ fd. filter condensers.

R_1 and R_2 —Resistors.

A —Milliammeter.

$XX O_1$ —Oscillograph element for a.c. rectifier input.

O_2 —Oscillograph element for d.c. rectifier output.

A.c. input voltage, 775 volts; d.c. output voltage, 607 volts; d.c. output current 57 ma.

ciency for a perfect rectifier is 81.2%. This follows from a consideration of the geometrical properties of the sine curve.

In determining the output voltage and load, it should be remembered that the greater the load up to a certain point, the greater the voltage drop across the rectifier; with an input voltage of 750, a load of 50 milliamperes may give an output voltage of 600 volts or more; a load of 100 milliamperes will probably reduce the voltage (output) to about 550 or less. The exact value may be obtained from the curves given in Fig. 2.

The ease with which a rectifier of this type forms is remarkable. It may be connected directly to the high voltage supply without danger to the transformer windings. There will be a very large current drain lasting for a matter of seconds, after which the current falls very rapidly; the rectifier is formed completely in three minutes. This short time of formation is in sharp contrast to the time required for rectifiers having large aluminum plates and a borax solution, the time of formation for the latter often being a matter of hours rather than of minutes.

There are at least three reasons for the rapid formation of this rectifier: The aluminum used

is very pure and has a polished surface; the area of the aluminum plate is very small; and the solution is of complex organic compounds rather than the simple inorganic salts such as sodium bicarbonate or borax. Of these reasons, the first two are probably more important than the last, and the matter of electrode area is probably the most important of all.

For example, Holler and Schrodt have found that an area of one square centimeter forms almost at once, whereas an area of three hundred square centimeters requires several hours for complete formation. In the first case, twenty-five volts were used for forming and in the second, 120 volts were used. This might be interpreted in one of two ways; either the cell forms less rapidly with the higher forming voltage or some minimum value of forming current per square centimeter of aluminum is required. I am inclined to believe that the latter is correct for this reason:

If two aluminum cells are set up — one having an active electrode area of one square inch and the other an active electrode area of fifty square inches and a direct current is applied to each cell, it will be found that the small cell forms in a few minutes while the large cell requires a much greater time.

In this case equal potentials are applied to each cell and the same current flows through each. This condition, while theoretically impossible, may be closely approximated by making the internal resistance of the two cells as nearly alike as practicable. This may be accomplished by spacing the plates of the small cell very closely and the plates of the large cell some distance apart. Since equal currents are flowing through each cell, it follows that the current density is much less in the large cell than in the small one, thus making it appear that a minimum forming current is required.

The solution employed in this rectifier is one given by Kryter and has the following formula and operating characteristics:

Formula:

| | |
|------------------------------|------------------|
| Ammonium citrate | 425 gms. |
| Citric acid | 368 gms. |
| Ammonium phosphate | 150 gms. |
| Potassium citrate | 8 gms. |
| Distilled water | 1,000 gms. (cc.) |

Operating characteristics:

| | |
|--|----------------|
| Working voltage, r.m.s. | 160 volts. |
| Breakdown voltage, r.m.s. | 210 volts. |
| Critical temperature | 120 deg. F. |
| Useful life of 100 cc. of solution | 69 ampere hrs. |

In the rectifier described, each cell contains about twenty cc. of solution. With a d.c. load of 100 milliamperes this means an operating life of at least 175 hours.

It is possible to use other solutions in the rectifier than the one just given. The operating characteristics, however, will vary with the solu-

tion. Either borax or baking soda may be used, but in such cases the maximum working voltage will be less than 160 volts per cell. Furthermore, it must be remembered that the life of a simple, inorganic solution such as borax is much less

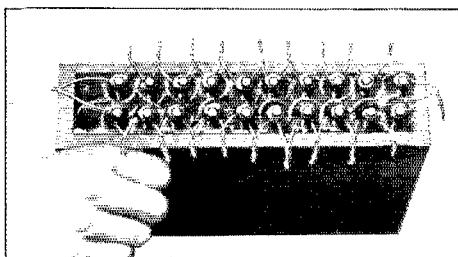

A TOP VIEW OF THE COMPLETED RECTIFIER

than that of an organic solution, thus necessitating more frequent change of the solution.

Since the first part of this article was written, the rectifier output has been checked with an oscillograph, the records being shown in Fig. 3. The output wave shows complete rectification, being totally above the zero axis. As might be expected, since the internal capacity of the cell used as a unit is low, any smoothing effect in the rectifier itself is very small. This may be seen in curve "A". With the output fed into a condenser, a distinct smoothing effect is evident. This becomes more pronounced as the capacity is increased. "B" shows the effect of connecting a 2- μ f. condenser across the output side of the rectifier and "C" shows the effect of four microfarads. The addition of a choke of 36 henries gave (at least as nearly as the oscillograph could show) pure d.c., the trace being a straight line. The circuits used are shown in Fig. 4.

The results obtained with the oscillograph make it quite evident that there is no excuse for not obtaining pure d.c. with a reasonably small filter; certainly a filter consisting of a 36-henry choke shunted on each side with a 2- μ f. condenser is not an elaborate filter system.

A load of 54 milliamperes was on the d.c. output at all times, and the rectifier was permitted to operate constantly for a period of two and one-half hours. Slight heating was observed, the temperature rising to about 100 deg. F. This emphasizes that the rectifier is capable of handling intermittent loads well in excess of 54 milliamperes, 100 or more milliamperes being permissible under ordinary operating conditions.

Strays

After the recent broadcast from WIMK about the new regulations one chap wrote in and wanted to know about the new 30- and 60-meter bands! Of course "mc." and "mtr." do sound a bit alike.

The Annual Meeting of the A.R.R.L. Board

By K. B. Warner, Secretary

THE Board of Directors of the American Radio Relay League held its annual meeting in Hartford, on May 2d and 3d, under the chairmanship of President Maxim. These annual meetings are the most important affairs in government of our League, for here the directors assemble from all over the country and for two days exhaustively examine the work of the A.R.R.L. and make new plans based on their nation-wide study of conditions and members' desires. All sixteen of the directors, whose names appear each month on page 6 of *QST*, were present except Mr. Babcock from the Pacific Division, who was ill but who sent as his alternate Mr. Foster G. Strong, W6MK, of Long Beach, California. The headquarters officers of course were also in attendance.

After the roll call and the approval of the minutes of its previous meeting the Board proceeded at once to the hearing of reports. Each of the officers presented a comprehensive report on his stewardship of certain branches of A.R.R.L. affairs, telling of the work of the past year and making recommendations for the future. The General Counsel of the League similarly reported. The Canadian General Manager and each of the division directors presented a report on the affairs under his jurisdiction, how the members feel about this and that, the troubles encountered, the new ideas suggested. All these reports the Board heard and accepted, and listed the topics brought up for careful consideration.

Mr. Maxim and Mr. Stewart were unanimously reelected president and vice-president, respectively, for 1930 and 1931. There were no other names in nomination.

The Board examined and ratified the acts of the Executive Committee in the past year, appropriated funds for the expense of the annual meeting, sent a telegram of good cheer to Mr. Babcock, regretting his absence, and then tackled its first knotty problem.

OUT-OF-BAND OPERATING

This first problem was a study of ways and means to confine amateur operation to the authorized bands, a subject which every active amateur knows to be a vital one right now. Much thought was given to the establishment of marker signals on the limits of each band, to increased standard-frequency transmissions and to other practical aids of similar nature. Because any such program to be successful must be based on sound technical plans, this part of the subject was referred to the Executive Committee for further

study. It developed that there was general sentiment amongst the members that there was no excuse for most off-wave operating, that for the most part it was inexcusable carelessness, and that there was widespread demand amongst the great law-abiding majority of amateurs that the Government do something about it. Somewhat to the surprise of each other, every director reported that the amateurs in his division were united in urging a drastic enforcement policy, with the suspension of licenses as the penalty for violation, provided, of course, that guilt is established. It was the nation-wide sentiment that it was time to do something, that the rights of the majority must not be jeopardized by the carelessness of a few, and that the job was up to the Department of Commerce as the radio-policing agency of the Government. Accordingly, the Board unanimously voted to advise the Department of Commerce, Radio Division, that it is the desire of the League that the Secretary of Commerce comply with Section 5(D) of the Radio Act of 1927, as amended, by immediately putting into effect the policy of suspending the operator's licenses of all persons consistently violating the regulations of the Commission by operating outside the frequency bands prescribed for amateur services. It also instructed that in all cases where the Communications Department of the League acquires evidence satisfactory to it of consistent off-wave operation, the Communications Manager shall forward such evidence to the Secretary of Commerce with a specific request for suspension of operator's license. With the new monitoring station of the Radio Division in Grand Island, Nebraska, and the new equipment at each district headquarters, disciplinary suspensions should now be expected by the persistent violators.

'PHONE OPERATION

As at the two previous meetings, the question of 'phone operation came in for a good share of the Board's attention, and, like the previous meetings, not only was the problem acted upon the first day of the meeting but it was taken up for reexamination the second day and again carefully scrutinized. The Board had before it two petitions from 'phone men asking the League to sponsor a widening of the 3500-ke. 'phone privilege. It had counter requests from C.W. men that 'phone be moved to the high-frequency end of that band, to utilize the harmonic-family then made available for three-band crystal-controlled C.W. operation. 'Phone operators interested in this general sub-

ject are requested to see this month's editorial page, where it is more fully discussed. The overwhelming majority of amateur sentiment, as collected in each division by the directors, was against any widening of the band but in favor of a regulation which would require more ability of the 'phone operator, because 'phone is admittedly a much more complex art than C.W. Such a policy would confine 'phone operation to the men who know something about it and, by eliminating the unqualified operators, would increase the effective range of the facilities available for men who have the knowledge and the equipment to do real 'phone work. Thus the Board unanimously voted to seek no extension in the telephone range now, to leave it where it is, and to seek the creation of an amateur telephone operator's license, to be required for all amateur telephone operation, the same to be given only to operators having at least one year's experience in the amateur operator's class or higher, and having special technical qualifications; in other words, to require for any 'phone operation about the same qualifications as are now necessary for the 14-mc. band. This view, incidentally, was heartily recommended by numerous experienced 'phone men.

INTERNATIONAL AFFAIRS

The Board unanimously voted that the League should undertake amateur representation at the next meeting of the C.C.I.R., at Copenhagen in 1931, and at the next conference for the revision of the international convention, at Madrid in 1932. Plans were made for a publicity campaign, international in character, to start a year before Madrid and having for its aim the production of a favorable background for amateur radio at that conference. Meanwhile it is hoped that the A.R.R.L. can assist the I.A.R.U. organization in solidifying its position in the international field, which should be of invaluable assistance at both of these conferences; and plans thereto were left with the Executive Committee.

The Board made an additional appropriation of funds to be drawn upon by the Executive Committee for furthering the membership development program which is now under way, based upon the beginner's booklet which has been mentioned in *QST*. The resumption of national conventions was again asked by the Central Division, but again turned down by the Board for the same reasons as in the past; that such affairs are never national in scope and that they cannot be "conventions" because, under our constitution, League business is handled by the Board and not at meetings of the membership; it reiterated the statement of policy adopted at the 1927 meeting and published in *QST* for April of that year. The editorial policy of *QST* was discussed, the salaries of officers reviewed, and a careful study made of the problem of better contact between directors and their members.

SOME AMENDMENTS OF BY-LAWS

Some changes were made in the by-laws affecting areas outside of continental United States and Canada. It was felt that such areas which are not governed by the domestic radio laws of the two nations in which the League is centered should not participate in the making of League decisions. So long as they are part of League divisions they do thus improperly participate, members there vote for director and are entitled to instruct the director, and in fact a member in such an area is eligible to stand for election as director even though he does not operate under United States or Canadian radio law. These areas were originally incorporated in A.R.R.L. divisions in the desire to extend the operating activities of the Communications Department to them, but in the process they became part of the whole administrative field of the League. A further problem arose from the fact that some of these areas are so distant that there has not been sufficient time for the casting of ballots in the election of directors.

In this consideration it was considered desirable to retain in the administrative area served by the League the Territory of Hawaii, the Territory of Alaska, and the Island of Porto Rico, because these are governed by our domestic radio law and are in fact parts of the inspection districts of the Department of Commerce. The Board so amended the by-laws, however, as to eliminate Newfoundland, Labrador, Cuba, the Isle of Pines and the Philippine Islands as parts of our A.R.R.L. divisions. It was desired, nevertheless, to retain these areas within the scope of the Communications Department, as has been requested by them, so a further amendment was made whereunder the operating territory of the Communications Department is defined as consisting of the A.R.R.L. divisions plus certain other territory attached to but not forming part of the divisions, as follows: Newfoundland and Labrador, attached to the Maritime Division; Republic of Cuba and the Isle of Pines, attached to the Southeastern Division; and the Philippines, attached to the Pacific Division. Thus there is no change in C. D. activities in these areas.

The date for the receipt of ballots in director elections was changed to December 20th instead of December 1st.

The one-year-old provision in the by-laws that a candidate for S.C.M. must be the holder of an O.R.S. appointment was repealed. Experience has shown that an existing S.C.M., by his control of the appointment of O.R.S.'s, has an unwarranted power over the selection of his successor, and in some cases it was being abused; so the provision was eliminated.

THE TEMPORARY CERTIFICATE

Many directors reported abuse, in their districts, of the temporary operator's certificate,

(Continued on page 80)

New Two-Volt Tubes

THE R.C.A. Radiotron Company has recently announced the production of three new tubes, all designed to operate at the same filament potential, 2 volts. A general purpose tube, a power output tube, and a screen grid tube form the new series. The general-purpose tube, known as the UX-230, and the screen grid tube, the UX-232, correspond approximately (in characteristics other than filament voltage and current) to the Type '01-A and Type '22 respectively. The power output tube has no approximate counterpart in the present smaller sizes of audio output tubes, but to some extent averages the characteristics of the present Type '12-A and '71-A.

THE UX-230

The new general-purpose tube is similar to the Type '99 in external appearance, but the elements are those of the Type '01-A reduced to an appropriate size to fit the envelope. The small standard base and pin connections are used. The tentative ratings and average characteristics of this tube are listed below. The corresponding characteristics of the Type '01-A are also given for comparison.

| | UX-230 | UX-201-A |
|-------------------------------|--------|-------------|
| Filament voltage | 2.0 | 5.0 |
| Filament current, amperes | 0.06 | 0.25 |
| Plate voltage (maximum) | 90 | 90-135 |
| Grid voltage (C-bias) | -4.5 | -4.5 to 9.0 |
| Plate current, milliamperes | 2.0 | 2.5 |
| Plate resistance, ohms | 12500 | 11000 |
| Amplification factor | 8.8 | 8.0 |
| Mutual conductance, micromhos | 700 | 725 |

The approximate direct inter-electrode capacitances of the UX-230 are as follows:

| | |
|-------------------|---------------|
| Grid to plate | 6 μ fd. |
| Grid to filament | 3.5 μ fd. |
| Plate to filament | 2 μ fd. |

The tube is suited to all uses to which a Type '01-A may be put, either as a radio-frequency amplifier, detector, or intermediate audio amplifier.

THE UX-231

The UX-231 is designed "for use in the last audio stage only," and is capable of delivering a moderate amount of undistorted power output to the loud-speaker. In appearance it is exactly the same as the UX-230, the only noticeable difference in the construction being in the spacing of the grid wires. Tentative ratings and average characteristics of this tube are as follows:

| | |
|--|----------------|
| Filament voltage | 2.0 volts |
| Filament current | 0.150 amperes |
| Plate voltage, maximum and recommended | 135 volts |
| Grid voltage (C-bias) | -22.5 volts |
| Plate current | 8 milliamperes |
| Plate resistance | 4000 ohms |

| | |
|--------------------------|----------------|
| Amplification factor | 3.5 |
| Mutual conductance | 875 micromhos |
| Undistorted power output | 170 milliwatts |

The approximate direct inter-electrode capacitances are the same as those given above for the UX-230.

When operated at the recommended plate voltage the grid bias should never be lower than the values specified above, since a lower bias will



THE UX-230

cause an increase in plate current which may adversely affect the performance of the tube. When used correctly the output may be fed directly into a loud-speaker of suitable impedance without the use of an output transformer, since the plate current is comparatively low.

THE UX-232

The new screen-grid tube has about the same external appearance as the Type '22, but the construction of the elements is somewhat different, the control grid and inner screen grid being oval instead of cylindrical, and the filament is in the form of an inverted "V." The arrangement of the elements is shown in an illustration.

The average characteristics of the tube are listed below, together with the corresponding figures for the Type '22.

| | UX-232 | UX-222 |
|-------------------------------|--|---------|
| Filament voltage | 2.0 | 3.3 |
| Filament current, amperes | 0.06 | 0.132 |
| Plate voltage, maximum | 135 | 135 |
| Grid voltage (C-bias) | -3.0 | -1.5 |
| Screen voltage, maximum | 67.5 | 67.5 |
| Plate current, milliamperes | 1.5 | 1.5 |
| Screen current | Not over $\frac{1}{2}$ of plate current. | |
| Plate resistance, ohms | 800,000 | 850,000 |
| Amplification factor | 440 | 300 |
| Mutual conductance, micromhos | 550 | 350 |

The effective grid-plate capacitance of the UX-232 is 0.02 μ fd., maximum.

(Continued on page 32)

Official Frequency System Progress

Elgin Observatory to Succeed W9XL—W1AXV Schedules— New Marker Station System to be Inaugurated

SINCE the publication of the Official Frequency System news in May *QST* there have been important developments towards improving and expanding the League's frequency calibration service to amateurs. In addition to a change in administration of the System which centers the supervision at Hartford headquarters, a new standard frequency station has been appointed to succeed W9XL; prospects of a Pacific Coast station (to make the third and complete station for the S.F. net) are in sight; complete coordination of the operation of the whole system is being realized; and the Official A.R.R.L. Frequency Standard is expected to be in operation at Hq by the time this issue of *QST* is out.

THE NEW S.F. STATION

The League has been fortunate indeed in securing the cooperation of the Elgin Observatory of the Elgin National Watch Co. at Elgin, Ill., and in having this competent research organization accept appointment for the transmission of Official A.R.R.L. Standard Frequencies. The standard frequency station at Elgin will be in charge of Mr. F. D. Urie, W9SI, Director of Research. He will have as his assistant Mr. R. S. Neidigh, W9BEP. Both these gentlemen are active, dyed-in-the-wool hams, experimenters of the first water, and more than ordinarily capable of handling such little things as standard frequency transmissions of ultimate accuracy. The time determination facilities available at the Observatory are to play an important part in the precision radio frequency work, as might be expected, and contributions to ham radio additional to the standard frequency transmission can be expected from the fellows at Elgin.

The Elgin Observatory now has the experimental call W9XAM assigned for the transmission of time signals on 4795 kc. (see June *QST* for skeds) and there is a possibility that this call will be used for the S.F. transmissions also. The S.F. transmitter will be a 500-watt rig, monitored by a piezo frequency standard having an accuracy of better than .01%. The standard will be checked against the National Standard at the Bureau of Standards, Washington, prior to its installation at Elgin.

The setting up of a station for the transmission of standard frequencies is not something to be completed in a Saturday afternoon—the job is a precise one and requires some time. It is

hoped that sufficient progress will be made to allow publication of tentative schedules of W9XAM S.F. transmissions in the September issue of *QST*.

W1AXV ACTIVITIES AND SCHEDULES

Standard frequency transmissions, QRG service (see May *QST* for details) and official observing activities at W1AXV are going full blast. Howard Chinn, Paul Hendricks and the rest of the gang at Round Hill are hitting the ball right along—but not getting deserved cooperation from the fellows for whom they are giving the service.

W1AXV wants more reports. Such reports are necessary to show what areas W1AXV is covering, with the various transmissions so that the proper times of day for different frequencies can be determined more exactly and also to assist in studies of skip distances, zones of reception and so on for the amateur frequencies on which the schedules are sent. Every time you use the S.F. transmissions of W1AXV, send in a report. To make the reporting easier, we have plenty of S.F. Report Blanks here at Hq. Just drop a card asking for them. They will be sent “no charge”—and postpaid.

All reports should be addressed to the Standard Frequency System, *QST*, Hartford, Conn. A notation of the report is made for our files and the original is then sent to the proper S.F. station.

If you are not making use of the schedules—for the love of Mike Henry use them! From now on the schedules will be published in every issue of *QST*. If you don't know how to calibrate your frequency meter, monitor, or what-have-you from S.F. transmissions, dig up K. V. R. Lansingh's dope in September, 1929, *QST* (page 36) and find out how. It may mean saving your license from cancellation because of off-frequency operation.

Here are the schedules for W1AXV Standard Frequency Transmissions during July and August. Keep them on your operating table.

DATES OF TRANSMISSION

| Date | Schedule |
|-----------------|----------|
| July 11, Friday | A |
| July 18, Friday | BB |
| July 25, Friday | B |
| July 27, Sunday | C |
| Aug. 8, Friday | A |
| Aug. 15, Friday | BB |
| Aug. 22, Friday | B |
| Aug. 31, Sunday | C |

STANDARD FREQUENCY SCHEDULES

| Time (p.m.) | Frequency, kc. | | Time (p.m.) | Frequency, kc. | |
|----------------|----------------|------|----------------|----------------|--------|
| | A | B | | BB | C |
| 8:00 | 3500 | 7000 | 4:00 | 7000 | 14,000 |
| 8:08 | 3550 | 7100 | 4:08 | 7100 | 14,100 |
| 8:16 | 3600 | 7200 | 4:16 | 7200 | 14,200 |
| 8:24 | 3700 | 7300 | 4:24 | 7300 | 14,300 |
| 8:32 | 3800 | — | 4:32 | — | 14,400 |
| 8:40 | 3900 | — | | | |
| 8:48 | 4000 | — | | | |

The time allotted to each transmission is now 8 minutes, divided as follows:

2 minutes — QST QST QST de W1AXV

3 minutes — Characteristic letter "G" broken by call letters.

1 minute — Statement of frequency in kc. to nearest integral figure and announcement of next frequency.

2 minutes — Time allowed to change to next frequency.

The frequencies announced by W1AXV are accurate to within 0.01%.

The time is E.S.T.: 8:00 p.m. at W1AXV is 0100 G.C.T. and 4:00 p.m. is 2100 G.C.T.

European listeners are urged to use and report on Schedule BB which is transmitted particularly for them.

W1AXV QRG SERVICE

More fellows ought to take advantage of the "individual QRG service" being offered by W1AXV. Anyone who can raise W1AXV during the hour preceding each S.F. schedule can have his transmitter frequency checked to within 0.1% by simply asking for a check. Complete details of the service were given in May *QST* (page 47). Very few have taken advantage of this opportunity on the first transmissions and more users are wanted.

The frequency used by W1AXV during each QRG period will be approximately the middle frequency of the S.F. sked which follows. The exact frequency for each period will be:

Preceding schedule A, 3700 kc.

Preceding schedule B, 7100 kc.

Preceding schedule BB, 7100 kc.

Preceding schedule C, 14,200 kc.

"MARKER STATIONS" TO BE APPOINTED

A selected group of amateur stations which operate on precise frequencies near the limits of the amateur bands are going to be appointed "Marker Stations." To qualify for such appointment, the station must be one equipped with adequate precision frequency apparatus to guarantee that it can maintain its designated frequency to within 0.1%. The types of transmitters best for this service are crystal-controlled outfits with crystals operated at constant temperature and self-controlled sets which are continuously monitored by a constant-temperature crystal standard. The frequency of the station's standard must be ac-

curately known and frequently checked against standard frequency transmissions. Calibration by the Bureau of Standards at Washington would be best of all.

Such marker stations will not be permitted to operate "flat on 7000" or on any band's limiting frequency. The frequency specified must be not closer than 0.1% of the limit.

If you have the equipment and ability to render service to amateur radio as the operator of a Marker Station, write HQ and give us the dope. The number of stations which can be appointed must be limited in number and they must be the best we can find. Their calls and operating frequencies will be published regularly in *QST*.



— J. J. L.

New DeForest Tubes

THE DeForest Company has recently brought out a d.c. screen-grid tube which, so far as we know, has no counterpart in the types made by other manufacturers. It is known as the 422-A, and is equivalent to the 422 except that the filament consumption is only 60 milliamperes, as compared with 132 m.a. for the usual '22. The filament voltage is 3.3. The drain on the "A" battery is, therefore, the same as with a Type '99, which makes the tube well suited for portable receivers. The 422 and 422-A differ from other Type '22 tubes in that their plate resistance is 250,000 ohms, with a mu of 150, and mutual conductance of 600 micromhos. With this low plate resistance a greater portion of the theoretical amplification of the tube can be realized in practical circuits.

The new 566, a mercury-vapor rectifier, is similar to the UX-866, although differing in several important respects. The maximum inverse peak voltage rating is 7500, and the peak current is 600 m.a. The construction of the filament is rather novel, because it is in the form of a horizontal "Z" instead of the usual inverted "V". This construction makes the plane of the anode and the plane of the filament parallel.

There is also a 572, with the same sort of envelope as the UX-872, but with internal construction like the 566. The inverse peak voltage rating on this tube is also 7500, with a peak current rating of 2.5 amperes.

Strays

The Constitution and By-Laws of the League have been reprinted in revised form showing all amendments up to May 15, 1930. A copy is available to any member of the League upon request.

Naval Reserve Holds Its First National Emergency Drill

By William Justice Lee*

THE Volunteer Naval Communication Reserve held its first national emergency drill by radio on May 1, 1930. This was an event that had been looked forward to for many months, not only by various Naval Reservists in all parts of this country, but also by the personnel of the Office of Naval Communications, Navy Department, Washington.

At 4 p.m. E.S.T. on May 1st a despatch addressed to the Commandant of each Naval District in the continental United States was handed to the supervisor in Radio Central, Navy Department, Washington. This message was classified as urgent, taking precedence over what is known as priority traffic, and instructed each Commandant to arrange to have either the master or alternate reserve radio control station of his district manned at 10 p.m. E.S.T. This also included the Naval Districts on the Pacific Coast.

Some few days prior to this emergency drill, instructions had been forwarded by the Chief of Naval Operations to the Commandant, Twelfth Naval District, San Francisco, instructing him to designate one of the two Twelfth Naval District Reserve control stations as the senior control station for the West Coast. Accordingly Reserve Control Station NDH, located in San Francisco, was so designated. In the meantime instructions had been forwarded to the Commandant, Ninth Naval District, Great Lakes, Illinois, to arrange so that when the national emergency drill was conducted, Master Control Station NDS, Chicago, could act as relay for any traffic between the east and west coasts. There was no advance notice given to the reserve personnel as to just what date would be decided on for this emergency drill as otherwise the emergency feature would not have amounted to much.

The senior control station for the United States was NKF, the transmitter of which is located at the Naval Research Laboratory, Bellevue, D. C., and which is keyed from Radio Central, Navy Department. This station and all others in the master control reserve net operate on 4045 kc.

The purpose of this drill was to determine speed of mobilization, completeness of representation of districts, control over the reserve stations by each district Commandant and the feasibility of relaying radio messages back and

forth across the United States over the Naval Reserve Net. In the urgent message of instructions sent to Commandants on May 1st one requirement was that certain districts should originate short messages, some of which were to be addressed to the Chief of Naval Operations, Washington, and others addressed to districts on the opposite coast. The plan of the drill was worked out so that each district, both east and west coast, would either send or receive one message.

Promptly at 10 p.m. NKF, with the writer as operator, broadcast a short message of instructions and then proceeded to call each station in numerical order of districts, beginning with the first and ending with the ninth. Every naval district reported with a station manned and ready for traffic. On the west coast according to instructions, the Eleventh and Thirteenth Naval Districts reported to senior control station NDH at San Francisco in the Twelfth Naval District.

By 10:33 p.m. a Naval Reserve radio station in every Naval District in the United States had reported itself manned and ready for traffic. This constituted a 100% mobilization, based upon the orders from the Chief of Naval Operations. Most of the eastern Districts originated messages as instructed and sent to Chief of Naval Operations through NKF. There were one or two stations that failed to originate messages, but in the main compliance with orders was very complete.

The naval districts represented, the call letters of the stations on the air, and the locations were as follows:

- District of Columbia — NKF, Bellevue, D. C. (Senior Control)
- First Naval District — NDA, Medford, Mass.
- Third Naval District — NDF, South Manchester, Conn.
- Fourth Naval District — NDC, Wilmington, Del.
- Fifth Naval District — NDE, Baltimore, Md.
- Sixth Naval District — NDJ, Atlanta, Ga.
- Seventh Naval District — NDL, Orlando, Fla.
- Eighth Naval District — NDD, Pensacola, Fla.
- Ninth Naval District — NDS, Chicago, Ill.
- Eleventh Naval District — NDV, Los Angeles, Calif.
- Twelfth Naval District — NDH, San Francisco (Senior Control)

*Lieut. Comdr., U.S.N.R., Navy Department, Washington, D. C.

Thirteenth Naval District — NDQ, Seattle, Wash.

NDH of the Twelfth Naval District relayed for 12th and 13th Naval Districts for purposes of transcontinental communication.

Arrangements had been made with the national headquarters of the American Red Cross, Washington, for a message to be sent by them to the American Red Cross representative in San Francisco. The plan provided for this message to be forwarded via NKF Washington, NDS Chicago, and NDH San Francisco, and to be delivered by NDH. A reply was to be obtained and returned over the same route. The message from Washington was given filing time of 10:10 p.m. This was sent to NDS at 10:52 p.m. and delivered by NDH to addressee in San Francisco at 11:20 p.m. The reply was filed by Red Cross, San Francisco, two minutes later at 11:22 p.m. and delivered to Red Cross, Washington, at 2:22 a.m. May 2nd. The total time elapsed was three hours and thirty minutes. This is comparatively slow, transcontinental relays having been accomplished before in less time, but they were always organized along beforehand and involved considerable preparation.

As far as the National Emergency Drill was concerned, the maximum advance preparation was six hours and many of the stations did not receive their notice to be on the air until just before the time set, as instructions had to be relayed from the Commandants, in some cases several hundred miles by telephone or telegraph. In addition to this there was a very severe electrical storm in the neighborhood of Chicago, heavy atmospherics seriously delaying the reception of traffic from the West Coast. The east-bound Red Cross message sent by NDH to NDS had to be repeated several times and some words in the message had to be repeated fifteen times before reception was finally completed and the message received for. The operator on duty at NDS was none other than Lieutenant Commander R. H. G. Mathews, C-V(S), (Matty of 9ZN), and although he reported his antenna had been twice struck by lightning during the drill, no serious harm was done and he stuck to his station until the traffic was cleared. The drill was concluded at 2:07 a.m. E.S.T. May 2nd by the following message:

NDH NDS V NKF BT WELL DONE 0207 VA

There certainly was a thrill for everyone who took part in this drill. It was a wonderful thing to hear each district station answer smartly and in order when it was called.

Let us stop and think what this means. In 1925 when the Volunteer Communication Reserve was first worked out on paper there were no naval reserve stations and very few officers and men — certainly less than 150 in the whole United States. During the course of the next five

years this small organization developed and expanded until it now has one or two reserve control radio stations in every naval district, assigned a naval call ("N" call). Many of these stations are privately owned, although the Navy is now planning to furnish government transmitters to certain districts during the coming year. The progress from nearly nothing in 1925, to the present time, is shown when every continental naval district can man a reserve station during an emergency drill with six hours or less notice. A special frequency for the Naval Reserve represents another great advance, for a few years ago there was no special frequency provided for naval reserve radio communication.

In the matter of personnel, great strides have also been made and the Volunteer Communication Reserve today represents over 2000 officers and men appointed and enlisted from among radio engineers, commercial operators, and the amateurs. We are probably safe in saying that the Communication Reserve today represents over 1000 of the best amateur stations in the United States.

There are many Navy and Naval Reserve activities in which our Communication Reservists take part. Recently the *Eagle 52* has been making week-end cruises from the Philadelphia Navy Yard and the ship's radio is manned by a Volunteer Communication Reserve crew, consisting of one officer and three or four men. The Commanding Officer of the *Eagle 52* has expressed himself as pleased with the services performed by these reservists and in fact it is understood that until these arrangements were made this vessel had not satisfactory communication with its district headquarters. The same system is being followed in the Fifth Naval District at Baltimore and in other naval districts.

There are few amateurs to-day who do not know something about the Communication Reserve. Almost anyone who is equipped to listen on the eighty-meter band (4000 kc.) can hear naval reserve stations operated every night in the week except Saturday and Sunday. The control stations will be found on 4045 kc., between NAA on 4015 kc. and WIR on 4050 kc. One of the most active nights in the week is Thursday, because on that night the national drill net is operated from NKF. At 9:30 p.m. E.S.T. each Thursday NKF sends a short message broadcast by radio telegraph to all districts except the West Coast. When this is concluded a short drill is held, and messages sent and received in tactical procedure.

The writer has been connected with amateur, experimental and naval reserve radio for years and has seen the Naval Communication Reserve grow from almost nothing to its present state of development. It seems now almost safe to predict that within a very few years more this branch of

(Continued on page 34)

Hamming With a Portable in Africa

By Clyde De Vinna*

SENDING a troupe of thirty people into Central Africa to make a motion picture from the popular book "Trader Horn" was in itself somewhat of a problem, and as the problem got more and more nearly toward a solution, many smaller and erstwhile unthought-of details began to crop up. At the outset it had been decided to establish our base at some central point, there to have our offices and laboratory for the processing of the film as we "shot" it. Immediately came the thought, "How to keep in touch with that base?" for we were certain to be moving about the country; more than likely to be completely out of touch with the telegraph system, and yet it was imperative that fast and constant contact be maintained with the laboratory, for our following move depended upon their okeh on the film sent in from that location. Moreover, we must keep in touch with our business manager who would be "out ahead" of the company making arrangements for forthcoming moves, and also to be reckoned with were arrangements for supplies (must have food!) — medical emergencies to be considered — and many such items.

It came somewhat naturally that a ham should be the solution; indeed, what problems and emergencies of like nature during recent years have not been solved by hams?

Perusal of the call book and a hurry up message to WIMK brought a list of the most active amateurs in British East Africa. A 'phone call to our old and reliable friend Ralph Heintz in San Francisco brought him down on the next train with one of his compact little portable outfits. Fred Roebuck, late of KUP, came along for moral support, but we gave him plenty of work to do when he arrived.

The demonstration of the set at the studio that afternoon was attended by a large and enthusiastic gathering. Incidentally, the sound department of the studio includes in its personnel a great many hams and ex-hams; as our "audience" increased, the population of the sound department decreased proportionately — so much so that the boss himself came out and asked us if we would please shut down so they could do a little recording in the sound department.

The set is a gem. Completely portable and independent, it can function in any location, and on very short notice. There are six units in the outfit, each with a heavy canvas cover, and the whole lot together weighs just over two hundred

pounds. Power is derived from a gas-engine-driven magneto generator which supplies the primary of the plate transformer at 65 volts, 240 cycles, and filament current at 10 volts. The transmitter is H. & K's modification of the standard t.p.t.g., using one "50-watter" and is simple, yet exceedingly flexible and efficient.

The receiver is standard detector and two-step, using tube-base coils and Western Electric "N"

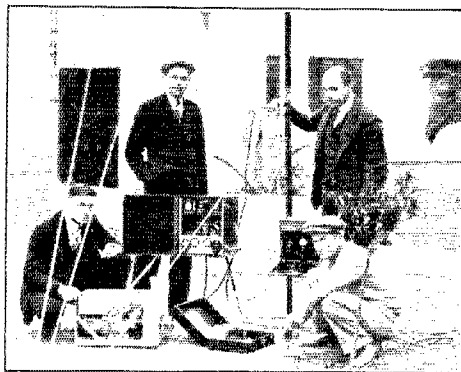

Photographs by Bob Roberts, M.G.M. cameraman with "Trader Horn" African Expedition.

THE COMPLETE OUTFIT SET UP FOR TEST IN HOLLYWOOD

The gasoline engine generator set is on the ground at the left with the spare-parts box opened beside it. The 50-watt transmitter and the receiver are on the tripods, near the base of the telescoping antenna. W. S. Vandyke, director of "Trader Horn," stands behind the transmitter while Ralph Heintz, designer of the outfit, holds down the antenna. Fred Roebuck, ex-KUP and W6XBB, is custodian of the power supply with Clyde De Vinna unsuccessfully attempting to hide behind the small bush.

tubes. Both the transmitter and receiver will operate on any frequency between 3700 and 19,000 kilocycles.

The radiating system consists of a telescopic brass mast (which can be extended to a maximum height of about thirty-five feet) as the antenna, and an adjustable counterpoise.

A 200 candle-power light is furnished which, when connected to the generator, supplies illumination for night setups. Incorporated in the receiver is a drawer which carries the headphones, spare tuning coils, and a wavemeter. Another felt-lined compartment carries the two transmitting tubes (one spare) and five receiving tubes. A compartment in the back holds three No. 6 dry cells comprising the "A" battery and two blocks of small 22½-volt "B" battery. Both the transmitter and receiver are provided with detachable

* W6OJ-W6ZZK, ex-FK6CR, Chief Cinematographer, 8029 Hemet Place, Hollywood, Calif.

legs, and the lid of the receiver forms the operating desk when open. The accessory case is used as a seat. The outfit is truly an independent unit.

So much for description. As to performance, it's the berries. Something in the neighborhood of 700 messages were exchanged between our outfit

A special license was granted to Mr. Sydney Pegrume, FK5CR, at Nairobi, to handle the traffic at the headquarters end.

A finer lot of chaps than the personnel of VPQ would be mighty hard to locate; the chief, George F. K. Ball (VQ4MSB), Sam Hughes, and L. J. Hughes — all friendly and more than anxious to cooperate.

Immediately upon being authorized to operate our set under the call FK6CR, a test schedule with VPQ was arranged for each evening, and was carried out during the entire trip with very few misses. This was interesting to us, and I believe was of considerable value to the Government; a complete log was kept, and also made a very comprehensive record of transmitting and receiving conditions throughout the colony.

"Peggy" — then FK5CR and now VQ4CRE — was whole-hearted in his cooperation, and went to no end of trouble and extra work in rebuilding, etc., to take care of his end. That the deal was a success is due just as much to his efforts as to those of anyone. It's true that he had never handled traffic before (being a law-abiding Britisher), but a ham's a ham under any flag and there's not much that can stop him! A little kind assistance from "Mac" now and then, and everything went swimmingly.

A preliminary scouting trip served admirably to get the arrangement broken in, and by the time we swung into production some six weeks

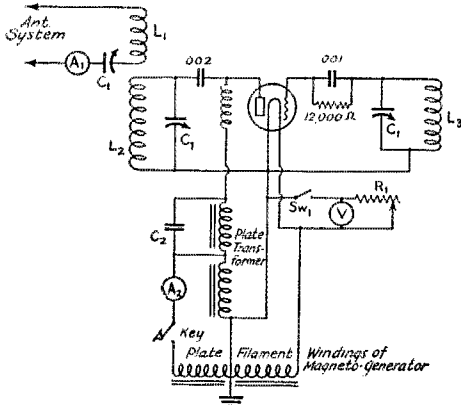

FIG. 1.—THE H. & K. 50-WATT T. G.T. P. TRANSMITTER CIRCUIT

The plate supply is a.c. and is now illegal for amateur use in the U. S. A.

L_1 , L_2 and L_3 — Copper-tubing antenna, plate and grid coils equipped with plug-in mountings. Any one of the eight coils may be plugged in the antenna, plate or grid circuit. This arrangement gives a frequency range between 19 mc. and 3700 kc. with a set of eight coils having 3, 4, 6, 7, 10, 11, 14, and 16 turns respectively. The diameter of each is approximately 3 inches.

C_1 — 450- μ fd. transmitting variable condensers.

SW — Protective switch in tube base to disconnect shunt filament rheostat when the tube is removed.

RFC — Plug-in radio-frequency choke.

R_1 — Shunt filament rheostat. The characteristics of the magnet type generator make this filament control most satisfactory.

C_2 — Condenser to improve power factor of supply.

A_1 — 0-2 amp. antenna ammeter.

A_2 — 0-5 amp. a.c. supply ammeter.

V — 0-15 volt filament voltmeter.

in the field and the base station in Nairobi, working from 50 to 1500 miles and under nearly every conceivable condition — but I'm getting a little ahead of my yarn.

Our arrival in Nairobi and inquiry as to the license situation was met with the information that it would be difficult if not impossible to obtain the desired authority to use the set, the "powers that be" there not being entirely in sympathy with the amateur, and less than that where our semi-commercial proposition was concerned. Several interviews were had with the postoffice authorities and, fortunately, we were able to interest them in the short-wave phase of radio. A demonstration of the set one afternoon, working with their government station VPQ at Mombasa (a distance of about 500 miles) was very interesting to them and with the aid of the bunch at VPQ, as well as those at Nairobi, arrangements were finally made to operate the set.

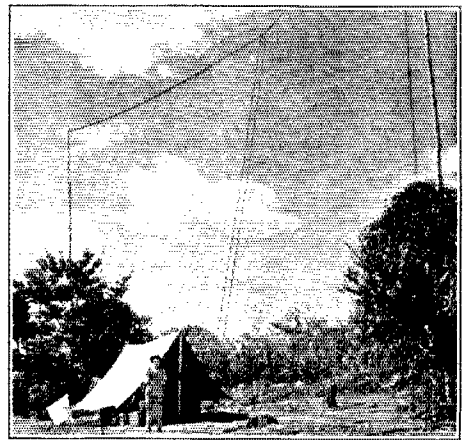

SET UP FOR OPERATION IN THE BELGIAN CONGO

This QRA is some 2000 miles from the west coast of Africa. The set is in the tent with the portable Zepp antenna swung above it between the two trees. This antenna system gave very good results on both the 7- and 14-mc. bands.

after our arrival in the country, everything was running smoothly, or as nearly so as could be expected.

Most of our moves were made by automobile; a specially designed Hudson carrying the most

vital parts of the camera outfits and the radio set. Thanks to very efficient co-workers, I never had to bother about details of camera organization, and was able to start putting up the set immediately upon reaching a location. Mr. Van Dyke, our director, gave me full leeway in this respect, and many a choice tent site was given up to the radio department because it was the most suitable spot for the set. It's odd how often this coincidence happened — the most pleasant spot in camp proving to be the most efficient location for the wireless set (MIM).

Since most of our work was in the wooded sections of the country, the telescopic mast was given up in favor of the old familiar "Zepp," thereby gaining not only speed of getting into operation but also in overall signal efficiency. The detachable feeders described in a recent issue of *QST* were a great help in getting the set up quickly.¹ The radiator was 65½ feet long, and the feeders about 38 feet. Series tuning was used in the 7-mc. band and parallel tuning for 14 mc., the transmitter being provided with convenient facilities for this change. When conditions were such that 3500-ke. seemed advisable a separate counterpoise was put up, but the great bulk of the work with Nairobi was done in the 7-mc. band.

Operating conditions in Africa are in general pretty bad, at least in those parts of the country where we worked. We were at an average elevation of about 4000 feet, but usually more or less surrounded by mountains as high as 14,000 feet or so, and something in this combination of high, cool altitudes and the warm air currents from the sub-tropical sections of the country made for some mean weather conditions. Static abounds and almost every day we were visited by thunderstorms and often found it necessary to ground the antenna and let it rain.

Our work developed into a more or less regular routine; the VPQ sked at 6:30 p.m. local time, and FK5CR at 6:45. We usually cleared him before dinner (7:30), although frequently the schedule was resumed after dinner. When there were no other demands, we used to work one or more of the Philippine gang in the early evening, they having just finished with their W6 skeds; had many fine QSO's with them and gave them quite a bit of traffic for the folks back home. Some evenings afforded sufficient spare time for chats with some of the European stations (there are many splendid ones), or with some of the South Africans. Many enjoyable friendships and "unofficial" skeds were thus made.

The outstanding pleasant recollection of the

¹Nov. 129 *QST*, pp. 43.

trip, however, is the way W1MK kept after us — "RP" and some of the rest of that outfit at Hartford pounding away "blind" night after night for months. W1MK was heard on every sked that I was able to listen to, and we tried our durndest to get through to him, but it wasn't in the cards; 7 mc. simply couldn't make the grade. We heard hundreds of W's in the 7000 band, in every district except the sixth and seventh, but couldn't raise a single one of them.

Incidentally, one gets a great idea of the situation generally, and of the rotten (apologies to T O M) notes and rottener operating practice, by getting off at sufficient distance to hear nearly all of the stations come together in a sort of a focus. To the credit of those who deserve it, and there are many, let it be said that there was a great improvement noticed during our stay down there; during 1929 there seemed to be a sort of general cleaning up and general betterment of signals. Up to the time of departure, however,



THE "TRADER HORN" COMPANY ON THE UPPER NILE IN UGANDA COLONY

The portable set followed everywhere, from dense jungle to rocky gorge, keeping contact with the outside world.

Utopia had not been reached! It was interesting to note some features of the more consistent signals. The best ones heard did not necessarily originate at the high powered stations; in fact, one of the two sixes heard was using a single 210 — our friend W6BWS in Phoenix, Arizona. The other six was W6EIL, Oren Baker of Los Angeles, using a 50-watter. Checkups have indicated that signals from a well-adjusted, intelligently operated low-power layout will run circles around the so-called high-powered set operated carelessly. You fellows who sit back here in this land of QRM cannot imagine how I longed for a QSO with some of your good stations — and I nearly burned up that little generator trying to raise some of you,

especially OM Roebuck, who I knew was pulling for me from KUP and W6XBB.

14-mc. signals finally came through, but the trouble with them was that they came in beginning about 11 p.m. local time, and even the most enthusiastic of us can't stay up half the night and then get up before daybreak the following morning. Some mighty fine QSO's were had with 1's and 2's on 14 mc., though. A fairly com-



SHOOTING SCENES IN THE CROCODILE POOL

The armament wasn't donned for photographic effects — sometimes a "crock" made shooting necessary with weapons as well as cameras.

plete log was kept, and some of these days I hope to QSL each of them. Because of the pressure of work since our return I have had to neglect them somewhat, which wasn't my intention by a whole lot, but they can take this as an open letter of appreciation until I have a chance to write them a better one.

When I had time, I sent in lists of calls heard down there — not complete, by any means, but enough to give an idea of how the signals were coming through.

During the months of our stay many interesting experiences were had — some funny, and some not so humorous. The radio set was a never ending wonder to the natives — they could never understand it, of course, but they associated it with the land telegraph system; in fact, the first few moves we made the gang whose duties were to take care of the tents stood by to help dig up the wires which they were sure we had buried some place! Assistance was never lacking, and the boys would help to whatever extent they could — putting up the lines for the antenna, or putting up my tents in record time — but they would not touch a wire or any part of the set proper. I found out later that Mr. Waller, our safari superintendent, knowing their liking for bright or glittering things, had very seriously cautioned them against meddling with the equipment, telling them that if they touched anything connected with the radio set, huge tongues of flame were sure to leap out and completely consume them. Needless to say, nothing was ever bothered. After their fashion of naming everyone in the party — not always complimen-

tary — the natives styled me "the master who talks with the winds" — descriptive, at least.

In Africa, four o'clock tea is an institution, and we quickly fell into the habit. In this connection are served what they term "biscuits" (we know 'em as cookies), and one particular variety became such a favorite with the gang that it became difficult to keep a sufficient supply on hand. The head boy of the commissary department used to keep a few tins of them hidden away for some of his favorites, or at least we so suspected. One afternoon the steamer had just arrived with a consignment of supplies previously ordered by radio, and I knew that in the shipment were several cases of these particular biscuits, so when my personal boy arrived with the tea minus the favorite wafers, the head boy was summoned. He protested at great length that there were none of the favorite biscuits in camp, nor had there been any for a great many days; whereupon I explained, through the interpreter, of course, that I had spoken to the wind gods in connection with this momentous matter, and that they had assured me that upon this very day would arrive several cases of that particular delicacy — in fact, that right at that very moment, down at the landing a mile or so below camp, they were being unloaded. He could scarcely believe his ears. After a visit to the landing proved that the wind gods were correct, never again was there a scare-



SHOOTING A SOUND SEQUENCE IN A NATIVE VILLAGE, BRITISH EAST AFRICA

The condenser microphone is suspended above the author's head and connects to the portable amplifier equipment at the right. The actual recording takes place in the sound truck parked in the background.

ity of the good biscuits, or of anything else in the store!

It wasn't all a joke down there, however, by a great deal; seamier sides put in appearance frequently. Late one night a playful cloudburst filled our camp with a few feet of water; the wind blew, and several tents came down, among them the one housing the transmitter. Imagine a high-frequency transmitter soaking wet! Once we had the "Zepp" tied off to an old dead tree; the wind brought the tree down alongside my tent. And so on. Each new location had its thrill of a new and

usually different setup — new problems to be worked out. Without the splendid cooperation of my fellow workers, cameramen, sound crew and electricians, the success of the effort would not have been nearly so marked; but they were with me 100%, and often put in a good many hours of extra work to help me out of one difficulty or another.

We finally evolved a scheme which saved us a good deal of effort as well as adding to the efficiency of the set. When we were in one of our semi-permanent camps where we would be likely to remain for a week or more, we put up the whole camp equipment, which included a Kohler lighting plant, Frigidaire, projecting machine, etc. — in other words we lolled in the lap of luxury, at least temporarily. We obtained a half-kilowatt 500-cycle generator, vintage of about 1910, which we hooked to the Kohler, controlling it by means of a remote control magnetic switch (dope from QST) to cut off the a.c. at the machine, eliminating the hash. The scheme worked splendidly, putting an R5 to R6 signal into the East Coast U. S. A. stations, and giving FK5CR plenty of signal strength to help battle the static. A great deal of our traveling was done with a rather limited camp equipment. However, when we planned to be in a locality but a short time, only the necessities were taken, and those occasions brought on the use of the gas engine generator. Nearly as good results were had, however, and some of the stations expressed a preference for the 240-cycle note.

There were times when the set had to be carried by porters, sometimes to quite a distance, and at such times the equipment was quite likely to receive various and sundry bumps and jolts; but it showed no ill effects from such treatment. Once the generator fell into the Nile River, but seemed none the worse for it. Getting thoroughly soaked by the numerous rainstorms was more or less a regular occurrence, and while the cases show considerable wear and tear, the "works" never missed a shot.

One move we made, across Lake Albert and down the Nile, called for a stay of three days on the S.S. *Lugard*, one of the river type of steamers which serve that territory. It was with a great deal of doubt that we put up the set, because the best installation we could get resulted in the aerial dangling out toward the stern not more than ten feet above the galvanized iron roof that covered the whole ship; visions of absorption, wobblulation and what-not came to mind, and you can imagine my embarrassment when VPQ reported the loudest sigs of the whole trip — FK5CR said he thought we had arrived in Nairobi, and the W's gave me R7! We had a lot of fun out of it, and Captain Cullum, the genial skipper, got a great kick out of sending TRs to his headquarters — the first ship equipped with wireless on Lake Albert! Another great scout,

Captain Cullum; true, the ice supply was a little shy, but everything else was FB!

Practical results had from the set were legion. Aside from our routine work, there were a great many instances where it saved us many times its cost and bother of maintenance. Once, for instance, we divided our outfit, taking a skeleton



IMAGINE A HIGH-FREQUENCY
TRANSMITTER SOAKING WET

The author is cleaning the outfit up after a cloudburst. No harm done, however, because the set is designed to work in the rain — the specifications call for operation of the set after a hose has been turned on it!

crew into the Belgian Congo for three or four weeks work and sending the remainder of the party to Kampala, agreeing to a rendezvous some weeks later. After a few days of the bad weather then prevalent in the Congo, however, Mr. Van Dyke decided to recall the rest of the company and resume work along the original lines. With the use of native runners and the land telegraph, this probably could have been accomplished in ten days or two weeks; thanks to the radio we were all back together and ready to resume work in four days. Figure this out at the rate of \$5,000 per day, which is the estimated cost of our operations throughout the entire trip.

Dr. Clarke, our jolly and well-liked safari surgeon, found that some of his pet serums had been lost during one of the moves; a message to Nairobi started a fresh supply to us that night. Measurements for a broken piece of camera equipment were sent in by radio, and a new part left Nairobi the next morning. Details for the construction of a specially built camera car to be used in photographing animals were sent in, and the car was waiting for us when we arrived in Nairobi a week later.

One of the troupe was so worried about the condition of relatives ill in Nairobi that he announced that he was leaving for there the following morning; this would have stopped production absolutely, as there was nothing we could do without him, he being in every scene, and the trip to Nairobi and return would have taken from a week to ten days. But "Peggy" cranked up his trusty Rugby (he is an automobile electrician by trade) and following a conference with

the hospital officials as well as with the party in question, sent me a lengthy and detailed report of the situation, and we resumed production as usual the next morning.

Reception was uniformly difficult; QRN with us almost constantly as well as other forms of diversion. One night I was QSO W2FP, at about five p.m. his time, and he complained that the QRM from the passing automobiles (14 mc.) made it very difficult to work. I replied that QRM from the hyenas yipping around my tent made it difficult to read his R5 sigs at times, so we were even. It was true, too; we were down in the game country, and the hyenas were thick around the camp after the bait we were putting out for other animals.

For the most part, the conventional single wire receiving antenna was used, length proportional to the QRN at the time, some experiments were made with the tuned doublet as described in *QST*, but there wasn't sufficient time to give it a thorough trial.

Radio work in Africa is very seasonal. There are months when it is impossible to work any DX at all, and other times when signals come in well from nearly all over the globe. One night I clicked with a fellow in Cairo, Egypt, who told me that he had been listening for months, and mine was the first signal he had heard. Verily, the one main requisite of hamming in Africa is patience, and plenty of it.

They're a fine bunch of hams down there, aggressive and keen on their organization; they publish a snappy journal called "QTC" which they kindly mailed to me each month while we were there.

En route both ways a good deal of fun was had with the set. One time, from about the center of the Red Sea, we worked a station in Venezuela, as well as some not so far away. The trip was very interesting from a fraternizing standpoint. Obviously I cannot call the ships by name, but we were on British, German and Italian ships, and I found the operators uniformly courteous and friendly, and all very much interested in the little set, as well as the project in general. I even maintained sked with one of the ships for months, whenever he came within range. "Sat in" on the various ships, and had plenty of fun doing it. Incidentally, one ship had a difficult press sked

to be kept, and the operators were amazed at the way the little Heintz and Kaufman receiver outperformed their rather elaborate screened-grid affair, which it did time after time.

FK6CR is history now, but there remain a lot of mighty pleasant memories from the trip. The W6 gang was mighty loyal and fine in the way they kept looking for us and trying to raise us, as were the hams pretty well all over the U. S., and I feel under great obligations to all of them. The set is being overhauled now, getting ready for another trip which may come up within the next few months, and perhaps then I may QSO some of the stations I missed on the African trip.

For the benefit of those who may be interested, the picture made in Africa on this trip is "Trader Horn," and will probably be released during 1930 by Metro-Goldwyn-Mayer. While you are enjoying it you can figure that "ham radio" meant a lot to us down there, both from the standpoint of time saved and of having our hobby right along with us to pass away the spare time which otherwise would have been tedious in the extreme.

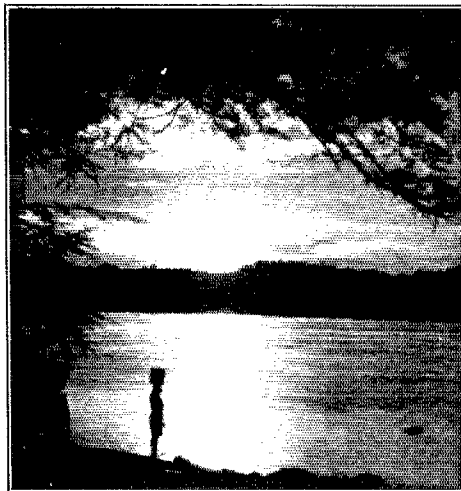

TIME FOR EVENING SKEDS

Sunset across the Upper Nile at the camp near Murchison Falls, Uganda, B. E. A.

Strays

W9NJ found this one in a newspaper story of recent Marconi radiophone experiments:

"Senatore Marconi reported that his power, taken from a storage battery, was only about three-quarters of a kilowatt and that he was broadcasting on a frequency of 11,254 *horsepower kilocycles*."

Maybe he uses a prony brake as a frequency meter!

If it weren't for the newspapers we'd be short of "strays." A paper in Houghton, Mich., referring to the *Handbook* called it the *QST Handbook*!

Correction

In Fig. 1 on page 10, May *QST*, the plate and grid of the UX-842 modulator tube were reversed in the drawing. The plate should be connected to the choke T_1 and the grid to the secondary of the microphone transformer.

VE2CA

A Medium-Power Station of Modern Design

IT often happens that people who have something to talk about are most inclined to say nothing. If Jim Lamb hadn't dropped in on VE2CA during his vacation last summer, we probably wouldn't have had an opportunity to present this station description in *QST*—and we feel sure the amateur fraternity will be in-

a Hartley circuit. While no exceptional work was done, many fine chats were had with the gang on this continent. In April, 1928, the 203-A died of old age and an 852 was installed, with greatly improved results. In the fall of 1928, spurred on by the League's Technical Development Program, the high-C Hartley was tried, and after

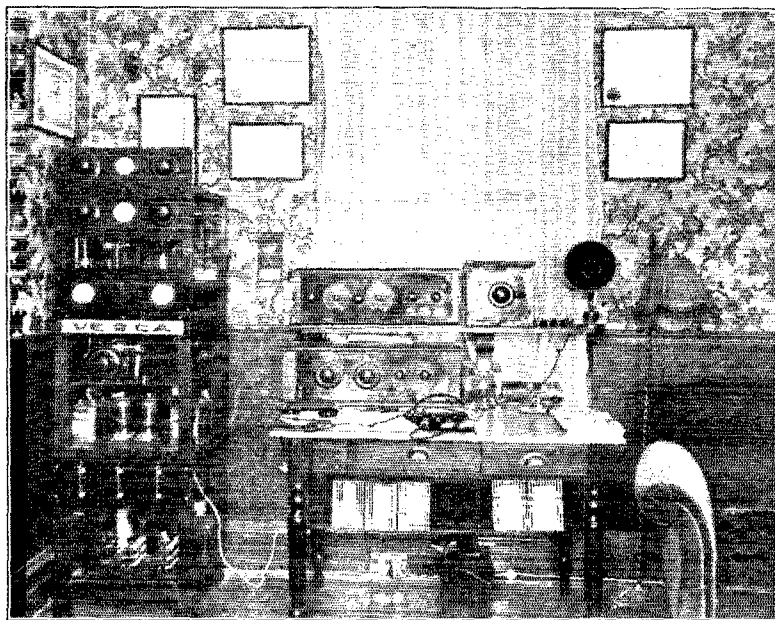

STATION LAYOUT AT VE2CA

As the set is located in the living room, "haywire" apparatus is out of the question.

terested in it, because everything is home-made with the exception of those parts which are more economically bought than manufactured in the ordinary home workshop. Furthermore, it's a good job, as those who have heard or worked VE2CA will testify.

The owners are Mr. and Mrs. Earle H. Turner, of St. Lambert, P. Q. They both operate; in fact, the OW has been handling most of the QSO's during the past few months. Those of us who are married know what such coöperation means; and the others don't need a whole lot of imagination to appreciate it. Earle didn't say just how the Mrs. came to take up amateur radio—maybe it was in self-defense.

The station first went on the air in December, 1927, with a UV-203-A tube of ancient vintage in

considerable experimenting, during which much copper tubing was wound and junked, the present 7000-kc. transmitter emerged. In the meantime the owners became much enthused over the possibilities of the 14,000-kc. band, and a second transmitter for this band only was installed early this year.

A general view of the station is shown in the first photograph. The apparatus is located in the living room and space is limited; consequently the equipment is compact and designed to present a neat appearance. The large frame at the left holds the two transmitters and the power supply; the receivers, monitor, frequency meter and keys being on the operating table at the right and on the shelf above it. Most of the work is done on the 7000-kc. and 14,000-kc. bands, and the

sets can be quickly shifted from one band to another.

THE TRANSMITTERS

Two identical transmitters are mounted on the frame, one permanently on 14,000 kc., the other

The filament voltmeter, with a double-pole double-throw switch for connecting it across either the filaments of the rectifier tubes or the oscillators, and the plate milliammeter are mounted on the latter panel.

Since both transmitters are the same electrically and very nearly so mechanically, there is no need to consider them separately. The 14,000-kc. transmitter is just below the sign with the station call letters, with the parts mounted in breadboard fashion. Two switches (not visible in the photo) provide the means of transferring the plate and filament supply from one set to the other. One, a triple-pole double-throw switch, serves as a change-over for the filament leads and negative high voltage. A single-pole double-throw switch takes care of the positive high voltage.

A UX-852 is used in each transmitter. The photograph of the rear of the top section of the frame shows the arrangement of the parts of the 7000-kc. transmitter, that of the 14,000-kc. set being similar. The tank inductance is made of 5/16-inch copper tubing wound to an outside diameter of 4 inches, and is bolted directly on the tuning condenser. This coil and the antenna coupling coil are mounted on glass rods, and the coupling is varied by sliding the antenna coil along the rods. The grid and plate

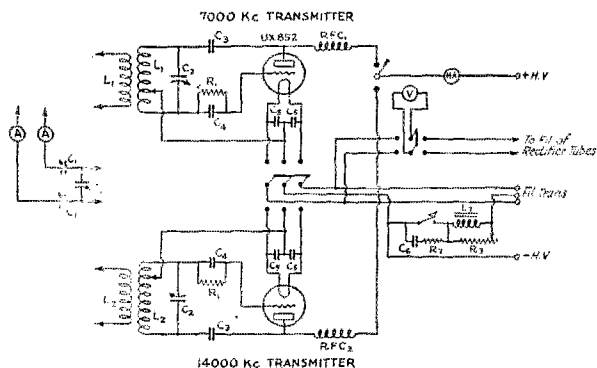

FIG. 1. — THE TWO TRANSMITTERS AT VE3CA

C_1 — 250- μ fd. antenna tuning condenser.

C_2 — 250- μ fd. tank condenser, double-spaced.

C_3 — 2000- μ fd. 5000-volt condensers.

C_4 — 250- μ fd. 5000-volt condenser

C_5 — 5000- μ fd., receiving type.

C_6 — 2- μ fd. telephone condenser.

L_1 — 4 turns of 5/16" copper tubing, 4" diameter.

L_2 — 3 turns of 5/16" copper tubing, 4" diameter.

L_3 — Special choke — see text.

R_1 — 20,000-ohm grid leak.

R_2 — 500 ohms.

R_3 — 500-ohm variable resistor.

RFC_1 — 160 turns of No. 30 d.s.c. on 1" form.

RFC_2 — 160 turns of No. 30 d.s.c. on 1/2" form.

A — Antenna ammeter, 0-3 amp.

MA — Plate milliammeter.

V — Filament voltmeter.

with interchangeable coils for the other two most popular bands, although used mainly for 7000-kc. work. The frame itself is built in two sections; the lower, of heavy construction, containing the power supply equipment and the 14,000-kc. transmitter, extending up to the sign with the station call letters; the top section, of lighter construction, holding the meter panel, 7000-kc. transmitter, and antenna tuning apparatus. The top section may be dismantled by simply removing three wood screws which hold it in place, this arrangement making it easy to get at any portion of the transmitter without the aid of a step ladder. Binding post strips are mounted on the rear of both sections, connections between the two being made by jumper wires. The entire framework is 18 inches square and approximately 6 feet high. It is solidly built and all apparatus is rigidly mounted, with the result that no trouble has been experienced from vibration.

The top panel contains the two series tuning condensers in the feeder system and one of the antenna ammeters. The panel immediately below it contains the other antenna ammeter, the tank condenser of the 7000-kc. transmitter, and the antenna parallel-tuning condenser. Part of the 7000-kc. transmitter can be seen through the opening between this panel and the one below it.

blocking condensers are mounted on the leads between the tank inductance and the tuning con-

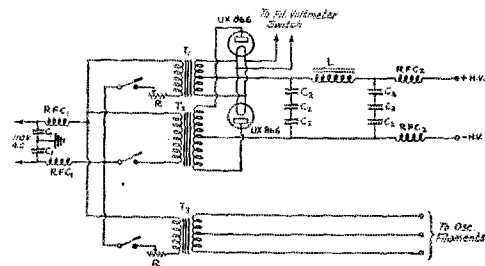

FIG. 2. — POWER SUPPLY EQUIPMENT

C_1 — 2- μ fd.

C_2 — 4- μ fd., 1000-volt filter condenser.

R — Resistors to control filament voltages — see text.

RFC_1 — 85 turns of No. 12 d.s.c. on 2 1/2" tube.

RFC_2 — 200 turns of No. 30 d.s.c. on 1" tube.

L — Filter choke.

T_1 — Filament transformer for UX-866's.

T_2 — Plate transformer.

T_3 — Filament transformer for oscillators.

The construction of the filter choke and the transformers is described in the text.

denser, a portion of each of the leads being flattened out and drilled to take bolts to which the blocking condensers are fastened. The flexible

leads furnished with the tube serve as connections between these condensers and the tube itself. The grid leak is mounted vertically and so placed that the leads are very short. The same is true of the r.f. choke in the plate circuit — the lead between this choke and the plate terminal of the tube is only one inch long.

The tank condensers in both transmitters are rebuilt receiving condensers. That in the 7000-kc. set is a Cardwell, the one in the 14,000-kc. set is an Admiral. Both were originally 43-plate condensers, and alternate plates in both stator and rotor were removed to make a double-spaced 23-plate condenser with a maximum capacity of approximately 250 $\mu\mu\text{fd}$.¹ The plate-spacing and insulation of these condensers is sufficient to withstand the r.f. voltages encountered in a transmitter using the high plate voltage taken by the 852. The capacity is somewhat less than that usually considered "high-C" in most amateur transmitters, but it should be pointed out that the characteristics of the 852 are such that a lower C/L ratio will give the same results — so far as frequency stability and freedom from "wobulation" are concerned — as a much higher ratio with other types of tubes, such as the 210 and 203-A. However, high-C is only a means to an end — the proof of the pudding¹ is in the results — and VE2CA's signals are invariably reported pure d.c. and often crystal-controlled. Part of it is undoubtedly in the care used in tuning the sets; the antenna coupling in particular is always very loose, 8 inches or more usually separating the coils.

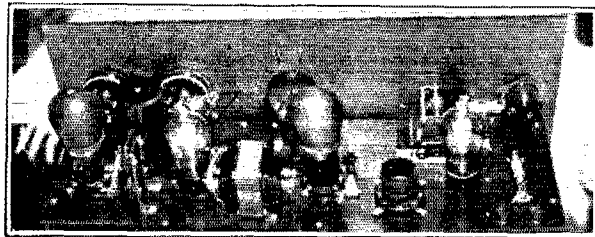

BEHIND THE PANEL OF THE 4-TUBE RECEIVER

Since the rear view of the 7000-kc. transmitter was taken, a Marconi T250 tube (rated at 250 watts) has been mounted alongside the 852 and can be put in the circuit in place of the latter if desired. The power output with this tube is high, but the note is not so good as with the 852, with the result that the latter is used most of the time.

POWER SUPPLY EQUIPMENT

The power supply comprises the customary transformer, rectifier and filter, with UX-866 mercury-vapor rectifiers. The oscillator and recti-

¹ Recent measurements made in the QST lab on two Cardwell condensers similarly rebuilt indicate that the maximum capacity is 205 $\mu\mu\text{fd}$.

fier filaments are supplied by separate transformers built for the purpose, the output voltages of which are regulated by separate rheostats in each primary.

The rectifier and filter occupy the compartment immediately below the 14,000-kc. transmitter. The transformers, resistors, and r.f.

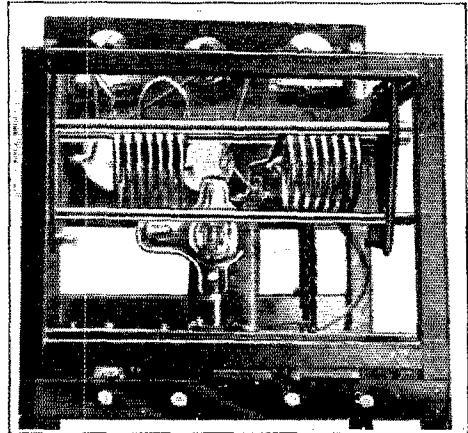

A REAR VIEW OF THE 7000-KC. TRANSMITTER
The mechanical arrangement of the 14,000 kc. set is similar.

chokes associated with the power equipment are in the lowest compartment. The three single-pole single-throw switches on the panel at the top of this compartment break the 110-volt line to each of the transformers. The lower section of the frame is constructed of heavy material, as it has quite a bit of weight to carry.

While the arrangement differs very little from standard practice for such equipment, it is of interest because the filter choke and the three transformers are entirely home-constructed. These units are therefore worthy of some description.

The plate transformer is wound on a core of square cross-section with a window $3\frac{1}{4}$ inches square. Each leg of the core is $1\frac{3}{4} \times 1\frac{3}{4}$ inches. A winding form to fit over one of the legs was made of 1/16-inch fiber, with circular end pieces of the same material. These end pieces are 6 inches in diameter, and are glued to the ends of the square form. Three layers of Empire cloth were wound over the form to provide good insulation; 6800 turns of No. 28 d.c.c. were then wound on the form, taps being brought out so that voltages of 750, 1050, 1350 and 1700 may be obtained each side of the center-tap. The finished winding was taped by passing through the center hole and over the top until the coil was completely covered, after which it was placed on the core leg and firmly fastened in place by means of small wooden wedges.

The primary winding is on the opposite leg, a layer of tape first being wound around the core, and small fiber end pieces installed to hold the coil in place. This coil has 220 turns of No. 12 d.c.c. Another layer of tape is wound on top of the finished winding. Angle iron braces hold the core

in this case are made of brass, as magnetic material would defeat the purpose of the air gap.

The choke and transformers were thoroughly coated with black Duco after finishing in order to present a neat and business-like appearance.

The rheostats in the primary of each filament transformer (marked "R" in Fig. 2) are wire-wound resistor units taken from an old commercial spark transmitter. Three of the units, which are wound on hard rubber strips, are used in series with each transformer, mounted one above the other, the top one having a slider and bar taken from an old two-slide tuner mounted on it for fine adjustment. Coarse adjustment is obtained by means of a clip on the bottom resistor.

Three 4- μ d., 1000-volt condensers in series are placed on each side of the choke to complete the filter. The total effective capacity is therefore 2 $\frac{2}{3}$ μ d., which has been found adequate for giving a pure d.c. signal in conjunction with careful adjustment of the transmitter.

To prevent any r.f. which may feed back into the power equipment from getting into the 110-volt line, a radio-frequency choke is placed in each 110-volt lead. A pair of 2- μ d. condensers connected in series across the line, with the common connection grounded, are used as further protection from feed-

back. This arrangement is of value in reducing interference with broadcast receivers operating on the same line. R.f. chokes are also provided in each high voltage lead, in addition to those in the transmitter itself.

ANTENNA SYSTEM

VE2CA uses the popular Zeppelin antenna, designed for fundamental operation in the 7000-ke. band, harmonic operation being used for the higher frequencies. The antenna proper is 67 feet, 9 inches long, with 39-foot feeders. The feeder spreaders are hard-rubber rods 10 inches long, drilled near the ends to fit the wire, with a longitudinal hole at each end tapped to take a 6-32 machine screw. When the screws are tightened the spreader cannot slip along the wire. These rods make very good spreaders, as they are mechanically strong, are good insulators and their weight is negligible.

The antenna and feeders are both constructed of No. 12 enameled wire. The ends of the feeders are brought into the station through Electro-se lead-in insulators inserted in a board which is placed in the window frame at the top. Connections between the lead-in bushings and the transmitter itself are made of copper tubing, as can be seen from the photograph of the station. Either series or parallel tuning of the feeders can be used.

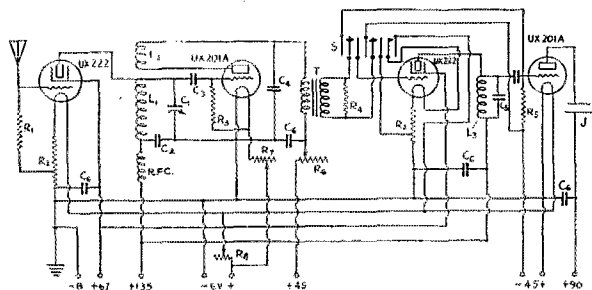

FIG. 3.—IN THIS RECEIVER EITHER PEAKED OR STRAIGHT AUDIO AMPLIFICATION MAY BE USED

- C_1 — Sliding-rotor tuning condenser.
 C_2 — 4000 μ d.
 C_3 — 100 μ d.
 C_4 — 3000 μ d.
 C_5 — 6000 μ d.
 C_6 — 1- μ d. by-pass.
 L_1 - L_2 — Plug in coils wound on tube bases. Wound by "cut-and-try" method to cover amateur bands.
 L_3 — Ford coil secondary.
 R_1 — 10,000 ohms.
 R_2 — 15-ohm resistor tapped at 10 ohms.
 R_3 — 10-megohm grid leak.
 R_4 — .25 megohm.
 R_5 — 8-megohm grid leak.
 R_6 — 50,000-ohm variable resistor.
 R_7 — 30-ohm filament rheostat.
 R_8 — 10-ohm filament rheostat.
 RFC — 100 turns of No. 26 d.s.c. on 1" form.
 T — 10-1 audio transformer.
 S — Yaxley 8-spring jack switch.
 J — Open-circuit jack.

tight, and a bakelite strip (on which binding posts are placed to serve as terminals) is mounted on the braces.

The filament transformers are similarly constructed. That for the 866's is wound on a 1 $\frac{1}{4}$ x 1 $\frac{1}{4}$ inch core with a 2" x 3" window. The primary has 440 turns of No. 20 d.c.c., the secondary 16 turns of No. 12 d.c.c., the latter winding being center-tapped. This transformer gives 4 volts, which allows the operator to compensate for fluctuations in line voltage, which are frequent at VE2CA's location. The filament transformer for the 852's is wound on a shell-type core, the cross section of which is 1 x 3 inches, with 2" x 3" windows. The windings are placed on the center leg, the primary having 550 turns of No. 16 d.c.c. and the secondary 65 turns of No. 12 d.c.c., center-tapped.

The core of the filter choke is rectangular, 1 square inch in cross section with a 2 $\frac{1}{2}$ x 6-inch window. One leg is removable, and the coil was wound on it after the usual layers of Empire cloth and tape had been put on. The end pieces are bakelite. The coil consists of 13,000 turns of No. 26 enameled wire, with a layer of paper between each layer of the winding. This leg of the core is not butted directly against the other section, but is held about $\frac{1}{8}$ inch from it by bakelite spacers, in order to provide an air gap. The braces to hold the parts of the core in place

The antenna system produces entirely satisfactory results on both 7000- and 14,000-kc.

A separate antenna, 60 feet long and 40 feet high, is used for reception.

KEYING

Center-tap keying is used, and a filter is provided to eliminate clicks. The filter is the usual lag circuit, and the connections are as shown in Fig. 1. The choke is wound on an old audio-transformer core, following the same construction as outlined above for the filter choke, except that the air gap is only $\frac{1}{16}$ inch. The coil was scramble-wound and as much wire was used as the space in the core window would allow. The wire is No. 28 d.c.c.

This filter is quite effective in eliminating BCL interference.

RECEIVING EQUIPMENT

Two receivers are installed at VE2CA; one, a four-tube receiver patterned after the set originally described in QST for November, 1928; the other, a conventional Hartley with a two-stage audio amplifier.

The four-tube receiver is the one on the shelf above the operating table in the station photograph. The "innards" of the set are shown in another photo. The panel is of bakelite, 7 x 18 inches, and is backed with a $\frac{1}{16}$ -inch brass sheet of the same size. The inside of the cabinet is completely lined with copper foil. The apparatus is mounted on a subpanel, with all wiring underneath, which makes the inside of the set present a neat appearance.

The plug-in condensers for various bands used in the original model of this set were not looked upon with much favor, so a "sliding-rotor" condenser was substituted. This was made by rebuilding an old Silver-Marshall 140- μ fd. condenser. With proper adjustment of the sliding plate, the various bands can be spread very nicely. A 7-plate midget condenser can be clipped across this condenser for tuning outside the amateur bands.

Either peaked or straight audio amplification may be used at will, change-over being effected by throwing the jack switch shown in Fig. 3. The switch is a Yaxley product, and has eight springs. When thrown to the position for straight audio amplification, the filament circuit of the UX-222 in the peaked stage is opened, thus saving filament current and also lengthening the life of the tube. The Ford coil secondary in the peaked stage is placed inside a bakelite tube of the proper diameter, with a bakelite disc at the top. It is between the two tubes on the left-hand side of the sub-panel in the photograph of the receiver.

Coils for this receiver are wound on old tube bases. As is always the case, the correct number of turns on each coil was arrived at by experiment, and no details are given here.

The wiring diagram of the Hartley receiver is shown in Fig. 4. It is provided with jacks in the audio stages to permit using either one or two steps of amplification, the last jack also having filament control for the last tube. Regeneration control is capacitive.

The tuning condenser is a rebuilt Cardwell 11-

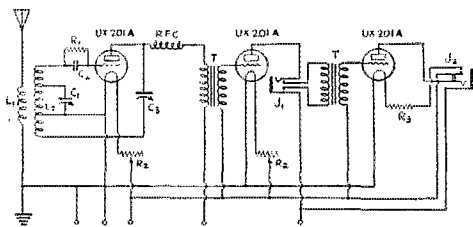

FIG. 4.—THE HARTLEY RECEIVER

- C₁ — Tuning condenser described in text.
- C₂ — 150 μ fd.
- C₃ — 250- μ fd. condenser for regeneration control.
- L₁ — 5 turns of No. 28 d.c.c., 3" in diameter.
- L₂ — 7000 kc., 16 turns of No. 28 d.c.c., 3" in diameter, with condenser across 8 turns.
- 14,000 kc., 7 turns, with condenser across 3 turns.
- R₁ — 10-megohm grid leak.
- R₂ — 20-ohm filament rheostat.
- R₃ — No. 1-A Amperite.
- T — 3-1 audio transformer.
- J₁ — Double-circuit jack.
- J₂ — Open-circuit jack with filament control.

plate tandem affair, in which there are two separate sets of stationary plates. One section is double-spaced and cut down to three plates, and is used for tuning on the 7000- and 14,000-kc. bands. The other section has three plates with normal spacing, and gives good spread on the 3500-kc. band. Both sections may be connected in parallel to cover frequencies outside the bands allotted to amateurs.

The coils are home-made "low-loss" type, space-wound. They are wound with No. 18 d.c.c. wire on a piece of thin celluloid which is wrapped around a 3-inch wooden form. The turns are spaced by winding No. 22 d.c.c. wire between them. After the coil is completed, it is dipped in acetone and allowed to dry, after which the wooden form is removed. This method of construction results in a mechanically strong coil with good electrical characteristics. The finished coil is clamped between two thin bakelite strips and mounted on an old tube base, connections going to the pins in the base. The same primary coil is used for all bands, and is clamped on a slotted bakelite strip which is mounted on a hard-rubber pillar. Coupling is varied both by sliding the slotted strip on which the coil is mounted toward and away from the grid coil, and also by changing the angle between them.

This receiver is not as selective as the four-tube receiver, but is useful when static is strong and QRM not bad, because the antenna coupling can be reduced, and the signal-static ratio thus improved.

As is the case with all really up-to-date amateur stations, a monitor is always used for checking the character of the signal and the position of the transmitter in the band being used. This one is built in a large tin biscuit box (on the shelf above the operating table in the photo), and uses a type 01-A tube in a simple tickler circuit. Three dry cells light the filament, and plate supply is provided by a large 22½-volt B battery. A wavemeter (built before we started to think in kilocycles) is part of the left-over 1928 equipment, and is used for rough checking and as an aid in preliminary winding of coils for both transmitter and receiver.

OPERATION

As can readily be imagined, shifting from 7000- to 14,000-kc. or vice-versa is a matter of only a few seconds. Either transmitter may be used by simply throwing two switches and placing the antenna clips on the proper coupling inductance. Only the antenna tuning controls need be touched, and these can be readily set at predetermined points. The system proved its value during the recent International DX contest, when on different occasions a foreign station was heard calling CQ on the other band and the change-over was made in time to effect a QSO.

VE2CA has worked 36 different countries, including WFA, Byrd's Antarctic base, and is the owner of a WAC certificate. An accurate log is kept of all stations worked, and any changes in the transmitter are noted on it. Experiments which prove to be worthwhile can thus be incorporated permanently in the sets. The operators' chief pleasures are DX and rag-chewing, although traffic is never turned down.

New England Division Convention

THE best of spring weather ushered in the 1930 New England Division Convention on April 25th at the Hotel Bancroft, Worcester, Massachusetts. The morning was spent in hamfesting and in getting acquainted, and the young ladies at the registration booth were kept busy signing up the delegates.

Mr. C. J. Green, W1ASU, Chairman of the Convention Committee, formally opened the convention at shortly after 2 p.m. The first speaker was Mr. E. L. Battey, Asst. to the Communications Manager, A.R.R.L., who led the convention in a traffic meeting. Off-frequency operation and the new regulations were the big matters under discussion. The roll call of SCMs and RMs was answered by SCMs Weeks, Tessmer and Kraus, who spoke on conditions in their respective sections. Following the traffic meeting, Chairman Green introduced Mr. K. B. Warner, Secretary, A.R.R.L. who gave a very interesting

talk on amateur legislation. The delegates received much information from this talk to clarify their ideas regarding amateur radio at "national and international radio conferences."

The afternoon technical talks were excellent. Mr. R. S. Briggs, W1BVL, explained the principle of the pentode and its application to amateur use. Mr. O. P. Susmeyan described the use of the dynatron characteristic in a heterodyne frequency meter, emphasizing the stability of a dynatron oscillator. Both Mr. Briggs and Mr. Susmeyan were from the Champion Radio Works., Inc., Danvers, Mass. Prof. H. H. Newell of Worcester Tech. gave a talk on tubes as high frequency amplifiers, and clearly explained his various points by the use of an oscillograph.

The evening session was devoted to entertainment and contests under the direction of Mr. U. E. Duval and Mr. L. R. Peloquin, W1JV. The usual run of contests with a few new ones worked in were ably conducted by W1JV. Two vocal artists brought the gang several selections. The Worcester Radio Association presented an amusing farce on A.R.R.L. Headquarters entitled "Wanted, an Assistant Editor." The Eastern Massachusetts Amateur Radio Association's jazz orchestra livened up the evening under the direction of "Red" Cooley, W1AAC. By 11:30 every one was ready to "close shop" and the convention was called off until the following day, Saturday, the 26th.

Saturday morning found the gang visiting broadcast stations WORC and WTAG and the Engineering Building of the Worcester Polytechnical Institute. The boys at Tech gave the delegates quite a treat by showing what 300,000 volts can do! At about 10 a.m. the Army-Amateur and Naval Reserve meetings were held at the Bancroft. Captain Lowman and Lt.-Comdr. Frederick J. Bailey, U. S. N. R., gave those interested some valuable dope on the Naval Reserve and ten new men were signed up. When the various groups had returned from their visits and had assembled again, Chairman Green turned the floor over to Mr. Pratt of the R. C. A. Institutes, Inc., who gave a fine talk and answered many questions regarding the Radio Industry, Talking Pictures, etc. Mr. J. D. Crawford, General Radio Company, brought the convention a most interesting talk on Frequency Standardization, explaining the method of checking the frequency of a crystal-controlled oscillator against Mean Solar Time.

The usual luncheon recess was cheerfully welcomed and the delegates returned full of pep for the long afternoon session. Mr. F. H. Schnell, Chief of Staff of the Radio & Television Institute, Chicago, in typical "Schnell" style, described his newly developed superhet. Mr. F. A. Cowan, A. T. & T. Co., made some of the fellows realize what they are doing when they QRM GBW and

(Continued on page 54)

Experimenters' Section

IMPEDANCE MEASUREMENT WITH THE PLIODYNATRON

By Paul D. Zottu*

IN the February issue of *QST*, Mr. Newbold spoke of the dynatron and listed some practical applications. In the same article he also mentioned the pliodynatron. It is concerning this device that I wish to add to his list another application — an application which I believe will be found very useful and at the same time replace instruments costing many times the price of the device. The pliodynatron can be used to measure the r.f. impedance of a tuned circuit. For this type of work it is probably

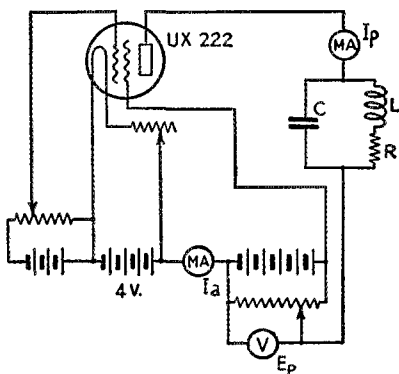

FIG. 1-A

by far the best instrument at the disposal of the amateur. I have used the device for nearly a year and have found it a most indispensable instrument.

It is well known that a circuit made up of L , C , and R , with the elements disposed as shown in Fig. 1-A, will oscillate when it is connected in parallel with a negative resistance equal to the effective impedance Z of the tuned circuit. The impedance of the tuned circuit at resonance is equal to $\frac{L}{RC}$. It has been shown¹ that the pliodynatron can furnish such a negative resistance. The negative resistance of a pliodynatron can be varied in a number of different ways, such as by varying the screen grid voltage, control grid voltage or filament emission. Observations have shown that it varies approximately as the inverse of the cathode current, or expressing the same thing mathematically,

$$r = \frac{K}{I_a} \tag{1}$$

where K is a constant depending upon the characteristics of the tube and the particular conditions under which it is operated, and r is the negative resistance of the device.

In order to determine K it is necessary to obtain a few curves showing the relation between I_p and E_p for different values of I_a . In taking these curves the control-grid and screen-grid voltages should be kept constant. The control grid bias should be of such a value that approximately the desired value of anode current is obtained when the filament is at three volts. The data from which the curves of Fig. 1-B were drawn was taken with no bias on the control grid, which resulted in a wide variation of K for Curve III. The screen grid voltage for a Type '22 tube may be as high as 75 volts positive. For a given value of I_a vary E_p and note I_p . If accuracy is desired, E_p should be varied in small

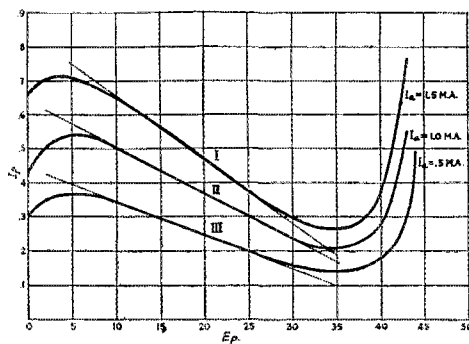

FIG. 1-B

steps, such as two or three volts at a time. A sufficiently sensitive plate-current meter should be used in order to give readable plate changes. The circuit used for this purpose is given by Fig. 1-A, with the exception that the tuned circuit is shorter. When this data is plotted, curves similar to those of Fig. 1-B will be obtained. With some tubes slight undulations may appear in the curves.

Choose on these curves a value of E_p about which the curves appear to be straight. Determine the slopes of the different curves for this particular value of E_p , substitute the value of the slope² and I_a in Eq. (1), and calculate K . K is calculated for all of the curves, and the mean value is taken as the value to be placed in the equation. The curves of Fig. 2 give values of $K_1 = 81.1$, $K_2 = 74.8$, $K_3 = 50.8$.

$$K = \frac{K_1 + K_2 + K_3}{3} = 68.5.$$

* 10 Wesleyan Place, Middletown, Conn.

¹ The Dynatron, A. W. Hull, Feb., 1918.

² Value of slope is equal to r . — Error.

The equation for this particular tube now stands

$$r = \frac{68.5}{I_a} \quad (2)$$

To measure the impedance of a parallel-resonant circuit connect the combination in series with the plate lead. Set E_p at the value for which K was calculated, 20 volts in the above example, and vary I_a by varying the filament current. When $r = \frac{L}{RC}$, oscillations will be set up in the circuit. These oscillations can be detected either by noting the sudden change in the plate current or by listening for a beat note in another local oscillator. The value of I_a at which oscillations just start is substituted in (2) and r is determined. The value of r is also the value of $\frac{L}{RC}$ or the impedance of the parallel circuit.

The impedance of choke coils at approximately their natural period can be determined in exactly the same manner. The plate to screen grid capacity of the tube is approximately 12 μ fd. and this is effective across the coil. For coils with low capacity this becomes a factor which cannot be neglected.

AN UNUSUAL R.F. CHOKE

W. D. Smith, W6DOI, of San Diego, California, has spent a great deal of time experimenting with r.f. chokes, and has finally arrived at a design which seems to be "holeproof" over the entire frequency range from 200 kc. to 28,000 kc. But let him tell it in his own words:

"The subject of r.f. chokes, after having been discussed again and again, is, as far as I am able

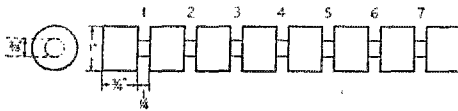

FIG. 2

All sections are wound in the same direction, with No. 28 enamelled wire. Turns in each slot are as follows:

| | |
|------------------------|------------------------|
| Slot No. 1 — 313 turns | Slot No. 5 — 331 turns |
| “ “ 2 — 151 “ | “ “ 6 — 151 “ |
| “ “ 3 — 294 “ | “ “ 7 — 293 “ |
| “ “ 4 — 113 “ | |

The winding in slot No. 1 is the hot end of the choke, No. 7 going to the supply line.

to determine, still as hazy, elusive, and unsolved as ever.

"Did you ever see a Hartley-circuit grid dip meter capable of constant frequency change from 30 megacycles to less than 100 kc., with constant output, and without holes? This undoubtedly brings to your mind the subject of r.f. chokes. Such a meter is more than a possibility as I am possessed of one, designed and built by myself.

"About three years ago I undertook a study of r.f. chokes and their action for my own edifica-

tion, and after endless experimentation and measurements incident thereto, evolved a theory which to date seems to be watertight, and provides chokes for any frequency up to their overall fundamental frequency — which may be so low that it is of no practical consequence from a radio standpoint.

"This system consists of a series of pie-wound sections on a straight-line form, with determinations of component sections as follows: Section at load end — resonant period approximately one-third of signal frequency; the inductance, expressed in m.h., to be a prime number; next section — same construction, except inductance value prime and resonant at one-seventh of signal frequency, spaced on the form in such a manner that the mutual inductance between the two sections is not greater than one-half the inductance of the load section; these are followed by five other sections of the same coupling, but each maintained in prime inductive relation to every other section in the choke. Wire size and dimensions of the form will necessarily be governed by the load requirements of the d.c. circuit to be fed.

"Applying this theory to ham use, unless you are possessed of more rapid methods of calculation than I, entails a vast area of paper and a number of good pencils, together with quite a lot of patience. However, I have found that a much more simple method of calculation, and one that works with entire satisfaction from the ham standpoint, may be used. This has been proved to my satisfaction by risking my thermo-galvanometer, tightly coupled to the outside end of my choke on a $\frac{1}{4}$ -kw. oscillator while it was continuously varied in frequency from 28,000 kc. (the highest frequency at which it would oscillate), to 200 kc., with a maximum deflection of less than 1.5 m.a. over the entire frequency range.

"The amateur version consists of coupling the sections on the form not closer than $1\frac{1}{4}$ times the mean coil diameter, and maintaining the number of turns in each section in prime relation to each other. I have built and used hundreds of these chokes since the original design was evolved, and have found an invariable gain in efficiency when they have been used to replace other chokes of whatever type or design.

"A sketch of the usual choke used in any r.f. transmitting circuit intended for power outputs of less than $\frac{1}{2}$ kw. and frequencies of 500 kc. or more is shown in Fig. 2."

A PANEL SAW

The chap who gave birth to this idea is too modest — or sensitive — to let us mention his name. In spite of this deprecatory attitude, however, the gadget is a handy one for taking care of a mean job, namely, sawing panels.

How many of us have wanted to saw through a foot or so of sheet bakelite and wished the hack-

saw manufacturers had been a little more generous with the space between the brace and the blade? Well, why not make a special saw for the job? The only materials necessary are three pieces of wood, a hacksaw blade, a few feet of wire, and some nails. It's as simple as the accompanying photograph.

The wood pieces used should be heavy enough not to bend when the saw is in operation, and the distance between the saw blade and the cross piece must be sufficient for the job in hand. Tension on the blade is regulated by twisting the wire after the manner of a turnbuckle, a heavy screwdriver being the "twister." As a matter of fact, if a "high-hat" job is wanted a turnbuckle could be placed in the wire, and the whole thing

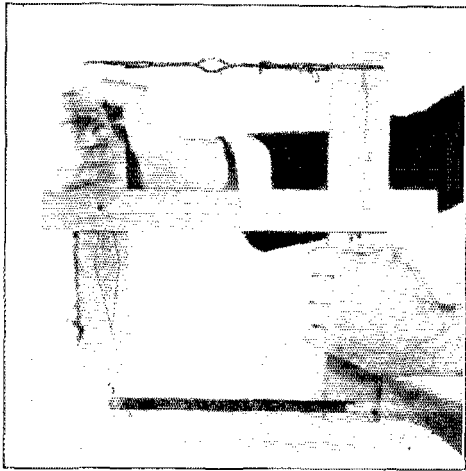

A PANEL SAW

could be dressed up a bit. One made out of odds and ends works just as well, however.

A HANDY WAY TO LAY OUT COILS

Since the coils for an amateur-band receiver always have to be made to order, it is quite an advantage to have a coil form which can be used for experimental coils only. Bob Chipman, VE4IC, of Winnipeg, Canada, took an old tube base and mounted four binding posts on it, each of the posts being connected to a prong in the base. Small machine screws and nuts will do just as well. A sketch of the idea is shown in Fig. 3.

This base is used only during the cut and try process, and after the proper number of turns for both tuning coil and tickler have been determined for any particular band a separate coil is made up in permanent form on another base. This does away with the bother of soldering and unsoldering wires in the pins, pushing the wire through holes in the base each time a turn is removed, and other time-wasting maneuvers which cannot be avoided unless a special base such as this is used.

The device has another advantage, because

other types of coils which will not fit in the pocket in a tube-base coil receiver may be tried out by

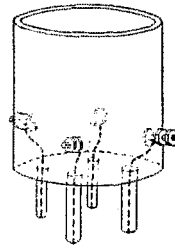

FIG. 3

simply running wires from the coil terminals to the binding posts on the base.

ELIMINATING KEY CLICKS

We should very much like to think that the key-click problem has been solved to everyone's satisfaction, but unfortunately it hasn't. Thumps very often refuse to yield to rational treatment, much to the disgust of both amateur and B.C.L., and then sometimes a simple stunt will be hit upon which restores peace in the neighborhood. While the methods described below may not fall in this class, they have been successful in each individual case, and will be worth a trial, whether or not other means have failed.

Robert T. Foreman, W9ZZE, of Tucson, Arizona, had a lot of trouble with an a.c. broadcast receiver, and after trying all sorts of thump filters and wave traps, finally resorted to a filter in the supply line to the broadcast receiver. When this filter was installed, the clicks could no longer be heard.

The wiring of the filter is shown in Fig. 4. The inductances are old Ford spark coil primaries, and the condensers are .006 μ fd. each. The filter is placed as close to the receiver as possible — in this case it was mounted in the same cabinet. If

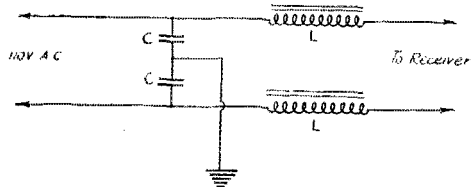

FIG. 4

L — Primary of Ford spark coil (vibrator must be shorted out if primary is not removed from coil assembly).
C — .006 μ fd.

compactness is wanted, the primaries can be removed of course from the coils.

When the key is placed in the primary of the plate transformer there is usually not so much trouble from clicks caused by a steep r.f. wave

front, but breaking the primary current gives the same effect in an a.c. receiver as turning a lamp on the same line on or off. An arrangement which eliminates the spark at the key thus serves the double purpose of reducing this effect and saving the key contacts. W8AQ, E. H. Gibbs, Wadsworth, Ohio, had this trouble, and found an inexpensive solution for it.

R.f. chokes are placed on each side of the key, and a .5 μ f. condenser is shunted around them. The condenser absorbs the spark, and the chokes "wash out" any high-frequency currents which may be set up. A diagram of the arrangement is shown in Fig. 5.

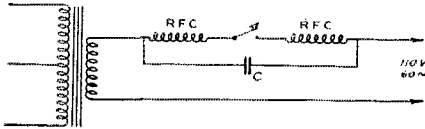

FIG. 5

RFC — 150 turns of No. 24 d.c.c. on 1-inch form. Larger wire should be used if the transformer draws more than about 75 watts.

C — .5 μ f.

The chokes must be wound with wire which is heavy enough to pass the primary current of the plate transformer without too much voltage drop. No. 24 is large enough for a set using a single Type '10 tube. Higher powers will take a proportionately larger wire size.

Milton Gilbert, W2BBP, also had some trouble with clicks, and eliminated them by using the circuit shown in Fig. 6. It is a somewhat unorthodox lag-circuit arrangement, but W2BBP says he has had no trouble with clicks since using it.

It is probable that a great deal of the success of an arrangement of this sort is dependent on the adjustment of the transmitter, as is the case with any of the usual lag circuit. With different transmitter adjustments, different values of both choke and condenser will prove most effective. A little experimenting is therefore needed in order to get the best possible results.

THE RESISTANCE BRIDGE IN THE APRIL "X"-SECTION

Mr. Normal Moll, Toledo, Ohio, has called our attention to the fact that the fundamental equations for the resistance bridge given on page 47 of the April issue were set up incorrectly.

These were given as

$$E_a = I_a R_a = I_b R_b$$

$$E_b = I_a R_a = I_b R_b$$

but should have been

$$E_a = I_a R_a = I_b R_a$$

$$E_b = I_a R_b = I_b R_b$$

This makes no difference in the final result, however, because the inequality disappears as

soon as the IR drops are put in the form of a ratio. The statement that $R_x = R_y (R_b/R_a)$ is therefore correct.

Mr. Guy A. Simmons, Jr., of Little Rock, Ark., writes as follows regarding the bridge:

"It might be well to bring out that this type of bridge will be accurate only when non-inductive resistances are being measured. Other resistances are accurate at the frequency of the buzzer being used.

"A refinement which would make the tone obtained from the buzzer smoother and prevent the

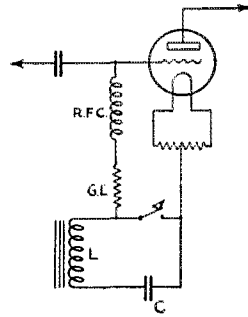

FIG. 6

L — 30-henry B-eliminator choke.
C — .003 μ f.

bridge from affecting the tone of the buzzer would be to place a large fixed condenser in one of the leads from the buzzer to the arm of the bridge. This would also tend to prevent sparking at the contacts of the buzzer and prolong their life. This condenser should be fairly large, 1 mike or so, in order not to appreciably attenuate the current supplied to the bridge by the buzzer. The condenser used does not have to stand high voltages and could be any low-voltage receiving condenser.

"Many school laboratories use a modification of this type of bridge in which a meter stick with a section of resistance wire stretched its length is used. A fairly high resistance (per foot) wire must necessarily be used. The connections are the same as those in article by Mr. Whitacre, although a battery and galvanometer are usually used."

A NEAT "CLIP" FOR TRANSMITTER COILS

A new use for the National "Grid-grip" is suggested by W1CRC. It makes an excellent "clip" for a copper-tubing transmitter coil, fitting the 3/8-inch size snugly, and can be squeezed together a bit to fit 1/4-inch tubing. The idea is illustrated in Fig. 7.

The grid-grip should be slipped on the coil before the ends are flattened to make connecting lugs. A piece of flexible wire of the required length is soldered to it, and the other end of the wire is soldered in a phone tip. The tip is plugged into a tip-jack, which may be mounted permanently in the transmitter.

In this manner it becomes possible to change coils in a Hartley transmitter, for instance, without readjusting the clip the next time that particular coil is used. The phone tip and jack are used simply for convenience — a binding post would serve equally well, although a little more time would be needed to make connections. The grid-grip makes a good connection — better than an ordinary clip — and in addition has no iron in it. Ordinary clips are usually made of iron or steel and then plated with copper or nickel, and get quite hot even with a low-power set. Unnecessary

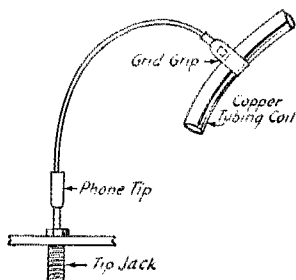

FIG. 7

heating means an unnecessary loss of energy which might better be expended in useful radiation.

A FLEXIBLE RECEIVER

By A. E. Harrison*

THE receiver described is not radically new, or very different from most ham receivers, but several ideas have been combined to make it flexible and yet not complicated or expensive. No photographs of the receiver are available, as it has been changed from time to time as different ideas were tested.

The tuning inductance is a variometer. It covers either the 3500-kc. or 7000-kc. band by changing the position of the rotor. The stator has 12 turns, a coil of 6 turns on each side of the shaft, on tubing 2 inches in diameter. The rotor is a short UX tube base with the prongs removed and also has 12 turns. The tickler has 6 turns on both rotor and stator. It is wound next to the shaft with No. 36 d.s.c. wire. This makes an efficient tickler winding but occupies one tenth as much space as larger wire. As shown in the photograph, the variometer was mounted on a '99 tube base in order to replace the tube-base coils formerly used, without changing the set.

This variometer is not completely satisfactory, as it does not include the 14,000-kc. band, and the oscillation control must be changed when changing bands. With an equal number of tickler turns on the rotor and stator, more detector voltage or feed-back capacity is required to cause oscillation as the frequency is increased.

This might be remedied by putting more turns on the stator than the rotor or vice versa. A variometer covering three bands may be designed

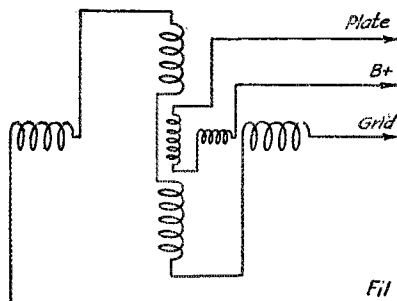
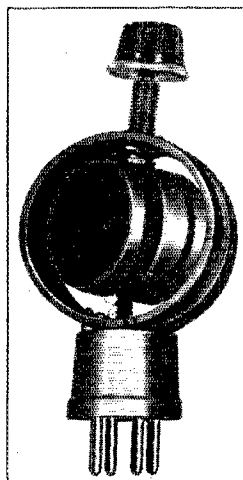

FIG. 8. — WIRING OF THE VARIOMETER

If all coils are wound in the same direction the connections should be made as shown. Further details are given in the text.

with the rotor and stator closer together, using a rotor turned on a lathe and form wound stator coils.

The tuning condenser is a rebuilt "Pilot" midjet. The stator plates were removed and a



THE VARIOMETER

portion of one side filed out. This gives the receiver a tuning curve that is nearly straight-line frequency. Three plates were assembled on the stator, then the two screws were cut with a hacksaw about $\frac{1}{16}$ of an inch from the third plate. Threaded bakelite bushings $\frac{1}{4}$ inch thick hold the three plates in place and allow two more plates to be assembled on the stator but insulated from the other three plates. The rotor was not changed.

For 3500-kc. operation five stator plates are used, spreading the band over 50 dial divisions. Only two plates are used for tuning 7000 and 14,000 kc. A switch should be arranged to add the

* W6BMS, 1630 Buena Ave., Berkeley, Calif.

other three plates to the circuit when tuning 3500 kc.

In the diagram of the receiver, Fig. 9, a Type '99 is shown as a volume control. It is semi-automatic in action, reducing volume on loud signals but allowing weak signals to come in at practically full strength. Another advantage of this control is its action on key clicks from the

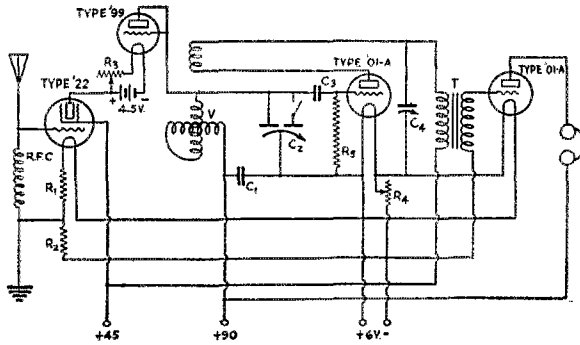

FIG. 9. — THE COMPLETE RECEIVER

- V — Variometer described in text.
 C₁ — .006 µfd.
 C₂ — Tuning condenser described in text.
 C₃ — 100 µfd.
 C₄ — 250 µfd.
 R₁ — 10 ohms.
 R₂ — 5 ohms.
 R₃ — 60-ohm rheostat.
 R₄ — 20-ohm rheostat.
 R₅ — 2 megohms.
 RFC — Short-wave choke.
 T — Audio transformer.

transmitter. The shock to the detector is reduced when the key is pressed, allowing better break-in operation. It would probably reduce the interference from a nearby station; however, this has not been checked as operation recently has only been in the 3500-kc. band and no other stations in this neighborhood seem to be using that band. Complete shielding of the receiver would make this control more effective.

Strays

The Jewell Electrical Instrument Company, 1650 Walnut St., Chicago, is publishing a neat little time conversion chart which is a handy adjunct to the radio shack. It is similar to the one described in *QST* some months ago and in the *Handbook*, and it is possible to determine the hour in any part of the world corresponding to a given local time. Provision is also made for finding whether the time indicated is for the same date or not. The chart is being distributed free of charge, and can be obtained by simply addressing a card to the above address.

Amateurs experimenting with television and photo-electric cells will find much to interest them

in "Photo Cells," by D. E. Replogle, published by the Jenkins Television Co., 346 Claremont Ave., Jersey City, N. J. The booklet explains the action of the various types of cells and gives considerable data on circuits and characteristics, together with information on photo cells marketed by the Jenkins organization. It is in loose-leaf form, and supplementary sheets will be issued from time to time. The price is twenty-five cents.

Most amateurs are addicted to poring over catalogs, and one of the best we have seen recently is the "Catalog and Data Book," published by the Offenbach Electric Company, 1452 Market St., San Francisco. As the name indicates, there is much more in it than just prices on manufactured parts. The book has 370 pages, divided into eighteen sections, each dealing with a class of apparatus, such as condensers, resistors, meters, amateur transmitting and short wave equipment, panels, etc., and with each section there is a great deal of design data and generally useful information on that particular subject.

Nearly all standard brands of apparatus are listed in its pages. The book is well printed on good paper stock, and is well worth the dollar charged for it. It is a handy reference book to have around the station.

If You Buy "QST" On the Newsstand—

Perhaps you haven't previously seen the Communications Department section with its operating news. This section of the magazine, with its news on the practical activities of amateurs all over the country, including your own locality, appears in newsstand copies only during a couple months in midsummer. Normally it is an extra section of 16 pages bound into only those copies which go direct to members of the A.R.R.L.

If you are interested in these informative operating articles and the chatter of local news everywhere, it is one additional reason why you should join the League and have the membership edition of "QST" delivered to your door every month. See the convenient application blank on page 94.

I. A. R. U. NEWS

Devoted to the interests and activities of the

INTERNATIONAL AMATEUR RADIO UNION

President: H. P. MAXIM

Vice-President: C. H. STEWART

Secretary: K. B. WARNER

Headquarters Society:

THE AMERICAN RADIO RELAY LEAGUE, Hartford, Conn.

MEMBER SOCIETIES

American Radio Relay League
 Asociacion E. A. R.
 Associazione Radiotecnica Italiana
 Canadian Section, A.R.R.L.
 Deutscher Amateur-Sende-und Empfangsdienst
 Experimenterende Danske Radioamatorer
 Nederlandsche Vereeniging voor Internationaal Radio-amateurisme

New Zealand Association of Radio Transmitters
 Norwegian Radio Relay League
 Radio Society of Great Britain
 Reseau Belge
 Reseau Emetteurs Francais
 South African Radio Relay League
 Wireless Institute of Australia

Conducted by Clinton B. De Soto

WITH this issue of *QST* the task of accumulating and compiling the material which appears regularly in this department falls into new hands. No peroration or lengthy announcement of this change is necessary or desirable, since we are all chiefly interested in the news itself as herein published — not in the personalities behind that news.

We hope mainly to retain that fine degree of real, spirited interest in the information contained in the department which has been evinced by so very many amateurs from all parts of the world. We hope the high standards of fullness in detail, of promptness in preparation, of accuracy in statement which have governed the contributions to these pages in the past by many valued contributors will be maintained and appreciated by all concerned. — *C. B. D.*

Miss Barbara Dunn, G6YL, again contributes another change of address by a QSL Forwarding Bureau. The present address of the Hungarian QSL Bureau is as follows: M.R.A.E., I. Zirken Janka, Utea 14/B, Budapest.

This will correct and supplement the general list published in the November, 1929 issue of *QST*.

A brief Chinese report carries the information that the power input allowed Hongkong amateurs is 10 watts. They are licensed to work on the 7-, 14-, and 28-mc. bands.

The regular June Calendar of the I.A.R.U. will have been sent out to all the National Sec-

tions just about the time that this issue is published. Another society is being proposed for membership, the *Rede dos Emissores Portugueses*; it is hoped that it will not be long before this organization is welcomed into the Union.

Duly representative national amateur societies which may wish to affiliate with the I.A.R.U. are invited to communicate with the Secretary, at 1711 Park St., Hartford, Conn.

We have received here a good many DX Time Tables which are of value mainly in a very restricted area, and we haven't felt them generally useful enough for publication. If any one is interested in tables for special places and regions we will be glad to give whatever information we have on file. (For example we have a very fine report on Porto Rico and vicinity only. To the K group living there and others interested in working into there it would prove invaluable.) We will be only too glad to answer any inquiries.

AUSTRALIA

By Alan G. Brown, VK3CX

Much activity was shown here during the tests; mainly on 7-mc. band, since the 14-mc. band did not come up to expectations in regards to contact with the U. S. A. Most of the chaps engaged in the tests have the same growl, and that is that there weren't enough W stations participating, because about one in every two stations worked didn't have a test message. Some very fine totals

were run up, but as yet we don't know who will be the winner.

The Victorian Division of the W.I.A. has their club rooms in fine shape now and a loan library of radio instruments and radio books which is a great help to members who want to make certain experiments and yet don't want to buy all the expensive parts necessary.

The Aero Club Division of the Institute is doing very fine work out at the Essendon Aerodrome and working consistently plane to ground with low-power plane sets. The ground station VK3WI is perhaps the most up-to-date station in the whole of Australia. The small plane transmitter working on the bottom edge of the 42-meter band under the call VK3WT has been heard at least 1000 miles away when the plane was in the air, with an input of only 3 watts.

All the interstate divisions of the W.I.A. have their own stations on the air regularly now. The calls are: VK2WI, VK3WI, VK4WI, VK5WI, VK6WI, VK7WI. Practically all are crystal-controlled and they handle much of the Institute traffic, thus saving much correspondence and bringing divisions closer together.

On the 14-mc. band a few of the old-timers and some new hams are all out after DX and at present getting plenty of it. With inputs ranging from 3 to 30 watts they are working all continents regularly with little trouble.

BELGIAN SECTION

By Paul de Neck, Pres., Réseau Belge

The DX period seems to have come back on the 14-mc. band, and every day, from 1700 to 2300 G.C.T. a fierce traffic is being carried. New Zealanders and Aussies come first, together with a few South African and Rhodesian stations. After this the great lot of U. S. hams from the 1, 2, 3, 8, and 9th districts literally cover the scale. Later come the South Americans, mostly LU and PY, with a few CX and CE. We can again find our good friend CE7AA, who came through a few days ago.

Of the few records to be listed:

ON4JJ had his 14-mc. 'phone received in Australasia.

ON4BZ and ON4UU made their first Japanese QSO.

ON4HP achieved his code WAC in one night.

ON4OR made his first U. S. A. contact with only 3 watts input.

On the 7-mc. band the regular traffic was handled between European stations and a few Americans.

ON4JQ, with 40 watts input on 7 mc., was received on 'phone in Europe with a regular QRK R8.

We note with sadness the sudden death of one of our best friends in Europe, SU8AN, Mr.

Nahmias of Cairo. He was certainly one of the best known amateurs in our country, and the first DX made by a lot of us in our first attempt to quit the continental area.

Many ON's had good chats with SP3YL and SP3KYL. We know now that these stations are owned by two young girls, movie stars of their own country. Splendid! Hi!

Our SP friends tell us that there are six YL's in the L.K.K. gang right now: SP3HR, SP3ER, SP3IA, SP3HB, SP3KYL, and SP3YL. Let us try to get them on the 'phone sets, OB's!

Now, could we say something about the new WAC Certificates? Why not register and classify

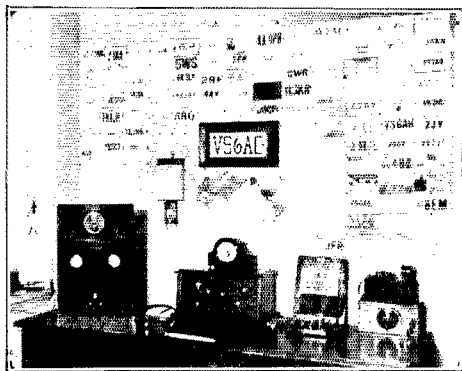

V56AC, THE STATION OF J. J. ALVAREZ, 6 CAMERON ROAD, KOWLOON, HONGKONG. THIS STATION FIRST CAME ON THE AIR NOVEMBER 2, 1929, AND HAS SINCE WORKED ALL CONTINENTS AND 22 COUNTRIES, WITH A TOTAL OF 190 STATIONS

The transmitter uses one Type 210 in an Ultratraction hookup. The transmitting antenna is a voltage-fed Hertz, as described by Mr. Windom in QST for September, 1929. The receiver is an ordinary Schnell detector and one-stage audio using tube base coils.

these certificates at the date of receipt of the last QSL card bringing their proofs? It would be much more correct than the actual method of listing them by the time of their delivery.

For the old ones, our friend Mr. K. B. Warner could ask the national sections interested to send a paper giving again the said date, after which he sends back a small label with this date written on together with the I.A.R.U. seal and his signature, the label to be affixed on the WAC certificate by its owner.

The preparations for our July International Amateur Congress are going strong. We have the official authorization to install two 100-watt 'phone and code sets, one in Liege and one in Antwerp, working in the 40- and 85-meter bands during the period of the exhibitions.

In regard to the suggestions regarding the dating of WAC Certificates as advanced by Mr.

(Continued on page 66)

The Communications Department

F. E. Handy, Communications Manager
 E. L. Battey, Asst. Coms. Mgr.
 1711 Park St., Hartford, Conn.

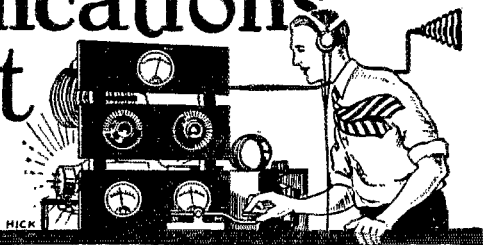

Your Log

By Eugene A. Hubbell*

"OA4J, why that's funny. I don't remember calling him. Let's see, he says 'Sorry you didn't hear me come back to your call. Your signals very nice, QSA3, here.' I wonder what the log-book shows for that night."

The log-book showed nothing in the way of operation for that night. So our "ham" friend went in doubt the rest of his days as to whether that card really belonged to him, or to another station. The up-to-the-minute station owner could tell in a minute whether he had called OA4J that night, and would be absolutely certain as to whether the card was rightfully his.

A log-book is usually found in every amateur station, but in how many logs can an entry be found of a call not answered, a CQ without replies? Few keep a record of these transmissions, yet it should be done, IF THE LOG IS TO BE COMPLETE! A complete log is the careful record of all transmissions from the station to which it belongs, with associated data. The Federal Radio Commission has adopted new amateur regulations which make it imperative that every station keep such a record.

A log-book furnishes a record of stations worked, first of all, with date and time. Then it should give the frequency or

and "no," consequently their use fixes their meaning more firmly in our minds, and shortens the work considerably.

The second item records a CQ which went unanswered, but which might possibly have been heard and answered, although the sending station did not know it. If a card comes in from Himalaya, Tumbuku, or Java, one can immediately verify the transmission. The third entry records the transmission made while tuning the antenna circuit after a QSY to 7 mc. Too many times a station tunes up the antenna circuit and sends test for minutes at a time without signing. When through testing, SIGN YOUR CALL signal.

The fourth item records a call which went unanswered again. However, it furnishes valuable information. Perhaps some Official Observer sends you a card saying you were heard off-frequency on the 7-mc. band June first, at 7:00 p.m. CST, calling CQ. Your log at once furnishes the information you were transmitting at that time, but that you were NOT calling CQ. Information of this kind may prove to be very valuable in saving your license, for the time is near at hand when off-frequency transmission will meet prompt punishment.

It is up to each amateur to dope out his own system. This gives an idea of the writer's conception of a complete and accurate log, that may be kept with a minimum of work, recording every transmission. Whether you use this form or

| Date | Time | Called | QSO | QSL | My | Signals | | | |
|------|------|--------|-----|-----|-----|---------|----------------|--------|--------|
| | | | | | | His | Remarks | Input† | Freq.† |
| 6-1 | 0010 | HC1FG | C | 6-1 | DC4 | RAC4 | rainy | 45w | 14 mc. |
| 6-1 | 0030 | CQ | N | | | | | 45w | 14 mc. |
| 6-1 | 0040 | Test | | | | | † QSY to 7 mc. | 60w | 7 mc. |
| 6-1 | 0100 | WSBHZ | N | | | XDC4 | | 60w | 7 mc. |

frequency band, on which the station was worked, and as required by the F.R.C., the input power to the final stage of the transmitter. It should also contain a record of tests sent, when tuning the transmitter, providing the antenna was coupled, also all unanswered calls and CQs. Optional items are records of signal strengths, weather, whether QST was sent or received, traffic handled, etc. It should be comparatively simple to keep and entries should be easily made. A sample form for such a log is indicated herewith.

The first entry records the working of HC1FG on June 1, at 0010 GMT, the C under QSO indicating contact was made and a QSL was sent the same day. Under signals the station calling received a report of DC, QSA4, while HC1FG's signals are given as RAC, QSA4. The weather was rainy, input to the transmitter was 45 watts and the frequency was the 14-mc. band. A letter can be used to indicate the band, A for 1750 kc., B for 3500 kc., etc. The signal reports may be cut to a few indicating letters and figures, thus: AC, RAC, NDC, DC for corresponding modulation, or lack of modulation, on the signal, while simply 1, 2, 3, 4 and 5 indicate the degree of reliability or signal strength (QSA) and the audibility (R1, etc.) if asked. Under the QSO column, C and N are international abbreviations for "yes"

another, keep a complete log, and mark yourself down as operator of a truly modern station operated systematically and legally in every respect. You will find the record valuable on many occasions.

WDDE

Paul K. Davis of Chicago (W9ADU) will operate WDDE this year, and he plans to contact amateurs on 5555, 8330 and 11,110 kc. The expedition and MacMillan's schooner *Borvoin* set forth in mid-June. The party will visit Labrador, Greenland, and Iceland. Jenkins and Adair, Inc., of Chicago have built the new high-frequency equipment for WDDE.

About the time this notice appears in print we expect to be able to include later and more specific information in telegraphic broadcasts from Headquarters concerning the

† A suggestion to eliminate the necessity for columns for the frequency and input power is to write a statement including both these items across the whole page, opposite the time entry, each time the change is made to a different transmitter or different operating frequency. — F. E. H.

C, W, and H are often used to denote "called," "worked" or "heard" respectively. — F. E. H.

* W9ERU, 227 N. 4th St., Rockford, Ill.

frequencies and operating hours of WDDE. Davis asks your cooperation in handling this traffic through general amateur contacts and schedules with the stations that prove

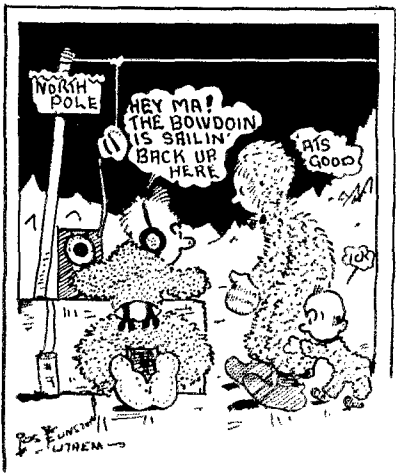

most consistent. We must look for WDDE outside the regular amateur channels (where all *bona fide* expeditions are now licensed) and do the usual good communication job. Plan to contact WDDE and help all you can!

Traffic Briefs

In two months on 14 mc. W1AMQ contacted 40 states, all U. S. districts, Canadian fourth district, four continents and eleven countries. FB!

A route known as the "Oriental" extends from Paris, France, to Shanghai, China, and is lined up as follows: K41DJ-W6AD-W9COS-W8YA-W3BF. W2ZC is transatlantic station for the route and completes it to England, France and Berlin. Traffic for the Orient is cleared through the Philippines. This route functions daily and at this writing is one of our most reliable chains.

WSAJC says, "A sked East beats a CQ East by about three days."

Mrs. N. M. Adams of Klamath Falls, Oregon, was very pleased to receive a Mother's Day greeting by amateur radio from her son, who is stationed at Tientsin, China. W6BSQ, who delivered the message, says that the letter of appreciation and thanks he received from Mrs. Adams surely makes one realize that *deliveries count!*

When the ships of the combined Battle Fleet and Scouting Fleet, U. S. N., terminated maneuvers for a recreation period in various ports of the West Indies, amateurs in the Porto Rico-Virgin Island section saw an opportunity to obtain traffic — and lots of it. K4KD at St. Thomas, V. I., manned by operators of NBB, got most of it as the majority of the vessels were in that port. K4AKV at Ponce had three battleships in his port. K4KD, not being at a port of visit, sent a message to the commander of the Scouting Fleet offering the facilities of his station for message service to the United States. The commander forwarded the invitation to all the other ships, and some 100 messages were received at K4KD as a result. K4KD handled most of his traffic on regular schedules with W1MK and W2FN. W4DK gave K4KD his traffic on schedule. At one time W1MK took 23 messages in a string from K4KD, and on another occasion took 52 in a row. On different occasions W2FN took 31, 55, 84 and 108 in a string. All traffic was handled on the 7-mc. band.

K4KD tells us that a very fine time conversion chart for the DX man is obtainable from the Superintendent of Documents, Government Printing Office, Washington, D. C. This is known as "Standard Time Conversion Chart," miscellaneous publication No. 81, and may be procured at 10 cents per copy, cash only, no stamps accepted.

W9CSR received the first Amateur Extra First ticket issued in Colorado.

W9CEQ and VK5HG have a total of 365 QSOs to date, their schedule having extended over a period of a year and a half! They are at present engaged in handling traffic to Washington, D. C., for the Magnetic Observatory of the Department of Terrestrial Magnetism, Carnegie Institute at Watheroo, West Australia. The route is VK6MO-VK5HG-W9CEQ-mail.

We wish to report the following brief sketches of amateur cooperation with the Connecticut National Guard 115th Observation Squadron flight from Hartford, Conn., to Miami, Fla., and return. At Hartford W1MK was on the job. W3MF at Jacksonville handled a number of messages and reports for the fliers and entertained them during their stay in that city. The Miami Amateur Radio Club sent messages filed with them by Western Union to W4AGR at Tampa for relay, as all of their stations were tied up in connection with their cooperation at the All-American Air Races. W8DBK, W8DSN and W8QU were on the job at Dayton to take care of messages that the Squadron wished to send from that city. At Cleveland W8ACR and W8BF cooperated.

Traffic Summaries

(APRIL-MAY)

| | |
|--|--------|
| Pacific led by Los Angeles | 12,029 |
| Atlantic led by Western Pennsylvania | 2952 |
| New England led by Eastern Massachusetts | 2316 |
| Hudson led by Eastern New York | 1982 |
| Central led by Illinois | 1827 |
| Southeastern led by Florida | 1566 |
| Midwest led by Missouri | 1457 |
| Dakota led by Southern Minnesota | 1443 |
| West Gulf led by Northern Texas | 1115 |
| Northwestern led by Oregon | 788 |
| Delta led by Mississippi | 553 |
| Roanoke led by Virginia | 247 |
| Rocky Mountain led by Utah-Wyoming | 135 |
| Quebec | 123 |
| Vanalta led by British Columbia | 103 |
| Ontario | 90 |
| Prairie led by Saskatchewan | 60 |
| 586 stations originated 7042; delivered 6190; relayed 15,554; total 28,786. (88.5% del.) | |

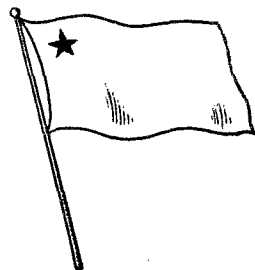

Los Angeles retains its hold on the Banner with a total of 3186! This can't go on forever!! The Traffic Banner goes each month to the section with the largest total of real messages. A traffic summary showing the standing of the various divisions for the past month is printed above. What place does yours take? What Section will carry the Banner next month and help its Division head the list?

BRASS POUNDERS' LEAGUE

| Call | Orig. | Del. | Rel. | Total |
|--------|-------|------|------|-------|
| KALDJ | 480 | 213 | 174 | 867 |
| KAIHR | 378 | 122 | 360 | 860 |
| W8YA | 154 | 14 | 590 | 858 |
| W6HM | 121 | 598 | 4 | 723 |
| W9COS | 109 | 259 | 300 | 668 |
| W6BZY | 24 | 25 | 496 | 545 |
| W3BWT | 113 | 138 | 289 | 540 |
| W1MK | 59 | 79 | 355 | 493 |
| W6WA | 130 | 276 | 47 | 453 |
| W5WW | 53 | 100 | 285 | 438 |
| W6AWF | 31 | 56 | 344 | 431 |
| W2QU | 164 | 236 | 4 | 404 |
| W6EIB | 279 | 42 | 80 | 501 |
| W6ALX | 164 | 25 | 204 | 393 |
| W2CXL | 41 | 16 | 281 | 338 |
| W9BN | 156 | 93 | 74 | 323 |
| W1CMZ | 17 | 32 | 262 | 311 |
| W8DGN | 47 | 10 | 250 | 307 |
| W8DEP | 19 | 30 | 252 | 301 |
| W8AKW | 24 | 27 | 492 | 279 |
| W6QP | 71 | 46 | 157 | 274 |
| K4KD | 7 | 7 | 248 | 262 |
| W6ALU | 2 | 9 | 248 | 259 |
| W5AKD | 4 | 7 | 212 | 223 |
| W3ZF | 49 | 80 | 104 | 227 |
| ACSWB | 135 | 78 | 7 | 220 |
| KAI PW | 123 | 58 | 36 | 217 |
| W6FRK | 6 | 66 | 98 | 170 |
| W8DRG | 88 | 64 | 14 | 166 |
| W1WV | 51 | 51 | 81 | 163 |
| W7AMF | 52 | 56 | 54 | 162 |
| W6AOA | 10 | 52 | 47 | 154 |
| W4QL | 38 | 52 | 52 | 142 |
| W5HY | 40 | 57 | 26 | 123 |
| W8DKC | 20 | 57 | 36 | 111 |
| W1BKR | 46 | 57 | 6 | 103 |
| W8MC | 15 | 59 | 15 | 89 |
| W5AOD | 15 | 61 | 10 | 86 |

The several amateur stations responsible for the best traffic work — the ones that are "setting the pace" in worthwhile traffic handling — are listed right up near the top of our B.P.L., the figures giving the exact standing of each station accurately.

All these stations appearing in the Brass Pounders' League are noted for their consistent schedule-keeping and dependable message-handling work in amateur radio. Special credit should be given to the following stations in the order listed responsible for *over one hundred deliveries* in the message month: W6HM, W6WA, W9COS, W2QU, KALDJ, W3BWT, KAIHR, W8YA, W6WW.

Deliveries count! A total of 200 or more bona fide messages handled and counted in accordance with A.R.R.L. practice, or just 50 or more deliveries will put you in line for a place in the B.P.L. Why not make more schedules with the reliable stations you near and take steps to handle the traffic that will qualify you for B.P.L. membership also?

Traffic Briefs

Two of our most excellent outlets for Nicaraguan traffic are W2QU and W9BCA. W2QU handles an average of 400 to 500 messages per month on regular schedule with NN1NIC. He mails a copy of each message received to its destination whether relay is made by radio or not. W9BCA has an equally reliable hook-up four nights a week. He can be found on approximately 7200 kc.

W1MK

A.R.R.L. Headquarters' Station W1MK operates on frequencies of 3575 kc. and 7150 kc. Robert B. Parmenter, "RP," is the chief operator; his list is familiar to most of the amateur fraternity. Occasionally other members of the Headquarters' staff operate at W1MK. Their personal signs may be found in the QRA Section of QST.

Throughout the following schedules Eastern Standard Time will be used.

OFFICIAL AND SPECIAL BROADCASTS are sent *simultaneously* on 3575 kc. and 7150 kc. at the following times:

- 3:00 p.m.: Sun., Mon., Tues., Thurs., and Fri.
- 10:00 p.m.: Mon. and Fri.
- 12:00 p.m. (midnight): Sun., Tues., and Thurs.

GENERAL OPERATION periods have been arranged to allow every one a chance to communicate with A.R.R.L. Headquarters. These general periods have been arranged so that they usually follow an official broadcast. They are listed under the two headings of 3500 kc. and 7000 kc. to indicate whether the watch is devoted to listening on the 80-meter band or to the 40-meter band.

3500 kc.

8:10 p.m. to 9:00 p.m. on Sun., Mon., Tues., Thurs., and Fri.

10:00 p.m. to 11:00 p.m. on Tues. and Thurs. (No OBC sent before these periods.)

12:00 p.m. to 1:00 a.m. (or later) on Sunday night (Monday morning).

7000 kc.

10:10 p.m. to 11:00 p.m. on Sun., Mon., and Fri.

12:00 p.m. to 1:00 a.m. on the following nights (actually on the morning of the day following): Mon., Tues., Thurs., and Fri. (Only on Tues., and Thurs. does the OBC precede these periods.)

SCHEDULES are kept with the following stations through any of which traffic will travel expeditiously to A.R.R.L. Headquarters, on 3500 kc.: W1ACH, W1BXB, W1CTL, W1ZA, W2JF, W3BWT, W3CBT, W3ZF, W4PM, W8CEO, W9OX, VE9AJ; on 7000-kc.: W4SK, W6CIS, W6DEP and W6OJ.

ELECTION NOTICES

To all A.R.R.L. Members residing in the Sections listed below: (The list gives the sections, closing date for receipt of nominating petitions for Section Manager, the name of the present incumbent and the date of expiration of his term of office.) This notice supersedes previous notices.

In cases where no valid nominating petitions have been received from A.R.R.L. members residing in the different Sections in response to our previous notices, the closing dates for receipt of nominating petitions are set ahead to the dates given herewith. In the absence of nominating petitions from Members of a Section, the present incumbent continues to hold his official position and carry on the work of the Section subject, of course, to the filing of proper nominating petitions and the holding of an election by ballot or as may be necessary. Petitions must be in Hartford on or before noon of the dates specified, all of which are 1930.

| Section | Closing Date | Present SCM | Present Term of Office Ends |
|------------------|---------------|-------------------|-----------------------------|
| Virginia | July 15, 1930 | J. F. Wohlford | Dec. 2, 1928 |
| Alaska | July 15, 1930 | W. B. Wilson | Mar. 28, 1930 |
| N. Y. C. & L. I. | July 15, 1930 | M. B. Kann | June 28, 1930 |
| Utah-Wyoming | July 15, 1930 | P. N. James | |
| Vermont | July 15, 1930 | Clayton Paillette | July 28, 1930 |
| Iowa | July 15, 1930 | H. W. Kerr | July 28, 1930 |
| Ohio | July 15, 1930 | H. C. Storr | July 28, 1930 |
| Mississippi | July 15, 1930 | J. W. Gullett | July 28, 1930 |
| Southern Texas | July 15, 1930 | R. E. Franklin | July 28, 1930 |
| Kansas | July 15, 1930 | J. H. Amis | July 28, 1930 |
| Arkansas | Aug. 15, 1930 | H. E. Vette | Aug. 28, 1930 |
| Kentucky | Aug. 15, 1930 | J. B. Wathen | Sept. 8, 1930 |
| Maritime* | Aug. 15, 1930 | (resigned) | |
| Indiana | July 15, 1930 | D. J. Angus | |
| North Carolina | July 15, 1930 | Hal Justice | |
| Michigan | July 15, 1930 | Dallas Wise | |

Due to the resignations in the Utah-Wyoming, Indiana, North Carolina, and Michigan Sections, nominating petitions are hereby solicited for the office of Section Communications Manager in these Sections and the closing date for receipt of nominations at A.R.R.L. Headquarters is herewith specified as noon, July 15, 1930. Reports from QRS in these sections should be sent to the Acting SCM listed on page 5 of QST.

* In Canadian Sections nominating petitions for Section Manager must be addressed to Canadian General Manager, Alex Reid, 169 Logan Ave., St. Lambert, Quebec. To be valid such petitions must be filed with him on or before the closing dates named.

To all A.R.R.L. Members residing in the Sections listed:

1. You are hereby notified that an election for an A.R.R.L. Section Communications Manager, for the next two-year term of office is about to be held in each of these Sections in accordance with the provisions of By-Laws, 5, 6, 7 and 8.
2. The elections will take place in the different Sections immediately after the closing date for receipt of nominating petitions as given opposite the different Sections. The Ballots mailed from Headquarters will list the names of all eligible candidates nominated for the position by A.R.R.L. members residing in the Sections concerned.
3. Nominating petitions from the Sections named are hereby solicited. Five or more A.R.R.L. members residing in any Section have the privilege of nominating any member of the League who holds an O.R.S. appointment in their Section as candidate for Section Manager. The following form for nomination is suggested:

Communications Manager, A. R. R. L.
1711 Park St., Hartford, Conn.

(Place and date)

We, the undersigned members of the A. R. R. L. residing in the Section of the Division hereby nominate as candidate for Section Communications Manager for this Section for the next two-year term of office.

(Five or more signatures of A. R. R. L. members are required.)
The candidate and five or more signers must be League members in good standing and the candidate must be the qualified holder of a Communications Department, Official Relay Station appointment or the petition will be thrown out as invalid. The complete name, address, and station call of the candidate should be included. All such petitions must be filed at the headquarters office of the League in Hartford, Conn., by noon of the closing date given for receipt of nominating petitions. There is no limit on the number of petitions that may be filed, but no member shall sign more than one such petition.
4. Members are urged to take initiative immediately, filing petitions for the officials for each Section listed above. This is your opportunity to put the man of your choice in office to carry on the work of the organization in your Section.

— F. E. Handy, Communications Manager.

ELECTION RESULTS

Valid petitions nominating a single candidate as Section Manager were filed in a number of Sections and before the closing dates that had been announced for receipt of such peti-

tions. As provided by our Constitution and By-Laws, when but one candidate is named in one or more valid nominating petitions this candidate shall be declared elected. Accordingly, election certificates have been mailed to the following officials, the term of office starting on the date given.

| | | |
|----------------|-------------------------|---------------|
| Quebec | Alphy Blais, VE2AC | Jan. 21, 1930 |
| Alberta | Fred Barron, VE45C | Jan. 21, 1930 |
| Saskatchewan | W. J. Pickering, VE4FC | May 15, 1930 |
| Sevards | Keston L. Ramsey, W6EAD | May 15, 1930 |
| Southern N. J. | Bayard Allen, W3ATJ | May 15, 1930 |

In the Northern Texas Section of the West Gulf Division, Roy Lee Taylor, W5LJ, J. H. Robinson, Jr., W5BG, and John Adams, W5BH, were nominated. Mr. Taylor received 24 votes, Mr. Robinson 21 votes, and Mr. Adams 8 votes. Mr. Taylor's term of office began April 25, 1930.

In the North Dakota Section of the Dakota Division, Guy L. Ottinger, W3BYE, and Wellesley Beeman, W3DFG, were nominated. The first balloting resulting in a tie vote, a second set of ballots were distributed. Mr. Ottinger received 21 votes, and Mr. Beeman 14 votes. Mr. Ottinger's term of office began April 25, 1930.

In the Western New York Section of the Atlantic Division, John R. Blum, W3CCK, and Don Farrell, W3DSP, were nominated. Mr. Blum received 89 votes, and Mr. Farrell 58 votes. Mr. Blum took office May 15, 1930.

In the Wisconsin Section of the Central Division, C. N. Crapo, W3YD, and A. D. Sanial, W9AZN, were nominated. Mr. Crapo received 45 votes, and Mr. Sanial 28 votes. Mr. Crapo's term of office begins July 1, 1930.

DIVISIONAL REPORTS

ATLANTIC DIVISION

SOUTHERN NEW JERSEY—SCM, Bayard Allen, W3ATJ—W3DH will QRT in June until the University reopens in September. W3ATJ handled a few from Porto Rico. W3UT is ready for the tests on 28 mc. W3ACK will have a portable under shadow of WSC's mast this summer. W3HS, an old-timer, is back using 7 mc. exclusively. W3ARP and W3WW, both ops at WPG, have QRM from the BC studio. W3KJ has installed push-pull. W3ASG has become a 'phone addict. W3BUF hooked his first Hawaiian. W3BVG has gone to the Moody Bible Institute in Chicago. W3ADL is kicking out FB with a new S2 on 7 mc. W3ATV is a new op in Ocean City. W3AWJ is on 14 and 7 mc. W3AS is on at a new QRA. W3AIU has been on a three-weeks' visit to N. Y. C. W3BAN, with no current available in his home, has rigged up a 110-volt magneto to a sewing machine, and is stepping on it. W3BWJ is heard occasionally on 14 mc. W3AWL has applied for ORS appointment.

Traffic: W3FD 132, W3ATJ 54, W3UT 21, W3AWL 6, W3ASG 39.

MARYLAND-DELAWARE-DISTRICT OF COLUMBIA—SCM, Forrest Calhoun, W3BBW—If any of you want your ORS put in storage for the summer, say so and then you will be safe from cancellation. Maryland: W3CGC leads this state in traffic: W3AIL, a new one in Cumberland, sent in a nice total. W3LA is experimenting with Airplane Xmitters. W3AFF says QRN is messing up everything. W3AOO got a new 210, and blew it, so is back with a 112. W3BBW is experimenting with voltage feed hertz. W3GF is trying for a commercial ticket. W3BCX and W3DG are going to experiment with television this summer. W3NY will qsp anywhere in South America. W3VJ has a code class and club going fb. W3BBF is a new Baltimore ham using a 860 on 14,000 kc. Delaware: W3ALQ leads this state with a very low total. W3AJE says he can't hear anything but QRM on 7 mc. W3HC reports several new ones in Delaware. District of Columbia: W3WTT still sends in his usual load. W3BF says the leaves on the trees absorb lots of his radiation. W3PM has an A. C. receiver perking. W3CDQ said the Washington Radio Club banquet was a "wow." Vice President Stewart of A. R. R. L. and Paul M. Segal, Rocky Mountain Division Director, attended. W3GT is trying to get on 28 mc. W3OZ nearly missed this report.

Traffic: W3BWT 540, W3BF 103, W3CGC 42, W3PM 25, W3AIL 16, W3LA 15, W3AFF 11, W3CDQ 8, W3ALQ 4, W3BBW 3, W3AOO 3, W3AJH 2, W3HC 1, W3OZ 38.

EASTERN PENNSYLVANIA—SCM, Don Lusk, W3ZF—During the past month the SCM has been extremely busy because of a new arrival (a YL opr). W8VD's doctor forbid him to follow radio as a hobby, but you will find him on most every Monday Eve. If some one could find

a solution for W3AKB's MOPA, she will be his sked any ole day. The SCM takes pride in W3MC's fine showing in both traffic and 00 reports. W3AUR evidently is in earnest about his ORS and is now eligible. Ditto to W3UH, who reported by telephone. A word of warning is issued to those who fail to report next month and thereafter: Cancellations are in order and the following will be crossed off unless satisfactory explanations are forthcoming: W3LC, W3NF, W3TB, W3DHT, W3AWO, W3CWO, W3UX, and several prospective non-ORS will have to start all over again unless action is taken immediately. W3AQN is moving to Canada and promises all 'phone men a report. His address will be care MacLareus Dam, Via Buckingham P. O., Quebec, Canada. W3EU rebuilt his haywire into a glass cabinet. W3ZF is coming back to Xtl after cussing a self-excited rig that went bluey.

Traffic: W3ZF 227, W3UH 85, W3MC 80, W3EU 34, W3AUR 28, W3AKB 6, W8VD 6, W3DZ 5.

WESTERN PENNSYLVANIA—SCM, A. W. McAuly, W3CEO—W8YA, in spite of poor radio weather, maintains 16 schedules and the Section Leadership. W8DLG is still going strong. W3CEO has schedules with two Directors and W1MK. W3CNZ is on 7000 kc. after midnight. W3CMP is building a new transmitter. W3DUT is on Sundays. W8AGO wants a Friday schedule. W3BQR, of State College, will be at his home station, W3AHZ, during the summer vacation. W3ARC works the Division Director on A.-A. sked. W3AVY is on consistently. W3DKS and W3AWR are active in Uniontown. W3BRM is moving. W3APW is troubled with QSX. Reports are still coming in from W3CFR in Rio de Janeiro. W3GU and W3KD will keep a schedule with W3CMP until after the convention. A Naval-Amateur Reserve unit is in the process of formation in Erie. W3CLQ has been released, and Heck is going after a two-letter call. W3ASE says he can check frequency to about 3 kc. J. M. Gates, an invalid in South Fork, Pa., is studying the Code and is planning to build a transmitter. W3OB has moved. The SCM would like to have his new address. W3CYG wants to try for an ORS. All hams should watch for the Standard Frequency schedules announced in QST, and copy the signals.

Traffic: W8YA 858, W8DLG 154, W3CEO 62, W3CNZ 23, W3CMP 17, W3DUT 11, W3DKS 9, W3AGO 3, W3BQR 37, W3APW 19, W3AVY 18, W3AWR 11.

WESTERN NEW YORK—Acting SCM, J. H. Blum, W3CCK—W3CPC has skeds with Porto Rico. W3AFM should send a description of his station to headquarters. W3DDL is moving for the summer. W3CUT is having wonderful success with A. C. receivers. W3CYG is experimenting with antennae. W3BOX is back on the air. W3DME uses XTAL on all bands. W3IH is getting out fine with his high-powered fone. W3DNE is home from the Navy for a few days. W3DSP has two XTALS on 3.5 mc. with a push-

pull amplifier. WSBJO has a complete new xmitter. WSBLP is active again for the summer. WSDEJ is a Y.L. op. WSDSA has application in for O.R.S. WSABQ receives some very FB letters from hams. WSBGV is on 14 and 3.5 mc. WSBVA reports the activities of the Jamestown gang. The Jamestown Amateur Radio Association is now affiliated with the A.R.R.L. WSAVM is rebuilding. WSAWM is blowing apparatus. Hi. WSBIF is awaiting receipt of new station license. WSBUT and WSCLB are on more or less. WSCMN is in a sanatorium at Dansville. W8NW is active. W8BAV is off forever — at its present location. W8BYD has fairly good results with his 112 on 4 and 7.3 mc. W8NW, W8AVM, W8BIF and W8BUT received their first-class operator's licenses at Buffalo. Annual Meeting — R.A.W.N.Y. The Buffalo Club or R.A.W.N.Y. held its annual meeting at the Hotel Sagamore in Rochester on April 26. T. W. Connette, W8AFM, acted as chairman and introduced the speakers as follows: Dr. Grinnell, U. S. Radio Inspector, who spoke on Standards of Frequency. W8CKC gave a campaign speech. John Long of WHAM told of his work on 56 mc. Mr. Robert S. Burnap of the R.C.A. told of the efficiency of the 221 as a detector for the higher frequencies. Mr. R. B. Dome of G. E. told about the short wave antennae at Schenectady. Ralph Riemann led a discussion on the aforementioned sky wires. The R.A.W.N.Y. wishes to go on record as having sponsored and held the largest unofficial meeting or convention in the East. There were 102 present including several members of the Snarks — an affiliated club in Western N. Y. Credit of this meeting should be given to T. W. Connette and Johnnie Miller of W8AFM.

Traffic: W8AFM 1, W8BJO 61, W8CPC 24, W8CSW 0, W8BLP 0, W8DSP 20, W8CRC 25, W8DSA 36.

CENTRAL DIVISION

INDIANA — SCM, D. J. Angus, W9CYQ — The Fort Wayne Radio Club is going to have a big picnic, June 21st and 22nd, at Lake George. The Navy gang at Fort Wayne are going to put in a new radio station for drill work. W9AEL, W9FHZ and W9FVY are new stations at Fort Wayne. W9GFJ moved and had his station going before the furniture had all been moved. Hi. W9ETH, W9DWL, and W9BHM have changed to Xtal in the last month. W9BWI is on the air after a month of rebuilding. W9CVX is increasing power. W9COI is in New Mexico for his health. W9RW is building new receivers. W9A00 is going well with a 50 on 7000 kc. W9FXM is back from the hospital and wants a Michigan schedule. W9EPH sends in a report for the Richmond gang.

Traffic: W9AIP 23, W9GGJ 22, W9GCO 7, W9AKJ 22, W9BKJ 10, W9GJS 20, W9A00 6, W9CWS 26, W9CMQ 2.

ILLINOIS — SCM, F. J. Hinds, W9APY — W9FBT has installed another 250 on his fone set. W9CSP is now on 7000 kc. Fireworks were displayed at W9EHQ when they forgot to cut in a primary resistance in the 1000-volt transformer on a 210. Hi. W9ACH is exploring the 14,000-kc. band. W9ANX blew his filter and is staying off until things are fixed. W9DLV uses 2 201A's with fine success. W9BNL and W9FIE have made application for ORS. W9BNI has been handling traffic from Hawaii and Guam via relay on west coast. The Centralia hams had a portable fone on a ham-fest picnic 15 miles from town, and kept in touch with the home base all the time. W9ASY and W9APY each have new screen-grid sets going nicely. Illinois Bell Telephone Radio Club has a code class of 17 new prospective hams. W9BDW was QSO WFAT and took traffic. W9TT is back in Chicago and will start up an outfit under W9PK. W9ERU has been spending his time on 7- and 14-mc. bands. W9DSS has quit blowing blocking condensers and has taken to blowing transformers. Hi. W9FTQ worked Africa with his 210. W9BXB is building a new transmitter. W9BAI has a remote control outfit. W9PA has a new typewriter, so things may go faster there when he gets up speed. W9BEF has heard plenty of DX on 14 mc., but has been unable to work any. W9CPY, W9BIF, W9BOY, W9FFR, W9AGT, and W9BEF had a two and a half hour fone QSO together one Sunday morning. W9KA is moving again. W9CKZ is building a new AC receiver. W9GJJ graduates from school this month. W9GIV says, "My Kingdom for a Crystal." W9BNI has a crystal, but won't take a kingdom for it.

W9DGI is in the experimenting mood. W9ALZ was married this month. W9AKA and W9TQ will soon step off into the unknown realms of married life. W9DOX has been trying to find why his set is QSK. W9EGY received a QSL from Budapest, Hungary, reporting his 3500-ke. signals. W9BZO threatens to drag his crystal down to 28 mc. W9ACU is still working 7- and 14-mc. bands with his 171-A and 180 volts of B batts. W9CFW is remodeling the outfit into a nice cabinet. W9AAE is erecting a new mast for the business end of his new MOA. W9FPN and W9LJ are busy with exams. W9FPN desires schedules with 28-mc. stations. W9AFF is on 14 mc. and finds things slow. W9DCK has been on 3500 fone lately. W9CZL reports traffic and DX fine on the 7-mc. band. W9AFN is R9 with the BCL's. W9BIR is starting in business. Reception is poor at W9BVP. W9CNY is overhauling. W9FDJ is using the W9BYC circuit in May QST and says, "How it does work."

Traffic: W9DZM 146, W9BVP 65, W9CKZ 50, W9CZL 31, W9AMO 25, W9ASY 24, W9DGI 23, W9BZO 20, W9BNL 19, W9FCW 16, W9LL 13, W9FDJ 10, W9PA 10, W9DCK 9, W9AFN 8, W9ACU 7, W9APY 7, W9BIR 7, W9CFW 7, W9GIV 7, W9KA 4, W9AKA 3, W9BDW 3, W9ERU 3, W9BMQ 2, W9CNY 1, W9FPN 1.

OHIO — SCM, H. C. Storek, W8BYN — All of us are looking forward to the coming convention at Dayton. W8CNO still leads the section. W8BAC comes second, and says he has been mostly on 14 mc. W8NP voices the common complaint, radio conditions rotten and schedules non-existent. W8BKM says the same. W8AQ is having 'phone QRM. W8CSS has been trying his hand at 'phone. W8CFT wonders how many of these 'phone men ever saw a telegraph key. W8BBH has his crystal rig going. W8ADS says he has been sick. W8TK says that if QRN does not soon stop there is going to be another ham set listed in the ham ads. W8EJ advises that he is getting things together for crystal control. W8DMX cannot understand why stations make schedules and then fail to keep them. W8APC has about given up the ship until QRN lets down. W8BBR is still on the sick list. W8CX has a good formulae concerning YLs and DX, best yet. Hi. W8BRB is a newcomer. W8BDU reports the Naval Reserve unit coming fine up his way. W8REA is still going strong. W8PL says air has been dead. W8HH has nothing to say for himself. W8DBK will be on the air from Georgia, 1st of August, with portable call W8ZZC. We have a new ham with us in the person of J. W. Hardesty, W8DAI, an old Morse man. W8JC recently moved to Dayton, but he keeps the set on the air. W8CFL says his main trouble is with "A" batteries. W8BZL is quite active in tests, and adds his vote in favor of a public list of off-wave offenders. We lose W8RN again. He is on KFNA. He reminds me of the old song about "On again, off again, gone again, Finnekan." Hi. W8IF has been off the air on account battery trouble. W8BYN has also been off the air as he has been away from home.

Traffic: W8CNO 86, W8BAC 48, W8NP 41, W8BKM 34, W8AQ 26, W8CSS 23, W8CFT 22, W8BBH 22, W8ADS 16, W8TK 16, W8EJ 10, W8DMX 7, W8APC 7, W8BRB 6, W8CX 6, W8BRB 4, W8BDU 4, W8BEA 4, W8PL 3, W8HH 2.

KENTUCKY — SCM, J. B. Wathen III, W9BAZ — What goes on here? Few reports and low totals. We can't all be winners, but our place is to show 'em that Kentuckians are Thoroughbreds! Lean on those keys. W9OX staggered over the line to win his second lap. Tied with W9AZY at two all. W9BAN took a flyer, but fell a trifle short. W9FZV has plenty of traffic but no takers. W9BAZ is off for two weeks, as the house is being remodeled. W9GGB has pinned his reputation to a single 210. Bad conditions broke up skeds for W9DDQ. W9ELL is getting out very well with 14-mc. fone. W9EYW has built another xmt which is the last word in performance. W9AZY has a new receiver for DX. The BCL's are trying to hook their sky-wires to W9BWJ's new tower. W9AUH reports schedule with W2VO. W9AXU breaks loose with news on his remote control. W9ZZE is on the move again. W9DAI is unsuccessfully attempting to raise Cuba. W9AIN has been seen frequently with "the yL." W9AJY is a source of wonder to guests of the Kentucky Hotel. A prize will be given to the ORS handling highest total for the summer months (July, August and September), so better get your skeds oiled up now.

Traffic: W9OX 51, W9BAN 45, W9FZV 37, W9BAZ 18, W9GGB 13, W9DDQ 11, W9AUH 6, W9EYW 9, W9ELL 11, W9AZY 7, W9BWJ 6, W9AXU 3.

MICHIGAN — SCM, Dallas Wise, W8CEP — W8CPB has a fifty on 7000 and a 250 on 14,000 kcs. W8GJ thinks he will die of old age before he gets a crystal to perk. W8DDO is pounding along in the same old way. W8TJ is back again, but reports poor WX for radio. Army activities hampered the gang at WYE. W8DYH has been busy sending code practice for beginners. If interested, listen on 3600 kcs. Tuesdays and Thursdays, at 7 p.m., E.S.T. W9AXE reports good DX signals on 14 mc. W8BRO wants to go to camp with the National Guard in July. Any other Hams interested get in touch with W8DMS at Detroit. W8CKZ is getting ready for summer, but not with the old transmitter. W8PP is teaching a couple of beginners the code. The baseball season is QRming the traffic down at W8DED's. W9GJX came down to Ypsi for the Hamfest. W9CE reports poor conditions on both 7 and 14 mc. W8AJC is busy with the Army Net. W9EQV is studying for a commercial ticket. W9EGF says all the schedules have gone "Hay Wire." W8ZF hopes to get into the traffic column next month. W8JD has hooked up with the National Guard. W8DFS has been troubled by the heavy QRN. W8CEG is a newcomer from Detroit. W8CU can't get the insects out of his MOPA. W8ACB is playing around with a screen-grid detector circuit. W8BRS reports things dull. The Michigan Hamfest at Ypsilanti National Guard Armory was the best attended of any held to date, there being about 118 Hams present. W9GJX and W8BRS were two of the notables present. W8DMS, W8CAT, W8VST, W8COW and W8DYH put the job over, and we'll say "Well done." Having served as your SCM for the past three years, I feel that I can no longer attend to the duties. This will be my last report. I wish to thank you, gang, for your splendid cooperation. Until after the regular SCM election to be held later, please send reports to Kenneth Conroy, W8DYH, 7553 Robinwood, E. Detroit, Mich. Cul, gang, and hope to QSO from W8CEP. 73.

Traffic: W8ACB 11, W8CEG 3, W8JD 129, W8ASO 6, W9EGF 13, W9EQV 2, W8AJC 61, W9CE 5, W9GJX 5, W8DED 3, W8PP 32, W8CKZ 4, W8BRO 26, W9AXE 16, W8DYH 36, WYE 68, W8TJ 12, W8DDO 19, W8CPB 12, W8CEP 8, W8COW 19.

WISCONSIN — SCM, C. N. Crapo, W9VD — W9DTK has his new AC receiver completed. W9FSS has no Army Net to worry about during the summer. W9FAW has a new DeForest 510. W9VD now has a new screen grid DC receiver, frequency meter, and Hi C transmitter all in good working order.

Traffic: W9DTK 66, W9FSS 3, W9FAW 1, W9VD 4.

DAKOTA DIVISION

NORTH DAKOTA — SCM, Guy L. Ottinger, W9BVF — I sure do appreciate being made SCM, fellows, and will try to fill the office in the most efficient manner. W9IK, W9CUU, W9EEK, W9FLF, W9FMC, and W9DYA enlisted in the Naval Reserve. W9FCA says he is going to Coyne next fall. W9DM handled some traffic W9DGS is QRL work. W9DFG states that the radio wx is very poor. W9BVF handled a rush message via NNINIC and WU from a U. S. Marine Aviator, who cracked up in Nicaragua. W9DYA may not get in the Naval Reserve because of his eyes.

Traffic: W9BVF 48, W9DGS 16, W9DM 5.

SOUTH DAKOTA — SCM, D. M. Pasek, W9DGR — The Sioux Falls gang report a fine picnic at Iowa State Park, the Juverne, Minn., gang being there en masse. W9DNS is very busy at KSOC. X9BQV stopped at W9CIR for a nice visit. W9DB is working on a 3.5 mc. xtal outfit. W9CKT has a portable (W9DUS) outfit. The following A-A stations are active on schedule: W9DB, W9DNS, W9CIR, and W9DGR.

Traffic: W9DNS 92, W9DB 11, W9DGR 2.

NORTHERN MINNESOTA — SCM, C. L. Jabs, W9BYH — W9AV is planning on a mercury arc. W9DOQ reports W9CYZ, a new station at Virginia. W9EHO has a rotary converter but is too busy with farm work to use it. W9EGU had a fine trip to Hartford to attend the A.R.R.L.

Board of Directors meeting. W9GGQ asks to have his O.R.S. put on the inactive list for the summer months. W9FAQ sends in a fine letter reporting on activity at his station. W9BVH expects to be on again after making a few minor changes.

Traffic: W9AV 27, W9DOQ 4, W9BVH 7.

SOUTHERN MINNESOTA — SCM, J. C. Pehoushek, W9EFK — W9COS could only handle 668 msgs. this month. Hi! Leach at W9BN has been rebuilding. W9DRG rates a WAC certificate. W9BKX is going into his usual summer experimentation and improvement period. W9AIR attended two banquets. W9BXE was on the rifle range most of last month. W9ABK is on at W9BXE some. W9AQH has moved to Lake Minnetonka, where he has a beautiful 860 crystal-controlled set in his shack. Ex-W9LL is now W6IL at Los Angeles. W9GHO is putting in crystal control. W9BHZ is planning on lots of fishing. W9DGE is operating on the river. W9EFK is on spasmodically. W9FYL expects to be on regularly through the summer. W9BSH is QRL at WRHM. W9FLE was sorry not to make the Ames convention. W9GGA, W9DHP, W9CIX, W9DGW and W9DOP are all on the inactive list. W9EOH is with KSTP. W9BQF has three transmitters on three bands. W9YC staff has been rebuilding WLB. Cotton, W9DPX, will be the R. 1. at Portland, Oregon, after graduation. W9DBC has been quite sick but is improving rapidly. W9FFE has been assigned to ex W9DZA. W9BIY is at KSTP.

Traffic: W9COS 668, W9BN 323, W9DRG 166, W9BKX 42, W9BXE 12, W9GHO 7, W9AIR 7, W9BHZ 4, W9DGE 1, W9EFK 1.

DELTA DIVISION

TENNESSEE — SCM, James B. Witt, W4SP — It looks like summer weather has started taking its toll. W4FR will be off the air most of the summer as he is going to the country. W4LU will handle some of his traffic. W4VK will also be away most all summer. W4AHR, who was formerly at W9ALY and W9AGD, has applied for an ORS certificate. Philip Stout of old 5XK will be on soon with call letters W4AAD at Kingsport. W4AFS has skeds with nine different stations. Whether you are an ORS or not, send your reports in, fellows.

Traffic: W4AFS 63, W4FR 32, W4VK 23, W4AJQ 8, W4KH 4, W4CW 2, W4SP 4.

MISSISSIPPI — SCM, J. W. Gullett, W5AKP — The following stations are members of the Army-Amateur Radio System: W5AKP, W5FQ, W5AAP, W5AAZ, W5BBX, W5BHL, W5AZV, W5BQL, W5BLL, W5GG, W5AWP, W5BEV, W5ZZO, W5AUB, and W5BHC. W5AAP says traffic has fallen off greatly. W5AAP and W5BHI have new transmitters going in the 700-kc. band. W5AHR is a new station in Corinth. W5BHL has made application for ORS appointment. W5AZV reports that Jackson Amateur Radio Association has been formed with himself as president; W5BHL vice-president and W5BNW treasurer. W5BOT is a new station in Jackson. W5AED is back with us after several months' illness. W5GQ is talking of rebuilding his transmitter. W5BMA has moved from Ellisville to Laurel. W5AKP has two new Western Electric 211E tubes and is debating as to just what he wants to do with them.

Traffic: W5AKP 88, W5AED 83, W5AAP 20, W5AWP 18, W5AZV 13.

LOUISIANA — SCM, Frank Watts, Jr., W5WF — The first item on the clip this month is to mention the LOUISIANA Convention, to be held in Shreveport sometime during the latter part of the summer. We also will welcome any op from out of the state. W5BHV reports that the OW has taken up ham radio and will apply for license. W5EB, who is the Director from Delta Division, visited W5CMP on his return trip from Hartford. W5YW says they are always looking for traffic. W5ANA is now working on a xtal rig. W5ZW is the call assigned for the use of the Pelican Wireless Club of Monroe. W5BDJ is on the inactive list. W5ACY is now in the Army-Amateur Net. W5NO is operated by a group of operators of a seismograph party. W5MH reports that 7 mc. is the only band he can work. W5WF was disrupted for a few days on account of storm blowing antenna down.

Traffic: W5ANA 50, W5WF 49, W5YW 28, W5EB 23, W5BHV 19, W5ACY 1, W5PG 12, W5BKL 13.

HUDSON DIVISION

EASTERN NEW YORK — SCM, H. J. Rosenthal, W2QU — W2ALI is moving to Newburgh. W2AVS is back on the air after a six months' vacation. W2BAI is working on 28 mc. W2BKN says DX is good on 7 mc. W2ACB entertained several of the A. R. R. L. Directors and showed them through the G. E. Laboratories. W2FO had bad luck with traffic this month. W2ANV says that 7 mc. is entirely dead during the day. W2BRS is also known as W1ARL when at his home in Danbury, Conn. W2SZ is off the air while experiments are being conducted. W2RD was the only Bronxville ham reporting. W2ACY is marking time on 7 mc. before going back to 35 mc. W2LU reports the Schenectady Amateur Radio Assn. now has 84 members. W2BJA is going to put in pure DC. W2BWV again reports that he is moving to the Eighth District. W2QU has arranged with the Pilot Good Will South American Flight to handle its traffic via station NNINIC.

Traffic: W2QU 404, W2LU 135, W2ANV 96, W2BAI 53, W2BWV 38, W2RD 29, W2AVS 15, W2ALI 11, W2BRS 6, W2ACY 5, W2ACB 3, W2BJA 3, W2BKN 2.

NEW YORK CITY AND LONG ISLAND — Acting SCM, V. T. Kenney, W2BGO — Manhattan — A non-ORS, W2AJP, comes through with a total that beats all ORS in his boro except W2AFO, and while using 201A tubes is getting reports from ZL and VK on his signals. W2AFO leads his boro besides doing lots of OO work. W2BXW, a new ORS, wants skeds with Florida and Vermont. W2BDJ had an early vacation. W2BNL says he met old 2DN on the air; after being off the air for seven years DN comes back on 3.5 mc. W2AOY says the only QSO lately was by flashlight and key with a gob on one of the battleships lying in the harbor. W2BZN requests QSOs with the local gang. Bronx — W2AII leads the Bronx. W2CYX is visiting at various conventions around the country. W2AET keeps them going. W2AQQ is having his troubles with BCL cutting down the sky wire. W2VG has QRT most skeds until the cooler weather. W2APV can now be heard on the 14 mc. fone band with a fine signal. Brooklyn — W2ATZ is getting D3 reports without any filter in the transmitter. W2ARQ's new YL is causing plenty of QRM for him. W2APK sends in a good total. W2PF, Army Radio Aide, helped man the Hudson Division convention. W2CCD is just about ready to hit the sea again for the summer. W2BIV, OO, has a 14 mc. fone going. W2BEV, a new ORS, promises to make the BPL next month. W2BJF sends his first report. W2AQQ tells us he'll be on 14,000 kc. for the summer. W2BRB is working on direction finders and aircraft radio. Long Island — W2AVP, the old reliable, has a new ham operating at his shack; he is W2CGA. W2AYM, the Boy Scout station, goes on the inactive list.

Traffic: Manhattan — W2AJP 48, W2AFO 44, W2BXW 17, W2BDJ 8, W2BNL 2, Bronx — W2AII 77, W2BGO 47, W2CYX 45, W2AET 19, W2AQQ 12, W2VG 2, Brooklyn — W2ATZ 34, W2ARQ 58, W2APK 52, W2PF 28, W2CCD 27, W2BIV 17, W2BEV 8, W2BJF 5, W2AQQ 3, Long Island — W2AVP 52, W2AYM 1.

NORTHERN NEW JERSEY — SCM, A. G. Wester, Jr., W2WR — W2CNL turns in the usual excellent total. W2JF complains of bad wx and cancellation of skeds. W2DX has a YL who keeps him off the air. W2AOS says that QRN has dropped his traffic figures. W2WR has been to Atlantic City on business. W2APU and W2QVQ complains about the 7 mc. band. W2CWK has too much business pressure to pound brass. W2AGX is rebuilding and installing an 852. W2AVO has been busy in a BC station. W2BPY intends to install xtal. W2PC has installed a xtal and is on 7060 kc. with a pair of fifty watters in push pull in the final amplifier. W2CJX is another who complains about poor conditions. W2BTI and W2BMT paid a visit to our YL station, W2BY. W2BZB is out for DX on the 14-mc. band.

Traffic: W2JF 86, W2ACS 21, W2APU 2, W2CWK 4, W2JC 14, W2AGX 3, W2AVO 22, W2BPY 12, W2PC 15, W2CJX 16, W2BZB 3, W2CXL 338.

MIDWEST DIVISION

NEBRASKA — SCM, C. B. Diehl, W9BYG — W9ANZ has been very ill. Mrs. W9ANZ reports for him this month. W9QY and W9BOQ are busy with farm work. W9EEW runs away to Chgo this month.

W9DTH can't scrape up much this time. W9DVR reports. W9EBF says QRN heavy. W9FAM is rebuilding for higher efficiency. W9EHW is "Cat-Hauling" power supply for DC fone. W9BHN, a new ORS on 7100 kcs., has nice total. W9DI is rebuilding for 14 mc. 9GFG, a new CC station, is on the air at Lincoln. W9BQR is building a Zepp Ant.

Traffic: W9QY 12, W9DTH 3, W9EBF 1, W9BHN 10, W9DI 2.

IOWA — SCM, H. W. Kerr, W9DZW — Davenport leads the gang this month with W9ACL in the lead, followed closely by W9FUD. W9BCA has a KFR6 sked. W9FZO notes the TSARC plan a new club house and permanent station. W9DXP notes prospects for club at Des Moines: W9BSZ is active. W9APM is rebuilding. W9HD is xtal-controlled. W9FFD has been 14,000 kc. since convention. W9DUN, another newspaper and golf bug, reports a few. W9GKL reports for Ames. W9FWG has visions of a new xmtr. W9EOP finishes college. W9EJQ has his Amateur Extra First. W9BTL will be on again with brother Glen at the key. W9AIR and gang called on W9DIU, W9EJQ and W9DGW on trip to convention, also on W9EXQ and W9DXO. The Ames convention was a WOW, and no one went to sleep on a solid day of technical stuff. Our thanks to all who helped make such a fine meeting.

Traffic: W9ACL 68, W9FUD 47, W9BCA 44, W9DZW 41, W9FZO 22, W9DXP 18, W9FFD 9, W9DUN 7, W9GKL 2, W9FWG 2, W9EOP 2, W9EJQ 2.

KANSAS — SCM, J. H. Amis, W9CET — The usual summer slump is with us. Your SCM doesn't like to cancel ORS appointments, but it will be in order if you don't report each month. W9DFY takes traffic honors. We are glad to see W9FKD putting out large traffic totals again. W9CET is all set for the 23-mc. tests. W9FLG has been winding some new power transformers. W9GFO is leaving the section to enter radio school in New Orleans. We're sorry to lose you, OB. W9CFN finds it impossible to keep skeds on account of bad wk. W9BTG gets R-5 from WFBT in N. Z. with 20 watts input on 14 mc. W9HL reports little activity in western Kansas. W9ESL lost his two lattice masts in the big tornado. Say, gang, let's all get on 14 mc. for the summer and keep our traffic up. The Topeka W.S.N.R. unit drills each Wednesday nite at their Armory on the State Fair grounds. The dates for the Midwest Division Convention will be September 5th-6th at Topeka. The K.V.R.C. is busy making plans. At the first meeting in May the K.V.R.C. elected the following officers for the coming year: W9CET, President, W9FLG, Vice-President, W9DEB, Secretary and Treasurer.

Traffic: W9DFY 80, W9FKD 55, W9CET 52, W9FLG 28, W9GFO 24, W9CFN 14, W9BTG 10, W9HL 5.

MISSOURI — SCM, L. B. Laizure, W9RR — St. Louis reports W9DXY led in traffic. W9FTA was second. W9AMR was off doing considerable rebuilding. W9DYJ is down on 14 mc. W9ECI sends in a first report. He has applied for ORS and OBS appointment. W9DQN led Missouri this month with the assistance of W9ECS and W9ALC, who have been operating much of the time. W9CFL handled considerable U.S.N.R. traffic. W9DPA sends in a "Calls heard" DX list. W9GGI is still getting started. W9AKZ rebuilt the works. W9BMA is running 6 skeds. W9ASU was in Kansas City for an operation, but is back home, now. W9FUN has been trying out electrolytic filter condensers. W9AOU and W9API are two new stations in Webster Groves. W9EDK had considerable trouble lately, moving and changing jobs. W9EYG is now on in Monett. W9GAR reports a new ham organization started in his section known as the South Missouri Association of Radio Amateurs which W9CLU and W9GAR are taking the lead in promoting. W9EP is still open for east and west skeds. W9BJA has been having trouble with filter condensers. W9CDU says he will be on 7 and 14 mc. until fall. W9ENF was on more this month. W9DHN had school QRM most of the month. W9DNO was only on two days when home week-ends. W9BGN represented the St. Joseph gang this month. W9DCD sent in a long report. W9GAW was killed in a motorcycle accident. W9AWE is busy running a summer resort camp.

Traffic: W9DXY 104, W9FTA 50, W9AMR 6, W9DYJ 5, W9ECI 11, W9DPA 3, W9AKZ 62, W9BMA 90, W9CFL 75, W9DQN 307, W9EPX 3, W9BJA 17, W9CDU 30, W9ENF 10, W9DHN 12, W9DNO 8, W9BGN 52, W9GAR 52.

NEW ENGLAND DIVISION

EASTERN MASSACHUSETTS — SCM, Miles Weeks, W1WV — W1CMZ, W1WV and W1BR head the list this month and make BPL. W1CMZ has a new monitor and is contemplating crystal. W1ASI has entirely rebuilt everything. W1RV is now op on S.S. *Santa Rita*, New York, to Valparaiso, Chile, and has resigned his ORS. W1QZ blew his 210. W1BBT reports a fine time on the U.S.N.R. cruise. W1WU is winding a new 1 KW. transformer. W1LQ is building separate outfits for 3500 and 14,000 kc. W1BLD expects to be on regularly now that school is over. W1BKB was very QRL at WPC this month. W1AAT has been sick. W1BZQ still reports difficulty in getting skeds on 7000 kc. after midnight. W1WV has been keeping occasional skeds with W10-XS, one of the Boston to New York Transport planes. A new MOPA is now perking at W1ACH. The ORS appointment of W1RL has been cancelled for inactivity. W1AZE handled some foreign traffic. W1CHR and W1CQN again report some traffic. The Eastern Massachusetts Amateur Radio Association and this section were well represented at the Worcester Convention. The Association is planning a club house of its own and looks forward to a larger membership than ever next fall.

Traffic: W1CMZ 311, W1WV 163, W1BKR 103, W1ACH 102, W1AZE 79, W1BZQ 54, W1BKB 46, W1WU 4, W1CQN 4, W1ANK 2.

MAINE — SCM, G. C. Brown, W1AQL — Manley Haskell, chairman of the Committee on Arrangements, says that the convention at Portland will be better, bigger and merrier than ever. Don't forget the dates: August 22d and 23d. W1ALZ has been confined to the house for some time with a severe attack of pleurisy. W1AQD reports handling traffic from New Zealand and Chile. W1AUR is second high in traffic. W1AHY says that traffic is picking up over his way. W1BFZ has been struggling through a bad power leak. W1CDX's new QRA is: 174 Eastern Prom., Portland, Maine. W1QH has been testing on 28 mc. The Queen City Club recently enjoyed its first outing of the season at W1BFZ's camp at Hermon Pond. W1ARV says that Jack Pierce, formerly of W1EB, is the proud father of an eight-pound daughter. Congratulations, OM.

Traffic: W1AQD 89, W1AUR 21, W1CDX 12, W1AHY 6, W1BFZ 3, W1KQ 3, W1AQL 2.

RHODE ISLAND — SCM, C. N. Kraus, W1BCR — W1BML, W1GU and W1CPH are new prospects for ORS. W1AMV is back from a trip down south, where he has been operating on airplanes for the Pan-American Airways. W1AWE is hot on the trail of a good note. W1BCR's transmitter is undergoing changes. W1MO is active on 7 mc. W1CPH recently received his commercial ticket. W1GV reports Cranston activities direct to HQS. He, W1OU, W1AFO and W1AJP are using 'phone. ExW1AABP expects to be back on 'phone shortly. W1GV is a newcomer to our ranks. The Radio Club of R. I. received the fone signals from KHJQ, the airplane (*New Arabella*), while they were flying over New England. Club meetings are held every Monday evening. A cordial invitation is extended to all amateurs to attend. Address is 67 Pearl Ave., East Providence.

Traffic: W1BCR 11, W1MO 14, W1GV 6, W1OU 1.

CONNECTICUT — SCM, Fred A. Ellis, Jr., W1CTI — W1ATW has rebuilt his receiver. W1HQ says very little doing in Milford. W1AMQ received his ORS appointment. W1AGZ has been appointed official observer. W1MK says summer is breaking up a lot of skeds. W1CKP reports things quiet there. W1AFB still keeps a sure-fire sked with W1JN. W1BQH has school QRM. W1ATG tells of W1APN, old 1WZ, now in Bridgeport with a 210. W1AKI sends in his initial report and asks for an ORS. W1BOD was on the delivery end of a fast message from Chile. W1AJB reports. W1ABL is pushing out a lot of traffic on 7100 kc. W1JN is signing off for exams and vacation. W1AQC reports working KHJQ, the plane, *New Arabella*, on its flight from Hartford to Pawtucket. W1BJK gets on 3.5 mc. once a week for Army traffic. W1UE will soon be on at new QRA in Elmwood. W1TD has been working hard fixing up new rooms for the club. W1AGZ is experimenting with different types of antennae. W1CTI sticks to the 3500-kc. band. W1AMG got his report in just in time to make the write-up. W1RP is buying a new bug.

Traffic: W1MK 493, W1AMQ 46, W1HQ 3, W1ATW 32, W1AFB 79, W1AKI 2, W1BOD 17, W1AJB 3, W1ABL 76, W1JN 55.

VERMONT — SCM, Clayton Paulette, W1IT — W1CGX is again high man with a total of 73. W1BD comes next with 29. W1AOC reports. Most of the stations in the state have cancelled their skeds for the summer.

Traffic: W1CGX 73, W1BD 29, W1AOC 10, W1IT 6.
WESTERN MASSACHUSETTS — SCM, Dr. J. A. Tessmer, W1UM — W1NS had a race with W1BZJ for first one working all districts on 3.5 mc. W1NS won with his 210. W1CTF is bothered with much QRM from local YL's. W1COS is attending Sam Curtis' Radio School in Boston. W1ARP has a baby YL. W1AMF has the most beautiful transmitter. W1ARP has been in N. E. or N. J. W1BLV and W1CRL visited W1MS. W1BKQ had a hum-dinger Spring Ham Fest and Pitch Party. W1AJK is in Brookline and comes to Worcester week-ends. W1AMQ is on 3500 and 14,000 kc. wid a 7 1/2-watter. W1BVR is still on the 3500-kc. band. W1BNL is building a new traffic tuner. W1APL will be on regularly soon. W1BG is experimenting with 'phone.

Traffic: W1BVR 29, W1AQM 10, W1APL 3, W1ZA 69.

NEW HAMPSHIRE — SCM, V. W. Hodge, W1ATJ — W1APK sends in an interesting report of two-way airplane work with KHLQ, the plane *New Arabella*. W1AEF doesn't have time to pound the old key much. W1COW will be on at W7ANZ on 14 mc. in a month. W1AUY reports things very quiet in Meredith. W1IP is going to rebuild the whole works. W1ABC, a new station in Claremont, is reaching out with a 201-A. W1UN is building some portable sets for use in the White Mountains. The SCM reports a new Jr. Op., born May 23.

Traffic: W1APK 17, W1COW 9.

NORTHWESTERN DIVISION

MONTANA — SCM, O. W. Viers, W7AAT-7QT — W7AAW and W7HP are the only reporting stations this month. The fellows who have been sleeping for the past two or three months had better come to life, or there will be some ORS tickets cancelled!! W7AAT is still on 7040, 7020 and 3790 kc.

Traffic: W7AAT 91, W7AAW 89, W7HP 2.

OREGON — SCM, Wilbur S. Claypool, W7UN — Coos Bay scores again. W7AMF makes BPL on deliveries. W7UD hands in his first total. W7PE is using Electrolytic Condensers in his filter. W7ALM is going great on K7 traffic now. W7MY reports traffic. W7TO is heading for Alaska this summer. W7WR asks to be placed on inactive list for the summer. W7MV had such a hot report he wrote it in red ink. He is using fone on 3500 kc., as does W7WH. W7IF reports via radio. W7AHJ and W7AJX report in fine shape. The OW always leads TOM in TFC. W7AIG reports rotten radio WX in his town. W7QK hopes to hang up a WAC with the new Hi-pwr. he uses. W7AMQ has an 852 perking now. W7SU has his XTAL going. The SCM is using MOPA with good success on 3500 kc. W7ANJ is also using it. W7AJW has put in DC. W7QY is in line for ORS.

Traffic: W7AMF 162, W7PE 58, W7UD 102, W7ALM 40, W7MV 17, W7MY 23, W7WR 18, W7TO 20, W7AHJ 9, W7AJX 6, W7AMQ 24, W7IF 10, W7AIG 2, W7UN 27.

WASHINGTON — SCM, Gene Piety, W7ACS — The first place in traffic is taken by W7QF on his first report. He is vice-president of the Spokane Radio Ops Club and says that the plans for the convention are coming along fine. Mason is back from the Byrd expedition, and the gang gave him a coming home party, in the Bergonian Hotel in Seattle. Thirty-four amateurs attended, and a good hamfest was held. W7ACY has been working a little dx. W7FJ complains about school exams. W7AG is trying out 3.5-mc. fone. W7AFD blames low traffic on poor conditions. W7TX is not having much luck with his Alaskan skeds. W7ANP reports tonsillitis. W7BB reports from Canal Zone. W7JNS reports between school tests. K7AIF (W7AF) sends in reports and asks gang to look for him. Don't forget the convention on August 29th and 30th.

Traffic: W7QF 33, W7TX 18, W7AG 10, W7ACY 6, W7TK 4, W7AJS 3, W7NR 3, W7AFD 4, W7FJ 1, K7AIF 8.

PACIFIC DIVISION

SANTA CLARA VALLEY — SCM, F. J. Quemant, W6NX — With 723 messages to his credit — 598 delivered — all transpacific, Colonel Foster, W6HM, finished a most successful season of message handling. For the next several months W6HM will be silent while the Colonel vacations in British Columbia. W6YG continued to handle many msgs on sked. W6ALW is putting in xtal control on 7200 kc. W6DQH has moved out in the country where QRM is negligible. W6BMW has been experimenting with portable radiophone. W6BAX reports lots of DX on 28 and 14 mc. W6EEC is using 14 mc. with good results. W6AME answered the lure of the trout streams this month. W6CTE is op on the U. S. S. *Admiral Peoples*. W6AZS is another 14 mc. man. W6CHC, W6AYT and W6BBG are new Modesto hams. W6BBG is a YL and second op at W6DQH. W6DCI received portable call W6AHT. W6RRV was QSO SA and Asia on 14 and 7 mc. W6FV will soon be on the air. W6CLP and W6KU are on 7 mc. W6EJ and W6BZZ are active fone stations. W6QA is on 7 and 3.5 mc. with xtal control.

Traffic: W6HM 723, W6YG 99, W6ALW 72, W6DQH 61, W6BMW 30, W6EEC 3, W6AME 2, W6NX 10.

EAST BAY — SCM, J. Walter Frates, W6CZR — With the northwest trades pushing white fleecy clouds across the perfect indigo of a May sky, the meadow larks trilling in the green foothills, and that faint sparkle about the YL's eyes, our traffic handlers have climbed into their tin chariots and have scampered away after that elusive CQ of the spring. All of which means that the fellows are not reporting as well as they might. W6AWF has just gotten his commercial ticket. W6EIB at Vallejo ran him a close second through his work installing a booth during the pow wow of the Red Men in his home city. The station was built up with the help of W6ABJ. The outfit was operated under W6EIB's portable call. W6EIB expects to be off the air for a month or so while he changes himself and family into a new hogan. W6ALX declares that 7025 kc. signals are the bunk these days. W6BPC reports receiving a letter from a ZL in which the Zedder says that he has heard all U. S. districts on 3500 kc. and about 20 U. S. A. fones on this band. W6BZU out at Concord isn't letting the call of spring and the droning of the humbees bother him as far as traffic is concerned. W6ARI, new station reporting, was rounded up by our rotund CRM, W6AQ. W6ASH reports that he is working in a bona fide radio shop now. W6CGM is a fireman on the Western Pacific and the other day his locomotive with the OM in the cab got tuned in on the same wave with a Key System street car, ruined the street car, and gave 11 passengers spots before the eyes. He told W6AN, section secretary and an official of the street car company, at the official investigation of the crash that it wasn't personal. Anyway W6CGM says that 00 work and busting up W6AN's rolling stock keeps him too busy for traffic. W6BIW announces that he has been monkeying with 28 mc. W6RJ is busy doing 00 work. W6AIN says he is going on a vacation. W6BI reports that he is busy getting six USNR fone and CW sets on the air for code practice and drill on 1875 kcs. W6AQO is one of the new fellows brought in by W6AQ. W6ATT is still doing his old BC and ham stint. W6ALV is still busy with that YL. W6ZA has announced his engagement, and W6CQG, Vollmer, got married a few weeks ago. W6IP spent a short visit home before returning to the Orient on KDUY. W6DDA is also back from a voyage.

Traffic: W6AWF 431, W6EIB 401, W6ALX 393, W6BPC 136, W6BZU 72, W6ARI 72, W6ASH 43, W6CGM 37, W6BIW 37, W6RJ 22, W6AIN 18, W6BI 17, W6AQO 4, W6ATT 3.

LOS ANGELES — Acting SCM, C. A. Nichols, W6ASM — Well, gang, this is my last report as acting SCM, so I will take this opportunity to thank you one and all for your splendid cooperation. Mr. Sandham is back on the job again. Let's all continue to give him our best efforts. The following make the BPL this month: W6BZY-W6WA-W6DEP-W6AKW-W6QP-W6AKD and W6AOA. The Short Wave Club of Pasadena has been holding some interesting meetings of late. Through the courtesy of the Automobile Club of So. Calif. and W6FE, the Long Beach gang

had the opportunity to see the outfit and car that the SCM used on his trip. The ARRC continue to have some peppy meetings. The Bakersfield gang once more take the traffic banner among the clubs, their total being 919. W6WA is responsible for the reports each month. W6MA now has a frame for her operators license. W6ZZA is rebuilding his portable into xtal control. W6BVZ has a new 210. W6EQD now has his xtal outfit on 7154.8 kc. W6AM says that 14,000 kc. is sure fb for dx now. W6BRO is not on much since the IPH expedition returned. W6ABK says work takes up his time. W6ERL has new QRA. W6CZT is changing both xmitters to MOPA. W6CXW wants a sked with a nine near Chicago. W6BCK is another unfortunate one that has to work for a living. W6TE is rebuilding his xmitter so as to make a more substantial bid for the ARRC Cup. W6DVA has been up to San Francisco. W6EAF reports a visit by W6AM. W6AWY wants the Heavyside layer to behave. W6UJ complains of bum conditions in the 7000-kc. band. W6AKD reports being heard in Africa on 28,000 kc. while using a 5-watt xmitter. W6QP wants traffic. W6AKW continues to handle Philippine traffic. W6DEP handles plenty of traffic. W6BZY leads the section in traffic. W6BFI is waiting for a 250-watt jug. W6ID is building new receiver like the one Schnell had at the convention. W6DZI reports a few blowouts. W6ACL is rebuilding receiver. W6ESA now has xtal control. W6FJ says that his 210 xmitter works better than his 50-watt outfit. W6ASM won the croquetted water bucket in the traffic contest between the "Pico Twins." W6BXR annexed an OW in April. W6BVV is going to college and dreaming of football and YLs.

Traffic: W6BZY 545, W6WA 453, W6DEP 291, W6AKW 279, W6QP 274, W6AKD 229, W6AOA 154, W6AOB 137, W6DLI 129, W6UJ 89, W6ETJ 95, W6DQV 73, W6AWY 63, W6ETN 51, W6EAF 51, W6ENH 37, W6DVA 29, W6TE 29, W6BCK 27, W6CGY 23, W6AGR 14, W6FENQ 14, W6CXW 12, W6BGF 11, W6CZT 11, W6ERL 10, W6ESA 10, W6ASM 5, W6COT 5, W6ABK 4, W6FJ 4, W6BRO 4, W6AM 3, W6EQD 3, W6CIX 2, W6BVZ 1, W6ZZA 1, W6MA 1, W6AZL 1.

SAN FRANCISCO — SCM, C. Bane, W6WB — The report this month might well be headed "Rebuilding." This new ruling about DC has set all the boys to tearing up the old heap and installing something different. W6ERK leads the parade in traffic. W6EKC comes along with a very close second. Incidentally, both W6ERK and W6EKC make the BPL. W6DFR is to be complimented on the way he handles the A-A schedules each Monday night. Another new man to report this time is W6DCD, who breaks in with a very good total. Beginning June 15th — July 15th all ORS in this section will be required to have a total of at least 20 messages each reporting month. Failing to comply with this rule for two consecutive months will result in cancellation. W6PW reports as usual. OM Phalen sends in his report for the first time in quite some little while. W6AC is still haunting the 14-mc. band. W6AMP has finally succeeded in getting DC after months of lost sleep! W6DTZ is concerned about 14 mc. dx work. W6EPT is with us again. W6ATI has drawn up elaborate plans for his new xtal set. W6KJ and W6BTO are complaining about absence of sigs on 28 mc. W6ETR is scouting around for a rock which he plans on putting in very shortly. Once there was a station called W6BIP, who used to lead the section. He is now on the very bottom of this report — why?

Traffic: W6ERK 170, W6EKC 111, W6DFR 88, W6DCD 53, W6PW 57, W6EJ 16, W6AC 13, W6AMP 13, W6DTZ 7, W6WB 6, W6EPT 5, W6ATI 2, W6KJ 2, W6BTO 1, W6ETR 2, W6BIP 1.

ARIZONA — SCM, H. R. Shortman, Jr., W6BWS-W6VV — W6ALU makes the BPL with a fine score. He wants a couple of good skeds east. W6BJF and W6EFC report good traffic work. W6DGN has rebuilt his station. W6DRX, a new man in Phoenix, is doing nice work. W6DCQ is still monkeying with a 3500-kc. phone. W6DXC, another new man, is getting all set for some big traffic work. W6AYO is now living in Phoenix, having an operators job at KOY. W6DRE reports installing a pair of UX 852's. W6AAM, an old time, is back on the air with a UX 210 in TPTG. W6BHC spent two days in Phoenix. W6EFC reports rotten DX and bad QRN. W6EAA is back on the

air using a UX-210 on 14 mc. W6EOF changed his transmitter from Hartley to TPTG with gratifying results. W6EH, W6EOF, and W6BWS-W6VV, the "Three Musketeers" held a big reunion when W6EH spent a week in Phoenix on business. W6CDU is operating at W6ALU. W6BWS-W6VV reports that he now has a junior operator at KGSJ, in the person of W6EEB-W6ECW from Los Angeles. W6BJF has a new "all electric" receiver. The SCM has heard from W6DAU. W6ANO is still pounding commercial brass at KGSJ. W6EL installed a 14 mc. phone transmitter in an aeronca monoplane to operate a public address station on the ground in a demonstration at the Phoenix Sky Harbor Airport. W6AWD reports moving. W6DWP, who was formerly 8API of the old spark days, reports that he is back with the gang.

Traffic: W6ALU 259, W6BJF 106, W6EFC 66, W6AWD 10, W6DWP 7, W6EAA 2, W6EOF 1.

SAN DIEGO — SCM, H. A. Ambler, W6EOP — W6AXV leads the section and makes the BPL. He is taking out an ORS soon. FB, W6BXX, a new ORS, is rebuilding for all bands. W6ACJ found time to handle a few. W6EPZ worked LU3FA and got R8. W6ADC got his 50 watter going. W6CTP worked Hungary with 112A and 200 volts of B batts. W6EPF is troubled with power noises at his new QRA. W6BGL is on fone now. W6EOS is still rebuilding. W6BAM is going to be in on the 28 mc. tests. W6AEP reports lfe slow. W6ECP expects to be going strong soon. W6EOP and W6DAI are on fone. W6HY is heard on 14, 7, and 3.5 mc. quite often. W6DNL is away with the fleet. W6QY is on 14 mc. at his new QRA. W6DNS and W6DGV is very QRL with YLs. W6EOL is on with a 210. W6DNW is still putting out ice cream between ham hours. W6CTR is on fone and is going to build a 50-watt set soon. W6AJM expects to be in on the 28 mc. tests. W6BFB has a 250 watter.

Traffic: W6AXV 238, W6BXX 96, W6ACJ 63, W6EPZ 40, W6ADC 25, W6CTP 19, W6EPF 13, W6BGL 9, W6EOP 9, W6EOS 6, W6BAM 4, W6AEP 4.

NEVADA — SCM, Keston L. Ramsey, W6EAD — The Nevada Amateur Radio Association is getting a fine start and promises to be a thriving Club. W6UO is busy with Army-Amateur work. W6EGA, a new amateur at Yarrington, is on the air with an 852. W6BTJ is getting ready for the 28 mc. tests. W6ZO has given up radio for the summer in favor of aviation. W6AJP is on 7 mc. W6CRF is almost ready for some work with 3500 kc. fone. W6BRV is building a receiver. W6CHG is pretty quiet now. W6CDZ promises a report for next month. All active amateurs get in touch with your SCM. We need a R.M. and some ORS. Let's turn in some real reports for Nevada this summer. Fellows wanting skedules with Reno, Nevada, get in touch with W6EAD.

Traffic: W6UO 11.

HAWAII — SCM, L. A. Walworth, K6CJB — K6EWB has taken the ORS exam and has been appointed Route Mgr. also. He is sending out ARRL broadcasts for the Hawaiian Section at 5:30 p.m. h.s.t. on Wed., Fri., and Sun. on 14 and 7 mc. simultaneously. The SCM visited Maui the week before Easter and was entertained by K6DYC, K6DQQ and K6ERO. K6DYC, K6DQQ, K6ERO, K6CEU, K6EWB and K6CIB form the net of Official Observers to check up on Amateur operation. K6AXX, James Matsueda, of Kalului, Maui, walked in on the SCM and announced he has moved to Honolulu. K6AXK is rejoining over a commercial ticket. K6ACR, K6ALM and K6CIB visited several Schofield stations on Easter Sunday. K6BOE reports his portable call is K6DQF. K6CEU is also using a portable, K6EGD. K6CIB just rec'd some fine fotos of W9GV's ether wrecker. K6DYC is completely rebuilding his set and erecting a 75-foot mast for joint use of himself and K6YAJ. K6EWB and K6BXW report little activity on 56 and 28 mc. K6ALM reports on 28 mc. QSO with W6BXV. K6ALM is building an AC short wave receiver. K6EUV is heart broken because he lacked two deliveries of making BPL. K6DXD has just started and belongs to a new ham, Ralph Wolfe of Hq. Co. 35th Inf., Schofield Bks, T. H. K6DUD, Tex Stafford, Officers Quarters, Marine Barracks, Pearl Harbor, T. H., is another new station. China and the Philippines are routing through K6BXW and K6EWB now. K6BXW, K6EWB and

K6DXD have totals large enough to make the BPL, but they cannot be listed therein as we haven't complete figures on number of messages originated, delivered and relayed. Let us have the dope next time, OMs.

Traffic: K6BXW 871, K6EWB 548, K6DXD 202, K6DQQ 116, K6EVV 99, K6AVL 66, K6DV 50, K6CIB 29, K6BOE 20, K6BJJ 12, K6ERH 11, K6ACR 10, K6ACW 8, K6ERO 9, K6DYC 6, K6ALM 5, K6DPG 0, K6UD 27.

PHILIPPINES — SCM, S. M. Mathes, KAICY — This report received by radio via W6HM. It is impossible in this report to express in mere words how the PI gang has missed KAICY. It seems that everybody is blue. At the suggestion of KA1HC the PI gang has moved to the upper part of the 7-mc. band in order to give the W's the lower part and thus avoid interference with traffic. KA1ZA is going to discard his 500-cycle note and put pure DC on the air soon. KA1HR is again climbing to the top. KA1EL went to Baguio with a portable set but nobody has heard of him since. KASAA is keeping regular schedule with KA1XA. KA1XA is building an MOPA. KA1PW was the last station to work KA1CY in the Philippines and also the first one to greet him at W6HM on his arrival in the U. S. KA1AC is on vacation in Japan. KA1DL has a schedule with W6HM twice a week. KA1DJ still leads the way in traffic, which is the outcome of many well kept skeds on 7143 and 14,290 kc.

Traffic: KA1DJ 867, KA1JR 80, KA1PW 217, KA1HR 860.

CHINA — This report sent in by radio via KA1JR and W6HM. AC8WB makes the BPL. AC9EB put in new 210 with 400 volts on plate.

Traffic: AC8WB 220, AC8RV 220, AC8AG 35, ACSTJ 26, AC9GH 28.

ROANOKE DIVISION

NORTH CAROLINA — SCM, Hal S. Justice, W4TS — W4JR is all set for some good A-A net work. W4AHH handled an important message through WFAT. Prof. W4DW operates consistently at State College. W4TS is on when time permits. W4ZB was sick part of the month. It is with regret that I find it necessary to resign as SCM. I thoroughly appreciate the way you fellows have stuck by me. An acting SCM will be appointed to handle the affairs of the Section until a permanent SCM is elected. Very 73.

Traffic: W4ZB 53, W4TS 15, W4DW 13, W4AHH 10, W4JR 6.

VIRGINIA — SCM, J. F. Wohlford, W3CA — W3BZ attended the Directors meeting in Hartford. W3ARU is still the high traffic man of the State. W3CA is building rig for CW and fone with xtal control. W3BDZ is still tinkering with his phone outfit. W3WO is on inactive list. W3CKL has finished VPI and will leave shortly for NYC. W3ZA is getting out fine with his fone since adding xtal and buffer stage. W3BGS threatens to bust some fones now that he has power at his place. W3HY will be at NKF part of summer. W3AAJ is active again. W3ALS visited W3CKL during Easter. W3AQK qualifies for an ORS. W3NO is President of Richmond Amateur Club. W3AMB is operating a portable from the Scout Camp. W3ABC is now an ORS. W3ASA is operating a beautiful new 50-watt outfit. W3AKV has a crystal controlled 50 watter. W3TJ and W3FE are heard on occasionally. Miss W3IB couldn't make the banquet because she had to buy a present for the boy friend. W3AEL and W3AEW are new hams in Richmond. The Richmond Short Wave Club is taking a State-wide census of ham activities in preparation for a Virginia Convention in October.

Traffic: W3ARU 93, W3HY 17, W3ALS 16, W3AAJ 1, W3AMB 2, W3ABC 3, W3AQK 6, W3FJ 10, W3ASA 2.

ROCKY MOUNTAIN DIVISION

UTAH-WYOMING — Acting SCM Lewis D. Stearns, W6BTX — W6RV and W6CNX are on 14,000 kc. for the summer. W6EKF has a commercial ticket. W6DPJ leads the section in traffic. W7AAH is Net Control of Wyoming. W6BTX, present Acting SCM, regrets that he cannot continue in this capacity, due to his going to University of California for the summer for graduate work. Hereafter, all reports in this section should be mailed to

Cutler R. Miller—W6DPJ—121 East 2nd North St., Provo, Utah. W6DPJ will act as SCM until election.

Traffic: W6RV 11, W6BTX 2, W6DPJ 48, W6CNX 14, W6EKF 12, W7AAH 29.

COLORADO—SCM, C. R. Stedman, W9CAA—W9CLJ walks off with the high score. W9EAM says he will be off for a while on account of the fishing season. W9YL, a new station operated by an old-timer, Mr. Cassell, is located at the University at Boulder. W9CRS has a new wave meter. W9EFT, a 'phone man at Haxtun, sends his first report. W9CAA moved to a new location. W9AAB is still on 7000 kc. W9CAB is getting the power supply straightened out. W9RQO is threatening to get on again, if he can get the necessary cash.

Traffic: W9CJL 14, W9EAM 4, W9CSR 1.

SOUTHEASTERN DIVISION

ALABAMA—SCM, Robert Troy, Jr., W4AHP—W4LM leads the state in traffic. W4TI sets a fine example in reporting by special delivery. W4AHP has installed 566 rectifiers. W4AAQ wants A-A traffic to pick up. W4AHR is busy with school work. W4JQ has joined the A-A net. W4HB has moved to Birmingham. We are very sorry to lose W4ADN, who has gone to Atlanta. W4HI at Maxwell Field has a fine one outfit on 1750 kc. W4AEZ is having hard luck with his one set. W4AKB is busy with his job. W4AJR is having receiver trouble. W4AKM will be back in the A-A net soon. The SCM would like some reports from south Alabama, and a few more from Birmingham.

Traffic: W4LM 147, W4AKM 17, W4TI 23, W4AHR 13, W4AAQ 13, W4AHP 11, W4JQ 10.

GEORGIA—SOUTH CAROLINA—CUBA—ISLE OF PINES—SCM, M. S. Alexander, W4RZ—W4JL was in an accident a short while ago and lost the little finger of his left hand, so guess he will be off the air for some time. W4SS and W4DV have their transmitters going on the 28-mc. band. W4AFQ has been very active in the Army-Amateur net. W4PM has handled 397 messages during the last three months. Say, fellows, let's not let the summer vacations affect us so much that our traffic total will fall far below the standard. Let's try to keep the activities going during the summer.

Traffic: W4JD 48, W4AAV 34, W4AFQ 24, W4SI 32, W4KV 38.

PORTO RICO—VIRGIN ISLANDS—SCM, E. W. Mayer, K4KD—We led the division in traffic for April, which speaks well for our small section. K4AKV reports 14 mc. giving poor results. K4KD has rebuilt to MOPA with a much improved signal. K4DK is going to try 28 mc. Some interest is being shown in San Juan vicinity, and I hope to visit the gang on my vacation and help those on the air who express their wishes. Delinquent ORS this month are K4AAN and K4ACF.

Traffic: K4KD 262, K4DK 144, K4AKV 1.

FLORIDA—SCM, Harvey Chafin, W4AH—W4PAWI—W4QL leads the section and makes the RPL. FB. W4SK reports a new amateur at Melbourne Beach, W4PU. W4SK is testing with a 3500-kc. fone. W4AKH reports for W4UJ. Both of these stations are applying for an ORS appointment. W4ALH is keeping two skeds daily. W4AFT sends in a very fine total for a non-ORS. W4JO is section control station of unit 5 for the U.S.N.R. W4QV is on the 3500-kc. band now with a 100-watt fone set. W4GD is building a high-power all-band transmitter with the MOPA ckt. W4AGN, the Naval Reserve station, has moved. After W4MM read the new requirements of the Federal Radio Commission he installed two recto-bulbs, and worked his first DX station, OA. He also reports for a new amateur in Clear Water, W4RK, who is getting out of the state with a 112 high-power transmitting tube, Hi. W4AKA and W4JM are the only stations reporting from St. Pete. W4TG is burning up the ether with a 100-watt set. W4WW is going to Detroit, and will be there until the U. of F. opens next September. W4MS was in Gainesville operating W4QA until June 1st, but is back in Pensacola at a new QRA. W2NE's

QST of the Australian-New Zealand test broadcast was handled as the most important traffic at W4ADP this month. W4ABF has moved from the U. of F. City to Orlando, and his QRA is Box 836. W4OZ takes part in the U.S.N.R. drill on Thursday nites, and is also keeping a schedule with the U.S.N.R. station, W4QC, at Key West. W4JM has quit all of his DX for a while until he finishes his MOPA set. W4AGY promises to have a larger total next month. W4FV says that he only lacks one European QSO to qualify for a WAC certificate. W4ACM, the U.S.N.R. station, handled quite a bit of tfe. this month. Mr. Jim Joyner has just received his commission for the Tampa U.S.N.R., and W4AH will be the Chief Operator very shortly. W4AKJ, W4BN and the SCM are using 3500-kc. fone sets. Don Hawley and George Wells at Plant City have a station ready to go, and are applying for a license.

Traffic: W4QL 142, W4SK 108, W4AKH 63, W4ALH 61, W4AH 59, W4AFT 52, W4JO 34, W4GD 45, W4QV 27, W4MM 19, W4ACM 46, W4AKA 20, W4TG 19, W4WW 10, W4MS 9, W4ADP 8, W4ABF 7, W4OZ 7, W4JM 5, W4AGY 7.

WEST GULF DIVISION

OKLAHOMA—SCM, Wm. J. Gentry, W5GF—W5VQ is high man and not an ORS either. W5AUV wants to know what has happened to traffic. W5AYF reports a hot hook-up with W5ASQ. W5OJ made his first report. W5GF is operating at all times he can get away from business. The SCM would like to have more reports from the gang.

Traffic: W5VQ 111, W5AUV 14, W5OJ 7, W5GF 3, W5AYF 2.

NEW MEXICO—SCM, Leavenworth Wheeler, Jr., W5AHL—W5AOD has a new AC screen-grid receiver. W5TV, with a prospect, spent part of one Sunday at W5AHL. W5BH reports a new station W5AUW on 7 mc.; also W5ZZG, ex-W6DMQ, on 14 mc. W9COI is in Albuquerque, and is having his outfit shipped out. W5AHL slipped despite five regular skeds.

Traffic: W5AHL 112, W5AOD 86, W5TV 21, W5BH 1.

SOUTHERN TEXAS—SCM, Robert E. Franklin, W5OX—A number of the fellows are rebuilding to conform to the new FCC regulations. It is with deep regret we mourn the passing of our good friend, Mr. Fred Kush, W5HS, of San Antonio. We extend our sincerest sympathies to his family. W5AB—W5BBY is the possessor of a nice new ORS certificate. W5VY-ZG reports handling much traffic. W5TD now boasts a completely AC-operated station. W5BKW turned in a nice report. W5EI has been doing some nice relay work with an ORS certificate in view. W5BHO is still having trouble with his speed. W5JR has been experimenting with screen-grid detectors. W5BOC is a new station in Houston. W5AEA has been letting golf take up most of his spare time.

Traffic: W5BKW 51, W5EI 34, W5BHO 14, W5TD 8.

NORTHERN TEXAS—SCM, Roy Lee Taylor, W5RJ—I sincerely thank all of you for your votes and the confidence you have shown in me by electing me SCM. If I can come near our past SCM, Mr. Robinson, W5BG, in his reports, I will have done well. W5VW leads the section with a whale of a total. W5HY did storm relief work in the recent Frost, Texas, disaster, advising W5TM in Hugo, Okla., as to friends at Frost. FB! W5BAM is doing F. B. O. O. work. W5BAD said the recent tornado took his shack for a ride. W5BG is keeping a sked with KFR6. W5AAE is working both coasts with a 201A on 7000 kc. W5BNN is a very promising newcomer. W5BBF reports. W5GZ expects to make up for lost time when the school closes its doors. W5RJ is rebuilding to crystal control. W5LY wants wall paper badly from some of the boys he has worked. W5BND is building A.S.G. received. W5AZP is having a hard time raising stations.

Traffic: W5HY 113, W5BAM 27, W5BAD 18, W5BQ 12, W5BNN 3, W5AAE 6, W5GZ 2, W5LY 1, W5RJ 20, W5WW 438, W5BBF 1.

CANADA

The Director of Radio, Department of Marine at Ottawa, has authorized the use of telephony in the 14-mc. band. Before using this band for tone work it will be necessary to have a visit from your local Radio Inspector, who will, on being satisfied after inspection that the station complies with the requirements, endorse the license.

Due to the midsummer season, I notice a big decrease in traffic totals. Your CGM would like to impress upon all members the importance of being on at least once a week during this period. More stations are coming on each week for our weekly get-together, so if you operate only one evening of the week make it Wednesday night for contact with Canadian stations.

CANADIAN GENERAL MANAGER
ALEX REID, VE2BE

QUEBEC DIVISION

QUEBEC — SCM, Alphy Blais, VE2AC — Our CGM, VE2BE, went to Hartford on May 2nd and 3rd to attend the meeting of the A.R.R.L. Board of Directors. VE2CA is our most active station. The XYL VE2CA handled her first message. Look in this QST and see the beautiful arrangement of VE2CA's station. Our old faithful VE2BB is going strong as ever. VE2BZ has a pure DC note on 7 and 3.5 mc. VE2AC was busy getting married and honeymooning, but he'll be on the air regularly now, coaching a future XYL operator. VE2AP has been busy with his exams. VE2AA is still chasing these elusive DX stations. I would like to hear from anybody desiring to become an amateur. Possibly we can give the newcomers a hand and speed them through their first steps.

Traffic: VE2AC 54, VE2BE 26, VE2BB 15, VE2CA 12, VE2BZ 5, VE2BG 11.

ONTARIO DIVISION

ONTARIO — SCM, E. C. Thompson, VE3FC — Central District: VE9AL leads the way in traffic again this month. VE3GT worked VK using 4 201-A tubes as oscillators in the TNT circuit with but 180 volts on the plate. VE3DW is still hammering away with his single 201-A. VE3AD will be up in Muskoka with a portable station during July and August. VE3VS is getting ready to leave for the North, where he will operate a station at Orient Bay for the Forestry Branch Fire Ranger Service. VE3GM is preparing to use 'phone on the 14-mc. band. VE3CB reports that VE3DD has vacated for the Forestry Service in the North. VE3DA is busy with the militia. Northern District: G. V. Lawrence, VE3ET, ASCM — Our new man, VE3HD, is having a grand time on 7 mc. VE3BD is putting in DC. VE3DM is rebuilding to TNT. VE3HU will soon be going better than ever on 7 mc. VE3ET paid a short visit to VE3DM and VE3HD, and was treated royally. VE3BH's sked with VE3AR is not working very well. VE3GC is ditching the B bats in favor of a transformer and rectobulbs. VE3ET has moved and, for the summer, reports should be addressed to him at Norembeqs, Ontario.

Traffic: VE9AL 32, VE3GT 30, VE3VS 10, VE3CB 8, VE3GM 3, VE3DA 7, VE3HD 4.

PRAIRIE DIVISION

MANITOBA — SCM, A. V. Chase, VE4HR — VE4BQ has moved from Winnipeg. His new QRA is Calgary, Alta. A welcome reappearance on the air has been made by VE4DY. VE4RR has been assigned the official call VE4AE. VE4HV would like QSO with the Winnipeg gang on 7 mc. VE4GL has now got his TPTG working in fine shape. VE4DK has gone to Camp Borden for a three months' course in flying. VE4JB has been getting prepared for the forthcoming 28-mc. tests. VE4DY promises to be on the air next month.

Traffic: VE4DJ 12, VE4HR 9, VE4BU 3, VE4DY 1, VE4AE 1.

SASKATCHEWAN — SCM, W. J. Pickering, VE4FC — VE4BB is now an ORS. VE4BX turns in the best message total. VE4BL follows close behind. VE4EF has left for Winnipeg. VE4GR reports a hamfest between the Saskatoon and Biggar gang at Biggar. Spring work and rotten weather have kept VE4HH out of the traffic. VE4GO is building a new power supply. VE4FC is on when time permits. VE4HO and VE4HY have amalgamated.

Traffic: VE4BX 17, VE4BL 16, VE4GR 1.

VANALTA DIVISION

BRITISH COLUMBIA — SCM, J. K. Cavalsky. VE5AL — VE9AJ is continuing to broadcast weekly bulletins of local doings in the Ham game. VE5CF is burning the midnight oil over the week-ends. We regret that Bert King, the famous Java King of VE9AJ, is leaving for the South, and wish him the best of luck. VE5BE is on again after plenty of remodelling. VE5BC has junked his screen-grid receiver. VE5CR still keeps his set perking. VE5EF has been heard on fone. VE5AL worked a balloon and a ship, and is now looking for a submarine. Hi. From Prince Rupert we learn that VE5GT is making his Xtal perk with nice results. He was visited recently by VE5FI. VE5CM has gone to sea. VE5DX is doing nice work. Victoria — We offer our congratulations to VE5CO, who is being married shortly. VE5DU is hitting out fine with his TPTG. VE5EC says his old 202 has lost its punch, so is putting in a 210. New stations in the city are VE5AD, VE5HR, VE5DY, VE5HP and VE5CB. VE5HR is using a 201A. VE5AD is on 3.5 and 7 mc. using a 210. VE5CB is going strong with a 201A.

Traffic: VE5AL 24, VE5CF 9, VE5CR 3, VE5GT 12, VE5HR 5.

ALBERTA — SCM, Fred Barron, VE4EC — DX is with us again, gang, in spite of the poor weather conditions. VE4EA worked two ZL's and a K6. VE3GD hooked up with OA4Q on 14 mc. VE4BQ, formerly of Winnipeg, is now active in the South. Ex-VE3AI is awaiting a VE4 call. VE4CE and VE4IO are looking for DX, or what have you. Mrs. VE4EI again tops the list for traffic. VE4GK sends in a nice traffic total. VE4BV has been receiving some very pretty poetry. Hi Hi VE4BJ is a new local. VE4GY is also a new ham at Fort Saskatchewan, using M. G. VE4DZ is QRT, due to lack of time. VE4AF is still working with Xtal control. VE4HM is active when possible. VE4HC says things dead around his shack. VE4EC has not been doing much, but always expects to. Hi.

Traffic: VE4EI 29, VE4GK 21.

MARITIME DIVISION

NEWFOUNDLAND — Acting SCM, E. V. Jerrett. VOSZ — We take pleasure in congratulating VOSMC, our first W. A. C. VOSWG is coming South, and hopes to visit most of the local boys. VOSAW gets excellent reports with his new rig on 14,000 kc. VOSMC has begun experimenting on 28,000 kc. VOSZ put up a new voltage-fed Hertz and worked Argentina on 14,000 kc.



Boyd Phelps, known since 1921, as BP, appropriately has the call W2BP, and spends his summers in Minnesota where he operates W9BP. He says the formula for getting the same call as your initials is to wait until the chap with the desired call dies, then get him to sign over his old license (We want more information on this point, BP.), hold it until it has expired one day less than six months, have no other station license, file a new application with the expired license, and pray.

In disclosing this we hope mortality will not be increased among us because we hold a much coveted call.

Calls Heard



**ON R470, M. de Waepenaert, 22 Rue des Soeurs-
Noires, Termonde, Belgium**

14,000-ke. band

wlaao wlabg wlaeb wlaf wlafd wlagi wlagk wlamq
wlaqt wlasf wlaw wlaze wlibf wlbhm wlbjn wibke wibux
wibwa wicaw wicok wicow wicp wicz wily wimp
wiqv wiry wiuw wivz wiwe wiew w2aaw w2acd w2adp
w2aeb w2aey w2afr w2afu w2ag w2ahz w2ait w2ajb w2ajj
w2amm w2amr w2aoo w2aow w2aoy w2aqi w2arb w2arj
w2ary w2auu w2aww w2ayj w2bbp w2bda w2bey w2bia
w2bih w2bka w2bla w2bok w2bon w2bru w2buy w2bwc
w2cug w2el w2fp w2ku w2mb w2oa w2ov w2qn w2ra w2sn
w2zg w3adh w3adz w3afu w3ake w3aog w3aqi w3ati
w3auo w3bhv w3dh w3jr w3in w3bm w4ael w4akh w4akt
w4gq w4gw w4pz w4ql w8adm w8bbp w8bct w8bhz w8baz
w8bf w8bjv w8bhp w8blh w8bsl w8bww w8cew w8ced
w8cug w8ddl w8dpo w8dxo w8dea w8dem w8hcx w8kr w9an
w9asl w9aze w9bba w9bvf w9eix w9mt en8rux aulbz
cm8uf fm8cr fm8fa fm8fr fm8tui lu8dt nj2pa py1cd py2ay
py2bg velas velbr velco veldr ve2bb ve2bd ve2ea ve4bd
ve4ic ve8ao vk2ay vk2lx vk2ns vk2rx vk2wu vk2zx vk3go
vk3pa vk4br vq4ere vo8me vu2zx su8rs z2bg z3as z3bb
zs5d zs5n zs5w zt5r

**H. T. Petersen, "Fribe," Ostergade,
Norsresundby, Denmark**

7000-ke. band

Heard in Sumatra

w6jn w6dea w6eaf w6elm w6ac w6aw wpm k1xa k1ze
k1ce k1pw k1hr k1cy k1cl k1dj k1cm k1hc ac2ft ac9gh
ae5go ea1ab j3cek om1tb kp3pr vk2ow vk2hm vk5hg vk5wr
vk5mj vs8ab vs6ah vs7ap

Heard in Singapore, F. M. S.

ae8ls fo3sr

Heard in Indian Ocean

ka1hr kalce vk2lv vk6wi vk6dx

Heard in Suez Canal

d4va ear98 f8rsb i1fg oh2kz on4uu paouy

**W8HX, C. G. Mellor, 274 W. Calthrop Ave.,
Syracuse, N. Y.**

7000- and 14,000-ke. bands

ce2ab ce3dg ce3dj ce3aa cm2sh cm2jm cm2jt cm2yb cm5by
cm5ex cm5fl cm5uf cm8qb cm8j ct1aa ct1ad ct1bx ct1by
ct1ep ct2aa ct2am ct3ab cx1af cx2ak cx7 d4abg d4xn
ear1 ear110 ear113 ear21 ear152 f8ag f8bha f8br f8cs f8ct
f8da f8dhf f8dmc f8dot f8ef f8er f8ex f8fr f8gdb f8hr f8jq
f8lgb f8lx f8oa f8olu f8pam f8prw f8rex f8rjh f8sun f8swa
f8xd fm8cr fm8gke g2ao g2bm g2dz g2gt g2gm g2ip g5by
g5is g5ml g5ms g5yx g6ia g6lb g6lk g6pa g6rb g6vp g6wt
g6xb g6xq haf8b helij helle he2jm i1ll k4aan k4akv
k4dk k4kd k6boe k6ewb k6eqm k6galm k6bhl ka1sr ka1re
kfr5 kfr6 hu1ba lu1jf lu2aa lu2ad lu2bj lu2ea lu2dj lu3de
lu3dh lu3fa lu3fk lu3oe lu3pa lu4da lu4dq lu5bz lu5oh
lu5dj lu8dj lu8dy lu8en lu9ce lu9dt nn1nic nn1se nn7c
nj2pa on4j on4l on4p on4q on4t oh7nb on4fp on4ft on4gn
on4he on4jj on4kj on4lx on4ka on4ro on4uu oz1k oz7y
pa0aw pa0qf pa0zf px1 py1aa py1ah py1aw py1cd py1cm
py1dc py1li py2ad py2ay py2ba py2bf py2bg py2bk
py2cm py2ig py2ih py2ik py2qb py3ah q1la x1laa sn1aa

sp1ae su6w ti2ea ti2fg tg1je velal velam velap velar velbr
velce velco ve2aa ve2ak ve2ap ve2ak ve2ar ve2bb ve2be
ve2bn ve2cg ve3be ve3bq ve3cm ve3dr ve3eo ve3ft ve3ta
ve4ai ve4al ve4bc ve4be ve4bq ve4cs ve4ct ve4cu ve4ck
ve4ex ve4dq ve4ec ve4ek ve4el ve4ic ve4fx ve4fg ve4go
ve4hg ve4hr ve4hx ve4ic ve4ur ve5al ve5ao ve5aw ve5bl
ve9si vk2ay vk2hk vk2kj vk2no vk2rf vk3ac vk3es vk3go
vk3jk vk3kl vk3pp vk3rg vk4bh vk4cg vk4dh vk5hg vo8ne
vo8an vo8aw vo8ne vq2bh x1g x2r x9a z1aa z1lak z1lft
z12ab z12ac z12dq z12gl z12gq z13ao z13am z13bb z13bt
z17ab z1sp z1sn z1sr z1sa z1sm z1sn z1su z1tl z1tr z13am
zt5r zuld zu6n

**W9BFW, Chester Rector, R. F. D. No. 1, Tipton,
Ind.**

3500-ke. 'Phone band

w1ay w1amq w2baj w2boz w2bqy w3aex w3aid w3ain
w3ani w3dsz w3vw w4ce w4eoh w4hn w4id w4pd w4qz
w4vk w5aw w5er w5kx w6das w6kp w7acj w7ce w8adx
w8ahz w8ajh w8akf w8aof w8aou w8arh w8awi w8azo
w8bae w8bf w8bie w8bik w8bir w8biz w8buw w8byr w8bz
w8ejd w8ek w8elx w8cmd w8esa w8evr w8dbq w8dz w8doc
w8dnd w8dl w8dwn w8dwx w8fu w8ha w8ia w8jh w8rd
w8wf w8wm w8aid w9auv w9bbz w9bei w9bjw w9byp
w9daq w9dtu w9dvi w9efw w9eia w9eng w9etd w9fke
w9fle w9frr w9get w9ghx w9mke w9mw w9qy ve3rf

**W2BER, David Paxton, 15 Thompson St.,
Troy, N. Y.**

14,000-ke. band

w6ae w6ael w6akf w6amp w6an w6aoe w6aqy w6azl
w6ban w6bkw w6blx w6box w6bto w6chy w6ctp w6cyb
w6dbt w6dgn w6dgp w6dmk w6dpa w6dte w6egh w6epb
w6epi w6eug w6eup w6hv w6id w6ip w6kb w6kt w6ky
w7aew w7ait w7amo w7anx w7ek w7if w7je w7mu w7qy
w7sg w7ty ve5ao ve5aw ce3ag ce3aa cm8uf f8ef f8ex f8fem
f8fr f8cs f8hr f8lgb f8prw f8rex f8sm g2gm g2jm k4kd
k6ctf oa4j on4fp on4jj on4us x9a

**W9AZY, Carl Newman, 402 Tenney Ave.,
Louisville, Ky.**

3500-ke. 'phone

w6bik w6eme k4kd k4kd k5dd k6av1 k6dv k6eqb k6ewb
z11aa z1lfe z1ldf z1lwn z12ac z12bg vk2ns vk3bq vk3es
vk3ls vk3pp vk3zw vk4bh vk4hl vk4ml vk5wr vk6sa
vk7ch hel1g ok1na f8er f8rit f8sx nn7c wia sn1ap pxr g5by

**N1DN, Delbert Miller, aboard U.S.S. Tennessee,
Guantanamo Bay, Cuba**

7000-ke. band

ab6 g5by hel1g ka1ce ka1hr ka1pw k1dj k4qv k4acf
k4kd kfr6 nn1nic nn1se nn1az ve1gd vk2bj vk2ow vk5fr
vk7ox vk2ev vk3pp ve3dd kaldo w1cow w1cte w1mk
w1rv w1ags w1bbz w1bil w1rd w2aof w2cxl w2amr w2bo
w2bau w2are w3anh w3aws w3adx w3bm w3ant w3my
w3aaw w3nn w4gk w4dr w4aik w4qv w4ct w4akg w4lj
w4is w4ahq w4aeq w5ain w5ann w5bj w5bah w5es w5fo
w5rx w5se w5sy w5sav w5bhq w5bki w5wu w5aea w5aap
w5bkg w5aqx w5lva w5aao w5pa w5bhz w5blb w6adt
w6ait w6aix w6ami w6amw w6aoo w6ata w6aw w6awe

(Continued on page 74)

Correspondence

The Publishers of QST assume no responsibility for statements made herein by correspondents.



The New Regs

Kennedy, Ala.

Editor, *QST*:

I am very much elated over the new regulations, and believe they are a decided step forward. I have kept a log of every transmission I have made since I went on the air, and don't see how any ham can operate with any satisfaction without keeping one.

One thing about the new rules — I am one of the chaps with no filter but a rectifier, so must add the filter. Hi! Good-bye r.a.c. for me, and here's hoping the others with r.a.c. and a.c. do the same thing, for I know we will have more operating enjoyment if the bands are not crowded out with a.c.

— M. H. Grantee, W4AG

W1AXV's Transmissions

Saranac Lake, N. Y.

Editor, *QST*:

I wish to state that I took advantage of W1AXV's offer to measure any amateur frequencies. I read of it in the May issue of *QST* and worked him on the May 2nd, Friday evening schedule.

This is a very valuable service and I, for one, greatly appreciate it.

I have a high "C" frequency meter as described in November *QST* and I use all the standard frequency transmissions to check up on its calibration every week.

Many thanks to the staff at W1AXV.

— J. T. Dowdell, WSDSA

An Invitation

2 Chepstow Road, Croydon, England

Editor, *QST*:

We should like, through the medium of *QST*, to invite and welcome to Croydon, all transmitters who intend visiting England during the coming summer.

Ring G5BY at Croydon 2578 any day about 7 p.m., and we will do our best to give all a real good time.

— Geo. G. E. Bennett, G5BZ,
A. L. O'Hefferman, G5BY,
for "The Croydon Gang"

From an O. O.

Sorento, Ill.

Editor, *QST*:

As an Official Observer, I have sent out more than 200 cards to off-wave stations during the past six months, and while engaged in this work it has dawned upon me that a little comment on the subject of answers to these cards is in order. Many amateurs write and advise that they were accidentally out of the band and will be found where they belong in the future. Fine; that's what we want to hear.

Now here is where the rub comes in. A great many of them will write, and in doing so will request answers to their letters and in many cases some information; now if these hams want answers they should be courteous enough to put in a stamped, addressed envelope for the convenience of the O. O., and be sure that they really need answers before writing. Although we all like to correspond with our friends of the key and mike it will be appreciated that 50 or 60 letters in a month take stationery and time, to say nothing of postage. All this comes out of the O. O.'s pocket.

For the benefit of those who are profiting by our work, I wish to list the following points:

1. When we say your call was heard, that call was the one. There is no guess work; we check and re-check and (as Andy tells Amos) "double-check," so if you were not on, someone was *with your call*. We appreciate that no one likes to be accused of off-wave operation who isn't guilty, so naturally we listen until certain of the call.

2. If your call was heard and you were not operating, write the O. O. and tell him, but don't ask him to hunt the pirate. Notify your supervisor. He has men to check up on unlicensed operation. The O. O. is glad to get the letter and know you were not guilty, but hasn't time to play detective.

3. If you have some technical questions or want some information, enclose a stamped, addressed envelope; the O. O. will appreciate it, and I'm sure he will be a good sport and answer it if possible. Of course, if you want to know about adjusting a transmitter or anything of that sort write to the A. R. R. L. Technical Information Service or to some other information bureau, or better still ask some nearby ham to help you, but be sure he knows the construction and

SM

You'll Know When You Hear It—This Is The Real "Auto-Set"

Three Screen-Grid Tubes

Direct Tuning

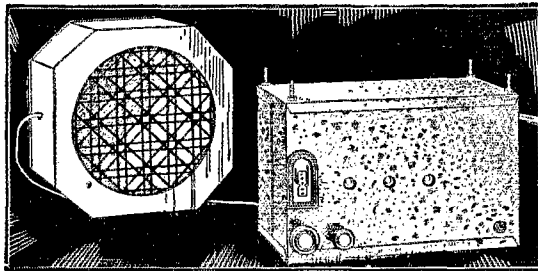

S. G. Power
Detector
Sensitivity

On the market since June 1st, the S-M 770 Auto-Set has proven itself to have everything:

1. SENSITIVITY — 2.5 to 14 microvolts per meter (an average of 8 over the broadcast band). That's one of the things that makes possible real console-model reception.

2. THREE SCREEN-GRID TUBES — giving you console-model wallop.

3. SCREEN-GRID POWER DETECTION — as you know, five times better than a '27 detector!

4. ABSOLUTE TUNING — directly through a regular S-M 810 illuminated drum dial, eliminating dubious control through a "remote" shaft—another feature exactly like the finest console.

5. SMALL SIZE — 12 inches long by 7½ inches high and 6¼ inches deep — a pocket edition expressly designed for its job.

6. NO CUTTING UP THE CAR — mounts on brackets under the cowl to the right of the driver's seat where the dial and controls are easily seen and accessible.

7. SPECIALLY DESIGNED SPEAKER — 9½ inches wide and only 3 inches deep, magnetic, with matched impedances, fitting under the cowl to the left of the receiver.

8. RESISTANCE-COUPLED DETECTOR — giving fidelity fully equal to modern full-size receivers.

The S-M Auto-Set was designed by the world-famous Silver-Marshall laboratories to give absolutely everything regardless of price — but the price is remarkably low:

S-M 770 Auto-Set complete, except for tubes (3-'24, 1-'12A, 1-'71A) and speaker, \$79.50 list. Parts total \$61.40 list.

S-M 771 Auto-Set Accessories, including all necessary installation equipment except tubes and batteries, \$17.50 list.

S-M 870 Automotive-type Magnetic Speaker. Complete with mounting brackets, \$15.00 list.

The New Short-Wave 737 Shows What a "Bearcat" Is

Designed to lick anything in the short-wave class, the 737 Bearcat does — and how! It has two screen-grid tubes — will reach out and drag 'em in by the heels — is plenty selective — and you can spread the ham bands without taking the set apart and throwing half of it away. It's completely shielded — has its own cabinet — and its own built-in power supply!

Eight specially-designed plug-in coils (included

in the list price) cover from 16.6 to 200 meters — all foreign and American short-wave broadcasting as well as the ham bands. Four extra coils (\$5.50 list) cover the American broadcast band. What more could you ask?

Tubes required: 2-'24, 1-'27, 1-'45, 1-'80.

737 Short-Wave Bearcat, completely factory-wired and tested, less tubes and speaker, \$139.60 list. Parts total \$109.50 list.

The Radiobuilder, Silver-Marshall's publication telling the very latest developments of the laboratories, is too valuable for any seibuilder to be without. Send the coupon for a free sample copy. If you want it regularly, enclose 50c for next 12 issues.

4,000 Authorized S-M Service Stations are being operated. Write for information on the franchise.

SILVER-MARSHALL, Inc., 6409 WEST 65TH ST.
CHICAGO, U. S. A.

Silver-Marshall, Inc.
6409 West 65th St., Chicago, U. S. A.

.... Send your latest catalog, with sample copy of the Radiobuilder.

.... 4c enclosed; send Data Sheets on 737 and 770.

.... 10c enclosed; send five new S-M Data Sheets (including the 737).

Name.....

Address.....

Cunningham RADIO TUBES

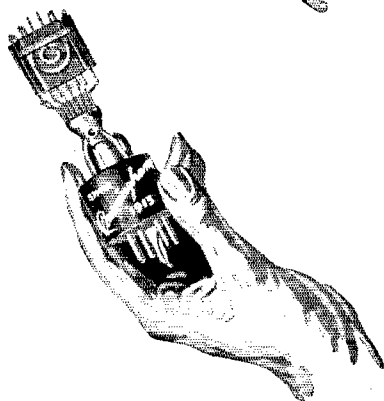
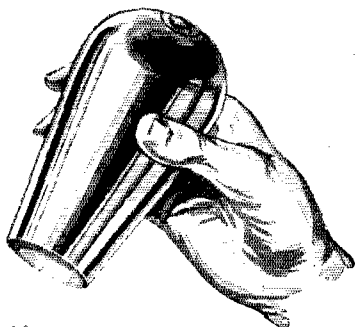

Where Tube Similarity Ends —and National Popularity Begins

Quality is enhanced by
comparison.

That's why Cunninghams
always come up smiling.

E. T. CUNNINGHAM, Inc.

NEW YORK CHICAGO SAN FRANCISCO
DALLAS ATLANTA

operation of radio apparatus himself — some don't.

4. A notification that your station was off-wave does not mean that your license, O. R. S. certificate or anything else will be cancelled, but don't be careless about it, for after three or four reports showing continued off-wave operation in the face of notification this is the best you can expect. Always answer an off-wave card, for that is the only check we have; and unless you do we take it for granted you were operating. If you were not, and we *do* hear you later off-wave, you get two black marks where only one is deserved.

5. The observer isn't trying "to get something on you." He is trying to preserve your operating privileges and the privileges of all other amateurs, and you should consider that you are lucky that the R. I. didn't happen to be listening in instead.

I have any number of very friendly letters from the many hams I have notified, and appreciate them very much. I have answered a number of letters requesting information and am glad to help a brother ham whenever possible. Considerable time is spent here in checking, and this comes off the time I might be working myself; thus you can appreciate why I must be brief in handling notifications.

One point I must add here: a great deal of off-wave work is the result of using one of the condenser and coil frequency meters and having enough error in the check to spell the difference between the right and wrong side of the fence. A heterodyne frequency meter is the best bet, and no ham who uses one is found off-wave, providing it is properly calibrated.

We must get inside our bands and stay there. The O. O.'s are doing their bit; give them your cooperation.

— T. R. Pugsley, W9BNR

A Lucky Chance

Editor, *QST*:

A couple of months ago, we happened to be in Cook's Strait, New Zealand, en route from Auckland to Wellington. While in Auckland I had visited ZL1FW and some of the others and believe me, they treated me fine and came down to look over the arc on WQBV.

The other night after leaving I was listening in on the old short waver and heard my friend Earl Wiseman of W6BBR working 1FW. Eric told him that W6CHT had visited him the night before and after signing off, Earl called W6BVS, another member of the Hollywood gang, and told him I was in New Zealand.

"Well, that's fine," said Bivis, "maybe George is listening to me now. Hello OM." and he sent a nice long message with all the latest dirt.

Maybe that didn't make me feel FB! It was just like a letter from home and had not been prearranged. BVS just had enough faith in his old fifty to try a "blind" message, and it got through.

— George Derry, W6CHT, WQBV

SPRAGUE

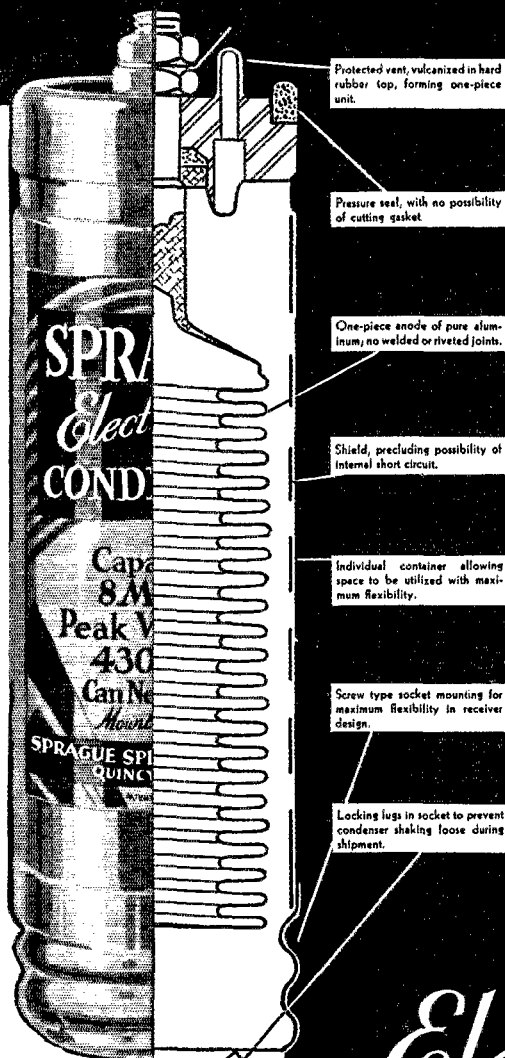

Capacity
8 MFD
Peak Voltage
430 DC
Can Negative

Here you **SEE**
why it's
Years Ahead!

JUST glance at the diagram here, and you'll see Sprague superiority at a glance. Notice the exclusive, one-piece, round-edge anode—no soldered or welded joints either above or below the solution.

See the breather vent sealed by a soft rubber nipple, inseparably vulcanized to a hard rubber top—an absolutely leak-proof one-piece construction.

Don't miss the screw threaded, individual mounting—adapting the Sprague condenser to all types of sets.

And then bear in mind that its 8 MFD capacity is concentrated within a space of $1\frac{3}{8}$ " diameter x 5" overall. Giant capacity in midget size.

SPRAGUE SPECIALTIES COMPANY
QUINCY (Boston) MASS.

Manufacturers also of the well-known
SPRAGUE PAPER CONDENSERS

Electrolytic CONDENSER

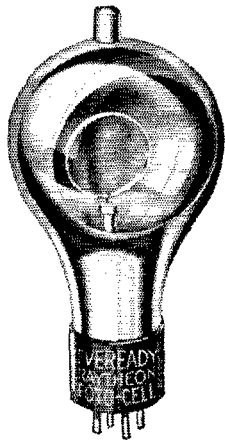

EVEREADY RAYTHEON TUBES FOR TALKING PICTURES, TELEVISION AND ALL INDUSTRIAL PURPOSES

The Eveready Raytheon Foto-Cell is a long-life transmitting tube for talking pictures and television. It is also finding new industrial uses every day, such as paper testing, color matching, automatic counting, control of illumination and many others. In several standard types, or made to specification.

The Eveready Raytheon Kino-Lamp, for television reception, has uniform glow over the entire plate, and its reproductive qualities are perfect without the need of mirrors or ground glass.

Write, if you are interested in talking pictures, television or Foto-Cell applications of any kind. **Free**—Eveready Raytheon Technical Bulletin No. 1, dealing with the Kino-Lamp, and No. 2, covering the Foto-Cell.



The Eveready Hour, radio's oldest commercial feature, is broadcast every Tuesday evening at nine (New York time) from WEAJ over a nation-wide N. B. C. network of 30 stations.

NATIONAL CARBON CO., INC.

General Offices: New York, N. Y.

Branches: Chicago Kansas City New York
San Francisco

Unit of
Union Carbide



and Carbon
Corporation



Trade-marks

CQ Again

838 Hauser Blvd., Los Angeles, Calif.

Editor, *QST*:

If I am not mistaken there was once upon a time printed in *QST* a letter upon the subject of "CQ". Judging from the noises in our 20- and 40-meter bands I think it's about time for another one.

A "CQ" is all right in its place, and there are times when rather long calls are justified. However, there's a limit. My particular pet peeve is the lad who persists in blatting out a string of "CQs" from fifteen to forty in length. His usual procedure is to slur the signature a couple of times, and then start another series.

But this pest is not the worst. The operator who really deserves the guillotine is the one who breaks the monotony of his endless "CQ" with drawn-out inserts of "dah did dit, dah dit dit daahhh —." He usually pulls this stunt during those limited periods of the day in which DX is good, and consequently time is rather precious.

For goodness sake, gang, let's see if we can't get rid of these nuisances. And in the meantime, let us limit our own "CQs" to not more than five without a signature, and let's be especially careful never to "CQ DX" without immediately signing our call and hence indicating what is DX in relation to our QRA.

— J. Lee Smith, WCAWP

QSP

1216 Utah St., Toledo, Ohio

Editor, *QST*:

There is a little matter which I have had on my mind for quite some time. I am an old ham, having been in the game way back when . . . and therefore ought to know what I am talking about. The matter I wish to speak about concerns the old custom of handling messages.

It seems that some hams have absolutely no scruples about messages at all. They will cheerfully take one and then as cheerfully forget about it. They don't care whether it gets to its destination or not. What shall we do with this kind of a ham? The answer is, nothing, because it is a matter of honor and nothing else. We give a message in the faith that it will be relayed in the near future; but whether it is or not we do not know.

Just the other day I was talking to a ham about this matter and he said to me, "I'll tell you what I do with most of messages." He said, "I throw them in the wastebasket."

Now, I ask you, is there a spark of manliness in this kind of an operator? I think he is a disgrace to the fraternity. The least a ham could do would be to say that he does not want to QSP and let it go at that.

With me it is a point of honor to get the message away, no matter if I must send it by mail. Recently I had a message for California and could not get rid of it so I sent by mail, since it had to be there by New Year's. One thing I always tell my brother hams is that if they ever give me a message, they can depend on its getting through.

— Spot Neubrecht, WSBTAM

RADIO
TELEVISION-TALKING PICTURES

TUNE IN ON R.T.I.

BIG MONEY NOW!

More to Come



Radio now offers ambitious men the greatest Money-Making Opportunity the world has ever seen! Hundreds of trained service men are needed by radio dealers, jobbers, and manufacturers!

A "trained" Radio "Service and Repair" man can easily make \$40 to \$50 a week, and it's very common for a trained man with experience to make \$75 a week and up.

BIG MONEY for spare-time Radio Work is easily made in every city and village. You can now qualify for this Big-Pay work quickly through R. T. I. Get the Big Money Now and go up and up in this Big Pay field. The Radio industry calls for More Men, and R. T. I. supplies what the industry wants you to know.

Supervised by Radio Leaders

R. T. I. training is prepared and supervised by prominent men in radio, television and talking picture engineering; distributing; sales; manufacturing; broadcasting, etc. These men know what you must know to make money in Radio. You learn easily in spare time at home with the R. T. I. wonderful combination Testing Outfits, Parts, Work Sheets, Job Tickets. It is easy, quick and practical—covers everything in Radio—includes Talking Pictures and the latest in Television.

\$60—\$70—\$80—PER WEEK AND UP. That's what R. T. I. training leads to. Send for the R. T. I. Book.



No Experience Needed

ALL YOU NEED is the ambition and the ability to read and write. The Radio industry needs practical trained men. Remember, R. T. I. makes it easy to earn spare time money while you learn at home.

More to come

THE MEN who get into this Big-Money field now will have an unlimited future. Why? Because this billion dollar Radio industry is only a few years old and is growing by leaps and bounds. Get in and grow with it. \$10 to \$25 per week and more is easily made in spare hours while you are preparing for Big Money. TELEVISION, too, will soon be on the market, so the leaders say. Be ready for this amazing new money-making field. Remember, R. T. I. "3 in 1" home-training gives you all the developments in Television and Talking Picture Equipment, together with the complete R. T. I. training.

Warning

Do not start R. T. I. training if you are going to be satisfied to make \$15 or \$20 per week more than you are now. Most R. T. I. men will make that much increase after a few weeks. There is no reason to stop short of the Big Money Jobs or the Big Profits in a spare time or full time business of your own. No capital needed. Get started with R. T. I. now. Make money while you learn at home.

R. T. I. Book Now FREE

The thrilling story of Radio, Television and Talking Pictures is told with hundreds of pictures and facts—thousands of big money jobs and spare time money-making opportunities everywhere. Send for your copy now. **USE THE COUPON.**



Let **F. H. SCHNELL** and the R. T. I. Advisory Board Help You. Twenty years Radio experience. First to establish two-way amateur communication with Europe. Former Traf. Mgr. of American Radio Relay League, Lieut. Com. U. S. N. R. Inventor, designer, consulting Radio engineer.

Assisting him is the R. T. I. Advisory Board, composed of men prominent in the Radio Industry. These men know Radio and will help you succeed in their field.

RADIO & TELEVISION INSTITUTE
Dept. 10B
4806 St. Anthony Ct. Chicago

RADIO & TELEVISION INSTITUTE
Dept. 10B, 4806 St. Anthony Court, Chicago
Send me Free and prepaid your **BIG BOOK** "Tune In On Big Pay" and full details of your three-in-one Home Training (without obligating me in any way).

Name.....
Address.....
City..... State.....

THE R. T. I. ADVISORY BOARD. These men are executives with important concerns in the radio industry—manufacturing, sales, service, broadcasting, engineering, etc., etc. They supervise R. T. I. Work Sheets, Job Tickets, and other training methods.

R. T. I. R. T. I. TRAINS YOU AT HOME FOR A GOOD JOB OR A PROFITABLE PART TIME OR FULL TIME BUSINESS OF YOUR OWN

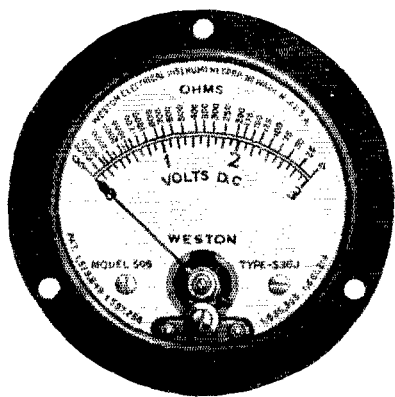

Weston Model 506 Resistance Meter

WESTON announces a miniature instrument for radio service men's use, known as Model 506 Resistance Meter. By means of this instrument direct indications can be obtained of resistance values from 10 ohms to 10,000 ohms. It can also be used for making continuity tests.

The Model 506 Resistance Meter operates on two flashlight cells or any other 3-volt D. C. supply. To use this instrument it is only necessary to make a series circuit of the meter, the 3-volt battery and the resistance to be measured.

This instrument is enclosed in a standard 2" panel type case for flush mounting. It has an etched "volt-ohm" scale. It can be mounted on a panel or used in a portable unit by placing it in a small box together with the two flashlight cells.

For complete information and prices, write direct to the factory, Radio Engineering Dept.

Weston Electrical Instrument Corp.

602 Frelinghuysen Avenue, Newark, New Jersey



I.A.R.U. News

(Continued from page 48)

de Neck, we will be glad to receive opinions from the other sections.

BRITISH NOTES

By J. Clarricoats, G6CL, *Honorary Secretary*,
R.S.G.B.

British amateurs join with those of the world in expressing their sympathies with their German colleagues in the untimely death of Dr. Wilhelm Titius, the illustrious Editor of their official organ "CQ."

Such losses are inevitable, but the gap left is always difficult to fill; we sincerely trust that one as keen and loyal to the Amateur Cause will shortly be found to take his place.

The results of the British 28-mc. tests are almost complete, but the difficulty of making a thorough investigation of each claim has retarded the progress somewhat.

We can, however, announce that Mr. J. W. Mathews (G6LL), the best known of all British ten-meter amateurs, has won the Powditch trophy.

Mr. Mathews' success and the success of the tests generally was only brought about by the whole-hearted coöperation of the amateurs of the world, and through the medium of these notes we thank all who have assisted us in this organized attempt to probe more deeply into the mysteries surrounding the 28-mc. band of frequencies.

To our President, Mr. Gerald Marcuse, we owe a debt of gratitude. Through his efforts we have been granted permission to operate our stations between the hours of 1500 G.C.T. on Saturdays to 2400 G.C.T. Sundays, in the wavebands around 75 to 85 meters.

This permission is granted to all holders of Trans-Oceanic licenses and will be extended to such others of our members who apply through the Society. We hope the opening up again of this band will result in the removal of much local work from the overcrowded lower bands.

Conditions on the 7- and 14-mc. bands were in general worse than previous years. No important work has been recorded.

We have the pleasure of stating that the B.E.R.U. continues to extend at a rapid rate. Iraq is now a firmly established link in our chain of Empire groups.

We shall be glad to forward particulars of membership to anyone interested. Our Headquarters are at 53 Victoria St., London, S.W. 1.

We had the pleasure of a visit at Headquarters from Mr. J. L. Leistra, PC2, of the Hague, Holland, during the writing of these notes. It was a most enjoyable occasion for us.

RCA

Radiotron

UV-851

A General Purpose Tube for High-Power Amateur Stations

Modulator, Power Amplifier, or Oscillator—in whichever of these ways amateurs choose to use Radiotron UV-851, they will be delighted with its powerful behavior.

Its ability to modulate without distortion 400 watts of oscillator input power in radiophone transmitters: to handle 100 watts of undistorted power output as an audio amplifier: to deliver 1000 watts of useful power output as an oscillator at 3000 kilocycles or below: or to supply 1000 watts of peak power output as a radio-frequency amplifier—these are the operating characteristics which make Radiotron UV-851 such an excellent all-purpose transmitting tube.

*For further information
write*

RCA-VICTOR COMPANY, INC.

233 Broadway

NEW YORK CITY

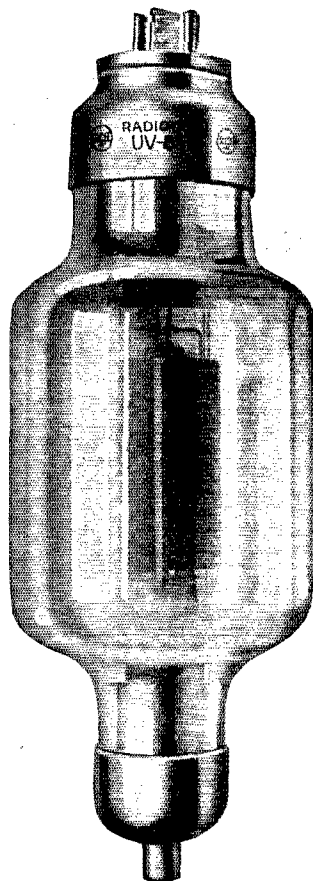

| | |
|------------------------------|------|
| Filament Volts | 11 |
| Filament Amperes | 15.5 |
| Amplification Factor | 20 |

Modulator

| | |
|---|------|
| Plate Volts | 2000 |
| Grid Bias Volts | -80 |
| Plate Current (ma.) | 105 |
| Plate Resistance (ohms) | 2300 |
| Max. Plate Dissipation (watts) | 600 |
| Osc. Input Watts for each UV-851 (Mod. Factor 0.6) | 400 |

Oscillator and R. F. Power Amplifier

| | |
|--------------------------------|------|
| Max. Operating Plate Voltage | |
| Modulated DC Plate Volts | 2000 |
| Non-modulated DC Plate Volts | 2500 |
| Max. DC Plate Current (amps.) | 1.0 |
| Max. Plate Dissipation (watts) | 750 |
| Power Output (watts) | 1000 |

Can you turn back the pages of time?

If you have the 1920 series of *QST* — and probably you have not — you are one of the few. Even 1922 and 1923 copies are getting scarce. And copies before the war! Well, let's change the subject.

A few years from now *QST* copies of to-day no doubt will be just as scarce. Every reader of *QST* appreciates its reference value. We are daily reminded of this fact by the many requests we get for back copies, many of which we cannot supply.

Next year — or probably later this year — you will be looking for a certain 1930 issue of *QST*. You had better resolve right now to keep your copies in a

QST Binder

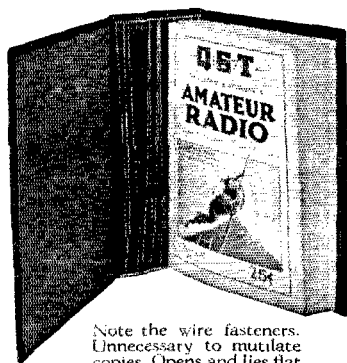

Note the wire fasteners. Unnecessary to mutilate copies. Opens and lies flat in any position.

One-fifty each
postpaid

A binder will keep your *QST*s always together and protect them for future use. And it's a good-looking binder, too.

QST
1711 Park St., Hartford, Conn.

GERMAN SECTION

By W. Rach, D4ADF, Sec'y, D.A.S.D.

Dr. and Mrs. Wilhelm Titius

It is our unhappy duty to record the sudden death of Dr. Wilhelm Titius, editor of the German organ "CQ," and council member of the German I.A.R.U. Section, the D.A.S.D.

Dr. and Mrs. Titius met their death in a disastrous motor accident on April 11, 1930.

Dr. Titius was one of the oldest amateurs in the country. Through his death German amateurs lose a good friend and a valuable co-worker, whose real amateur spirit was known everywhere, and it will be very difficult to fill the gap caused by his sudden death.

In the passing of an esteemed contemporary, may we point to the monumental work he has achieved, and convey our sincere personal desolation and regrets to the bereaved, and our mourning German friends.

On June 7-9, 1930, the fifth annual German amateur convention will take place at Halle a/S. Here is the program:

Saturday, June 7th. 8:00 p.m. Official opening at the Hotel Rotes Ross.

Sunday, June 8th. 11:00 a.m. Business meeting and lunch.

Monday, June 9th. Lectures on various subjects.

Tuesday, June 10th. Visit to the Institute of Technology, of the high frequencies at Koethen.

It is hoped that many amateurs from all parts of Germany and Austria take part in the convention, and, of course, all friends from abroad are heartily invited. We should appreciate a short note from any of our foreign friends who are likely to attend the convention.

Activity on 3.5 mc. has increased somewhat during the period covered by this report. D4ABV, D4GT, and D4GL having been heard by the Silesian stations on this band, while D4ADF of Berlin and D4UAB of Bamberg are carrying out regular tests on "80."

14 mc. has been most unsuitable for DX the last few weeks, only a very few South Americans having been heard here on that frequency. Nevertheless D4BY succeeded in establishing about thirty contacts with the Aussies and Zedders.

DUTCH NOTES

By H. Pomes, Ass't Traffic Mgr. N.V.I.R.

The 'phone business still remains the same, big activity on 40 meters and only a few men on eighty. Several Dutch hams organized 'phone tests in this latter band, and one after another

World-Wide Reception

with the NEW

Norden-Hauck - Short Wave

SUPER DX-5

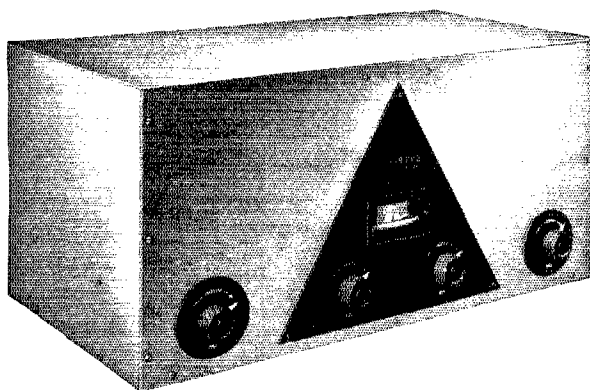

Size: 9 x 19 x 10 inches. Weight 30 pounds

Ideal for Amateur Reception

Entirely New Advanced Design New Pentode Tube

Sensational Distance Range 20-200 Meters Reliable Performance

Adaptable for Long Waves and down to about 10 meters for
Experimental Reception

A-C and D-C Models

NORDEN-HAUCK, Inc.

5-7 South Street

Engineers

Philadelphia, Pa., U. S. A.

Write, telephone or cable TODAY for Complete Information

FOR PURE D.C. POWER SUPPLY

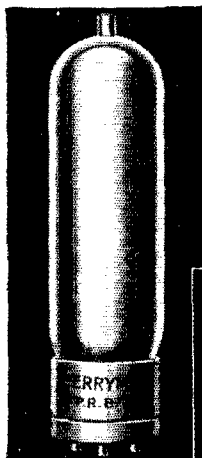

P. R. 872

Fil. Volts - - 5
 Fil. Amps. - - 10
 Peak Inverse
 Volts - - 5,000
 Peak Plate
 Amps. - - 2.5
 Voltage Drop - 15
 Overall
 Length - 8 1/2"
 Overall
 Diam. - 2-5/16"
 Price - - \$18.00

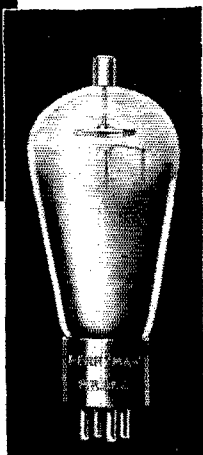

P. R. 866

Fil. Volts - 2.5
 Fil. Amps. - 5
 Peak Inverse
 Volts - 5,000
 Peak Plate
 Amps. - 0.6
 Voltage
 Drop - - 15
 Overall
 Length 6 1/2"
 Overall
 Diam. 2 3/8"
 Price - - \$8.00

UNDER the new regulations all amateurs must use an adequately filtered D. C. current supply.

P. R. 866 and P. R. 872, both mercury vapor rectifiers, besides emitting a wave form easy to filter, furnish a stable source of plate voltage—full load or no load, because both tubes possess a low and practically constant voltage drop. The unusually long life of the P. R. 866 and P. R. 872 is due to the low operating temperature of the oxide coated filament combined with the extremely low voltage drop resulting from their mercury content.

Use these Perryman rectifiers, famous for their rugged strength, in bringing your station in line with the new regulations.

Attractive prices for licensed amateurs

PERRYMAN ELECTRIC CO., Inc.,
 4901 Hudson Blvd., North Bergen, N. J.

Enclosed please find money order for \$.....for
 check

..... P. R. 872 at \$18.00. P. R. 866 at \$8.00.

Name.....Station.....

Street.....

City.....State.....

finds out that it is not so bad after all, for this kind of work.

In the 7-mc. band circumstances have been pretty good for communication with European, East Asian, and North African stations, but DX stations were seldom heard and were not worked. Usually about midnight all reception is restricted to some local stations.

The 14-mc. band offered many fine occasions for DX work, especially on April 5th, 6th, and 7th for communication with the U. S. A. PAODW is crystal-controlled now, and works with his new transmitter almost every station he hears. PA0ZK and PA0ZF had several fine DX QSO's. PA0QF had a sked with PK2AJ and worked him several times during two or three hours. On April 7th he worked all continents; he surely keeps a record in putting pins in the map on the wall!

Every day Asia and Australia may be heard until 1800 G.C.T.; then African stations become audible, though not so loud as in the preceding period. After sunset American stations are heard, especially the South Americans at about 2300 G.C.T.

On 28-mc. SU8RS and PA0VN are heard.

There are several Dutch hams who are equipped with crystal-controlled stations. The number of licensed amateurs still increases, and many others are preparing for the exams. If matters go on in this way all will have gotten their official certificate by the end of the year.

J. Clarricoats, Hon. Sec. of the R.S.G.B. and B.E.R.U. has communicated to us a suggestion made by Dr. Curt Lamm, D4AFA, of the D.A.S.D., to the effect that wherever possible, contracted forms should be used when giving QRAs to DX stations. These abbreviations are intended to take their place in the already extensive ham vocabulary of abbreviations as a group for international use primarily. We are printing the two lists enclosed with the suggestion, one each for Great Britain and Germany. At the same time we request all I.A.R.U. member societies who may be impressed with the usefulness of the idea to make up and forward us a list of their important cities, and a contracted form for each. The following lists will serve as a basis upon which to work, if the scheme is deemed worthy of universal consideration.

Great Britain

London.....LDN
 Manchester.....MCR
 Glasgow.....GLW
 Birmingham.....BHM
 Bristol.....BTL
 Edinburgh.....EBORO
 Newcastle-on-Tyne.....NWC
 Liverpool.....LVP
 Dublin.....DBN
 Coventry.....CVY
 Belfast.....BLFT
 Cambridge.....CAM

Germany

Berlin.....BLN
 Hamburg.....HMB

BARGAINS

ARMY AND NAVY RADIO SURPLUS

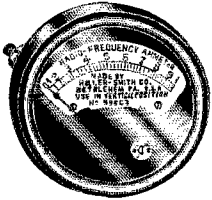

Ammeter, R.F., 0-10 amp. zero adjuster, 4 in. diameter. A real buy at.....\$6.50

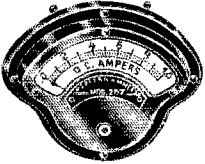

Ammeter, Weston No. 267. Double reading 40-6-50. Voltmeter, Weston No. 267, 0-75 volts, each.....\$6.50

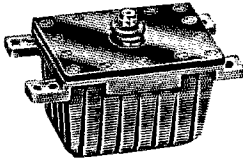

Condensers, Mica, op. volts 12,500 cap. .004
Dubilier, new.....\$17.50
Dubilier, used..... 15.00
Wireless spec. New..... 15.00
Wire spec. Used..... 12.50

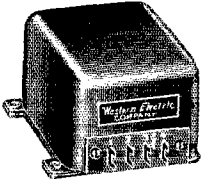

Transformer West. Elec., output, No. 102A, 4 to 1 ratio.....\$3.50
Transformer West. Elec., output, No. 202A, 5 to 1 ratio.....\$3.50
Transformer West. Elec., input, No. 201A, 7 to 1 ratio.....\$3.50

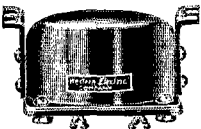

Coils, Retardation, West. Elec. Co. 57C, .83 ohm, 2 windings .08 henry.....\$1.00
Ret. coil West. Elec., No. 65A, 1800 ohm, 12 henry \$2.00
Ret. coil West. Elec., No. 66A, 85 ohm, 1.3 henry.....\$1.50
Ret. coil West. Elec., No. 64B, 11 ohm, 1 henry.....\$1.50

- Motors 1-30 H.P. back geared 110A. C. variable speed, auto reverse type) has cost one thousand uses, a very good buy. Regular price \$35.00.....\$7.50
- Edison storage battery cells, nickel alkali, 225 amp. hour, 1.2 volt type A-6, weight per cell 20 lbs..... 4.00
- Induction coil, platinum contacts. (Hi. pitch buzzer)..... 1.50
- Magnetos, Army mine and ringer type, 4 large magnets..... 1.00
- Magnetos, 3 bar ringer (bridging type) ideal tester..... 5.00
- Generators, Westinghouse 110 volt, A.C. 900 cycles, 200 watts, self excited..... 15.00
- Generator ¼ kw. 500 cycle, 300 volt, self excited, can be hand driven..... 25.00
- Voltmeter, D.C. portable new Weston model 45, 3 scale 0-15-150 guaranteed ¼ of 1% accurate..... 40.00
- Loud Speaker Unit 193 West. Elec. Ideal for monitoring. Transmitter with Horn..... 5.00
- Keys, transmitting, Navy, back connected on bakelite base. 2 kw., ½ inch silver contacts..... 5.00
- Keys, xmitter, 2 kw., comb. relay and hand ½" silver contacts..... 10.00
- Keys Navy, ¼" silver contacts..... 1.50
- Charging panel, Navy type, S.E. 899, 32 volt, Ward Leonard, var. and fixed res., Weston voltmeter and ammeter, Sanganio ampere hour meter. Complete with all switches. Regular Price \$145..... 30.00
- Receivers, S.E. 143 and I.P. 500..... 100-150
- Relays, West. Elec. types, 122-AR, 122-DH, 149-T, 172-B..... 2.50
- Elec. Engineers Handbook, 1600 pages, "Foster"..... 2.00
- Practical Wireless Telegraphy, by "Elmer E. Bucher"..... 1.00
- I. C. S. Elec. Engineers pocket handbook..... .75
- Rheostats vitrohm, variable Ward Leonard, 500 ohm .2 to 1.5 amp. 35 tap field reg. type..... 5.00
- Rheostat, vitrohm, variable, Ward Leonard, 6 ohm 15-5 amp. bat. charge type..... 3.50
- Resistors, vitrohm Ward Leonard, with leads, ass. sizes per doz..... 1.50
- Relays 2 and 5 kw. (110 or 220 volt) ½ silver contacts..... 7.50
- Relay West. Elec. low voltage, 2 upper and 3 lower platinum point screws, 3 contact arms..... 5.00
- Extra platinum contact screws or arms..... 3.50
- Amplifier, W. E. Radiophone, C.W. 926, 3 Stage..... 15.00
- Heterodyne, Signal Corps, type B.C. 104, 1000 to 3000 meters, with detector..... 15.00
- Air compressors, Kellogg, Model T, 1 ½ cu. ft. per min. weight 6 lbs., 600 R.P.M., 125-lb. Requires ¼ h.p..... 3.00
- SPECIAL — U. S. Army instruction book on telephony or telegraphy. Hundreds of pictures and diagrams..... 1.00
- Microphone, Army Trench, sensitive..... 1.50
- Microphone, Aircraft, Magna-Vox, very sensitive..... 1.50
- Charging Board, 32 volt, complete with Weston No. 269 voltmeter 0-50, auto cutout resistances, switches, etc., on slate base, \$60 value..... 15.00
- Generator, airplane, Signal corps, with shaft, can be used as motor, 12 volt 34.6 amps, 5000 R.P.M..... 10.00
- Generators, 12 volt, 60 amp. has automatic controls..... 20.00
- West. Elec. Dynamotor, C.W. 927, two D.C. 32/350 volt dynamotors in noiseless hangar. Used in parallel gives 160 mts at 350 volts, series gives 80 mts. 700 volts, suitable for xmitters and receivers. New low price..... 20.00
- West. Elec. switchbd. control panel for above dynamotors, has switches, 0-50-500 voltmeter, complete filter system etc. Special..... 8.00
- Ammeters, D.C. portable, new Weston model 45, 3 scale 0-1.5-15-150 with 3 scale external shunt and leads ¼ of 1% accurate..... 40.00
- Ammeter, Weston No. 425 thermo-couple 0-2 amp., mtd. on large bakelite base with D.P. hi voltage switch..... 7.50
- Ammeter 50-0-50, Wetghse, B.T. flush mtg..... .75
- Ampere hr. meter, Sanganio, battery charge and discharge, type MS 0-500 sec., capacity 2 amp. h. con. Milliammeter, Westinghouse, 0-150 surface mtg., b. con. Motor generator, Crocker Wheeler or Holtzer Cabot, 110 D.C. 220 A.C. 500 watt, 500 cycle. Ball bearing..... 50.00
- Complete line 500 cycle motor generators ¼ to 5 K.W. Transformers, General Electric, 125 to 2500, with primary center tap, 60 cycle, 200 watt..... 7.50
- Transformer, Amertran, oil immersed, 1 K.W., 500 cycle, 220/8000 volt..... 10.00
- Condensers, transmitting, Murdock .0017 mfd. 12,000 volt, ideal for plate blocking..... 2.50
- Condenser, Dubilier, mica, op. volts 12,000 cap. .0004..... 10.00
- Condenser, Dubilier, mica, volts 40,000 cap. .0012-.001-0008 or .001..... 30.00
- Condenser, Dubilier, mica, op. volts 8500 cap. .001..... 10.00
- Headphones, West. Electric No. 194W same as C.W. 834, 2200 ohms, D.C. slightly used, Navy type..... 5.00
- Holtzer Cabot, "Mike" Utah type, carbon granular transmitter, Special..... .95
- Western Electric Radiophone Transmitter unit, 326W..... 1.50
- Dynamotor, aircraft 32/275 volt, with shaft..... 10.00
- Edison storage bat. cells, miner type M8, non-spill, 1.2 volt, 11 amp. never used, per cell..... 1.50
- NAVY Dynamotors General Electric 24/1500 volt. 233 mts. (Extended Shaft — \$3.00 extra)..... 37.50
- New spare armatures, G. E. 24/1500 volts..... 12.50

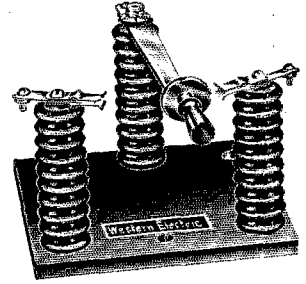

Lightning Switch, High Grade W.E. Heavy Copper Blade and Contacts. Size 7 x 8 x 6 high. While they last. \$3.50

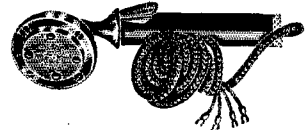

AT LAST — Genuine Western Electric Hand Microphone Home Broadcaster. \$3.50 used, \$5.00 new.

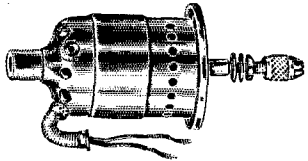

Portable Hi-speed Universal Hamilton-Beach Drill, takes up to 1 in. Complete with Chuck, Buff and Grind Attachment.....\$7.50

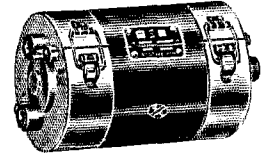

NEW LOW PRICE
Dynamotor 32/350 volt, ball bearing, 80 mts. Spectal.....\$12.50

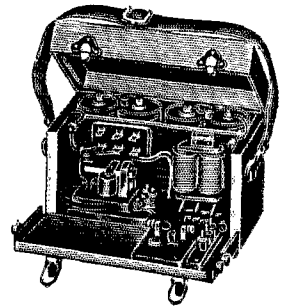

U. S. Army Telegraph Set, key, sounnder, D.P.D.T. switch, 2 large magnets, in portable carrying case. Less Batteries.....\$6.00

Largest Radio and Electric Supply House in U. S. specializing on Army and Navy Surplus. Write us your particular requirements. Sufficient postage and deposit of 20% required on C.O.D. orders. NO. C.O.D. ON CANADIAN ORDERS. DUE TO LIMITED GOV'T SURPLUS WE DO NOT ISSUE CATALOGS.

MANHATTAN ELECTRIC BARGAIN HOUSE, Dept. Q, 105-7 Fulton St., New York City

Say You Saw It in QST — It Identifies You and Helps QST

Learn Radio Telegraphy

THIS new library contains the essential information for the student who wishes to learn radio telegraphy. The books are especially written for home study work. Not only are all the essential facts concerning radio telegraphy given, but the questions and answers which are used for government examinations are all covered.

Library of Practical Radio Telegraphy

647 pages, 5½ x 8, 314 illustrations

VOLUME I — Practical Radio Telegraphy. The theory and practical operation of all types of modern commercial arc, spark and vacuum tube transmitters. Complete data on all kinds of up-to-date radio receivers. Each chapter is devoted to a definite assignment of work, enabling the home-study reader to enjoy a course in the theory of radio telegraphy which is easy to follow.

VOLUME II — Radio Operating Questions and Answers. Second Edition. This volume covers the advances since 1921 in the art of radio communication. It takes into account the new technique of broadcast-station operation and considers electrical, mechanical and physical improvements. Questions and answers on the leading problems of radio operation are most carefully worked out for the student preparing for his operator's license.

Examine these books — No money down.

Examine these books — use them for 10 days free. Then, after you have seen them, decide if these books aren't worth five dollars to you. If you keep them you have only to remit \$1.00 in 10 days and \$2.00 a month for two months. If they are not satisfactory you have only to return them.

Fill in and mail this coupon — NOW!

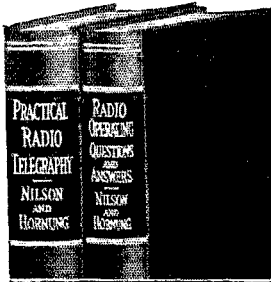

McGraw - Hill FREE Examination Coupon

McGRAW-HILL BOOK CO., INC.
370 Seventh Avenue, New York

Gentlemen: — Send me the New Library of Practical Radio Telegraphy, all charges prepaid, for 10 days' Free Examination. If satisfactory I will send \$1.00 in ten days and \$2.00 a month until \$5.00 has been paid. If not wanted I will return at your expense.

Name.....
Home Address.....
City and State.....
Name of Company.....
Occupation.....QST. 7-30.

“HAMS” — SERVICEMEN EXPERIMENTERS TECHNICIANS

Send for our new Radio Bargain Bulletin No. 31, just off the press.

Chocked full of standard items you want, at greatly reduced prices.

AMERICAN SALES CO.

19-21 Warren St.

New York City

| | |
|-----------------------------|------|
| Brandenburg (Havel)..... | BRDB |
| Breslau..... | BRSL |
| Bremen..... | BRM |
| Chemnitz..... | CHNZ |
| Dortmund..... | DTMD |
| Dresden..... | DSDN |
| Duesseldorf..... | DSSD |
| Elberfeld..... | ELBF |
| Erfurt..... | EFT |
| Frankfort (Main)..... | FRFM |
| Frankfort (Oder)..... | FFO |
| Halle (Saale)..... | HAL |
| Hannover..... | HNVN |
| Karlsruhe (Baden)..... | KLRH |
| Kassel..... | KSSL |
| Koln..... | KLN |
| Koenigsberg (Proussen)..... | KBG |
| Leipzig..... | LZG |
| Leignitz..... | LGTZ |
| Magdeburg..... | MGB |
| Muenchen..... | MCHN |
| Nuernberg..... | NBG |
| Stettin..... | STN |
| Stuttgart..... | STGT |

Let's have lists from all the other countries to complete the table now.

WAC

The following were issued WAC certificates during the year 1929: Ladislav Vydra, EC2YD; Gilmer Kirkelie, W6BZD; J. H. Robinson, W5AKN-W5BG; R. G. M. Anthony, OA5CM; Charles A. Topping, SCIAH; H. D. Huston, W9FXR; Miguel Moya, EAR1; LeRoy Moffett, Jr., W5ZAV; F. G. Calvert, FOA3C; Roger Pierson, ef8AXQ; Maurice Hupel, ef8AAP; Henry Clive St. John, VK2RX; Geo. G. C. Bennett, G5BZ; Charles P. Tennant, FOA40; Jack Kazuo Shibata, K6ALM; C. J. Mumford, CT1BL; Francesco de Albuquerque (Mangualdo), CT1CF; Maxwell Kelch, W6DZD; T. A. St. Johnston, G6UT; J. J. Frederikse, enOFF; Leif Salicath, LA1G; Robert E. Carter, W6CIH; G. A. Baker, W6CHY; Masayuki Hisamoto, K6CLJ; F. Salles Botelho, SB2BG; Leo A. Paul, OA3LP; Eugene Stadden, W7IF; A. O. L. Strickers, NRDM; Alex McIver, ZT5E; H. S. Jones, W6AX; G. Emrys Jones, G6XB; H. Littman, D4FN-D4XN; Kendall Curtis, W1AKM; Eric Neilsen, Jr., SC7AA; D. C. Sayer, W2GP; D. E. Klumb, W7AFO; W. H. Treston, W3JM; R. A. Hill, ZS1A; Bruce Hoag, W8AXA; W. P. Brown, W3PF; H. V. Wilkins, G6WN; Frank Miller, VE1BR; Oscar Egenes, ZT5R; Christoph Schmelzer, D4AAR; K. Beintema, PB7; A. C. Edwards, G6XJ; V. Chennel, VK5JH; G. S. Samways, G6OH; E. T. Warner, GBVJ; H. L. Garfath, G2BM; Geo. M. Rose, Jr., W4JS; Clayton S. Waldradth, W9DLY; J. C. Stannow, OZ7Y; Leslie Carr, W9AOK; W. G. Chase, W1BKR; Keith Howard; Roy Clarke, ZL2AW; Leo Charette, W1A BD; George S. Yerbury, W2AI; Harry E. Smith, G6UH; John Koski, W6DBO; J. C. L. Edwards, G5UQ; John A. Roehm, W3ADM; L. A. Moxon, G6XN; Carl Wiedenhammer, W1ZL; J. Burleigh Scott,

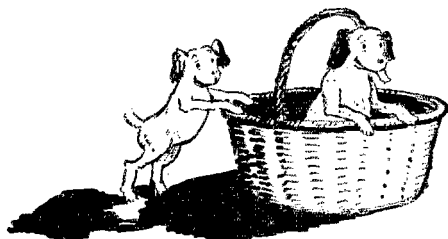

“Since
Hector Was a Pup”

Not long ago, a Ham wrote us—“I’ve been using CARDWELL’S since Hector was a pup”—Amateur radio presumably being the pup referred to.

Much has happened since Amateur radio was in its infancy, but CARDWELL condensers still retain the confidence not only of discriminating Amateurs but of Professionals—Engineers and Designers backed by unlimited resources which permit of exhaustive tests to determine comparative condenser worth.

You, too, may prevent or eliminate condenser trouble by using the simple, sturdy CARDWELL for transmitters or receivers.

If you have difficulty in obtaining CARDWELL condensers locally, we shall be glad to serve you direct. Literature may be had for the asking.

CARDWELL CONDENSERS

THE ALLEN D. CARDWELL MFG. CORP.
81 Prospect Street, Brooklyn, N. Y.

Since broadcasting began

“THE STANDARD OF COMPARISON”

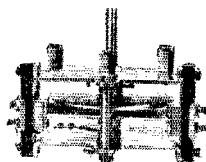

The 201E

A 2 plate variable condenser having the stator plate readily adjustable to permit changes in maximum capacity ranging from 50 to 10 mmfds, with a constant minimum of 7 mmfds.

STANDARD

Quartz Plates

for the amateur and experimental bands. These STANDARD plates are ground with exactly the same care—the same precision—used in preparing plates for broadcast and commercial stations. Fully guaranteed.

Prices

Frequency stated to within one-tenth of one percent — maximum power

1715-2000 KC — \$12.50
 3500-4000 KC — 16.50
 7000-7300 KC — 35.00

Quartz plate-holders. Temperature control equipment. Full line of equipment to fit the amateur's requirements — and pocketbook.

Send for descriptive literature.

STANDARD
 Radio Laboratories
 602 Slaughter Bldg. Dallas, Texas

EASTERN AMATEUR HEADQUARTERS

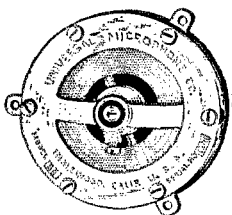

A Special
Model "BB"
Microphone

Net weight, 1 lb.
 Packed weight, \$25
 1 1/4 lbs.

A two-button microphone built especially for voice pick-up, public address work and for amateur broadcasters and experimenters. Its frequency range is from 50 to 3000 cycles, 100 ohms per button, and operates on 6 volts and 8 to 10 mls per button. A split primary microphone input transformer must be used with this microphone. Accurately machined, and silver plated. Each unit carefully tested before shipment.

Blueprint of hook-up included with each unit. Diameter, 3 inches; thickness, 1 1/2 inches.

Special Discount to Amateur and Service Men. Hams, send for Special Amateur Catalog

M. & H. SPORTING GOODS CO.
 512 Market St., Phila., Pa.

E17C; G. E. Brown, ZL4AE; Charles W. Randall, VS3AB; R. Herdin, W2RS; Gordon Fletcher, W4AEF; E. C. Hagar, W1AZE; L. Grannini, W6WF; A. C. Simons, G5BD; W6ANN, W. A. Adams, Jr.; A. Creixell, EAR65; W. S. Plyler, W4ABV; T. Woodcock, G600; P. M. Huybregson, PA0QF; W. H. Heathcote, ZT6X; H. A. Maxwell Whyte, G6WY; M. M. Hill, W5EB; G. B. Ragless, VK5GR; W. S. Davison, G15WD; Alois Wierauch, OK1RV; H. R. Drinker, W7MO; R. Toussaint, ON4US; C. S. Hunt, G6NT; Hector Soula, LU8EN; Th. Wilmlink, PB7W; Jose de Penha-Gracia, CT1BY; R. A. Bartlett, G6RB; C. H. Hill, ZS4M; E. H. Turner, VE2CA; G. W. Hamilton, W6AWZ; B. Pothast, PA0DW; Z. S. Bresinski, SP3KX; C. R. Plant, XW7EFF; J. Scorgie Owner, G6XQ; Dante Bolaffi, I1TU; Joseph Betz, W2BJG; Maurice Meunier, ON4CK.

Calls Heard

(Continued from page 59)

w6axm w6ayq w6bdx w6bgl w6bh w6bjb w6bjg w6boe w6bpo w6brh w6bt1 w6btk w6bvy w6by w6bz w6cdj w6ceg w6caw w6cim w6cto w6cul w6cyr w6cyx w6czq w6czz w6der w6djp w6drx w6dto w6dyj w6dyl w6eaa w6ebz w6ecc w6edd w6eel w6ekj w6elt w6eop w6eou w6esa w6etn w6euh w6ew w6fn w6ma w6se w6st w7aab w7aac w7aah w7aax w7aie w7aii w7ait w7aj w7ajw w7amx w7ao w7be w7er w7fl w7il w7kg w7it w7mv w7pp w7qb w7rt w7wl w7acy w7mb w7afx w7ajh w7ce w7fu w7ahw w7id w7aqz w7io w7jc w7my w7aed w7aoq w7aiz w7qf w7ua w7ab w7gp w8bcf w8bcj w8bgv w8cfw w8cjo w8dud w8lt w8uf w8cum w8tm w8re w8bws w8dpo w8dxn w8cau w8dnn w8aav w8hyc w8bpf w8bgx w8ddk w8cb w9ads w9akz w9aqs w9bez w9vk w9vxx w9cag w9ce w9eph w9pve w9ey w9dgz w9dlh w9dsk w9dtj w9ehf w9flg w9fxj w9fyp w9nk w9lz w9rk

Heard at Anchor in Guantanamo Bay

w6am w6djp w6eup w6asm w6dxy w6dyn w6bck w6axf w6dtd w6esc w6ewf w6ato w6bpm w6elf w6ebg w6aqo w6ael w6fp w6car w6aeu w6czf w6bip w6ig w6abg w6dui w6bz1 w6la w6by w6iq w6eqb w6bbq w6brf w6cjj w6ebz w6epx w6btu w6cim w6esg w6ecq w6axa w6dwt w6djo w6bk w6edg w6asj w6eib w6bkx w6wf w6uf w6adl w6dzy w6ajw w6ucg w6coa w6cii w6dwi w6adw w6dep w6chl w6ebp w6amw w6cul w6aga w6kbp w6awy w6bdd w6bxw w6boq w6egu w6pbp w6chx w6czl w6hhw w6eye w6eio w6dis w6azy w6gij w6fcw w6bay w6bbl w6ghg w6eci w6amv w6hw w6cou w6ae w6hto w6bkq w6yc w6ayw w6arn w6aip w6nb w6ed w6fgq w6au w6bye w6ariu w6cfa w6bxu w6bez w6lfg z1ao k6ceu k6bxw z1ziw

W9GHI, Karlton Marquardt, Baldwin, Kans.

14,000-ke. band

oa4j pylaw pylah pylcm py2bf py2av hc2jm ce2ab ce3ce f8hr cx1fb lu1ba lu2ii lu2at lu2dj lu2aa lu2ca lu3fa lu3dh lu4da lu6fc lu8dy lu9ce em2sh cm5cx on1fp ve5aw velbr ct1by ct6d et1aa ct1bx he1lc cx1fc g2bm g5lw g5by g2oa g5kt x9a nj2pa vk4ak vk5hk wsg rsq j5h

14,000-ke. 'phone

w1cei w5dd w5rd w3ep w5dno ve3ej

VS7AP, A. M. Rohim, Wellawatte, Colombo, Ceylon

w6eop w6clz w6cuh w6bah w6ef w6dqu w6fk w6dyc w6def vk2ed vk2es vk2ek vk2he vk2hu vk2ja vk2jc vk2jj vk2jl vk2jp vk2jy vk2jz vk2kj vk2ns vk2ow vk2rx vk2zu vk3bq vk3bw vk3ce vk3ec vk3de vk3dx vk3go vk3jo vk3jr vk3kh vk3lp vk3or vk3pa vk3pm vk3rh vk3rj vk3rp vk3rx vk3wo vk3vx vk3zo vk3aw vk4bb vk4bh vk5by vk5cm vk5dx vk5gr vk5hg vk5it vk5ja vk5mb vk5rw vk5wr vk6ag vk6fl vk6ft vk6wr vk6he vk6lg vk6mu

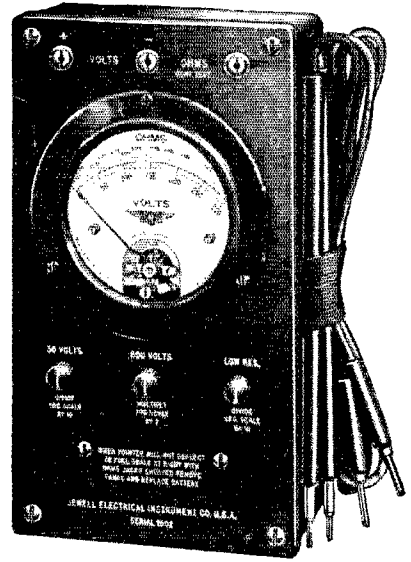
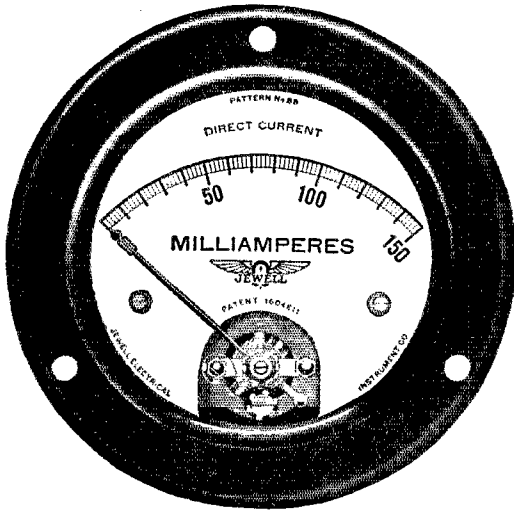

Panel Instruments for Radio Amateurs

Accurate electrical measuring instruments are the keys to achievement in amateur radio work. Amateur operators of today who are doing the worth while things are the amateurs who have acquired the habit of using electrical instruments to secure exact working data.

It may be true that a certain amount of success in amateur transmitting and experimenting can be accomplished with limited measuring apparatus, but the same amount of effort directed through the use of exact measuring instruments will accomplish immeasurably more.

Every amateur operator should have a new Jewell radio bulletin which gives certain wiring diagrams and describes the Jewell line of amateur instruments as well as radio service instruments. Mail coupon for your copy.

FREE to Amateur Operators

For the benefit of our friends in the amateur operating field, we have made a time and date chart that shows comparative time throughout the world. To secure one of them free merely mail us your name, address and call number.

30 YEARS MAKING GOOD INSTRUMENTS

JEWELL

JEWELL

Radio Instruments

A New Volt-ohmmeter for Service Men

The Jewell Pattern 574 is designed especially for making rapid checks of voltage resistance and continuity in radio service work. The 3½-inch Jewell meter has scales of 0-100,000 ohms and 0-300 volts. Push button switches decrease the ohmmeter range to 1-10 its value and the voltmeter range to 1-10 its value and also double its range.

The panel carries complete operating instructions. A 4½-volt battery mounted beneath the panel makes resistance checking and continuity tests convenient. Test leads with plugs that fit into the jacks further increase the convenience of using this instrument. The voltmeter has a resistance of 1,000 ohms per volt.

Mail the coupon for literature describing the Jewell Pattern 574 Volt-ohmmeter and copy of the new Jewell radio bulletin.

Jewell Electrical Instrument Co.
1612-C Walnut St., Chicago

Of course I want your new bulletin describing instruments for amateur and service work. Please mail it today.

Name

Address

Call Number

MORE BARGAINS!!

QUALITY MERCHANDISE AT LOWEST PRICES
MONEY RETURNED IF NOT SATISFIED

Only a few hundred more of the well-known PARCON High Voltage units at these low summer prices. Every one brand new. Neat metal cases. Filter Condensers: (All Ratings Continuous DC Working Voltages) 1000 Volt. 1 Mfd. — \$1.80. 2 Mfd. — \$2.10. 4 Mfd. — \$3.55. 6 Mfd. — \$4.70. 8 Mfd. — \$5.95. 2000 Volt: 1 Mfd. — \$3.80. 2 Mfd. — \$5.90. RCA or Stromberg-Carlson Filter Condensers. Metal cases. Lug terminals. 4 Mfd. 650 Volt DC Working — \$3.05. Two for \$7.75. 7 Mfd., 650 Volt — \$2.60. Four for \$9.60. 2 Mfd., 450 Volt — \$7.50. Six for \$4.20. High-grade unmounted 2 Mfd., 850 Volt DC Working filter condensers. Mfr's type. Of highest quality dielectric and aluminum foil. A quantity of these units may be series-parallelled for any desired voltage and capacity. 70c each. Four for \$2.50. Eight for \$4.65. Twelve for \$6.45. Twenty for \$10.00.

FRESHMAN POWER TRANSFORMERS. A heavy, well-built transformer in compound filled case. Has a 375 volt winding and two 7 1/2 volt center-tapped windings. 125 Watt. 7 1/2 lbs. Complete power supply for 710 Amplifier, Transmitter, or Eliminator. — \$2.10. Two will give 750, 7 1/2, 7 1/2, 7 1/2, and 7 1/2 Volts. All center-tapped. SPECIAL 1 Two for \$3.95. THORDARSON Power Transformers: Type T-3202. 250 Watts, 1200, 7 1/2, 7 1/2, and 3 Volts. All CT. — \$5.75. T-3321. 175 Watts, 1100, 7 1/2, 7 1/2, and 3 Volts. All CT. — \$4.50. T-2430-A. 150 Watts, 800 and 5 Volts. CT. — \$3.95.

FILAMENT TRANSFORMERS. Well-constructed. Metal-cased. 75 Watt. 7 1/2 Volt — \$2.80. 7 1/2 Center-tapped — \$3.75. 7 1/2 CT and 7 1/2 — \$4.25. 7 1/2 CT and 7 1/2 CT — \$4.95. 10 Volt — \$3.25. 10 CT — \$3.75. Unmounted 7 volt, 50 watt filament transformer. Easily rewound for any voltage. Can be used to operate bells, buzzers, etc. — \$1.10. Two for \$1.70. RCA 3:1 Audio transformers — \$1.15. Output transformers — \$1.20.

POWER CHOKES: 30 Henry, 175 Milliampere. A well-made choke with a quality core of air-gap construction. Mounted. 5 lbs. — \$2.25. 30 H., 120 MA. — \$1.75. 2 1/2 Amp "A" 6 lbs. — \$1.95. 1/2 Ohm, 2000 MA, 5 H. Key thump filter choke, 6 1/2 lbs. — \$2.95. Thordarson T-2458 Double Choke, Each 18 H., 250 MA. — \$6.25. RCA double filter chokes. Metal case containing two 30 H., 80 MA chokes. RCA Part No. 8336, 1000 volt insulation. Connected in parallel total is 30 H., 160 MA. 6 lbs. SPECIAL — \$2.50.

Guaranteed TUBES. Unconditional FREE 60 Day Replacement. A guarantee that really means something! UX-250 — \$4.85. UX-210 — \$3.95. UX-281 — \$3.25. UX-222 — \$3.25. UX-224 — \$3.05. UX-245 — \$1.75. Every tube tested before shipping. Good tubes at lowest prices: (3 free replacements) UX-250 — \$2.20. UX-210 — \$2.10. UX-281 — \$1.50. Other types in catalog.

RCA Wire-wound, Vitreous-enamelled 5000 ohm, 50 watt Grid Leaks. With mounting rod. SPECIAL — 49c. Two for 89c. Bradlevstat E-210 rheostats — \$1.50. RCA 2 1/2 Amp. power rheostat — 60c.

2% discount for full remittance (plus postage) with order. A 20c charge is made on orders under \$2.00. Send for details of our FREE QSL FORWARDING SERVICE. "QUICK SERVICE" SEND FOR CATALOG

HARRISON RADIO CO.

35 Ft. Washington Ave. New York City

LEADERS — because specialists in radio resistors

The high quality and completeness of the ELECTRAD line of resistors and voltage controls commend them for every radio and power supply purpose.

Write Dept. 175 Varick St., New York, N.Y.

Q-7, for Data

ELECTRAD

ALUMINUM SHIELDS

BEAUTIFUL SILVER DIP FINISH
Genuine ALCOA Stock

5 x 9 x 6, \$1.89 14 x 6 x 6, \$3.95

Any size to order in 24 hours.

ALUMINUM COIL SHIELDS

Natural Finish 3 1/4 x 6 1/4 straight, 49c

Flanged 3 1/4 x 4 1/2, 60c blast or polish, 20c extra Flanged 3 x 4 1/2, 55c

2 1/2 x 2 Hand Hole Cover, 48c

ALUMINUM TUBE SHIELDS

2 1/2 x 4 1/4 straight 48c

1 1/2 x 4 1/4, inc. base 48c

2 x 4 1/4, inc. base 48c

TEST LEADS — No. 18 R. C. wire — 3in. Radion Sleeves over

Phone tips on one end, Phone tips or Spade lugs on other end,

20 in. long 49c, 36 in. long 65c. Just the thing for meters and

other uses. Insulating washers for binding posts on metal, 15

for 10c. Insulated tip jacks, 12c. Duplicator Condenser .01 or

.015, 34c. Insulated coupling or shaft extension, 33c. G. R.

type stand-off insulators, 4 colors, 17c. X-L variometers

model "N" 29c. 115 up-to-date set diagrams, 8 1/4 x 11 loose

leaf perforated, \$2.50. Please include postage.

BLAN, The Radio Man, Inc. 89X Cortlandt Street

New York City

vk7eh vk7lj zllar zllaa zllao zllrf zllwf zllfu zllgh
zllbp zllbe zllba zllas zllcm zllbg zllma zllao zllg
g5pi g5bd g5nf g2dz g2kf ce5aa ce2ab ce3bf oa4j oa4k
lu2aa lu6fc lu3fa lu4bi zu2uu x9a pylax pylah pylaw
vs6ab vs6ae vs6af vs6ag vs6bh vs6bc vs6ca pk1cl pk1ex
pk1jr pk3bm pk4bo pk4az pk4kr pk4pa file kaljr ct1aa
ct1bx pm3a zslp zuld z1tf z52n z52s z52a zt2c zt2e z55u
zt5e zt5l zt5q zt5x zu5b zt5r zt6x zu6a zu6e zu6n zu6s
zu6w zu6r z55w zt5v z54a z54m z54e z56p

Marshall Goldberg, 6231 South Park Ave., Chicago, Ill.

wlaak wlaal wlabz wlaeh wlaek wlaep wlaew wlafb
wlafu wlaiv wlaic wlabl wlaem wlaaz wlaof wlaqt
wlarg wlars wlawf wlabl wbae wlbiz wlbiz wlbj wlbkf
wlbkr wlbux wlbw wiby wlbvy wldcq wlecl wlof
wlohe wloco wlepi wlerw wldo wldp wlfk wlgw wlii
wljr wlmk wlovo wlmw wlno wlno wlno wlpd wlpi
wlpm wlpy wlrp wlry wlvy wlwy wlxab wlxe wlyb
wlz w2abu w2acd w2ace w2adh w2aeh w2aeu w2afj
w2afz w2agj w2ahg w2ahi w2ail w2ajt w2alz w2apd w2api
w2apy w2aqh w2aqj w2aqt w2arb w2arv w2aui w2aur
w2auu w2avz w2baa w2bac w2bbt w2bey w2bhv w2bie
w2biv w2bjm w2bkw w2bvk w2blx w2bmk w2bnx w2boa
w2bpg w2bpm w2bu w2bvq w2bwk w2cqq w2evj
w2exl w2ez w2ezr w2di w2dk w2do w2fn w2fp w2gt w2hr
w2jd w2kj w2kx w2l w2md w2se w2up w2wf w2ws w2xam
w2xd w2xy w3aac w3adi w3adm w3ael w3afj w3afx w3ahp
w3aih w3ajh w3an w3asg w3atz w3avd w3avf w3awb
w3ax w3bd w3bhx w3bnc w3bnf w3bnu w3bq w3edu
w3ece w3egf w3fx w3gf w3gt w3hg w3ht w3hy w3jm w3kt
w3on w3pf w3qw w3ut w3wm w4aa w4ac w4ef w4eio
w4afk w4agz w4aha w4ahl w4ahr w4akq w4aq w4ar w4ca
w4el w4fx w4hh w4hs w4ib w4ky w4ly w4m w4n w4qb
w4sn w4to w4ve w4wm w5adv w5aeq w5afi w5agq w5arz
w5asq w5atf w5aqv w5awz w5ayl w5ayy w5bzx w5bj
w5im w5om w5pc w5sw w5tz w5uf w5va w5az w5co
w6ags w6akw w6ap w6arv w6awq w6bqk w6ebv w6eui
w6evn w6cww w6eyp w6ezy w6dbd w6dcq w6dqg w6dna
w6dqv w6dag w6dtz w6dvd w6da w6ea w6hm w6lx w6nz
w7aex w7ajj w7akp w7ale w7ek w7ga w7hp w7id w7nr
w7pe w7vk nj2pa pylid ve2ae ve2az ve2be ve2ce ve2be
ve2eq ve2fe ve2rf ve2jd ve2kq ve2ax ve4hx ve4io ve4jb
ve4mo ve5cp em4 ddfc kee kll kwe ftf pgg pwaz uok

William Hanson, 61 Bishop St., New Haven, Conn.

3500-kilocycle phones

w2bee w2gj w8pk w8bp w8amq w8emu w4amq w8ajh
w8rl w2ahl w8rd w3za w2aba w9bwi whdq w9bt w9tbl
w8aud w3nj w1ai w3cv w8dpd.

1750-kilocycle phones

w8wf w9ff w8rd w2gj wky w3aly.

W2BMG, David B. Terriere, Box 221, Hempstead,

N. Y.

w6chi w6ejw cm5fl ct1bv ear62 ear69 ear16 ac1fm eb4hd
eb4bn eb4de eb4di eb4ef eb4ew eb4hp eb4jz ef8cp ef8he
ef8ip ef8ax ef8gab ogr4

W2EB, E. Seiler, 1614 Peoples Ave., Troy, N. Y.

3500-kilocycle phones

w1afd w1aoi w1aqh w1nh w2ahl w2amb w2aoi w2ga w2gj
w2kr w2at w3blp w3eah w3ee w3ez w3mp w3oo w3rb
w4aaq w4to w8adf w8adm w8az w8af w8aof w8ayl w8by
w8cjb w8coj w8esa w8ewu w8ddl w8ku w8pk w8rd w9bwy
w9dzt w9fld w9ft

VESET, G. V. Lawrence, Box 186, Parry Sound,

Ontario, Canada

14,000-kilocycle band

em2jt d4dba f8kf f8wb g2ao g4ml g5by k4akv nj2pa nkf
pylid velap velar ve4dk ve4fv ve4hh ve4mo ve5bl vo8ae
vo8rg w4aew w4afe w4ah w4ahs w4ea w4ip w4ne w4nl
w4pk w4up w4vj w4we w5abi w5abf w5bcm w5ebf w5rg
w6ac w6aov w6bws w6do w6dvp w6dyb w6eb w6eof
w6dvp w7akp w7fb w7ga w7nr w7pv w7si

7000-kilocycle band

aa2ok cm5fl d4dba d4uj f8eo f8gq f8hpo g5by g5bz g6rb
g6yq kdvs kfr5 ve4as ve1br vk2bk vk2jh vk2rb vk5hg
w4ac w4ace s4adn w4aef w4aej w4ahl w4ahq w4aiv w4aki



Those at the forefront of American radio had the foresight to standardize on the foremost resistances.

There is a DURHAM Resistance for every purpose. Write for data sheets and prices of ratings in which you are interested.

DURHAM
METALLIZED

RESISTORS & POWEROHMS
INTERNATIONAL RESISTANCE CO.
2006 Chestnut Street, Philadelphia, Pa.

The NEW Easy-Working
GENUINE MARTIN

VIBROPLEX No. 6

Reg. Trade Marks: Vibroplex; Bug; Lightning Bug

IN COLORS: Blue — Green — Red

10 New features. Easy to operate. Easy on the arm. Fast or slow. Transmits signals unequalled for strength, clarity and beauty.

Black or Colored, \$17 Nickel-Plated, \$19

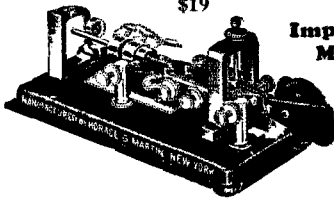
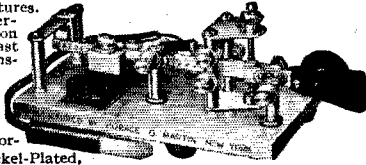

Improved MARTIN Vibroplex

Black or Colored, \$17
Nickel-Plated, \$19

Special Martin Radio Bug — Extra large, Specially Constructed Contact Points for direct use without relay. Black or Colored, \$25

Your old Vibroplex accepted as part payment
Remit by Money Order or Registered Mail
THE VIBROPLEX COMPANY, Inc.
825 Broadway, New York City
Cable Address: "VIBROPLEX" New York

w4ak w4aq w4bl w4br w4ef w4dx w4ei w4fe w4gd w4kz
w4ln w4pk w4qp w4sh w4ut w4va w4vi w4vm w4ay
w5adp w5adv w5arp w5aef w5aha w5ain w5aly w5aot
w5aqe w5asn w5aue w5awq w5axo w5aye w5bbe w5bfb
w5bbo w5bcz w5bj w5ge w5gf w5gr w5fq w5iz w5ja w5jo
w5mx w5oc w5oq w5ty w5yw w6am w6dsg w6dyj w6dyl
w6ee w6ekf w6eop w6ke w6kg w7ac w7aoo w7rz w7tu
xe6l xe5l zllax zifam

3500-kilocycle band

velbi velbn w4ag w4hk w4ky w4ll w4rm w5aae w5bad
w5bag w5lr w5ma w5oe w5om w5pp w5qa w5rg w6don
w6dyl w6dnz w6rj w7ab w7hv w7vn

3500-kilocycle phones

veldq ve3dp ve3ey wlabz wibgq wicz w2agy w2ait
w2aow w2bee w2bac w2st w3abn w3aeq w3bfz w3bj
w3cgd w3ckj w3ev w3mb w5kx w6ean w8abi w8apy w8aei
w8afq w8akp w8aux w8bhf w8ecz w8eix w8emw w8esu
w8evh w8dpd w8dvw w8gl w8ux w9axz w9bcm w9bfb
w9eby w9dds w9dzt w9fal

X3A, G. W. Lord, Toluca, Hgo. Mexico

14,000-ke. band

w1bw w1bux w1rk w1ae w1az w1nx w1bs w1vd w1mb
w1va w1tt w1jn w1jm w1kd w1de w1ly w1jr w1aks w1uj
w1qg w1dv w1ql w1bce w1aqe w1oy w1ai w1oq w1bcn
w1cno w1auz w1dep w1id w1rd w1zdp w1dpo w1bct
w1dae w1caq w1cwc w1sau w1ai w1dij w1cdo w1apx
w1dij w1df w1du w1ef w1be w1ji w1eag w1bpb w1ged
w1els w1ads w1bb w1eps w1frq w1bmu w1lm w1fr w1akt
oa42 oa4j ce2ab vk2rx he2jm zlap zliaa

3500-ke. band ('phone)

w5kx w6ep w6abf

OKPR19, Alois Weirauch, Mestec Kralove,
Czechoslovakia

14,000-ke. band

ve2be vk2ns w1ae w1bl w1bx w1caw w1ph w2aey w2auu
w2cuq w2ho w2rr w2qn w2vd w3ajh w3ju w3mz w1er
w8afm w8apb w8bf w8bti w8bjv w8caq w8ddl w8djp
w8hx

7000-ke. band

w1air w1ajm w1ajq w1bet w1bjo w1wg w1vp w2ali w2amb
w2awu w2bia w2bjo w2boz w2btz w2uc w3aho w3ree w3ld
w4ak w4aeq w4ake w4al w1jb w1pz w1ux w1ghw

W9BWK, W. D. Marshall, 806 Galena Blvd.,
Aurora, Ill.

7000- and 14,000-ke. bands

w6aae w6aaz w6abp w6ac w6ael w6acp w6add w6adw
w6afc w6afi w6ags w6agv w6ahp w6aj w6ajt w6ak
w6ake w6akd w6akf w6akg w6alw w6am w6ame w6amw
w6anj w6aoe w6apd w6aqj w6asl w6ase w6ata w6atj
w6atm w6ato w6atr w6atu w6auk w6aum. w6aut w6awd
w6awg w6awp w6awq w6awz w6axf w6axw w6ayg w6ayj
w6azl w6azy w6bam w6bax w6bba w6bbh w6bbj w6bck
w6bet w6bfb w6bfe w6bfp w6bgl. w6bhr. w6bhy. w6bix.
w6bjf w6blk w6bly w6bne w6bpg w6bpm w6bqj w6bqk
w6bqp w6brv w6bsj w6bsn w6btl w6bto w6btz w6bub
w6bux w6bvx w6bxr w6bxy w6by w6byb w6byo w6bzd
w6hgz w6hnr w6hyz w6ead w6ear w6eaz w6erz w6esj w6esq
w6ete w6eto w6etp w6euc w6ucl w6uum w6uus w6euw
w6exw w6eyb w6eyz w6eyi w6eze w6ezn w6ezz w6dak
w6dbt w6deg w6dej w6duu w6dev w6de w6dep w6dfs
w6dgn w6dgg w6dex w6dil w6diz w6djq w6dkv w6dlm
w6dmk w6dns w6dog w6doq w6doz w6dpl w6dps w6dqj
w6dqy w6drb w6dre w6das w6dte w6dtu w6dtz w6dwi
w6dwh w6dyb w6dyk w6dym w6dyn w6dyv w6dyz w6dzi
w6dzm w6dzq w6dex w6eab w6eac w6eak w6eap w6eau
w6eav w6ebg w6ebx w6eod w6eac w6ecn w6edo w6eem
w6eep w6efe w6efg w6efk w6egv w6egz w6ehi w6eip
w6ehu w6ehw w6eib w6eif w6eip w6eje w6ejh w6eke
w6ekw w6ele w6ely w6emd w6eob w6eop w6eoz w6epd
w6epi w6epz w6epz w6eqf w6eqj w6eqn w6eau w6ebi
w6esa w6egz w6ejt w6etn w6etr w6ets w6eug w6euh
w6eup w6eva w6ew w6ewf w6fe w6ft w6gt w6id w6io
w6jn w6kg w6mx w6nx w6pi w6qy w6se w6si w6su w6uc
w6ue w6vz w6wb w6xbb w6yl w6yq w6yx w6zi w7aar
w7aat w7aax w7aay w7aaz w7abq w7ac w7ad w7aey
w7adb w7aeq w7aew w7afl w7ajx w7akb w7aoo w7aou
w7aho w7ahw w7ahz w7ait w7ajh w7akm w7akz w7alv
w7alw w7amo w7amx w7anj w7anz w7ao w7aob w7aoc

Build Your Own Multi-Range Volt-ammeter

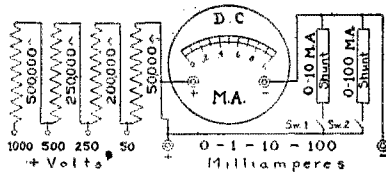

The Super Akra-Ohm wire-wound Resistors and Shunts afford an inexpensive way to build an accurate Multi-Range Volt-ammeter as shown in the above diagram. We manufacture wire-wound resistors of any value from 0.01 ohms to 10 meg-ohms. They are carefully designed to insure an accuracy of 1 per cent and a constant permanency of calibration. Their use is highly recommended for Laboratory Standards, High Voltage Regulators, Telephone Equipment, and Television Amplifiers, Grid and Plate Resistors, etc.



Prices range from \$1.25 for 100 ohms to \$4.00 for 500,000 ohms

SHUNTS for increasing the range of milliammeters. \$3.00 each. Send us your dealer's or jobber's name and we will send you Bulletin 100-C, containing the original voltage multiplier chart for the use of Super Akra-Ohm Resistors for constructing Multi-Range Voltmeters.



Shallerross Mfg. Company
ELECTRICAL SPECIALTIES
700 PARKER AVENUE
Collingdale, Pa.



Leeds Listening MONITOR

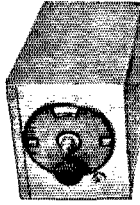

For checking your note, its stability and whether D.C. or not. THE ONLY SURE CHECK. Gives you an accurate idea as to what your signal sounds like to the other fellow. The Leeds Monitor is encased in an aluminum shield, 5" x 3" x 9" overall. Completely shielded, with batteries self contained. Supplied with A. & B. batteries, but without 1-UX, 199 tube.

Special **\$15.00**

Make your own transmitting and receiving coils. Copper tubing transmitting inductance.

| | Size of tubing | | |
|-------------|----------------|------|-------|
| Inside Dia. | 3/16" | 1/4" | 5/16" |
| 2 1/8" | 9c | 10c | 12c* |
| 2 3/8" | 9c | 10c | 15c* |
| 3 1/8" | 10c | 12c | 17c* |

Prices per turn

Thordarson B-Eliminator Transformer **\$1.65**

Thordarson 150 watt Transformer **\$3.50**

Leeds 50 watt socket specially priced. See previous issues of QST for details.

LEEDS

The Home of RADIO
45 VESEY STREET

NEW YORK

New York's Headquarters

for

Transmitting Apparatus

When in Town Visit Our Store

EVERYTHING IN
ACME JEWELL PYREX
BRADLEY FLERON
THORDARSON
ELECTRAD NATIONAL
LYNCH SIGNAL
FLECHTHEIM
NATIONAL RECTOBULB
GENERAL RADIO
CARDWELL
IN STOCK

Leeds Microphone STANDS



Beautiful oxidized copper finish. Very sturdy construction. Artistically designed, effective appearance.

Desk Type, Price..... **\$4.75**

Floor Type, Adjustable to 7 feet Price..... **\$9.75**



NEON GLOW LAMPS

Super Sensitive For wave meter and other uses; candelabra base. 1/2 watt, 3/8 inch diameter. 1 3/4 inch long over all. Special..... **\$1.75**

Porcelain base socket for above lamp..... **10c**

Aluminum Shield cans and panels of every description to order.

ACME For Transmission

Again we have accomplished the unusual. We are now the only distributors of ACME products. Write for Bulletin 110 giving complete line and latest special prices.

DUBILIER HIGH VOLTAGE FILTER CONDENSER

4 MFD. D.C. Working Voltage 600 V

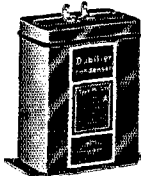

These Filter Condensers are designed for use in filter circuits in Transmitters, and all high Voltage Socket power devices and Power Packs.

TYPE PL 571
List Price \$7.25
SPECIAL \$1.89

SHORT WAVE X-MITTER

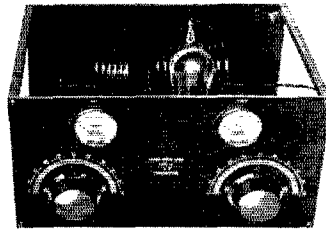

7 1/2 watt Hartley type Transmitter. Will operate with a 201-A tube, with 90 volts on the plate, up to a 1-UX-210, with 30 watts input; has plug in transmitting coils. List price — kit \$55. Completely constructed \$70.

Special Offer, completely constructed

\$57.50

THORDARSON DOUBLE FILTER CHOKES

CONTAINS TWO 18 HENRY 250 MILL CHOKES

Heavy duty, rugged double Filter Reactor for Filter Circuits in Transmitters, Power Amplifiers, "B" Eliminators and various other purposes. Each Choke has a 2000 Volt insulation and the D.C. resistance of each Choke is 108.5 ohms. When connected in series this Filter Reactor has a capacity of 36 henries at 250 mills, and when connected in parallel 18 henries with 500 mills carrying capacity.

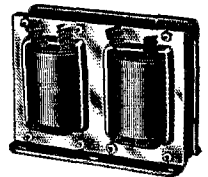

SPECIAL \$6.25

MODEL T-2458
List Price \$19.50



Special LEEDS lead in bowls made of Pyrex. Two cups size 3 1/4" dia. x 2 1/4" high; supplied complete with 1 1/2" brass rod and hardware. Price **\$2.25** complete.

Larger size cups 6" dia. x 4 1/4" high; complete set two cups, hardware and 2 1/2" brass rod. Price complete **4.25**

LEEDS RADIO LABORATORIES

Precision Custom Built Short Wave Receivers and Transmitters

This department under the supervision of the Short-Wave Specialist Jerome Gross. We design, construct and advise on any material for the "Ham" Broadcasting station or laboratory. Write Jerry Gross for advice on any of your problems.

PLEASE PRINT YOUR NAME AND ADDRESS PLAINLY TO AVOID DELAY

WRITE FOR SPECIAL PRICE LIST

MAIL ORDERS FILLED SAME DAY 10% Cash Must Accompany All C. O. D. Orders



NEW CATALOG

All the latest dope on
**A.C. RECEIVERS
 BEGINNERS' KITS**

Including new booklet No. 50 on
**Multistage Transmitters
 for Phone and C.W.**

50 pages of up-to-the-minute
 data mailed immediately

PRICE 50c



**RADIO ENGINEERING LABS.
 INC.**

**100 WILBUR AVENUE
 LONG ISLAND CITY, N. Y.**

w7ad w7bd w7be w7dp w7el w7ek w7fa w7fh w7fi w7fl
 w7fx w7gj w7lx w7if w7iq w7jc w7jt w7ka w7ko w7li
 w7lz w7mo w7na w7nh w7nm w7nr w7nv w7ny w7pg
 w7pr w7pu w7qb w7qd w7qr w7qy w7ri w7rp w7sg w7su
 w7td w7tx w7ty w7ui w7un w7vk w7vy w7wg w7wl w7wr
 w7zzb ce2ab ce3ac ce3bf ce3dg ce5aa ce7aa cm2ac cm2jm
 cm2sh cm2wa cm2xa cm2yb cm3dg cm5ex cm5fc cm5ry
 cm8le cm8uf cm8yb ct1aa ct1bx ct1cw ct1af ct1fb freari
 g5by g5ml g5ms helgf hel1g hc2jc hc2jm kfr6 kfzt k1aan
 k1aky k4dk k4kd k6alm k6boe k6dd k6etf k6ewb k6wz
 lu1ba lu2dj lu2ea lu2do lu2fi lu3de lu3dh lu3fa lu3fk lu3hc
 lu4bi lu4dq lu5ac lu9be lu9dt lu6fe nj2pa uncab nu1cab
 nn1se nn1nic nn7c oa1j oa4o oa4q oa4r pylaa pylah
 pylaw pylca pylcl pylcm pylia py2ab py2ad py2ak
 py2ay py2az py2ba py2bf py2bg py2ig py2ik py2in py2qb
 py2qh ti2ea ti2rs ti2wd ve1as ve1br ve1cc ve1co ve1dq
 ve1dr ve2aa ve2ac ve2ai ve2ay ve2bd ve2bh ve2ea ve2af
 ve2ai ve2aj ve2at ve2bc ve2be ve2bl ve2bm ve2bu ve2bu
 ve2bx ve2ck ve2cp ve2dj ve2ee ve2fd ve2fk ve2fx ve2gd
 ve2gi ve2gu ve2gv ve2ha ve2hm ve2hr ve2hu ve2ie ve2ig
 ve2js ve2kl ve2vw ve2va ve2al ve2ao ve2aw ve2ep vk2hu
 vk2jc vk2nb vk2ns vk2ow vk3es vk3hk vk3hl vk3jk
 vk3jy vk3ml vk3pp vk3pr vk3tm vk3wo vk4hg vk5hg
 vk5it vk5os vk5wr vk6wi vk7ch vk7dx vo8ae vo8an vo8aw
 vo8mc x1nq x2x x9a x9d z11bb z12be z12ac z4tm z1rc
 xoz7aw xoz7xu xw1m xqla hi2 dn3 wfa xda

Your Broadcast Receiver as a Short-Wave Superhet

(Continued from page 14)

that the fault was with the individual tubes. If the above figures are typical, probably four out of five Type '27 tubes will be satisfactory, although if a number of tubes are available, it is well to select the best of the lot and use it in the converter, because a tube which is hummy on short-waves will usually be suitable for use in the broadcast receiver itself.

In conclusion, we may say that we believe most difficulties can be overcome by the application of a little common sense in hunting for their cause. Once the rough spots, if any are encountered, are ironed out, the results should be more than satisfactory.

The Annual Meeting of the A.R.R.L. Board

(Continued from page 21)

that arrangement whereunder the Secretary of Commerce authorizes the operation of an amateur station by the holder until he can be personally examined but for not to exceed one year. It seems that many extraordinary "dodges" are invented by the holders to escape appearing for examination, because they know they are not qualified. With due consideration for crippled operators unable to travel and others who may have excellent excuse for not appearing, the Board voted to request the Department of Commerce to enforce the regulations on the temporary certificate, to end the abuse now existing.

The thanks of the League were voted to stations W1AXV and W9XL for their very valuable services as standard-frequency stations in the transmissions sponsored by the League. The board ordered spread upon its records a state-

BANKRUPT RADIO STOCKS FULLY GUARANTEED

Tubes UX type, 30 day replacement guarantee, No. 210, \$2.25; No. 250, \$2.35; No. 281, \$1.85; No. 280, 95c; No. 245, \$1.25; No. 224, \$1.25; No. 227, 75c; No. 226, 65c; No. 171, 75c.

Low Power Transmitter, adaptable for phone or code. With plug-in Coils.....\$14.75

Short Wave Sets, one tube complete with 5 coils, 14 to 550 meters.....\$6.45

Stromberg Carlson telephone transmitter on desk stand.....\$2.75

B Eliminator, Dry, 180 volts, will operate up to 10 tube set, with 280 tube, fully guaranteed.....\$6.75

250 or 245 Power Condenser Blocks, 12 Mfd., 1000 volt A. C. test, tapped 2,2,2,4,1 and 1 mfd.....\$4.75

2 Mfd. Condenser Packs, 2000 volt A. C. test \$7.90 1500 volt.....\$3.80

Double Chokes, 30 henry each, 160 mls., 1500 vt. test, shielded.....\$4.95 130 mls.....\$3.75

Power and Filament Transformers for 226, 227 and 171 tubes, with double choke.....\$4.00

No. 1003 Power Transformers, shielded, Sec. 600 V. for one 281, one 250, one 227, four 226 tubes and 2 chokes.....\$5.00

A-C-A. B. C. Power Packs, completely assembled, \$8.75. 250 V. B. also has A. C. filament for up to 9-tube set. Can be used as B eliminator. Make your battery set all electric, or build your A. C. set around this pack. 280 tube for this pack, 95c extra.

Thordarson Transformers, 1 to 1.....\$1.00

CHAS. HOODWIN Co.
 4240 Lincoln Ave., Dept. G-8, Chicago, Ill.
 DEALERS IN BANKRUPT RADIO STOCKS

CROSLLEY RADIO

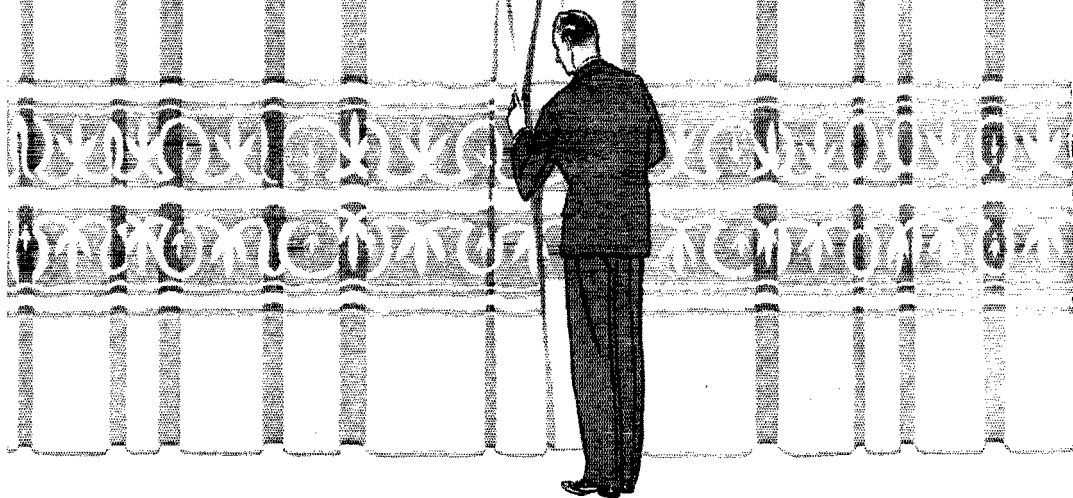

THE CROSLLEY RADIO CORPORATION

Powel Crosley, Jr., PRES. Cincinnati, O. Home of WLW - "the Nation's Station"

You're *THERE* with a Crosley

SOME SET!

The Hy-7 "Brought in stations I never heard before." Captain H. W. Atkins, S.S. Aryan.

"California and English 20-meter amateur fone are pie. Tuning world without antenna is new. Sydney, 2ME like local." B. H. Taylor, Haverhill, Massachusetts.

"Some set! Every other set I've had would not get any 20-meter signals." W3PT.

"I never heard anything like the HY-7. Gets signals I can't hear on my regular receiver." W1AGZ.

"Only use 5-foot aerial on the HY-7. It certainly is a greater performer." W1CMP.

"That set is a peach, you don't say enough about it, it's worth bragging about." W1HN.

We'll let the users do the bragging. We're too busy making and improving the HY-7. Complete descriptive article 50c, gives theory and design data. Write for circular and prices on D.C. kit or either A.C. or D.C. ready-made receiver.

Special Work — Here's what H. E. Brummelle of the Chile Exploration Company says of his special HY receiver, "I have the best outfit this side of the Equator."

Also Jewell, Weston, Cardwell, Electrad, Sangamo, Tobe, Thordarson, Yaxley, National, Frost, Pilot, Signal, Hammarlund, Clarostat, etc.

Hatry & Young

119
Ann St.



Phone
5-2755

HARTFORD - CONNECTICUT - U.S.A.

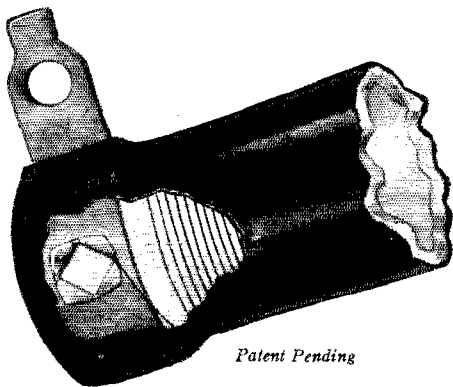

Patent Pending

Two New Contacts for You

Our Catalog

brings simplified Resistance Computing Tables. Write us for it — and ask too for a description of the New HH Contact.

ONE of them is shown above — the new Eyelet Contact that is now a standard part of every HH RESISTOR. It has been universally approved by Electrical and Radio Engineers for its effective reduction of contact resistance through increased, fixed contact areas between wire and terminal.

The other new contact is the one that we welcome between your organization and ours. We are making RESISTORS for an impressive list of leaders in the industry. There are definite reasons why you should be among them. May we tell you what they are?



RESISTORS



Hardwick, Hindle, Inc.
218 Emmet St. Newark, N. J.

ment adopted in the consideration of questions of policy brought forward by letters to some of the directors from some of their constituents. The members of the Board agreed to undertake the operation of a radio net of their own on the air, the Directors' Chain, and they elected Professor Woodruff as chairman thereof.

The foregoing account is at best an outline of the definite actions taken by the Board. It cannot begin to record the discussions which took place on the many angles not only of these questions but of about every other problem that could be thought of. In addition to their formal meeting the directors inspected the properties of the League, the offices and the headquarters station W1MK, and found time to better their acquaintance with the headquarters personnel and its work.

Somebody recently wished out loud that when Warner wrote up these Board proceedings for *QST* he would cut out the moralizing, give a bald recountal of the facts, and refrain from "interpreting." We've done our best, but we can't refrain from concluding that it was a good meeting and that it shows that we have a strong and workable system of self-government in our League.

New Two-Volt Tubes

(Continued from page 22)

It will be noted that the mutual conductance of the new tube is about 50% greater than that of its predecessor, with a slight decrease in plate resistance. Greater amplification can therefore be expected from the UX-232 when substituted for the Type '22 without any changes in circuit constants other than those necessitated by the lower filament voltage and a slight increase in the grid bias. When used in present receivers operating from a 6-volt battery, both these changes can be made simultaneously by the insertion of a 50-ohm resistor in the negative leg of the filament, the grid return being made to the battery side of the resistor.

Screen-grid voltage should be obtained from a tap on the "B" battery rather than from a dropping resistor connected between the plate and screen grid. Variations in screen current of individual tubes make this necessary. As with all screen-grid tubes, the screen-grid should be bypassed to ground by a comparatively large condenser.

The new tubes have been designed to be non-microphonic, and therefore should find wide application in automobile receivers and other portable sets. The low filament current and voltage make dry-cell operation entirely practical, although care should be taken to maintain the actual voltage on the filaments at not more than two volts. It is therefore recommended that a filament voltmeter be employed, particularly when dry cells are used.

IF YOU WANT TO BE
SITTIN' PRETTY.
THEN ~ USE THE
COMPLETE
THORDARSON
ELECTRIC POWER
SUPPLY. ES YOU'LL
HV A 1930
SIGNAL OM

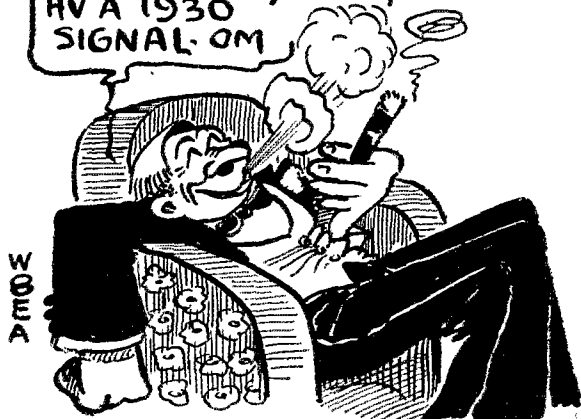

THE BEST IS NONE TOO
GOOD FOR YOUR TRANS-
MITTER —
USE THE BEST!

JUST A REMINDER —

WE STILL HAVE AN
AMATEUR LOG BOOK FOR
THE HAM WHO DID NOT
GET ONE OR THE
BEGINNER WHO WANTS
TO KNOW WHATS IT
ALL ABOUT, SO SEND
IN YOUR QSL CARD OR
LETTER.

IT HAS A LOT OF GOOD
HAM DOPE IN IT
THAT YOU CAN USE.

THORDARSON ELECTRIC MANUFACTURING CO.

Transformer specialists since 1895

Huron, Kingsbury and Larrabee Sts.

Chicago, U. S. A.



REGULATIONS

REQUIRE

ADEQUATELY FILTERED

DIRECT CURRENT POWER SUPPLY!

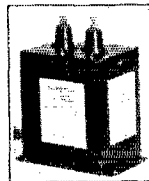

The best way to comply with these new regu-
lations is to use Tung-Sol Filter Condensers.

1 Mfd. 1000 volts*
\$6.00
2 Mfd. 1000 volts*
\$12.00

**OIL DIELECTRIC
BETTER FILTERING
LONGER LIFE**

1 Mfd. 2000 volts*
\$12.00
2 Mfd. 2000 volts*
\$24.00

*Working voltage

TUNG-SOL CONDENSERS, INC.

2317 Calumet Avenue, Chicago, Illinois

Formerly Brown & Caine

Condenser Specialists since 1920

FROST-RADIO engineers have banished noise from wire-wound volume controls!

THE necessary use of wire-wound Volume Controls in high gain Radio Receivers has presented fresh problems to the manufacturer of potentiometers and rheostats. Previous standards and methods of manufacture having proved to be wholly inadequate, radically new and different materials and processes were required, and it remained for FROST-RADIO Engineers to develop these.

They have perfected an automatic device for rounding and polishing the contacting edge of the wire. This process so perfectly forms the wire edges that there is not one ten-thousandth of an inch difference in height between any adjacent wires. A velvet smooth contacting surface is thus provided.

They have proven that the new FROST-RADIO Volume Controls will withstand a fatigue test of two hundred thousand half-cycles, at a speed of thirty per minute, without evidence of wear on wire edge or contact arm, and that they are as perfectly noiseless at the completion of test as before being subjected to fatigue.

A complete treatise on the subject of volume controls has been prepared by our research laboratory. We will be glad to send a copy to any interested engineer.

HERBERT H. FROST, INC.
Main Offices and Factory: ELKHART, IND.

THE A.R.R.L. LOG SHEET

New Regulations Require Station Log

The new amateur station regulations of the Federal Radio Commission, announced in May QST, oblige every amateur station to maintain a log of operating activity. Every station ought to keep a log. A.R.R.L. has been preaching it for years. Now it becomes compulsory under the regulations.

A well-kept log gives proof of station transmissions. It is invaluable in checking up the records of your work. Its presence identifies your station as a systematic one. The Government now requires it as a record of transmitting activity.

Being purchased now in large quantities, the price of the Log Sheet has been substantially reduced. The new low prices:

| | |
|----------------------|--------|
| 100 sheets | 50c |
| 250 sheets | \$1.00 |
| 500 sheets | 1.75 |

(Postpaid)

**THE AMERICAN
RADIO RELAY LEAGUE**
Hartford, Conn., U.S.A.

A few sample tubes have been tested and found to work very satisfactorily on high frequencies. Thumping the table or even the receiver itself



AN EXPLODED VIEW OF UX-252

failed to set up the usual annoying ringing noises common to most d.c. tubes, particularly those of the '99 Type.

— G. G.

Naval Reserve Holds Its First National Emergency Drill

(Continued from page 26)

the Naval Reserve will be one of the largest. Aviation and radio are going forward hand in hand and the time has come already when aviation cannot get along without radio. In the future the operations of our surface, air and undersea fleets will become more and more dependent upon radio communication. Those of us who follow the military side of radio are qualifying ourselves for future service in time of need.

New England Division Convention

(Continued from page 38)

GBS. A good description of Aircraft Radio Equipment and the use of Beacons was given by Mr. A. P. Bock of Westinghouse. Mr. A. D. MacLeod, Champion Tube Works, Inc., brought the fellows some useful suggestions on "Telephony in the Amateur Bands."

The call to the Banquet Hall came at about 6:30 p.m. Close to 225 were in attendance. Entertainment was furnished by an orchestra, and several YL singers and dancers (ask Doc Tessmer, W1UM, about the YL). Director Best officiated as toastmaster and very ably carried out his part of the program. The speakers were President

Vitrohm Stabilizing Resistors

When the plate potential of radio transmitters is supplied by filtering rectified A. C. it is common practice to connect a stabilizing resistor across the output of the plate supply.

The advantages are:

1. Protects the filter condensers from high peak voltages, which lengthens their life.
2. Steadies the note.
3. Tends to eliminate chirps.
4. Discharges condensers when key is open.

Send for circular 507, describing Vitrohm Resistors for radio. It will be sent without charge upon request. You will find in this circular Vitrohm Resistors to meet every radio requirement.

| Output Voltage | Total Resistance | Vitrohm Resistors |
|----------------|------------------|-------------------------|
| 250 | 25,000 ohms | 1—Cat. 507-65 |
| 550 | 50,000 ohms | 1—Cat. 507-68 |
| 1000 | 50,000 ohms | 2—Cat. 507-65 in series |
| 1500 | 60,000 ohms | 3—Cat. 507-5 in series |
| 2000 | 80,000 ohms | 4—Cat. 507-5 in series |

WARD LEONARD ELECTRIC CO.

Mount Vernon, New York

OUR CATALOGUE IS READY

Write for it—Lowest Prices

218 Chestnut Street

HALL'S

Harrisburg, Pa.

We give you prompt service whether your order is large or small—
All orders mailed the same day

—:— We Pay the Postage —:—

SPECIAL—100' No. 12 Enamel Wire 75c

QUARTZ OSCILLATING CRYSTALS

Scientifically Prepared for Maximum Power and Unconditionally Guaranteed 1 in. square sections, (within 1/2 of 10/0 of your specified frequency), supplied promptly at the following prices:

| | |
|--|---------|
| 75-100 meters | \$12.50 |
| 100-200 meters | 10.00 |
| 200-600 meters | 15.00 |
| 1 in. Tested blanks, 200-400, 400-600 meters | 5.00 |
| Dustproof Bakelite mounts | 3.00 |

(An accurate Calibration furnished with each crystal)

Sections of any practicable dimensions made to order

(Charges for grinding to exact frequencies given on request)

J. T. Rooney, B. Sc., 4 Calumet Bldg., Buffalo, New York

"Fifteen years' crystallographic experience"

"A pioneer crystal grinder"

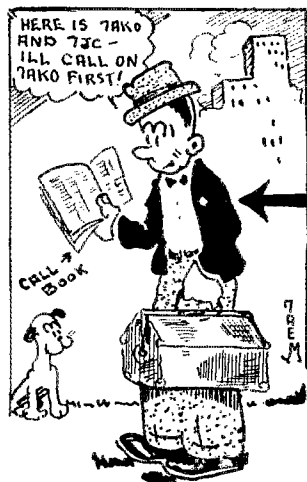

When You Go Calling on Hams Wear Your A.R.R.L. Emblem



A handsome creation in extra-heavy rolled gold and black enamel, 1/2" high, supplied in lapel button or pin-back style. The personal emblem has come to be known as the sign of a good amateur. It identifies you — in the radio store, at the radio club, on the street, traveling — you can spot an amateur by it. Wear your emblem, OM, and take your proper place in the radio fraternity. Either style emblem, \$1.00, postpaid.

American Radio Relay League

1711 Park Street, Hartford, Conn.

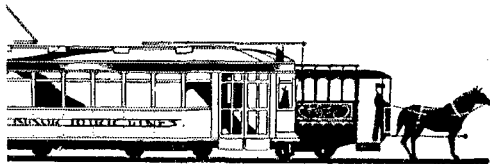

"Whoa! FLORADORA"

... and being a good ol' mare she threw herself in high whenever traffic became halfway profitable.

The controller box on the modern street car puts Floradora to shame.

In your radio, the control makes all the difference between raucous, crackly noises and smooth, velvety reception.

CENTRALAB performance explains why you will find these volume controls in millions of modern sets.

Write Dept. 320-F for Free Booklet, "Volume Control, Voltage Control and Their Uses"

Centralab

Central Radio Laboratories

Dept. 320 F, Keefe Ave., and Humboldt MILWAUKEE, WIS.



Do You want to be a High Class Radio Operator?

You can be a Clear, Fast Sender, able to work with the best of them. You can be a Rapid, Accurate Receiver, able to copy the fast stuff with pen or typewriter. The Successful Methods used by the fastest and highest paid Radiomen are taught to you in

The Candler System of High-Speed Telegraphing

It is a Post Course of intensive training for developing Receiving and Sending Speed quickly through Scientific Methods (not trick theories). It trains the Brain, Muscles and Nerves to Co-ordinate in doing fast, accurate work. It develops the power of Concentration; gives you Confidence by making you sure of yourself at all times. No matter what your speed now is, we guarantee to increase it.

In big land stations and on ships at sea are successful operators who have taken and are taking the Candler System. "I owe my speed (55 wpm) to your System." — Theo. McElroy, World's Champion. "Can copy fast stuff 3 to 5 words behind easily." Radio-Typing Course is best for radiomen. — Raymond H. Bell, U.S.S. Idaho. Thousands of letters like these pour into our offices from all over the world. There's no substitute for the Candler System of High-Speed Telegraphing.

If you want to get out of the "slow class" and do something, write for further information about this great Course and what it has done for over 45,000 operators. Give your present speed and tell us what you want to accomplish. Also ask about Radio-Typing Course.

The CANDLER SYSTEM CO.
Dept. RL.

6343 South Kedzie Avenue Chicago, Illinois

Maxim, Radio Inspector C. C. Kolster, Major Platt, K. B. Warner, A. A. Hebert and E. L. Battey. The call for state and district delegations revealed hams from each New England state and the 2nd, 3rd, 5th and 9th districts. Last, but not least, on the program was the distribution of prizes. Providence was chosen as the seat of next year's convention.

The Worcester Radio Association, under whose auspices this convention was held, did a mighty fine job of it, and they have set a high example to be followed by other committees. Save your pennies for 1931 at Providence!

— E. L. B.

Silent Keys

It is with deep regret that we record the passing of these amateurs:

Glenn G. Austin, W3ARK-W3AMG, Washington, D. C.

J. McRobb, VE2AU, Montreal, P. Q.

Ralph B. Nelson, W6CBN, Alameda, Calif.

H. L. Robinson, VE2BC, Montreal, P. Q.

Strays

Correction

The following amendments should be made to "The ABC of Filter Design," April QST.

In Fig. 9, R_o should be 100,000 ohms instead of 50,000.

Page 37, left-hand column:

$$R = \frac{r_p \times R_o}{r_p + R_o} = \frac{2 \times 10^5}{12} = 16666 \text{ ohms.}$$

Therefore Z_i or $Z_\pi = 16666 \text{ ohms.}$

$$L_k = \frac{.0797 \times 16666}{20000} = .066h.$$

$$C_{\mu fa.} = \frac{79700}{20000 \times 16666} = .000239 \mu fd.$$

Page 38, left-hand column:

$$C_1(\mu fa.) = \frac{(10000 + 110000) 10^6}{4 \times 3.14 \times 100000 \times 110000 \times 8350} = .000182 \mu fd.$$

$$C_2(\mu fa.) = \frac{10000 \times 10^6}{3.14 \times 110000 \times 10000 \times 8350} = .00346 \mu fd.$$

The equations on page 37 can be changed to give the results directly in microfarads and millihenrys if put in the following form:

$$C_1(\mu fa.) = \frac{(f_1 + f_2) 10^6}{4\pi f_1 f_2 2} \quad (5)$$

$$C_2(\mu fa.) = \frac{f_1 \times 10^6}{\pi f_2 (f_2 - f_1) Z} \quad (6)$$

$$L_2(mh.) = \frac{(f_2 - f_1) Z \times 10^3}{4\pi f_1 f_2} \quad (7)$$

SEND FOR THESE BULLETINS

A brand new line of transformers and chokes



Acme has a new line of transformers and chokes — 43 different items. Just drop a card today to the Acme Apparatus Corporation, Cambridge, Mass., Dept. Q-2, ask for Bulletins 110, 111 and 112 and learn all about this new apparatus.

Since vacuum tube transmission began, Acme has been making transformers and choke coils, and everyone remembers the Acme Spark Transformers in the early days.



ACME ~ for transmission

BROADCAST MICROPHONES

Scientifically designed and constructed. Unexcelled for quality and output.

TYPE TSD, Two-button type, stretched diaphragm. A truly precision instrument \$60.00

TYPE SHD, Single button. Excellent for ordinary ham or public address work \$12.50

Write for circulars and full details.

Expert repairing and overhauling on all types. Reasonable rates.

RADIOPHONE ENGINEERING BUREAU
P. O. Box 88, Salem, Mass.

Massachusetts Radio and Telegraph School

18 Boylston Street, Boston

Send for Catalogue

Tel. Hancock 8184

Established 1905

TRANSMISSION CONDENSERS



Send for interesting data and price sheet on Transmission Condensers with working voltages up to 3000 D.C. for use with the following tubes: 203A, 204A, 210, 500W, 851, 852, 860, 865.

CORNELL ELECTRIC MFG. CO.
Long Island City New York

Oscillating Quartz Crystals

Guaranteed easy oscillators carefully selected and ground for maximum output

| | |
|--------------|---------|
| 1715-2000 kc | \$15.00 |
| 3500-4000 kc | 15.00 |
| 7000-7300 kc | 20.00 |

All crystals are calibrated within 1/10 of 1% of the frequency. Ground to 1/4 of 1% of the frequency specified. Ground to 1/10 of 1% of frequency specified, \$2.00 additional.

Precision crystals can be supplied from 14000 kc (20) to 15 kc (20000) on order.

B. F. WALTER

43 Bleecker Street

Newark, N. J.

SUPER-DAVOHM RESISTORS

preferred and specified by experts the world over, for



laboratory standard
high voltage regulators
vacuum tube plate resistors
vacuum tube grid resistors
voltmeter multipliers
telephone equipment
television amplifiers
fading controls
isolation resistances

Catalogue sent on request

If your dealer cannot supply you—write us

THE DAVEN COMPANY

158 Summit Street, Newark, N. J.

Resistor Specialists

"Standards of Efficiency"

5 to 5 million ohms; guaranteed 1% tolerance

AD. AURIEMA, INC.
 Manufacturer's Export Managers
 116 Broad Street, New York, N. Y.

Scientifically equipped
 to economically export
 dependable receiving
 and transmitting radio
 apparatus

It's EASY to Get a HANDBOOK

(Sixth Edition)

DIRECTIONS:

Realizing that Handbook must be had, proceed as follows:

- (1) Fill out below, tear off.
- (2) Reach in pocket, produce U. S. A. \$1 bill, old or new size (we don't care).
- (3) Clip together, mail us.

Handbook Factory,
 1711 Park, Hartford.

SEND IT AT ONCE.

(Name)

(Street or P. O. Box)

(City and State)

When examining the edges of a crystal for small cracks or chips, the range finder of an ordinary Kodak makes a first-rate microscope. Hold the crystal next to the finder and get your eye as close as possible. The finder has more magnification than a reading glass. — ex W6BOY, W6BZW.

W2AUY recently built a Zepp antenna, and his YL wanted to know what the "ladder" was for!

A band-spreading condenser of the split-stator type can be made quite easily from an old two-gang condenser. This eliminates the difficulty of insulating the two stator portions from each other. — W2A VS.

Another newspaper gem: "It takes at least one microphone to by-pass audio-frequency currents and that is what you are trying to get rid of."

A Crosley "Musicone" frame makes a good-looking microphone stand. Three brass springs from the 5-and-10 form the suspension. The three-cornered spider on the frame should be cut out with a hacksaw and the rough edges finished off with a file or hammer. The frames can often be picked up for a nominal sum at a junk shop.

A handy gadget for holding a pick-up lamp during tuning, neutralizing, etc., is a spring clothes-pin. A flashlight lamp socket can be mounted on it, and the loop formed by a piece of wire between the two screws on the socket. By this means the lamps can be readily replaced. The business end of the clothes-pin is of course clamped over the tubing in the inductance. — R. B. Southworth.

The tin cans that the old DeForest tubes were packed in make excellent tube shields, according to W9ACC. The screw top serves as a mounting base, and the can can be cut off at the other end to the required length. W9ACC also suggests that the large-size salt shakers (1 to 1½ pints capacity) obtainable at 5- and 10-cent stores can be used in the same way to form coil shields.

We have received some complaints from QST advertisers to the effect that they often receive orders from hams who neglect to sign their names or give addresses. Incidentally, this also goes for a lot of fellows who write in to Headquarters. Naturally the recipient of the letters can't be expected to have clairvoyant powers or some sort of divining rod to make the missing dope disclose itself. So be sure to give your name and complete address when writing if you have any hope of receiving an answer. Call-letters are not enough; they change so fast the call-book people have a hard job keeping up with them.

WSJT calls our attention to the fact that the winding form of the 75-watt size Electrad resistor makes a good form for a space-wound r.f. choke. There are 107 grooves on this size.

QST Oscillating Crystals

REDUCED PRICES EFFECTIVE APRIL 1st, 1930

AMATEUR BANDS:

Summer is coming, and no doubt you are going over your transmitter removing those weak links so as to get the most possible efficiency from your set.

One item of great importance is the *frequency stability* of your set. Does it *stay on one frequency*? If not, our *power crystals* will solve that problem. SCIENTIFIC RADIO SERVICE crystals are *known* to be the best obtainable, having ONE single frequency and highest output. With each crystal is furnished an accurate calibration guaranteed to *better than a tenth of 1%*. New prices for grinding *power crystals* in the *amateur bands* are as follows:

1715 to 2000 Kc band. \$15.00 (unmounted)
 3500 to 4000 Kc band. \$20.00 (unmounted)
 7000 to 7300 Kc band. \$40.00 (unmounted)

BROADCAST BAND:

Power crystals ground in the 550-1500 Kc band accurate to plus or minus 500 cycles of your specified frequency fully mounted for \$55.00. In ordering please specify type tube, plate voltage and operating

temperature. All crystals absolutely guaranteed regards to output and frequency and delivery can be made within two days after receipt of your order.

CONSTANT TEMPERATURE HEATER UNITS:

We can supply heater units guaranteed to keep the temperature of the crystals constant to *better than a tenth of 1 degree centigrade* for \$300.00. Two matched crystals, ground to your assigned frequency in the 550-1500 Kc band with the heater unit complete \$410.00. More detailed description of this unit sent upon request.

ATTENTION AIRCRAFT AND COMMERCIAL RADIO CORPORATIONS:

We invite your inquiries regards your crystal needs for Radio use. We will be glad to quote special prices for POWER crystals in quantity lots. We have been grinding *power crystals* for over *seven years* being *pioneers* in this specialized field, we feel we can be of real service to you. We can grind *power crystals* to your specified frequency accurate to plus or minus .03%. All crystals guaranteed and prompt deliveries can be made. A *trial will convince you*.

SCIENTIFIC RADIO SERVICE

"THE CRYSTAL SPECIALISTS"

P. O. Box 86

Dept. P-12

Mount Rainier, Maryland

We design special equipment to order covering

Short Wave Receivers and Transmitters

Laboratory Instruments

Power Supply, etc.

Send in your complete specifications and we will immediately forward our estimates.

Calibrated Wavemeter \$12.50
 Range 17 to 200 meters

Audio Oscillator 17.50
 40 to 5000 cycles

Wireless Egert Engineering Inc.
 179 Greenwich Street, New York City, N. Y.

BECOME A RADIO OPERATOR

See the World, Earn a Good Income,
 Duties Light and Fascinating

LEARN IN THE SECOND PORT U.S.A.

Radio Inspector located here. New Orleans supplies operators for the various Gulf ports. Most logical location in the U. S. A. to come to for training.

Our students qualify for the various branches of radio. Runs to all parts of the world. Positions Ashore and Afloat. Special courses. Day and Night classes. Enroll any time. Oldest and Largest Radio School South.

Literature on request.

GULF RADIO SCHOOL

844 Howard Ave.

New Orleans, La.

AN
 EVER
 INCREASING
 NUMBER

OF BROADCAST STATIONS
 AMATEURS, EXPERIMENTAL LABS

ARE USING **FLECHTHEIM** EXCLUSIVELY
 SUPERIOR CONDENSERS

A
 FEW
 OF THE
 REASONS
WHY!
 HIGHEST
 QUALITY
 CONSERVATIVE
 RATING
 REASONABLE
 PRICE
 PROMPT
 DELIVERY

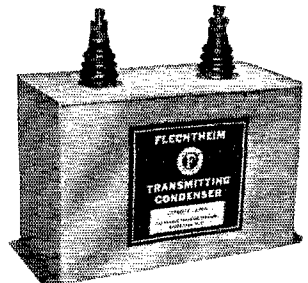

TYPE VM 200-2 MFD.
 5000 V D.C. - 3300 rms RAC

Catalog No. 21—for the asking

A. M. FLECHTHEIM & CO., INC.

136 Liberty Street

New York, N. Y.

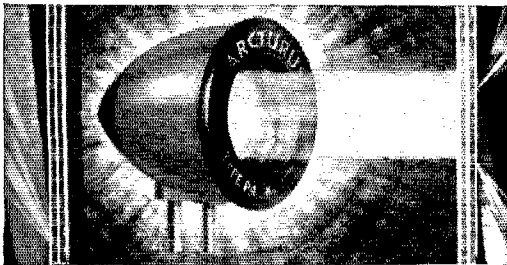

This Advanced Photo Cell

means improved operation of Sound Picture Equipment; Sorting, Checking, and Matching Equipment; Railway Signal Systems; Chemical and Medicinal Analysis; Burglar Alarms; and dozens of other mechanical and electrical devices.

Send today for complete information about the Arcturus Photolytic Cell, and get started in photo-electric research. Photo-Electric Division, Arcturus Radio Tube Company, Newark, New Jersey.



ARCTURUS

PHOTOLYTIC CELL

The Electric Eye for Every Industry

MADE BY THE MAKERS OF ARCTURUS BLUE TUBES

The HAND That Encircles The WORLD

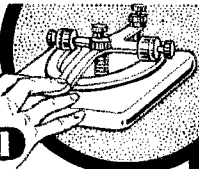

There's ROMANCE IN TELEGRAPHY
The man who knows the code is in touch with the world. Become an expert operator, make big money. LEARN IN YOUR OWN HOME—easily, quickly with TELEPLEX—the Master Teacher.

Write for folder "Q7"

TELEPLEX CO.
76 Cortlandt St., New York

Teleplex



P A C E N T

Duo Lateral COILS

The complete line of all standard turn ratios preferred by leading laboratories and engineers.

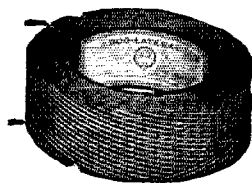

Write for information and prices

PACENT ELECTRIC CO., Inc.
91-7th Avenue New York City

Heard in a ham supply store:

Ham: "Gimme a double-O one condenser."

Salesman: "Fixed?"

Ham: "Naw! I wanta new one."

—W9FGQ

W6BGC suggests that aluminum meat loaf pans, obtainable almost anywhere for about twenty-five cents, are fine for stage shields. The pan is mounted upside-down on an aluminum sheet of the same size.

Charles S. Taylor, 1883-1930

IT is with deep regret that we must chronicle the passing of C. S. Taylor, W8PJ, at Buffalo on March 4th. He was nearly 47 years old. Known as the friend of every amateur in the region, he had been active in amateur radio affairs in the Western New York Section for a number of years. He was Section Communications Manager and Secretary-Treasurer of the Radio Association of Western New York.

He was born in Buffalo, New York, May 18, 1883, his first interest in wireless communication being aroused by attendance at meetings of the Buffalo Wireless Club about 1912. Experimenting with the crude apparatus of the time his "spark" was first heard on the air about 1915. He continued an ardent student of radio until the coming of the war temporarily silenced the amateur.

When the ban was lifted after the war W8PJ again returned to the air. Taylor was prominent in the early development of amateur radiophone in Western New York, coming on the air with 'phone late in 1920. He introduced to the Buffalo Police Department the possibilities of this type of communication. News items were broadcast. All early Buffalo radio fans heard his voice and listened to his entertainments. During 1921 the transmitter was moved to the Elmwood Music Hall in Buffalo. A concert by Geraldine Farrar was broadcast, the first high class broadcast for the vicinity. These early incidents held his interest.

Continuous activity identified Taylor with all developments of amateur radio. In 1926 his activity in the A.R.R.L. field organization resulted in his election as Section Communications Manager of Western New York, a position held and the duties of the office faithfully and carefully executed until his death. He was Secretary-Treasurer of the Radio Association of Western New York for two years and also an active member of the Volunteer Naval Communication Reserve. His key is silent but he will be remembered by all as a real friend.

NEW GOVERNMENT REGULATIONS!

"Adequately filtered D.C. power supply or arrangements to produce equivalent effects must be used."

(Copied from Official Broadcast NR338, April 4.)

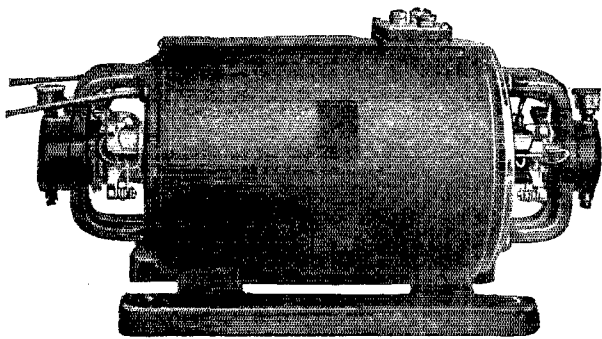

Type MG200, 2 bearing motor-generator set

One sure way to comply with these new regulations is to put an ESCO Motor-Generator behind your transmitter.

They are not expensive and they give you "More Miles per watt."

Write for bulletin 237G, listing over 500 combinations.

If you haven't already received your copy of Filter Facts write for it today — its yours for the asking.

ELECTRIC  **SPECIALTY**
COMPANY

225 SOUTH ST.

STAMFORD, CONN.

Manufacturers of motors, generators, dynamotors and rotary converters

H I L E T

Announces new line of adjustable gap Giant Choke Coils with the same dollar value that made our transformers popular thruout the world. 100H-80 MA, 22 lb., \$12.00. 50H, 160 MA, 22 lb., \$12.00. 30H-320 MA, 25 lb., \$14.00. 15 H, 500 MA, 32 lb., \$18.00. 3H-4000 MA, 22 lb., \$12.00. Transformers — 500 watt, 1000-1500 each side, \$15.00. 250 watt 500-750-1000 each side, \$10.50. 150 watt 325-375 each side, \$9.00. Filament any voltage. Tapped primary \$6.50. Specials to order. Prices are mounted with leads. For Deluxe model with fuse and terminals add \$3.50. Name Plates for transmitter panels engraved to order, \$2.00. Blanks, 75c. Write for specifications.

One Day delivery

HILET ENGINEERING CO., Orange, N. J.

TRANSFORMERS

Guaranteed — Mounted — Complete
2 kw 2000—2500 each side \$40.00
700 watt 1000—1500 each side 14.50
250 watt 500—750—1000 each side
unmounted \$10.00; mounted \$11.50
Auto-Transformers, Chokes, Polyphase and 25-cycle
Transformers. Add \$2.00 for fil. winding
WGES FRANK GREBEN
1927 So. Peoria Street, Pilsen Sta. Chicago, Ill.

Oscillating Quartz Crystals



For Commercial Stations
For Dealers
For Amateurs

POWERTYPE CRYSTALS ARE RECOGNIZED AS THE BEST

No off frequency operation with a POWERTYPE crystal

Guaranteed — easy oscillators, carefully selected for maximum output, and ground to your approximate frequency which is stated accurately to within one-tenth of one percent.

1715-2000 Kilocycle band \$10.00
3500-4000 Kilocycle band 15.00
One-inch oscillating blanks 4.00
Dust proof, plug-in Crystal Holders 6.00

We also supply "POWERTYPE" crystals to broadcast and commercial stations.

With all crystal blanks we furnish grinding instructions.

FREE Simply send name, no obligation, for full information on crystals, holders, blanks, heater ovens, etc.

"CLEAR AS A CRYSTAL"

American Piezo Supply Company
1101 Huron Building Kansas City, Kansas
Specialists in frequency precision

A New All A. C. S. W. THRILL-BOX

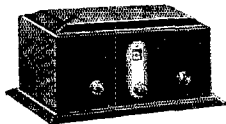

Adaptable to wide spread of amateur bands. Highly sensitive. Easy to assemble.

DOUBLE SCREEN-GRID

No Hum with headphones, single dial control. Uses all heater tubes. Made also in new battery model.

Send today for Special Bulletin No. 141

NATIONAL CO. INC.

61 Sherman Street

Malden, Mass.

HAM-ADS

(1) Advertising shall pertain to radio and shall be of nature of interest to radio amateurs or experimenters in their pursuit of the art.

(2) No display of any character will be accepted, nor can any special typographical arrangement, such as all or part capital letters be used which would tend to make one advertisement stand out from the others.

(3) The Ham-Ad rate is 15c per word, except as noted in paragraph (6) below.

(4) Remittance in full must accompany copy. No cash or contract discount or agency commission will be allowed.

(5) Closing date for Ham-Ads is the 25th of the second month preceding publication date.

(6) A special rate of 7c per word will apply to advertising which, in our judgment, is obviously non-commercial in nature and is placed and signed by a member of the American Radio Relay League. Thus, advertising of bona fide surplus equipment owned, used and for sale by an individual or apparatus offered for exchange or advertising inquiring for special equipment, if by a member of the American Radio Relay League, takes the 7c rate. An attempt to deal in apparatus in quantity for profit, even if by an individual, is commercial and takes the 15c rate. Provisions of paragraphs (1), (2), (4) and (5) apply to all advertising in this column regardless of which rate may apply.

PLATE power for your set, the very heart of its performance. For quietness, DX ability, life-long permanence, absolute dependability, lowest ultimate cost, no other plate source even approaches the achievement of an Edison steel alkaline storage B battery. Built painstakingly; every joint pure nickel, upset electrically welded. Genuine Edison Electrolyte. Our list describes complete batteries, construction parts, enameled aerial wire, silicon steel. Available immediately. filament and plate transformers for the new 872 rectifier, complete plate power units. Rectifier Engineering Service, radio W8ML, 4837 Rockwood Road, Cleveland, Ohio.

THE finest in radio for amateur, broadcast and marine. The most modern short-wave receivers. Four to ten tube designs. Radiophone CW transmitters of any power or type. We make a complete line of apparatus, including speech amplifiers, filter coils, inductances, power units, etc. Any special apparatus, designs, built to order, using your parts if desired. Prices on request. New bulletin lists complete line of apparatus. Write for copy. Ensign Radio Laboratory, 1527 Grandview St., S. E., Warren, Ohio.

AMATEURS—experimenters, builders. We serve over 4000 I.R.E., A.R.R.L., etc., experimenters and "nuts." Full discounts, \$50,000 stock, approved parts—no sets. Over four pounds catalog, circuits, data, prepaid, 50c. Weekly bulletins (new items, results of experiments, etc.) 20 weeks \$1.00. Sample experimenters "Over the Soldering Iron" magazine, 25c. Transmitting data, price list, etc., 25c. Kladag Radio Laboratories, established 1920, Kent, Ohio.

SPECIAL rectifier aluminum, \$1.25. Lead, \$1.00 square foot. Elements 1 x 4 15 cents, 1 x 6 17 cents pair. All prepaid. Best silicon transformer steel cut to order, 25-35 cents pound. Postage extra. George Schulz, Calumet, Mich.

A.R.R.L. sweater emblems should be worn by all League members. They are yellow and black 5" x 8" diamond, felt letters and embroidered symbol. Only \$1.00. Money order or currency only accepted. Eric Robinson, 135 Jefferson Road, Webster Groves, Mo.

WE build anything from a crystal holder to a broadcast station. Smith, 65 Glenwood Road, Montclair, N. J.

TELEGRAPHY—Learn Morse and wireless telegraphy. Big salaries. Tremendous demand. Expenses low, can earn part. Catalog free. Dodge's Institute, Wood St., Valparaiso, Ind.

CRYSTALS carefully ground for highest output demanded by modern transmitters. Frequency precision, 1% at room temperatures. 7000 kc., \$15; 3500 kc., \$12; 1750 kc., \$9; guaranteed blanks, \$4. W9DRD, Herbert Hollister, Edwardsville, Kans.

5-WATT tubes. Brand-new at \$1.00 each. These are rugged, thoroughly tested tubes. Renmo Tube Co., 115 Newbury Ave., Atlantic, Mass.

QSLs—plain at \$1.00 per hundred. W9BEU, 9032 Windom. St. Louis, Mo.

G.E. 1000-watt transformers, 1100-2200-4400 each side center tap. Used by Cornell, Navy, and 300 hams. Guaranteed unconditionally. \$12. F.O.B. Detroit, Fred G. Dawson, 5740 Woodrow, Detroit, Mich. Some 500 watters, no center tap (bridge circuit) \$5.00.

A NEW Neon television lamp, J-30, specially designed for intensity and smooth plate glow, \$2.50. For 12-inch scanning disc. Jenkins Laboratories, 1519 Connecticut Ave., N.W., Washington, D. C.

WANTED—all parts for 250-watt tptg high power xmtr. Described in Handbook. Also power supply and tubes. W9DSE, Bridgeport, Nebr.

SEVERAL a.c. broadcast receivers and dynamic speakers to trade for 2000-volt power supply and tubes. Need parts to build 250-watt, phone transmitter. W8CXD, 210 Taylor St., Sandusky, Ohio.

WANTED—radio operators for the National Guard. Captain Dunn, 211 Sherman Ave., New York City.

SHORTKUT to code reading speed. W3PT Leisman raised 10 to 25 in six hours. W7PT O'Reilly from 5 to 18 in two evenings. Reports from 500 users contain surprising facts. Mailed on request. Dodge Radio Shortkut, Box 100, Mararoneck, N. Y.

TRADE typewriter Oliver No. 9 or Corona No. 3 portable for transmitting parts. What have you? Lowell Ecker, Sedan, Kans.

JEWELL 199 a.c.-d.c. set analyzer. Practically new. Going to sea. Best offer takes it. H. F. Swearer, 404 Maple Ave., Bellefonte, Del.

GENERATORS, double current aeroplane type, 5-600 volt, \$20. Omnigraph, 5 dial, \$8. Sherwood, W5BH.

RELAYS—windings and contacts to your specifications, 75 cents up. Want Weston model, 301 meters, good or damaged. Write for dope. G. V. Morris, Eugene, Ore.

SELL—new never used Aero automatic tuning unit. \$15. W9FDY, 2256 Berwyn Ave., Chicago, Ill.

BARGAINS—new UX865, \$10; Weston meters: 425, 0/5 amps., \$4.50; 267, 0/300 m.a. \$6.50. Radio, 133 Commercial St., Lynn, Mass.

SELL—Hammarlund DeLuxe 4-tube shortwave receiver. 14 to 225 meters, very neat, good results, type A Sangamo transformers, tubes and Acme speaker. \$60 for all. Carl Eastje, Denison, Iowa.

BARGAINS—Pilot a.c. superwasp with cabinet and tubes. Perfect condition. \$60. David Miller, 1402 Oak St., Niles, Mich.

QSL cards, two colors, \$1.00 per hundred. Free samples. W8D7Y, 257 Parker Ave., Buffalo, N. Y.

CRYSTALS—80 meter band \$10; 160 meter band \$7; 40 meter band \$17.50; ground to specified frequency. Oscillating blanks, \$3.50. W9DDL, 222 W. 73 Terrace, Kansas City, Mo.

GENUINE General Electric Navy five watters type CG1102 filament voltage 7.5 volts. Plate up to 750. Each tube in original carton. Only \$1.25 each. Four to six pounds of radio equipment in our surprise package for only \$1.00 each. Please include postage. Money back if not satisfied with contents. Sent c.o.d. if desired. E. P. Hufnagel, 879 S. 18th St., Newark, N. J.

GRAMMIGRAPHS, Teleplexes, Codegraphs, transmitters, wasps, transmitting tubes, Vibroplexes. Bought, sold, traded. Ryan Radio Co., Hannibal, Mo.

QSLs, 100 two-color, \$1.00. Stationery, amples, W9CKA, Corwith, Iowa.

W8DXB—amateur lone 14250-ke. crystal research summer months, all hours, desires scientific data, signal strength, dx, fading and skip. W8DXB, Spencer, Ohio.

BULLETIN available, standard amateur apparatus. Special modulation chokes, transformers and filter chokes. Push pull and multistage transmitters. Pontiac Engineering Co., 1100 Avenue I, Brooklyn, N. Y.

MERCURY vapor Rectobulbs are the ideal rectifier tubes. 7000 V. type, \$24; TR3 3000 V., \$10; RS1 1000 V., \$5.25. Both U. S. A. and foreign orders shipped prepaid the day received with safe delivery and satisfactory operation guaranteed. Shipped on trial if you wish. Maximum discounts on any item of apparatus for amateur, broadcast, or commercial stations. Inquiries appreciated. Henry's Radio Shop, W9ARA, Butler, Mo.

SELL or trade: RCA 293-A, 211, 852, 845, 204-A; WE211D, 212D; power Xtals; Xmtr: 6-400 and 24-1500 V dynamos; 500 and 1500 V. MGs; Teleplex; other apparatus. W9ARA, Butler, Mo.

FOR sale: Western Electric 750-volt and Robbins and Myers 500-volt motor generators, also R.C.A. 250 and 210s. All A-1 condition. V. P. Baughn, Washington Court House, Ohio.

PEAKED audio and microphone transformers, \$1.00 each; panel mounting d.c. meters at \$3.00 in following ranges: 50 volts; 10 milliamperes; 10 amperes; 60 amperes. Jas. Coe, Box 151, Ft. Sam Houston, Texas.

TUNGARS—full-wave (Westinghouse) 2 amperes, for "Keep-alive" \$2.00. Oversize 210s, large plate \$3.53, 2S1's, 750-volt rectifiers, \$1.95. Tested in transmitter and guaranteed W9DWA, R. V. Howard, 5508 Fulton St., Chicago.

WILL trade complete station and accessories for motorcycle in good condition. W9GKH, Milledgeville, Ill.

SELL—U. S. Motors Corp. 2 1/2 kw, 32-volt light plant with 16 cells 300 ampere-hour glass storage battery. Never used and in original crates. Worth over \$700. Will accept any reasonable offer. K. P. Chai, Kohala, Hawaii.

30-watt Tuned Plate, Tuned Grid transmitter. Husky, filtered power supply, wavemeter, tuned antenna, UX281 rectifier tubes included. Brand new, best parts, good results. Priced reasonable; write for details. Also 7 1/2-watt transmitter for sale. Two-tube, short wave receiver, tube base coils, almost new, \$9. Hal Justice, W4TS, Canton, N. C.

TYPE 806 mercury vapor tubes, \$3.00 each. New, first quality, thirty-day unconditional guarantee. E. Ewing, Jr., 29 S. LaSalle St., Chicago, Ill.

FLECHTHEIM 1500-volt condensers, porcelain insulators, 2 mfd., \$1.50; 4 mfd., \$7, used. Merphon condensers, \$1.75. New National 3000-volt, .00045 with vernier dial, \$9.50; .00023-6000 volt, \$12.85. Jefferson 300-volt center-tapped transformers, \$1.65. Pilot D. C. Super Wasp kit, \$28.90, with a pair of Timmons' phones free. Pilot A. C. Super Wasp kit with cone speaker and power pack \$50. Newest type Rectobulbs R3 mercury vapor, \$10 prepaid. 281 type mercury vapor, \$7 prepaid. Allen Bradley radiostat, new type 500 watt, \$5.50. Aero Monitors, \$10.85. R.E.L. Wavemeters, \$16. Pilot and Silver Marshall coil forms, \$3.30. Wire-wound 5000-ohm grid leaks, \$3.39. Freshman 375-volt, not center-tapped, and two 7½ center-tapped filament windings, \$2.25. Signal High Frequency buzzer, \$.95. New Cardwell .00035 SILF condensers, \$.79. No. 14 cotton cov. red enameled aerial wire, \$.90 hundred feet. No. 12 solid enameled aerial wire, \$.95 hundred feet; \$1.80 two hundred feet coils. R.E.L. 50-watt sockets, \$1.50. Used Kellogg double-button microphones, \$35. Sangamo 5000-volt .00025, .0005, .001, .002 mica condensers, \$1.50. Thordarson key click filter chokes, 1½ Henry, 200 mill, \$2.95. Thordarson modulation transformers, \$2.95. Latest Amateur Call books, \$.55. Used Western Electric 212D 250-watters, \$35. R.E.L. sockets for same, \$9. New UX 852, \$28. Slightly used R.C.A. 211, \$17. Slightly used 204As, \$50. R.C.A. UV 217As, \$7.50 each. UX 866s, \$11.85; New UX 851 1000-watt, \$250. Western Electric 211A, D, or E 50-watt, \$15, slightly used. New 211Ds, \$29. Jefferson, 30 Henry chokes, 100 mills, \$3.25. Thordarson twin chokes, 20 Henry, 250 mills, each \$6.25 2500-volt lamp 133 segment Spaulding generator, directly coupled to G.E. five-horse-power motor, cost \$650, special \$225. Here's a real buy. Limited quantity new original cartons Gold Seal UX 227 tubes, \$.89 each; UX 245, \$1.15; UX 280, \$1.05; R.C.A. High Mu UX 240, \$1.00; R.C.A. Voltage Regulator UX 874, \$3.25. Broadcast microphone cases, \$2.25. Thordarson 400-volt each side center, 150 watt, \$3.90. Signal Corp 3-16" silver contact keys at \$.95. One thousand ohm relays, \$1.25. Chemically pure aluminum, \$.70 sq. ft. Also aluminum panels and corner strips for any size cabinet. Write for prices and free Ham sheet, 19 Strand enamel silk-covered Latexdach wire one cent a ft. New Signal bugs, \$12 net. Moving to larger quarters. Visit our radio shack when in town. Good time assured. What have you for sale or trade? We carry everything for the Ham. More foreign trade solicited. 24-hour service. Uncle Dave, 117 N. Pearl St., Albany, N. Y.

REAL BUYS — power transformers, 150 watts, 600 v. 7½ ct., 7½ ct., 1½, 2½, ideal for 210 transmitter, \$3.50. Mounted Double Chokes: 2-3 h. 125 ma. sections, \$2.95; 2-30 h. 200 ma. sections, \$4.85. R.C.A.-Victor 30 h. 125 ma. chokes, \$1.95. Igrad Filter Condenser blocks, 10 mfd. 600 d.c. working; \$4.25. Columbia Transmitting filter condensers, working voltage 1000 d.c. 1 mfd., \$1.40; 2 mfd., \$2.30; 4 mfd., \$3.80; 1500 d.c. 1 mfd., \$3.00; 2 mfd., \$4.50; 4 mfd., \$8.95. Special unmounted filter condensers, 850 d.c. working voltage, 1 mfd., 4 for \$1.35, 8 for \$2.60; 2 mfd., 4 for \$2.60, 6 for \$3.75; 8 for \$4.80. Guaranteed high quality tubes, X281, \$2.25; X250, \$2.75; X210, \$2.95. All our merchandise guaranteed. Cash or C.O.D. Write for free list. Columbia Specialty Co., 1038 Longwood Ave., New York City.

CRYSTALS — Power type, one peak, frequency to 0.1%, 1750 kilocycles, \$5.00; 3500, \$7.50; 7000, \$12.50. Via Air Mail. More dope, write Smith, W6BCX.

CANADIANS. VE5CT quitting. Sell everything dirt cheap. Write me your wants.

TRANSFORMER specials — mounted, guaranteed. 110-volt, 30 cycles, 150-watt 500-0-500, 7½, \$4.50; 550-0-550, 7½, 7½, \$81.050-0-550, 7½, 7½, \$7; 250-watt 550, 750 each side center, 7½, 7½, \$10.50; 700-watt 1000, 150 each side center, \$14.50; 30 H. 35 m.a. double choke, \$1.75; 30 H. 160 m.a. adjustable choke, \$4.50; 30 h. 250 m.a., \$6.75; 2 m.f. working voltage 1000 filter condensers, \$2.40; 75-watt filament transformers, 5000-volt insulation, center tapped, 7½, 7½, \$3; 10-volt, \$3; 12-volt \$3, 2½, 2½-volt \$3; 350-0-350, 5, 2½, 2½, \$4.50. New Cunningham 381 tubes, \$4.25. Electrone Labs., S34 N. Randolph St., Philadelphia, Pa.

SELL Deluxe short-wave transmitter, xtal control, 3 stages, plenty xtals, compactly built, flexible, shielded, separate power supply for low and high power stages. Puts 300 watts into a Hertz. Price, \$350. 15 cents stamps brings photo and complete description. W2PX, R. F. D. No. 5, Schenectady, N. Y.

3SLs — \$.50 and up for two colors. Many models. Lots of cartoons drawn by W7AEM. Radio Press, 3336 Eastside Ave., Cincinnati, Ohio.

VIBROPLEXES, new, rebuilt; parts. Lydeard, 28 Circuit; Roxbury, Mass.

TRADE or sell limited number eighty meter crystals unconditionally guaranteed eight dollars each. Robert Foreman, WOZZE.

FOR sale or trade. Branch model forty B eliminator power amplifier units. Supplies 500 volts filtered d.c. at 50 mills, 480 volts at 100 mills, etc. Ideal for power supply for a 210, or for speech amplifier for B.C.L. receiver. Rectifier uses a 281, amplifier uses a 210. Listed at \$95.00. Will sell or trade on basis of \$10.50 each, prepaid. Money back if not satisfied. Robt. M. Smith, Box 25, Argentine Station, Kansas City, Kans., W9LD.

BARGAINS — portable transmitter, Kennedy 150-25,000 meters. Receiver, Grebe CR-18 short-wave, Dynamotor 24/1500 volts. Other items. Write Frank Nunez, 472 Massachusetts Ave., Boston, Mass.

LOGS — QSL cards, stationery, etc. Hillcrest, Cranesville, Pa. 6000 V. 12000 V. 3-phase drive motorgenerator, \$1500.00; 3000 V. 6000 V. 3-phase drive motorgenerator, \$750.00; 2000 V. 500 W. 1-phase drive, \$195.00; 1500 V. 400 W. 3-phase drive, \$125.00; 1000 V. 300 W., \$95.00; 1000 V. 250 W., \$85.00. ¼ hp. 3450 r.p.m. motors, \$10.50. Converters, 32 V. d.c. to 110 V. a.c., \$35.00. Queen City Electric, 1734 Grand Ave., Chicago.

SILVER-Marshall 737 Bearcat short wave receiver, wired, \$83.50. All S-M parts in stock, 40% and 2% to hams. Write for best prices on 737 kit and for our special price list on standard parts. Radio Inspection Service Co., 193 Trumbull St., Hartford, Conn.

SELL or trade — surplus radio parts. Send postal for list. Wallace Bearden, 18 Junction St., Mansfield, Ohio.

Q R A SECTION

50 c. straight with copy in following address form only:

W1APW — Charles R. Sauer, 656 Courtland Ave., Bridgeport, Conn.

W1CPH — Thos. L. Siglin, Jr., 16 Sylvan Ave., Edgewood, R. I.

W2CDG — Bill Dailey, 566 55th St., Bay Ridge, New York City.

W3CZS — Wm. S. Watson, 432 N. McKean St., Butler, Pa.

WIMK

A.R.R.L. Headquarters

R. B. Parmenter, Chief Op. "rp"

The following calls and personal signs belong to members of the A.R.R.L. Headquarters gang:

- W1AKW—W1KP Clyde J. Houldson "ch."
- W1BAW R. B. Beaudin.
- W1BDI-W1XL F. E. Handy "fh."
- W1CDE Geo. Grammer "hg."
- W1DIE J. J. Lamb "jim."
- W1EEL K. B. Warner "kb."
- W1ESA A. A. Hebert "ah."
- W1FL-W2JR G. Donald Meserve "dm."
- W1SZ-W1BIZ C. C. Rodimon "rod."
- W1UE E. L. Battery "ev."
- W9KL Clinton B. DeSoto "ds."

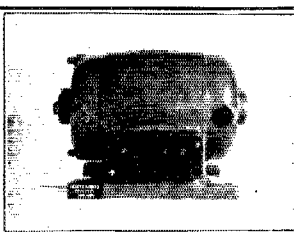

U. S. NAVY SURPLUS

- General Electric 24/750-volt 150-watt Dynamotors . . . \$27.50
 - General Electric 24/1500-volt 350-watt Dynamotors . . . \$7.50
 - 500-watt 500-cycle generators with exciters . . . \$7.50
 - Westinghouse 27.5/350-volt 80 mills . . . \$12.50
 - Twins for double voltage or current . . . \$20.00
 - Shafts for external drive \$3.00 additional
- HENRY KIENZLE, 501 E. 84th Street, New York
Pioneer Distributor of Government Surplus
Complete list on request

"HAM'S"—SERVICEMEN EXPERIMENTERS TECHNICIANS

Send for our new Radio Bargain Bulletin No. 31, just off the press.

Chocked full of standard items you want, at greatly reduced prices.

AMERICAN SALES CO.

19-21 Warren St. New York City

To Our Readers who are not A.R.R.L. members

WOULDN'T you like to become a member of the American Radio Relay League? We need you in this big organization of radio amateurs, the only amateur association that does things. From your reading of *QST* you have gained a knowledge of the nature of the League and what it does, and you have read its purposes as set forth on page 6 of this issue. We should like to have you become a full-fledged member and add your strength to ours in the things we are undertaking for Amateur Radio. You will have the membership edition of *QST* delivered at your door each month. A convenient application form is printed below — clip it out and mail it today.

A bona fide interest in amateur radio is the only essential qualification for membership

AMERICAN RADIO RELAY LEAGUE
Hartford, Conn., U. S. A.

I hereby apply for membership in the American Radio Relay League, and enclose \$2.50 (\$3 in foreign countries) in payment of one year's dues, \$1.25 of which is for a subscription to *QST* for the same period. Please begin my subscription with the issue. Mail my Certificate of Membership and send *QST* to the following name and address.

.....
.....
.....

Do you know a friend who is also interested in Amateur Radio, whose name you might give us so we may send him a sample copy of *QST*?

.....

Thanks

For Your Convenience

QST'S INDEX OF ADVERTISERS IN THIS ISSUE

| | |
|---|--------------|
| Acme Apparatus Corporation..... | 57 |
| American Piezo Supply Co..... | 91 |
| American Sales Company..... | 72, 93 |
| Amaral Corporation..... | 96 |
| Arcturus Radio Tube Co..... | 90 |
| Auriema, Inc., Ad..... | 88 |
| A.R.R.L. Application Blank..... | 94 |
| A.R.R.L. Emblem..... | 85 |
| A.R.R.L. Handbook..... | 88, Cover 17 |
| A.R.R.L. Log Sheets..... | 84 |
| A.R.R.L. Special Offer..... | Cover 111 |
| Blan, The Radio Man..... | 76 |
| Burgess Battery Co..... | Cover 17 |
| Candler System Company..... | 86 |
| Cardwell Mfg. Corp., Allen D..... | 73 |
| CeCo Mfg. Company..... | 95 |
| Central Radio Laboratories..... | 86 |
| Cornell Elec. Mfg. Co..... | 87 |
| Corning Glass Works..... | 4 |
| Crosley Radio Corp..... | 81 |
| Cunningham, Inc., E. T..... | 62 |
| Daven Company..... | 57 |
| DeForest Radio Company..... | 1 |
| Electrad, Inc..... | 76 |
| Electric Specialty Co..... | 91 |
| Flechteim & Company, A. F..... | 89 |
| Frost, Inc., Herbert H..... | 84 |
| General Radio Company..... | 2 |
| Greben, F..... | 91 |
| Gulf Radio School..... | 89 |
| Hall's..... | 85 |
| Hardwick, Hinde, Inc..... | 82 |
| Harrison Radio Company..... | 76 |
| Hatry & Young..... | 52 |
| Hilet Engineering Co..... | 91 |
| Hoodwin & Company, Chas..... | 80 |
| International Resistance Company..... | 77 |
| Jewell Electrical Instrument Co..... | 75 |
| Klenzle, Henry A..... | 93 |
| Leeds Radio Company..... | 79 |
| Manhattan Electric Bargain House..... | 71 |
| Massachusetts Radio & Telegraph School..... | 57 |
| McGraw-Hill Book Company..... | 12 |
| M & H Sporting Goods Co..... | 74 |
| National Carbon Company..... | 64 |
| National Company..... | 91 |
| Norden-Hauke, Inc..... | 69 |
| Pacent Electric Company..... | 90 |
| Perryman Electric Company..... | 70 |
| QST Binder..... | 68 |
| Radio Engineering Laboratories..... | 80 |
| Radiophone Engineering Bureau..... | 87 |
| Radio & Television Institute..... | 65 |
| RCA Victor Corporation..... | 67 |
| Rooney, John T..... | 85 |
| Scientific Radio Service..... | 89 |
| Shallcross Mfg. Company..... | 78 |
| Silver-Marshall, Inc..... | 61 |
| Sprague Specialties Company..... | 63 |
| Standard Radio Laboratories..... | 74 |
| Teleplex Company..... | 90 |
| Thordarson Electric Mfg. Co..... | 83 |
| Tung-Sol Condensers, Inc..... | 83 |
| Vibroplex Company..... | 78 |
| Walter, B. F..... | 57 |
| Ward Leonard Electric Co..... | 85 |
| Weston Electrical Instrument Corp..... | 66 |
| Wireless Egert Engineering Co..... | 89 |

"We express our praise for the high standard of quality, dependable service and performance of CeCo Tubes."

F. H. WALTER, Prince-Walter Co., Lowell, Mass.

Get your DX accurately and quietly. Station signatures need not be lost . . . even though world distances are encountered. Controlled uniformity of electrical characteristics and electrical capacities . . . and designed freedom from noise are insured by 64 major tests that are given each CeCo Tube before it's finally packaged."

DO YOU KNOW?

1. That CeCo pioneered the 5-element vacuum tube—known as the A. C. Pentode, and the 224.

2. That the CeCo plant contains 3½ acres of floor space and employs over 1,000 persons.

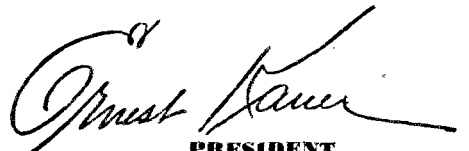

**PRESIDENT
CECO MANUFACTURING CO., INC.
PROVIDENCE, R. I.**

● The CeCo Couriers broadcast Monday nights over the Columbia Chain from 22 stations.

CeCo Tubes are licensed under the patents and applications of the Radio Corp. of America and affiliated companies.

CeCo 1930
Radio Tubes

Say You Saw It in QST — It Identifies You and Helps QST

MERSHON

ELECTROLYTIC

CONDENSER

The Pioneer

First patented in 1911. First publicly displayed for use in radio receivers in 1921 — and in continuous development and production since then — the Mershon Condenser is unquestionably the pioneer, practical, successful electrolytic condenser. And by virtue of the vast experience and research behind it, it is today years ahead of any other condenser in the field. It was first to provide high capacity in small space, to afford absolute freedom from puncture and to embody a service life measured in years, rather than weeks or months.

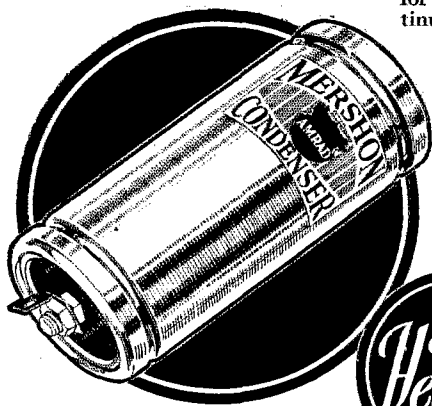

Single Anode
inverted type



Multiple Anode
upright type



31 Manufacturers Use It as Standard Equipment

The fact that 31 of the leading set manufacturers of America use Mershon Filter Condensers as standard equipment in their products, is proof of the premier position they hold in the radio field.

Engineers and manufacturers, as well as experimenters — thinking solely in terms of maximum efficiency and reliability — have found in the Mershon vastly improved performance and substantial savings in space, cost and service.

The new booklet "Puncture-Proof Filter Condensers" describes the Mershon Condenser, and shows how it can be effectively used in power converter equipment.

THE
AMRAD CORPORATION
255 College Avenue
MEDFORD HILLSIDE, MASS.

Special Offer—

During July and August only
 A year's subscription to *QST*

(either new or renewed)
 and a copy of the sixth edition of the
Radio Amateur's Handbook

By Handy and Hull
 (in its 79th thousand)

\$3.00
 (foreign countries \$3.50)

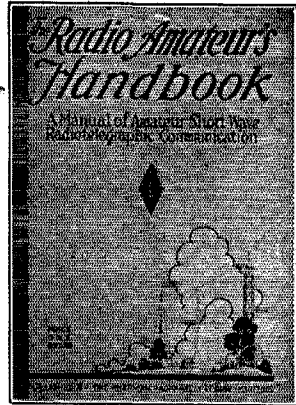

FOR NEWCOMERS IN THE GAME

The Handbook is an eminently practical manual of amateur radio in all its phases, published by the American Radio Relay League, the amateur's own organization. It starts at the beginning and tells the whole story: What amateur radio is, How to be a radio amateur, How to obtain your license, How to build the simple apparatus of a simple station, How to build the best known equipment for the most modern station, How to operate your station. Enough information to keep you fascinated for five years.

FOR PRACTICAL AMATEURS

The Handbook is the daily working guide of successful amateurs the world over. Technical and operating matters treated in every form, from the simplest to the most elusive and complex. Not only all sorts of modern transmitters and receivers but solid chapters on power supplies, antenna systems, keying methods, frequency measurement and monitoring, crystal control, radio-telephony. Not only apparatus but operating procedure, traffic handling, reports, how the Communications Department works.

EVERYTHING YOU WANT TO KNOW

SPECIAL OFFER A copy of the \$1.00 edition of the HANDBOOK;
 a year's subscription to *QST* and a year's membership in the American Radio Relay League.

ALL FOR THREE DOLLARS!

(Foreign countries \$3.50)

Note: If you want your copy of the Handbook in stiff buckram binding add \$1.00 to your remittance.

Even if you are already a member of the League and a subscriber to *QST*, you may avail yourself of this offer. Simply mention that fact and instead of entering it as a new subscription we will extend your present subscription for another year, and send a copy of the Handbook at once.

AMERICAN RADIO RELAY LEAGUE

1711 Park Street
 Hartford, Connecticut
 U. S. A.

AMERICAN RADIO RELAY LEAGUE
 Hartford, Conn., U. S. A.

Dear Sirs:

I want to take advantage of your Special Offer and enclose remittance.

I am
 am not a member of the League.

.....



EXPERIENCE

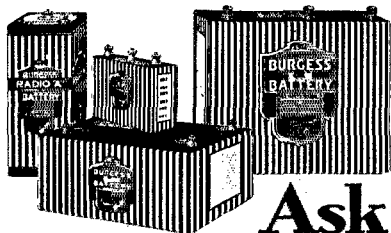

We learn by experience! That's the reason Burgess Batteries are the regular choice of so many who want—or need—dependable dry battery service. *They* have learned by experience!

Ask *any* Radio Engineer”

BURGESS BATTERY COMPANY

MADISON,

WISCONSIN