

QST

DEVOTED ENTIRELY TO

AMATEUR RADIO

PUBLISHED SINCE 1915 BY THE AMERICAN RADIO RELAY LEAGUE INC.

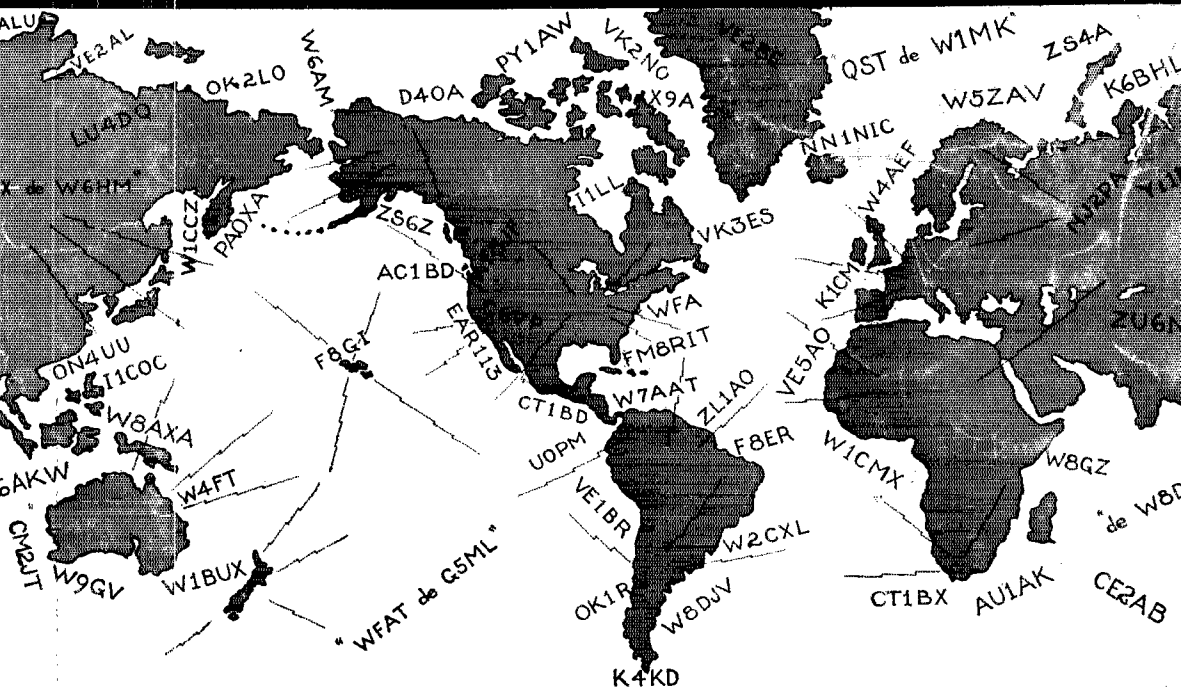

All Countries Participating **WORLD-WIDE CONTEST** Now in Progress

MARCH, 1930

25¢

DIRECT FOREIGN RADIO RECEPTION

*Without Dependence
on Local Re-Broadcasting*

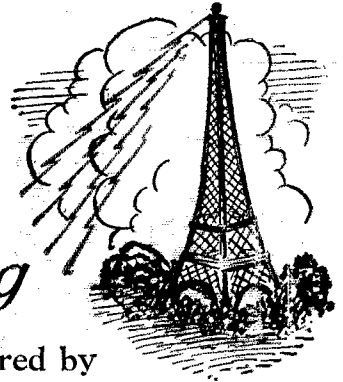

You'll like this S.W. job as engineered by Kruse, Geloso and Grimes, who have mastered the problem of A.C. Short-Wave reception, using a Screen-Grid Amplifier.

PILOT SUPER-WASP

Short-wave and Broadcast Receiver, 14 to 500 Meters
In Kit Form for A.C. or Battery Operation.

CUSTOM SET BUILDERS' PRICES

Krr K-115—The A. C. Super-Wasp. Use your own ABC pack or Pilot K-111 at \$16.50, specially designed for the Super-Wasp. Power Pack and Tubes extra **\$34⁵⁰**

Krr K-110—The battery-operated Super-Wasp. Batteries and Tubes extra **\$29⁵⁰**

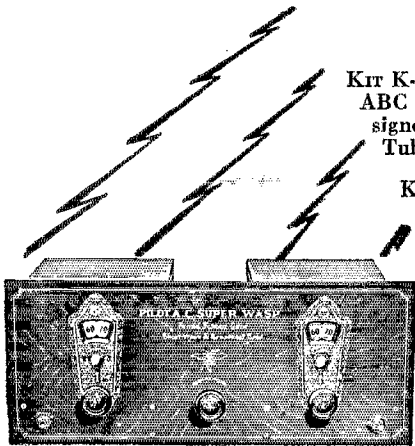

PILOT RADIO & TUBE CORP.

323 Berry Street, Brooklyn, N. Y.

234 So. Wells Street, Chicago, Ill.

1278 Mission St., San Francisco, Cal.



JOINING THE RADIO INTERNATIONAL GUILD

"H"

costs only 50c for a full year's membership, which includes lapel pin, certificate, and the Guild's Official Organ—"Radio Design" published quarterly. Enclose 50c coin or stamps with this coupon, and return to Radio International Guild, 103 Broadway, Brooklyn, N. Y.

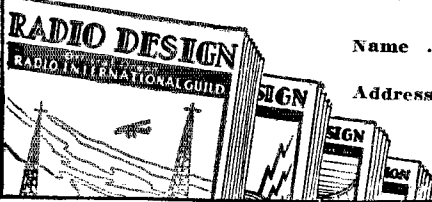

Name

Address

City State.....

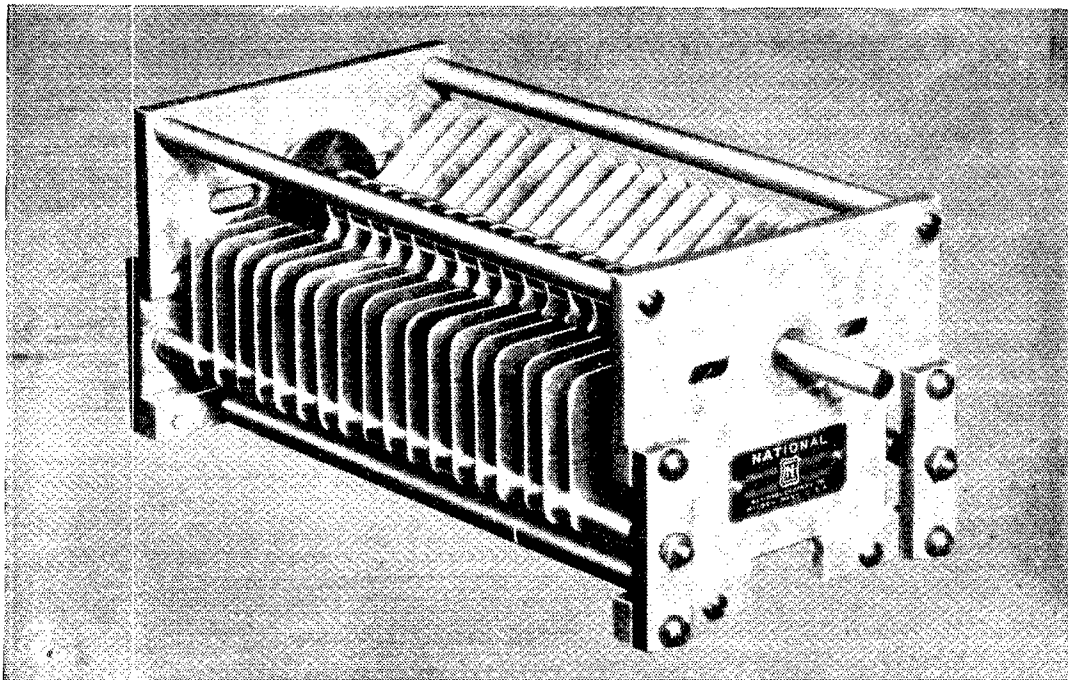

NATIONAL TMU NEW MODEL TRANSMITTING CONDENSERS

These new transmitting condensers are made in two series: 5000 volt and 7500 volt, and embody all the very latest features for efficiency and steadiness of signal. All plates have rounded edges, and similar fine points of design and sturdy construction will be found throughout.

MICALEX INSULATION

NATIONAL TMU Transmitting Condensers can be furnished with Micalex insulation under special license agreement with R. C. A. Under this agreement Micalex insulated TMU Condensers may be sold only for amateur and experimental uses.

It is not possible for us to furnish Micalex insulation for condensers intended for commercial uses. In such cases we are equipped to furnish Krolite and rubber or other standard and accepted insulating materials.

PRICES

Model TMU Condensers are made in stock sizes up to .0005 mfd. in the 5000 volt series, and up to .00025 mfd. in the 7500 volt series. Special sizes can be made to order. Write us today for complete prices and information, mentioning QST.

NATIONAL Amateur Equipment is used and approved by transmitting and receiving amateurs the world over. Special types of transmitting condensers and other amateur equipment made on order. Prices gladly sent on receipt of specifications.



NATIONAL VELVET VERNIER DIALS Original Model A

The original and matchless Velvet Vernier Dial used by amateurs the world over. Available in various divisions. List Price: 3 1/2" diameter or 4" diameter, \$2.50.

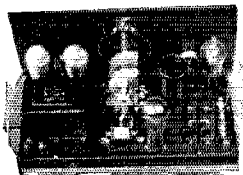

The NATIONAL SW-4 Screen-Grid Shortwave set, a compact efficient shortwave set with an audio system really designed for shortwave work. Equipped with special cabinet and coil storage for 5 coils in addition to the one in use in the set. Will operate on NATIONAL No. 3580B power-supply unit. List price of parts with four transformer coils, without cabinet or tubes, \$49.50 — cabinet \$5.25 extra.

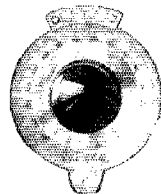

The NATIONAL Precision Velvet Vernier Dial Type N, a 4" solid German silver precision dial with real vernier making accurate reading possible to 1/10 division. Especially designed for shortwave receiver, transmitting and precision laboratory equipment uses. List price each, \$6.50.

Write for
full information
and prices

NATIONAL COMPANY INC.
ENGINEERS AND MANUFACTURERS
61 SHERMAN ST., MALDEN, MASS.

Established 1914  W. A. Ready, Pres.

Say You Saw It in QST — It Identifies You and Helps QST



TEMPERATURE-CONTROL BY GENERAL RADIO

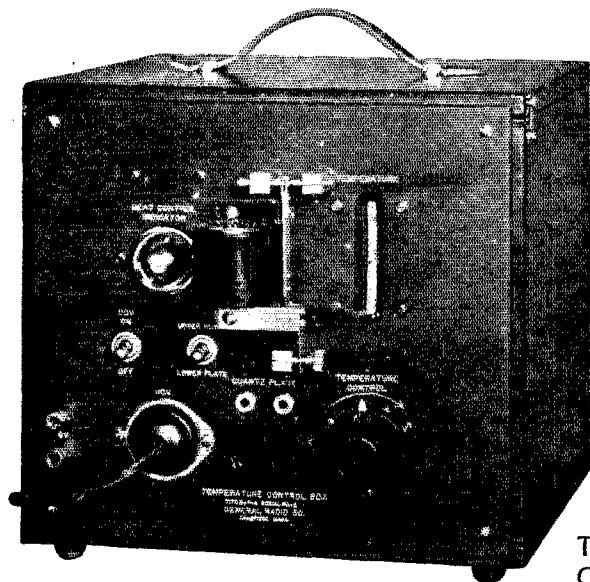

Type 547-A
Temperature-
Control Box

IN the course of research that has extended over more than a year, the General Radio Company discovered that a temperature-control unit which is to operate satisfactorily outside of a constant-temperature room must be more than an assembly of thermostats, heaters, and insulating materials. As a result of this work, we announce two single-stage constant-temperature boxes with excellent characteristics.

The Type 547-A Temperature-Control Box maintains its temperature at any assigned value between 40 and 60 degrees C. within ± 0.1 degrees C. for a variation in room temperature of ± 20 degrees F. The heater operates from the 110-volt power supply. There is provision for controlling two Type 376 Quartz Plates, but the box is by no means limited to that use. Price: \$150.00.

The Type 547-B Temperature-Control Box is similar, but it maintains its temperature to within ± 1.0 degrees C. under the above-mentioned conditions. Its price is \$140.00.

GENERAL RADIO COMPANY

30 STATE STREET

CAMBRIDGE A, MASSACHUSETTS



QST



The Official Organ of the A.R.R.L.

VOLUME XIV

MARCH, 1930

NUMBER 3

Editorials	7
United States Civil Service Examination	8
Frequency Standardization <i>J. K. Clapp and John D. Crawford</i>	9
Doings at Headquarters	15
New England Division Convention	15
Coöperating with the B. C. L. <i>The Old Connecticut Yankee</i>	16
14-Mc. 'Phone Transmission <i>Beverly Dudley</i>	17
Roanoke Division Convention	29
Movies Available	29
Official Frequency System	30
Electrolytic Condensers and a High-Voltage Rectifier <i>Clark C. Rodimon</i>	31
A New Condenser for Amateur Tuners	34
Say, Son — <i>The Old Man</i>	35
Election Notice	36
A High-Gain Direct-Coupled Power Amplifier <i>George E. Fleming</i>	37
Some Constructional Kinks <i>George Grammer</i>	41
The Southeastern Division Convention	44
Experimenters' Section	45
W9BVH	48
I.A.R.U. News	52
Calls Heard	54
Correspondence Department	55
Book Reviews	78
Ham-ads and QRA's	92
QST's Index of Advertisers	94

QST is published monthly by The American Radio Relay League, Inc., at Hartford, Conn., U. S. A. Official Organ of the A.R.R.L. and the International Amateur Radio Union

James J. Lamb
Technical Editor

Kenneth B. Warner (Secretary, A.R.R.L.), *Editor-in-Chief and Business Manager*
Beverly Dudley
Assistant Technical Editor

Clark C. Rodimon
Assistant Editor

David H. Houghton
Circulation Manager

G. Donald Meserve
Advertising Manager

Advertising Offices 55 West 42d Street, New York City
Editorial Offices 1711 Park Street, Hartford

Subscription rate in United States and Possessions, Canada, and all countries in the American Postal Union, \$2.50 per year, postpaid. Single copies, 25 cents. Foreign countries not in American Postal Union, \$3.00 per year, postpaid. Remittances should be by international postal or express money order or bank draft negotiable in the U. S. and for an equivalent amount in U. S. funds.

Entered as second-class matter May 29, 1919, at the post office at Hartford, Connecticut, under the Act of March 3, 1879. Acceptance for mailing at special rate of postage provided for in section 1103, Act of October 3, 1917, authorized September 9, 1922. Additional entry at Concord, N. H., authorized February 21, 1929, under the Act of February 28, 1925.

Copyright 1930 by the American Radio Relay League, Inc. Title registered at United States Patent Office.

MERSHON

ELECTROLYTIC

CONDENSER

ENGINEERED into your circuit or built into your set — the MERSHON Electrolytic Condenser modernizes its construction and insures its efficiency.

It saves weight, space, cost, trouble and replacements! It gives you capacity far beyond your fondest dreams!

For instance, 72 microfarads in 32 cubic inches

It gives you a new low hum-level; and a new high standard of tone quality.

And because it's self-healing, it gives life-time, wear-proof, trouble-free service that makes its low first-cost its last cost as well.

Our Engineering Department will be glad to give you full details of the proper installation for your new circuit or set. Just address

Mershon Division
THE AMRAD CORPORATION
 Medford Hillside, Mass.



DISTRIBUTORS

Here's your golden opportunity to make real money with the Mershon Line. The first time a distributing proposition has ever been available. Wire us for full details at once.

SELF-HEALING.

Section Communications Managers of THE COMMUNICATIONS DEPARTMENT, A. R. R. L.

Eastern Pennsylvania	W3ZF	ATLANTIC DIVISION	Don Lusk	116 West Wyoming Ave.	Germantown, Phila.
Maryland-Delaware-District of Columbia	W3BBW		Forrest Calhoun	1636 Thomas Ave.	Baltimore, Md.
Southern New Jersey	W3BWW		Norman R. Weible	120 Frazer Ave.	Collingswood
Western New York	W8PJ		C. S. Taylor	598 Masten St.	Buffalo
Western Pennsylvania	W8CBO		A. W. McAuly	309 Third St.	Oakmont
		CENTRAL DIVISION			
Illinois	W9APV		Fred J. Hinds	3337 Oak Park Blvd.	Berwyn
Indiana	W9CVO		D. J. Angus	310 N. Illinois St.	Indianapolis
Kentucky	W9BAZ		J. B. Wathen, III	Mockingbird Valley	Louisville
Michigan	W8CEP		Dallas Wise	9187 Falcon Ave.	Detroit
Ohio	W8BYN		H. C. Storck	694 Carpenter St.	Columbus
Wisconsin	W9VD		C. N. Crapo	443 Newton Ave.	Milwaukee
		DAKOTA DIVISION			
North Dakota	W9DVV		B. S. Warner	309 4th Ave.	Enderlin
South Dakota	W9DGR		D. M. Pasek	780 Illinois St.	Huron
Northern Minnesota	W9BVH		Carl L. Jabs	1822 James St.	St. Paul
Southern Minnesota	W9EFK		J. C. Pehoushek	60 Melbourne Ave., S. E.	Minneapolis
		DELTA DIVISION			
Arkansas	W5ABI		H. E. Velte	315 No. Jackson St.	Little Rock
Louisiana	W5WF		F. M. Watts, Jr.	1716 Park Ave.	Shreveport
Mississippi	W5AKP		J. W. Gillett	1708 23rd Ave.	Meridian
Tennessee*	W4SF		James B. Witt	532 N. Fifth Ave.	Knoxville
		HUDSON DIVISION			
Eastern New York	W2QUJ		H. H. Rosenthal	Box 740	New Rochelle
N. Y. C. & Long Island*	W2BGO		V. T. Kenney	1836 Hone Ave.	Bronx
Northern New Jersey	W2WR		A. G. Wester, Jr.	50 Princeton St.	Maplewood
		MIDWEST DIVISION			
Iowa	W9DZW		H. W. Kerr		Little Sioux
Kansas	W9CET		J. H. Amis	915 Lincoln Ave.	Topeka
Missouri	W9RR		L. B. Laizure	8010 Mercier St.	Kansas City
Nebraska	W9BVG		C. B. Deihl	5605 Cedar St.	Omaha
		NEW ENGLAND DIVISION			
Connecticut	W1CTI		Frederick Ellis, Jr.	7 Union Ave.	Norwalk
Maine	W1AQL		G. Brown	269 N. Main St.	Brewster
Eastern Massachusetts	W1WV		M. W. Weeks	40 Norfolk Rd.	Chestnut Hill
Western Massachusetts	W1UM		Dr. John A. Tessmer	8 Schaffner St.	Worcester
New Hampshire	W1ATJ		V. W. Hodge	227 Main St.	Claremont
Rhode Island	W1BCR		C. N. Kraus	92 Keene St.	Providence
Vermont	W1IT		Clayton Paulette		North Troy
		NORTHWESTERN DIVISION			
Alaska	WWDN		W. B. Wilson	U. S. LHT Fern	Ketchikan
Idaho	W7ACN-JL		James L. Young	303 13th Ave., So.	Nampa
Montana	W7AAT-7QT		O. W. Viers		Red Lodge
Oregon	W7UN		Wilbur S. Claypool	1059 Greenwood Ave.	Portland
Washington	W7ACS		Eugene A. Piety	912 No. Ainsworth St.	Tacoma
		PACIFIC DIVISION			
Hawaii	K6CFQ		F. L. Fullaway	2714 Manoa Rd.	Honolulu
Nevada*	W6UO		C. B. Newcombe		Verington
Los Angeles	W6EQF		B. E. Sandham	4508 8th Ave.	Los Angeles
Santa Clara Valley	W6NX		F. L. Quemont	1348 Hanchett Ave.	San Jose
East Bay	W6CZR		F. Walter Frates	439 62nd St.	Oakland
San Francisco	W6WB		C. F. Bane	262 Castro St.	San Francisco
Sacramento Valley	W6DON		Everett Davies	Rt. 5, Box 380	Sacramento
Arizona	W6RWS		Russ Shortman	519 W. Madison St.	Phoenix
Philippines	K4ICY		S. M. Mathea	Army-Navy Club	Manila
San Diego	W6EOP		Harry A. Ambler	4101 Hamilton St.	San Diego
		ROANOKE DIVISION			
North Carolina	W4TS		Hal S. Justice	Box 552	Canton
Virginia*	W3CA		J. F. Wohlford	118 Cambridge Ave.	Roanoke
West Virginia	W8JM		D. B. Morris	703 Maryland St.	Fairmont
		ROCKY MOUNTAIN DIVISION			
Colorado	W9CAA		C. R. Stedman	1641 Albion St.	Denver
Utah-Wyoming	W6BAJ		Parley N. James	430 "D" St.	Salt Lake City
		SOUTHEASTERN DIVISION			
Alabama	W4AHP		Robt. E. Troy, Jr.	516 Cloverdale Rd.	Montgomery
Florida	W4AII		Harvey Chann	6002 Suwanee Ave.	Tampa
Georgia-So. Carolina-Cuba-Isle-of-Pines	W4RZ		M. S. Alexander	79 Rogers St., S. E.	Atlanta
Porto Rico-Virgin Islands	K4KD		E. W. Mayer	Box 103	Ensenada, P. R.
		WEST GULF DIVISION			
Northern Texas	W5BG		J. H. Robinson, Jr.	522 Cumberland St.	Dallas
Oklahoma	W5CF		W. J. Gentry	538N. Pettenger St.	Shawnee
Southern Texas	W5OX		R. E. Franklin	1806 Valentine St.	Houston
New Mexico	W5AII		Leavenworth Wheeler, Jr.	Box 33	Valmora
		MARITIME DIVISION			
Maritime*	VE1DQ		A. M. Crowell	69 Dublin St.	Halifax, N.
		ONTARIO DIVISION			
Ontario	VE3FC		E. C. Thompson	266 Queensdale Ave.	Toronto, O
		QUEBEC DIVISION			
Quebec	VE2AC		Alphy Blais	Box 221	Thetford Mines
		VANALTA DIVISION			
Alberta	VE4EC		Fred Barron	Warwick Apts., 95th St.	Edmonton
British Columbia	VESAL		J. K. Cavalsky	4868 Blenheim St.	Vancouver
		PRAIRIE DIVISION			
Manitoba	VE4HR		A. V. Chase	109 Lanark St.	Winnipeg
Saskatchewan*	VE4FC		W. J. Pickering	514 19th St. W.	Prince Albert

*Officials appointed to act until the membership of the Section concerned choose permanent SCMs by nomination and election.

The American Radio Relay League

The American Radio Relay League, Inc., is a non-commercial association of radio amateurs, bonded for the promotion of interest in amateur radio communication and experimentation, for the relaying of messages by radio, for the advancement of the radio art and of the public welfare, for the representation of the radio amateur in legislative matters, and for the maintenance of fraternalism and a high standard of conduct.

It is an incorporated association without capital stock, chartered under the laws of Connecticut. Its affairs are governed by a Board of Directors, elected every two years by the general membership. The officers are elected or appointed by the Directors. The League is non-commercial and no one commercially engaged in the manufacture, sale or rental of radio apparatus is eligible to membership on its board.

"Of, by and for the amateur," it numbers within its ranks practically every worth-while amateur in the world and has a history of glorious achievement as the standard-bearer in amateur affairs.

Inquiries regarding membership are solicited. A bona fide interest in amateur radio is the only essential qualification; ownership of a transmitting station and knowledge of the code are not prerequisite. Correspondence should be addressed to the Secretary.

DIRECTORS

President
HIRAM PERCY MAXIM
Drawer 2102,
Hartford, Conn.

Vice-President
CHARLES H. STEWART
St. David's, Pa.

Canadian General Manager
ALEX. REID
169 Logan Ave.,
St. Lambert, P. Q.

Atlantic Division
EUGENE C. WOODRUFF
234 W. Fairmount Ave.,
State College, Pa.

Central Division
Election in Progress

Dakota Division
CY. L. BARKER
Henning, Minn.

Delta Division
M. M. HILL
P. O. Box 274,
Natchitoches, La.

Hudson Division
A. LAFAYETTE WALSH
220 West 42d St.,
New York City

Midwest Division
LOUIS R. HILBER
718 N. Gilbert St.,
Iowa City, Iowa

New England Division
FREDERICK BEST
13 East Crescent St.,
Augusta, Maine

Northwestern Division
K. W. WEINGARTEN
3219 No. 24th St.,
Tacoma, Wash.

Pacific Division
ALLEN H. BABCOCK
65 Market St.,
Southern Pacific Co.,
San Francisco

Roanoke Division
W. TREDWAY GRAVELY
Box 245,
Danville, Va.

Rocky Mountain Division
PAUL M. SEGAL
Box 1771,
Denver, Colo.

Southeastern Division
HARRY P. DOBBS
245 Spring St., N. W.,
Atlanta, Ga.

West Gulf Division
FRANK M. CORLETT
2515 Catherine St.,
Dallas, Tex.

OFFICERS

President HIRAM PERCY MAXIM, Hartford, Conn.
Vice-President CHARLES H. STEWART, St. David's, Pa.
Secretary KENNETH B. WARNER, Hartford, Conn.
Treasurer ARTHUR A. HEBERT, Hartford, Conn.
Communications Manager F. EDWARD HANDY, Hartford, Conn.

GENERAL COUNSEL

PAUL M. SEGAL, 534 Washington Bldg., Washington, D. C.

ADDRESS ALL GENERAL CORRESPONDENCE TO THE EXECUTIVE HEADQUARTERS AT HARTFORD, CONN.

EDITORIALS

WITH Sacred Wouff-Hong dangerously brandished in extended right arm, Ye Ed with left hand rapidly pick-picks following interesting tune on well-battered editorial typewriter as this month's words of cheer and wisdom. The words, we hope, will be found wise; for they are not, we fear, very cheery.

We amateurs must become more frequency-conscious than we are. There is too much off-wave working, and we are getting into trouble for it. There are many stations working outside the amateur bands. We are interfering with other services. The protests are accumulating and trouble is ahead for amateur radio if we do not correct the situation. We are making a bad record for our entrance at coming international conferences, Madrid in particular. *QST* has had many an editorial on the necessity for complying with the regulations. Sometimes our members are inclined to wonder why Headquarters harrasses them on this question when the federal government itself is lax in enforcement. It is for our own good that *QST* does it. We see without question the troubles in store for amateur radio if we do not improve our ways. We must be more careful and more precise in our frequency settings. Just listen to some of the things we are doing:

There is a public transatlantic telephone service between England and this country. One of the frequencies used by the British station is 14,440 kc. (20.78 m.). On Christmas day American amateurs put this important circuit out of business completely for six hours. Holiday daylight operation on "20", of course, but outside our band. We've done it every Sunday since. This is GBW. Another of the British 'phone transmitters in this circuit, GBS, uses about 6985 kc. (42.95 m.). We similarly put it out of business frequently. These frequencies are unfortunately near our own bands, only 15 kilocycles away from our 7000-band and 40 kilocycles away from our 14,000-band, but we can't help that. England made the assignments and they are proper enough under the I. R. C. The GBS frequency is *between* the edge of our "40" band and WIZ, yet many amateurs seem to think that WIZ is a safe limit for them. It isn't. Our band does *not* run down to WIZ. WIZ is on 6965.3 kc.

Then there's the Army-Amateur system frequency of 6990 kc., "inside" of both the AT&T 'phone and WIZ, and completely over-run by amateurs, but outside our band.

Incidentally, while we're talking about "40", WEM's assigned frequency is 7400, not 7300.

It is not the high-frequency limit of our band but a third of the width above it. Yet amateurs are about as thick between 7300 and 7400 as within the band.

There's similar trouble on "80", only more so if possible. The channel at 4045 kc. (74.165 m.) belongs to the Navy and is used by Pearl Harbor and also by fourteen Navy and Naval Reserve stations east of the Mississippi for reserve work. It is being badly interfered with. The Navy Department files from five to ten complaints a week with us and has now adopted the policy of referring its complaints to the Department of Commerce for real action. Now NAA itself is outside our band, being on 4015 kc. (74.72 m.), but this pet Navy channel is away out beyond that, and almost to WIR. WIR is on 4054 kc. (74 meters flat) and thus is not at all the edge of our band but a whole meter away.

Does any amateur think that we can bust up the AT&T and the Navy and make them like it? Does anyone think we're crying wolf when there is no wolf?

Off-wave operation of course is a direct violation of the terms of a station license. Then there is this specific reference in paragraph 5 of Article 4 of the Washington Regulations: "In cases where frequency *bands* are assigned to a specified service, stations in that service must use frequencies sufficiently *remote from the limits* of these bands, so as not to produce serious interference with the work of stations belonging to services to which are allocated immediately neighboring frequency bands." (Italics ours.) Great Britain gives her amateurs only 7050 kc. to 7250 kc. so they'll be more likely to remain with the band internationally designated for amateurs. We've asked for, and received, the whole band, on our representations that we'll stay inside it, but we're not doing it!

We've said many times before, and we repeat it here, that this is a problem which each individual amateur must solve in his own station. Our League can work for all of us as a class, to get our operating regulations specified satisfactorily and to protect our rights, but we begin to lose our standing as a class when many individuals amongst us start violating these agreed regulations. The League can't go out and tune and supervise every member's station. The individual must do that. It is, we repeat, of the utmost seriousness that each amateur make himself precision-frequency conscious and acquire accuracy in his own station.

Some amateurs, a very few, work off-wave

deliberately. They are in the same class as any other deliberate law-breaker and we hope we'll be pardoned for hoping that their halcyons soon break, their condensers blow and their tubes burn out. We would be much better off without them. With most off-frequency amateurs it's a case of ordinary carelessness or dumbness. Replies to our Official Observers indicate that the great bulk of such illegal operation is unintentional. But the excuses! "I thought WIZ marked the limit of our 49-band." It doesn't, OM: it's 35 kilocycles or over 10% outside our band. "I thought WEM was our high-frequency limit at 40." It isn't, OM: it's a round hundred kilocycles from our edge. "I thought I was adjusted all right but found out that my mother had dusted in my radio room and disturbed the setting." For the love of Microfarad! "I thought —" Why didn't you *know*? Dusted, eh? Doesn't every amateur know enough not to open up on a transmitter without checking the frequency afresh? (At least, why couldn't these eggs put their sets in boxes, or put set-screws on the shafts, or hang a sign on the radio-room door: "No dusting wanted to-day"?)

There is only one safe policy: Never operate a transmitter without checking its frequency against a known source. It is not enough to check it against a flimsy heterodyne calibrated month before last, either. That is not a "known source." Check the heterodyne too, against known signals. Check it first, in fact.

There has been much material in *QST* on cheap and easy methods of deriving precision settings for transmitters. Dig 'em down, OM. We'll have more, too; much more. Here are some more simple suggestions. Build yourself a sturdy unshielded heterodyne — coil, condenser and tube. Something like Dudley's in November *QST*, for instance. Put it on a shelf on the wall above your left shoulder. *Leave it there* — never remove it.

Don't use it as a monitor; build yourself another portable shielded heterodyne for that. Use this one on the shelf only as a miniature sender. Do your listening only on your receiver and your monitor. Get that? All right, now listen on your receiver and receive some signals of known frequency: Standard Frequency transmissions, harmonics of known broadcasting stations, commercial stations on known frequencies. Each time you receive such a signal, reach back and tune this sturdy heterodyne to zero beat with that signal in the receiver. That is then a known frequency on the heterodyne. Do that with more known signals — many of them. Thus you acquire a calibration, a curve for your heterodyne. Keep it up. Check it every night. Add points, perfect the curve. Verify it constantly. Never trust it to be right from night to night without verification. You'll learn to verify it within 60 seconds of opening the station each night, and then you can rely on it. Now remember to leave it on its shelf. You're going to use a separate shielded heterodyne for a movable monitor. Plug the 'phones in the monitor now, start up the transmitter, find it in the monitor, monitor it for quality. Shut off the transmitter and turn on the heterodyne frequency-meter (for that is what it is, now that you have it calibrated), adjust the frequency-meter until you hear *it* in the monitor. Then read your frequency and know where you are. Do this every time you open the station. Get frequency-conscious! Remember that everlasting personal vigilance is the only way to keep on a legal frequency.

We A.R.R.L. folks have licked many a hard job where the only solution lay in the cooperation and effort of the individual member, his realization that he must do his own part or the game is hurt for him and everybody else. This is a prime example of such a case. You must do this yourself. *It's up to you!*

K. B. W.

United States Civil Service Examination

THE United States Civil Service Commission announces the following open competitive examination:

JUNIOR PHYSICIST

Applications for junior physicist must be on file with the Civil Service Commission at Washington, D. C., not later than March 25th.

The examination is to fill vacancies in the U. S. Naval Research Laboratory, Bellevue, D. C., and in the Bureau of Standards, Department of Commerce, Washington, D. C., and in positions requiring similar qualifications.

The entrance salary is \$2000 a year. Higher-salaried positions are filled through promotion.

The work of the Bureau of Standards includes many branches of physics, chemistry, and engineering, such as mechanics, heat, optics, electricity, sound, metrology, metallurgy, radio, electronics, engineering (gas, electrical, mechanical, etc.), also industrial technology, including research and standardization, and offers valuable experience in these professions, combining as it does theoretical, experimental, and practical work. Applicants should indicate what lines of work they would prefer and also what lines of work they consider themselves best prepared to undertake, briefly setting forth their reasons. The duties of the appointee will be in connection with original investigations in some field of the Bureau's work. The chances for advancement are good for those who prove capable.

(Continued on page 37)

Frequency Standardization

A Precision Method for Checking the Frequency of a Crystal-Controlled Oscillator Against Mean Solar Time

By J. K. Clapp* and John D. Crawford*

Frequency measurement is, in our mind, the most acute problem in amateur radio today. A situation exists which must be squarely faced and which cannot be tolerated long. Although the frequency standard described by the authors is much more precise than the requirements of amateur radio demand and far too elaborate an apparatus for anything but laboratory use, it is indicative of the advanced status of frequency measurement. The comparatively high precision attained by good frequency meters calibrated from such a standard must be obvious.

A frequency standard almost identical with the one described in this article and fully as accurate is used to monitor the standard frequency transmissions of W1XV, which are sponsored by A.R.R.L. Calibration of your own frequency meter from these transmissions will provide a secondary frequency standard with accuracy of calibration adequate for amateur purposes.

It is by the proper use of such accurately calibrated secondary standards that we must put our transmitter frequencies in order. The days of frequency indication in terms of "two notches below W1Z" and "about a half-meter below W1MK" are long since past — although many seem unaware of it. — EDITOR.

AMATEUR, commercial, and military needs for radio channels have multiplied with such extreme rapidity during the last year that we are already feeling the effects of severe crowding. Every cycle of band width has been definitely allocated by international agreement and the trespass of one service upon the band of another has become an offense even more serious than trespass upon another's

His very life depends upon keeping all that belongs to him and he jealously guards it from encroachment by others. Then comes a time when surveys are made, corner markers are put in place, and trespass becomes a serious offense.

A few years ago when there were few channels in use, it made little difference what operating frequency a station chose so long as it did not seriously interfere with anyone else. As the de-

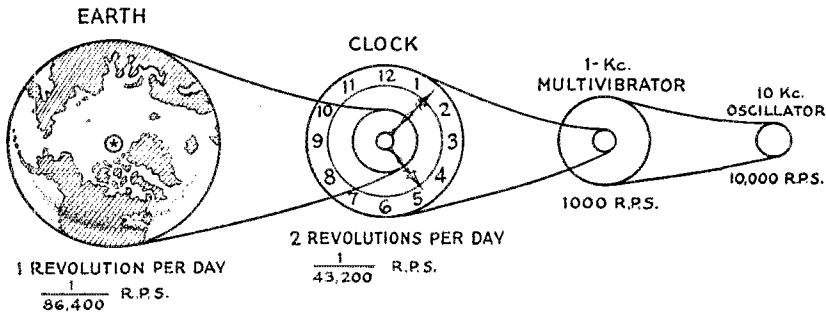

FIG. 1. — AN IMAGINARY MECHANICAL SYSTEM FOR TIMING THE 10-KC. OSCILLATION OF A TRANSMITTER BY THE ROTATION OF THE EARTH

Needless to say, the proportions are far from actual.

land. This congestion of radio services is in many ways analogous to the problem presented by an increasing population on an island whose boundaries are, of course, immutably fixed. When the population is small and there is plenty of room for everyone, the location of the boundary between one plot of ground and another is not a matter of great concern. As the number of inhabitants increases, crowding begins and an individual has only enough land for his own use.

mand for channels increased, however, more attention was of necessity devoted to keeping each station somewhere near its assigned frequency. Now, definite boundary lines have been established and to each station falls the individual responsibility of keeping within them. The amount of allowable drifting or "slopping-over" into adjacent channels is lessening just as fast as progress in frequency standardization will let it. Furthermore, as the tolerance becomes smaller, the enormity of trespass becomes greater. Fre-

*General Radio Co., Cambridge A, Mass.

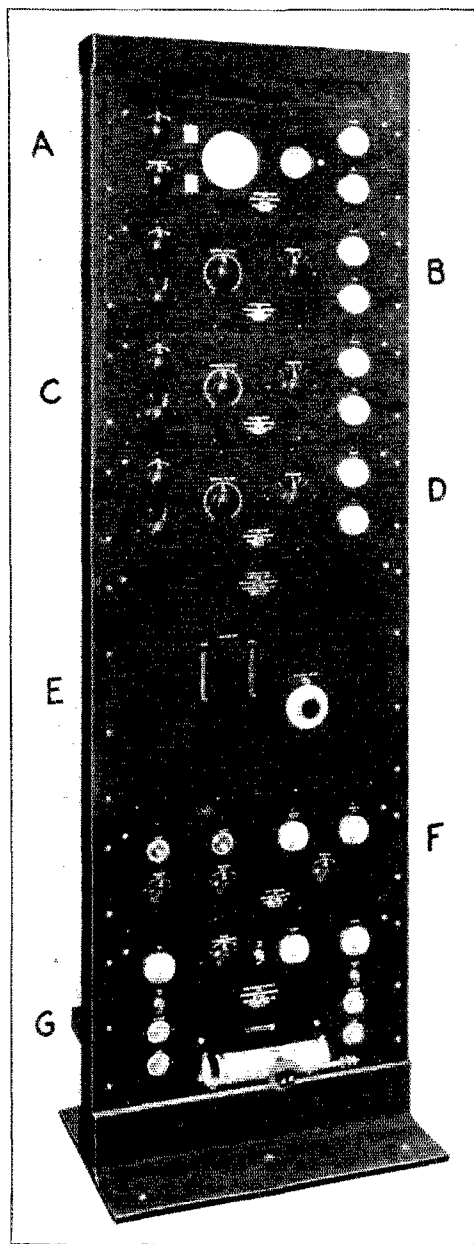

THE COMPLETE FREQUENCY STANDARD ASSEMBLY

The units indicated by the letters are as follows:

A — The timing unit containing the amplifier and synchronous clock.

B-C-D — Multivibrators.

E — Temperature control box and oscillator unit.

F — Power control for the temperature equipment and oscillator.

G — Power supply control for the entire assembly.

The assembly is mounted in a standard relay rack.

quency standardization is, therefore, of vital concern to all.

For the individual station there are already means for measuring the limits outside of which he may not go. Frequency meters of one kind or another are available if one chooses to look for them, but all depend for their calibration upon a direct comparison with a standard of known reliability. If a tuned-circuit frequency meter or a piezo-electric oscillator is the station standard, it depends upon the calibration made by the manufacturer who probably compared it with a piezo-electric oscillator whose frequency was known with a higher order of precision. "How," the reader asks, "does the manufacturer measure the frequency of his standard oscillator?" Perhaps he compares it with another standard still more precise. Who checks the latter standard? We shall discuss the general aspects of this problem and then describe a solution that has been worked out in the laboratories of the General Radio Company.

To describe the means by which we obtain the ultimate standard of frequency it is first necessary to understand one extremely important but simple concept. It is known in one form or another to all of us: that frequency and time mean the same. By frequency we mean the number of events that occur in a given time interval, and the same idea may be expressed by specifying the time that elapses between events. Sixty cycles per second conveys exactly the same information as one-sixtieth of a second per cycle; one is merely the reciprocal of the other. The designers of electric clocks recognize this principle by driving a clock train from a synchronous motor which operates from the commercial alternating-current power supply. Whether or not the clocks keep true time depends entirely upon the accuracy with which the generating station maintains its frequency. The clock, therefore, is a standard of time; it is also a standard of frequency. A piezo-electric oscillator is a standard of frequency; it is also a standard of time.

With this idea in mind we look about us for the most reliable standard of time or frequency that we can find and after examining all man-made clocks, we go back — as does the astronomer — to the diurnal revolution of the earth for our fundamental standard of time, because we know that the earth turns on its axis at a uniform rate. The length of each Solar Day (as determined by the transit of the sun across a given meridian) changes from day to day throughout the year, but the astronomer averages this value, calls it the Mean Solar Day, and takes the $1/86,400$ th part of it for the standard second. We now have a standard time interval (and a standard of frequency) upon which we can depend.

In the United States the U. S. Naval Observatory at Washington makes daily determinations of the length of the Mean Solar Day from which

they adjust their standard clocks. With these as a reference, time signals are transmitted by radio for the use of everyone who cares to listen. The same process is repeated in other principal countries of the world and by means of time signals these daily determinations of the Mean Solar Day are inter-compared. Then, if we can find a way of making this ready-made frequency standard meet our needs, we have a basis for international frequency standardization.

Before a standard operating at a frequency of one cycle per day can be used for making radio-frequency measurements, some kind of an intermediate mechanism must be provided. To give

at present is a temperature-controlled piezo-electric oscillator which must operate of necessity at radio frequencies. One of the most convenient counting mechanisms is the clock train used in exactly the same way as in a time-keeping clock where it counts the number of impulses of the

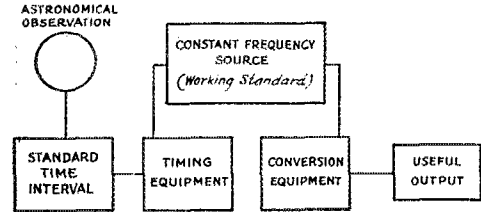

FIG. 2.—OUTLINE CHART FOR A FREQUENCY DETERMINATION SYSTEM

some idea of the magnitude involved in such a transformation, suppose that we have a transmitter operating at 10 kilocycles and that we wish to check its frequency against the rotational frequency of the earth. Then imagine the earth to be a huge pinion-gear rotating once in every twenty-four hours. Imagine, furthermore, that the transmitter is another gear turning once in every ten-thousandth of a second. To link the two would require an intermediate gear train with a ratio of 1 to 864 million.

At first glance a precise comparison between quantities so vastly different in magnitude would seem to be impossible, but there are several ways of accomplishing it, all of which may be represented by the outline of Fig. 2.

We first establish a source of radio-frequency voltage whose frequency is as constant as is possible for us to make it, in order that we may say safely that its frequency at any instant will deviate from its average frequency by an extremely small amount. Next, if we provide some means of counting the number of cycles executed by the working standard during a given interval of time, we can compute the average frequency of the working standard by taking the ratio between "number of cycles" and "interval of time." If this time interval has been precisely determined in terms of the Mean Solar Day, we have at once determined the average frequency of the working standard in terms of the rotational frequency of the earth. This is the first step in linking a radio-frequency standard with the rotation of the earth.

The best working standard that we can obtain

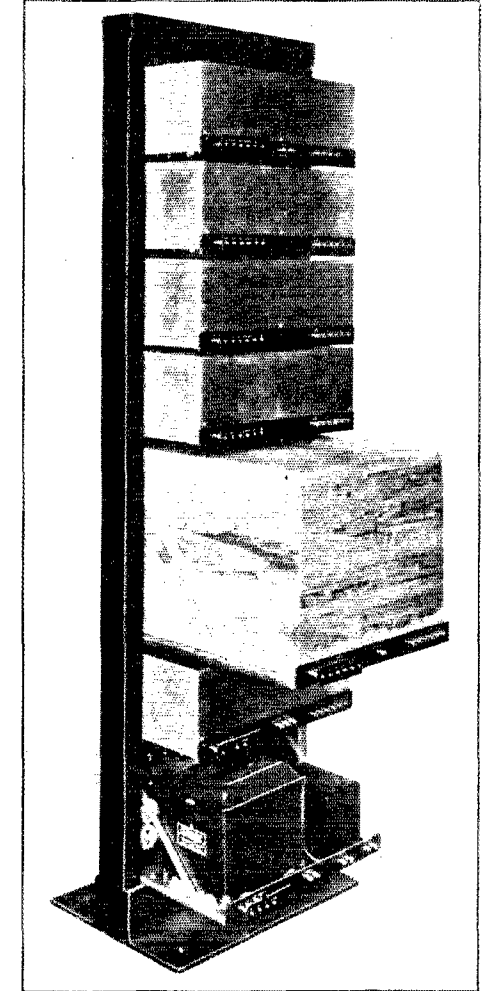

THE REAR OF THE STANDARD FREQUENCY ASSEMBLY

The covers are of nickel-plated brass with the exception of the temperature control and oscillator box which is of balsawood. Jack-top binding posts facilitate making connections between the units.

pendulum or the balance wheel. By driving the clock train with a synchronous motor, as is done in the commercial electric clocks previously referred to, we have at once a means of counting the number of cycles executed by a source of alternating current in a given time interval. A

synchronous motor to operate at radio frequencies is for practical purposes an impossibility, so we again adopt the idea of frequency conversion and look for some means of "reducing" the high frequency of the working standard to a lower one (say 1000 cycles per second) at which a synchronous-motor-driven clock can be made to

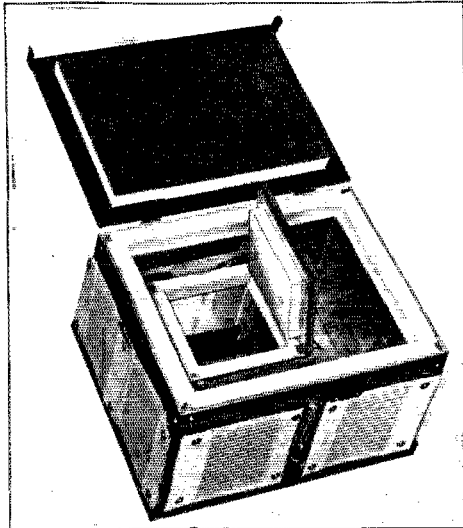

THE TEMPERATURE-CONTROL BOX REMOVED FROM ITS BALSAWOOD HOUSING

The oscillator fits in the compartment to the right. The quartz plate is mounted in the inner box. There are two stages of heat control, one on each box. The Ohm-spun heaters cover all sides of both boxes and separate thermostatic controls for each set of heaters give a fine degree of temperature regulation. One of the mercury-column type thermostatic controls is mounted on the face of the outer box and the other is between the case and heater of the inner box. The boxes are constructed of sheet aluminum and asbestos board.

operate satisfactorily. The actual method of accomplishing this reduction in frequency is described in detail in another part of this article.

Having established a constant-frequency source and compared it with the standard time interval by means of the intermediate timing equipment, we are now ready to make practical use of the frequencies which we shall derive from it. Fortunately this is the simplest part of the entire problem, for the technic of obtaining useful frequencies from a single frequency standard is known in a rough way, at least, to everyone who has ever had experience with vacuum-tube oscillators. A large number of harmonic frequencies, which are multiples of the standard frequency, can be derived directly from the working standard itself and, by the addition of special distorting oscillators and amplifiers, the number of these higher frequency points can be extended over a wide range.

THE FREQUENCY STANDARD

In the foregoing discussion we have outlined in a general way a few of the fundamental problems involved in frequency standardization. We now propose to describe the equipment that has been developed in the laboratories of the General Radio Company for making direct frequency comparisons with the rotational frequency of the earth. The equipment is in many respects a unique development which was occasioned, of course, by the necessity for maintaining frequency stand-

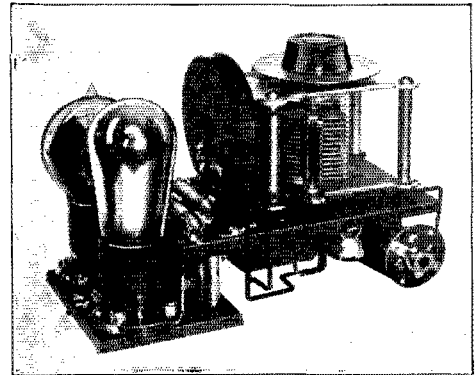

THE OSCILLATOR AND ITS ISOLATING AMPLIFIER

The rear tube is the oscillator and the other the amplifier. The plate inductance is mounted between the tubes and the tuning condenser. The small bushing at the lower-right is that of a universal joint used in connecting a dial on the control panel to a small vernier condenser which permits minute changes in frequency. The entire sweep of this control causes a frequency variation of only four parts in a million.

ards having a precision well in excess of the precision of calibration that General Radio would be expected to undertake within the next few years. That the development has been successful is evidenced by the fact that the entire standard of frequency assembly has been put upon a commercial basis and the units are now being supplied to other laboratories interested in the standardization of frequency. This fact emphasizes better than anything else the idea that this equipment is rugged, reliable and highly precise.

Because the entire system can be so readily broken down into discrete groups, the standard-frequency assembly has been built up on the unit plan. As shown in the accompanying photograph, the equipment is designed to mount in a standard telephone relay rack. At the bottom of the rack are placed the power and heat-control panels, the first carrying trickle chargers for both the 6-volt and 150-volt batteries which supply the entire equipment, and, the second, the series resistance and relays for controlling the amount of heat supplied to the temperature-control unit. The temperature control unit is the large unit near the center of the assembly and

above it are mounted, in order, three multivibrator units and the timing amplifier.

A brief outline of the mechanism of operation of the assembly described above may now be given.

TEMPERATURE CONTROL UNIT AND OSCILLATOR

The temperature-control equipment is designed to maintain the temperature of the crystal within 0.01 degree C., and the crystal oscillator circuit with its isolating amplifier to within 0.1 degree C. The temperature control system is based upon two complete units, each with its own heaters, thermostat and heat-distributing and attenuating layers, one mounted within the other. With this construction, the inner unit has to operate against only the small fluctuations in temperature which remain from the control of the larger unit. The crystal mounting is placed in the inner unit; the circuits, drive tube and isolating amplifier, are placed in the outer unit. The circuit has been carefully chosen and adjusted so that the frequency of the crystal oscillator is as independent as possible of the variations in the coils, condensers, resistors, and tubes. A long-life repeater tube is employed as the driving tube and is operated at greatly reduced voltages, so that its estimated life is five years; the tube in the assembly at the General Radio Company's laboratory has been in continuous operation for

tal frequency-control element in the assembly is a piezo-electric oscillator, in which the quartz bar is kept as free from the effects of circuit changes as possible. This oscillator operates at a convenient value of frequency, in the neighborhood of 100 kilocycles. For mechanical reasons, it is not feasible to operate any form of "cycle counter" directly at this frequency, so it becomes necessary to reduce the value of frequency by frequency-

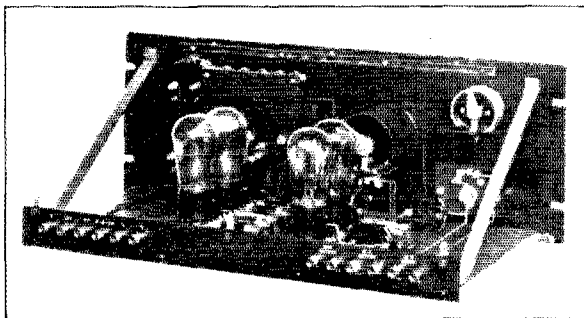

ONE OF THE MULTIVIBRATORS

The tubes at the left are the multivibrators and those to the right are the input and output amplifiers. Sanyamo fixed condensers and their tap switch, used for tuning the multivibrator circuit, are on the small panel behind the tubes to the left. The large potentiometer partly obscured by the amplifier tubes is for adjusting the control voltage and hence the "control order" of the multivibrator as described in the text.

dividing equipment. This is where the multivibrators come into the picture.

THE MULTIVIBRATORS AND SYNCHRONOUS CLOCK

A multivibrator, in one of its simplest forms, is just a two-stage resistance-capacity coupled amplifier with the output connected directly back to the input. Under these conditions the amplifier "motor-boats" violently at a frequency determined mainly by the values of resistance and capacitance employed. It is a rather special type of oscillator, since it has no "LC" circuit, and for this reason it has been given other names, among them being "multivibrator" and "relaxation oscillator." It is a characteristic of this class of oscillator that the frequency of oscillation may be influenced readily by the introduction of a small harmonic voltage into the circuit. The multivibrator frequency does not change smoothly or continuously with the magnitude of this introduced voltage, but assumes discrete values which are definitely related to the frequency of the control voltage. This is best illustrated by an example:

Suppose that the multivibrator alone operates at a fundamental frequency of something like 1 kc. and that we introduce into its circuit a voltage from an ordinary oscillator operating at a fundamental frequency of 10 kc. and, furthermore, that the magnitude of this 10 kc. voltage is adjustable. On introducing a small voltage, we

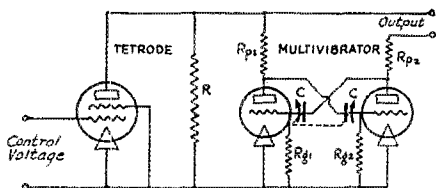

FIG. 3. — A SCHEMATIC MULTIVIBRATOR CIRCUIT

The screen-grid tube is the input-coupling amplifier and the two triodes are the oscillators. The frequency of oscillation is determined by the capacitance of the condensers C and the resistance of R_p .

nearly two years. The average frequency of the crystal oscillator has been constant within plus or minus two parts in one million over a period of several months; the average daily frequency generally lying within one part in one million of the weekly or monthly average. This accuracy is perhaps more readily understood when it is stated that the output frequency at 1,000,000 cycles per second (1000 kc., in the middle of the broadcast band) is known to better than two cycles per second, or within 0.0002 per cent. The fundamen-

find that the multivibrator frequency may change slightly, but that it assumes a frequency of *exactly one kc.*, or a frequency which is *just one-tenth* that of the controlling oscillator. As we increase the controlling voltage from the 10-kc. oscillator, the frequency of the controlled multivibrator will not change until the voltage introduced has been increased by an appreciable amount. When the voltage has been increased enough, the multivibrator's fundamental frequency will suddenly change to a *higher* value, which will be found to be just *one-ninth* that of the controlling oscillator, and so on, for *one-eighth, one-seventh*, etc. While the multivibrator is in control at *one-tenth* of the frequency of the controlling oscillator, its *tenth harmonic is synchronized with and controlled* by the fundamental frequency of the controlling oscillator. This condition may be maintained for long periods of time (weeks and even months) and while so

tions of the crystal; one second on the clock face then corresponds to exactly 100,000 oscillations of the crystal. If the crystal frequency is exactly 100,000 cycles per second, then the clock keeps true time; if the crystal frequency is higher than 100,000 cycles per second, then the clock gains on true time in the same percentage that the crystal frequency is above 100,000 cycles per second. If the clock is compared accurately with standard time, as by comparison with the time signals transmitted from the Naval Observatory, then the number of seconds recorded by the clock in twenty-four hours (or other standard interval) to the number of seconds in the true time interval is the ratio of the frequency of the crystal to 100,000. By means of auxiliary equipment on the clock, it is possible to compare the clock reading with the radio time signals to 0.01 second in twenty-four hours. If the clock gains 0.1 second in twenty-four hours, the crystal frequency is roughly one part in a million above 100,000 cycles per second or the average crystal frequency is 100,000.1 cycles per second.

It is evident now that the purpose of the frequency-dividing equipment and the synchronous-motor clock is to count the number of cycles executed by the crystal oscillator in a standard time interval. Since the definition of frequency is "the number of recurring events, of identical nature, occurring in one second," we see that this means of "timing" a crystal is a fundamental one, since the number of cycles executed in the standard time interval is determined. While we speak of this equipment as a "frequency standard," the real standard is the period of the earth's rotation on its axis. The crystal, or working standard, is simply the intermediate oscillator, of constant frequency, employed in stepping up the frequency of the earth's rotation (one cycle in twenty-four hours) to a convenient value (100,000 cycles per second) for use in radio-frequency measurements.

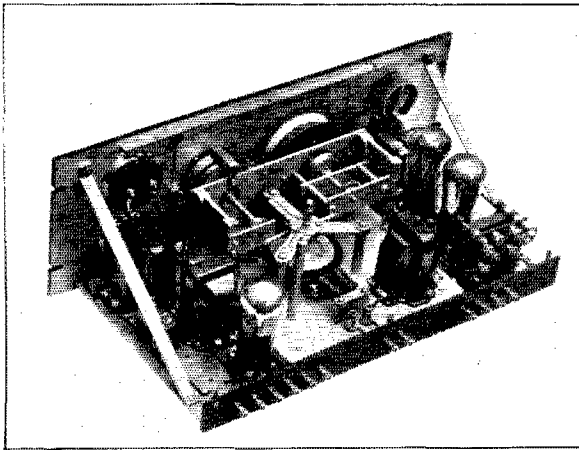

BEHIND THE PANEL OF THE TIMING UNIT

The synchronous motor with its central shaft is in the centre. The motor is driven by three pairs of coils, which are energized by the output of the 1-kc. multivibrator. The motor shaft is connected by gearing with the clock at the right and the micro-dial at the left. It is by means of the latter that accurate comparisons with standard time signals are made. The tubes, with the auxiliary apparatus shown, constitute the amplifier for the 1,000-cycle input.

maintained constitutes a practical frequency divider. By choice of the circuit conditions, a given frequency may be divided by any whole number between 2 and, roughly, 50. In the standard-frequency assembly the 100-kilocycle crystal frequency is divided by 10 to obtain a 10-kc. fundamental frequency, harmonics of which are desired for calibration purposes as mentioned above, and then this 10-kc. fundamental frequency is again divided by 10 to obtain a 1-kc. fundamental frequency for the operation of the synchronous motor of the clock.

In this arrangement, one cycle of the 1000-cycle output corresponds to *exactly 100 oscillations*

Two multivibrators are employed as frequency dividers for reducing the frequency of the working standard to a value such that a synchronous motor may be operated. For convenience in making use of existing equipment, the output frequency was chosen at one kilocycle; the synchronous motor with its clock train was designed to keep true time when supplied with a frequency of exactly this value. For further convenience the frequency dividing stages are arranged so that the first operates at a fundamental frequency of 10 kc. Harmonics of this frequency are available for calibrating purposes, and this arrangement provides standard frequencies at every 10 kc.

over a considerable portion of the frequency scale. This is particularly useful in the broadcast band of frequencies, where the channel assignments are based upon this separation; a standard frequency is available directly from the equipment for each of these channels, and the frequency is known with the same percentage accuracy as the frequency of the working standard. The third multivibrator unit is employed as a frequency multiplier, or harmonic emphasisizer, for increasing the energy of the harmonics of the crystal oscillator; this unit is of particular value in obtaining standard frequencies in the high-frequency portion of the radio-frequency spectrum (short wavelengths).

In the standard operated at the General Radio laboratories, the crystal happens to be adjusted for 50 kc. instead of 100 kc. In one day this crystal executes 4,320,000,000 oscillations. If the time signals are exact (which they are not, due to the lag of telegraph lines and errors in the transmitting clock, so that the signals must be corrected for precise work) and the clock is compared with them to the nearest 0.01 second, the number of cycles executed in twenty-four hours is counted to within plus or minus 250 cycles. This crystal executes 1,580,000,000,000 oscillations in one year, and since it has been running nearly two years it has executed over 3,000,000 million oscillations — and it is still able to “shimmy”!

USING THE STANDARD

So far we have been concerned mainly with the method for determining the frequency of the crystal oscillator. Having established a standard of frequency, the next problem is to make use of it. In the assembly described, separate output amplifiers are provided on each multivibrator unit, so that through these amplifiers we have available distorted wave outputs at fundamental frequencies of 100, 10 and 1 kilocycles per second. For the two higher, the harmonic output is sufficient to permit heterodyne measurements to be made on harmonics as high as the 300th — that is, the 100-ke. multivibrator produces harmonic frequencies which are useful in the range from 100 to 30,000 kilocycles, at intervals of 100 kilocycles. The 10-ke. multivibrator has a useful harmonic output from 10 to 3000 kilocycles at 10-ke. intervals. The 1-ke. multivibrator output contains appreciable harmonics which have been employed to as high as 50 kilocycles. By combining the outputs of two or more multivibrators, a standard frequency may be obtained very near to any desired radio frequency. Through the use of an auxiliary multivibrator (operating on alternating current) and a synchronous motor fitted with a tone generator having a number of rotors, a large number of frequencies may be obtained at values below 1000 cycles per second. With the entire assembly, thousands of standard frequencies, lying between 0.5 and 30,000,000

cycles per second may be obtained, each being known with the same percentage accuracy as the frequency of the main crystal oscillator is known.

Doings at Headquarters

AT present weather conditions seem to be excellent for radio work. Fellows in the office have been taking advantage of this and the three popular amateur bands are occupied every night with stations of our Hq. gang. W1AL-W1CEI is an active radiophone on 14,300 kc. This 'phone has been operating noon-times and early evenings with excellent results. In fact, it is this 14-mc. transmitter which is described in the present issue of *QST*. Speaking of 'phone stations on 14 mc., one associates that with the necessary permission to operate on that band of frequencies. F. E. Handy has an extra first class license and permission to operate 'phone from W1BDI. R. B. Parmenter has an “extra” license as well as permission for transmission of radiophone signals from W1MK. J. J. Lamb also has the same form of license and permission to operate W1CEI on 14 mc. Bev. Dudley, W1AL, and C. C. Rodimon, W1SZ, have the necessary permission for telephone transmission on 14 mc. Quite an imposing bit of 'phone interest from this office, we would say.

A. L. Budlong was away for a few days' rest in middle January, playing the hermit aboard a steamer going south.

Chris Kenefick, W1PX, has left our organization to accept a position with the Crowell Publishing Co. R. B. Beaudin, W1BAW, succeeds him in the Circulation Department.

“FH” and “EV” have been helping out at W1MK during the Army Air maneuvers between Selfridge Field, Mich., and Spokane, Wash.

“RP” has returned to W1MK after honeymooning for two weeks in New York City and Philadelphia.

— C. C. R.

New England Division Convention

Worcester, Mass., April 25th and 26th

JUST a preliminary announcement, fellows, of the coming Convention to be held in the Hotel Bancroft, Worcester, Mass. Watch for our circulars. Worcester Radio Association is working hard for your interest. Plan to attend.

Strays

W1WE has his station located in the kitchen pantry according to Wood of W1AYG. Those of us who live in boarding houses rather like the idea.

Coöperating With the B. C. L.

By The Old Connecticut Yankee*

I WANT to give you boys a little of the history and experiments we carried on in the early days of amateur fone. The first fone I used was in the spark days when we used a system of modulated spark. We used to connect a mike across the spark gap and, as we pushed the key, yell in the mike thus modulating the spark. Of course, the spark burned up the carbon in the mike, but we had it all figured out to send 20-word messages by using plug-in mikes. Some nights when we'd want to keep going all night we worked it like the old Revolutionary War days. In those days they had a guy with a pocket full of powder to refill the muskets, but we had a fellow with a pocket full of carbon. This method wasn't very satisfactory, and about this time Hiram heard that damped waves was going out of style with prohibition coming along, so he went around to see about getting some tubes made. Of course I'd been experimenting with a tube on my own, the sketch of which is shown in Fig. 1.

The flame heated up the filament in the tube (we knew it in them days as sour mash) 'till it gives off electrons which when condensed have quite a potential power. They then flowed through the O.T. Coil into the grid-leak and thence to the well-known grid-leak drip-pan. This certainly proved more than satisfactory in results. Hams from all over the country stopped in to see me and invariably it was received with open mouth.

Well, the war came along and the government began closing down stations all over the country. I didn't pay much attention to all this 'till finally one day I got a letter which is shown below. The original I carry around in my pocket. In fact I'm still wearing the same suit on Sundays and the letter's been in the pocket ever since.

WHITE HOUSE

May 17, 1817.

WOODY DARROW,
Radio 1AOZ,
Waterford, Conn.

As you perhaps have learned we are closing down all the amateur stations in the country. We didn't like to call your attention to it knowing how sensitive you are on such matters, but I and the Cabinet think it's time you should know. We're closing down all the rest of the stations in the country so you might as well shut up, too, because you won't have anybody to talk to.

Fraternally yours,

WOODROW WILSON,
President of United States,
(Democrat.)

*W3JZ, Woodrow Darrow, 5623 Germantown Ave., Germantown, Pa.

Well, that shut things up 'till after the war when things started again — mainly BCL's. They heard my fone, got jealous and used theirs. The darn thing always rang my house. Wasn't more than a day or so ago one called up, and I'll try and give you the conversation from my side of it.

"Hello. . . ."

"Yes, this is the W3JZ who's doing the broadcast. . . ."

"You can hear me? Well, aren't you glad? I got a darn good station here. . . ."

"What were you listening to? . . ."

"WJZ? Yea, they got a good station too. . . ."

"WJZ? You say you can't hear WJZ when I'm on? Well, that shows I got a better station than

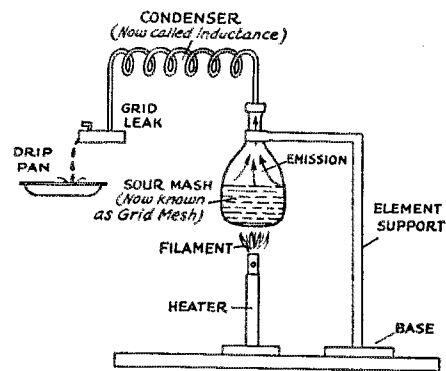

INDIRECT HEATER TYPE TUBE
FIG. 1

them, and the best man wins. What kind of a set have you got? . . .

"Yes, I know you have a good set; otherwise you wouldn't hear me so loud. What is it, a nine tube set or something? . . ."

"It hasn't got any tubes! What has it got? . . ."

"A piece of rock-candy! Mister, that's not rock-candy, that's 'Gillina' — a mineral.

"No, not mineral oil — mineral. I bet you've got a lot of money invested in that set. How much did it cost? . . ."

"Two dollars! Oh! Mister, they saw you coming! Well, do you want to know how to stop hearing me?"

"You do? . . . All right.

"You know the antenna, the wire that is tied on the tree? . . ."

"Yes, that's right; the one the birds sit on. Well, pull that wire off the set. Now you know

(Continued on page 82)

14-Mc. 'Phone Transmission

Considerations in Radiophone Design, and the Construction of a 14-Mc. 'Phone Transmitter

By Beverly Dudley, Assistant Technical Editor

The assembly of material for this article constitutes not only the constructional and operative details of a single transmitter but also represents the experiments and experiences of QST's technical staff with a number of c.w. and 'phone transmitters. The intention is to specify not only how a successful transmitter should be constructed and adjusted but also how not to do it. The information given is equally applicable to c.w. and 'phone transmitter design. — EDITOR.

THE band of frequencies from 14,100 to 14,300 kc. which has been opened recently for radiophone communication offers intriguing possibilities as well as unexpected difficulties to those technically qualified amateurs who are licensed to use this band for voice transmission. It is certainly interesting to conceive of the possibility of talking

technically qualified amateurs will be apparent when the problems involved in the design of such transmitters are considered. The prime considerations are influenced by the frequency at which the transmitter is operated. The transmitter must generate a carrier of constant and unvarying frequency, but this alone is not sufficient. The frequency of the emitted signals must be

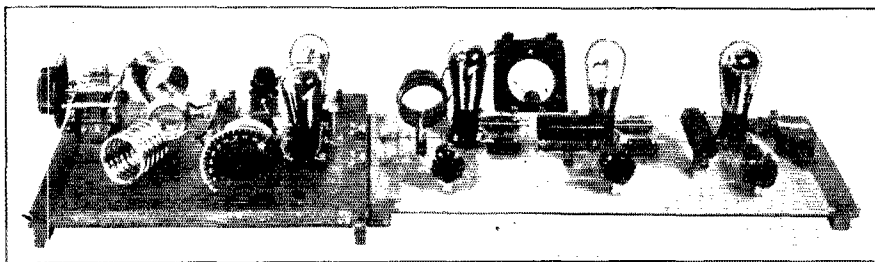

THE RADIO-FREQUENCY PORTION OF THE TRANSMITTER

The unit at the left is the push-pull modulated amplifier. The frequency doublers and crystal-controlled oscillator are at the right.

with some amateur in a far corner of the world, not in the familiar language of dots and dashes, but in the language of speech.

Some of the difficulties of international radiophone communication have been mentioned editorially. The difference in language and dialect is bound to be a major factor in international communication, but it is not the only factor. The technical difficulties of a 14-mc. 'phone are so much greater than those of a 3.5-mc. 'phone that those of us who have had experience with both bands insist that the technical difficulties in high-frequency 'phone transmitters increase directly as the square of the frequency. A 14-mc. 'phone transmitter is not a simple outfit to properly construct and operate; neither is it a cheap undertaking.

Perhaps the good judgment of the Federal Radio Commission in issuing permission to operate 14-mc. 'phone transmitters only to

accurately known, and *must be kept between the limits of 14,100 and 14,300 kc.*

High-frequency phenomena immediately impose the condition that the successful high-frequency 'phone transmitter utilize an oscillator-amplifier type of circuit with high degree of frequency constancy, for the frequency inconstancy tolerances are very limited at 14 mc. High-frequency oscillators are inherently inconstant in frequency; it is impossible to keep such an oscillator perfectly constant in frequency without using crystal control and frequency-multiplying amplifiers if any power is to be taken from the transmitter. The variations in frequency which occur when self-excited oscillators are used at 14 mc. are sufficient to cause serious phase distortion at the receiving station and to adversely affect the quality of the transmitted speech. Phase distortion is caused by the varying lengths of paths of multiple-path signals as the

frequency is slightly shifted. The idea may, perhaps, be better understood from reference to Fig. 1, where *T* represents the transmitting station, *R* the receiving station, *L* the length of the path of the transmitted signal at a frequency *f*, and *L'* the length of the path of the signal at a frequency *f'*. The difference in the lengths of the paths ($\Delta L = L' - L$) may be sufficient to cause the signal traveling over the path *L'* to require an appreciably greater time to reach the re-

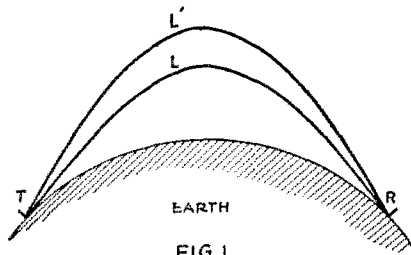

ceiving station than that required by the signal traveling over the path *L*. Of course the time interval for the complete transmission is only a fraction of a second, and the difference in time for the signals to travel over the two separate paths is considerably less. Nevertheless, the time difference may be sufficient to cause phase distortion, for serious interference will result if the difference in time of transmission over the two paths is only 0.001 second. The difference in frequency causing the transmission over paths of different lengths may very easily occur with unmodulated self-excited oscillators, and this condition is vastly aggravated if the oscillator is being modulated, for the process of modulation itself causes the frequency of an oscillator circuit to vary over a wide frequency band, because of the drastic plate-voltage changes which accompany it.

Frequency modulation in a 14-mc. radiophone transmitter is, therefore, a serious matter, especially when attempts are made to obtain a high percentage of modulation from the transmitter. It is under such conditions that frequency "wobulation" is most pronounced and speech is the least intelligible. The only alternative is to reduce the modulation to such a point that the carrier frequency has at least some semblance of being constant, but when this poor practice is resorted to the ratio of the interference range of the transmitter to its effective communication range is greatly increased, and the modulation capability is very small.¹

¹ Modulation capability is defined as "the maximum degree of modulation (expressed as percentage) that is possible without appreciable distortion employing a single frequency sine-wave input and using a straight line rectifier coupled to the antenna in conjunction with an oscillograph or harmonic analyzer to indicate to character of the output."—Report of the I. R. E. Committee on Broadcasting, *Proc. I. R. E.*, January, 1930.

The same high modulation factors desirable at broadcast frequencies are desirable and obtainable at 14 mc. However, it is only with a very constant-frequency carrier that a 'phone transmitter can be made to have a high percentage of modulation and at the same time be free from frequency flutter or "wobulation." It is therefore evident that the most successful 14-mc. 'phone transmitters will be oscillator-amplifier transmitters (with crystal control of the frequency of the oscillator) having high modulation factors. Moreover, the oscillator must be thoroughly isolated from the modulated amplifier.

CONSIDERATIONS IN THE DESIGN OF THE R. F. SYSTEM

A successful 14-mc. 'phone transmitter is not an outfit that can be put together during a Saturday afternoon and operated that evening. There are considerations to be made in the design of the transmitter long before any of the component parts are purchased or assembled.

Of course the first thing for the amateur to do before considering the construction of a 14-mc. 'phone transmitter is to obtain permission from the Supervisor of Radio to use the band of frequencies from 14,100 to 14,300 kc. for radiophone transmission. Those who hold Amateur Extra First Class licenses may obtain permission by returning their station license to the Supervisor of Radio with a request that permission to operate in this 'phone band be granted. Holders of other classes of amateur licenses may be granted permission to operate in the 14-mc. 'phone band provided that, in the opinion of the Supervisor of Radio, they possess the necessary technical qualifications to construct and operate such a transmitter successfully without undue interference to other services.

Assuming that permission to operate in this band has been granted, the first technical consideration in the design of the 'phone transmitter is to decide on the power rating of the modulated amplifier. It is then necessary to work backwards and so design the frequency doublers and oscillator that the modulated amplifier will receive sufficient excitation when operated as a Class C amplifier.² With the radio-frequency system designed, the modulator should be the next consideration. The method of determining the correct modulator for a radio-frequency amplifier of given power may be determined from the load characteristics of tubes suitable for modulation³ or from the various articles which have recently

² See "Vacuum Tube Amplifier Definitions" by Dart and Atwater, *QST*, September, 1929.

³ "Little-Known Tubes—UX-841 and UX-842" by H. P. Westman, *QST*, July, 1929.

"The UV-845" by James J. Lamb, *QST*, November, 1929.

appeared in *QST*.⁴ With the size of the modulator determined, it is then a simple matter to design a high quality audio amplifier to provide full

grid excitation to the modulator for voice inputs to the microphone. This procedure in design will result in a transmitter having the proper relationship between the radio-frequency and audio-frequency portions of the outfit, and in the development of the most economic and best performing type of transmitter possible. The design outline given above is infinitely better than the usual amateur practice of using the biggest tube available for the final radio-frequency amplifier and then building the modulator with whatever equipment is still available after the radio-frequency system is completed. Careful application of the design outline given above may even indicate that best 'phone performance will obtain if the biggest tube available is used as the modulator rather than as the modulated radio-frequency amplifier, for in radiophone transmission we are not interested so much in the power output as we are in the variation of power output in accordance with speech signals.

Since constancy of frequency is of inestimable importance in any high-frequency transmitter and is especially important in high-frequency 'phone transmitters, the attainment of greatest frequency-stability makes the use of a crystal-controlled oscillator imperative. Unfortunately the use of a crystal-controlled oscillator is associated with the complexities of multiple-tube amplifiers and frequency doublers, for it is virtually impossible to obtain satisfactory quartz crystals having a natural frequency of vibration at 14 mc. Moreover, even if it were possible to obtain such a quartz plate, the crystal would be useful for only the 14-, 28- and 56-mc. amateur bands; it would be of no practical use in the other amateur bands. The problem then resolves itself to the use of a 7- or 3.5-mc. crystal-controlled oscillator and frequency doublers—certainly not a cheap although, for technical reasons, a highly recommended arrangement.

In high-frequency transmitters difficulty is almost universally experienced in keeping radio frequency currents where they belong. Radio-frequency feedback invariably is the cause of a

goodly portion of the difficulties encountered in amateur transmitters, and this is especially so in transmitters using a multiplicity of doublers and

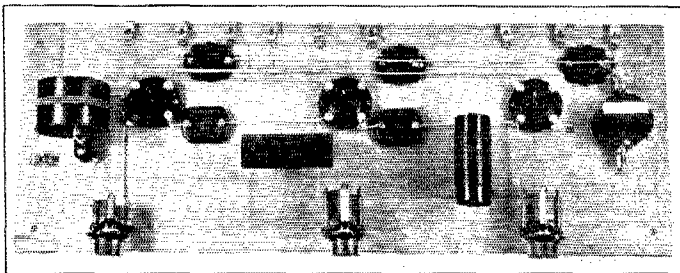

THE FREQUENCY DOUBLERS AND OSCILLATOR

The 14-mc. doubler is at the extreme left, the 7-mc. doubler in the center and the 3.5-mc. oscillator with the crystal, at the right. All of the coils are made plug-in and are tuned with midget condensers. The coupling and grid voltage by-pass condensers may also be seen.

amplifiers. Radio-frequency feedback from the amplifiers to the oscillator results in an inconstant or unstable carrier, so that the received signal "creeps" and is often rough or "fuzzy." Radio-frequency feedback to the audio system may cause the audio amplifier and modulator unit to overload for no readily apparent reason; it may aggravate any tendency of the audio unit to howl or "motor-boat" and may seriously impair the quality of audio amplification. Since, with Heising modulation, the radio and audio output systems converge at the constant current choke, there is an excellent opportunity for radio-frequency current to enter the audio system through the back door of the modulator tube. The judicious use of r.f. chokes and by-pass condensers is helpful in reducing radio-frequency feedback, but even with all the care that the amateur can (and sometimes does) exercise to keep r.f. currents out of the audio system by these means, there is still the possibility of undesirable radio-frequency currents being present in the audio system. Physical separation of the radio and audio units is perhaps the cheapest and most effective method of keeping the two classes of currents in their respective circuits, and is highly recommended in any 'phone installation.

There are also difficulties involved in keeping both radio-frequency and audio-frequency currents out of the power supply equipment. Audio-frequency feedback, fortunately, is seldom troublesome, and may usually be eliminated or reduced to a negligible quantity through the use of a few large by-pass condensers. With radio frequencies we have another story. Radio-frequency feedback into the power equipment imposes unnecessary strain on the insulation and invariably produces feedback in the audio and radio systems of the transmitter if it is not already present there. There is, furthermore, a moral problem involved when amateur 'phone transmissions are piped into the neighboring

⁴"Vacuum Tube Layouts for Telephone Modulation" by E. E. Spitzer, *QST*, February, 1930.

"The Use of the Distortion Rule in Power Output Calculations" by K. S. Weaver, *QST*, November, 1929.

"Vacuum Tube Amplifier Definitions" by H. F. Dart and C. K. Atwater, *QST*, September, 1929.

"Choosing the Proper Modulator Tube" by W2JS, Experimenters' Section, *QST*, September, 1929.

broadcast receivers via the power lines. We have been led to understand that this is not a matter which can be lightly neglected.

To make the subject complete, there is the problem of radio-frequency chokes; what uncertain little devils they are! But we are not going into the discussion of r.f. chokes. We have managed to get along with the aid of Mr. Lid-

amplier is also of assistance in reducing spurious oscillations.

Single-ended amplifiers are usually difficult (if not altogether impossible) to completely neutralize, but the use of push-pull amplifiers makes perfect neutralization possible with considerably more ease of adjustment. Push-pull amplifiers have the additional advantages of reducing the effective tube capacitances across the resonant circuit, of being more stable and constant in frequency, or being easier to handle, and of making possible the reduction of the radio-frequency potential on the grid and plate circuit chokes.

To properly excite the output amplifier, the output of the last frequency doubler, should provide sufficient grid swing to run the grid of the Class C amplifier positive over a considerable portion of the radio-frequency cycle. Therefore, there must be plenty of power to properly excite the modulated amplifier, and since the majority of amateur 'phone transmitters fall down on this point, the matter can hardly be emphasized too strongly. The amplifier feeding the modulated amplifier should be comparable in power rating to the power rating of the output amplifier. A UX-201-A tube, for instance, could never in all the wide world properly excite a neutralized UX-210 tube operated as a Class C amplifier with anything like the rated voltages and currents applied to the respective tubes.

Frequency multiplication in doubler amplifiers occurs in the plate circuit of the amplifier rather than in the grid circuit, although there may be some slight tendency for doubling to occur in the grid circuit. The tube does not respond to the second harmonic of the preceding oscillator or amplifier and operate with

any appreciable degree of satisfaction with its plate circuit tuned to the same frequency as that of the harmonic exciting voltage. Rather, the grid of the doubler is kicked less negative during the peaks of the exciting voltage at the frequency at which the preceding tube is operated, the fly-wheel effect of the tank circuit carrying on through the radio-frequency cycle at double the frequency of the exciting voltage. This fact should be considered in winding the chokes for the grid and plate circuits, for the choke in the plate circuit of a frequency doubler should have its maximum impedance at twice the frequency of the grid choke, which is wound for the exciting frequency.

Experience with several tubes of different μ and power rating indicates that the high μ tubes are best suited for use as frequency multipliers. The principle reason for this is that comparatively little grid excitation is required to operate them, while at the same time relatively high

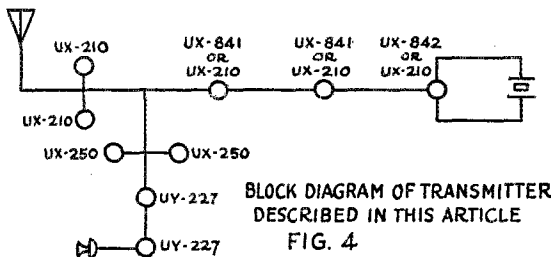
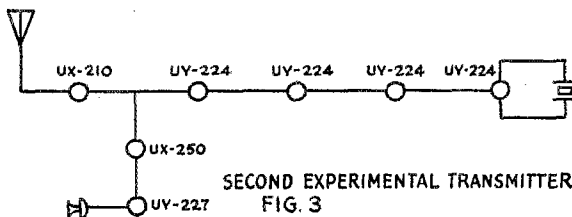
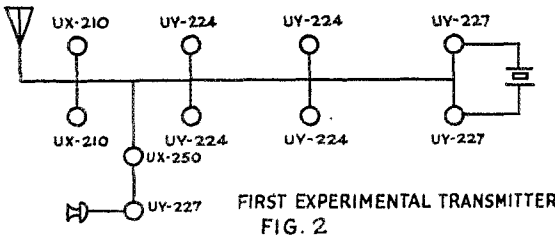

bury's article in the October, 1927, *QST*, and a moderate amount of patience with the pesky things. However, we have still to see the time when the insertion of a radio-frequency choke in a circuit is not attended with half a dozen frowns and uncertainties.

Good practice dictates that the final amplifier in the high-frequency transmitter be operated on the same frequency as the preceding amplifier. An output amplifier which is also a frequency doubler is not recommended, and for this reason it is essential that the output amplifier be neutralized. Neutralization is also beneficial in reducing spurious or parasitic oscillations of which several types have been classified.⁵ The insertion of resistors of a few hundred ohms or small r.f. chokes in the grid circuit of the final

⁵ Short-Wave Transatlantic Radio Telephony, especially the article, "The Radio Transmitters" by E. B. Ferrell, *Bell Laboratories Record*, July to October, 1929.

voltage amplification may usually be expected from a circuit properly using a high μ tube. Relatively high bias is required for optimum operation of frequency doublers to obtain a distorted wave shape in the plate circuit and high μ tubes, therefore, permit an economy in bias-batteries. Although high μ tubes have been found to be well adapted to use in frequency doublers, this statement is intended to apply only to triodes. Screen-grid tubes, although they may be obtained with higher amplification factors than triodes, are not well adapted to frequency multiplications.⁶ Therefore, although the use of a screen-grid tube is advantageous in reducing to a minimum reactions of the modulated amplifier on a preceding amplifier or oscillator, it is not practicable with a screen-grid buffer to combine the functions of a buffer amplifier and frequency multiplier in a single stage.

The radio-frequency system is only half of a 'phone transmitter, however, and in some respects it is the simpler. The audio system, including the modulator, requires just as much consideration as the radio-frequency portion for the attainment of distortionless amplification and effective modulation.

CONSIDERATIONS IN AUDIO-SYSTEM DESIGN

Not only in broadcasting stations, but in amateur stations as well, the use of a good double-button microphone is desirable for faithful conversion of speech into electrical impulses. The use of such a microphone immediately implies the employment of high quality audio amplifiers of relatively high gain, for the double-button microphones are much less sensitive to speech than the single button microphones. The high gain which is required in such amplifiers creates a tendency to howl which must be checked before feedback becomes sufficiently serious to affect the quality of speech. The tendency of the amplifier to howl or sing is also of importance since it reduces the modulation capability. Finally, in the speech system we have the modulator, whose purpose is to vary the carrier in accordance with speech.

The principle difficulty with many modulators used in amateur stations is that the constant current choke isn't that sort of a thing at all. The inductance of an iron-core coil rapidly slides down in the direction of zero as higher and higher values of direct current flow through the windings and cause saturation. Now the constant current choke must pass the plate current of all the modulator tubes as well as that of all the modulated amplifier tubes, and while doing this, it must have sufficient inductance to maintain the drain on the plate power-supply constant

regardless of the audio-frequency fluctuations of plate current. This is really not so big an order for a good choke coil, but an inadequate choke can ruin what would otherwise be a mighty respectable 'phone transmitter.

This rather extended discussion and outline of high-frequency radiophone design brings up the question of economic considerations, and it might just as well be said here, before the transmitter used at W1AL-WICEI is described in detail, that from the amateur stand-point, a

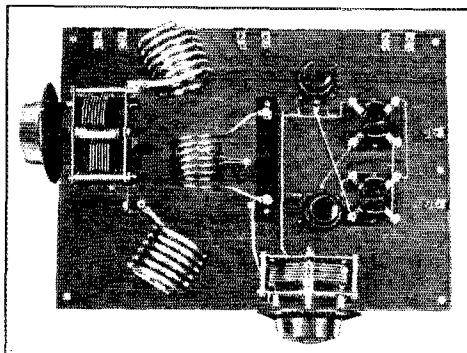

A TOP VIEW OF THE MODULATED AMPLIFIER

The antenna series tuning condenser and coupling coils are at the left, coupled to the plug-in center-tapped plate circuit inductance. The two neutralizing condensers may be seen to the left of the sockets.

14-mc. 'phone can have little economic consideration. A successful 14-mc. 'phone transmitter cannot be a cheap transmitter to construct. The economic aspects are secondary to the technical considerations. Not only is a successful 14-mc. 'phone transmitter out of the reach of the inexperienced because of legal consideration, but it is also beyond the reach of many new amateurs for economic reasons.

SOME EXPERIMENTAL TRANSMITTERS

Before the final transmitter was completed and put on the air, two preliminary experimental transmitters were built and tested. In an effort to keep the expense of the transmitter to a minimum, both of the experimental models used receiving tubes in part, although there seemed to be little possibility of success in following such a course. However, successful operation with receiving tubes on the 3500-ke. 'phone band offered some promise and a trial could do no harm.

The first transmitter used the tube arrangement shown in Fig. 2. The oscillator, first frequency doubler, and the final amplifier used the low-power 'phone equipment recently described with, of course, the necessary changes to operate on 14 mc. rather than on 3.5 mc.⁷ A second fre-

⁶ "An Investigation of the Phenomena of Frequency Multiplication as Used in Tube Transmitters" by R. M. Page, *Proc. I. R. E.*, September, 1929.

⁷ "An Effective Low-Cost 'Phone and C.W. Transmitter of Modern Design" by James J. Lamb and Beverly Dudley, *QST*, September, 1929.

quency doubler, similar to the first, was connected between the two radio-frequency units. As expected, the push-pull amplifiers were found to be poor frequency doublers, and even with the connections of one of the output coils reversed the excitation to the final amplifier was insufficient for Class C operation.⁸ To bring the excitation to the proper level at least one additional stage of amplification (and possibly two stages) would have been required. This arrangement, besides being unwieldy, defeated the prime consideration of economy, which had been hoped for as its desirable feature. Obviously this type of transmitter was entirely out of consideration. The modulator was not even connected to the radio-frequency portion of the transmitter; that would have been futile.

A second transmitter, which was little more successful than the first, used the tube arrangement indicated in the block diagram of Fig. 3. This transmitter used seven tubes, most of which

that there seemed little use of doing anything with the set.

By this time we had become thoroughly convinced that it was neither economically nor technically expedient to use receiving tubes in a 14-mc. transmitter requiring frequency doublers. A new transmitter was designed and constructed following the block diagram of Fig. 4. Its performance is up to expectations and is the basis of the constructional portion of this article.

A SUCCESSFUL 14-MC. 'PHONE TRANSMITTER

In building this 'phone transmitter it was decided that the power output should be not less than 10 watts. This immediately suggested that two UX-210 tubes in push-pull be used in the output amplifier, and imposed the condition of using two UX-842³ or, preferably, two UX-250 tubes in parallel, as modulators. With the 3575-ke. crystal on hand it was necessary to use an oscillator in the 3.5-mc. band, a frequency

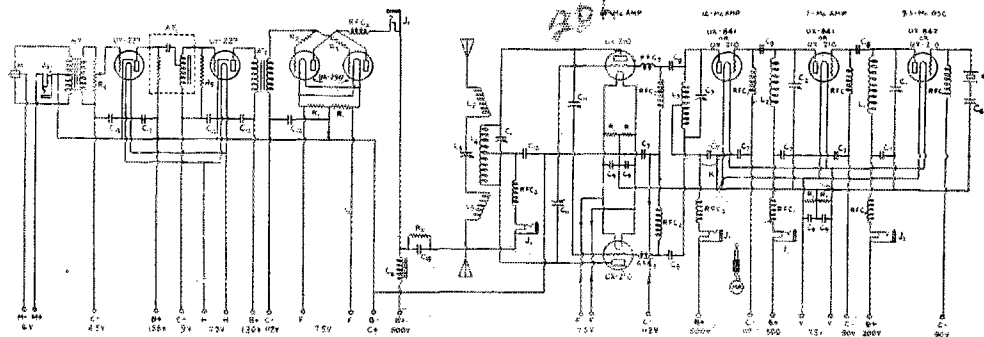

FIG. 5.— WIRING DIAGRAM OF THE COMPLETELY ASSEMBLED TRANSMITTER

L₆ is a 50 henry, 300 milliampere modulation choke. The letters designating the other pieces of apparatus correspond to the designating letters on the other circuit diagrams.

were receiving tubes, against the ten used in the transmitter represented by Fig. 2. The crystal-controlled oscillator operated in the 3.5-mc. amateur band, and was followed by two frequency doublers. After this came a second amplifier using a receiving tube and operating in the 14-mc. 'phone band, and the final amplifier which employed a UX-210 tube on the same frequency. It was with this transmitter that we were best able to check the results given in Page's paper and satisfy ourselves of the inadvisability of using screen-grid tubes as frequency doublers.⁹ The UY-224 tubes were removed and UY-227 tubes temporarily substituted, but this change did not permit of sufficient increase in power to satisfactorily excite the UX-210 tubes for Class C operation, although the output was noticeably increased. The transmitter was modulated with good results as far as quality was concerned, but the power output was so meagre

doubler in the 7-mc. band, and a second frequency doubler operating at 14,300 kc. The 7.5-watt tubes were decided upon in order that sufficient excitation to the modulated amplifier would be obtained without overloading any of the preceding tubes. Full excitation of the modulator tubes was obtained with a double-button microphone followed by a two-stage amplifier having a voltage amplification of 800.

It will be noticed from the block diagram of Fig. 4, as well as from the wiring diagrams, that the low- μ low-impedance UX-842 tube is given preference over the general purpose UX-210 for use as the crystal-controlled oscillator. Experience with both tubes indicates that the UX-842 is a better crystal oscillator tube than the UX-210. Similar experience in comparing the UX-210 with the high- μ high-impedance UX-841, shows that the UX-841 is the better frequency doubler. However, if these tubes are not available UX-210 tubes may be used quite successfully. Two UX-210 tubes in push-pull provide

⁸ See "Thermionic Vacuum Tube" by Van der Bijl, pp. 261.

the specified power output, and make a very suitable load for the two modulator tubes. UY-227 tubes are used in the speech amplifier stages.

THE OSCILLATOR AND FREQUENCY DOUBLERS

While it is desirable when designing a 'phone transmitter to start at the output and work backwards, just the reverse process appears to be best in building the various units and in getting them to function perfectly. For this reason the oscillator and frequency doubler unit will be described first.

Fig. 6 shows the schematic wiring diagram, while the method of construction is evident from the photographic cuts. Bread-board construction is used because of its simplicity and because it lends itself to picture description much better than panel construction. The component parts used in the construction of this unit are mounted on a well-seasoned board 9 inches wide and 24 inches long. All parts except the r.f. chokes, plate circuit by-pass condensers, plate current jacks, and filament center-tapped resistor and by-pass condensers are mounted above the board. This construction keeps all of the higher r.f. voltage wiring on top, so the leads may be made as short and direct as possible; only the wiring and apparatus operating at d.c. voltages appear beneath the supporting base.

The oscillator is crystal-controlled and is provided with switch-jaws so that one of several crystals may be plugged into the grid circuit at a moment's notice. A blocking condenser in series with the crystal prevents the bias battery from becoming short-circuited if the crystal should be taken out of the holder and the two plates accidentally come in contact with one another. Bias to the oscillator tube is fed to the grid through a choke coil. The plate circuit of the oscillator (and amplifiers) is series fed to reduce the work of the radio-frequency chokes.

The frequency doublers use UX-841 tubes. Neither of the doublers is neutralized, although there is no reason why they could not be, and there are good reasons why they should be, even though neutralization reduces the output by eliminating regeneration. It will be noticed that a slightly different arrangement of the inductance and capacitance is used in the plate circuit of the second frequency doubler than is used in the first. The split coil or "balanced" arrangement is necessary to have high radio-frequency voltages at both ends of the coil so that the respective

grids of the push-pull amplifier will be properly excited 180° out of phase. If the more common arrangement used in the first doubler circuit were to be employed in coupling the output of the frequency doubler to the modulated amplifier, one grid of the push-pull amplifier would take all the excitation while the other grid would be at ground potential and receive no excitation. The amplifier would fail to operate push-pull under these conditions.

In building the oscillator and frequency doubler unit, care should be exercised to see that good mica condensers are used to couple the plate circuit of one tube to the grid circuit of the following tube. The coupling condensers have not only the d.c. plate voltage, but in addition the grid bias voltage across them. Thus, if the plate voltage is 500, and the grid bias of the following tube is 135 volts, the d.c. voltage

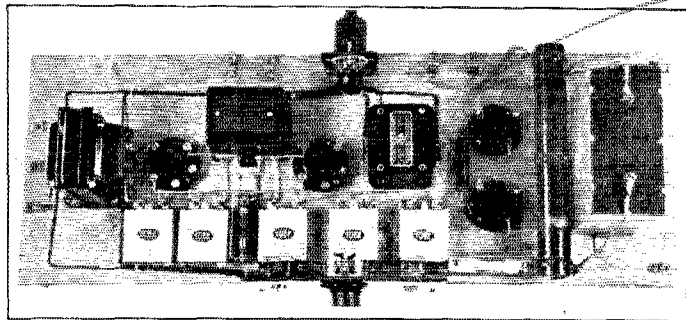

LAYOUT OF THE SPEECH AMPLIFIERS AND MODULATOR

From left to right may be seen the Ferranti microphone input transformer, first speech amplifier socket, Silver-Marshall type 255 audio-coupling unit, the second speech amplifier socket, 3-1 type A Sangamo audio transformer, modulator tube sockets, plate voltage dropping resistor and the 2-ufd. audio by-pass condenser. The jacks for measuring microphone current and modulator plate current, as well as the gain control, are mounted on the bakelite panel.

across the condenser is 635 volts, and this is in addition to any radio-frequency voltage across the condenser. A breakdown of a coupling condenser short circuits the plate and grid battery voltages, and causes the grid of the succeeding tube to have a high positive bias applied to it. Failure to use good mica coupling and blocking condensers, therefore, may be the cause of ruining some perfectly good tubes as well as a violent strain on the plate supply and bias-batteries.

The modulated amplifier is constructed in bread-board style similar to the construction of the oscillator and frequency doublers. Here, as in the case of the former unit, all high radio-frequency voltage wiring is above the supporting base-board, only the d.c. voltage wiring, chokes, by-pass condensers and filament center-tapped resistor remaining below. A small radio-frequency choke coil is included in the grid circuit of each tube to minimize any tendency on the

7-1/2" x 9"
3 1/2"
1007

part of the amplifier to oscillate. The neutralizing condensers are made from 100 μ fd. midget receiving condensers by removing alternate plates and spacing those remaining so that the total capacitance of the altered condensers is approximately 25 μ fd. each. A small by-pass condenser

having a voltage transformation of approximately 5. The second speech amplifier uses a UY-227 tube, as does also the first amplifier, and the output of the second amplifier is coupled to the grids of the modulator tubes through a 3/1 ratio audio transformer. A 100,000-ohm potentiometer is connected across the secondary of the microphone transformer, with the center arm connected to the grid of the first tube and is used as the gain control. A 100,000-ohm fixed resistor is connected across the first audio transformer secondary.

The total voltage amplification from the grid of the first tube to the grids of the modulator tubes is approximately 800. A 300-ohm resistor is inserted in the grid circuit of each modulator tube to prevent any tendency of the modulators to oscillate at ultra high frequencies. The series plate resistor for reducing the plate voltage to the modulated tubes and the 2- μ fd. audio by-pass condenser across it are at the extreme right of the modulator unit.

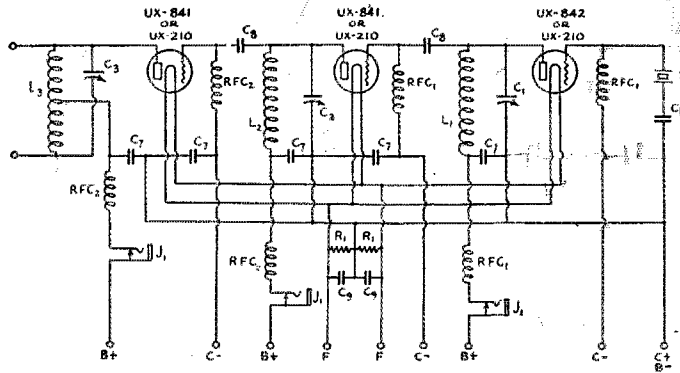

FIG. 6.—SCHEMATIC WIRING DIAGRAM FOR THE OSCILLATOR AND FREQUENCY DOUBLER UNIT

- L_1 —30 turns of No. 24 wire on tube 1.5 inches in diameter.
 L_2 —18 turns of No. 24 wire on tube 1.5 inches in diameter.
 L_3 —4 turns of No. 14 wire on tube 2.5 inches in diameter.
 C_1 —100- μ fd. oscillating tuning condenser.
 C_2 —100- μ fd. first frequency doubler tuning condenser.
 C_3 —50- μ fd. second frequency doubler tuning condenser.
 C_4 —500- μ fd. blocking condenser.
 C_5 —1000- μ fd. by-pass condenser, 1000-volt break-down.
 C_6 —100- μ fd. coupling condenser, 5000-volt break-down.
 C_7 —1000- μ fd. by-pass condenser.
 R_1 —75-ohm filament resistor.
 J_1 —Plate current jack.
 RFC_1 —Radio-frequency choke; 200 turns of No. 38 wire on $\frac{1}{2}$ -inch dowel.
 RFC_2 —Radio-frequency choke; 100 turns of No. 38 wire on $\frac{1}{2}$ -inch dowel.
 X —Crystal and Mounting.

is used across the plate battery to provide a path of low reactance to radio-frequency currents. This condenser must be sufficiently small to offer high reactance to audio frequencies or some of the higher speech frequencies will be by-passed and the quality of speech may be impaired. A 100- μ fd. condenser is satisfactory. The plate coil is center-tapped and is tuned with a 250- μ fd. condenser. The antenna coils and series tuning condenser will depend upon the type of antenna used; for a half-wave "split" antenna and feeder system, two coils of six turns each together with a 350- μ fd. condenser are satisfactory. The schematic wiring diagram is given in Fig. 7.

Little need be said concerning the construction of the speech amplifier and modulator unit. The wiring diagram of Fig. 8 and the cut show the details much better than a good many written words. A microphone input transformer having a ratio of 28.5/1 is used to couple the double-button microphone to the grid circuit of the first speech amplifier. The output of this amplifier is fed to a resistance-inductance audio coupling unit

operate properly begins. One cannot simply connect the various units to any filament, grid, and plate voltage supply system and hope that good quality transmission will result from haphazard adjustment; 14-mc. 'phone transmitters don't follow that sort of procedure and the job is considerably more complicated. However, by sectionalizing the various portions of the transmitter and working with only one circuit or amplifier until it is functioning satisfactorily, the complexity may be kept to a minimum. The following suggestions are as applicable to c.w. transmitters as to radiophone transmitters; c.w. men too can benefit by following the suggestions given.

The first point of attack is the oscillator. A quartz crystal having a natural frequency of vibration between 3525 kc. and 3575 kc. is connected in the grid circuit of the oscillator tube, the 3500-ke. inductance is plugged into the plate circuit, and filament power is switched on. A 0-100 d.c. milliammeter provided with flexible leads and a telephone plug is connected in the plate circuit by means of a closed circuit jack connected in

ADJUSTING AND OPERATING THE TRANSMITTER

When the construction of the three units has been completed, the real fun (or work) of getting the 'phone to

the plate lead and fastened below and at the rear of the base-board. Grid and plate voltages are applied to the tube and the plate circuit tuned to resonance as indicated by a pick-up lamp or by the variations in plate current. Plate voltage of from 180 to 220 is sufficient for the oscillator tube and, if a UX-842 tube is used, the grid voltage will be of the order of 90 volts. For a UX-210 oscillator the bias will be about 45 volts. Plate current will be approximately 15 or 20 milliamperes under these conditions. When the crystal is oscillating properly it will be possible to light to full brilliancy a flashlight lamp connected in a one-turn pick-up coil when the coil is coupled to the inductance in the plate circuit.

When the oscillator is functioning properly and is giving a reasonable power output, the first frequency doubler should be put into operation by following a similar procedure. The tube is operated with a plate voltage of 500 and the grid bias is adjusted for maximum power output obtainable with safe plate dissipation. Using a UX-841 frequency-doubler, under these conditions the cut-off bias is approximately 17 volts (62 volts for the UX-210), but maximum power output obtains with a bias of about 67 volts (112 volts for the UX-210). The plate current under these conditions is entirely due to grid excitation. Increasing the grid excitation will increase the plate current, while the plate current will be made to decrease as the bias voltage is increased. Ordinarily plate currents of 30 to 35 milliamperes are permissible with the UX-841, whereas slightly higher values are allowable if a UX-210 is used as the frequency doubler; but in any case the maximum safe plate dissipation rating of the tube must not be exceeded. This implies that the plate circuits are loaded, a condition not met when adjustments are first made, and for this reason it may be advisable to make all adjustments at first with reduced plate voltage. The final adjustments can be made later with full plate voltage with greater safety than if full power is attempted at the start.

When the bias is adjusted for obtaining maximum output with safe plate dissipation, it may be found that the power output can be slightly increased by retuning the oscillator plate circuit slightly for tuning adjustments are very likely to be different with the first frequency doubler operating than when no load except that of the pick-up lamp (which caused some detuning) is coupled to the oscillator. Proper adjustment obtains when the oscillator tank circuit is so tuned that the plate current of the doubler is a maximum.

Adjustment of the second frequency doubler is pretty much the same process as that just outlined. The plate milliammeter is connected by plug and jack in the plate circuit of the second frequency doubler and the bias arbitrarily set at approximately 67 volts or more, after which

the plate voltage is applied. In tuning the plate circuit of this tube, which will be biased beyond cut-off, the plate current will dip to a minimum as resonance is reached, and increase as the circuit is detuned. The proper tuning adjustment is that at which the plate circuit is tuned for the dip in the plate current. Here again, of course, the bias will have to be adjusted for maximum power output with the tube operating cool. A bias of 90 volts, with plate current of some 40 to 60 milliamperes, is approximately correct for this

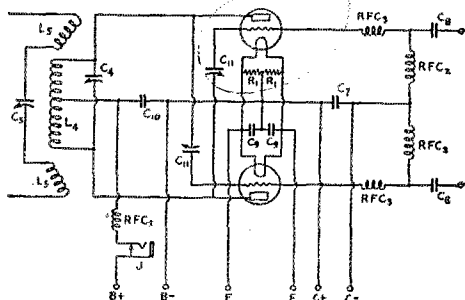

FIG. 7.—THE PUSH-PULL 1½-MC. MODULATED AMPLIFIER CIRCUIT

- L*₁—6 turns of 3/16-inch copper tubing, center-tapped.
- L*₂—6 turns of 1/4-inch copper tubing.
- C*₁—250-μfd. tuning condenser.
- C*₂—350-μfd. antenna tuning condenser.
- C*₃—100-μfd. coupling condenser, 5000-volt break-down.
- C*₄—1000-μfd. filament by-pass condenser.
- C*₅—100-μfd. by-pass condenser, 5000-volt break-down.
- C*₆—25-μfd. neutralizing condenser.
- RFC*₁—Radio-frequency choke, 100 turns of No. 38 wire on 1/2-inch dowel.
- RFC*₂—Radio-frequency choke, 20 turns of No. 24 wire 1/2 inch in diameter.
- J*₁—Plate current jack.

stage with the UX-841. Higher bias will be required for a UX-210 tube. If line voltage is subject to appreciable variation, perhaps the bias will require changing as the primary voltage of the plate supply unit increases and decreases. Under such conditions it appears to be advisable to keep the bias automatically adjusted for plate voltage variations by using grid-leak in addition to grid-battery bias. Since all of the amplifier tubes draw a rather heavy grid current this procedure should work out very well. However, this has not been found necessary with the transmitter described in this article.

It may be found that because both sides of the tuning condenser in the plate circuit of the second frequency doubler are at high radio frequency potential, body-capacitance effects may be troublesome in tuning the plate circuit, but after a few trials the proper adjustment may be obtained easily. Although the plate tank of the second frequency doubler should be adjusted for the plate current dip, the plate circuits of the preceding tubes should be tuned to bring the plate cur-

rent of the last tube to a maximum — other conditions remaining unchanged.

The method of adjusting the transmitter with respect to juggling the grid and plate voltages has been outlined, but it should not be forgotten that during the tuning process a monitor is a valuable guide in indicating the quality of the carrier. The frequent use of a monitor during the tuning and adjusting process is highly recommended.

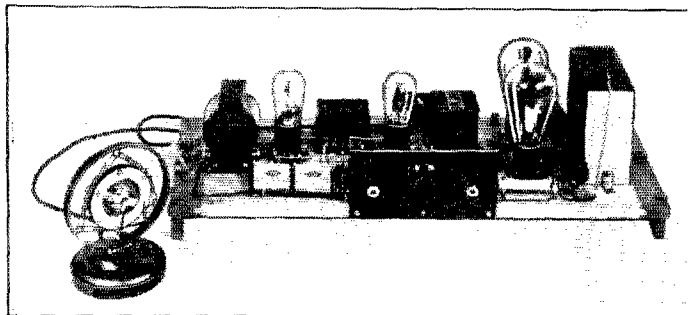

THE UNIVERSAL MICROPHONE, SPEECH AMPLIFIERS, AND MODULATORS

And now we come to the modulated amplifier which in some ways is simpler and in other ways more difficult of adjustment than the other radio-frequency circuits. Operation of the modulated amplifier is simpler in that the grid and plate voltages may be more accurately predetermined than those of the oscillator or frequency doublers. It is also easy to determine when the amplifier is being properly modulated, although it is not always an easy matter to rectify the faults if the system does not operate exactly as it should. This alone is an excellent reason for giving sufficient time to the design of the modulator, speech amplifier, oscillator, frequency doublers, and output amplifier, before any constructional work is attempted.

Unfortunately the plate-characteristic curves for the UX-250 tube are not available at the time of writing, so that it is impossible to specify exactly the proper voltage relations to give complete modulation when using UX-250 tubes to modulate the UX-210 amplifiers. Nevertheless, a sufficiently high modulation factor is obtained by operating the UX-250 tubes with from 450 to 500 volts on their plates and dropping this through a series resistor so that the plate voltage on the modulated amplifiers is 350.⁹ This fixes the plate voltage of the modulated amplifier at 350 and for the conditions of Class C operation, the grid bias must be greater than the 44 volts required to produce cut-off. Experience indicates that for Class C operation "double cut-off bias"

usually is approximately correct and a bias of 90 volts is convenient and satisfactory for a first trial.

We must introduce the modulator tube into the picture at this time to operate the modulated amplifier and for convenience and the saving of time, it will be best to determine that the speech amplifier and modulator are operating properly before work on the modulated amplifier is started.

This is a simple matter, for the unit must function as a high quality audio amplifier. The heaters of the UY-227 tubes are lighted and 90 volts applied to the plate of the first amplifier and 135 volts to the second. The grid bias, as determined from the technical data sheets supplied with the tube, then becomes 4.5 volts for the first tube and 9 volts for the second. The microphone is operated with a current of about 10 milliamperes per button, and to make the best use of double-

button transmitters, the current through both buttons must be approximately the same.

When the speech equipment is properly adjusted, the plate current of the modulator tubes remains essentially constant as the microphone is spoken into. Otherwise, distortion is present in the audio system, and the plate and grid voltages must be juggled until the condition for distortionless amplification is obtained.

With the modulator and modulated amplifier connected together through the constant current choke coil as indicated in the complete wiring diagram of the transmitter in Fig. 5, the next job to be tackled is neutralization of the push-pull amplifier.

Of the amplifiers with which we are familiar the push-pull type is the easiest to neutralize. Their neutralization may be completed with a nicety of adjustment difficult to obtain with single-ended amplifiers. A pick-up coil and flashlight lamp is usually used to indicate the degree of neutralization, but this method is not very accurate for low power transmitters and there are at least two better methods of indicating neutralization. Perhaps the simpler of these two is to use a pick-up coil of one or two turns of wire connected to a low-scale reading thermo-galvanometer or thermo-milliammeter. A thermo-galvanometer having a full scale deflection of 100 milliamperes is very satisfactory for this purpose, and if a current squared meter is used, it later may be used advantageously to determine whether the modulated amplifier is operating as Class C or not. The pick-up coil is coupled to the tank circuit of the push-pull amplifier and the plate circuit tuned to resonance with the excita-

⁹ See "Vacuum Tube Layouts in Telephone Modulation" by E. E. Spitzer, QST, February, 1930.

tion voltage, but with no plate voltage applied. The neutralizing condensers are then adjusted *simultaneously* until the galvanometer deflection is reduced to zero. The plate circuit should then be tuned slowly above and below the resonant frequency and the neutralizing condensers slightly readjusted until no deflection of the galvanometer needle occurs for *any setting* of the tuning condenser. The amplifier will then be neutralized. A vacuum tube voltmeter may be used to indicate complete neutralization as well as the galvanometer and is the most sensitive of the three methods.¹⁰ (Incidentally, a "modulometer" is just as essential a piece of equipment to the 'phone man as a monitor and is deserving of a lot more attention than it has been receiving.) During the proc-

ess of neutralization grid bias should be applied but the plate voltage must be "off."

ciently increase excitation, the plate voltage on the oscillator may be slightly increased. Ordinarily this will not be the case, although it is a possibility if the transmitter design and adjustment are not thoroughly correct. The antenna may be coupled to the output amplifier, and it will be found that when the antenna is tuned to resonance and the modulated amplifier loaded, the plate current will increase to about 60 milliamperes. The antenna current under these conditions will vary with the type of antenna used. Using a 3500-kc. Zeppelin antenna at W1AL-WICEI the set puts 0.1 ampere into the 65-foot feeders; with a fundamental doublet arrangement operating at 14.3 mc., antenna currents of from 0.3 to 0.5 ampere are obtained. It

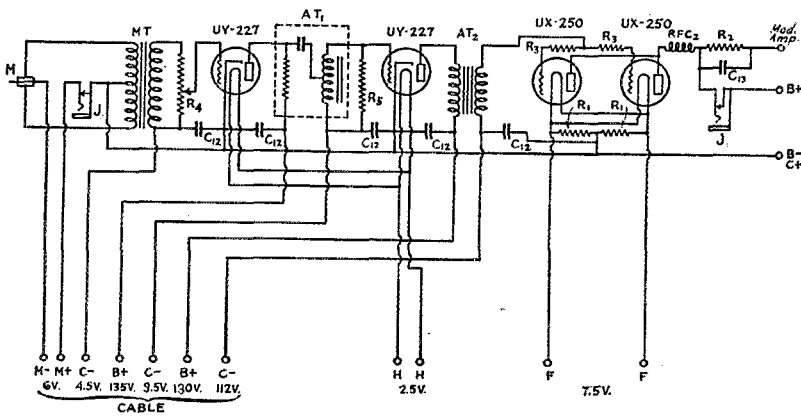

FIG. 5. — THE SPEECH AMPLIFIER AND MODULATOR

- C₉ — 1000- μ fd. filament by-pass condenser.
- C₁₂ — 1- μ fd. by-pass condenser.
- C₁₃ — 2- μ fd. audio by-pass condenser.
- R₁ — 75-ohm filament resistor.
- R₂ — 2000-ohm plate voltage dropping condenser.
- R₃ — 300-ohm grid resistor.
- R₄ — 100,000-ohm gain control.
- R₅ — 100,000-ohm resistor.
- AT₁ — Audio-frequency coupling unit.
- AT₂ — Audio-frequency transformer.
- J₁ — Modulator plate current jacks.
- J₂ — Microphone current jacks.
- M — Double button microphone.
- MT — Microphone coupling transformer, 28.5/1.

ess of neutralization grid bias should be applied but the plate voltage must be "off."

When the push-pull amplifier is completely neutralized, plate voltage may be applied through the dropping resistor connecting this amplifier with the modulator. The grid bias on the UX-210 tubes should be approximately 90 volts and excitation should be such that the plate current is about 40 milliamperes without the antenna coupled to the plate circuit of the tubes but with the plate tank tuned to resonance, as indicated by the plate current dip. If it is not possible to obtain this plate current with 90 volts of bias the probability is that the frequency doublers are not properly exciting the push-pull stage. If readjustment of the doubler circuits does not suffi-

was found that with the 3500-kc. Zeppelin antenna, considerable interference was created in the vicinity of 1200 kc. when the feeders were connected to the plate tank. It seems that such antenna systems, working against ground as quarter-wave radiators at lower frequencies determined by the antenna plus feeder length, may be the cause of considerable interference when shock-excited by a higher frequency signal.

The remedy, of course, is to use either a smaller and more suitable 14-mc. antenna or the larger antenna inductively coupled to the tank circuit. Perhaps in this lies the explanation of much B.C.L. interference otherwise inexplicable. Telegraph transmitters might be similarly effected.

The transmitter is now ready for the final test of determining whether or not the push-pull amplifier is operating as Class C and of determining

¹⁰ See "The Modulometer" by James J. Lamb, QST, August, 1929.

the percentage of modulation. In making these tests it is advisable to disconnect the antenna from the radiating system and employ a dummy antenna to reduce interference to a minimum, especially since these measurements may be made just as well on a non-radiating antenna system.¹¹ It is desirable first to determine whether or not the push-pull amplifier is adjusted to operate as a Class C amplifier.

In Class C amplifiers it is requisite that the power output vary as the square of the plate voltage. A simple method of determining that this condition exists is to measure the dummy antenna current when the UX-210 tubes are operated at their normal plate voltage of 350, and again when the plate voltage is raised to twice this value. The antenna current in the latter case should be twice the antenna current obtained with normal plate voltage. If it is not, the amplifier is not operating as Class C. Another way of checking operation of Class C amplifiers is by using a current squared thermo-galvanometer and pick-up coil coupled to the tank circuit of the amplifier so that when the plate voltage is 700, a full scale deflection will be obtained. With normal plate voltage (350 volts) the deflection should be just half of that obtained with the higher plate voltage. If the meter is not a current-squared meter but reads current, the scale reading in the second case should be 70% of the deflection obtained with the higher plate voltage. Methods of determining modulation percentages have been thoroughly covered and we are not going into an extended discussion of these determinations.¹² As a final test, the quality of voice signals with zero-beat reception on an oscillating receiver should be good. If signals are rough or "fuzzy" it is quite evident that frequency modulation is present in a considerable amount. Zero-beat reception is a real test for the constancy of the carrier. When a well-designed 'phone is used at the transmitting end, zero-beat reception may be advantageously used to reduce interference because of the increased selectivity of an oscillating receiver.

POWER SUPPLY

The power supply for the transmitter described in this article should, of course, be considered at the time the transmitter is being designed. This transmitter requires a 500-volt power supply, capable of delivering at least 300 milliamperes: a "B" battery or substitute delivering about 30 milliamperes at 200 volts in addition to about 10 or 15 milliamperes at 100 volts, one transformer

delivering 3.5 amperes at 2.5 volts, and another transformer delivering about 10 amperes at 7.5 volts.

This covers the salient points of a successful 14-mc. 'phone transmitter and outlines the construction and operation of a particular transmitter which has been found to be entirely satisfactory. Small constructional details involved in such a transmitter are not given, nor should they be necessary, since those who obtain permission to operate 14-mc. 'phone sets will have the technical qualifications to deviate from the outline given above where such changes seem necessary and desirable.

The set described in this article is capable of producing a 10-watt constant frequency carrier, which can be modulated completely with the modulator unit described. The radio-frequency portion of the system may be used as a constant-frequency transmitter with a power output of 20 watts, and may be keyed in the return lead of the first 14-mc. amplifier, as indicated at the point, K, of Fig. 5.

The transmitter described in this article has only been on the air a few days at the time of writing this story, but it performs very satisfactorily. Stations which have worked W1AL-W1CEI report the quality of signals unusually good, with a high modulation factor. The voice is usually reported as being louder than the carrier signal and no difficulty is experienced in receiving the voice on zero beat when modern band-spread tuners are used. In one or two instances, where the operator at W1AL-W1CEI was known personally to the receiving operator, reports have been received that the station was identified by the operator's voice. Such reports at 14 mc. are the result of careful design, the application of modern advancements in communications engineering, and a good many hours of test work in ironing out the "bugs" that invariably show up in transmitters. By following the design and operating data presented in this summary of high-frequency 'phone technique, the amateurs qualified to operate 14-mc. 'phone transmitters can duplicate the results we have obtained. By following guess-work design and haphazard adjustment, the amateur will get nowhere.

LINEAR AMPLIFIER

There seems to be a general misconception as to the proper function and adjustment of linear amplifiers used after the modulated amplifier, and a few words regarding this class of amplifier seem quite appropriate, in concluding this article. Linear amplifiers are used after modulation to increase the radio frequency power output of the transmitter. They are operated so that the power output is proportional to the square of the excitation voltage; that is, as Class B amplifiers. The carrier power output is one fourth of the tube power rating given by the manufacturer, al-

¹¹ Dummies for the Amateur, Correspondence Section, QST, October, 1929.

¹² "The Use of the Electron Tube Peak Voltmeter for the Measurement of Modulation" by C. B. Jolliffe, *Proc. I. R. E.*, April, 1929.

"The Modulometer" by James J. Lamb, QST, August, 1929.

though on peak-voltage swings the maximum instantaneous power output is that of the tube rating. That is to say, the carrier output of a UX-210 tube—for instance—operated as a linear r.f. amplifier is 1.87 watts, although on the peak swings the instantaneous power output may rise to 7.5 watts.

The adjustments for a Class B linear amplifier—whether push-pull or single ended—are simple and may be divided into three steps:

1. The grid bias must be adjusted for cut-off. This may be determined either experimentally by increasing the bias until no plate current indicates on the plate circuit milliammeter, or may be calculated quite accurately for triodes by taking as the cut-off bias value the operating plate voltage divided by the μ of the tube.

2. Excitation is adjusted by coupling to the preceding amplifier until the power output is a maximum. This condition obtains when the antenna current is a maximum.

3. Excitation to the Class B amplifier is then reduced until the power output is one fourth of the maximum value obtained under the conditions given in paragraph 2. This condition is obtained when the antenna current is one half of the maximum antenna current.

The excitation adjustment is made, (A) by varying the coupling between the plate circuit of the modulated amplifier and the grid circuit of the linear amplifier or (B) by increasing the value of the series resistance and decreasing the shunt resistance in the grid circuit of the linear amplifier. A specific example will, perhaps, make clearer the adjustment of linear amplifiers.

Suppose we wish to operate a UX-852 tube as a linear amplifier following the 14-mc. 'phone described in this article. The operating plate voltage is, let us say, 2000. The cut-off bias, *Ec*, will then be

$$\text{cut off bias} = \frac{\text{operating plate voltage}}{\text{amplification factor}}$$

In our case the cut-off bias will be 2000/12 or 167 volts. This bias is applied to the tube and the tank circuit tuned to resonance, as is also the antenna circuit. Suppose that with all circuits in resonance and maximum excitation applied to the UX-852, we obtain 1 ampere antenna current. This is the best condition for operation as a c.w. transmitter, but the amplifier does not operate as a Class B linear amplifier and is not suited for 'phone transmission. It will be necessary to reduce the excitation to this amplifier (without changing any adjustment except excitation) until the antenna current is 0.5 ampere. (It seems needless to say that the excitation should be reduced by decoupling and not by detuning any of the low-power r.f. amplifiers.) The amplifier is now properly adjusted to function as a linear amplifier for 'phone transmission under these conditions.

DX

This radio telephone with an output of ten watts has carried on communication with New Zealand from Hartford.

Movies Available

AS mentioned in the article "Amateur Radio and the National Air Races" (December, 1929, *QST*), the official movie of the amateur communications work will be available for showing at radio club meetings and conventions anywhere in the country, by paying the transportation charges and guaranteeing safe handling of the film. This 16 mm. film requires about 20 minutes for a showing and it makes a permanent record of a splendid example of thorough amateur communications organization work. Requests for the film should be addressed to A.R.R.L. Headquarters, and will receive attention in the order in which they reach this office.

Roanoke Division Convention

Charlotte, N. C., March 21st and 22nd

OH, Yea! Who said we were not going to have another convention? Take notice, you doubting "Thomas," that the Charlotte Radio Association is roaring and ready to put over the best convention ever held in this section, and extends to everybody in the division and surrounding states a most cordial invitation to attend. We had good speakers last year, and we expect to have some good ones this year and besides you will have plenty of entertainment. The Chamber of Commerce will be the place where all events will be held. There are a number of good reasonable hotels a short distance from the meeting place. Remember, fellows, that while we are a small division we have always had a good percentage attendance and let's see if we cannot make it 100% this year. Communications Manager Handy will be the official representative from A.R.R.L. and the Executive Committee may be able to send another man with him. Chairman E. J. Gluck, c/o Broadcasting Station WBT, Charlotte, N. C., would like to hear from you all.

Strays

The new national frequency standard at the Bureau of Standards is built so as to be accurate to within one part in 20 million. This means that measurements can be made in the 28,000-ke. band with precision of almost one cycle. Just think, slightly more than one cycle and not accounted for!

Official Frequency System

THE Official Frequency Station Committee, a part of the Experimenters' Section of the A.R.R.L., has arranged the services described below for the benefit of the members of the League and others who may wish to use them.

1. Standard Frequency Transmissions are sent by the Standard Frequency Stations W9XL and W1XV (known as O.F.S.-S.F.) on definite schedules with a high degree of accuracy. All the principal amateur bands are covered, several points being given in each so that frequency meters may be accurately calibrated.¹

These transmissions are based on piezo-electric frequency standards. The standard used by W9XL is checked at intervals by the Bureau of Standards at Washington. That used at W1XV is checked against the standard time interval in the M. I. T. laboratory at Round Hill.

2. Official Frequency Transmissions are sent by Official Frequency Stations (known as O.F.S.) at a somewhat lesser degree of accuracy. These stations do not transmit on regular schedules but announce their frequency at the end of at least every other transmission during their regular amateur operation. Such stations will measure the frequency of your transmission upon request.

Practical suggestions are always welcome and should be sent to the proper member of the Committee which is composed of the following: Don C. Wallace, W6AM, Chairman in charge of O.F.S., Room 410, 209 Pine Ave., Long Beach, Calif.; Prof. C. M. Jansky, Jr., care of University of Minnesota, Minneapolis, Minn.; and Killian V. R. Lansingh, W6QX, in charge of O.F.S.-S.F., Box 666, Hollywood, Calif.

STANDARD FREQUENCY SCHEDULES

Friday Evening Schedules *Friday and Sunday Afternoon Schedules*

Time (p.m.)	Frequency, kc.			Time (p.m.)			
	A	B	AB	BB	C	CD	
8:00	3500	7000	7000	4:00	7000	14,000	
8:12	3550	7100	7100	4:12	7100	14,100	
8:24	3600	7200	7200	4:24	7200	14,200	
8:36	3700	7300	7300	4:36	7300	14,300	
8:48	3800	3500	4:48	14,400	
9:00	3900	3650			4:00	14,400
9:12	4000	3850				
9:24	4000				

The time is the local standard time at the transmitting station. 8:00 P.M. at W1XV is 0100 G.C.T. and 8:00 P.M. at W9XL is 0200 G.C.T. Similarly, 4:00 P.M. at W1XV is 2100 G.C.T. and 4:00 P.M. at W9XL is 2200 G.C.T.

¹ See "Utilizing Standard Frequency Transmissions," QST, Sept., 1929.

DATES OF TRANSMISSION

Date	Schedule	Station
March 7, Friday	A	W1XV
" 9, Sunday	CD	W9XL
" 14, Friday	BB	W1XV
" 14, Friday	AB	W9XL
" 21, Friday	B	W1XV
" 28, Friday	AB	W9XL
" 30, Sunday	C	W1XV
April 4, Friday	A	W1XV
" 6, Sunday	CD	W9XL
" 11, Friday	BB	W1XV
" 11, Friday	AB	W9XL
" 18, Friday	B	W1XV
" 25, Friday	AB	W9XL
" 27, Sunday	C	W1XV

Schedule "BB" sent at 2100 G.C.T. on one Friday of each month is transmitted at that hour for the particular benefit of European stations. If sufficient reports on its reception are not received, it will be discontinued.

THE STATIONS

W1XV: Massachusetts Institute of Technology, Communications Department Experiment Station, Round Hill, Dartmouth, Mass., H. A. Chinn in charge. Uses Eastern Standard Time and characteristic letter "G."

W9XL: Northwestern Broadcasting, Inc., R. F. D. No. 3, Anoka, Minn., H. S. McCartney in charge, assisted by Lyall K. Smith, Ivan H. Anderson and George Collier. Uses Central Standard Time and characteristic letter "D."

DIVISION OF TIME

A total of 12 minutes is allotted to each transmission divided as follows:

- 4 minutes — QST QST QST de (call letters).
- 3 minutes — Characteristic letter ("G" or "D") sent very slowly and broken by call letters each half minute.

1 minute — Statement of frequency in kilocycles to nearest integral figure.

4 minutes — Time allowed to change to next frequency.

ACCURACY

The transmissions of both stations will be within 1/10 of 1% of the frequencies herein announced, which is considerably better than the accuracy to which the average good amateur frequency meter can be calibrated and maintained constant. During each transmission by W1XV the integral frequency nearest its exact frequency within 1/100 of 1% will be announced for the benefit of those able to use such accuracy, but for all general amateur purposes the frequency of transmission of both stations may be

(Continued on page 80)

Electrolytic Condensers and a High-Voltage Rectifier

By Clark C. Rodimon, Assistant Editor

IN 1922 the old five-watter, UV-202, was the popular transmitting tube for the amateur. Filters and rectifiers were not a necessity unless a radiotelephone transmitter was aimed at. If a filter was desired it could be purchased for a small sum, as the voltages encountered were under 1000. The rectifier could be made up from jelly glasses, provided "canning" season wasn't on, and enough might be appropriated. An r.a.c. note is easier to filter at 200 meters than on our higher frequencies, so the filter and rectifier needed very little time, thought and cash to construct. The more prosperous amateur used the UV-203, but this rated 50-watter would not stand any overload, so the amateur still had only plate voltages of 1000 and under to consider. Of course, there were exceptions. We would hear of a ham in some other district who operated a station using a UV-204. This amateur probably used a motor-generator for plate supply and needed no filter, or he had a "sync" rectifier and *didn't want a filter*.

Alas, poor Yorick, times have changed. For the price of a 50-watter the amateur can purchase a 75-watter. Tubes of this variety thrive on 2000 volts — and up; the 204-A and larger tubes need at least 2000 volts for plate supply. Thus the rectifier and filter problem is entirely in a different class from that of by-gone years.

We have always used paper dielectric condensers for our filter circuits, unless the "pie-plate" variety of electrolytic happened to be successful. These paper condensers always did their filtering in great style, until the voltage happened to exceed the rating of the condenser. Then it was necessary to acquire more condensers until they blew up on unintentional overloads. Where are these condensers we used to have? Probably they are exactly in the same heap at your station, as they are at the station of this ham. In a weak moment the condenser rating was over-stepped and the resulting crackling and fireworks got to be a familiar sound just as we were at the crucial moment in a QSO. Nothing is left of these condensers now save possibly "jolted" memories.

The trend at present seems to be in the use of manufactured electrolytic condensers in B.C. power packs; why shouldn't we give this type of condenser a trial? For one thing, it has the inherent merit of not being permanently damaged when "over-volted." Why wouldn't this be just the condenser for a high-voltage filter?

With these cross questions and answers in our minds we decided to give electrolytics a trial. The Sprague Specialty Company, Quincy, Mass., just starting production on this form of condenser, offered us the use of several of their models for test and the Amrad Corp., Medford Hillside, Mass., also shipped us some of their Mershon electrolytic condensers.

The characteristics of these condensers are as follows: (A) High capacity; (B) Medium voltage rating; (C) Compactness; (D) No residual charge; (E) Not ruined by puncture; (F) No heavy charring surges; (G) No surges with keying; (H) Need no attention, and (I) Longevity. Look-

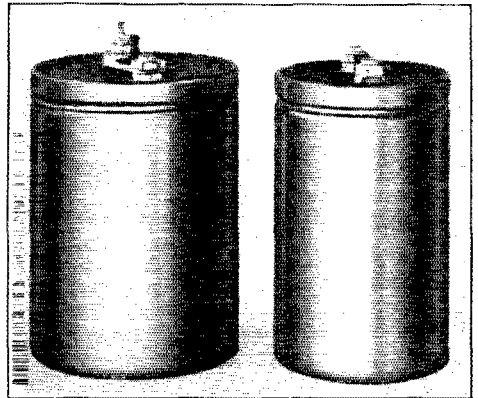

ELECTROLYTIC CONDENSERS

ing over the characteristics of this condenser, we are impressed by its apparent usefulness.

Taking each characteristic in turn and commenting on it, we note that these condensers are made in several different capacity ranges, from 8 μ fd. to 72 μ fd. The ones we have been experimenting with are the 18- μ fd. single-anode type. Each condenser when used alone or in parallel with like condensers will filter up to 425 peak volts.

These condensers come in metal cans. The Amrad condenser is 4 inches high and 3 inches in diameter; the Sprague condenser is 4 inches high and 2½ inches in diameter, though a later model is 1¾" in diameter having a screw base and mounting socket. Both types are the single anode variety, the metal can being the cathode. Electrolytic condensers come with one, two, three

and even four anodes. Each anode to cathode is the rating in capacity of the condenser. For example, a four-anode 8- μ fd. condenser has four anodes and each one has a capacity of 8 μ fd. to cathode. With all four anodes connected in parallel by a jumper, the condenser has a capacity of 32 μ fds.

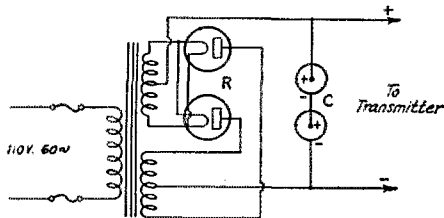

FIG. 1.—POWER SUPPLY FOR VOLTAGES UNDER 550

R—Rectifier tubes may be UX-281 or UX-866.
C—Electrolytic condensers of 18 μ fd. capacity.

The single anode variety is recommended for high-voltage series operation. When used in series the cells should be connected as one would connect cells of a battery; anode to cathode. The anode of the condenser connects to the positive high voltage; this is necessary because the polarity of the condenser must coincide with the polarity of the rectifier.

The next point to consider is "no residual charge." When the high voltage is shut off there is no charge left in the condensers. They will not hold a death defying jolt after the power is turned off.

An overload on the condenser from high voltage surges only makes more load for the rectifier and decreases the capacity of the condenser during the overload. The electrolytic condenser of 8 μ fds. only builds up to about 1.1 times the r.m.s. voltage of the rectifier as compared to about 1.4 times the r.m.s. voltage for 2 μ fds. of paper condensers. Therefore, they are suitable for use with the UX-866 rectifier tube when voltages slightly in excess of 1750 (recommended limit of the UX-866) are contemplated. When using paper condensers and over 1750 volts r.m.s. through the rectifier tubes, the peak inverse voltage of 5000 for the UX-866 may be exceeded with probable ruination to the filament of the rectifier tube. However, voltages up to 2100 volts r.m.s. will be safe for UX-866 tubes with at least 3 μ fds. effective capacity with electrolytic condensers.

The next point in consideration is the lack of charging surge when the high voltage first passes through the rectifier and charges the condensers. This initial charge is considerably less with the electrolytic condenser and thus keying surges are minimized thereby benefiting voltage regulation, rectifier tubes, transmitting tubes and the characteristics of the emitted signals.

OPERATION

Experimental tests were run with electrolytic condensers in a filter with a transmitter in actual operation. These tests were conducted at W1SZ and voltages between 1500 and 3000, r.m.s., were used. Attention centered on 2000 volts r.m.s.

One of the disadvantages that we saw might result from connecting any number of these electrolytic cells in series was that the voltage division between cells might not be uniform unless we used some sort of auxiliary voltage divider. This voltage divider consisted of ten-watt, 200,000-ohm resistors. One resistor was connected across each set of three cells when six were used in one block for 2000 volts. These were found to be satisfactory.

Knowing the amateur mind and how hard it is for him to wait for apparatus, besides his inherent economy using as little apparatus as is possible, we tried the condensers across the rectifier without voltage dividing arrangement of any sort to see what would happen. However, we could not trust more than 300 volts per cell with this arrangement so seven cells were used in series for 2000-volt operation.

This arrangement was used over a period of three weeks which meant just about 100 hours of actual operation. At times the voltage was run up to 3000 r.m.s. with eleven cells in series, and no

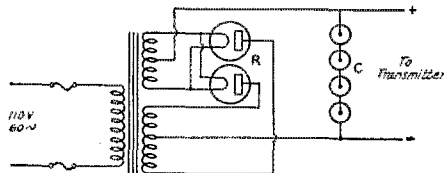

FIG. 2.—POWER SUPPLY FOR VOLTAGES UNDER 1100

R—UX-866 Rectifier tubes.
C—18- μ fd. single anode electrolytic condensers.

attempt at voltage division. With eleven cells in series and each cell having a capacity of 18 μ fds., it didn't seem reasonable that there would be much filter action. However, this was not the case. The note was very nearly the same as with only six or seven cells in series at 2000 volts. It is reasonable to suppose that in the case of six in series there was a capacity of 3 μ fds., and with eleven in series the capacity was approximately half this amount.

DIFFERENT FILTER COMBINATIONS

To the original six cells in series we put in parallel another batch of six in series. Thus we added another 3 μ fds. of capacity to the filter. The output or signal did not change; evidently the first condenser had filtered all that could be filtered by a condenser in this position. A 15-henry choke was then put in the positive lead behind the first condenser, but there was no

further smoothing of the output noticeable, and the output voltage decreased slightly because of the increased drop through the choke. Then the other 3 μ fds. was added after the choke, making 3 μ fds. each side of a 15-henry choke. This did not improve matters noticeably. Thus our original arrangement of six cells in series using voltage dividers, or seven cells in series without voltage dividers, seemed to be as much filter as was needed. What did the note sound like? This is not a fair question to answer until the circumstances are described. These condensers were being used in the last stage of a crystal-controlled transmitter which had d.c. on the preceding stages. However, and to our surprise, the note was very nearly without modulation when listened to at a distance of one mile. Almost without exception, the note was reported as d.c. This was not a complete test, though, so the tests were repeated with a self-excited transmitter.

TESTS WITH HIGH- AND LOW-C SELF-EXCITED TRANSMITTERS

A high-C 7-mc. transmitter was used in the "lab" for our self-excited arrangement. The power was a UX-210 with 500 volts of r.a.c. from a UX-281 rectifier. The original filter consisted of 2 μ fds. of condenser either side of a 30-henry choke. This resulted in a d.c. carrier. We

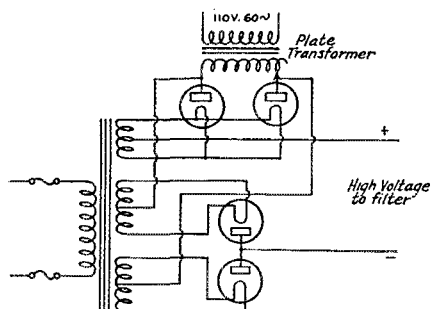

FIG. 3.—SINGLE-PHASE FULL-WAVE SERIES RECTIFIER CIRCUIT

Recommended for voltages between 1800 and 3500 r.m.s and peak current of .6 amp.

substituted six electrolytic condensers in series with no voltage dividers, without the choke of the original filter; the resulting carrier was d.c. We did not have a high-power self-excited transmitter available to use, but there is no reason that results should not check those of the low-power transmitter. This high-C transmitter was then converted to a low-C Hartley and tests repeated. With the original filter the note was d.c. However, with the six electrolytics in series and no choke the note had r.a.c. present. With the choke included the note was once more d.c. With the low-C transmitter the carrier was at no time steady.

CONCLUSION

For transmitters of 1930 calibre we found that six electrolytic condensers of the type we tested in series would filter an r.a.c. carrier to d.c.

Six electrolytic condensers in series were sufficient to withstand 2000 volts r.m.s when using

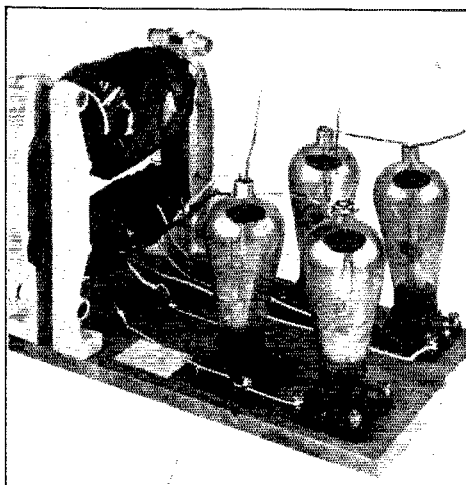

THE COMPLETE 3500-VOLT RECTIFIER

voltage dividing resistors. Seven were used for the same voltage, without voltage dividers, with equivalent results.

THE RECTIFIER

Since the coming of the UX-866 type of hot cathode mercury-vapor tube, the amateur has had at his disposal a rectifier tube with practically no voltage drop and one capable of rectifying comparatively high voltages. Its merits have been aired in the columns of QST before this so the details of its operation will not be gone into. However, more stress should be placed on the advisability of using these tubes in series when voltages over 1750 but under 3500 are to be rectified.

Fig. 3 shows the rectifier circuit which was hooked up and used in connection with the filter mentioned before. With this arrangement the tubes will stand 10,000 volts inverse peak, which is to say, 3500 volts r.m.s. The peak-current rating of .6 remains the same with 4 UX-866 in this series (single-phase full-wave four-tube) circuit as when using two of them in a single-phase full-wave rectifier circuit. This rectifier was found easy to filter and caused no trouble or annoyance at any time. Any transmitter using a tube larger than a 50-watt has enough elements to cause trouble and annoyance without having the rectifier and filter kick up.

FILAMENT TRANSFORMER FOR RECTIFIER

With voltages of the order of 10,000 peak inverse and all wires at this potential to ground, it

is necessary to insulate the filament transformer and windings for this voltage. In the photograph of the rectifier may be seen the home-made transformer. This transformer was made after deliberation as to where three filament transformers

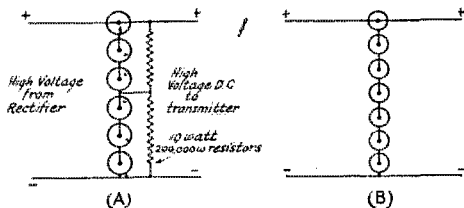

FIG. 4.—ELECTROLYTIC FILTER FOR 2000 VOLTS

- (A) Six cells in series with voltage dividers. See text.
 (B) Seven cells in series without voltage dividers.

with 2.5 volt secondaries insulated for 10,000 volts could be secured. The only logical solution seemed to build one up. The necessary constructional dope was found in the *Handbook* so work proceeded — and halted, for only half of the original core was available. However, work went ahead, regardless. It was necessary to wind about 300 extra turns on the primary to compensate for lack of core material, but the resulting transformer was worth those extra turns. Using a voltmeter and with one UX-866 tube as a load, the turns were put on each secondary until the 2.5 volts were secured. The regulation was surprisingly good from no-load to full load of the rectifier tubes. In fact, as reported in January *QST*, the voltage went up as the load was applied. Eureka! This was too much. After brain storming and joking over the results we effected a cure. The voltmeter was moved away from the field of the core! The drop in each secondary winding was then barely noticeable on the voltmeter when the load came on.

Plenty of empire cloth was used. The Standard Electrical Handbook rates one thickness of empire cloth to withstand 11,000 volts but, to be on the safe side, three layers were put around all windings. The resulting transformer was far from original specifications in design but in operation it was all that could be desired.

In closing it might be well to state that the price of electrolytic condensers does not make them prohibitive for the amateur pocketbook. Each condenser retails for about \$4. Thus the total cost of a 2000-volt filter supply will be approximately \$30.00 — 1½ cents per volt or \$10.00 per microfarad.

We are indebted to Mr. R. U. Clark, formerly of the Amrad Corporation and now with the Sprague Specialities Company, for the details and constructional data on electrolytic condensers.

A New Condenser for Amateur Tuners

PERHAPS the most tedious job around the modern amateur station is the construction of the proper tuning inductance to give wide "dial spread" of the amateur bands with a small tuning condenser. If it were possible to change the capacity range of the condenser, the work of constructing amateur band tuners could be simplified.

Such a condenser, known as the type 201-E taper plate condenser, has recently been marketed by the Allen D. Cardwell Mfg. Corp. of Brooklyn, N. Y., and is shown in the cut. The condenser is provided with one rotor plate, and one stator plate. By loosening the nuts holding the stator plate to the insulating cross arm, the stator

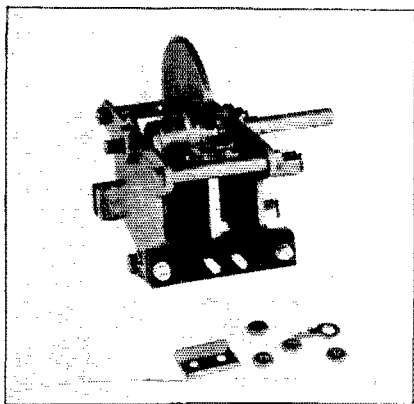

plate may be moved away from the rotor plate any distance up to about a quarter of an inch. This provides a condenser with a minimum capacity of approximately 6 $\mu\text{fd.}$ and a maximum capacity (depending upon the adjustment of the stator plate) of from 11 $\mu\text{fd.}$ to 50 $\mu\text{fd.}$ With the sliding stator plate, slight miscalculations in the inductance of the tuning inductance can be compensated for by setting the stator plate so that the entire amateur frequency band is covered.

— B. D.

Strays

When in doubt — use a frequency meter.

Bayne of W4AAQ reminds us that key clicks can sometimes be eliminated by connecting two 1- $\mu\text{fd.}$ condensers in series across the 110-volt line and grounding the center or common terminal of the two condensers.

SAY, SON—

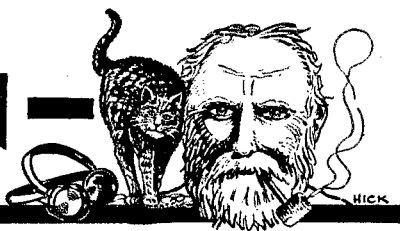

Beats there a breast in Hamateur Radio which isn't thrilled to bits by the good news that The Old Man is coming back to QST? — back with all his trappings, the Wouff-Hong, the Rettysnitch, the Blifsky and sundry Uggerumpfs, the Little Wife, Kitty and the old cob. T. O. M., a genial old pirate to those who operate decently, is yet the Awful Ogre standing over amateur radio and meting out punishment to those who transgress. His classic yarns in QST about things that are "rotten" in amateur radio, though filled with a pungent humor, are mighty good for what ails us. He has this month some very pregnant comment on one situation which is certainly "rotten." Let his announcement be a warning! — EDITOR.

SAY, SON, now listen: I'm coming back into the game. I am needed. I've been thinking about it for a year. And the good old Wouff-Hong and Rettysnitch are coming along, too. The two latter still carry the gory stains of the past. Both have been sharpened up good and proper and they are all set for the worst. Please let all hands be advised as, of and from this date, that certain Young Squirts have been selected to be Wouff-Honged and Rettysnitched 'twixt now and the full of the second moon hence. Certain others are going to get a fatherly pat on the back. They deserve it. But, by Gorm, it will not be pats that will be dealt to some of the amateurs I notice running loose today. Things sure have come to a pretty pass while I have had my back turned. But it is going to be fixed in the good old-fashioned way we used to fix things in amateur radio. That's what the Wouff-Hong and the Rettysnitch are for. They have cleaned up dirty messes before and they can do it again. And so this old gink, with his trusty cob pipe and his Kitty, desires to have it understood by every amateur, old or young, on all continents, whether QST-English is understood or not, that the old-time soap kettle has been retrieved, set up, filled with high-boiling-point transformer oil, equipped with a brand new automatic forced-draft white-flame burner, and that the first frequency gargler caught transmitting out of the amateur bands is going to get swoggled with the Wouff-Hong, skewered with the Rettysnitch business and then boiled in transformer oil.

Now listen again: Certain Young Squirts of today may think they can do with amateur radio what they see being done with prohibition. Well, your uncle is here to tell them QSD. And there's a period after that QSD and not a query. If they think this is hot air, let them seek out any old-time amateur. Let them ask him what became of and happened to those brash young radio

pollywogs of other days who got out of the amateur band. Let them ask what became of those gay young swashbucklers who used to butt in and QRM the first trans-continentals. Let them ask where the remains may be found of those brave babies who QRMed the BuStands fading tests. Just let them ask. It will be good for their souls to find out. If they do not chatter the fillings out of their teeth and if every hair on their soft beans does not stand up stiff and shoot blue corona, then we will take the matter up with the Royal Order of Wouff-Hong and have the Committee on Diabolics prescribe something. They have had experience and know how.

Yes, you Young Squirts who are off the track in amateur radio, it's all down in the book, written in gory red in the sacred annals of amateur radio. And to help matters along a trifle, your aged uncle has come back, maybe a little whiter, maybe a little more gnarled, but by heck fifty times more bloodthirsty. The Old Cob and Kitty are still going strong — especially the Cob. The wife hasn't been able to sit in the same room with it for a couple of years past. Kitty is just as good a cuspidor as ever, and any Young Squirt not knowing what all this means better catch the next bus and consult with the nearest old-timer.

One more Sunday School announcement: While this old mill is working, just let me say that the first blood to be let is probably going to be from those unfortunates who were careless enough to have busted the transatlantic telephone service on Christmas Day by being out of the amateur bands. I copied Handy's broadcast on that and it clearly shows who my first candidates ought to be. That's not altogether a healthful thing for an amateur to do. Every one of those frequency jumpers better grab his wave-meter while the grabbing is good and beat it for the tall timber, for, come hell or high water, he is in for it. The chances are that every amateur wave-meter

will have to be compared with a crystal-controlled master meter that is accurate to 7×10^{-7} of a cycle before we get done with this out-of-band business. The owner of any wave-meter that is out more than 1 feel like specifying at the time gets the works — Wouff-Hong, Kettysnitch and Boiling.

S'allfrnw.

The Old Man.

Election Notice

To All A.R.R.L. Members Residing in the
CENTRAL DIVISION

1. You are hereby notified that a special election for A.R.R.L. Director is about to be held in the Central Division, A.R.R.L., to fill the remainder of the 1929-1930 term left vacant by the death of Clyde E. Darr. Your attention is invited to Section 1 of Article IV of the Constitution, providing for the government of A.R.R.L. affairs by a Board of Directors; Section 2 of Article IV, defining their eligibility; and By-Laws 9 to 18 providing for their nomination and election. Copy of the Constitution and By-Laws will be mailed any member upon request.

2. The election will take place during the month between March 15 and April 15, 1930, on ballots which will be mailed from Headquarters in the first week of that period. The ballots will list the names of all eligible candidates nominated for the position by A.R.R.L. Central Division members.

3. Nominating petitions are hereby solicited. Ten or more A.R.R.L. members of the Central Division have the privilege of nominating any member of the League in that Division as a candidate for Director therefrom. The following nominating form is suggested:

(Place and date)

*Executive Committee,
American Radio Relay League,
Hartford, Conn.*

Gentlemen:

We, the undersigned members of the A.R.R.L. residing in the Central Division, hereby nominate, of, as a candidate for Director from this Division for the remainder of the 1929-1930 term.

(Signatures and addresses)

The signers must be League members in good standing. The nominee must be a League member in good standing and must be without commercial radio connections. His complete name and address should be given. All such petitions must be filed at the headquarters office of the League in

Hartford, Conn., by noon of March 15, 1930. There is no limit on the number of petitions that may be filed, but no member shall append his signature to more than one such petition.

4. This election is the constitutional opportunity for members to put the man of their choice in office as the representative of their Division. They are urged to take the initiative and file nominating petitions immediately.

For the Board of Directors:

K. B. WARNER, *Secretary.*

Hartford, Conn., January 1, 1930.

Strays

For the information of amateurs we publish below the contents of General Order No. 75 of the Federal Radio Commission, dated October 30, 1929.

1. Every licensee operating a radio station under a license from the Federal Radio Commission who receives a notification from a Department of Commerce Supervisor or Inspector regarding any violation of the Federal laws in force, or any violation of the orders or regulations of the Federal Radio Commission or any violation of the terms and conditions of the station license, shall within three days of receipt of such notice send a written reply in triplicate to the Supervisor or Inspector from whom the notification was received.

2. The answer to each notice shall be complete in itself and shall not be abbreviated in the least by reference to any other communications or answers to previous notifications that the licensee may have received and answered.

3. If the notification relates to some violation that may be due to the physical or electrical characteristics of the transmitting apparatus the answer to the inspector shall state fully what steps if any are being taken to prevent future violations and if any new apparatus is to be installed the date such apparatus was ordered shall be given, the name of manufacturer and promised date of delivery.

4. If the notification of violation relates to some violation caused by lack of attention or improper operation of transmitter, the name and license number of operator in charge shall be given.

The American Radio Relay League has pleasure in announcing the reappointment of Mr. Paul M. Segal, of Washington, D. C., as its general counsel. Mr. Segal was formerly the League's counsel but necessarily resigned that post upon joining the legal division of the Federal Radio Commission in early 1929. With his return to private practice, as reported in our last issue, his services again became available to the League and were promptly embraced by our Executive Committee.

The operator who is using the call XW2PX in European waters may have a dozen or more QSL cards by informing W2PX of his proper address.

H. D. Pendleton of Waterford, Conn., and a side-kick of the "Old Connecticut Yankee," says that aluminum salt- and pepper-shakers, which can be purchased in a variety of sizes, can be used for shields for vacuum tubes or plug-in coils.

A High-Gain Direct-Coupled Power Amplifier

By George E. Fleming*

BEFORE taking up the discussion of direct-coupled amplifiers, it may be well to consider the function of an amplifier in the general sense. There is only one thing that an audio amplifier system is supposed to do, and a good many things that it is not supposed to do. The fewer things an amplifier does, the better it is.

The one function of an audio amplifier, as we see it, is to take an audio frequency signal of small magnitude and increase this signal to one of large magnitude without altering its original form. It should not discriminate against one band of audio frequencies in favor of another; should not alter the wave form or phase of the original signal.¹

Although much excellent work has been done on the problem of audio amplification in recent years and one has only to listen to a modern broadcast receiver and compare it with one of five or less years ago to realize that real progress has been made in this field, even the best systems available leave much to be desired this side of perfection. We all realize this, but a hasty review of existing systems may make a few facts more apparent.

Let us consider the transformer coupled amplifier first, since it is the most popular type. In Fig. 1 we have the fundamentals of a transformer-coupled stage.

The fallacy of expecting perfect reproduction is immediately apparent when we consider that the signal voltage developed across the load in the plate circuit of VT is directly proportional to the reactance of the load. In this instance the load is inductive and follows the formula $XL = 2\pi fL$, where f is the frequency of the alternating signal voltage in cycles per second, and L is the inductance in henrys. It will be seen that as f increases the load reactance increases proportionately, since L remains constant. Because the load reactance increases with frequency, it follows that the voltage developed across the load should increase with frequency. In actuality it does, and the low-frequency response of such a system will be

neglected in favor of the high-frequency response. To get an appreciable reactance at low frequencies, the value of inductance in the primary must be high. This means a great number of turns on a large core.

The principal advantage of this type of amplifier is that we can have a voltage step-up in the transformer itself. Therefore, to realize upon this voltage step-up the ratio of turns in the secondary to those in the primary must be high. A trans-

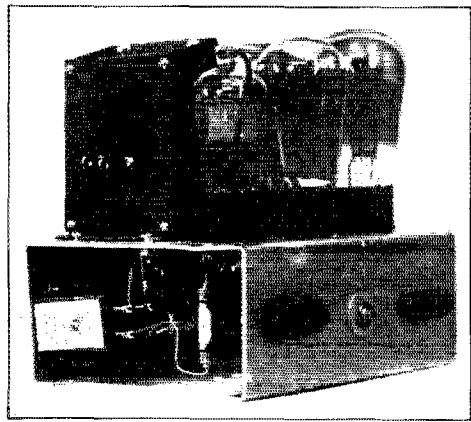

THE AMPLIFIER COMBINED WITH ITS POWER SUPPLY

The small filter required permits an unusually compact assembly. The jacks at the left are for phonograph pick-up input and those at the right for connection to the speaker. The slotted shaft in the center is that of the potentiometer. The tubes, from left to right, are the screen-grid input tube, power amplifier, and full-wave rectifier.

former with a three-to-one ratio must have, of course, at least three times as many secondary turns as primary turns. As we are definitely limited in how low we can go in primary turns, it follows that the only way to get this ratio is to use an extremely large secondary.

In the use of this large secondary we run into distributed capacity effects very quickly since in effect we have a quite appreciable capacity shunting the secondary. This accounts for the sharp high-frequency cut-off found in so many modern amplifiers, with the accompanying lack of brilliance. Also, the sibilants are frequently conspicuous by their absence.

No mention will be made of wave-form distortion, hysteresis, the effect of saturation of the core by direct current flowing in the primary, resonance, etc. Doing so would prolong this article unnecessarily.

* Loftin-White Laboratory, 11 West 42nd St., New York City.

¹ The component frequencies in a complex wave-form must maintain their proper phase relations with respect to each other when the signal is passed through the amplifier. If the coupling devices offer widely different reactances to the various frequencies, a shift in phase relation sufficient to cause noticeable distortion may occur. This phase of phase alteration does not involve the complete phase reversal between the grid and plate circuit of a tube or slight phase-shifts which affect the whole complex wave-form uniformly.

— Editor.

The case against resistance coupling, however, is not quite so condemning. Certainly it has advantages over the transformer type.

In Fig. 2 we see a resistance coupled stage. There are not the phenomena of frequency discrimination noted before except in the case of C_1 . C_1 is a series reactance, capacitive in nature, placed so as to isolate the plate of VT_1 and the

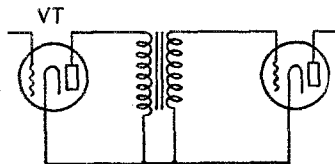

FIG. 1

grid of VT_2 in a direct current sense, yet coupling them in an a.c. sense. This capacity, however, will show discrimination against low frequencies unless it is made very large. It will follow the law

$$X_C = \frac{1}{2\pi f C}$$

where C is the capacity in

farads. We may assume that the condenser has negligible reactance at 60 cycles if it has a capacity value of 4 μ fd. or so. In this case the resistance of R_2 must be small to permit the condenser to discharge, otherwise the grid of VT_2 will become blocked. We are all familiar with this phenomena, having experienced it frequently.²

Now a little consideration of this diagram will show us that in an a.c. sense the series combination of C_1 and R_2 is in shunt with R_1 . This pre-

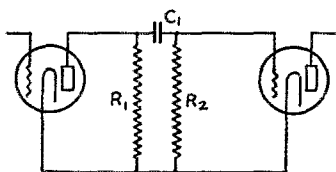

FIG. 2

cludes the possibility of getting any appreciable load resistance in the plate circuit of VT_1 , for if R_1 is made very large in an effort to do this, the d.c. drop across it is entirely out of proportion and the d.c. supply voltage will have to be unreasonably high. Therefore, we see that even though we use high μ tubes, our amplification per stage is definitely limited, and several stages are required to get any gain at all. Some engineers have made an effort to use a screen-grid tube as an amplifier in such a circuit, but the plate impedance of these tubes is so high that only a very small part of their theoretical amplification is realized.

In Fig. 3 we have the rudiments of a direct-coupled stage of amplification. We find here none of the undesirable phenomena noted in the preceding cases we have considered. We see only one resistance, with the plate of VT_1 coupled conductively to the grid of VT_2 . There is no possibility of frequency discrimination, wave-form distortion, phase shift, or any of the other contingencies we must try to avoid, as neither inductance nor capacity is used.³ Theoretically, it is the perfect amplifier and the system is fundamentally sound.

Dr. Pierce realized the truth of these statements fifteen years ago, went into the Patent Office with the basis of the present amplifier, and was granted patents covering the system. The Bureau of Standards has used a similar system for several years as being the only one capable of nearly perfect amplification. However, every such system has certain drawbacks that prevent general use of the amplifier.

Let us hastily run over the problem that faced Commander Loftin and Mr. White when they at-

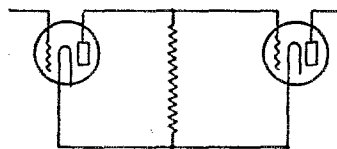

FIG. 3

tempted to make such a system operate. To begin with, they had just what has been described: a theoretically sound system that simply would not work. The reason, principally, is that the grid bias to the last tube is furnished through a common resistance that also furnishes plate potential for the first tube. If the various potentials are juggled so that the system is in a state of equilibrium, the moment a signal is applied to the grid of the first tube, the state of equilibrium is disturbed. The grid potential and consequently the plate current of the last tube, go off at various tangents. The Bureau of Standards has attacked the problem by making the grid bias of the first tube manually variable, and putting a current indicator in the plate circuit of the last tube. In this way, the system was made to behave somewhat as long as someone stood by and continuously adjusted the bias. This, of course, was highly unsatisfactory and resulted in a system that was entirely unsuited for general usage.

There is also a drift effect that is annoying. With nothing to apparently disturb the state of equilibrium of the system, the plate current of the last tube begins to drift until it is some hundred per cent out of line and, of course, the tube is en-

² "Motor-boating." — Editor.

³ Stray circuit capacities and tube capacities not considered here. — Editor.

tirely off its operating curve. This, and various other wrinkles, had to be ironed out.

The problem was attacked from various angles. No effort will be made to go through the tedious history of all the experiments that were tried and all the blind alleys that were explored. Only brief mention will be made of a few of the several ways that were evolved.

One of them (perhaps it will be remembered) was published about two years ago.⁴ This system took advantage of the property of a filament to vary its emission with temperature. This property was used to vary the bias on the first tube and worked out very satisfactorily. It was abandoned, however, in favor of other systems, because even a UX-199 costs money and adds another tube to the system.

Various bridge systems were tried with success, and may be used even now in special applications. Also, the property of an ordinary lamp to change its resistance with current flow was used successfully. This, however, is subject in a lesser degree to the same objections to which the 199 tube was subject.

The simplest as well as cheapest system discovered is to use a little resistance in the cathode of the first tube to over-bias this tube, and to make the grid-return positive so as to partly cancel out the bias. Such a system is shown in Fig. 4.

We all know that when a tube has a signal applied to the grid, the space current increases. If we self-bias the tube by a series resistance in the cathode, the drop across this resistance will be greater when a signal is applied. The percentage of increase is ordinarily insufficient to keep the grid negative when a large signal is applied, but by over-biasing and cancelling with a positive potential from a different source we increase the effect many fold. This is the system used to stabilize the Loftin-White amplifier.

In Fig. 5 we have a complete diagram of the amplifier. We will not dwell at length on the stabilizing scheme, since we hastily covered that before. However, in this diagram the resistance R_K is the negative biasing resistor referred to above. The drop across this resistance is about 15 volts and the grid return is made 13 volts positive to cancel all but 2 volts, which is the normal negative bias under which we operate this tube.

We have been asked repeatedly how it is possible to conductively couple the plate of VT_1 and the grid of VT_2 when the first is positive and the second is negative. As a matter of fact, they are both at the same potential, but the plate of VT_1

is positive and the grid of VT_2 is negative to their respective cathodes, which are maintained at different potentials. The diagram shows a common resistance R_c , forming the only coupling medium for both elements. The plate current of VT_1 flowing through this resistance will cause a voltage drop across it, and since it returns to a point at approximately the same potential as the cathode of VT_2 , we see that the grid of this second

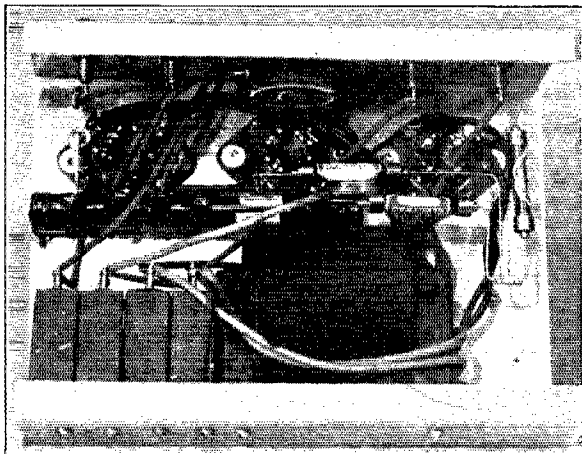

BENEATH THE BASE OF THE AMPLIFIER
Transformer, condensers, and resistors are arranged compactly.

tube will be negative with respect to its cathode by the drop across R_c .

To satisfy the condition of maximum gain, we want the same drop to occur in this resistance as occurs across the plate circuit of the first tube. This is readily accomplished by returning to a point somewhat positive with respect to the cathode of the second tube, thereby getting sufficient drop to bias the second tube. In Fig. 5, we drop 145 volts in the resistance R_1 and apply 145 volts to the tube. Since we have 195 volts in the arm and the grid of VT_2 must be 50 volts less than this, we go up, about 90 volts, and satisfy the condition. These values are worked out proportionately and will vary with the voltage available. We are assuming 450 volts available from the filter, in this instance.

There is only one other point that we will dwell on at any length. That is the "hum-bucking" effect. There is no need for one to be willing to construct a power pack that will give perfectly hum-free output. However, such a pack costs real money to build. The amplifier will actually amplify at 60 cycles, so the hum presents a real problem. However, since we already have a large resistance in the cathode that must be by-passed, we might as well utilize the fact that we have a filter circuit handy.

If we have a poorly filtered source of d.c. there will be a hum-voltage in the arm. Therefore,

⁴ Direct-Coupled Detector and Amplifiers, *Proc. I.R.E.*, March, 1928.

let us pick a point on the arm where the phase of the supply hum bucks the phase of the hum present on the grid, and return the high side of the cathode resistance there through a 1- μ f.d. condenser. This point is just above the grid return, and if it were not for variations in tubes,

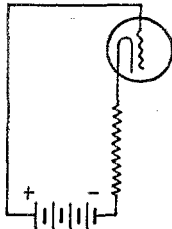

FIG. 4

might well be fixed. However, tubes do vary, so this point is variable by making a portion of the arm a 200-ohm potentiometer. With this circuit and with a filter using one choke with one "mike" before it and nothing after, the hum is reduced practically to inaudibility. The by-pass condensers shown are 1- μ f.d. each.

We will attempt to make the closing of this article as short as possible, but we feel that it will be of interest to know what one may expect of a system of this kind. Curves run on such an am-

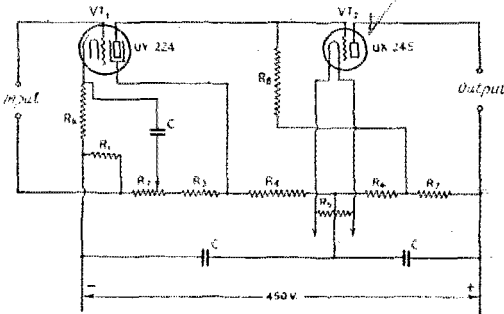

FIG. 5 — CIRCUIT OF A TYPICAL DIRECT-COUPLED AMPLIFIER

- R_k — 50,000-ohm resistor.
- R₁ — 425-ohm resistor.
- R₂ — 200-ohm potentiometer.
- R₃ — 775-ohm resistor.
- R₄ — 4700-ohm resistor.
- R₅ — Filament center-tap resistor.
- R₆ — 40,000-ohm resistor.
- R₇ — 100,000-ohm resistor.
- R₈ — 0.5-megohm complying resistor.
- C — 1- μ f.d. each.

plifier as we have just described show that the system in itself is capable of practically flat amplification from 30 cycles to about 7000 cycles. At 7000 cycles the curve begins to droop because of the input capacity of the output tube; we can use a simple form of neutralization here and carry the curve out flat to above 10,000 cycles. If a

screen-grid output tube should be used, no such phenomena would occur. At the low end the cut-off is set by the output device used but even with commercially available output units the drop begins at less than one hundred cycles.⁶

The uses of such an amplifier are manifold. The most obvious ones, of course, are in broadcast and short-wave receivers, speech amplifiers for public address work, and in transmission. By properly proportioning the voltage on the first tube we may have a very sensitive detector, yet one that will handle signals of large magnitude before overloading. The sensitivity in this case will be equal approximately to that of a sensitive grid-leak detector while its overload point will exceed an ordinary power detector. This sensitivity, to a very large extent, is because practically no load is presented to the previous tuned circuit.⁶ This results in a marked resonance-rise that is all but lacking in the conventional detector circuit. Selectivity is greatly increased in this circuit for the same reasons. We believe that with amplifiers capable of such extraordinary gain, we will witness a radical improvement in phonograph pick-ups and microphone, since it is relatively easy to design faithful apparatus of this type if sensitivity is unimportant.

The voltage gain of the little job illustrated is about 450 and with another stage it may easily run to between 40,000 and 100,000. In television experiments, an amplifier of such fidelity and gain is a necessity, for faithfulness, combined with high gain, is essential. With a three-tube job, a 250 in the last stage is easily overloaded when the input is taken from a photo-electric cell.

It may be mentioned that by taking advantage of the trigger action mentioned in the first part of this article, a printer may be worked on c.w. signals without the use of any type of heterodyne to make the signals audible.

Strays

A good frequency meter for the amateur station doesn't cost much to make, costs little or nothing to calibrate, and is mighty good insurance when one remembers that even the patience of the RI is not infinitely elastic.

The *Wireless World* recently called our attention to an unusually selective receiving circuit which would permit reception of two 'phone stations operating close as 100 cycles to one another. We wonder what is done with the sidebands.

⁶ For design of output-coupling devices see, "Matching the Speaker to the Output Tube, *QST*, Jan., 1930. — Editor.

⁶ As long as the screen-grid tube does not draw grid current, its input resistance is very high. The tube will not draw grid current until the input signal voltage approaches in magnitude the negative bias value. However, the grid bias of VT₁ is automatically variable and the grid is kept negative even on strong signals. The power amplifier tube will overload before the grid of VT₁ becomes positive. — Editor.

Some Constructional Kinks

By George Grammer*

WHILE most of the following material is without doubt familiar to a great many amateurs, some of the newer hams have not had the opportunity to profit by the experience of others. Nearly all of these suggestions, when encountered for the first time, will bring forth that time-worn expression, "Why didn't I think of that before?" — all of them being so obvious that they are usually overlooked. We can't attempt to list all the little stunts and devices we have seen and used to make constructional work easier and better — we couldn't remember them all at once. Perhaps some of you fellows who read this have some pet schemes of your own that would be of help to the rest of us. If so, shoot them along; if a thing proves useful to one chap the chances are it will be equally so to hundreds of others.

TUBE BASE COILS

The glass envelope of most makes of receiving tubes is held in the base by means of a cement which softens when heated. If the tube is cooked for fifteen minutes or so in boiling water, the cement will soften sufficiently to allow the glass and the base to be separated without undue difficulty. Hold the bulb in one hand and the base in the other; then twist with sufficient force to break the joint. The wires can be broken off by continuing the twisting process until the strain causes them to fracture. The excess cement can easily be scraped out of the base with a penknife. Caution: Use heavy gloves when doing the twisting. The tube is hot and there is some danger that the glass will break. Don't use a good pot for the cooking — the cement is hard to remove once it gets a grip.

Cleaning out the prongs sometimes is a tiresome job, especially if the quite general process of heating the prong and poking through it with a wire is employed. Any wires soldered in the prongs should be cut off as short as possible inside the base, and the prong thoroughly heated with a well-tinned soldering iron until the solder runs. At this point the tube base should be held in the hand and given a quick flip; the wire and excess solder will be quite effectively ejected, leaving a clear channel. This sounds so simple as to be foolish, but it does the trick. Needless to say, a little care must be used in picking the "flipping" location, as hot solder is not altogether beneficial when spattered on good furniture.

A good job of winding can easily be done by measuring off the length of wire required for the

coil, fastening one end in the proper pin in the base, clamping the other end in a vise, and stretching the wire taut; the wire can then be wrapped tightly and evenly around the form by turning it in the hands and walking toward the vise. The required length of wire, in feet, may be found by multiplying the number of turns to be put on the

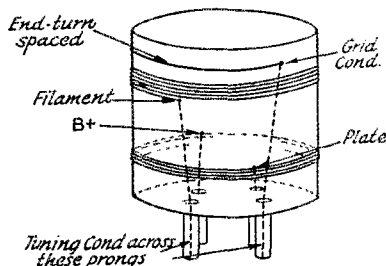

FIG. 1.— ARRANGEMENT OF CONNECTIONS ON A TUBE-BASE COIL WITH THE GRID-END TURN SPACED TO GIVE BAND-SPREADING

tube-base by .36. The turns can be spaced in this method of winding by simply judging the spacing by eye. If the builder hasn't sufficient faith in his eyesight or wants a more even job, two wires may be wound at the same time in "parallel," the second one of course being removed later. However, spaced windings are very rarely necessary except when the coils are intended for very high frequencies, and in a few special cases to be considered farther on.

A point which seems to worry beginners is that of getting the coil connections in the proper pins. Any pin arrangement may be used. The only thing to keep in mind is that the same arrangement must be used on all coils intended for a particular receiver. Personally, we prefer to use the two heavy prongs (filament) for the tuning coil connections, and the two small ones (grid and plate) for the tickler because the connections are easy to remember. However, any other combination will work equally well.

Getting the right number of turns on the coils is always a problem. Unfortunately, it is impossible to give any definite specifications, because it is rarely possible to estimate correctly the maximum and minimum capacities which will be connected across the coil. If the tuning condenser were the only factor to be considered it would be a simple matter to work out coil sizes for any frequency. However, with the small capacities used to tune high-frequency receivers the additional capacity

* A.R.R.L. Technical Information Service.

introduced by the detector tube and the wiring are of the same order as the tuning capacity and cannot be measured or calculated easily. Therefore the only method to follow is that of cut-and-try. If the amateur bands are to be spread over as much of the dial as possible the cut-and-try process is likely to be tedious, but cannot be avoided. It

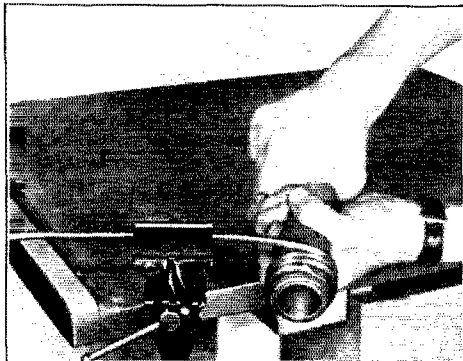

WINDING A COPPER-TUBING INDUCTANCE

One end of the tubing is held in the vise and the other is flattened out and bolted to the pipe used as a winding form. Putting on the tubing and turning the pipe in the hands, the operator walks towards the vise. The turns should be wound as closely together as possible and spaced later.

often happens that one turn makes a great deal of difference, particularly on the 14,000- and 28,000-ke. bands. In such a case if we find that 6 turns, for instance, are too many, and 5 are too few, spacing the last turn will be very helpful. The rule is to wind the larger number of turns, then move this last turn away from the others a little at a time until the band is covered on the dial the way it is wanted. Adjusting by cutting off a fraction of a turn at a time will accomplish the same result, but is not so easily done nor so flexible.

When the final adjustment is made the spaced turn must be fastened in some manner so it cannot move and shift the band off the dial. Colloid or Duco are excellent for holding the wires in place, and it is a good idea to coat the whole coil, because a change in temperature may cause the wire to expand and loosen up.

The tickler coil is another source of much grief. It seems to be the habit of ticklers to get connected in the circuit so the tube will not oscillate. There is a simple rule to follow so that the direction of winding for oscillation will be correct:

Wind both the grid and plate coils in the same direction, the grid coil at the upper end of the form and the plate coil at the bottom. The two inside ends of the coils go to the filament (for the grid coil) and plus "B" (for the plate coil). The top end of the grid coil is connected to the grid condenser and the bottom end of the plate coil goes to the plate.

The tickler must be added to or subtracted from until the tube oscillates smoothly over the entire range of the tuning coil and condenser. More cut-and-try. Important: Don't make the final adjustment on the tuning coil until after the tickler question is definitely settled; the tickler always has some tuning effect and you may have to do the work all over again.

SHIELDING

There seems to be a lot of misunderstanding regarding shielding. Aside from making the set dust-proof (which a cabinet will do just as well) shields may be used for two purposes: First, to prevent unwanted coupling and feedback between two circuits; second, to prevent pick-up of signals or interference between the coils and wiring. Obviously, shielding of the first type is only necessary when two tuned r.f. circuits must be isolated, as when tuned r.f. amplification is used. Shielding an untuned r.f. antenna coupling tube is useless from this standpoint. On the other hand, it is almost indispensable if the set incorporates tuned r.f., particularly at high frequencies. In the popular types of high-frequency receivers using a stage of screen-grid tuned r.f. ahead of the detector, only the r.f. stage or the detector stage need be completely shielded, preferably the detector for optimum selectivity. Shielding both stages perhaps makes a more complete job of it, but is not entirely necessary.

An aluminum or copper shield of the usual thickness around an audio amplifier is a joke for shielding purposes. About the only thing an audio

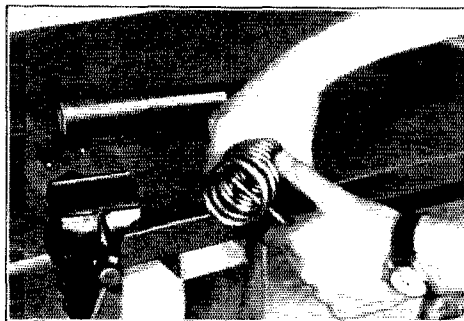

SPACING THE TURNS OF A COPPER-TUBING INDUCTANCE

The degree of spacing depends on the diameter of the spring-tool used.

amplifier need be shielded against is a.c. pickup from the house lighting system, and a shield to be effective at commercial house lighting frequencies would have to be made of thick sheet iron. Practically all types of audio transformers now available are completely enclosed in heavy iron cases and the shielding provided by the case is usually sufficient.

A point regarding r.f. shields which has recently been brought to our attention is that such shields should not be used as a common ground or common minus "A" connection for r.f. circuits if the shield is to be effective in eliminating hand-capacity. Even though such connections may be only a few inches apart, the shield has sufficient reactance at high frequencies to cause minute potential differences between these points, and when this occurs the tuning effect of the operator's hand is likely to be quite annoying. The moral is to make all the "ground" connections with insulated wires and ground the entire group at a single point on the shield; or, as an alternative, insulate the metal panel from the shields in the set and make a single ground connection to the panel from the common shield connections.

WINDING COPPER TUBING

Nice shiny copper-tubing coils look hard to make, but really aren't. The 3/16" size can be wound by hand in the same manner as ordinary wire; just a little more exertion is required. It can be wound on a piece of pipe or heavy tubing of the proper diameter. The tubing should, of course, be soft copper, such as that used for automobile gasoline connections, and in automatic refrigerators. The hard-drawn variety is much harder to handle.

When the 1/4" size is used a little different method is advantageous. One end of the tubing should be flattened and a hole drilled through it. A similar hole is drilled at one end of the iron pipe or other form around which the tubing is to be wound, and the tubing bolted to the pipe. The free end of the tubing may then be held in a vise; the tubing is straightened out and pulled taut, and winding accomplished by turning the pipe in the hands and walking toward the vise, keeping as much tension as possible on the tubing; 3/8" tubing can be wound in the same way, but more strength is needed.

The coil ends may be flattened out with a hammer, but a much neater job can be done by squeezing the tubing in a vise. A little care must be used in the flattening process in order to avoid cracking the tubing, but if the pressure is applied slowly no trouble will be encountered. The ends may then be rounded off and smoothed with a file.

If the tubing to be wound has some bends in it which prevent making an evenly wound coil, they may be ironed out without much difficulty by applying a little pressure to the tubing in the vise. (It will be seen that a vise is a most useful piece of equipment — also a great time-saver.) Another method of straightening is to place the tubing between two flat boards and rolling it. Small irregularities which cannot be entirely eliminated by either of these methods will usually disappear when the coil is wound.

We generally like to have the coil stay bright and shiny after it is wound, but the copper is sure

to turn a muddy-brown color if some measures are not taken to prevent it. Before winding, the tubing should be thoroughly cleaned and polished with steel wool and after winding a final polish should be given. The coil will be nice and bright, but don't make the mistake of applying lacquer to it directly. We did this on some coils made up recently, and they were badly discolored in a few days. The steel wool is somewhat greasy, and the coil must be thoroughly cleansed of grease before any coating is applied. Give it a good scrubbing with a little denatured alcohol on a soft rag. Then brush on the lacquer as soon as the alcohol evaporates. Duco "clear" varnish diluted with Duco "thinner" is excellent for the purpose. The thin coating offers no particular insulation to clip connections, so there need be no fear on that score.

The turns in the coil can readily be spaced correctly by inserting the round shank of a screw driver between them and giving a slight twist. A piece of wood of about the same thickness as the desired spacing may also be used to accomplish the same result. It should be spiralled through the coil between the turns from one end to the other. Simply holding the ends of the coil in both hands and pulling the turns apart does not generally result in a very even job; the outer turns will be spaced more widely than the inner ones.

INSULATING SHAFTS FROM METAL PANELS

It very often happens that the shaft on a variable resistor is connected to one side of the

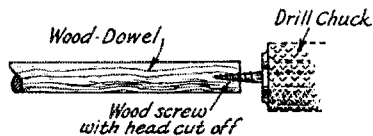

FIG. 2. — DOWEL MOUNTED ON A WOOD-SCREW HELD IN A DRILL CHUCK READY FOR WINDING
R. F. CHOKE

unit and sometimes it is necessary to insulate a condenser shaft from the panel. If the resistor is to be placed in the circuit in such a way that grounding either side is impossible, as in the case of a regeneration control resistor, it becomes necessary to insulate the shaft from the metal panel. Such insulation is of course unnecessary if a bakelite or similar panel is used.

It is a little hard to make a really good job of it without going to the trouble of manufacturing a special bushing. However, a simpler means will in most cases be entirely satisfactory. The hole in the panel should be drilled somewhat larger than the shaft of the unit, so that the shaft may be inserted without touching the panel at any point. The next step is to cut two washers from thin bakelite, fiber, or stiff cardboard, making them a

little larger than the hole in the panel. These washers are then drilled so that the shaft will fit snugly. In mounting the unit, one washer goes on each side of the panel. It is therefore necessary to space the shaft in the hole carefully so it will not touch the panel; winding some string or heavy thread around the shaft will help here. Once the shaft is correctly spaced, the nut on the front panel may be tightened up, assuming the unit is of the "single-hole mounting" type. If enough string is wound around the shaft to keep the unit from slipping, there will be no danger from accidental short-circuits. Similar methods for other types of units should readily suggest themselves.

WINDING R. F. CHOKES

Anyone who has tried to wind several hundred turns of fine wire by hand on a form of small diameter will appreciate a labor saving device such as this one. We don't intend to give any specifications for chokes of various bands in this

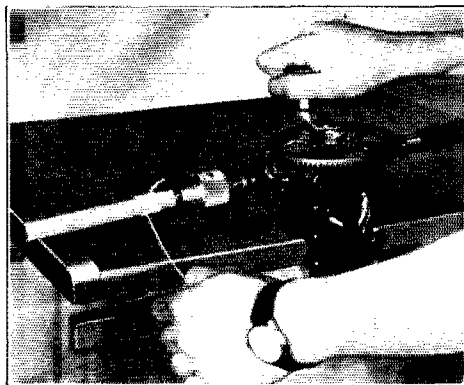

WINDING A CHOKE-COIL

A projection on the frame of the drill is clamped in the vise. Knowing the number of turns made by the chuck for each revolution of the handle, the number of turns in the coil is determined by counting the turns of the crank.

story — we've never yet found the exact combination ourselves.

However, assuming the builder knows exactly what he wants, the actual winding can be done in a few minutes by the use of a hand drill. Most of us have been using pieces of wooden dowel of the proper diameter for winding chokes. They make very good forms and are quite cheap, compared with composition tubing. Saw or file the head off a wood screw about one inch long, then grip the screw in the chuck of the drill with the business end out. Now set the dowel in our old friend, the vise, and sink the screw into the end of it far enough to make it hold solidly. The screw should be centered in the end of the dowel as closely as possible.

Fasten the drill horizontally in the vise in such a manner that the handle can be turned freely,

and you will be all set to turn out choke coils in quantities with very little expenditure of time or effort. One hand is used to turn the drill, while the other feeds the wire. After a few minutes practice it will be found that the coils will be much more evenly wound than it is possible to get them by hand, and the wire will stay in place better.

After the chokes are wound it is a good idea to paint them with acetone or collodion, as the wood may shrink and the winding come loose if the coils are not doped.

The Southeastern Division Convention

THE Southeastern Division does not hold conventions very often, but when it does it is put over with a bang. After a silence of six years, the second convention was held at Atlanta, Ga., on December 27th and 28th and those members residing in the division who did not attend surely missed a treat. There was a large delegation from Alabama; Florida was well represented also, and a few came from the Delta and Roanoke divisions — that's the spirit that makes "ham radio." Dr. A. Hoyt Taylor, of the Naval Radio Laboratory gave us some real information on "The Radio Frequency Spectrum" and also on crystal grinding. Dr. J. H. Dellinger, Chief of Radio Section, Bureau of Standards, Washington, spoke on "Radio Frequency Measurements" and "Radio Beacon Developments." Much to our surprise the delegates began to arrive early and it enabled the committee to carry out the program to the letter. With one of the largest busses at the disposal of the delegates visits were made to the new broadcasting station WSB owned by the Atlanta Journal where all courtesies were extended the visitors. Then followed a visit to the airport and an opportunity given to inspect one of the latest radio transmitters for airplane use. A trip to historic Stone Mountain was also taken.

Major Van Nostrand, U. S. Radio Supervisor, was kept busy with examinations, besides helping the Committee with the "stunts"; and moreover proved himself a very good toastmaster at the banquet. Mr. Boucheron, District Sales Manager, R.C.A., reminiscing on the early days of radio and "Daddy" Wills, General Manager, Georgia Power Co., gave us something to think about with his subject. K. B. Warner, Secretary and Editor, ranking representative from A.R.R.L. Headquarters, gave a good talk on his activities at The Hague Conference and was also kept busy answering numerous questions. Fieldman Hebert, the other Headquarters' representative was seen "hamfesting" most of the time during the two days, but had his "inning" at the banquet.

(Continued on page 80)

Experimenters' Section

An Effective Break-In Arrangement

By A. W. McAuly*

THIS description of the keying system being used at present at WSCEO is offered with the hope that some of the ideas can be adapted to meet conditions in many amateur stations and so promote the more general use of a good break-in system. A 100 per cent break-in system should meet the following requirements.

1. Operation should be independent of the receiver tuning, even if the receiver is tuned exactly on the transmitter frequency.
2. The receiver should be in perfect receiving condition the instant the keying contacts part.
3. A perfect reproduction of the keying should be heard in the 'phones and the intensity of this signal should be adjustable so as to exactly offset background noise in receiver when key is up.

The system described here meets these requirements when used with a self-controlled transmitter.

Whether or not it would be satisfactory when used with transmitters of the oscillator-amplifier type depends upon local conditions to a large extent. The transmitter at WSCEO is keyed primarily by opening the lead to the primary winding of the plate transformer. However, since

means of the usual condenser-resistance combination. A second set of contacts on the same relay is used to stop the tube oscillation. These contacts may be placed in the center tap, grid line, or plate line with about equal results. There is less spark at these contacts when placed in the center tap, but there seems to be a noticeable frequency flutter when the contacts close. With the key up, it is impossible to tell by listening in the receiver whether the transmitter is turned on or not.

Near the receiver, a second double-contact relay is operated from the keying lines. One set of contacts serves to short circuit the input to the receiver. Before this was done, there was a noticeable lag between the opening of the key and normal receiver operation. The second set of contacts short circuit the secondary winding of an output transformer. No sparking occurs at these contacts since the energy in the circuit is very low.

The keying signal in the 'phones is produced by a good high pitched buzzer, connected in series with the primary winding of a small transformer, the secondary of which may be tapped or shunted by a variable resistor and connected in series with the fones. This transformer needs but small windings on an iron core such as that of a telephone induction coil. As an alternative to the buzzer, the output from the monitor, possibly amplified and with volume control, could be fed into the 'phone circuit through an output transformer.

Telegraph sounders and standard relays may be fitted with extra contacts and used for double-contact relays. They should have high resistance windings (20 to 60 ohms) and the air gaps adjusted rather widely for fast action.

REGENERATION CONTROL

A lot may be said for, and against, the various methods of controlling regeneration in high-frequency autodyne receivers. The present tendency is toward the use of resistance control of regeneration, but even this system is not entirely satisfactory. For some time an idea has been afloat that a much better arrangement than any we are using would be to use an additional tube for controlling the strength of oscillation or the degree of regeneration of the detector circuit. The following, from C. W. Brewington, Lieutenant Commander, U. S. Navy, is an intriguing method of control which is recommended for trial in amateur receivers:

"The excellent article, 'Resistance Control of Regeneration,' in the August number of QST was of great interest to me. I have been dissatisfied for some time with all methods of regeneration control for high frequency receivers, and I think I have tried them all. Shortly before I read the

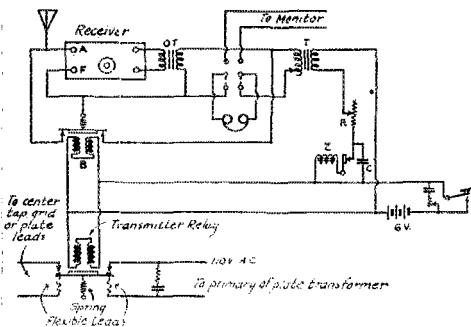

FIG. 1.—KEYING SYSTEM AT WSCEO

- B — Double contact relay.
- OT — Output transformer.
- T — Induction coil.
- R — 10 ohm rheostat.
- Z — Buzzer.
- C — 0.5-pfd. condenser.

the power in this circuit is something like 175 watts it is necessary to make provision for absorbing the spark at the contacts. This is done by

* WSCEO, 309 Third St., Oakmont, Penn.

article in the August QST I had worked out a scheme for resistance control of regeneration that I hope will be an improvement over present meth-

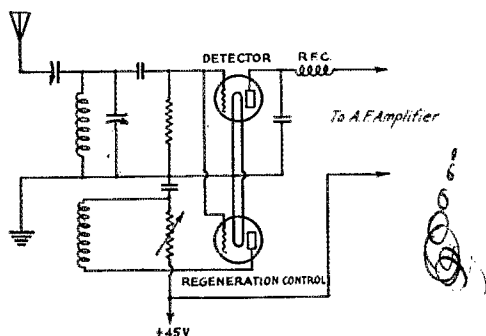

FIG. 2. — AUXILIARY TUBE FOR CONTROLLING REGENERATION

The upper tube is the detector, the lower is the regeneration control tube. The constants of this circuit are similar to those used in any high-frequency receiver and need not be given here.

ods. I have ordered the materials to build a receiver and try it out, but it will be several months before the parts reach me on this station.

"The hook-up is shown in Fig. 2. The upper tube in the diagram is the detector while the lower tube merely furnishes the regeneration.

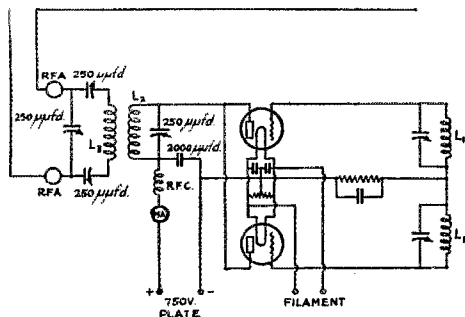

FIG. 3. — A METHOD OF ACCURATELY TUNING TUBES OPERATED IN PARALLEL

MA — Plate current milliammeter.

RFA — Radio frequency ammeter.

RFC — Radio frequency choke.

L_1, L_2, L_3 will, of course, depend upon what band the transmitter is working in.

This idea is not original with me; I believe credit belongs to a Westinghouse engineer. I have used the system with very gratifying results on the first radio frequency tube of a poorly designed old neutrodyne, but I believe it possesses several real advantages for a high frequency receiver:

"The detector plate voltage remains constant, which it does not do with the usual method of resistance control of regeneration.

"Detuning effects of the regeneration control should be less, due to the constant plate voltage. (The internal capacitances of tubes vary to a

slight degree, but enough to cause detuning at high frequencies with varying plate voltage.)

"The regeneration control should not be noisy as the variable plate circuit resistance has been taken out of the detector plate circuit."

Another alternative of this arrangement, although not mentioned by Mr. Brewington, is to connect both grids through proper grid condensers and leaks to the tuned circuit, thus providing each tube with its own grid leak and condenser. This arrangement should provide more flexibility since the coupling to the tuned circuit, and the grid bias to each tube could be varied independently. In either case a smooth regeneration control should result.

Operating Tubes in Parallel at 14 mc.

By Norman L. Penny

THE transmitter at W4ZQ is a rather interesting one. It has been used for Field Artillery use where mobility is absolutely necessary, and where it would not be practical if it were not portable. This transmitter was part of the main communication system at Camp Jackson, S. C., in recent army maneuvers and performed very creditably.

The set is a modified tuned-grid tuned-plate arrangement, as shown in Fig. 3. Separate tuned grid circuits are used for both tubes which are used in parallel operation, and this arrangement provides a steady signal, greater output and more control over the character of the emitted signal than if a common grid tuning circuit were used. The additional circuit also permits an ease of adjustment which makes it a simple matter to operate the two tubes satisfactorily at frequencies as high as 14 mc. The two tubes may be tuned to exactly the same frequency notwithstanding the fact that the inter electrode capacitances of one tube may be slightly different from that of the other.

The transmitter uses 50-watt tubes and operates on the 1750-, 3500-, 7000- and 14,000-ke. amateur bands. The transmitter is completely enclosed in a wooden cabinet which completely protects it from injury and dirt. Additional equipment for this set includes an antenna and dynamotor, and a 12-volt, 300-ampere-hour storage battery.

THE SPACE CHARGE DETECTOR

The UX-222 and the UY-224 have often been used as screen-grid amplifiers and detectors, but the use of these devices in space charge circuits is relatively unknown.

Mr. G. W. Bolithe, W6BZP, finds that the space charge detector circuit of Fig. 4 gives very good results. With the proper control grid voltage the tube may be made to oscillate so

smoothly that the point at which the tube does oscillate will be difficult to determine. Fringe howl is also reported to be absent with the proper grid voltage.

The circuit shown is used for operation in the 7000-ke. amateur band. The circuit may perhaps be used as well on the 14,000-ke. band although the capacity between the plate and the screen

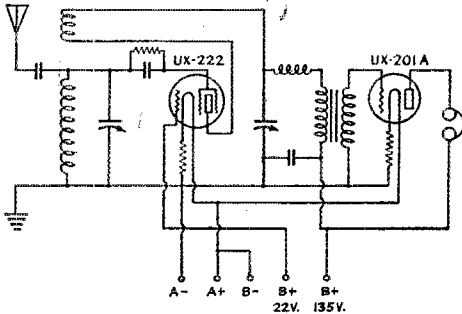

FIG. 4. — SPACE CHARGE DETECTOR

grid (which is used as the control grid in this case) will be rather high so that it would seem that the usual screen grid connections would be more desirable at the higher amateur frequencies.

PHONE TRANSMITTERS

During the past year considerable material on 'phone transmission has appeared in *QST*. The requirements of a good amateur radiophone transmitter were given in the April, 1929, *QST*. This was followed by articles on methods of measuring percentages of modulation, the description of a modern broadcasting station, constructional data on an inexpensive 3500-ke. amateur 'phone transmitter, and several more or less technical articles on the proper operation of tubes and tube circuits.

And now that half of the 14-me. amateur band is open to 'phone transmission there will undoubtedly be further interest in the subject. As a result, we are concluding this month's Experimenters' Section with a bibliography on the more important articles which have recently appeared on 'phone; all of which will be of interest to those who have obtained permission to operate 'phone transmitters in the 14-me. band.

BIBLIOGRAPHY ON 'PHONE TRANSMITTERS

QST References:
 Modulation in Radio Telephony — Part 1, by R. A. Heising, July, 1921.
 Modulation in Radio Telephony — Part 2, by R. A. Heising, August, 1921.
 My 'Phone Isn't Much, If Any, Broader Than C. W., by Robert S. Kruse, November, 1927.
 This Amateur 'Phone Business, by Lackey and Spencer, January, 1928.
 A 'Phone Transmitter for the Beginner or Advanced Amateur, by R. W. Tanner, July, 1928.
 The Construction of a 3500-ke. Crystal-Controlled 'Phone, by Earle W. Springer, December, 1928.

Modern Practice in High-Frequency Radiotelephony, by R. A. Hull, April, 1929.
 The Modulometer, by James J. Lamb, August, 1929.
 An Effective Low-Cost 'Phone and C. W. Transmitter of Modern Design, by James J. Lamb and Beverly Dudley, September, 1929.
 WTIC — A Modern 50-kw. Broadcast Station, by James J. Lamb, October, 1929.
 Vacuum Tube Layout for Telephone Modulation, by E. E. Spitzer, February, 1930.
Proceedings of the I. R. E.:
 Modulation in Radio Telephony, by R. A. Heising, August, 1921.
 Power Amplifiers in Trans-Atlantic Radio Telephony, by A. A. Oswald, and J. C. Schelling, June, 1925.
 KDKA, by D. G. Little and R. L. Davis, August, 1926.
 Recent Developments in Low Power and Broadcasting Transmitters, by I. F. Brynes, May, 1928.
 The Use of the Electron Tube Peak Voltmeter for the Measurement of Modulation, by C. B. Jolliffe, April, 1929.
 An Investigation of the Phenomena of Frequency Multiplication as Used in Tube Transmitters, by R. M. Page, September, 1929.
 Speech Input Equipment, by D. G. Little, November, 1929.

Bell System Technical Journal:

Modulation in Vacuum Tubes Used as Amplifiers, by Eugene Peterson and Herbert Evans, July, 1927.

Reference Books:

Radio Amateurs' Handbook, Chapter VI (6th edition).
 Principles of Radio Communication, Chapter VIII, by J. H. Morecroft.
 Radio Telegraphy and Telephony, Chapter XXVI, by Duncan and Drew.
 Thermionic Vacuum Tube, by H. J. Van der Bijl.
 Elements of Radio Communication, Chapter VI, by J. H. Morecroft.
 The Radio Manual, Chapter 6 (3rd printing), by Sterling.

United States Civil Service Examination

(Continued from page 8)

The optional subjects are (1) electricity, (2) heat, (3) mechanics, (4) optics, (5) physical metallurgy, (6) radio.

Competitors will be rated on general physics, mathematics through calculus, and practical questions on each optional subject chosen.

Full information may be obtained from the United States Civil Service Commission, Washington, D. C., or the secretary of the United States Civil Service Board of Examiners at the post office or customhouse in any city.



A copy of, "Radio Noises and Their Cure" is a sixty-four-page manual and catalogue dealing with practically all cases of radio interference and their elimination. The booklet should prove of considerable value to service men, and can be obtained for twenty-five cents from the Tobe Deutchman Co., of Canton, Mass.

W9BVH

STATION 9BVH, owned and operated by C. L. Jabs, of 1822 James St., St. Paul, Minn., went on the air during 1924, and the owner, like most beginners, had difficulty with unsteady signals, poor antenna construction, and the other run of difficulties which only the beginner can get into. Dr. A. Hoyt Taylor's talk on crystal-controlled oscillators at the third National Convention in Chicago in 1925 was responsible for the station becoming crystal controlled. The original transmitter did not work at all according to Hoyt, so during the latter part of 1927 it was decided to build a crystal-controlled transmitter which could be operated on any of the popular amateur bands.

The transmitter which was evolved is interesting and unusual. It is not so expensive as one might imagine and is unusually flexible, is completely shielded except for the final amplifier, and can be changed to operate in any of the more commonly used amateur frequency bands in a short time. The photographs show the construction of the transmitter, while Fig. 1 shows the wiring diagram used. The wiring diagram is drawn so that it is similar in layout to the mechanical arrangement of the apparatus.

THE TRANSMITTER

The transmitter uses five tubes and is built on a brass panel 12" x 24". This base is covered with a $\frac{3}{8}$ " board to make the mounting of the apparatus easy, and to reduce the capacity between the tube sockets and the brass panel. Starting from the oscillator tube (the lowest one

the 7000-ke. band, and finally, the 14,000-ke. frequency doubler and amplifier. UX-201-A tubes were chosen for use in the oscillator and first two frequency doublers. To the right of this triangu-

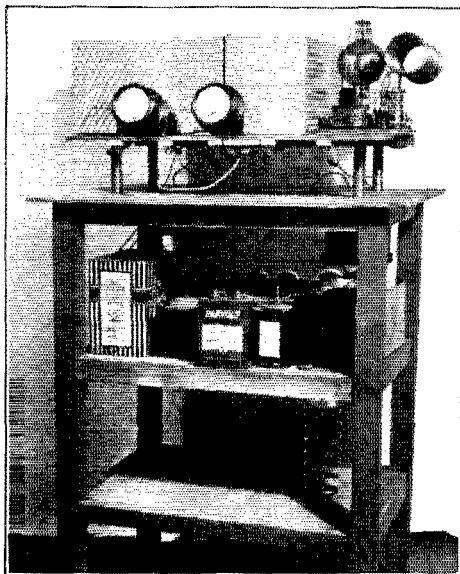

THE TRANSMITTER AND POWER SUPPLY UNITS

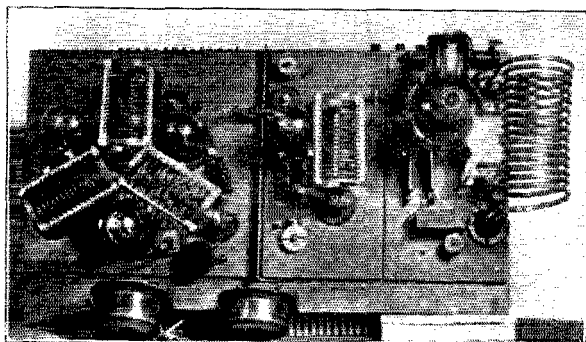

TOP VIEW OF TRANSMITTER WITH COILS AND TUBES IN PLACE

in the pin-wheel arrangement) and going around in clockwise direction we see the crystal mounting and oscillator tube, which operates in the 3500-ke. band, the oscillator tank circuit, the frequency doubler and tank circuit operating in

lar arrangement is an amplifier which may be used as an additional frequency doubler, if necessary.

A UX-210 tube is used in this amplifier, while a UX-852 tube is used in the final amplifier.

All plate blocking and grid condensers are mica insulated receiving condensers with the exception of the plate blocking condenser in the final amplifier, which is a 6000-volt Wireless Specialty transmitting condenser. Pilot midget condensers are used to tune the oscillator and frequency doublers because of their small size. The use of the small condensers is desirable for making the transmitter compact, and after more than a year's use, the insulation is found to be as good as when the condensers were originally put into the circuit. Resistance bias, which is obtained

by using the IR drop across 5000-ohm variable resistors, is used. The use of variable grid leaks is a decided improvement over the use of fixed grid resistors.

The coils for the oscillator and doubler stages

were homemade as follows: Rings of bakelite tubing, $\frac{5}{16}$ " long, and 2" in diameter were cut and are used to support the wooden strips which hold

this is a rather tedious job and requires plenty of patience, a strong and sturdy coil results if proper care has been taken with its construction.

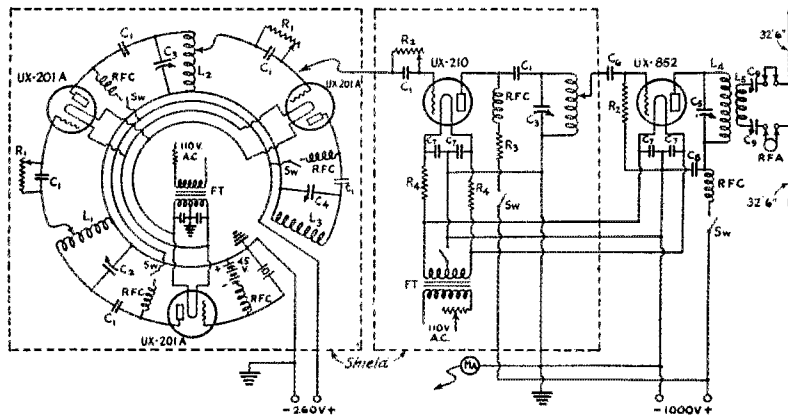
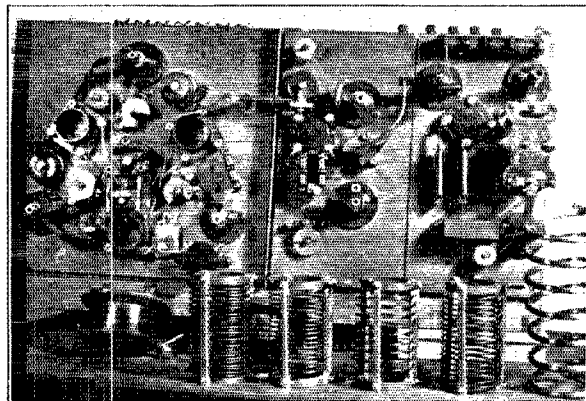

FIG. 1. — THE TRANSMITTING WIRING DIAGRAM OF THE TRANSMITTER AT W0BVH. NOTE THE ROMAN CANDLE EFFECT!

- L₁ — 50 turns of No. 12 enamel wire.
- L₂ — 17 turns of No. 12 enamel wire.
- L₃ — 10 turns of No. 12 enamel wire.
- L₄ — $\frac{1}{4}$ " copper tubing. Size of coil depends upon frequency band being used.
- L₅ — Antenna inductance, $\frac{1}{4}$ " copper tubing.
- C₁ — 2000- μ fd. mica receiving condenser.
- C₂ — 25-plate Pilot midget receiving condenser.
- C₃ — 13-plate Pilot midget receiving condenser.
- C₄ — 7-plate Pilot midget receiving condenser.
- C₅ — 11-plate double-spaced General Instrument condenser.
- C₆ — 1000- μ fd. mica receiving condenser.
- C₇ — 6000- μ fd. receiving condensers.
- C₈ — 2000- μ fd. 6000-volt transmitting condenser.
- C₉ — Antenna series tuning condenser.
- R₁ — 500- to 5000-ohm resistor.
- R₂ — 15,000-ohm resistor.
- R₃ — 10,000-ohm plate voltage dropping resistor.
- R₄ — 1-ohm filament dropping resistors.
- RFA — Radio frequency ammeter.
- RFC — Radio frequency choke.
- MA — 0-500 milliamperes plate current meter.

the coil. Next, three pieces of birch, $\frac{1}{4}$ " thick and $\frac{3}{8}$ " wide were made, clamped together, and drilled with a No. 34 drill to take No. 12 wire.

All coil forms are of the same length, but those with fewer turns are made with greater spacing between turns. General Radio plugs hold one of the birch pieces to the bakelite ring and are used to plug the coil into the tank circuit with General Radio jacks mounted on porcelain stand-off insulators. The coils for the final amplifier are made of $\frac{1}{4}$ -inch copper tubing which is polished with emery cloth and given a coat of varnish to preserve the finish and to keep the radio frequency resistance constant.



A TOP VIEW OF THE TRANSMITTER WITH SHIELDS, COILS AND TUBES REMOVED

The coils were then constructed by winding No. 12 wire on a 2-inch form, and the wire was threaded through the three birch strips, after which the strips were bolted to the bakelite rings. Although

of the milliammeter is provided with a flexible lead. In making plate current measurements, the switch for the tube whose plate current is desired, is opened, and the flexible lead of the milliammeter

is clipped to the jaw of the open switch. With all the switches closed, plate voltage is applied to all tubes. The use of plate switches is found advantageous for cutting amplifiers out of the circuit, and is a great convenience when one is working on the transmitter and does not wish to come in contact with the plate supply system.

Only one filament voltmeter was available so all the filament transformer primaries were wired in parallel and resistance wire, taken from an old soldering iron, was put in the primary circuits until the proper voltages were obtained from the secondary windings of the transformers. A heater unit, in series with a type 210 Allen-Bradley resistor, is used to compensate for line voltage variations. A Thordarson filament transformer is used for both the UX-852 and the UX-210 tubes, the voltage for the 210 tube being reduced from 10 to 7.5 volts by equal resistors in each side of the filament line so that the center tap will be maintained for both tubes. The filament transformer for the UX-210-A tubes is rebuilt from an old battery charger.

A general survey of the transmitter shows that it can be changed rapidly to almost any sort of transmitter. It can be operated on any amateur band from 3500 kc. to 28,000 kc. with good output since the UX-852 always acts as the output tube. The set can even be made to operate in the 56,000-ke. band if so desired by using the 852 as a frequency doubler. In all cases, the transmitter is crystal-controlled. The 210 amplifier is used at all times, and when operating in the 7000- and 14,000-ke. bands, the respective low-power frequency doublers are cut out of the circuit by opening the plate switch, removing the tank inductances, and by placing the grid clip of the 210 amplifier on either the oscillator or the first frequency doubler tank circuit. In making changes from one band to another, it is only necessary to change the inductance of the 210 and 852 amplifiers, and since all inductances are made to plug into jacks, this is a simple process. Tuning is simplified by scribing marks on the condenser plates to indicate the proper setting so that it is only necessary to set the rotor plates to the proper mark to properly tune the tank circuit. This is practically essential since it is difficult to get at the knobs of the small tuning condenser with the inductance in place. By removing the 210 tube from its socket and tuning L_2C_3 and L_4C_5 to the same frequency, a tuned-grid tuned-plate transmitter may be obtained.

POWER SUPPLY

A 450-watt Thordarson transformer, with 1000 volts and 1500 volts each side of the center tap is used to furnish plate power to the UX-852, and

through a series resistor, to the UX-210. The plate transformer for the 201-A tubes is made from a 75-watt Acme filament and plate transformer. The filament windings were removed and additional turns were added to each side of the high voltage secondary winding to increase the plate voltage.

Two separate rectifiers are used with a somewhat unusual filter arrangement, as shown in

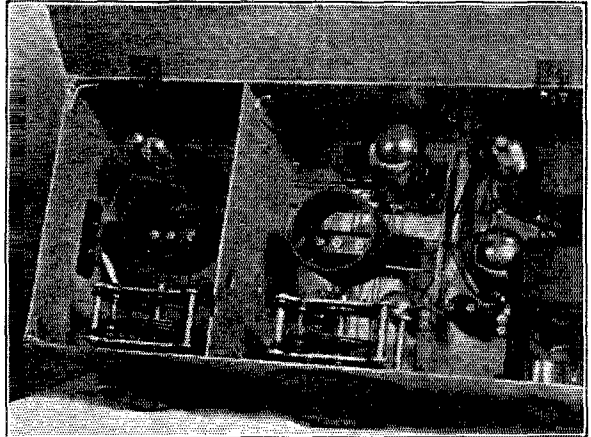

THE RECEIVER

All of the receiving equipment is not visible in the photograph. A monitor, to the right of the audio transformers, does not show, but one is used at W9BVH.

Fig. 3. The filters consist of one 30-henry choke coil and a total of eight 1- μ fd. condensers. The choke was first used in the positive side of the low voltage supply, but it was found that better results could be obtained by placing the choke in the negative side, so as to be common to both plate supply units. Keying is accomplished by opening the filament center tap of the 10-volt

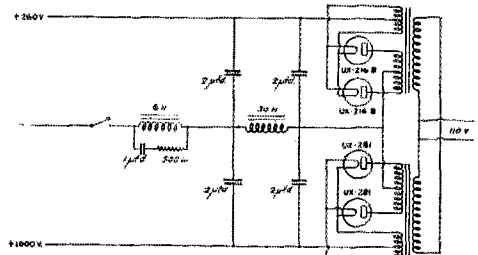

FIG. 2 THE PLATE SUPPLY AT W9BVH

filament supply, which opens the filament return of both the 210 and the 852 tubes. A key-thump filter, consisting of a six-henry choke shunted with a 1- μ fd. condenser and a 500-ohm resistor is found to be quite effective. Although slight clicks may be heard in the high frequency receiver there is no sign of key clicks in the broadcast receiver in another part of the house.

With such a transmitter it may be surprising to know that only one antenna is used at W9BVH. We have described absorption type frequency meters, monitors, heterodyne frequency

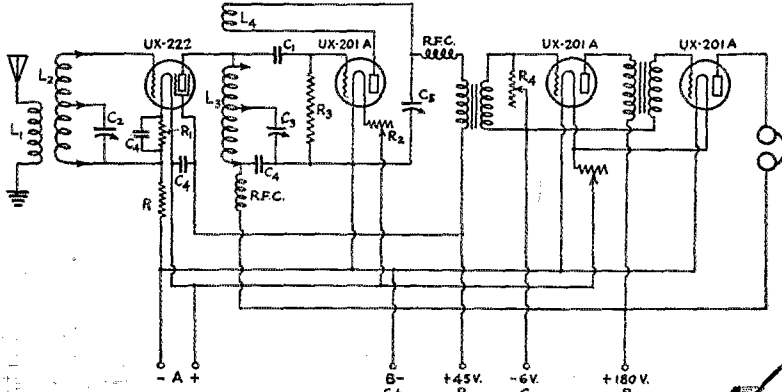

FIG. 3—ANOTHER ARRANGEMENT OF A FOUR-TUBE RECEIVER

- L₁ — 3 turns for 3500 kc.
2 turns for 7000 kc.
1 turn for 14,000 kc.
1 turn for 28,000 kc.
- L₂ — 16 turns for 3500 kc.
7 turns for 7000 kc.
9 turns for 14,000 kc.
4 turns for 28,000 kc.
- L₃ — 17 turns for 3500 kc.
10 turns for 7000 kc.
6 turns for 14,000 kc.
- L₄ — 3 turns for 14,000-ke.
- T₄ — Ticker.
- C₁ — 100-μfd. grid condenser.
- C₂ — 5-plate General Radio condenser.
- C₃ — 4-plate General Radio condenser.
- C₄ — 6000-μfd. screen grid by-pass condenser.
- C₅ — 23-plate Pilot midget regeneration control condenser.
- R₁ — 10-ohm filament resistor.
- R₂ — 20-ohm rheostat.
- R₃ — 10-ohm rheostat.
- R₄ — 500,000-ohm volume control.

The antenna consists of a 32' 6" length of drain spouting standing vertically on top of the bungalow. A piece of 1 1/4" brass tubing of the same length is mounted horizontally in the back yard. Two feeder wires eight feet long connect the antenna, and counterpoise to the antenna series tuning condensers. For 3500-ke. operation loading coils are plugged into the antenna leads and the antenna operates as a folded Hertz. For operation in the 7000-ke. band, the system is used as a quarter-wave current-fed line. For 14,000-ke. operation the horizontal brass tubing is disconnected by means of a switch and the antenna system becomes a Zeppelin. This Zeppelin is operated on its second harmonic when 28,000-ke. work is carried on.

THE RECEIVER

The wiring diagram of the receiver is shown in Fig. 3, and the photographs will show the general constructional details. The set is similar to the four-tube screen-grid receivers which have been so often described in QST. Dial spread is obtained at the higher frequency bands by shunting the tuning condenser across only a portion of the coil. A throttle condenser is used to control regeneration instead of resistance control.

Straits

We have been ranting and raving about frequency measurements since Hector was a

meters, and combinations of the above until we think every amateur should be able to draw these diagrams in his sleep. And so, when Christmas and New Year's come around, some dozen or two amateurs, home for the holidays, get on the air and tune their transmitters anywhere from 50 kc. 150 kc. or more out of the bands. But then, we suppose, that is a perfectly good way of committing radio suicide, if we may use that expression.

'Sfunny, but we have had more inquiries about QST 'phone articles from broadcast "engineers" than from amateurs.

We are informed by JMC that the ballots for the I. R. E. election, which were counted on January 6th, gave the presidency of the Institute for the year 1930 to Lee DeForest.

We have a story from W6DZL to the effect that he rejuvenated a couple of defunct but not burned-out UV-202 tubes by placing them in the sun. W6DZL says that "Sun's rays are good for sick people so maybe it will be good for sick tubes." At the end of six months the tubes were found to be normal.

We think that Richard Mead must recently have acquired the sixth district call, because he failed to mention that "it was due to the California climate."

I. A. R. U. NEWS

Devoted to the interests and activities of the

INTERNATIONAL AMATEUR RADIO UNION

President: H. P. MAXIM

Vice-President: C. H. STEWART

Secretary: K. B. WARNER

Headquarters Society:

THE AMERICAN RADIO RELAY LEAGUE, Hartford, Conn.

MEMBER SOCIETIES

American Radio Relay League

Asociacion E. A. R.

Associazione Radiotecnica Italiana

Canadian Section, A.R.R.L.

Deutschen Amateur Sende und Empfangs Dienstes

Experimenterende Danske Radioamatorer

Nederlandsche Vereeniging voor Internationaal Radio-amateurisme

New Zealand Association of Radio Transmitters

Norwegian Radio Relay League

Radio Society of Great Britain

Reseau Belge

Reseau Emetteurs Francais

South African Radio Relay League

Wireless Institute of Australia

Conducted by A. L. Budlong

WHEN we printed that appeal to The Old Man in the January issue we had a secret hope that he would see it and reply to us in some form or other. And that is exactly what happened! It is a real pleasure to reproduce herewith what is now one of our most prized possessions — a letter from T. O. M. himself:

"I saw it all right, Son, in your I.A.R.U. column, and it sure does get a man's goat to be asked about a thing that has been carefully explained. But don't let it bust your nervous system. It's one of the regular things to expect in human nature. Maybe you have done the same thing yourself in the past. I have done worse. I drove down a one-way street the other day and got away with it 100%. They would have hanged me if there had been a cop around. And did you never get a B battery of 45 volts hooked up to the 5-volt filament of a tube? I have, and it doesn't help matters any to tell me that I ought to have known better. No, it's a case of patience and tolerance. Lay in a good stock of both. You must have need for both in carload lots in your job.

Best 73s,

— T. O. M."

Beginning with this month, we are devoting space at the end of the I.A.R.U. News department for a listing of all members of the WAC Club up to the present. All those who became members in the first year of the club's existence

(1926) are listed this month. Members for 1927 will appear next month, and so on until the entire list has been presented.

At this time we also wish to announce formally the taking over of all WAC matters by the International Amateur Radio Union. Readers will recall that we discussed this possibility several months ago. On February 1st, the Union actually took over the issuance of all future WAC certificates, as well as the records and supplies kept up to that time by the A.R.R.L.

WAC is now a Union matter, and all WAC applications should be addressed to the I.A.R.U. Headquarters at Hartford. A new certificate has been printed up, too. It is considerably superior in appearance and stock to the old one put out by the A.R.R.L. and is something any amateur will be proud to have in his shack. We hope to print a reproduction next month.

A.R.R.L. membership is now no longer a requirement for the issuance of a WAC certificate. Any amateur anywhere in the world, regardless of membership in the A.R.R.L. or any other amateur organization, may apply for a certificate. The general requirement of QSL cards confirming two-way communication with amateurs in each of the six continents still stands.

It is probable that some arrangement will be made whereby amateurs who are members of Union sections may submit their cards to their respective society headquarters for confirmation,

and obtain a WAC certificate by sending a statement of this confirmation to Union Headquarters, a suggestion to this effect having been formally made by the Reseau Belge. This will eliminate the necessity of sending valuable and prized QSL cards in the mails all the way to the United States. Details of this arrangement, if confirmed, will be announced in the next issue.

In the November, 1929, issue we mentioned that PY1AW had worked all continents in one night. Now comes Alan Smith, G6VP, who states that he has done this on *two* occasions, once on April 1, 1929 (!!! — A. L. B.), and again on October 30, 1929. He submits the proof, too! FB!

That radio schedule for the foreign report is not working out so well, apparently. Guess Doc Seeleth better begin warming up!

Now to the DX lists. These continue to be wanted, apparently, and a number of fellows have written in that the times given work out pretty well in the majority of cases. Our biggest trouble is getting lists that give times for the seasons when the lists will actually appear in *QST*. We might suggest that anyone sending in any lists now do so on the basis of *summer* work — June, July and August. Thanks.

We reproduce first some additional lists from G6ZR, Mr. C. R. Ponting. They are for both 7000 kc. and 14,000 kc., and cover the months of March, April and May. Give them a try and let us know how well your experience checks.

7000-kc. Band

(For March, April and May. Times are GCT)

North America (Eastern Part).....	2400-0600
North America (Western Part).....	0300-0530
South America (E. & S.E. coasts).....	0130-0330
South America (W. & N.W. coasts).....	0330-0500
Asia.....	2230-2400
Africa.....	2230-2330
Oceania (Australia and N. Z.).....	0400-0630

14,000-kc. Band

(Despite the reduction in the period in which stations are workable, I have to note these three months, together with a portion of June, as the best period throughout the year; signals attain remarkable strength and very little difficulty is experienced in working almost any part of the world at the due time, and under normal conditions. — G6ZR.)

North America (Eastern Part).....	2130-0100
North America (Western Part).....	0330-0730
South America (E. & S.E. coasts).....	2100-2300
South America (W. & N.W. coasts).....	0200-0600
Asia.....	1700-2100
Africa.....	2000-2230
Oceania (Australia and N. Z.).....	0500-0700

We are indebted to Lyle Geary, VE5AW, at Whitehorse, Yukon, for the following 14,000-kc. table which should be good for the spring.

Europe.....	0230-0900 (best from 0700-0900)
South America.....	0200-0530
New Zealand.....	0500-0900
Australia.....	0500-0900
Japan.....	0630-0900
Asia.....	0730-0830
Africa.....	No data. (But would like some!)

And to round it out we have some 14,000-kc. lists from Mr. E. G. Calvert, ZS5W, at Natal, South Africa. The data was compiled last fall, but stands a good chance of working equally well about this time of the year. Times are GCT again.

North America.....	2030	Very weak
South America.....	1500-1600	Heard occasionally
Australia.....	1430-1630	Good strength
Europe.....	1645-1815	Usually very good
Asia.....	1530-1700	Usually very good

More lists next month. Incidentally, we want to express our thanks to those who continue to cooperate by sending in these lists. Sometimes just one or two items are received — not enough for a list — from one person, but even this is helpful, since it acts as a check against lists which are printed.

BELGIAN SECTION REPORT

By Paul de Neck, President, *Reseau Belge*

Completely disgusted by the long silence on their favorite band, many of the 14,000-kc. men



THIS IS SWISS HB9F OWNED AND OPERATED BY MISS MADELEINE MORET, LAUSANNE, SWITZERLAND

It will probably come as a surprise to many amateurs to know that this well-known call (formerly H9XF) is operated by a "YL." HB9F has been in operation since May, 1927, and is officially licensed now, being one of the six Swiss stations in this class. Miss Moret tells us that in addition to working on 40 and 20 meters, her station will soon be equipped for work on 10, FB!

changed for the 7000-kc. territory. Alas for impatience! While they found 7000 jammed with hundreds of signals, the few who remained on good old "20" had a full hand of fine DX!

(Continued on page 32)

Calls Heard



**VK3CX, Alan G. Brown, 8 Mangarra Rd.,
Canterbury Et, Victoria, Australia**

14,000-ke. band

wlaix wlaqt wibd wleek wifl wimo wivc wizz
w2ait w2arb w2ayr w2bjg w2bwc w2cxl w2mb w2rs w3dh
w3pf w4atbv w4aef w4aek w4ahl w4akh w4alg w4jm w4oz
w5aqe w5aay w5df w5jv w6aaaz w6bax w6ete w6euh w6dak
w6dyu w8auz w8bww w8bv w8cfl w8era w8evo w8dly
w8dpo w8duw w9bmu w9dgg w9ef w9fhe w9giy w9ghx
aclbd ac8hm ce3ab ct1aa d4aar d007 ear2l ear59 f8axq
f8da f8ex f8fk f8fr f8ha f8hr f8gdb fa8bak file f8lrp fm8bg
fo8sr g2lz g5by g5bz g5ml g5pj g5qv g6lk g6nt g6wo g6xj
g6yv he2jm il0cc jldex j2eb j3dd k6aac k6bhl k6boe k6ett
kaljr lu2ca oa4j oa4q oa4z oh2nm oh2od ok2rm ok2ny
ok2si on4fe on4fp on4ro on4wm on4uu oa7y pa0ldw plkjr
pk3bm pk4az sp3ar sp3wr su8rs su8wy un7ww uo0y vq2bh
vq4ere vs1ab vs3ab vs6ab vs6ae vs6af vs6ag vs6ah vs7ap
vu2dr vu2ev vu2hc vk3rx xu2uu yilae z4im z5fr pmz

George Maxey, 304 South G St., Tulare, Calif.

3500-ke. 'phone band

wlaby w1egr w2aca w2bp w3bfz w3ans w3cv w4fe w4hh
w1uh w4pw w4lq w5abo w5kx w5awg w5awp w5um w6dke
w6ry w7aut w7aeu w7fe w7hn w7if w7ko w7agi w7tj w7oq
w8aeo w8ant w8ahx w8ajs w8asy w8ej w8cix w8dmi w8epi
w9agx w9dxo w9dpg w9mim w9fig w9felx w9gbq w9fz w9flz
w9ean w9evq w9ewx w9eyv w9bag w9cha w9ahq w9qy
w9dlc w9dvq w9avu w9eng w9ghx w9dva w9ema w9aho

**Thomas Hale, 2412 Front St., Cuyahoga Falls,
Ohio**

14,000-ke. band

py1aw py1er py2ay py2bf py2bk py2ih py2qb py3ab py3le
lu2h lu3dh lu3fa lu4da lu4di lu6aj lu6ie lu8dy cm2jt cm5iy
cm8fr ce2ab ce3bf ce5aa ce3ac f8tyd f8gdg oa4j oa4q he2jm
on4he zrlt oh7nb ve5aw x9a klaky w10xx

**W4AKH, E. W. Connell, 230 Sorrento Rd.,
South Jacksonville, Fla.**

14,000-ke. band

ce3ag ce3bf cm2jt cm2sh cm5ae ct1aa ct1bx ct1xb d4xn
ear06 f8da f8ex f8ha f8rko f8hx f8zie g2nh g5by g5bz g5ma
g6nt g6rb g6vj g6vp g6wl g6xb g6xc il0cc k4aky k6aac
k6boe lu2ca lu3fa lu8dy lu9dt oa4j on4fe on4fp on4he on4us
py1ah py1aw py1ia py2ay py2bf py3ah sn1aa ve5ep ve5aw
vk2ek vk2kj vk2ma vk2lj vk2he vk2we vk3iy vk3wo vk5gr
vk5it vk5wr vo8me vo8ae vq2bh x9a z1lan z14ao z1p z1pi
zs4a zs4im zs5u zutia zu6n x2x zu5up 56a

**CM2SH, Silvio Hernandez, Calle 27, No. 89,
Vedado, Habana, Cuba**

7000-ke. band

w6dsk w6egh w6edd w6eeg w6bqk w6sf w7aah w7afr hclfg
he2jm ti2wd ti2hv wbc kfr5 nn1nic nn1fx nn7nic x29a ve2be
ve2hd ve3tb

14,000-ke. band

w6dyv w6bho w6bau w6de w6ae w6re w6ejc w6dmk w6ete
w6dev w6egq w6dak w6io w6aiw w6ezm w6awp w6ave
w6eop w6euh k1aky k1aan w7amx w7pw w7fh w7su w7aoq
w7a g6vp g6wt g5ml g5by f8da f8ex f8jf x8hpg f8fr on4uu
on4ww on4he on4fp ve1as ve1dq ve1am ve1br ve2bg ve2bd

ve2ea ve2ac ve2ay ve2bh ve3dd ve3bk ve3fl ve3hb ve3bo
ve3eo ve3dy ve3cj ve4ar ve4bq py2bf py4ah pytel py1ia
py1ca py2ay py2ak py2qb py3ah he2jm ti2hv ct1bx vk2no
vk2jz vk2kj vk5gr vk5wr vk6he vo8ae vo8mc oa4j on4q
lu2ca lu3dh lu5ae x2x x9a

**W9UM-W9BOH, M. W. Macy, Lake Wawasee,
Syracuse, Ind.**

7000-ke. band

w6adw w6aef w6ael w6afu w6akb w6akw w6am w6amp
w6ams w6amw w6ank w6anl w6aoc w6aop w6ayf w6avq
w6awp w6axm w6aye w6bam w6beh w6bck w6bg w6bgh
w6bjf w6bjl w6bpe w6bpm w6bpo w6bys w6bwi w6bxi w6by
w6byz w6cae w6cet w6eds w6egx w6ehw w6eii w6eix w6eif
w6eok w6eeg w6ecq w6exi w6eaz w6dak w6day w6der w6dde
w6ddg w6dfs w6dgy w6dit w6doz w6djp w6drg w6dsi
w6dsp w6dte w6dtd w6dui w6dvy w6dyn w6dyz w6dzz
w6ebg w6ebn w6ebv w6ebx w6ee w6edy w6egv w6ehi w6eii
w6eje w6eke w6ele w6elm w6ely w6enx w6epd w6eeg w6eif
w6eiu w6erx w6esa w6esp w6euh w6eia w6evf w6ew w6fd
w6eux w6it w6hm w6ka w6nz w6os w6qi w6qp w6qw w6se
w6vt w6wa w6wb w6xbb w7aah w7aat w7aaz w7aed w7adg
w7af w7aif w7aho w7aht w7ahw w7aic w7aiz w7alk w7amo
w7aoq w7as w7bb w7ce w7fl w7gp w7hv w7jp w7kq w7li
w7lt w7lz w7mh w7mo w7mr w7nf w7or w7pa w7pe w7pp
w7qp w7qr w7ud w7un w7up w7uz w7vk w7zab k4kd k4auu
k4caf k4dk k6bhl k6cib k6oa k6v5 kalce kalhc kalhr kalzr
ka1dj lu2ca vk2aw vk2eb vk2gj vk2ke vk2hu vk2hw vk2je
vk2jt vk2ns vk2rb vk2rf vk2rg vk2ek vk3ag vk3ak vk3ax
vk3kj vk3jk vk3pa vk3pp vk3pr vk3rg vk3sh vk3ru vk1bh
vk1eg vk4em vk4jr vk4ju vk5ax vk5do vk5hg vk5wr vk6lr
vk7ew vk7lj ve1bh ve1ar ve1ep ve1gk ve1gm ve1hp ve1cp
ve5ev ve5ji x1xaa ac8rv ti2ea ti2hv ti2wd cm2iq cm2jm
cm2yb cm5by cm5fe cm5f cm2mp cm8by cm8le cm8ut
cm8ur cmz4 cmz12 cmz9 cmz3 cmz56 he1dr he1fg he2je
f8rkl f8rcm f8asy g5by g6rb nj2pa x9a x25a x29a z1lbb
z1lbl z1lfr z1lft z1lfu z1zab z1zab z1zbb z1zbb z1zpg
z13ag z13aj z13as z13bb z13cm z13ez z14am z14ao z14p z1bi
nn1fx nn1nic nn2nic uneb nn7z nn4x eu94 xw1m rpx 8aa
nurl obg obe rb45 55x cabl wfa vjp h1a pza xba1 kfat jes

**W9FPN, George F. Levy, 5730 West 23rd Place,
Cicero, Ill.**

py1aa py1aj py1as py1aw py1bl py1ca py1ia py1el py1id
py1em py1bt py1br py2ad py2ak py2aj py2ay py2bf py2bm
py2bu py2bz py2qb py2ik py2ih py3ah py5af ce1ah ce2ab
ce3ab ce3ac ce3ag ce3bm ce3bf ce3cj ce5aa cm2jt cm2sh
cm62 cm5ex ct1aa ct1bx ce2ak lu3dh lu3fa k4aan k4aky
kni k6ett kfu5 kfr5 g2av g2kf g5gd g6lk g6wt f8ex f8j
f8wb ti2ae ti2ea pa6ct nj2pa oa4o on4j on4fp on4ww x1u
x9dm alf ap1 wdde wfa wx2yz 55x lu3pa

**W1BCF, Vernon R. Brien, 68 Peck St.,
Attleboro, Mass.**

3500-ke. band

w1aev w1ad w1adw w1aif w1agn w1ajm w1ajp w1amq
w1awn w1bk w1bkn w1brk w1bl w1bnl w1blo w1bux
w1bsj w1egx w1elm w1cov w1erd w1ctn w1kq w1og w1tp
w1ps w1ue w1qp w1wa w2aed w2ag w2agk w2ahj w2am
w2ame w2aqo w2aru w2axl w2awe w2bfz w2bue w2bvt
w2bx w2by w2ewk w2dy w2ou w2se w3ac w3alg w3aso
w3aun w3cab w4qo w8aje w8aor w8eco w8en w8eqj w8th
velaf ve2bb

(Continued on page 60)

Correspondence

The Publishers of QST assume no responsibility for statements made herein by correspondents.



Too Bad the Contest is Over!

Savannah, N. Y.

Editor, QST:

A few nights ago I copied a broadcast from W1MK which said that the station contest was concluded. That was a sad blow to me as I had

noticeable one being the idea of the "unimportance of short leads" à la Hatry.

All joking aside, isn't this typical of 1912 when *Modern Electrics* was the Ham's Bible and the R. I. was worrying about other things than hams? I came across it the other day while sorting over a pile of old magazines. If you can

• A MODERN AMATEUR WIRELESS STATION •

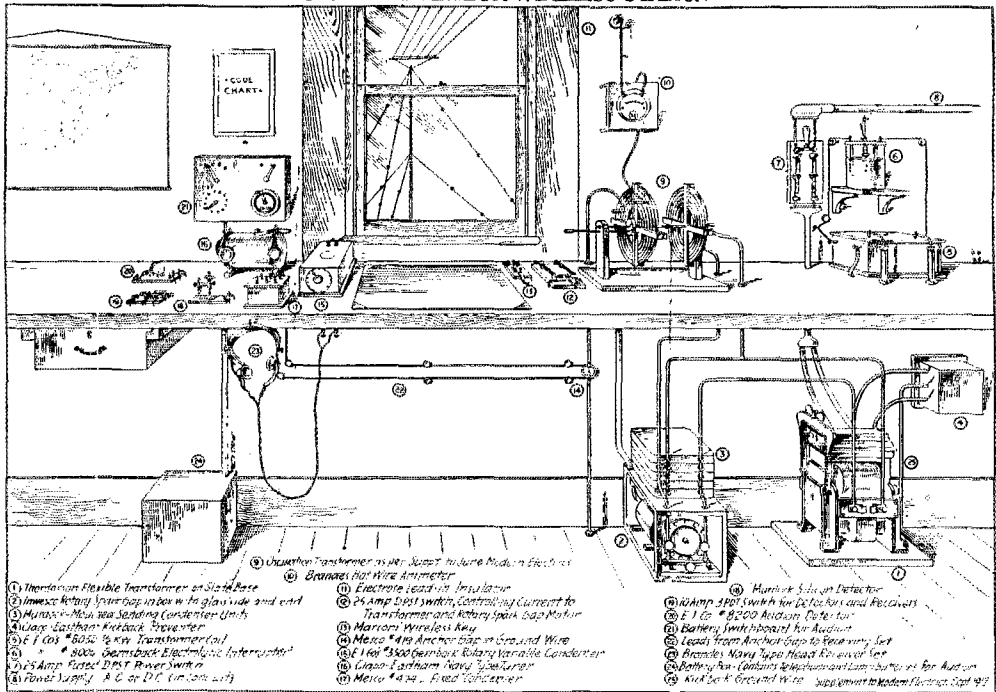

wished to enter my own station in the contest. The saddest part is that I was held up by the fact that my lithographer was unable to get me a good lithograph of the station in time to get under the wire.

However, knowing that you are somewhat indulgent at Headquarters and that you may stretch the rules slightly to enable me to compete, I am submitting a picture of my layout. The picture is so clear that I feel no further write-up is necessary.

For the benefit of the craft, I do wish to say that several recent ideas have been incorporated in the design of the outfit, probably the most

use it go to it, but please return it to me when you are through as I intend to have it framed as a memento of the days when the E. I. Co. was one of the main supply houses of the country.

E. B. Reddington

"Vacuum Tube Layouts—" Corrected

General Electric Co.,
1 River Road,
Schenectady, N. Y.

Editor, QST:

I find that a number of errors were made in my article in February QST, the fault being

entirely mine. Most of these errors were in tables on page 19. The correct figures are given below.

At the bottom of page 19, the sentence beginning "To find the true modulation factor for such a circuit . . .", should read: "To find the true modulation factor for such a circuit, the modulation factor is read from one of the curves

G5BY Receives His Cup

2 Chepstow Road,
Croydon, England

Editor, QST:

I wish to thank you very much indeed for your letter of the 18th ultimo and to tell you that the

RADIOTRON UX-210 LAYOUT

Amplifier or oscillator	UX-210
" plate volts	350
" plate amps.	.050

MODULATOR

Tube	Plate voltage	Plate m.a. per modulator	Volts grid bias	Volts peak grid swing	Modulation factor	Ohms dropping resistance
1-UX-842	425	28	-93	81	0.50	1500
2-UX-842	425	20	-107	107	0.73	1500
1-UX-250	450	50	-81	81	0.68	2000
2-UX-250	450	40	-86	86	0.73	2000

RADIOTRON UV-211 LAYOUT

Amplifier or oscillator	UV-211 or UV-203-A
" plate volts	1000
" plate amps.	.150

MODULATOR

Tube	Plate voltage	Plate m.a. per modulator	Volts grid bias	Volts peak grid swing	Modulation factor	Ohms dropping resistance
1-UV-845	1250	51	-200	112	0.43	1667
2-UV-845	1250	51	-200	200	0.85	1667

FULL POWER RADIOTRON UX-852 OR UX-860 LAYOUT

Amplifier or oscillator	UX-852 or UX-860
" plate volts	2000
" plate amps.	.125

MODULATOR

Tube	Plate voltage	Plate m.a. per modulator	Volts grid bias	Volts peak grid swing	Modulation factor	Ohms dropping resistance
1-UV-849	3000	100	-133	125	0.85	8000

RADIOTRON UV-204-A LAYOUT

Amplifier or oscillator	UV-204-A
" plate volts	2000
" plate amps.	.200

MODULATOR

Tube	Plate voltage	Plate m.a. per modulator	Volts grid bias	Volts peak grid swing	Modulation factor	Ohms dropping resistance
1-UV-849	3000	100	-132.5	78	0.54	5000
2-UV-849	3000	100	-132.5	125	1.00	5000

of Figs. 2 to 6 at the intersection of the amplifier plate current multiplied by the ratio of supply to amplifier plate voltages, and the plate supply voltage and the calculation made as follows:"

In example 2, page 20, the amplifier should draw 200 m.a. This changes R to 5000 ohms, p to 0.675 and M to 1.01.

E. E. Spitzer, Research Laboratory

cup has arrived safely and in excellent condition.

It is a most beautiful trophy and I must express my appreciation of the A.R.R.L. in offering such a wonderful prize for the station description contest. I must also take this opportunity to thank the editors of QST for the great, and unexpected, honor they have done me in awarding the first prize to my station.

A SAFE GUIDE

in the selection of insulation for Radio Transmitting and Receiving Sets

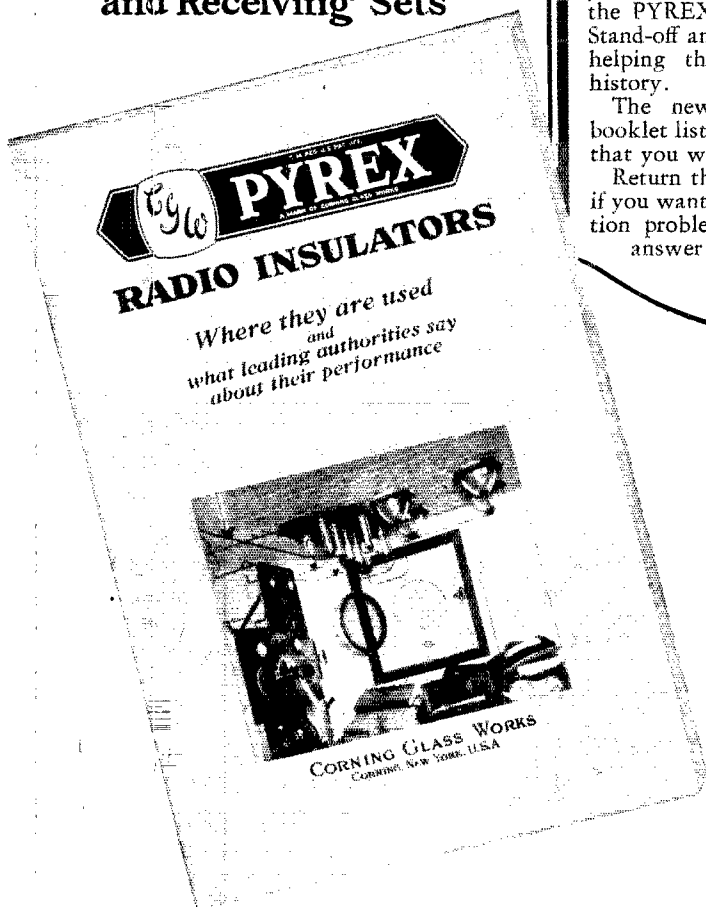

OVER 300 broadcasting stations, leading radio telegraph systems, the United States Army, Navy, Air Mail, Coast Guard and Ice Patrol Services, explorers like Commander Byrd, and exacting amateurs everywhere have utilized PYREX Insulators in many spectacular achievements.

Regardless of whether you are sending or receiving — on land, sea or airplane — you should be thoroughly familiar with the PYREX Antenna, Strain, Entering, Stand-off and Bus-bar Insulators that are helping these leaders to make radio history.

The new PYREX Radio Insulator booklet lists all types and sizes with data that you will want for ready reference.

Return the coupon for your copy, and if you want further advice on any insulation problem, our Technical Staff will answer your questions promptly.

Send the coupon for your copy

CORNING GLASS WORKS
Corning, N. Y.

Gentlemen:

Please send me copy of your new bulletin on Radio Insulators.

Name

Address

QST 3-30

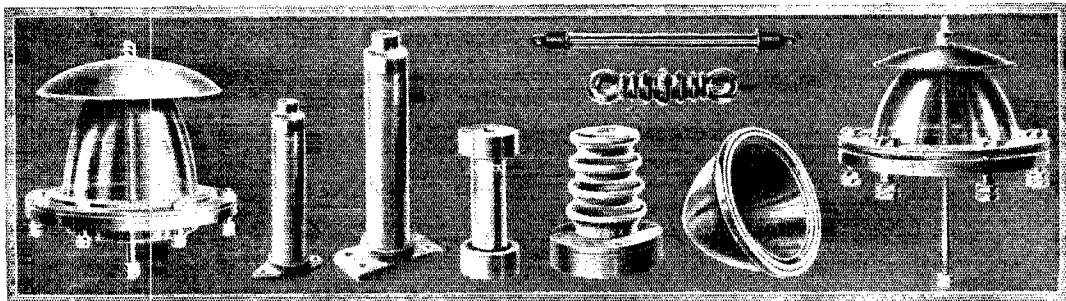

MILLIONS of Bradleyunits

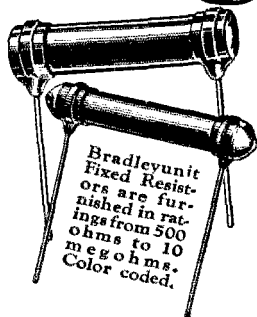

In
Radio
Sets
TODAY

MANUFACTURERS of leading radio receivers are using millions of Bradleyunits for grid leaks and plate coupling resistors, because Bradleyunits are absolutely noiseless in performance. In radio sets, Bradleyunits are specified because their accurate rating is unaffected by temperature, moisture and age. In production, Bradleyunits are preferred because they are not fragile. There are no breakage losses. You too can benefit by standardizing on Bradleyunit Solid Molded Resistors.

Write for complete information and prices, today!



The huge Allen-Bradley plant at Milwaukee provides unlimited research and production facilities.

ALLEN-BRADLEY CO.
277 Greenfield Ave. Milwaukee, Wis.

Allen-Bradley
PERFECT RADIO **AB** RESISTORS.

I hope to be able shortly to send you a photograph of the cup occupying the "place of honor" at my station.

Again thanking you, with very 73,

H. L. O'Heffernan, G5BY.

Comments on 14 Mc. 'Phone

8505 167th St.,
Jamaica, L. I., N. Y.

Editor, *QST*:

The A.R.R.L. has won a well deserved vote of thanks from the many amateurs interested in short-wave radiotelephony for its efforts and success in getting another band opened for their rapidly increasing numbers and especially a band capable of international work. In discussing this band with 'phone men, almost to a man they have believed it will greatly reduce the very overcrowded condition that now exists in the so-called 80-meter 'phone band. Let us take a look at what may be expected of this new band, based on c.w. telegraphy because little data exists on telephony on such waves.

First off, we find that although we, as pioneering amateurs, have been playing with short waves for years and with our thousands of possible observers at every finite distance conceivable, yet we have no comprehensive curves or charts as to what any wave could be expected to do under various seasonal and darkness conditions. Therefore I turn to data compiled by various government and commercial sources for the Federal Radio Commission. It states that the new 'phone band is absolutely useless at midnight in the winter for any work whatsoever beyond the 35-mile ground wave. This may be a surprise to some, as many 'phone men have done little code work in the past few years and I recollect none that I have ever heard in the 20-meter band. Now it so happens that the terrible 'phone interference that is supposed to get relieved by this new 'phone band happens to be at its worst at or within a few hours of midnight and during the winter; in other words, at a time when the new band is unworkable. Due to the long winter nights, midnight conditions exist to a certain degree over all the ordinary amateur working hours. Even at noon in winter the skip distance in which no signals are heard is given as 820 miles and signals are stated as being unreliable beyond 4000 miles.

From the same source we find that in midsummer at midnight the skip is 2200 miles, enough to exclude most parts of the U. S. working within itself, and that while a range of 7000 miles is possible, it is dangerously near the end of the curve labelled "no longer useful" so that erratic results might be expected. This leaves only the conditions of midday midsummer to be considered, a time when a few of us will try out the new band on a rainy Saturday afternoon or Sunday, provided we have gone through the red tape of having our licenses fixed up. The skip is given as 350 miles and good reliability may be expected up to 1600 miles. It would seem as though amateurs would obtain better ranges, as

Headquarters for Radio Instruments

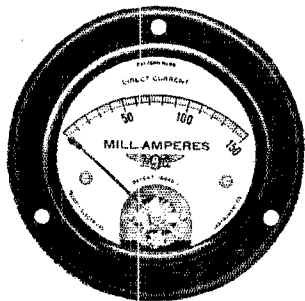

Jewell Instruments have been the favorites of amateur broadcasters since the very inception of popularized radio. Today the Jewell line of Miniature Instruments for amateur broadcasters is more complete than ever before. To the old favorites has been added a new line of bakelite case instruments for flush type mounting. New ultra sensitive D.C. and high frequency meters are also available. Equip your 1930 transmitter with these new instruments.

Jewell 199 Set Analyzer

This is the lowest priced complete set analyzer on the market. It is remarkably simple to operate and makes every essential field service test. Thousands of radio service men have found the Jewell Pattern 199 the key to profitable service work. The Jewell Pattern 199 plus Jewell Radio Service Data, when used with the Jewell Chart Method of set analysis, eliminates guesswork in servicing.

Jewell 409 Set Analyzer

Similar to the well known Pattern 199 but has four instruments instead of two. Gives filament, grid, and plate voltages as well as plate current, simultaneously, for instant comparison. Unquestionably the deluxe kit for those who want the last word in portable set analyzers. Pattern 409 is backed by the same complete data service which has been a great factor in the popularity of the Jewell Pattern 199.

Every service man should have a Jewell Pattern 199 or 409 Set Analyzer. For sale by leading radio jobbers.

Jewell offers a complete instrument service to radio amateurs, service men, and manufacturers. Write us about your instrument problems

30 YEARS MAKING GOOD INSTRUMENTS
JEWELL
409 SET ANALYZER

Jewell Electrical Instrument Company
1642-C Walnut Street, Chicago, Ill.
Please mail booklet entitled, "Instructions for Servicing Radio Receivers," and circular describing the complete line of Jewell Radio Instruments.

Name.....

Address.....

TESTING INSTRUCTIONS FOR SERVICE MEN



For
use
with

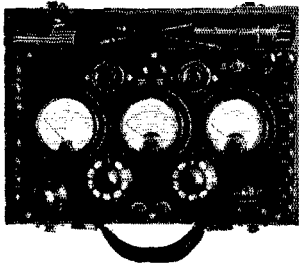

Model
547

RADIO SET TESTER

This Instrument, and this Manual which is furnished with it, together provide the most complete and up-to-date equipment available for servicing radio receivers. Electrical data for practically every set on the market is contained in this book — which is made up in loose-leaf form so that purchasers of the instrument who turn in registration cards are automatically supplied with latest information.

This instrument has achieved wide success among dealers and service men. It is preferred because of its dependability, ingenious design providing ease of operation, compactness and light-weight portability. It will make all the required tests on any A. C. or D. C. set. Durable bakelite case and fittings. Provided with 3 1/4" diameter instruments.

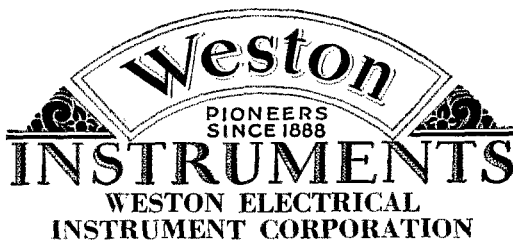

602 Frelinghuysen Avenue

Newark, N. J.

60

Say You Saw It in QST — It Identifies You and Helps QST

these figures are for a high degree of commercial reliability but on the other hand are for 10 kw. in the antenna, so perhaps they are not far off for average amateur conditions. (By way of comparison with conditions more familiar to the 'phone amateur, these same tables give a midday mid-summer range for our 3500-kc. band of about the 85-mile ground wave, a midday winter range of 182 miles, a summer midnight range of 1200 miles, and a winter midnight range reliable up to 3800 miles.) Whereas telephony was considered as having a range of about 10% of that of its carrier, newer and more complete modulation methods have increased this percentage greatly.

From the above it appears that the 3500- to 3550-kc. part of the 3500- to 4000-kc. band is going to be little better than before. Several of us will have two transmitters or be able to convert our sets but there will be little overlapping of usefulness, few times when we will have much question as to which is the better, and this does not help our congestion at the time it needs it. At this moment I have just swung my dial slowly and counted 16 'phone stations operating or trying to operate in their one-tenth of the band, and 5 code stations in the remaining nine-tenths of the band. It seems to me that relief lies in letting the 'phone fellows spread out in the band or at least say from 3500 to 3750 kc. which would be only half. There are a few c.w. fellows in the 'phone band now and they must feel infinitely more crowded than if they were just out of it, even though the proposed new 'phone band extension included them. As has been observed by others, the c.w. fellows in the band usually have good notes and can operate through quiet hours whereas practically all 'phones shut down, thus my proposed extension would give the c.w. fellows full run of the whole band for the best and most convenient 2 1/2 hours of the evening and if they want to keep away from the 'phone altogether they can cut four feet off the antenna if necessary and spend a few moments grinding off the crystal, which is much easier than putting some back on either.

Amateur telephony has been growing at the rate of about a thousand new stations per month in a band suited for three stations according to commercial standards. I believe in making room for this growth and only wish a solution for the bedlam on 7000 kc. appeared as simple.

— Boyd Phelps, W2BP

QST Gets Him on the Air

2900 Carson Road,
St. Louis, Mo.

Editor, QST:

It is about a year and a half since an ambition of more than twenty years standing has been realized. Station W9GAC came into being using only QST for all necessary information. I have never been in doubt of frequency stability or the character of the emitted signal. The high-C transmitters are wonders, the tuning dope equally as good, the receivers are second to none, and

PERRYMAN

Rectifiers

P. R. 872 - P. R. 866

HOT CATHODE MERCURY VAPOR TUBES



P. R. 872	
Fil. Volts	5
Fil. Amps.	10
Peak Inverse Volts.	3,000
Peak Plate Amps.	2.5
Voltage Drop	15
Overall Length	8 1/2"
Diam.	2.5/16"
Price . . .	\$18.00

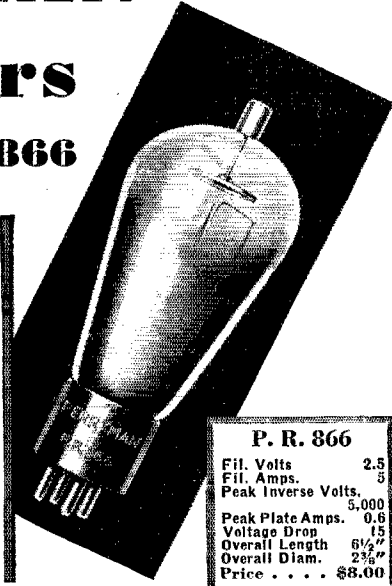

P. R. 866	
Fil. Volts	2.5
Fil. Amps.	3
Peak Inverse Volts.	5,000
Peak Plate Amps.	0.6
Voltage Drop	15
Overall Length	6 1/2"
Overall Diam.	2 3/8"
Price . . .	\$8.00

THE P. R. 872 and P. R. 866 have met with instant acceptance by transmitting amateurs. Transmitting amateurs tell us these two new tubes fill their need for a reserve supply of rectified current.

The P. R. 872 furnishes an extra large supply of rectified current. It has more than four times the capacity of the P. R. 866. The P. R. 866 is suitable for the transmitting amateur who needs 0.6 ampere maximum output. Because the P. R. 872 and the P. R. 866 possess a low and practically constant voltage drop, both tubes furnish a stable source of plate voltage.

Built with the same rugged strength for which all Perryman Tubes are famous, combined with the low operating temperature of the oxide-coated filament and the extremely low voltage drop resulting from the mercury content, the P. R. 872 and the P. R. 866 open new fields for amateurs.

FOR LOW-POWER TRANSMISSION

- P. A. 250 . . . \$11.00
- P. A. 245 . . . 3.50
- P. A. 210A . . . 9.00

(Oxide-coated filament, standard 210 characteristics)

The same rugged construction which has made Perryman tubes famous, assures extremely uniform characteristics. These tubes operate on guaranteed grid current at the rated voltages. Each of these tubes is specially selected and tested to suit the particular requirements of radio amateurs.

SPECIAL, ATTRACTIVE PROPOSITION FOR LICENSED AMATEURS

PERRYMAN ELECTRIC CO., INC., 4901 Hudson Boulevard, North Bergen, N. J.

Please send me the following tubes:

.....	P. R. 872	@	\$18.00
.....	P. R. 866	@	8.00
.....	P. A. 250	@	11.00
.....	P. A. 245	@	3.50
.....	P. A. 210A	@	9.00

for which I am enclosing (Money order) for \$.....
(Check)

Name..... Station.....
Street.....
City..... State.....

DON'T YOU BE DISAPPOINTED TOO!

Every day we are requested to furnish back copies of *QST* — which we gladly do if they are still in print. The request frequently reads something like this "Please rush a copy of the issue of *QST*. Mine is lost or misplaced. Can't proceed with my new transmitter until I get that copy."

What a sad blow if that issue is out of print! Unfortunately, we frequently have to give the bad news.

Now, knowing that *QST* probably has greater reference value than any other radio publication, you should resolve to keep past and future issues in a

QST Binder



Note the wire fasteners. Unnecessary to mutilate copies. Opens and lies flat in any position.

One-fifty each
postpaid

A binder will keep your *QST*'s always together and protect them for future use. And it's a good-looking binder, too.

QST
1711 Park St., Hartford, Conn.

what a godsend is the monitor when correctly calibrated!

I have visited but two amateur stations and only one amateur has called here. Still, I have had no trouble getting started. I do not think that a single operator QRT on me when I was starting in. New operators should realize that often their call is lost in the interference but the real amateur has never quit on the job yet.

Wish I could thank personally all of those patient fellows who helped me along with code practice when ten words a minute was some speed for me to copy.

—E. L. Likert, W9GAC

The Old Order Changeth

210 N. Knox Ave.,
Topeka, Kan.

Editor, *QST*:

Perhaps you have the idea that I am a sensible, well-balanced sort of cuss. I hope so. Some such impression on your part is going to be necessary if you are to hear me through. I hope so — but never mind; I shall plunge.

I like my fiction wild. It provides a mental joyride which takes me away from plugging facts and thereby acts as a tonic. This month's tonic, however, was a bit adulterated with science. In the January number of *Ghost Stories* is an article on telepathy by Upton Sinclair. Cuts are shown of pictures drawn by one person in secret and other cuts show another person's impressions, presumably gained by means of mental telepathy, of these pictures. The cuts are very convincing.

What has this to do with amateur radio? Here is where I fear you will send for the wagon. I think I am sane and, honest, I'm sure I'm sober.

Ever since entering the ham game I have had a mental system of break-in thrust upon me. At the time of my first QSO I was afflicted with the usual nervous thrill, the intensity being so great that I couldn't send and had to give that fellow up. The same thrill often occurs today in much milder form after several years of operating and thousands of QSO's. There's nothing odd in that, but (gee, I'm afraid to go on!) the "thrill" sometimes occurs while I am still calling (receiver dead as a doornail) and invariably means that I have hooked my party. My little hunch is never present when I have visitors in the shack.

I have never mentioned the phenomenon before because I hate nothing worse than being called a liar. I mention it now only to give it as my reason for placing faith in the Sinclair article.

The article has given me an idea for a ham game. As a scientific experiment, it would likely prove fruitless, but regarded merely as a game, it ought to be highly entertaining — more so than radio checker matches, at any rate.

Suggested rules:

1. Get QSO.
2. Agree as to who shall act as Nr. 1 party.

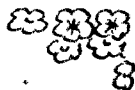

-NEATH THE SPANGLES BEATS A HEART O' GOLD



BUT we fear that not every tinsel heart was as the lily. Many were the scheming adventuresses that sought to ensnare some fair youth. And even today many a spangle glosses over imperfect craftsmanship. Too often, glitter passes as worth.

The Cardwell Condenser spurns the spangle. Divested of tinsel, it stands unashamed, a masterpiece of workmanship.

Cardwell Condensers are or can be made in sufficient variety to suit most needs for broadcast and commercial transmitters, amateur transmitters and receivers. The super rigid Taper Plate is ideal for short-wave receivers. Send for literature.

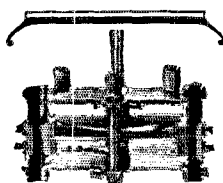

The 201-E (2 plates). A taper plate condenser for short wave receivers. The stator plate is adjustable, affording maximum capacities of from 50 to 10 mmfd. Price \$4.

CARDWELL CONDENSERS

THE ALLEN D. CARDWELL
MANUFACTURING CORPORATION

81 Prospect Street, Brooklyn, N. Y.

Since broadcasting began

"THE STANDARD OF COMPARISON"

Cunningham RADIO TUBES

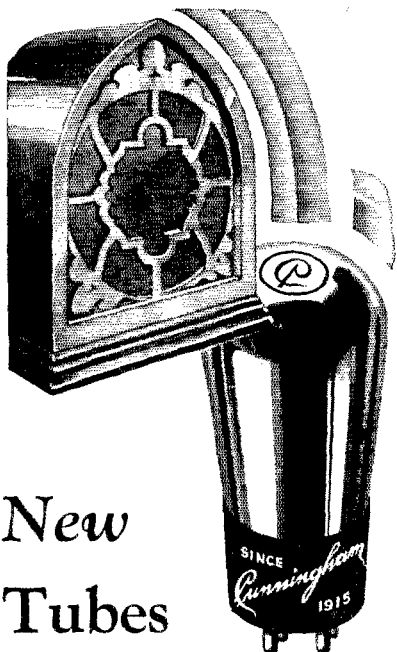

New
Tubes

add New Energy

RADIO tubes are an integral part of your radio equipment and require intelligent selection and care.

It's false economy to use inferior quality tubes at the expense of quality reception.

*Cunningham Radio Tubes
have embodied in-built
quality since 1915*

E. T. CUNNINGHAM, INC.

New York Chicago San Francisco
Atlanta Dallas

Manufactured and sold under rights, patents,
and inventions owned and / or controlled by
Radio Corporation of America.

3. Prepare two sheets of paper with carbon between, at each station.
4. Sign off.
5. Nr. 1 party draws a picture (not of a radio object — it might be guessed) during the next five minutes and concentrates upon its appearance for another five.
6. Nr. 2 party passively draws whatever comes to mind during the second five minutes.
7. Carbon copies are kept and originals are mailed to each other *immediately*.

Fraud would be practiced, of course, if we attempted to make a serious matter of such game. Here is my idea: There's fun in the thing — the farther they miss it, the greater the hilarity. In the event of a success, there would be at least two parties who knew there was no fraud. These parties would be bound to continue the experiments and might uncover some new knowledge.

It strikes me, as an afterthought, that if the thing proved to be a grand success, we could throw away our transmitters and eat fish to increase our power!

Please don't trouble to answer this; I understand.

—Jim McCormick

The Old Man at VE2BB

1015 West St.,
Utica, N. Y.

Editor, *QST*:

Mr. Charles J. Dawes, VE2BB said some nice things about the way hams treated him, in November *QST*, but I think it is no more than right to let the world know, through *QST* if you care to, what a nice friendly ham he is.

—Edward R. Kingsland, W9ABQ

Getting Results with the Doublet

Pointe du Bois,
Manitoba, Canada

Editor, *QST*:

The doublet antenna for receiving is producing the goods just as claimed in the *QST* article. In fact, WGY and KDKA, considerably out of the band come in with more volume than with a 100-foot antenna.

Most of the time the background noises are severe here because of the local power plant and it's high tension wires. In extreme cases one of the feeder wires is disconnected at the set with very quiet results and not much loss in signal strength. Thanks are due the authors of the article.

—J. H. Brownell, VE4BU

Strays

MILWAUKEE QSO PARTY

The Milwaukee Amateurs' Radio Club is staging their annual stag banquet and QSO party on March 22. There will be popular speakers, prize drawings, and entertainment. Everyone is invited. Write the club at 601 Enterprise Bldg., for further dope.

REL PARTS FOR "BREADBOARD LAYOUTS"

Many of the finest amateur stations use Breadboard layouts. REL parts are ideal for this type set. Coils, Condensers and Chokes have been designed to insure the shortest possible connections, the most compact arrangement and the most efficient operation.

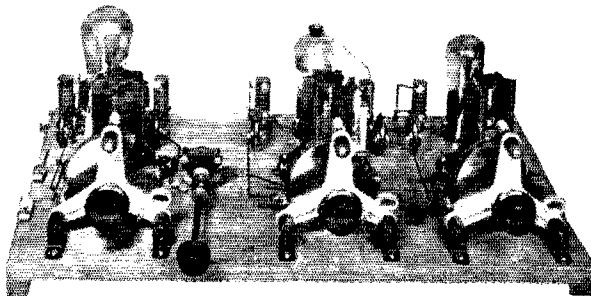

The above is an illustration of a breadboard layout employing one UY-227, one UY-224 and one UX-245 in a modern M.O.P.A. circuit. This transmitter was built by W2BNC, Brooklyn, New York, using REL parts.

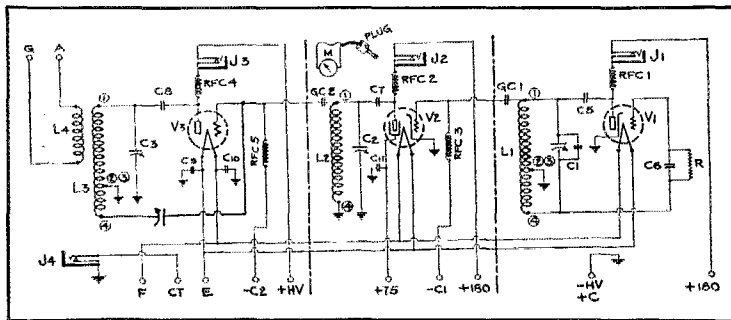

Above is the exact wiring diagram used in this most successful and ultramodern transmitter. Plug-in coils are REL Cat. No. 215, Variable condensers are REL Cat. No. 181-B and Choke Coils are REL Cat. No. 132. The use of REL parts will be your assurance for satisfactory performance.

REL Plug-in coils may be secured for any circuit or any wave length. Blank coils will be gladly supplied. Turns may be easily added or taken off.

REL Variable condensers may be secured in all standard capacities. Easily removable stator plates allow a quick change in maximum capacity.

REL RF Choke Coils are made to operate on any specified frequency or in any circuit. **WRITE** for complete Booklet describing REL parts and how to use them.

W2XV transmits every Wednesday and Friday evening between the hours of 8 and 10 P.M. Eastern Standard Time on 8650 Kcs.

RADIO ENGINEERING LABORATORIES, INC.
100 WILBUR AVENUE, LONG ISLAND CITY, N. Y.

FROST-RADIO

As the world's largest manufacturers of high grade variable resistors, we are singularly well equipped to supply your requirements, no matter what they may be.

Write us in detail regarding your variable resistor problems, and have us submit samples to meet your specifications.

HERBERT H. FROST, Inc.

Main Office and Factory: ELKHART, IND.

HERBERT H. FROST, Inc.
160 North LaSalle Street, Chicago

Send me your Parts Catalog by return mail. I understand that it will be sent to me FREE and postpaid.

Name

Address

City State

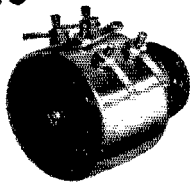

No. 890. Double depth metal shell unit in rheostat or potentiometer type. Rotors in same electrical connection. Composition elements, 5,000 ohms to 1 megohm in each unit. Diameter, 1 7/8 in. Depth of shell, 1 3/16 in.

BANKRUPT RADIO STOCKS

Fully Guaranteed

- 2 Mfd. Condenser Packs, 2000 v. A. C. test \$7.90; 1500 v. \$3.80
- 250 or 245 Power Condenser Block \$4.75
1000 v. A. C. test tapped 2, 2, 2, 4, 1 and 1 mfd.
- ABC power Packs, completely assembled. \$8.75
350 v. B. also has A. C. filament for up to 9 tubes set. Can be used as B eliminator. Make your battery set all electric or build your A. C. set around this pack. 280 type tube for this pack 95c extra.
- Double chokes, 30 henry each 160 mils 1500 v. test shielded \$4.95; 130 mils. \$3.75
- Short Wave sets, one tube complete with 5 coils, 30 to 550 meters. \$6.45
- A. C. Power, Filament and Choke Pack. \$4.25
- No. 1003 Power Transformers, shielded. Sec. 600 v. For one 281, one 250, one 227, four 226 and 2 chokes. \$5.00
- 7 tube A. C. Sets. \$24.50
- Tubes, UX type. Guaranteed. No. 210, \$2.25; No. 250, \$2.35; No. 281, \$1.85; No. 280, 95c; No. 245, \$1.25; No. 224, \$1.65; No. 227, 75c; No. 226, 65c; No. 171, 75c; No. 190, 95c.
- Microphone Transformers 95c; Thordarson 1 to 1 Audio 95c; Variable condensers 50c; Coils 35c.

CHAS. HOODWIN CO.

4240 Lincoln Ave. Dept. C-8 Chicago, Ill.

Dealers in Bankrupt Radio Stocks

Calls Heard

(Continued from page 54)

W2MQ, Frank C. Seid, 120 28th St., Woodcliff, N. J.

w6du w6do w6eju w6auk w6fd w6ft w6lh w6xbb w7ahw w7ny w7qf ve2am ve2ay ve3dd veiar ve3jw x2ax rx1aa nna1ac ct1bx cm2ac cm2co

S. W. Wardle, Woodford Leigh, Clarence R., N. S. W., Australia

7- and 14-mc. bands

ac1bd ac2ff a8mg ce2ab ce3bf s5yg g6vp geo j1zz j3er j3iz kfu5 klaf k1ce klcm k1el k1fe k1hr k1re k6acw koavt k6bbw k6bjj k6boe k6bra k6cib k6dvt k6erh lu1da oath oa4f oa4q oa4t py2ad py2bg py2bk rx1aa su8wy w2ajp w2cbs w2cbx w2cd w1ne w6w w6waj w6bta w6iuh w6dbd w6dly w6dky w6dmm w6dwm w6am w6tm w7bb w7bkg w7efr w7cw w8axz w8evn w8eve w8aab w8erb w9dgz w9ebo w9erm w9wx wsbs x9a

W5NW, Wayland M. Groves, Box 637, Baytown, Texas

7000-kc. band

em1by em2xc kalee kalem ka1ey ka1dj ka1he ka1hr ka1mm ka1nj ka1pw ka1zg k4kd k6bra k6dju vk2ns vk2wj vk3eb vk3ml vk4hg vk6mu vk6sa vk6vi vk7dx vk7lj zl1aa zl3bb zl4bn na1nic

W9AEX, Francis Wentura, 311 Jersey St., Quincy, Ill.

7000-kc. band, Jan. 29th

w1ag w1ft w5arp w8bws w8cvq w8dgb w8on w9acw w9aix w9amt w9aqz w9awa w9bzm w9civ w9cto w9ley w9eji w9eru w9feq w9ffd w9fus w9dgu w9so

7000-kc. band, Jan. 30th

w1aau w1aow w1con w4nn w6aew w6avj w6awp w6ayg w6bcw w6bfb w6bpo w6bqk w6bqp w6byb w6cye w6ckx w6cok w6cqs w6etz w6daw w6dhw w6dpl w6dpl w6dzm w6dzb w6eau w6ehp w6sf w7kp w7iq

W1MS, Charles H. Horton, 173 N. Adams St., Manchester, N. H.

14,000-kc. band

ce2ab ct1bx f8fk g5rs lu3dh oz7y pylsa ve2bdv ve3az vk2ak ce3ag ct1aa f8hr g6nf na1xlr pax1 py2ay ve3aq ve1ar vktak cm2bt d4bg f8lmm g6rb on4he pylah ve3bo ve3bq vo8aev cm5ex f8da g5bz he1fg on4us pylaw ve3fl ve3di vo8inc f8ex g5ml he2jm on4uu pylia ve3dr ve4ie

VK2JZ, A. S. Mather, 14 William St., Singleton, N. S. W., Australia

14,000-kc. band

ac3fr ac1bd vs6ag vs6ah pk3bm pk4az z1lfv oatt lu3dh z1lbg z1lfw z1zbg z1zda z1zaj k6boe w8auz ve6he z6ix zu6n pa0dw ru2dr pk1yr w8euz w6bax w6ete oa4j ce2ab z1lfu z1zbx z1zgh g6rb vs6af ve5aw f8ex f8hr on4us on4ka j2by ka9ms j3iz ka1jr fi8lrp vk6ja

W6DZQ, Henry Eckhard, 533 Valencia St., San Francisco, Calif.

3500-kc. 'phone band

w6abf w6alz w6aob w6ary w6aut w6baa w6bbj w6bif w6biu w6bhq w6buz w6byk w6cix w6cvi w6eac w6ebm w6eeq w6erc w6eru w6kr w6fe w6fj w6kt w6nx w7if w7lq

W9BTG, John H. Allen, 406 South 7th St., Seneca, Kansas

as2 av2 ce1ah ce2ab ce2be ce3bf ce3bm ce3ej cm2ay cm2co cm5ex cm5fc cm5fl cm7hh cm8by cm8mf crkk ct1ew er3 fgb he1dr kaaan k6alm k6ns k6boe k6dgt lu2o lu8en ni2pa nitc nj2pa n1nic n6wv n6x pel pecc ps pylca pylia ti2hw ti2wd ver velam velda ve1dr ve5ak ve5aw ve9av ve9sj



Tune in on a Lifetime of **THRILLING ADVENTURE**

Learn **RADIO**

...And See!
the World!

WHY not go around the world... *seeing things* ... *doing things* ... *making Good Money* ... *getting somewhere in Life* ... **WHY NOT LET RADIO PAY YOUR WAY!** That's what RCA Institutes has done for other men ... That's what it can do for you. Radio needs you **TODAY!** ... Thousands of positions now open! Why be merely a "radio fan," when you can so easily use the knowledge you already have as a stepping-stone to success. RCA Institutes gives you all you need to know about Radio to prepare you for a well-paid job in the fastest-growing industry of today! You get the "how" as well as the "why" of commercial radio. Nationally known experts direct your studies ... You are *trained* to "make good" by men who have "made good."

A Commercial License Can Easily Be Yours

Never before have there been such opportunities for rapid advancement. The entire radio world is crying for men ... *trained* men ... RCA Institutes' men. That's why large broadcasting sta-

tions, manufacturers, dealers, as well as steamship companies are continually asking for RCA Institutes' graduates. They know that these men have the knowledge and ability to hold good positions in Radio. . . . You, too, can get that knowledge.

The Only Course Sponsored by the Radio Corporation of America

RCA, the world's largest radio organization, stands squarely behind every lesson that you study. A thorough knowledge of commercial Radio can now be yours through the RCA Institutes' home-laboratory training course. You obtain a sound practical education in radio in your spare time . . . You get the "inside" information right at the source of radio achievement . . . direct from RCA. You learn radio by actual experience with the remarkable outlay of apparatus given to every student of this course.

Clip this Coupon Now!

See for yourself how RCA Institutes actually trains men for success in Radio. *Thousands* of graduates of this course are now holding responsible positions. **WRITE FOR THIS FREE BOOK TODAY.** . . . or ask for your copy at any one of our resident schools. 40 fascinating pages, each one packed with text and illustrations telling all about the amazing opportunities in commercial radio, the world's fastest-growing industry!

For the added convenience of students who prefer a Resident Study Course, RCA Institutes, Inc., has established Resident Schools in the following cities:
New York . . . 326 B'way
Boston, Mass. . . 899 Boylston St.
Philadelphia, Pa. . . 1211 Chestnut St.
Baltimore, Md. . . 1215 N. Charles St.
Newark, N. J. . . 560 Broad St.
Home Study graduates may also attend any one of our resident schools for post-graduate instruction at no extra charge.

Clip this Coupon NOW!

RCA INSTITUTES, INC.

Formerly
Radio Institute of America



RCA INSTITUTES, Inc.
Dept. QST-3, 75 Varick Street, New York

Gentlemen: Please send me your **FREE 40-page** book which illustrates the brilliant opportunities in Radio and describes your laboratory-method of instruction at home!

Name.....

Address.....

Announcing Oscillating Quartz Discs

We announce oscillating quartz disc crystals of the finest grade — ground by experts to your exact specified frequency!

All crystals are ground to absolutely correct setting of the optical and electrical axis and are fully guaranteed as regards output and frequency precision. Only the finest grade of piezo-electric quartz is used.

Our crystals are perfect discs. There are no corners to crack. Symmetrical vibrations within the disc reduce stresses and give maximum power output.

Note our prices on oscillating discs in the 7000 kilocycle band. No frequency doublers are needed with these little jewels!

Try a 7000 kilocycle crystal for that new 14,000 kilocycle phone!

Kilocycles	Wave-length	Precision	Precision	Precision
		3%	1%	0.1%
600-1000	300-500	\$12.00	\$16.00	\$25.00
1000-1500	200-300	11.00	15.00	22.50
1500-3000	100-200	10.00	14.00	20.00
3000-4000	75-100	10.00	14.00	20.00
4000-6000	50-75	11.00	15.00	22.50
6000-8500	35-50	12.00	16.00	25.00

The above prices are for disc crystals supplied to the exact frequency specified by the user and to the precision chosen.

Prices of specially matched oscillating quartz discs, accurate to plus or minus 200 cycles, furnished on request.

Every crystal comes complete with spring pressure type of holder, free of charge. A laboratory certificate of exact frequency is supplied with each crystal.

Order direct from this advertisement

CLIFFORD E. HIMOE
W2AW.....318-320 Lafayette Avenue
ex-WNP.....Passaic, New Jersey

vk2hm vk2jo vk2lv vk3es vk3jy wfa wgrd wsc x2tf x29a
x5z x9a x9gf xw1m y1ax yna z7x z1lan z1no z1fw z1zbl z55x

W9FGW, Paul Bowden, Aurora College,
Aurora, Ill.

7000-kc. band

cm2jm em2yb em5fe hc1dr k6bra nn1nic ti2hv tg2clo x29a
nfx wsbs 55x

14,000-kc. band

ce1ah ce1al ce2ab ce2bm ce3ab ce3ac ce3ag ce3as ce3bf
ce3bm ce3da ce5aa cm2ay cm2jt cm5ex ct1aa ct1bx cx1fb
d1aan f8aja f8da f8ex f8gdb f8ix f8orm f8pb f8rmf f8wb
fm8fva fmtun2 g5by g6bh g6er g6ia g6nt g6uh g6wy g6xb
hc1fg hc1le hc2jm i2ea k4kd k6acw k6etf kfr5 lu1ba lu2ca
lu2dj lu3dh lu3fk lu4da lu8dj lu8dy lu9tr nj2pa oajj oa-to
oa4q oa4r oa4s oa4t oa4z oa4pj pa0zf pylaa pylah pylaq
pylaw py1ax py1be py1em py1id py2ak py2ih py5aa sniaa
ti2hv vk2dy vk2hl vk2jv vk2jl vk2no vk2ns vk2rx vk3af
vk3ep vk3pa vk3wx vk3xo vk4bh vk5aw vk5hj vk7j vobae
vo8wg x1g x3a x9b x8hpg xpa0zz wx2yz z1lan z1ao z1aw
z1fc z1fr z1fw z1zbc z1zbl z1zbc z1zga z1zgh z1zgo z1zgm
z1zao z1zba z1znu wfa wlat wsbs

W5PG, Noll J. Melancon, 492 1/2 S. Johnson St.,
New Orleans, La.

7000-kc. band

cm3by cm7hsm cm7li j3cf k6ewb ka1ee ka1hr ka1pw nu7nic
om1tb ve2bv ve3cb ve4bx ve4jb vk2cz vk2hk vk2ns vk2ow
vk3pr vk4cg vk4gr vk4mm vk5hg vk5it vk6sa zsm5 z1kf

AC8HM, H. MacGowan, Care American Club,
Shanghai, China

7000-kc. band

ac2az ac2ff ac3ma j3by kalaw ka1ee ka1dj ka1hc ka1hr
ka1hw pmz va1ag vk2ak vk3fr vk4do vk6mo w6am w6amw
w6evn w6eyi w6hm w6jn z1bi

14,000-kc. band

ce3ac ce3ag ce3ff f8lrp j2by j3cf oa4ma vs6ae vs6af vk2cv
vk2kl vk3pm vk4bh vk4rj w6awp z1fc z1fr z1ft z1fw
z1iao z1lap z1zaw z1zbx z1zax z1zax lu2ca lu3de lu3dh lu3fa
lu6aj lu8dy pk3bm pylia py2bg py3ah

H. J. Conti, 15 Harbor Terrace Drive, Rye, N. Y.

w6aax z6agg w6akw w6bhd w6bez w6bfg w6bqw w6bvx
w6chl w6dea w6dqy w6dtd w6dto w6dzk w6dzy w6ec w6efh
w6egk w6eva w7ahw w7fl w7nr k4aan k4kd k6avl k6eck
kdv5 kfr5 cm2ef cm2co cm2ro cm5fe cm5fl cm8uf nj2pa
nn1nic nn3nic nn7nic nr2wd ve2ay ve2be ve2br ve3ay ve3bt
ve3vs ve6az f8gdb py1at py1id vk3jk z14av zsiwe

VQ4CRE, Sydney A. Pegrume, c/o Barclays Bank,
Nairobi, Kenya, B. E. A.

w1aqt w1ber w1bux w1om w2ai w2cpj w2jn w2mb w3pf
w3chi w8dme w8axa w8z w9brx f8jf f8fk f8ws f8whg f8ha
f8xz f8wb f8da f8ep f8rmf f8orm f8eo g6ut g6vp g6wt g6wy
g6pa g6nf g5uq g2ej g6it g6wk g6rb g6yb g6fy z2zn
z44m z55r zuld z6fn z6fw g6wl g6hp g6by k1hr k1cy k1em
y1ilm y1mdz py2ah py2ba ct1bx fa8bak ve1br ct1aa fa8bm
fa8kik vs7ap d4kg d5ai la1p pb7w pa0qf vu2dr ac1bd ok1ab
on4fp on4jj on4ja ar5ufm plk1r oz7bl su8an

W1AZE, Elliott C. Hagar, 30 Adams Ave.,
West Newton, Mass.

14,000-kc. band

ce2ab ce3ag ce3bf cm2jt cm2ah cm5ex ct1aa ct1bx cx1ao
d4jl d4ar ear62 f8ar f8cs f8da f8dot f8er f8fg f8fk f8whg g2ao
g2dt g5bz g5ml g5wk g5yg g6bd g6nf g6qb g6rb g6un g6vp
g6wy hc2jm k4aky k4kd lu3de lu6fe nkf oa4q on4ar on4fp
on4hc on4hp on4jj on4us on4uu oz7y pylaw pylca pylia
rx1aa x3a ex4rn zslp z44m

VK5GR, G. B. Raglees, South Road, St. Mary's,
South Australia

14,000-kc. band

w1ahx w1aqt w1bcb w1cer w1lo w1zz w2aaw w2abu w2aog
w2bcd w2biv w2el w2hq w2ig w2jn w2rs w3adm w3bth w3aef
w4akt w4ct w4pd w5afb w5ql w5wg w6ael w6bam w8aac

"Here at last is The Book that we of the Radio profession have needed for a long time. It is the best and most complete handbook ever published" says J. H. Bloomenthal, Chief Radio Operator, U. S. S. B. Steamship "East Side".

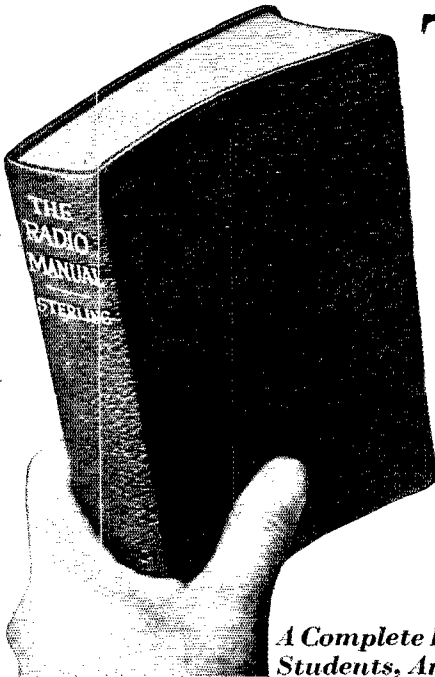

THE RADIO MANUAL

A New Edition

By G. E. STERLING, Radio Inspector and Examining Officer, Radio Division, U.S. Dept. of Commerce.

Edited by ROBERT S. KRUSE, for five years Technical Editor of QST.

Here's the answer to every question about the principles, methods, or apparatus of radio transmitting and receiving. A complete course in radio operation, simply and clearly presented in a single volume. Important new chapters on aircraft radio equipment; Practical Television and Radiomovies with instructions for building a complete outfit; radio interference; 100% modulation; latest equipment of the Western Electric Co.; the Marconi Auto-Alarm System, and many other recent developments have been added in this new edition. THE RADIO MANUAL continues to be the one complete handbook covering the entire radio field.

A Complete Handbook of Principles, Methods, Apparatus for Students, Amateur and Commercial Operators, Inspectors

Complete Preparation for Government License. 16 Chapters Covering

1. Elementary Electricity and Magnetism
2. Motors and Generators
3. Storage Batteries and Charging Circuits
4. Theory and Application of the Vacuum Tube
5. Fundamental Circuits Employed in Vacuum Tube Transmitters
6. Modulating Systems Employed in Radio Broadcasting
7. Wavemeters, Piezo-Electric Oscillators, Wave Traps and Field Strength Measuring Apparatus
8. Marine Radio Transmitters including new types of long wave, medium wave and short-wave transmitters
9. Radio Broadcasting Equipment including, for the first time in any text book, the complete equipment of Western Electric 5 kilowatt broadcasting transmitter; used in over 75% of American broadcasting stations
10. Arc Transmitters including description of Federal Marine 2 Kilowatt Arc Transmitter; Type M 4151; also models "K" and "Q"
11. Spark Transmitters including description of Navy Standard 2 Kilowatt Transmitter
12. Commercial Radio Receivers and Associated Apparatus including, for the first time in any text book description and circuit diagram of Western Electric Superheterodyne Receiver Type 6004C
13. New Marine Radio Equipment explained, including the British Marconi Auto-Alarm, which keeps SOS watch during operator's absence
14. Marine and Aircraft Radio Beacons and Direction Finders
15. Aircraft Radio Equipment, including descriptions of R.C.A. and Western Electric Transmitters, and the Reed Course Indicator
16. Amateur Short Wave Apparatus. Complete details of construction, operation and licenses
17. Television and Radio Moving Pictures, with instructions for building a complete outfit, by C. F. Jenkins, the inventor
18. Radio interference — Methods for Determining Its Cause and Means of Elimination
19. Radio Laws and Regulations of the U. S. and International Radio Telegraph Convention. Quotations of all important sections
20. Handling and Abstracting Traffic

Examine It Free

Never before has so complete a treatment of radio theory and operation been compressed into a single volume as in this Revised Edition of THE RADIO MANUAL. Here is information that otherwise you could secure only by consulting many different books. And every detail is vouched for by authorities of the first rank. The Manual is profusely illustrated with photographs and diagrams. There are 800 pages, bound in flexible fabricoid that is extremely durable. The immediate demand for so valuable a handbook will quickly exhaust the first edition. To be sure of receiving your copy without delay, order at once. The volume will be sent for free examination. Pay or return in 10 days.

Order On This Coupon

D. VAN NOSTRAND CO., INC.
250 Fourth Avenue, New York City

Send me THE RADIO MANUAL for examination. Within ten days after receipt I will either return the volume or send you \$6.00 — The price in full.

Name QST 3-30

St. and Number

City and State

Business Connection

Wireless or Morse
TELEGRAPHY
 Quickly and Easily Learned with the
INSTRUCTOGRAPH

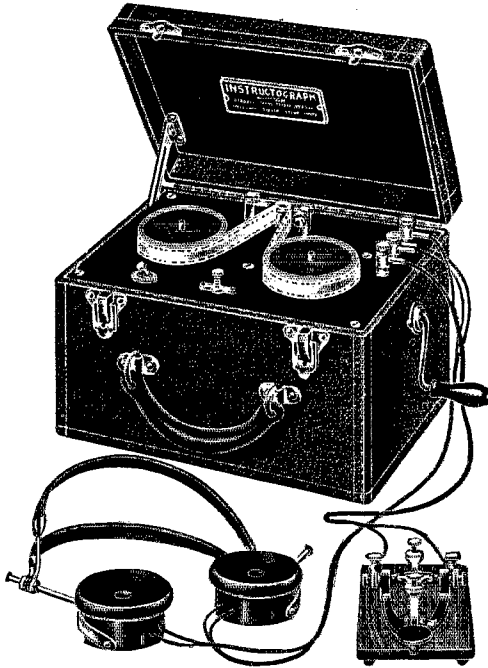

Big Demand for Operators

Here's your big chance! The chance you've hoped for, longed for, waited for. The chance to get into this uncrowded field where the work is easy and fascinating, the opportunities unlimited, the pay good and where you can pick the job you want on land . . . sea . . . air.

Learn in a Few Weeks

The *Instructograph* saves you both time and money. Instead of months by other methods—it teaches you in a few weeks. It is ready at any time or all the time to practice with you—to teach you how to be a good sender—a good receiver, and a good operator. Simple as A, B, C.

True Wireless Tone

The use of *Radio Tube and Head-Phones* in place of buzzer, is an exclusive feature of the *Instructograph* and gives you the *true wireless tone*. You don't have to learn all over again to get your license, when you learn with the *Instructograph*.

Big, Full Tapes

Plenty of them. Wireless or Morse. For beginners or advanced students. Big full tapes. 200 feet of signals on each. Alphabets . . . words . . . numbers . . . messages . . . radiograms . . . etc. Run at any speed. Tapes are perfectly cut after the Standard prescribed by the Dept. of Commerce, Radio Div., and are a big help to the student in getting his license. Our handsome *Free Brochure "A World of Opportunity"* explains everything. Don't turn this page until you've told us where to send *Your copy*.

INSTRUCTOGRAPH INSTITUTE
 608 South Dearborn Street, CHICAGO, ILL., U. S. A.

w8aat w8ath w8apb w8ayo w8bys w8cft w8cjh w8dae w8dju
 w8dlo w8wo w9ama w9beu w9cse w9cex w9djh w9dpy w9eap
 w9ef w9eta w9ftz w9giz w9pu ac1bo ac3fr ce1ah ce3ab cm2jt
 cm5fi ct1aa ct1bx ct1auk d4hi d4jl ear59 eu2fd eu5bh fs8xq
 f8bq f8oa f8rk f8gob f8rft f8whg f8lpr fm8kik fo3sr g2bm
 g5bz g5bz g5ml g5yk g6gc g6ni g6rb g6xc haf3h haf8h j2by
 j2eb j3cf j3dd k6boe k6bxw lu4da oa4h oa4l oa4o oa4q oair
 oatt ok2fd on4dj on4fp on4ho on4ij on4uu on4ww pa0d
 pa0qf pk1jr pk3bm pk4az pk4ho rx1aa r12hy un7ww ux2uu
 ve2ac ve2hg ve3bk vq2bh vs6ag vs8ah vs7ad vs7ag vs7ap
 vu2bg vu2dr vu2ev y1iao y1ilm zs2n zs5w zt2e zt5r zt0x
 zu3b etbj kfu5 sp3wr su8gm su8py su8yu wia

7000-ke. band

w1erw w2anr w2boz w2ce w3anh w3ajz w3btq w3bth w4aaq
 w4et w4du w5al w5aqe w5afx w5bbc w5bdh w5awf w6avq
 w6bz w6cht w6eak w7aed w7bb w8eo w8drj w9azy w9ckq
 w9gy w9erd ve2bb ve4bq ve5dd k6cjs k9pb omitb j3cr
 ac8rv ear18 f8gd

W8APQ, Martin L. Croft, Martinsburg, Penna.

14,000-ke. band

ce2ab ce3ab ce3ac ce3bf ce5aa cm2ft cm2sh ct1aa ct1ak
 ce5aa cm2jt cm2sh ct1aa ct1ak ct1bx cx2ak cx2akv cx2bt
 d4an d4oa d4ua f8brd f8da f8dh f8ex d4oa d4ua f8brd f8da
 f8dh f8ex f8fk f8gdb f8jf f8kz f8pro f8rvl f8sua f8xw g2bm
 g2ma g2oa g2oq g2un g5bj g5ms g6rb g6rv g6sm g6wy g6xc
 hel1g hc2jm ilcoc kfu5 k4akv k4kd lu1ba lu1jm lu2ca lu3fa
 lu3fg lu8dj lu8dy lu9dt oa1j oa4o on4gm on4gw on4bc on4hp
 on4ij on4us on4uu pa0qf pk3bm py1ah py1an py2aj py2an
 py2bg py2bz py2qa py2qb py3ah sm6ua vq4cre x9a zu5b

7000-ke. band

cm2jm cm2xc em5by em5ry em8by em8uf em8se ct1as ct1bx
 ct1en ct1ep ct2ac ct2af ear152 g5is g6wt k4aan k4acf k4dk
 k4kd k6bra kdv5 kfr6 rx1aa ve4be ve4bq ve4bu vk2ag vk2ho
 vk2hk vk2hm vk2kh vk2ku vk2oa vk2ow vk2se vk2xy
 vk3pp vk2pr vk3pv vk4ao vk4bh vk4do vk4ju kk5ax vk5it
 vk5jo vk7dx vo8ae z1ldj z1lio z1zbe z1zci 55x kflf

3500-ke. band

cm0b3 w5ajm w5lr w6aan w6bao w6bwm w7aat w7if

VE3DF, W. J. Stauffer, 332 Dundas St., Galt, Ont., Canada

3500-ke. 'phone band

w1ajt w1bmc w1cz w1qk w1qo w2aac w2aow w2baj w2bqy
 w2bn w2ey w2hk w2ju w2nj w2boz w2ag w2agc w3mp w3js
 w3oo w4pk w5adu w5bhf w5kx w8aei w8aeo w8bxy w8cib
 w8dur w8avi w8cfx w8gy w9acx w9avu w9bwi w9cmz w9csl
 w9gh w9gw ve2dn w9qy

W1ABG, Al Giddis, 53 Lamb St., Lowell, Mass.

7000-ke. band

cm5fc em5ry em5by f8rit hel1g hel1dr ve4dj x9a vs1a

14,000-ke. band

ce2ab ce3bf ce3bm ce3dg ce5aa cm2jt cm2sh cm5ex cm8uf
 f8da f8ex f8ho f8hr f8px f8sua g2ml g6wt hel1g hel2jm
 k4akv k6boe lu2dj lu3dh lu8dg oa1j k6boe on4fe on4ho
 pk1de pk6fe py1am py1aw py1ia py1qk py2ay py2ih py2qb
 ve3aw vk2rx vo8ae vo8aw vo8me x9a x58 z1lfz z1lir z1lao
 z1zgh z1zax z1zbg wfa vk3wm z1zbg z1zac vk3rk vk2ww
 'Phone

w8auu w8rd w5ql

ZL4BII, S. W. Boon, Box, Stratford, N. Z.

3500-ke band

w6dli w6dte w6dfr w6dqv w6auc w8atd w9bn

W2AFJ, H. Yahnel, Helmetta, N. J.

ve3bq ve3cz ve1ce ve4ih ve4bd ve3cz ve3eb k4aan k4kd
 vo8mc vo3eb g5by g2ao g5bd sm4xx ka1ce kalhr vk3rg
 vk2lm vk2bu vk7lj vk5gr vk3pp vk3ax vk5hg vk3bc vk3pa
 vk5it vk3or vk2ns em5by em8uf em5ry em8uf em2jm nn7nic
 nn7xo nn7xj ea1b ex7 z1cem z1zci z1zbb z1zao x9a hel1g
 nj2pa rx1aa kfr6 on4ka wfat x2x k4zt

Crosley gives them what they want in radio

... at lowest possible prices

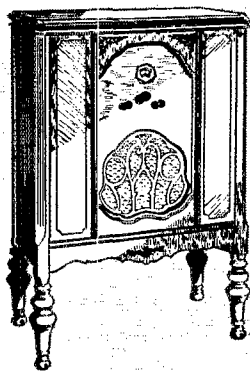

\$112

(Without tubes)

CROSLY 33-S. *This graceful Crosley 7-tube Screen Grid cabinet model, with Dynacoil Speaker, is beautifully finished in two tones of satiny walnut veneer. Only \$112 (without tubes).*

Other handsome 7- and 8-tube Screen Grid table and cabinet models, \$56.50 up!

Western prices slightly higher

Radio buyers are all the same. They're looking for TONE and PERFORMANCE — and they'll pay for it *if they have to*. But when they find a rich, clear tone and perfect performance in a set at about *half the price* they expected to pay . . . THEY'RE SOLD!

That's what they find in Crosley Radio! That's the reason Crosley sets are moving out of dealers' stores faster than ever! Value like this has never been equalled before in radio history.

Crosley gives them what they want. Screen Grid — remarkable selectivity and volume — triple range control — and a remarkable tone developed according to suggestions from world-famous musicians. *Every modern feature* at prices that are almost unbelievable! No wonder they're all buying Crosley Radio!

THE CROSLY RADIO CORPORATION

Powel Crosley, Jr., Pres.

CINCINNATI, OHIO

Home of WLW—"the Nation's Station"

You're there with a

CROSLY

Say You Saw It in QST — It Identifies You and Helps QST

America's

most highly endorsed, best written and most up-to-date
radio text and reference book

"RADIO THEORY & OPERATING"

992 Pages

800 Illustrations

By **MARY TEXANNA LOOMIS**

President, and Lecturer on Radio, Loomis Radio College.
Member Institute of Radio Engineers

Now nearing 50,000 circulation. Adopted and used by all the Government radio schools, all the leading radio schools of this country and Canada, and nearly 400 universities, technical colleges and high schools. Why bother about having a dozen or more radio books when this covers everything? And the price is only —

\$3.50 — Postage Paid

47 chapters covering the entire subject, including Television, Radio Construction, Radio Repairing, Radio Servicing, Marine Radio Operating, Radio Compass Work, Land Radio Operating, Broadcasting, Airways Communications, Message Forms, 1929 Radio Laws, Latest Diagrams, Junior Engineering.

For sale by practically all bookdealers this and foreign countries. Or sent, postage paid, on receipt check or money order.

LOOMIS PUBLISHING COMPANY

Dept. 5

WASHINGTON, D. C.

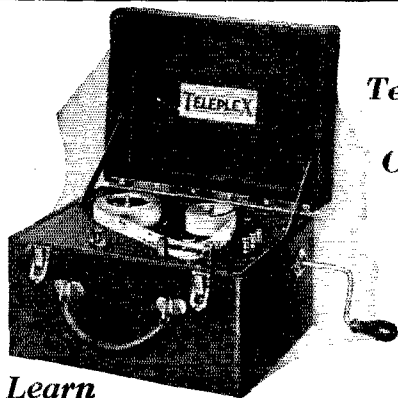

It
Teaches
the
Code!

Learn
Telegraphy with **TELEPLEX**

TELEPLEX is the practical code instructor. Works automatically. Waxed tape records send signals like a real operator. Complete code instructions furnished with every Teleplex. Sends messages, radiograms, etc. — regular code traffic like an expert operator. Used by all leading schools. Endorsed by U. S. Navy. **Guaranteed to teach you the code or it costs nothing.** Speedy, simple, clear. Ideal for advanced students or beginners.

FREE 10 DAYS TRIAL!

So sure are we that you will be absolutely satisfied with your purchase, that we will let you try it in your own home **ON 10 DAYS FREE TRIAL!** You are the sole judge. Where can you match that astounding offer? **ACT TO-DAY!** Write for full facts about Teleplex. No obligation.

TELEPLEX CO., Dept. P-12, 76 Cortlandt St., New York, N. Y.

X1C, Marcos Veramendi, Chopo Num. 209,
Mexico D. F.

w0ea w9ban w9fwn w9eaw w9ekq w9aru w9esd w9cvt w9ekz
w9adh w9efj w9cjin w9btg w9bgd w9acp w9h8m w9c9r w9sahh
w7lj w7ua w6eit w6ban w6ayq w6mm w6apg w6alf w6alu
w5df w5akl w5awd w5uf w5aak w5jc w5bek w4ez w4ap
w4aba w4avj w4pk w4abv w3awm w3cdq w2re w2akd w2alu
ear04 ti2hv helif

J. F. Quigley, 645 Polk Blvd., Des Moines,
Iowa

1750-ke. 'phones

w2xg w3alv w4ew w4lt w5aag w5anz w5aki w5anj w5ajn
w5axl w5avb w5aet w5baa w5bhf w5bey w5fk w5ej
w5lm w5gg w8ms w8ayy w8dxm w8dyb w9awe w9aua
w9app w9ayv w9ara w9akl w9atk w9aus w9bbs w9bfe
w9bsp w9bdf w9bue w9hak w9ekw w9cwf w9cef w9coe w9cop
w9ens w9ebr w9dax w9dsi w9dky w9dqw w9dqv w9diu
w9dyo w9erx w9eeq w9esb w9ehv w9efp w9epw w9ecd
w9esl w9ekl w9ear w9eli w9eor w9flz w9fxy w9fkx w9fuv
w9fle w9flb w9faw w9fel w9fdj w9gdb w9cjb w9cip w9kx
w9or w9mm

BRS261, Harry W. Daly, 73 Castleton Road,
Goodmayes, Ilford, England

7000-ke. band

w1abn w1ae w1ajc w1akt w1arg w1axx w1bds w1zw w3ard
w3aw w3ed w4afw w4ne w4ft w4qv w4yh w8bid w9baz
ct1aa ct1bd ct1ce ct1ep ct1ow d4abg d4hg d4ic d4kqc
d4sa d4sl d4uj ear1 ear2 ear98 ear125 ear141 ear144 ear149
ear152 earfu earx earz f8cco f8cw f8ef f8flz f8glm f8nnc f8oa
f8rex f8ro f8rkt f8syy f8tex f8wba f8wlt f8wa f8xy x8tpa
ha3px fm8bg fm8eb fm8mst fm8vx ilcac ilcoe ilmm ilto
on4atu on4co on4el on4fm on4je on4jx on4vy on4yy ohint
oh3nq ok2et ok2va ok2vp pa0abc pa0bn pa0pz pa0uz pa0xz
pa0yy sp3ar sp3ju sp3lz sp3sg

14,000-ke. band

w1ae d4hi fm8smu ct1by g5ma g5ml g6nf g6ll g6un sn1aa

L. A. Walworth, Honolulu, T. H.

w1afr w4ayj w3exl w4ahl w4aea w5afh w5ag w5beb w5bhj
w5ed w5pqm w5jm w7nf w8acd w8axj w8edi w8enr w8evo
w8dem w8em w8ads w9am w9bmu w9bwf w9cwx w9cyx
w9ejp w9emr w9geu w9bs ve3ez vk2am vk2sa vk3ax
vk3or vk3pp vk3pr vk4go z11bb z11fe z12ab z12bz z12bx z12da
z12df z12fm z12fr z13bb z13cm z13cr z14aj

VE3ET, G. Y. Lawrence, Box 186, Parry Sound,
Ontario, Canada

ce2ab ce3ag ce3bf em2jt em2mp em5ex em5fc em5by em8uf
ct1bx cx1fb cx1om cx2ac er3 g5by g5bz g5ml g6nf g6vp
helif he2jm k4aad k4aef k4akv k6dv k6cqm k6erh k6oa
lu2bx lu2ca lu3dh lu3fa lu4dq lu6aj lu8dj ku9da lu9dt nj2pa
un1nc nmx oa4j oa4q oar on4he oza pax1 py1aa pylah
pylaw py1ca py1cl py1em pylcr py1fa py1ih py2ab py2aj
py2ba py2bf py2qb py3ah py7ab py8ia ti2ea ti2hv ti2wd
vk2hm vk3ax vk7ch vo8ae vo8an vo8me vo8wq wfa x1nq
x2x x5a x9a x29a xw6chk z11fo z12gh z13as z13cm z1tax z2n
ze1m

W2GT, G. B. Angle, 104 Lutgcn Place, Linden,
N. J.

ap1 em2jt epic ei8b e8aap f8aje f8btr f8lx f8rko f8rmf
f8wb g2ao g5by g5bz g6ia g6ll g6vp g6wy g6yn kfr5 kfr6
kdv5 nn1nc nn2nc nn7nc nq5fe nr2ags on4fp velbr velce
velco vel2be vel2br vel3ay ve4hh ve4mo ve5cj w6ah w6ap
w6avj w6bchy w6cww w6dgq x9a z11ax z12ac z34m z6da epc
prr rwx

W'SBSL, R. B. Greenman, 98 Groton Ave.,
Cortland, N. Y.

14,000-ke. band, June 6th to June 16th

ce2ab em2jt ct1aa ear10 f8aja f8axq f8ct f8gdb f8he f8jf
f8oa f8pro f8sbw g5bj g5rm g5ml g5wk g6dh g6xe g6zj
g6za k4kd kfr5 on4bc on4fm on4ft on4gm on4jj on4us



Power Transformers

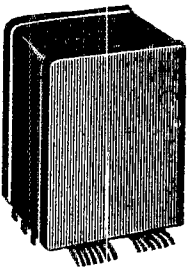

For UY-224 Screen Grid and UX-245 Power Tubes

TYPE GW-380

This shielded Power Transformer was made by General Electric Company. It is an excellent Power Transformer for making up A.C. Receivers, Power Packs, or converting Battery Sets for A.C. operation.

Size: $5\frac{3}{4} \times 4\frac{3}{4} \times 3\frac{1}{4}$ "
Weight $6\frac{1}{2}$ lbs.

Primary voltage 110-120 volts, 50-60 cycles A.C. current, filament rating 60 watts. Rated to supply filament voltage for two 224, three 226, one or two 245 and one 28C, also high plate voltage of 600 volts center-tapped for UX-280 tube. This Power Transformer is very conservatively rated and is exceptionally well built.

SPECIAL \$5.75



Double Filter Chokes



Contains Two 30 Henry 80 Mill Chokes

This heavy duty, rugged, double Filter Choke is excellent for all types of filter circuits and experimental work in receiving sets, power amplifiers, eliminators, transmitters and various other purposes.

Made by General Electric Company for Radio Corporation of America, and is RCA Replacement Part No. 8336 for the Radiola 33, 18 and 17.

Each Choke has a 1000 Volt insulation test and the D.C. resistance is 500 Ohms.

When connected in parallel these double Filter Chokes have a capacity of 30 Henries at 160 Mills, and when connected in series have 60 Henries at 80 Mills.

Fully shielded in metal case with special insulating compound. Made of the best parts, including the highest grade of silicon steel.

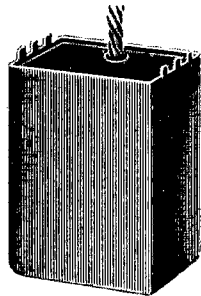

Weight 6 lbs.
Size: $5\frac{1}{4} \times 3\frac{3}{4} \times 2\frac{3}{8}$ "
List Price: \$10.05

SPECIAL \$3.75



Dubilier High Voltage Filter Condenser

4 MFD. D. C. WORKING VOLTAGE 600 V

These Filter Condensers are designed for use in filter circuits in Transmitters, and all high Voltage Socket power devices and Power Packs.

TYPE PL 571

List Price \$7.25

SPECIAL \$2.25

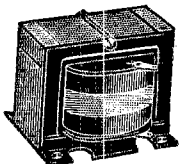

30 HENRIES

FILTER CHOKES

120 MILLS

Manufactured by the Chicago Transformer Corp.

These Filter Chokes have a D.C. resistance of 400 Ohms. Made of Armco extra special transformer steel. Extra size core. Tested at 1600 Volts. With Mounting brackets.

Fine for any type filter circuits.

SPECIAL \$2.25

THORDARSON POWER TRANSFORMERS

150 WATT

Delivers 800 Volts (350 m. a.) center-tapped, also 5 Volts (4 amps.) center-tapped.

Excellent for use in furnishing power supply to a Transmitter or Power Amplifier.

Using this Thordarson Power Transformer in conjunction with a Filament Transformer is all that is necessary to build up the finest and most powerful A.C. set.

Operates on 90-125 Volts, 50-60 cycles A.C. current.

This rugged, heavy duty Power Transformer weighs $10\frac{1}{2}$ lbs.

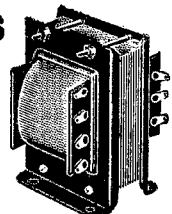

SPECIAL \$3.95

Model T-2430-A
Size: $6\frac{1}{4} \times 4\frac{1}{2} \times 5$ "
List Price: \$24.00

AMERICAN SALES CO., 19-21 Warren Street, New York City



WITH EVEREADY RAYTHEON 4-PILLAR TUBES, YOU CAN GET THE MOST FROM YOUR PRESENT RADIO RECEIVER

People in all parts of the country are telling of the greater power, increased distance, improved tone, and quick action of these remarkable new tubes. The reason is that Eveready Raytheons are built stronger — immune to the bumps and jolts of shipment and handling.

They come to you in as perfect condition as when they leave our laboratory test-room.

The Eveready Raytheon 4-Pillar construction is exclusive and patented. Examine the illustration at the bottom of this page. See how the elements of this tube are anchored at eight points.

This is of particular importance in tubes of the 280 rectifier and 224

screen-grid type which have heavier elements, and in tubes used for push-pull audio amplification, where uniform characteristics are most essential. Eveready Raytheon 4-Pillar tubes come in all types. At your dealer's. He also has the famous BH tube for "B" units.

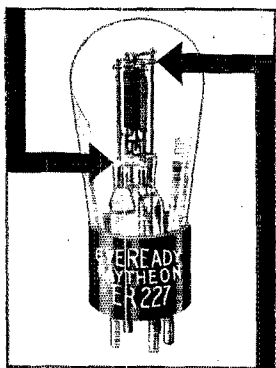

Showing the exclusive, patented Eveready Raytheon 4-Pillar construction. Note the sturdy four-cornered glass stem, the four heavy wire supports, and the bracing by a stiff mica sheet at the top.

NATIONAL CARBON CO., Inc.

General Offices:
New York, N. Y.

Branches: Chicago, Kansas City,
New York, San Francisco



Unit of Union Carbide
and Carbon Corporation



TRADE MARKS

Say You Saw It in QST — It Identifies You and Helps QST



Eveready Raytheon Screen-Grid tube, ER 224. The weight of the four large elements in this type of tube makes the exclusive Eveready Raytheon 4-Pillar construction vitally important.

How to hook up, test, adjust and repair modern radio sets

NEW REVISED EDITION—JUST OUT

PRACTICAL RADIO CONSTRUCTION AND REPAIRING

By James A. Moyer and John F. Wostrel

Faculty, University Extension, Massachusetts Department of Education

353 pages, 5 1/2 x 8, \$2.50 postpaid

THE new edition of this practical work brings the material right up to date—covering the radical changes in receiving set construction in the past few years.

This book strikes a universal appeal among amateurs, dealers, servicemen and those who experiment with hookups and receiving set equipment.

It gives efficient methods for locating trouble quickly and making workmanlike repairs. Operation details of numerous typical sets are given. The new edition covers the function of speakers (including the dynamic type), chargers, battery eliminators, socket-operated sets, etc. The recently aroused interest in short-wave reception is reflected in a section which deals with the construction of a receiver adapted to this wave band.



Examine this book for 10 days FREE!

Simply clip and mail the coupon

McGraw-Hill Free Examination Coupon

McGraw-Hill Book Co., Inc., 370 Seventh Avenue, New York

Please send me a copy of Moyer and Wostrel's PRACTICAL RADIO CONSTRUCTION AND REPAIRING, New Edition, \$2.50, for 10 days' free examination. I agree to remit for the book or return it postpaid within 10 days of receipt.

Name
 Home Address
 City and State
 Position
 Name of Company QST 3-30

EASTERN AMATEUR HEADQUARTERS

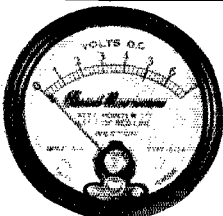

\$7 SPECIAL
Weston
 Volt Meter \$1.79

7 volt d. c. Not many at this price
 Complete Parts
 Lottin-White Power Pack

R. C. A. Sockets for Transmitting, \$1
 Hams, send for Special Amateur Catalog
M. & H. SPORTING GOODS CO.
 512 Market St., Phila., Pa.

py2bk pk4az yilac yilmdz yi2gq en6ak fm8jo fm8us fg8hpg
 gblo rwx wlat xpa0zz

28,000-kc. band

g2bm g2cx g2od g5bz g5wk g6hp gy1l g6qb g6wy wik

W8DHC, O. L. Sanitti, 1546 W. Grand Ave.,
 Detroit, Mich.

14,000-kc. band

ce2ah ce2ab ce2ax celai celah ce3ac ce3bm ct1bx ct1by
 ct1aa ct3ab d4al la2bx rxf5 xpa0zz paowz paowj paofp
 paogw paowr paowim on4ft on4fp on4jj on4fq on4gm
 on4uu fqpm fq8wb f8rv f8er f8pro f8orm f8ep f8toy f8whg
 f8jf f8acj f8axq f8sm f8jt f8dmf f8xh f8jia f8dot f8ypz f8rrr
 f8wzk f8lou k7gm f8aap f8ho f8fc z12ac z12bf z12ae k6eat
 k6kd e4ne f8rn x9a x9j nmxb ear28 eari ear37 sadt9 sadq4
 pylib pyliid pyler pylat pylcm pylca pylaa pylib pyloc
 py2ak py2al pylaw pylcl py2bh py2bi py2ii py3em py3ah
 nj2pa z54m z6fx pk8az oz7b su8an f8xwb g5by g5bd g5ml
 g5wf g5wk g5vj g2rv g2vd g6vp g6xb g6nt g6xc g6er g6dr
 g6mc g6dh g6xn gyuu g6yq g6wy rwx

VE3RF, H. M. Tattersall, 19 Silverbirch Ave.,
 Toronto, Canada

ce3ac ce3bf ce2ab ct1aa ct1by ct1bx cx2ak ear1 ear65
 ear91 f8aap f8aja f8axq f8btr f8eo f8er f8he f8orm f8ve
 fqpm f28wb g2vq g5by g5bj g5ul g6ia g6qb g6vp g6xb
 k4akv k4kd k4ni kfr5 lulez lu4dq lu9dt nr2ags nr2ea on4di
 on4bt on4fp on4ft on4gn on4ou py1aw pylib pylcm pylcl
 pyliid py2ak py2al py2ij py3ah paoff pala rwx rju solaa
 spjst su2bc wsq x8wb x8a x8a xpa-0-ss xuz z54a w5ana
 w5bev w5qe w6ary w6asl w6bam w6avj w6adp w6ahp
 w6eh w6dyj

W6CBW, Edwin H. Porman, 1091 Wesley Ave.,
 Pasadena, California

w1acb w1acd w1air w1aux w1are w1axr w1cpt w1cz w1fw
 w2abs w2aeh w2alw w2alx w2akv w2akw w2aoz w2api w2ata
 w2ayj w2bhr w2bo w2box w2cg w2cvu w2me w2vq w3api
 w3ard w3asa w3asd w3awb w3aws w3bnu w3kz w3lz w3mb
 w4aef w4ahz w4ahq w4ahr w4ib w4me w4my w4pau w4rb
 w4tk w5aak w5ach w5af w5ana w5aod w5aqe w5atz w5axx
 w5bac w5bfq w5gi w5ix w5jc w5jw w5kn w5mx w5oc w5pa
 w5pg w5qq w5to w5ty w7aat w7aav w7ab w7aea w7aek
 w7amj w7ams w7dp w7gf w7ip w7mo w7na w7pl w7ar
 w7ts w7wg w7uj w8amt w8bgi w8bys w8cft w8cjt w8cnz
 w8cws w8dfo w8iq w8it w9caa w9eyu w9cki w9dkm w9dro
 w9ejh w9erm w9eq w9es w9gdv w9rr w9as k1af k1bd
 k1hrkljr k1mc k1pw k1ts k4aan k6acw k6ch k6cjs k6djw
 k6dv k6ene k6eqm k6etf k7aer k7ahr k7amz k7aqa k7hl
 vk2ac vk2hm vk2ho vk2kw vk2ow vk2ns vk2tw vk2zr
 vk3hd vk3go vk3jk vk3jr vk3kw vk3rj vk4ab vk5em vk5hg
 vk5jg vk5jh vk5xg z11ax z11ft z11fw z11fx z12ac z12aw z12bi
 z12bo z12bv z12go z13as z13aj z13cl z14ae j3cc j4dk j4zz j9fs
 ac1lf ac1pp ac3bo ac8rv ve2ax ve4af ve4cu ve4cn ve4ey
 ve5az ve5bh ve5bu ve5dk ve5hc au1kab f15au g5nl ew9do
 rxf5 kfr5 om1tb np5ar em2er oa4q f8bm mu6 nmlnic xw1
 xee1 xer2 nm6x xau2

W2AQQ, Alfred Hecht, 346 Gates Ave., Brooklyn,
 N. Y.

7000-kilocycle band

w6akm w6bew w6cha w6cui w6dec w6dyj w6dgy w6dtu
 w6dzy w6ejj w6ebp w6edd w6erl w6hnp w6hvw w6le
 w6qu w6eten w6ht w7ts w7wg em2ay em2af ct1aa ear10
 ear94 ear98 k4aan kfr5 nr-2wd ti2hv ve4bx ve4ci zw-1xw

ex-W3ACY, J. Elbert Poist, 24 E. Middle St.,
 Hanover, Pa.

14,000-kilocycle band

f8lou f8wzk f2nm f8gd b f8em f8er f8lbg f8ho f8op f8hs
 f8xh f8tr f8tm f8tgb f8mrg f8ypz f8lx f8acj f8jf f8kz f8eo
 f8jt f8tr f8fd f8orm f8pro f8btr f8sm f8rk f8et f8aap f8wb
 g2xv g2qv g2zp g5by g5uw g5ml g5bj g5bz g5yx g5xq
 g5lv g5vl g5rm g6xb g6xn g6yq g6vd g6bd g6qb g6oh
 g6xj g6ia g6er g6hp g6za g6hf g6dr d4uj d4al i1to n2nar
 nncab nbcy on4fp on4bu on4ft on4pi on4uu onva pylaa
 pylca py2ih py2ca py2ak py2al pylaw ct1aa ct1bx ct1by
 eb4uu eb4dj ear37 ear65 ear96 ear98 au8an se2bl sp3bp
 hf13an nr2ags egen8axq pa0fp xpa0ja xpa0zz lu3dh celah
 ce2ab rx1aa kfr5 k4kd k4ni k4akv k6alm k6dtg nj2pa
 ve4fn ve4ib ve4hc ve4fk ve4tr ve4hr ve4gu ve5aw w6aws



SOUND REPRODUCTION

SINCE the inception of modern radio amplification the engineering laboratories of Thordarson have developed hundreds of transformers used in solving the problems of sound reproduction.

Standard units include those for coupling a microphone, a phonograph pickup or a radio tuner into any type of audio frequency amplifier.

Other units are available for coupling the output of an amplifier into transmission lines or directly into loud speakers.

Still other units allow coupling from any line into loud speakers or into additional amplifiers.

Your own work may be made easier and more profitable if you make use of Thordarson engineering service as applied to Thordarson transformers, chokes and amplifiers.

Tell us of your requirements and let us submit suggestions for an installation which will add to your good reputation.

THORDARSON

Transformer Specialists Since 1895

Microphone Transformers
Line to Tube, Tube to Line, Line to Line
Mixing Transformers Coupling Reactors Filter Chokes
Impedance Matching Transformers
Speaker Coupling Transformers
Complete Amplifiers

Thordarson Electric Manufacturing Company
Huron, Kingsbury and Larrabee Streets, Chicago, Ill., U. S. A.

DOUBLE YOUR SPEED

Make MORE MONEY

Through The CANDLEY SYSTEM Courses in Speedhand—High-Speed Telegraphing and Telegraph Touch-Typewriting.

Speedhand—A complete system of telegraphic-code shorthand, increases transmitting speed 50% in one day. Send whole words instead of single letters. Big demand for Speedhand-code operators. **The Candler System Course in High-Speed Telegraphing**—A course of training for Radio Operators, designed to bring about complete Co-ordination of all the facilities used in telegraphing so that sending and receiving becomes easy and natural. McElroy, world's champion radio operator endorses no other course. **Telegraph Touch-Typewriting**—the only typing course teaching the correct use of the "mill" in telegraphy. Doubles typing speed in few days. Employers of radio operators are constantly seeking operators who have the ability and courage to do FAST work. These courses are guaranteed to develop SPEED in any operator. Money back if not satisfied. Write for particulars. State if interested in combined or separate courses.

THE CANDLER SYSTEM CO.
6343 S. Kedzie Ave., Dept. RL
Chicago, Ill.



Walter H. Candler
Former World's Champion Operator and Author of The Candler System Courses

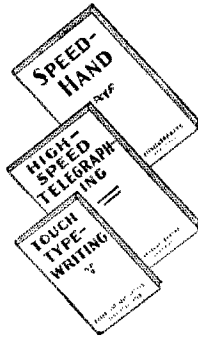

w6ags w6czm w6jn w6eez w6ehf w6avj w6bcs w6dgg w6xi w6qy w6bam w6akw w6egm w6efe w6am w6cte w6dtu w6emt w6bay w6fk w6ddj w6wb w6hb w6dxj w6eou w5eaa w6epz w6dcv w6cu w6dpj w6awp w6eug w6dmk w6dbq w6aob w6ern w6eot w7ph w7ga w7li w7ld w7kq w7pv w7ek w7hr w7ur w7si w7fh w7afu w7acy w7akv w7agb x1j x9a x9b xj uolkr vk2jz vk2ns vk2lm vk2rx vk2lj vk3pm vk3ot vk3kj vk3ip vk3ka vk3ct vk3op vk3go vk4bb vk5aw vk5hg z1iao z1aac z1zaw z1zbg z1zao z1zba fit ifa fnsm fogn wia wfat.

W6EFA, Joseph P. Waller, 833 W. 41st St., Los Angeles, Calif.

j1ct j2nk j3cc ka1f k1bd k1cy k1cm k1hr k1pw k3aa k3dev k7am k7ap oa4g oa4f va4cm va4dm va4gd va5ac va5cj ve5hc ve9aw vk2hm vk2ho vk2nb vk3rb vk3yx w1ad w1ade w1are w1asy w1zw w2acy w2alu w2aib w2alz w2ags w2bek w2evu w3cwk w2il w2if w2no z1lfw z1zaw z1zas

W2GN, Henry F. Schreiber, Radio Operator, S.S. Lancaster, Argonne Steamship Co., New York City, N. Y.

w1ajo w1amd w1bdk w1erw w1ld w1fg w1mk w1rp w1yr w2aaj w2alh w2alu w2ap2 w2aub w2bai w2bfl w2bhr w2bhv w2bia w2bpf w2bsk w2bhw w2erb w2exl w2fn w2ft w2htr w2rd w3aer w3afm w3ahw w3ajh w3apf w3atj w3avf w3avo w3ekl w3sz w3wvf w4aav w4abv w4aij w4bn w4cl w4dj w4hd w4ll w4pq w4qv w4ve w4vw w4wz w5ada w5ain w5aqe w5aoz w5bez w5bj w5kz w5ka w5pa w5zk w6adj w6aga w6ast w6ave w6awa w6ayo w6bhy w6bjw w6bly w6boa w6bpm w6bvs w6bys w6cha w6dgu w6dju w6dhw w6dnf w6doj w6drn w6dui w6ebn w6eds w6eoo w6egk w6eif w6ekw w6emd w6enw w6eos w6epi w6eta w6ft w6gz w6ll w6st w7ahb w7dd w6pp w7qf w6tj w6aku w8aut w8ayh w8bfe w7blb w8bpf w8bwm w8cas w8cxc w8dlg w8dyo w8iq w8jp w8mbw w8np w8rh w8ut w9ael w8ama w9atq w9baz w9dna w9dwa w9dyp w9dzm w9ecz w9ei w9eip w9enr w9fba w9fzo w9cox w9gi w9jl w9lk w9qu w9um nn1nc nn1eic kdvt kfu5 ve4dj ve4je ve1br helgf om5ff cm2by om5by kj0cr t92hv k2rbv k3aan k6bra k6ejs k6ck k6dtg

Which ?..

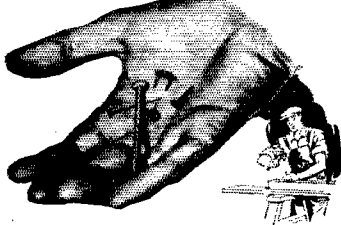

would you buy
to nail a plank?

Our catalog
is helpful

Hardwick, Hindle Catalog No. 429 fills the need for a terse Resistor manual. It shows styles, types of mountings — and gives clear Resistance Tables. May we send it?

No question about it, is there? One glance at a nail and you know its purpose; one glance at a nailing job, and you know which nail to use.

But RESISTORS are different. They demand specialized knowledge, specialized handling, specialized application.

We have organized a special Rush Order Department — and within 72 hours after your specifications reach us, we can have finished samples on their way to you.

We believe that we can produce exactly the Resistor equipment you need. In fact, we have proved just that in serving many of the country's largest users. May we include you?



RESISTORS

HARDWICK, HINDLE, INC.
Sales: 122 Greenwich St. New York City
Factory: 215 Emmet St. Newark, N. J.

Book Reviews

By James J. Lamb, Tech. Ed.

Principles of Radio, by Keith Henney. Published by John Wiley & Sons, Inc., New York City (Chapman & Hall, Ltd., London). 477 pages, 306 figures. Price, \$3.50.

This book is chocked full with meat for the experimenter. Starting with the fundamental concept of the electron theory and immediately introducing the reader to the methods of graphically representing electrical phenomena, the author concisely and picturesquely progresses through the principles of radio and radio equipment with a clarity of explanation seldom found in technical literature. Withal, there is none of that sacrifice of exactitude which often accompanies the attempt to explain a highly technical problem in understandable language. The subjects are all pertinent to modern radio. There is no space wasted on the archaic or purely historical type of equipment. Numerous applicable problems and examples are included together with experiments intended to "give the feel" of the apparatus. The subjects treated range from the fundamentals of electricity to the most modern concepts of modulation and detection. The information on vacuum tubes is particularly pertinent. We must frankly state that we are justifiably enthusiastic about Keith Henney's "Fundamentals."

The Radio Manual, by George E. Sterling. Edited by Robert S. Kruse. (Second Edition.) Published by D. Van Nostrand Co., Inc., New York City. 797 pages, 348 illustrations. Price, \$6.00.

Contains new chapters on television, aviation and marine equipment as well as new material on high-percentage mod-

SM

Here's a New Amplifier With a Wallop You'll Never Forget!

The New S-M 692

Power, and more power—more gain than you ever imagined could come out of a three-stage amplifier—that's the new S-M 692.

Tone quality—a flat curve (within 2 DB) from 60 to 12,000 cycles—within 4 DB from 44 to 13,000 cycles. Set one up—give it a big job to do—watch it do it—and you'll know why we feel so proud of it!

You'll notice right away the difference in the "highs"—the usual falling-off around 6,000 cycles simply doesn't start till up around 11,000. Bass reproduction is full, but without over-emphasis. Voltage amplification totals 4,000—three times the usual three-stage total! With proper input there is plenty of gain—as high as 90,000—even for "distant" microphone pickup—or 20,000 from a standard phonograph pickup. High resistance input—operate the 692 out of any source of impedance up to 100,000 ohms. Operate it directly into any speaker system—five taps give output impedances from 8 to 125 ohms—eliminating any possible distortion in speaker transformer.

Test the 692 just once on your oscillator—and you'll use it thereafter as a standard to test your speakers!

Tubes required: 1—'24, 1—'45, 2—'50, and 2—'81.

Price, completely wired, less tubes, \$147 net.

The Radiobuilder, a monthly publication telling the very latest developments of the S-M laboratories, is too valuable for any setbuilder to be without. Send the coupon for a free sample copy, or to enter your subscription if you want it regularly.

Over 3,000 Authorized S-M Service Stations are being operated. Write for information on the franchise.

SILVER-MARSHALL, Inc., 6409 WEST 65TH ST.
CHICAGO, - - U. S. A.

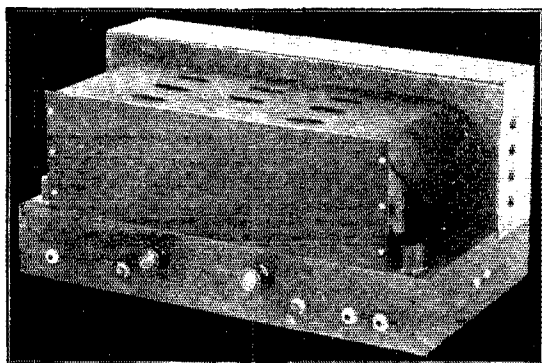

S-M 692 Amplifier

And the Ideal Tuner

The S-M 712 Tuner is a fitting companion to the 692. Just the radio tuner you've been looking for as a feed for that power installation. And what a tuner! All-electric, pre-selector, power detector, special 5-gang variable condenser elimi-

nating the verniers of its predecessor the famous Sargent-Rayment 710, battleship shielding cabinet, individually shielded r.f. coils, and all r.f. circuits individually by-passed and isolated in a manner that renders the receiver absolutely stable and free from oscillation. And above all it's absolutely guaranteed to out-distance and out-perform all competition regardless of price.

Tubes required: 3—'24, 1—'27. Wired, less tubes, \$64.90 net. Parts total \$40.90.

The Short-Wave "Bearcat"

The first *all-electric* short-wave set on the American market, the S-M 735 is easily the "bearcat" of them all. Newly-designed plug-in coils, a regenerative power detector, a screen-grid r.f. stage, an excellent audio amplifier, built-in power unit—all these combine with other features to present astonishing quality in a remarkably inexpensive receiver. Price, wired, less tubes, \$64.90. Parts total \$44.90. Tubes required: 1—'24, 2—'27, 2—'45, 1—'80.

Silver-Marshall, Inc.
6409 West 65th St., Chicago, U. S. A.
... Send your latest catalog, with sample copy of the Radiobuilder.
... For enclosed 10c, send five new S-M Data Sheets, including those on the 692 and the 735.

Name.....
Address.....

DODGE RADIO SHORTKUT QUICK RESULTS LICENSED HAMS INCREASE SPEED

To Encourage Others Some State the Fact

W1ATO	Stuck at	10	Raised to	25	Quickly
W4QY		15		30	5 Hours
W5SN		12		25	Quickly
W6BVX		12		20	Quickly
W7ACC		10		15	Very Soon
W8ANP		10		20	Easily
W8BEV		12		24	Very Easy
W8BEA		20		25	Very Soon
W8BPJ		12		20	Very Soon
W8CCS		12		30	Very Soon
W9CEC		10		18	One Week
W9CET		12		20	Few Days
W9CMW		15		25	3½ Hours
W9CSK		13		22	3 Weeks
W9DRZ		10		25	QSZ to QSO
W9EBF		10		25	Very Easy

W1H-W6XAD-W8AND-W8BZP-W9UZ (well known Old Time Brass Pounders and Instructors) Recommend this Method

Official List 1928 Identifies Stations Named To PROVE What Can Be Accomplished REPORTS from 500 Users go with Radio Shortcut

DODGE HIGH SPEED
QUICKLY puts 20-25 Hams and Commercials in the 35-40 per Class

Radio Shortcut \$3.50, High Speed \$2.50, Money order, Foreign Add 50 Cents, C.O.D. and Postage in U. S. if remit One Dollar.

C. K. DODGE

Box 100 Mamaroneck, New York

90J

of La Grange, Ill., says:

New Super Wasp AC Short Wave Receiver

Is a Wow!

Got 5SW Phone Broadcast first night in operation. Comes in kit form or completely constructed.

1930 Ham-Book FREE

Everything for Hams. Crystals and Crystal Holders. 3000 volt new type R3 Recto bulbs (\$10.00). If it's good, we've got it!

Send today for your free copy

Chicago Radio Apparatus Co.
Dept. Q

415 S. Dearborn Street Chicago, Ill.

ulation systems and other subjects additional to those treated in the former edition — which has been reviewed in *QST*.

Practical Radio Construction and Repairing, by James A. Moyer and John F. Wostrel. (Second Edition.) Published by McGraw-Hill Book Co., Inc., New York City. 353 pages, 163 figures. Price, \$2.50.

This book, a revision of the first edition with the same title, contains new material on modern a.c. receivers which will be welcomed by the practical service man. In addition to this new section, the remainder of the text has been completely revised and brought up to date.

The Southeastern Division Convention

(Continued from page 44)

J. E. Hodge, W4BY, gave an address on "Piezo Crystals," and made us realize that crystal grinding is not so simple as we sometimes are led to believe. The Radio Corporation showed their interest in the event by having two good engineers, Messrs. Rothenberger and Lamont, give a talk on "Characteristics of New R.C.A. Tubes." The Naval Reserve was represented through Director Dobbs and Mr. Boucheron and the Army by Col. J. J. Grace, Signal Officer, 4th Corps Area, whose address at the banquet was enlightening and to the point. The stunts proved instructive and interesting and enabled a large number of the fellows who participated to win valuable prizes donated by so many of the advertisers in *QST*. (Fellows, don't forget to acknowledge those prizes to the donors.)

After the banquet and the award of prizes the floor was cleared and everyone enjoyed dancing. Yes! there were plenty of YL's and OW's present. This ended a well-planned convention with credit to Director Dobbs, Henry Reid, President Atlanta Radio Club, and all members on the committee.

— A. A. H.

Official Frequency System

(Continued from page 30)

assumed equal to the figures as herein given. While no responsibility, financial or otherwise, is assumed for the accuracy of these transmissions, every effort will be made to have it exceed the figure given.

Reports on Standard Frequency Transmissions are solicited from all who take advantage of this service. No matter how far from or how near to the transmitting station you may be, your report will be of value to us. Standard blanks which will facilitate your filling out and our handling of the reports are available on request. All such requests and reports should be addressed to: Experimenters' Section, American Radio Relay League, 1711 Park St., Hartford, Conn.

After your report has been checked and acknowledged, it will be forwarded to the Standard Frequency Station upon whose signals it comments.

Amateur's Bookshelf

GOOD TEXTBOOKS and operating manuals should be on every amateur's bookshelf. We have reviewed practically all the books in which the amateur would be interested, and have arranged to handle through the *QST* Book Department at A.R.R.L. Headquarters those volumes which we believe to be the best of their kind. Take pride in a small but good radio library; buy a few good books and get into the habit of reading them.

Manual of Radio Telegraphy and Telephony, by Commander (now Admiral) S. S. Robison, U.S.N. Published by the Naval Institute. Covers both the theoretical and practical fields. A *QST* book review on this work stated in part: "Ranks with the very best of all published radio matter. . . . It is perhaps the best radio book that ever came to this desk." Every amateur should own a copy. 895 pp., 6 $\frac{3}{4}$ x 9. \$4.00

Principles of Radio Communication, by Prof. J. H. Morecroft. An elaborate general textbook, and one of the recognized standards on theory for the engineering student. A working knowledge of mathematics is desirable for the reader who expects to get the greatest benefit from this work. 935 pp., 5 $\frac{3}{4}$ x 9. . . . \$7.50

Elements of Radio Communication, by Prof. J. H. Morecroft. This is a new book by the author of the "Principles" listed above. It is about half the size of the larger work, and the subject is treated in more elementary fashion. Simple algebra is sufficient. An excellent book for the "first-year" student. 269 pp., 170 illustrations. . . . \$3.00

Radio Engineering Principles, by Lauer and Brown. While not as voluminous as "Morecroft" this excellent general textbook on radio principles is the favorite of many students. A moderate knowledge of mathematics is desirable. 300 pp., 5 x 9. . . . \$3.50

Experimental Radio, by Prof. R. R. Ramsey. Revised Edition. A splendid book for the experimenter. This is a laboratory manual, describing 128 excellent experiments designed to bring out the principles of radio theory, instruments and measurements. 229 pp., 5 $\frac{1}{4}$ x 7. . . . \$2.75

Radio Theory and Operating, by Mary Texanna Loomis. Although giving a moderate amount of theory, it is essentially a practical handbook for commercial and broadcast operators, and as such ranks among the foremost publications of this sort. Used as a textbook by many radio schools. Revised to include 1929 regulations. A good book for any amateur. 992 pp., 800 illustrations. . . . \$3.50

The Radio Manual, by George E. Sterling. Another excellent practical handbook, especially valuable to the commercial and broadcast operator, and covering the principles, methods and apparatus of all phases of radio activity. Includes 1929 regulations. Over 900 pp. . . . \$6.00

Radio Telegraphy and Telephony, by Duncan and Drew. Still another work along the lines of a general practical handbook. In size it is approximately the same as the two listed just previously, and the subject matter generally follows along the same lines. A good book in this class. 950 pp., 468 illustrations. . . . \$7.50

Practical Radio Telegraphy, by Nilson and Hornung. Written particularly for the student training for a commercial license, and covering theory and apparatus. A practical handbook. 380 pp., 223 illustrations. \$3.00

Thermionic Vacuum Tube, by H. J. Van der Bijl. For many years this has stood out above all other works as a theoretical textbook and treatise on the vacuum tube and vacuum tube circuits. A knowledge of higher mathematics is required. Not a book for the beginner, but for the laboratorian and engineering student it is without a peer. . . . \$5.00

Radio Operating Questions and Answers, by Nilson and Hornung. Revised Edition. This is intended as a companion volume to "Practical Radio Telegraphy" by the same authors. In conjunction with that work it should leave the commercial license applicant well prepared for his examinations. There is a chapter on amateur license questions and answers, too. 267 pp., 5 $\frac{1}{2}$ x 8. . . . \$2.00

How to Pass U. S. Government Radio License Examinations, by Duncan and Drew. Intended as a companion volume to "Radio Telegraphy and Telephony" by the same authors, as a guide to the applicant for commercial licenses. It is not a text in itself. The chapter arrangement follows that of the sections of the commercial theoretical examination, each being made up of typical examination questions and their answers. 169 pp., 92 illustrations. . . . \$2.00

Theory of Radio Communication, by Lt. John T. Filgate, S.C., U.S. Army. An excellent book on the theory of receivers, transmitters and associated equipment for those familiar with elementary electricity and magnetism. 250 pp., 180 illustrations. . . . \$2.00

Radio Traffic Manual and Operating Regulations, by Duncan and Drew. A book for students, amateurs or radio operators who contemplate entering the commercial field; it will enable you to learn quickly and easily all the government and commercial traffic rules and operating regulations. 181 pp. . . . \$2.00

ABC of Television, by Raymond F. Yates. A practical treatment of television with particularly complete chapters on photo-electric cells, amplifiers and scanning methods. 205 pp., 78 illustrations. . . . \$3.00

Prices include postage

Read em' and learn!

AMERICAN RADIO RELAY LEAGUE, INC.

1711 Park Street, Hartford, Connecticut

The **NEW Easy-Working**
GENUINE MARTIN

VIBROPLEX No. 6

Reg. Trade Marks: Vibroplex; Bug; Lightning Bug

IN COLORS: Blue — Green — Red

10 New features.
Easy to operate. Easy on the arm. Fast or slow. Transmits signals unequalled for strength, clarity and beauty.

Black or Colored, \$17 Nickel-Plated.

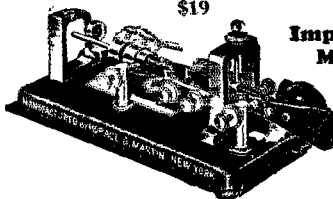
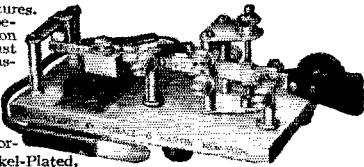

Improved MARTIN Vibroplex

Black or Colored, \$17
Nickel-Plated, \$19

Special Martin Radio Bug — Extra large. Specially constructed Contact Points for direct use without relay. Black or Colored. \$25

Your old Vibroplex accepted as part payment
Remit by Money Order or Registered Mail
THE VIBROPLEX COMPANY, Inc.
825 Broadway, New York City
Cable Address: "VIBROPLEX" New York

THEY STAND THE GAFF

Whether used in line, power pack, large or small transmitter, in all electric receiver or battery-operated short-wave receiver, the

CLAROSTAT

resistors, in variable, fixed and automatic forms and in every conceivable resistance range and capacity, stand the gaff. Noiseless. Stay put. Foolproof. Reliable. Precise settings. And cheapest in long run.

WRITE for data on complete line of Clarostat aids to better radio. If you prefer, ask your dealer to show you the line.

CLAROSTAT MFG. CO., Inc.

Specialists in Radio Aids

283 N. 6th St.

Brooklyn, N. Y.

LEARN RADIO

in a school with a reputation
for graduating competent men

Dormitory — Laboratory
Workshop

SUBJECTS TAUGHT

Commercial Radio Radio Service
Radio Broadcast Navigation
Radio Mathematics
Laboratory
Vitaphone — Movietone

Write for further information



COMMERCIAL RADIO INSTITUTE

38 W. BIDDLE ST. **FOUNDED 1920** BALTIMORE, MD.

OFFICIAL FREQUENCY STATIONS

(Required accuracy 3-10 of 1%)

W1AVW-W1ZL, W1AWW, W1AXA, A1BD, W1BZQ, W1CCW, W1CK, W2BO, W2CDC, W2CLA, W2DS, W2EF, W2MU, W2UV, W4BY, W4LK, W5EW, W5OX, W5SP, W4ZAV, W6AKW, W6AM, W6AYC, W6ACE, W6AVJ, W6BB, W6BGM-W6CVO, W6BMW, W6BRO, W5BZU, W6CAE, W6CDY-W6CPX, W6CMP, W6EC-W6XE, W6QL, W6QX, W6WN, W6ZV, W7AAT, W7GQ, W8AQ, W8APZ, W8BZT, W8EQ, W8GZ-W8ZG, W9AHQ, W9ACG, W9BGH, W8BGK, W9BVC, W9CPM, W9EGU, W9IG, G2PD, G2NM, G5BY, G5YK, G15NJ, VE2BE, VE3CO, VE3FC, VE4BT, VK5BG, VK5LF, VK7CW and ZL2AC.

STANDARD FREQUENCY TRANSMISSIONS OF WWV

Schedules of standard frequency transmissions from WWV, The Bureau of Standards, Washington, D. C. will be found on page 8 of the January issue of *QST*.

— J. J. L.

Coöperating With the B. C. L.

(Continued from page 16)

the ground wire; the one that goes to the pipe that goes down in the cellar? . . .

"Yes, I know you've been down in the cellar. . . . Sure I could tell. . . . Certainly I'll come over some time. Well, pull the ground wire off. Now have you got a nice coal stove with a fire in it? . . .

"You have. Well, that's fine; everything is working out perfect.

"Have you got a lifter for the lid so you won't burn your hands? . . .

"You have? . . . Mister, I'll have you all fixed up in no time. Now lift the lid on the stove and put the set in and turn on the drafts and wait a half hour. Then call me back and let me know if you still hear me. . . .

"Oh, don't thank me. It's a pleasure to help a B. C. L. out of agony. Call me up any time, old-timer, and I'll be only too glad to help you. . . . "That's all right; forget it. Good-bye."

So you see, boys, that's the best way to handle B. C. L.'s. Be nice to them; help them through coöperation. They appreciate it and it helps amateur radio. I wouldn't be at all surprised if that fellow would never forget me for what I done for him. Well boys, that fills up my corner, and leaves you with a moral lesson: "If you can't turn an honest penny, turn a dial."

I. A. R. U. News

(Continued from page 53)

ON4UU has now worked five continents on 'phone, his music and speech being understood in New Zealand, Dutch East Indies, Asia Africa and Porto Rico. He is on every morning with ZL and VK skeds. ON4JA QSO'd SN1AA at Ascension. (SN1AA is now off the air, incidentally, having returned to his home in England. — A. L. B.) ON4RE worked the New Hebrides islands, and

THORDARSON TRANSFORMER

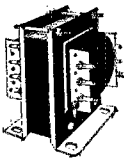

150 watts, 400 volts each side of centre tap at 375 M. A. 5 volt filament, centre tap. Fine for power supply for 7½ watt or for crystal control power supply. Specially priced for a short time only. Each \$3.95

LEEDS

The Home of RADIO
45 VESEY STREET
 NEW YORK
New York's Headquarters for
Transmitting Apparatus
When in Town Visit Our Store

THORDARSON B-Eliminator TRANSFORMER

using the Raytheon B-H tube. Will carry the maximum current consumption without overheating. 285 volts on each side of centre. Lower voltage may be obtained if desired. Listed at \$5. Special NOW only \$1.65

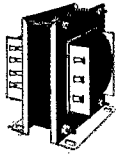

Make your own transmitting and receiving coils. Copper tubing transmitting inductance.

Size of tubing		
Inside Dia. 3/16"	1/4"	5/16"
2 1/8"	9c	10c
2 3/8"	9c	10c
3 1/8"	10c	12c

Prices per turn

Ham Green, double silk covered, No. 16 receiving inductance.

2" diameter 30c per inch
 3" diameter 35c per inch

EVERYTHING IN
 ACME JEWELL PYREX
 BRADLEY FLERON
 THORDARSON
 ELECTRAD NATIONAL
 LYNCH SIGNAL
 FLECHTHEIM
 NATIONAL RECTOBULB
 GENERAL RADIO
 CARDWELL
 IN STOCK



NEON GLOW LAMPS

Made by General Electric Co., type G. 10, standard base 101 uses as illustrated in QST May, 1928, issue page 17. Price only 65c

Aluminum Shield cans and panels of every description to order.

DUBILIER HIGH VOLTAGE FILTER CONDENSER



TYPE PL 571
 List Price \$7.25

4 MFD. D.C. Working Voltage 600 V

These Filter Condensers are designed for use in filter circuits in Transmitters, and all high Voltage Socket power devices and Power Packs.

SPECIAL \$2.25

THORDARSON DOUBLE FILTER CHOKES

CONTAINS TWO 18 HENRY 250 MILL CHOKES

Heavy duty, rugged double Filter Reactor for Filter Circuits in Transmitters, Power Amplifiers, "B" Eliminators and various other purposes. (Each Choke has a 2000 Volt insulation and the D.C. resistance of each Choke is 108.5 ohms. (When connected in series this Filter Reactor has a capacity of 36 henries at 250 mills, and when connected in parallel 18 henries with 500 mills carrying capacity.

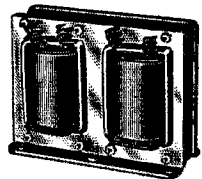

MODEL T-2458
 List Price \$19.50

SPECIAL \$6.25

THORDARSON - R 210 Power Compact Transformer

Supplies 400 Volts to the plate and 7½ Volts to filament on a U X 210 tube; also the filament current for the U X 216 B. Contains 2 choke coils of 80 M.A. current capacity for the filter circuit.

List Price \$20. Special \$8.95



By
Insistent Demand

LEEDS 50-watt socket, positive contact; heavy phosphor bronze springs, heavy brass shell; highest grade porcelain insulated base; will hold your tube in one position. Specially priced.

1930 SHORT WAVE RECEIVER

A short wave receiver that's got them all beat. Best circuit design and finest mechanical construction. 3-Tube Receiver — detector — 2 audio, using three 201-A tubes. Universal type, continuous range 15 to 100 meters; amateur type covers Ham bands 20-40-80 meters with generous spread on the dial. List price \$60. Special Offer, net \$37.50*

SHORT WAVE X-MITTER

7½ Watt Hartley type Transmitter. Will operate with a 201-A tube, with 90 volts on the plate, up to a UX-210, with 30 watts input; has plug in transmitting coils. List price — kit \$55. Completely constructed \$70. Special Offer, completely constructed \$57.50*

LEEDS RADIO LABORATORIES

Precision Custom Built Short Wave Receivers and Transmitters

This department under the supervision of the Short Wave Specialist Jerome Gross. We design, construct and advise on any material for the "Ham" Broadcasting station or laboratory. Write Jerry Gross for advice on any of your problems.

PLEASE PRINT YOUR NAME AND ADDRESS PLAINLY TO AVOID DELAY

WRITE FOR SPECIAL PRICE LIST

MAIL ORDERS FILLED SAME DAY
 10% Cash Must Accompany All C. O. D. Orders

WHAT MORE
CAN YOU EXPECT FROM TUBES?

1. quick action
2. clear tone
3. long life

GET THE FACTS
FROM YOUR DEALER

ARCTURUS
LONG-LIFE
RADIO TUBES

STANDARD for EVERY
leading set

ARCTURUS RADIO TUBE COMPANY
NEWARK, NEW JERSEY

P A C E N T

Duo Lateral COILS

The complete line of all standard turn ratios preferred by leading laboratories and engineers.

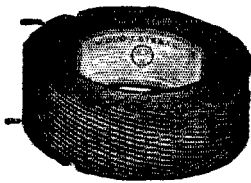

Write for information and prices

PACENT ELECTRIC CO., Inc.
91-7th Avenue New York City

DON'T LOSE SIGHT—

of the fact that the E. F. Johnson Co. is a pioneer jobber of transmitting equipment of all kinds. We particularly invite requests for quotations from broadcasters, educational institutions, Government departments, etc., as well as our old friends, the Amateurs.

New DE FOREST Transmitting Tubes

Write for details on these and on our new CONDENSER MICROPHONE combining unsurpassed performance and attractive price.

E. F. JOHNSON CO., Waseca, Minnesota

ON4FP, one of our best DX men, worked Japan with 80 watts input to a Mesny push-pull.

The 14-mc. band is absolutely dead in the dark hours, and the only possible working hours are about 0730 GCT, when the VK and NZ stations begin to come in, until 1000 GCT — and then back again, with sometimes W6- and W7- at about 1500 GCT.

From 1700 to 1900 South Africa comes through well, with some of the northern districts of the United States showing up occasionally.

During daylight, European stations are heard well, but as all the traffic is congested on the 7000-ke. band, our 14-mc. band is usually infested with plenty of second harmonics!

Many of the Belgian stations are now having an informal contest to see who has worked the most countries. Some of them are up in the 50's and 60's already. However, we do not know whether to count countries by the old system of intermediates, or to count every separate country or colony. What has the I.A.R.U. to say about this? (See below, following this report — A. L. B.)

We have thought over the matter presented by Mr. de Neck in the last part of his report. It seems to us that the only logical way to establish the count is to count one for each country or separate colony. The old international intermediates frequently included more than one colony under one intermediate, simply because there were very few amateur stations in those colonies, and it did not seem worthwhile to create separate intermediates for five individual colonies when there might be but four amateurs total between them. However, for the purpose of counting countries in a contest, it is neither advisable nor logical to adhere to this system. Count every separate colony or country as one count, ON's.

FRENCH SECTION

There is no formal report from the French Section, but we wish to make mention of the fact that the *Reseau Emetteurs Franois* now has a splendid little magazine all its own — *REF!* Congratulations, OM's! The first issue appeared in December, and is highly interesting reading. We hope to see copies regularly from now on.

Incidentally, it is printed by one of its members, G. Veuclin, F8BP.

BRITISH SECTION

By J. Clarricoats, Honary Secretary, R.S.G.B.

There has been no outstanding amateur event recently outside of the success mentioned later under 28-mc. work. The annual general meeting of the Society was held on December 13th, when the new Council was elected, and the Wortley-Talbot and Rotab cups awarded. Following the meeting, Dr. McLachlan lectured on and demonstrated his new invention, the "Novotone" which is an electrical compensator designed to reintroduce the musical registers which are cut off by the usual gramophone and pick-up.

On 7000-ke. DX conditions have been normal

RADIO
TELEVISION-TALKING PICTURES

BIG MONEY NOW!

More to Come

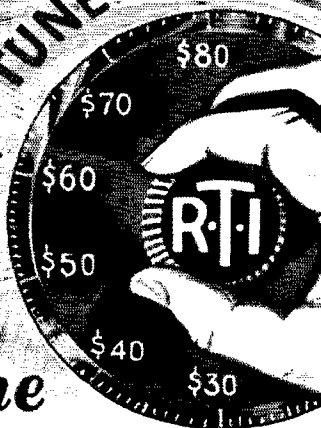

Radio now offers ambitious men the greatest Money-Making Opportunity the world has ever seen! Hundreds of trained service men are needed by radio dealers, jobbers, and manufacturers!

GOOD JOBS are open in all branches of Radio, where qualified men easily earn \$60 to \$100 per week and even \$10,000 a year jobs are plentiful.

BIG MONEY for spare-time Radio Work is easily made in every city and village. You can now qualify for this Big-Pay work quickly through R. T. I. Get the Big Money Now and go up and up in this Big Pay field. The Radio industry calls for More Men, and R. T. I. supplies what the industry wants you to know.

Supervised by Radio Leaders

R. T. I. training is prepared and supervised by prominent men in radio, television and talking picture engineering; distributing; sales; manufacturing; broadcasting, etc. These men know what you must know to make money in Radio. You learn easily in spare time at home with the R. T. I. wonderful combination **Testing Outfits, Parts, Work Sheets, Job Tickets.** It is easy, quick and practical—covers everything in Radio—includes Talking Pictures and the latest in Television.

\$60—\$70—\$80—PER WEEK AND UP. That's what R. T. I. training leads to. Send for the R. T. I. Book.

No Experience Needed

ALL YOU NEED is the ambition and the ability to read and write. The Radio industry needs practical trained men. Remember, R. T. I. makes it easy to earn spare time money while you learn at home.

More to come

THE MEN who get into this Big-Money field now will have an unlimited future. Why? Because this billion dollar Radio industry is only a few years old and is growing by leaps and bounds. Get in and grow with it. \$10 to \$25 per week and more is easily made in spare hours while you are preparing for Big Money. TELEVISION, too, will soon be on the market, so the leaders say. Be ready for this amazing new money-making field. Remember, R. T. I. "3 in 1" home-training gives you all the developments in Television and Talking Picture Equipment, together with the complete Radio training.

Warning

Do not start R. T. I. training if you are going to be satisfied to make \$15 or \$20 per week more than you are now. Most R. T. I. men will make that much increase after a few weeks. There is no reason to stop short of the Big Money Jobs or the Big Profits in a spare time or full time business of your own. No capital needed. Get started with R. T. I. now. Make money while you learn at home.

R. T. I. Book Now FREE

The thrilling story of Radio, Television and Talking Pictures is told with hundreds of pictures and facts—it's hundreds of big money jobs and spare time money-making opportunities everywhere. Send for your copy now. **USE THE COUPON.**



Let F. H. SCHNELL and the R. T. I. Advisory Board Help You

Twenty years Radio experience. First to establish two-way amateur communication with Europe. Former Traf. Mgr. of American Radio Relay League. Lieut. Com. U. S. N. R. Inventor, designer, consulting Radio engineer.

Assisting him is the R. T. I. Advisory Board, composed of men prominent in the Radio Industry. These men know Radio and will help you succeed in their field.

RADIO & TELEVISION INSTITUTE
Dept. 103
4806 St. Anthony Ct. Chicago

RADIO & TELEVISION INSTITUTE
Dept. 103, 4806 St. Anthony Court, Chicago
Send me Free and prepaid your **BIG BOOK "Tune In On Big Pay"** and full details of your three-in-one Home Training (without obligating me in any way).

Name
Address
City State



THE R. T. I. ADVISORY BOARD. These men are executives with important concerns in the radio industry—manufacturing, sales, service, broadcasting, engineering, etc., etc. They supervise R. T. I. Work Sheets, Job Tickets, and other training methods.

R. T. I. R. T. I. TRAINS YOU AT HOME FOR A GOOD JOB OR A PROFITABLE PART TIME OR FULL TIME BUSINESS OF YOUR OWN

a
SMOOTH start
and a
STEADY pull

THE giant electric locomotive starts with velvet smoothness and pulls the heaviest loads over steep mountain grades with steady, unflinching power. **IT'S ALL A MATTER OF CONTROL.** The increased sensitivity of your radio demands the S-m-o-o-t-h control that only Centralab can give. Noiseless, free of inherent sputtering — self-inflicted static. For smooth, quiet, velvety radio reception your radio must be **CENTRALAB** equipped.

Write Dept. 320 F
 For Free Booklet
 "Volume Control,
 Voltage Controls
 and Their Uses"

Centralab

Central Radio Laboratories

Dept. 320 F, Keefe Ave. and Humboldt
 MILWAUKEE, WIS.

TRI-STATE HEADQUARTERS

PENNSYLVANIA — OHIO — WEST VA.

WHOLESALE RADIO

To DEALERS and SET BUILDERS we offer the most prompt and efficient service. We handle only the best merchandise and give **MAXIMUM DISCOUNTS.**

GET OUR CATALOG

CAMERADIO

430 WOOD ST.

at Diamond St.

PITTSBURGH PA.

Oscillating Quartz Crystals



Guaranteed — easy oscillators, carefully selected for maximum output, and ground to your approximate frequency which is stated accurately to within one-tenth of one percent.

1715-2000 Kilocycle band \$12.50

3500-4000 Kilocycle band 17.50

One-inch oscillating blanks 5.00

We also supply "POWERTYPE" crystals to broadcast and commercial stations.

Write for literature

American Piezo Supply Company

1101 Huron Building Kansas City, Kansas

Specialists in frequency precision

for the time of the year, but local contacts are the only ones which can be considered as satisfactory owing to the continual interference from other stations. North Americans have been audible on most evenings, but very few British stations have been able to QSO them except with high power. It will be of interest to see if conditions improve in February and March (as expected) on this band.

On 14-mc. conditions have been generally poor after dark, the only good QSO's being made during the late afternoon or early morning. North Americans have been poor; on the other hand, Australasians have been audible up to 1000 GCT on some mornings.

Very few South Africans have been heard in London. On 28 mc. we have pleasure in recording the first two-way contact between South Africa and Great Britain. This was made on Sunday, December 22nd, by Mr. Wilkinson, G5WK. On the same day several other Britishers worked North Americans on this frequency. This seems to have been the best Sunday for 28 mc. since last winter. South America and Australia are now the outstanding continents to be worked on this frequency. A large number of our members is experimenting on this wave and providing conditions remain good, many new successes should be obtained shortly.

The recent suggestion made by the *Reseau Belge* regarding the certification for WAC awards by each National Section is receiving consideration by our Council. Efforts are also being made to place on record the first contacts between Great Britain and the other countries of the world on all amateur bands. Coöperation is asked from all pioneer foreign and colonial stations. Claims from overseas should be made to J. Clarricoats, at 53 Victoria St., London, S.W. 1, England.

Foreign readers of these notes are invited to correspond with the Honorary Secretary at the Society's address concerning membership in the R.S.G.B. and B.E.R.U.

(We continue with portions of the report of the British Section for the preceding period, which arrived too late to be included in this department last month.)

Amateurs generally will be interested to learn that the treasured Rotab Cup has this year been awarded to Maurice Pilpel (G6PP) in recognition of his excellent low-power work and for his endeavors on behalf of the R.S.G.B. Mr. Pilpel is British QRA manager.

The Wortley-Talbot Cup has been presented to Messrs. Noden and Somerset in recognition of their pioneer work on 56 mc. Interest in low power and 56-mc. operation will receive a definite boost as a result of these awards.

During the coming year the R.S.G.B. will have Mr. Gerald Marcuse again as its president, while Mr. H. Bevan Swift remains acting vice-president. Mr. E. Dawson Ostermeyer continues as honorary treasurer, whilst Mr. John Clarricoats succeeds Mr. G. F. Gregory as honorary secretary.

BARGAINS

ARMY AND NAVY RADIO SURPLUS

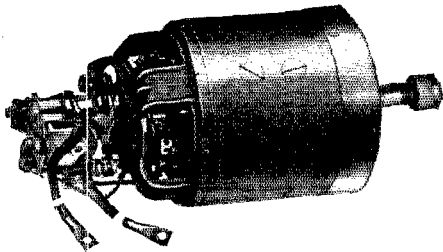

Generator, airplane, Signal Corps, with shaft, can be used as motor or bat. charger, 12 volts, 33.6 amp, 3000 R.P.M. . . \$10.00

Western Electric Dynamotor C.W. 927. Two 32/350 volt dynamotors in shock-proof hanger. Used in parallel give 160 mils. at 350 volts, in series, give 80 mils. at 700 volts. Can be used to operate transmitters to 50 watts from a 32 volt D.C. 1.5 amp. input. Two dynamotors in hanger. 25.00
Single dynamotor without hanger. 15.00

West. Elec. Switchbd. C.W. 928. Control for Dynamotor C.W. 927. Has starting switches, fuses, 0-50-500 voltmeter, switches for testing main lines and output. Also complete filter system. Special. 8.00

Ammeter, Westinghouse, type C.A., either 0-1, 2 or 3 amps., zero adjustment, flush mounting. State size 5.00

Ampere hour meter, Sangamo, battery charge and discharge, type MS, 2 sizes, 0-300 and 0-500. List \$50.00. 10.00

Milliammeter, Westinghouse, type C.A. 0-500, zero adjustment, flush mounting. 5.00

Voltmeter, Westinghouse, type C.A. 0-25, zero adjustment, flush mounting. 5.00

Voltmeter, Westinghouse, A.C. 8" diameter with external resistance 0-175 volts, 60 cycle power house type. 12.50

Voltmeter, Westinghouse model PT. 3 scale, 0-5, 0-7.5, 0-150 for measuring A, B and C voltages, portable Bakelite case. Special. 3.00

Motor generator, Crocker Wheeler, 110 D.C. 220 A.C., 500 watt, 500 cycle. Ball bearing. 50.00

Complete line 500 cycle motor generators 1/4 to 5 K.W. Prices on request.

Transformers, General Electric, 125 to 2500, with center tap, 60 cycle, 200 watt. 7.50

Transformers, Simon, 220 to 11500 closed core, 1/2 K.W., 500 cycle, "pancake" secondary. 5.00

Air compressors, Kellogg, Model T. 1 1/2 cu. ft. per min. weight 6 lbs., 600 R.P.M., 125-lb. pressure. Requires 1/4 h.p. 3.00

Condensers, Dubilier, mica, working volts 12,000, capacity .0004. 10.00

Condensers, Dubilier, mica, 40,000 volt, .0012-.001-.0008 or .003 mfd. 30.00

Condensers, transmitting, Murdock .0017 mfd, 12,000 volt, ideal for plate blocking. 2.50

Condensers, Wireless Specialty, copper glass leyden jar, 10,000 working voltage .002 mfd. 2.00

Condensers, Dubilier, mica, transmitting, 8500 working voltage .004 mfd. 10.00

Condensers, Dubilier, mica, transmitting, 12,500 working voltage .004 mfd. Prices on request.

Transmitter, telephone, Holtzer Cabot, carbon granular.95

Western Electric Radiophone transmitter unit 326 W. 1.50

Headphone, double Holtzer Cabot, U. S. Navy.75

Headphone, Army, with strap, 120 ohm.75

Headphone, Radio School, leather headband, 75 ohm. 1.50

Keys, transmitting, Navy, back connected on bakelite base. 2 kw. 3/4-inch silver contacts. 5.00

Keys, transmitting, Airplane flameproof, silver 1/2 inch contacts, with blinker light mounted on Bakelite base. 2.00

Charging panel, Navy type, S.E. #39, 110 volt, Ward-Leonard with automatic release, var. and fixed res., Weston voltmeter and ammeter, Sangamo ampere hour meter. Complete with all switches. 30.00

Buzzers, Western Electric, Extra quality, high frequency. 1.50

Receivers, Navy, C.N. 113, 300-2500 meters, crystals. 7.50

Receivers, Navy, C.N. 240, 1000-10,000 meters. 50.00

Receivers, S.E. 143 and I.P. 500. Prices on request.

Amplifier, W. E. Radiophone, C.W. 926. 15.00

Heterodyne, Signal Corps, type B.C. 104, 1000 to 3000 meters, with detector. 15.00

Loudspeaker Unit, Western Electric, 193 W. Ideal for monitoring your transmitter. Without cord. 3.00

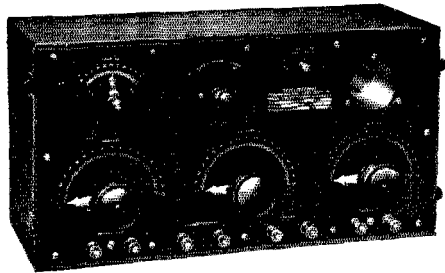

Receiver, Army Type 122, 175-775 meters. Especially recommended for 'standby' for coastal Broadcast stations as required by Dept. of Commerce. \$50.00

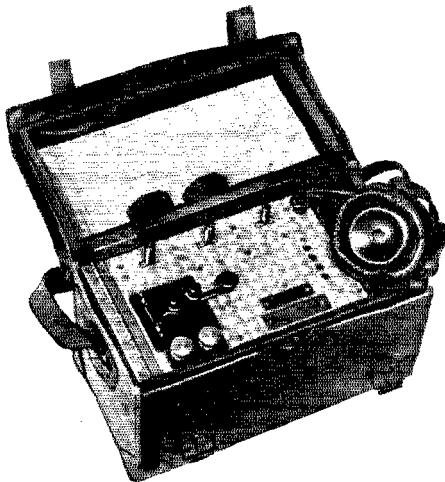

Telegraph and buzzer portable sets, mahogany case, 2 tone 4 contact platinum point high frequency buzzer, 2 telephone toggle switches, potentiometer, sending key, 3 mfd. condensers, transformer and 2 choke coils, receiver, \$30. value. \$ 5.00

Magnetos, Army mine and ringer type, has 4 large fixed magnets. Good value. 1.00

Battery, U. S. Army, lead-acid type, 10 volt, 20 ampere hour. Consisting of 5 individual 2 volt cells in carrying case. 5.00

Individual 2 volt cells, minus electrolyte. 1.00

Sounders, Signal Corps, 120 ohms, with adjustable magnets. 2.50

Generators, Westinghouse 110 volt, A.C. 900 cycles, 200 watts, self excited. 15.00

Storage batteries, Edison Nickel Alkali 225 amp. hr. A-6 type 1.2 volts per cell, weight each 20 lbs. 4.00

Voltmeters, D.C. portable new Weston model 45, 3 scale 0-3-15-150 guaranteed 1/4 of 1% accurate. 40.00

Ammeters, D.C. portable, new Weston model 45, 3 scale 0-1.5-15-150 with 3 scale external shunt and leads 1/4 of 1% accurate. 40.00

Generators, 12 volt, 60 amp. has automatic controls. 20.00

Motor generator, R & M, 110 D.C. 3 1/2 h.p., 2 kw. 20 volt 80 amp. Great for large station filament supply. 125.00

SPECIAL — U. S. Army instruction books on elementary and advanced telephony and telegraphy. Hundreds of pictures and diagrams. 1.00

Largest Radio and Electric Supply House in U. S. specializing on Army and Navy Surplus. Sufficient postage and deposit of 20% required on C.O.D. orders. NO C.O.D. ON CANADIAN ORDERS.

MANHATTAN ELECTRIC BARGAIN HOUSE, Dept. Q, 105-7 Fulton St., New York City

A New RECTOBULB Type R81

Mercury Vapor Efficiency in —

RECTIFICATION **LOAD CAPACITY**
REGULATION **FILTERING**

To be installed in place of any Type 281 Rectifier Tube — simply plug in — that's all.

Fil. Volts.....7.5 Fil. Cur.....1.25
Plate Volts.....750 Plate Mils.....150

ONLY 10 VOLTS DROP IN TUBE

Price \$7.00 each

Sent Postpaid if cash with order — **Immediate delivery**

Type R3 RECTOBULBS

Still "SUPREME" as 3000-volt — 250 Mil. Transmitting Rectifier — ask the "HAM"

Price \$10 each

Rectobulb Distributors — **CHIRAD** — Chicago —
Fort Orange Dist. Co., Albany, N. Y.

Guaranteed Repairs

UX852.....	\$16.50	WE211.....	\$16.50
UV203A.....	211 — 845		\$19.00
UV204A.....	\$60.00	WE212.....	\$40.00

NATIONAL RADIO TUBE CO.

3420 18th Street San Francisco, Calif.
"A HAM INSTITUTION"

ALUMINUM BOX SHIELDS Beautiful Silver Dip Finish

Genuine Alcoa Stock
5" x 9" x 6", \$1.89. Any size made to order in 24 hours.
Genuine Baldwin Type "C" phones \$3.65 pr.

Write for price list

BLAN, The Radio Man, Inc.
89Q Cortlandt Street New York City

QUARTZ OSCILLATING CRYSTALS

Scientifically Prepared for Maximum Power and Unconditionally Guaranteed
1 in. square sections, of your approximate specified frequency, supplied
at the following prices:

75-100 meters.....	\$12.50
100-200 meters.....	10.00
200-600 meters.....	15.00
1 in. Tested blanks, 200-400, 400-600 meters.....	5.00
Dustproof Bakelite mounts.....	3.00

For 1 1/2 in. sections, above prices are doubled.

Sections of any practicable dimensions made to order. Prompt Delivery
J. T. Rooney, B. Sc., 4 Calumet Bldg., Buffalo, New York
"Twelve years' crystallographic experience"

BECOME A RADIO OPERATOR

See the World, Earn a Good Income,
Duties Light and Fascinating

LEARN IN THE SECOND PORT U.S.A.

Radio Inspector located here. New Orleans supplies operators for the various Gulf ports. Most logical location in the U. S. A. to come to for training.

Our students qualify for the various branches of radio Ashore and Afloat. Every graduate placed. Runs to all parts of the world.

Special courses. Day and Night classes. Enroll any time.
Oldest and Largest Radio School South.

Literature on request.

GULF RADIO SCHOOL

844 Howard Ave. New Orleans, La.

NETHERLANDS SECTION

By H. Pomes, Assistant Traffic Manager,
N.V.I.R.

Taken in general, conditions were rather poor around the first of the year. Little activity was noticed in the 3500-ke. band; there are some hams who use 'phone in this band, but only European stations may be logged.

During daylight communication was possible with all European countries on the 7000-ke. band; we are sorry to state, however, that a good QSO is often spoiled by one of the many 'phone stations still operating in this band. After sunset reception decreases, and at 2200 GCT only a few stations can be worked. Most of the time the reception of W's was terrible. Only a few good QSO's have been established by Dutch hams in this band, for the greater part with stations in an eastern direction.

The 14,000-ke. band maintains its capricious behavior. Usually the reception of European stations is pretty good, and occasional fine DX has been made. PAØXG worked W7- twice and POØZK did it once. Other Dutch stations have worked South Africa and Australia from time to time. It is only fair to state, however, that these communications were made only over short periods and under favorable conditions.

No reports have come in on work in the 28-mc. band.

The number of licensed Dutch hams still increases, and club activity is great now. Many courses are given for those hams preparing for the official examinations. As our Government wants the stations to be controlled and approved by the Technical Service, everyone is busy revamping his outfit. Many "1929" sets are being built, and Hull's fine articles in *QST* are being studied by an increasing number of hams.

Our annual meeting will be held on February 16th, at Utrecht; we hope to have many foreign hams there, and will send in a report on it as quickly as possible.

NEW ZEALAND SECTION

By Edward McKay, ZL1BE, N.Z.A.R.T.

One of the outstanding events last fall was the many contacts made with European and American stations on the 14,000-ke. band.

The N.Z.A.R.T. now has official stations in operation for the reception of the Byrd Expedition signals, and much reliable data is expected to eventuate as a result of this.

It is the intention of the Association to organize another international test with the United States on the 3500-ke. band, and as soon as arrangements at this end are completed we will get in touch with the A.R.R.L.

At present all activities are centered on our forthcoming Radio Exhibition in which the N.Z.A.R.T. hopes to further our cause and bring before the public the actual value of ham radio. A detailed account of this will probably be incorporated in the next report. In the meantime we

TALKS TO LONDON FROM PLANE IN AIR

Reporter in Craft Speeding
Over City Has Conversation
Across the Ocean.

THREE CALLS ARE MADE

Words Understood Clearly in Spite
of Static—Electric Experts
Pleased With Results.

Special to The New York Times.
HADLEY FIELD, N. J., June 25.—
Flying at ninety miles an hour today
with a thick fog blanket blotting out
the earth below him, W. W. Chap-
lin, Associated Press reporter, casu-
ally turned to a microphone and
asked for the London office of the
news association. The request, re-
layed through the laboratories of the
Bell Telephone Company, passed on
to the radio news radio telephone
station at Belfast, Me., and then car-
ried again on the air across 3,000
miles of ocean to London.
The connection was made quickly
and Chaplin asked that Miss Martha
Dalrymple of the London office be
called to the phone. The conversa-
tion, once greetings were over,
Chaplin said later, had to do mostly
with the weather. It was broken
somewhat by static, but the two
persons talking, one in a fog-bound
plane a half-mile in the air and the
other in a fog-bound London office,
understood each other and ex-
changed greetings.

"ESCO" Airplane Generators provided the power for this remarkable achievement

Two "ESCO" Airplane Generators (wind driven) were mounted on the Bell Telephone Airplane. One supplied power to the transmitter and the other to the receiver. Both were of standard "ESCO" design which insures reliable service under the severe operating conditions common to aviation.



Low wind resistance, light weight, non-corroding parts, ball bearings, tool steel shafts, steel shells, cast steel pole pieces, weather proof construction, many sizes to choose from, high voltage and low voltage windings to suit individual requirements, are a few of the many reasons for "ESCO" generators being the first choice.

ELECTRIC SPECIALTY COMPANY

225 SOUTH ST.

STAMFORD, CONN.

Manufacturers of motors, generators, dynamotors and rotary converters

ELECTRAD

Transmitter Grid Leak

Serves Better, Because Better Built

Write Dept. Q.1
For Details 175 Varick St., New York, N.Y.
ELECTRAD
INC.

TRANSFORMERS

Guaranteed — Mounted — Complete

600 watt 800—1200—1800 each side \$17.00
700 watt 1000—1500 each side 14.50
250 watt 500—750—1000 each side
unmounted \$9.75; mounted \$11.50
Auto-Transformers, Chokes, Polyphase and 25-cycle
Transformers. Add \$2.00 for fill winding
SCES FRANK GREBEN
1927 So. Peoria Street, Pilsen Sta. Chicago, Ill.

AEROVOX

BUILT BETTER
CONDENSERS AND RESISTORS

THE MOST COMPLETE LINE OF
CONDENSERS AND RESISTORS

Write for the Research Worker
A free monthly publication

AEROVOX WIRELESS CORP.

78½ Washington St., Bklyn., N. Y.
PRODUCTS THAT ENDURE

SPECIAL Colored Official League Emblem

FOR SECTION COMMUNICATIONS MANAGERS
AND OFFICIAL RELAY STATIONS

SEE MENTION IN COMMUNICATIONS DEPARTMENT—THIS ISSUE

RED BACKGROUND
(for S.C.M.'s only)

BLUE BACKGROUND \$1 EACH
(for O.R.S.'s only) Postpaid

ONE-HALF INCH SIZE

AMERICAN RADIO RELAY LEAGUE

1711 Park Street, Hartford, Connecticut



Say You Saw It in QST — It Identifies You and Helps QST



for phones

This husky well filtered power supply is just the thing. Send us your order today and build your new phone or cw transmitter around this wonderful unit.

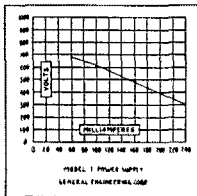

Supplies both filament and plate current for four 210 tubes. Priced for less than you can buy the parts to build it.

Price \$25.00



GENERAL ENGINEERING CORP.
CHARLOTTE MICHIGAN



Massachusetts Radio and Telegraph School

18 Boylston Street, Boston
Send for Catalogue

Tel. Hancock 8184 Established 1905

Do you know that the latest Handy and Hull Handbook is available in bound form—\$2.00 per copy, postpaid.

When ordering a copy of this new sixth edition, look at your present copy and determine if you want your next copy in more permanent form.

BROWNING-DRAKE

screen-grid RADIO

A good set to own
A reliable one to recommend
A profitable one to sell

The same quality in construction that won for Browning-Drake kits such a lasting reputation.

An unusually attractive franchise offer for dealers

BROWNING-DRAKE CORPORATION
228 Calvary St., Waltham, Mass.

1,500,000 people listen in on Browning-Drakes

are all hoping it to be as successful as the N.V.I.R. exhibit described in the September issue of QST.

NORWEGIAN SECTION

By G. H. Petersen, Secretary, N.R.R.L.

During the last month still more Norwegian hams have changed to the 14-mc. band, and reports almost unanimously point out that conditions on this band have been very encouraging. LAIG reports working New Zealand every Sunday morning, 0700-0900 GCT, but nothing was heard from VK during this period. Some W stations are generally heard around 1300-1600 GCT, but no stations have been worked. At Bergen, LAIJ has found out that 14 mc. is just the thing to use for the WAC certificate, and his surely will not be far off.

There are few reports on the 7000-ke. band, and they generally say conditions have been bad.

We were all very glad recently to get news from Hartford that the N.R.R.L. had been recognized as the Norwegian national section of the I.A.R.U.

At N.R.R.L. Headquarters we have been discussing and studying the results of the Hague Conference, preparing to meet our authorities in an official meeting, as our license conditions will have to be revised. In view of the position of several European governments toward the amateurs, one certainly cannot underestimate the importance of the A.R.R.L.'s representative at this conference and his work for amateur radio.

Incidentally, in noting the remark that LAIJ has found 14,000 kc. just the thing for getting a WAC, the compiler of this department—who also issues the WAC certificates—may state that he estimates more than 60% of the WAC certificates issued during the last four months have been earned mostly or entirely by working on the 14,000 kc. band.

We wind up this month with a list of WAC certificates issued during the first year of the existence of that award—1926.

WAC—1926

Brandon Wentworth, nu601; Clair Foster, nu6HM; H. Cooley, nu1AAO; A. H. Asmussen, nc4GT; R. Bartholomew, np4SA; D. C. Wallace, nu9ZT; Andre Courtois, eb4YZ; F. S. McKeever, nu9DNG; F. Johnson Elser, op3AA; Jack Berliant, nu2APV; Manuel J. Felizardo, op1AU; M. E. Lawson, nu5ACL; J. C. Goulden, nu5JF; B. Walsh, eg2IT; Frank R. Neill, gi5NJ; Sgt. Chas. W. Remer, op1CW; J. M. Davidson, fo1SR; C. H. Jackson, nu1CMP; Jefferson Borden, 4th, nu1CMX; R. Pirotte, eb4RS; the Hixon family, nu7IT; Joseph Grahn, nu1CH; R. Raven-Hart, ch9TC; R. E. Harris, nu5TW; E. H. Burgman, nu6CTO; Borders and Margraves, pi1BD; J. K. K. Grindle, nu9BSK; J. M. Eubanks, nu4SI-4TN; R. E. Earle, ss2SE; J. C. Harrison, g5XY; Luis Desmaras, ch2LD; Rene Bulet, ef8CS; J. Goldstein, nu2CRB; Alfred Short, oa2SH; C. F. and V. H. Todd, nu7VH-7TM.

QST Oscillating Crystals

AMATEUR BANDS:

(New prices effective October 1st 1929)

Winter is here and no doubt you are going over your transmitter removing those weak links so as to get the most possible efficiency from your set.

One item of great importance is the *frequency stability* of your set. Does it *stay on one frequency*? If not, our *power crystals* will solve that problem. SCIENTIFIC RADIO SERVICE crystals are *known to be the best obtainable*, having ONE single frequency and highest output. With each crystal is furnished an accurate calibration guaranteed to *better than a tenth of 1%*. New prices for grinding *power crystals* in the *amateur bands* are as follows:

1715 to 2000 Kc band \$18.00 (unmounted)
 3500 to 4000 Kc band \$25.00 (unmounted)
 7000 to 7300 Kc band \$45.00 (unmounted)

BROADCAST BAND:

Power crystals ground in the 550-1500 Kc band accurate to plus or minus 500 cycles of your specified frequency fully mounted for \$55.00. In ordering please specify type tube, plate voltage and operating

temperature. All crystals absolutely guaranteed regards to output and frequency and delivery can be made within two days after receipt of your order.

CONSTANT TEMPERATURE HEATER UNITS:

We can supply heater units guaranteed to keep the temperature of the crystals constant to *better than a tenth of 1 degree centigrade* for \$300.00. Two matched crystals, ground to your assigned frequency in the 550-1500 Kc band with the heater unit complete \$410.00. More detailed description of this unit sent upon request.

ATTENTION AIRCRAFT AND COMMERCIAL RADIO CORPORATIONS:

We invite your inquiries regards your crystal needs for Radio use. We will be glad to quote special prices for POWER crystals in quantity lots. We have been grinding *power crystals* for over *five years*, being *pioneers* in this specialized field, we feel we can be of real service to you. We can grind *power crystals* to your specified frequency accurate to plus or minus .03%. All crystals guaranteed and prompt deliveries can be made. A *trial will convince you*.

SCIENTIFIC RADIO SERVICE

"THE CRYSTAL SPECIALISTS"

P. O. Box 86

Dept. P-9

Mount Rainier, Maryland

TRANSMISSION CONDENSERS



Send for interesting data and price sheet on Transmission Condensers with working voltages up to 3000 D.C. for use with the following tubes: 203A, 204A, 210, 500W, 851, 852, 860, 865.

CORNELL ELECTRIC MFG. CO.
 Long Island City New York

TRANSMITTING GRIDLEAKS



5000 OHMS

These genuine General Electric wire-wound Gridleaks have a rating of 55 watts in continuous duty.



Large enough for 250 watters.

SPECIAL 65c

AMERICAN SALES CO., 19-21 Warren St., N. Y. C.



Something New

Within the near future there will be some remarkable changes in the design of Short Wave Receivers. WIRELESS EGERT ENGINEERING intends to keep well in line with this progress. Watch our advertisements for an announcement of our development. We are sure that they will be well worth your while.

Special Equipment built to order

Short Wave Calibrated Wavemeter \$12.50
 Audio Oscillator \$17.50

Wireless Egert Engineering, Inc.

179 Greenwich St. New York

HILET

high-grade radio equipment is used thruout the world because it is backed by a guarantee to give and keep giving service. Adding to the art of amateur radio, we now offer a TRANSMITTER NAME PLATE for your panel; shows call letters, power, wave length, designer, etc. Blanks, 75c; Stamped to order, \$1.50; Engraved and black filled, \$2.00. Send for circular. CHOKES—with gap adjustment 500 M.A. 30 H. \$25.00; 250 M.A. \$7.50; 160 M.A. \$6.00; 100 M.A. \$3.00. TRANSFORMERS—Z-K.W. 2000-2500 volts each side \$40. 700 Watts 1000-1500 each side, \$14.50. 250 Watts, 500-750-1000 each side, \$10.50. 150 Watts, 375-325 each side, \$8.50. All models can have filaments added. *Specials to order — write for specifications. (One day delivery.)*

HILET ENGINEERING CO., Orange, N. J.

DON'T STRANGLE

That transmitter of yours with a high resistance rectifier that lets only gurgles, chirps and peeps trickle through. Pull her wide open—backed by that most powerful of rectifiers — the Mercury Arc. Converts 99% of high voltage AC input into a smooth, steady flow of direct current. Cheapest of all rectifiers per watt output, lowest in renewal cost. Maximum life, no filament to blow or lose emission. Output continuously maintained at peak, far above any transmitter demand. Starts instantly and automatically. Latest data and diagram sheets ready to convince you. Your station a sure winner — here's how.

RECTIFIER ENGINEERING SERVICE, W8ML, 4837 Rockwood Road, Cleveland, Ohio

HAM-ADS

(1) Advertising shall pertain to radio and shall be of nature of interest to radio amateurs or experimenters in their pursuit of the art.

(2) No display of any character will be accepted, nor can any special typographical arrangement, such as all or part capital letters be used which would tend to make one advertisement stand out from the others.

(3) The Ham-Ad rate is 15c per word, except as noted in paragraph (6) below.

(4) Remittance in full must accompany copy. No cash or contract discount or agency commission will be allowed.

(5) Closing date for Ham-Ads is the 25th of the second month preceding publication date.

(6) A special rate of 7c per word will apply to advertising which, in our judgment, is obviously non-commercial in nature and is placed and signed by a member of the American Radio Relay League. Thus, advertising of bona fide surplus equipment owned, used and for sale by an individual or apparatus offered for exchange or advertising inquiring for special equipment, if by a member of the American Radio Relay League takes the 7c rate. An attempt to deal in apparatus in quantity for profit, even if by an individual, is commercial and takes the 15c rate. Provisions of paragraphs (1), (2), (4) and (5) apply to all advertising in this column regardless of which rate may apply.

PLATE power for your set, the very heart of its performance. For quietness, DX ability, life-long permanence, absolute dependability, lowest ultimate cost, no other plate source even approaches the achievement of an Edison steel-alkaline storage B battery. Built painstakingly: every joint pure nickel, upset electrically welded. Genuine Edison Electrolyte. Our list describes complete batteries, construction parts, enameled aerial wire, silicon steel. Available immediately, filament and plate transformers for the new 872 rectifier, complete plate power units. Rectifier Engineering Service, radio W8ML, 4837 Rockwood Road, Cleveland, Ohio.

SPECIAL rectifier aluminum, \$1.25. Lead, \$1.00 square foot. Elements 1 x 15 cents, 1 x 6 17 cents pair. All prepaid. Best silicon transformer steel cut to order, 25-35 cents pound. Postage extra. George Schulz, Calumet, Mich.

THE finest in radio for amateur, broadcast and marine. The most modern short-wave receivers. Four to ten tube designs. Radiophone CW transmitters of any power or type. We make a complete line of apparatus, including speech amplifiers, filter coils, inductances, power units, etc. Any special apparatus, designs, built to order, using your parts if desired. Prices on request. New bulletin lists complete line of apparatus. Write for copy. Enssall Radio Laboratory, 1527 Grandview St., S. E., Warren, Ohio.

AMATEURS — experimenters, builders. We serve over 4000 I.R.E., A.R.R.L., etc., experimenters and "nuts." Full discounts. \$50,000 stock approved parts — no sets. Over four pounds catalog, circuits, data, prepaid, 50c. Weekly bulletins (new items, results of experiments, etc.), 20 weeks, \$1. Sample experimenters "Over the Soldering Iron" magazine, 25c. Transmitting data, price list, etc., 25c. Kladag Radio Laboratories, established 1920, Kent, Ohio.

2000V, 2000W, 3-phase drive motor generator, \$275. 2000V, 1000W, 3-phase drive, \$225. 2000V, 500W, 1-phase drive, \$195. 1500V, 400W, 3-phase drive, \$125. 1000V, 300W, \$95. 1000V, 250W, \$85. ¼ h.p. 345/ speed motor, \$10.50. ½ h.p. synchronous 1800 speed motors, \$20. 8V, 5-ampere generators, \$6.50. 75V, 100W, 32V, drive motor generators, \$37.50. ¼ h.p. 32V, motors, \$9.50. ¼ h.p., \$12.50. ½ h.p., \$24.50. Queen City Electric, 1734 Grand Ave., Chicago.

ARRL sweater emblems should be worn by all League members. They are yellow and black 5" x 5" diamond, felt letters and embroidered symbol. Only \$1.00. Money order or currency only accepted. Eric Robinson, 135 Jefferson Road, Webster Groves, Mo.

SALE — Western Electric tubes, No. 101F, fine amplifiers, may be used in transmitters, 69c. each (tested). Radio Salvage, 1063 W. Van Buren St., Chicago, Ill.

TELEGRAPHY — Learn Morse and wireless telegraphy. Big salaries. Tremendous demand. Expenses low, can earn part. Catalog free. Dodge's Institute, Wood St., Valparaiso, Ind.

PRINT your own radio call cards, stationery, circulars, advertising, etc. Junior press, \$5.90; job presses, \$11; rotary, \$149. Print for others; big profit. Easy rules furnished. Write for catalog presses, type, paper, etc. Kelsey Company, Q-54, Meriden, Conn.

PANEL engraving — finest workmanship on radio laboratory apparatus. Request price list. A. L. Woody, 19 S. Wells St., Chicago, Ill.

CRYSTALS of highest quality. 7000 kc., \$19; 3500 kc., \$14; 1750 kc., \$9; Guaranteed blanks, \$4. W9DRD, Herbert Hollister, Edwardsville, Kans.

ULTRATONE air column speakers 10½" High 14½" Wide 11½" Deep. Direct from factory. Each \$1.25. Ultratone Manufacturing Co., 1046 W. Van Buren St., Chicago, Ill.

SELL — Three tube, old style Aero, S.W. receiver. ¼ h.p., G.E. Motor. Old Edison Miliograph. 8 tube Ultradyne receiver. B eliminator. X-ray milliammeters, Bristol one stage amplifier. Other parts. Make me an offer. Marcus Beekman, Natchez, Miss.

10,000 volt blocking condensers, flint glass dielectric, replaceable plates, all capacities, .002, \$4.50. W9DBJ.

WANTED — marble base transmitting key. W6NH.

TRADE — 5 Western Electric 1 mfd. condensers, 100 volt, for mg. 750 watt or more. W5BHY, K. L. Horton, Clovis, New Mexico.

GENERATOR — Heints and Kaufman, 900 cycle, 250 watt. Never been used. Make offer. W1CHP, 24 Salem Street, Andover, Mass.

WE supply parts for receivers, transmitters and power supplies. Specialists in push pull transmitters and special apparatus. Pontiac Engineering Co., 1100 Ave. I, Brooklyn, N. Y.

BARGAINS — one pair IREL inductances \$6.00, two short wave receivers, two stages \$30.00 each, one 75 watt transmitter complete with power supply mounted on engraved panels and hand rubbed mahogany frame \$125.00, 50 watt transmitter similar to above \$100.00, 7.5 watt transmitter \$30.00. Set QST's since second issue. Make offer. Send for list. W4C'K selling out. R. B. Ladd, P. O. Box 2688, Miami, Fla.

BARGAIN — UV204A slightly used. Guaranteed perfect. \$60. W2AVF.

TRADE General Radio wavemeter, 3 Weston meters, 1 Cardwell xmitting condenser, and 2 IREL xmitting coils, for a high grade electric radio. Mr. Clyde Peterson, 3623 Warsaw Ave., Cincinnati, Ohio.

TRADE complete television outfit ready to operate. Wholesale cost \$50. Will trade for radio receiving equipment. Make an offer. Platten Radio Co., 103 N. Broadway, Green Bay, Wis.

SELL — brand new National SW4W receiver, completely wired, with six coils, 15-560 meters. Cost \$65. — sell \$35. W9EYF.

JEWELL No. 54, 1000 ohms per volt 0-200 volts with external resistor \$14. 0-1000 volts \$13. No. 74, 0-1000 volts without resistor \$5.75. Edison "A" unit with 5 ampere Tungar charger \$30. Cost \$90. Audio coils 30c. Hilet transformers and chokes in stock. See Hilet advertisement. Write for details. M. Litch, Park Drive, West Orange, N. J.

EXCHANGE on Remington typewriter No. 12, for complete CW transmitter as described in QST page nine, September issue. Must be built in fashion as described. R. L. Toups, W5MH, Iota, La.

WANTED — Kennedy all-wave receiver 150 to 20,000 meters. State condition, price, etc. Howard Keil, 27 Condon Ave., Buffalo, N. Y.

SELL 204A tubes \$75. New, in original, unbroken packages. Guaranteed good condition. WSQT, E. H. Mitchell, 217 E. Main Cross St., Findlay, Ohio.

WANTED — 6-400 or similar dynamotor. W7SK.

WANTED — a burned out 860. E. Ewing, Jr., 29 S. LaSalle St., Chicago, Ill.

QSL cards, cartoons, stationery, wall cards, etc. Selden, Craneseville, Pa.

SELL — U. S. Motor Corp. 2½ kw. 32 volt electric plant with 16 cell 300 ampere glass storage battery. New and in original crate, \$400. A real bargain. K. P. Chai, Kohala, Hawaii.

FOR sale — Grebe CR-9. W6NH.

ANXIOUS secure November, December 1915 QST's. Also all 1916 except October and December. Your own price. W9APM, Des Moines, Iowa.

QSLs, 100 two color \$1.00. Samples. W9CKA, Corwith, Iowa

SELL or exchange. G. E. Rotary converter and transformer, 110 d.c. to 110 a.c. 60 cycles, output 600 watts. J. L. Preston, 22 Williams Lane, Chevy Chase, Maryland.

TUNGARS — full wave. Can be used half-wave. Two ampere. Mogul base. For "keep-alive", A-eliminators, chargers, etc. See January advertisement. \$2.00 prepaid. W9DWA.

FOR sale — 2 mfd. condensers, fifty cents, ¼ mfd. thirty-five cents each. Five 600 volt d.c. ¼ mfd. condensers center tapped. W6DCQ, Guy N. Carter, 1436 E. Fillmore St., Phoenix, Arizona.

SELL — 72 volts Willard Bs, \$10. Excellent condition. Also 500 volt mg. set, brand new, \$35. W3BKL, 403 W. North St., York, Penn.

DO you prefer adjectives to facts? New shortwave, double detection screen grid six tube kit. Complete theory and description in article for 50c. Nothing but facts — you judge. Get the dope now. Hatry & Young, Hartford, Connecticut.

BARGAIN offer — Super Mo-Pa, 750 volt powerpack, receiver, wave meter, good condition, \$100.00. Individual parts cost more. First money order takes outfit. W4AFW, J. B. Floyd, Oxford, N. C.

TRADE complete high and low power xmitr and receiver for a good outboard motor and boat. Joe Martonosi, 1107 W. Jefferson Blvd., South Bend, Indiana.

HOT wire ammeters 0.5 and higher ranges. \$2; miscellaneous d.c. meters \$3; General Radio wave meters 180-710 meters complete with galvanometer, \$4; easily changed to short wave-lengths. Coe. Box 151, Ft. Sam Houston, Texas.

SALE: RCA inductance \$1.00; mercury arc \$7.50 keep alive with 2 Tungars, \$10.00; Acme 1 stage power amplifier \$4.00; lineman's 0-130 volt a.c. voltmeter in carrying case \$8.00; desk telephone \$4.00; Thordarson 12 volt center tapped filament transformer \$7.00; 7½ volt filament transformer center tapped \$5.00; 3 tube short wave receiver \$8.00; 4 tube, 1 screen grid, short wave set \$15; 7 tube all purpose, QST type super \$40. Have a.c. operated all purpose super so can't use above. Send cash or stamp for reply. W9ENG, Mound Valley, Kansas.

EX-Navy dynamotors ideal for battery operation also supplied with extension shafts for external motor or engine drive. General Electric 24/1500 volt, 233 amperes \$37.50; 24/750 volts \$27.50; 12/350 volts \$15. Westinghouse 6-15 volts 500 watts \$15; 10/350 \$18; 27.5/350 \$12.50. Twins for 700 volts \$20; Shaft extension \$3.00, 900 cycle \$2.5; ½ Kw 500 cycle with exciter \$15. 1 KW Crocker-Wheeler motor generators \$135. Complete list, Henry Kienzle, 501 East 54th Street, New York.

PIEZO quartz plates — guaranteed perfect oscillators 700 kc., \$40, 3500 kc., \$15, 1750 kc., \$10. Dr. Gerald W. Fox, physicist, W8BNT, 419 W. State, Ann Arbor, Mich.

SURPRISING bargains in surplus radio apparatus. Send stamp for list, Louis Moravec, Shevlin, Minn.

CRYSTALS — Unconditionally guaranteed excellent oscillators. One inch square sections of your approximate specified frequency — 3500-ke. band, \$10.00; 1750-ke. \$8.00; Guaranteed blanks, \$1.00. One day service. Precision Piezo Supply, 427 Asia St., Baton Rouge, La.

RECTOBULBS, hi-power \$10, 281 type \$5.25; Power crystals 85 or 170 meter \$12; RCA and WE trans. tubes; 25% off on REL, Jewell, Leach, Signal, Ward Leonard; 30% on Thordarson, Sangamo; 35% on Tobe and Flechtheim. Any other apparatus. Henry's Radio Shop, W9ARA, Butler, Mo.

W2ALU moves a rain! This time to 77 Pennington Avenue, Passaic, New Jersey. Give us a ring when you are in New York City. Knight and Link.

TYPE 866 seconds (new tubes). All characteristics normal. Mercury vapor 2.5V filament. Guaranteed perfect operation and safe delivery, \$5. each. E. Ewing, Jr., 29 S. LaSalle St., Chicago, Ill.

WAVEMETERS \$3.00 postpaid. Solid. Accurate. Guaranteed. E. Bromley, 7023 37th Ave., Kenosha, Wis.

275 volt generators, \$5, 200 watt 500 cycle \$10, ¼ kw. motor generators (d.c. drive 500 cycle, \$20, a.c. drive \$30, 0-500 voltmeters \$3. R. Wood, 46-20 102nd St., Corona, N. Y.

WANTED Navy Standard Receivers SE143 SE1220 SE1420 IP500 IP501 also spark gap units, Paul Trautwein, 38 Park Place, New York.

GUARANTEED merchandise at sensational prices. Money returned if not satisfied. We now ship C.O.D. More Parson condensers at less than manufacturer's prices. Every one brand new. Transmitting filter condensers, 1000 Volts DC working; (Remember that the "Working Voltage" of a condenser is usually one-half the "Test Voltage" so don't be misled by "Test Voltage" ratings). 2 Mfd. — \$2.40, 4 Mfd. — \$3.95, 6 Mfd. — \$5.15, 8 Mfd. — \$6.90, 1750 Volt DC working; 1 Mfd. — \$3.70, 2 Mfd. — \$5.30. Mica grid-plate condensers: .002, .001, or .0005 Mfd. 750 volt working — \$.96, 1500 volt — \$1.18, .002 mfd., 2250 volts — \$1.73 Freshman 10.1 mfd. 850 volt working, replacement condenser blocks. Tapped at 1-1-1-2-2-4 mfd. Special — \$2.55. Tobe 600 volt tapped, metal-cased blocks: 10 mfd. — \$3.25, 15 mfd. — \$4.45. Special high-grade unmounted 850 volt DC working filter condensers: A quantity of these units can be series-paralleled for any desired capacity and voltage. 2 mfd. — \$.70 each. Four for \$2.60. Eight for \$4.80, Twelve for \$6.60, 1 mfd. — \$.35, Four for \$1.35, Eight for \$2.45, Sixteen for \$4.50. U. S. Tool .00014 variable SLF condensers — \$.98. Guaranteed UX-231 tubes — \$2.45, UX-250 — \$2.95, 50,000 ohm volume controls: Frost — \$.98, Bradleyohm (with knob) — \$1.18. Well-made power chokes, 30 Henry, 175 Milliamperes. — \$2.25, 30 H, 120 MA — \$1.75, 2½ Ampere "A" eliminator choke — \$3.25, Thordarson T-2458 double choke — \$6.25. Braeh 125 Watt power transformers, 600, 7½, & 7½ volt center-tapped, secondaries. Ideal for UX-210 transmitter or amplifier. — \$3.75, Ward-Leonard 5000 ohm, 60 watt mounted grid-leaks — \$.85. Send for "specials", Harrison Radio Co., 35 Ft. Washington Ave., New York City.

SIX tube double-detection shortwave receiver, designed by L. W. Hatry, Screen grid first-detector operated space-charge; pickup coil eliminated, making adjustment easy; repeat point off dial; high-mu second detector, C.W. or phone. Complete article on theory and construction 50c. Standard kits available ready to wire. Aluminum base, shielded intermediates ready made. Write for prices on parts or kit. Hatry & Young, Hartford, Connecticut.

TRADE 210 and 250 and 281 new tubes for meters, transformers, condensers or what have you? Lowell Ecker, Sedan, Kansas.

OMNIGRAPHS, teleplexes, transmitters, receivers, monitors, waps, mikes, 50 watters, Vibroplexes, rectifiers, portables, dynamotors, motor generators. Bought, sold, traded. Ryan Radio Co., Hannibal, Mo.

QSLs, \$1 per hundred. W9BEU, 9032 Windom, St. Louis, Mo. **AMPEON** guaranteed x210-x250-x281s postpaid, \$2.10 each. Nassau Radio, Seaford, N. Y.

FOR sale: Used 387 WE mike, \$17.50, changing to condenser mikes. W.D.G.Y., Minneapolis.

G.E. transformers 1000 watt 1100-2200-4400 each side e.t., \$12.00. F. O. B. Detroit, Mich. Write for other uses. F. G. Dawson, 5740 Woodrow Ave., Detroit, Mich.

WANT: UX860. Will swap Springfield rifle in excellent condition for equivalent transmitting apparatus. Write W2CUF, Rye, N. Y.

Q R A SECTION

50 c. straight with copy in following address form only:

W2EJI — Hackensack Radio Association, YMCA Building, Hackensack, N. J.

W6DEP — L. F. Lynde, 261 Orizaba Ave., Long Beach, Calif. W9CXG — Charles M. Conley, Box 686, Burlington, Colo.

W9DFS — Harry Casserie, 1504 W. 14th Place, Chicago, Ill.

QSL cards \$1 per 100. Two colors. W8AAM, 533 Manhattan, Hazleton, Penn.

WIMK

A.R.R.L. Headquarters

R. B. Parmenter, Chief Op. "rp."

The following calls and personal signs belong to members of the A.R.R.L. Headquarters gang:

W1AL B. Dudley "bd."
W1BAW R. B. Beaudin
W1BDI-W1XL F. E. Handy "fh."
W1CEI J. J. Lamb "jim."
W1DF Geo. Grammer "hg."
W1EH K. B. Warner "kb."
W1ES A. A. Hebert "ah."
W1FL-W2JR G. Donald Meserve "dm."
W1SZ-W1BIZ C. C. Rodimon "rod."
W1UE E. L. Battey "ev."

ACME WIRE PRODUCTS

Coils — Magnet Wire Wound
Magnet Wire All Insulations
Varnished Insulations
Parvolt Filter and By Pass Condensers

All products made to Recognized Commercial Standards including those of:

National Electric Mfrs. Assn.
Radio Manufacturers Assn.
American Society for Testing Materials

For 25 years manufacturers and suppliers to the largest and most discriminating users.

THE ACME WIRE CO.

NEW HAVEN, CONN.

Branch Offices:

New York Cleveland
52 Vanderbilt Ave. Guardian Bldg.
Chicago
842 N. Michigan Ave.

To Our Readers who are not A.R.R.L. members

WOULDN'T you like to become a member of the American Radio Relay League? We need you in this big organization of radio amateurs, the only amateur association that does things. From your reading of *QST* you have gained a knowledge of the nature of the League and what it does, and you have read its purposes as set forth on page 6 of this issue. We should like to have you become a full-fledged member and add your strength to ours in the things we are undertaking for Amateur Radio. You will have the membership edition of *QST* delivered at your door each month. A convenient application form is printed below — clip it out and mail it today.

A bona fide interest in amateur radio is the only essential qualification for membership

AMERICAN RADIO RELAY LEAGUE
Hartford, Conn., U. S. A.

I hereby apply for membership in the American Radio Relay League, and enclose \$2.50 (\$3 in foreign countries) in payment of one year's dues, \$1.25 of which is for a subscription to *QST* for the same period. Please begin my subscription with the issue. Mail my Certificate of Membership and send *QST* to the following name and address.

.....

.....

.....

Do you know a friend who is also interested in Amateur Radio, whose name you might give us so we may send him a sample copy of *QST*?

.....

Thanks

For Your Convenience QST'S INDEX OF ADVERTISERS IN THIS ISSUE

Acme Wire Company	93
Aero Products, Inc.	95
Aerovox Wireless Corp.	89
Allen-Bradley Company	58
American Piezo Supply Co.	86
American Sales Company	78, 91
Amrad Corporation	81
Archurus Radio Tube Co.	74
Atriema, Inc., Ad.	94
A.R.R.L. Application Blank	81
A.R.R.L. Book Dept.	81
A.R.R.L. Emblems	89
A.R.R.L. Handbook	76, 90, Cover 111
Blair, The Radio Man, Inc.	88
Browning-Drake Corp.	90
Burgess Battery Company	Cover IV
Cameradio Co.	86
Candler System Company	78
Gardwell Mfg. Corp., Allen D.	63
Central Radio Labs.	86
Chicago Radio Apparatus Co.	80
Clarostat Mfg. Co.	82
Commercial Radio Institute	82
Cornell Electric Co.	91
Corning Glass Works	97
Crosley Radio Corp.	71
Cunningham, Inc., E. T.	61
DeForest Radio Co.	96
Dodge, C. K.	80
Electrad, Inc.	89
Electric Specialty Co.	89
Frost, Inc., Herbert H.	86
General Engineering Corp.	90
General Radio Company	83
Greben, F.	89
Gulf Radio School	88
Hardwick, Hindle, Inc.	78
Hilet Engineering Co.	91
Hinoc, Clifford E.	68
Hoodwin Company, Chas.	66
Instructograph Institute	70
Jewell Electrical Instrument Co.	59
Johnson Company, E. F.	81
Leeds Radio Company	83
Loomis Publishing Co.	72
McGraw-Hill Book Company	76
Manhattan Electric Bargain House	87
Massachusetts Radio & Telegraph School	90
M. & H. Sporting Goods Co.	76
National Carbon Company	75
National Company	1
National Radio Tube Co.	88
Pacent Electric Company	84
Perryman Electric Co.	81
Pilot Radio & Tube Corp.	Cover 11
QST Binder	62
Radio Engineering Labs.	65
Radio & Television Institute	85
RCA Institutes, Inc.	67
Rectifier Engineering Service	91
Rooney, John T.	88
Sangamo Electric Company	Insert
Scientific Radio Service	91
Shallcross Mfg. Company	74
Silver-Marshall, Inc.	79
Telex Company	72
Thordarson Elec. Mfg. Co.	77
Van Nostrand Co., D.	69
Vibroplex Company	82
Weston Electrical Instrument Corp.	60
Wireless Egert Engineering	91

AERO SHORT-WAVE Automatic TUNING UNIT

(Protected by patents pending.)

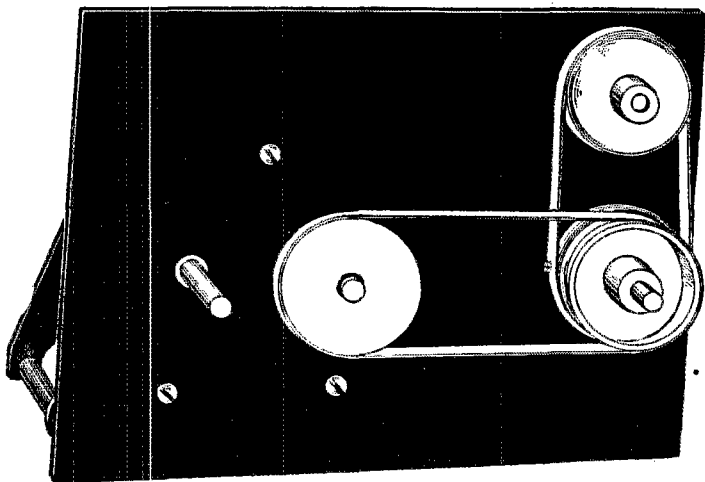

Features

- Automatic range, 15 to 90 meters; full range, up to 200 meters.
- No plug-in coils used in automatic range.
- Easiest tuning device known.
- Tunes even more slowly than broadcast receiver.
- Special attachment enables it to reach 200 meters.
- Anyone can operate it.
- The days of fooling with plug-in coils are over. Amateurs can now have a real thrill by this new automatic tuning device. Read the complete story in February *QST* and then mail your order to Aero Products for the complete built-up unit. Be first to use this remarkable short-wave apparatus.

A Marvelous Improvement

NO PLUG-IN COILS

Range 15 to 90 meters. Easiest tuning short-wave receiver known. The tuning unit consists of two controls. The right-hand control, which will be termed the shift control, and the left-hand control, the actual tuning device. In addition to these two controls it will, of course, be necessary to have a regeneration control. For those who desire to employ it for television or the upper phone band, a special attachment may be secured.

OPERATION

The tuner is operated in the following manner. As a specific example, with the right-hand dial set at nine degrees, revolving the left-hand dial through 180 degrees, you will cover from 19.1 to 22.6 meters. The next step will be to move the shift dial to 13 and tuning over 180 degrees, as before, this time covering from 21.9 to 25.7 meters. This process is continued through 180 degrees on the shift dial until you have reached the maximum automatic wave length, which is 90 meters.

You will note that the tuning dial, in the first instance, when tuned through 180 degrees, covers only 3½ meters, whereas ordinarily when using plug-in coils your tuner, when passing through 180 degrees, generally covers at a minimum of 25 meters. This same speed of tuning is maintained throughout the entire short-wave spectrum, and it is for this reason that this tuning arrangement surpasses any known method.

This unit is furnished completely assembled to the amateur, and may be built into either a short-wave converter or receiver.

For those desiring to go from 90 to 200 meters a special device may be had, making its range then from 15 to 200 meters.

A general chart is furnished with each unit, specifying the settings for the shift dial, which will enable you to approximate the wave length for each setting on the shift dial.

This tuner is not sold through the usual trade channels, but is sold to amateurs only direct from factory at special low net price. Be sure to send post office or express money order for \$19.50 with your order. Shipments will be made in the order received. Be first to order. Attach your money-order to coupon below and mail today — NOW!

PRICE ONLY \$19⁵⁰ NET

AERO PRODUCTS, INC.
4611 E. Ravenswood Ave., Dept. 330, Chicago, U.S.A.

Dear Sirs:

I want to be one of the first to secure the new Aero Short-Wave Automatic Tuning Unit. Enclosed is money order for \$19.50 which is your low opening net price to amateurs only.

Name.....

Street and No.....

City.....State.....

AERO PRODUCTS
INCORPORATED

4611 E. Ravenswood Avenue Dept. 330
Chicago, Illinois, U. S. A.

All Worthy of The Name

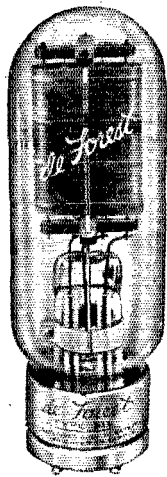

Audion 511

De Forest

REG. U. S. PAT. OFF.

The De Forest reputation for engineering skill and painstaking precision has been zealously guarded in the production of all De Forest receiving and transmitting Audions. The De Forest Engineering staff is continually bringing out new developments which will be announced from time to time in this publication.

The new D. C. Screen Grid Audion for Portable Sets

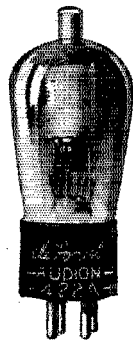

Audion 422A

Transmitting Audions

- 510**—15 Watt Oscillator
- 503A**—50 Watt Oscillator and R. F. Power Amplifier
- 511**—50 Watt Oscillator, R. F. Amplifier, Modulator or R. F. Power Amplifier
- 545**—50 Watt A. F. Amplifier and Modulator
- 552**—75 watt Oscillator and R. F. Amplifier
- 504A**—250 watt Oscillator, Modulator or R. F. Power Amplifier
- 500**—500 watt Special Oscillator
- 520B**—5000 watt Oscillator and R. F. Power Amplifier—water cooled
- 565**—7½ watt Screen Grid R. F. Amplifier
- 560**—75 watt Screen Grid R. F. Amplifier
- 561**—500 watt Screen Grid R. F. Amplifier
- 566**—A half-wave hot cathode, mercury vapor rectifier. Medium Current.
- 572**—A half-wave hot cathode, mercury vapor rectifier. Heavy Current.
- 601**—Vis-ion Neon lamp.
- 602**—Photo Electric Cell.

422—Long life, oxide-coated filament which insures ample emission. Interchangeable with standard—22 type tubes but with a higher actual gain per stage because of lower plate resistance and high mutual conductance. Non-microphonic because of special design of filament and rigidly supported elements.

422A—Valuable for portable installations. Filament rating .06 amp. at 3.3 volts. Operating characteristics and life same as 422.

499—Non-microphonic long-life—99 type tube. Valuable for portable work. Sturdy and uniform. Containing the special oxide-coated filament standard with all De Forest receiving Audions.

503A—An improved “50 watter” interchangeable with standard—03A types. Especially valuable as a medium power, self-excited oscillator or radio frequency power amplifier.

511—Audion 511 is similar in construction to 503-A but also suitable as an audio-frequency amplifier as well as an oscillator and radio frequency power amplifier. Interchangeable with standard—11 types.

545—Designed especially as a modulator or audio-frequency power amplifier. Interchangeable with standard—45 type Transmitting tubes.

566—A high grade hot-cathode mercury vapor rectifier. Especially designed to prevent breakdown between anode and filament. Filament rating 2.50 volts at 5 amps. Max. inverse peak, 7500 volts.

For further information consult your local dealer or address—

De Forest Radio Co.
Passaic New Jersey

Receiving Audions

- 401A**—Detector-Amplifier
- 410**—Power Amplifier
- 412A**—Detector-Amplifier, Power Amplifier.
- 422**—Standard D. C. Screen Grid Amplifier.
- 422A**—A 60 m. a. D. C. Screen Grid Det.-Amp.
- 424**—A. C. Screen Grid Amplifier.
- 426**—Amplifier (A. C. Fil)
- 427**—Detector-Amplifier (A. C. Heater Type)
- 440**—High Mu Audion
- 445**—A. C. Power Amplifier
- 471A**—Power Amplifier, Last Audio Stage
- 471B**—Power Amplifier, Last Audio Stage
- 480**—Full-Wave Rectifier (125 M. A.)
- 481**—Half-Wave Rectifier (110 M. A.)
- 450**—Power Amplifier
- 499**—60 m. a. General Purpose

AND NOW IT'S 70,000 READERS!

That's the number who have put their
reliance in the A.R.R.L. Handbook

All over the world the Handbook has been sent, in five successive editions, to tell its story of practical amateur radio to beginner and old-timer alike. It has quickly established itself as the standard manual of the practicing amateur. Everywhere it is hailed as the greatest fund of helpful information that an amateur ever saw.

And now, with the necessity of printing additional copies for the orders that roll in every day, additional material has been added in the same helpful fashion. We are now distributing

THE *The Sixth Edition of* RADIO AMATEUR'S HANDBOOK

By Handy & Hull

Revamped and overhauled as the Handbook always is before each successive edition, this new printing contains new and modernized material on two subjects of current importance: Crystal Controlled Transmitters and Radiotelephony. Thus, more than ever, it contains the answers to your questions. Between these covers is everything the A. R. R. L. can think of that is worth the telling for the guidance of a practical radio amateur.

It tells the story of amateur radio; what it is all about; how to become an amateur; how to build and adjust your apparatus; how to operate your station.

For the more advanced amateur there are working descriptions and building instructions for all kinds of receivers, transmitters, antenna systems, frequency-meters, power supplies, modulation systems, monitors, and keying methods; and detailed explanation of the complexities of modern operating procedure.

A world of valuable information, printed in "QST" format and bound in durable paper covers so that the price may be modest.

Blue-and-Gold Paper Cover, \$1.00

Stiff Buckram Binding, \$2.00

◀ *We honestly don't see how you can get along
without the Handbook. Order yours to-day!* ▶

American Radio Relay League, Hartford, Conn., U. S. A.

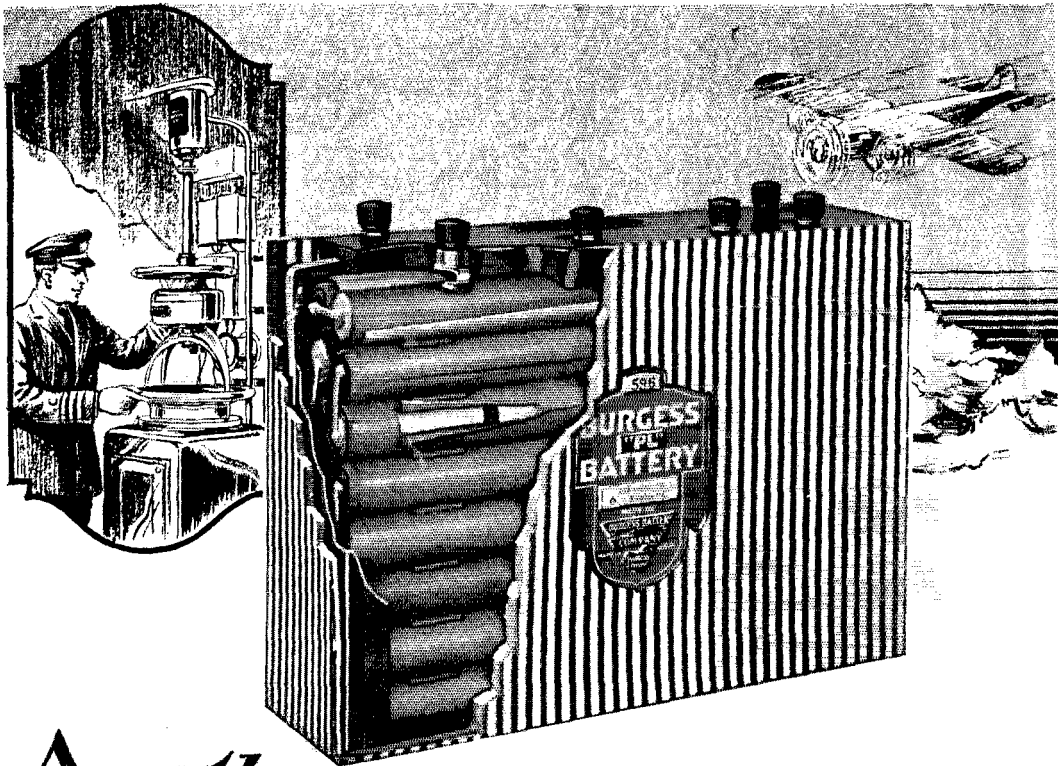

Another Contribution!

In line with the policy of keeping abreast of the times, Aircraft battery No. 596 was designed—a Burgess contribution to the country's newest transportation and industrial giant. Actual experience has demonstrated that the rugged Burgess "stick" construction admirably meets the exacting requirements of Aircraft radio.

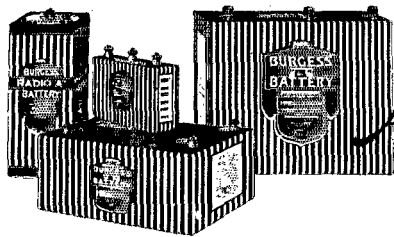

Ask any Radio Engineer

BURGESS BATTERY COMPANY

MADISON,

WISCONSIN

The Communications Department

F. E. Handy, Communications Manager
E. L. Battey, Asst. to Coms. Mgr.
1711 Park St., Hartford, Conn.

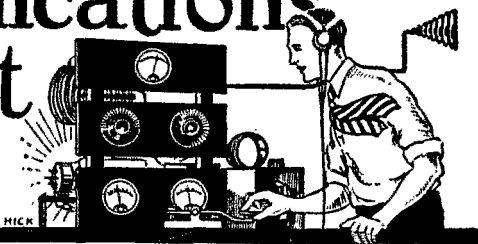

Making and Keeping Schedules*

By E. A. Hubbell †

IT is easy to make schedules with stations. A consistent operator on 3500 kc. has perhaps a request once every week or two for a "sked," if he does any great amount of work on the air. However, this does not mean that these schedules will be either profitable or successful. A schedule to be profitable should be made between operators of approximately the same speed or copying abilities. Furthermore, the definite purpose for which the schedule is made must be understood or agreed to by each operator for satisfactory results.

It is absolutely exasperating to QSO some of these new hams night after night, when they cannot copy ten, or even five per, and when the whole QSO is made of QSZ and slow sending. It is understood that these men must get their training somewhere, but that place is *not* on the air. It is very possible to work up a decent copying speed through the use of the commercial stations so conveniently (?) dotted about on the frequency spectrum. It is possible to become a good operator through listening to good operators, and through studying frequency articles in *QST* and the *Handbook*.

Why should some new ham take up an experienced operator's time in learning the code? That can be done by persistent copying of commercials. Likewise, why must a new ham learn his procedure from QSO entirely? There is plenty to be learned in the *Handbook* and *QST*. So, put some more study and thought on both sending and receiving, and more than a little on operating, before making schedules.

Make your skeds with a definite purpose. Explain to the other fellow that you want to handle traffic, or that you want to chat, or that you want to test, or that you merely want code practice, before you make the "sked." Then he will be prepared for what you want to do, and he can refuse the sked, if he doesn't want it.

If your purpose is to handle traffic, have some for the other fellow. Not necessarily three messages an evening, but have one every now and then. If you cannot pick them up on the air, originate a few. If your purpose is to chat, make notes of what you want to talk about before the QSO begins. If you want to test, have everything ready for the test.

Keep schedules by *being on time*, if possible. Keep schedules by *being on frequency*. Keep schedules by *thorough, patient, sincere and repeated efforts* by trying to QSO for at least four or five skeds after the first failure to QSO. Too often fellows quit a "sked" if the other man is not there on the dot. However, circumstance makes it necessary for the best of operators to miss "skeds" now and then. So have a little consideration for the other fellow's difficulties, and make them as small as you can, by trying your best to be on.

Traffic handling is the best stuff to cement a schedule. When you *know* the other fellow is there, with traffic to push through, you will be there also, to help him out. And when you finish the job, don't keep him from his next "sked" by a long-winded chat, but let him go. In all operations, apply the Golden Rule.

A recent article in *QST* referred to the operating done by commercials. The thing we must admire about commercials is the way they are more on schedule. If they have any traffic, they can get it off, because the other fellow is *there*

* From the December issue of *Twelve Skeds*.

† W9ERU, 27 N. Fourth St., Rockford, Ill. — O.R.S. Co.

when he is supposed to be. Radio becomes increasingly more interesting, and profitable to a man, if his schedules work when and as they are intended to work.

Off-Frequency Stations

A Request from the U.S.N.(C)R.

THE general subject of amateur frequency observance is discussed editorially this month. In addition some specific interference troubles and possible consequences were discussed in the columns of February *QST* with special reference to the 7000 kc. and 14,000 kc. amateur bands.

Now comes a friendly request from the Navy Department relating to interference noted on the 4045 kc. channel adjacent to the 3500 kc. amateur band. The Naval station at Pearl Harbor, T. H. and several Naval Reserve stations east of the Mississippi River use the channel on which interference has been found. The Navy Department does not wish to have to take official action which might bring hardship to any amateurs and therefore requests the careful and prompt consideration of amateurs in adjusting and monitoring transmissions to keep them always *within* the amateur bands.

With two such excellent "markers" as NAA (4015 kc.) and WIR (4054 kc.) there is no excuse for an error in calibration that permits an amateur to adjust his transmitter to 4045 kc. In cases of repeated interference after due notice has been given we believe that the Navy Department is entirely justified in taking up the complaints through official channels and have little sympathy for the operators responsible for the off-frequency operation. Continued carelessness or wilful off-frequency operating cannot be permitted, especially when it may injure our good friends in the Navy Department.

All amateurs are requested once more to attend to their methods of frequency checking, and to make a practice of checking adjustments and measuring frequency regularly before going on the air, to effect a speedy improvement in this situation which has brought in complaints concerning different amateur bands. After all, careless or improper methods are our worst enemies. Prompt formation of the right habits in operating procedure and adjustments will get at the heart of the situation. Every station should have a good frequency standard to be used daily and to be checked often for permanency of calibration.

— F. E. H.

A.R.R.L. PINS FOR MEMBERS, O.R.S. AND S.C.M.'S

A number of inquiries has been received recently regarding the availability of suitable insignia for Official Relay Station appointees. This item is written to point out that there are now three kinds of membership insignia available, making it possible for us to recognize fellow members instantly when meeting them at hamfests and conventions or when visiting with out-of-town hams. Special emblems for O.R.S. and for Section Communications Managers of the same size and form as the well-known black and gold A.R.R.L. membership pin but differing in color were authorized by the League's Executive Committee late in 1926.

The new pins have a neat and attractive appearance. All bear the design of the standard membership pin but red is authorized for Section Managers — and blue as a background for Official Relay Station appointee's insignia. The pins are advertised elsewhere in this issue. Don't forget to include your O.R.S. certificate number when ordering, OM

BRASS POUNDERS' LEAGUE

Call	Orig.	Del.	Rel.	Total
W6AD	192	518	1056	1766
W2CXL	351	151	842	1324
KA1HR*	475	137	265	1217
W6AKW	39	269	824	1132
W1MK	244	157	379	780
W9COS	139	450	182	771
W3BWT	253	142	328	723
W9LQ	13	26	651	670
W7LAT	83	152	329	564
KA1DJ*	430	100	10	540
W2QU	137	345	46	528
W8CNO	57	26	408	491
W6CBW	38	12	317	467
W6HM	39	308	—	457
W2AFV	19	61	346	426
W9DNZ	35	24	306	365
W6EIB	25	18	320	363
W8AEQ	50	5	300	355
W6DTH	148	79	129	356
W3ARU	125	35	186	346
W3NF	12	38	280	330
W6AMW	17	6	302	325
W8DLG	13	26	262	301
W2SC	72	31	188	291
W1AMZ	39	82	189	285
W8DYH	18	60	204	282
W9BN	137	74	64	275
W9BVF	14	4	238	256
W5LJ	119	38	94	251
W8RN	47	16	182	245
W8BBR	9	14	222	245
W2BGO	63	50	123	236
W9CFN	31	21	185	236
W8BYH	58	3	170	231
W8DQP	89	44	98	231
W8CZ	37	61	142	230
W9CAA	13	30	185	228
W8JD	4	40	184	228
W1ANH	28	24	174	226
W6ERK	62	47	116	225
W9FTG	40	6	178	224
W9PAM	10	—	212	222
W3EF	59	18	144	221
W6EFC	—	—	221	221
W6AWF	29	64	126	219
W8CRI	18	13	185	216
W8BJO	63	70	84	214
W6DKV	22	9	182	213
W6AQA	114	8	88	210
W5HY	40	80	90	210
W9CFL	13	160	36	209
W4AGR	19	7	182	208
W9BRG	179	28	237	207
W5AJD	22	4	180	206
W1CGX	31	42	130	203
W8BY8	23	32	148	203
W6EDK	30	25	146	201
W6BP	12	52	126	200
W1WV	40	62	90	192
W2PF	34	104	46	184
W3CGC	35	52	84	171
W7BB	29	104	36	169
W1ACH	29	57	80	166
W6WA	9	46	62	160
W9UM	32	53	68	155
W9DEJ	51	52	46	149
W4OZ	37	70	8	127
W9UJ	6	105	8	119
W4LA	28	53	16	97
W6EQF	14	75	—	89
W6CIS	7	60	18	85

The several amateur stations responsible for the best traffic work — the ones that are "setting the pace" in worthwhile traffic handling — are listed right up near the top of our B.P.L. — the figures giving the exact standing of each station accurately.

All these stations appearing in the Brass Pounders' League are noted for their consistent schedule-keeping and dependable message-handling work in amateur radio. Special credit should be given to the following stations (in the order listed) responsible for *over one hundred deliveries* in the message month: W6AD, W2CXL, KA1HR, W6AKV, W1MK, W9COS, W3BWT, W7AAT, KA1DJ, W2QU, W6CBW, W6HM, W9CFL, W2PF, W7BB, W6UJ.

Deliveries count! A total of 200 or more bona fide messages handled and counted in accordance with A.R.R.L. practice, or just 50 or more *deliveries* will put you in line for a place in the B.P.L. Why not make more schedules with the reliable stations you hear and take steps to handle the traffic that will qualify you for B.P.L. membership also!

* These figures are one-half of a two-months' report.

High-Quality Signals

3500 kc. band: W1ACH, W1AJB, W1AOL, W1BDX, W1BAX, W1CGX, W1CQR, W1MK***, W1IT, W1QT*, W1ZL, W2ACB, W2AG***, W1AIZ*, W2ALK, W2ALO, W2BQC, W2BS, W2CXL***, W2JF, W2SC*, W3ADE, W3AWQ, W3BO*, W3BQ, W3BWT, W3GS, W3LA (cc), W3OZ, W3CN, W4ABV, W4JR, W4OC*, W5APG, W7AAT*, W8APQ, W8ARN***, W8AYC, W8BAA,

W8BBR*, W8BGW, W8BRO, W8BRS, W8CCH, W8CEO, W8CEP, W8CMP, W8CNO*, W8CSB, W8CSU, W8CUG, W8DAQ**, W8DH, W8DIL, W8DUQ, W8EB*, W8FE, W8JD*, W8LT, W8NZ, W8OK, W8QL*, W8WJ, W8WO, W9APG, W9BN, W9BZO*, W9CFL, W9COG, W9CUH, W9CYQ***, W9DCD*, W9DLQ, W9DSC, W9DXP (cc), W9DXZ***, W9EBO*, W9EHD, W9EJQ, W9EMR*, W9ENE, W9ERC*, W9EZQ, W9FLK, W9FUD, W9GFB, W9GKF.

7000 kc. band: W1ABZ, W1AFP, W1AGI, W1AGN, W1AMD, W1ANH, W1BJC, W1BKS, W1BNM, W1CIO, W1ID, W1LK, W1MK****, W1SZ, W1VS, W1WV, W2AKM, W2ALO, W2AUN, W2BCM, W2BFF, W2CXL, W2FM, W2GX, W2KR, W2QN*, W2RQ, W2UK, W2WT, W3ABO, W3ANH, W3AOJ, W3BF, W3BUF, W3EE, W3HG, W3UI, W4AAQ, W4E1*, W4HE*, W4LL, W4LM, W4PM, W4PX, W4RM, W4WN, W4WZ, W5AFG*, W5AFX*, W5AHI, W5AOM, W5BAT, W5BBV, W5GAB, W5AM**, W5ASJ, W5AEV, W5AQ*, W5CQK, W5CLF*, W5CUL, W5DFS, W5DPF, W5EDS, W5EQE, W5EIF*, W5EPE, W5IO, W5KD, W5NZ, W5PW, W5TM, W5WB, W5WN*, W5ZBJ, W5EL, W5YA, W5AS, W5AGI, W5ARO, W5ARX, W5BCQ, W5BKN, W5BLH*, W5BNE, W5BRS, W5CNB, W5PCP, W5PCM, W5DGM, W5DUQ, W5DWQ, W5DYH, W5EB, W5EQ, W5FZ, W5GZ, W5IM, W5JB, W5LT, W5NP, W5SE, W5YA, W5AC*, W5ACZ, W5AFB, W5AIR*, W5AMK, W5APM, W5AQH, W5AQS, W5AQZ*, W5ARK, W5AYD, W5AZY, W5BAZ, W5BEZ**, W5BMQ, W5BNW, W5BSH, W5BVH, W5COS*, W5CRD, W5CTW**, W5CVN, W5CVT, W5DJB, W5DN, W5DXP*, W5EFL, W5EGE, W5EG*, W5EGW, W5EHO, W5ELL, W5EOP, W5EPV, W5ETD, W5FGB, W5FIS, W5FTR, W5FV, W5FZQ, W5GHW, W5OB, W5OJ, W5NY, W5QF*, W5YC*, X1AM, K4BJ, K4DK, K4KD, VK2AR, VK2DY, VK2HC, VK2RF, VK3OR, VK3PP*, VK3RG, VE3DA, ZL2AB, ZL2AC.

14,000 kc. band: W1ABN, W1AHC, W1AXA, W1BJD**, W1BUX, W1CIO, W1CMX, W1DA, W1DP*, W1MK, W1OG, W1OK, W1VC, W1WE, W1WV, W1ZA, W2AEY, W2BG* (cc), W2FL** (cc), W2FP** (cc), W2JN***, W2MB**, W2NM**, W3PF*, W4AKM, W4EJ, W4PD, W5AAK, W5BCM, W5QJ, W5WG, W6AFC, W6ATT, W6BAM, W6BUX, W6BXL, W6BXW, W6CUH***, W6ZM, W6EGK, W6WB*, W7EK*, W7EL, W8AFM, W8BWW, W8CPC, W8CRA, W8CUT, W8DJV, W8DRP, W8FZ, W9ANZ, W9BHR, W9CVP, W9DEF** (cc), W9DGH, W9DXP* (cc), W9EOP, W9FRQ, W9FXV, W9GDH, VE1BR, VE2AC, VE2AP*, VE2CA*, VE5AW, VOSMC, VK2BG, VK2CS, VK7LJ, G20D*, G5BJ, G5IS*, G5KH, G5ML, G5WK*, G5YQ, G5YK, G6LL*, G6WN, G6WT*, G6NF*, G6BQ, PY1AA, PY1AH*, PY1AW, PY1CA, PY2AD, PY2AY, PY2BA, PY2BF, ON4FP, ON4WW, ON4HC, OH2NM, LU8DH*, LU7FC, ZL2BG, ZL2BX, NKF, X9A, ZS1P.

Good 14,000 kc. tones: W9ANZ*, W9QY.

Good 3500 kc. tones: W3AIN, W6ABF, W6BBJ, W6RJQ, W6EX, W6KT, W8AJH, W8CVR, W8DCE, W8RD*, W8WF*, W8WO, W9BAG, W9BJW, W9BW, W9FK*, W9KE*.

Well-operated stations: W1MK**, W1WV, W2BEK, W2CXL**, W2FL, W2JF, W2SC, W3HG, W3OE, W4OC, W6AKW, W6AM, W6AWP, W6CUH*, W6TM, W7AAT, W7EK*, W8AJ, W8CEO, W8CUC, W8CSU, W8DYH, W8EB, W8HE, W8JD*, W8LT, W9APV, W9BZO, W9COS, W9CYQ**, W9DXZ, W9EJQ, PY1AH.

PREHISTORIC SIGNALS

3500 kc. band: W1ACV, W1AEZ, W1AKC, W1APL, W1BGW, W1BHJ, W1CAA, W2ACL, W2AVQ, W2BAE, W2BCK, W2BWI, W2GP, W3AJR, W3ASO, W3BE, W8ACZ, W8AVA, W8DYV.

7000 kc. band: W1ACE, W1AFA, W1AWE, W1BCN, W1CDT, W1CKD, W1CZN*, W1EA, W1GW, W1RW, W1VZ, W2AFO, W2AIS, W2AVS, W2BHR, W2BIA, W2BJE, W2BOX*, W2CYJ*, W2GP, W2HH, W2RS, W2UG, W2VC, W3ACW, W3AJW, W3AFP**, W3ARD**, W3BHD, W3BHP, W3BNU*, W3BQV, W3NA, W3PX, W4AET**, W4AGR, W4FT*, W4GK, W4HC**, W4KQ, W4LT, W4SX, W4Y, W4ZW, W5AIN****, W5ANA, W5BQJ, W5GR, W5HV, W5KD*, W6AJN, W6AKW, W6AOE*, W6AYC*, W6BAX, W6CTZ, W6CUM, W6DAK, W6DUI, W6DUT, W6DWY, W6EDV, W6EGR, W6VT, W7BB, W7FO, W7QD, W8AA**, W8ADJ, W8AED, W8AEW, W8AKO, W8AKZ, W8ALB, W8ANK, W8AQZ, W8BTH, W8BUH, W8CI, W8CJ, W8CMB.

W8CNX*, W8CNZ, W8DAR, W8DBE, W8DC, W8DEN, W8DD, W8DJV, W8DPT, W8EK, W8MA, W8NR, W8SX, W8TI, W9AEA, W9AGK, W9AK, W9AKG, W9AKV, W9AOG, W9AS**, W9AYW, W9AZN, W9BDW, W9BIL, W9BJC, W9BLY, W9BNF, W9BUH, W9CHI, W9CIC, W9CLU, W9CRJ, W9DOM, W9DPR, W9DQ, W9DTS, W9DWK, W9ECZ, W9ELO, W9ENT, W9EVE, W9FNK, W9FTZ, W9GDM, W9GHM, W9HD*, W9PP, W9PT, W9SP, W9US**, 22D*, VE3BO, VE3BQ, VE3ER, VE3JW, VE4BR, G5RZ*, G5PL*, G5RM, G6NT, G6WY, HC1FG, OA4J, K4AAN, K4YT, K7AK, K7ANS, K7FQ, F8EF, F8EX, F8GDB, F8WHG, F8XYZ, NN1NIC**, NNCWS, NNCAB, YM4ZO, EU2AL OZ7Y.

14,000 kc. band: W8DHC, W9BZS, W9GHH, W9MT, G5PL, G6GD, G6WY, VE3BO, EAR116, OK1AU, CTBJ, OH1NH, RKV.

NOTE. — The stars indicate the number of extra times stations were reported.

Traffic Summaries

(DECEMBER—JANUARY)

Pacific led by Los Angeles	14,794
Central led by Ohio	8,518
Atlantic led by Maryland-Delaware-D. C.	5,570
Midwest led by Iowa	5,030
New England led by Eastern Mass.	4,867
Hudson led by Northern New Jersey	4,336
Dakota led by Southern Minnesota	2,774
Northwestern led by Washington	2,728
West Gulf led by Northern Texas	2,518
Southeastern led by Florida	2,302
Roanoke led by Virginia	2,014
Delta led by Mississippi	783
Rocky Mountain led by Colorado	627
Ontario	352
Prairie led by Manitoba	212
Quebec	153
Vanalta led by British Columbia	78
862 stations originated 13,291; delivered 11,107; relayed 31,362, total 57,486. (84.5% del.)	

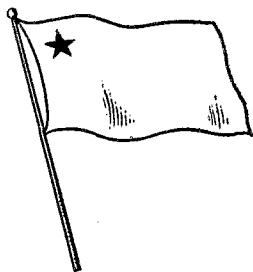

The Los Angeles Section in the Pacific Division took the Traffic Banner away from East Bay this month after the latter had carried it for two successive months. This banner goes each month to the Section with the largest total of real messages, and so far it seems to be a private fight between Los Angeles and East Bay. Ever since the institution of the banner one of those sections has carried it. Why don't the other sections get into action and make it a "free-for-all"? A traffic summary showing the standing of the various Divisions for the past month is printed above. What place does yours take? What Section will carry the Banner next month and help their Division head the list?

LOS ANGELES AND EAST BAY SECTIONS CONCLUDE TRAFFIC CONTEST

Have you noticed those sixth district stations in the BPL? And which stations have been carrying the traffic banner? Then we are sure you will be interested in a summary of the results of the contest which was conducted between October 26, 1928, and November 15, 1929, following a challenge by the East Bay Section.

The competition was mutually financed by the two Sections. Three cups were awarded and these are shown in the photograph with their custodian, Section Manager J. Walter Frates of the East Bay Section. The large cup is

held by the Section Manager of the winning Section "for the Section" and the smaller cups awarded to the high traffic men in each Section. The losing Section furnished certificates for presentation to every O.R.S. in the winning Section also. The traffic totals in this contest reached an astounding figure of real worthwhile messages, indicative of the success of one of our most important and vital



amateur activities. The Los Angeles Section is pronounced the winner and gets the big cup! The totals of the two Sections are as follows: Los Angeles, 32,478; East Bay, 28,134.

L. R. Potter, W6AKW, Lancaster, Calif., was the high man for the winning Section, taking the cup with 3735 messages. W. A. Hammond, W6ALX, Oakland, Calif., was high man winning the cup in the East Bay Section by handling 3502 messages. W6CHA and W6IP received honorable mention as having the next highest individual traffic totals in their respective Sections.

S.C.M. Frates' comments will be of interest. He says, "Everyone had a lot of fun. Both sections showed a lot of other sections how to handle traffic on a large scale. I know that the contest stimulated the traffic work in other Sections of the Pacific Division. We of the East Bay Section are not a bit downcast by the result, for we were outnumbered almost three to one and as a matter of fact expected a worse defeat. We are considering the proper basis for another contest next year, and think other sections in the Division may be willing to go in if we can arrive at a percentage basis to nullify the advantage of size."

W1MK

OFFICIAL AND SPECIAL BROADCASTS are sent simultaneously on 3575 kc. and 7150 kc. at the following times: E. S. T.

8:00 p.m.: Sun., Mon., Tues., Thurs., and Fri.

10:00 p.m.: Mon. and Fri.

12:00 p.m. (midnight): Sun., Tues., and Thurs.

GENERAL OPERATION periods have been arranged to allow every one a chance to communicate with A.R.R.L. Headquarters. These general periods have been arranged so that they usually follow an official broadcast.

SCHEDULES: At the time this issue goes to press W1MK's schedules are being resumed after being temporarily discontinued during the period of cooperation with the Army Air Corps flight from Selfridge Field, Michigan to Spokane, Washington and return. April QST will contain a revised list of schedules.

ELECTION NOTICES

To all A.R.R.L. Members residing in the Sections listed below:

(The list gives the Sections, closing date for receipt of nominating petitions for Section Manager, the name of the present incumbent and the date of expiration of his term of office.) This notice supersedes previous notices.

In cases where no valid nominating petitions have been received from A.R.R.L. members residing in the different Sections in response to our previous notices, the closing dates for receipt of nominating petitions are set ahead to the dates given herewith. In the absence of nominating petitions from Members of a Section, the present incumbent continues to hold his official position and carry on the work of the Section subject, of course, to the filing of proper nominating petitions and the holding of an election by ballot or as may be necessary. Petitions must be in Hartford on or before noon of the dates specified, all of which are 1930.

Section	Closing Date	Present SCM	Present Term of Office Ends
Nevada	Mar. 20, 1930	C. B. Newcombe	Sept. 15, 1928
Virginia	Mar. 20, 1930	J. F. Wohlford	Dec. 2, 1928
Tennessee	Mar. 20, 1930	Polk Perdue (resigned)	Oct. 2, 1930
No. Dakota	Mar. 20, 1930	Burt S. Warner	July 28, 1930
Northern			
Texas	Mar. 20, 1930	J. H. Robinson	Mar. 7, 1930
Alaska	Mar. 20, 1930	W. B. Wilson	Mar. 28, 1930
Hawaii	Mar. 20, 1930	F. L. Fullaway	Jan. 7, 1930
N. Y. C.			
and L. I.	Mar. 20, 1930	M. B. Kahn	June 28, 1930

Due to the resignation of Mr. Polk Perdue, W4FI, in the Tennessee Section, and Mr. Burt S. Warner W9DYV of No. Dakota Section effective at once, nominating petitions are hereby solicited for the office of Section Communications Manager in these Sections and the closing date for receipt of nominations at A.R.R.L. Headquarters is herewith specified as noon, March 20, 1930. Reports from ORS in these sections should be sent to the Acting SCM listed on page 3 of QST.

CANADA

Nominating petitions for Section Managers in Canada should be addressed to Canadian General Manager, Alex Reid, 169 Logan Ave., St. Lambert, Quebec. To be valid, petitions must be filed with him on or before the closing dates named.

Saskatchewan	Mar. 20, 1930	W. J. Pickering	Dec. 2, 1928
Maritime	Mar. 20, 1930		

To all A.R.R.L. Members residing in the Sections listed:

1. You are hereby notified that an election for an A.R.R.L. Section Communications Manager, for the next two-year term of office is about to be held in each of these Sections in accordance with the provisions of By-laws, 5, 6, 7 and 8.

2. The elections will take place in the different Sections immediately after the closing date for receipt of nominating petitions as given opposite the different Sections. The Ballots mailed from Headquarters will list the names of all eligible candidates nominated for the position by A.R.R.L. members residing in the Sections concerned.

3. Nominating petitions from the Sections named are hereby solicited. Five or more A.R.R.L. members residing in any Section have the privilege of nominating any member of the League who holds an O.R.S. appointment in their Section as candidate for Section Manager. The following form for nomination is suggested:

(Place and date)

Communications Manager, A.R.R.L.
1711 Park St., Hartford, Conn.

We, the undersigned members of the A.R.R.L. residing in the Section of the Division hereby nominate as candidate for Section Communications Manager for this Section for the next two-year term of office.

(Five or more signatures of A.R.R.L. members are required.)

The candidate and five or more signers must be League members in good standing and the candidate must be the qualified holder of a Communications Department, Official Relay Station appointment or the petition will be thrown out as invalid. The complete name, address, and station call of the candidate should be included. All such petitions must be filed at the headquarters office of the League in Hartford, Conn., by noon of the closing date given for receipt of nominating petitions. There is no limit on the number of petitions that may be filed, but no member shall sign more than one such petition.

4. Members are urged to take initiative immediately, filing petitions for the officials for each Section listed above. This is your opportunity to put the man of your choice in office to carry on the work of the organization in your Section.

— F. E. Handy, Communications Manager.

ELECTION RESULTS

Valid petitions nominating a single candidate as Section Manager were filed in a number of Sections on or before the closing dates that had been announced for receipt of such petitions. As provided by our Constitution and By-laws, when but one candidate is named in one or more valid nominating petitions, this candidate shall be declared elected. Accordingly, election certificates have been mailed to the following officials:

Montana	Orville W. Viers, W7AAT Red Lodge, Mont.	Jan. 21, 1930
East Bay	J. Walter Frates, W6CZR 368 62nd St., Oakland, Calif.	Jan. 21, 1930
Louisiana	F. M. Watts, Jr., W5WF 1716 Park Ave. Shreveport, La.	Jan. 21, 1930
West Virginia	D. B. Morris, W8JM 703 Maryland Ave. Fairmont, W. Va.	Jan. 21, 1930
Quebec	Alphy L. Blais, VE2AC Box 221 Thetford Mines, P. Q.	Jan. 21, 1930
Alberta	Fred Barron, VE4EC Warwick Apts., 95th St. Edmonton, Alta.	Jan. 21, 1930

DIVISIONAL REPORTS

ATLANTIC DIVISION

EASTERN PENNSYLVANIA — SCM, Don L. Lusk, W3ZF — A new policy goes into effect this month, and you will receive a letter soon relative to obtaining and holding an ORS. It is important! Be sure to read it. We have to take our bats off to W3NF, our RM, who leads in traffic this month. The SCM comes second with W3QP third. W3QP is very active these days. FB, Jack, W3BQ has a fine total, but will have to cancel some of his skeds due to school QRM. W3AIZ is working all bands with a 210 and handling traffic nicely. W3GS will be QRL with school work from now until June. His call in Washington, D. C., is W3BF. W3MC has been appointed Official Observer and turned in a nice list of offenders. W3TB says he will be running an xtal set before long with an 852 as a PA. W3AKB couldn't find time for ham radio this past month. W3DZ has only 200 volts on his xmitter. W8DHT is

having a lot of trouble with his college work. W3AUR organized the Lower Merion Amateur Radio Club and wants to hear from men in this section. FB, OM, W8VD is rebuilding his station completely. W3CDS reports no traffic and no skeds. W3ZF has a 250-watter xtal controlled.

Traffic: W3NF 330, W3ZF 164, W3QP 162, W3BQ 117, W3AIZ 115, W3GS 95, W3MC 62, W3TB 51, W3AKB 19, W3DZ 14, W8DHT 12, W3AUR 3.

SOUTHERN NEW JERSEY — SCM, N. R. Weible, W3BWJ — Activity in this section continues to increase and a great number of stations are getting their share of traffic and DX. W3ASG is high man this month and finds that good schedules help roll up the total. The total at W3DH was badly cut because of Christmas holidays. W3AFN sent in a very good initial report. W3BWJ found more time for operation this month. W3SO will soon be operating on schedule. W3ATP and W3AIU keep their

respective towns on the traffic map. The shack at W3AWL is being relocated. W3ATJ has had bad QRM from the rush for new automobile licenses.

Traffic: W3ASG 88, W3DHF 59, W3AFN 50, W3BWJ 42, W3SO 29, W3ATP 14, W3AWL 7, W3AIU 7, W3ATJ 4.

MARYLAND-DELAWARE-DISTRICT OF COLUMBIA — SCM, Forrest Calhoun, W3BRW — Fellows, let me thank you all for your splendid cooperation in making this one of the most active sections in the League. I also want to thank all the non-ORS who are sending in reports. Maryland: W3BRW leads the state, but missed the BPL by four. W3CGC is close upon the SCM and made the BPL on deliveries. FB, W3IA, a new ORS, helped in the Spokane flight cooperation. W3AFF, "the voice of Western Maryland," sent in a nice report. W3GF sent his report to the wrong address and nearly missed the issue. W3AHL spent the holidays at his station in New Jersey. W3ARO. W3DGD worked ON4KA and ZLIFR on 7 mc. W3NY was QSO LU3FA twice and CE2AB once. We have an old one back with us again, W3AEA, who is trying to get back in shape again. W3ED promises to help us put this section over. Two old-timers are also starting in Baltimore again: they are W3AHG and W3BD. W3AJR is QRL school, but handled some traffic. Delaware: Only one station reported, W3AJH, who said things are nil there. I sure wish the fellows in this state would follow the Maryland non-ORS and send in some reports.

D. of C.: Our RM, W3BWT, did some fine work on the Army Arctic flight. W3PM, a new ORS, sent in a good report and wants skeds on 7000 kc. He also handled AB6 traffic. W3ASO was quite busy during the flight and had our YL, W3CDQ, as an op at his shack. W3OZ, another newcomer, sent in a good first report. W3BF arranged more than nine skeds and says he can handle at least 50 per week over them. W3CAB did some fine work with W3BWT on the Air Corps flight and got some great publicity for hams. W3LX also helped out at W3ASO; W3CDQ keeps a sked with our director, W3CMP. W3GT was op on AB6 during the flight. W3ALF is still on 14,000 kc. W3AKR just came out of the hospital in time to report. I would like to congratulate all who helped with the Army Air Corps flight for their fine work.

Traffic: W3BWT 723, W3BRW 196, W3CGC 171, W3PM 134, W3ASO 86, W3LA 94, W3OZ 84, W3BF 66, W3CAB 54, W3AJR 21, W3AFF 21, W3CDQ 18, W3LX 20, W3GF 12, W3GT 10, W3ALF 8, W3AHL 7, W3AJH 3, W3DGL 1.

WESTERN NEW YORK — SCM, C. S. Taylor, W3PJ — The work of amateurs in Western New York this month was exceptionally fine. W3ADE, W3AFM, and W3OA handled traffic between Buffalo, Niagara Falls and Lockport, directing the reconstruction of destroyed power, telegraph and telephone lines. W3CHG did his part in the Lackawanna R. R. tests opening up communication between Buffalo, Binghamton and Scranton, Pa. The SCM thanks all those who were active for their faithful service which was so quickly rendered in 100% A.R.R.L. style. The ORS who failed to report this month can expect to have their ORS cancelled as I stated a few months ago, that all ORS who failed to report would be cancelled. W8ABV has been assigned the job of OO and will report all bad sigs and off-frequency stations to A.R.R.L. Headquarters. Another Official Broadcasting Station has been added to Western New York — W3AFM. Some very fine radiofone stations are now active in Western New York, and the SCM would like to hear from the operators. W3ADE rebuilt his transmitter in less than a half hour. W3AGI operates remote control for B.B.C. Co. W3AKZ is handling traffic. WSAMA urgently requests the gang to come to the A.R.R.L. Convention at Erie, Pa., in 1930. W3APD has built a new 7½-watt transmitter. W3ATH is now handling a few messages. W8AVM is studying the U.S.N.R. code. W8AWM has been experimenting with a low-power transmitter. W8AYN expects to handle traffic again. W8RAV suffered antenna loss during sleet storm. W8BEN and W8BFQ have been handling traffic. W8BCM has a new filter system. W8BGN states that 25% of the hams on 14 and 7 mc. are out of the band. W8BGV is doing fine traffic work. W8BHK is handling traffic again. W8BIF worked French stations and many 6's and 7's. W8BJO makes the BPL this month. W8BMJ, the ORS of Gloversville, is handling traffic. W8BUP has joined the U.S.N.R. W8BWT is working 7 and 14 mc. W8BYD wants schedules. W8CMW states his new 132-foot Hertz antenna gives him 200% better results than any other antenna. W8CNX

handled 192 messages. W8CPC worked ZL3AJ and ZSIP. W8CSW is building new fone set at college. W8CVJ is on 14 mc. and states it's not so good as yet. W8CYG is going strong again with traffic and schedules. W8CYQ hopes to make the BPL every month from now on. W8DII has many schedules. W8DME got his new amateur first ticket. W8DQP wants schedules west of Glen Falls. W8DSA has many schedules. W8DSP is handling traffic. W8DYI is a new ham at Dunkirk, N. Y. W8OA copied AB6 Saturday, January 11th, and turned in report of Army fliers to local newspapers. W8QB wants schedules. W8TH handled messages during storm. W8UL, expects to build a small set for handling local traffic.

The Radio Association of Western New York meets the second and fourth Saturday of each month at 113 High St., Buffalo, at 8:00 p.m., in the Grattwick Laboratories Building. "Welcome" is the password.

The Jamestown Amateur Radio Association meets Friday evenings in the Westminster Presbyterian Church at West 3rd St. and Larkin St.

Notice to all ORS holders: Please inform me at once if you are not active so I can cancel your ORS and reissue it to others who are worthy of holding same.

Traffic: W8ADE 4, W8AGI 18, W8AKZ 36, W8ATH 8, W8AYN 12, W8AVN 5, W8BEN 39, W8BCM 83, W8BFQ 24, W8BGV 16, W8BHK 31, W8BIF 22, W8BSO 214, W8BMJ 28, W8BUP 13, W8BUT 3, W8BYD 11, W8CMW 72, W8CNX 192, W8CPC 33, W8CSW 2, W8CVJ 3, W8DII 116, W8DME 25, W8DQP 231, W8DSA 19, W8DSP 84, W8DYI 28, W8OA 67, W8TH 6, W8UL 1.

WESTERN PENNSYLVANIA — SCM, A. W. McAuley, W8CEO — W8DLG, with a bunch of schedules working in fine shape, leads the section this month. W8CUG also has a nice list of schedules. W8YA is active as usual. W8CFR is planning a trip to Brazil. W8CMP has a new ORS certificate on the wall. W8AAG is operating in the 3500-kc. band now. W8CEO and W8HK handled press from the Army planes on the Michigan-Spokane flight. W8DHW handled a few in spite of medical exams. W8AJE says that it is hard to make QSO after dark. W8AGO has completed his new crystal-controlled transmitter. W8DKS sent in another fine long letter about activity in Uniontown. W8AYH is building a new 3500-kc. transmitter to handle U.S.N.R. traffic. W8APQ is joining the U.S.N.R. He landed an amateur extra first at the last exam. FB, OM, W8CRA is putting up a new antenna to work all bands. W8CQA reports from Warren. W8DNO can now work all bands. W8DYL has installed a new mercury arc and a new TP TG 14,000 outfit. W8AVY reports regularly. W8BHN has applied for 14,100 kc. phone privileges. W8DNU has cards from several foreigners worked. The Erie Amateur Radio Club is open to every one, whether or not he owns a transmitter. Try a meeting.

Amateurs in this section are warned to watch their frequency closely. Many hams still continue to operate without the use of a monitor. Anyone who can afford any kind of transmitter can afford a monitor. This is especially important when working in the narrow bands. Good radio weather is here. Make the most of it.

Traffic: W8DLG 301, W8CUG 182, W8YA 94, W8CFR 78, W8CMP 68, W8AAG 38, W8CEO 25, W8DHW 16, W8BGW 10, W8AJE 10, W8GI 8, W8AGO 6, W8DKS 4, W8AYH 29, W8APQ 24, W8CRA 15, W8DNO 15, W8CQA 12, W8AVY 6.

CENTRAL DIVISION

OHIO — SCM, H. C. Storek, W8BYN — Hurrah for our side, gang! Five in the BPL this month! It's getting to be an old story about W8CNO. She leads again this month — and what a total! W8RN also turns in a great total, tying with W8BBR. We again lose W8RN as he is going to school in Chicago. He will be senior op at WFL while there. W8BBR deplors the fact that there are few reliable schedules to be had. W8GZ got his total from the AA nets. W8CRI got his total and made the BPL, in just ten days of operating. W8CWC is still nursing a broken wing. W8NP is using an 852 and reports FB results. W8AQ is now ORS and reports that he worked WFA on 14 mc. W8ADS is building a new receiver, a "Bearent." W8BKM reports traffic business booming. W8DTC is again on the air. W8BAC is now going it in double harness. W8DDF has gone back to Purdue. W8APC wants schedules in Cleveland. What say, Cleveland gang? W8LI has been having a fine time copying AB6 via WIMK. W8DDK is putting in

as much time on the air as his work allows. W8DMX reports still more pep at his station. W8CCS says he has not been on much because of bad QRM. W8CX desires a schedule in Columbus. We regret to announce that W8AYO is with us no longer. He has accepted a position with KOY in Arizona and will be a W8 there. Sorry to see you go, OM, and best of luck. W8ARW has been making his phone perk. W8BEA is moving his station to the attic again. W8IF says his east generator brush went West and wants an explanation. Hi. W8DBK reports that their club has new rooms in the Norwood Power Building. W8OH is kept busy operating both that station and the one at his high school. W8DDQ. W8DPF is putting in crystal control. W8BBH has hopes to being on the air again soon. How often must the SCM appeal for reports on good signals and well operated stations? Let's have more of them. How many operators are there in this section who are too bashful to apply for ORS? A sincere interest in traffic is necessary, though. We don't care to correspond with operators who want wall paper only. Here's also a call for stations possessing well-calibrated frequency meters to serve as Official Observers. If any of you can qualify for either of these, let's hear from you. The SCM will have his big station going again shortly. Meanwhile, he is licensed as W8MR with the little one. So long for this time.

Traffic: W8CNO 491, W8RN 245, W8BBR 245, W8CG 230, W8CRI 216, W8CWC 171, W8BYN 108, W8JC 93, W8NP 81, W8AQ 68, W8ADS 63, W8BKM 56, W8BAC 42, W8DDF 40, W8ACP 29, W8LI 17, W8DDK 17, W8DMX 12, W8CCS 11, W8CX 11, W8AYO 10, W8ARW 9, W8BEA 7, W8IF 5, W8DBK 5, W8OH 2.

KENTUCKY — SCM, J. B. Wathen, III, W9BAZ — Encouraged by the spirit shown by the Louisville gang in organizing a radio club, the SCM offers the duplicate of prize won last year by W9FS. Rules of contest are same as before. W9AZY got all his traffic on 7 mc. W9OX specializes in new hams. W9AUH is snagging furiners as usual. W9GBX likes to mix DX with his traffic. W9EYW is on regularly without QRM from BCLs. A new xmtr gets xtal reports for W9ARU. W9GGB's lower total is due to waiting for grid leak. W9ELL craves response from Ky. hams interested in U.S.N.R. W9ENR has replaced his 852 with 210 to increase DX. W9BEW got new power transformer, W9GAQ new tubes and W9CEE got nothing — but he reported! W9AIN not under way good yet. W9FZY has 500 w. more or less perking on all bands. W9FKM has rebuilt everything from sky-hook to ground-clamp. W9GAL is expecting a 7-mc. xtal. W9AXU and W9BGD are new calls in Louisville. W9BAN wants ham fotos to fill his "Who's Who" book. W9GJE is once more getting active. In order to hear his new xmtr, W9DQC hopped off to Cuba. W9FQN has rebuilt around an 852. W9BWJ's protégé, W9EGO, is coming along fine. An 852 on 14 and 7 mc. and two 203A's push-pull are blushing at W9BAZ. New members in the Section are requested to get in touch with the SCM or the RM, W9AZY.

Traffic: W9BAZ 103, W9AZY 77, W9OX 70, W9ELL 38, W9AUH 24, W9GBX 20, W9EYW 19, W9BAN 15, W9GGB 15, W9CEE 14, W9ENR 12, W9FKM 8, W9BGD 7, W9AIN 6, W9ARU 5, W9FZY 5, W9AXU 4, W9GAL 3, W9GJE 2.

WISCONSIN — SCM, C. N. Crapo, W9VD — W9FSU has new antenna and wants schedules on 3.5 mc. to boost his traffic totals. W9EBO has been on 14 mc. most of the month. W9DJK rebuilt his outfit and still has a high traffic total. W9SO has been doing a lot of organization work in the College Radio Union. W9DTK wins a year's subscription to QST from W9ESF. W9ESF is rebuilding. W9DND is arranging schedules with W9DLQ. W9EGU and west coast. W9EFX blew his 210 and is now using a 250. W9FAW expects an 852 next pay day, and after that he wants to get into the BPL. W9FSS has been appointed Route Manager for Wisconsin. W9AZN has new nine-tube crystal-controlled transmitter going, and reports very good results. W9DLQ doesn't have much time to pound brass. W9VD has been busy building a new frequency meter and calibrating coils to cover all the amateur bands. W9BWZ is on occasionally. W9ESM now has a 204A on 14 mc. and reports good results all over North America. W9EYH has been working a little DX lately, including KFR6 and Australia. W9ESZ reports for the first time and has 50 watts and a Hi C Hartley on 3500, 7000 and 14,000 kc. W9BIB sends his greetings.

Traffic: W9FSU 184, W9EBO 151, W9DJK 149, W9SO 119, W9DTK 71, W9DND 54, W9EFX 46, W9EYH

38, W9FSS 32, W9FAW 27, W9AZN 26, W9DLQ 26, W9VD 16, W9BWZ 10, W9ESM 8, W9EAR 5, W9ESZ 4, W9BIB 2.

MICHIGAN — SCM, Dallas Wise, W9CEP — W8CAT is the world's fastest transmitter builder. He builds seven or eight different transmitters in a day. W8DYH is QRT, work, but can be heard most every evening. W8AZ is a newcomer located at WEMIC at Berrien Springs. W8BGY is now State Net Control for the 6th Corps Area Army Net. W9DUC of Marquette wants ORS application blanks. W9GJX, our own YL, is on an extended visit to Detroit and Ohio. W8AEQ leads the boys this month and handled 75 per cent of his traffic on 3500-ke. band. W8DDO has a new MOPA using 201A and a DeForest 510. W8DVC has been handling some Army traffic lately. W8BV of Holland worked five countries with his 120. W8ACB says he was unable to hear AB6 after he left Detroit. W9AXE at Laurium was QSO AB6 and handled messages and press receiving write-up in the local paper. FB, OM, W8DMS performed the usual very good work. W8PP of Monroe has been sick, but is now on the road to recovery. W8CKZ now has an 752 perking, and says it gets out great. W8JD has worked all districts with his xtal control 210 on 3500 kes. W9EQV has been experimenting with key thumb filters and borrows W9CEX's dog to keep the BCLs away. W8MV and W8AZD have combined stations and work in both 7000- and 14,000-ke. bands. W8BUC is using two 852s in a self rectified circuit. W8CU is building a heterodyne frequency meter per November QST. W8ASO has moved and expects to be with xtal control in a week or so. W9EGF was QSO AB6 when they were at Amasa. W8AUT works a little DX now and then. W8BRO has changed his OBS schedule to 1 am. W8RS is busy organizing the Chair Warmers Relay Net. W8BWJ, a newcomer, reports from Dayton. W8MA is operated by the U. of D. with W8BBI and ex 8DQD as ops. W8BFH still finds time to handle traffic. "JR" of W8AUB was married recently and is now living in Detroit. W8BFL turns in a report for the Jackson gang and says W8BKJ has a C.C. set going on 3500 kc. W8DYR is rebuilding. W8BPP says DX is not so hot on 14,000 kc. W8CPB will operate on both 3500 and 7000 kc. soon. W8DED turns in a nice list of high quality sigs and well-operated stations. W8LU reports good DX on 7000 kc. W8CEP had a little hard luck, losing an antenna, plate transformer and rectifier tube.

Traffic: W8AZ 20, W8CAT 136, W8DYH 282, W8BGY 138, W9DUC 16, W9GJX 119, W8AEQ 355, W8DDO 43, W8DVC 11, W8BV 2, W8DED 16, W8ACB 8, W9AXE 78, W8DMS 55, W8PP 60, W8CKZ 28, W8JD 238, W8AZD 30, W9EQV 22, W8BUC 33, W8CU 13, W9EGF 97, W8AUT 6, W8BRO 52, W8BRS 15, W8BWP 55, W8MA 12, W8BFH 79, W9AUB 18, W8CPB 2, W8CEP 32, W8WO 20.

ILLINOIS — SCM, F. J. Hinds, W9APY — W9ASY had a fine traffic month and then the 50 went West. W9TC is the new Ill. Bell Telephone Co. Radio Club station. 3500 is still the best band says W9AKA. W9DSS is trafficking on 3.5 mc. W9ANQ reports two new stations in his town. W9EYZ tore out the mercury arc and installed rectobulbs. W9AD had to quit 3.5 and use 7 mc. so he could not interfere with fones. W9GKG is a new ham, and gets a kick out of ham radio. W9EWV has gone back to college for a spell. Looks to W9AHK like the gang on 7 mc. is coming up to 3.5 mc. W9DWA worked New Zealand this month and is out for an ORS. W9APD worked G5BY with a 210. W9BEF had to give up 3.5-mc. fone. W9BRIQ pounds in on east coast regularly. W9GJJ is an active and new ORS. W9BHW blew up the filter condensers. W9CRR is ready for traffic and fone on 3500 kc. W9DAX is on 1765 kc. with a MOPA fone. W9AFN is on fone. W9TJ went back to Missouri. W9BDW is now on 14 mc. only and uses 281s. W9DZG did most of his traffic this month on one schedule. W9FO wants GRA's of PY8IA, PY8IB, K4DK and HJ1A. W9CYB has a few 852s on 3.5 and 7 mc. W9BEO has a junior op. W9DJ handled all his traffic this month on fone. W9CZL has a new ham on and uses VF Hertz. The antenna and counterpoise at W8BNN came down in sleet storm. W9AFN can QSY to any ham band in two minutes. W9ACT handled press and traffic from the Army flight. Ecuador was the best DX at W9ACU with the 171. W9GV is going on a trip to Honolulu and is taking a portable transmitter along. W9CNY works for Postal Telegraph, and says traffic is very good. Hi. W9CUI will be on fone shortly. W9AFF is going strong, on 3560 kc. W8FDZ desires an ORS. DX is still good at W9BRX. W9KB says there are 10 hams

in his part of town and all are on at the same time. According to reports, some of the rust is coming off the hook at W9BZO. Sickness in the family prevented W9FCW from getting his usual DX and traffic. After an absence of five years, W9DRP is again with us. FB, OM, W9CKM is hot after traffic and wants lots of it. W9KA handled his one message and worked Z84M. W9DCK worked G5BY. W9GIV bagged NN1NIC using a five watt heater with 24 watts input. W9BFF was married. W9DGK heard ILL and has a special condenser for full coverage of the dial for reception. W9FPN can be found on 14 and 28 mc. W9BSH is back at Rantoul going in fine shape now. W9FDJ is adding a pair of 50-watters. W9ERU has a brand new Hi C UX860 Hartley. W9FFQ seems to have a crush on Cubans.

Traffic: W9ASY 116, W9FDJ 94, W9AD 92, W9AHK 84, W9FDY 53, W9AMO 80, W9DGG 20, W9DGG 68, W9BZO 57, W9FO 56, W9DQG 55, W9AFN 50, W9APY 49, W9ACU 47, W9DXZ 46, W9GIV 38, W9BHW 37, W9CUH 33, W9ALK 30, W9EWV 30, W9EQZ 30, W9GV 30, W9CZL 24, W9BVP 23, W9DSS 23, W9BFF 20, W9DJ 20, W9DWA 13, W9CNY 16, W9KB 16, W9AA 12, W9ANQ 12, W9DCK 10, W9FCW 9, W9CRR 8, W9BDW 7, W9CKM 6, W9FPN 5, W9BSH 4, W9GJJ 1, W9KA 1, W9ERU 129.

INDIANA — SCM, D. J. Angus, W9CYQ — The Radio Traffic Association of Fort Wayne has changed its name to the Fort Wayne Radio Club and has reelected Springer, W9BWI, president. The R. I. expects to make the rounds in Indiana this month. W9BWI is trying to be the second Henderson, saying "doggone" over the air. W9UM is the banner station in the state for traffic with 155. A considerable number of stations lost their antennas in the sleet storm that demoralized wire systems in the state the fore part of the month. W9GKI is on the AA net now. W9AKJ, formerly W8CRH of South Haven, Mich., is at Elkhart and wants schedules with South Bend and Fort Wayne on 7000 kc. W9GJS has increased his power to 30 watts. W9EXW has blossomed out with an 852, two 806's and a xtal. W9EF has moved to another location and finds that he is now unable to get the extreme DX that he did formerly. W9UM is an official observer and is turning in some very interesting reports. W9BZZ, RM, wants to hear from the gang. The OTRC in South Bend is going fine. W9AJH is QRT until he gets a motor-generator. W9AKD has a new Hertz. W9DOY, W9DFB, and W9AKJ are believed to have gone up for exam. Jan. 22. What luck, OMs? W9RE, an old-timer, is digging his junk out of the attic and is going on the air again. W9FCX has chicken QRM — they get into his shack and try to hatch his tubes! W9GJ's plate transformer went west and left him with a stack of messages on the hook. W9FZQ is rebuilding and hopes to be on soon with a MOPA. W9RW keeps a sked with W9ERU regularly. W9BUJ is just starting and has radio sales and service QRM. W9EEO has a new junior op. W9CMQ is rebuilding. W9EPH is being overhauled. W9BPP is a new station that will be on 3500-ke. fone and CW. W9ESG is on the air with fone in the 3500-ke. band. The Richmond Radio Club has been reorganized, and is for licensed ops only. Beginners are helped to get on the air, but regular members must be licensed. W9FKE is going over big on 3500-ke. fone. W9BZZ is on 7000 kc. and 14,000 kc. with hi C CW. W9CWS is a new call issued to Jerry Bettley of old W9CFH.

Traffic: W9DBJ 105, W9EXW 61, W9BKJ 39, W9GGJ 39, W9AKJ 37, W9CFJ 24, W9EF 22, W9CHC 22, W9AXI 17, W9GKI 16, W9AET 14, W9GJS 13, W9FYB 14, W9EVB 11, W9GGP 10, W9DDB 9, W9GCO 7, W9AEB 6, W9AEB 5, W9CYQ 21, W9UM 155, W9CWS 25, W9FKE 15, W9BZZ 4, W9FZQ 57, W9DSC 28, W9EMR 74, W9AEA 27, W9RW 24.

DAKOTA DIVISION

SOUTHERN MINNESOTA — SCM, J. C. Pehoushek, W9EFX — This section is booming now with six applications for ORS and three stations in the BPL. I still want to hear from the Fairmont, Marshall, Pipestone and all of the Heron Lake fellows regularly. A large number of stations had skeds during the Army Air Corps flight and have been keeping schedules that are on the skeleton route for traffic from AB6 and press from HQ and to HQ. There is also a large amount of 3500- and 7150-ke. fone activity. The fifth annual T.C.R.C. Old-Timers Banquet was held Jan. 17 at the Minneapolis Y.M.C.A. and was a huge success. Claude Sweeney and R. K. Viles, men who were instrumental in T. C. organizations as far back as 1910, told of their trials and tribulations. S. B. Young, W9AQH, showed

moving pictures of the amateur stations at the Cleveland Air Races, some G. E. films pertaining to radio and a reel of Twin City stations taken by himself two years ago. The Program Committee consisting of Clint Janes, W9KS, W. W. Swanson, exW9OY, and P. R. Gould, W9DHP, also had a number of popular radio entertainers to balance a dandy program. W9COS couldn't stretch his 771 to 1000 nobow. W9BN blew generator and was on watch about 18 hours daily during the flight with power pack. W9DRG got enough Christmas greetings to do him for a year. W9GGA bemoans the fact that he couldn't make the BPL on his first report. W9DGE and W9DOE have been working on the U.S.N.R. station located at the old Calhoun Boat Club. W9AIR does more towards welding this section together than any other man, by his nerve for hamfests and visiting. W9DSH-W6AWR has gotten the bug hot and says look for him on 7 mc. W9CY is getting back into old form. W9DHP was on 7 mc. all Xmas vacation. W9CIX is also warming to the job. W9FCD is in Minneapolis again and working out fine on 7 and 14 mc. W9EPK is on with the old Meissner. W9BHZ is on consistently. W9EYL has his new TPTG 210 working FB. W9BKX has his new generator in and says watch his smoke. W9EAT wants to tell the gang that 1750-ke. fone is the goods. W9DMA likes 14 mc. W9DBC has the NW Bell riding him, so didn't get much time to push brass. W9DGH is getting out nicely on 14 mc. with his xtal. W9EOH is working at KSTP now. W9FLE is another fone addict. W9FNK at Rochester shows promise. W9BNN and W9CKU were hosts at a hamfest Jan. 5. W9FUI, W9FLE, W9BQF, W9GGA and W9DGH all applied for ORS. Let's give East Bay and some of these other sections a run.

The lack of flight news in the Twin City papers is explained as follows. Every paper was called daily and given the Press by at least one T. C. station and then they printed only AP stuff or used our stuff for fills or footnotes under Minneapolis below the AP dispatch.

Traffic: W9COS 771, W9BN 275, W9DRG 207, W9GGA 84, W9AIR 71, W9DGE 100, W9DSH 52, W9CY 28, W9DHP 13, W9CIX 11, W9FCD 10, W9EFK 10, W9EYL 7, W9BKX 6, W9EAT 6, W9BHZ 11.

NORTHERN MINNESOTA — SCM, C. L. Jabs, W9BVH — We almost did it this month. Only two ORS failed to report. W9CTW, the RM leads in traffic. W9EHI kept special skeds for the flight and reports a nice bunch of traffic. W9CKI has gone sailing on salt water. Our Division Director, W9EGU, is back on the air at his new location and is working out better than ever. W9GGQ has a new 852 and a new pilot wasp receiver. W9BVH has a new receiver using push-pull detectors. W9EGN worked WFA. W9AH says AB6 sure keeps the gang guessing. W9DOQ has a lot of local QRM and is unable to do much DX. W9GKO reports his traffic by radio. W9AV had to stay up all night so his traffic total wouldn't be thirteen. H. W9ADS worked Nava. W9BCT is trying to get a good signal on the air so he can keep schedules. This was a fine report, fellows. Let's keep up the fine work. Tell the RM what skeds you keep and write to him if you want some.

Traffic: W9CTW 165, W9EHI 97, W9EGU 78, W9GGQ 46, W9BYH 43, W9EGN 36, W9AH 35, W9DOQ 31, W9GKO 19, W9AV 17, W9ADS 13, W9CTY 12, W9EHO 6, W9BCT 5.

NORTH DAKOTA — SCM, B. S. Warner, W9DYV — The ORS are doing very good work in this section. W8BVF QSP'd quite a little press for the Army planes. FB, OM, W9IK is doing some nice work with his fone these cold wintry nights. W9DGS is a new ORS. W9DFG handled press from the Army planes to W1MK. W9FCA has increased power from a 171 to 210 and says that he gets very good reports from both coasts. W9DYA reports a new screen-grid receiver perking nicely. W9DM has been troubled with his rectifier tubes. W9DFG is a new ORS and says that he has just received a new 852 tube. W9CDO has not been on touch. W9FHP sends in his first report. He assisted in the flight cooperation and is after an ORS appointment. W9BPM at the "U" assisted W1MK several times in getting press from the Army fliers. W9FZP also assisted in the flight work.

Traffic: W9BVF 256, W9BFG 51, W9DGS 69, W9FCA 20, W9DM 9, W9DYA 3, W9CDO 3, W9FHP 11.

SOUTH DAKOTA — SCM, D. M. Pasek, W9DGR — W9DB's 3500-ke. fone is working nicely. W9FOQ is active. W9DNS has two schedules with W9BN each day except Sundays. W9CKT, Madison, is operating consistently on 7 and 3.5 mc. W9NM got about seven peeps out of his 210

and it went west. W9FJR, Pierre, reports slight activity. W9CIR, Mitchell, is a new AA station and is on 3.5 mc. with xtal. W9YAM operators have been busy studying for a commercial in order to op KUSD. The following stations are slightly active: W9FKV, W9CGH and W9DYX.
Traffic: W9DB 35, W9DNS 35, W9DGR 26.

DELTA DIVISION

ARKANSAS — SCM, Henry E. Velte, W5ABI — W5JK reports that his chemical rectifier has been frozen up part of the time. W5QV at Johnson is on 7000 kc. W5HN uses code on 7 and 3.5 mc., and has a neat change-over arrangement so that xtal-controlled fone may be used on 3550 and 1775 kc. W5ABD is on 7000 kc. with a 50-watt. W5BKB is a new station in L. R. Welcome, OM. Well, gang, what seems to be the matter? Where are all those reports that we usually get? The SCM would like to hear from any of the gang who would be interested in taking over the appointment as Route Manager. We also need several Official Observers. Here's hoping that you all will catch hold of the rope and help the SCM pull Arkansas over the top.

Traffic: W5ABI 54, W5HN 14, W5JK 11.

TENNESSEE — Acting SCM, James B. Witt, W4SP — Activities are increasing all over the state. W4VK is a new ORS and comes through with a fine report. He would like sked with anyone interested in handling traffic. It looks like Memphis and Chattanooga are running a race for traffic handling honors. Memphis is leading them just a little. W4FR of Chattanooga has the best report this month. W4KH of Memphis has bought a new UX852 and hopes to work some DX. W4RP, W4EE and W4CW send in nice reports. W4ABR is back again this month. W4RO is a new station at Morristown, Tenn. W4AFS is the Army Amateur Net Control Station for the state. W4FX and W4HK have put in MOPA transmitters. Fellows, let's have a bigger and better report next month.

Traffic: W4FR 46, W4RP 45, W4RO 36, W4EE 33, W4CW 29, W4VK 17, W4KH 9, W4ABR 9, W4SP 6, W4AFS 24.

LOUISIANA — SCM, M. M. Hill, W5EB — Activity for our section is on an increase after the holidays. The Shreveport gang seems to be coming to the front with new stations and renewed activity. W5BEM is an ex-ship op and belongs to U.S.N.R. W5ANC is open for visiting hams who want to pound brass. W5AGJ is owner and operator of KRMD. W5APA leaves for position in Lab. of American T. & T. in New York City. W5ASJ will be on the air soon. W5AWL works as second op at W5WF. W5AXA is financially embarrassed, but will be on the air before long. W5AYA says Western Union takes up most of his time. W5FX is away at school. W5KH is Chief Engineer at KTSI. W5KZ is unable to get station going. W5NV has his fone down at present. W5WY is sea-going op at present. W5RR is father and son station. W5BAJ is attending college. W5WF says holidays cut his total. W5BDJ and W5BEV are conducting tests with aeroplane xmitters. W5YW leads the bunch this month with fine total. W5PG, the only New Orleans station to report, has a new screen-grid receiver. W5ANQ had a sinking feeling when he knocked over his 852 and sent it West. W5NS has everything for his new xtal xmitter and will be on soon. W5AFE is too busy to be on much. W5EB is building new radio room.

Traffic: W5YW 91, W5BDJ 8.

MISSISSIPPI — SCM, J. W. Gullett, W5AKP — W5FQ is no longer an ORS as his membership in the League expired and he has failed to renew same. We are sorry to lose him. W5AJJ reports that QRM from business and the junior operator keep him off the air. W5RF is building a short-wave layout and will be heard in the 7000-kc. band shortly. He is located in Ellisville. W5APO in Natchez is on regularly with a UX852. W5AED says that QRM on 7000 kc. would disgust anyone. W5AAP has a schedule with the SCM every day at 1:45 p.m. W5BEV has his xtal-controlled transmitter going on the 7000-kc. band. W5AWP is using a 50-watt fone layout on 3520 kc. W5AZV worked New Zealand using a UX-245 in the 7000-kc. band. W5AOM is out for BPL and ORS. He has schedules with W4AG, W5AQY and W5BAT in the 7000-kc. band. W5BBL operates a fone in the 3500-kc. band and is looking for someone to test with him. W5GQ has a new raft of filter condensers and says his note is FB again. W5AKP is in the 7000-kc. band with a 50-watt and has schedules with W5AAP, W5RRL, W4CX and W4MP. Gang, I am looking for a report from every active A.R.R.L. member in Missis-

siippi. Be sure that they reach the SCM before the 20th of the month so that they can be included in the report that is sent to Headquarters.

Traffic: W5AKP 117, W5AOM 99, W5AED 41, W5AAP 38, W5AZV 18, W5BEV 18, W5AWP 16, W5BBL 4.

HUDSON DIVISION

NEW YORK CITY AND LONG ISLAND — Acting SCM, V. T. Kenney, W2BGO — Last month's report is something to be ashamed of! Instead of our section being in sixth or seventh place in the line-up of sections of the U. S. A. and Canada, we ranked 13th, and that is rank. We can never expect to get the traffic banner that way, gang. All ORS are not reporting. Cancellations are being made regularly as well as appointments, and cancellations will continue to be made unless the reports are forthcoming. W1AAV is making the rounds of 2nd district stations; this YL is a real honest-to-goodness ham and just loves to talk radio. Manhattan: By keeping 17 skeds a week, W2AFV leads his boro with a total to be proud of. W2SC, Army station at Bedloe Island, is going steady with Joe Hudson back at the key. W2BCB is working too hard and too long hours at present to make the BPL. W2AFO has again taken up his duties as 00; please cooperate with him in keeping your signals in the band where they belong. W2AOY has built a monitor and reports a list of 1929 signals as well as another list of 1914 signals. W2BVF is keeping 14 skeds a week, as well as operating his W8BHK station once in a while. W2AVK puts a real kick into that 250-watt of his. W2BNL has recovered from pneumonia, and we can all say we are happy to hear the good news. His 3.5-mc. fone is a real pleasure to listen to. W2OV is going strong with a new outfit. Bronx: W2APV requests the gang to listen for him at NJ2PA, where he is spending three months. W2BGO is keeping traffic going with 20 skeds a week. W2VG, a prospective ORS, is looking for traffic on 3.5 mc. W2CYX-W2KC is still with us. W2ALI keeps skeds with W2JO. W2AET's troubles are antennae and BCL's. W2BBY tells us that every time he CQs a new local ham comes back and monopolizes his time. W2AFT sends in his resignation as ORS, due to inability to devote enough time to traffic. Brooklyn: W2PF, radio aide of the 2nd Corps Area AA Radio Net, leads Brooklyn in traffic this month, and has taken over the sked with NJ2PA that W2APV has been handling. W2BO, our Brooklyn 00 and standard frequency station, tells us that quite a few 2nd district stations are logged off frequency; watch your step, gang, and remember the "golden rule." W2CRB is a member of WNYC's staff and invites the gang to see him there. W2AVE sends in his first report. W2CCD-APB is finishing his course at Brooklyn Law School and is soon to step out as a barrister. W2BEV goes on our list of ORS in the near future, and has only been on the air since Jan. 8. Long Island: W2AVP reports 596 QSOs during the past year; four months of that time were spent at sea. W2BNX has a transmitter on each of the most popular (or crowded) bands and informs us that "Bill" of W2BNK will resume activity at W3MJ. W2ATT-W2AYM, the Boy Scout station, is now using a 310 tube, the old VT2 having gone "west." W2BFP is operating on the 3.5-mc. band and asks for QSOs. W2BVP-W2BGU wants the following question answered, "Why is it that whenever I call a fast CQ, no one answers, but every time I call a slow one, I'm swamped with returns?"

Traffic: Manhattan: W2AFV 426, W2SC 292, W2BCB 14, W2AFO 14, W2AOY 12, W2BVF 7, W2AVK 3. Bronx: W2APV 92, W2BGO 246, W2VG 45, W2CYX 48, W2ALI 17, W2AET 12, W2BBY 3. Brooklyn: W2PF 184, W2BO 80, W2AVE 30, W2CRB 20, W2CCD-APB 13, W2BEV 3. Long Island: W2AVP 81, W2BNX 24, W2ATT-AYM 8.

EASTERN NEW YORK — SCM, H. J. Roseuthal, W2QU — W2LU and W2OP take the place of honor this month for their wonderful work in handling emergency traffic during the recent sleet storm in upper New York state. W2LU was on the air continuously for five days and nights. W2ACB entertained W3AMP during the Christmas holidays. W2BJA is back on the air and looking for skeds. W2BKN suggests licenses of off-wave amateurs be cancelled. W2RD is building a new phone transmitter. W2AYK is going to rebuild and have a real station. W2ANV is pushing Army Amateur activities along in his section. W2BMC was elected president of the Radio Club of Yonkers. W2ACD is now on 3.5 mc. and installing a crystal. W2ALI is getting out much better with his new 100 watt-transmitter. W2QU had a busy month handling Christmas

messages from NNINIC. W2MA left for South America to install aircraft and ground stations there. W2BUW has put in a phone along with the rest of the bunch in Bronxville. The Larchmont Radio Club has changed its name to the Pioneer Radio Laboratories and amateurs are invited to visit their new clubhouse. Unit 3 of the Naval Communication Reserve held their first meeting at which Commander Clark and Lieutenant Finch were present.

Traffic: W2QU 528, W2CUF 166, W2LU 139, W2ACB 49, W2BUW 38, W2RD 38, W2ANV 46, W2OP 32, W2ALI 29, W2ACD 29, W2BMC 10, W2AYK 7, W2BJA 3, W2BKN 3.

NORTHERN NEW JERSEY — SCM, A. G. Wester, W2WR — Traffic this month took a jump and your SCM is pleased with not only the traffic figures but also the number of reports received from non-ORS. Our section is leading the Division in traffic. Keep up the good work, fellows. W2JF just missed the BPL by two messages. W2AOS is proud that he has not missed reporting for two years. W2APU worked plenty of stations but had poor luck with traffic. W2JC has just installed a Hartley High C on 3.5 mc. W2CJX added a few new countries on his DX climb. W2BY is training two YLs to become amateurs. W2IS is still very QRL with college and WMBS. W2JX just missed going to S.A. for the Standard Oil Co. as Radio Operator aboard the plane *Creole*. W2AOP has resigned his ORS, as his station license expired. Who sent in that report on Elizabeth amateurs? You didn't sign it, OM. W2IY is experimenting with all types of circuits. W2CRW will be back on shortly with a 201A. W2CQZ, now signing W2LV, is still very busy with WEAF. W2AWG is a new station and has a good signal. W2CZZ is doing fine work with his S52 TPTG. W2CYQ has been silent due to an orchestra and a YL. W2BFL is a good clearing station for European traffic. W2ANJ has deserted 7 mc. for 3.5 mc. W2BSS is another new ham in Elizabeth. W2AOD joined the married ranks and despite that bought 2 WE250 tubes. W2BJP, our sea-going operator, had the pleasure of pounding out an SOS on his last trip. W2AEY is stepping out fine on 14 mc. W2CQD on 7 mc. is getting cards from all over the world. W2CXL has the largest traffic total. The xmitter at W2CXL uses 2 UX204-A's with input of only 285 watts. W2AS is busy at Princeton College getting W3DH back on the air. W2DV had trouble with bad radiating harmonics. W2CRO made a good comeback and gathered traffic from all districts. W2CWK has been appointed an ORS. W2BME is installing xtal control. W2AHO, an ex-commercial op, is getting on the air with a 210. W2BJS is building an MO and will be heard on 3500-ke. fone. W2CWK is dreaming about an MOPA in push pull. Most of the traffic at W2AI is African. W2AUP is now operating in the 3.5-mc. band consistently. W2BKY makes an initial report and says Perth Amboy has 20 amateurs on the air. W2AGX, another new reporter, says that after a year he is tired of "tnx for rept w1 CUL" and wants to handle traffic. W2BCA is rebuilding his station and will be heard shortly. We are indebted to W2BWH for information on the Hackensack Radio Assn. W2WR has his are going again and continues to work the west coast with perfect ease.

Traffic: W2WR 2, W2JF 94, W2AOS 45, W2APU 5, W2JC 13, W2BDF 23, W2CJX 14, W2CXL 1324, W2AS 19, W2DV 19, W2CRO 38, W2CWK 96, W2AI 14, W2AUP 10, W2BKY 14.

MIDWEST DIVISION

IOWA — SCM, H. W. Kerr, W9DZW — The RM takes a big lead this month and exemplifies what a few good skeds will accomplish. Next in line comes W8DNZ of the A.A.R.A. Iowa 3rd District Net Control Station and further exemplifies what is possible in traffic with the Army Net as the foundation for contacts. W9DNZ needs more active Army Net stations in his district. Write him, gang. It might be noted that the Signal Corps are terminating appointments where no reasonable activity is shown. It follows that the SCM will have to terminate some ORS unless there is more activity and this is last warning. W9DXP of the State AA control station increases his totals with the Network also. He worked AB6 first night out and handled traffic. W9IZW had a paper "The Amateurs in Emergencies" and presented it before the Meteorological Division of the American Society of Advanced Science in annual convention at Des Moines, Dec. 27th. It developed that the representatives of the airways took special interest in the subject and in discussion, cited several instances where the

amateur in sending information of coming storms had greatly assisted in the safety of aircraft navigation. On this trip GP visited EX9BKV, W8DXP, W9APM and W9EIT. The MOFA's at W9DXP and W9APM are worth taking time to look over. W9FFD copied press from planes. W9FZO says the Hertz after Sept. QST? plan is a WOW. W9FUD puts Davenport on the traffic map. W9BCA holds to his NNCAB skeds as usual. W9FLK radios his report. W9EIW reports sub-zero weather in the operating room, but hatches a bit of traffic as well as chix (they operate a hatchery). W9EOP lost his antenna in a snowstorm. W9EHR says rotten luck with his 50-watter. W9CKD, a new ham, reports for the first time. W9DPL gets the 250-watter on the air a little. W9CAC is new call for Iowa National Guard, Headquarters Co., 168th Infantry at Des Moines. W9BPF sends a card to say that he is back on the air. W9FWG is sent away to Bell Telephone School. OK, OM, we'll give you time off! W9DGP, a "damn good photographer," enlivens Griswold. W9CCE is schooling at Valparaiso. W9FAR has joined the gang at the USN station at San Diego, Calif. W9FQG just gets in with a little report and to say his DX is K7AAJ. Begin making plans to be at Ames early in May, probably May 9 and 10 — see next QST.

Traffic: W9EJQ 670, W9DNZ 365, W9DXP 167, W9DZW 137, W9FFD 123, W9FZO 67, W9FUD 62, W9BCA 43, W9FQG 34, W9FLK 26, W9EIW 25, W9EOP 17, W9EHR 15, W9CKD 15, W9DPL 7.

NEBRASKA — SCM, C. B. Diehl, W9BYG — W9EEW is very busy at this time and does not have much time for radio. W9QY is having a lot of fun. W9DTH wants 3.5 mc. schedules. W9DFR is very busy at KOIL. W9DVR hands in a nice one this time. W9FAM again rings the bell. Keep it up, OM. W9DI is away at school. W9BOQ says all his schedules are FB. W9CHB is busy at school. W9CDB still has trouble with the 44,000 over his shack. W9BQR is rebuilding. W9BYG had to slow down on advice of the "Medico."

Traffic: W9DTH 1, W9DVR 24, W9FAM 222, W9BOQ 175, W9DHC 48.

MISSOURI — SCM, L. B. Laizure, W9RR — W9DXY took the lead in St. Louis with W9ZK following. A good many messages were added to the totals of W9DXY and W9PW by USNR schedules. W9ZK is building a new xtal set for fone and CW on the 14- and 3.5-mc. bands. W9DUD is already using one on 14 mc. W9REU was confined to the shack by illness, but put in the time looking for AB6. W9AMR rebuilt the set and was kept busy with exams. W9PW is keeping a number of skeds, including the U.S.N.R. sked with NDS on Thursday and Friday. W9GHG made a number of DX contacts and handled some Army traffic. W9FUN was QRT rebuilding and QRM school. W9EDK moved to 6358 Delmar Blvd., Apt. 405, University City. W9FTA applied for OBS appointment, schedule 10 p.m. daily 7000 kc.

Nevada, Mo., hams reported strong this month. W9EFR spent his vacation pounding brass and building a 3.5-mc. fone. W9CDU rebuilt the station completely, and reports all US districts worked on 3.5-mc. fone. W9EOG just completed his transmitter for 7 mc. W9DHN, Route Manager, says skeds lost account trying to rebuild for xtal. W9GBT just received his ORS appointment and handles 72 messages. W9FYM is a new ORS. W9FCS was moved by the W. U. to Moberly, Mo. W9DNO pounded brass hot and heavy when home for week-ends and holidays. W9CJB sent in a second report from his home at Festus after coming back from Panu, trip, announcing the arrival of Mary Ellen (jr. op), Jan. 9th. W9GCL still keeps up the reporting average of the section regardless of totals. FB, OM, W9BJA hammered on the BPL entrance this month with 194 messages. W9ENF is a new ORS. W9FBF sent in a report for both W9FBF and W9FSL. FB, W9GAR sends in a good report reviewing the past year as well as the current month. W9DCD was hooked and his report received via radio at the SCM station. W9AWE has been converted from fone to CW.

W9CFL led in Kansas City with a BPL score of 209 messages in spite of a week spent in Chicago at the RMA convention and looking after U.S.N.R. matters. W9CBB handled 186 messages for second high, but was off the last two weeks moving, new QRA 1017 Bales Ave., E. C., Mo. He has applied for ORS. W9BMA was third, keeping 4 skeds and received his ORS. W9DQN had customary upset in his working hours which broke up a sked with W9GFO. W9RR was too busy with U.S.N.R. work this time to

handle traffic regularly. W9AIL also took part in this. W9AKZ sent in his first report.

Traffic: W9FTA 7, W9DXY 160, W9ZK 56, W9DUD 7, W9BEU 28, W9AMR 10, W9PW 38, W9GHG 20, W9CDU 34, W9EFR 27, W9DEN 182, W9GBT 72, W9FYM 9, W9DNO 49, W9CJB 28, W9GCL 1, W9BJA 194, W9FBF 8, W9GAR 9, W9DCD 36, W9DQN 82, W9BMA 130, W9CBA 186, W9CFL 209, W9RR 19, W9AKZ 91.

KANSAS — SCM, J. H. Amis, W9CET — Two stations make the BPL — W9CFN and W9BTG. W9CFN leads the section and will be on with xtal soon. W9BTG is a close second. W9FLG, the RM, is getting back in his old form again with 9 skeds going. W9SS has 6 skeds and has a new screen-grid receiver. W9AES is keeping two daily skeds on 3500 kc. W9BWV is still strong for his single control transmitter. W9FXY would like skeds on 3500 kc. and 7000 kc., and is after an ORS appointment. W9CCS has a commercial 2nd now and is going to K.U. W9HL has been on the sick list. Tom Wherry reports for the first time, but fails to give the SCM his call. Hi. W9CET is off the air rebuilding his xtal rig. W9BEZ is on more now since the Xmas rush is over. W9CKV is strong for his new screen-grid receiver. W9ESL has junked his M.G. in favor of UXS86's. W9FIG is on again with a 203A on 7000 kc. W9FYP is using 866s on his 204A with much better results. W9GHI is selling his fone rig in favor of an 852 on 14,000 kc. and promises to make the BPL soon. W9DEB is having trouble with key clicks in local BCL receivers. W9FKD has moved to Emporia. The K. V. R. C. handled a lot of Xmas traffic by cooperating with the local newspapers. There is room for several ORS appointments at the present time, so please get in touch with your SCM.

Traffic: W9CFN 236, W9BTG 224, W9FLG 126, W9CET 110, W9SS 64, W9AES 62, W9BWA 41, W9FXY 40, W9CCS 31, W9HL 23, W9GFM 18, Tom Wherry 22, W9BEZ 15, W9CKV 13, W9ESL 13, W9FIG 13, W9FYP 11, W9GHI 8, W9DEB 27.

NEW ENGLAND DIVISION

CONNECTICUT — SCM, F. A. Ellis, Jr., W1CTI — W1BWM is on the air nearly every morning from 7:15 to 7:50. W1JN at Yale says his low total is due to Christmas vacation and mid-year exams. W1BGC has an 852 on 7180 kc. W1ATW has installed a new power transformer and joined the Navy net. W1AFB is working a lot of DX. W1BOD reports by radio direct to the SCM. W1BHM has a nice DC note on 3500-ke. band. W1BQH had a portable (W1BI) in Brookline, Mass. W1HQ is open for schedules. W1AMG says the Twin City Radio Club had a mystery night. They have their meetings Thursday evenings. W1ATG is on 7200 kc. and reports trouble getting a pole to stay put. W1APJ is getting lined up for an ORS. W1ZL has been experimenting with 28 mc. W1VB works both 7000 kc. and 3500 kc. W1ADW is using 14,000 and 3500 kc. W1ATL, a new station in Danbury, is coming along well. W1AOI has a nice 1930 DC signal on 3900 kc. and works the west coast. W1RM reports a new ham. W1AVC, in Bridgeport, W1ABL sends in their first report. They are using a 210 with 350 volts from a BC eliminator on 7 and 14 mc. W1AJS sends in his first report and wants information about an ORS. He reports 7 mc. no good during foggy weather. W1CTI handled a few and is keeping several schedules. W1MK has been busy with AB6 and the Spokane fight. W1TD reports just in time to make this write-up. W1UE is kept busy operating W1MK during the Spokane fight.

Traffic: W1BWM 2, W1JN 28, W1BGC 6, W1ATW 15, W1AFB 78, W1BOD 15, W1BHM 8, W1HQ 5, W1AMG 26, W1ATG 4, W1APJ 15, W1VB 58, W1ADW 8, W1AOI 37, W1CTI 62, W1ABL 10, W1AJS 13, W1MK 780, W1TD 16, W1UE 122.

MAINE — SCM, G. C. Brown, W1AQL — There seems to be some little misunderstanding on the part of a few of the gang as to the reporting dates of each month. The reporting month ends at midnight on the 15th and the totals should be forwarded to your SCM on the 16th, so his report should be en route to Headquarters on the 20th of each month. The recent sleet storm sure did raise havoc with some of the fellows' antenna systems and incidentally caused a drop in most of the totals. W1ANH is high man this month with a fine total. W1CDD says that he had his transmitter installed in a local department store during Christmas week and handled a fine bunch of traffic. W1COM sends in a good total this month. W1ATO also has a good report. W1AFA says that he will have a xtal on the air soon. W1IR has been

issued a ticket for an ORS. He did a bit of emergency traffic work during the recent sleet storm which hit Portland so hard. FB, OM. W1VF desires some good schedules with some of the gang who may have traffic for Canada. W1BFZ has joined the National Guard and has the rating of Radio Serg. W1QH reports being busy on the new quarters for the Queen City Radio Club. W1BKN spent a week end at W1ANH. W1ACW is at radio school in Boston.

Traffic: W1ANH 226, W1CDX 167, W1COM 161, W1ATO 149, W1AFA 107, W1KQ 66, W1IR 65, W1AQD 29, W1VF 19, W1BFZ 11, W1AQL 8, W1QH 5, W1AHY 5, W1ACV 20, W1ACW 22, W1BKN 144.

EASTERN MASSACHUSETTS — SCM, M. W. Weeks, W1WV — For the third consecutive month W1CZM leads the section making BPL with W1WV and W1ACE. W1ASI has come up to 3500 now for more traffic. W1ARS is contemplating rebuilding. W1WU has acquired a new Ford but says it hasn't helped his note any. W1BLD finds it hard to be on much due to school work. W1BOD is finding some traffic on 14,000 and reports QSO ZSAM. W1CZM reports conditions on 7000 make schedules there rather unreliable. W1ACA tried for traffic on all bands this month. W1AZE reports DX improving on 14,000 kc. W1KH was QSO Germany and France on 7000 and took an active part in covering the Army Aircraft Spokane fight with W1WV for local newspapers. W1WV was QSO AB6 just before the flight started. W1ZZ is maintaining his schedules with WFA with moderate success. Lack of consistent DX weather seems to be responsible for the scarcity of DX in this section. W1AGS has his 204A perking on 7000 supplied with 3000 volts from a pair of 28Is. Official Observers in this section report a decrease in the number of off-wave stations logged, but there is still room for further improvement. W1RV turns in his initial report with a fine traffic total and ORS ambitions. Other ORS applicants are W1QZ and W1AAT. W1LM is ambitious to make BPL more often. The Eastern Massachusetts Amateur Radio Association continues to have well attended meetings on the first and third Wednesdays of each month. Code classes and demonstrations with an actual transmitter in operation are being given.

Traffic: W1CZM 285, W1WV 192, W1ACH 166, W1LM 140, W1RV 103, W1LQ 82, W1KH 64, W1ACA 55, W1WU 49, W1ASI 45, W1AZE 42, W1CRA 38, W1QZ 24, W1AAT 20, W1BOD 16, W1AGS 12, W1ARS 6, W1ANB 5, W1AGN 5, W1BLD 3, W1TL 3.

WESTERN MASSACHUSETTS — SCM, Dr. J. A. Tessmer, W1UM — W1BVR has a 50-watter on 7200 kc. W1BNL has schedules with W1BXC, W3BG, W1VG and W1ARJ. W1ZB, a new ORS at Chicopee Falls has lined up five schedules and QSO'd ON4AU. Old W1WYU is with us again on 7250 kc. with a 210 and 350 volts. W1CTF raised his power to two UX201's. W1ZA reported direct to Headquarters by radio. W1BGM has rebuilt his entire shack. W1AMZ is at Schenectady until April 1st. Meet W1ATC, located at Williams College, Williamstown, operated by "JK", W2AWL, and "RA." W3CGF, W1BMM is building a new xmitter for phone and CW. W1ADO works NR drills every Tuesday and is busy at the club putting W1BKQ on the air. W1BKA, the Worcester Radio Association, is having its bi-weekly meetings at 274 Main St., Worcester, Mass., Room 301, at 7:30 p.m., Thursday, and 11:00 a.m., Sundays. All hams are welcome. The Worcester Radio Association has the New England Convention this year and some entirely new innovations are to be added. Save everything for April 25th and 26th. It will be the biggest radio treat you ever attended.

Traffic: W1DR 12, W1ZB 13, W1BNL 60, W1BVR 7, W1ADO 19, W1ACV 20, W1ASU 3, W1NS 82, W1BZJ 12, W1BGC 3, W1AMZ 62, W1TC 3, W1BMM 7, W1ZA 32.

NEW HAMPSHIRE — SCM, V. W. Hodge, W1ATJ — W1APK says he has four spare 50-watters, so intends to be on for a while. W1BFT has been busy with frat work. He is going to relay the dope on the Winter Carnival from Hanover to Durham via W1YB and W1BET. W1AUE has been doing a little DXing and rag chewing. W1AUW says his xtal fone rig is perking fine. W1IP handled a nice bunch, and is keeping a lot of skeds daily. W1CDT is experimenting with the Hertz antenna. W1AFD is using a new 852 in a high-C rig. W1UN reports a new Junior Operator on Dec. 30th. Congrats, OM. W1MS sent in a nice DX list and is experimenting on 28 mc.

Traffic: W1IP 143, W1APK 14, W1CDT 14, W1BFT 12, W1AUW 12, W1ATJ 10, W1AUE 10.

VERMONT — SCM, Clayton Paulette, W1IT — Well, fellows, here we are again. Look! See our man in the BPL.

this month!! I knew you fellows would come across pretty soon. Our Chief Route Manager, W1CGX, can be found on 3675 kc. every evening at 6:45 pm. W1BDX turns in a fine report and considering his obstacles, he is going FB. We have a new station reporting this month. W1BD of Barre. He reports taking press reports from Army airplanes for his local paper. W1IT has three skeds working nicely now and gets great pleasure out of QSOs within the state. W1AD, who is on the air with an 852 xmitter, says that he intends to put Bellows Falls on the map. Our ex-SCM gives us a report this month. FB, Chas.

Traffic: W1CGX 203, W1BDX 104, W1BD 62, W1IT 18, W1AD 18, W1AJG 8.

RHODE ISLAND — SCM, C. N. Kraus, W1BCR — W1MO is using two 852's in push-pull. W1TQ is on 3.5 mc. with fone. W1CBS is on 3.5 and 7 mc. with a 210. W1CPH is up at Phillips Academy. W1BCR is on 3540 kc. with a 7½-watt fone. W1AWE worked Greece. The Radio Club of R. I. has just appropriated \$200 to complete work on the building.

Traffic: W1BCR 21, W1MO 14, W1AWE 2.

NORTHWESTERN DIVISION

WASHINGTON — SCM, E. A. Piety, W7ACS — If the reports continue to roll in like they did this month, we will surely have a fine section here. I wish to thank you all for your support and congratulations, and I hope I shall be able to continue to deserve them. W7BB is again the high man this month and is holding down four fine DX skeds. For the first time we have a report from Mount Tacoma. At Longmire W7GY is doing a lot of experimenting on a portable receiver and transmitter for fire-fighting work. W7ABX, W7AIZ and W7SG were busy in Spokane with communications for the pursuit group. 3.5 mc. is kept alive by W7KO and W7ACA. W7IZ is raising power to a measly 500 watts. W7AG uses a couple of 204A tubes in push-pull and runs a portable with one 50-wattier under the call W7SL. A 204A is also working nicely for W7LZ in Seattle. W7AMO runs up a good total with his 7.5. W7GP and W7AIT also help to keep Olympia on the air. A kick is expressed by W7AHM, who says that he thinks hams ought to stay off the frequency used by W1MK during OB skeds. My opinion exactly, and incidentally, the 10 p.m. broadcast comes in best here. He also says that W7AFD is the most northern ham in the NW. W7AHL, W7TZ, W7AHF and W7OJ keep Grays Harbor on the air. This is the first report from W7OJ. W7TK, W7AJ, W7AJH, W7PU, W7MR, W7AAX and W7RT. Everett is kept on the air by W7NR, W7ACY and W7TK. We have a new ham in Quilcene, W7AGR. W7ACO of the same place is going to the U. of W. W7NA also attends U. of W. W7KT is back in Tacoma after operating KIT and W7AOL in Yakima for a while. "Doc" Bennett of the old spark days is back and is one of the ops at W7AJH at Fort Worden. W7AFO is with the telephone company in Seattle and is getting paid for going to school for the next three months. W7BZ, the CRM of the Tacoma U.S.N.R., is on with a couple of fifties (Navy) and is using an elaborated copy of the Marshall receiver, and how that set worked! W7DK at last has a home of its own. When you are in Tacoma, drop in at the shack and look it over. It's a real club house. We have openings for a couple of OO stations in this section. If you can qualify, drop me a line. Your support is fine, fellows, and if you care to see your section on the map, please report on the 16th of each month. 73.

Traffic: W7BB 169, W7AMO 113, W7OV 76, W7ACS 65, W7ACA 59, W7TX 58, W7GP 53, W7NA 52, W7KO 49, W7OJ 48, W7AHM 41, W7PU 38, W7AAX 30, W7NR 28, W7RT 27, W7AJH 24, W7AG 19, W7ACY 18, W7MR 18, W7LZ 18, W7KT 17, W7AIZ 17, W7ABX 14, W7NS 13, W7IZ 12, W7TK 6, W7GY 5, W7AJ 4.

IDAHO — SCM, James L. Young, W7ACN-7JL — The plea for reports in the January issue was nobly answered by one lone letter from W7AFT of Elk River. What is the matter with the rest of the hams in the best state in the U.S.A.? The SCM, as some of you know, is a photographer, and to interest you more in reporting, he offers to make free post-card photos of your station from your own film, one photo for each message handed during the month. Write the SCM for further dope. W7ACD leads the traffic list this month, with W7ALW next. W7ACL got out fine, and worked plenty of DX with his 3500-ke. phone set until he got a QSL from a neighbor across the street. W7AOC and W7GU are on regularly with key and phone in Boise. W7ACP is kept busy chawing out his slop jars and shoveling snow from the sky pipe. W7ACD is working VK and all districts regularly. W7PR of Nampa worked all districts and a number of

Aussies with a pair of 201A's and 270 volts of B batteries on 14 mc. The SCM will have, in addition to his home station, a new station at the College of Idaho starting February 1st. This station will sign W7JL, with three ops and a flock of beginners. W7KI (ex-7AFK, not W7KA as given in January report) sold his transmitter and is rebuilding. There are four new hams in Nampa, all students in the radio class of the Nampa High School, as follows: W7AJJ, Truman Miller; W7AJK, Warren Davis; W7AHS, Russell Miles; and W7AID, Fred Robinson. W7ACK, their instructor, is rebuilding his home station and the school station. W7HK, W7CW, Jim Munro of Boise, visited us while on shore leave from the airplane carrier U.S.S. *Lexington*, where he now tickles a key for Uncle Sam. "Babe" Lavern Martin, ex-7LN and ex-ADM of Idaho, six years ago, is with us again and on the air with a new call in Hazelton, Idaho. W7QA has a pair of fifties on all three bands and is on every night. W7ALW reports DX scarce. Now gang, don't forget the free photos but remember, no photos unless TEN stations report for the month. All new hams and those wanting to get started are invited to write the SCM for any dope or help needed. The SCM also wants candidates for ORS, RMI, OBS and OO. Active stations please try to line up for one or more of these appointments.

Traffic: W7ACD 54, W7ALW 25.

OREGON — SCM, W. S. Claypool, W7UN — W7PL is doing FB work in the OO and OBS line. W7AIC reports things going great in Gresham. W7ALM, our newest ORS, is a FB traffic man. W7MY has a good report. W7AFL reports for the first time. W7ZD holds down the Portland end of the non-stop Portland to Astoria traffic route with W7ALM on the other. W7PE is holding out on the news. W7AMF applied for ORS. W7AIG surprises us with a report. W7WIF is battling with power leak. W7IF is 100% for an ORS relay party soon. W7WL says the post office keeps him busy during the holiday and QSL season. W7AHJ, the only known OW operator in this section, handled as many as her OM, W7AJK. W7AMQ is with us again. W7ABH asks for honorable discharge after several years as a FB ORS. Granted OM. He is oping on the S.S. Brookings W7XA. W7JC says he thinks he will quit the ham game. W7AJW is the station of the Rose City Amateur Radio Club. Competition has again started in the north with the new SCM of Washington pushing hard. Congrats, OB.

Traffic: W7AIC 126, W7ALM 106, W7MY 84, W7AFL 80, W7ZD 65, W7PE 50, W7AMF 46, W7AIG 33, W7UN 71, W7WR 33, W7PL 147, W7IF 25, W7WL 25, W7AHJ 3, W7AJK 3, W7AMQ 2.

MONTANA — SCM, O. W. Viers, W7AAT — W7FL, W7DD, W7EL and W7AAW are the only ORS in this section who ever take two minutes to write out their report and send it in. FB. Keep up the good work; and to the rest of you who are fall g to report — you know what's going to happen!! W7DD h s a pair of 852's doing their stuff on 7075 kc. W7FL has recovered from his recent accident with a train. W7AAW handled some traffic for the Army flight. W7EL has his dynamotor putting out some nice signals now. W7ANT is working fone on 3500 kc. W7AHN says phone isn't what it's cracked up to be so he's going to be a CW man from now on. W7AAT has two transmitters going full blast on 3500 and 7000 kc. Let's have more reports next month, boys.

Traffic: W7AAT 564, W7DD 34, W7AAW 33, W7EL 21, W7FL 10

PACIFIC DIVISION

SANTA CLARA VALLEY — SCM, F. J. Quement, W6NX — The traffic handling activities of the Section were very heavy this month. Colonel Foster, W6HM, leads the Section with 457 — all foreign and 368 delivered. The new 500-watt xtal-controlled xmitter at W6HAI has one of the most beautiful notes heard on the air. W6BYH with daily skeds turned a neat total of 231. FB, OM, W6DQH, the new RMI, started things going with a bulletin directed to all ORS. W6DCP is taking care of the Santa Cruz traffic along with W6YG. W6YG requests skeds with other high schools. W6BMW tried 14,000 kc., but reports little traffic on that band. W6ALW lost his pole in storm. W6CXT is a prospective ORS. W6ESW has been instrumental in forming a radio club in Pacific Grove. W6AME is trying 14,000 kc. W6BNH is getting his set in readiness for any emergency. He is located in Power House in High Sierras. W6AAZ copied the press dispatches from W1MK during the Army flight. W6NX is building new receiver. W6BAX worked all continents in 10 hours on 14,000 kc. W6BHY is always

ready for S. J. traffic. W6DCI won the prize at the last Tri-Sectional meeting held in San Jose. The Modesto Radio Club held a Hamfest on Feb. 15th which was a huge success. Let's have a 100% report next month.

Traffic: W6HM 457, W6DYH 231, W6DQH 80, W6DCP 75, W6BMW 36, W6YG 35, W6ALW 18, W6CXT 18, W6ESW 13, W6NX 9, W6AME 4, W6BNH 6, W6AAZ 4.

EAST BAY — SCM, J. Walter Frates, W6CZR — Owing to the fact that many of the biggest traffic men in the Section have their stations temporarily dismantled and are rebuilding for the opening of spring and summer traffic work, the totals for the section this month dropped considerably after winning the traffic banner for the country two months in succession. W6EIB, RM for Vallejo, came out on top again this month. He reports working VK on New Year's morning and has skeds with W5BBI and K7EH. W6AMW at Mare Island is clicking off the traffic in FB shape. Two of their best skeds are with ZL4AO and K6EWB. W6AWF is coming up among the leaders again after rebuilding his transmitter and seeing his YL, W6ETA, off for L. A. W6BYS makes the BPL this month. W6CUO has moved to San Francisco from Napa to work for the fone company. W6CZN is having trouble with his screen-grid receiver. W6AUT worked four states on fone using loop modulation. W6EDK was the main East Bay contact with the First Pursuit Group flight through W7AAT and W7ADX. W6EDK was reported heard on 3500 kc. in New Zealand by Mark Churton of Auckland. W6BIW says most of his traffic was gathered during the first week of the year when he had plenty of time. W6EDO maintains that he is going to change his transmitter from 852s in self-rectification to 852s in push-pull with W6EX rectobulbs. W6BMS, the Berkeley cherub, has a 1929 transmitter which refuses to work in 1930. Stew bad! W6ASH announces that he has rebuilt his transmitter, and put up a new antenna. W6ALX is still pounding away with his school work. Army amateur net, and other activities. W6AQ is being kept busy as the new secretary of the Oakland Radio Club. W6BHF continues to rap out a bit of traffic every month. W6CZR has been doing some traffic work in the day time when he can steal enough time to keep away from his several avenues of work. W6CSU reported for the first time this month. W6RJ reports that his 400 volts on 3500 kc. has been heard in Australia. W6BZU at Concord is working hard at his central California skeds. W6EDS is back on the air with his high-power transmitter, using a crystal, and is getting out in FB shape. W6EDR is trying to arrange skeds. W6EJA of Point Richmond is operating aboard the S. S. *Admiral Watson*, WGCK, running between San Diego and San Francisco. W6IP has left for Nagasaki as operator on the Dollar Liner, *President Lincoln*. W6IT has removed to the San Francisco Section.

Traffic: W6EIB 363, W6AMW 325, W6AWF 219, W6BYS 203, W6EDK 201, W6BIW 138, W6EDO 113, W6BMS 107, W6ASH 56, W6ALX 48, W6AQ 33, W6BHF 31, W6CZR 22, W6CSU 20, W6RJ 19, W6AUT 16, W6RZU 14, W6EDS 12, W6EDR 10.

SAN FRANCISCO — SCM, Clayton Bane, W6WB — It seems that every time we get started reporting nicely there must come the inevitable let down. W6AD keeps us out of the dog house this time with a wonderful total. It isn't good cricket to let one man carry the load. Wake up, gang. W6ERK makes the BPL as usual and says he has sold his 852 and put in MOPA with 210s. W6BIP makes BPL also, but has been putting in most of his time trying to work South Americans on 14 mc. W6CIS makes the BPL on deliveries. W6ATI has built a new receiver that he claims beats 'em all. W6AMP blew his power supply again and is off trying to promote a new one. W6DFR is still keeping the A-A Network going strong, and sends in his usual good report. As the new president of A.R.A., W6PW has kept the club going stronger than ever. FB, OB, W6PQ, a new man, reports this time with a good total. He is located in the Presidio at S. F., and is using a 50 running under loaded. Hi. W6DZZ says that this is probably his last report for some time to come as he is going to college. We are glad to see W6EEC, another new man, reporting this trip and urge all you new fellows to follow suit. W6BBL also reports for the first time and says he will be among those present from now on. W6DZQ sends in his report and a list of "30" signals. The entire section joins in expressing their deepest sympathy to W6WN and his family over the loss of his mother, who passed away this month.

Traffic: W6AD 1766, W6ERK 225, W6BIP 200, W6CIS 85, W6DFR 34, W6PQ 23, W6DZZ 17, W6EEC 12, W6BBL 10, W6WN 2, W6WB 6, W6DZQ 3.

SAN DIEGO — SCM, H. A. Ambler, W6EOP — W6ACJ leads again with three daily skeds. He is the west coast station of the Atlantic-Pacific coast chain, so shoot him your east traffic and it will go right through. W6ACJ has been appointed RM to help W6EPF. W6EPZ turns in a nice total. W6BGL is on again. W6EOS is rebuilding. W6EPF reports his sked with W6TM working again. W6BAM is going on 3.5 mc. soon. W6EOM says the wind blew down his zepp. W6BFE is now using a 50-watter instead of the 852, and is getting out FB. W6AET and W6DOB were married in October. All hams welcome at 3808 39th St. W6DOB is twisting dials at KFSD now. All ORS not reporting for three months will be cancelled, so if you want to hold that ticket, send in your reports regularly.

Traffic: W6ACJ 123, W6EPZ 81, W6BGL 77, W6EOS 32, W6EOP 30, W6EPF 23, W6BAM 10, W6EOM 6, W6CTP 3, W6BFE 3.

LOS ANGELES — SCM, B. E. Sandham, W6EQF — Our traffic total is going up like a freight elevator — but let's be thankful it's not going down. W6AKW, W6CBW, W6DKV, W6AOA, W6WA and W6EQF all make the BPL this month. The traffic total is 3720. The A.R.R.C. held its annual banquet and elected officers for this year: W6EJ, Pres.; W6FE, Vice-Pres.; W6BZE, Sec.; W6AEL, Treas. A new club is announced as the Monrovia High Frequency Club. Its officers are W6BES, Pres.; W6EQO, Sec. and Treas.; W6BTU, Tech. Chairman; W6ESG, Publicity. The other clubs of the Los Angeles Section offer their congratulations to the new one. The Long Beach Club went visiting, picking up hams as they went along — ELZ hanging on a spare tire. A club traffic contest has also been started by with rectobulbs, crystal and filter as prizes. FB. The Pasadena Short Wave Club is sponsoring the coming quarterly A.R.R.L. banquet. Its new officers are W6KA, Pres.; W6AXE, Sec. and Treas.; W6ZBW, Comm. Chairman; W6EAN, Entertainment Chairman. The Tri-County Club held a meeting in the mountains, taking along a portable and shoveling snow to keep warm. W6AKW handled over 1100 messages this trip on skeds with KA1AF, W1MK and three others. He wants to hear from those interested in Army-Amateur net. W6CBW has high total from skeds with KA1HR and W2BYS. W6DKV made a portable for W6AEF, who is blind. W6WA turns in another good report of Bakersfield district totals and activity. W6AOB discarded fone — BCLs too hot. W6DQV is building a new transmitter for 7 mc. W6ETN changed from MOPA to Hartley. W6ENH, W6EIQ, W6ENQ, W6CUC and W6EQI are all rebuilding and going into U.S.N.R. W6IAM is using Schnell's peaked audio system and two six-phase rectifiers on transmitter. W6L.N, ex-9DKM of Denver, asks for ORS. W6ZBJ is about the only active ham at Santa Barbara. W6ETJ has five skeds. W6EKE delivered a message to LaCrescenta 12 hours after filed in Minnesota. FB. W6EKC is on with an 852. W6AVJ coming on with fone on 3.5 mc., using 250-watt modulator and 852 oscillator. W6BGF is becoming interested in traffic. W6ACL worked G5BY on 14 mc. W6ESA has new traffic receiver. W6ID built a high power TPTG after QST, and reports FB. W6BZR worked WFA and delivered message to newspaper at Sausalito. W6BBO sends in his first traffic report in this district. W6CUH worked all continents in 24 hours during Xmas vacation. W6EQD is now on with 50-watter. W6EFA is using remote control for three miles by intermediate xmitter on 28 mc. working main xmitter. W6BSL had call changed to W6YAB. W6EAU has low total due to work. W6COT now owns a blown 210 and his shack was flooded by the rain-storm. W6DZI is trying to get rid of QRM with shielded antenna. W6BGC is back on with 250-watter. W6BVZ was overcome by smoke from burning plate transformer. Hi. W6MA likes peaked audio receiver for cutting QRM. W6BUX is on with a 50-watter. W6UJ enjoyed a good bunch of Christmas traffic. W6DHR had his portable. W6DKD, up in Big Pines during snowstorm, seven hams being snowed in there. W6ABK is off until crystal arrives. W6AGR is on now with crystal. W6AKD reports. W6OF reports two feet of snow at his QRA in the mountains. W6BEI is coming on with 250-watter and 866's. W6FJ should have zeros printed on his report cards and save time. Hi. W6AGR is now crystal-controlled on 7010 kc. W6CZT reports traffic. W6CBS built a new receiver and transmitter. W6CGY reports traffic and good QSOs. The SCM made his total with Xmas Philippine traffic and is rebuilding the receiver. If you fellows are at all interested in leading the rest

with traffic, send in your reports by the 15th. The L. A. Section wants to keep the traffic banner, and it means that you must report. Will all OO's please report all off-band operation to offender or SCM.

Traffic: W6AKW 1132, W6CBW 467, W6DKV 213, W6AOA 210, W6DLI 177, W6BCK 120, W6UJ 119, W6WA 160, W6AM 94, W6EQF 89, W6LN 71, W6ZBJ 68, W6DQV 66, W6ETJ 65, W6A0B 65, W6EKE 59, W6EKC 52, W6AVJ 51, W6BGF 37, W6AKD 35, W6BDR 36, W6DYJ 34, W6ACL 30, W6AXE 33, W6BCO 29, W6BEB 27, W6ESA 26, W6ID 24, W6DOZ 22, W6BZR 22, W6BBO 19, W6CUH 18, W6EQD 16, W6EFA 16, W6ABI 15, W6ELZ 15, W6EYK 14, W6EIN 12, W6CHW 11, W6YAB 10, W6BES 10, W6EAU 10, W6EIF 10, W6CZT 9, W6EAN 8, W6CGY 8, W6BIF 7, W6AIX 5, W6CLX 5, W6COT 5, W6EQW 5, W6DZI 5, W6BGC 4, W6HT 3, W6BYZ 1.

ARIZONA — SCM, H. R. Shortman, W6BWS — W6EFC has a UX210 perking on 7 mc. and is looking for east and west schedules. W6CWI is off the air rewinding a burned-out MG. W6DRE is working at KOY. W6DGN, a new man in Tucson, is having trouble getting started. W6ANO is back in Flagstaff getting reconciled to married life. W6EH is still with Western Air Express in Los Angeles. W6EJK is the call of Robert G. Horton, chief operator of Standard Airlines, Inc., at Phoenix. W6EOF is now chief operator, technician, announcer, and janitor at KFXV in Flagstaff. W6BWS has a new YL in Globe, and wishes W6AZM would come back on the air to QSP daily traffic there for him. Hi. W6CDU is at last at work on his "he man" station. W6AWD, our newest ORS, has some "hot" cards and the SCM advises everyone to QSL so they may get one. W6EJF says the DX boys sure have rotten receivers. W6EAA is studying hard at school. W6DIE says the landlord made him take all his antenna down. W6HS is now living in Phoenix. W9LK is talking of having his equipment brought to Phoenix, and going into "cahoots" with the SCM on his new station. Dale Hammersly, ex-W9EH, is now with the Telephone Company, and spends his spare time operating at W6BJF. The technical staff of KTAR is composed of ex-W6CAJ, W6DGY and W6BWS. W6DGY is getting ready to put a couple of 50-wattors on in push-pull TPTG. W6CWG is coming back on the air as soon as he re-winds his plate transformer. W6CCL is still out on the briny deep. W6BBH is operating his broadcast station KOY. W6DSA is now in Hawaii. W6AAP has moved to Phoenix. W6EKY comes out and says he has quit the game for good. W6CDY-W6CPX is busy at KGAR. W6ELI is proprietor of a new radio store in Phoenix; see him when buying new apparatus (free adv.) Hi. W6DTU is still pounding away on 14 mc. and leads in traffic. W6DCQ got a lot of publicity in the local newspapers and is now high hatting the gang. Hi. W6BJF is the Arizona Route Manager and follows desiring schedules should get in touch with him. W6AUI is still a flat-footed cop passing out QSLs for the Phoenix Police Department. W6CXW is getting along fine with his Storage Battery shop. We would like to hear from W6SW, W6CAP, W6RS, W6CBJ, W6AZM, W6AZU, W6AZV, W6DLE, W6YB, W6EKA, W6PZ, W6BYD, W6BJJ, W6BLP and W6BHC.

Traffic: W6DTU 350, W6EFC 221, W6BJF 79, W6CDU 57, W6AWD 18, W6EAA 4.

PHILIPPINES — SCM, S. M. Mathes, KAICY — This report was received by radio via W6HM and covers both December and January activities. ORS appointments were issued KAIAF, KAICY, KA1HR and KA1JR. KA1AB reports burned-out generator. KA1AC is now on with a 50-wattor and has a sked with KA1JR daily. KA1AF stayed continually with PMZ until they left Borneo on Jan. 7. He was of valuable assistance to Dutch Government when captain of Military Guard was murdered by the natives. KA1CM now handles Coast sked temporarily for KA1AF besides his regular skeds. KA1CE has sharpened his note some. KAICY tries to greet the gang daily, but secretarial work prevents hamming in early hours of evening. KA1DJ is a fast, snappy station with a gang of good ops. They handle Detroit-Spokane Army flight press from Potter, W6AKW, and relayed to Manila Daily Bulletin. FB, OMs. KA1EL is doing good work. KA1HC handles traffic through to coast several nights each week. KA1HR held a YL party in December with Miss Evelyn Cheel of W6EVA and Miss Virginia Brewer of W6ETA. A two-way WSO was made with G5BZ, Crocyden, Surrey, England, on New Year's Eve. Schedules at KA1HR: Manila time: K6DPG, Honolulu, 5:00; KA9PB, Zamboanga, 5:15; AC8AG, Shanghai, 5:30; AC8ZW, Shanghai, 6:00; OM1TB, Guam, 7:30; VK6MO,

Australia, 8:00, Wednesdays and Sundays; W6TM, Williams, Calif., 9:00. The QRH is 7050 kc. The sked with VK6MO is for handling messages relating to observations of terrestrial magnetism at Observatory station at Watheroo, West Australia. KA1JR now has pure DC from a motor generator. Main sked is with W6HM daily. KA1MC is dismantling and will leave for the States in March. Goodbye and good luck, OM. KA1RC seems to be getting out. KA1ZC has the broadcast signal in the Philippines Section. KA1CY has given them a rectifier and filter condenser, which it is hoped they will use. KA9PB is on daily in the Southern Island. Hong Kong hams are now licensed and operating under prefix VS. All but one station is using less than ten watts power and all but two stations need only two more QSOs to qualify for WAC certificates. Cary is still using ACSRV at Shanghai, although Wilson has returned to States. AC5GO (ex-VE5GO) is on three times a week, signing AC8GO. ACSHM and AC8TS frequently work Sixes; ACSHM is keeping skeds three times a week with W6HM. Doc Malcolm, Chefoo, whose station was closed on evidence of an informer, had to dismantle his transmitting antenna and is now on using his receiving antenna during the emergency.

Traffic: December and January: KAICY 95, KA1DJ 1080, KA1HR 314.

SACRAMENTO VALLEY — SCM, Everett Davies, W6DON — This report was received late and by telegram due to an auto accident which the SCM was in.

Traffic: W6TM 617, W6BSQ 131, W6BDX 129, W6AIM 16.

ROANOKE DIVISION

NORTH CAROLINA — SCM, Hal S. Justice, W4TS — The Club House of the Charlotte Amateur Radio Association was destroyed by fire the night of January 11, and it is planned to have it rebuilt in time for the Roanoke Division Convention, March 21st and 22nd. The club goes on record for a law against the use of raw A.C. The Radio Inspector was in Charlotte recently, and several of the fellows lost their licenses. W4ABV leads in traffic this month. W4DW, a member of the faculty with the Chemistry Department, N. C. State College, is rebuilding and making things hot for the freshmen. W4BC thinks the UX250 FB on 14,000 kc. W4JR attended the Southeastern Convention in Atlanta, and reports a great time. Gluck, W4CQ, and Rosekrans, W4AGE, are working hard for the Roanoke Division Convention in March. W4WE was off the air most of the month due to vacation. W4AFW wants a good receiver. W4OC is doing some U.S.N.R. work, and says DX is bum. W4AA-W4ACA-W4ABC-W4NG is busy broadcasting. WNRK burned out two generators and pressed into service the 250-watt rectobulb power supply of W4AA, with FB results. W4AHH is rebuilding, the new outfit to use a 211-D crystal-controlled. W4UB handled many Xmas messages and is working up several skeds. W4TN is back at University of N. C. after pounding brass through Xmas vacation. W4EC has installed 50-watt c.c. using rectobulbs for rectifiers. W4AB sends in his last report, as he is leaving for Hartford, Conn., soon. W4ZD, station of the Davidson Radio Club, Davidson College, works on three bands consistently, and is ready to keep skeds with anyone. W4AEW is wondering if the 4's are afraid of 3500 kc., as it is hard to move traffic south. W4ZB keeps seven skeds and has worked all continents. W4FT handled most of his traffic with Nicaragua, using a UV849 350-watt tube in TPTG circuit with mercury arc rectifier.

Traffic: W4ABV 176, W4AEW 138, W4UB 101, W4FT 76, W4ZB 42, W4ZD 38, W4AB 37, W4EC 30, W4TN 30, W4TS 20, W4DW 18, W4AHH 17, W4OC 15, W4AA 11, W4WE 10, W4BC 8, W4JR 5.

WEST VIRGINIA — SCM, D. B. Morris, W8JM — All reports were received by radio this month. W8TB is a new brother at W. V. U. and is coming along fine. W8BCN is trying to make an MOPA work, with no success. W8ACZ still keeps Fairmont ahead in messages and wants some good skeds south. W8TI is handling messages for students at D-E, using a 201A. W8JM is rebuilding after returning from taking tests in Pittsburgh. W8VZ dropped in town and said "tell gang Hello." W3UO is too busy with WMMN at present to be on the air. W8ACZ says he will have two new hams on the air in Fairmont within the next month. W8BPU-W8BR-W8AYI-W8CCN-W8BDP-W8CSR all report and say Hello. Don't forget the Roanoke Division Convention at Charlotte in March. Some radio hi-lights are

going to be there, but can't tell you yet who they are. You had better be there.

W8HD sends in the following report: W8OK is still working A-A net control, W8DNM changed to W8WK. W8SV is building an xtal set. W8RI is rebuilding with W8BDX. W8BTU worked his first six and seven, W8DPO is now on 3.5 mc. W8BWK is also working on 3.5 mc. with an 852. W8HD is getting R8 from west coast on 3.5 mc.

Traffic: W8OK 114, W8BTU (Dec.) 143, (Jan.) 29, W8IB 44, W8HD 28, W8ACZ 50, W8JM 30, W8BCN 15, W8TI 10, W8IB 5.

VIRGINIA — SCM, J. F. Wohlford, W3CA — W3ARU spent Xmas holidays at home, but the station has done excellent work with the assistance of four other operators. W3AHW has had the BCLs after him about key thumps. W3AJA, a new ham, went off the air until he could kill the key thumps. W3MO expects to get on the air soon. W3KU is on 7040 kc. when operating WTAR and YX permit. W3WM is back on air after repairing burned-out transformer. W3AER is using 204A with rectobulbs on 7 and 14 mc. W3TN has gone to sea again. W3PK traded his \$52 for a 50-watter. W3FP is trying to get a German 500-watter to oscillate on 7 mc. W3SZ sold out to W3FP. W3ADD is using a 50-watter. W3ERD is handling traffic when he has the time to be on. W3FJ made a trip to New York and visited some of the hams. W3HO was on the air at intervals. W3BZ is working sked with W8CMP at 8 p.m. W3ZA expects to bring out a regular "can" buster on phone shortly. W3BDZ says weather too cold to spend much time in the shack. W3AQW, a new station in Roanoke, broke out with phone. W3WO blew plate transformer. He is to be appointed ORS when he gets station on air again. W3CKL has crystal control on both 3.5 and 7 mc. The SCM would like to suggest that stations in and around Norfolk get in touch with W3ARU and let him have your monthly reports not later than 17th of each month, and the Richmond hams get in touch with W3FJ.

Traffic: W3ARU 346, W3AHW 10, W3FJ 221, W3HO 21, W3WO 139, W3CKL 21, W3CA 26.

ROCKY MOUNTAIN DIVISION

COLORADO — SCM, C. R. Stedman, W9CAA — W9CAA leads in traffic and makes the BPL. W9CVE is applying for an ORS appointment. W9CSR is getting tired of blowing dust out of his transmitter and is going to put it in a cabinet. CSR says he is going to use 14,000-ke. fone. W9EJW was at home during the Xmas vacation and worked quite a few. W9BVO is on lately. W9DQV was also on during Xmas vacation. W9CDE feels that he is too busy to be on the air this winter. W9CND has been turning some attention to traffic. W9EDM has about all he can do to keep his school work up. W9BTO at last has a set that gets out and is doing some very good work. W9CCM is studying Morse and is also brushing up for a commercial ticket. W9CAA's father is on with the call W9CAB on 7000 and 14,000 kc. W9COC is on 3500 kc. W9EAM says he is going all he has time for.

Traffic: W9CAA 228, W9CVE 176, W9EDM 25, W9CSR 5.

UTAH-WYOMING — SCM, Parley N. James, W6BAJ — W7AAH leads the section with a nice traffic report. W6DPJ comes a close second, pounding brass when not too busy at school. W6BTX is still pounding away with a fifty on 7000 kc. W6BAO, an old-timer, is back on the air once more. W6CNX was only on three days, but handled a few. W6BAJ was too busy to get on but handled about 500 at KGTU. HI.

Traffic: W7AAH 49, W6DPJ 48, W6BTX 40, W6EKF 24, W6BAO 18, W6CNX 14.

SOUTHEASTERN DIVISION

ALABAMA — SCM, S. J. Bayne, W4AAQ — W4PAI has moved his location due to the National Guard Headquarters being changed. It is reported that W4WS will return to Mobile. W4LM is the proud possessor of a new commercial license. W4AAH is conducting a code class at his place of business and hopes to develop some new stations. A water pipe burst and flooded W4JY's outfit during the hard freezes. Polk Perdue, W4FI, formerly of Tennessee, is now located in Birmingham, and on the air constantly with two ops. W4VC is having BCL trouble at times due to recent QRO. W4WR has sold his outfit and is to return to Boston in the near future. W4AX is heard occasionally on Sundays. W4AKM is experimenting with fone, and should have a good one in the near future. W4ALG

is trying out fone possibilities on 14 mc. W4AG is a new station in Kennedy and his first report is a splendid one. W4GN has moved to Palos and has again been joined by Mr. Vandiver, W4KA. W4TI is away for a two weeks' vacation. W400, 120 West Water Ave., has taken the air at Selma with a first-class fone. W4TI reports another new station at Selma who has applied for license. W4CB, our new Tuskegee station, uses a UX245 with loop modulation and handled 61 messages all on fone in two weeks. W4IA makes the BPL using fone entirely. Schedules were kept with W4CB and W4FY. W4AQ has six ops and 204A's on 14 and 7 mc. and contemplate fone on 14 mc. W4LT has moved his shack to a new location and installed two 852's in parallel. Reports from Troy are lacking. W4EW is temporarily off the air. W4AHR leads the state in traffic, the greater part handled on the Army Amateur Net. W4AHP is building an AC screen-grid receiver. W4AJR is having more than his share of xmitter trouble. W4AKB hopes to have a 50-watter soon. W4HB has completed his new transmitter, as well as a new receiver. W4AP won a General Radio Wavemeter at the Atlanta Convention. Ex-W4ADN of Elberton, Ga., is now located in Montgomery, and will be active shortly. Ex-W4MY is now located at Lexington, Nebr., as W9BVK. W4AAQ handled considerable traffic on the Army Amateur Net.

This being the first report for the New Year and the final report for your present SCM, it appears that a brief review of the year's progress is in order. 1929 saw the establishment of nine new stations in South Alabama, as well as others throughout the state. There are approximately twice as many new stations as those who have become inactive. We now have eleven Official Relay Stations and every month, more stations than we have ORS have reported traffic. A total of 4987 messages were reported handled to the SCM. Last but not least, there were eleven attendants from Alabama at the Southeastern Division Convention in December, of which six were from Montgomery.

This being my last report as SCM, I wish to express my appreciation for all the kind help and cooperation you have given me during the year. I hope that everyone will be even more cooperative with the next SCM. May I wish you all every success during 1930 and very 73.

Traffic: W4AHR 127, W4IA 97, W4ALG 89, W4AAQ 70, W4AG 67, W4CB 60, W4AQ 45, W4AHP 39, W4AKM 39, W4LM 35, W4FI 31, W4AAH 23, W4TI 19, W4PAI 10, W4AP 6.

GEORGIA-SOUTH CAROLINA-CUBA-ISLE OF PINES — SCM, M. S. Alexander, W4RZ — Well, the gang in this section is waking up at last and the reports are piling in. If we keep it up, we will have the best section in the Division. W4AAM is off the air for a while, as he is building an xtal-control phone station for 3500-ke. band. W4AHA hopes to have a MOPA going before long. W4AJH in Augusta wants to know why his news never gets in QST. That Augusta bunch is getting pretty good, but I can't get enough dope to make a sentence. If you fellows will send in your reports in more detail, they will get in print. W4JL is on the air with RAC, as he blew up his condensers. W4SI has just been appointed Official Broadcast Station. Tune up on his wave and get the latest dope from headquarters. W4CM has ideas of a 250-watt phone station, but I think the company he works with might object if he borrows the necessary equipment. Hi, CMSUF gets his reports in from way down in Cuba, and we are surely glad to hear from him and any of the other Cubans. He expects to put in xtal before long. W4PD is doing a lot of fone work on 3.5 mc. and he handled most of his traffic this month via fone. W4RZ has been keeping a nightly schedule for the past 15 days, but not much traffic was handled. If any of you want ORS certificates, drop me a line and the questionnaire will be forwarded to you. W4JD has worked all but the 6th and 7th districts, having been on the air since November 20, 1929.

Traffic: W4KV 185, W4PD 40, CMSUF 51, W4CM 10, W4SI 46, W4JL 2, W4YA 15, W4AJH 19, W4AHA 63, W4RZ 16, W4JD 17.

PORTO RICO-VIRGIN ISLANDS — SCM, E. W. Mayer, K4KD — This report was received by radio at W2FN. All reports this month received by radio at K4KD. K4AKV and K4AAN and K4KD all handle traffic. K4DK is a new station at St. Thomas, but inactive at present, as he was detailed to operate WICA, S.S. *Western Ocean*, on trip to New York. K4RL visited the SCM. K4ACF has tube trouble, but still has hopes. K4KD has a pet power leak to add to his present difficulties, but maintains ten skeds weekly.

Traffic: K4AAN 36, K4AKV 23, K4KD 65.

FLORIDA — SCM, Harvey Chafin, W4AII — W4AGR, W4OZ and W4QL lead the list this month. W4AGR and W4OZ make the BPL. W4OZ is installing a MOPA using a 210. W4SK sure did work some FB DX this month. W4NB is keeping three schedules at present. W4AGY reports that he, W4QL and W4NB had their stations at the All-American Air Meet to report the races. That sure is a fine way of advertising amateur radio, fellows. KDV5 reports that the weather has a lot to do with his not QSOing many U. S. stations. W5MS the "XYL" and W4ABJ keep a daily sked with her OM through W4QA. OM1TB is now in Pensacola and will be on the air soon. W4QA is a new station in Gainesville using a 50-watter. W4SY is spending most of his time on 14 mc. W4AFZ is still active. W4JO is in Miami now. W4AKH reports, W4ACM, the U.S.N.R. station at Tampa, would like to have a few skeds on Thursdays about 9:30 p.m. Mr. R. W. Shriner has taken it over from Mr. Houstain Wall. W4KW, ex-9BSL, is an ORS prospect. W4KW, W4HY, and W4TK also report. W4ALH is using an REL 852 job. W4JM and W4SK will receive their ORS appointments soon. Starting February 1st, every ORS will receive a mimeographed bulletin from the SCM. Non-ORS may obtain copies by writing to him.

Traffic: W4AGR 208, W4OZ 127, W4QL 107, W4SK 75, W4NB 66, W4AGY 64, W4MS 62, KDV5 69, W4QA 55, W4AII 30, W4SY 20, W4AFZ 18, W4JO 18, W4AKH 13, W4ACM 12, W4TK 5, W4HY 4, W4KW 3, W4AKW 4.

WEST GULF DIVISION

SOUTHERN TEXAS — SCM, Robert E. Franklin, W50X — Route Manager W5ABQ is forming a traffic route throughout the section. Get in touch with him and get in on this line-up. Through the courtesy of Mr. Milton G. Hall, Radio editor, the *Houston Post Dispatch*, the Houston Radio Club has been receiving quite a bit of boosting. The President, W50X, is going to conduct a code class on 1750-ke. band for about fifteen beginners. Corpus Christi's new YL has been given the call W5BKG and is now on the air. W5AJD is high man this month making the BPL again. W5AQY sends in a nice total and is on with 250-watt xtal-controlled outfit. W5MS sends in the Corpus Christi dope to the SCM. W5MX and W5TO of Corpus are back on the air again. W5BBY is going to apply for a commercial ticket the next time the R. I. comes around. W5NW will soon have his 250-watt xtal-controlled set going. W5AFB has just put in an xtal-controlled set and wants the gang to look for him on 7116 kc. W5ABQ is still rebuilding, but is keeping some skeds with a borrowed set. W5GS has a sked with W5AQY and is taking care of Houston traffic. There are a lot of good stations in this section that are never heard from. Send in your reports, OMs. We are always glad to hear from you.

Traffic: W5AJD 206, W5AQY 167, W5MS 130, W5BBY 83, W5AHB 50, W5OX 12, W5NW 15, W5GS 9, W5ABQ 8.

NORTHERN TEXAS — SCM, J. H. Robinson, W5BG — W5RJ is sure keeping things going. Any of you fellows who want a trade should get in touch with W5RJ. W5HY is keeping skeds with State schools and finds lots of traffic this way. W5BAM, the new OO, is sure sending the warning curds to the out-of-band fellows. W5BAD got a 50-watter for Xmas, but it was soft, so he is using the old CX310. W5BBF heard AB6 testing, also W1MK's broadcasts on the flight. W5GZ lost an 852. W5JA is still using the old 852 with all he can get on it. W5JP is still using the xtal set, a duplicate of WIZ. W5AAE is working on 1815 kc. Good stuff, OM. W5DF has worked his first Aussie. W5AMH has a dandy new four-tube receiver that brings them all in, but says the xmitter doesn't keep up with it. He asks that you fellows who hear his sigs report. Help him along, fellows. W5BG is remodeling the xmitter. That 3-below-zero weather we had froze all the spiders in the variable condensers.

Traffic: W5RJ 251, W5HY 210, W5BAD 154, W5BAM 90, W5BBF 70, W5GZ 32, W5JA 23, W5JD 18, W5AAE 14, W5DF 1, W5AMH 1, W5BG 1.

NEW MEXICO — SCM, Leavenworth Wheeler, Jr., W5AHI — Several ailments this month! W5AJL lost a new 210, frequency meter, and a TC ammeter, but claims it wasn't too much output that blew the latter. Hi. W5TV had his Hertz pulled down by inquisitive burros! W5BH sure likes 14,000 kc. W5AOD comes across with a FB report and has visions of BPL. W5ZM reports the radio club at NMMI as having eight members meeting tri-weekly for code practice. Best of luck, fellows. Being a lineman keeps W5EF on the jump this time of year. W5ZE reports for the first

time. FB. W5BGN has sold out to W5AOU and is leaving the store for a time. W5BHY wishes to make known his new QRA — 104 Gidding St., Clovis, W5AHI missed BPL on account of the traffic slump after Xmas. The SCM is mighty pleased with all the activity. We've staged our comeback — are we going to keep it up? Applications are in order for RM, ORS, OBS, and OO.

Traffic: W5AHI 183, W5AJL 113, W5AOD 84, W5ZM 22, W5RH 20, W5ZE 9, W5EF 6, W5BGN 6, W5TV 5.

OKLAHOMA — SCM, W. J. Gentry, W5GF — Congratulations to W5AUV, high man and new ORS. W5CB and W5ALM tied for second. W5DH is a good prospect for ORS. W5AAV has a new bug. W5ASQ is building an xtal rig and busy with I.B.P.C. W5BEE has a new MOPA outfit going. W5FS is busy with school work. W5AYF has been sick for some time and we all hope he has a quick recovery. W5IH is working (hard) in Ponca City. W5GF is very busy with his service personnel. W5AFH is busy with the YLs.

Traffic: W5AUV 128, W5CB 114, W5AZM 107, W5ASQ 37, W5GF 34, W5AAV 30, W5DH 26, W5AFH 24, W5BEE 16, W5FS 5, W5AYF 2, W5IH 2.

CANADA

CANADIAN GENERAL MANAGER, ALEX REID, VE2BE

We are in the midst of SCM elections in several divisions and consequently this has its effect on the month's reports. Mr. Jerrett, VO8Z, of Briggs has been appointed Acting SCM for Newfoundland, and we are now assured of monthly reports from the Island. It has been suggested that our prayer meetings which were held on our old 52-meter band be resumed on 3750 kc. every Wednesday evening at 11 p.m. E.S.T. If trouble is experienced on 3750 kc., try 7000 kc. or 14,000 kc. We would like to have this one night in the week for Canadian stations to have the opportunity of working one another. Here is a chance for SCMs, ORS, Route Managers and hams in general to handle traffic, pass along ideas and chew the rag. Let us make Wednesday night known from coast to coast from now on as Canada night. Would all stations wishing to hold skeds in the Trans-Canada Relay Route kindly advise your SCM or the CGM at once, by card or radio, as there are still several gaps to be filled in the chain before we can make this a twenty-four-hour service.

MARITIME DIVISION

NOVA SCOTIA — Acting SCM, A. M. Crowell, VE1DQ — While there is a fair amount of activity locally with the Halifax gang, the reports are not coming in. If your station is active on the air, it surely is worth sending in a report about. VE1AS has been going strong on 14,000 kc. and has had a sked with VO8AE. VE1DQ has been on 14,000- and 3500-ke. tone and is playing with a new s.g. receiver. VE1AW was heard on 14,000 kc. VE1CC has discovered a thrill in collecting BCL reports on his broadcasting. As not one station outside of the Halifax gang has reported this month, your acting SCM requests the gang to either cooperate in getting this section on the map by reporting regularly, or elect an SCM whom they will stand behind. Reports must be forthcoming in order to carry on. Get busy, gang.

NEWFOUNDLAND — Acting SCM, E. V. Jerrett, VO8Z — Say, boys, our little isle is to have some space in QST again, and I hope you will aid me in making that space interesting by sending in reports of what you're doing. Keep up the ham spirit and make 1930 a real live year. VO8MC has a new phone going with good success. VO8AW has returned to 7000 kc., and looks for local contacts on Sunday afternoons. VO8C has a new rectifying system and his note is very much improved. VO8AN is back on the air again after a long absence, due to break-down in power supply. Glad to hear your fist again, OM. VO8AE is on regularly both on 14,000 and 7000. He has a sked with W2KU and handles a big bunch of traffic. VO8WG reports that his generator has gone dead and to get going again he has to

send dog teams to Rigolet, 90 miles distant, to gather up all available B batteries. VO8Z will soon have a transmitter going on 3500 and hopes some of the bunch will also get interested in that band. He handles lots of traffic to VO8WG, North West River, Labrador.

QUEBEC DIVISION

QUEBEC — Acting SCM, Alex Reid, VE2BE — Even before this goes to the printer you will know who your next SCM will be as nominations close on Jan. 21st. VE2AP expects to pull off a big get together soon. VE2BB has been appointed Eastern Canada representative of the T. & R. bulletin and would be glad to receive any news items for the RSCB. VE2AP and VE2BH have completed the McGill College Radio Club station and have made a fine job of it. VE2CA has just completed a new 14,000-ke. transmitter. VE2HV has the sympathy of the whole division in the loss of his son, Allan. VE2AX is building a push-pull xtal transmitter. Plante of VE2BZ has a very fine DC note on 3750 kc. VE2AC again leads the division in traffic totals. VE2AY has turned in a number of fine traffic reports and expects that he will get an ORS certificate from the new SCM. VE2BE worked WFA several times during January. VE2BB, one of our stations in the All-Canada Route, reports progress in the route and traffic moving at many points. We need several more stations in this division on the above route.

Tr. fic: VE2AC 62, VE2BE 29, VE2BB 28, VE2AY 12, VE2BZ 12, VE2AL 10.

ONTARIO DIVISION

ONTARIO — SCM, E. C. Thompson, VE3FC — Central District: VE3BC bursts forth this month with a truly wonderful traffic total and says that he has capped the climax as it were, and from now on must do a little school work. VE9AL's new super-station will be on the air before this is read, crystal-controlled with an UV-861 in the last stage. VE9BJ is now on 3.8 mc. regularly, keeping traffic schedules and working very good DX. VE3BO does consistent work on 14.16 mc. VE3BP is using a low-powered MOPA with a 245 amplifier on 3.7 mc. VE3GF is making friends on the 7-mc. band. VE3CL has turned to the 3.5-mc. band and says that conditions there suit him fine. VE3DY is heard using phone on 3546 kc. VE3CJ is adhering closely to 14.2 mc. with good DX. VE3EQ remarks on peculiar conditions on the 3500-ke. band. VE3DS went on the air Dec. 1st with a new TPTG transmitter and established contact with many stations on 14- and 7-mc. bands. To VE3BL and VE3CJ goes the credit of getting VE3FC on the air after the owner of the latter, through a knee injury, was confined to his bed. Thanks to these men, Thompson can now operate the set without having to move from one position and the long days are whiled away agreeably. VE3DA has a fine traffic total. Southern District: C. D. Lloyd, VE3CB, ASCM — VE3HB, VE3FD and VE3CB-VE3DD performed valuable emergency service during Christmas season when bad ice storms disrupt all communication systems in their locality. Mighty good work, boys. VE3HB is using 14-, 7-, and 3.5-mc. bands. VE3CB-3DD also uses all three bands and keeps traffic schedules with Toronto, etc. VE3FD is using a pair of 210s in push-pull oscillator on the 3.5-mc. band. VE3AQ was on the air, using a crystal oscillator during Christmas holidays. VE3AD at Grimsby is on the air again, using 7-mc. band, and is much interested in traffic. Ottawa District: VE3XO blew a pair of 852 tubes. The Power Company was after Henderson, VE3AT, for using too much juice. Hewson worried about filters and also had to move part of his junk out of the cellar.

Traffic: VE3BC 110, VE3ET 53, VE3CB 48, VE3DA 33, VE3HB 25, VE3DS 17, VE3FD 10, VE3AQ 11, VE3CL 8, VE3AD 8, VE3BO 6, VE3BP 6, VE9BJ 9, VE3FC 4, VE3EQ 4.

PRAIRIE DIVISION

MANITOBA — SCM, A. V. Chase, VE4HR — VE4AR of Boissevain, Man., leads the section in traffic. VE4FN is rebuilding to a MOPA and an AC screen-grid receiver. VE4BQ was heard on 28mc. in England. VE4CB (Winnipeg) and VE4JR (Boissevain), two new stations, made their appearance this month. VE4DK has the finest note in this section. VE4IC is handling traffic, but does not report. VE4JD and VE4HR are handling

traffic for VE4BQ, whose transmitter has developed trouble. Conditions in the 14,000-mc. band have been very spotty this month and schedules have suffered in consequence.

Traffic: VE4AR 39, VE4BQ 33, VE4DJ 23, VE4HR 11, VE4BU 4.

SASKATCHEWAN — SCM, W. J. Pickering, VE4FC — Traffic in this section made a big upward move this month, and would always be in a higher place if all who handle messages would report each month. Once more VE4IH tops the class and is tickled with the way the Sask. gang are on the air these days. A nice total comes from VE4GR who originated most of his messages. VE4GO made three contacts with New Zealand in one night, and has had good results on the 28-mc. band. One of the recent entrants into the game, VE4HP, turns in his first message report. VE4CN has a TPTG outfit working. VE4HD is changing over to TPTG.

Traffic: VE4IH 51, VE4GR 25, VE4GO 16, VE4HP 10.

VANALTA DIVISION

BRITISH COLUMBIA — SCM, J. K. Cavalsky, VE5AL — Vancouver: VE5CF cinched the traffic honors this month, and credits his MOPA and single wire current feed antenna with the compliment. VE5BC is busy with some rectifier jars and a new receiving antenna. VE5AL is now set for all bands and trying to tie into a sked with eastern Canada. VE5AK is on 14 mc. VE5BA is trying to buckle the plates of his 280 tube. A new ham in this section, VE5DR, will be going full swing very shortly. As soon as the jars thaw out at VE9AJ, we expect to be on the air often. Prince Rupert: VE5AR has a sked with VE5CL and VE5BD and handles some real traffic. VE5GT is push-pull crazy and is going to try a push-pull antenna. Yukon: VE5AW has worked all continents and is now eligible for the W.A.C. Fine work, OM, Rosslund: This is a new part heard from, and the SCM is always glad to get reports. VE5AA and VE5AI are experimenting with a crystal fone set and hope to hook up with the coast.

Traffic: VE5CF 38, VE5AK 4, VE5AL 11.

Traffic Briefs

W8CEP calls attention to page 84 of the Sixth Edition of the Radio Amateur's Handbook whereon it is stated under the "Circuit of the High-Powered Transmitter" that "One UX-204-A tube and mountains" are some of the apparatus required. W8CEP says he has the UX-204-A but unfortunately is unable to obtain the mountains. Hi.

W9GV is visiting Hawaii and is on the air with portable W9ZZG on approximately 7180 kc. He wants to work as many ham stations as possible while on this trip. Keep an ear open for him, fellows.

At the time this issue goes to press we have information that the Yacht *Betty R* expects to leave Miami, Florida, about the middle of February for the Bahamas, making headquarters at Nassau. The *Betty R* will probably be cruising in those waters until early in April. The call letters of the yacht are KDTF and 3420 kc. will be the principal frequency, although 5525 kc. will also be used. Mr. E. C. Crosseit, W1CCZ and owner of KDTF, requests that amateurs watch on those frequencies as communication with amateurs is desired.

Late and additional reports:

VE4EC is the only one reporting for his Section this month.

Traffic: VE4EC 25.

Official Broadcasting Stations

CHANGES AND ADDITIONS
(Local Standard Time)

W6ESA (7150). Mon., Wed., Fri., 5 p.m.; W8BRO (7000). Mon., Fri., 1 p.m.; K4KD, 11 p.m., E.S.T.; W9BEF (7000). Tues., Fri., 11 p.m.; W9AIR (1750). Wed., 8:30 p.m.; (3900). Mon., Fri., 8:30 p.m.

From now on —



THE set manufacturer to stay in business will be the one who plays safe by refusing to take the risk of using parts of uncertain performance or dependability. When competition whets its blade and selling costs go up, it becomes increasingly important to hold assembly costs as low as possible.

Take mica condensers for example. Unless capacity ratings are accurate, a terrible burden is thrown on the inspection department and "rejects" pile up until

they exceed the stock of usable condensers on hand. It doesn't require much imagination to picture what happens to production costs under such circumstances.

When you order Sangamo Condensers you need not make over-allowances for "rejects." The reliability of Sangamo ratings is attested to by a number of nationally known radio manufacturers.

And Sangamo is equally reliable as a source of supply.

SANGAMO High Voltage Condensers

Tested at 5000 volts d. c. and 3500 a. c. and built to Sangamo standards, known throughout the radio world, amateurs, commercial men and manufacturers have learned to depend on Sangamo High Voltage Condensers. Accurately rated and adequately tested — these condensers offer the maximum protection in high voltage, high frequency circuits.

SANGAMO ELECTRIC CO.

SPRINGFIELD, ILLINOIS, U. S. A.

Manufacturers of Precision Electrical Apparatus for 30 Years

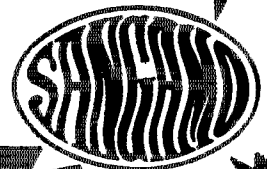

See Reverse
Side

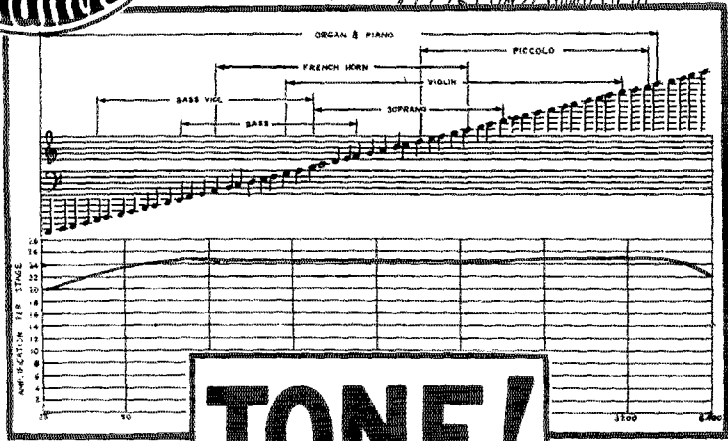
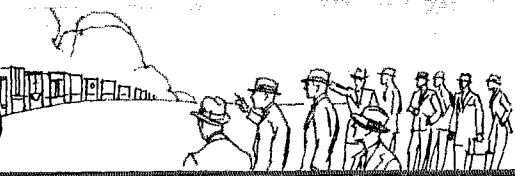
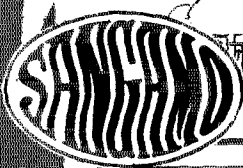

TONE!

Curve of Type "A" Sangamo Straight Audio Transformer showing uniformity of amplification at all audible frequencies.

What happens out on the "skirmish line"?

When your set goes up to the front line to meet prospective buyers—does it have an outstanding strategic advantage over competition or is it just a "long, hard pull" for your dealers?

Radio receivers must satisfy two different types of buyers. One is the amateurs who not only know the difference between good and indifferent performance but who understand what causes the difference. They are also an important recommending factor in the final purchase of all receivers.

The other type is not technical-minded but regards a radio receiver simply as a musical instrument.

To both classes *tone quality* is all-important. When a dealer tells an amateur that your set has Sangamo Transformers in the "audio end" he *knows* that the tone will be right. He also has more confidence in your set all the way through because he knows that no manufacturer who uses Sangamo Transformers will jeopardize their performance by using inferior parts elsewhere in the set. When equipped with Sangamo Transformers, your set need only be demonstrated to sell those who judge by ear alone.

Sangamo "A" Line Transformers are built for the custom set maker or manufacturer who wants a "tone" advantage over competition. The cost is slightly higher but is more than offset by the increased salability of the receiver.

"A" Line Transformers

- Type A straight audio amplification, list price, \$10.00
 - Type B Push-pull Input Transformer for all tubes, list price, 12.00
 - Type C-171 Push-pull Output, for 171 or 250 type power tubes with cone speaker list price, 12.00
 - Type D-210, same as C except for 210 and 112 power tubes list price, 12.00
 - Type H-171, Push-pull Output for 171 or 250 power tubes for Dynamic Speaker list price, 12.00
 - Type G-210, same as type H except for 210 and 112 tubes, list price, 12.00
 - Type F Plate Impedance for use as a choke to prevent oscillation and for impedance coupled amplifiers, list price, 5.00
- Unusual facilities for furnishing transformers with or without cases ready for mounting and quick assembly with the receiver. Prices on application.*

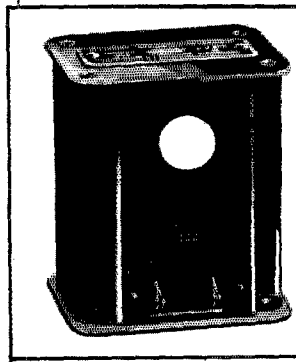

PIN THIS TO YOUR LETTERHEAD AND MAIL
SANGAMO ELECTRIC CO.
Springfield, Illinois, U. S. A., Dept. R94

(For manufacturers) I am interested in engineering data regarding your transformers and condensers.

(For set builders) Please send circulars describing your apparatus and latest audio hook-ups. I inclose 10c to cover cost of mailing.