

QST

DEVOTED ENTIRELY TO

AMATEUR RADIO

PUBLISHED SINCE 1915 BY THE AMERICAN RADIO RELAY LEAGUE INC.

Revolutionary Tuner Design!

18 to 100 meters without changing coils

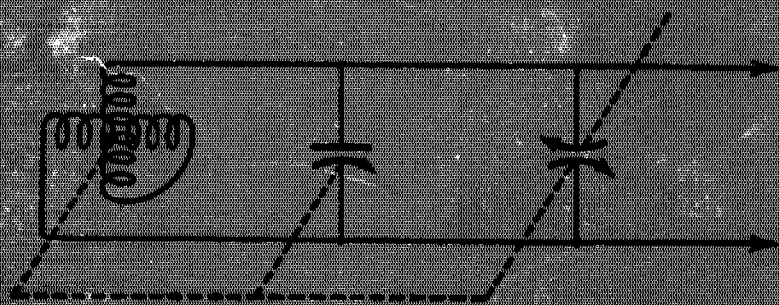

IN THIS ISSUE

FEBRUARY, 1930

25¢

"Theory of Radio Communication"

By LIEUT. JOHN T. FILGATE
Formerly Instructor at U. S. Army Signal School

Published with approval of U. S. War Department, this is first public printing of the officers' radio manual used by U. S. Army Signal Corps. A splendid technical textbook for advanced Radio Amateurs. 250 pages, 200 illustrations. Postpaid anywhere. **\$2.00**

"Radio Physics Course"

By ALFRED A. CHIRARDI
B. S. in Electrical Engineering; Instructor in Radio and Electrical Engineering, Hebrew Technical Institute; Consulting Engineer, Pilot Radio & Tube Corp.; Associate Editor, "Radio Design"

A complete course, simple enough for the novice, yet technically correct, covering the entire range from radio fundamentals to short-waves, television and the "talkies." A valuable reference work of 400 pages with 300 illustrations. Postpaid anywhere. **\$2.50**

These books Published Exclusively by
RADIO DESIGN PUBLISHING CO.
103 Broadway, Brooklyn, N. Y.

"PILOT'S SCREEN-GRID

BROADCAST RECEIVER

A Popular-priced Kit Embodying Push-Pull Audio and Latest Refinements of High-Priced Screen-Grid Receivers.

FEATURES

Push-pull audio two screen-grid amplifiers fully shielded 7 tubes including rectifier highly selective and so sensitive it operates perfectly on 10-foot indoor aerial easily assembled and wired removable bottom on cabinet permits easy access practically any 171-a power pack may be used.

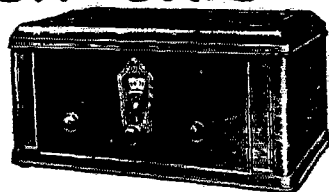

Custom Set-Builders' Prices

- Kit No. K-123—Complete Kit of parts for Pilot Screen-Grid Receiver, including walnut-finished metal cabinet, but without Power Pack. **\$2975**
- Kit No. K-122—Complete Kit of parts for Pilot Screen-Grid Receiver, including drilled front panel. (Does not include cabinet or Power Pack) **\$2550**
- Kit No. K-124—Complete Kit of parts for Pilot Screen-Grid Receiver, including walnut-finished cabinet and ABC power pack. **\$4625**

A.C. and Battery-Operated Short-Wave Kits

A. C. Super-Wasp K-115
—Custom Set-Builders' Price (Power Pack and Tubes Extra) **\$34⁵⁰**



Battery Super-Wasp K-110—Custom Set-Builders' Price. **\$29⁵⁰**

"PILOT RADIO & TUBE CORP.

World's Largest Radio Parts Plant—Established 1908
323 BERRY STREET, BROOKLYN, N. Y., U. S. A.

Going Strong!

CROSLY SCREEN GRID—TONE TESTED RADIO

—a Sensation at these Prices!

DEALERS all over the country report record sales on Crosley Radio. And no wonder! Screen Grid—Tone Tested radio at these phenomenal prices represents value never before equaled in radio history!

Month after month, Crosley advertising in leading magazines and farm papers is carrying the convincing story of Tone Tested radio into millions of homes. Prospective customers right in your own town are being told how world-famous musicians "tone-test" Crosley radio and give their advice and suggestions directly to Crosley engineers. And many of them go to a Crosley dealer to hear this finer tone and buy Crosley radio!

But see the sets themselves. Compare them point for point with sets selling at double the price. And then you'll see why they're selling!

Get in touch with your Crosley distributor today. Let him tell you the Crosley story. Get your share of this profitable business! The Crosley Radio Corporation, Powel Crosley, Jr., Pres., Cincinnati, Ohio. Home of WLW — "The Nation's Station."



\$112 (without tubes)

CROSLY 33-S. This graceful Crosley 7-tube Screen Grid cabinet model, with Dynacoil speaker, is beautifully finished in two tones of satiny walnut veneer.



Other handsome 7 and 8 tube Screen Grid table and cabinet models, \$56.50 up!

Western prices slightly higher

You're there with a

CROSLY

Duncan and Drew's 3 Radio Books Widely Known—Widely Praised

"The Outstanding Book in its Field"

Radio Telegraphy and Telephony



By Rudolph L. Duncan
and C. E. Drew
R.C.A. Institutes, Inc.

ONE reviewer says: "This is one of the most complete textbooks written on radio communication with 950 pages of the latest practical and technical information. Principles, methods and equipment are described in language readily understood by both novice and expert. It opens with a complete explanation of magnetism and the electron theory and continues so that the reader gains a thorough understanding of the fundamental principles. It devotes whole chapters to the Production of Electromotive Force, Electromagnetic Induction, Motor Generator-starters, Curve Diagrams, etc., until it reaches the chapters on Commercial Broadcast and Telegraph Transmitters. Diagrams accompany the descriptive matter, and the treatment throughout is lucid. The book will undoubtedly remain a standard for some years to come."

Price, \$7.50

HOW TO PASS U. S. Government Radio License Examinations

DON'T take any chances. Careful study of this book will insure success in obtaining your Government Radio License, because it contains full particulars, questions and answers, on the latest radio examinations by the government.

Duncan and Drew know from rich experience what information you will need, and it is all clearly set forth here — in the most complete and most recent book on the market.

259 questions with complete answers show you just what will be expected of you.

Order a Copy Now!

\$2.00

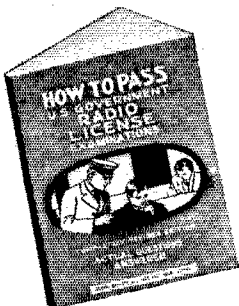

RADIO TRAFFIC MANUAL and OPERATING REGULATIONS

HERE is a book for students, amateurs and operators who contemplate entering the commercial field. With the help of this little book — the only complete one of its kind — you may learn quickly and easily all the government and commercial traffic rules and regulations.

This is a veritable encyclopedia of information concerning the code, the operating rules of the Radio Marine Corporation of America, the International Radiotelegraph convention, the United States radio act of 1927, the ship act of July 23, 1912, and regulations concerning the issuance of radio operator's licenses.

An excellent index in the back of the book makes every topic easy to locate.

\$2.00

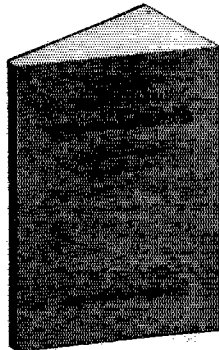

ON APPROVAL COUPON

John Wiley & Sons, Inc.
440 Fourth Avenue, New York

Gentlemen: Kindly send me the following books for free examination. I agree to remit the price within ten days after receipt or return the books postpaid.

Radio Telegraphy and Telephony (\$7.50)
How to Pass (\$2.00)
Radio Traffic Manual (\$2.00)

Name

Address

Reference

QST 2-30

Section Communications Managers of THE COMMUNICATIONS DEPARTMENT, A. R. R. L.

Eastern Pennsylvania	W3ZF	ATLANTIC DIVISION	Don Lusk	116 West Wyoming Ave.	Germantown, Phila.
Maryland-Delaware-District of Columbia	W3BBW		Forrest Calhoun	1636 Thomas Ave.	Baltimore, Md.
Southern New Jersey	W3BWJ		Norman R. Weible	120 Frazer Ave.	Collingswood
Western New York	W3C1P		C. S. Taylor	598 Master St.	Buffalo
Western Pennsylvania	W8CEO		A. W. McAuly	309 Third St.	Oakmont
		CENTRAL DIVISION			
Illinois	W9APY		Fred J. Hinds	3337 Oak Park Blvd.	Berwyn
Indiana	W9CYO		D. J. Angus	310 N. Illinois St.	Indianapolis
Kentucky	W9BAZ		J. B. Wathen, III	Mockingbird Valley	Louisville
Tennessee	W8CEP		Dallas Wise	9187 Falcon Ave.	Detroit
Michigan	W8BYN		H. C. Storck	694 Carpenter St.	Columbus
Wisconsin	W9VD		C. N. Crapo	443 Newton Ave.	Milwaukee
		DAKOTA DIVISION			
North Dakota	W9DYV		B. S. Warner	309 4th Ave.	Enderlin
South Dakota	W9DGR		D. M. Pasek	780 Illinois St.	Huron
Northern Minnesota	W9BVH		Carl L. Jabs	1822 James St.	St. Paul
Southern Minnesota	W9EFK		J. C. Pehoushek	60 Melbourne Ave., S. E.	Minneapolis
		DELTA DIVISION			
Arkansas	W5ABI		H. E. Velte	315 No. Jackson St.	Little Rock
Louisiana	W5EB		M. M. Hill		Oakdale
Mississippi	W5AKP		J. W. Gullett	1708 23rd Ave.	Meridian
Tennessee*	W5WP		James B. Witt	832 N. Fifth Ave.	Knoxville
		HUDSON DIVISION			
Eastern New York	W2OU		H. H. Rosenthal	Box 740	New Rochelle
N. Y. C. & Long Island*	W2BGO		V. T. Kenney	1836 Hone Ave.	Bronx
Northern New Jersey	W2WR		A. G. Wester, Jr.	50 Princeton St.	Maplewood
		MIDWEST DIVISION			
Iowa	W9DZW		H. W. Kerr		Little Sioux
Kansas	W9CET		J. H. Amis	915 Lincoln Ave.	Topeka
Missouri	W9RR		L. B. Laizure	8010 Mercier St.	Kansas City
Nebraska	W9BYG		C. B. Deihl	5605 Cedar St.	Omaha
		NEW ENGLAND DIVISION			
Connecticut	W1CTI		Frederick Ellis, Jr.	7 Union Ave.	Norwalk
Maine	W1AQL		G. C. Brown	269 No. Main St.	Brewer
Eastern Massachusetts	W1WV		M. W. Weeks	40 Norfolk Rd.	Eastnut Hill
Western Massachusetts	W1UM		Dr. John A. Teasmer	8 Schafner St.	Worcester
New Hampshire	W1ATI		V. W. Hodge	227 Main St.	Claremont
Rhode Island	W1BCR		C. N. Kraus	92 Keene St.	Providence
Vermont	W1IT		Clayton Paulette		North Troy
		NORTHWESTERN DIVISION			
Alaska	WWDN		W. B. Wilson	U. S. LHT Fern	Ketchikan
Idaho	W7ACN-JL		James L. Young	303 13th Ave., So.	Nampa
Montana	W7AAT-7QT		O. W. Viera		Red Lodge
Oregon	W7UN		Wilbur S. Claypool	1059 Greenwood Ave.	Portland
Washington	W7ACS		Eugene A. Piety	912 No. Ainsworth St.	Tacoma
		PACIFIC DIVISION			
Hawaii	K6CFQ		F. L. Fullaway	2714 Manoa Rd.	Honolulu
Nevada*	W6UO		C. B. Newcombe		Verington
Los Angeles	W6EQF		B. E. Sandham	4508 8th Ave.	Los Angeles
Santa Clara Valley	W6NX		F. J. Quemant	1348 Hanchett Ave.	San Jose
East Bay	W6CZR		J. Walter Frates	368 62nd St.	Oakland
San Francisco	W6WB		C. F. Bane	262 Castro St.	San Francisco
Sacramento Valley	W6DON		Everett Davies	Rt. 5, Box 380	Sacramento
Arizona	W6BWS		Russ Shortman	519 W. Madison St.	Phoenix
Philippines	KAICY		S. M. Mathes	Army-Navy Club	Manila
San Diego	W6EOP		Harry A. Ambler	4101 Hamilton St.	San Diego
		ROANOKE DIVISION			
North Carolina	W4TS		Hal S. Justice	Box 552	Canton
Virginia*	W3CA		J. F. Wohlford	118 Cambridge Ave.	Roanoke
West Virginia	W8VZ		F. D. Reynolds	Box 1200	Fairmont
		ROCKY MOUNTAIN DIVISION			
Colorado	W9CAA		C. R. Stedman	1641 Albion St.	Denver
Utah-Wyoming	W6BAJ		Parley N. James	430 "D" St.	Salt Lake City
		SOUTHEASTERN DIVISION			
Alabama	W4AAQ		S. J. Bayne	2 Cramer Ave.	Montgomery
Florida	W4AII		Harvey Chafin	6002 Suwanee Ave.	Tampa
Georgia-S. Carolina-Cuba-Isle of Pines	W4RZ		M. S. Alexander	79 Rogers St., S. E.	Atlanta
Porto Rico-Virgin Islands	K4KD		K. W. Mayer	Box 103	Ensenada, P. R.
		WEST GULF DIVISION			
Northern Texas	W5BG		J. H. Robinson, Jr.	522 Cumberland St.	Dallas
Oklahoma	W5GF		W. J. Gentry	610 Pottenger St.	Shawnee
Southern Texas	W5OX		R. E. Franklin	1806 Valentine St.	Houston
New Mexico	W5AHI		Leavenworth Wheeler, Jr.	Box 33	Valmore
		MARITIME DIVISION			
Maritime*	VEIDQ		A. M. Crowell	69 Dublin St.	Halifax, N. S.
		ONTARIO DIVISION			
Ontario	VE3FC		E. C. Thompson	266 Queensdale Ave.	Toronto, 6
		QUEBEC DIVISION			
Quebec	VE2BE		Alex Reid	169 Logan Ave.	St. Lambert
		VANALTA DIVISION			
Alberta	VE5AL		J. K. Cavalsky	4868 Blenheim St.	Vancouver
British Columbia	VE5AL				
		PRAIRIE DIVISION			
Manitoba	VE4HR		A. V. Chase	109 Lanark St.	Winnipeg
Saskatchewan*	VE4FC		W. J. Pickering	514 19th St. W.	Prince Albert

*Officials appointed to act until the membership of the Section concerned choose permanent SCMs by nomination and election.

FOR FIFTEEN YEARS

the General Radio Company has been manufacturing instruments for the amateur which have made a reputation for sound design, quality, and reliability. Among these are

Frequency Meters

Quartz Plates for

Piezo-Electric Oscillators

Audio-Amplifier Transformers

Power-Supply Transformers

Variable Air Condensers (for
work on short waves)

New items are under development. Send for Bulletin 931-X and ask to receive future announcements as they appear in the *General Radio Experimenter*

GENERAL RADIO COMPANY

30 STATE STREET

274 BRANNAN STREET

CAMBRIDGE, MASSACHUSETTS

SAN FRANCISCO, CALIFORNIA



QST



The Official Organ of the A.R.R.L.

VOLUME XIV

FEBRUARY, 1930

NUMBER 2

Editorials	7
Mr. Terrell Reports on the Amateur	8
Revolutionizing High-Frequency Tuner Design	<i>W. H. Hoffman and D. H. Mix</i> 9
Replacing Antenna Halyards on an 80-Foot Mast	<i>L. B. Robbins</i> 15
Vacuum Tube Layouts for Telephone Modulation	<i>E. E. Spitzer</i> 17
A Flexible Tube and Set Tester	<i>Herbert W. Jones</i> 21
A Power Supply for the Low-Power Transmitter	<i>George Grammer</i> 23
Clyde Elden Darr	25
Winding Data for the Tube-Base Coil	<i>George Grammer</i> 26
Easy Correction of Line Voltage	<i>C. Warren</i> 28
Locking the Transmitter	<i>Rufus P. Turner</i> 29
Election Notice	30
Improvements in the High-Frequency Receiver	<i>E. J. Gluck</i> 31
While Listening In	<i>Geo. P. Taylor</i> 32
The Dynatron	<i>W. H. Newbold</i> 33
Doings at Headquarters	36
A Three-Phase High-Voltage Rectifier	<i>F. O. Tribbey</i> 37
High-Frequency Inductances	<i>M. A. Ausman</i> 38
Passing the Government Examinations for Operator's License — Part II	<i>Beverly Dudley</i> 39
West Gulf Division Convention	44
WIKH	45
Pacific Division Convention	50
Experimenters' Section	51
I.A.R.U. News	55
Calls Heard	57
Correspondence Department	58
Silent Keys	78
Ham-ads and QRA's	92
QST Index of Advertisers	94

QST is published monthly by The American Radio Relay League, Inc., at Hartford, Conn., U. S. A. Official Organ of the A.R.R.L. and the International Amateur Radio Union

Kenneth B. Warner (Secretary, A.R.R.L.), Editor-in-Chief and Business Manager

James J. Lamb
Technical Editor

Beverly Dudley
Assistant Technical Editor

Clark C. Rodimon
Assistant Editor

David H. Houghton
Circulation Manager

G. Donald Meserve
Advertising Manager

Advertising Offices.....55 West 42d Street, New York City
Editorial Offices.....1711 Park Street, Hartford

Subscription rate in United States and Possessions, Canada, and all countries in the American Postal Union, \$2.50 per year, postpaid. Single copies, 25 cents. Foreign countries not in American Postal Union, \$3.00 per year, postpaid. Remittances should be by international postal or express money order or bank draft negotiable in the U. S. and for an equivalent amount in U. S. funds.

Entered as second-class matter May 29, 1919, at the post office at Hartford, Connecticut, under the Act of March 3, 1879, acceptance for mailing at special rate of postage provided for in section 1103, Act of October 3, 1917, authorized September 9, 1922. Additional entry at Concord, N. H., authorized February 21, 1929, under the Act of February 28, 1925.

Copyright 1930 by the American Radio Relay League, Inc. Title registered at United States Patent Office.

The American Radio Relay League

The American Radio Relay League, Inc., is a non-commercial association of radio amateurs, bonded for the promotion of interest in amateur radio communication and experimentation, for the relaying of messages by radio, for the advancement of the radio art and of the public welfare, for the representation of the radio amateur in legislative matters, and for the maintenance of fraternalism and a high standard of conduct.

It is an incorporated association without capital stock, chartered under the laws of Connecticut. Its affairs are governed by a Board of Directors, elected every two years by the general membership. The officers are elected or appointed by the Directors. The League is non-commercial and no one commercially engaged in the manufacture, sale or rental of radio apparatus is eligible to membership on its board.

"Of, by and for the amateur," it numbers within its ranks practically every worth-while amateur in the world and has a history of glorious achievement as the standard-bearer in amateur affairs.

Inquiries regarding membership are solicited. A bona fide interest in amateur radio is the only essential qualification; ownership of a transmitting station and knowledge of the code are not prerequisite. Correspondence should be addressed to the Secretary.

DIRECTORS

President
HIRAM PERCY MAXIM
Drawer 2102,
Hartford, Conn.

Vice-President
CHARLES H. STEWART
St. David's, Pa.

Canadian General Manager
ALEX. REID
169 Logan Ave.,
St. Lambert, P. Q.

Atlantic Division
EUGENE C. WOODRUFF
234 W. Fairmount Ave.,
State College, Pa.

Central Division
Election in Progress

Dakota Division
C. L. BARKER
Henning, Minn.

Delta Division
M. M. HILL
P. O. Box 274
Natchitoches, La.

Hudson Division
A. LAFAYETTE WALSH
220 West 42d St.,
New York City

Midwest Division
LOUIS R. HUBER
718 N. Gilbert St.,
Iowa City, Iowa

New England Division
FREDERICK BEST
13 East Crescent St.,
Augusta, Maine

Northwestern Division
K. W. WEINGARTEN
3219 No. 25th St.,
Tacoma, Wash.

Pacific Division
ALLEN H. BARCOCK
65 Market St.,
Southern Pacific Co.,
San Francisco

Roanoke Division
W. TREDWAY GRAVELY
Box 245,
Danville, Va.

Rocky Mountain Division
PAUL M. SEGAL
Box 1771,
Denver, Colo.

Southeastern Division
HARRY F. DOBBS
245 Spring St., N. W.,
Atlanta, Ga.

West Gulf Division
FRANK M. CORLETT
2515 Catherine St.,
Dallas, Tex.

OFFICERS

President HIRAM PERCY MAXIM, Hartford, Conn.
Vice-President CHARLES H. STEWART, St. David's, Pa.
Secretary KENNETH B. WARNER, Hartford, Conn.
Treasurer ARTHUR A. HEBERT, Hartford, Conn.
Communications Manager F. EDWARD HANDY, Hartford, Conn.

ADDRESS ALL GENERAL CORRESPONDENCE TO THE EXECUTIVE HEADQUARTERS AT HARTFORD, CONN.

EDITORIALS

SURPRISING as it may seem at first glance, most amateurs who complain that interference to-day is very severe and that they have difficulty in communicating, turn out to be chaps who have not yet put into employment the new ideas which amateur radio generally adopted as "1929 necessities." You'd think that amateurs encountering troubles in operating would be the most likely ones to apply the known cures. But maybe it's another way of saying that those who have embraced the new ideas are the ones who have no reason to complain, so perhaps it's not strange that it is the non-users who are not getting as much out of their operating time as they expect.

We're thinking, of course, of those simple and inexpensive solutions of practical operating difficulties which the A.R.R.L. technical development program brought forth as fundamentals for modern amateur operation. For receivers, open scales and peaked amplifiers. For transmitters, "High-C" oscillators or oscillator-amplifier circuits, better plate supply, improved keying, and much emphasis on the use of the monitor both as a gauge of quality and as a guide to frequency location. Technical information on these subjects, dug up at much expense and published in a year of the most helpful *QST*'s ever turned out, has not been employed as generally as it should.

Why should a fellow complain that the bands are horribly congested when he still used his 1928 tuner and does not make use of open scales and a peaked amplifier? By asking this question we mean to say, of course, that such a fellow ought not to complain. Instead, he ought to rebuild his tuner. He would find then, as countless amateurs have, a new order of effective selectivity, an ability to differentiate between closely-packed signals that has all the effect of a widened band.

If one sits down to a modern tuner and makes a careful examination of one of the busier amateur bands, he is immediately struck by the fact that there are places in the band where many amateur signals are stuck closely alongside one another and frequently on top of one another, while at other places in the band there are spots that are virtually quiet. Even in the 7000-band in the busy evening hours there is a very unequal division of stations throughout the band, with unusual congestion in certain places for no apparent reason. This shows no intelligent use of the

monitor. The monitor is an essential in a 1930 station. Let such stations, having difficulty working through QRM, examine the entire amateur band on an open-scale tuner, and select for themselves a transmitting frequency in one of the less-occupied portions. By means of a monitor the transmitter frequency may then be transferred to that spot in the band. We plead again for the intelligent use of the monitor — it will eliminate these haphazard agglomerations of stations on one frequency. Of course if everybody who read *QST* accepted our advice, everybody would be shifting frequency simultaneously to-night and new peaks of interference would be appearing on last night's quiet frequencies. But everybody will not follow our advice, so that you can improve *your* operation if you'll get out from under that stack of QRM and shift to to-night's relatively quiet frequency, wherever in the band you find it.

There is no denying that present-day amateur radio demands of its adherents a better technical job than did the ham radio of yesteryear. The amateurs who are getting the most satisfaction from their operating to-day are those with stable transmitters and peaked receivers. Such stations, however, seem more and more to be working amongst themselves. The other fellow, with a 1928 signal from his transmitter, is perforce out of things, largely because the audio selectivity of a modern receiver makes it impossible to "copy" him. 1928 signals are about as useful as 1928 bird's nests, but unfortunately they are much more numerous. There are far too many atrocious signals still on the air. In fact there is only one word we can think of that fittingly describes the average signal of to-day. It is not a polite word, not a beautiful one, but it's one of those pointedly descriptive American ones. The word is *lousy*. There is, we think, no excuse at all for this condition! Vacillating, erring, weak-minded signals, wobbled by every influence encountered in their electrical lives! Out with them! They disgrace modern amateur radio, their owners in particular. *Delouse* that signal, OM. It can be done so easily. See recent *QST*'s: make the circuit High-C and then monitor it to know what you have. Then "rich rewards shall be yours." You'll work 'em where you lose 'em now. You'll be proud of the sig. The leading stations, with their modern audio selectivity, will start working you as one of the signals that stand still well enough

to copy in the haze. And gradually the number of bum signals will dwindle until it consists only of the current fellow who hasn't heard of *QST*!

What we mean by all this is that there are still far too many stations that have not profited by A.R.R.L. specifications for inexpensive 1930 re-

building, and that present difficulties in operating are very largely chargeable to that fact. Your file of *QST* and your *Handbook* will enable you to take advantage of the results of that A.R.R.L. program.

K. B. W.

Mr. Terrell Reports on the Amateur

IN his annual report to the Secretary of Commerce, Mr. W. D. Terrell, Chief of the Radio Division of that department, pays splendid tribute to the work of radio amateurs and points out the wisdom of this country's policy towards them. We quote that portion of Mr. Terrell's report dealing with the amateur:

"At the end of the fiscal year there were 16,829 licensed amateur radio stations, a decrease of 99 as compared with the previous year, when there were 16,928. While other countries are worrying over the problem of controlling, taxing, and discouraging the few surviving amateurs they have, this country is constantly endeavoring to keep this large and useful group of experimenters engaged in useful and interesting work. The latest proposal they have put forward is a request for permission to carry on radiotelephone communication in the 20-meter band, from 14,000 to 14,400 kilocycles. If given this privilege, the amateurs expect to carry on international radiotelephone communication in this high-frequency band.

"In order to continue satisfactory operation under the restricted frequency bands imposed by the Washington convention, intensive technical development has been carried on by the amateurs during the past year. This, the American Radio Relay League reports, has resulted in marked advances in apparatus and methods. In March, 1928, the band 28,000 to 30,000 kilocycles, 10.7 to 10 meters, made available to amateurs in the Washington convention, was opened to their use in this country. They have given particular attention to work in this band, and two-way communication has been established between amateurs in this country and in Europe, South America and New Zealand. European amateurs have succeeded in communicating from Europe to South Africa and India on similar frequencies. On their more useful frequencies, numerous amateur stations have now been in communication with as many as 50 foreign countries. There is an increase in amateur interest in radiotelephony and many amateurs now seek an opportunity to duplicate by voice the long-distance work which they have successfully accomplished by radiotelegraphy.

"The amateur again demonstrated his great value as a means of emergency communication to

storm-stricken communities during the West Indian hurricane in September, 1928. At the Virgin Islands, when the Navy station was destroyed, one of the operators, who maintained an amateur station, put his set on the air and broadcast a warning to the United States in advance of the disturbance. As a result, amateurs in Florida and other Southern States had established emergency communication routes before the storm had reached this continent. Particular credit is due to two amateurs at Palm Beach who, although they lost their homes and personal belongings, put their amateur set into operation, and for three days furnished the only means of communication with northern points from the distressed area. State, Army, and municipal authorities were high in their praise of this service.

"In addition to emergency work, amateurs afforded home contact with many exploring and scientific expeditions."

Strays

CHANGE IN STANDARD FREQUENCY SCHEDULES

Effective Sunday, Feb. 2nd, Standard Frequency Schedule "CD" transmitted by W9XL will start at 3:00 p.m., C. S. T., instead of at 4:00 p.m. as announced in the January issue of *QST*. The frequencies transmitted and division of time will be the same as previously announced.

"Skeezix" of Gasoline Alley fame may some day grow up to be a real radio amateur. Just recently he put up an antenna using wire which he found "while the telephone men were having lunch." We're hoping to sell Walt a *Handbook* for the youngster.

W6BLR is owned by A. Ham, 624 S. 14th St., San Jose, Calif.

—W6ID.

QST's Catch Fire!

En route from Concord, N. H., where *QST* is printed and mailed, a railway mail service car caught fire, due to defective wiring, near Ayer, Mass., and a number of magazines were destroyed. Amongst them were a few sacks of *QST*.

If you had to write for a duplicate we offer this as an explanation.

Revolutionizing High-Frequency Tuner Design

A Highly Selective Receiver Which Covers 13,000 kc. Without Plug-in Coils

By W. H. Hoffman and D. H. Mix*

The enthusiastic reception given this receiver by amateurs assembled at the Pacific Division Convention, where it was first presented by Fred Schnell, is indicative of the popularity which its type will enjoy among amateurs and all high-frequency enthusiasts the world over. Actual operation of the receiver is a revelation in selectivity and generally pleasurable reception. — EDITOR.

SATISFACTORY tuning control at the high frequencies in which the transmitting amateurs, the short-wave broadcast enthusiasts and the commercial interests are deeply interested, has been a more or less serious problem ever since the use of these frequencies

est movement of the vernier knob of the tuning control caused the signal to disappear and it was possible to hold the signal for any appreciable length of time only when the operator used a vise-like grip on the tuning knob and held his breath.

With the coming of peaked audio to increase

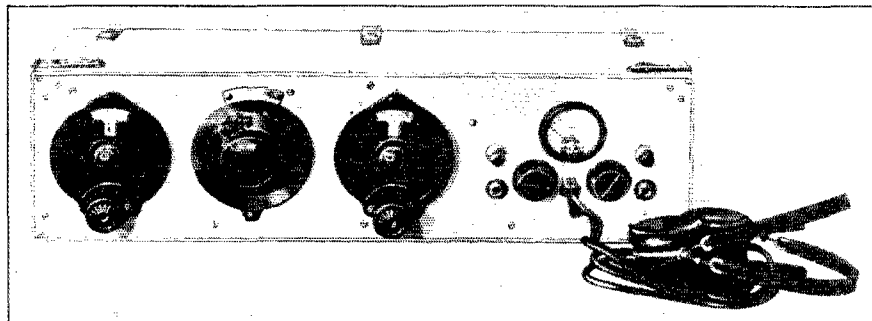

THIS RECEIVER COVERS 13,000 KC. WITHOUT CHANGING A COIL

A high degree of selectivity is attained by use of peaked audio amplification.

was inaugurated. For the amateur the difficulty has become much more serious since the new International regulations, effective since January 1, 1929, sliced the amateur channels to a minimum and forced thousands of amateurs to crowd their transmitter frequencies into three or four bands of a width of only a few hundred kilocycles each. Along with these conditions came an urgent need for a more selective receiver and one which would tune slowly enough so that the pitch of the beat note might be conveniently and easily changed to suit the conditions of interference. With most tuners in use prior to January 1, 1929, the slight-

selectivity, this difficulty was increased tremendously. Realizing the necessity for improvement, several articles appeared in *QST* and elsewhere describing tuners whose tuning capacities were so reduced that the tuning range was limited to only a few hundred kilocycles. This secures the desired results so far as convenient tuning control is concerned. However, if the entire range of the earlier receivers (about 20,000 to 3000 kc.) is to be maintained, an array of some dozen or fifteen plug-in coils is required. Also, a capacity sufficiently small to tune satisfactorily at 15,000 kc. will be excessively slow at 3000 kc. unless some such arrangements as suggested in a recent article in *QST* are used, with which it is necessary not

* W9EK-W9XH-W9AT-W9WF, Engineering and Research Dept., Burgess Battery Company, Madison, Wis.

only to change coils but also to alter the tuning capacity.¹ With these conditions prevailing, it is not surprising to find many operators who confine their entire activity to one of the bands exclu-

range is exceptionally close to straight-line frequency. A glance at the accompanying graphs of Fig. 1 will show how closely this is approximated. The solid lines show perfect straight-line-frequency tuning, while the dots are actual points taken on the receiver.

The tuning system itself is composed of three separate items, all mounted as a single unit on a small bakelite panel. Two of these items are quite new in the short-wave field.

The inductance is in the form of a small variometer. In shunt with the variometer is a "micro" type variable capacity of 135 μ fd. maximum. In shunt with this capacity is another variable capacity of special design in which both rotor and "stator" plates are movable. The action in general is this: The variometer and "micro" condenser tune the circuit to approximately the desired frequency while the special condenser acts as a vernier capacity of variable ratio and tunes over the desired band. The shafts of the variometer, the "micro" condenser, and the "stator" plates of the special condenser are linked to a single control dial on the panel by means of a system of belts and pulleys. This constitutes a "shift" dial by means of which the operator may shift to any one of thirteen over-lapping ranges at will within a fraction of a second. The rotor plates of the special condenser are turned by a second dial which constitutes the usual band tuning control. The plates of the special condenser are so designed that whatever the position of the shift dial, the frequency range of the tuning control remains approximately constant at less than 1500 kc. per band.

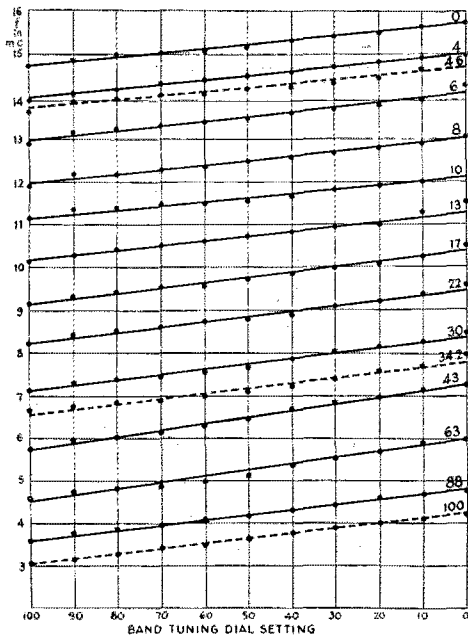

FIG. 1. — TUNING CHART FOR THE RECEIVER

The figures along the right-hand side indicate the shift-dial setting for the band covered. The three amateur bands are shown by the dotted lines.

sively, for by the time he has shifted his transmitter and receiver to another band, the operator finds it is time to retire. In addition, we find a large number of amateurs whose tuners are not capable of tuning to frequencies used by expeditions, naval stations, aircraft, etc., since many are unwilling to build and adjust the necessary additional coils.

It has been with these points in mind that the engineers of the Radio Laboratory of the Engineering and Research Department of the Burgess Battery Company have designed a decidedly new and unique tuning system. This system covers all frequencies from 16,000 to 3000 kc., or approximately 19 to 100 meters without the use of plug-in coils or the necessity of any other alteration inside the receiver. This has been done without sacrifice in the sensitivity of the receiver. At no place within the frequency range of the receiver does the tuning "speed" exceed 1500 kc. per 180-degree dial movement and tuning over the entire

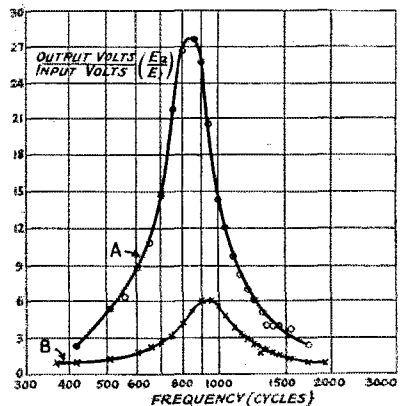

FIG. 2. — RESONANCE CURVE OF THE AERO HI-PEAK AMPLIFIER COMPARED WITH THAT OF THE SAME AMPLIFIER USING A FORD SPARK-COIL SECONDARY

The variometer is provided with a stationary tickler winding for regenerative purposes. It is a feature of this arrangement that the necessity for

¹ High Frequency Receivers for the Coming Year, *QST*, Nov., 1928; Radio Amateur's Handbook, Chapter V.

wide variation in oscillation control often found in short-wave receivers of wide tuning range is practically eliminated since the coupling between the variometer windings and the tickler automatically increases or decreases respectively as the inductance of the variometer nears its maximum or minimum values.

The practical theory of the design is as follows: When tuning is accomplished by variation of a condenser in shunt with a given inductance, the range over which the circuit will tune depends upon the ratio of minimum to maximum capacity of the condenser. In detail, the ratio of the square of the maximum frequency to the square of the minimum frequency obtained in the circuit

which it is desired to pick out 1500 kc. For example: In a change of from 15,000 to 13,500 kc., we have a ratio of only 1 to 1.11, while in a change of 4500 to 3000 kc., we have a ratio of 1 to 1.50, and at all intermediate points on the frequency scale, the ratio varies between these two limits. From this data, we can calculate that, if we desire to cover the range of 15,000 kc. to 3000 kc. in steps of 1500 kc., the tuning condenser must have a variable ratio of its minimum to maximum so that the ratio may be set to any desired point between $(1.11)^2$ or 1.2 and $(1.50)^2$ or 2.25. If wider total ranges of frequency are to be covered by the receiver, it will be necessary to provide means of increasing the variation in capacity

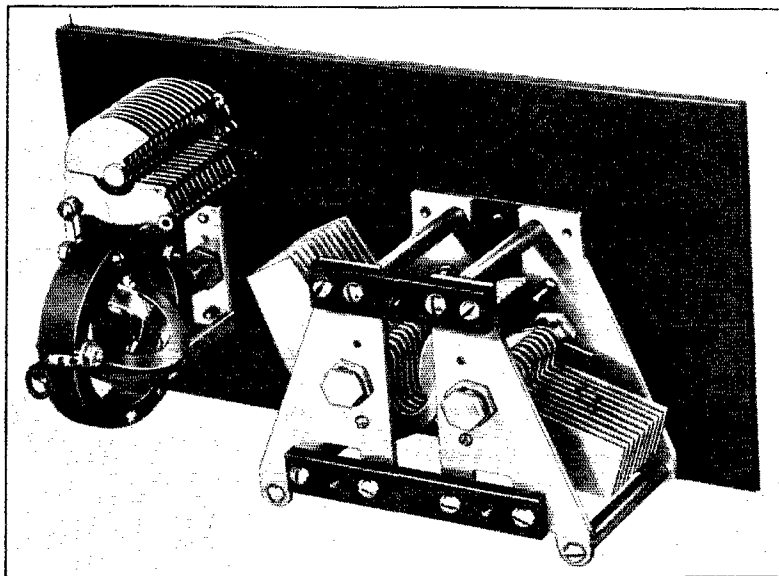

THE COMPLETE TUNING UNIT

The specially designed variable condenser is at the left. The variometer which constitutes the inductance is immediately below the midget variable condenser. The shafts of the right-hand section of the special variable condenser, the variometer and the midget variable condenser are rotated simultaneously by two belts and three pulleys which are on the front side of the panel. The pulleys are all of the same diameter giving 1-to-1 ratio. The left-hand section of the special variable condenser is rotated by a separate control for tuning over the 1500-kc. bands.

is equal to the ratio of the minimum capacity to the maximum capacity of the tuning condenser, or:

$$\left(\frac{f_{\max}}{f_{\min}}\right)^2 = \left(\frac{C_{\min}}{C_{\max}}\right)$$

If a definite frequency range is chosen over which the given circuit must tune with 180-degree dial movement (inductance remaining constant, 1500 kc. in this case) it will be seen that the ratio of maximum to minimum frequency varies with respect to the point in the frequency spectrum at

ratio. Since the extent of the variation in this ratio increases as the square of the increase in frequency range, it will be seen that if the range is extended sufficiently, a limit will be approached determined by mechanical and electrical difficulties. Fortunately, the band of frequencies in which the amateur is chiefly interested falls within these limits. This receiver has not been designed to include the 30,000- and 60,000-kc. regions, but it is our opinion that for most satisfactory work at these higher frequencies a distinctly separate receiver designed for that particular work should be used.

When a variable condenser of the ordinary type is used, we always run into the difficulty of unequal frequency span between the high- and low-frequency ends of the receiver range. A condenser which is small enough to tune nicely at 15,000 kc. will tune unnecessarily slowly at 3000 kc. and requires the use of a large number of plug-in coils because of the successively smaller ranges covered

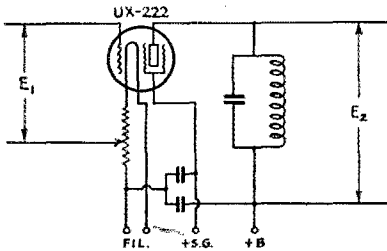
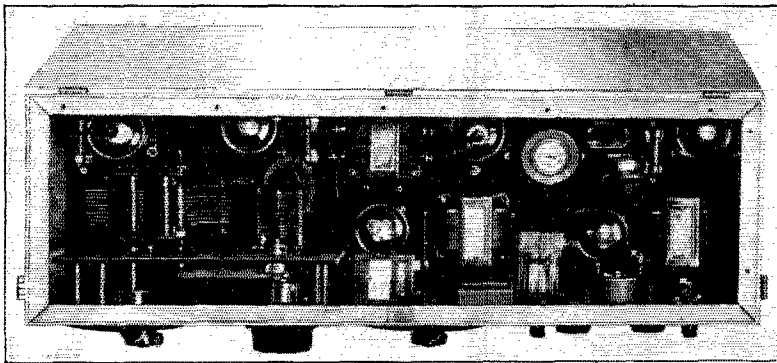

FIG. 5.—THE PEAKED AMPLIFIER ON WHICH THE MEASUREMENTS SHOWN IN FIG. 2 WERE MADE.

by the condenser as the receiver is adjusted to lower frequencies. In case the tuning condenser is made large enough to tune satisfactorily at 3000 kc., only a few coils will be necessary (note the early short-wave receivers) but as the receiver is adjusted to the higher frequencies the frequency coverage will become so great that the successful

the high frequency end, while a corresponding dial movement at the lower frequency end must cause relatively large areas of rotor and stator plates to become interleaved. This may be accomplished in a number of different ways, most of which involve the mechanical shifting of the "stator" plates. In this particular design, which is mechanically simple, it is accomplished by rotating the "stator" plates on an auxiliary shaft, these plates being so shaped that the rotor plates, when turned, interleave with progressively smaller or larger portions of the "stator" plate areas depending upon the position to which the "stator" plates are turned. The plates are so shaped that the correct ratio of maximum to minimum is obtained at all portions of the range. Both rotor and "stator" plates have been further designed so that when used with the associated additional capacity and variometer, almost absolute straight-line-frequency band tuning over the entire range of the receiver is obtained. An additional feature in the simplicity of the design is that, as may be noticed from the cut, the rotor and stator plates are so formed that their size and shape are identical but they are mounted in reverse positions.

Since it is undesirable from both the standpoint of mechanical simplicity and electrical efficiency to use a small inductance and cover the entire range by means of a large capacity, our old friend the variometer has once again been brought back



LOOKING DOWN INTO THE RECEIVER

The tuning unit is at the left. Most of the wiring and the by-pass condensers are beneath the bakelite sub-base.

tuning of a sharp signal will become almost impossible. The reason for this is that the minimum and maximum capacities of the usual condenser remains constant and no means are provided for shifting the ratio from minimum to maximum capacity.

In order that a fair value of inductance may be used, the condenser must be of such design that 180-degree dial movement causes very small areas of rotor and stator plates to become interleaved at

from oblivion. By means of this we are insured of a fair proportion of inductance in circuit at all points within the frequency range of the receiver.

Likewise, it is desirable to have a certain amount of minimum capacity in circuit when working at the lower frequencies where it is possible to use it. This is supplied by the 135- μ mf. "micro" condenser.

Now as to the manner in which these units are assembled in practical form for simple adjust-

same type is used in the second stage of one of the amplifiers to provide means of securing good quality with voice reception, while an Aero "Hi-Peak" tuned impedance is used in the second stage of the other amplifier to secure maximum selectivity in telegraphic reception. This tuned impedance has been especially designed for the purpose and its decided improvement over the usual Ford coil secondary may be seen from the comparative curves of Fig. 2. A four-pole double-throw Yaxley switch throws the headphones to the output of either amplifier through an output transformer (Thordarson R-76), which protects the headphones from d.c. kicks. The switch also makes the necessary connections to place either amplifier in operation. A load compensating resistance is shunted across the filament circuit of the peaked audio system so that the filament voltage remains constant when the change from flat to peaked audio is made.

Referring to the photo of the exterior of the receiver, the panel and case are made of 1/16-inch sheet aluminum. The panel size is 22 inches by 6 inches and the case is 7½ inches deep. The center dial is the shift dial, a National type N which may be reset to any particular setting with great accuracy. Since the divisions on this dial are cut into the metal, it is a simple operation to mark the dial with ink at the points denoting the different bands. The dial to the left is the band tuning control. It is a National type B which, having a reduction ratio of 20-to-1, is well suited for this purpose. The dial to the right is the oscillation control and may be replaced by an ordinary knob with some sacrifice of convenient control. Of the two large knobs under the filament voltmeter, the one to the left is the filament rheostat while the one to the right is the volume control which is quite necessary if headphones are to be used. The small knob to the right of the voltmeter is the filament switch, and the one to the left is the switch controlling the changeover of audio systems.

The interior view shows the general arrangement of the apparatus. The tuning system may be seen in the lower left hand corner, the panel on which the tuning unit is mounted being 8½ inches by 5 inches. The variometer is wound with No. 24 d.s.c. wire. It has 4¾ turns 1½ inches diameter on the stator and 4½ turns 1¼ inches diameter on the rotor. A fixed tickler of 5 turns of No. 28 d.s.c. wire is mounted adjacent to the stator winding. The special condenser has a total of 21 plates.

The antenna coupling tube and the detector tube are immediately to the rear. While the antenna coupling tube adds materially to the sensitivity of the receiver, its more important function is that of eliminating all body capacity effects and insuring constant calibration of the receiver regardless of antenna conditions. The two audio systems may be seen to the right of

the changeover switch. The absence of wiring above the sub-base will be noticed since most of the wiring and the by-pass condensers have been located under the sub-base. All wiring is tightly bound together in place with heavy thread. It will be noticed from the circuit diagram that by-pass condensers have been generously used in all battery leads. This was done in an attempt to remove the "threshold" howl and other objectionable audio squeals. The efforts were well rewarded with a remarkably quiet receiver free from audio squeals or whistles of any kind.

As an indication of how closely a particular tuning setting may be duplicated, it has been found possible to reset within audibility of a d.c. signal at frequencies as high as 12,000 kc. although settings above this frequency may vary two or three divisions on the tuning dial. Since the beginning of the tuning range may be placed at any desired point by means of the shift dial, it is easily possible to place each of the amateur bands in the exact center of the dial. In Fig. 1, intermediate curves are given for the 14,000 and 7000-kc. bands. The 3500-kc. band happens to fall on one of the regular ranges. The shift dial on this receiver has been marked with red ink at the points denoting the amateur bands to distinguish them from the regular points which are marked with black ink.

This receiver has worked out most satisfactorily in every respect in practice and the builder of one similar to it will find that he has a receiver of good sensitivity, increased selectivity, one free from audio noises, and one which is a real pleasure to handle.

BURGESS LABORATORY TUNER TO BE MANUFACTURED

Just as we go to press, we are advised that the 3000 to 16,000-kc. tuner described by Hoffman and Mix is being manufactured by Aero Products, Inc., of Chicago, and that units will be ready for delivery about April 1st. Inquiries concerning the tuner should be addressed to Aero Products, Inc., 4611 East Ravenswood, Chicago, Ill.—*Editor.*

Strays

"If any of the fellows want a real workmanlike aluminum panel for the 1929 receiver that does not show finger prints and doesn't look like a boiler plate, try this stunt which looks 100 per cent on my new receiver.

"Turn down or carefully whittle one end of a 4-inch piece of ¾-inch wooden dowel so that it will fit into a drill chuck. The other end is left ¾ inch. The idea is to cover the panel with overlapping circular spots in straight rows, made by applying No. 120 emery mixed with oil to the ¾-inch end of the dowel and rotating it on the panel with the drill until the spot is of the desired brilliance. The result is like a basket of diamonds — only less expensive." — WIGZ.

Replacing Antenna Halyards on an Eighty-Foot Mast

By L. B. Robbins*

DOWN on Cape Cod there is a little group of hams centered in Harwich and the radio trouble they don't get into during twelve months of the year isn't worth mentioning.

A year or so ago WIARC, known to the tax collector as Horace Hentz, lost a perfectly good halyard from one of a pair of the nicest transmitting masts the Cape can boast of. He has a pair of masts nearly eighty feet high built as only a sea-faring Cape Codder can build them. They tower above everything in the surrounding terrain. One night, during a cold, Atlantic sleet gale, the halyard on one of the masts parted company with itself. One half came down by the most direct route while the other snaked up through the pulley and came down with the antenna and the rest of the works in a nice tangle. That put WIARC's transmitter out of business for quite a while.

He tried for the best part of a year to get another halyard up to and through the pulley by hook or crook. He tried looping a block and tackle around a stay (guy wire) and tying it up with a kite. Then he attempted to fly a box kite over the mast tip and pull it down when directly over the mast to loop a ring holding over the pulley such a mast was out of the question.

Finally, Hentz rigged up a little "jury" sky wire close to the ground and transmitted for a while but all the time his mind was on the two useless masts outside in the yard.

Last summer a new ham, from Hopedale, Mass., came down to the Cape and moved into a summer house near WIARC. His name is E. A. Darling and he goes by the *nom de plume* of WICRZ. When he gets interested in a thing he sees it through. He and WIARC soon became acquainted and the first thing I knew WIARC called me up one hot day to say that WICRZ had doped out a scheme to get a pulley up to the mast tip without stirring off the ground. Would I come over and give them a lift? I would and I did.

WICRZ certainly had a novel scheme. He had built what I shall henceforth call a "jigger." It

looked like a cross between a Kansas grasshopper and a steam engine. It had everything but brains. If some other forlorn brass pounder with an empty pulley at the top of a nice high mast doesn't build one I'll miss my guess, because it did the trick.

The "jigger" had a base made of pine four inches wide and about a foot long. At the bottom

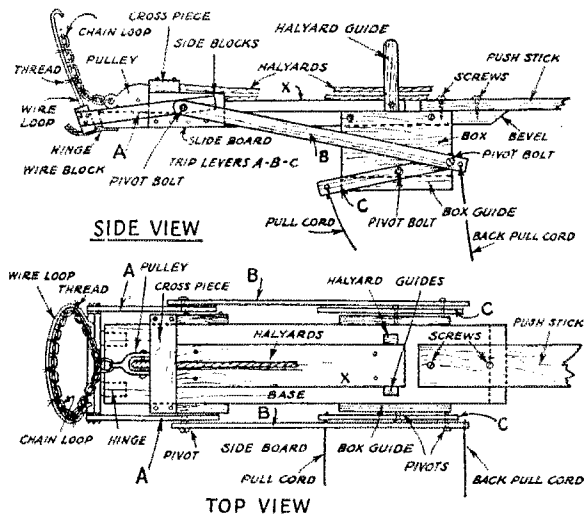

DETAILS OF THE CONSTRUCTION OF THE JIGGER

of one end was hinged a stick across its width and into two holes in the stick were thrust the ends of a loop of stiff, heavy wire. A few inches back were two side boards with a cross piece over the tops, and down the middle of the base was nailed a narrow stick, "X." At its end were nailed two uprights for halyard guides. A stick, "A," was nailed to each end of the hinged piece and led back to the sideboards. These ends were then pivoted by small bolts to two longer sticks, "B," leading back almost to the end of the base. Directly under the halyard guides a wooden box was fastened to the under side of the base and to the bottom of this box were pivoted two levers, "C." The ends of "B" were pivoted to the back ends of "C." A pull cord was tied to the front end of "C" and a back pull cord to the back end of "B." The new pulley was wired to a loop of chain and this was then tied with thread to the wire loop at the end of the "jigger." The pulley was laid edgewise

*WIAFQ, Harwich, Mass.

on the base under the cross piece and the new halyard rove through it and led along "X" between the halyard guides. The halyards were laid

mentioned, were beveled to ride over the many insulators inserted in the mast stays.

When all was ready one side of the "jigger" box was opened and the box fastened in place again around one of the mast tip stays. Then the free end of one of the 16 ft. strips was screwed to the back end of the "jigger." Halyards were laid in the guides and the jigger carefully pushed up the stay. When the end of the 16-foot stick was reached a second was fastened to the first. Screws were always used to add strength to the assembly. The combined weight of sticks, halyards, and "jigger" became almost unmanageable by the time the "jigger" had reached the mast tip and it took two men to steady it. Finally an observer

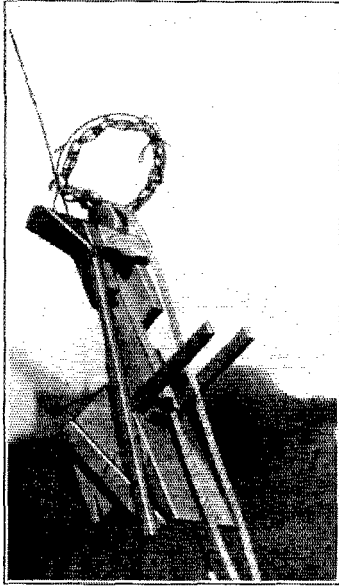

A CLOSE-UP OF THE "JIGGER"
(Minus feathers!)

along the ground, pull cords were cleared for action and the hoisting apparatus was prepared.

Hoisting apparatus consisted of five 16 ft.

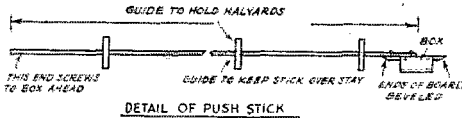

DETAIL OF PUSH STICK

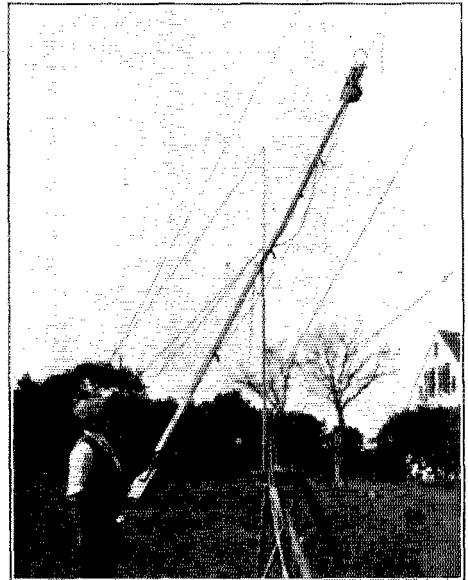

THE "JIGGER" WITH SEVERAL LENGTHS OF
HOISTING FURRING

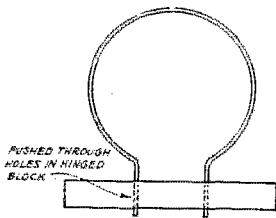

DETAIL OF WIRE LOOP

lengths of 1" x 2" furring with three pairs of guide sticks nailed along their edges. At one end of each stick was screwed half the length of a one foot board with a box similar to the one on the "jigger" screwed to its edges. The ends of all these boxes and the end of the jigger, it might be

with a pair of field glasses was stationed at one side to give the signal when the wire loop crawled up over the mast tip. When this crucial moment arrived a quick pull was given on the pull cord. This tripped the levers and the loop settled down horizontally in place right over the top of the mast. It was there to stay. The back pull cord was for tipping it up again if necessary but it wasn't needed.

The "jigger" was then lowered. The wire pulled out of the hinged stick and the chain and pulley, wire loop, halyards and all were left at the top of the mast. It was only necessary to pull down the sticks, disassemble them and clear the stay supporting the "jigger." The halyards were straightened out, and the antenna attached and hoisted to its place in the sky.

(Continued on page 20)

Vacuum Tube Layouts for Telephone Modulation

By E. E. Spitzer*

IN telephone modulation the ideal to be striven for is complete modulation of the carrier output (that is, 100 percent modulation¹) without the introduction of noticeable distortion in the audio frequencies transmitted. If the modulation is below 100 percent, part of the carrier power is being wasted and the service range of the transmitter is reduced without any

age and tank current in Class C amplifiers, there is also a linear relation between plate voltage and plate current. In other words, as far as the high voltage supply is concerned, the amplifier acts like a pure resistance. This fact makes it possible to use a three-electrode tube to vary the plate voltage of the amplifier, in accordance with the audio signal, with a low amount of distortion. The problem of obtaining the largest possible variation of amplifier plate voltage is exactly the same as the problem of obtaining the largest power output from a loud-speaker tube.³ The same limitations hold in both cases, namely, the grid of the modulator or loud-speaker tube must never go positive and the percentage second harmonic introduced into the plate voltage variation must be limited to a definite value, usually 5 percent.⁴

It is well known that loud-speaker tubes with a low amplification factor give a greater undistorted power output than tubes with a high factor. The same thing is true of modulator tubes. As an

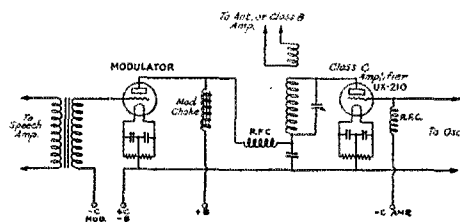

FIG. 1

reduction of the interference range. Requirements for a satisfactory 'phone transmitter cannot be met by a haphazard combination of vacuum tubes. Special tubes have been developed and are available for modulation purposes.

In this article discussion will be limited to one method of modulation, namely, the constant current system. This system has so far proved itself more simple and more efficient than other systems. It makes use of the fact that there is a linear relation between oscillating tank current and plate supply voltage in properly adjusted Class C amplifiers.² For 100 percent modulation the amplitude of the carrier must be varied from twice its mean value to zero. Consequently, by reason of the linear relationship between tank current and plate voltage, the plate voltage must vary over a similar range, i.e., from zero to twice its normal value. If the plate voltage of the Class C amplifier is varied over less than this range, less than 100 percent modulation is obtained.

Besides the linear relation between plate vol-

* Research Laboratory, General Electric Company, Schenectady, N. Y.

¹ Modulation factor may be defined as the variation in amplitude of a modulated wave from its mean value expressed as a ratio to the mean value. It may be expressed on a percentage basis. Thus, 50% modulation is the same as a modulation factor of 0.5.

² Vacuum Tube Amplifier Definitions, QST, Sept., 1929.

³ A Class C amplifier is essentially the same in action as an oscillator. There must be sufficient grid excitation to permit the tube to deliver full output and, thus, to insure the essential linear relation between plate voltage and output tank current. — Editor.

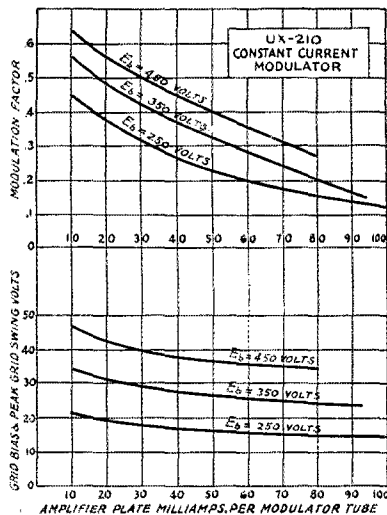

FIG. 2

example, let us compare the UX-210 and the UX-842⁴ as modulators. These tubes have the same oscillator output rating and are of the same

³ "Loud-speaker tubes" are the same as "power output tubes." These are the UX-171-A, UX-245, UX-842, UX-250, UV-845 and UV-849. All but the last have been written up in QST. — Editor.

⁴ QST, July, 1929, page 29.

construction, except for a difference in grid mesh, and consequently differ in amplification factor. The μ of the UX-210 is 8, while the UX-842 has a μ of 3. Suppose a UX-210 Class C amplifier operating from a 350-volt supply and

tubes which permit accurate prediction of the percentage of modulation with any tube layout. The method of obtaining these data will not be explained because it is rather complicated. Their use will be illustrated by several examples. These data are shown in Figs. 2 to 6. The curves apply only to the type of circuit shown in Fig. 1, where the mean plate voltages on the oscillator and modulator are the same. In each case the upper curves give the maximum modulation with a distortion limit of 5 percent. The lower curves give the grid bias and grid swing required by the modulator tube.

Example 1: Class C amplifier consists of one UV-211 drawing 100 milliamperes. Plate supply voltage, 1000. What percentage of modulation can be obtained with one UV-845 modulator?

Referring to Fig. 5, it is seen that at an amplifier current of 100 mls and a plate voltage of 1000, the modulation factor is .62. From the lower portion of Fig. 5 it is seen that a negative grid bias of 150 volts and a peak grid swing of the

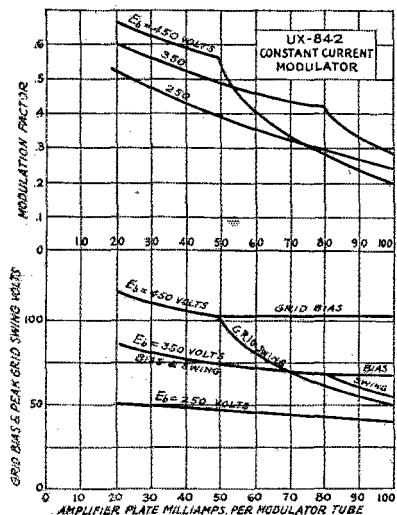

FIG. 3

normally drawing 35 milliamperes is to be modulated in the circuit of Fig. 1.

Calculations from the static characteristics of these tubes show that when the UX-210 is used as a modulator, a modulation factor of 40 percent

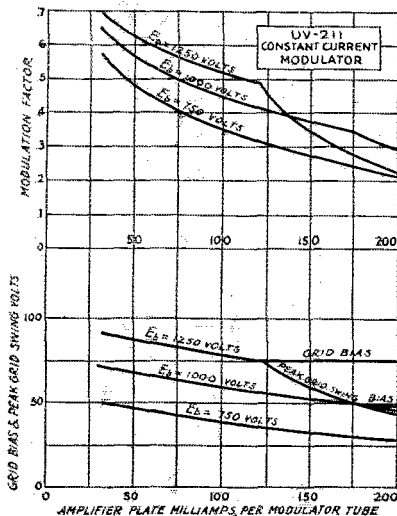

FIG. 4

can be attained. The UX-842 will modulate the amplifier up to 55 percent. This clearly shows the advantage of the low μ tube.

Data will now be given on a series of modulator

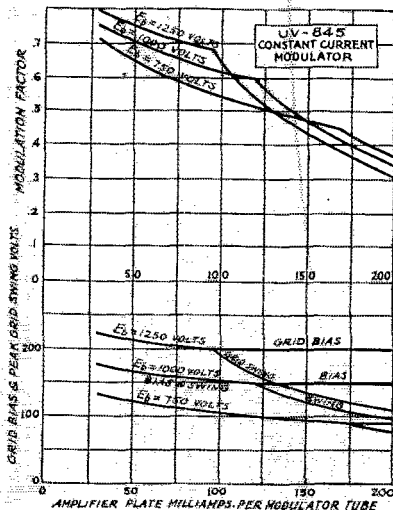

FIG. 5

same value are required. Sufficient amplification must be supplied between the microphone and the modulator grid to give this 150-volt swing.⁵

As long as the mean amplifier and modulator voltages are the same, it is impossible to get 100 percent modulation, regardless of the number of modulator tubes used in parallel. 100 percent modulation can easily be obtained, however, by running the amplifier at a lower voltage than the modulator. This is accomplished by connecting a voltage dropping resistor between the plate voltage supply and the amplifier plate.⁶ This resistor is by-passed by a condenser of low reactance at

⁵ For information on speech amplifier design and determination of modulator grid-swing value see QST, Aug., 1929, pages 11 and 12. — Editor.

⁶ QST, April, 1929, page 10; Low Cost 'Phone, Sept., 1929.

RADIOTRON UX-210 LAYOUT

Amplifier or oscillator
 " plate volts UX-210
 " plate amps. 350
 .060

Tube	MODULATOR					
	Plate voltage	Plate m.a. per modulator	Volts grid bias	Volts peak grid swing	Modulation factor	Ohms dropping resistance
1-UX-842	425	28	-93	81	0.50	1250
2-UX-842	425	20	-107	107	0.73	1250
1-UX-250	450	50	-81	81	0.68	1667
2-UX-250	450	40	-86	86	0.73	1667

RADIOTRON UV-211 LAYOUT

Amplifier or oscillator
 " plate volts UV-211 or UV-203-A
 " plate amps. 1000
 .150

Tube	MODULATOR					
	Plate voltage	Plate m.a. per modulator	Volts grid bias	Volts peak grid swing	Modulation factor	Ohms dropping resistance
1-UV-845	1250	51	-200	136	0.545	1667
2-UV-845	1250	47	-204	204	0.890	1667

LOWER POWER RADIOTRON UX-852 OR UX-860 LAYOUT

Amplifier or oscillator
 " plate volts UX-852 or UX-860
 " plate amps. 1250
 .125

Tube	MODULATOR					
	Plate voltage	Plate m.a. per modulator	Volts grid bias	Volts peak grid swing	Modulation factor	Ohms dropping resistance
1-UV-845	1250	57.5	-200	155	0.53	0
2-UV-845	1250	42.5	-208	208	0.73	0

FULL POWER RADIOTRON UX-852 OR UX-860 LAYOUT

Amplifier or oscillator
 " plate volts UX-852 or UX-860
 " plate amps. 2000
 .125

Tube	MODULATOR					
	Plate voltage	Plate m.a. per modulator	Volts grid bias	Volts peak grid swing	Modulation factor	Ohms dropping resistance
1-UV-849	3000	100.	-133	125	1.00	8000

RADIOTRON UV-204-A LAYOUT

Amplifier or oscillator
 " plate volts UV-204-A
 " plate amps. 2000
 .275

Tube	MODULATOR					
	Plate voltage	Plate m.a. per modulator	Volts grid bias	Volts peak grid swing	Modulation factor	Ohms dropping resistance
1-UV-849	3000	100.	-132.5	83	0.58	3630
2-UV-849	3000	100.	-132.5	125	1.00	3630

audio frequencies, as shown in Fig. 7. To find the true modulation factor for such a circuit, the modulation factor is read from one of the curves of Figs. 2 to 6 at the intersection of the amplifier plate current and the plate supply voltage, and the calculation made as follows:

Let E_b = supply voltage
 E_o = mean amplifier plate voltage

ΔE_o = volts variation of amplifier plate voltage
 p = modulation factor read from curve
 M = modulation factor of amplifier tank current

I_o = mean amplifier plate current
 R = voltage dropping resistance in ohms

Then $\Delta E_o = pE_b$
 $E_o = E_b - I_o R$

Hence,

$$M = \frac{\Delta E_o}{E_o} = \frac{p E_b}{E_b - I_o R} \dots (1)$$

Example 2: Calculate the modulation factor of the system shown in Fig. 7. The amplifier is to

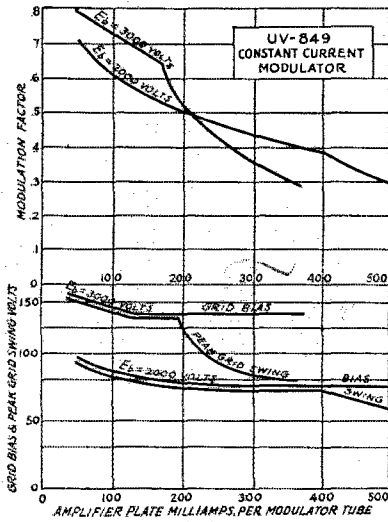

FIG. 6

operate at 2000 volts drawing 250 milliamperes and the modulator at 3000 volts. The drop in R, therefore, must be 1000 volts.

Hence,

$$R = \frac{1000}{.250} = 4000 \text{ ohms.}$$

From Fig. 6, $p = .69$, by equation (1)

$$M = \frac{.69 \times 3000}{2000} = 1.03$$

The voltage swing on the grids of the modulators would have to be cut down slightly by means of

This computation can be made directly from the load characteristic plotted on the plate current-plate voltage curves for the modulator tube being considered. Such curves for the UX-842 are shown on page 28, QST, July, 1929, and for the UV-845 on page 25, QST, Nov., 1929.

To determine the proper amplifier mean plate voltage (d.c. plate voltage) for a desired percentage of modulation,

$$E_o = \frac{E_{max} - E_{min}}{2M}$$

- Where E_o = mean plate voltage of Class C amplifier.
- E_{max} = maximum value of modulator plate voltage.
- E_{min} = minimum value of modulator plate voltage.
- M = percentage of modulation, expressed as a decimal.

Similarly, to determine the percentage of modulation obtainable with a given value of amplifier mean plate voltage,

$$M = \frac{E_{max} - E_{min}}{2E_o}$$

— Editor.

the gain control in order not to shoot over 100 percent modulation.

TYPICAL MODULATION LAYOUTS

The purpose of this section is to suggest modulator layouts both for those who are planning to convert a telegraph into a telephone and those who are planning the construction of a new telephone transmitter. To those coming under the first classification, it is suggested that the output tube be modulated directly. The following tables give the best modulator layouts for the most commonly used output tubes. For those starting in new, any of these layouts can be chosen and if, later, it is desired to increase the power of the transmitter, additional stages of Class B amplification can be added without changing the original layout. The modulated r.f. output of the low power transmitter can be amplified directly then. Class B amplification must be used in the added stages rather than Class C amplification because the former will amplify the modulated carrier without distortion, whereas the latter will not.

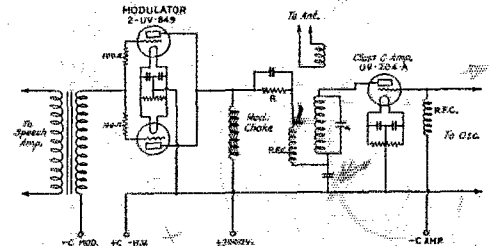

FIG. 7

Thus it is possible to start in a modest way without the necessity of discarding tubes when the power is to be increased later.

In each of these layouts, several modulator combinations are given. The modulators are usually run at a higher voltage than the amplifiers to give a greater modulation factor. This necessitates the use of a voltage dropping resistor (R in Fig. 7) whose value is given in the last column.

Where two modulator tubes are specified, they are to be connected in parallel.

It will be noticed that the UX-852 is run at 1250 volts with the UV-845 as modulator. If it is to be operated at 2000 volts, a modulator tube rated at 2000 volts or more (such as the UV-849) would be best. By operating at 1250 volts the UV-845 modulator can be used. This layout will put out only about one half the power but is less expensive than the layout using the UV-849 modulator.

Replacing Antenna Halyards

(Continued from page 16)

Who says this wasn't a clever idea? It worked to perfection and any ham with similar troubles will find the building of such a "jigger" well worth the time and effort.

A Flexible Tube and Set Tester

By Herbert W. Jones*

WITH the continuous advent of new types of tubes and receivers on the radio market, it is difficult to keep the test set up-to-date unless it is designed with the utmost care in flexibility and adaptability to changing conditions as an objective. The tube and set tester shown in the photographs and diagrammed in Fig. 1 possesses these qualities of flexibility and adaptability and may be expected to greet the coming of new type tubes and receivers with ready readings.

The adaptability feature is obtained by making use of adapters accommodating four- or five-prong tubes while the flexibility is realized by

the panel is 8 inches wide by 10 inches long. This leaves a space of 2 inches at one end, this space being sufficient to contain the necessary cords

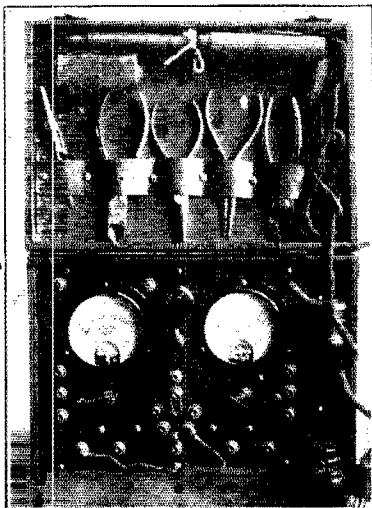

THE TEST SET READY FOR OPERATION

A complete complement of necessary tools is fitted in the lid, while the compartment at the right provides space for the cables and plugs. The one and only switch immediately below the tube-socket is used for the grid-shift test.

the incorporation of pin-jacks in conjunction with flexible cords in place of the usual conglomeration of switches and push-buttons. But two meters are required and the arrangement permits compacting the whole set, including necessary service tools, in a comparatively small case. The cost, incidentally, is nominal to say the least. This one represents an outlay of \$28, tools included.

CONSTRUCTION

The carrying case is 8 inches wide by 12 inches long by 3 inches deep, inside dimensions, while

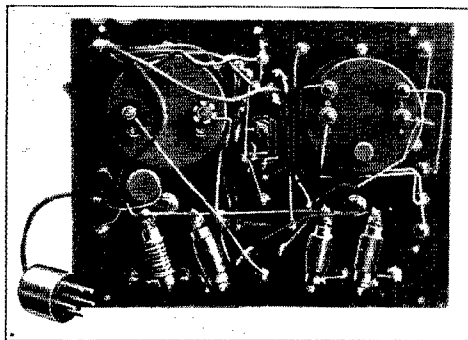

THE WORKS BEHIND THE PANEL

The a.c. voltmeter is at the right. The milliammeter is to the left with its shunt immediately below it. The Darohn resistors used as multipliers in converting the milliammeter to use as a voltmeter are mounted along the bottom. The tube-base at the left is plugged into the receiver being tested.

and plugs. Mounted on the panel front are the meters, pin-jacks, UY-type socket, and grid-shift switch. The multiplier resistors and milliammeter shunt are on the back of the panel, while the tools fit into place in the cover. The five pin-jacks connected to the socket terminals are so located as to conform to the arrangement of contacts in a UY-type socket. This similarity in location of the respective terminals makes it easier to remember the proper connections for various tests. A piece of felt "pool-table" cloth has one of its edges tacked to the inside of the front edge of the case. When "on location" this cloth is folded back under the test set and contributes to the service man's good will by preventing the scratching and marring of the customer's furniture when the tester is set up for business.

Two adapter plugs are required, one for adapting a four-prong base to a five-prong socket and one for adapting a five-prong base to a four-prong socket. Pilot sub-panel type sockets, one UX and one UY, are used in conjunction with the tube bases, one UY and one UX respectively. These sockets are easily fitted to mount snugly inside the top of the tube bases by dint of a little filing. Fig. 2 illustrates the proper connections between the sockets and their respective tube-bases. For connection between the test set and receiver, a five-wire cable 36 inches in length terminating in a UY-type tube-base properly

* W9DUH, 3107 So. 14th St., Omaha, Neb.

connected is used. For checking a receiver utilizing tubes of the UX-type, either a.c. or d.c., the cable-plug is used in conjunction with the four-prong to five-prong adapter, the tube from the receiver being placed in the five-prong to four-prong adapter and plugged in the test-set socket.

In addition to the equipment shown in the photographs and circuit diagram, there are two

obtained. Since the meter scale is divided into 100 divisions, each division represents 0.1 volt on the 10-volt tap, 0.2 volt on the 50-volt tap, 2.5 volts on the 250-volt tap and 5 volts on the 500-volt tap.

The procedure for checking either a.c. or d.c. receivers and tubes is, in general, the same. The cable-plug is first inserted in the socket of the receiver. If this socket happens to be that of a four-prong tube, the "5-to-4" adapter is fitted to the cable plug, while for UY-type sockets the plug is simply inserted in the socket without the adapter. The tube from the receiver is next inserted in the socket of the test set, the "4-to-5" adapter being used if the tube is of the UX type. For three-element tubes, the procedure is then as follows:

Filament voltage, a.c. — Insert tip of cord 4 in a.c. voltmeter jack, 3-volt range for -227, -224, -226, -245, etc. type tubes and 15-volt range for -250 and -210 type tubes.

Filament voltage, d.c. — Cord 2 plug in one of F_2 jacks, one plug of cord 1 in the other of F_2 jacks. The other plug of cord 1 is inserted in the 0-10 d.c. voltage jack. If milliammeter (now reading as a d.c. voltmeter) reads backwards, reverse plugs in F_2 jacks.

Plate voltage — One plug of cord 1 in P_2 jack, other plug in d.c. voltage jack of desired range. Cord 2 in F_2 jack for UX-type tubes, in C_2 jack for heater type tubes.

Plate current — Cord 2 in P_2 jack, cord 3 in 0-10 or -100 milliamperer scale jack, depending on normal plate current rating of tube. Lower scale is used for all except power tubes rated at over 100 milliamperes plate current.

Grid bias — Cord 2 in G_2 jack, one plug of cord 1 in d.c. voltage jack for desired range, other plug of cord 1 in F_2 jack for UX-type tubes and in C_2 jack for UY-type tubes.

Tube test, d.c. tubes — Cord in same jacks as for plate current test. Shift grid bias by means of switch, SW.

Tube test, UY-type tubes: Same as above except that G_2 is shorted to C_2 for zero grid bias test.

On screen grid tubes tests for filament and plate voltage are identical with those for three-element tubes. Tests on the grid circuits are, however, considerably different and must be treated.

Screen grid voltage — Plugs of cord 1 in d.c. voltage jack and d.c. voltage jack for range desired (usually 0-250 volt jack). Cord 2 in F_2 jack for -222 type tubes or C_2 for -224 type tubes.

Control grid bias — Same as for three-element

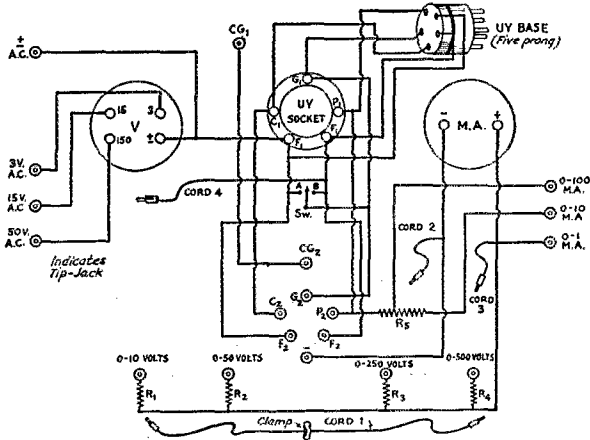

FIG. 1. — THE CIRCUIT DIAGRAM OF THE TESTER

R_1 — 10,000-ohm Super Davohm resistor.

R_2 — 50,000-ohm Super Davohm resistor.

R_3 — 250,000-ohm Super Davohm resistor.

R_4 — 500,000-ohm Super Davohm resistor.

R_5 — Cut-down spool wound with No. 30 copper wire. Tapped for 100-milliamperer range. Correct number of turns must be determined by experiment and calibrated against a standard milliammeter.

V — Type 74 Jewell a.c. voltmeter, 0-3, -15, -150 volts.

MA — Type 64 Jewell d.c. milliammeter, 0-1 milliamperer.

SW — Single-pole double-throw Yazley switch with flat spot filed on cam so that switch can be set in "off" or "neutral" position.

The concentric circles indicate the cord-tip jacks.

"exploring cords." Each of these is 36 inches long, both ends of one of them terminating in cord tips. The other is of the same length and also terminates in cord-tips, but one end has an additional short lead terminating in a clip for the control-grid tip of a screen-grid tube.

Additional necessary details of construction and wiring are clearly shown in the photographs and Figs. 1 and 2.

USING THE TEST SET

To the service man familiar with the usual run of making tests on receivers and tubes, the operation of this set will be perfectly obvious. Details of procedure for several typical tests will not, however, be amiss.

By means of an appropriate tapped shunt resistor, the milliammeter full-scale reading is made either 10 or 100 milliamperes, while by use of the Davohm resistors used as multipliers in connection with the same meter, d.c. voltage full scales of 0-10, 0-50, 0-250 and 0-500 are

(Continued on page 70)

A Power Supply for the Low-Power Transmitter

By George Grammer*

A GREAT many requests have been received for information on the construction of a power supply suitable for use with the transmitter described in December, 1929, *QST*, as well as for other types of transmitters using a UX-210. While there is nothing particularly difficult about the construction of such a power supply, it is appreciated that the beginner is not always in possession of the necessary information, simple though it may be. The unit to be described is one which represents good practice for such an outfit, giving as it does a d.c. supply for the transmitting tube which is for all practical purposes adequately filtered, and capable of producing excellent results in conjunction with a transmitter that is correctly adjusted.

Of the many types of rectifiers available, vacuum tubes are the most satisfactory. They have the advantages that they are easily procured, are silent in operation, take up little space, and are capable of passing considerable current with comparatively little voltage drop. In addition, they are quite cheap, especially the so-called "gyp" tubes, many of which are very satisfactory. Some years ago good tube rectifiers were scarce and expensive, which accounted for the popularity of the chemical rectifier; at present the small additional first cost is more than compensated for in better voltage regulation and freedom from operating difficulties, together with elimination of the frequent cleaning and attention required by the electrolytic rectifier.

There are many transformers now available which have a 1100-volt center-tapped winding, in addition to low voltage windings which supply filament power for the rectifier and power tubes. For transmitter work, one which has two 7.5-volt filament windings is required, unless a separate filament transformer is used for the transmitting tube, in which case one filament winding on the power transformer will be sufficient.

It is better to use a separate filament transformer for the oscillator tube, because the filament voltage will be less affected by the fluctuating load on the plate supply transformer caused by keying. A change in the oscillator filament voltage causes the frequency to change somewhat also, and may result in chirps. However, a separate transformer means more expense, which the builder may not wish to incur.

It is the aim of every amateur who is considerate of the other fellows and proud of his own station to make his transmitter note as steady and nearly pure d.c. as possible. Much depends on the adjustment of the transmitter; this has been dwelt upon many times previously in *QST* and need not be gone into here. Of almost equal importance is the filter used, by means of which the



SUGGESTED POWER SUPPLY ARRANGEMENT

Any convenient layout may be used, as the efficiency of the unit will not be affected by the physical relation of the parts. The one shown is, however, quite compact.

rectified "humps" of alternating current are smoothed out to approximate the type of current supplied by batteries. Long experience at many amateur stations has proved that a simple filter of the type shown in the diagram, known as the "brute force" filter, is ample, and capable of fulfilling the demands of the most critical ham, always provided, of course, that the transmitter itself is adjusted in such a manner as to do justice to a reasonably good plate supply. The development of high-voltage power packs for broadcast receivers has made good filter choke coils and condensers easily obtainable, at much lower cost than previously, and the investment in a good filter is amply justified.

We are quite safe in saying that the power supply illustrated is capable of producing a pure d.c. signal with a good transmitter. Undoubtedly some users will not be able to attain such a note; the answer to such unfortunates is to first put their transmitter house in order before condemning the high-voltage system. All the filter in the world will not help a poorly adjusted high-frequency transmitter.

* A.R.R.L. Technical Information Service.

In building up any power supply unit, it is always well to keep in mind that all the equipment must be amply rated if satisfaction is to be obtained. This is particularly true with filter condensers. Many amateurs, either through lack of

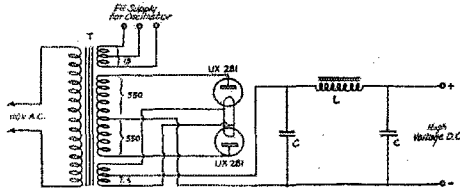

FIG. 1. — THE CIRCUIT DIAGRAM

T — Power Transformer. One with two 7.5-volt center-tapped filament lighting windings and one 1100-volt center-tapped winding is required.

C — 2- μ fd. 1000-volt (working voltage rating) filter condensers.
L — 30-henry filter choke. 50 milliampere capacity for transmitters using a single UX-210, 150 milliampere or larger for two UX-210's.

knowledge or through lack of application of the information they may have, lose sight of the fact that filter condensers must have a voltage rating sufficient to withstand the peak voltages which are encountered in a rectifier system. With alternating current the voltage varies between zero and 1.41 times the r.m.s. value (the value used in all a.c. voltage specifications), assuming a pure sine wave. (Consequently the filter condensers must be able to stand at least 550×1.41 , or 775 volts.) Considerable distortion is sometimes introduced in the wave form in commercial distribution circuits, which may mean that the peak voltage will rise to a value greater than 1.41 times the effective voltage. In addition, there is always the possibility of r.f. feeding back from the oscillator to the power supply, placing a still greater strain on the condensers. The reason for specifying filter condensers rated at a working voltage of 1000 is therefore readily apparent.

The filter choke presents a somewhat different problem. There is not so much danger here of actual damage to the choke, provided, of course, the current-carrying capacity of the wire with which it is wound is not exceeded. The trouble is that the design is likely to be such that even with a comparatively small direct current flowing in the winding the inductance will drop to a value much lower than its nominal rating, with the result that the choke has very little smoothing effect. Much depends upon how the manufacturer rates his apparatus. A good choke always has a core of fairly large cross-section, depending, of course, on the amount of current it is rated to carry, with an air-gap which is large enough to prevent magnetic saturation of the iron. The wire itself must be large enough to prevent undue loss of voltage from excessive resistance. About the only assurance the purchaser has that these

things are right is the reputation of the manufacturer.

From the foregoing there is an obvious conclusion to be reached; it pays to buy only the best when a power supply is being considered. Although it may be necessary to spend a few more dollars at the beginning, the difference will be more than repaid in performance of the apparatus and lack of replacement expenditures, which are almost sure to be the result of misguided economy.

The various parts themselves may be arranged in practically any manner which suits the builder's fancy. The arrangement shown in the photograph is quite compact, fitting on a 10" x 14" baseboard, which makes the unit match up with the receiver and transmitter described respectively in the November and December, 1929, issues of QST. There is very little to be said about either building or operating it. It should, of course, be handled carefully, because the voltage is high enough to cause considerable discomfort, if not serious injury, should the operator come in contact with the high voltage terminals when the power is on. In particular, the output terminals should never be short-circuited with the power on; this is almost certain to destroy the rectifier tubes.

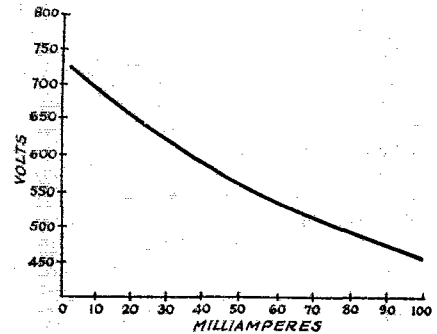

FIG. 2. — A TYPICAL VOLTAGE REGULATION CURVE

This curve will not necessarily be true for all similar units, but is indicative of the results which may be expected.

When the unit is finished, the wiring should be carefully checked before testing. Once the builder is satisfied it is correct, the transformer may be connected to the 110-volt line, and if the tubes light and nothing else happens, everything is probably O.K. The current may now be turned off, and a screw driver touched across the output terminals. If a hot spark jumps, the unit is functioning. Never make this short circuit test with the power turned on. If there is no spark, something is wrong, the wiring should be checked, and the parts tested, if necessary.

Good filter condensers will hold a charge for a long time, sometimes for days. Therefore it is

(Continued on page 72)



Clyde Elden Darr

1879-1929



IT IS our unhappy duty to record a Silent Key at WSZZ. Clyde E. Darr, for many years Director from the Central Division of the A.R.R.L., passed on at his home in Detroit on December 10th after an illness of some months. He was nearly 51 years old.

Darr was one of the best known figures in American amateur radio and a host of friends feel a great loss in his passing. He had an active part in amateur affairs, both locally and nationally, for many years, where his faithfulness and loyalty were unbounded.

He was born in Champaign, Illinois, January 28, 1879, receiving his early education in the public schools of that city and entering business college in Detroit in 1895. He was first an accountant, following that profession for some years in Detroit and New York City, but returned to Detroit to study art and be-

came a very capable illustrator. For the past seventeen years he was art director in the advertising department of the Timken Axle Company of Detroit. Radio amateurs all over the world knew him well in his capacity of artist, for no less than sixty-nine of the cover illustrations of *QST* have been the handi-craft of SZZ, displaying his keen sensing of the atmosphere of "ham radio."

Darr's early communication efforts started with boyhood back-yard tin-can telephone lines and the usual neighborhood telegraph circuit. He became interested in amateur radio in 1912 and from this time on was a dyed-in-the-wool ham. He was pre-war 8AJD. After the war he developed 8CB until

it earned one of the coveted Z calls of those days, SZZ. As he progressed his home became the clubhouse for local amateurs. His experiments were many and he became the leader of amateur affairs in his locality. For many years he was president of the Detroit Radio Association. His was the first station

to broadcast music in Detroit, and he assisted in the installation of the *Detroit News* station, one of the pioneer broadcasting stations of the country.

Few men have a more active record in A.R.R.L. life. Early after the war he was appointed Assistant Division Manager of the Central Division, remaining in charge of Michigan until early 1926, when he became the Manager of the Division. Later that year, when the S.C.M. system went into effect, he became the S.C.M. for Michigan, which post he held until late 1927. In February of

1922 he was elected to the Board of Directors of the A.R.R.L. That was before the days of Division Directors. In the spring of 1924, in the first election under our present constitution, the Central Division chose him as its director and he was reelected every two years thereafter, serving a total of over seven years on the A.R.R.L. Board.

On just the week-end before his death an A.R.R.L. message party was held for Darr, bringing him hundreds of messages of cheer and good wishes from amateurs all over the country. Thus his amateur radio was with him until the end. *Vale, WSZZ!*



Winding Data for the Tube-Base Coil

By George Grammer*

WHILE the charts appearing in the December, 1928, issue of *QST* are of considerable assistance in the calculation of the inductance and frequency range of many coils, they are not particularly adapted to one of the most popular coils found in the amateur receiver. The use of old tube bases as forms upon which to wind a coil results in values which do not, in a great many cases, fall upon the axes as shown in the December charts because of the rather small radius and comparatively large number of turns involved. This could be overcome by extending the axes which, however, would be somewhat inconvenient due to mechanical limitations.

Because of their extreme popularity and the frequency with which information concerning these coils is needed, it was thought that a special chart for this type of coil would be useful. The radius of the coil being constant (11/16 inches) naturally results in considerable simplification which has allowed the addition of a few more related scales which will be of assistance in making general computations.

Let us assume we have a coil of a certain number of turns and length. By connecting the proper values on scales III and IV with a straight-edge, we can read directly the inductance in microhenries on scale V. Now, if we know the capacity range of the circuit in which the coil is to be used, we can hold the point obtained on scale V and swing the straight-edge to the lower and higher capacity values on scale VII, thus obtaining the frequency range directly from scale VI. There are two important things to remember in these calculations: scales IV, V, and VI have two sets of values labelled A and B. Use all A or all B scales for any one set of computation as the results will be far from correct if the A scales are used for part and the B scales for the remainder of the work. The other point is that the minimum capacity of the circuit (assuming it to be the grid circuit of a detector tube) in which the coil is used will not be only that of the variable condenser employed. The minimum capacity of the circuit will usually be many times that of the condenser's minimum, and this will materially decrease the highest frequency to which the circuit will tune as well as reduce the minimum to maximum capacity ratio and the tuning range of the set.

If we wish to know what inductance will be obtained by winding a given number of turns of a definite size of wire upon a tube base, we connect

the proper values on scales I and II for which position of the straight-edge we can read the length of the coil on scale I-II. By transferring this value to scale III, the previously described procedure may be repeated to obtain the tuning range or inductance.

Perhaps the case that will be most common will be of determining the proper number of turns of a given size of wire to obtain a desirable tuning range in the receiver. The first step in these calculations will be that of determining the capacity range of the circuit. The minimum and maximum capacity of the tuning condenser should be known and to these values should be added the "dead" capacity of the other parts of the circuit which parallel the coil and condenser. These comprise the capacity of the tube and coil base and socket, grid-to-filament capacity of the tube, capacity of the wiring, etc. If the antenna is coupled through a small capacity, this will cause a further increase. It is extremely difficult to assign a value for this capacity but in most cases it will probably fall somewhere between 20 and 40 $\mu\text{fd.}$, although it is perfectly possible to have values differing from these.

If a source of frequency measurement is at hand, the maximum and minimum values of capacity in the circuit can be closely approximated in the following manner. First, measure the frequency range obtainable with a given coil, which may of course be one already in use or may be constructed for the purpose. Then find the inductance of the coil from the chart. Having this point determined on scale V, swing the straight-edge between the proper frequency values on scale VI and read the corresponding range of capacity on scale VII. These limits will generally be found close enough to serve for future calculations.

The straight-edge should be run from the point on scale VII corresponding to the capacity of the circuit with the tuning condenser at maximum through the point on scale VI corresponding to the lowest frequency desired in the range of that coil. The point at which it crosses scale V will give the required inductance. Holding this inductance value, the straight-edge can be shifted along scale VII to the lowest value of capacity to check the highest frequency to which the circuit will tune. If the range is too large, the tuning capacity may be reduced or additional fixed capacity employed; the former is preferable. If the range is sufficient, the value of inductance can be varied to put the desired frequency range in the center of the capacity range which

* A.R.R.L. Technical Information Service.

will give more margin as regards the difference between the actual and the guessed-at value of "dead" capacity.

In order to determine the number of turns of wire necessary to give the desired inductance, the number of turns of wire per inch should be

The formula from which the chart was constructed assumes that the coil is in free space, a condition which is of course not realized in practice. The presence of another coil near the one under consideration, such as a tickler coil wound close to the tuning coil or an antenna coil closely

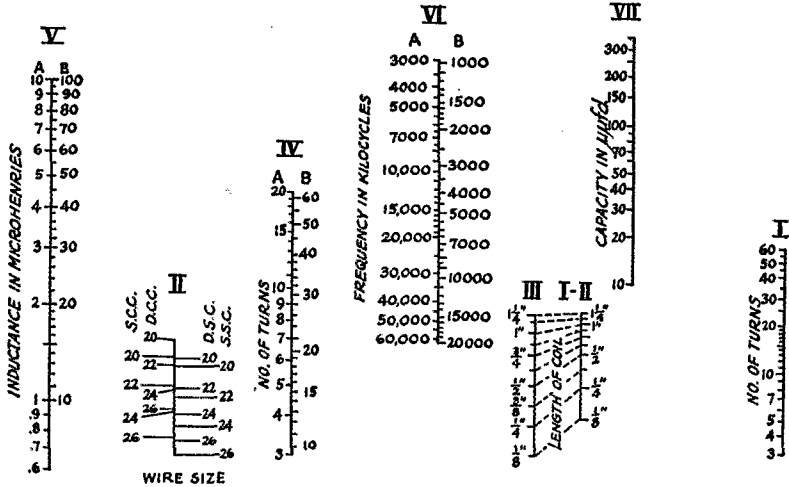

known. By lining up the one-inch point on scale I-II with the size wire and type of insulation as given on scale II, the straight-edge will indicate the number of turns per inch on scale I.

The last step is to find the number of turns to give the required inductance and give the proper length of winding. This value has been reached when the straight-edge connects the inductance value on scale V with the number of turns on scale IV which will just take up the length of winding indicated on scale III. A few trials may be necessary to arrive at this value, but there should be no great difficulty in reaching the proper answer. After the figure has been obtained it would be advisable to go through the problem from the other end to see if the coil determined upon will give the frequency range desired with the change in capacity permitted by the circuit.

The above solution is predicated on the assumption that the wire will be wound with no spacing between the turns. The desired inductance may be obtained without reference to wire size by choosing any convenient length and winding in that space the number of turns indicated on scale IV by the straight-edge when placed so as to connect the proper values on scales III and V. In this case the only limitation to be observed is that a size of wire must be chosen which will allow winding the necessary number of turns in the given space. The use of scales I, II and I-II will readily check this. The wire should be wound so that the spacing between the turns is uniform.

coupled thereto, may result in an effective value of inductance quite different from that which might be expected from calculation. However, if coupling between the coils is loose or capacitive instead of inductive antenna coupling is used, the inductance of the coil will not be effected to any great extent. For many reasons a tickler coil of small diameter compared to that of the tuning coil is desirable, and it has been found that a jumble-wound coil of about 1/4-inch diameter placed inside the tube base at the bottom is very satisfactory. This construction has the added advantage that the coil is easily removed for changing the number of turns if necessary, its field can be readily reversed without rewinding or changing connections, and fine adjustment of feedback may be had by bending it in relation to the tuning coil. Such a coil also has less effect on the constants of the tuning coil than one wound directly alongside it.

It might, at first glance, be considered inadvisable to base a coil design upon a guess that may be very considerably in error. However, there is little else that one can do. This in itself is an excellent reason for the use of the chart which will allow the mathematical work to be done with sufficient accuracy and a considerable saving of time over the use of calculations based directly upon those formulas involved. In all high-frequency work, particularly where the frequency range of the coil will be small, it will be necessary to do the final cutting under oper-

(Continued on page 28)

Easy Correction of Line Voltage

By C. Warren*

ALTHOUGH the a.c. line voltage is usually up around 125 to 130 volts all day, it often happens that along towards evening when the time comes to work more real DX the line voltmeter is found floating around 90 degrees F. — which is not so hot. The first thing Brother Ham generally does is to waste some vitreolic language on the power company. Then he swears that he is going to buy said power company and run it to suit himself — or move out of town.

However, every cloud has a silver lining, and "there are many, many ways of skinning a cat." There is a simple and cheap remedy for even such iniquitous afflictions and here is the one for bad line voltage regulation.

If, after rummaging through the spare-parts box, you find that you are not the owner of a toy (train) transformer, go out and get one, even if you have to buy it. It should have a primary voltage rating of 110 volts, a tapped secondary ranging between 6 and 20 volts in steps of 2 or 3 volts, and its secondary should be capable of carrying the plate transformer primary current. After said toy transformer has been procured, it should be connected as shown in the diagram of Fig. 1.

As an example, if the plate transformer primary is rated at 110 volts and the secondary at 575 volts each side of the center-tap, the ratio is 1 to 5 for each half of the secondary winding. When the line voltage slides down to 90 volts, the secondary voltage becomes 90 times 5 or 450 volts. As shown on the diagram, the secondary of the toy transformer is connected in series with the line voltage and, if the polarity of the toy transformer windings is correct, the voltage applied to the primary of the plate transformer can be brought up to the rated 110 by setting the toy transformer tap-switch on the right tap. If the polarity of the two windings of the toy transformer happens to be reversed, the voltage on the plate transformer primary will be reduced instead of raised and it will be necessary to change connections. However, with the connections properly made for boosting the line voltage, the potential across the plate transformer primary becomes the much desired 110 and the R9 signals sally forth.

If the power transformer is a real rugged one and can stand a little overload without burning up, it is possible to obtain a little more kick from it by adding a few extra volts to the primary supply. Suppose the line voltage to be 115. With

the 5 to 1 transformer, the secondary voltage is 575 each side of center-tap. Now by adding, say, 8 volts to the primary supply via the toy transformer, the secondary voltage is raised to 615.

If the filament winding is a part of the same transformer, it must be remembered that the filament supply voltage will be proportionately

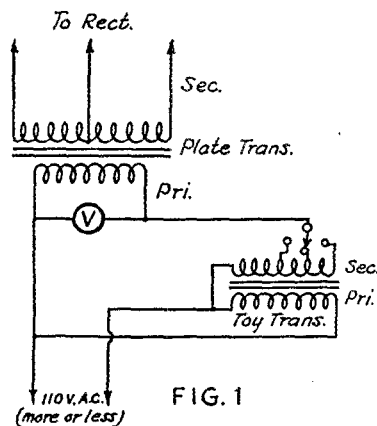

FIG. 1

affected. If the filament winding voltage rating is 7.5, the step-down ratio is 110 to 7.5 or 14.6 to 1. Increasing the primary voltage to 118 volts raises the filament voltage by .55 volts. With a 10-volt winding, the increase would be .72 volts. Usually the filament voltage as measured at the socket terminals is a little low and no harm is done. Remember it is always better to operate the filaments at rated voltage rather than below rated voltage. In trying to get a little more punch out of the plate supply, however, be warned not to go too high or you may be minus a perfectly good power transformer — and perhaps a few tubes as well.

If too high line voltage is the affliction, it may be reduced by connecting the primary and secondary windings so that they buck each other. This method is preferable to using a resistor in the plate transformer primary since it does not affect the voltage regulation as seriously. The same applies to primary control of filament transformer voltage.

Winding Data for the Tube-Base Coil

(Continued from page 27)

ating conditions regardless of the method of calculation employed. This chart should be of considerable help under these conditions.

*W2BVA, Engineering Department, Weston Electrical Instrument Corp., Newark, N. J.

Locking the Transmitter

By Rufus P. Turner*

By rendering the inductive and capacitive values in the radio transmitter permanently fixed, we parallel a condition resulting when the transmitter controls are mechanically locked against adjustment or accidental variation. Such "tightening" of a transmitter, through the employment of constant LC values, is the electrical analogy of fastening the set on one frequency, an amateur practice very popular in some localities in the days when operation upon the single wavelength of two hundred meters was desired. Some of the old-timers will possibly recall how variable condenser shafts and inductance clips used to be soldered fast in the desired two-hundred meter position after the inspector had paid his visit.

Mechanical locking of the controls is to some degree unreliable, but the writer believes that in some equivalent practice there lies a refuge for the 1930 operator, who, though financially unable to provide himself with constant-frequency gadgets, would like to work his set upon a single frequency. If a transmitter is sturdily constructed, then the process of tightening explained herewith is certain to insure constant-frequency operation, provided the operator takes care to keep his antenna scrutinously taut at all times.

In conducting a series of experiments at W9FZN, precedent to the writing of this article, the following order or procedure was observed:

1. A non-varying antenna was erected (see Fig. 1).
2. All lead-in and other wires were made as taut as was mechanically possible.
3. A simple tuned-plate tuned-grid circuit was arranged, which embodied no permanent coils or variable condensers but which was provided with clips for connection to external inductances and capacities.
4. Experiments were launched, clipping in several coils and condensers, cutting and trying the values, and carefully measuring the corresponding frequencies of the combination.

THE ANTENNA

An ordinary wire antenna is always the one part of the transmitter which is apt to cause trouble, its values shifting in proportion to the sagging of the system. The antenna problem was solved by erecting a vertical brass-pipe radiator, as in Fig. 1. To eliminate worries of the same order in connection with a counterpoise, a ground connection was employed.

THE EXPERIMENTS

The cut-and-try experiments began with the building of three simple fixed condensers, whose maximum capacities were found to be 500 μfd . These condensers consisted of a single sheet of mica with a sheet of tinfoil secured to either side

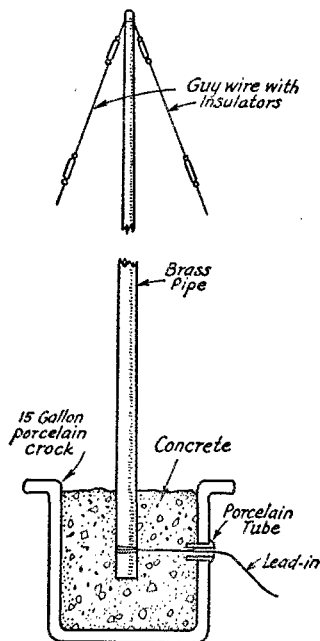

FIG. 1.—THE GENERAL IDEA OF THE ANTENNA IS SHOWN HERE

The weight of the 15-gallon porcelain crock full of concrete will be sufficient to support with the assistance of the guy wires the brass-rod antenna.

with a thin layer of paraffin. Three coils were made of small diameter copper tubing, ten turns per coil, three-and-one-half inches in diameter. The condensers are represented in the circuit in Fig. 2, by C_1 , C_2 , and C_3 ; and the coils by L_1 , L_2 and L_3 .

The set was put into operation with maximum values of both coils and condensers and the frequency found to be far too low. Then the plates of C_1 , C_2 and C_3 were carefully trimmed on the edges with a sharp knife to reduce their capacities and a fraction of a turn unwound from the coils. The frequency was checked again and so on until the frequency of 3500 kc. (85.7 meters) was reached. By the same cut-and-try method, all the values of inductance and capacity to tune

* W9FZN, 604 East 51st Street, Chicago, Ill.

the circuits to this frequency were arrived at. The coils and condensers were then very carefully removed from the set and carried to an engineering laboratory where their values were measured with scientific precision, and where good grade mica condensers were built of a capacity corresponding to those brought to the laboratory. The capacities of these instruments (the fixed

mit. Another trial method would be to provide plug-in variable condensers and a standard set of tuned-plate, tuned-grid coils. After the set is accurately adjusted to the desired frequency, the condensers may be carefully removed, their settings not being disturbed, and their capacities measured in the laboratory. Then fixed condensers might be built which correspond in capacitative values to the capacity settings of the variable ones.

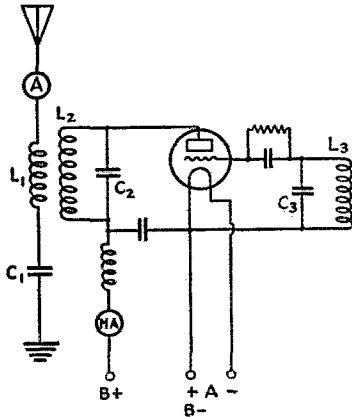

FIG. 2. — IN THE ARMSTRONG CIRCUIT SHOWN, THOSE CAPACITIES AND INDUCTANCES LABELLED ARE THE ONES TREATED IN THE ARTICLE

mica condensers) are unusually ticklish, often differing from each other by a tiny fraction of a micro-microfarad, and there are no such capacities in the marketed fixed condensers.¹ But the writer believes that should a sufficient number of experimenters become enlisted to the cause of fixed-tune transmitters, our manufacturers might be persuaded to supply the fussy capacities.

By the same cut-and-try method fixed inductance and capacity values were found for the 7300-kc. frequency (41.1 meters) and also for 14,400 kc. (20.83 meters). The eventual result was a transmitter that might be operated upon either 3500, 7300 or 14,400 kc. without fear of harmful deviation from the operating frequency.

CONCLUSION

Values of the inductances and capacities found usable at W9FZN are not presented herein, as the writer considers it unnecessary since those values vary in accordance with certain local and individual conditions. The first step is to erect a "fixed" antenna and then proceed with the rest, using the writer's cut-and-try method or proceeding mathematically on paper if the experimenter's engineering knowledge will per-

¹ A cheaper method would be to start off with a suitable fixed condenser and cut the inductance until the proper conditions are obtained. While this would undoubtedly entail considerably more work, the expense would also be very considerably less.—EDRON.

Election Notice

To All A.R.R.L. Members Residing in the CENTRAL DIVISION

1. You are hereby notified that a special election for A.R.R.L. Director is about to be held in the Central Division, A.R.R.L., to fill the remainder of the 1929-1930 term left vacant by the death of Clyde E. Darr. Your attention is invited to Section 1 of Article IV of the Constitution, providing for the government of A.R.R.L. affairs by a Board of Directors; Section 2 of Article IV, defining their eligibility; and By-Laws 9 to 18 providing for their nomination and election. Copy of the Constitution and By-Laws will be mailed any member upon request.

2. The election will take place during the month between March 15 and April 15, 1930, on ballots which will be mailed from Headquarters in the first week of that period. The ballots will list the names of all eligible candidates nominated for the position by A.R.R.L. Central Division members.

3. Nominating petitions are hereby solicited. Ten or more A.R.R.L. members of the Central Division have the privilege of nominating any member of the League in that Division as a candidate for Director therefrom. The following nominating form is suggested:

(Place and date)

Executive Committee,
American Radio Relay League,
Hartford, Conn.

Gentlemen:

We, the undersigned members of the A.R.R.L. residing in the Central Division, hereby nominate of as a candidate for Director from this Division for the remainder of the 1929-1930 term.

(Signatures and addresses)

The signers must be League members in good standing. The nominee must be a League member in good standing and must be without commercial radio connections. His complete name and address should be given. All such petitions must be filed at the headquarters office of the League in Hartford, Conn., by noon of March 15, 1930.

(Continued on page 74)

Improvements in the High-Frequency Receiver

As Found at W4CQ-WBT

By E. J. Gluck*

IN October, 1928, we prepared an article describing a high-frequency superhet receiver which was in use by the gang at WBT. Quite a little interest was evinced in the layout as it combined simplicity, economy and results. Since that time WBT has been changed from a 1-kw. to a 5-kw. outfit and the super does its stuff better than ever by operating in the next room to the big 5-kw. R.C.A. job. A number of changes have been worked out and will probably be of interest to those who are using the old rig.

First, the input transformer to the intermediate amplifier was changed so as to give a band-pass effect. To accomplish this the primary which was originally small and untuned, was made the same size as the secondary and tuned by a midget condenser of 50 μ fd. capacity. As shown by Lester L. Jones in the May, 1928, *I.R.E. Proceedings* in his discussion on F. K. Vreeland's paper on band-pass filters, the band-pass action can be obtained by tuned coupled circuits which resolve themselves into the Vreeland circuit except with looser coupling (inductive instead of direct). These coils can be made by winding two bunch-wound coils on a one-inch form consisting of 1000 turns each and mounting them coaxially side by side with a sheet of empire cloth between and tuning each with a 50 μ fd. XL or midget condenser.

A good idea is to let the control knob of the secondary tuning condenser project through the front of the panel so it can be adjusted. On some signals quite an improvement in signal-to-noise ratio can be obtained by detuning this circuit slightly. The primary-tuning control when once set should not be changed as it will throw off the tuning range of the first-detector grid circuit due to the change in the plate load. Notice that no other condenser is used as a by-pass across the terminals of the first-detector plate circuit.

However, at 30,000 kc. it may be necessary to use a 250 μ fd. condenser as shown in the dotted lines to secure oscillation when using 199's, which is the case here.

The UX-222 stage ahead of the first detector-

oscillator was added mainly out of respect to the other fellow. The gain is small with the untuned input, but worthwhile. However the main reason is that this stage not only eliminates all tuning effects due to different sized aerials and swinging or loose antenna systems, but effectively prevents the continuously oscillating first detector from merrily sending out a carrier wave in our own already-crowded bands or in some other person's back yard. One will find upon adding this stage that a few turns will have to be removed from the inductance to bring the tuning range of the first detector input circuit down. The small capacity of the 222 will load it up some.

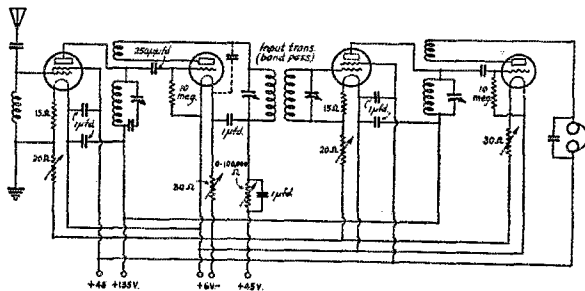

FIG. 1.—THIS MODIFIED ARRANGEMENT EMPLOYS AN UNTUNED R.F. STAGE TO PREVENT RADIATION OF THE OSCILLATIONS PRODUCED BY THE FIRST DETECTOR

The input transformer to the intermediate-frequency amplifier is designed to allow a band of frequencies to be passed. This is accomplished by using very tight magnetic coupling and tuning the two circuits to slightly differing frequencies.

Both the resistor and r.f. choke methods of coupling the antennas were tried and it was found that more background from the B/C transmitter was received with the resistor than the choke. The one in use is 200 turns on a $\frac{3}{4}$ " hard-rubber rod. Doc. Woodruff will probably throw up his hands in horror, but one of his justly-famous doughnut variety will be equally effective! The midget variable shown in series with the antenna is used about half way in while the big B/C transmitter is on, which is most of the time, to keep the r.f.c. from getting hot! No kidding!

Incidentally if you should hear WBT's rebroadcasts of NAA time at noon, these signals are picked up on the rig described above on NAA's 9,000-ke. wave and rebroadcast.

* W4CQ-W4AGE, Engineer, WBT, Charlotte, N. C.

While Listening In

By George P. Taylor*

CQ hounds. More CQ hounds; and those who CQ East (or West) for ten minutes without signing, "... and never the twain shall meet." The distinctive fist of unmistakable identity, "rp" at WIMK. WIZ's everlasting string of dots. The kick one feels on hearing a real op behind a big CC outfit. Excuses for not being in the band. Can't someone originate a Q sig to mean, "Vy glad QSO om es hpe euagn sn 73"? The fellow who very obligingly gives your frequency as "Abt 9 points fm WIZ." WSAO coming thru so easily with his p.d.c. when 90% of the rest are behind the "screen." Photo of a ham station with S.R.O. hung on the 40-meter transmitter. Nice code practice with NAA after 9 p.m. time signals. Trying to copy XDA press in Spanish and translate to English "in your head" all at 30 per!

The "log-cosine" artists in QST who expect everyone to understand it. The hurried but anxious poring over Calls Heard before the post-man gets out of sight. And the indignation that you are absent from the Divisional Reports only to remember that —!

"Untin' Bowler" sounds more like a Pullman car name. The ham or hams who fill the lulls in a QSO with OM's galore. A strange QRMless feeling when copying 500 cycles past oscillation. Who is this "AMSHIBO" that NAA sends so much traffic to? Overhead a frank description of some fellow's note, "Sounds like a power-leak to me." You can certainly "feel" 550 volts d.c. The silver plated thumb tack waiting for that first ZL card. Trying to read your own writing in ye olde log book. Waiting for some "local" to sign his CQ only to find that it happens to be a European. The ham who says OK when he really means ND. That helpless feeling, trying to tune a strange receiver. BCL's listening to code and invariably asking "What's he saying?" And you answer that he is discussing the Farm Relief Bill with a Washington ham ... why not? They never know. That fiendish glee, or what is it, that some hams get in answering a directional CQ when they are in the opposite direction? Six "comebacks" with six SK's at the end of each. 100 degrees in the shade, energy — zero, then, "Sorri om fone rang pse repeat nr 3 CK 45. . . ." Grr, bring on your padded cells!

That "convenient switching arrangement," the nearby woodshed. Curiosity satisfied about how these high ratio vernier dials work; mine is a "one-to-one" now. W9CAT and W9DOG should go R.C.C. on general principles. Day

*W9BAN, 728 Second St., Henderson, Ky.

dreams of a 1-kw. C.C. Is five meters up or down? Plans of a "CQ machine" never quite worked out. Funny names we run across in the call book. The QRM that piles up on Standard Frequency stations. Wonder how many different ops there are at W2CXL? The more or less amusing "vocal c.w." heard on 80-meter 'phone stations. "Correspondence" contributors who have had "something on their chest" for a long time. The party who won't QRX on a nice three-way hook-up. Fairy tales: "Like 40 fine OT no QRM at all down here." Hearing the "Russian" of a compensated wave and failing to locate the English side. The two big pen-and-ink battles; 'phones and QSL. The Golden Rule works splendidly with the QSL problem . . . figure it out. That messy job we plan to do *tomorrow*: putting fresh solution in the rectifier. The limited vocabulary of a key and the new words it learns when you work a YL op. The keen 'photo-print QSL card of W6DFR. The many and varied definitions of the QSA system; opinions not so varied. Expeditions, and the inevitable argument about who got this or that one the strongest. W7AAT with four or five different tones with instantaneous interchangeability. (Gee, can I get by with that last eight-dollar word?) Lastly, the ham who kills time by giving his "specifications" such as age, weight, height, and would tell you 'what he had for supper with very little encouragement.

Strays

Paul M. Segal, ex-W9EEA of Denver, A.R.R.L. Director for the Rocky Mountain Division and former A.R.R.L. General Counsel, in December resigned his post as assistant general counsel of the Federal Radio Commission to enter private practice. He spent nine months with the Commission, during which time he was the author of much important work in the legal division's complex field. Feeling now the call to the wider and more remunerative fields of private practice, he has associated himself with the firm of Donovan & Bond, 534 Washington Bldg., Washington, D. C., where he will specialize in radio law and practice before the Commission.

Have you heard this one?

A Texan returned a neon tube to a New York concern because it was defective. The "defect" turned out to be the fact that the neon tube did not have a filament! *Caveat emptor!*

The Dynatron

A Review of a Forgotten Device, With Some Suggestions for a Revival of It

By W. H. Newbold*

THE subject to be presented in this article is not new. Quite to the contrary, it was originally offered in the radio literature of eleven years ago. In the February, 1918, issue of the *Proceedings* of the I.R.E., there appeared an article entitled "The Dynatron" by A. W. Hull. Four years later, in the March, 1922, issue of the *Proceedings*, a second article entitled "The Dynatron Detector" was presented. Since that time, little has been heard of the device. Undoubtedly the fact that tubes possessing desirable characteristics were not then available to the experimenters had much to do with retarding its field of usefulness. This is no longer the case, for many of

due to the force of its impact. Normally these "impact electrons" or "secondary emission

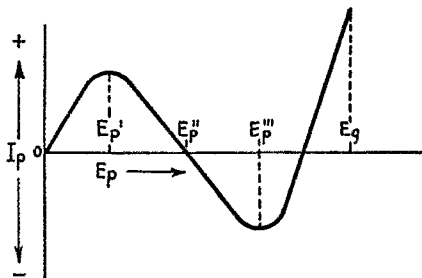

FIG. 2.— TYPICAL DYNATRON CHARACTERISTIC

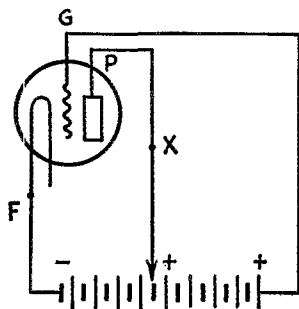

FIG. 1.— THE DYNATRON CIRCUIT

the four-element tubes have a pronounced dynatron characteristic. The writer believes that other experimenters will find this a very interesting device, as he has, and that it should find numerous applications.

THE DYNATRON PRINCIPLE

Before going farther, it would be well to get a good understanding of just what the dynatron is, and how it operates. Suppose three elements are arranged as shown in Fig. 1, where "F" is a hot filament, "G" an open grid, and "P" a solid plate. "G" being at a higher positive potential than "P." Some of the electrons emitted from "F" will get through "G" and continue to "P". Now it is well known that when an electron strikes a metal surface, it may liberate one or more electrons from that surface,

electrons" return at once to the plate from which they originated, for it is usually at the highest positive potential of any element in the vicinity, and there is then no attraction for it to go elsewhere. But in this case, "G" is at a higher positive potential than "P," and it may have a greater attraction for these impact electrons than "P". If this be the case, there are two currents flowing between "G" and "P" in opposite directions, the one consisting of electrons emitted from "F" and flowing through "G" to "P" and the other being the impact electrons emitted at "P" and flowing to "G".

The exact manner in which these electrons behave depends largely upon the relative potentials of "G" and "P". If a current meter be placed in the plate circuit at "X", and the plate voltage be varied, a curve will be obtained similar to that shown in Fig. 2. Briefly the curve may be explained thus: As the plate voltage is increased positively from zero, an increasing number of electrons gets through the grid to the plate, but their velocity at impact is not sufficient to liberate impact electrons until a plate voltage E_p' is reached. Beyond this point, an increasing number of impact electrons are liberated and return to "G". At E_p'' , they are exactly equal to the number striking "P" and the plate current meter reads zero. In other words, the effective current flowing between "G" and "P" is zero. At still higher plate voltages, more impact electrons are returning to "G" than there are filament electrons striking

* Langhorne, Penn.

"P," and the plate current meter must be reversed, for the effective plate current is now in the opposite direction. This reverse current reaches a maximum at a plate voltage E_p''' and beyond this point again decreases to zero and increases in the usual direction. This is because

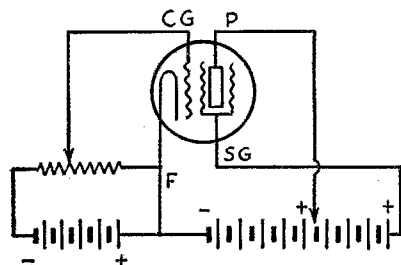

FIG. 3.—THE PLIODYNATRON CIRCUIT

the plate voltage is approaching the grid voltage, and the grid no longer holds any attraction for the impact electrons emitted at "P". When E_p exceeds E_g the plate current is composed entirely of electrons emitted from "F" and the device operates as any normal three element tube.

The most interesting section of this curve lies between E_p' and E_p''' .

A little thought shows that this region possesses a very unusual characteristic, for an increase in plate voltage gives a decrease in plate current. The simplest way to explain this is to say that under the requisite voltage conditions, the region between "G" and "P" within the device possesses a negative resistance characteristic. It cannot be over-emphasized, however, that this characteristic is due solely to the liberation of impact electrons from the plate, "P", under the bombardment of electrons from the filament, and that this liberation of impact electrons from a cold anode is a very erratic phenomenon. It is the writer's understanding that one of the chief reasons this device has not been put into practical usage by commercial interests has been their inability to effectively control the impact electron emission properties of metals suitable for anode use.

It is but a short step further to introduce a second grid into the element structure of the dynatron. This will be a control grid, placed next to the filament, as shown in Fig. 3. The bias placed upon this grid controls the number of electrons from "F" that get through it and continue on to "G" and "P", and so this grid may be made to effectively regulate the magnitude of the negative resistance developed between "G" and "P". When this fourth element is present, the device is called a "pliodynatron."

THE UY-224 TYPE TUBE AS A PLIODYNATRON

Thus far, nothing has been said regarding the application of this dynatron theory to any

of the tubes available today. Of course, a tube intended primarily for use as a dynatron would be designed differently than one intended for other purposes but, happily, the new a.c. screen-grid tubes possess a very good dynatron characteristic. Fig. 4 shows a family of E_p , I_p curves taken on an R.C.A. UY-224 tube with constant E_{cg} of 75 volts at various E_{sg} values. Perhaps the reader may have noticed that most of the published characteristics on these tubes do not include the lower region, where E_p is less than E_{sg} , but here it is—a pronounced dynatron characteristic, with currents of low magnitude. It should be understood, however, that the static characteristic in this region is subject to wide fluctuation, and no promise can be made that two tubes will be found that possess the same traits. The writer has not investigated many of the UY-224 type tubes of other manufacture, but it is quite likely that they all have a negative resistance region similar to that shown in Fig. 4.¹

Since the d.c. value of R_p under any static condition may be obtained from the slope of the E_p - I_p curve at that point, the numerical value of the negative resistance can be obtained from Fig. 4 in this manner. The fact that the slope in the negative resistance region is different for various control-grid biases indicates that this is a convenient method of controlling the magnitude of the negative resistance.

In selecting an operating point, it is desirable to locate the plate voltage in the middle of the

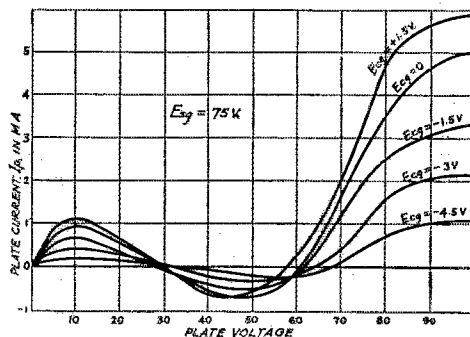

FIG. 4.—DYNATRON CHARACTERISTIC OF THE UY-224 TUBE

negative resistance characteristic. As the curves show, the mid-point shifts somewhat with the control-grid bias, E_{cg} , but in general occurs when the plate voltage, E_p , is about 40 per cent of the screen grid voltage, E_{sg} . The voltage

¹The "dynatron kink" in the characteristic curve for the UX-222 is shown on page 16, QST, December, 1927. Experiments involving the dynatron characteristic of the UX-222 are described on page 49, QST, January, 1928, and in the Experimenters' Section, QST, Oct., 1929. Dynatron characteristics for the UY-224 are shown in Fig. 1, page 41, QST, June, 1929.—EDITOR.

values are not critical. The screen-grid voltage may vary widely, and as long as E_p is kept in proper relation to it, a suitable operating point will be maintained. High voltages, however, mean excessive currents which may damage the tube. Coincidentally, this operating point may also be the point where the plate current, I_p , is zero. This is a condition that is desirable in some applications, but is not necessary. Some tubes may be found in which I_p never reaches zero or reverses, but so long as their I_p-E_p curve possess a region of negative slope of sufficient steepness, they have an adequate dynatron characteristic.

SOME PRACTICAL APPLICATIONS

And now a few words regarding the uses of this device. First and foremost, it is a very interesting oscillator. Fig. 5 shows the circuit arrangement, using a UY-224 tube. Obviously, it is the essence of simplicity. For all practical purposes the oscillations occur at a frequency determined solely by "L" and "C". ("C", of course includes the C_p-C_{s0} of the tube, which is about 15 μ afd.) A. W. Hull has shown that the only requirement for oscillation is that

$$r < \frac{L}{RC}$$

Where r is the numerical value of the negative resistance in ohms; R is the resistance of the LC circuit at the frequency of oscillation, determined by

$$f = \frac{1}{2\pi\sqrt{LC}}$$

L is in henrys and C in farads. The expression $\frac{L}{RC}$ will be recognized at once as the impedance of the parallel resonant circuit at the resonant frequency. To insure oscillation, then, there are two requirements. The negative resistance should be made low and the tuned circuit

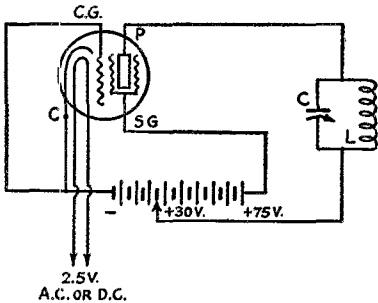

FIG. 5. — THE UY-224 AS A DYNATRON OSCILLATOR

and the erratic behavior and high current that result from a positive bias on the control grid. The tuned circuit impedance may be maximized by proper choice of L/C ratio and low loss construction. At broadcast frequencies, a circuit of the usual constants will be found satisfactory.

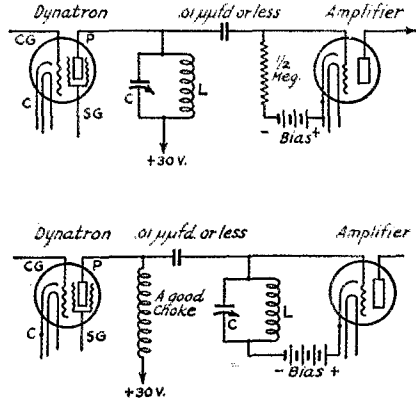

FIG. 6. — OUTPUT COUPLING CIRCUITS FOR THE DYNATRON OSCILLATOR

However, at audio frequencies more care is required. An air core coil is practically essential and large wire must be used to keep down the resistance. Condenser losses also become important and only the best grade of paper or mica dielectric condensers are satisfactory. The difficulties increase as the frequency desired decreases. The writer has succeeded in making the device oscillate at frequencies as low as 100 cycles. Regarding the high frequency limit, little is known. Undoubtedly there is a definite limit, determined in part by the C_p-C_{s0} of the UY-224 type of tube. Experiment at high frequencies should prove very interesting.

There are several other peculiarities of this device as an oscillator that should be mentioned. It is inherently a rather feeble oscillator. It will not supply any appreciable power to another tuned circuit coupled to it. Instead, it will stop oscillating. It can, however, be coupled to another tube by some such arrangement as is shown in Fig. 6, and this second tube may have considerable power output. As normally operated, it has numerous harmonics and, in general, the stronger it oscillates, the greater they are. Hull has shown mathematically that when

$$r = \frac{L}{RC}$$

the generated oscillation is pure sine wave, and for the case where

$$r < \frac{L}{RC}$$

(which is the general case), harmonics are present. The frequency stability is very good, being

impedance high. The minimum value of the negative resistance, as shown in the curves of Fig. 4, is limited by the particular tube being used,

mainly critical to filament temperature. Under normal conditions, with the applied voltages held constant within 5 per cent, the frequency stability compares favorably with the non-temperature-controlled crystal oscillator.

One interesting application of this device is its use as a self-modulated oscillator. Fig. 7 shows the circuit and constants which the writer used in one instance. The dynatron is simply made to oscillate at an audio frequency and a radio frequency simultaneously. Either frequency is under complete control by the constants

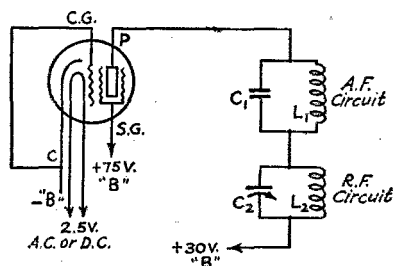

FIG. 7.—THE DYNATRON AS A SELF MODULATED OSCILLATOR

Audio frequency circuit: L_1 —.552-henry air-core inductance with a d.c. resistance of 350 ohms. C_1 —.061- μ f. paper dielectric condenser. Audio-frequency oscillation at 400 cycles. Radio-frequency circuit: L_2 —250-microhenry inductance. C_2 —20-to 400- μ f. air condenser. Constants of r.f. circuit depend upon frequency of oscillation desired.

of its LC circuit and may be directly calculated from these constants. The degree of modulation resulting has not been measured, but it is very likely in the region of 100 per cent. Such an oscillator, with refinements, should be useful in the alignment and neutralization of broadcast receivers. The fact that the audio frequency is under complete control and may be chosen to suit the individual is a feature which most self-modulated oscillators do not possess. The a.f. note from such an arrangement is quite pleasing to the ear. For those interested in an "electrical piano", this makes an interesting plaything. A keyboard may be arranged to place various capacitances in the audio frequency LC circuit, and the "music" may be reproduced through any broadcast receiver by tuning the radio-frequency LC circuit to a convenient broadcast band frequency.

SOME SUGGESTED APPLICATIONS

As has been shown, the dynatron is capable of supplying negative resistance to any parallel resonant circuit. If

$$r > \frac{L}{RC},$$

the circuit will not oscillate, but in effect it will function as if R had been reduced. It should then be possible to greatly increase the selectivity

of an r.f. or a.f. circuit by connecting the dynatron across it. This increases the instability of the system, but should make an interesting field for experiment as applied to the radio-frequency or peaked audio-frequency amplifier of a short-wave receiver. Another suggestion which might prove of value is the incorporation of the dynatron with the forgotten super-regenerative circuit. It has possibilities in any application where a "trigger action" is required.

No attempt has been made in this short review to completely cover the dynatron and its field of application. Those who find the subject of interest are referred to the two I.R.E. articles previously mentioned. The first is a thorough mathematical treatment of the device, and the writer acknowledges it as the source of the greater part of the information here presented. The second article deals with the use of the pliodynatron as a detector, an interesting application which has not been mentioned in this paper. Certainly the device deserves more consideration than it has received in the past, and the writer would be glad to hear from those who find time to adapt it to useful purposes.

Doings at Headquarters

WE are in the thick of the holiday season as this is written. We take this opportunity to thank the many amateurs and well-wishers from all over the world who have added to our cheer and inspiration by their many expressions of good will. In return it is our hope that Santa was right bountiful with crystals, tubes and what-nots.

W6OJ-FK6CR, Mr. Clyde DeVinna, cameraman for M-G-M photoplays, stopped at Hartford one afternoon on his return from a nine-months' "shooting" of the talkie "Trader Horn" around Belgian Congo, Africa. He was just chock-full of hair-raisin' tales of African big-game encounters. It seems that a portable low-power transmitting rig was most important in several instances in keeping harmony and good spirits around the camp fires. We spent an afternoon perusing his unique photographs and mementos.

Mr. Walter Knight, W1CNA, was "in our midst" one afternoon after having returned from a run to the Orient. He is now with the Unifruit, running south this winter.

Messrs. Warner, Hebert and Lamb have once more added themselves to our ranks after trips to the West Coast. Each returned by a different route; "KB" through central U. S. A. stopping over at the Grand Canyon; A. A. H. going south to Texas and home via Washington, D. C., while J. J. L. went north and stopped over for a short visit at his home in Michigan, N. D.

Although our Communications Department has been having its matrimonial and family up-

(Continued on page 43)

A Three-Phase High-Voltage Rectifier

By F. O. Tribbey*

THE rectifier in use here consists of a three-phase full-wave mercury arc rectifier which is sometimes referred to as a six-phase rectifier. The only prerequisite in the way of power supply not generally found in amateur stations is that three-phase service be available.

The parts required for this rectifier are as follows:

- 3 single-phase full-wave mercury arc tubes.
- 3 combination tanks and cradles.
- 1 remote-control solenoid with levers and springs.
- 3 3-henry sustaining chokes each capable of carrying about 8 amperes.
- 3 surge arrestors (5-watt, 1000-ohm resistors).
- 3 ballast resistors, variable to 20 ohms to carry 0.3 amperes.
- 1 keep-alive transformer, with 50-volt plate and 4-volt filament windings.
- 1 polyphase high-voltage plate transformer or three single-phase pole transformers.
- 3 1½ henry chokes.
- 2 2-ampere Tungar bulbs.
- 1 30-henry filter choke.
- 1 1½-henry filter choke.
- 3 1-μfd. filter condensers.

The tanks that hold the oil for cooling the arcs are 6 inches deep by 6 inches wide by 12 long. They are mounted side by side with two inches space between each tank. The shaft that holds the tubes is made of copper tubing. It is flattened out where it goes around each tube, and another piece which passes around the other side of the tube to clamp it, is bolted to the shaft.

The collars formed by the two pieces of flattened tubing are padded and hold firmly but not tightly each individual tube. The three shafts are ganged and one end is fastened to the tilting solenoid. This solenoid is extra heavy and tilts the three arcs as a unit. Light engine oil is used for cooling purposes and the tubes are mounted clear of the bottom and sides of the tanks.

The primary of the keep-alive transformer is wound for 220-volt operation. Its output is 10 amperes at 50 volts. It also carries a filament winding of 4 volts for the Tungar tubes, the filaments of which are hooked in series. This is advisable because their filaments require over 10

amperes at only two volts. In warm weather the keep alive circuit for the three tubes requires 5 amperes at 33 volts. In winter they require 6 to 7 amperes. This current flow is regulated by ballast resistors in the keep-alive circuit. The solenoid is in series with the keep-alive circuit of the front tube. The ballast resistor should be adjusted to give the lowest current in this circuit. Should the line voltage drop, the front arc will go out first and cause the automatic solenoid to tip all arcs, putting them in operation again in

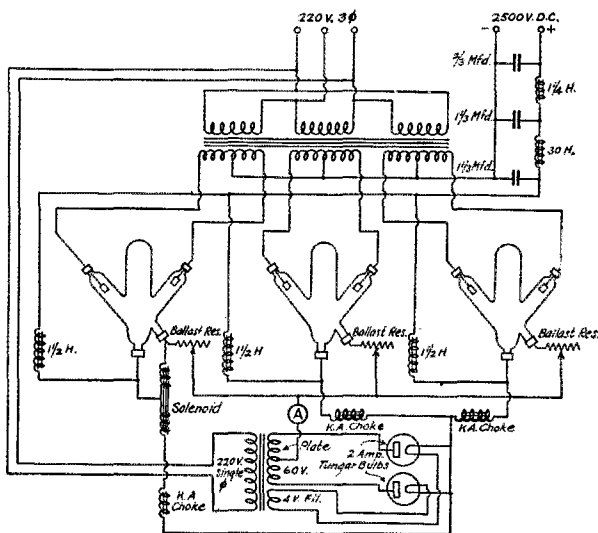

less than two seconds. The arcs seldom go out. The main line switch has two sets of points, the first contact operating the keep-alive transformer and the second set controlling power to the plate transformers. In this way the keep-alive can be turned on for adjustment or observation without having the plate transformers in operation.

The small 1½-henry chokes shown in the diagram are to prevent feed back through the high-voltage lines causing the arcs to go out. If separate keep-alive supplies are used for each arc these chokes may be omitted, but their use simplifies the problem and reduces the cost considerably. The surge arrestors are not shown on the diagram but are mounted on the keep-alive sustaining chokes. They are connected in parallel to the chokes and prevent flashovers.

The lowest frequency present in the output of the three-phase full-wave rectifier is 360 cycles

* W5KX, 120 Main St., Purcell, Okla.

(Continued on page 74)

High-Frequency Inductances

By M. A. Ausman*

THE current flowing into a condenser is given by:

$$I = \pi 2fCE \quad (1)$$

The voltage across an inductance is given by:

$$E = I2\pi fL \quad (2)$$

Thus, the current into a condenser (voltage constant) and the voltage across an inductance (current constant) increases as the frequency increases. Both of these facts tend to make the small capacities between different portions of the circuit more important. At low frequencies in general, the current in different points in a circuit is the same, and displacement currents are present

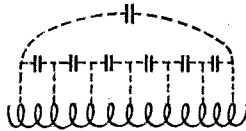

FIG. 1

only when relatively large condensers have been intentionally inserted in the circuit. The inductances and capacitances are definitely localized or lumped. At very high frequencies, however, or when the dimensions of the circuit are comparable to the wavelength, the presence of distributed capacity becomes of vital importance in the efficiency of the inductance.

Distributed capacity may be represented schematically by Fig. 1; a voltage curve is shown on the preceding inductance. It is shown by Equation 1 that there will be a greater current flowing at the voltage node, distorting the waveform, dephasing the current and resulting in loss.

The following is the result of calculations showing the impedance of a condenser at various frequencies, from the formula:

$$Z = \sqrt{R^2 + \frac{1}{(2\pi f)^2 C^2}} \quad (3)$$

Frequency in cycles (meters)	Impedance in ohms		
	1 μ fd.	0.1 μ fd.	0.01 μ fd.
60.	2653.	26530.	265300.
1000.	160.	1600.	16000.
1,000,000. (300)	0.16	1.6	16.
10,000,000. (30)	0.016	0.16	1.6
60,000,000. (5)	0.00266	0.0266	0.266

Now, consider the average broadcast coil of wire 0.026" in diameter (0.020" is about equivalent to B. & S. No. 24) spaced twenty turns to

the inch. The centers of the turns are 0.05" apart. For the sake of ease of calculation, consider the capacity between two turns of a coil as equivalent to the capacity between two rings, in this case, 0.020" in diameter and 0.05" apart. The capacitive area of these rings, effective, is 0.0986 square inches, considering the coil to be three inches in diameter. Now, calculating the capacity from the formula:

$$C = \frac{2,248 K A}{d \times 10^6} \quad (4)$$

where A = area in square inches (in this case, 0.0986).

d = spacing (0.05 inches).

K = dielectric constant which for air is 1.

If cotton or enamel insulation is used, the figure will be higher.

The capacity is calculated to be 0.000000443 μ fd. or 0.443 μ fd. At a frequency of 1,000,000 cycles the impedance is 3,450,000 ohms and at 60,000,000 cycles this impedance becomes 57,600 ohms between turns.

Due to the increased radio frequency resistance of wire at higher frequencies, the wire size goes up to about 0.1" diameter. Immediately, the impedance value of the distributed capacity is divided by five (considering the same spacing between turns) or becomes 11,500 ohms. Meanwhile, the number of turns has fallen off and consequently the voltage between turns has increased enormously. The current flow is thence very great between turns. The waveform is highly distorted and the overall efficiency is extremely low. The stability control also suffers by distributed capacity.

Now, suppose that at a frequency of 60 mc. the coil is enlarged so one turn will furnish the desired inductance and practically dispense with distributed capacity. Then the field of the coil becomes so extended that it induces currents in every piece of metal within a dozen feet. Thus it is practically impossible to situate a coil so that its losses will not be augmented by the effect of metallic objects in its field. Parenthetically, it has been my experience to be in the immediate vicinity of an oscillator putting about twelve kilowatts into the antenna at 60 mc. and the field was so intense that metal rods held in the hand became unbearably hot.

A 60-mc. coil for reception should be about two and one half inches in diameter and wound one turn to about every eight inches of flat ribbon about one half inch wide. The ribbon for a

* Heintz and Kaufman, San Francisco, Calif.

(Continued on page 76)

Passing the Government Examinations for Amateur Operator's License

By Beverly Dudley, Assistant Technical Editor

IN TWO PARTS — PART II

THE last issue of *QST* contained a list of questions and answers concerning the rules and regulations, governing radio communication, which should be useful to prospective amateurs. The second part of this article deals with questions and answers concerning the operation and construction of the amateur station. Although the list of questions given here includes practically all of those asked on the amateur examination, the reader may desire to study the subject more fully. The *Radio Amateur's Handbook* or any other good text will be an invaluable aid in preparation for the examination for amateur operator's license.

Q. 31. Draw a neat wiring diagram of the transmitter and receiver you intend to operate, using standard schematic symbols to represent the various parts. The diagram should show the source of power, antenna and ground, and the name or purpose of each part should be indicated.

A. 31. The applicant for an operator's license is expected to draw diagrams of the apparatus he intends to operate. Any diagrams that *QST* presents can only be considered as examples of what is required. Fig. 1 and 2 are diagrams of simple amateur receivers, while Figs. 3 and 4 are transmitter diagrams. Explanatory legends are given in the cut labels of these figures.

The applicant should prepare and thoroughly understand similar drawings of his own equipment. Diagrams such as are given in Figs. 1, 2, 3 and 4, should not be memorized. The purpose of the examination is to test the applicant's knowledge of the circuit arrangement and the function of the parts. Therefore it is essential that diagrams prepared for the examination be thoroughly understood, not merely memorized.

Q. 32. Draw a diagram of a simple filter system suitable for use on the plate supply system of a vacuum-tube transmitter.

A. 32. A "brute force" filter, consisting of a 2- μ fd. condenser, a 30-henry choke coil, and another 2- μ fd. condenser, is shown in Figs. 3 and 4. The *rated working voltage* of the condensers should be at least equal to the *peak voltage* of the power supply.

Q. 33. Explain the operation of a vacuum-tube oscillator.

A. 33. Suppose we have a regenerative circuit

as shown in Fig. 5 tuned by the coil L_1 and the condenser C_1 in the grid circuit.

The battery A heats the filament which emits electrons when sufficiently incandesced. The battery B is arranged to put the plate of the tube at a positive potential with respect to the filament. Regeneration or feed-back is provided by the coil L_2 . Because of the amplifying properties of three-element vacuum tubes, the power in the

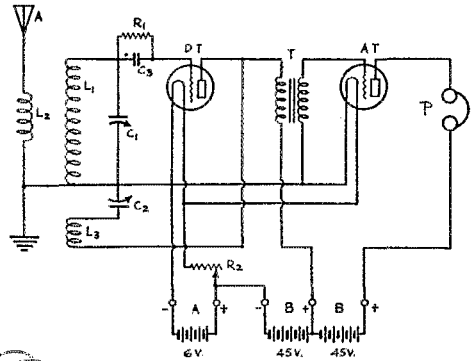

FIG. 1. — A SIMPLE RECEIVER WITH RESISTANCE CONTROL OF REGENERATION

- A — Antenna.
- G — Ground.
- DT — Detector tube.
- AT — Amplifier tube.
- T — Audio frequency amplifying transformer.
- P — Phones.
- L₁ — Grid or tuning coil.
- L₂ — Regeneration coil or tickler.
- C₁ — Grid tuning condenser.
- C₂ — Antenna coupling condenser.
- C₃ — Grid condenser.
- C₄ — Radio frequency by-pass condenser.
- R₁ — Grid leak.
- R₂ — Filament rheostat.
- R₃ — Regeneration control resistor.

Cuts needed.
#1 & 2
QJN

plate or output circuit is greater than that in its input or grid circuit, the additional power being obtained from the B battery. Some of the power in the output circuit will be fed back into the grid circuit. If any disturbance now occurs in the grid circuit L_1C_1 and changes the potential of the grid, this effect will be amplified and will be observed as a considerable change in the plate

current of the tube. Since the plate current flows through the coil L_2 , this change in plate current will induce further changes in the grid voltage of the tube. If this induced voltage is in the same direction as the initial disturbance (i.e., if L_2 is correctly poled with respect to L_1) the same effect is repeated in greater amplitude. If the power

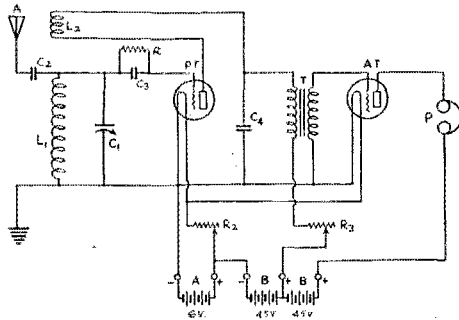

FIG. 2. — ANOTHER SIMPLE TWO-TUBE AMATEUR RECEIVER

- A — Antenna.
 G — Ground.
 DT — Detector tube.
 AT — Amplifier tube.
 T — Audio frequency amplifying transformer.
 P — Phones.
 F_1 — Grid tuning coil.
 L_2 — Antenna coupling coil.
 L_3 — Tickler or regeneration coil.
 C_1 — Grid tuning condenser.
 C_2 — Regeneration or throttle condenser.
 C_3 — Grid condenser.
 R_1 — Grid leak.
 R_2 — Filament rheostat.

fed back from the plate circuit to the grid circuit is sufficient to overcome the losses in the grid circuit, the process builds up to one of continuous oscillation, the amplitude of oscillation being limited only by the curvature of the tube characteristic curves. The frequency of the generated oscillations is, to a very close approximation, determined entirely by L_1C_1 .

Q. 34. Name some conditions which might prevent a vacuum tube from oscillating.

A. 34. There are several reasons why a vacuum tube may not oscillate. The most common ones are listed below:

- (1) Insufficient grid excitation or feed-back.
- (2) Insufficient precautions to keep the audio frequency and direct current in their proper circuits.
- (3) Incorrect or insufficient filament, grid or plate voltage.
- (4) Reversed plate-battery polarity.
- (5) Defective vacuum tube.
- (6) Unusually high losses in the oscillating circuit.

Q. 35. What is a spark transmitter?

A. 35. A spark transmitter is one which utilizes the oscillatory discharge of a condenser

through an inductance and a spark gap as a source of its radio-frequency power.

Q. 36. Why are not amateurs permitted to use spark transmitters?

A. 36. Amateurs are refused permission to use spark transmitters because such transmitters, emitting damped waves, generate an unnecessarily broad and interfering signal.

Q. 37. Explain fully the operation of the transmitter you intend to operate.

A. 37. Here again it should be remembered that the equipment used by the applicant should be described in detail. The following examples are given to indicate what the answers may be like.

In both transmitting circuits (Figs. 3 and 4) the filament of the oscillator OT is heated by the secondary winding S_1 of the power supply transformer T, while plate power is supplied by the secondary S_2 of the transformer. The grid condenser C_4 and leak R_1 provide the proper grid bias when the tube is oscillating, and the key K is used to break the circuit in order to form dot-and-dash characters for signaling purposes. The filter, consisting of the condensers C_5 and the iron-core choke L_4 , smooths out pulsating rectified voltage to direct (continuous) voltage. The resistors R_2 are used to provide a filament center tap for the grid and plate return leads, while the condensers C_2 across these resistors are used as radio-frequency by-passes.

In the tuned-grid tuned-plate circuit shown in Fig. 3, the two-element tubes RT rectify the alternating current for the plate power supply. The filaments of the rectifiers are heated by the secondary winding S_2 of the transformer T. The condenser C_5 is a radio frequency by-pass condenser across the plate voltage supply. When the grid circuit containing the coil L_3 and the condenser C_2 is tuned to nearly the same frequency as the plate circuit which contained the coil L_2 and condenser C_2 , the feed-back through the grid-plate capacity of the tube is sufficiently high to cause the tube to oscillate. The frequency of oscillation is determined by the contents of L_2C_2 and L_3C_2 . These oscillations are transferred to the antenna circuit by means of inductive coupling between the coils L_1 and L_2 . The condensers C_1 are used to tune the feeders F of the Zeppelin antenna, Z, and also to obtain the proper current distribution, as indicated by the ammeters, A. Both ammeters will indicate the same amount of current when the feeders are properly tuned.

The operation of the Hartley circuit of Fig. 4 is somewhat different. In this circuit a number of jars, J, form an electrolytic rectifier for rectifying the alternating plate voltage. These jars contain lead and aluminum electrodes in a solution of borax or ammonium phosphate. Since a shunt-feed circuit is employed, a radio frequency choke coil, L_3 , is necessary to keep radio frequency

voltages out of the rectifier and filter system, while the blocking condenser C_5 prevents short-circuiting the plate supply power through the coil L_2 and at the same time permits the passage of radio frequency power. The circuit is tuned by varying the total number of turns in L_1 and by varying the capacitance of C_2 .

Q. 38. What is the principle advantage of a direct-current plate supply over a plate supply of alternating current?

A. 38. When direct current is supplied to the plate of an oscillator tube, the tube oscillates continuously and steadily at one frequency. The signal from such an oscillator is musical, when an autodyne receiver is used and tuned to within a few hundred cycles of the frequency of the transmitter. When the plate supply is alternating current, the tube oscillates intermittently and only when the plate is at a positive potential with respect to the filament. The frequency of oscillation depends to some extent upon the plate voltage, with the result that the circuit does not oscillate at a single frequency, but oscillates over a band of frequencies as the alternating plate voltage varies from zero to its peak positive value. The result is a "broader" and more interfering signal.

Q. 39. Explain how you would tune a regenerative receiver to a weak continuous-wave signal.

A. 39. The tuning circuit of the receiver should be adjusted as closely to the desired frequency as can be judged from previous experience with the receiver. The tickler or regeneration control should be advanced until a click or thud is heard, which indicates that the detector circuit is oscillating. With the tube oscillating, tuning of the grid or input circuit is varied until the desired signal is heard. The circuit should then be slightly retuned to produce a beat note of pleasing pitch, after which the regeneration control should be retarded until the tube is on the verge of oscillation at which time it is in its most sensitive condition for the reception on weak continuous-wave signals.

Q. 40. Explain in detail the operation of the receiving equipment you intend to use.

A. 40. In Figs. 1 and 2, signals are intercepted by the antenna-ground system and are transferred to the grid circuit. In the case of Fig. 1 coupling is through a small coupling condenser C_2 , whereas in the case of Fig. 2, inductive coupling between L_1 and L_2 is used to transfer the voltage from the antenna circuit to the grid circuit. In both circuits the condenser C_3 and leak R_1 determine the normal grid bias of the detector tube, DT. The filament temperature is adjusted by the rheostat R_2 . The output of the detector tube is coupled to the audio frequency amplifier through the audio transformer T, while the 'phones are used to make plate current variations of the audio amplifier audible.

In Fig. 1 regeneration is controlled by varying

the plate voltage of the detector tube through the series resistance R_3 . A condenser C_4 is used as a by-pass to provide a low impedance circuit back to the filament for the radio frequency component of the rectified signal.

In Fig. 2 the detector plate voltage is kept constant. Coupling between L_1 and L_2 is fixed, and regeneration is controlled by varying the capacitance of the "throttle" condenser C_2 .

Q. 41. What should you do on hearing a ship making a distress signal?

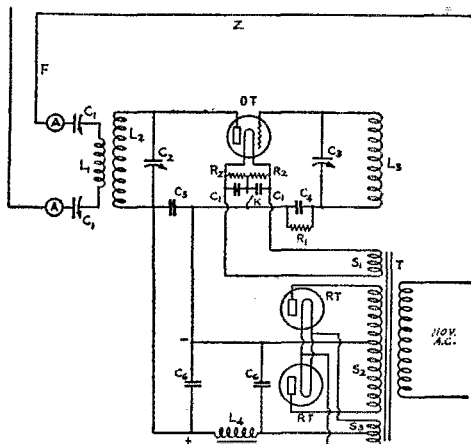

FIG. 3.—SIMPLE AMATEUR TUNED-GRID TUNED-PLATE TRANSMITTER

- F — Feeders for Zepplin antenna.
- Z — Zepplin antenna.
- A — Antenna ammeters.
- OT — Oscillator tubes.
- RT — Rectifier tubes.
- T — Power supply transformer.
- L₁ — Antenna coupling coil.
- L₂ — Plate coil.
- L₃ — Grid coil.
- L₄ — Filter choke coil.
- C₁ — Feeder tuning condensers.
- C₂ — Plate circuit tuning condenser.
- C₃ — Grid circuit tuning condenser.
- C₄ — Grid condenser.
- C₅ — Plate blocking condenser.
- C₆ — Filter condensers.
- C₇ — Filament by-pass condensers.
- T — Power supply transformer.
- S₁ — Oscillator filament heating secondary of T.
- S₂ — Plate supply secondary of T.
- S₃ — Rectifier filament heating secondary of T.
- R₁ — Grid leak.
- R₂ — Filament center tap resistors.
- K — Key.

A. 41. All transmission capable of interfering with the signals of the distressed ship, or of stations communicating with it must be stopped immediately. The operator should continue to listen until it is apparent that the ship is receiving assistance. If no one seems to answer the ship, full particulars should immediately be transmitted by land line to the nearest commercial or government station. Everything possible should

be done to bring assistance to the distressed ship without risking radio interference to those in a position to aid.

Q. 42. State the proper procedure to follow in reactivating a 201-A tube.

A. 42. A 201-A tube may be reactivated by operating the filament at 18 volts for one second, after which the filament should be "aged" by operating it at 7 volts for from 5 to 7 minutes. During this operation no plate voltage should be applied.

Q. 43. How would you test an audio-frequency transformer for an open circuit or burnt-out wiring?

A. 43. A continuity test should be made with a battery and a milliammeter, a head-set or a flash-

part of the output power of a vacuum tube reacts upon its input circuit in such a manner as to reinforce the initial power or input signal and thereby increase amplification.

Q. 45. What effects would result if the polarity of the A battery were reversed in a receiver?

A. 45. Although the signals might be weaker, it is quite possible that the effects of a reversed A battery would not be noticed.

Q. 46. What would happen if the B battery connections were reversed?

A. 46. If the B battery polarity was reversed the receiver would become "dead" and be totally inoperative.

Q. 47. Draw a diagram of a frequency-meter using a thermo-galvanometer.

A. 47. Diagram of an absorption type frequency meter using a galvanometer as a resonance indicator is given in Fig. 6.

Q. 48. Explain briefly vacuum-tube detector action.

A. 48. In a detector circuit using a grid leak and condenser, the grid condenser is connected between the grid of the tube and the tuning circuit. The side of the condenser connected to the tuning circuit becomes alternately positive and negative as the signal is received. At a given instant, let us say that this plate of the grid condenser is positive. The other side of the condenser will take on a negative charge of equal amount by robbing the grid of some of its electrons. This leaves the grid itself relatively positive with respect to the filament, permitting a momentary increase in plate current. During this instant the positive grid attracts more electrons from the filament. As soon as the negative half of the cycle occurs, the plate of the grid condenser which was negative before, now becomes positive, repelling its electrons and forcing them on to the grid so that it becomes negative. The negative grid repels additional electrons but holds all that it has received. It continues to gain electrons during each positive half of the radio-frequency cycle. The result of a continued damped or modulated group of oscillations is to make the grid more negative. This causes audio frequency

dips in the plate current in accordance with the modulation of the incoming signal. Between every group of oscillations the negative charge has time to leak off through the grid leak, allowing the plate current to return to normal.

Q. 49. Explain how you would determine if the frequency of your transmitter was within the legal requirements.

A. 49. This is a very important question, the answer to which depends upon the measuring

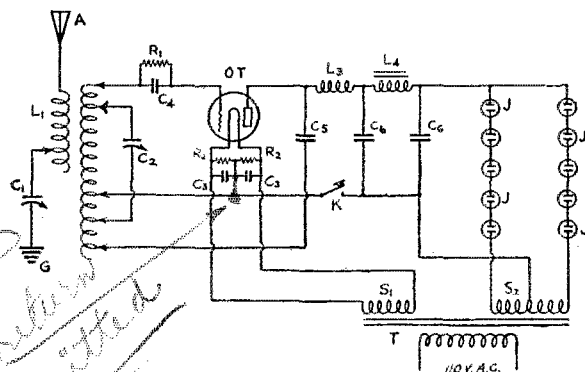

FIG. 4.—SIMPLE HARTLEY TRANSMITTER

- A — Antenna.
- G — Ground (or counterpoise if one is used).
- OT — Oscillator tube.
- P — Power supply transformer.
- J — Rectifier jars.
- K — Key.
- L₁ — Antenna coupling coil.
- L₂ — Tank circuit inductance.
- L₃ — Radio frequency choke coil.
- L₄ — Filter inductances.
- C₁ — Antenna tuning condenser.
- C₂ — Tank circuit tuning condenser.
- C₃ — Filament by-pass condenser.
- C₄ — Grid condenser.
- C₅ — Plate circuit blocking condenser.
- C₆ — Filter condensers.
- R₁ — Grid leak.
- R₂ — Filament center tap resistors.
- J — Jars for chemical rectifier.
- T — Power supply transformer.
- S₁ — Filament heating secondary of T.
- S₂ — Plate supply secondary of T.

light bulb. The winding to be tested should be directly in series with the battery and the milliammeter. If the milliammeter shows current flowing through the circuit, the windings are continuous. If a flash-light bulb is used in place of the milliammeter, the bulb should glow. If a head-set is used, a click should be heard every time the circuit is made and broken.

Q. 44. What is regeneration?

A. 44. Regeneration is the process by which a

equipment available. One desirable method of measurement is briefly explained:

An oscillating vacuum-tube circuit which is mechanically rugged may be used as a heterodyne frequency-meter provided it has been calibrated against some standard and is frequently checked to insure retention of accuracy. To use it, the phones are connected in the plate circuit of the oscillator and the tube circuit tuned to zero-beat with the transmitter. Reference to the calibration curve will indicate the frequency of the transmitting station.

Q. 50. What would be the effect of applying excess voltage to the filaments of vacuum tubes?

A. 50. The useful life of the tube would be greatly decreased.

Q. 51. What would be the effect if the filaments were operated below their normal voltage?

A. 51. If the voltage applied to the filament is too low, there will be insufficient electron emission. In a receiver this would result in weakened signals. In a transmitter whose tubes are operated at normal plate voltage, low filament voltage would result in decreased output and shortened tube life.

Q. 52. Why is it necessary to have all connections in good condition?

A. 52. All connections should be well made to prevent high resistance contacts, and to prevent noise in receivers.

Q. 53. Why is a C battery used in a receiver?

A. 53. A C battery is used to maintain the grid at a sufficiently negative potential to cause a minimum of grid current to flow as well as to prevent the grid from becoming positive during the reception of strong signals.

Q. 54. Of what use is the plate milliammeter in a vacuum-tube transmitter?

A. 54. The plate circuit milliammeter shows the amount of plate current taken by the tube. Thus

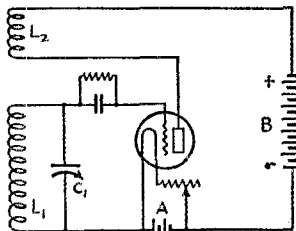

FIG. 5. — SIMPLE OSCILLATOR CIRCUIT

it indicates whether or not the vacuum tube is drawing normal plate current as recommended by the manufacturer. It may also be used to indicate whether the circuit is oscillating or not, and whether or not the tube is overloaded.

Q. 55. What effect does a swinging antenna have on emitted signals?

A. 55. With a self-excited transmitter, a swinging antenna will change the frequency and

strength of the emitted signals. In oscillator-amplifier transmitters or in crystal controlled transmitters the only effect will be to change the strength of the signals, not the frequency.

Q. 56. Can a modulated wave be received on a receiver employing a crystal detector?

A. 56. Yes.

Q. 57. State what you would do if the detector tube oscillated too freely.

A. 57. The tickler or regeneration control should be retarded if the receiver oscillates too freely. If a throttle condenser is used, its capacitance should be reduced; if resistance control of

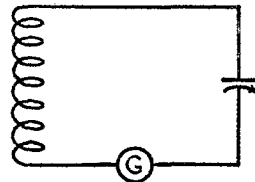

FIG. 6. — FREQUENCY METER WITH GALVANOMETER INDICATOR

regeneration is used, increasing the resistance will in most cases reduce regeneration; if a movable tickler coil is used, the coupling between the grid and plate coils should be loosened.

Q. 58. Explain why an antenna should be rigidly constructed.

A. 58. The antenna should be constructed in a strong and rigid manner primarily for safety reasons. The antenna should be kept clear of trees, buildings, or structures, if possible, and should not be constructed so that any portion of it can at any time come in contact with electric wires or transmission lines. The antenna which is rigidly constructed will also help to radiate better signals since it will not be affected by strong winds sufficiently to cause swinging signals.

Q. 59. What is a counterpoise?

A. 59. A counterpoise is a system of wires or other conductors forming the lower capacity area of a condenser antenna. It is elevated above, and insulated from the ground.

Q. 60. What is a pure wave?

A. 60. A wave may be said to be pure if (when the antenna is oscillating at two or more frequencies) the energy of the smaller wave is 10 per cent or less of that of the power of the larger wave.

This completes the series of articles on "Passing the Government Examination for Amateur's Operator's license." It is hoped that the questions and answers contained in QST last month and this will help some to acquire an operator's license. With this series of questions and answers as a guide, and with "A Simple 1750- and 3500-ke. Receiver" in the November, 1929, issue of QST, and "The Single Control Transmitter" in the December, 1929, QST, aiding in the con-

struction of a receiver and transmitter, the beginner should be well provided with material to get his station operating satisfactorily.

Doings at Headquarters

(Continued from page 36)

sets this past month, we still find the mailing room at capacity every night with announcements of tests, relays and bulletins. F. E. H. was greeted with another son, Herbert William, on November 19th. Our own Robert B. Parmenter, known throughout hamdom as "RP" at WIMK, took the step into eternal earthly bliss on December 24th. Mrs. Parmenter was formerly Miss Frances Sandberg of New Britain, Conn.

George Grammer of our Technical Information Service is the proud father of a baby daughter born on December 24th.

Guess the R. I. must have seen the photo in December QST of the transmitter that R. B. Beaudin built, for he is now the possessor of the call WIBAW.

Well, fellows, now that we have given out our intimate secrets we will see if we can fill up the rest of the magazine with some hot dope on amateur equipment.

—C. C. R.

The West Gulf Division Convention

WHILE the weather was not any too pleasant, the enthusiasm of the delegates from every part of the division attending the third annual convention of the West Gulf Division at San Antonio, Texas, November 22nd and 23rd, made up for it. With Radio Supervisor Theodore G. Deiler in attendance a number of the "hams" were given an opportunity to pass their examination, and from the very beginning the committee in charge saw to it that the program was kept up, and while there were very few technical talks—one especially was most interesting; a practical demonstration and talk on the "interference problem," given by Mr. Joe B. McShane, of the San Antonio Public Service Co.

With several automobiles and a large bus a trip was made to Fort Sam Houston where the delegates were officially received by the officer in charge and an opportunity given to every one to inspect WVB thoroughly and become familiar with the Signal Corps unit of the Army. Later in the day another trip was made to Kelly Field where WYG and the air beacon were inspected.

At the traffic meeting S. C. M., Bob Franklin, had a chance to talk to the O.R.S. and was followed by Fieldman Hebert, representing A.R.R.L. Headquarters, who spoke for the Communications Department.

Of course there were plenty of stunts including cracker eating, soda pop bottles, liar's contest, etc.; just plenty to make every one feel good. San Antonio can feel proud of its amateur stations, as most of them are "1929 type," and one would have to go a long distance to find better stations than W5AHB, W5JC, W5AZD and W5UX. One of the real souvenirs of the Convention is the photograph of the delegates taken in front of the Alamo.

Like all well arranged conventions the banquet was the big event and with a number of YL's and OW's present to lend dignity, it was a big success. Director Frank M. Corlett was the Toastmaster and carried out his part in his very efficient manner. The principal speakers were: Radio Supervisor Deiler; Capt. J. G. Anthony; Lieut. F. J. Keane; John C. Stroebel (old ex-SZW) and A. A. Hebert, who reviewed the legislative work of the A.R.R.L. during the past 15 years.

Our thanks certainly go to the radio manufacturers for their donations of trophies which really help so much to make a convention successful.

The Committee of the San Antonio Radio Club, consisting of Jim Rives, Malcolm McCarty and J. B. Yantis, worked hard and deserve credit for their efforts.

Houston made a successful bid for the 1930 convention. Fellows, begin to save your pennies and plan to attend.

—A. A. H.

Strays

With the servicing of radio receivers becoming more and more specialized, the tinkerer who "once owned a home-made crystal set" is no longer qualified to do a thorough servicing job. The Northwest Radio Trade Association, of Minneapolis, examines those who intend service radio sets and issues certificates to those who successfully pass the examination. Thus, the N.R.T.A. assures the jobber, the dealer, and the customer who has a qualified radio technician servicing the set that the work will be intelligently and carefully performed.

The Station description contest is over but we will continue to run station description articles. Let us have a description of your station, OM. It will be interesting to the others.

The New York papers of October 7th carried the news that the home of Dr. Walsh had been blown up. Gas had been left on in the director's home, which later became ignited. We hope that by this time Dr. Walsh has recovered from the losses sustained in the explosion.

W1KH

A Neat and Effective Amateur Station Which Is Making the Most of Present Conditions

STATION W1KH is owned and operated by G. W. Bailey, 74 Webster Road, Weston, Massachusetts. The owner was an ardent B.C.L., and beginning in 1921 read *QST* from cover to cover. In the winter of 1927 it was decided that the short waves were more interesting than the longer ones, and a transmitting station was planned, all necessary information being gathered from *QST*. Although the owner was over forty, not much difficulty was found in learning the code and getting a license. As a result W1KH went on the air in March, 1927.

Not wishing to forego the sociability of his family, Mr. Bailey built the station into a set of bookshelves in the living room. Out of consideration for the OW, neatness was a great factor in the design of W1KH. The presence of an active sub-junior op of three years (the junior op is eleven) made it advisable to make the station proof against shocks to investigating small fingers. All the components are in dust-proof cabinets and all the wiring covered and completely shock-proof. In November and December, 1928, the transmitter was rebuilt and a new receiver installed, bringing the station up to 1929 requirements.

THE TRANSMITTER

The Hartley circuit was chosen for the transmitter, believing it to be the most simple and effective oscillator circuit for amateur use. It was also decided to use low power, not because of economy and ease of operation, but because DX records which might be made would certainly be much more interesting if made with a 210 tube than if accomplished with a 204-A. At first only one 210 tube was used with a plate voltage of 500

volts. One day the station was visited by "Don and Dick" of W1FL fame, and at their suggestion another 210 was added and has been there ever since.

The panel is 12" x 18" and is of bakelite. The frame for the transmitter was made up of the so-called "printer's furniture" which has been boiled in paraffin. A groove was cut in the sides of the frame members into which were later fitted pieces of plate glass. When the frame was completely assembled, the transmitter was enclosed on the top, bottom and on three sides by plate glass, while the front panel was of bakelite. The glass sides and top form protection against dust and inquiring fingers, but still enable the operator to view the equipment.

As may be seen from the photo, three meters are arranged across the top of the panel, plate current at the left, filament voltage in the center and radio frequency current at the right for one feeder of the Zeppelin antenna. The other r.f. meter for the other "Zepp" feeder is back of the panel, face up.

The current is read through the glass top.

At the left of the lower portion of the panel is the primary tuning condenser, in the center the filament rheostat and switch and at the right, antenna tuning condenser for one "Zepp" feeder. The condenser for the other feeder is on the right side of the frame on a bakelite strip which also carries the two outside leads on the "Zepp" feeders. At the bottom of the frame on the same side is another strip with binding posts which carry the plate, filament and key leads. The transmitter is complete in itself and may be removed from the shelf in a few seconds by loosening eight binding posts on the right side.

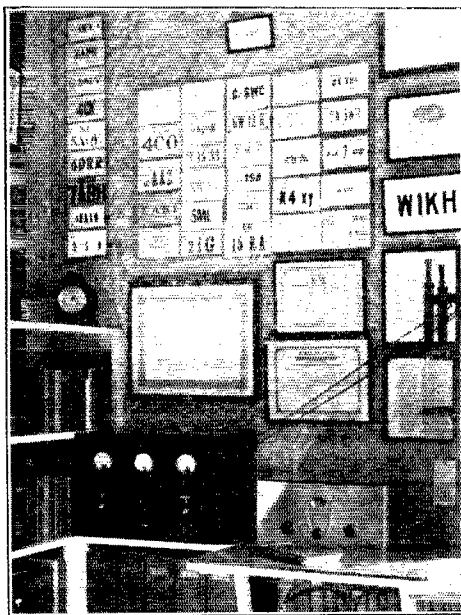

A GENERAL VIEW OF W1KH

Note the convenient arrangement of equipment in this neat station.

The bottom of the transmitter is a glass panel, but across the frame is a bakelite strip which holds the tube, grid leak, choke, key thump choke and supports for the inductances. These supports are bakelite panel brackets placed on end with bakelite spacers at the top of each bracket to hold the glass rods which suspend the inductance. These brackets are secured by shoe lace lashings, so there is no metal in the field of the inductance.

All the inductances are made of copper ribbon,

the plugs are pushed into the jacks a secure connection is formed and the High-C current does not heat them enough to damage them.

The primary tuning condenser is a 350- μ fd. condenser with double spaced plates. The inductance in the tank circuit is so figured that the condensers run with their plates nearly all in on the three bands. National dials which may be marked in pencil are used on the condensers. In addition a chart is kept handy showing the settings of condensers and resulting frequencies for all three bands.

The first grid leak used was a 5000-ohm unit, but it was found that a 10,000-ohm leak helped to produce a true 1929 signal, in spite of the fact there is some decrease in plate current. The center tap resistances are the good old Christmas tree lights. The question of r.f. chokes was studied very carefully. The best choke was found to be 80 turns of 20 s.c.c. wire wound upon a paraffined wooden dowel $\frac{1}{2}$ " in diameter.

A steady signal has been the goal of this station since its beginning, and the transmitter and all its parts are solidly built and securely fastened in place with the result that the station is invariably reported "steady." Without a doubt the steady signal has been a factor in the DX communications.

POWER SUPPLY

This station has a real emergency power supply, using an A battery for filament and 700 volts of wet storage B batteries for plate supply. The storage B batteries were bought at a time when B eliminators were coming into use and dealers were glad to get the storage batteries off their hands at a low price. The batteries are divided into sections, as can be seen in the photograph, each section having an independent double-pole double-throw switch so that the batteries can be cut off the main line and switched on to the output of the charger. Every three months they are removed from the bench and cleaned and the water brought up to level. They need no further attention except charging, for another three months.

A second-hand 600-volt motor-generator was purchased and set up in the cellar. It rests on several inches of rubber scrap which makes it free from vibration. Underneath the scrap is a sheet of zinc. A large box entirely covered with zinc, salvaged from a neighbor's old refrigerator, completely shields that motor generator. Holes are cut in the zinc box and are covered with copper screening for ventilation. The leads are of BX which is grounded. In spite of these precautions there is considerable interference when the motor-

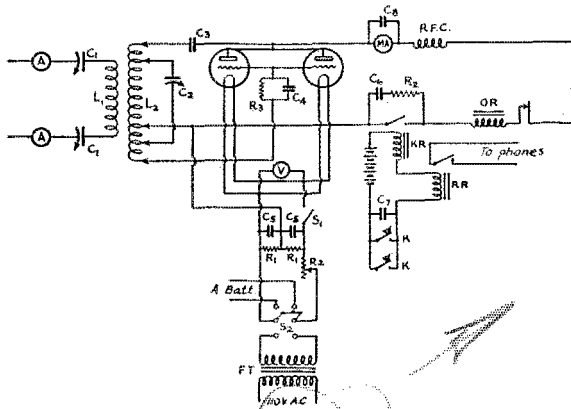

FIG. 1. — THE TRANSMITTER

- | | |
|--|--|
| L_1 — Plug-in antenna coil. | R_3 — 10,000-ohm grid leak. |
| L_2 — Plug-in oscillator coil. | R_4 — 1000-ohm keying resistor. |
| C_1 — Feeder tuning condensers, 350 μ fd. | A — Radio frequency ammeter — 0-1 $\frac{1}{2}$ amperes. |
| C_2 — Oscillator tuning condenser, 350 μ fd. | FT — Filament transformer. |
| C_3 — 500- μ fd. plate blocking condenser. | K — Key. |
| C_4 — 250- μ fd. grid condenser. | KR — Keying Relay. |
| C_5 — 2000- μ fd. filament by-pass condensers. | MA — D.c. milliammeter — 0-150 milliamperes. |
| C_6 — 4- μ fd. keying condenser. | OR — Overload relay. |
| C_7 — 1- μ fd. keying condenser. | PR — Pony relay to short circuit phones. |
| C_8 — 2000- μ fd. protective condenser. | S_1 — Filament switch on transmitter panel. |
| R_1 — Christmas tree lamps for obtaining center tap. | S_2 — Filament switch to change from regular to emergency filament supply. |
| R_2 — 10-ohm rheostat. | |

nickel-plated, and wound on glass supports. The primary coil for 3500 kc. has 11 turns. The secondary has 7 turns. This 7-turn secondary is used as the primary on the 7000-ke. band. The secondary for 7000-ke. transmission has 5 turns. On 14,000 kc. the small diameter coil used for the primary has 7 turns and the secondary has 7 turns. The number of turns on all these bands has been found by "cut-and-try" until there are no dead ends.

R.E.L. clips which clamp on the ribbon and are secured with screws are used. To the tops of these clips are securely soldered General Radio miniature jacks. The various leads to the inductances are No. 10 flexible double insulated cables with General Radio miniature plugs securely soldered to the inductance end. When

generator is in operation. This makes break-in operation uncomfortable, and it is not often used except with emergency plate supply.

During the first part of 1929 two Raytheon 866 tubes were purchased and experiments were made with them to determine the best filter to use. Working on the principle that full-wave rectification gave a 120-cycle hum, a tuned filter was

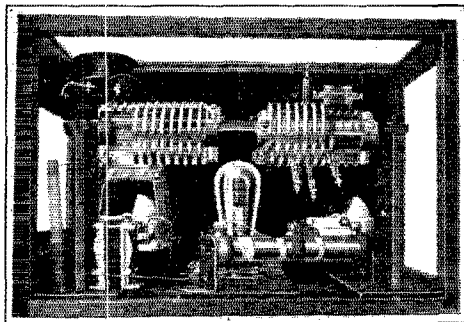

A REAR VIEW OF WIK'S TRANSMITTER

made which works very satisfactorily. As shown by the diagram, a condenser of 6 μ fd. is first placed across the output of the two tubes. Then in the negative side is a $1\frac{1}{2}$ -henry choke across which is a 1.1 μ fd. condenser which tunes the choke to 120 cycles. A smoothing condenser of 5 μ fd. is then placed across the line. In the negative lead another $1\frac{1}{2}$ -henry untuned choke takes care

50-watt Mazda lamp in the primary of the filament transformer. The resistance of the lamp is just sufficient to reduce the voltage the desired amount. The lamp is shunted by means of a switch which is at the operator's hand on the upright board alongside the key. Back of this shunting switch is another switch which cuts the current to the primary of the plate supply transformer and the transmitter filament supply transformer. The A battery supply to the receiver runs through a relay so that when the receiver is turned off the a.c. supply to the transmitter tubes and power supply transformer and tubes is cut off. The transmitter cannot accidentally be left with the current on if the receiver is shut off.

Across the output of the filter is a 1000-volt meter which draws about 15 milliamperes. A Clarostat (super-power) resistance was added across the output and is regulated to draw a current of about 15 milliamperes making a total bleeder current of about 30 ma. This current keeps the condensers at their r.m.s. voltage and gives a smooth output which has been almost invariably reported as d.c. on all bands. This resistance also discharges the filter condensers almost instantly after the transformer primary current is cut off, so there is no danger to the operator from condenser shocks.

In the event of the failure of the primary current for the rectifier and the tube filaments, a simple flip of two four-pole double-throw cam switches shifts the power supply instantly from the filter and alternating current to B battery and

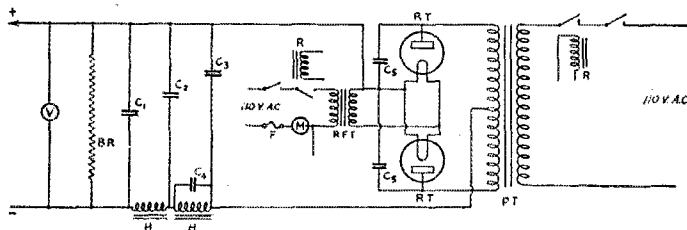

FIG. 2.—THE RECTIFIED A.C. PLATE SUPPLY

- C₁ — 10- μ fd. 1000-volt filter condenser.
- C₂ — 5- μ fd. 1000-volt filter condenser.
- C₃ — 6- μ fd. 1000-volt filter condenser.
- C₄ — 1.1- μ fd. 200-volt fixed condenser to tune choke to 120 cycles.
- C₅ — 2000- μ fd. 1000-volt condenser.
- BR — Bleeder resistor.

- F — Fuse.
- H — $1\frac{1}{2}$ -henry filter choke coil.
- M — 50-watt Mazda lamp.
- PT — Plate transformer.
- R — Relay switches operated by receiver A battery.
- RFT — Rectifier filament transformer.
- V — Plate voltmeter.

of any 60-cycle hum in the circuit. Finally a 10- μ fd. condenser goes across the line which insures smoothness of output. The two small chokes in the negative line cause a very small voltage drop so that the total drop of the plate supply when the key is pressed is only 75 volts. An output of 800 volts is available under conditions of no load.

The 866 tubes remain lighted while the station is in operation, but when the plate supply is not being used the filament voltage of the 866 tubes is reduced from 2.5 to 1.75 volts by means of a

A battery. In actual practice this change has been made on failure of the power line in the middle of a message without the loss of a single word, simply by repeating the word upon which the change in power was made. There was no noticeable change in the note or frequency at the receiving end.

KEYING SYSTEM

The key and relay are in the negative lead to the transmitter, so they work with either power

supply. A Leach relay is placed directly in the negative lead and has across its contacts a 4- μ f., thousand-volt condenser in series with a thousand-ohm Electrad wire wound resistor. Between the relay and the plate of the tubes is a 1½-henry choke coil. The relay is operated by a hand key in series with four dry cells. In parallel with the

OW to inquire if the operator was making a radio station or getting in training for the manipulation of the balyards of a sailing vessel. In the March, 1928, *QST* came the article giving the basic principles of the "Zepp" antenna, and it was found that the antenna corresponded to the rules, almost to the inch!

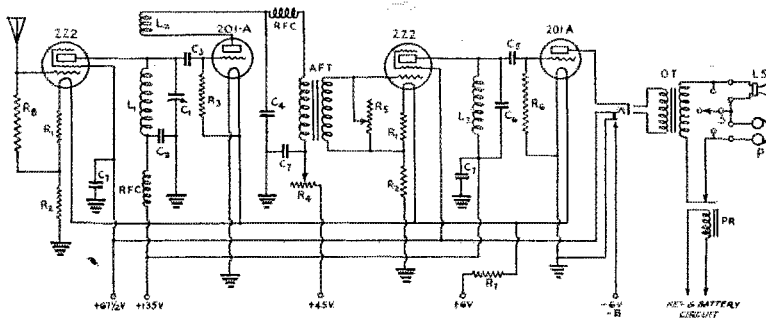

FIG. 3.—THE RECEIVER AT W1KH IS THE POPULAR 4-TUBE SET

- | | |
|---|---|
| C ₁ — Plug-in midjet tuning condenser. | R ₆ — 8-megohm grid leak. |
| C ₂ — 4,000- μ f. fixed condenser. | R ₇ — Filament ballast resistor for .75 amperes. |
| C ₃ — 100- μ f. grid condenser. | R ₈ — 10,000-ohm gridleak-type resistor. |
| C ₄ — 2000- μ f. by-pass condenser. | L ₁ , L ₂ — Plug-in coils. |
| C ₅ — 6000- μ f. audio grid condenser. | L ₃ — Secondary winding of Ford ignition coil. |
| C ₆ — .006- μ f. audio tuning condenser. | AT — Audio transformer, 6-to-1 ratio. |
| C ₇ — 1- μ f. by-pass condenser. | LS — Loud speaker. |
| R ₁ — 10-ohm fixed filament resistor. | OT — Output transformer, 1-to-1 ratio. |
| R ₂ — 5-ohm fixed filament resistor. | P — Phones. |
| R ₃ — 5-megohm grid leak. | PR — Pony Relay in key circuit. |
| R ₄ — 50,000-ohm variable resistor. | RFC — Radio-frequency choke. |
| R ₅ — 200,000-ohm variable resistor. | S — Three point switch. |

hand key is a Vibroplex. The two keys have a small 1- μ f. condenser across their contacts which eliminates sparking. Also in series with the hand keys and battery is the magnet of a twenty-ohm pony relay which is used to break the receiver telephone circuit. Tests on neighbors' receivers show that there is no interference whatever in the broadcast band.

ANTENNA SYSTEM

Since the house in which the station is located is on a hill surrounded by tall pine trees it was necessary to use the trees for antenna supports for the cost of masts was prohibitive. Although the pines are tall and stout, there is a certain amount of sway in strong breezes which must be considered. For this reason the Zeppelin type of antenna was chosen. As 7000-ke. was considered the band most likely to be used a full wave 7300-ke. flat top was put up. The feeders were arbitrarily cut to suit the height of the pine tree support. Resonance on the transmitter took place a little above the band, and it was brought within the band by cutting down the length of the flat top. The feeders were cut again to suit the physical dimensions of the pine trees, and it was discovered that there was considerable difference in the antenna current. This led to a series of cut-and-try experiments on the feeders which finally led the

Later it was decided to do considerable work on 14,000-ke. and a separate "Zepp" was put up alongside the house, following the rules of the March, 1928, article. The flat top is 34 feet 5 inches long and the feeders are 17 feet 2 inches long. At first the spreaders for the feeders were glass toothbrush cases as recommended in *QST*, but when the March article came out they were taken down and in their stead was put ¼-inch maple dowels boiled in paraffin. The feeders are spaced 8 inches apart and the dowels are placed every three feet. As a result the feeders and their spreaders all sway as one piece and do not affect the note. Foreign stations have reported the note very steady when the antenna has been swaying considerably.

The large "Zepp" is connected to the transmitter by means of two knife blade switches which may be thrown over to ground. One-fourth-inch copper tubing is used for the leads from the transmitter to the knife switches and from the switch points to the window lead-in. This tubing makes a very rigid connection which entirely eliminates danger of unsteadiness of signal due to vibration in the station. The feeders are led through holes bored in the window pane against which General Radio porcelain wall insulators are placed back to back and joined together through the hole in the glass by a

threaded rod. General Radio jacks are soldered to each of the metal rods of the wall insulators, and also to the switch points on the knife blade switch. To make the change from the large antenna to the small the knife switches are thrown out and two lengths of copper tubing with General Radio plugs soldered to each end are then pushed into the jacks of the wall insulators and the knife blade switch points, making a very rigid connection, yet instantly removable. When the small "Zepp" is being used, the receiving antenna connection is connected to the feeder to the flat top of the large "Zepp" and the B.C.L. antenna is connected to the short feeder.

THE RECEIVER

The good old Reinartz circuit was used for receiving until November, 1928, when the article on receivers by Hull was published.

The four-tube receiver was assembled and worked fairly well, until at the end of two weeks it was discovered that the control grid of a screengrid tube was on the top of the tube instead of the bottom. After the correct connections had been made the receiver proved to far surpass any other circuit, both as to selectivity and volume!

The circuit and general arrangement of parts is the same as in the Hull receiver shown in the *Handbook* with the exception of the 'phone circuit. The panel is aluminum rubbed down with wire wool and oil, giving a dull silver finish. The cabinet is made of whitewood, painted with aluminum paint to match the panel. The cover is a sheet of plate glass with beveled edges to match the cover of the transmitter. The glass cover allows the operation of the receiver to be observed and visiting hams may criticize the workmanship without bothering to remove the cover.

The volume is so good on this receiver that a loud speaker is used nearly all the time, almost all foreign signals being easily read with the speaker. The coils for the different bands are so wound that the top of each band comes in at 95 and the bottom at 10 on the dial, this being done by spreading the windings of the coils. The tickler coils are so wound that regeneration takes place at about the same spot on the battery resistor control, on all bands. Once the correct regeneration point is set, the control is not touched again while working on any one particular band. There is very little trouble from QRM, as the full dial coverage on the band insures separation of signals and when two signals are very close together the thousand cycle peak of the tuned Ford coil brings out the desired signal, leaving the interference signal well in the background. The only QRM impossible to copy is, of course, that encountered

when one signal is exactly the same frequency as another, which rarely happens.

Since there are two antennas at the station, the idle one is used for the receiver, the difference in lengths of the antenna having no effect upon the calibration of the receiver. The change in an-

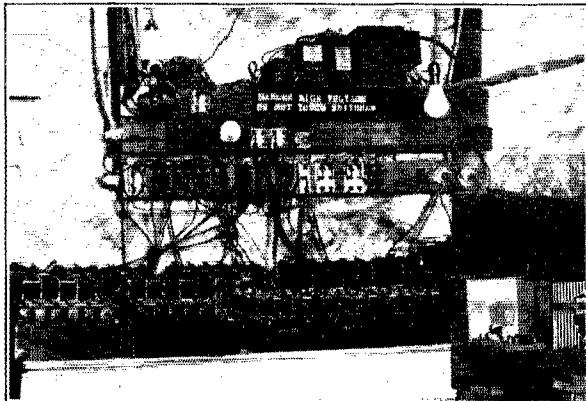

THE EMERGENCY PLATE SUPPLY IS KEPT IN THE BASEMENT

A bank of storage batteries supplies plate power when the 110-volt line fails.

tennas is made with the General Radio plugs and jacks.

The A battery is a storage battery in the cellar, with a Rectox trickle charger permanently connected to it. The a.c. supply to the charger is switched on and off by a relay through which the receiver A battery runs. In addition the other A battery which runs the B.C.L. superheterodyne has a charger switching relay which is also in series with the receiver A battery circuit. Thus when the receiver is turned on the two relays cut out the two chargers and insure a quiet battery circuit. The B batteries are heavy duty dry batteries. On account of the number of relays in the receiver A battery circuit, a two-volt cell was added to the ordinary six-volt battery and a rheostat placed at the battery in the cellar so that a permanent adjustment could be made so the automatic regulators in the receiver would keep the tube voltage at exactly the right point.

As coils on the Hull receiver are made to cover only the three amateur bands, the old Reinartz receiver has been kept in use for other frequencies.

THE MONITOR

The circuit for the monitor as shown in the *Handbook*, page 139 (fourth and fifth editions), is assembled in an ordinary tin pail with a handle, as may be seen in the photo. The 'phone jack controls the filament and it is only necessary to plug in the 'phones to start the monitor tube oscillating. When a change is made from one band to another, in spite of the fact that the dials on the

transmitter are calibrated, the signal is tuned in on the monitor and after listening for quality, the monitor is left oscillating and the receiver tuned to zero beat note with the oscillator. As the receiver is calibrated, the frequency is known at once. However, as a double check, the frequency is measured with a General Radio frequency meter.

There are two G. R. frequency meters at W1KH, one covering the frequencies from about

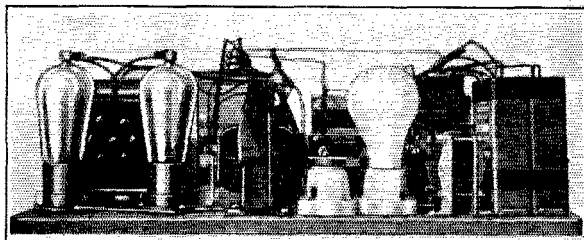

866 TUBES ARE USED IN W1KH'S RECTIFIER

1000 kc. to 20,000 kc. and the other covering only the bands assigned to amateurs. Precision of the meters is checked by the standard frequency transmissions of W1XV and W9XL, and the calibration of the receiver is checked at the same time.

The monitor is not calibrated, as the calibration of the receiver is believed to be sufficient. Only the 7000-kc. coil is used in the monitor, as harmonics or sub-harmonics are used for the other two bands.

OPERATION

The operator pushes in the 'phone plug of the receiver which starts the receiver and the rectifier tubes. As the 866 tubes require about two minutes to warm up, the time is spent in going over the band observing conditions, and if there are no particular messages on hand, looking for directional CQ's or DX. When the tubes have warmed up, the plate current is started and the 'phone plug is put into the monitor and the quality of the signal is observed. Then the receiver is tuned to the monitor and the position of the signal noted on the receiver with reference to other signals. If there is found to be considerable QRM close to the station signal, the frequency of the transmitter is changed slightly until the station signal falls into a quiet "hole" in the band. This method is invariably used at the start of operation and is found to be very effective in avoiding QRM, particularly when calling foreign stations.

The calling of DX stations is limited to three minutes and a very useful gadget to check this time is a three-minute sand glass which may be purchased at a low price at almost any hardware store. This glass is inverted at the start of the call and the call ended when the sand runs out.

As the station is an ORS, the chief interest is in traffic. As many deliveries as possible are made by telephone, which is at the operator's elbow, and in many instances, including foreign contacts, the station sending the message is asked to QRX while an answer is obtained from the party to whom the message is sent. If the message cannot be telephoned or relayed, it is mailed within forty-eight hours of receipt.

Schedules are kept with various stations, the most interesting one being a tri-weekly schedule with the Grenfell Mission in Labrador.

Almost every day an obliging amateur situated in a town ten miles away is called by telephone and the quality and position of the station signal checked, and as this friend is very critical, the steadiness and tone of the signal is never allowed to wander far from standard.

The constant aim of the station is steadiness of signal. The operator is always ready to chew the rag whether the station is next door or in the Antipodes, and in many cases both domestic and foreign friendships formed over the air have been renewed through correspondence, which is kept on file for ready reference.

The Pacific Division Convention

"Greetings from little america to the radio amateurs of the Pacific division stop'am glad of this opportunity to acknowledge the big debt our north- and south-pole expeditions owe to the amateur radio operators stop I wish to thank them for their helpfulness and to express my admiration of the high sense of honor they show in handling messages stop it is radio that has made this expedition possible stop cordial good wishes in which all of little america joins

Richard E. Byrd"

WITH the above message the Tenth Annual Pacific Division Convention was duly opened at Los Angeles, California, on the morning of November 29th and 30th at the Hotel Alexandria, and with the largest attendance of any previous convention, which spoke well for the publicity sent out by the Amateur Radio Research Club which was sponsoring the affair.

Director Babcock, recently recovered from an operation, was in attendance and after welcoming the delegates turned the first meeting over to B. E. Sandham, W6EQF, Chairman. This was the signal for two days of real "ham" activities. The first speaker of the convention was A. A.

(Continued on page 76)

The Experimenters' Section

THE practice of monitoring transmissions with the aid of shielded autodyne receivers, or monitors, as we have come to call them, is certainly a worthwhile practice, and the general use of monitors marks one of the milestones of progress in amateur radio. But there are monitors and monitors, and a poorly built, or improperly used monitor may be worse than useless by leading the amateur to believe that his signal is much better than it really is. Even with the best of monitors there are certain factors in their use which are somewhat puzzling and have not been entirely satisfactorily explained. Among these is the fact that the heterodyne signal, as heard on one side of resonance, is quite different from that heard on the other. A point which seems to be neglected by most amateurs who do make use of a monitor is that it is not possible to get an accurate knowledge of the character of the emitted signal by listening to the transmitter with a too persistent oscillator. An accurate estimate of just how the signals will sound at the receiving end can only be simulated by employing a monitor which approaches an autodyne receiver in operation. This means that regeneration must be under control.

The following article will help to clear up some of the difficulties which have been encountered in the construction of satisfactory monitors.

Notes on the Monitor

By George Grammer*

FOR some time the suspicion has been lurking in the back of our minds that perhaps some of our monitoring methods are not all they should be. Lest this be misinterpreted, we shall insert here an emphatic statement: Any form of monitor is infinitely to be preferred to none at all. This discussion is intended to point out a few shortcomings of some of our more commonly used monitoring arrangements, and is only secondarily concerned with the well-known advantages of monitoring.

The simplest, and also the poorest means of listening to the transmitter is to tune the receiver to some harmonic of the transmitted frequency. Generally the pick-up is so strong that no very definite conclusions can be reached. There is also always the danger of picking up emanations which are not true harmonics—re-radiations from guy wires, house wiring, etc., which may be anything from raw a.c. to pure d.c., and which utterly misrepresent the actual character of the transmission.

The true harmonics themselves may likewise differ considerably from the fundamental in tone. The higher the harmonic the more pleasing, apparently, the character of the signal; but which harmonic are we to believe?

Another monitoring scheme is to tune the receiver so that the transmission will be picked up on one of the receiver harmonics. This is a little

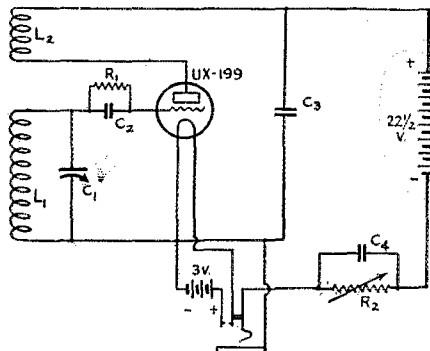

FIG. 1.—DIAGRAM OF MONITOR

The coils are wound on tube bases. Some changes will undoubtedly be necessary to get the proper frequency coverage, but these sizes will serve as a starting point.

- L₁ — 3500 kc. — 27 turns of No. 30 d.c.c.
- 7000 kc. — 1 1/2 " " " 23 d.s.c.
- 14,000 kc. — 6 " " " " "
- L₂ — 3500 kc. — 15 " " " 30 "
- 7000 kc. — 8 " " " " "
- 14,000 kc. — 6 " " " " "
- C₁ — 50 μfd. maximum capacity (either midget or standard size condenser cut down to about 3 plates).
- C₂ — 250 μfd.
- C₃ — 2000 μfd.
- C₄ — 1 μfd.
- R₁ — 2 megohm grid leak.
- R₂ — Variable resistor, preferably carbon type, 0-50,000 ohms or more; exact value not critical.
- J — Filament control jack.

better, not quite so much pick-up, and perhaps a better indication of the true character of the signals, since the receiver harmonics will not modulate the signal if batteries are used. However, we have the same old trouble again in that the higher the harmonic used, the better the transmitted note seems.

The third method, and no doubt the one most commonly used, is that employing a small shielded oscillator, with or without amplification. This is much better; in fact, it is the best we know of at present, but a few things should be kept in mind when using it.

It has become quite common practice to combine the frequency meter and monitor into one

* A.R.R.L. Technical Information Service.

instrument. In order to keep the calibration as nearly permanent as practical, the monitor has been built with two things in mind, first, the production of comparatively strong oscillations, and second, reduction of controls to a minimum to avoid errors both in calibrating and in using the device. For most work this may be all right (most amateurs not being purists), both these design tendencies militate against good monitoring. A receiver which is oscillating strongly tends to iron out to some extent modulation and frequency variations. The proof of this is very simple. Try varying the regeneration control on your receiver while listening to some station. Consequently the monitor must be capable of oscillating weakly if a true picture is to be had. Again, to obtain stability an oscillator must utilize a High-C circuit, just the opposite from the conditions in the receiver.

The answer is obvious; the functions of the monitor and frequency meter should be separated in the interests of the exact truth. The monitor should be built to resemble a receiver as closely as possible, except that no audio frequency amplifiers should be used, as they also tend to iron out low frequency modulation. The monitor and its batteries should be entirely shielded so that no extraneous fields can influence the response to the signal. The monitoring should be done on the same frequency as the transmitting; harmonics are taboo. A regeneration control is of course a necessity, and the monitor should be operated in exactly the same manner as a receiver, with the tube just oscillating, not trying to act as a detector and a power plant at the same time.

It should be necessary to say nothing more, since practically any ham is capable of building a simple one-tube receiver. However, for the benefit of those who undoubtedly will want constructional details, a diagram is appended, showing constants for a monitor suitable for the 3500 to 7000- and 14,000-kc. bands. The arrangement of the B battery, regeneration control and 'phones is a little different from the usual receiver, since the device is supposed to be entirely enclosed in a shielding container. The 'phones and regeneration control are at zero r.f. potential with this arrangement, thus eliminating body capacity effects. The 'phone jack need not be insulated from the shield, although the regeneration control resistor must be, unless one is used in which the shaft is "dead." As is always the case with high frequency receivers, the coil sizes specified probably will not work out exactly right and will need some adjusting. Any other successful receiving circuit will be equally satisfactory so long as regeneration can be controlled, but regeneration must be under control for proper monitoring.

REDUCING THE STATIC/SIGNAL RATIO

An idea which is well worth while where static is unusually severe is brought to our attention by

Mr. Fred J. Elser, Bauio, P. I. The device for reducing the signal static ratio consists of using a high gain audio amplifier, with the 'phones in the plate circuit of the last amplifier, but with the filament of this tube turned off. This system was used at K3AA with a 10/1 audio transformer, a 201-A tube followed by a 6/1 audio transformer, and finally, another 201-A tube, with its filament out. Obviously, sufficient gain must be provided in the first two stages of amplification to enable the signal to pass through the dead stage of amplification. Of course, signal strength will be reduced, but so will static. The net result of such an arrangement is that even the weakest signals can be copied through heavy static, and can be read perfectly unless there is QRM on exactly the same frequency as that of the signal it is desired to receive.

L. W. Hatry suggested a similar arrangement, which, it appears, would be an improvement over the method outlined above. Hatry's idea of reducing the static/signal ratio was to operate the last tube of a multi-stage audio amplifier without plate voltage, but with the filament lit, as usual. In either case sufficient excitation to swing the grid of the last tube positive will be required. The static/signal ratio under these conditions is never greater than unity, so that even in cases of worst static, the device has possibilities. As a matter of fact, the advantages of this system show up best when static is heaviest.

NOTES ON RADIO FREQUENCY RESISTANCE OF INDUCTANCES

We, like our British contemporary, have noticed that some manufacturers are quite proud of the fact that their inductances intended for high frequency operation are nickel plated. Either because of ignorance of high frequency conduction properties, or through a misguided effort to improve the appearance of their product, advertisements appear which herald, instead of hush up, the fact that high frequency coils are nickel plated.

"Radio Conductors Compared," which appeared in the November 6, 1929, issue of *The Wireless World*, dealt so directly and accurately with the subject of high frequency conductors that it seems advantageous to bring that article to the attention of QST readers. The following paragraphs are extracted from "Radio Conductors Compared" by W. H. F. Griffiths.

"Although at wavelengths round about 30 meters (10,000 kc.) the resistance of a copper wire is increased from six to eight times its original value by nickel-plating it to a thickness of a few ten-thousandths of an inch only, tinning the same wire with a similar coating will only produce a 30 percent increase in its resistance, although the specific resistance of nickel and tin are of the same value. Many regard commercial

tinned copper wire with the utmost suspicion and will not employ it despite the fact that soldering is greatly facilitated by its use. It can be stated, however, that the thickness of tin on the surface of this wire is such that it does not affect appreciably the resistance on wave lengths higher than 100 meters (3000 kc.).

“Another interesting example of the importance of the knowledge of radio-frequency conductivity is that of the relative conductivity of copper and silver. It is generally supposed that silver is a much better conductor than copper, but even for direct current it is only about 6 percent better. At high radio-frequencies, on all but the finest wires, this advantage is reduced to 3 percent, there being virtually no difference between the two metals. This also, of course, applies equally to the relative effectiveness of copper- and silver-plating of conductors. A little greater advantage may be gained in the case of silver-plating copper coils due to the fact that the silver deposited is pure electrolytic metal, whereas the copper is hard-drawn and consequently impure. In this connection it may be of interest to note that the high-frequency resistance of a hard-drawn copper conductor is reduced by 2 or 3 percent by copper-plating.

“Again, the difference in the conductivities of copper and aluminum is reduced at high frequencies. At ordinary frequencies aluminum is about 70 percent higher in resistance than copper, whereas at radio-frequencies only a 30 percent increase is produced by the substitution of the lighter metal. This fact combined with its low specific gravity makes aluminum suitable for such conductors as plates for variable condensers.

“Thus it is seen that specific resistance is of less importance in radio-frequency conductors

obvious that in the case of electro-plated conductors it is the metal with which they are plated that determines largely the skin depth and resistance.

“Wires of low resistance, such as copper, are rendered much less conducting by plating with

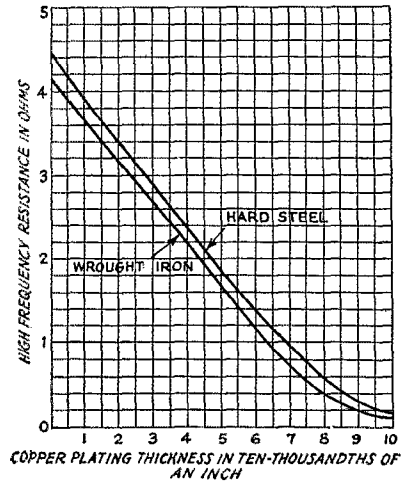

FIG. 3

high-resistance and permeable metals, such as nickel, and wires of high resistance and permeability are rendered much more conducting by plating with, say, copper. For short-wave circuits copper or brass parts and wires should never be nickel-plated for the purpose of finish unless the thickness of plating can be ascertained with accuracy. Copper or brass parts may be tinned, however, without greatly affecting their high-frequency resistance.

“In Fig. 2 is shown the increase in resistance of one yard of 16 S. W. G. brass and copper wire, due to nickel-plating and tinning, to various thicknesses up to 1 mil. The measurements were effected at 10,000 kilocycles (30 meters), and the curves show well the great difference between the skin effect of tin and nickel, a difference which is practically wholly due to the paramagnetic properties of the latter, because the two metals are of roughly the same specific resistance.

“The question of finish for short-wave coils of bare copper wire or braid always calls for much consideration, more especially as this has often to be done after the coil has been completed on its insulating former. Copper, if left exposed to the atmosphere, will tarnish very quickly. Lacquer cannot be applied readily after winding. Gilding the wire or braid prior to winding provides a very effective and enduring finish, but the specific resistance of gold is appreciably greater than that of copper, and the gold-plating thickness must in consequence of this, be kept very thin.

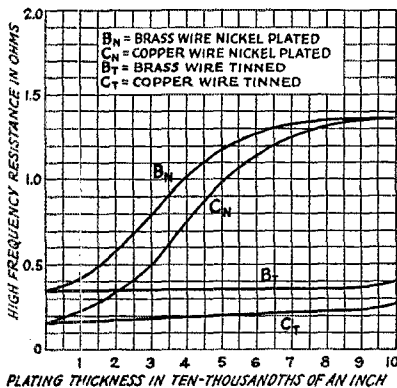

FIG. 2

than in ordinary electrical circuits, but that iron, steel and nickel are to be avoided. Moreover, since the current at high radio-frequencies only penetrates into the skin of a conductor, it is

"Iron, steel and nickel wires are tremendously reduced in resistance at high radio frequencies by a thin coating of copper. In Fig. 3 is shown the reduction of resistance of a yard of 16 S. W. G. wrought iron and hard piano steel wire at 30 meters by copper-plating to various thicknesses up to 1 mil., the approximate skin depth for copper on the wrought iron wire is seen to be about 27 to 1, and the effect of such a reduction upon the tuning sharpness of a resonant circuit is shown by the comparative resonance curves of Fig. 4 for a circuit formed with this wire before and after plating. The length of wire was merely bent into a 9 in. diameter loop and tuned by a variable condenser of about 240 $\mu\text{fd.}$ at 30 meters 10,000

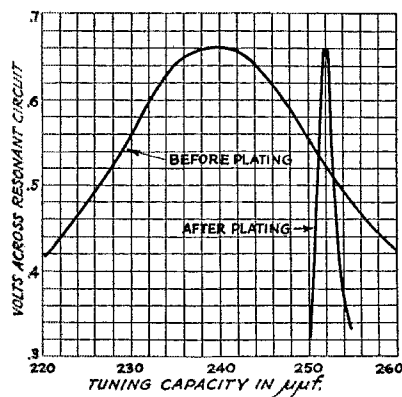

FIG. 4

kc. From Fig. 3 it is seen that with only one-thousandth of an inch of copper-plating on the iron and steel wires their resistances are reduced to the values of the solid copper wire of Fig. 2, proving that the skin depth of copper at 30 meters is of the order 0.001 inch. Where great rigidity or mechanical strength is desirable, it is thus possible to use steel wires as portions of radio-frequency circuits, providing they are thinly coated with copper."

BIBLIOGRAPHY ON CONSTANT FREQUENCY TRANSMITTERS

Much has been said, and written, on the subject of constant frequency transmitters. With the narrower bands assigned for our use beginning last year, the subject became increasingly more important. The appended bibliography does not include all of the articles which have been published regarding constant frequency transmitters, but it does contain some of the more important ones likely to be of interest to amateur operators.

QST:

SELF-CONTROLLED CONSTANT FREQUENCY TRANSMITTERS

- A Constant Frequency Transmitter, by Hoffman, pp. 36, July, 1927.
- A Low-Power Master-Oscillator Transmitter, by Dudley, pp. 10, February, 1928.
- A 'Phone Transmitter for the Beginner or Advanced Amateur, by Tanner, pp. 23, July, 1928.
- Overhauling the Transmitter, for 1929, by Hull, pp. 9, August, 1928.
- The Oscillator-Amplifier Transmitter, by Hull, pp. 9, September, 1928.
- Adopting Medium and High Power Self-Excited Transmitters to 1929 Service, by Hull, pp. 25, September, 1928.
- Push-Pull Transmitters, by Lamb, pp. 13, December, 1928.
- A Poor Man's M. O. P. A., by McCormick, pp. 25, January, 1929.
- A Crystal Note Without a Crystal, by Cooper, pp. 17, January, 1929.
- An Effective Low-Cost 'Phone and C.W. Transmitter, by Lamb and Dudley, pp. 9, September, 1929.

CRYSTAL CONTROLLED CONSTANT FREQUENCY TRANSMITTERS

- Adjusting the Crystal Controlled Transmitter, by Wells and Tillyer, pp. 29, June, 1926.
- A 20-40- and 80-Meter Crystal-Controlled Transmitter, by Root, pp. 33, August, 1926.
- A Flexible Crystal Transmitter, by Glaser, pp. 18, June, 1927.
- Low Power Flexible Crystal Control for Four Amateur Bands, by McMinn, pp. 15, April, 1928.
- A 28-Megacycle Crystal Controlled Transmitter, by Chinn, pp. 29, November, 1928.
- Construction of a 3500-kc. Crystal Controlled 'Phone, by Springer, pp. 9, December, 1928.
- The UV-861 in Action, by Rodimon, pp. 44, February, 1929.
- An Effective Low-Cost 'Phone and C.W. Transmitter, by Lamb and Dudley, pp. 9, September, 1929.
- Proceedings of the Institute of Radio Engineers:*
- Piezo-Electric Crystal Controlled Transmitters, by Crossley, pp. 9, January, 1927.
- Recent Developments on Low Power and Broadcasting Transmitters by Bryne, pp. 614, May, 1928.
- An Investigation of the Phenomena of Frequency Multiplication, by Page, pp. 1649, September, 1929.
- Bell System Technical Journal:*
- A High Precision Standard of Frequency, by Marrison, pp. 493, July, 1929. (This paper also appeared in the *Proc. I.R.E.* for July, 1929.)

Textbooks:

- Thermionic Vacuum Tube, by Van der Bijl.
- Principles of Radio Communication (Chap. 6-8), by Morecroft.
- Thermionic Vacuum Tube Circuits (Chap. 4), by Peters.
- The Radio Manual (Chap. 5-9), by Sterling.
- Elements of Radio Communication (Chap. 4), by Morecroft.

Strays

General Radio type 247-P plugs have a 6-32 thread and will screw into the tapped contacts of Sangamo condensers. This combination provides a handy unit when plug-in fixed condensers are required.

If the knob on the Pilot illuminated dial (type 1276) is replaced with a geared dial, such as the Univernier which was popular several years ago, a very high ratio dial can be made which should be just the thing for tuning your high frequency receiver.

I. A. R. U. NEWS

Devoted to the interests and activities of the

INTERNATIONAL AMATEUR RADIO UNION

President: H. P. MAXIM

Vice-President: C. H. STEWART

Secretary: K. B. WARNER

Headquarters Society:

THE AMERICAN RADIO RELAY LEAGUE, Hartford, Conn.

MEMBER SOCIETIES

American Radio Relay League

Asociacion E. A. R.

Associazione Radiotecnica Italiana

Canadian Section, A.R.R.L.

Deutschen Amateur Sende und Empfangs Dienstes

Experimenterende Danske Radioamatører

Nederlandsche Vereeniging voor Internationaal Radio-amateurisme

New Zealand Association of Radio Transmitters

Norwegian Radio Relay League

Radio Society of Great Britain

Reseau Belge

Reseau Emetteurs Francais

South African Radio Relay League

Wireless Institute of Australia

Conducted by A. L. Budlong

SORRY, gang, but the preamble to this department is going to be short and sweet this month. In the first place, both Warner and Hebert have been away pretty much recently on long trips. In case you don't see the connection, it happens that when "AAH" is away from HQ, yours truly is supposed to "double" in the job of being office manager, and when "KB" is traveling some sort of an attempt is made to "double" on that desk and keep it free from the more routine matters, at least. So when both of 'em hightail it at the same time, things get rather busy — and stay busy.

If that isn't reason enough, bear in mind that the time this is being written is about one week before Christmas, and certain important purchases simply must be made, packages wrapped — and sneaked in the back way, cards sent out, and what not. (Which reminds me that I positively must get that tree this afternoon before all the good ones are gone. . . .)

With which explanation and apology, we plunge immediately into the business at hand.

Three U. S. hams applied for that foreign schedule we mentioned a couple of months ago. And none of them got it! It seems that the foreign ham had beat us all to it and in the meantime had acquired himself a schedule with a West Coast amateur. However, the three applicants are being kept on file in case the schedule fails. Dr. Sceleth, W9GV, will get first whack at it. In case he can't

make it, Mr. George Mesher, W6ERK, will inherit a try, and if both of these two fail, Louis Patla, W9EAP, will have to hold the fort.

A couple of corrections to our list of QSL bureaus: Mr. J. D. Chisholm, the QSL Manager for the Radio Society of Great Britain, and Miss Barbara Dunn, G6YL, both write to state that the QSL bureau address for all British cards, as well as cards for the Irish Free State and all British colonies or mandated territories is: *Inc. Radio Society of Great Britain, 53 Victoria St., London, S. W. 1, England.*

In addition, Miss Dunn kindly volunteers the information that two QSL bureaus should be used for Swiss cards. For unlicensed stations, cards should be sent through the D.A.S.D., Blumenthalstrasse 19, Berlin, W. 57, Germany. Cards for licensed Swiss stations may be sent to the S.A.S.U., Radio Club of Zurich, Spyrstrasse 32, Zurich, Switzerland. Swiss calls consisting of one letter after the figure are licensed (HB9D, etc.). Those with two letters after the figure are unlicensed (HB9MQ, etc.).

Our thanks to Miss Dunn and Mr. Chisholm.

If any further corrections to the QSL Bureau list are in order, don't hesitate to send them in. This applies to anybody.

Now to the DX Time-tables. W6QL, Mr. J. R. Wells, of Patton, Calif., is responsible for the one

we reproduce this time, and it should help Pacific Coast amateurs considerably. We are trying another idea on the time this month — giving the GCT, as usual, but also giving the local time for the area concerned — Pacific Standard Time being inserted in this case. Do you like that better?

Some of the lists supposed to be in this issue will have to wait over until March.

7000-kc. Band

Asia: Countries of China, Malay States, Japan, Borneo, Ceylon, Sumatra, India and U.S.S.R. 1200-1530 (4 a.m.-7:30 a.m. P.S.T.) with exception of Japan which is from 0900-1600 (1 a.m.-8 a.m. P.S.T.).

South America: Argentina, Brazil, Chile, Peru, etc. From 0130-0730 (5:30 p.m.-11:30 p.m. P.S.T.).

Australia: 0600-1530 (10 p.m.-7:30 a.m. P.S.T.) with the exception of the Sixth District, which is rarely heard before 1200 (4 a.m. P.S.T.).

New Zealand: Same as Eastern Australia.

South Africa: 0200-0500 (6-9 p.m. P.S.T.) and 1400-1530 (6-7:30 a.m. P.S.T.).

North and Western Africa: 0330-0500 (7:30-9 p.m. P.S.T.). (Winter.)

Western Europe: 0400-0600 (8-10 p.m. P.S.T.). (Very scarce.)

14,000-kc. Band

Asia: Japan, 0600-0800 (10-12 p.m. P.S.T.). All others 1300-1600 (5-8 a.m. P.S.T.).

South America: 2230-0500 (2:30-9 p.m. P.S.T.). Some "freaks" as late as 0800 (midnight, P.S.T.).

Australia: 0400-0700 (8-11 p.m. P.S.T.). Worked VK7CH at 1800 (10 a.m. P.S.T.) but this is unusual.

South Africa: 0300-0600 (7-10 p.m. P.S.T.). But very few signals from this region are heard on 14,000 kc.

North and West Africa: 0400-0600 (8-10 p.m. P.S.T.). (Summer.)

Western Europe: 0200-0630 (6-10:30 p.m. P.S.T.). Best at 0400-0500 (8-9 p.m. P.S.T.).

Many thanks, W6QL! More lists from others are always welcome. If any lists are sent in now, it is a good idea to make them up on the basis of late spring work, as it will be about then before they appear in QST, if our usual schedule maintains.

Whoopee! Our first radio'd report! It's from an unusual quarter, too, so we're going to stick it right up here in front, instead of burying it somewhere in the middle, as it would be if the usual alphabetical sequence were carried out.

The following good news from China comes from VS6AH, an officially licensed ham at Hongkong, to W6AD and from him to W9COS, who

mailed the dope to HQ. It wasn't in the form of a message — merely a recital of recent happenings, passed on from one station to the other, but it gets mentioned just the same. Here's the dope:

CHINA

Hongkong amateurs have recently received new licenses and calls, and have, during the past two or three months, established themselves firmly in the 7000- and 14,000-kc. bands. The prefix is "VS."

And now to the other reports:

BELGIAN SECTION

By Paul de Neck, President, Réseau Belge

With the coming of winter, amateur activity is increasing. As contrasted to the experiences of late summer, the 14,000-kc. band is now doing very little in DX work, being successful only during the daytime, and then mostly for European contacts.



THIS IS STATION G6CI, OWNED AND OPERATED BY BRIAN W. WARREN, OF 19 MELVILLE RD., COVENTRY, ENGLAND

The receiver is at the left, and just above it is the 28-mc. transmitter. On the wall to the right is the t.p.t.a. 14-mc. c.c. layout. Part of the power supply is to the left of this unit, while the remainder is under the operating table. The station is a WAC, as may be seen, and has also worked WFA, the Byrd Expedition.

The actual winter conditions seem to be, thus, exactly the reverse of last year, when 14,000-kc. work was excellent.

In spite of this, some fine work is being done by Belgian hams. Japan and China came in for occasional contacts by ON4FM, ON4BZ, ON4HP, ON4US and ON4RS — the latter, incidentally, having worked 61 different countries in addition to being the third Belgian amateur to connect with Hawaii.

The Byrd Expedition in the South Polar Regions has been worked by ON4FP, who also worked all six continents in twelve hours, and has a total of 63 countries to his credit. He is one of our leading DX fiends!

(Continued on page 64)

Calls Heard



AC8HM, H. MacGowan, care American Club, Shanghai, China
7000-kc. band

j3cq j3cr k1he k1af k1am k1ce k1em k1dj k1hr k1jr k1kr k1pp k6boe z6bra k6cjs k7ad k9pl om1tb sm5uk vk2hc vk2lj vk3pp vk3rg vk5wr vk6mu vk7dx vs6ag v2dz w6ad w6am w6axc w6bzy w6cto w6cul w6dgg w6dnn w6ehz w6eoo w6egu w6ehi w6ciu w6cke w6ept w6epz w6eqf w6elm w6jpw w6tm w6wa z12bb z12be z12gr z13cm z14ax
14,000-kc. band

ac1bd ac2ah ac3fr ac8jk ac8te ce2ab ce2sb ce3be ce3hf ce2ak k6xra u2ca lu3fa lu7je lu8dy py2ah py2ba py2be py2br py2bg py2uk py1br py1ca vk2ce vk2ek vk2hc vk2hu vk2no vk2rc vk3go vk3rg vk4hk vk4jr vk4rb vk5gr vk6mu vq2bh vs6ag vs6ah w7be wsbs z1lan z1lap z12ac z12dx z12gh z13as z12ap

G5GP, G. Parslow, 27, Eastbourne Road, Totting Junction, London, England
7000-kc. band

w1ajc w1avg w1awe w1awk w1bhl w1bnd w1bs w1bsn w1cjc w1lc w1mk w2aet w2afe w2agb w2aoj w2ape w2asz w2bfl w2bfn w2bg w2bgn w2bka w2bkg w2cuo w2cxl w2kr w2ql w2sm w3afv w3ag w3ago w3ahp w3an w3apf w3auw w3avv w3ard w3bm w3br w3ej w3ep w3hz w3nt w3rn w4af w4agr w4ak w4ao w4ay w4az w4bw w4hd w4h w4ma w4pf w4ql w4uc w4ua w4ty w4tl w4adh w4afk w4sbt w4shy w4aj w4bw w4ct w4ce w4dew w4dm w4dxx w5pp w9ak w9az w9azy w9ba w9dl w9etp w9ftd w9kce w9tt vo8c ve2bd ve2ca k4ba

Fred Karklin, Apartado 101, Monterrey, N. L., Mexico

w1ahx w1ak w1ala w1axx w1bga w1bga w1bks w1bop w1bsn w1bvr w1cdg w1cft w1cmz w1if w1mk w1rp w1si w2aih w2ais w2aix w2ama w2apk w2auj w2avm w2apk w2auj w2avm w2aya w2baz w2bdf w2bjo w2bmm w2bmo w2bnx w2bqr w2buw w2fh w2gx w2kx w3abd w3afx w3aix w3als w3bm w3bph w3ee w3ep w3la w3pm w3ww w4au w4acn w4aef w4ahl w4ex w4ft w4ih w4iu w4ud w4kp w4ne w4qy w4rp w4vj w4wm w5aa w5auk w5acc w5aea w5aem w5ag w5aha w5alm w5aqy w5atn w5auh w5ayo w5azr w5bac w5bat w5bfz w5fv w5ms w5uf w6ac w6acj w6afa w6ags w6akf w6bif w6bmo w6bvx w6bvx w6bwq w6blz w6by w6cbp w6cfc w6cyg w6cib w6cks w6cgy w6cib w6cks w6cjk w6cwf w6czl w6dgg w6dli w6dto w6dxn w6dyj w6dzy w6ea w6dis w6dle w6emd w6eng w6eoz w6eoz w6dph w6er. w6es w6esap w6ew w6id w6op w6vj w6wa w7abk w7ad w7af w7ah w7ad w7ah w7at w7iw w7amx w7anj w7be w7ce w7de w7ed w7ed w7it w7li w7mo w7mr w7my w7nf w7qf w7qy w7auv w7auv w7bcj w7bts w7cek w7cfl w7emb w7cut w7di w7dod w7dps w7duh w7sjc w7rh w7adz w7afx w7agd w7amr w7agz w7as w7asv w7azs w7ban w7bjg w7bhg w7bir w7bpb w7xr w9cbj w9cdx w9cjq w9cuc w9cve w9cde w9ddv w9dho w9dod w9dtx w9dyu w9eap w9eaw w9ecz w9eub w9fi w9fir w9fqz w9fs w9fuq w9gzu w9gzy w9gkm w9ot cm5fc he1dr k4aa k4dk ve2ca ve2ay ve3cl ve3gd ve3gd vk3rg xlsc xx29a

Lawrence R. Mitchell, 1106 Kenneth Drive, Lakewood, Ohio

w9fke w9bjv w9mm w9ful w9fuj w9fel w9eyv w9ewx w9bag w9dph w9fyf w9dzt w9emt w9for w9dj w9daq

w9aum w9gkx w9dcq w9eyl w9aer w9fle w9bxu w9eri w9eqx w9bch w9vei w9gki w1qo w2bo w3go w4ce w5awg w5tx wswm wswk w8ahz w8adf w8bux w8dbq w8doc w8rl w8bdl w8akw w8akh w8hco w8ih w8baw w8dsl w8dbu w8ce w8bmc w8dsa w8scu w8rv w8bf w8af w8dot w8avi w8sauw w8ej w8aju w8blu w8bye w8afq w8bpd

AU1AK, H. Egorov, Frunze St. 28 Tomsk, Siberia, U. S. S. R.
14,000-kc. band

w1da w1anz w1anq w1sz w2ai w2cox w2coz w2vd w2fzx ac3fr af2qg ar8ufm au7ne au8sz ce2ac ce3ac ct1aa ct1bx ct1br ct1bl d1aar d1uj d1abg d1fw d1un d1za d1ul d1kg d1uak d1vp d1aon d1ld d1ao d1an d1yt ear21 ear113 eu2bg eu3ca eufcf eu5bh eu6kg ilfc es3cx f8aup f8azo f8brd f8da f8dot f8faf f8gbd f8gi f8glm f8he f8id f8jf f8it f8klm f8lb f8rem f8rko f8rrr f8sm f8tan f8wb f8whg f8wrg f8xf f8xh f8zx fa8bak fm8gkc fms8gs fms8jo fms8bk fm8gkc fk2ms fk6er g2ai g2bm g2dh g2dz g2ma g2ol g2ux g5bj g5cy g5fx g5jg g5jw g5lv g5ml g5mq g5ms g5sy g5tz g5ub g5uq g5uw g5ux g5wk g5wp f8gyk g5yx g6br g6da g6ge g6hp g6ll g6nf g6nt g6oh g6pa g6qb g6rb g6rr g6ur g6vw g6vj g6vp g6wl g6wt g6xj g6xd g6xn g6yx g6yk g6yv g6mu haf3c ilgl latw oa1s oh2nab oh2nad oh2nag oh3np oh3ax ok1fm ok1m ok2kw on4bz on4fe on4fh on4fm on4fp on4ft on4gm on4gw on4he on4hl on4hp on4id on4ja on4j on4ko on4my on4rs on4rv onr33 on4us on4uu on4vo oz2j oz3a oz7ag oz7ly oz7y xoz7so palhb palbx palkb palmm palpb palqf palva palwx pk1jr pk4az py2be sm5tm sm5ry sm6ua sm6ze sdpa sp3at sp3kv sp3lx sp3lm sp3pb su8rs su8rp su8kw un7tw vk4oce vs3ab vs7ap yilmdz y12gg zs1m zs5w

W1BUX, Douglas Borden, Touisset, Mass.

ac1bd celah celah celah ce2ab ce3ab ce3ac ce3ag ce3bf ce3bm ce3aa cm2jt cm5cx ct1aa ct1br ct1bv ct1bx ct3aa ex2ak ex2bt ex3ah d1aar d1abg d1an d1fw d1hn d1jh d1kg d1ma d1mf d1uak d1uac d1uj d4yt ear21 ear37 ear96 ear113 ear116 ear155 ei2d ei7c ei8b ei8c fa8bak f8aup f8aju f8axq f8bq f8brd f8cna f8da f8dmf f8dot f8er f8ex f8fk f8fr f8fst f8gdb f8gy f8ha f8he f8ho f8hr f8ix f8jc f8jf f8jm f8lmu f8lgb f8mmp f8oa f8olu f8rbp f8rko f8rmf f8rvh f8sua f8wb f8whg w8wp f8wrg f8xh f8xw f8zb f8zi f8zh f8zj f8zlf g2ma g2nh f8wrg f8xh f8xw f8zb f8zi f8zx fk5er fk6er fm8gkc fms8it fm8mu g2bm g2by g2dh g2dz g2es g2ij g2kf g2ma g2nh g2od g2op g2ux g2yv g5bd g5bj g5by g5bz g5lv g5ml g5ms g5mu g5qa g5qf g5rm g5rs g5ru g5sy g5ub g5uq g5uw g5vm g5wp g5xd g5za g6aj g6bd g6bj g6bx g6by g6ch g6dh g6gc g6gs g6gt g6hp g6ko g6hb g6hk g6mc g6nf g6nt g6py g6qb g6qz g6rb g6rr g6rv g6sm g6ut o6uz g6vp g6wl g6wn g6wo gywt g6yy g6xb g6xc g6xg g6xj g6xq g6yc g6za g5nj g6wrg haf3c haf3xx haf5b hb9d hb9g ilau ilcoe k5aan k4kav k4kd lu2bx lu2ca lu2fi lu3de lu3dh lu3fa lu3fk lu3pa lu4da lu4dq lu6er lu7je lu8dy lu9dt nj2pa oa4o on4q oa4r oa4t oh7nb ok1rv ok2ny on4am on4ar on4bz on4ck on4fe on4fm on4fp on4gn on4gw on4he on4hp on4ja on4j on4km on4ro on4rs on4us on4uu on4wk on4w on4zz on4j onr33 oz2j oz2j oz7t oz7y palap paldy palv palvw palxb palx palmm palqf palss patvn palw palw pa7w pe7 pylaa pylah pylaw pylax pylbr pylca pr1ed pr1cl pr1om pyler pylia py2ad py2aj py2ak py2ay py2ba py2bf py2bg py2bk py2ih py2ii py2ik py2qa py2qb py5af sm5uk sm6ua sn1aa sp3kv sp3lx sp3y1 su8kw su8rs su8y ti2ags ti2ea ti2hv vk2lj vk2no vk2r vk3go vk4jr vk5wr

(Continued on page 80)

Correspondence

The Publishers of QST assume no responsibility for statements made herein by correspondents



A Correction

Radio-victor Corporation of America,
233 Broadway, New York City.

Editor, QST:

My attention has been called to the article on the UY-227 appearing on page 45 of the December issue of QST. There are a couple of statements in this article which I believe are undesirable and to which I want to call your attention.

The statement that "The tube (UY-227) can be operated from a 6-volt storage battery by inserting a proper resistor to pass 1.25 amperes, as shown in Fig. 1," is questionable from the amateur's standpoint.

As you know the normal heater current of the UY-227 is 1.75 amperes. If this current is to produce the required drop to give 2.5 volts across the heater terminals, a resistor of approximately 2 ohms should be used. The heater will be operated under recommended voltage conditions.

While it may be possible to use a 2.6-ohm resistor and to operate some UY-227's on a heater current as low as 1.25 amperes (the corresponding voltage is about 1.45 volts), the practice is most certain to be troublesome either initially or later on. Such an operating point is too far down on the heater characteristic for successful operation.

Rather than a fixed resistor to give reduced heater voltage, I would suggest that a variable resistance be employed. Then amateurs can adjust the rheostat to the lowest voltage at which satisfactory performance is obtained. If the particular tube in use will operate at 1.5 volts, very well and good; but if it does not, and many of them will not, it is a simple matter to increase the voltage until satisfactory operation is obtained. In this way amateurs can conserve their battery supply and yet not sacrifice tube performance. Of course, it is the preferred practice to always use the recommended rated voltage for best all-round results.

In connecting three UY-227's in series for operation from a 6-volt battery, satisfactory performance may or may not be obtained depending upon the tubes involved. When the battery is fully charged only 2 volts will be applied to each tube. Then as the battery discharges, the voltage per tube will gradually decrease until 1.7 or perhaps 1.5 volts is all that is available. If an amateur has one or more UY-227's that will not perform satisfactorily at these low voltages, he will become exasperated in trying to find out why

he can't get results. He will not realize that a voltage of 2.5 volts on the heaters will undoubtedly solve his troubles. It is dangerous, therefore, as you can see, to recommend such low voltages.

While it is true that the heater voltage of the UY-227 and the UY-224 is not critical, it should not be allowed to deviate widely from its normal rated value, if successful operation is to be obtained. Individual UY-227's may perform successfully at these lower voltages but they are the exception rather than the rule.

—C. D. Mitchell, Radiotron Division

[Mr. Mitchell is correct. The heater current should be kept at 1.75 amperes when using the 224 or 227 tubes. The above remarks apply equally to the statements made last month in "The A.C. High Frequency Receiver." Although we have had reasonably good success with reduced heater current, such practice is not recommended. — EDITOR.]

From QST's Printers

Rumford Press, Concord, N. H.

Editor, QST:

Mr. Davis drew our attention to the article in the November *American Magazine*, "Minute Men of the Air," and we at Rumford have read it with a great deal of interest. May we express to you our hearty congratulations upon this evidence of the soundness of the plan as originally conceived and its splendid management during the years both before and since the war. I think that this article is one of the finest write-ups of an adventure in business as well as science that I have read for a long time. To Mr. Maxim, and you his associates, is due a great amount of praise for the vision and the tenacity shown in the history of the League.

Incidentally, we are mighty happy to be playing a very small part in the scheme of things through the production of QST.

— W. B. Patterson

On G5BY's Cup

597 North James St., Hazleton, Penn.

Editor, QST:

Kindly extend, with the "cup," my congratulations to G5BY on taking it away from us.

A N N O U N C I N G

OSCILLATING QUARTZ DISCS

We announce oscillating quartz disc crystals of the finest grade — ground by experts to your *exact specified frequency!*

All crystals are ground to absolutely correct setting of the optical and electrical axis and are fully guaranteed as regards output and frequency precision. Only the finest grade of piezo-electric quartz is used.

Our crystals are perfect discs. There are no corners to crack. Symmetrical vibrations within the disc reduce stresses and give maximum power output.

Note our prices on oscillating discs in the 7000 kilocycle band. No frequency doublers are needed with these little jewels!

Try a 7000 kilocycle crystal for that new 14,000 kilocycle phone!

<i>Kilocycles</i>	<i>Wave-length</i>	<i>Precision 3%</i>	<i>Precision 1%</i>	<i>Precision 0.1%</i>
600-1000	300-500	\$12.00	\$16.00	\$25.00
1000-1500	200-300	11.00	15.00	22.50
1500-3000	100-200	10.00	14.00	20.00
3000-4000	75-100	10.00	14.00	20.00
4000-6000	50-75	11.00	15.00	22.50
6000-8500	35-50	12.00	16.00	25.00

The above prices are for disc crystals supplied to the exact frequency specified by the user and to the precision chosen.

Prices of specially matched oscillating quartz discs, accurate to plus or minus 200 cycles, furnished on request.

Every crystal comes complete with spring pressure type of holder, free of charge. A laboratory certificate of exact frequency is supplied with each crystal.

Order direct from this advertisement

CLIFFORD E. HIMOE

W2AW
318-320 Lafayette Avenue

✓ ✓ ✓

ex-WNP
Passaic, New Jersey

WIRELESS or MORSE

or both *quickly* and *easily* learned with the

INSTRUCTOGRAPH

Used Everywhere



WHY LOSE TIME and WAGES?

Why lose time and wages dallying along when the *INSTRUCTOGRAPH* is ready at any time or all the time to *PRACTICE* with you — *TEACH* you, and make you a *good operator*?

JOBS EVERYWHERE

LAND * * * * * **SEA** * * * * * **AIR**

Begin *NOW!* Tremendous demand for good Wireless and Morse operators. Good pay. Wonderful opportunities for quick advancement to executive positions.

IMPORTANT!

Note the *HEAD-PHONES*. Uses radio tube — no buzzer. No other like it. You get the *true wireless tone*. And you don't have to learn all over again to get your license. Adjusts to any *SPEED* you wish.

BIG FULL TAPES

Plenty of them. 200 feet of signals on each. *Think of it!* Alphabets — words — numbers — radiograms — etc. Specially prepared for beginners. Also tapes for advanced students. Special attention given to *all license matters* that you must know.

Many other features. Write to-day—*NOW* for full details. No obligation.

INSTRUCTOGRAPH INSTITUTE

608 South Dearborn Street, CHICAGO, ILL., U. S. A.

Ask him to show it to Sir Lipton and see if it will help pacify the old gentleman any!

Now let's start something on 1930 equipment.

— *H. M. Wallace, W5BQ*

One Way of Increasing Traffic

Monroe, La.

Editor, *QST*:

As a member of the League I would like to turn loose just one small suggestion.

Many of us have equipment which is no longer of use to us which we would like to sell or trade for other equipment. We could incorporate this in a message and give it to some one we QSO who in turn, if he does not wish to trade, passes it on to someone else until eventually the message reaches a fellow who needs the equipment mentioned in the message.

This type of message should only be passed short distances at a time. Of course there is the disadvantage of receiving the same message twice, but I don't think this would be very troublesome. After a reasonable lapse of time after the origin of the message (say two weeks), the message should be killed if it is still unanswered and the originating station informed of this. This would prevent such messages becoming a nuisance.

To a fellow with two or three schedules daily this would make an interesting method of handing two or three messages and in so doing, boost his monthly total.

— *H. B. Sorensen, W5BHV*

A Prodigal Son?

Summit, N. J.

Editor, *QST*:

Have read with no little interest the letter of W2AW in the September issue, and G2HJ in the December. Let me express my viewpoint on rag chewing.

In the good old days of 1913-14, when there were more unlicensed amateurs than otherwise, I operated a "bootleg" ham station "CH" in Chicago, and returned to the air after the war as 9ASR. Many a friendly chat was held over the air with such local men as AW, LP, CAB, RG (Matty) and many others. When the "Chicago plan" was put into effect I was plumb disgusted, and gave up ham work then and there. The relaying and handling of traffic had no particular lure for me, since my day's work consisted of doing that very thing commercially.

The attitude of the two correspondents referred to above instills new hope in my bosom. Has the day of the rag-chewing amateur returned? If I really believed it, I would dig up the old head phones, and buy myself a small bottle (though I sure would love to hear the tone of the old rotary), dust off the old bug, and be prepared to take all comers between four and forty w.p.m.

It would at least be interesting to obtain a more general consensus of opinion regarding this lost art.

— *Charles Manley*

PERRYMAN

announces

2

NEW TRANSMISSION TUBES

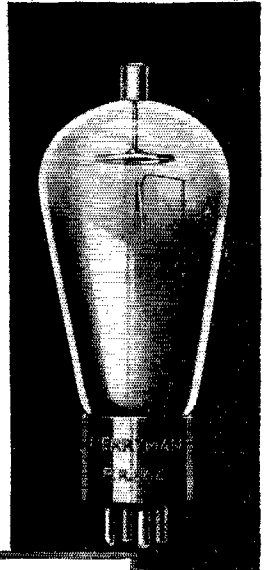
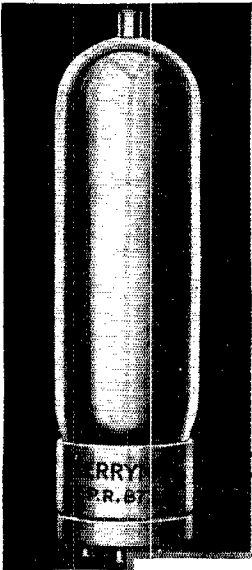

P. R. 872	
Fil. Volts	5
Fil. Amps.	10
Peak Inverse Volts.	5,000
Peak Plate Amps.	2.5
Voltage Drop	15
Overall Length	8 1/2"
" Diam.	2-5/16"
Price . . .	\$18.00

THE P. R. 872 is made especially for the transmitting amateur who desires a large reserve supply of rectified current. It has more than four times the rectified current capacity of the P. R.

P. R. 866	
Fil. Volts	2.5
Fil. Amps.	5
Peak Inverse Volts.	5,000
Peak Plate Amps.	0.6
Voltage Drop	15
Overall Length	6 1/2"
Overall Diam.	2 3/8"
Price . . .	\$8.00

866. The P. R. 866 is suitable for the amateur transmitter who needs 0.6 ampere maximum output.

The P. R. 872 and the P. R. 866 furnish a stable source of plate voltage—full load or no load, because both tubes possess a low and practically constant voltage drop.

Built with the same rugged strength for which all Perryman Tubes are famous, combined with the low operating temperature of the oxide-coated filament and the extremely low voltage drop resulting from the mercury content, the P. R. 872 and the P. R. 866 open new fields for amateurs.

FOR LOW-POWER TRANSMISSION

- P. A. 250 . . . \$11.00
-
- P. A. 245 . . . 3.50
-
- P. A. 210A . . . 9.00

(Oxide-coated filament, standard 210 characteristics)

The rugged construction due to the famous patented Perryman Bridge assures extremely uniform characteristics. These tubes operate on guaranteed grid current at the rated voltages. Each of these tubes is specially selected and tested to suit the particular requirements of radio amateurs.

SPECIAL, ATTRACTIVE PROPOSITION FOR LICENSED AMATEURS

PERRYMAN ELECTRIC CO., INC., 4901 Hudson Boulevard, North Bergen, N. J.

Please send me the following tubes:

- P. R. 872 @ \$18.00
- P. R. 866 @ 8.00
- P. A. 250 @ 11.00
- P. A. 245 @ 3.50
- P. A. 210A @ 9.00

for which I am enclosing (Money order) for \$
(Check)

Name Station

Street

City State

Bradleyunit Fixed Resistors

are
Unaffected
by
Moisture,
Temperature
and
Age

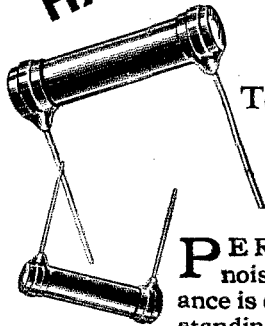

PERMANENT noiseless performance is one of the outstanding features of the Bradleyunit Fixed Resistor. Solid Molded in construction, its accurate rating is unchanged by variations in temperature and moisture. Age does not affect its silent operation.

Leading manufacturers of nationally known receivers rely on Bradleyunits for grid leaks and plate coupling resistors. You, too, can benefit by using them. Investigate today! Send specifications for complete information and prices.

Bradleyunit Resistors are furnished in ratings from 500 ohms to 10 megohms. Equipped with cadmium plated lead wires up to 6 inches in length. Color coded for quick identification.

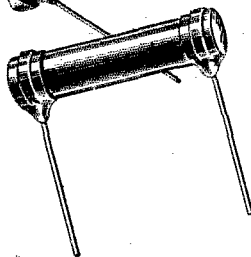
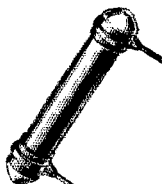
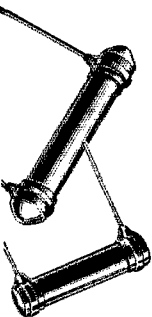

ALLEN-BRADLEY CO.

277 Greenfield Ave.

Milwaukee, Wis.

Allen-Bradley
PERFECT RADIO RESISTORS.

A Real Thrill for Dad

Shreveport, La.

Editor, *QST*:

I wish to call your attention to the fact that while you have issued two membership certificates to R. A. Crain, it happens they are for father and son, both having the distinction of being a member of the League. My son has been a member for several years, but I have just taken up wireless, and, to be frank with you, I am getting the thrill of my life.

Being an old telegraph operator it was not very hard for me to acquire, and you can imagine how thrilling it is to me when I tell you that my boy (who is attending Louisiana State University and will graduate in electrical engineering this year) and I communicate with each other every day at one o'clock by radio. Can you imagine anything more delightful? I read an article some time ago, the title of which was to the effect that the low wave wireless operator got the real thrill out of radio, and I certainly concur in that statement.

— Robert A. Crain

Open House

123 Washington St., Portsmouth, Va.

Editor, *QST*:

Now that my career as a commercial operator at sea is over (I hope) I think it is about time I wrote a few lines to express my deep appreciation for the courtesy and kindnesses extended me by the many hams I have visited in my rambles. During the time I have been at sea I have visited upwards of a hundred amateurs and with but one exception I have been treated as though I were a life-long friend.

It is my belief that amateur radio is second to none as a fraternal organization as well as one devoted to the scientific side of radio. I know this, that many an hour and many a day that would have been otherwise more or less lonely or monotonous, such as it is inevitably to a stranger in a strange town where he is unknown and knows no one, has been actually made pleasant and agreeable through the medium of amateur radio.

But what's the use of saying more? Mere words cannot express the deep appreciation I feel for the wonderful way in which I have been treated, so it must be sufficient to say, "They're a great bunch; would that everyone in this world were like them."

When any of the hams are in this "neck of the woods" I really want them to drop in. The key to my shack is theirs.

— John Carl Morgan, Jr., W3KU-W3AEE

Food for Thought

Stanford University, Calif.

Editor, *QST*:

I am taking the liberty of writing to you concerning an idea which occurred to me while listening to a lecture on "The Propagation of

SM

And Now— “722” Results for Battery Users!

The New 722DC Battery Operated

The S-M laboratories are glad to announce the 722DC—a new high-performance battery-operated receiver—a fitting companion to the all-electric 722. Incorporating all the new circuit refinements of the 722, it was developed to fit the special requirements of the ideal battery receiver.

It has four tuned circuits including a “siamese” band-selector circuit used as an antenna coupler. This double tuned circuit is followed by two of the S-M 123 high-gain interstage tuned transformers used in the a. c. 722. The unusually uniform gain ratio has been maintained.

The volume is controlled by changing the potential on the screen-grids, giving a smooth, uniform control from zero to maximum. The S-M 270 transformer is used to couple the first audio to the two power tubes, connected in push-pull. The use of resistance coupling in the first stage, together with the low-ratio push-pull transformer and the low-impedance '12A tube in the first stage, gives such a flat frequency characteristic that the quality of reproduction is virtually limited only by the speaker itself.

Tubes required: 3—'22, 3—'12A. Wired, less tubes, \$57.50. Parts total \$38.50.

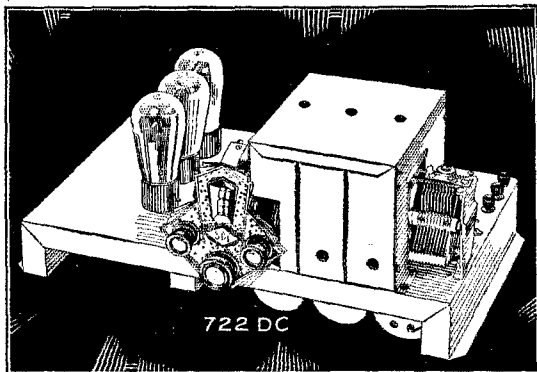

S-M 722DC Band-Selector Six

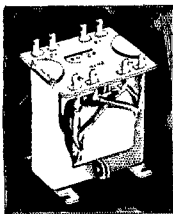

S-M 249

filter between antenna and first r. f. stage, and two in cascade. It is tuned by an illuminated drum dial controlling a die-cast, “bathtub” four-gang condenser with individual compensators. All r. f. circuits are individually bypassed; coils are individually shielded, as are r. f. and detector tubes and three sections of the gang-condenser.

The a. c. 722 uses 3—'24 tubes, 1—'27, 2—'45, and 1—'80. Wired, less tubes, \$74.75 net; parts total \$52.90.

New Filament Transformer

The S-M 249 Filament Transformer, a companion to the 247, meets exactly the requirements of modern receivers using heater and '45 type tubes. The center-tapped secondary (2.5 volt, 3 amp.) is for use especially with '45 tubes, and another 2.5 volt winding will supply 9 amp. for 5 heater type ('27, '24) tubes. Ratings are conservative: 50 per cent overload permissible for short intervals. Price, \$3 net.

Detailed descriptions of new receivers, parts, and other new developments as they are produced in the S-M laboratories are published in THE RADIOBUILDER before announcement anywhere else. The S-M 722DC Band-Selector Six and the S-M 249 Filament Transformer were described in the Christmas issue. Send coupon at once for a sample copy.

Custom builders have profited immensely through the Authorized S-M Service Station franchise. If you build professionally, write us.

SILVER-MARSHALL, Inc., 6409 WEST 65TH ST.
CHICAGO, -- U. S. A.

Silver-Marshall, Inc.
6409 West 65th St., Chicago, U. S. A.
... Send your new fall catalog, with sample copy of the Radiobuilder.
... For enclosed 10c, send five new S-M Data Sheets, including those on 722DC, 712, 735, and 677.

Name.....

Address.....

FULL VOLUME

OR THE MEREST WHISPER

*With no distortion along
the entire range*



Licensed under patents of the Radio Corporation of America and associated companies for radio, amateur, experimental and broadcast reception.

Designed for radio listeners who appreciate the reproduction of fine music exactly as broadcast; the AmerTran Push Pull Amplifier, type 2AP, will furnish ample volume for efficient loud speakers in large halls and moderate sized auditoriums, or can be tuned down to the merest whisper for home reception, *without distortion at any volume.*

The Type 2-AP is a high quality two-stage transformer coupled audio amplifier with a push-pull power stage. It is designed for A. C. operation with a—27 A. C. tube in the first stage followed by standard power tubes in the push-pull stage, and is intended to be connected to the detector of any good receiver and operated from an A. C. power supply system, such as the AmerTran Power Box, Type 21-D.

For complete information on the Type 2-AP Amplifier, write for Bulletin 1075-A.

AMERICAN TRANSFORMER CO.
Transformer builders for over 29 years
172 Emmet Street, Newark, N. J.

AMERTRAN

TRADE MARK REG. U.S. PAT. OFF.

Quality Radio Products

AMERICAN TRANSFORMER CO.
172 Emmet St., Newark, N. J.

Please send me Bulletin 1075-A containing complete information on Type 2-AP Amplifier.

Name.....
Street.....
Town..... State.....

Q.S.T.—2-30

High Frequency Waves," by Prof. Frederick E. Terman, of Stanford.

Since radio waves are reflected back to the earth by the Heaviside layer to a greater or less degree depending upon the density of this ionized layer, it stands to reason that if the density of the ions was great enough, all waves of whatever frequency would be completely reflected downward. If it were possible to produce such an ionized layer in the form of a parabola behind a vertical radiator, all waves would be propagated in one direction, parallel to the principal axis of the parabola. It might be possible to produce such a layer by arranging a battery of Coolidge cathode ray tubes in a parabola on the ground with their emission ends pointing upwards, since these tubes have the property of ionizing the air molecules in their path. Of course this method is far from practical, but I offer it merely as a suggestion. In the case of ultra-high frequencies, this method would not be so far fetched as the two or three foot radiator would be comparatively easy to enclose with the ionized zone.

Speculation along these lines might bring something to light, or at least furnish an idea for an amazing story! Hi!

Stanford has a "ham" station on the air, using the call W6DI. The radio club here was formed largely through the efforts of Prof. Terman and Allan Hoover, son of President Hoover.

—Orin C. Lewis, W6DZK, President Stanford Radio Club

I.A.R.U. News

(Continued from page 56)

Formosa was contacted by ON4CK, and Ascension Island by ON4JA.

The training ship *L'Avenir* (whose photo appeared in *QST* some time ago) is back again in Antwerp, coming there from Charleston, S. C., U. S. A., through Scandinavian waters.

Some changes have recently taken place in our officers (of the Reseau Belge): Mr. Desacgher, ON4JX, was elected District Manager of our Liege section, and Mr. R. Keerse, ON4GW, as D. M. of the Antwerp district.

We in Belgium had a very pleasant surprise during the fall in seeing our Union Secretary, Mr. K. B. Warner, the splendid fellow whose life could be summed up in the word "A.R.R.L.!" Our President, Mr. de Neck, saw him at The Hague, and had a long and pleasant chat with him. Afterwards, our Hon. Secretary, Mr. Urix, met him in Paris.

During the latter part of October the R. B. gang met in a very excellent hamfest; about 65 ON's were in the party, and in addition our good friend Mr. Larcher, F8BU, the Hon. Secretary of the R.F.F., accepted our invitation and came with a dozen of the leading French amateurs, amongst them being F8WB, F8HPG, F8RKO, F8FLM, F8BO, and F8HA with his charming

(Continued on page 66)

Service

**Big Profits
in it with
Reliable
Equipment**

"A penny saved is a penny earned" is not true in purchasing instruments for radio servicing work. The small difference in cost between the best obtainable meters and those of secondary value comes back to you many times over in the money you can make and the business reputation you acquire through the use of reliable equipment.

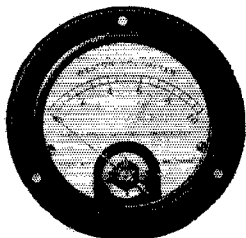

Shown above is typical design of miniature panel instruments—2" and 3¼" diameter—for use in the repair shop and in portable testing work. These are the instruments selected by Commander Byrd for his Polar expeditions. Preferred for their nicety of construction and superior electrical characteristics. Made in A. C., D. C. and Thermo-Couple Types, and in all the required ranges. Open scales almost to zero position. Designed for flush panel mounting. Write for Circular JJ, containing complete descriptions and prices.

WESTON ELECTRICAL INSTRUMENT CORP.
602 Frelinghuysen Avenue Newark, New Jersey

Weston
PIONEERS
SINCE 1888
INSTRUMENTS

YL. A good photo was taken of the whole gang, and will be sent along with the next report.

(Hope the photo includes that YL! — A. L. B.)

Before presenting the next report it might be well to include just a word about the situation at present existing in Czechoslovakia, as far as amateur societies are concerned. So far, two societies claim to represent the amateur; the K.V.A.C., which sends in the report printed herewith, and the S.K.E.C., which has rendered reports in the past. Both have petitioned for I.A.R.U. recognition, but a decision in the matter has not yet been made. It is hoped, however, that some settlement will be possible in the near future.

The editor of this department would like to take this opportunity of suggesting to our Czechoslovakian friends that they would benefit greatly by studying the last year's developments in amateur radio in Australia. Much the same situation existed there for a while, but was solved by the officials of the two societies concerned getting together, talking over their differences and amalgamating, a sporting and wise outcome. How about it, OK's?

CZECHOSLOVAKIA

By the K. V. A. C.

Although a great deal of work is being done on 40 meters in this country, many amateurs prefer to work locally on the 80-meter band.

The Ministry of Posts and Telegraphs created much happiness in the amateur ranks recently by announcing that amateur transmitting stations will now be officially permitted. Applicants will have to pass an examination on theory and practice, and must be able to send and receive 10 words per minute (50 letters per minute). Amateur licenses will be granted only for scientific and experimental purposes, and the government will have to be amply assured of these aims before any license will be issued. Maximum input will probably be limited to 50 watts in the final amplifier stage. A special law giving details of these arrangements is now being written up, and should be issued in the near future.

(Incidentally, the granting of amateur privileges in Czechoslovakia is a direct outcome of the Washington Convention of 1927, and the Hague Conference of 1929 — A. L. B.)

During the first part of November, 1929, the third annual meeting of the Ceskoslovensky Radiosvaz was held. The K.V.A.C. is the short-wave section of this parent society. Our president is Dr. Jan Safranek; the secretary, Mr. P. Motycka, and the treasurer, Mr. Max Paulik.

Active amateurs in Czechoslovakia at present are OK2YD, OK2SI, OK1RV, OK1VP, OK1OK, OK3SK and OK3NZ.

FRENCH SECTION

By Robert Larcher, Hon. Sec'y, R.E.F.

The end of the summer was favorable for morning contacts with the Pacific Coast of the



Tune in on a Lifetime of **THRILLING ADVENTURE**

Learn **RADIO**

...And See!
the World!

WHY not go around the world... seeing things... doing things... making Good Money... getting somewhere in Life... **WHY NOT LET RADIO PAY YOUR WAY!** That's what RCA Institutes has done for other men... That's what it can do for you. Radio needs you **TODAY!**... Thousands of positions now open! Why be merely a "radio fan," when you can so easily use the knowledge you already have as a stepping-stone to success. RCA Institutes gives you all you need to know about Radio to prepare you for a well-paid job in the fastest-growing industry of today! You get the "how" as well as the "why" of commercial radio. Nationally known experts direct your studies... You are *trained* to "make good" by men who have "made good."

A Commercial License Can Easily Be Yours

Never before have there been such opportunities for rapid advancement. The entire radio world is crying for men... *trained* men... RCA Institutes' men. That's why large broadcasting sta-

tions, manufacturers, dealers, as well as steamship companies are continually asking for RCA Institutes' graduates. They know that these men have the knowledge and ability to hold good positions in Radio... You, too, can get that knowledge.

The Only Course Sponsored by the Radio Corporation of America

RCA, the world's largest radio organization, stands squarely behind every lesson that you study. A thorough knowledge of commercial Radio can now be yours through the RCA Institutes' home-laboratory training course. You obtain a sound practical education in radio in your spare time... You get the "inside" information right at the source of radio achievement... direct from RCA. You learn radio by actual experience with the remarkable outlay of apparatus given to every student of this course.

Clip this Coupon Now!

See for yourself how RCA Institutes actually trains men for success in Radio. *Thousands* of graduates of this course are now holding responsible positions. **WRITE FOR THIS FREE BOOK TODAY...** or ask for your copy at any one of our resident schools. 40 fascinating pages, each one packed with text and illustrations telling all about the amazing opportunities in commercial radio, the world's fastest-growing industry!

For the added convenience of students who prefer a Resident Study Course, RCA Institutes, Inc., has established Resident Schools in the following cities:

New York . . . 326 B'way
Boston, Mass. 899 Boylston St.
Philadelphia, Pa. 1211 Chestnut St.
Baltimore, Md. 1215 N. Charles St.
Newark, N. J. 560 Broad St.
Home Study graduates may also attend any one of our resident schools for post-graduate instruction at no extra charge.

Clip this Coupon NOW!

RCA INSTITUTES, INC.

Formerly
Radio Institute of America



RCA INSTITUTES, Inc.
Dept. QST-2, 326 Broadway, New York

Gentlemen: Please send me your **FREE** 40-page book which illustrates the brilliant opportunities in Radio and describes your laboratory-method of instruction at home!

Name.....

Address.....

Cunningham RADIO TUBES

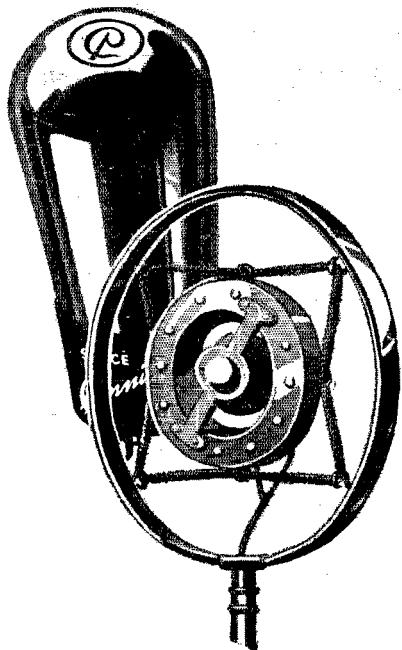

Guardians of pure tone

WHEREVER Cunningham tubes are used, they improve the quality of radio reception. Strict adherence to the finest radio principles marks the construction of each individual tube, with the result that "Cunninghams" meet the most exacting modern broadcast requirements.

*The name Cunningham
has meant absolute tube integrity
for the past 15 years*

E. T. CUNNINGHAM, INC.

New York Chicago San Francisco
Atlanta Dallas

Manufactured and sold under rights, patents
and inventions owned and / or controlled by
Radio Corporation of America.

United States. On 20 meters, F8EO, F8EX, F8JF and F8BQ were most active, and worked many W6 and W7 stations. Mr. Pieton was heard in Alaska with 3 watts input! F8FK and F8JF were also QSO Peru, Northern Canada (Yukon), Mexico and Hawaii.

Toward the East, conditions were generally good at night, and numerous contacts were made with Java, Sumatra, India, China and, occasionally, Japan. F8JA was QSO Siam, and OM Coutier was QSO YK2XX, in Formosa, both being contacts but rarely attained.

To the South, numerous QSO's were made with Africa, Australia, Kenya and Rhodesia. F8HR worked 'phone on 7000 kc. to a naval vessel in Cameroon, and OM Revirieux was QSO SN1AA (Ascension) with less than one watt!

The principal event during the Fall was the International Radio Exposition held in Paris, and at which the R.E.F. had an exhibition. Amateur transmitters and receivers were on view, and were in operation. These, as well as the exhibit of QSL cards confirming "first" contacts with the various continents, were the source of much interest to visitors. We are sure that amateur radio has been given a big boost here in France.

At the end of the exposition, a large banquet was held for members of the R.E.F. and many visiting foreign hams.

We take this opportunity of announcing that the R.E.F. will soon have a new official organ.

BRITISH SECTION

By J. Clarricoats, G6CL, R.S.G.B.

Conditions on both 7000 and 14,000 kc. were bad during October and early November. Very little DX was audible in London on the 14,000-kc. band after 1900 GCT. During the early afternoon certain eastern and southern DX was heard, but no consistency of reception was reported. On no evening during the month were North American signals clearly received, and, except for brief periods, South America, too, seemed dead.

Considerable interest has been aroused over here in connection with the 1715-kc. band. A large number of British stations have migrated to that frequency and are having an interesting time of it. After the feverish search for DX on the high frequencies it would seem that the old original transatlantic band is to come into its own again, amongst British amateurs. Reports from amateurs in other countries who receive our signals on this band will be very welcome.

Many amateurs north of England recently gathered in Manchester for a convention. A variety of interesting subjects was discussed, including recent developments which have taken place in connection with 56,000-kc. work. Mr. Noden, G6TW, one of our pioneer experimenters on this wave, gave details of his apparatus and paid a compliment to Mr. West and other well-known American amateurs who had, in the past few months, ploughed a lonely furrow in order to

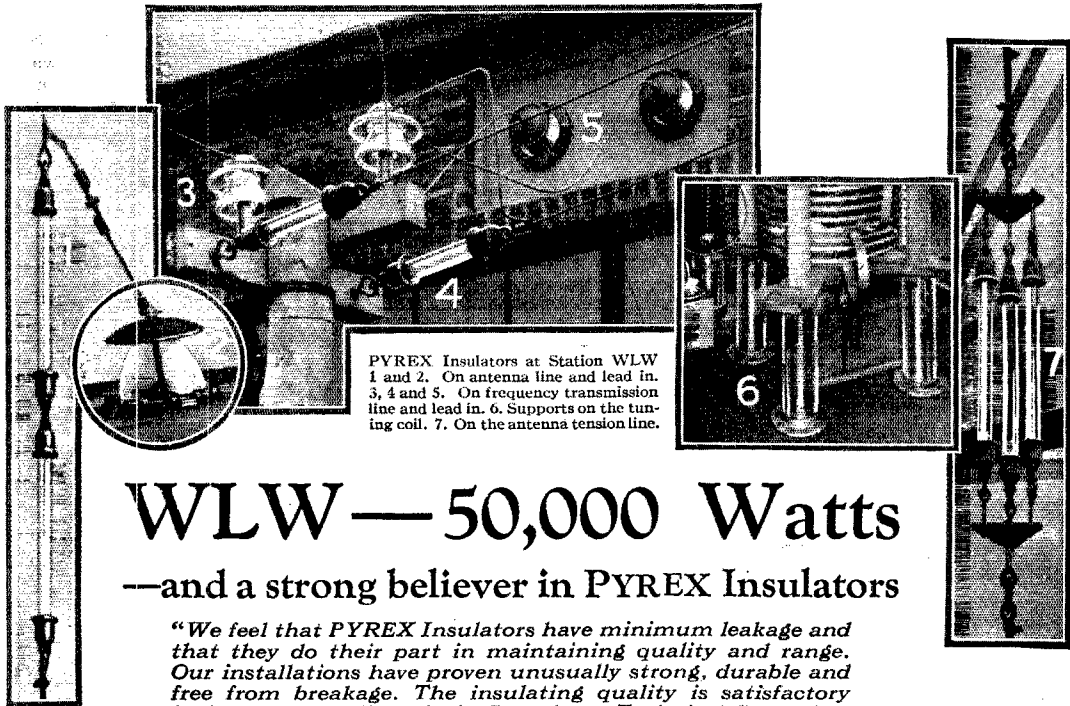

PYREX Insulators at Station WLW
 1 and 2. On antenna line and lead in.
 3, 4 and 5. On frequency transmission
 line and lead in. 6. Supports on the
 tuning coil. 7. On the antenna tension
 line.

WLW — 50,000 Watts

—and a strong believer in PYREX Insulators

"We feel that PYREX Insulators have minimum leakage and that they do their part in maintaining quality and range. Our installations have proven unusually strong, durable and free from breakage. The insulating quality is satisfactory in fog, rain, etc." — J. A. Chambers, Technical Supervisor

SUPER-POWER, advanced design, and PYREX Insulators throughout is the logical combination that has enabled its owners, Crosley Radio Corporation, to bring this fine new station into just prominence.

That PYREX Insulators have vindicated their right to exclusive use here is evident from the above comment.

An investigation of the 600 American broadcasting stations showed that PYREX Insulators were almost universally used on the antennae, that the

larger and new stations favor PYREX Entering Insulators on the lead-in, and that where conditions invite the use of stand-off, pillar and bus-bar types, PYREX Insulators are given the preference.

In the broadcasting stations, as in the U. S. Navy, Army, Coast Guard, Ice Patrol and Air Mail Services, PYREX Insulators have become the standard because of their uniformly successful performance.

A suitable type and size for every radio service is listed and priced in our PYREX Radio Insulator booklet. Write us for a copy and get PYREX Insulators from your nearest supply house, or if necessary from us direct.

CORNING GLASS WORKS, Dept. 64
 Industrial and Laboratory Division: CORNING, N. Y.



T. M. REG. U. S. PAT. OFF.



PYREX

A MARK OF CORNING GLASS WORKS

RADIO INSULATORS

Say You Saw It in *QST* — It Identifies You and Helps *QST*

Learn Radio Telegraphy

THIS new library contains the essential information for the student who wishes to learn radio telegraphy. The books are especially written for home study work. Not only are all of the essential facts concerning radio telegraphy given, but the leading questions and their answers which are used for government examinations are also covered.

Library of

Practical Radio Telegraphy

647 pages, 5½ x 8, 314 illustrations

By ARTHUR R. NILSON, Lieutenant (Technician) (Communications) U.S.N.R.; Member I.R.E.; Member Radio Club of America

and J. L. HORNING, Fellow Radio Club of America; Associate Member I.R.E.

The Library consists of two volumes:

VOLUME I—Practical Radio Telegraphy, covers the theory and practical operation of every type of modern commercial arc, spark, and vacuum tube transmitter; furnishes complete data on all kinds of up-to-date vacuum receivers. The book is arranged so that each chapter is devoted to a definite assignment of work — this enables the home-study reader to lay out a course in the theory of radio telegraphy which is easy to follow and grasp.

VOLUME II—Radio Operating Questions and Answers, Second Edition. This new revised second edition of Radio Questions and Answers covers the great advances which have been made since 1921 in the art of radio communication; it takes into account the new technique of broadcast-station operation which has been evolved through electrical, mechanical and physical improvements. Questions, with their answers, on the leading problems of radio operation have been carefully worked out, for the assistance of the student who is preparing for his operator's license.

SPECIAL OFFER

Examine and use this library for ten days free. At the end of this time, if the library proves satisfactory, send us only one dollar and two dollars a month until the special introductory price of five dollars has been paid. If the library is not satisfactory return it to us in ten days. The matter ends there. No agents. No red tape.

Send no money
Fill in and mail the
coupon today!

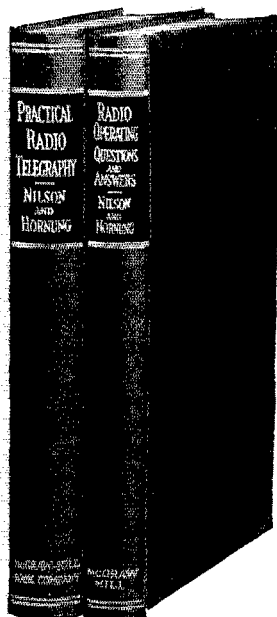

McGraw-Hill FREE Examination Coupon

McGraw-Hill Book Co., Inc.
370 Seventh Avenue, New York

Gentlemen: — Send me the New Library of Practical Radio Telegraphy, all charges prepaid, for 10 days' Free Examination. If satisfactory I will send \$1.00 in ten days and \$2.00 a month until \$5.00 has been paid. If not wanted I will return at your expense.

Name.....
Home Address.....
City and State.....
Name of Company.....
Occupation..... QST 2-30

probe the mysteries surrounding the ultra high frequencies.

The 28,000-ke. band has many adherents, but very little actual progress in connection with long-distance transmission or reception has been reported.

Since the inauguration of a Publicity Section, the membership of the R.S.G.B. has increased rapidly. Nearly one hundred new members have been enrolled since the Convention. Many of these fellows are from our British colonies and dominions, while many foreign amateurs have joined us. Colonial receiving stations are now being given a special identification number and it is hoped that this scheme will be found useful.

The annual meeting of the Society was held in London, on December 13th. It is hoped that a report of this will be available for the next issue.

LATVIA

We have been very much pleased to receive a petition from the *Latvijas Radio Biedrību Savienība* (Latvian Radio Amateur Union) for membership in the I.A.R.U. The usual investigation is being made, but it is hoped that we will be adding a Latvian amateur society to our Union list in the not far distant future.

We've just come across another QSL Bureau correction. Mr. W. R. Felton, Hon. Secretary of the Wireless Institute of Australia, advises us that the New South Wales Division of the WIA has been appointed official QSL Bureau for all parts of Australia. The address is "Hon. Secretary, W.I.A., Box 3129 P., G.P.O., Sydney, New South Wales, Australia."

— and now to buy that Christmas tree!

A Flexible Tube and Set Tester

(Continued from page 22)

tubes except that cord 2 is connected to CG_2 instead of G_2 .

Tube tests — The grid switch, SW , is placed in the "neutral" position and plugs in the same positions as for plate current measurement. The control grid clip in the receiver is connected

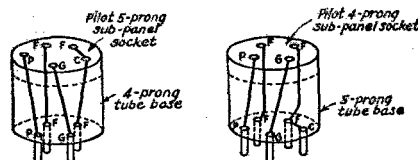

FIG. 2. — INTERNAL CONNECTIONS FOR THE ADAPTERS

Their construction is described in the text.

to the single end of the "exploring" cord, while the grid clip of the other end is connected to the control grid terminal of the tube in the test set.

SCREEN GRID TYPE RECEIVERS for the Amateur Station

MUST USE

REL COILS AND CONDENSERS

that give high amplification in the screen grid stage and allow flexibility in spreading stations.

For exclusive amateur band screen grid type receivers use REL Cat. No. 182-S Coil Kit (three coils and base) — high impedance primary will give real amplification step-up in the screen grid stage — adaptable to all circuits — covers the 20-, 40- and 80-meter amateur bands. Price \$10.00

For exclusive amateur band receivers use REL Cat. No. 187-E Condenser — adaptable to all circuits — the only condenser manufactured that will give full spread tuning on each of the popular bands. Price \$6.25

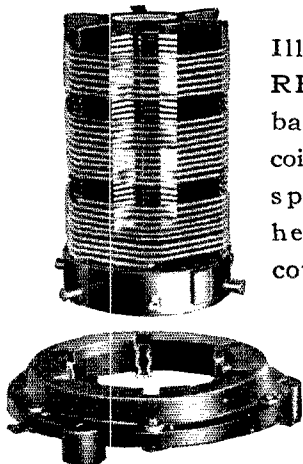

Illustrates the REL one-piece bakelite plug-in coil and base — space wound heavy enamel covered wire — positive contact — correctly designed.

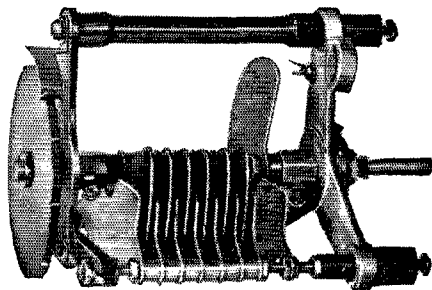

Illustrates the REL Cat. No. 187-E combined tank and vernier condenser — can be used to obtain full spread coverage of any desired narrow frequency band.

Write for the REL amateur booklet describing the Cat. No. 182-S Coils and Cat. No. 187-E Condensers. Another booklet describes how to construct and operate a Multistage 100% modulated amateur telephone station. This also contains a wiring diagram and complete information on a screen grid amateur band receiver.



Why not listen to our own experimental broadcast station W2XV each Wednesday and Friday evening between 8 and 10 P.M. Eastern Standard Time on 8650 Kilocycles



RADIO ENGINEERING LABORATORIES, INC.
100 WILBUR AVENUE, LONG ISLAND CITY, N. Y.

for phones

This husky well filtered power supply is just the thing. Send us your order today and build your new phone or cw transmitter around this wonderful unit.

Supplies both filament and plate current for four 210 tubes. Priced for less than you can buy the parts to build it.

Price \$25.00

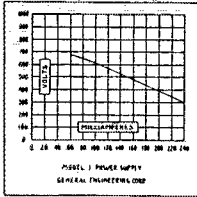
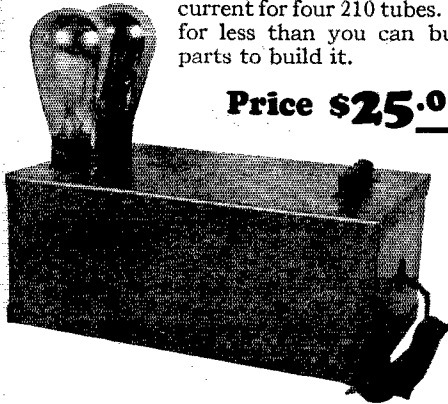

GENERAL ENGINEERING CORP.
CHARLOTTE MICHIGAN

The tip on the same end is plugged into the jack CG_1 . One tip of cord 1 is plugged in CG_2 . The other tip of cord 1 is touched to jack F_2 if the tube is of the -222 type or to C_2 if the tube is of the -224 a.c. heater type.

In addition to use in connection with the test-set in checking receivers and tubes, the two meters are available for other measurements, and the device really provides three effective meters for any measurements within their range. A.c. voltage measurements up to 150 volts may be made by making connection to the jacks provided at the left of the panel, while d.c. current measurements up to 100 milliamperes may be made by utilizing the "minus" jack at the lower center in conjunction with the jacks at the right. D.c. voltage measurements up to 500 volts are available with proper connections to the jacks lined up along the bottom of the panel.

Many other checks will be devised by the individual experimenter, and the field of usefulness of the test-set is only limited by the meter ranges and ingenuity of the man who has one.

A Power Supply for the Low-Power Transmitter

(Continued from page 24)

well to proceed cautiously when working around the set, because if the output of the power-supply is inadvertently short-circuited by the operator's body, even when the power is off, a rather disconcerting jolt will result. To be on the safe side, always discharge the condensers by means of the screw driver when adjusting the transmitter.

A good way to eliminate this danger, and at the same time take off the charge which accumulates on the filter condensers when the key is up, is to use a drain resistor. This is simply a high resistance which is connected directly across the output terminals of the power supply. A 50,000-ohm, 25-milliamper (30 watt) resistor is about right. When such a resistor is used, clicks are less likely to occur when the key is closed, which is a decided advantage when interference is caused with nearby broadcast receivers.

Fig. 2 shows the voltage at the output terminals of the unit shown in the photograph with varying plate currents. Although the transformer voltage is 550, it will be noticed that the output voltage is higher than this until about 50 milliamperes are drawn. This curve will not necessarily be true for all power supply units of this type, but it represents a fair average of the voltage which may be expected from such a system. A transmitter using a single UX-210 usually draws between 50 and 75 milliamperes, so it is safe to assume that the voltage will be 500 or more under all conditions except in the case of unusually low power line voltage.

Smooth, Flowing— POWER!

LIKE a deep, smoothly flowing stream the volume control on your radio, if it is a CENTRALAB, delivers a constant, uninterrupted flow of power that results in the purest, finest tone.

The most famous American radios are CENTRALAB equipped. Is yours?

Write Dept. 320F
For Free Book-
let "Volume
Controls, Volt-
age Controls
and Their Uses"

Centralab

Central Radio Laboratories

Dept. 320F, Keefe Ave. and Humboldt
MILWAUKEE, WIS.



Dealers Price
\$73¹²

RADIO SET ANALYSIS

OWNER: *Mr. J. P. Smith* DATE: *July 3, 1929*

ROCKET: *3000* NAME OF SET: *Chandler Model 3000*

TYPE OF RECEIVER	TYPE OF TUBE	POSITION OF TUBE	CURE OUT				MEASUREMENTS MADE IN SOCKET OF SET				TESTS IN TESTER			
			A VOLTS	B VOLTS	A VOLTS	B VOLTS	CATHODE VOLTS	NORMAL HEATER VOLTS	PLATE VOLTS	PLATE RESISTANCE	SCREEN VOLTS	SCREEN RESISTANCE	SCREEN CURRENT	SCREEN VOLTAGE
1	222	1st A	2.15	18.2	2.1	14A	3	2.2	2.6	5.6	3	76		
2	222	2nd A	2.15	18.2	2.1	14A	3	2.2	2.6	5.6	3	76		
3	222	3rd A	2.15	18.2	2.1	14A	3	2.2	2.6	5.6	3	76		
4	222	4th A	2.15	18.2	2.1	14A	3	2.2	2.6	5.6	3	76		
5	222	5th A	2.15	18.2	2.1	14A	3	2.2	2.6	5.6	3	76		
6	222	6th A	2.15	18.2	2.1	14A	3	2.2	2.6	5.6	3	76		
7	222	7th A	2.15	18.2	2.1	14A	3	2.2	2.6	5.6	3	76		
8	222	8th A	2.15	18.2	2.1	14A	3	2.2	2.6	5.6	3	76		
9	222	9th A	2.15	18.2	2.1	14A	3	2.2	2.6	5.6	3	76		
10	222	10th A	2.15	18.2	2.1	14A	3	2.2	2.6	5.6	3	76		

LINE VOLTAGE: *100* SET ON: *Set On* VOLUME CONTROL POSITION: *Full on*

SUGGESTIONS OR CHANGES MADE: *Set On*

BY: *Jim Moore*

Report of Receiver Test on Jewell Analysis Chart

Data on Receiver as Shown in Jewell Data Book

ATWATER-KENT — Model 55 A. C.

TUBE NO.	TYPE OF TUBE	POSITION OF TUBE	CURE OUT				MEASUREMENTS MADE IN SOCKET OF SET				TESTS IN TESTER			
			A VOLTS	B VOLTS	A VOLTS	B VOLTS	CATHODE VOLTS	NORMAL HEATER VOLTS	PLATE VOLTS	PLATE RESISTANCE	SCREEN VOLTS	SCREEN RESISTANCE	SCREEN CURRENT	SCREEN VOLTAGE
1	222	1st A	2.15	158	2.1	140	3	2.2	2.6	5.6	3	76		
2	222	2nd A	2.15	158	2.1	140	3	2.2	2.6	5.6	3	76		
3	222	3rd A	2.15	158	2.1	140	3	2.2	2.6	5.6	3	76		
4	222	4th A	2.15	158	2.1	140	3	2.2	2.6	5.6	3	76		
5	222	5th A	2.15	158	2.1	140	3	2.2	2.6	5.6	3	76		
6	222	6th A	2.15	158	2.1	140	3	2.2	2.6	5.6	3	76		
7	222	7th A	2.15	158	2.1	140	3	2.2	2.6	5.6	3	76		
8	222	8th A	2.15	158	2.1	140	3	2.2	2.6	5.6	3	76		
9	222	9th A	2.15	158	2.1	140	3	2.2	2.6	5.6	3	76		
10	222	10th A	2.15	158	2.1	140	3	2.2	2.6	5.6	3	76		

Radio Servicing at a Profit

The ability to instantly locate radio set troubles is essential in maintaining the confidence of customers in you as well as the line you sell. The quick elimination of set troubles not only reduces service cost but it is the key to satisfied customers that boost your organization.

The Jewell Pattern 199 Set Analyzer plus the Jewell method of set analysis quickly locates set troubles. It provides every essential radio service test (including screen grid receivers).

Jewell Analysis Charts furnished with Pattern 199's systematize testing — thus eliminating haphazard methods and putting radio servicing on a thoroughly scientific basis.

Jewell Pattern 199's are the lowest price complete set analyzers on the market, yet workmanship and materials of the entire unit are of the best. The 3 3/4 inch Jewell instruments are built to the highest standards. Furthermore, these instruments are backed by the Jewell Data Service, which includes up-to-the-minute data on the most popular receivers.

Every service man should have a Jewell Pattern 199 Set Analyzer. Sold by leading radio jobbers.

With the Jewell Method of set analysis readings from each stage are recorded on the analysis chart (shown at top of page). Set data is furnished in Jewell Instruction and Data Book (see specimen above) in exactly the same form for convenient comparison. By quickly and accurately locating set troubles the Jewell Pattern 199 is a big builder of service profits.

The new Jewell Instruction and Data Book is FREE to service men.

Mail coupon for your copy today.



Jewell Electrical Instrument Company
1642-C Walnut Street, Chicago, Illinois

Of course we want to know about the Jewell Method of Set Analysis. Mail booklet "Instructions for Servicing Radio Receivers" and complete data regarding the Jewell 199 Set Analyzer.

Name: _____

Address: _____

30 YEARS MAKING GOOD INSTRUMENTS

JEWELL

199 Set Analyzer

Say You Saw It in QST — It Identifies You and Helps QST

Which ?..

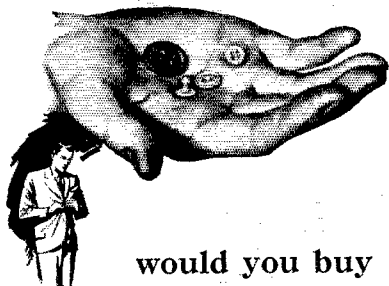

would you buy to
button your coat?

Our New Catalog

No. 429 is a veritable handbook of Resistor knowledge, Resistance Tables, suggestions and information. A request on your letter-head will bring your copy, post-haste.

There'd be no efficiency in a collar button or shirt button, would there? Similarly, there is little efficiency in a RESISTOR unless it is the right capacity, built to do the specific job.

Even a slight variation in specifications or from them can result in a marked loss of service.

We specialize in Resistors. Our stock models embrace a generous range of sizes, types, capacities and mountings. For special models—we will have finished samples on their way to you within 72 hours after your specifications reach us.



RESISTORS

HARDWICK, HINDLE, INC

Sales: Factory:
122 Greenwich St. 215 Emmet St.
New York City Newark, N. J.

BANKRUPT RADIO STOCKS

Fully Guaranteed

- | | |
|--|---------|
| 7 tube A. C. Chassis..... | \$24.50 |
| 7 tube A. C. Sets in beautiful table model cabinets..... | \$29.75 |
| 250 Power Amplifiers..... | \$19.75 |
| Short Wave Sets, one tube, complete with 5 coils; 30 to 550 meters..... | \$6.45 |
| A. C. Power and Filament Transformer..... | \$4.00 |
| A. C. Filament Transformer..... | \$1.95 |
| 16 Mfd. Condenser Blocks 1000 volts..... | \$3.90 |
| No. 1003 Power Transformers, shielded, Sec. 600 V., 7 1/2 V. C. T. to case, 1 1/2 V., 2 chokes. For one 281, one 250, one 227 and four 226 tubes..... | \$5.00 |
| No. 875 Transformer, Sec. 375 V.-375 V., 5, 5, 2 1/2, 1 1/2 and 1 1/2 V. High and low Pri. and 2 chokes. Will take care of 10 A. C. Tubes or less..... | \$4.25 |
| Vitrified Power Pack Resistances, 180 volt 16,600 ohms, tapped at 1500, 7800, 15,100 and 16,600 ohms..... | .90 |
| Tubes UX Type, guaranteed, No. 250..... | \$2.35 |
| No. 281, \$2.00; No. 280, \$1.25; No. 245, \$1.25; No. 224, \$1.75; No. 277, 75c; No. 226, 65c; No. 171, 75c. | |
| Audio transformers, 75c; Chokes, 90c. Variable Condenser, 50c; Coils, 35c. | |
| ABC Power Packs — \$8.75, 250 volts of B. Also has A. C. filament for up to nine tube sets. Can be used as B eliminator. Make your battery set all electric or build your A. C. set around this pack. 280 type tubes for this pack \$1.75 extra. | |

Send for Free List

CHAS. HOODWIN CO.

4240 Lincoln Ave., Dept. B-8, Chicago, Ill.

Bankrupt Radio Stocks

Election Notice

(Continued from page 30)

There is no limit on the number of petitions that may be filed, but no member shall append his signature to more than one such petition.

4. This election is the constitutional opportunity for members to put the man of their choice in office as the representative of their Division. They are urged to take the initiative and file nominating petitions immediately.

For the Board of Directors:

K. B. WARNER, Secretary.

Hartford, Conn., January 1, 1930.

A Three-Phase High-Voltage Rectifier

(Continued from page 37)

which allows a material saving on filter equipment due to the much higher cut-off frequency that is permissible. In addition to this, the magnitude of the 360-cycle ripple voltage is but 0.057 of the direct current output voltage as compared with a ripple voltage of 0.667 for the single-phase full-wave arrangement. The filter employed consists of two chokes, one of 30 henries and the other of 1.5 henries and three 1- μ fd. condensers.

The three wires of the primary 220-volt three-phase supply must absolutely balance as to voltage, for if they do not it is difficult to obtain a smooth output. The voltage drops about 20 volts in going through the arcs and the 235 milli-amperes drawn at 2100 volts barely warms the tubes. They can put out several times that amount without getting hot or causing any further drop in voltage. Our 220-volt primary supply here is 10% high and causes the output to be 2500 volts, d.c. By using a 750-watt iron heating unit in series with each primary wire we get the correct resistance for the conditions encountered to give an output of 2100 volts d.c.

OPERATING RESULTS

This rectifier has been in operation for eight months. For four months it supplied the plate for a 1750-ke. amateur phone. For the past four months it has supplied the plate voltage for a 3520-ke. crystal-controlled 75-watt phone. It supplies the plate of the UX-852 power amplifier, the two UX-852 modulators and, through resistors the plate of the intermediate amplifier. This transmitter has been on the air most every night, the plate-power supply having caused no trouble whatever nor has any work been done on it since it was installed eight months ago. The same tubes are in service and function just the same as they did when originally installed.



A 200-ohm potentiometer makes an excellent device for obtaining the center tap of the filament circuit on transmitters.

— W3CM

YOUR TRANSMITTER

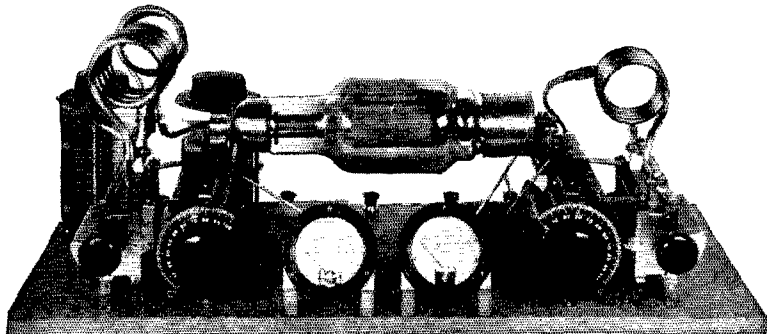

FOR 1930

NEW circuit perhaps—the latest in tubes—different, possibly, in many ways from your old one, but whether a new one is built or the old one revamped your one best bet is CARDWELL for condensers.

If you now use CARDWELLS—fine—if you don't, then CARDWELLS will make your set better, and if you don't know about CARDWELLS be sure to find out about them before you go ahead.

CARDWELL condensers are made in many types and sizes—for receivers, Amateur and Commercial transmitters and for broadcasting. Your request for literature or information will be promptly replied to.

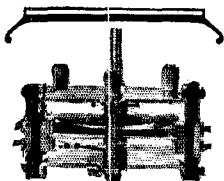

The 201-E (2 plates). A taper plate condenser for short wave receivers. The stator plate is adjustable, affording maximum capacities of from 50 to 10 mmfd.

CARDWELL CONDENSERS

THE ALLEN D. CARDWELL.
MANUFACTURING CORP'N.
81 Prospect Street, Brooklyn, N. Y.

SINCE THE BEGINNING OF BROADCASTING
"THE STANDARD OF COMPARISON"

90J

of La Grange, Ill., says:

New Super Wasp AC Short Wave Receiver

Is a Wow!

Got 5SW Phone Broadcast first night in operation. Comes in kit form or completely constructed.

1930 Ham-Book FREE

Everything for Hams. Crystals and Crystal Holders. 3000 volt new type R3 Recto bulbs (\$10.00). If it's good, we've got it!

Send today for your free copy

Chicago Radio Apparatus Co.

Dept. Q

415 S. Dearborn Street Chicago, Ill.



False Economy Is Costly

Nothing is likely to prove as costly as a cheaply made, over-rated condenser or resistor.

Whether you are a manufacturer, professional set builder or experimenter, you cannot afford the high cost of a cheap condenser or resistor.

Aerovox condensers and resistors are conservatively rated and thoroughly tested. They are not the most expensive, nor the cheapest, but they are the best that can be had at any price.

A COMPLETE CATALOG with illustrations and detailed descriptions may be obtained free of charge on request.



This is a monthly publication which will keep you abreast of the latest developments in radio. Free on request.



High-Frequency Inductances

(Continued from page 38)

coil for transmission should be one or one and a half inches wide and about twelve inches of conductor should be allowed for each turn.

These calculations have not been made with the amount of accuracy possible but have been made primarily to show the relationship between the various factors causing distributed capacity losses in high frequency inductances.

The Pacific Division Convention

(Continued from page 50)

Hebert, Treasurer-Fieldman, from A.R.R.L. Headquarters, who spoke on the legislative problems that have confronted amateur radio since 1912 and the prominent part taken by the A.R.R.L. during the past 15 years for the protection of amateur rights.

The thrill of the convention took place during the first afternoon when six large busses conveyed by three traffic motorcycle policemen left the hotel for Pasadena, — you may believe it or not, but it was an exciting ride fully appreciated nevertheless. At the California Institute of Technology, a special demonstration had been arranged and the delegates were given an opportunity to see what a million volts can do in performing spectacular displays. It certainly was impressive. At the Carnegie Institute for Scientific Display, several demonstrations were made for our benefit. The return trip was uneventful, but brought us back in time for dinner. Bob Parrish was in charge of the afternoon session and carried his part of the program as though he were a railroad conductor. Those who wandered about the city in the evening missed one of the best entertainments staged for the delegates which included good singing, dancing, jokes and stunts. It was a real "smoker." Later an open forum was started and everyone given an opportunity to express his opinions on matters for the good of the division. With visits to "ham" stations, CQ parties were in evidence the rest of the night.

Secretary-Editor K. B. Warner, the highest ranking officer from A.R.R.L. Headquarters, enlightened the delegates on the Hague meeting and briefly reviewed the 1927 International Radio Conference, and it is hoped every one realized the splendid work he has done not only for A.R.R.L. but also for amateur radio.

With C. A. Hill and C. A. Nichols in charge of sessions on Saturday a wonderful program of technical information was carried through. With Fred Schnell, former Traffic Manager A.R.R.L., and his description of a new receiver; Jim Lamb, Technical Editor of *QST*; J. T. Bray, Radio-victor Corporation; Homer Tasker of the Vitaphone Corporation and W. W. Bingham, Thordarson Mfg. Co., Chicago, enough information was given to satisfy everyone. Don Wallace, SCM, Los Angeles Section, although handicapped



AEROVOX OR Dubilier

7 MFD. HIGH VOLTAGE FILTER CONDENSER BLOCKS



SIZE 6" x 5" x 3 1/2"

CAPACITY	RATED D. C. WORKING VOLTAGE
2.0 MFD.	1000 V
1.0 " " "	800 V
1.	800 V
3.	400 V

Finest non-inductive High Voltage Filter Block ever made. Designed for use with UX-250 Power Tubes but can be used safely in filter circuits of transmitters or high power Amplifiers in any combination of capacities desired.

Each Unit is equipped with long, heavy, flexible leads, convenient for easy wiring, and also has mounting brackets. Latest design.

The insulation resistance of these Condenser Blocks is in excess of R.M.A. and N.E.M.A. standard requirements.

Due to the request of manufacturers of these Condenser Blocks we cannot divulge the high list price of same.

SPECIAL

\$3.25

PER BLOCK



LIST \$10.00

P. T. 537 FILAMENT RHEOSTATS

Rated to carry 15 amps.

An absolute necessity for the control of U.V. 203, 203A, 204, 204A and U.V. 851 Transmitting Tubes and 217, 217A, 217C and U.V. 1651 Rectifying Tubes.

Special \$3.75 ea.

ROTARY GRID CHOPPER WHEEL

MODEL P.X. 1638

and Contact Brush Model P.T. 1642

For use with C.W. Vacuum Tube Transmitters. Gives 100 per cent modulation since oscillation can be completely started and stopped at audio frequencies. The note obtained can be varied to any desired pitch by changing the driving motor speed. Complete with shaft bushing for 5-16" or 1/4" motor shaft. When ordering mention size wanted.



LIST \$7.45

Special \$1.25 ea.

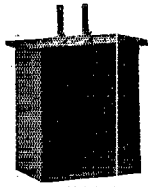

LIST \$25.00

2 HENRY FILTER REACTORS

Designed to carry 250 mills D.C. Resistance 20 ohms

Fine for use as Generator Filter, also as plate or Grid Reactor.

Manufactured by the world's largest electrical concern whose name we cannot mention.

Special \$3.50 ea.

VARIABLE MICA CONDENSER

MODEL U.G. 1819

Capacity .0001 to .005 Mfd.

A Mica Condenser which may be varied continuously from a minimum to a maximum value. Its capacity curve is a straight line, it has a very low electric loss. Used as a grid, antenna, or secondary tuning condenser.

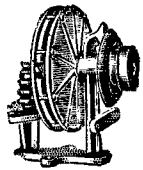

LIST \$8.75

Special \$1.75 ea.

THORDARSON DOUBLE FILTER CHOKES

CONTAINS TWO 18 HENRY 250 MILL CHOKES

This Thordarson heavy duty, rugged double Filter Reactor is excellent for Filter Circuits in Transmitters, Power Amplifiers, "B" Eliminators and various other purposes.

Each Choke has a 2000 Volt insulation and the D.C. resistance of each Choke is 108.5 ohms.

When connected in series this Filter Reactor has a capacity of 36 henries at 250 mills, and when connected in parallel 18 henries with 500 mills carrying capacity.

Weight for shipment 14 pounds. Dimensions 3 x 7 x 5 1/2 in. Equipped with mounting brackets.

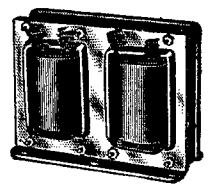

MODEL T-2458

List Price \$19.50

SPECIAL \$6.25

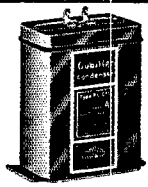

TYPE PL 571
List Price \$7.25

Dubilier High Voltage Filter Condenser

4 MFD. D.C. WORKING VOLTAGE 600 V

These Filter Condensers are designed for use in filter circuits in Transmitters, and all high Voltage Socket power devices and Power Packs.

SPECIAL \$2.25

AMERICAN SALES CO., 19-21 Warren Street, New York City

Here's the Answer

to every question about the principles, methods, or apparatus of radio transmitting and receiving. A complete course in radio operation in a single volume.

THE RADIO MANUAL

A New Edition

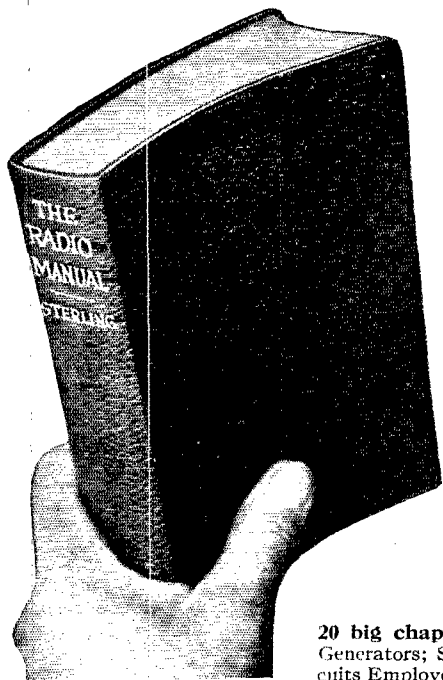

Complete
Preparation
for
Government
License

Complete new chapters on aircraft radio equipment; Practical Television and Radiomovies with instructions for building a complete outfit; radio interference; 100% modulation; latest equipment of the Western Electric Co.; the Marconi Auto-Alarm System; and many other developments of the past year. All this information is added in the new edition and, besides, the entire book has been brought right up to date with much new material. **The Radio Manual** continues to be the one complete and up-to-the-minute handbook covering the entire radio field.

A Complete Handbook of Principles, Methods, Apparatus for Students, Amateur and Commercial Operators, Inspectors

By G. E. STERLING, Radio Inspector and Examining Officer, Radio Division, U. S. Dept. of Commerce.

Edited by ROBERT S. KRUSE, for five years Technical Editor of QST.

20 big chapters cover: Elementary Electricity and Magnetism; Motors and Generators; Storage Batteries and Charging Circuits; The Vacuum Tube; Circuits Employed in Vacuum Tube Transmitters; Modulating Systems and 100% Modulation; Wavemeters; Piezo-Electric Oscillators; Wave Traps; Marine Vacuum Tube Transmitters; Radio Broadcasting Equipment; Arc Transmitters; Spark Transmitters; Commercial Radio Receivers; Marconi Auto-Alarm; Radio Beacons and Direction Finders; Aircraft Radio Equipment; Practical Television and Radiomovies; Eliminating Radio Interference; Radio Laws and Regulations; Handling and Abstracting Traffic.

An immense amount of information never before available including detailed descriptions of standard equipment is presented.

Examine It Free

Never before has so complete a treatment of radio theory and operation been compressed into a single volume as in this Revised Edition of **THE RADIO MANUAL**. Here is information that otherwise you could secure only by consulting many different books. And every detail is vouched for by authorities of the first rank. The Manual is profusely illustrated with hundreds of photographs and diagrams. There are 900 pages, bound in flexible fabrikoid that is extremely durable. The immediate demand for so valuable a handbook will quickly exhaust the first edition. To be sure of receiving your copy without delay, order at once. The volume will be sent for free examination. Pay or return in 10 days.

Order On This Coupon

D. VAN NOSTRAND CO., INC., 250 Fourth Ave., N. Y.
Send me the Revised Edition of **THE RADIO MANUAL** for examination. Within ten days after receipt I will either return the volume or send you \$6.00. — The price in full.

Name..... (QST 2-30)

St. and Number.....

City and State.....

America's

most highly endorsed, best written and most up-to-date radio text and reference book

"RADIO THEORY & OPERATING"

992 Pages

800 Illustrations

By MARY TEXANNA LOOMIS

President, and Lecturer on Radio, Loomis Radio College.
Member Institute of Radio Engineers

Now nearing 50,000 circulation. Adopted and used by all the Government radio schools, all the leading radio schools of this country and Canada, and nearly 400 universities, technical colleges and high schools. Why bother about having a dozen or more radio books when this covers everything? And the price is only —

\$3.50 — Postage Paid

47 chapters covering the entire subject, including Television, Radio Construction, Radio Repairing, Radio Servicing, Marine Radio Operating, Radio Compass Work, Land Radio Operating, Broadcasting, Airways, Communications, Message Forms, 1929 Radio Laws, Latest Diagrams, Junior Engineering.

For sale by practically all bookdealers this and foreign countries. Or sent, postage paid, on receipt check or money order.

LOOMIS PUBLISHING COMPANY

Dept. 5

WASHINGTON, D. C.

What are you kicking about?

How can you kick about QRM on 7000 if you haven't rebuilt your tuner to provide peaked amplification? Why holler about no clear places in the bands if you haven't a monitor whereby to locate your transmitter in a clear place? How can you expect a furriner to copy a bum 1928 signal in this A.D. 1930?

Give the old set a chance. Get onto these new and simple 1930 ways of making the old junkpile perk. In "The Radio Amateur's Handbook" for \$1 postpaid. Worlds of dope on everything else that tangles you. All ham. Sign up here:

A.R.R.L.,
1711 Park, Hartford.

You know what I need. Here's \$1. Send it quickly.

.....
.....
.....

Calls Heard

(Continued from page 57)

va2bh vp5oux vo8an vo8an vo8aw vo8mc vo8z x9a zlian
al1ao zllfr zllfw zs2n zsl4 zsl4c zsl4m zsl6z st6x zu6n zu6n
ctbj fgn gbvj kfu5

F8SPC, Monsieur P. Sergent, 4, A. des Tourelles,
Chatou, France

wlpz wicfy wljw wlcw wldp wlae wlegb wlbke wibal
wica wlaec wtago wlzsa w2box w2box w2alo w2by w2ave
w2efl w2bdf w2aab w2jv w2anr w3ot w3anh w3nt w3bre
w3awl w3ahc w3im w3ayl w4kh w4ahh w4qw w4ft w4kd
w4aef w8bgt w4aly w4aya w4atn w4gl w8enj w8adg w9yb
w9azq w9dgn un1nic vo8mc ka1zc

OZ1A, Neils Jacobsen, 29 Bredgade, Copenhagen,
Denmark

14,000-ke. band

au1ac au7ae au7kad fk2ms fm8rit pk4bo py1ah su8wy
us7ap vq2nc wlecz wicer wlkv w2fp w2jn w2rs w3ajd
w8axa w8hx yilmaz zsgz anlup au7ab fk6ter fm8rit su8kw
su8rs su8wy ve1br vu2dr w1afb w1apq w1ber w1dsi w1rw
w2aoc w2api w2arb w2bjg w2bka w2mb w2rs w3ajd z12ac
zu6n

H. W. Yahnel, P. O. Box 154, Helmetta, N. J.

7000-ke. band

ti2wd ve3oe ve3ez ve4ih fu8ske kdv5 x5zy x5q cm8le
ka1pw ka1rr z13cm z12bz vk3rg vk3pa vk6pk vk3rg k1aan
k4kd

14,000-ke. band

g6vp g6wt f8da on4fp on4fp zt1j zt1j zt5r ct1aa ear94
x9a py1ia vo8mc k4aky cm2sh cm2jt kfr7 ve1cc ve1br
ve1dd ve1ej ve1br ve1dr ve3hb ve4ag ve1dr ve1el z44m
zs2n zst4

Elliott C. Hagar, 30 Adams Ave., West Newton,
Mass.

14,000-ke. band

w1aze ce3bf ce3bm ct1bx d4xn ear96 f8da f8fk f8hr g2bm
g5ga g6nt g6vp he2jm lu3dh on4hc on4fw py1aa py1aw
py1em py2aj py2ba py2qb ve3ao vo8ae vo8aw vo8mc
w6sl wdre w6em w7bf wta zu6n

VE5AW, Lyle Geary, Box 76, Whitehorse, Yukon
Territory, Canada

ae8te ce2ab ce3bf ct1aa f8da f8dot f8eo f8fdb f8wb f8whg
g2ao g2iz g2ma g2nh g5by g5bz g5ma g5yg g6ec g6mn
g6wy j3rm klaf kl1em k1hr k1jr k6acw k6bhl k6bqh k6cfq
k6cjs k6toa oa4o oa4s oa4q on4bc on4ie on4fp on4hs on4us
om1tb pb7w py1ah py2bz rao3 ti2hc krf5 wsbs zslp zslm
zu6n

K6ACW, F. B. Hartman, 1034 Tenth Ave.,
Honolulu, T. H.

7000-ke. band

w1arr w1mk w4pk w5aye w6aie w6am w6amw w6ank
w6auo w6avj w6bbo w6bhv w6byu w6byv w6erz w6dre
w6day w6dy1 w6eel w6eii w6ekc w6epv w6epz w6ft w6gl
w6isf w6wa w7aah w7afr w7alm w8evq w9bmu w9bwt
w9bvh ve3gt vk3rg vk4hk vk5it z13bb bam wsbs.

14,000-ke. band

w4ly w6aaz w6ael w6aqq w6awf w6awp w6axm w6bax
w6byb w6cte w6dev w6dwi w6dyz w6edf w6ejc w6eus
w6fyq w6vz w7aav w7bew w9beu w9def ve1gd ve1go ve3aw
vk2cd vk2ed vk2hu vk3wo vk3wx vk4fq vk4rj vu2dr z11ab
z11aj z11an z11ao z11ap z11fw z12ac z12bi z12bg z12bx z12gd
z12gh z12gj z13mu z14bu ce3ab ce3ag ce3bf ce3bm ce2ak
he2jm lu2ea lu3de lu3pa lu4dq lu7je oa4q oa5l zs2n zt6x

W1BFT, C. B. Evans, 37 Madbury Road,
Durham, N. H.

ce1ah ce1ak ce2ab ce3ac ce3ag ce3bf ce3bm ce3ei cm2jt
cm2sh cm5ec cm5fl ct1bx ct2aa ct2ak d4ku ear21 ear96
ear155 f8brd f8da f8dot f8ex f8fk f8gq f8gy f8hr f8jd f8rbp
f8wb f8xz fk5er fm8smu g2ao g2ma g2vy g5bz g5nd g5ms

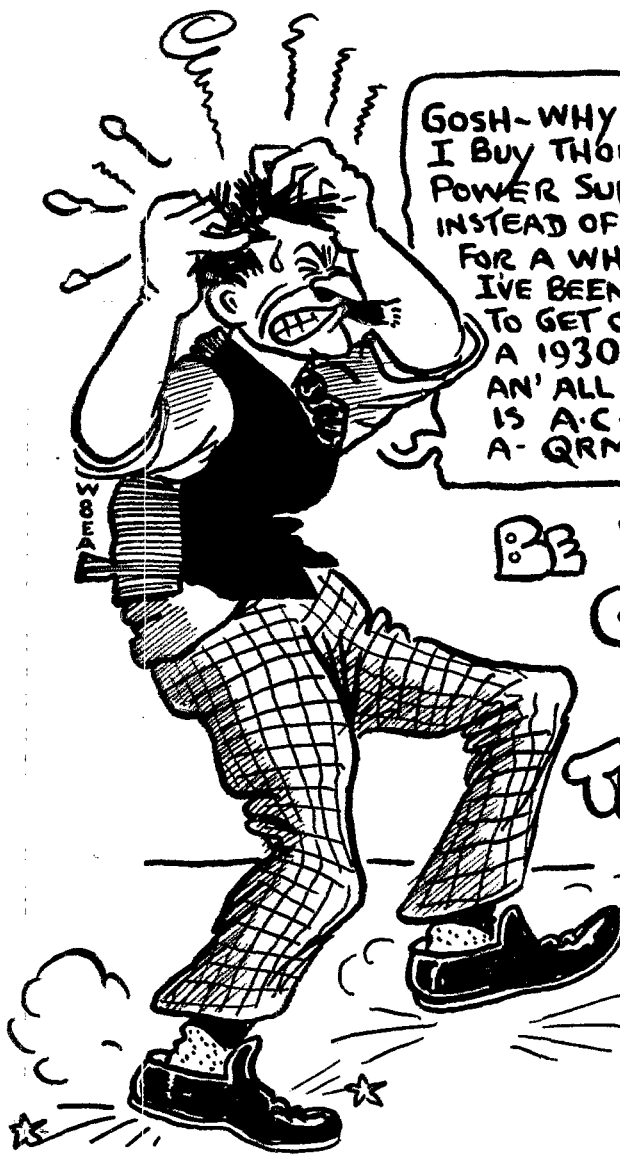

GOSH-WHY DIDNT
I BUY THORDARSON
POWER SUPPLY
INSTEAD OF THIS JUNK-
FOR A WHOLE WEEK-
I'VE BEEN TRYING
TO GET OUT WITH
A 1930 SIGNAL-
AN' ALL I KIN DO
IS A.C. WITH A LOT-
A-QRM~ WOW-

BE WISE-
GET THE BEST-
BUY
THORDARSON-
IT PAYS !!

DON'T FORGET
OM: UR QSL
CARD MEANS A
THORDARSON
LOG BOOK.
BETTER GET
URS NOW

THORDARSON

ELECTRIC MFG. COMPANY
500 WEST HURON STREET

CHICAGO, ILL.

ACME WIRE PRODUCTS

Coils — Magnet Wire Wound
 Magnet Wire All Insulations
 Varnished Insulations
 Parvot Filter and By Pass Condensers

All products made to Recognized Commercial Standards including those of:

- National Electric Mfrs. Assn.
- Radio Manufacturers Assn.
- American Society for Testing Materials

For 25 years manufacturers and suppliers to the largest and most discriminating users.

THE ACME WIRE CO.

NEW HAVEN, CONN.

Branch Offices:

- New York 52 Vanderbilt Ave.
- Cleveland Guardian Bldg.
- Chicago 842 N. Michigan Ave.

Amplifier and Service Engineers

HERE ARE THE SEASON'S MOST POPULAR ITEMS FOR 245 TUBE CONSTRUCTION

- No. 994 Power Amplifier Transformer.....\$12.00
- Either No. 2189 Push Pull Output Transformer.....\$12.00
- with No. 2142 Push Pull Input Transformer.....\$4.50
- or No. 3107 Straight Output Transformer.....\$12.00
- with No. 2158 Audio Transformer.....\$4.50
- No. D-946 Standard Condenser Unit.....\$22.50
- No. 5554 Double Choke (use in Filter Circuit).....\$11.00
- No. 2124 Transformer (Radio and Phonograph Amplification).....\$6.00

Check or Money Order will give you immediate delivery

Dongan Electric Manufacturing Co.
 2999-3001 Franklin St., Detroit, Mich.

g5qa g5ru g5yg g6nf g6nt g6rb g6ro g6un g6vp g6vr g6wl
 g6wn g6wt g6wy hb9d hc2jm kdv5 kfu5 k4akv k4kd k6bra
 la2b lu3dh lufcr ludy lu9dt luninc o4aj o4ao o4aq o442
 on4fp on4gw on4hc on4ij on4ro on4rs on4sc on4ta on4us
 on4uu oz5a pa0qf pylah pylar pylaw pylbr pylca pylcm
 pylcl pylia pylin py2aj py2ak py2ay py2bf py2ih py2sb
 py7ab snlaa ve5ak ve5aw ve5cl ve5cp ve5me ve5sw vp5oux
 vq2bh vu2dr vk2ku vk3ax vk3fp vk3wo vk3xd vk4bh
 vk5it w7aio w7agb w7aho w7ahx w7a1j w7aoq w7be w7fh
 w7if w7mo w7qd w8azy w8ad w8ael w8am w8awm w8axe
 w8axd w8awp w8aef w8asl w8axm w8aoc w8acp w8ac
 w8aqj w8awe w8aap w8bbo w8bpo w8bjw w8bwu w8brv
 w8bmt w8bzd w8bra w8bgn w8blu w8bzt w8byb w8blx
 w8bto w8bab w8bax w8bhx w8bhf w8bly w8bys w8czm
 w8cec w8cep w8euh w8eww w8eug w8eqg w8etp w8efb
 w8eot w8dpa w8dtt w8ddev w8dyk w8dea w8dyn w8dem
 w8djb w8dwi w8dwi w8dww w8dgg w8de w8dzy w8dys
 w8dev w8dyv w8dmk w8dre w8dyy w8dys w8dax w8dss
 w8dgg w8dyj w8ekr w8eru w8elm w8ebn w8eed w8eec
 w8ec w8ehi w8eho w8eug w8eqb w8eem w8epz w8ejc w8emd
 w8eaj w8ekw w8ql w8ro w8ta w8ay w8ns w8jc w8zbb w8og
 w8wh w8fx w8gr w8io w8ht x9a zl2oa zl4ao zs1p zs2c zs2a
 zs2s zs4a zs4m zs5w zt2b zt6x zu1d zu6n zu6z 56a

W2BXA, Ben Stevenson, 21 Randolph Place, Newark, N. J.

7000- and 14,000-cc. bands

cm2jt cm5fl cm2iq cm5fc cm5im cm2sh ct1bx ct1aa ct1ae
 ct1by pa0fp pa0fr pa0wr pa0az xpa0ja nr2ea ti2ags ti2hy
 vo8me vo8ae vo8aw k4acf k4aan un1nc un7nic d4xn d4jl
 sp3ar sp3pb yi2gq yilmdz heldr helcg ktr5 kfu5 kdvs
 ear98 ear94 ear6 k4ni k4kd k4akv cplaa ct3ab n2pa n1lug
 cx2ak sm6ua fk6cr vp5oux wfa wsg wdde pmz zl2df zl4ao
 zl2be zl2bz velbr velcc velbh velca, vel1da apl lu3dh lu2fi
 lu4da lu9dt lu2bx ce2bm ce2ab celah ce3bm ce3ab ce3bf
 k6bhl k6ekx k6tdg k6dmm k6avl k6cjs k6bra k1hr vk3pp
 vk2oj vk2rb vk3bq vk2dy vk2ku vk5aw vk5kj vk5it vk3jk
 on4fp on4gn on4uu on4ft on4gm on4dv on4fq on4ea on4hp
 on4ja on4jx on4rs on4rp on4rw g5bj goby g0xb g6wy g5rm
 g6xe g5yg g6wl g6za g2bm g6nt g5ml g6zn g5ux g5wk g6xj
 g6rb g6bd g6er g6ut g6pa g2od g6dn g6mc g5vm pylid
 pylah pylaa py2al pylaw scldr py2ik pylca py2az py2ay
 py2qa py2aj pylcm py2ik f8id f8eo f8cp f8hr f8hz f8he
 f8swa f8cij f8cte f8grg f8gko f8gdb f8hw f8wk f8orm f8ypz
 f8wzk f8jla f8dmi f8pro f8im f8dgo f8axq f8wb

W5LS, J. C. Johnson, 1821 W. Chestnut St., Denton, Texas

w1amu w1ani w1anx w1ajx w1auk w1bmn w1bld w1chs
 w1cmz w1cra w1dp w1fc w1mkn w1rd w1rp w1si w2abn
 w2aho w2anx w2aun w2avk w2aw w2bae w2bdf w2bfl
 w2biv w2bzw w2bqj w2bhw w2bjz w2cw w2cxl w2dh w2jt
 w2jv w2ku w2ld w2ms w2qn w2rd w2rt w2vc w2wr w3adx
 w3aeu w3af w3aft w3ahc w3aiz w3amb w3anh w3awm
 w3bei w3ur w3ny w3la w4acn w4afw w4abl w4ao w4ea w4ei
 w4ft w4hd w4hm w4hu w4la w4nb w4nr w4rf w4rm w4ua
 w4we w4zd w5aea w5afg w5ahq w5ajd w5aqe w5axs w5azs
 w5beb w5bcx w5rg w5td w6azn w6bam w6bef w6bmt
 w6btm w6car w6emo w6cck w6cw w6czc w6dzm w6dzy
 w6ea w6egh w6ekr w6elz w6eos w6eu w6eva w6hm w6id
 w6ty w7aah w7acd w7bb w7ed w8aa w8aa v w8agd w8aj
 w8akm w8alu w8aun w8axz w8ayo w8azq w8bef w8bez
 w8bdk w8bek w8bid w8bti w8bud w8bwk w8can w8chg
 w8cni w8cuq w8cvo w8czm w8ddg w8ejv w8li w8mb w8nl
 w8ql w8su w9amv w9amw w9ann w9apd w9aqs w9aux
 w9ayx w9ban w9beu w9bpq w9cdy w9civ w9ciy w9ekt
 w9cpj w9crd w9cwn w9cwv w9dfj w9dlu w9dpu w9dpv
 w9dsk w9dzm w9dzv w9eag w9efe w9egw w9ejp w9enr
 w9erv w9eab w9fey w9fse w9fi w9fsu w9fyp w9gdh w9ghg
 w9gij w9ll w9um w9yc bam hc2jc i1ll k6ecw kdvs ktr6
 kilhr ve2al ve3ch ve3cz ve3oh ve4af vk2hw vk7ew

G6WY, H. A. Maxwell Whyte, 24 Church Road, Forest Hill, London, England

14,000-cc. band

w1ae w1aqt w1awe w1bft w1bld w1bwa w1byv w1cek w1cph
 w1gf w1rw w2amr w2aox w2arb w2abi w2bec w2bih w2bjg
 w2bki w2bnp w2cex w2el w2rs w3ajd w3jm w3pf w3qw
 w4aef w8buz w8cew w8dpo w8drj w8za velbr ve2hd vo8ae
 vo8me vk2hc vk3bq vk3wx v7ap zs2n zs5w zs4m zu6n
 pylca pylcc py2bg ce2ab su8wy fm8gkc fm3ev fm8kik
 fm8rit ct2aa ct3aa vq4ere vu2dr xohng

THORDARSON TRANSFORMER

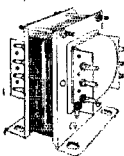

150 watts, 400 volts each side of centre tap at 375 M. A. 5 volt filament, centre tap. Fine for power supply for 7½ watter or for crystal control power supply. Specially priced for a short time only. Each **\$3.95**

Make your own transmitting and receiving coils. Copper tubing transmitting inductance.

Inside Dia.	Size of tubing		
	3/16"	1/4"	5/16"
2 1/8"	9c	10c	12c*
2 3/8"	9c	10c	15c*
3 1/8"	10c	12c	17c*

Prices per turn

Ham Green, double silk covered, No. 16 receiving inductance.

2" diameter.....30c per inch
3" diameter.....35c per inch

LEEDS

The Home of RADIO
45 VESEY STREET

NEW YORK

New York's Headquarters for

Transmitting Apparatus

When in Town Visit Our Store

EVERYTHING IN
ACME JEWELL PYREX
BRADLEY FLERON
THORDARSON
ELECTRAD NATIONAL
LYNCH SIGNAL
FLECHTHEIM
NATIONAL RECTOBULB
GENERAL RADIO
CARDWELL
IN STOCK

THORDARSON B-Eliminator TRANSFORMER

using the Raytheon B-H tube. Will carry the maximum current consumption without overheating. 285 volts on each side of centre. Lower voltage may be obtained if desired. Listed at \$5. Special NOW only **\$1.65**

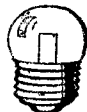
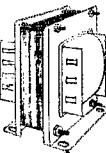

NEON GLOW LAMPS

Made by General Electric Co., type G. 10, standard base 101 uses, as illustrated in QST May, 1928, issue page 17. Price only.....65c

Aluminum Shield cans and panels of every description to order.

THORDARSON DOUBLE FILTER CHOKES

CONTAINS TWO 18 HENRY 250 MILL CHOKES

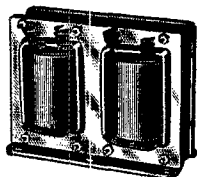

Excellent for Filter Circuits in Transmitters, Power Amplifiers, "B" Eliminators and various other purposes; has a 2000 Volt insulation and a D.C. resistance of 108.5 ohms.

When connected in series this Filter Reactor has a capacity of 36 henries at 250 mills, and when connected in parallel 18 henries with 500 mills carrying capacity.

Weight for shipment 14 pounds. Dimensions 3 x 7 x 5½ in. Equipped with mounting brackets.

MODEL T-2458

List Price \$19.50

SPECIAL \$6.25

Dubilier High Voltage Filter Condenser

4 MFD. D.C. WORKING VOLTAGE 600 V

Designed for use in filter circuits in Transmitters, and all high Voltage Socket, power devices and Power Packs.

SPECIAL \$2.25



TYPE PL 571

List Price \$7.25

1930 SHORT WAVE RECEIVER

A short wave receiver that's got them all beat. Best circuit design and finest mechanical construction. 3-Tube Receiver — detector — 2 audio, using three 201-A tubes. Universal type, continuous range 15 to 100 meters; amateur type covers Ham bands 20—40—80 meters with generous spread on the dial. List price \$60.
Special Offer, net..... **\$37.50***

SHORT WAVE X-MITTER

7½ Watt Hartley type Transmitter. Will operate with a 201-A tube, with 90 volts on the plate, up to a UX-210, with 30 watts input; has plug in transmitting coils. List price — kit \$55. Completely constructed \$70.
Special Offer, completely constructed..... **\$57.50***

LEEDS RADIO LABORATORIES

Precision Custom Built Short Wave Receivers and Transmitters

This department under the supervision of the Short Wave Specialist Jerome Gross. We design, construct and advise on any material for the "Ham" Broadcasting station or laboratory. Write Jerry Gross for advice on any of your problems.

PLEASE PRINT YOUR NAME AND ADDRESS PLAINLY to AVOID DELAY

WRITE FOR SPECIAL PRICE LIST

MAIL ORDERS FILLED SAME DAY 10% Must Accompany All Orders

FROST-RADIO

As the world's largest manufacturers of high grade variable resistors, we are singularly well equipped to supply your requirements, no matter what they may be.

Write us in detail regarding your variable resistor problems, and have us submit samples to meet your specifications.

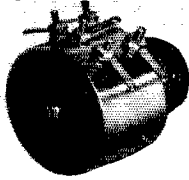

No. 890. Double depth metal shell unit in rheostat or potentiometer type. Rotors in same electrical connection. Composition elements, 5,000 ohms to 1 megohm in each unit. Diameter, 1 7/8 in. Depth of shell, 1 3/16 in.

HERBERT H. FROST, Inc.

Main Office and Factory: ELKHART, IND.

HERBERT H. FROST, Inc.
160 North LaSalle Street, Chicago

Send me your Parts Catalog by return mail. I understand that it will be sent to me FREE and postpaid.

Name

Address

City State

SPEED DOUBLED

Quickly With The CANDLER SYSTEM Course of Training in HIGH-SPEED Telegraphing.

Endorsed by world's fastest operators. Nothing else like it. Overcomes every handicap. Gives you alert, well-trained and perfectly CO-ORDINATED facilities necessary to high-speed work. DOUBLES speed of slow operators. Makes fast operators FASTER. Quick results. Satisfaction guaranteed or money back. Wonderful opportunities for Capable Radio Operators. Good pay. Don't delay. Write TO-DAY for full particulars.

The CANDLER SYSTEM CO.
6343 So. Kedzie Ave., Chicago, Ill.



WALTER H. CANDLER
"America's Famous
Developer of Expert
Operators"



Short Wave Measurement apparatus built to order to the accuracy you require

A Short Wave Wavemeter with a Calibrated Curve..... \$12.50

Audio Oscillator for Laboratory Testing..... \$17.50

Send for our information sheet on the above.

Long and Short Wave Receivers and Transmitters built to order.

Wireless Egert Engineering Inc.

179 Greenwich St.

New York

W2AJP, Norman B. Krim, 237 Haven Ave., New York City, N. Y.

7000-ke. band

as2 em2jm em2yb cm5fl ct2ac ear94 ear98 er3 f8pse g5by g5bz he1fg k4aan k6dy k6oa kdvs k6r k6rf kuvs n1jt n2pa nfx nmlnic ti2wd ti2zh vo8mc wsq wye x5z x9a x29a velad velap ve2af ve2am ve2ap ve2ay ve2be ve2bb ve3ay ve3cl ve3cz ve3oc ve3af ve3aj ve3ar ve3bu ve3hd ve3ic vk2jo vk2jt vk3pa vk3pp vk1em vk1em vk5aw vk5it vk5lf vk7cw vk3cw z1lar z1lbi z2ab z33cm z44ao w6nel w6aew w6iae w6aih w6aw w6ax w6akf w6am w6avq w6avj w6arv w6amw w6aun w6asm w6aso w6atp w6ajm w6aou w6aba w6bcj w6bht w6bzx w6bhf w6bpu w6bhw w6byy w6bfi w6cjs w6cya w6edu w6egx w6cem w6cj w6eui w6czm w6ddl w6dfs w6dea w6doi w6dre w6dtr w6dyl w6dzz w6dwi w6dzz w6ebn w6ebq w6edy w6efv w6egv w6eew w6eif w6eii w6eja w6eke w6eis w6elc w6eph w6epw w6eva w6esa w6esm w6esw w6eia w6erg w6enx w6ff w6fs w6ft w6ht w6id w6hm w6iz w6jv w6se w6tm w6wa w6wb w6wn w6yl w6xbb w6ajp w7aah w7acd w7af w7af w7ahw w7ed w7ek w7eq w7lz w7mo w7or w7qt w7tj

W8BSR, L. F. Strobel, 240 Harrison Ave., Cuyahoga Falls, Ohio

7000-ke. band

cm2mp cm5fl hc2bp hc2gr hc1aa klaf k1hr k6ejs k6elj k6dy n2pa ve1am velr ve1ac vk2ch vk2hm vk2ja vk2jl vk2jq vk2ju vk2kh vk2ru vk2vj vk3ax vk3hc vk3jl vk3jr vk3lj vk3ml vk3pa vk3pp vk3rg vk3ru vk3vp vk4hk vk5bj vk5gr vk5hg vk5hm vk5it vk5mj vk5rx vk5wb vk5wh vk5wr vk6lg vk6mu vk7ch vk7dx vq1aj w6ahh w6akt w6am w6asx w6awp w6bqk w6bts w6by w6com w6eui w6dhd w6dea w6dak w6dnn w6dwi w6ebg w6ehp w6ehi w6eif w6esb w6etb w6eva w6gh w6ju w7dd w7iy w7lz w7tx w7wl z1lbi z1lfv z1lgr z1zbp z1zbx z1zda z1zcm z1tzo z1taz z1av bal kflf kfu5 kfr6 nmfx wabs

W7ABH, Edwin Lorquist, 980 Northeast Tenth St., Portland, Oregon

7000-ke. band

ac1ab ac1ax ac1cl ac1ff ac1sm ac1pp ac2ff ac2al ac2ab ac2ek ac2db ac2el ac2ag ac2jk ac2te ac2rv ac2em ac2na ac2mp ac2xz aukab rim celac celaf celah ce2ah ce2ab ce2ac ce2ar ce2as ce2bl ce2ax ce2ab ce2aa ce2na cm2iq cm2la cm2cu cm2cf cm2ro cm2jt cm2ac cm5fl cm5cx cm5by cm5ry cm5fc cm5ea ct1bx cxiwa cxleg cxled cxlib cx2ak cx2ah cx7kk d4ku ellab f3oc f3ed f8est f8hc f8vud f8fx f8te f8ytr f8fd f8xo f8bpg f8ear f8jv fihva g5by g5nj g5qv g5ad g5yk g6mu gias hrlug hslhh hjos hcldr helcig hctem hc2jm hc2ea hc2ah ilay itch ifbd iler j4zz j1sm j1dj j1ak j1ak j1qb j1aw j1tm j1gs j2by j2dk j2ll j2bh j2yl j2bc j3cg j3ta j3cr j3et j3bq j4ck j4ak j4bk j4dx j7eb j7mf j9zz jxex jxix jhbb jxax jpbz kalad kalaj kalcm kalhr kalaq kalpw kalcy kaljd kalce kaljr kalzc kalzr kalxn kalaf kalbj kalre kalrd kalau kaljl kalrd kalaz kalmo kalxc kalzr kalbd ka3ac ka4aa ka7ad kfr5 kdvs kfus kez5 kfr6 k4aan k4kd k6amu k6kdi k6cl k6dwx k6boe k6chb k6eja k6eqm k6dyc k6oa k6duj k6dqn k6bjj k6alm k6bc k6aof k6bwh k6axw k6bdl k6aadh k6bww k6kk k6avl k6dqq k6bra k6brk k6bqh k6bbh k6buc k6de k6dgg k6acg k6edj k6dpp k6aay k6dba k6dy k6dce k6aj k6nl k6ch k6exy fil k7aks k7abs k7amm k7abe k7anq k7afe k7am k7aer k7ady k7if k7ak k7do k7km k7kn k7mn k7dq k7hl k7py k7em k7ee k7kx k7yz k7al k9pl k9br lueh8 lufh4 ludq4 lufec lu6c luag7 luxnl luhd4 luual lu2o oa4h oa4o oa4b oa4u oa4z oz7fr om1lb om2re nn1nic nn2nic nn7nic nn1st nmfx nncab nlx4 pk3bk plk1jr pk2aj plk opdkg pmz n1x1 py2ak pylib py1ah py1br py1ao py1bg py1id py1be py1eg py1ej py1cm py1ak py1ca py1ar py1aq py1ic py1aw py2ar py2ay py2aa py2af py2if py2aj py2id py2an py2ik py2if py2al py2ax py2iz py2il py3ac py3ab py9ab pynsm paora xpaosq xpaofa oip rx3om n2pa n2jp n2sp ss2bn ss1f ti2ea ti2ti ti2fg tige ti2ags ti2hv sj5bx velak vel2ay ve3dv ve3mv ve2be ve3kt ve3dz ve3es ve4he ve4ec ve4dv ve4dj ve4ei ve4vj ve5be ve5ac ve5bk ve5bn ve5ci ve5ef ve5go ve5ev ve5bf ve5co ve5gv ve5aj ve5av ve5au ve5fk ve5ad ve5as ve5dm ve5bu ve5ap ve5el ve5ar ve5en ve5ag ve5av ve5co ve5aw vk2aw vk2bb vk2bp vk2dm vk2ds vk2dy vk2ek vk2gv vk2hm vk2jk vk2jv vk2jy vk2kz vk2lm vk2mh vk2nb vk2no vk2ns vk2rb vk2rc vk2re vk2rg vk2rt vk2rx vk2sa vk2sh vk2ss vk2tm vk2uk vk2wk vk2xi vk2yi vk2zj

BARGAINS

ARMY AND NAVY RADIO SURPLUS

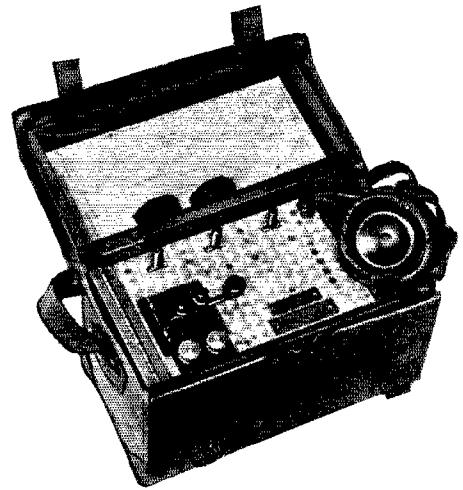
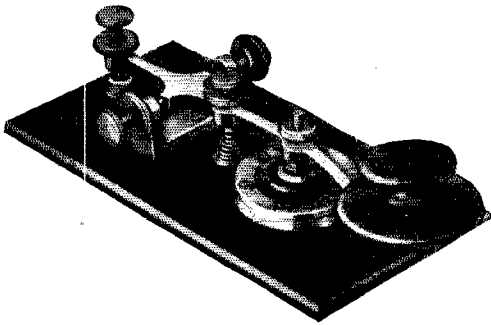

- Keys, transmitting, Airplane flameproof, silver $\frac{1}{4}$ " contacts, double skirt knob..... \$1.50
- Western Electric Dynamotor C.W. 927. Two 32/350 volt dynamotors in shock-proof hanger. Used in parallel give 160 mils. at 350 volts, in series, give 80 mils. at 700 volts. Can be used to operate transmitters to 50 watts from 32 volt D.C. 1.5 amp. input. Two dynamotors in hanger..... 25.00
- Single dynamotor without hanger..... 15.00
- West. Elec. Switchbd. C.W. 928. Control for Dynamotor C.W. 927. Has starting switches, fuses, 0-500 voltmeter, switches for testing main lines and output. Also complete filter system, Special..... 8.00
- Dynamotor, West. Elec. 12/350 volts, C.W. 1056 on heavy Bakelite base, with filter, 80 mil. output..... 18.00
- Dynamotor, G.E. Navy, Airplane, 24/1500 volts, 350 watt. Specially priced..... 32.50
- Dynamotor armatures, General Electric triple commutators, two sizes, D.C. 24/750 volt and 24/1500 volt, complete with ball bearings (build field and save \$30)..... 12.50
- Ammeter, Westinghouse, type C.A., either 0-1, 2 or 3 amps. zero adjustment, flush mounting. 5 size size Ampere hour meter, Sangamo, battery charge and discharge, type MS, 2 sizes, 0-300 and 0-500. List \$50.00..... 10.00
- Milliammeter, Westinghouse, type C.A. 0-500, zero adjustment, flush mounting..... 5.00
- Voltmeter, Westinghouse, type C.A. 0-25, zero adjustment, flush mounting..... 5.00
- Voltmeter, Westinghouse, A.C. 8" diameter with external resistance 0-175 volts, 60 cycle power house type..... 12.50
- Voltmeter, Westinghouse model P1. 3 scale, 0-5, 0-7.5, 0-150 for measuring A, B and C voltages, portable Bakelite case, Special..... 3.00
- Motor generator, Crocker Wheeler, 110 D.C. 220 A.C., 500 watt, 500 cycle. Ball bearing..... 50.00
- Complete line 500 cycle motor generators $\frac{1}{4}$ to 5 K.W. Prices on request.
- Transformers, Peerless, 120 input, 5-10-15 volt output, $\frac{1}{4}$ K.W., 60 cycle..... 7.50
- Transformers General Electric, 125 to 2500, with center tap, 60 cycle, 200 watt..... 7.50
- Transformers, Simon, 220 to 11500 closed core. $\frac{1}{2}$ K.W., 500 cycle, "pancake" secondary..... 5.00
- Air compressors, Kellogg, Model T. $1\frac{1}{2}$ cu. ft. per min. weight 6 lbs., 600 R.P.M., 125-lb. pressure. Requires $\frac{1}{2}$ h.p..... 3.00
- Condensers, West. Elec. 21AA, 1000 volt A.C. test, 1 mfd..... 1.00
- Condensers, Dubilier, mica, working volts 12,000, capacity .0004..... 10.00
- Condensers, Dubilier, mica, 40,000 volt, .0012-.001-.0008 or .002 mid..... 30.00
- Condensers, Dubilier, mica, working volts 3,600, capacity .32..... 10.00
- Condensers, Wireless Specialty, copper glass leyden jar, 10,000 working voltage .002 mid..... 2.00
- Condensers, Dubilier, mica, transmitting, 8500 working voltage .004 mfd..... 10.00
- Condensers, Dubilier, mica, transmitting, 12,500 working voltage .004 mid. Prices on request.
- Transmitter, telephone, Holtzer Cabot, carbon granular.. 95
- Western Electric Radiophone transmitter unit 326 W. Regular price \$12.00, Special..... 1.50
- Headphone, double Holtzer Cabot, U. S. Navy..... .75
- Headphone, Army, with strap, 120 ohm..... .75
- Headphone, Radio School, leather headband, 75 ohm... 1.50
- Keys, transmitting, Army practice, silver contacts..... 1.00
- Keys, transmitting, Airplane flameproof, silver $\frac{1}{2}$ " contacts, with blinker light mounted on Bakelite base. List \$7.50, Special..... 2.00

- Telegraph and buzzer portable sets, mahogany case, 2 tone A contact platinum contact high frequency buzzer, 2 telephone toggle switches, potentiometer, sending key, 3 mfd. condensers, transformer and 2 choke coils, receiver, \$30. value..... \$ 5.00
- Keys, transmitting, Navy $\frac{1}{4}$ K.W., "Mesco" silver contacts..... 2.00
- Buzzers, Century & Mesco high freq., 2 coils..... 1.50
- Buzzers, Western Electric, Extra quality, high frequency. Receivers, Signal Corps type, B.C. 14A, 200-500 meters, with cry. det. and Century buzzer in portable case.... 7.50
- Receivers, Navy, C.N. 113, 300-2500 meters, crystals.... 7.50
- Receivers, Navy, C.N. 240, 1000-10,000 meters, original cost \$500..... 50.00
- Receivers, S.E. 143 and I.P. 500. Prices on request.
- Insulators, Electrore, Navy receiving strain, 7" — per doz. 1.25
- Heterodyne, Signal Corps, type B.C. 104. 1000 to 3000 meters, with detector..... 15.00
- Coils, Choke, Western Electric Co. 57C. 83 ohm, 2 windings. Fine for filter..... 1.00
- Loudspeaker Unit, Western Electric, 193 W. Ideal for monitoring your transmitter. Without cord..... 3.00
- Magnets, Army mine and finger type, has 4 large fixed magnets. Good value..... 1.00
- Battery, U. S. Army, lead-acid type, 10 volt, 20 ampere hour. Consisting of 5 individual 2 volt cells in carrying case..... 5.00
- Individual 2 volt cells, minus electrolyte..... 1.00
- Generator, airplane, Signal Corps, with shaft, can be used as motor or bat. charger, 12 volts, 33.6 amp..... 10.00
- Sounders, Signal Corps, 120 ohms, with adjustable magnets..... 2.50
- Generators, Westinghouse 110 volt, A.C. 900 cycles, 200 watts, self excited..... 15.00
- General Radio Variable inductor, type 190, 150 M.H. or 650 M.H..... 6.50
- Relays, Western Electric 122 AB, double pole, double throw, 350 ohms, operates on 20 mils. 6 volts, handle 2 amps. per contact. Reg. price \$17.00..... 2.50
- Storage batteries, Edison Nickel Alkali 225 amp. hr. type A-6 1.2 volts per cell, weight each 20 lbs..... 4.00
- Voltmeters, D.C. portable new Weston model 45, 3 scale 0-3-15-150 guaranteed $\frac{1}{4}$ of 1% accurate..... 40.00
- Ammeters, D.C. portable, new Weston model 45, 3 scale 0-1, 15-150 with 3 scale external shunt and leads $\frac{1}{4}$ of 1% accurate..... 40.00
- Generators, 12 volt, 60 amp, has automatic controls..... 20.00
- Filters, heavy duty, West. Elec. 936 in steel cabinet, made for gasoline engines, line for motors, high frequency apparatus, etc. Has large inductance, high imp. chokes, low imp. h. cap. condensers..... 7.50
- Motor generator, R & M, 110 D.C. 3 $\frac{1}{2}$ h.p., 2 kw. 20 volt 80 amp. Great for large station filament supply. Price on request.
- SPECIAL — U. S. Army instruction books on elementary and advanced telephony and telegraphy. Hundreds of pictures and diagrams..... 1.00

Largest Radio and Electric Supply House in U. S. specializing on Army and Navy Surplus. Write us your particular requirements. Sufficient postage and deposit of 20% required on C.O.D. orders. NO C.O.D. ON CANADIAN ORDERS.

MANHATTAN ELECTRIC BARGAIN HOUSE, Dept. Q, 105-7 Fulton St., New York City

QST Oscillating Crystals

AMATEUR BANDS:

(New prices effective October 1st 1929)
 Winter is coming and no doubt you are going over your transmitter removing those weak links so as to get the most possible efficiency from your set.

One item of great importance is the frequency stability of your set. Does it stay on one frequency? If not, our power crystals will solve that problem. SCIENTIFIC RADIO SERVICE crystals are known to be the best obtainable, having ONE single frequency and highest output. With each crystal is furnished an accurate calibration guaranteed to better than a tenth of 1%. New prices for grinding power crystals in the amateur bands are as follows:

- 1715 to 2000 Kc band \$18.00 (unmounted)
- 3500 to 4000 Kc band \$25.00 (unmounted)
- 7000 to 7300 Kc band \$45.00 (unmounted)

BROADCAST BAND:

Power crystals ground in the 550-1500 Kc band accurate to plus or minus 500 cycles of your specified frequency fully mounted for \$55.00. In ordering please specify type tube, plate voltage and operating

temperature. All crystals absolutely guaranteed regards to output and frequency and delivery can be made within two days after receipt of your order.

CONSTANT TEMPERATURE HEATER UNITS:

We can supply heater units guaranteed to keep the temperature of the crystals constant to better than a tenth of 1 degree centigrade for \$250.00. Two matched crystals, ground to your assigned frequency in the 550-1500 Kc band with the heater unit complete \$360.00. More detailed description of this unit sent upon request.

ATTENTION AIRCRAFT AND COMMERCIAL RADIO CORPORATIONS:

We invite your inquiries regards your crystal needs for Radio use. We will be glad to quote special prices for POWER crystals in quantity lots. We have been grinding power crystals for over five years, being pioneers in this specialized field, we feel we can be of real service to you. We can grind power crystals to your specified frequency accurate to plus or minus .03%. All crystals guaranteed and prompt deliveries can be made. A trial will convince you.

SCIENTIFIC RADIO SERVICE

"THE CRYSTAL SPECIALISTS"

P. O. Box 86

Dept. P 3

Mount Rainier, Maryland

Build A BETTER B-Eliminator

With TRUVOLTS—the universal heavy duty wire-wound resistance. Safest, because air-cooled.

Write Dept. Q2 for Data

175 Varick St., New York, N.Y.
ELECTRAD
 INC.

HILET POWER TRANSFORMERS AND CHOKES

2 KW 2000-2500 volts each side, \$40.00. 700 watts, 1000-1500 volts each side, \$14.50. 250 watts, 500-750-1000 each side, \$10.50, unmounted \$9.75. 100 watt 325 volts each side, two 7 1/2 V windings, \$6.50. 100 watt filament any voltage \$4.50. Chokes with adjustable core 250 MA \$7.50. 160 MA \$6.00. 500 MA 30 H \$25.00. Specials to order. Write for specifications.

HILET ENG. CO. (One Day Delivery) ORANGE, N. J.

Radio Operators Wanted

Radio operators are officers aboard ships. Well paid, pleasant work, travel. You can qualify in a short time in our well-equipped school under expert instructors.



Write now for free booklet on "Opportunities in Radio."

WEST SIDE YMCA RADIO INSTITUTE
 111 West 64th Street, New York Established 1910

TRI-STATE HEADQUARTERS
 PENNSYLVANIA—OHIO—WEST VA.

WHOLESALE RADIO

To DEALERS and SET BUILDERS we offer the most prompt and efficient service. We handle only the best merchandise and give MAXIMUM DISCOUNTS.

GET OUR CATALOG

CAMERADIO
 430 WOOD ST.
 at Diamond St.
 PITTSBURGH PA.

PACENT

Duo Lateral
COILS

The complete line of all standard turn ratios preferred by leading laboratories and engineers.

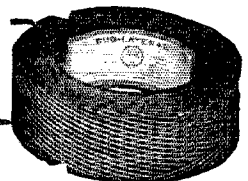

Write for information and prices

PACENT ELECTRIC CO., Inc.
 91-7th Avenue New York City

The NEW Martin VIBROPLEX No. 6

Reg. Trade Marks: Vibroplex; Bug; Lightning Bug

In Attractive Colors **Blue Green Red**

The smoothest, easiest-working bug on the market. 10 New Features. Fast or slow speed. A great bug for amateurs. Black or Colored. \$17 Nickel-Plated. \$19

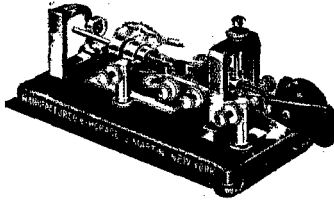
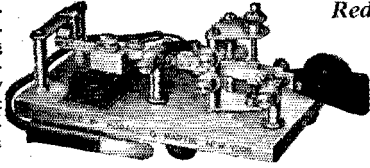

Famous Improved VIBROPLEX

Used by tens of thousands of operators because of its ease and perfection of sending. Black or Colored. \$17 Nickel-Plated. \$19

Special Radio Model Extra Large, Specially Constructed Contact Points for direct use without relay. Black or Colored. \$25

Your old Vibroplex accepted as part payment Remit by Money Order or registered mail

THE VIBROPLEX COMPANY, Inc.
825 Broadway, New York City
Cable Address: "VIBROPLEX" New York

QUARTZ OSCILLATING CRYSTALS

Scientifically Prepared for Maximum Power and Unconditionally Guaranteed 1 in. square sections, of your approximate specified frequency, supplied at the following prices:
75-100 meters. \$12.50
100-200 meters. 10.00
200-600 meters. 15.00
1 in. Tested blanks, 200-400, 400-600 meters. 5.00
Dustproof Bakelite mounts 3.00
For 1 1/2 in. sections, above prices are doubled.
Sections of any practicable dimensions made to order. Prompt Delivery
J. T. Rooney, B. Sc., 4 Calumet Bldg., Buffalo, New York
"Twelve years' crystallographic experience"

Massachusetts Radio and Telegraph School

18 Boylston Street, Boston
Send for Catalogue

Tel. Hancock 8184 Established 1905

Resistance from Alpha to Omega

No matter what your resistance problem may be, there is one universal solution—

CLAROSTAT

Variable and fixed resistors, volume controls, automatic line voltage ballasts, socket antennas, etc.

Write for literature to

CLAROSTAT MFG. CO., INC.
283 North 6th St., Brooklyn, N. Y.

W8wo w8xk w9aba w9aco w9adm w9ads w9aew w9aex
w9ajk w9akn w9an w9anq w9ast w9awp w9ayp w9axv
w9az w9azy w9bab w9baz w9bba w9bcs w9bez w9bq
w9bep w9bga w9bkd w9bkkz w9bms w9bms w9bmr w9bpb
w9bpm w9bqh w9bqc w9bys w9cas w9ccc w9ce w9cgh
w9civ w9ckf w9cmf w9cps w9csg w9csr w9cse w9ctv
w9ctv w9cuh w9cyp w9ew w9ewx w9djb w9dez w9df
w9dfd w9dfg w9dft w9dfb w9dqz w9dsk w9dj w9djh
w9dlm w9doq w9dpw w9dqw w9dqz w9drd w9dzz w9dza
w9ean w9eap w9eag w9ef w9egf w9egr w9egv w9emr w9end
w9eoc w9eru w9eta w9etp w9exb w9fey w9ffq w9fkl w9flh
w9flh w9fol w9foa w9frq w9fua w9fwg w9fxj w9fxo w9fxy
w9fyz w9gex w9gio w9ghv w9gka w9kbl w9ob w9si w9sj
w9um w9ve w9yc x1cs s9a z1lc z1bz z1da z1ch z1za z1zc

W9UM, W9BOH, Lake Wawasee, near Syracuse, Ind.

7000-kc. band

k4acf k4kd k6bex k6ejb k6dju k6dtg k6dv k6bra k6oa
k6owc k7iq kdv5 kfr5 kfr6 kfu0 velbw veicc velda velaf
vefbm veidj veitg veigo veiph veise veisak veisav veico
ve9ar vm2mp cm2iq cm2xc cm2yb cm5ic cm2fl cm8by
cm8ic cm8uf nmfx nm1fx nm1nic nm7nic nncab ti2ea ti2hv
ti2wd heldr helif he2jf he2jm he2bp zszb zszm zszo zszw
zuz6 ce2ab ce3ab ce3bf ce3ci pylah pylaw pylca pylcr
py2bf py2ik py3ah x9a x9b x29a vk2jr vk2jz vk2nb vk2rb
vk2rt vk2sk vk2ku vk2wz vk3jk vk3ka vk3pa vk3pp vk3pr
vk3rg vk5hg vk5mj vk5jh vk6ma vk7ch vk7ij zllbb zllbi
zllfr zllft zllfw zllab zlaw zl2be zl2bf zl2bz zl2gn zl3aj
zl3as zl3cg zl4ao zl4ay zl4hg ac8ag nj2pa f8ps fm8rdi oa4q
geo 98x 22d 55x xw6chk wfa wfat oosda

G2OL, S. W. Culler, 15 Queen's Garden, Ealing, W. 5, London, England

7000-kc. band

w1abm w1af w1aja w1ajc w1amd w1awk w1bks w2aft
w2apn w2auj w2ave w2avl w1bqr w1bvm w1czb w1zab
w3cdq w3pf w4ahq w4ag w4he w4lm w4wq w4rn w5afg
w5bbj w5bdj w5bek w5ql w5yd w5ayb w5bbk w5bcq
w5blh w5bth w5ces w5dar w5dbk w5em w5li w5sp w9adm
w9akk w9bab w9bic k4kd ve3tt vo8ae

W5AMH, B. Basden, 203 N. Archer St., Groesbeck, Texas

7000-kc. band

w1ahx w1ca widke w2bta w2cx w2bge w2afr w2el w3aw
w3atj w3abw w3ans w3awm w4aef w4ay w4el w4ft w4ajy
w4aiq w5aqe w5aqy w5bad w5aha w5azv w5bhv w5bbu
w5fb w5fc w5gp w5ww w5wf w5ww w5ajd w5ahk w5bmv
w5edv w5ear w7aat w7afr w8ayn w8aj w8ah w8bne
w8dlb w8ej w8bl w8bd w8btd w8vi w9axv w9bez w9apy
w9bma w9crd w9dpy w9eag w9eyw w9fy w9est w9fex w9fxm
w9ot w9yc w9df w9gex w9dex x29a nm1nic kfr5 k1hr x6bv
cm2ay nj2pa ti2wd om1tb x1j

14,000-kc. band

w1zz w9ef x9a

VK3CX, Alan G. Brown, 8 Mangarra Road, Canterbury, E. 7, Victoria, Australia

14,000-kc. band

w1bux w1dl w1dp w1za w2amr w2aq w2api w2arb w2ard
w2ary w2bfi w2bv w2bys w2mb w2rs w4aef w5al w5be
w5jv w5rg w5hau w5bax w5dew w5dlm w5eug w5sz w7afo
w7be w8axa w8bkh w8dqv w8gz w9abu w9beu w9crd w9dft
w9dzz w9ef w9ev w9gy wfa wfat wfsb ac1bd ac3fr celah
celai celak celab celac cel3e cel3f cel3m cm2jt ct1aa
ct1b cx1aw cx2ak d4ka d4yt eu3bh f8axg f8fk g6dh g6nf
g6rb g6vp g6wt hc2hp ilau j3dd k6bxw k6dhl k6ene kfu5
lu4dq lu8dy oa4l oa4o oa4t oa4q oa4p oa4hp pk3bm ve4bg
vs8ah vs7ap x9a yilac

7000-kc. band

w2ajp w1aa w4lm w5bc w5ql w6ad w6ags w6aas w6awp
w6bck w6bf w6cx w6dre w6eif w7ax w9af k1em k1hr
k1dj k1pw k6cjs w2fr ac8em ac8jk j3tz vs3ab vs6fe

K6BOE, William Leavitt, 2nd. Bn., 55th C. A., Ft. Ruger, Honolulu, T. H.

vk3is vk3rx vk2wc vk2jq vk3pa vk3wo vk3jr vk2zn vk2zs
vk4do vk4ri vk2hu vk2hu vk2jl vkhu vk2ek vk2dy vk3pp

TALKS TO LONDON FROM PLANE IN AIR

Reporter in Craft Speeding
Over City Has Conversation
Across the Ocean.

THREE CALLS ARE MADE

Words Understood Clearly in Spite
of Static—Electric Experts
Pleased With Results.

Special to The New York Times.
HADLEY FIELD, N. J., June 25.—
Flying at ninety miles an hour today
with a trick for blanket blotting out
the earth below him, W. W. Chap-
lin, Associated Press reporter, casual-
ly turned to a microphone and
asked for the London office of the
news association. The request, re-
layed through the laboratories of the
Bell Telephone Company, passed on
to the radio ocean radio telephone
station at Belfast, Mt., and then car-
ried again on the air, across 3,000
miles of ocean to London.
The connection was made quickly
and Chaplin asked that Miss Martha
Dalrymple of the London office be
called to the phone. The conversa-
tion, once greetings were over,
Chaplin said later, had to do mostly
with the weather. It was broken
somewhat by static but the two
persons talking, one in a fog-bound
plane a half-mile in the air and the
other in a fog-bound London office,
understood each other and ex-
changed greetings.

"ESCO" Airplane Generators provided the power for this remarkable achievement

Two "ESCO" Airplane Generators
(wind driven) were mounted on the
Bell Telephone Airplane. One sup-
plied power to the transmitter and
the other to the receiver. Both were
of standard "ESCO" design which
insures reliable service under the severe operating conditions
common to aviation.



Low wind resistance, light weight, non-corroding parts, ball
bearings, tool steel shafts, steel shells, cast steel pole pieces,
weather proof construction, many sizes to choose from, high
voltage and low voltage windings to suit individual require-
ments, are a few of the many reasons for "ESCO" generators
being the first choice.

ELECTRIC SPECIALTY COMPANY

225 SOUTH ST.

STAMFORD, CONN.

Manufacturers of motors, generators, dynamotors and rotary converters

TRANSFORMERS

Guaranteed — Mounted — Complete

600 watt 800—1200—1800 each side \$17.00
700 watt 1000 — 1500 each side 14.50

250 watt 500—750—1000 each side
unmounted \$9.75; mounted \$11.50

Auto-Transformers, Chokes, Polyphase and 25-cycle

Transformers, Add \$2.00 for oil winding

9CES FRANK GREBEN

1927 So. Peoria Street, Pilsen Sta. Chicago, Ill.

HALLMARK OF EXCELLENCE

for

FILTER CONDENSERS, BY-PASS
CONDENSERS, RADIO INTER-
FERENCE FILTERS AND POWER
FACTOR CORRECTION BANKS

Write for complete catalog of Cornell Products,
including our new "Cub" Condenser.



CORNELL ELECTRIC MFG. CO.
Long Island City New York

MERTZ

Screen Grid Tube Shields

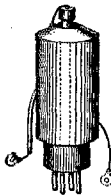

With Shielded Lead and
Ground Wire

PRICE 60c

Made of lead.

If dealer does not carry will be sent
direct on receipt of stamps or money
order.

MERTZ SPECIALTY CO.

1810 Stockton Street Wilmington, Delaware

BECOME A RADIO OPERATOR

See the World, Earn a Good Income,
Duties Light and Fascinating

LEARN IN THE SECOND PORT U.S.A.

Radio Inspector located here. New Orleans supplies
operators for the various Gulf ports. Most logical location
in the U. S. A. to come to for training.

Our students qualify for the various branches of radio
Ashore and Afloat. Every graduate placed. Runs to all parts
of the world.

Special courses. Day and Night classes. Enroll any time.
Oldest and Largest Radio School South.

Literature on request.

GULF RADIO SCHOOL

844 Howard Ave. New Orleans, La.

THE BIG PUSH

That batters thru to win. A crashing signal, with that most powerful of rectifiers—the Mercury
Arc — converting rough alternations into a smooth, irresistible energy flow. Instantaneous
starting (who wants to wait 30 seconds?), capacity beyond any transmitter demand continu-
ously maintained at peak, no filament to blow or lose emission. Cheapest of all rectifiers per watt
output, lowest in renewal cost. Your station a sure winner — Here's How!

RECTIFIER ENGINEERING SERVICE W8ML 4837 Rockwood Road
CLEVELAND, OHIO

A New RECTOBULB Type R81

Mercury Vapor Efficiency in —

RECTIFICATION **LOAD CAPACITY**
REGULATION **FILTERING**

To be installed in place of any Type 281 Rectifier Tube — simply plug in — that's all.

Fil. Volts 7.5 Fil. Cur. 1.25
Plate Volts 750 Plate Mills 150

ONLY 10 VOLTS DROP IN TUBE

Price \$7.00 each

Sent Postpaid if cash with order — *Immediate delivery*

Type R3 RECTOBULBS

Still "SUPREME" as 3000-volt — 250 Mil. Transmuting Rectifier — ask the "HAM"

Price \$10 each

Rectobulb Distributors — **CHIRAD** — Chicago — Fort Orange Dist. Co., Albany, N. Y.

Guaranteed Repairs

UX852 \$16.50 WE211 \$16.50
UV203A 211 — 845 \$19.00
UV204A \$60.00 WE212 \$40.00

NATIONAL RADIO TUBE CO.

3420 18th Street San Francisco, Calif.
"A HAM INSTITUTION"

MEN ARE IN DEMAND

IN ALL BRANCHES OF RADIO

Prepare thru a school with a reputation for efficiency. Our courses are easy, interesting and effective. We have large classrooms, laboratory, workshop, dormitory, and many other new features.

Subjects Taught
Commercial Radio Radio Service
Radio Broadcast Laboratory
Vitaphone-Movietone Navigation
Radio Mathematics

Literature upon Request



**COMMERCIAL
RADIO INSTITUTE**
38 W. BIDDLE ST. **FOUNDED
1920** BALTIMORE, MD.

NATIONAL TRANSMITTING EQUIPMENT

Standard 5000 and 7500 Volt Transmitting Condensers, the NATIONAL Model TMU. Navy and special types of transmitting condensers made to order. NATIONAL Velvet Vernier Dials, Types A and N (Precision Vernier.)

Used and Approved by Amateurs the World Over

NATIONAL COMPANY INC.
ENGINEERS AND MANUFACTURERS
61 SHERMAN ST., MALDEN, MASS.

Est. 1914 W. A. Ready, Pres.

vk2jj vk2ek vk3ex vk3pm vk2we vk3wx vk2ns vk1jr vk3cw vk2wu vk2ak z12bg z11ba z12gq z13aj z11ap z11ar z12gh z11bz z11bp z11an lu3dh lu4dq lu0dt lu2ca lu8dj lu3dh lu8en ce3bw ce3ba oa4t oa4h zuid z52n pk3bm x9a w6hi w6eug w6de w6hau w7nr w6dy w6ere w6drc w6bax w6bmx w6btg w6blx w6awt w6bjd w6eap ac8rv

VK7CH, C. Harrisson, Bellerive, Tasmania

w1ajt w1anz w1asp w1bdq w1ejc w1lg w1mk w1zz w2aq w2ag w2bjg w2bcr w2jn w2fa w2qf w2rs w3aqi w3aur w3pf w4abl w4abl w4aek w4be w4he w6avy w5bbu w3lp w5qa w6app w6anc w6aaq w6awf w6akd w6awa w6am w6aes w6awn w6bax w6by w6btm w6btz w6bpo w6bvq w6bno w6czm w6chl w6cjk w6czg w6cxz w6cut w6com w6dqy w6did w6ebn w6eju w6ehi w6epf w6eeo w6ebg w6elm w6eog w6ju w6zzb w7afu w7ahx w7akv w7bb w7hv w7lz w7lj w7uj w8apb w8era w8crj w8drj w8gz w8wo w9bcu w9dlj w9erm ve2ca oa4s k6etf k6tju k6boe k6cib k6bqk k6bra k6sqa k6bxw k1pw k1cm k1el k1jr k1sc k1xa k17fj g2xy g5by g5ml g6yx g6dh g6hp g6vp g6uh g6xe on4vu on4bt on4fe on4ja haf3an haf8b d4uah d4vp d4yt o27y oz7ly ok1ab f8cp f8da f8dmf f8eo f8db f8he f8hr f8lx f8olu f8rko f8rai ce3ab ce1ai ce3ab ce1ar x9a ac8rv lu3dh lu8dy su8dy su8rs yi1mdz uocx kd5 wsbs

Mark H. Churton, "Seaker," Wharf Road, St. Heliers Bay, Auckland, N. Z.

w1sz w1ry w1rw w1ajt w1zz w1ahx w2jv w2eug w2amr w2ai w2arb w2ajb w2bjg w2bcr w3aur w3oe w4ky w4iz w4akt w4aef w4alg w4du w5td w5qa w6ete w6bvz w6dam w6gz w6dji w6enn w6vz w6car w6qy w6bgk w6czm w6eau w6bjf w6cmj w7aax w7anj w7anh w7ts w7aov w7lj w7adb w8cut w8bai w8axz w8dyc w8lt w8ef w8beu w9anz w6bxx w9gv ve2be ve4dj celuh x29a om2rc f8rlt on4pf f8jf d4ug en8rux il1g pylaw pylah x6axw ilcoo x9a k1xa en8mb k6doe fm8smu lu8dy ac2fl d4yt ce3ac klaf k1dj ce3ab ti2hv g6wt ac1bd vs6ah oh3dl ac3fr eu2gl pk3bm vu2bg vs6ag kfu5 oa4q oa4r wsbs

G6YL, Miss B. Dunn, Felton, Northumberland, England

w1abn w1anh w1bs w1mk w2afz w2aif w2amr w2afz w2axl w2jc w2ku w2ov w3anh w4aef w4ft w4ql w5afm xw7ef kfr6 k4ac k4kd au7aa au7kn oa4o austr en8rx fm8fva fm8gke fm8kik fm8mst fm8rt xf8hpg xsm4zi eu9ak eu9be euhsak xeu3ag xeu3be frear149 frear153 freari su8rs ts4shr un7cc yi2zq ym4zo z12ab

W2AQQ, Herbert Goldstein, 1433 College Ave., Bronx, New York

7000- and 14,000-cc. bands

w5afo w5anc w5ann w5anq w5asq w5azr w5azs w5bbe w5bex w5bdy w5fq w5hn w5jd w5la w5ox w5p w5qe w5rg w5ru w5tw w5ux w5yw w5zk w6aef w6aew w6aku w6alx w6aos w6ady w6amo w6bpo w6bb w6bpg w6bqk w6by w6byf w6ciz w6by w6byf w6ciz w6cbu w6ced w6bet w6dzj w6diz w6drc w6dre w6dog w6dfs w6dix w6dclq w6doz w6ddb w6ehi w6dhj w6ele w6eva w6eos w6eta w6era w6ewf w6etp w6eiz w6eiz w6egk w6ft w6ju w6nl w6id w6wa w6sf w6qy w7lp w7lj w7qr w7ek w7ce w7li w7ahw w6ahw w7aef w7mo w7wp au7ab au12ra ce2ab ce3ac em1by em2jm em8lc em8ur eplaa c33ab ear12 ear14 ear21 ear69 ear86 ear98 eu2gd eu3bn eu3cp f8jf f8wb f8ic fm8kik iqpm g5by g5ub g6ni g6wt g6xn hc1lg hc2jm iler ilcoo j2by j4zx k1cm k1dg k4aan k4kd k6dgt lu2bj lu2fi lu3hd lu9dt nrfx na1nic n12pa oh2nm ok2yd on4pf on4us oomab pk1bh pk3bm pk4oz pylaw pylaw r11ax r15ax r55ox sm4xx sm5uk sp3ar sp3ba sp3sa t33it uolkr ve4bn ve4bu ve4bq ve4ec ve4ec ve4hy ve4ih vk2he vk2ij vk2rx vk3ax vk3jk vk3pp vk5am vk5hg vo8ae vo8wg va3ab x9a x29a v4cy yi2zq yi2ua z11fu z12ae z13am z13aj z13as z14ac z14ao z6ixn k1fl wsq kd5v kfu5 kfr5 kfr6 wts ozds ozik palfb palfr palrn palqn palrt xpa1ca xpa1jz nq2ay d4dk d4uo

W9FO, Arthur Bates, 508 South Dearborn St., Chicago, Ill.

7000- and 14,000-cc. bands

em5fl f8wb kd5v k6dy k6brn ti2wd ve4as ve4di ve5ao vk2hm vk2jc vk2lj vk2nb vk2wu vk3ax vk3or vk3pa vk3jk vk5by vk5hg z11bb z11bz z11ft z12ab z12bz z13as z13cm x29a



**LISTEN
TO THE FACTS**

< < < You Get > > >
7-SECOND ACTION
HUMLESS RECEPTION
FULL VOLUME when you use

ARCTURUS
 LONG LIFE
RADIO TUBES

ARCTURUS RADIO TUBE COMPANY
 Newark, New Jersey

ESICO

(Reg. U. S. Pat. off.) **"JUNIOR"**

Electric Soldering Iron

DESIGNED along the lines of ESICO
 CONSTANT DUTY irons which are
 used by practically all of the largest
 radio and electrical Manufacturers as
 well as the U. S. Navy.

\$2.75



If your Hardware, Electrical, or Radio dealer can't supply
 you, send money order or check direct to us.

Electric Soldering Iron Co., Inc.

135-141 W. 17th St., New York, N. Y.

**EASTERN AMATEUR
 HEADQUARTERS**

**[New BAIRD Short Wave Con-
 verters & Plug in Coils in Stock]**

**High Voltage Condensers
 Jewell TRIO in Stock**

**Lowest Prices on Aero
 and Thordarson Parts**

*Hams, send for our Special
 Amateur Catalog*

M. & H. SPORTING GOODS CO.

512 Market St., Phila., Pa.

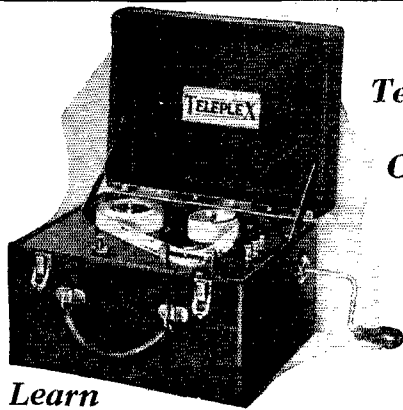

*It
 Teaches
 the
 Code!*

**Learn
 Telegraphy with TELEPLEX**

TELEPLEX is the practical code instructor. Works automatically. Waxed tape records send signals like a real operator. Complete code instructions furnished with every Teleplex. Sends messages, radiograms, etc. — regular code traffic like an expert operator. Used by all leading schools. Endorsed by U. S. Navy. **Guaranteed to teach you the code or it costs nothing.** Speedy, simple, clear. Ideal for advanced students or beginners.

FREE 10 DAYS TRIAL!

So sure are we that you will be absolutely satisfied with your purchase, that we will let you try it in your own home **ON 10 DAYS FREE TRIAL!** You are the sole judge. Where can you match that astounding offer? **ACT TO-DAY!** Write for full facts about Teleplex. No obligation.

TELEPLEX CO., Dept. 0-12, 76 Cortlandt St., New York, N. Y.

DON'T LOSE SIGHT—

of the fact that the E. F. Johnson Co. is a pioneer jobber of transmitting equipment of all kinds. We particularly invite requests for quotations from broadcasters, educational institutions, Government departments, etc., as well as our old friends, the Amateurs.

**New DE FOREST
 Transmitting Tubes**

now available in types corresponding to RCA Tubes. Write for complete data on these, the highest quality tubes made.

E. F. JOHNSON CO., Waseca, Minnesota

Oscillating Quartz Crystals



Guaranteed — easy oscillators, carefully selected for maximum output, and ground to your approximate frequency which is stated accurately to within one-tenth of one percent.

1715-2000 Kilocycle band **\$12.50**
 3500-4000 Kilocycle band **17.50**
 One-inch oscillating blanks **5.00**

We also supply "POWERTYPE" crystals to broadcast and commercial stations.

Write for literature

American Piezo Supply Company
 1101 Huron Building Kansas City, Kansas
Specialists in frequency precision

HAM-ADS

(1) Advertising shall pertain to radio and shall be of nature of interest to radio amateurs or experimenters in their pursuit of the art.

(2) No display of any character will be accepted, nor can any special typographical arrangement, such as all or part capital letters be used which would tend to make one advertisement stand out from the others.

(3) The Ham-Ad rate is 15c per word, except as noted in paragraph (6) below.

(4) Remittance in full must accompany copy. No cash or contract discount or agency commission will be allowed.

(5) Closing date for Ham-Ads is the 25th of the second month preceding publication date.

(6) A special rate of 7c per word will apply to advertising which, in our judgment, is obviously non-commercial in nature and is placed and signed by a member of the American Radio Relay League. Thus, advertising of bona fide surplus equipment owned, used and for sale by an individual or apparatus offered for exchange or advertising inquiring for special equipment, if by a member of the American Radio Relay League takes the 7c rate. An attempt to deal in apparatus in quantity for profit, even if by an individual, is commercial and takes the 15c rate. Provisions of paragraphs (1), (2), (4) and (5) apply to all advertising in this column regardless of which rate may apply.

PLATE power for your set, the very heart of its performance. For quietness, DX ability, life-long permanence, absolute dependability, lowest ultimate cost, no other plate source even approaches the achievement of an Edison steel-alkaline storage B battery. Built painstakingly; every joint pure nickel, upset electrically welded. Genuine Edison Electrolyte. Our list describes complete batteries, construction parts, enameled aerial wire, silicon steel. Available immediately, filament and plate transformers for the new 872 rectifier, complete plate power units. Rectifier Engineering Service, radio W8ML, 4837 Rockwood Road, Cleveland, Ohio.

EX-NAVY dynamotors and generators of unusual construction, ball-bearing and new. Shaft extension for external motor or gasoline engine, \$3 additional. General Electric 24/1500 volt, 350 watt, \$37.50; 24/750 volt, 150 watt with filter, \$27.50; 12/350 volt, 50 watt used, \$15; Holtzer-Cabot 12/500 volt, 35 watt, \$20; Westinghouse 6/15 volt, 500 watt, with propeller, \$15; 27.5/350 volt, 08 ampere special, \$12.50; twins for 700 volts, \$20; 10/350, \$18; 1/2-kw. 500 cycle with d.c. exciters, \$15; 900 cycle 200 watts, \$25. With complete aircraft spark transmitter, \$30. 1-kw. 500 cycle motor generators, \$125. Complete list. Henry Kienzle, 501 East 84th St., New York.

POWER crystals for broadcast and amateurs, ground to your frequency. Write and get our prices. Filter condensers, 1000 volts, d.c., \$2.50. All absolutely guaranteed. Fitzgerald Harrison Laboratories, 43 Summit Ave., New London, Conn.

TELEGRAPHY — Learn Morse and wireless telegraphy. Big salaries. Tremendous demand. Expenses low, can earn part. Catalog free. Dodge's Institute, Wood St., Valparaiso, Ind.

PRINT your own radio call cards, stationery, circulars, advertising, etc. Junior press, \$5.90; job presses, \$11; rotary, \$149. Print for others; big profit. Easy rules furnished. Write for catalog presses, type, paper, etc. Kelsey Company, Q-54, Meriden, Conn.

CRYSTALS of highest quality. 7000 k.c., \$19; 3500 k.c., \$14; 1750 k.c., \$9; Guaranteed blanks, \$4. W9DRD, Herbert Hollister, Edwardsville, Kans.

TRANSFORMERS — 100 watt, 110 volt, 60 cycle, 750 volts each side of center tap, one 7 1/2 volt, center tapped filament winding, \$7.25. Same as above but 2 filament windings, \$8. Same as above but 150 watt, \$9.25. Same as above but 250 watt, \$11.50. Heavy construction, no heating, good regulation. Remit 25% with c.o.d. orders. The above will operate two to four 210 tubes. Scott Coil & Transformer Co., New Albany, Miss.

SPECIAL rectifier aluminum, \$1.25. Lead, \$1.00 square foot. Elements 1 x 4 15 cents, 1 x 6 17 cents pair. All prepaid. Best silicon transformer steel cut to order, 25-35 cents pound. Postage extra. George Schulz, Calumet, Mich.

AMATEURS — experimenters, builders. We serve over 4000 I.R.E., A.R.E.L., etc., experimenters and "nuts." Full discounts, \$50,000 stock approved parts — no sets. Over four pounds catalog, circuits, data, prepaid, 50c. Weekly bulletins (new items, results of experiments, etc.), 20 weeks, \$1. Sample experimenters "Over the Soldering Iron" magazine, 25c. Transmitting data, price list, etc., 25c. Kladag Radio Laboratories, established 1920, Kent, Ohio.

ONE thousand watt G.E. transformers, eleven hundred, twenty-two hundred, forty-four hundred, each side c.t., as advertised QST twenty months, \$12 f.o.b. Detroit. Also 500 watters at \$6. Guaranteed unconditionally. F. C. Dawson, 5740 Woodrow Ave., Detroit, Mich.

CONDENSERS! We were fortunate in purchasing a quantity of Parcon condensers at extremely low prices and pass them along to you at practically the manufacturer's cost. Every one brand new. Transmitting filter condensers, 1000 volts d.c. working (remember that the "working voltage" of a condenser is usually one-half the "test voltage," so don't be misled by "test voltage" ratings). 2 mfd., \$2.40; 4 mfd., \$3.95; 6 mfd., \$5.15; 8 mfd., \$6.90. Buffer, 1.0-0.1 mfd., 97 c. 1750 volt d.c. working: 1 mfd., \$3.70; 2 mfd., \$5.30. Mica grid and plate condensers: .002, .001, or .0005 mfd.; 750 volt working, 96 c.; 1500 volt, \$1.18; .002 mfd., 2250 volt, \$1.73. Freshman 10.1 mfd., 850 volt block, tapped at .1-1-1-2-2-4 mfd., \$3.65. Unmounted 1 mfd., 1000 volt, 40 c., 4 for \$1.45, 8 for \$2.80; 1 1/2 mfd. add 15 c. Well-made, mounted power chokes, 30 Henry, 175 milliamperes, \$2.40. 30 H, 120 MA, \$1.90. Brach 125 watt power transformers, 600, 7 1/2 and 7 1/2 center-tapped, secondaries. Ideal for UX-210 transmitter or amplifier, \$3.75. Ward-Leonard 5000 ohm, 60 watt mounted grid-leaks, 85 c. Everything new and tested. "Quick service." Send for "Specials." William Harrison, 35 Ft. Washington Ave., New York City.

FOR sale. Two brand new Western Electric 211-D, 50-watt tubes, guaranteed \$15 each, or what have you. Send stamp for list other xtals. "Pep," P. O. Box 205, Montgomery, Ala.

HILET transformers and chokes, one day delivery. See Hilet advertisement. Jewell 54 d.c. volt-meter 1000 ohms per volt, 0-2000 ohms with external resistor, 14: 0-1000 volts, \$13; No. 74 a.c. 0-1000 volts, \$9. Edison 6 v. 150 AH battery, \$15; Edison "A" battery outfit with charger, \$30; audio coils 30 c. Write for specifications. Leitch, Park Drive, West Orange, N. J.

ONE UV204A, only \$75. Used only 18 hours. Guaranteed. E. J. Kerby, c/o A. A. Schneiderhahn Co., Sioux City, Iowa.

SELL — 7 1/2-watt Hartley d.c. full wave rectification complete. 3 tube receiver 150V B eliminator. H. W. Bartsch, Ft. Montgomery, N. Y.

W.E. mike double button, \$25; 2 UX250s, \$5; SE Co. hand telephone, \$5. Box Z, care QST.

OMNIGRAPHs, teleplexes, transmitters, receivers, monitors, wasps, mikes, 50-watters. Vibroplexes, rectifiers, portables. Bought, sold, traded. Ryan Radio Co., Hannibal, Mo.

250W-30W transmitters, tubes, parts. 0-250 or 0-500, 3 1/2 in. panel millimeter, \$3.75. C.O.D. Want 16 mm. camera. W16J, 1230 Ridgeley, Los Angeles.

2000V, 2000W, 3-phase drive motor generator, \$275. 2000V, 1000W, 3-phase drive, \$225. 2000V, 500W, 1-phase drive, \$195. 1500V, 400W, 3-phase drive, \$125. 1000V, 300W, \$95. 1000V, 250W, \$85. 1/2 h.p. 3450 speed motor, \$10.50, 1/2 h.p. synchronous 1800 speed motors, \$20. 8V, 5-ampere generators, \$6.50. 750V, 100W, 32V, drive motor generators, \$37.50, 1/4 h.p. 32V, motors, \$9.50, 1/2 h.p., \$12.50; 1/2 h.p., \$24.50. Queen City Electric, 1734 Grand Ave., Chicago.

CRYSTALS — sell power oscillators, tested 600v no twin frequency peaks — dirt cheap. Write W6EBV.

WESTINGHOUSE 250-wattors, \$30; Westinghouse 500-watt rectifiers, \$10; Western Electric 250-watt, \$30; 2 Western Electric 250-watt sockets, \$5 each; 500-watt Hartley transmitter complete, \$100; 900-watt, 500-cycle, 3000-volt center-tapped transformer, \$15; 6 Amertran amplifying transformers, 5 to 1, \$1 each. WSAM, Immel, 13408 Lauder, Detroit, Mich.

AERO short-wave receiver, \$17.50. Five Navy 5-watt tubes. First \$4.50 takes them. W1AVE.

QSLs, 100 two-color, \$1.00. Samples, W9CKA, Corwith, Iowa.

COMPLETE radio broadcasting equipment, good as new. As a whole or separately. Inquire Philip Godley, 23 Queen St., Philadelphia, Pa.

WANT: 204-A and 852 tubes. Vibroplex. Sell or trade: WE211D and 212D; RCA 860 and 211; power crystals; 6-400 V. dynamotor; omnigraph, other apparatus. W9ARA, Butler, Mo.

HATRY'S new super. Screen-grid first detector, separate heterodyne for C.W., greater stability, metal chassis, new kit, special intermediate frequency keeps second beat off oscillator dial — that repeat point out! Get prices, descriptive sheet. Also monograph on super, theory of set, design considerations for short waves, full hookup of new set, plans for novice, instructive, of permanent value. Price, 50 cents. Get your copy now; limited quantity. Hatry and Young, Hartford, Conn.

TRADE — New Pilot d.c. super-wasp for Kennedy Universal with amplifier. W. J. Beetham, Fennimore, Wis.

TRANSFORMER specials, 110-volt, 60 cycles, 500-0-500, 7 1/2, 150-watt, \$4.50. 650-0-650, 7 1/2, 7 1/2, \$7.750 each side, 7 1/2, 7 1/2, 150-watt, \$10.50. 0-550, 7 1/2, 7 1/2, \$3.75. 0-600, 7 1/2, \$3. Filament transformers, 7 1/2, 7 1/2, 75-watt, \$3. 10-volt center-tapped, \$3. 160 MA, 30-henry choke, \$4. 250 MA, 20-henry, \$5. Power pack transformers, 350-0-350, 5, 2 1/2, 2 1/2, \$4.50. Transformers for Raytheon B, \$2.25, 85 MA, 30-henry double choke, \$1.75. Complete power pack for 171 push-pull amplifier, \$9. For two 245 push-pull, \$12.50. Electrone Labs., 834 N. Randolph St., Philadelphia, Pa.

WANTED — Aero monitor, 852 and its power equipment. Sell: 1000-volt 2 mike Tobes. W8BJO, Dundee, N. Y.

SELL — W9GHI's complete 7½ w, 85-meter fone, DX xmitter, 750-v motor generator, tubes, meters, filter, mike, \$80. W9GHI, Baldwin, Kans.

TRADE — two 250-watt tubes, two hi-power rifles, 2000-volt transformer. Want S.M. 730, 50-watters, R.C.A. UP1016, UX852, or what have you? Box 21, Seaford, N. Y.

FOUR-TUBE '29 beaurat. Sell or trade, \$30. W7VB, 2918 Magnolia Blvd., Seattle, Wash.

QSL cards, two colors, \$1.00 per hundred. Free samples. W8DTY, 257 Parker Ave., Buffalo.

QSLs — your own design, lowest prices. Samples. W2AKE, 1317 Rosedale, New York City.

OLD reliable MOPA, d.c. power pack, receiver, wavemeter, \$100. Good condition, easy to operate. Gets results. Joe B. Floyd, W4AFW, Oxford, N. C.

TRADE crystals for what have you? W6EBV.

QSL cards, stationery, message blanks, cartoons, etc. Selden's, Cranesville, Pa.

WANTED — 250-watt spark transformer. Fred Rothberg, 2559 Lebanon Terrace, Astoria, N. Y.

SUPERHETERODYNE for short-waves, different, design backed by much experience. Does not take in 200-500 BCL band, short-wave fone and C.W. only — at last proper design for C.W. Get prices on kit or set. Designed by L. W. Hatry, who revised the QST super (see Sept. 1929 QST); contains many special features. Hatry & Young, Hartford.

RECTOBULBS hi-power, \$10, 281 type, \$7; 2 mid. 2000 wkg volt Tobes, \$11.70, Flechtheim, \$8.75; Jewell volt or MA meters, \$5.50, RF ammeters, \$9.90, set analyzer, \$72; Leach relays, \$9 and \$6.75; Super-Wasp d.c. \$29.40, a.c., \$34.40; Sangama .002 5000 V. cond., \$1.40; GE TBI's, 90 cents; 99.6% aluminum, 70 cents sq. ft.; WE and RCA tubes repaired. Any other apparatus. Henry's Radio Shop, W9ARA, Butler, Mo.

MUST sell UV206 1 KW used 20 hours. Make offer. L. M. Augustus, 416 Florence, Ypsilanti, Mich.

FOR sale — 450-watt 1500-volt Thordarson, \$8; 1½-henry Acme-plate reactors, \$2; 500-mil Jewell Thermocouple, \$7; Type

S REL inductance, \$2; 2 amp. Tungar type Charger and bulb, \$5; 110-volt DC 1/10 h.p. GE motor, \$5; 211 spark coil, \$4.50; Model 5-50 Crosley set and tubes. \$12. Robert D. Craig, 4414 Water St., Wheeling, W. Va.

SELL 4E Western Electric superheterodyne, \$100; W.E. 25B amplifier, \$40; new 215A W.E. tubes, \$2.50; W.E. 205D tubes, \$7.50. Also parts. A. H. Opfer, 1824 N. Luna Ave., Chicago, Ill.

RADIO supplies, magazines, exchange for guns and sporting magazines. Elmer Eaton, Olney, Tex.

SELL — receiver, mercury-arc transmitter. Cheap! Write George G. Smith, Clinton, Miss.

THE finest in radio for amateur, broadcast and marine. The most modern short-wave receivers. Four to ten tube designs. Radiophone CW transmitters of any power or type. We make a complete line of apparatus, including speech amplifiers, filter coils, inductances, power units, etc. Any special apparatus, designs, built to order, using your parts if desired. Prices on request. New bulletin lists complete line of apparatus. Write for copy. Enssall Radio Laboratory, 1527 Grandview St., S. E., Warren, Ohio.

HAMS: Get our samples and prices on printed call cards made to order as you want them. W9APY Hinds, 19 S. Wells St., Chicago, Ill.

SELL rack and panel-mounted 15-watt push-pull transmitter complete with power supply and tubes ready to use. Write for description. Want 50-watt parts. W9AJZ.

QSLs — plain at \$1.00 per hundred. W9BEU, 9032 Windom, St. Louis, Mo.

WANTED — your radio wants. Parts for that receiver, transmitter or power supply. Special apparatus. Pontiac Engineering Co., 1100 Ave. I, Brooklyn, N. Y.

PANEL engraving — finest workmanship on radio laboratory apparatus. Request price-list. A. L. Woody, 19 S. Wells St., Chicago, Ill.

SURPRISE for the amateur radiophone! Reasonably priced double button microphone, microphone transformers, modulation chokes. Advice and assistance. Write for our radiophone list. Hatry & Young, Hartford.

FOR sale — complete amateur station WICE. Cheap for cash. F. G. Carr, Lancaster, N. H.

Q R A SECTION

50 c. straight with copy in following address form only:

W2BJI — Hackensack Radio Association, Y. M. C. A. Building, Hackensack, N. J.

W2BSR — Arthur M. Braaten, Box 979, Riverhead, Long Island, N. Y.

W3ANB — Lieut. C. C. Paden, U. S. Coast Guard, Washington, D. C.

W4MR — Alva Parham, 1711 W. Lee St., Greensboro, N. C.

W8CUL — V. P. Bagnh, 323 Forest St., Washington Court House, Ohio.

W9AWR — William W. Roper, Box 383, Hopkinsville, Ky.

WIMK

A.R.R.L. Headquarters

R. B. Parmenter, Chief Op. "rp."

The following calls and personal sines belong to members of the A.R.R.L. Headquarters gang:

W1BDL-W1XL F. E. Handy "fh."

W1AL B. Dudley "bd."

W1FH K. B. Warner "kb."

W1BUD A. L. Budlong "bud."

W1CEL J. J. Lamb "jm."

W1ES A. A. Hebert "ah."

W1FL-W2JR G. Donald Meserve, "dm."

W1PX C. G. Kenefick "ck."

W1SZ-W1BIZ C. C. Rodimon "rod."

W1UE E. L. Battery "ev."

W1BAW R. B. Beaudin

It's EASY to Get a HANDBOOK

(Sixth Edition)

DIRECTIONS:

Realizing that Handbook must be had, proceed as follows:

- (1) Fill out below, tear off.
- (2) Reach in pocket, produce U. S. A. \$1 bill, old or new size (we don't care).
- (3) Clip together, mail us.

Handbook Factory,
1711 Park, Hartford.

SEND IT AT ONCE.

(Name)

(Street or P. O. Box)

(City and State)

To Our Readers who are not A.R.R.L. members

WOULDN'T you like to become a member of the American Radio Relay League? We need you in this big organization of radio amateurs, the only amateur association that does things. From your reading of *QST* you have gained a knowledge of the nature of the League and what it does, and you have read its purposes as set forth on page 6 of this issue. We should like to have you become a full-fledged member and add your strength to ours in the things we are undertaking for Amateur Radio. You will have the membership edition of *QST* delivered at your door each month. A convenient application form is printed below — clip it out and mail it today.

A bona fide interest in amateur radio is the only essential qualification for membership

AMERICAN RADIO RELAY LEAGUE
Hartford, Conn., U. S. A.

I hereby apply for membership in the American Radio Relay League, and enclose \$2.50 (\$3 in foreign countries) in payment of one year's dues, \$1.25 of which is for a subscription to *QST* for the same period. Please begin my subscription with the issue. Mail my Certificate of Membership and send *QST* to the following name and address.

.....
.....
.....
.....
.....

Do you know a friend who is also interested in Amateur Radio, whose name you might give us so we may send him a sample copy of *QST*?

.....
.....

Thanks

For Your Convenience

QST'S INDEX OF ADVERTISERS IN THIS ISSUE

Acme Wire Company	82
Aerovox Wireless Corp.	76
Allen-Bradley Company	62
American Piezo Supply Co.	91
American Sales Company	77
American Transformer Co.	64
Arcturus Radio Tube Co.	91
Aurilena, Inc., Ad.	78
A.R.R.L. Apparatus	65
A.R.R.L. Handbook	80, 94
A.R.R.L. Membership Blank	
Browning-Drake Corp.	96
Burgess Battery Co.	Cover IV
Cameradio Company	87
Candler System Co.	84
Cardwell Mfg. Corp., Allen D.	75
Central Radio Labs	72
Chicago Radio Apparatus Co.	75
Clarostat Mfg. Company	88
Commercial Radio Institute	90
Cornell Elec. Mfg. Co.	89
Corning Glass Works	69
Crosley Radio Corporation	71
Cunningham, Inc., E. T.	68
Dodge, C. K.	86
Donagan Elec. Mfg. Co.	82
Electrad, Inc.	87
Electric Soldering Iron Co.	91
Electric Specialty Co.	89
Frost, Inc., Herbert H.	84
General Engineering Corp.	72
General Radio Company	81
Greben, F.	89
Gulf Radio School	89
Hardwick, Hindle, Inc.	74
Hilet Engineering Co.	87
Hinze, Clifford E.	59
Hoodwin Co., Chas.	74
Instructograph Institute	80
Jewell Electric Instrument Co.	73
Johnson Co., E. F.	91
Leads Radio Company	83
Loomis Publishing Co.	80
McGraw-Hill Book Company	70
Manhattan Electric Bargain House	85
Massachusetts Radio School	88
Mertz Specialty Co.	89
M. & H. Sporting Goods Co.	91
National Company	90
National Radio Tube Co.	90
Pacent Electric Co.	87
Perryman Electric Co.	61
Pilot Radio & Tube Corp.	Cover II
QST Binder	86
Radio Engineering Laboratories	71
Radio & Television Institute	95
Radio-Victor Corporation of America	67
BCA Institutes	89
Rectifier Engineering Service	88
Rooney, John T.	88
Scientific Radio Service	87
Shalleross Company	78
Silver-Marshall, Inc.	63
Teleplex Company	81
Thordarson Elec. Mfg. Co.	81
Van Nostrand Company, D.	79
Vibroplex Company	88
Weston Electrical Instrument Corp.	66
West Side Y. M. C. A.	87
Wiley & Sons, John	2
Wireless Egert Engineering	84

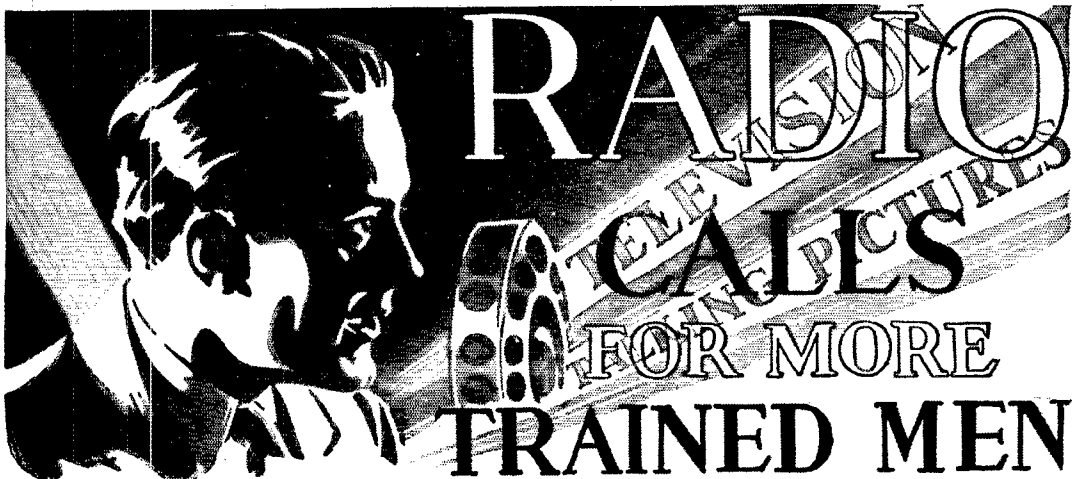

Big Money quick—the chance to more than double your salary—is offered to you now. RADIO has leaped from the experimental stage to a gigantic industry, employing many, many thousands and loudly calling for MORE TRAINED MEN to fill the Big-Pay jobs. TALKING PICTURES have taken the larger cities by storm and will sweep the entire country, opening up many new good jobs everywhere. TELEVISION now comes with even greater promise of a large number of good paying jobs and big profits for those who are prepared.

Big Money Now! More to Come

Here is an entirely new field of profitable employment—Big-Money Jobs—\$2500—\$3500—\$5000 and up, right now—lots of money easily made in spare time—increasing pay for you and more and more money as this new industry grows bigger and bigger.

ANSWER THE CALL—GET INTO THIS MONEY-MAKING INDUSTRY NOW!

The "R.T.I." famous "3 in 1" Home Training in Radio, Television and Talking Pictures makes it easy for men, young men and boys to get into this new field quickly. R. T. I. home training is practical and easy to understand. It trains your head and hands at the same time. Your opportunities for money-making are unlimited. Your age, amount of education, or experience make no difference. If you are interested and ambitious you can succeed. Are you willing to use a little spare time at home?

That is all you need to quickly start making money with R.T.I. material and home training. You will be ready for a good job or profitable business of your own, even before you finish the training. Remember—you learn at home in your spare time on actual equipment included in fine, big outfits sent you. R.T.I. with all its connections in the industry, keeps you up-to-date and pushing forward all the time.

R. T. I. Wonderful Free Book Nothing Like It Ever Published

No one can fully realize the amazing size and future growth of the Radio, Television, and the Talking Picture industries unless they know all the facts revealed in this R.T.I. book. It will open your eyes to the vast number of new money-making jobs—enormous spare-time profits—all within easy reach of ambitious men.

Big R.T.I. Book Free—While They Last

LET F. H. SCHNELL AND THE R. T. I. ADVISORY BOARD HELP YOU.

20 years' Radio Experience. First to establish 2-way amateur communication with Europe. Former traffic Mgr. of Am. Radio Relay League, Lieut. Com. U. S. N. R. Inventor and Designer. Cons. Radio Engineer.

Assisting him is the R. T. I. Advisory Board, composed of men prominent in the Radio Industry—manufacturing, broadcasting, engineering and servicing. All these men know Radio and will help you succeed in their field.

RADIO & TELEVISION INSTITUTE
 Dept. 12, 4806 St. Anthony Ct., Chicago

RADIO & TELEVISION INSTITUTE
 Dept. 12, 4806 St. Anthony Court, Chicago

Send me Free and prepaid your BIG BOOK "Time In On Big Pay" and full details of your three-in-one Home Training (without obligating me in any way.)

Name

Address

City State.....

\$500 in 2 Months
 Hasn't Finished the Course
 Your radio course enabled me to
 earn over \$500 in two months' spare
 time work.—J. Nofsinger, R. I.
 Box 37, Greenville, Ky.

\$80 a Week—Through R. T. I. Training
 I am earning \$80 per week and another \$20 a week in
 spare time Radio Work. Your Course was the best investment
 I ever made.—W. W. Mead, 815 W. 28th St., Indianapolis, Ind.

STEP UP QUICK TO A BIG-MONEY JOB THROUGH R.T.I. training in Broadcast-
 ing, Sales, Service, Manufacturing, Repairing, Ship and Station Operating, Installing,
 in business for yourself.

**R. T. I. R. T. I. TRAINS YOU AT HOME FOR A GOOD JOB OR A PROFITABLE
 PART TIME OR FULL TIME BUSINESS OF YOUR OWN**

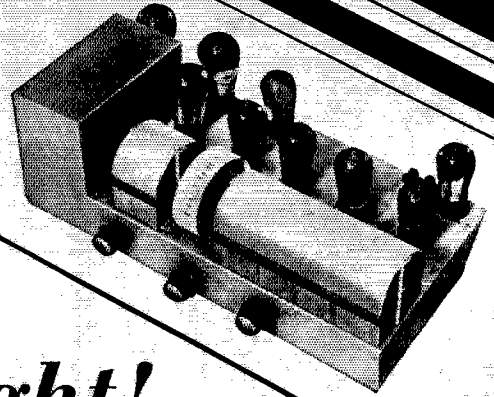

Engineered Right!

to take full advantage of its screen-grid tubes

Here's a set you can recommend with full confidence that it will perform — that it will get distance within reason, provide sharp selectivity and be outstanding in the quality of its tone.

You'll find in this

NEW *1930* **BROWNING-DRAKE** Screen Grid **RADIO**

the same quality in construction that won for Browning-Drake kits such a lasting reputation.

We would like to have you hear and test this set. We welcome inquiries at any time and can offer an unusually attractive franchise to you who are dealers.

BROWNING-DRAKE CORPORATION

228 Calvary Street

Waltham, Mass.

*Over 1,500,000 people listen-in on
Browning-Drake Sets*

60,000 AMATEURS CAN'T BE WRONG!

That's the number who have put their
reliance in the A.R.R.L. Handbook

All over the world the Handbook has been sent, in five successive editions, to tell its story of practical amateur radio to beginner and old-timer alike. It has quickly established itself as the standard manual of the practicing amateur. Everywhere it is hailed as the greatest fund of helpful information that an amateur ever saw.

And now, with the necessity of printing additional copies for the orders that roll in every day, additional material has been added in the same helpful fashion. We have pleasure in announcing the appearance of

THE *The Sixth Edition of* RADIO AMATEUR'S HANDBOOK

By Handy & Hull

Revamped and overhauled as the Handbook always is before each successive edition, this new printing contains new and modernized material on two subjects of current importance: Crystal Controlled Transmitters and Radiotelephony. Thus, more than ever, it contains the answers to your questions. Between these covers is everything the A. R. R. L. can think of that is worth the telling for the guidance of a practical radio amateur.

It tells the story of amateur radio; what it is all about; how to become an amateur; how to build and adjust your apparatus; how to operate your station.

For the more advanced amateur there are working descriptions and building instructions for all kinds of receivers, transmitters, antenna systems, frequency-meters, power supplies, modulation systems, monitors, and keying methods; and detailed explanation of the complexities of modern operating procedure.

A world of valuable information, printed in "QST" format and bound in durable paper covers so that the price may be modest.

Blue-and-Gold Paper Cover, \$1.00

Stiff Buckram Binding, \$2.00

◀ *We honestly don't see how you can get along
without the Handbook. Order yours to-day!* ▶

American Radio Relay League, Hartford, Conn., U. S. A.

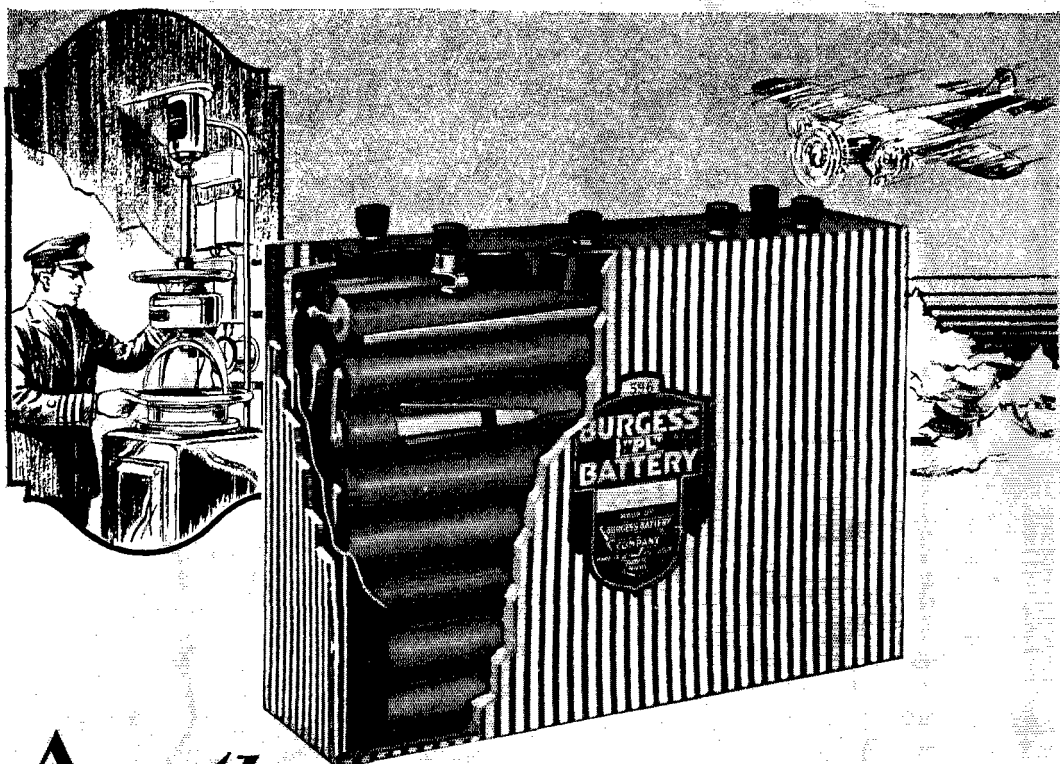

Another **Contribution!**

In line with the policy of keeping abreast of the times, Aircraft battery No. 596 was designed—a Burgess contribution to the country's newest transportation and industrial giant. Actual experience has demonstrated that the rugged Burgess "stick" construction admirably meets the exacting requirements of Aircraft radio.



Ask any Radio Engineer"

BURGESS BATTERY COMPANY

MADISON,

WISCONSIN

The Communications Department

F. E. Handy, Communications Manager
E. L. Battey, Asst. to Coms. Mgr.
1711 Park St., Hartford, Conn.

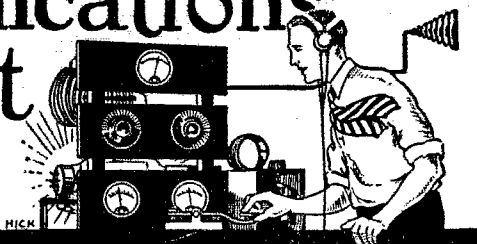

Changes in the Regulations for the Army-Amateur Radio System

THE revised general plan of the affiliation of the Signal Corps and the Transmitting Radio Amateurs of the United States together with detailed regulations for the operation of Army Amateur Nets under that plan was published complete in March, 1929, *QST*. The regulations under this plan have been changed recently, new regulations becoming effective November 15 1929. We shall not attempt to again treat the regulations in full herein, but it seems desirable to include all changes, and to summarize important paragraphs. Reference to March *QST* will show which portions of the operating regulations remain unchanged.

SECTION I. NET STATIONS, HOW SELECTED

A fourth paragraph has been added under this section relating to local nets. Local nets comprise all other local stations. The net control stations of local nets are sub-stations of the District Net. A brief tabulation helps to explain the complete Army Net organization.

<i>Net</i>	<i>Consists of</i>
Army	Army NCS and Corps Area NCS and alternates.
Corps Area	Corps Area NCS (at or near Corps Area headquarters) and State NCS and alternates.
State	State NCS (at or near each state capital in a Corps Area) and District NCS and alternates.
District	District NCS (approximately five stations to be located near the centers of the five geographical or congressional districts) and Local NCS and alternates.
Local	All other local stations.

It should be remembered that every station in one of the higher nets becomes the net control station for the next lower net, so that stations selected must be capable of working in the forward and in the lower net. It follows that operators must be well qualified and reliable.

SECTION II. FREQUENCY AND CALL SIGNAL ASSIGNMENTS

2. SPECIAL ARMY FREQUENCY. (a) A special Army frequency of 6990 kc. has been assigned for Army Amateur use for night transmissions by crystal-controlled stations in the Army and Corps Area Nets only, and IN AN EMERGENCY ONLY, for day or night transmissions by ANY Army Amateur Radio Station.

(b) For night relay purposes to Panama, Hawaii and the Philippine Islands, 6990 kc. may be used by the Army Amateur Station relaying to the above named stations, providing the relay station is crystal controlled.

3. CALL SIGNS. (a) The following special army calls are assigned for Army Amateur use only when using 6990 kc., as will be explained in paragraphs 4 and 5: Army NCS, Fort Monmouth, N. J., WLM; Corps Area NCS as follows: WLE, 1st C. A.; WLN, 2nd C. A.; WLQ, 3rd C. A.; WLR, 4th C. A.; WLH, 5th C. A.; WLT, 6th C. A.; WLU, 7th C. A.; WLJ, 8th C. A.; WLW, 9th C. A.

(b) Corps Area Signal Officers may assign army calls to specially selected crystal-controlled State NC stations for

use only on 6990 kc., as explained in paragraph 5. Such calls will consist of the special Corps Area Army call followed by a numeral. For example, Army calls assigned to State NC stations in the Fourth Corps Area would be WLR1, WLR2, etc.

(c) All Army Amateur Stations will use their call signals except as authorized in (a) and (b) above.

4. ARMY NET. The Army frequency of 6990 kc., the 7000-kc. amateur band, or the 3500-kc. amateur band, will be used in the Army Amateur Net as conditions demand. No station will transmit on 6990 kc. unless crystal-con-



CAPT. NORMAN LEE BALDWIN
Army-Amateur Liaison Officer

trolled. Crystals ground to 3495 kc. and holders will be furnished all Army Net stations upon application to the Chief Signal Officer. An accurate log will be kept of all transmissions on 6990 kc.

5. CORPS AREA NETS. (a) Frequencies in the 7000- or 3500-kc. amateur band will normally be used in all Corps Area Nets. Crystal-controlled Corps Area Net Control Stations only may use 6990 kc. for transmission on nights other than Monday. Such use will be restricted to night transmission exercises only, except in emergencies, and an accurate log of transmissions must be kept.

(b) Corps Area Signal Officers may grant special permission to selected individual crystal-controlled State NCS to transmit to the Corps Area NCS on 6990 kc. on nights other than Monday, stations when transmitting on this frequency to use their proper assigned Army call only, except that in an emergency, ANY Army Amateur may transmit on 6990 kc. using his amateur call signal.

6. STATE NETS. The 3500-kc. amateur band will be used. Since there are relatively few stations in each net, it is believed possible and practicable to have the transmitters and receivers of all stations in a net calibrated to operate on the same frequency. If it is found that the frequency selected by the Maine State Control Station, for example, conflicts with that of the New Hampshire Control Station, the Corps Area Signal Officer should direct one of them to shift frequency slightly.

7. DISTRICT NETS. Frequencies in the 1715-kc. or 3500-kc. band will be used.

SECTION III. HOW TO BECOME AN A.A.R.S.

Applications for Army Amateur Radio Station appointment are solicited by the Signal Officers in each Corps Area. An amateur to be eligible for appointment should:

1. Have a station in active operation capable of transmitting and receiving in the 3500-kc. band (or 3500- and 1715-kc. band) and capable of communication with other stations in the Corps Area or District.

2. Be capable of transmitting and receiving at at least moderate speeds (15 w.p.m.).

3. Be familiar with the purpose of the Army Amateur work as may be apparent from this article or as published fully in the article beginning on page 21 of March, 1929, *QST*.

4. Be willing to keep the weekly Monday night schedules in the nets to which he may be assigned, or other schedules that may be assigned for tests or relays.

Army Amateur work is extremely interesting, and sincere efforts cannot help but repay us in full for the time

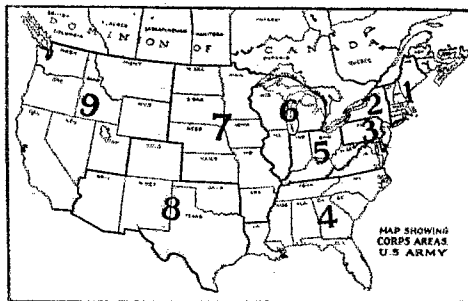

expended individually. Readiness for service in emergencies brings public esteem, and enrollment as A.A.R.S. is mutually helpful to the Signal Corps and the amateur. Army Net operation offers interesting operating tests, training in understanding and use of Z-signals, tactical procedure, and on occasion the coding and decoding of radiograms. All amateurs are invited to get in on these things. The season is advancing. Net operation is just getting in full swing. Our map of the Army Corps Areas will enable you to determine in which Corps Area you reside. Send your request for more information and your application for appointment as A.A.R.S. to the proper Corps Area Signal Officer.

- 1st Corps Area, Army Base, Boston, Mass.
- 2nd Corps Area, Governors Island, New York City.
- 3rd Corps Area, Baltimore, Md.
- 4th Corps Area, Atlanta, Ga.
- 5th Corps Area, Fort Hayes, Columbus, Ohio.
- 6th Corps Area, 1819 West Pershing Road, Chicago, Ill.
- 7th Corps Area, Fort Omaha, Omaha, Nebr.
- 8th Corps Area, Fort Sam Houston, San Antonio, Tex.
- 9th Corps Area, The Presidio, San Francisco, Calif.

Civilians desiring to join the Officers Reserve Corps should apply to the Commanding General of the Corps Area in which they reside.

The following are excellent operating rules observed closely by Official Relay Station appointees. We expect that observance of such rules is what makes O.R.S. operation stand out above operation by "just ordinary" hams who do not aspire to Official Relay Station prominence.

- 1. Be brief in calling, answering or handling traffic.
- 2. Avoid unnecessary remarks or repeats.
- 3. Be familiar with miscellaneous abbreviations and the Q Code, particularly the abbreviations most needful in everyday work.

4. Have a plate supply providing D.C. and good regulation.

5. Keep the transmitter adjusted for maximum frequency stability, good keying, a clear note, and the best output that will satisfy the other conditions.

6. Keep to one particular frequency when you operate in each band so that other stations will always know where to look for you.

7. Keep all schedules punctually, and avoid overrunning allotted periods.

8. Keep a log.

9. Be systematic in adjustment and operation of the station.

10. Cooperate with other stations, take part in all League activities, and report regularly to the Section Manager each month on the 16th of the preceding month.

8. LOCAL NETS. Frequencies in the 1715-kc. band will be used. The particular frequencies selected must be non-interfering with the frequencies used in the higher nets. Local nets will not operate on the same day as the higher nets.

SECTION IV. TRAFFIC

4. Insofar as practicable, Army radio procedure signals will be used in all transmissions in all nets.

5. Personal messages on hand at close of business should be forwarded by phone or mail to the addressee.

SECTION V. SCHEDULES

1. Schedules will conform to the latest edition of the master traffic schedule. Readers are referred to the diagram which accompanies this article.

SECTION VII. EMERGENCY OPERATION

1. (a) When an emergency of any nature threatens any portion of the United States, the Army Amateur Stations in that Corps Area are expected to man their stations; each net control station will endeavor to mobilize the stations in its net, and stand by prepared to send and receive on his net frequency any traffic to or from the threatened area until such time as he may be notified by the next higher net control station that his services are no longer required. If, after calling the higher NCS on the proper net frequency, no answer is received, the station, if possible, should call the Corps Area NCS on 6990 kc. and notify that station that his station is standing by. (Only in exceptional circumstances or upon the expressed consent of the Corps Area Signal Officer will Army radio traffic be handled with stations that have not been designated as A.A.R.S.)

(b) Any Army Amateur Radio Station having emergency or disaster information or messages should make every attempt to get them through to his Corps Area NCS without delay; for this purpose only the station, even though not crystal-controlled, may send a general call on 6990 kc. day or night. It is to be noted that this use of 6990 kc. corresponds somewhat to the use of the SOS signal.

SECTION IX. CORRESPONDENCE

1. The Army Amateur Liaison Agent, Fort Monmouth, N. J., is, for Army Amateur purposes only, directly under the supervision of the Chief Signal Officer, and is authorized to correspond directly with the Chief Signal Officer, with Corps Area Signal Officers and with radio aides on technical matters pertaining to the operation of the Army Amateur System. All directives, regulations, instructions, etc., will be issued by the Chief Signal Officer.

2. Radio Aides are encouraged to correspond informally with each other and with the Liaison Agent at Fort Monmouth on Army Amateur matters leading to improvements in the organization and operation of the System.

NEW LIAISON AGENT AND ALTERATIONS AT W2CXL

Under date of June 22, 1929, Captain Norman Lee Baldwin, well known to amateurs by his work at WSDKX, was appointed Army Amateur Liaison Officer, succeeding Captain Stanford. Captain Baldwin left his national guard detail in Michigan a year before that detail was up to carry on the work at Fort Monmouth.

Major D. M. Crawford, as officer in charge of the A.A.R.S. under the direction of the Chief Signal Officer, Major General George S. Gibbs, drew up the modified regulations which we have discussed briefly. Colonel G. E. Kumpke, at the time Commandant of the Signal School (now in the

Chief's Office), in the interest of amateur radio and the affiliation between amateurs and the Signal Corps, authorized and encouraged the rebuilding and experimenting at W2CXL which now has been completed by Captain Baldwin.

The new radiating system at W2CXL consists of a vertical antenna of 1½-inch galvanized iron pipe, 57 feet high from base to top, with a ½-inch braided copper ribbon soldered along its entire length, and mounted without the use of guy wires. The base rests on a heavy glass insulator on top of a paraffin soaked pole stub 3 feet off the ground. The center is supported by a heavy two-pin porcelain

MASTER TRAFFIC SCHEDULE ARMY AMATEUR RADIO SYSTEM
EFFECTIVE DECEMBER 1, 1930
All Times given in Eastern Standard Time

Corps Area	6:30-7:30	7:30-8:30	8:30-9:30	9:30-10:30	10:30-11:30	11:30-12:30	12:30-1:30	1:30-2:30	2:30-3:30	3:30-4:30	Remarks
1	D	B	C	B	A						A—Army Net
	C	A	D		D						
2	D	B	C	B	A						C—Corps Area Net
	C	A	D		D						
3	D	B	C	B	A						S—State Net
	C	A	D		D						
4		D	B	C	B	A					D—District
		C	A	D		D					
5		D	B	C	B	A					
		C	A	D		D					
6		D	B	C	B	A					
		C	A	D		D					
7			D	B	C	B		PAN			
			C	A	D			A			
8			D	B	C	B					
			C	A	D						
9			D	B	C	B	A	C	A	D	
			C	A	D		D				

stand-off insulator 6 inches long, on the cross arm of a 50-foot wooden pole. The antenna is also supported near the top by two 10-inch Pyrex stand-off insulators and a bakelite strip also mounted on a cross arm. A single wire feeder line is attached to the antenna 21 feet 3 inches from the base, and led into the station through 6-inch Pyrex bowl lead-in insulators. Used on the 3500-ke. frequency, a 58-foot horizontal counterpoise is employed with a .00015 µfd. series antenna tuning condenser. Throwing a SPDT switch connects the vertical antenna alone to the 7000-ke. transmitter, very loose coupling being obtained by use of a .00005 µfd. Cardwell transmitting condenser. The vertical antenna is at right angles to the cage antenna overhead (used by WTW on long waves) and to the power lines feeding the station. The counterpoise is also at right angles to the WTW antenna.

W2CXL maintains regular communication with all Corps Areas of the United States and the Canal Zone, and intermittent contact with practically all foreign countries. Since Captain Baldwin completed the new antenna installation, more consistent contacts have been maintained than previously in the history of the station, and interest and activity has grown correspondingly.

Queries About Our February Contest, The Third International Relay Competition

Is it permissible to have two or more operators at one station to take different shifts? Yes.

May I enter two stations in the contest? Yes, if you own two stations and wish to do so, but remember that this contest is between stations, not between operators, and if you divide your operating time between two or more stations, that you may not run up as high a score at any station as though you spent all available time at the key of one station.

Must all replies to messages be the right answer or an attempt at the right answer? Yes.

Must each message be copied without mistake? Yes.

On what frequency bands can foreign amateurs work? See Q 22, page 36, January, 1930, QST. The Washington Convention made the frequency bands, which are assigned

to us in the U. S. A. in full by our Federal Radio Commission, available to all governments for assignment in full or in part to the amateurs of different countries at the discretion of individual governments. Nearly all foreign nations have ratified the Convention and so nearly all foreign amateurs should be found on the same frequencies we normally use. Some governments have provided buffer bands or withheld certain bands from amateurs in their countries. Comb the central portion of our 14- and 7-mc. bands carefully at the right time and you will find 'em.

What is the best time to look for foreign amateurs in different countries? See the table in September, 1929, QST, page 42, and the DX time-tables in the I.A.R.U. Section in recent months.

What about disqualifications? Observers and individuals who take part are asked to report all off-frequency operation noted by them in full detail. One single such report will not disqualify a participant unless it can be verified beyond question. An award committee will pass on every case of alleged off-frequency operation in the light of the quantity and quality of evidence submitted, just as was done in the case of the last International Relay Party, and as in the case of our January All-Section Contest.

Who shall be disqualified? U. S. and Canadian stations outside their frequency bands during the competition shall be disqualified, especially if the evidence (time, date, frequency, material transmitted, etc.) indicates that they were engaged in calling or contacting other stations or establishing communication and not merely testing with monitor or frequency meter to determine their frequency location inside or outside the amateur bands. Foreign stations working such off-frequency stations shall likewise be penalized by disqualification. Because it is not possible for U. S. and Canadian amateurs to have before them an up-to-date copy of all the frequency territory legally assigned all different foreign amateurs, we cannot disqualify U. S. and Canadian participants similarly for working off-frequency foreign amateurs. However, if evidence that a station in a foreign land has operated illegally (not according to the government regulations of that country) is submitted and if complaint is entered by brother amateurs it will receive consideration. That station may be disqualified in fairness to the other amateurs of that country who "played the game" by close observance to the frequencies specified in their regulations. Since all amateurs in each locality are in direct competition such considerations will be entirely fair.

Amateur Radio Scores Again

INFORMATION received from W2LU, W8PJ and W8CHG tells us of the important emergency work done by amateurs during the terrific sleet and snow-storm that struck western and northern New York state on December 18th. Large sections were without outside communication after miles of telephone and telegraph lines were felled by the weight of the ice formation which followed nearly twenty-four hours of rain. The weight of the ice was so great that poles snapped like match sticks. And in the midst of all the turmoil, the radio amateurs again "came through with the goods."

The Niagara Falls Power Company, badly in need of communication with Buffalo and Lockport, asked W8OA to help. W8OA reached W8PJ at Buffalo, who called W8ADE at the A. T. & T. Buffalo office asking for his assistance and put W8OA in touch with W8AFM at Lockport. Stations W8ADE, W8OA and W8AFM kept their three respective cities in communication and many important messages were handled. W8PJ, SCM Taylor of Western New York, jumped into his car and drove to as many stations as possible around Buffalo and requested that they stand by for relief messages. He also originated a "QST" to A.R.R.L. members in Western New York saying, "Keep amateur stations going day and night if possible. CQ and QRX for message traffic only. Arrange schedules and keep them for message traffic only. Other means of communication badly crippled and unreliable." Broadcasts were sent from W8CHG, W8PJ, W8QB, W8CPC and other stations. W8PJ kept in touch with Buffalo amateurs by telephone. Many stations called on for help were disabled

when the sleet and ice brought down their antennas. In such cases, temporary antennas were hastily erected. Antenna systems were grounded by the ice coating, which was no less than 1/2-inch thick. WSCPC and WSCHG left their work to go home and cooperate. W8QB went on the air to help in any way possible. W8TH helped to keep W8ADE on the air. W8CGC helped at W8AFM. W8OA worked his station single-handed and kept both the A. T. & T. and the Power Company's traffic moving into Buffalo and Lockport, requesting supplies, men, etc.

The Lackawanna Railroad asked Taylor (W8PJ) for amateur assistance in getting messages to and from Binghamton and Scranton, stating that stations W8RA, W8RH and W8BTO would call Buffalo at a given time. W8QB, W8CHG and W8CUT immediately went on the job. W8CHG succeeded in contacting W8BTO at Binghamton and an hourly schedule was made. W8BTO, in turn, had a schedule with Scranton, thereby completing the amateur emergency circuit between Buffalo, Binghamton and Scranton. This work was done in the 7000-ke. band. The circuit proved invaluable to the Lackawanna in dispatching their trains. Kieman (W8CHG) took messages all day Saturday, the 21st, and Sunday, the 22nd, and by means of telephone communication with the officials of the Lackawanna terminal at Buffalo, was able to keep them prepared for all arrivals. At Binghamton W8BTO kept the railroad informed of departures from Buffalo and thereby prepared them. Had it not been for the work of the various amateurs, the railroad would have had to virtually stop operating. Mr. J. J. Graff, telephone engineer for the Lackawanna, stated, "These amateurs worked efficiently and well and were the best substitute for a regular telephone dispatching service that could be conceived." Mighty fine work, fellows!

Glens Falls was especially hard hit. By midnight of the 18th of December, conditions were at their worst. For a long period streets and houses were in darkness when the power failed. W8DQP rallied to the occasion and rigged up a "B battery" power supply to replace his regular RAC. After several CQs and QRRs, he raised W1LP at Camden, Maine, who assisted him in his endeavor to QSO stations in Schenectady and Albany. W1LP worked on both 3500 and 7000 kc. but was unable to contact either of those cities. W2GP, having heard a broadcast from WOR that Glens Falls was in trouble, called W8DQP and asked if he could assist. One of W8DQP's QRRs was picked up by W1VR at Cambridge, Mass., and as a last resort W8DQP had him wire W2LU and W2OP at Schenectady. W2OP and W2XCW the experimental station of the General Electric Company at Schenectady also helped in receiving messages from W8DQP. W2LU took press from W8DQP for the newspapers. He also handled reports from the Glens Falls Substation to the key station of the New York Power and Light Corp. at Rotterdam. W2BSH, also at Schenectady, cooperated with W2LU in keeping continuous schedules with W8DQP. During the entire seventy-two hour emergency period, Miller (W8DQP) had but four hours sleep and his good operating, patience and endurance have been praised by those who worked with him. The heavy ice brought down his antenna several times to add to the "pleasure" of the work.

Many very important messages were exchanged on the Glens Falls-Schenectady hook-up. All materials needed to repair the damaged power lines were ordered by radio. Ten trucks carrying over 20 tons of material were dispatched in response to radiograms. Additional linemen, tools and night lights came through after radio requests. Press was obtained each day for the local newspapers. Many personal messages were also handled. One regarding a death was put through after other means of communication had failed.

After reading over the above we cannot help but realize what an amateur station means to a community. We can better understand that our stations are not merely to be used for our own selfish purposes. In the case of all emergencies when other systems of communication fail, the amateur is called on. The public has learned to rely on amateur radio, and in the above-recounted storm officials of power and light, telephone, telegraph and railroad companies asked for amateur cooperation.

As for the stations in the western and northern New York state storm area; theirs was a job well done. Felicitations to every amateur who helped in the relief communication.

— E. L. B.

Warning—Off-Frequency Stations

CARELESSNESS is not to be tolerated much longer in this business of wandering from our frequency allocations. One day soon it is not beyond the realm of probability that Uncle Sam will start in making a few "examples" and then we betide the stations and operators who are caught out of bounds. With the increasing number of important commercial and government services working on either side of our hands, an amateur near 7000 kc. or 14,000 kc. who wanders off-frequency immediately trespasses on any one of several extremely valuable international communication channels. Not only is action possible against individual offenders through the Berne Bureau and our Federal Radio Commission with the frequency checking equipment of the Radio Division, but unless this situation is given proper attention by individual station owners we may find our position at future international conferences weakened by what seems like a general disregard of our frequency allocation.

Of course the individual at fault will hurt himself first of all, but his act in operating off-frequency, regardless of whether due to carelessness or intent, will reflect unfavorably on all amateurs. Our reputation for law-abiding rests wholly and utterly on each and every member and amateur operator. We hope never to see the day when our Federal Radio Commission finds it necessary to withhold part of the frequency bands made available for amateurs in the Washington Convention (1927) to provide so-called buffer bands at the edges of our frequency allocation because of alleged irresponsibility of transmitting amateurs. Yet this is exactly what many governments in other parts of the world have done!

Frequency meters and monitors, especially the latter, properly used will keep amateur stations on frequency. Too close coupling of a frequency meter to a transmitter may temporarily change a calibration and throw a station beyond the confines of the band. So a carefully and substantially constructed oscillating monitor is preferable to any other form of instrument. It can be checked against marker stations and standard frequency transmissions easily and frequently, too.

It is permissible to use so-called marker stations of known frequency stability (and whose frequency is accurately known) to locate the amateur bands. Too frequently the "marker stations" have been used improperly in the past, however. Some amateurs, we dare say, have adjusted their transmitters to get just as close to W1Z or WEM as practicable without recollecting that W1Z is 35 kc. outside one limit of our band, and WEM 100 kc. beyond the other limit! The proper way to use these stations is to use them to determine 6965.3 kc. and 7400 kc. respectively after which some simple calculations will determine the monitor dial settings for the true limits of the amateur bands.

Two of the transatlantic telephone channels, those of GBW, Rugby, England, and GBS, Rugby, England, 14,440 kc. and 6981.6 kc. respectively, have been rendered practically useless on some days due to the blanketing of reception by off-frequency amateur transmission. The first channel (GBW's) is used for daylight transmission, from approximately 9 a.m. to 5 p.m. E.S.T. depending on the season. About dark (E.S.T.) and sometimes until after midnight 6981.6 kc. is used. Interference conditions have occasioned many complaints to A.R.R.L. Headquarters by the Telephone Company and while all individuals responsible have been notified promptly (as many as twenty stations off frequency on just one of these channels have been logged in a single day!) more trouble from other off-frequency amateurs will unfailingly cause trouble on subsequent days. There seems to be some interference every day in the week although the QRM is heaviest and off-frequency operation is noted to be much worse on Sundays and holidays.

Several amateurs have been caught as far as 200 kc. outside the band and their frequencies measured by the A. T. & T. Company and other observers. Most of course are not as far off as this, but their operation is nevertheless illegal, in defiance of international law and of the Radio Act of 1927!

Careless amateur operation must be stopped to obviate official complaints that will hurt amateur radio for all of us. Every reader of these lines is requested to constitute himself an unofficial observer. Make sure of your own frequency first! Then please contact off-frequency amateurs

you are able to log and notify them of their situation. Most of those you contact will thank you generously, for carelessness is our worst opponent in this matter. We hope by such immediate action that an immediate improvement in the situation can be brought about.

Complaints that may be directed through official government channels due to amateur interference must be stopped by you and me at their source — and the best way to stop them is to prevent the interference before it ever occurs. Amateur radio must not suffer harm through lawless acts due to either carelessness or wilfulness of individual members. The A.R.R.L. stands for law-abiding operation and endeavors to encourage it in every way possible. The A.R.R.L. solicits reports of broadcast harmonics, of commercial encroachment in our bands, attempting in every case to correct the difficulty by getting in touch with the organizations directly concerned and bringing pressure to bear where necessary. During 1929 a splendid record of results and improvement or relief has been made in such cases. But the A.R.R.L. will back no individual who gets into trouble through his own fault or carelessness, injuring the chances of continued enjoyment for the whole amateur fraternity by his off-frequency operation.

Our advice is, *watch your frequency!* Avoid the danger of getting too close to the edge of the amateur bands. Use a monitor and listen to your own signal, and be sure of your frequency standards. *Know* you are right before going ahead. Refuse to take chances. Avoid future trouble for yourself and for all of us by *checking frequency often.*

—F. E. H.

In the region of 14,000 kc. the most effective marker stations are WIK 13,930 kc., WIY 13,867 kc., and GBW 14,440 kc.

7000-kc. band markers — GBS 6981.6 kc., WIZ 6965.3 kc., WEM 7400 kc.

Traffic Summaries

(NOVEMBER-DECEMBER)

Pacific led by East Bay	12,054
Central led by Michigan	7687
Atlantic led by Maryland-Delaware-D. of C.	4629
New England led by Connecticut	4512
Midwest led by Iowa	3838
Hudson led by Northern New Jersey	3825
West Gulf led by Southern Texas	1909
Roanoke led by West Virginia	1836
Dakota led by Southern Minnesota	1747
Northwestern led by Oregon	1046
Delta led by Louisiana	889
Southeastern led by Alabama	682
Rocky Mountain led by Colorado	247
Quebec	234
Ontario	179
Vanalta led by Alberta	143
Prairie led by Manitoba	89

754 stations originated 9147; delivered 9044, relayed 25,777; total 45,546. (99.1% del.)

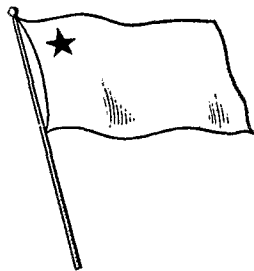

The East Bay Section in the Pacific Division leads the country again this month and takes the Traffic Banner. This is the second consecutive month East Bay has led. What's the matter with Los Angeles? This banner will go each month to the Section with the largest total of real messages. A traffic summary showing the standing of the various Divisions for the past month is printed above. What place does yours take? What Section will carry the Banner next month and help their Division head the list?

Q S T FOR FEBRUARY, 1930

BRASS POUNDERS' LEAGUE

Call	Orig.	Del.	Rel.	Total
W6AD	83	677	826	1586
W2CXL	276	140	876	1292
W6TMM	37	539	227	853
W3BWT	279	105	81	815
W8DYH	27	113	580	720
W6CBW	17	191	419	627
W9COS	86	158	316	560
W1MK	167	70	310	547
W6AMW	14	14	470	498
W6ETA	17	63	394	474
W6AWF	16	4	454	474
W6ERK	83	77	290	450
W6BIP	59	81	294	434
W6ALT	126	9	303	438
W8CUG	14	39	357	430
W2CUF	19	63	246	428
WYEF	168	14	244	426
W8CNO	31	19	356	406
W9EJQ	17	28	326	371
W6SS	365	—	—	365
W6OT	162	—	200	362
W9CFL	31	320	8	359
W1CMZ	61	49	242	352
W6EIB	10	25	314	349
W2QU	97	109	132	338
W6AKW	31	31	278	340
W9BN	169	75	82	326
W6AYC	164	4	136	304
W9BVF	42	14	246	302
W6BPK	13	10	266	289
W6DEM	67	74	140	281
W3ARU	22	34	224	280
W9CET	47	29	187	263
W6BSG	23	55	178	256
W6WA	38	6	201	245
W1UE	61	54	121	236
W1VY	37	87	110	234
W9ESP	4	4	230	230
W9RQC	—	—	230	230
W2AFV	15	36	176	227
W8CRI	37	7	180	224
W6DKV	9	18	192	219
W8EN	58	21	132	211
W6BCK	18	79	112	209
W9EBO	39	4	166	209
W7AAT	39	44	124	207
W8JD	13	42	150	205
W8SO	150	29	26	205
W1COW	11	11	2	204
W3GT	12	68	112	192
W6HM	—	138	42	180
W5HY	45	55	80	180
W6FPZ	23	50	104	177
W8EL	8	166	3	177
W5AJD	38	47	69	174
W5AHB	43	78	46	167
W1BKN	26	55	66	147
W4AHR	38	51	54	143
W1JN	71	79	19	141
W2PC	19	72	49	140
W9DJK	41	52	42	135
W5YW	40	53	40	133
W5BBF	18	54	62	121
KDV5	62	53	6	121
W8EKL	14	54	50	118
W2JF	7	61	44	112
W1LM	18	51	40	109
W9FFD	38	58	13	109
W6BVY	44	61	—	105
W5MS	29	51	22	102
W2AVP	6	62	20	88
W8AVH	8	52	15	75
W6BNY	5	52	11	68

The several amateur stations responsible for the best traffic work — the ones that are "setting the pace" in worthwhile traffic handling — are listed right up near the top of our B.P.L., the figures giving the exact standing of each station accurately.

All these stations appearing in the Brass Pounders' League are noted for their consistent schedule-keeping and dependable message-handling work in amateur radio. Special credit should be given to the following stations (in the order listed) responsible for over one hundred deliveries in the message month: W6AD, W8TMM, W9CFL, W6CBW, W8HL, W9COS, W2CXL, W6HM, W8DYH, W2QU, W3BWT.

Deliveries count! A total of 200 or more bona fide messages handled and counted in accordance with A.R.R.L. practice, or just 50 or more deliveries will put you in line for a place in the B.P.L. Why not make more schedules with the reliable stations you hear and take steps to handle the traffic that will qualify you for B.P.L. membership also!

* This is amateur traffic only, no official Army traffic being handled.

28 MC EXPERIMENTERS!

The Radio Society of Great Britain has arranged a series of 28 mc. tests to be held on four Sundays in March, the 2nd, 9th, 16th and 23rd. They will try to cover the full 24 hours of each day in a special effort to make contacts with new U. S. districts. British receiving stations will also take part by copying as many stations as possible. This may be just the chance you have been waiting for to try 28 mc.—you may be the first to discover some new characteristic of this band. All 28 mc. experimenters are urged to prepare and plan now to take part in these tests, working and copying as many British stations as you can. Send records of both reception and communications to G5VL, Contact Bureau, R.S.G.B., 53 Victoria St., London, S. W. 1. The A.R.R.L. would also appreciate hearing from any U. S. station that takes part in the tests. Now, go to it! We wish you all luck!

W1MK

A.R.R.L. Headquarters' Station W1MK operates on frequencies of 3575 kc. and 7150 kc. Robert B. Parmenter, "RP," is the chief operator; his fist is familiar to most of the amateur fraternity. Occasionally other members of the Headquarters' staff operate at W1MK. Their personal signs may be found in the QRA Section of *QST*.

Throughout the following schedules Eastern Standard Time will be used.

OFFICIAL AND SPECIAL BROADCASTS are sent *simultaneously* on 3575 kc. and 7150 kc. at the following times:

8:00 p.m.: Sun., Mon., Tues., Thurs., and Fri.

10:00 p.m.: Mon. and Fri.

12:00 p.m. (midnight): Sun., Tues., and Thurs.

GENERAL OPERATION periods have been arranged to allow every one a chance to communicate with A.R.R.L. Headquarters. These general periods have been arranged so that they usually follow an *official broadcast*. They are listed under the two headings of 3500 kc. and 7000 kc.; to indicate whether the watch is devoted to listening on the 80-meter band or to the 40-meter band.

3500 kc.

8:10 p.m. to 9:00 p.m. on Sun., Mon., Tues., Thurs., and Fri.

10:00 p.m. to 11:00 p.m. on Tues. and Thurs. (No OBC sent before these periods.)

12:00 p.m. to 1:00 a.m. (or later) on Sunday night (Monday morning).

7000 kc.

10:10 p.m. to 11:00 p.m. on Sun., Mon., and Fri.

12:00 p.m. to 1:00 a.m. on the following *nights* (actually on the morning of the day following): Mon., Tues., Thurs., and Fri. (Only on Tues. and Thurs. does the OBC precede these periods.)

SCHEDULES are kept with the following stations through any of which traffic will travel expediently to

A.R.R.L. Headquarters, on 3500 kc.: W1ACH, W1KY, W1VB, W1WV, W1ZA, W2JF, W3BWT, VE3BC, VE3DA, VE3ET, W8AAG, W8BFA, W8CUG, W8HL, W8JD, VE9AL, W9AEP, W9BLL, W9CX; on 7000 kc.: W4AGR, W6AKW, W6CIS, W6TM and W9QF.

GENERAL OPERATION NIGHTS

The above is the regular routine of W1MK operation and ordinarily is strictly adhered to. We are, however, testing out the practicability of "general operation" nights, on which no schedules are kept. The next *general operation nights* will be *Sunday, February 16, and Sunday, February 23*. W1MK will go on the air at the usual time, 7 p.m., E.S.T. *On the 18th operation will be confined to the 3500-kc. band only, and on the 23rd to 7000 kc. only*. Stations that have never worked "headquarters" are particularly urged to take advantage of these "general operation periods." If they prove helpful in making it possible for more stations to work W1MK and if sufficient interest is shown in them, we shall make them a regular feature.

Official Broadcasting Stations

CHANGES AND ADDITIONS

(Local Standard Time)

W1APK (7200), Mon., Thurs., 9 p.m.; Sun., Mon., Wed., Fri., 8:00 a.m.; W4ILM (7200) Sun., Wed., 7 p.m. (3600) Wed., Fri., 8 p.m. W8EQ (7150) Thurs. 9 a.m. W7PL (3550 kc.), Mon., Wed., 4:00, 7:00 p.m.; W8CHC (3750), daily, 7:30 p.m.; W8DED (3850), Sun., Mon., 7:30 p.m.

Traffic Briefs

Due to a most unfortunate typographical error, W1ZD was listed as W1ZL in the Navy Day Honor Roll. We regret this mistake and at this time want to announce W1ZD's rightful place on the Honor Roll.

The Northern Kentucky Radio Association ran a QSO contest from September 1st to November 1st, points being given as follows: Each QSO counted one point with the exception of QSOs with sixth and seventh districts, Central America, Canada and Cuba, which counted two points. All other DX counted five points. Suitable prizes were given the highest men. The scores of the participants are listed here in the order of points gained: W9BXK 512; W9FS 508; W9AWN 266; W8BAE 200; W9ETD 180; W9AID 150 and W9EAC 130. This contest aroused much interest and kept the gang on the air. This should be an interesting activity for other clubs.

DIVISIONAL REPORTS

ATLANTIC DIVISION

EASTERN PENNSYLVANIA — SCM, Don L. Lusk, W3ZF — We wish to welcome back into our gang our former SCM, W3QP. He wants a few skeds. W3AWB, W3DZ, W3ADE, W3CGS and W3AIZ made their first reports. Just show me you are earnestly interested in traffic work and you will get your ORS. I congratulate W3MC, a new ORS, on his fine total this month. W3NF has a new Xmtr working FB, W3OK and W3NF incorporated. W3CDS evidently is in earnest about skeds. Write W3NF, OM, he is the RM. W3UX, a prospective ORS, shot a nice total in. W3AKB has a new recur and can hear them all, but cannot work them. W8DHT reports W8AWO has a code class on Sundays, at 2 p.m., on 3850 kc. All are invited to listen in. W3BQ reports for 15 days only. W3ZF has the old 20th century ready to start again as soon as the oil is applied to the rusty parts. Come on you traffic hounds, W3TB's report was unfortunately not received in time last month. It was O-3, D-16, R21, T-40. He got it here on time this

month. W3LC is busy. W3AUR sent in a nice total and a neat picture of his station. Thanks, OM. W8VD sent in a bunch of 1902 signals that possess AC, etc. Thanks, Bert. W3WG is on a ship in South America.

Traffic: W3ZF 187, W3NF 140, W3UX 110, W3MC 105, W3AKB 61, W3QP 58, W3AUR 45, W3TB 44, W8DHT 33, W3BQ 27, W3LC 18, W3AWB 16, W3ADE 15, W3AIZ 14, W3CGS 11, W8AWO 10, W8VD 10, W3DZ 6.

MARYLAND-DELAWARE-DISTRICT OF COLUMBIA — SCM, F. Calhoun, W3BBW — Fellows, let me congratulate you on your fine work this month as there has never been, to my knowledge, a better month in this section! At this rate we can get that traffic banner yet. I also want to thank all the non-ORS who sent in reports. Maryland — W3BBW handled a few and got his new 7000 kc. — Hi C. Hartley going. W3AJR says *QST* nearly ruined him with his prehistoric signatures. Hi! W3GGC has two transmitters on the air. W3LA wants to become an ORS and needs some skeds. W3AHL is having a hard time keeping NSS off the air, as his antenna is almost under theirs. W3GF, one of our

new ORS, is having trouble keeping schedules, due to work at college. W3NY says he does not know how any one can handle traffic with all the QRM on 7 mc. Try 3.5 mc., OM! W3DG is on at last and needs skeds everywhere. Delaware, why don't some of those stations in Delaware report? You do not have to be an ORS. W3AJH was Q50 his first VK and only needs A5IA now for WAC. FB! W3ALQ is busy building a frame for his new transmitter. W3BWT, our RM, has a fine bunch of skeds; hence, the great total. You fellows, who want skeds, please write to him. W3GT, our flying ORS, has a nice sked for traffic to the coast and P. I. and China VIA W6AD. W3CAB, one of our old ORS, is back with us again and sent in a great total. W3ASO sent in a report. W3BF, who is also W3GS, is going to Bliss Electrical School. W3LX had a sked, but has not heard him since the first QSO. Hi! W3CDQ, our YL, has two skeds — one with OM director, W3CMP. W3AKR is using only 450 volts on a 50-watter, but is going to improve soon. W3PM, another non-ORS, says he is getting ready for his ORS. Thanks for those questionnaires sent in by our ORS, but why didn't the rest of you send them in? They give us some idea of what you want.

Traffic: W3BWT 815, W3GT 192, W3BBW 111, W3CAB 105, W3AJR 61, W3ASO 51, W3CGC 46, W3LA 44, W3BF 38, W3LX 26, W3CDQ 15, W3GF 9, W3AHL 10, W3AKR 6, W3NY 6, W3AJH 5, W3PM 1.

SOUTHERN NEW JERSEY — SCM, N. R. Weible, W3BWJ — W3DH continues to lead this section in amount of traffic handled with W3ASG running a good second. W3ARR keeps Trenton on the traffic-handling map. W3BWJ manages to keep several transmitters on the air. W3ATP has been experimenting with antenna, and is now stepping out in fine shape. W3ATJ is still busy with Army-Amateur schedules. There is a great deal of activity in Atlantic City and nearby points.

Traffic: W3DH 83, W3ASG 67, W3ARR 30, W3BWJ 18, W3ATP 7.

WESTERN NEW YORK — SCM, Charles S. Taylor, W8PJ — The report this month shows a very favorable increase over last month. To hold your ORS, you must have an average of at least 34 messages each month. Now, fellows, if you cannot handle this amount of traffic each month, kindly send in your ORS for cancellation. W8ATH blew one of his 50-watters. W8AVM is working on 14 mc. W8BAV is handling a few messages. W8BCM has three schedules. W8BGV has two separate transmitters going by remote control. W8BHK got home for Thanksgiving and handled a few messages. W8BJO keeps a regular schedule with Miami, Fla., and would like a Mid-West and West Coast schedule. W8BYO has five schedules. W8CDB is building a 250 crystal-control transmitter. W8CKC has been doing good work on radio-fone on 3550 kc. W8CNX handled 146 this month. W8CPC got his first class ham tag and is keeping schedules with K4AKV and W5AYY. W8CVJ reports inactivity. W8CYQ of Pennsylvania has just opened up a new station there on radio-fone and CW. W8DII has two schedules. W8DME took examination for commercial and is teaching a class of 12 the radio ham game, with W8HWE as his assistant. W8DXP schedules W8KR, W1ZA, W8OA and WYE daily. W8DYI is after ORS. W8OA has schedules with NDB regularly. W8AL has four traffic schedules and is hot after an ORS. Although a little late, I want to thank you all for your cooperation during 1929. I wish you great success in 1930.

Traffic: W8ADZ 8, W8ATH 24, W8BAV 14, W8BCM 55, W8BGV 6, W8BHK 22, W8BJO 77, W8BYO 7, W8CDB 140, W8CNX 146, W8CPC 18, W8CVJ 2, W8DII 72, W8DME 12, W8DSP 130, W8DYI 29, W8OA 46, W8QL 169.

WESTERN PENNSYLVANIA — SCM, A. W. McAuly, W8CEO — The reports of this month are the best we have had for a long time. Activity is on the increase. The RI held examinations in Pittsburgh this month, and it looks as though we are to have a number of new hams this winter. W8CUG had to cancel 14 skeds per week, but still rattles off the traffic. W8YA and W8DLG tie for second place. W8DLG is working on a seven-point system. He needs one more sked. W8CFR says that bad WX hampered traffic on 1400 kc. W8CEO sends A.R.R.L. broadcasts first at 20 wpm and then repeats at 10 wpm. W8AAG is active in the Naval Net. W8DYZ is leading his young brother into the game. Fern of W2CXL was a visitor at W8DUT. W8ARC has a real man-sized job as Secretary of the ATA. W8DKS sends in a report on conditions in Uniontown. W8AJE is trying to reduce BCL QRM. W8AJU has moved to a new QRA and has the

stick up. W8CRA has QSO'd W6BAX on 28,000 kc. W8KD is planning to build a complete new outfit. W8AYH is building a new rectifier. W8DNF is on the air with a 210 and Doc Woodruff's T.N.T. circuit. W8DNO has been rebuilt and is ready for action on 3500-kc., 7000-kc., and 14,000-kc. bands. W8AVY reports consistently. W8CQA is the only ham in Warren, and says he craves company. W8AZG, a former Pittsburgh ham, now in Sharon, Pa., is working lots of DX on the 7000-kc. band. W8CMP is getting to be a regular brass pounder. The SCM received a fine letter from W8DGW, an old-timer from Vandergrift. The A.T.A. put on a membership drive, offering a prize of ten dollars to the winner and five dollars to the runner-up. A considerable number of new numbers have been dug up as a result. The SCM is going to start the new year by cleaning up the list of ORS and retaining only those who report with reasonable consistency. Stations in position to handle on an average of 25 or 30 messages per month are requested to apply for an ORS appointment. If you hold an ORS appointment and cannot handle traffic, be a square shooter and ask for a suspension or cancellation. It is not fair to real traffic handlers to clutter up the ORS list with a lot of duds. W8BNU is working DX now. W8CZE is also QSO DX. The Atlantic Division Convention is slated for Erie later in the year. Start planning now, fellows.

Traffic: W8CUG 430, W8YA 110, W8DLG 110, W8CFR 101, W8CEO 36, W8AAG 15, W8DVZ 8, W8DUT 8, W8ARC 7, W8DKS 5, W8AJE 4, W8BGW 2, W8CMP 71, W8AZG 45, W8CQA 12, W8AVY 11, W8DNO 9, W8DNF 6, W8AYH 2, W8CRA 3, W8KD 1.

CENTRAL DIVISION

ILLINOIS — SCM, F. J. Hinds, W9APY — W9ERU has been appointed Route Manager for Illinois (outside of Chicago). W9DXZ is Route Manager for Illinois-Chicago Section. Notify these boys when you desire schedules, etc. W9ETP has entered the International Relay Contest. W9FFQ reports DX fine on 14 mc. W9BNO and W9AGV are working on their transmitters. W9DAJ uses B batteries with a 171. W9ERU has been appointed Dist. Net Control A-A station. W9BVV is poking out in great shape. W9BZD entertained the YL, W9GJX, November 30th. W9FPN has a low power MOPA set, and is going fine with it. W9BVD, W9BVV and W9BVG are the ops at W9FOV. W9BNR is erecting a VF Hertz for 7000-kc. work. W9BDW has a single 210 with 550 on plate. A new master oscillator set is being installed at W9GJJ. W9BHW finds it hard to keep schedules. W9AHK states the 65th Army net works every Monday, and can reach him then. Good news from W9BZO states that since he has been appointed OFS, he finds many hams seem to know their frequencies to within one kc. W9EHD has moved from Wisconsin to Illinois. W9CBK is about to move QRA's, but will soon be on again with a "xtal DC" note. W9EZZ reports the "Arc" on the rocks again. There is a new Hartley (also had QRM) at W9BMM. W9DXZ is again back with us and is starting up the old 20th Century route with W3ZF, W2BYO, W8EU, W9AIN, etc. Chicago Radiophone Club strongly approves of a wider band of fone frequencies for 3500 kc. W9EGR reports bad QRM on nights, 14-mc. band is now in use at W9BEF. W9DGC works well with A-A with W9FSU. All of the traffic at W9DJ was handled by fone this month. Fb, OT. Our newest traffic man is W9FGG. W9BKL keeps many schedules, but reports a nasty oil burner QRM. W9CKM is going at last, and is out for traffic. W9AFN was a winner in the HP M Relay. Fone and CW are both being used at W9AFN. W9CKZ is building up the crystal set. W9GIV says his 7000-kc. zep works fine on 3500 also. Illness at W9FCW has curtailed operations for the time being. W9FDY is now at home all day, so traffic is good. Hi. W9ACU did all his traffic this month with 150 volts on a 171A. W9CUH reports traffic picking up. W9AFF was a delegate to Los Angeles Convention and had a fine time. W9ALK is on 7 mc. again. W9DWA was heard in U.S.S.K. by ASIAD — FB, OM. Illness at W9FDJ held down traffic a bit. W9BNR will have a 210 single control xmitter going soon. W9CCZ teaches the YL code. Hi. W9IZ says we have a new ham in Chicago in W9BTM. A new MOPA is being used at W9CNY. W9FO wants QLA's of VE3JW, OZ7NN, T13XA, PY2BM, PY9AB, HI2HI, HI1A, X5Z, X2X, X1NQ, 22D, 29D, LU2T.

Traffic: W9FO 121, W9BKL 118, W9AHL 115, W9FDJ 113, W9FDY 97, W9DGC 76, W9CUH 64, W9EHD 47, W9AMD 43, W9BNI 36, W9APY 33, W9ERU 27, W9EZZ 27, W9BZO 24, W9CBK 24, W9ALK 21, W9ANQ 20, W9BMQ 20, W9DWA 19, W9BNR 17, W9ACU 15, W9AFN

15, W9BIHW 15, W9AD 14, W9BRX 14, W9CNY 14, W9DOX 13, W9GIV 13, W9FCW 11, W9BEF 10, W9ECR 10, W9BVP 9, W9CRR 7, W9AFF 6, W9DXZ 5, W9FGF 5, W9CKM 4, W9DJ 4, W9GJJ 3, W9CCZ 1.

INDIANA — SCM, D. J. Angus, W9CYQ — In order to promote traffic handling the SCM will appreciate it if every one who is interested in traffic and schedules in Indiana will send him his name, address, call, frequency and schedules. Immediately on the receipt of this information the SCM will send a card to each one giving the dope on all the rest, so that you will immediately have a list of all the traffic stations and their schedules. The Indianapolis Radio Club had a hamfest at Indianapolis, December 1st — about fifty hams attended. W9BWI has a very good fone station with 100% modulation. We should like to hear from more fone stations. W9UM, a new ORS, is doing some unusually good foreign work. W9AIP is again handling traffic. W9CHC is putting in crystal control. W9FYB is installing a station at the Bloomington High School. W9BPP is a new station in Richmond. W9ASX is going to operate on salt water. W9CGJ presented the A.R.R.L. with another member, born on Thanksgiving. W9RW is going as usual on schedules. W9AET is a new station at Fort Wayne. W9GFJ has changed to fone. W9MQ has a new portable set. W9BNY is a new fone station at Fort Wayne. W9BWI is putting a picture transmitting device on his transmitter. W9AHB is going good with his foreign DX on 7000 kc. W9GKI, a new ORS, is in the A-A network now. W9DDS is a new ORS at Purdue University. W9BFW is a new station at Tipton, Ind. W9UM and W9BKJ are the banner stations in Indiana, this month, so far as traffic is concerned.

Traffic: W9UM 126, W9BKJ 73, W9DDE 39, W9DBJ 45, W9EXW 42, W9GKI 22, W9GCO 14, W9AHB 1, W9RW 37, W9EVV 11, W9FYB 33, W9CHC 37, W9AIP 10, W9AFI 14, W9MQ 4, W9AET 9, W9CYQ 16.

KENTUCKY — SCM, J. B. Wathen, III, W9BAZ — For three solid hours the Louisville bunch, with ears flopping, soaked up ideas and facts as they rolled from the lips of A. A. Hebert. If you missed it, "It's just too bad." His talk revived several who were on the verge of passing out of this grand "game" of ours. Tnx, Hebie. W9OX, with a beautiful signal, leads the pack. W9CRD vamoosed to N. J. Kentucky welcomes the well-known W9AIN to her Blue Grass. W9GBX uses a tree-top for antenna support, and yet gets "steady" reports. W9BGA has a Belgian 50-watter. W9BXX rated an appointment in A-A Net. W9FZV uses a 25-H.P. motor to wind his plate transformer. W9FBA broke loose with another report. W9CEE gets his traffic on all bands. W9AZY received a card from Asia. W9BWJ was home for Christmas. W9EXW is still having trouble with skeds. W9DAI, a newcomer, in Outwood, would appreciate any help from the gang. W9FQN says Hello. Put something on those report cards besides message totals! No QSO's possible after 8:00 p.m. at W9GGB. U. of K. got anything to do with it? Hi. W9ETD is erecting a new mast. W9BAN's 210 draws plenty mills on 14 mc. Windmills or sawmills, George? W9AUH and W9ZZE have been appointed ORS. W9ENR is looking for skeds on 14 mc. W9DDH is a good bookkeeper, borrowed one two months ago and hasn't returned it yet. W9BAZ got a raise so blew himself to some new junk.

Traffic: W9OX 33, W9CEE 50, W9BAZ 41, W9BXX 37, W9EYW 33, W9GGB 22, W9ENR 16, W9AZY 13, W9AIN 11, W9BAN 11, W9FQN 9, W9FZV 7, W9ELL 6, W9GBX 6, W9AUH 4, W9ETD 4, W9MN 3, W9BGA 2, W9FBA 2.

MICHIGAN — SCM, Dallas Wise, W8CEP — W8WO has been working CW on 14,000 kc. and fone on 3500. W8CAT has been trying an MOPA. W8BGY has been busy with Army Net work. W8ZF has a class of 90 men and women learning code and amateur operation. FB, OM, W8AEQ is now a full fledged ORS. W8JD made the BPL for the first time. W8BRS is on 7300 kc. regularly. W9GJX, our own YL, advertises in the paper for traffic, but says the people up that way are bashful or something. W8DYQ of Port Huron is now active and looking for schedules. WYE of Selfridge Field has some very good schedules and some good ops on the job. W8AUT is using a voltage fed Hertz on 14,000 kc. and reports it FB. W8DFS says he wishes they would try and keep from getting him mixed with W8DSE. W8SS is working all bands and also fone. W8CKZ has moved the transmitter into the house again. W8AP is building a radio room in the basement. W8DDO uses a 171A with 250 volts on the plate. W8AAF has two new ops under his wing. W9CE

came back from the hunting trip OK, so guess he doesn't look like a deer. W8DSF has been off the air due to no power supply. W8CJ is using fone with an 852 for oscillator and modulator. W8ASO has been playing with television. W9AXE is on regularly now, and has a fine bunch of schedules. W8BNE has a fine xtal control outfit going on 7218 kc. W8BV has been doing DX on 7000 and 14,000 kc. W8DVQ now has a 203A and uses 281's for rectifiers. W8DED has become a DX and fone fiend. W8CPM is going to Florida for the winter. W8BWR reports they expect to have a complete change of equipment soon. W9EQV is a new ORS at Dollar Bay. W8HL was a busy man handling most of the deliveries during the message shower to W8ZZ. W8BRO reports some trouble with the BCLs. W9EGF is pepping up the gang in the North end. W8DAQ has been very busy. W8DYH has been working both 3500 and 7000 with a lone 210, and turned in the best total so far. W8BIL turned in a nice report from Grand Rapids, but as messages were not separated into relayed, delivered, etc., could not use it. It is with regret that we have to announce the death of our Director, Friend and Advisor, Clyde E. Darr, W8ZZ, on December 10th. We know that all will miss him greatly. The message shower for him was a complete success. About 300 messages came through, although some arrived too late to be delivered.

Traffic: W8WO 14, W8CAT 149, W8ZF 4, W8AEQ 20, W8JD 205, W8BRS 62, W8ACB 4, W8DYQ 14, W9GJX 22, WYE 426, W8AUT 5, W8DFS 27, W8PP 24, W8SS 28, W8CKZ 16, W8DHC 28, W8DMS 26, W8CU 6, W8DDO 23, W8AAF 14, W8CJ 45, W9CE 14, W9AXE 41, W8BNE 16, W8BFH 143, W8DVQ 7, W8DED 9, W8TJ 8, W8CPM 16, W8BWR 43, W9EQV 49, W8HL 177, W8BRO 133, W9EGF 26, W8DAQ 96, W8DYH 720, W8CEP 49.

OHIO — SCM, H. C. Storck, W8BYN — Interest seems to be improving, as shown by the reports. W8CNO takes high honors again, outstripping her nearest rival like a runaway. She totals 406 this month. She says the Chair Warmers Club furnishes a lot of the traffic. If you don't already know about this club, it is formed of shut-ins, who have their sets as their sole means of recreation, and every one of them is a mighty fine operator. RM General, W8CRI, comes along second with 234. Old reliable W8RN is again at the key and, as usual, when he is pounding ham brass, makes the BPL. He may be S.W. op at WFL after the holidays. Another old faithful, W8BRR, falls just a little short of BPL with 184 this month. His RM work keeps him busy. W8GZ is still wrapped up in AA work. W8SG is surely making a bid for recognition in traffic circles, and turns in 105. W8LT is going strong. Here's some tough luck taken with a smile. W8CWC broke his arm at the elbow, but says it will give him plenty of time for traffic. W8AQ is another tough luck bird. He has been laid up for three weeks with a badly scalded arm, but managed to get 47 through just the same. FB, OM, W8BKM says he is active with AA work. W8ADS kicks in with a nice total. W8NP blew his 281s, and will be on shortly with a couple of 866's and one 852. W8DBK popped out a 50-watter and an 866. He says their club is very active and is arranging for permanent club rooms. W8XC reports that he held a double QSO with his sister in Minneapolis. W8LI has just completed his first year on the air. W8DDK is on with a 210 again. W8ARW reports that his fone is now working FB. W8BEA announces that he and his gang are forming a high school club. W8CCS reports. W8ARP has not much time on the air. We have with us again, W8DMX, who is in improved health again and all primed for action on the air. Welcome! W8EJ is now Ensign in U.S.N.R. and is forming a unit in Youngstown. He reports the Mahoning Valley Amateur Radio Club quite active. W8OH says his whole transmitter blew up. W8APC received his blue ticket the day before his birthday and is all "het up." Hi, W8AYO is busy with consulting work on a new BC station for the Youngstown Police Department, including equipment for 9 cruising cars. W8DPF reports that the Buckeye S.W. Radio Association has "every ham an active ham" for its slogan, and they are going to put Akron on the map for next year. W8DHS has been on the shelf for a while, and says he's not so spry yet. W8CFL says he has no excuses for his zeroes this month. Space does not permit a report on the hardships W8LF has been through, but he is still alive and going. W8OQ is still on 14 mc., and reports no traffic there. The little 210, with little time to work it, has palled on W8BYN, and he has the bug for the air so badly that he is rushing work on BYN Sr. and hopes to be on soon with it. He thanks you, one and all, for your holiday greetings.

The SCM voices the regret of all Ohio at the passing of our beloved Divisional Director, Clyde Darr, W8ZZ. His loss will be keenly felt throughout the whole division and in the entire A.R.R.L.

Traffic: W8CNO 406, W8CRI 224, W8EN 211, W8BBR 184, W8GZ 144, W8SG 105, W8LT 90, W8CWC 86, W8AQ 47, W8BKM 39, W8BYN 39, W8ADS 35, W8NP 35, W8DBK 16, W8CX 15, W8LI 12, W8DDK 11, W8ARW 11, W8BEA 10, W8CCS 10, W8ARP 9, W8DMX 7, W8EJ 6, W8OH 5, W8APC 4, W8AYO 3.

WISCONSIN — SCM, C. N. Crapo, W9VD — W9EBO leads in traffic. W9SO had an aerial QSO party, with W8CVQ, W8LT, W9YC, W9AKL and W9DTI in attendance. W9DJK has schedules twice daily with W9BN and Army schedule with W9CD. W9FBJ has consistent Naval Reserve schedules and will soon be in the Army net also. W9DTK will have the 1 kw. tube working as soon as high voltage condensers are received. W9FAW is on regularly and keeping three schedules. W9DLQ has a crystal now, and will be heard with a new note in the near future. W9EFX handles a lot of Army traffic, but says the old 210 is on her last legs. W9FSS is putting in a 50-watt and tuning up more schedules. W9BWZ wants a schedule west. W9VD needs more schedules for Monday night from 7:00 to 10:00 p.m. in 3500-ke. band for Army traffic. W9EYH is not on very regularly. W9OT is getting 866's soon. W9BIB is on 7000 kc. occasionally.

Traffic: W9SO 205, W9DJK 135, W9FBJ 96, W9DTK, 76, W9FAW 73, W9DLQ 48, W9EFX 48, W9FSS 34, W9BWZ 32, W9VD 31, W9EYH 19, W9OT 12, W9BIB 3, W9EBO 209.

DAKOTA DIVISION

NORTHERN MINNESOTA — SCM, C. L. Jabs, W9BVH — By the looks of things the RM, W9CTW, is going to show the rest of the gang how much traffic should be handled by an ORS. He leads the section and wants all ORS to send him their schedules. The traffic total for the entire section is lower than the second highest man in the Southern Minnesota Section. Let's get our shoulders to the wheel and give them a little competition. W9DOQ is waiting for a couple of 866's, and reports the Duluth gang as getting all set for the winter. W9EGN is back on the air and worked WFA with a five-watt. W9GGQ is building a new transmitter. W9EHI has a QTZ transmitter working on 3500 and 7000 kc. W9GKO reports his traffic although he is not an ORS. FB. Would like to have all non-ORS report their traffic. W9AV says, "Let's put No. Minn. on the map." W9EGU is back on the air. Welcome back, OB. W9BMR has an 860 perking and says it will be crystal-controlled soon.

Traffic: W9CTW 81, W9DOQ 25, W9EGN 16, W9EHD 15, W9GGQ 13, W9BVH 13, W9EHI 11, W9GKO 10, W9CZY 3.

SOUTHERN MINNESOTA — SCM, J. C. Pehoushek, W9EFK — Traffic has been booming here, the gang turning in a dandy message total. There is a lot of 3500-ke. and 1715-ke. fone activity. There is room for a large number of ORS if the fellows will let me know what they are doing. I want an ORS certificate to mean something, and will not give one unless asked for it. W9COS, Route Manager, leads the section for the eighth time in the last eleven months. If you fellows want any skeds, drop Carl a line. W9BN makes the BPL with a dandy total. W9CYC, the U. of Minn., has the new xtal job going with Dick Cotton, W8DPX, as Chief Op. W9DGE, known all over the country as Hal, is back from Mississippi, and finds 7 mc. very FB. W9BHZ, Vic Volz, is pushing his share of traffic. W9EOH was QSO both WFA and WFAT Thanksgiving Day. W9DRG says the 201A is tired of handling all his traffic, so he thinks he'll raise power. W9BKX is going with only one generator. W9BNN, a new man at Heron Lake, has his 210 going on 7 mc. W9AIR has been trying 3500 and 1715-ke. fone, and gets a big kick out of it. Radloff wants all Minnesota Army-Amateurs to be on 3500 kc. Mondays at 7:30 p.m. W9DBC has been pretty busy. W9DMA is getting out fine with the new Zepp and T P T G. W9EAT is on 1715-ke. fone with 210 osc. 250 mod. and 112A speech amp. supplied from an Esco M. G. W9EYL has just finished rebuilding. W9DEP and W9CIX have been busy at the U. W9AMK and W9DOP promise some heavy brass pounding during vacation. W9EFK can't get his PA to amplify.

Traffic: W9COS 560, W9BN 326, W9YC 83, W9DGE 50, W9BHZ 50, W9EOH 42, W9DRG 41, W9BKX 36, W9AIR 9, W9DBC 9, W9DMA 5, W9EAT 1, W9BNN 18.

QST FOR FEBRUARY, 1930

SOUTH DAKOTA — SCM, D. M. Pasek, W9DGR — W9DNS sends in a full report of the S. F. gang. He reports W9AJP, W9FQH, W9DRB and W9FBB all more or less active. W9DIY made a trip to Chicago for a BC license. W9DNS keeps a daily sked with W9BN. W9DB has fone on 3.54 and cw on 3.9 mc. W9CKT at Madison is on 3.5 and 7 mc. regularly. W9CIR at Mitchell is on 3.5 almost every evening. W9EUH, Yankton, on 3.5, W9YAM, University, on 7, and W9DYX, Pierre, on the same wave are fairly active. The Army-Amateur net has been reorganized in the state with W9DB, Milbank, as State Control Station. The net operates every Monday evening from 7:30 to 11:30. Any station that desires to join the nets may find out more about it by writing or working W9DB.

Traffic: W9DB 5, W9DNS 5, W9DGR 3.

NORTH DAKOTA — SCM, B. S. Warner, W9DYV — W9BVF turns in a very nice traffic total this month as a result of keeping a few live skeds on 14 mc. W9FCA is getting out real well with a 171A and storage B batteries. FB, OM. W9DM, also using low power and B eliminator, reports working eight districts. W9DYA reports that cranking the megger is hard work, — how about some YL to help out? Hi.

Traffic: W9BVF 302, W9DM 7, W9FCA 6, W9DYA 2.

DELTA DIVISION

ARKANSAS — SCM, Henry E. Velte, W5ABI — Well, gang, this report winds up 1929 activities. As we look back over the past year we see much that has been achieved and realize how much more could have been done if we had only tried harder. Arkansas stands today in radio as well as she has ever stood. We can and will make the year of 1930 the biggest and best year that we have ever had, if we only try. Your SCM is cooperating with you and expects your cooperation in return. We were most pleased to have with us, on December 7th and 8th, Mr. A. A. Hebert, our A.R.R.L. treasurer from Hartford, who paid us a most pleasant visit. Among the stations visited were W5IQ, W5HN, W5LK, W5BDD, and W5ABI. A. A. H. had the pleasure of trying out several of the gangs' transmitters. He even helped to boost our traffic total. Hi. W5AQX worked W1MK and took several messages, one being for Mr. Hebert, who was in Memphis at the time, so he made good use of NBC wire to deliver the message to him. FB, OM. W5JK is still on the job. W5AZA at Magnolia, Ark., uses a pair of 210s on 7000 kc. W5IQ is on 7.15 mc. W5HN is getting out very nicely with his 75-watt xtal-controlled phone set on 1785 kc. W5BDD is on 7000 kc. with an 852. W5LK is working on a fone set. He has a good radio voice, as he was formerly announcer at KGJF. W5ABD is rebuilding his station. W5PX has reinstalled his transmitter. W5ABI now has two plate supplies, a MG set and a pair of 281's. The SCM wishes to thank all those who have helped to make 1929 a most successful year for the Arkansas Section. Good luck to all.

Traffic: W5AQX 35, W5ABI 21, W5JK 6, W5IQ 6, W5AZA 3, W5HN 2.

MISSISSIPPI — SCM, J. W. Gullett, W5AKP — W5FQ says he is going to let his subscription to QST drop. This will, of course, cancel his ORS. W5AWP is using fone on 3520 kc. W5AZV is rectifying 750 volts with two UX-171A tubes. He and W5BHL are constructing a fone set for the 3500-ke. band. W5BHL blew his only UX-210 and is now using a UX-245. W5AED has been on the sick list for three weeks and is now recovering from an operation. We are sorry to hear of your misfortune, OM, and wish you a speedy recovery. W5AOM is using two separate transmitters, one in the 7000-ke. band, and the other, which is a single control affair, as described in QST in the 3500-ke. band. W5APO of Natchez does lots of experimenting. W5AAP, who is the SCM's brother, visited Meridian for a few days and helped W5AKP back on the air. W5AJJ says he is having trouble getting an antenna pole up and for this reason is delayed in getting on the air. W5GQ is using a UX-280 as a full wave rectifier and is putting out about 650 volts with it. W5AKP is back on the air with a Western Electric 50-watt and has worked all U. S. districts in three nights.

Traffic: W5AKP 26, W5AWP 22, W5AZV 12, W5AED 10, W5AOM 9, W5AAP 6, W5FQ 10.

TENNESSEE — Acting SCM, J. B. Witt, W4SP — Activities have increased, especially in Chattanooga and Memphis. Mr. A. A. Hebert of Hqs. met with the fellows in Knoxville, Chattanooga, and Memphis, and they all enjoyed his talks very much. W4RP comes through with the

best report, and is rebuilding for 28 mc. W4HK is working on 28 mc., but has been unable to make contact so far. W4EE is building a 250-watt outfit. W4VK reports working OAAJ and has 6 skeds. W4CW sends in a nice report. W4FR sends in a good report, but promises a better one next month. W4AFS is the only station reporting from Nashville, and is working hard to keep the Army-Amateur net going in the state. Nearly all of our reports come from non-ORS. Let's have more reports from ORS or there will be some cancellations. Let's go, gang!

Traffic: W4RP 66, W4FR 28, W4EE 21, W4SP 17, W4KH 14, W4AFS 13, W4CW 8, W4VK 5, W4HK 2, W4FX 1.

LOUISIANA — SCM, M. M. Hill, W5EB — The mid winter season is now in full swing and the fellows are taking advantage of it. W5YW comes forward this month and makes the BPL using an 852 in Hi C circuit. W5ANQ has central La. on the map with 852 in a MOPA. W5VX has revived after months of silence. W5BDY has the usual QRM from the YL. W5JP has a UX250 going in fine shape. W5PG has a nice total and skeds aplenty. W5ANC has a 50-watter in a High C Hartley. W5ANA has a new 210 and says he will be in the February DX contest. Eureka! W5BDY has his cc going after many sleepless nights. W5UW is at sea, and contends that QST is the best magazine he can buy. W5WF reports a new ham in Shreveport, W5BJA. W5AXS reports confirmation of QSO with ZL1FT. W5BHV has an auxiliary transmitter, and won't be off the air again on account of xmitter trouble. W5EB will be back with the gang by the last of February. W5WG is on regularly now with his 210 in High C Hartley. W5KH and W5BEM are both back with us and have 50-watters.

Traffic: W5YW 133, W5ANQ 102, W5PG 83, W5BHV 71, W5WF 53, W5AXS 29, W5ANC 28, W5VX 21, W5ANA 20, W5BDJ 20.

HUDSON DIVISION

EASTERN NEW YORK — SCM, H. J. Rosenthal, W2QU — W2CUF takes all honors this month with nearly 450 messages. Incidentally he wins the prize offered several months ago to the station handling the most messages in sixty days. Congrats, OM. W2RKN is using B eliminators on his short-wave receiver and claims they work. W2ANV is looking for a few reliable stations in E. N. Y. for the Army Amateur net. W2BMC worked XW1M, a ship off the coast of Haiti. W2LU is keeping four schedules and handling his share of traffic. W2RD and W2ADY have joined the Naval Amateur Reserve. W2ACB is working the coast on 14 mc. and says amateur activity is increasing in Schenectady. W2AGY is busy this time of the year, so only handled a few messages. W2ALI expects lots of traffic in the future. W2BUW has joined the Naval Amateur Reserve and is keeping near the top of the traffic list. W2OP was off the air half the month. W2AYK finds his new job interferes with his brass pounding. W2QU has been appointed Unit Commander of the Naval Amateur Net in E. N. Y., and is looking for several new members to complete the unit. The Larchmont Radio Club has changed its name to The Pioneer Radio Laboratories and has raised \$1500 to buy and equip their new clubhouse.

Traffic: W2ACB 30, W2ALI 19, W2BMC 17, W2ACY 4, W2BKN 3, W2OP 12, W2RD 42, W2BUW 100, W2ANV 84, W2LU 51, W2CUF 428, W2QU 338.

NEW YORK CITY AND LONG ISLAND — Acting SCM, V. T. Kenney, W2BGO — The non-ORS are making a much better showing in traffic totals than the ORS. We have two new ORS this month and only one cancellation, but we promise more cancellations unless reports are forthcoming very soon. — MANHATTAN — The only BPL station this month is W2AFV, who is looking for some local skeds. W2SC is still receiving QSL cards from Australia and New Zealand reporting his 3.5 mc. sigs. W2HJ, College of the City of New York Station, tells us of the success of their C.A.U. parties. W2BCB is the old standby on Army night. W2AJP, a future ORS? while playing with an indoor antenna, succeeded in working G, X, NN, and the Sixth District. W2CUQ, our talented composer-ham, will QSP anything to VO on sked. W2AOY complains of QRM from a local ham. W2BNL and W2AFO, our Inwood representatives, are still with us, and W2AVK is doing his bit to put Inwood across as a traffic next of NYC. W2BBY promises plenty of activity very soon. W2QV, after returning from his trip to the coast, is on the air again with a 100-watt outfit on 7 and 3.5 mc. — BRONX — W2BGO leads the Bronx, and is moving traffic very pronto. W2FF-W2BBX

can always find real DX, as well as help us toward getting that traffic banner. Among the four ops at W2CYX is a YL who does a great deal of brass pounding. W2BPQ is looking for recruits for the National Guard to do their bit in getting W2BWI on the air. W2BWI is the station of a National Guard outfit in the city. W2ALI is having trouble, but expects to have better luck as the time rolls by. W2VG, a future ORS, has a 210 perking on 3.5 mc. — BROOKLYN — W2EV leads the Brooklyn bunch in traffic. W2BVF suggests that all traffic stations use a semi-commercial procedure when handling traffic. W2PF, Army Radio Aide, tells us that W2BRB is home again from Michigan. W2BIV has handled important traffic from Brazil. W2CCD-APB is very busy learning the whys and wherefores pertaining to law and soon hopes to be a lawyer-ham. We cannot very well reverse that and say "ham-lawyer." Hi! W2ATZ is delivering traffic for the Grenfell Mission, Labrador. — LONG ISLAND — As usual, W2AVP, RM for Long Island, leads his gang in traffic. Come on, gang, let us see some competition. W2OT, of the Nassau Radio Club, can be heard regularly, and will take your traffic. W2AIT-AYM, the Boy Scout station, is a new ORS and is keeping both calls on the air. W2BNX is back from the hospital and is keeping daily sked with XW2WS, which is traveling south around the "Horn."

Traffic: MANHATTAN — W2AFV 227, W2SC 59, W2HJ 39, W2BCB 22, W2AJP 14, W2CUQ 12, W2AOY 12, W2BNL 4, W2AFO 3, W2BBY 3, W2AVK 2; BRONX — W2BGO 134, W2FF 61, W2CYX 36, W2BPQ 20, W2VG 18, W2AET 4, W2AI 2; BROOKLYN — W2EV 134, W2BIV 110, W2PF 62, W2BIV 20, W2CCD 19, W2ATZ 8; LONG ISLAND — W2AVP 88, W2PT 16, W2ATT 13, W2BNX 5.

NORTHERN NEW JERSEY — SCM, A. G. Wester, Jr., W2WR — Traffic in our section took a leap and we could lead the division if some of our good traffic stations of last year should come through. W2JF and W2CXL both make the BPL again this month. W2AOS is going strong on Army-Amateur work and says traffic is jumping ahead. W2APU tried 7 mc., but got disgusted with the QRM, so went back to 3500 kc. Woodworth of W2JC is keeping that station off the air. W2BDF reports that his 500-watt station cuts through QRM with ease. W2ANG writes that he is ashamed of his past reporting record. W2CJX boasts a WAC certificate. W2BY complains that her set is rebuilt, but it will not perk. W2BIR, after a good shaking up, came through with a traffic report. W2CXL reports working WFA on December 1 and handling some traffic with them. W2AI was QSO ZU6N and took a message for delivery. W2CRO is back on the air, and can be found at the lower end of the 7-mc. band. W2DV handled most of his traffic in the Army network. W2CWK has applied for an ORS. W2AUP is using 14 mc. for DX and 3500 kc. for traffic work. W2WR is off the air temporarily due to trouble with the mercury arc.

Traffic: W2WR 9, W2F 112, W2AOS 19, W2APU 11, W2JC 7, W2BDF 7, W2CJX 12, W2BIR 4, W2CXL 1292, W2AI 10, W2DV 17, W2CWK 40, W2AUP 10.

MIDWEST DIVISION

IOWA — SCM, H. W. Kerr, W9DZW — The RM tops the list this month, followed by W9ESP with a nice bunch of relays. W9FFD hits the BPL on deliveries. W9PZO has an entirely new layout. OB from W9FFD on Monday and Friday at 9:45 — listen for them and let him know how you get and appreciate them. W9DXP has his best traffic month. Also his AA work is commendable. W9APM has that new 860 going and no trouble QSO'g either coast. W9BSZ, an old spark day ham, is on with CC. W9EIV works both coasts after 3:00 a.m. W9DNZ handles traffic on AA nites. W9EOP is another screen-grid detector enthusiast. W9FIF handles traffic and also wants a fone sked for fun. Thanks, Dick of W9ELY, for your offering. W9FLK reports a few, though he was unable to carry any skeds. In reporting W9EIV notes the former YL operator, now the OW with a call, W8DRB — Herm and Pauline send 73 to gang. W9BCA is very qrl. W9FJA wants to know where the Cedar Rapids hams are. A new station, W9DEP, has opened up at Fort Des Moines. It will be operated by the radio section of the 18th F. A. battery. W9FWG has exhausted all suggested remedies so far for "clix." — Help wanted! W9CCE is one of the boys who gets a few with a 20ia. W9GKL still upholds Ames' reputation. W9DPL uses 25 cycles on the 253-watter, now and

then, with 1500v. W9CKP wants to get started toward ORS certificate. Well, OM, it takes three months of good traffic reporting to have your application seriously considered. And now comes Iowa City with the Iowa Amateur Radio Club — fine. Now may we have a "Big Three Contest" between Sioux City, Ames and Iowa City? They are all college towns and good chances for traffic. Iowa is happy to congratulate her native son, Louis R. Huber, as the next Midwest Director. Plans are in the making for the Annual Convention and short course to be held at the Iowa State College, Ames, about May 16th-17th. The SCM wants to hear from every phone ham in the state with dope on his station for convention considerations. Write your thought on topics for discussion.

Traffic: W9EJQ 371, W9ESP 230, W9DZW 122, W9FZO 117, W9FFD 109, W9DXP 101, W9EIV 72, W9DNZ 41, W9EOP 34, W9FTF 33, W9ELV 31, W9FLK 29, W9EJW 27, W9BCA 25, W9FJA 15, W9FWG 9, W9CCE 7, W9GKL 4, W9DPL 2.

NEBRASKA — SCM, C. B. Diehl, W9BYG — W9ANZ now has Extra First Commercial ticket. W9QY is very busy experimenting with Xtal and phone. W9EEW is still very busy with his railroad. W9DTH is rebuilding plate supply. W9DFR is still experimenting with his Xtals. W9DVR is not on much, on account of the very serious illness of his father. W9FAM sure is a hound for traffic. Sic' Em. W9BOQ reports the two new stations in his city as going well. W9CHB hands in a nice total, and says the Radio Club at the University is going strong. W9BBS has a fine total. W9CDE gets drowned out with a 44,000-volt high line. W9BQR is having the time of his life in the post office, as this time of the year is his heaviest. W9EEQ, a new station in North Platte, turns in a fine total. W9EBF, a new station in Clay Center, is transferring his ORS from Colorado. W9DHC hands in a fine report. W9GBD also reports.

Traffic: W9ANZ 3, W9QY 2, W9DTH 2, W9DVR 2, W9FAM 169, W9BOQ 84, W9CHB 20, W9BBS 32, W9BQR 2, W9EEQ 44, W9DHC 27, W9GDB 12.

KANSAS — SCM, J. H. Amis, W9CET — Kansas has just closed the most successful traffic year in the history of the section, and your SCM is proud of the excellent work. Let's do even better in 1930! W9CET again leads the section. W9FLG warns the SCM that he will take him to a cleaning on this traffic business. Ye SCM is from Missouri. Hi. W9FKD has been converted to xtal control. W9DEB has been handling a lot of Xmas traffic. W9BTG has promised the SCM that he will be found in the BPL next month. W9AES has three skeds going. W9CKV wants some good reliable skeds. W9GFO has been working DX. W9HL has at last lined up a bunch of skeds. W9SS has a 1000-volt supply now, and gets better reports. W9GHI is on 14,000 kc. with CW and 3500-kc. fone. W9BMV has the QST single control xmitter going on 3500 kc., and says its FB. W9ESL wants skeds for traffic on 7000 kc. and 3500 kc. W9BEZ has been very busy at the P. O. with Xmas mail. W9CCS has come to life on 14,000 kc. and has an amateur extra first. A new xmitter is under construction at W9FZO.

The RM, W9FLG, wants the gang to listen for the ORS broadcast on Wednesday nights at 8:00 p.m., 3500 kc., which contains information of value to every ORS in Kansas. The K.V.R.C. meets the second and fourth Friday, 8:00 p.m., at the Topeka Chamber of Commerce. Visitors are always welcome. The Nemaha Radio Club meets on the second and fourth Thursday at various towns in northwestern Kansas. For information, write the secretary, W9BWV. Your SCM would like to see more stations keeping skeds. That would net the section more traffic.

Traffic: W9CET 263, W9CFN 89, W9FLG 60, W9FKD 58, W9DEB 57, W9BTG 32, W9AES 24, W9CKV 24, W9GFO 23, W9HL 22, W9SS 18, W9GHI 15, W9BWV 14, W9ESL 10, W9BEZ 10, W9CCS 3.

MISSOURI — SCM, L. B. Laizure, W9RR — Former Director Quinby has gotten back into brass pounding since turning the director job over to W9DOA, and led the gang in St. Louis. W9BMU has a bag full of ambitions to become a WAC member. W9AMR says his low power rig is performing up to all expectations. W9FTA had a good total. W9DZN is handling traffic with his portable station. W9GHM. W9FUN reports that W9AAO is now a benedict. W9GHG did his bit to lessen QRM by rebuilding the station for better sigs. W9ZK-W9AAU says conditions are as good as ever. W9CVT (ex W9FM), who has been absent some years, is back and ready to relay traffic. W9CBY

joined the traffic handlers this month with 46 messages. W9BMA is another to send in a first report. W9EQC has been on regularly. W9DQN has had to contend with frequent changes in working hours. W9RR is back on the air with the same old transmitter that has done duty for the past two winters. W9CFL is keeping most of the U.S.N.R. schedules for Kansas City. W9BSB is out of town a lot. W9AIL is on frequently. W9BMA applied for ORS. W9FBF reports another of those Columbia hamfests, attended by W9FBF, W9FSL, W9U1, W9ERM, W9EPV and W9BKQ. W9BKG has been at Rolla, Mo., editing a newspaper, and may move there for good. W9CJB has been visiting in Penn. W9FYM is interested in OBS appointment, as is W9GDU. W9EPX was home for the holidays and handled a few messages to keep in practice. W9BJA leads the gang outside St. Louis and K. C. with 152 messages. 1765 kc. has been resorted to to defeat QRM and skip effects between his station and W9AES. W9EFR reports everything OK at his place. W9CDU blew the works and was off all month. W9GCL reports he is still using the same layout. W9DEN, the RM, was second high in the stations outside K. C. and St. Louis with 99 messages. W9GBT applied for ORS.

Traffic: W9DZN-GHM 14, W9DXY 99, W9BMU 14, W9AMR 5, W9FTA 55, W9FUN 8, W9GHG 7, W9ZK-AAU 66, W9GBT 23, W9DHN 99, W9EFR 12, W9BJA 152, W9EPX 6, W9FYM 5, W9FBF 8, W9DQN 26, W9EQC 230, W9BMA 22, W9CBY-GBA 46, W9CVT 66, W9RR 16, W9CFL 359.

NEW ENGLAND DIVISION

MAINE — SCM, G. C. Brown, W1AQL — The SCM wishes to offer a few words of comment in regard to the questionnaires sent to the ORS appointees of Maine. The records of this office show some sixteen ORS in Maine, and out of that number there were five questionnaires filled out and returned to HQ. Now, fellows, this isn't a very good showing for the old Pine Tree State. Not only that, but we want this good old state of ours to be up and stepping with the rest of the world, so when we get anything to do for the good of the game, let us turn and give A.R.R.L. our whole-hearted cooperation. Thanks. The SCM had the pleasure of spending two weeks in Portland, during which time it was his good fortune to meet most of the Forest City gang. Active plans are under way for a real live-wire club which should be second to none in the Division. Good luck, fellows.

W1BKN is top liner this month. FB, Phil, W1ACW is leaving to attend school in Boston. W1ANH has recently been commissioned in the U.S.N.R. W1ATO also has received his U.S.N.R. Commission. Congratulations, fellows. W1ACV reports that he will be back in Maine. W1CDX says that he has phone going FB now. W1AFA has applied for his ORS ticket. W1ACW says he has a new receiver on the air and is going out for DX. W1IR sends in his first report this month. FB, OM; keep it up. W1QH has installed remote control and says that he finds break-in FB. W1AHY reports two reliable schedules and finds traffic picking up.

Traffic: W1BKN 147, W1ANH 137, W1ATO 101, W1ACV 67, W1CDX 56, W1AFA 49, W1ACW 47, W1IR 43, W1QH 31, Mrs. W1AJC 32, W1KQ 24, W1AUR 22, W1AJC 19, W1AHY 14, W1AQL 8.

EASTERN MASSACHUSETTS — SCM, Miles W. Weeks, W1WV — Once again W1CWM turns in a BPL total in spite of 7000 QRM and shutdowns for BCLs. W1WV also makes the BPL, and W1LM got in by the delivery route. One or two more deliveries would have put W1LQ and W1ACH in the same column. W1BBT finds DX good on 14 mc., and reports activity on the part of new hams in his neighborhood. Power leaks and business have prevented W1WU from being on more. The ORS appointment of W1CQ has been cancelled for failure to report. W1LQ is cleaning house for the DX contest and, besides, is busy with a new BC set. W1CRA is still trying to improve the note on his new MOPA, but handled some traffic. W1ACH now has three xmitters, one for each of the popular bands, and has added some new schedules. W1RY finds college restrictions necessitate resigning his ORS. W1ACA is finding more traffic on 3500. W1AZE handled traffic with four continents and kept a sked with VE5AO, a new station at Hudson Straits where mail comes only once a year. He is also keeping a sked with VOSAE as is W1KH. W1KY has moved to 43 Lake View Ave., Cambridge, and will be off the air for a while as a result. W1BZQ handled more traffic this month on 7000,

and feels encouraged about it. Our 7000-ke. traffic handlers seem to think conditions are improving a little on that band, which we are all glad to hear. W1QZ and W1AOT start reporting this month and have ORS ambitions. W1AAT writes there is considerable activity among Salem hams. W1AGS reports. Activity in the section is on the increase with fine cooperation from all.

Traffic: W1CMZ 352, W1WV 234, W1ACH 119, W1LM 109, W1LQ 108, W1CA 81, W1KH 68, W1BZQ 62, W1CA 59, W1AZE 33, W1ASI 31, W1AAT 30, W1KY 29, W1ARS 18, W1AOT 18, W1WU 14, W1BTT 6, W1QZ 4, W1BLD 3, W1AGS 7.

WESTERN MASSACHUSETTS — SCM, Dr. J. A. Tessmer, W1UM — W1BWy is on 7220 kc. and 3660 kc. Robert Long has left to reside in Poughkeepsie, N. Y. W1ASY, Hewinson, is a new ham in town. W1ASU says his xtal outfit is on the air on 7150 kc. W1BVR wants to know what to do about northern lights. W1APL is on 3500 and 7000 kc. W1BSJ is on Mondays between 5:30 and 6:30 p.m. All of the novelty is wearing off of W1ADO's 500-cycle note and expects to return to DC. W1AZA is on 3740 and 14,200 kc. W1ZB, who is ex-W9EEO, after having installed radio transmitters for Westinghouse in various parts of the globe has settled down in the good town of Chicopee Falls. W1BNL has a new monitor working. W1BKF has worked 26 countries with his 210, and now is going to use a 50. W1AZW says that our YL, W1AJJ, wasn't on much and consequently no traffic. W1BKG is going strong on 3500 kc. and wishes some early morning traffic. W1ARE is on now and then on 7000 kc. W1AZD has a new set on 14 mc. W1AMS also has a new 852 on 14 mc. W1CEK is still going strong on 14 and 7 mc. W1AZW and W1VW have just completed their 14-mc. fones. W1BKG is the Worcester Radio Club Association, at 274 Main St., Worcester, Mass. All hams are invited to sit in at meetings Thursday evenings. They want to let the gang know that the N. E. Convention will be on April 25-26, Hotel Bancroft. Mark your calendar now.

Traffic: W1BKF 7, W1BNL 15, W1ZB 29, W1ZA 46, W1ADO 23, W1APL 27, W1BVR 9, W1ASU 4, W1BWy 8.

NEW HAMPSHIRE — SCM, V. W. Hodge, W1ATJ — W1COW makes the BPL this month with W2EI as assistant operator. They have an 852 going in all bands. FB. W1APK is now an OBS. Watch for him on 3600 and 7200 kc. W1BFT handled a big bunch. W1AUY handles his traffic entirely by phone on 3530 kc. W1CDDT will be on with a DC note in a few weeks. W1AEF is still pounding away. W1IP almost made the BPL, but says outside (?) business took a lot of his time. W1CEQ pounded out a few in spite of college work. Simpson, W1HO-W2BQO, now holds an amateur extra first ticket. W1AFD, W1AUE and W1IP have been advanced to Radioman 2/c U. S. Naval Reserve.

Traffic: W1COW 203, W1BFT 128, W1IP 147, W1AEF 43, W1ATJ 30, W1CEQ 15, W1APK 6, W1CDDT 5, W1AUY 3.

VERMONT — SCM, Clayton Paulette, W1IT — Hello, gang, here we are on another month's activities. W1BJP and I had the pleasure to take a trip to Brattleboro, and on the way W1BDX joined us. We visited W1CGX, the Route Manager, and W1BCK. On the way home we called on W1AD at Bellows Falls. This state is all set now for very FB QSP to Canada. W1BDX and myself made a visit to Montreal, where we got acquainted with VE2AV and VE2DN, who both will be on 3500 kc. this winter and willing to handle traffic. We also visited VE2BE, the new Canadian General Manager, who accorded us a fine reception. VE2AC will be wide open for Canadian traffic this winter also.

The following Vermont stations are on the air regularly most every night: W1IT, W1CGX, W1BJP, W1BDX. The QRH of all four listed hovers right around 3695 kc., and all use DC. We are looking forward to at least two more traffic handling stations besides the four mentioned above, viz: W1AD and W1ATZ. W1ATZ writes me that he has recently acquired a wife. Congrats, OM. W1BD is on 3625 and 7250 kc. with crystal control, and is willing to take on skeds at any time. FB, OM. We will be very pleased to have you handling traffic with us.

Traffic: W1IT 3, W1BJP 8, W1CGX 23, W1BDX 43.

CONNECTICUT — SCM, Fred A. Ellis, Jr., W1CTI — W1AOI, RM of Northern Connecticut, reports by radio. W1ASD is operating W1JN at Yale using the 110 v. DC mains for plate supply. W1BYM is getting back in the game and hands in a nice total. W1AMQ has a new portable call, W1FJ. W1VB is keeping some fine schedules and has a DC note. W1AJB is keeping seven schedules and looking for

more, especially with New Haven and Hartford. W1UE is pounding out the traffic in fine shape and makes the BPL both ways. W1TD is on 3500 kc. for the winter and is anxious to arrange some reliable schedules. W1MK with RP at the key is keeping Hartford on the map and makes the BPL as usual. W1ATG is coming to life and will operate the Bridgeport Naval Reserve station. W1BWN has resumed activity on 3500 kc. and expects to operate regularly if BCLs permit. W1BJK is operating on 14,000-ke. band. W1AMG has moved, which accounts for his low total. W1BI — W1BQH is using a 100-watt TPTG on 3550 kc., and is open for Boston traffic. W1AJP sends in his report and wants an ORS ticket. Any other non-ORS please get in touch with the SCM. W1RP keeps a weekly schedule with 55X. W1NE reports by radio and operates on both 3500 kc. and 7000 kc. W1CTI is open for schedules with Conn. ORS. The QSO parties will be held on the 15th of each month — don't forget the call "CTNITE." Please help the SCM in making up the reports by mailing your form 1 cards the morning of the 16th. W1ADW reports a new station in Danbury, W1BEW. Welcome, OB. W1AOX has a fone on 14,000-ke. band. W1ZL expects to erect a station at his Brooklyn QRA.

Traffic: W1MK 547, W1UE 235, W1JN 141, W1AJB 110, W1BYM 69, W1CTI 65, W1AOI 48, W1RP 40, W1VB 37, W1APJ 9, W1NE 7, W1TD 3, W1AMG 6, W1BWN 1, W1AMQ 8, W1BJK 10, W1ADW 11, W1AOX 45, W1DF 5, W1AFB 107.

(November) W1RP 20, W1ZL 29, W1AOX 60, W1TD 8, W1AMQ 1, W1VB 49, W1AMG 14, W1CTI 101, W1UE 241, W1BOD 44, W1MK 745, W1BGC 6, W1APJ 10.

NORTHWESTERN DIVISION

OREGON — SCM, W. S. Claypool, W7UN — All but one ORS reported this month, and we hope to hear from you, W7ALK. W7PL, Oregon's most active ORS, is now OBS with OO coming up as soon as his GR frequency meter arrives. W7ALM, a new ORS, is second, and says "skeds are fine for good totals." W7AMF did very good work this month. Two new rectobulbs are in use at W7WL. W7MY had to replace a pair of 281's, but his report is good. W7ZD reports for the first time with FB total. A pair of 201's in push-pull are working at W7MV. All loud sigs at W7UN are copied on a sounder, as he has a vacuum tube relay going. W7AIC is installing a 50-watter. Not much new at W7SY. W7PE holds a very consistent sked with W7ACA. W7IF reports. W7EO is going to knock 'em all cold with the new xmitter he is building. W7WY is looking for traffic skeds in any direction. W7ABH was in for DX this month and was successful in QSO FMZ Chile, Canal Zone, Jamaica, Virgin Islands, K6 and 7 and ships. W7JC is Route Manager for southern Oregon as well as being an OBS. W7ALJ, the YL operator, holds skeds with W6RJ, and is on the air each Friday night on 3500 kc. W7WR will be going soon. W7AMQ and W7AIG report. W7WP went in for DX this month. An all-ORS QSO party is under way and letters are going out to all ORS in the section.

Traffic: W7PL 139, W7ALM 116, W7WL 86, W7AMF 55, W7MY 47, W7ZD 43, W7MV 30, W7AIC 49, W7SY 18, W7PE 14, W7IF 12, W7EO 12, W7WY 11, W7ABH 6, W7JC 7, W7WP 6, W7ALJ 1, W7UN 35.

MONTANA — SCM, O. W. Viers, W7AAT — W7FL is recovering nicely from his accident of being struck by a train while driving home for the holidays. These trains are hard to knock off the track, Jeff. W7AAW is handling more traffic every month. W7EL is back on the air and starting his good traffic work again. W7DD puts out a terrific signal on 7030 kc. W7AAT works on 7040 and 3680 kc. and wants good reliable schedules. What's wrong with the rest of the ORS in this section? Let's have more reports next month, boys.

Traffic: W7AAT 207, W7AAW 38, W7DD 35, W7FL 19, W7EL 20.

WASHINGTON — W7ACA reports direct to Hqs. and is keeping schedules with W7KD and W7PE. W7OI is making plans for a big 1930.

Traffic: W7ACA 40.

PACIFIC DIVISION

LOS ANGELES — SCM, B. E. Sandham, W6EQF — Here's the first story from the new SCM. Will all stations handling traffic, ORS or otherwise, kindly send in your reports on the 16th of each month? I will endeavor to keep the Los Angeles Section leading the nation

in traffic totals if you will offer your assistance by reporting. The A.R.R.C. put on a real convention. All clubs in this section are functioning well. A.R.R.C. elected officers for coming year. The Pasadena Club has speaker for every meeting. Long Beach Club is holding regular meetings with good attendance, and Tri-County Club is taking a trip into the mountains. W6WA drove in from Bakersfield just to have reports in on time. FBI W6CUH is QRL at college. W6ETJ is on all bands now. W6EKE is QRL on in January with two 852's. W6DKV worked five VE districts in two hours. W6ID is interested in new Schnell tuner seen at convention. W6CBW made the BPL. FB. W6AKW made the BPL, and says the PMZ expedition is closing. W6ESA built a new station, and his OW and OM are learning the code. FB. W6ASM has replaced his old receiver with one given him at the convention. W6FJ was QRL with convention. W6BFI is working for Comm. ticket. W6DZI has QRM from street car feeders and new ham starting up two blocks away. W6DLI is handling traffic on 3500-ke. fone. W6COT has a new DC note now. W6DPU reports. W7AM's traffic total jumps. W6EFA says new rectobulbs for Xmas. W6DHM makes the BPL both ways. FB. W6EAF says much skip trouble on 3.5 mc. W6HS is QRM with work. W6AWY is using xtal on fone. W6ID is waiting for new Schnell tuner. W6EPL is a new ham. Let us hear from you, OM. W6EQF cancelled sked with KA1CM on account of convention QRM followed by the SCM job. Hi. W6MA says the station is being changed somewhat. W6BTL dropped a bucket of paint over W6DHM while painting the new 80-foot pole. W6ZZA is now crystal-controlled with new antenna. W6EPH reports traffic, as does W6BCK. W6ESB has new station on the front porch. W6AVJ is piping the warm water in his 1 kw. tube to the washbowl. W6BNI makes the BPL and has Comm. ticket. Bakersfield hams are forming a new club. The SCM would like to hear from the northern part of the section. W6ACL is QRL with school. W6BVZ says he is going to have a PDC note. The R. I. is changing the calls of all school and college stations. W6AWP is still looking for Africa for his WAC. W6CBS is putting in new power supply, as his 281's boiled over. W6EVA reports the activities of Tri-County Club. She is installing new rectobulbs — likes the lavender glow. Hi. W6BSL reports traffic. W6AKD reports direct to HQ. W6CBW, W6AKW, W6DHM, W6WA, W6DXV, W6BCK, W6BNI all make the BPL. FB, fellows, keep it up!!

Traffic: W6CBW 627, W6AKW 327, W6DHM 281, W6WA 245, W6DKV 219, W6BCK 209, W6AM 147, W6ESB 90, W6BNI 79, W6AOB 62, W6UJ 48, W6ETJ 47, W6AOA 46, W6DLI 39, W6EAF 33, W6AVJ 29, W6AWP 17, W6AKD 16, W6ABI 15, W6CUH 14, W6ACL 14, W6BSL 12, W6ID 11, W6EVA 11, W6ENH 10, W6EFA 9, W6BFI 9, W6EKE 9, W6AXE 9, W6EQF 3, W6ESA 3, W6BJX 3, W6EPH 6, W6ZZA 4, W6COT 3, W6DZI 3, W6MA 3, W6ASM 1.

EAST BAY — SCM, J. Walter Frates, W6CZR — Traffic totals during the last month were excellent because of the remainder of the messages handled by the Oakland Radio Club from W6SS and W6OT from the Pacific Slope Dairy Show at the Oakland Auditorium. W6AMW came through as the high station in the section. Both Babcock and Lonie, the Marine owners of the station, keep it on the air pretty consistently. W6ETA handed in a high total, which is the last one she will count in this section, owing to the fact that she is moving to Los Angeles. W6AWF is elated by his total this month, and has every reason to be. W6SS pounded out traffic from the dairy show until the last ribbon had been pinned on the last cow and W6BSB's voice was hoarse from ballyhooing for the booth. W6OT, through the efforts of W6IT, W6ATT, W7NL and W6CZR relayed the stuff coming in from W6SS. W6EIB at Vallejo says that U.S.N.R. traffic is picking up because his station has been appointed section control station and all traffic must pass through him. W6EDK has been putting out a wicket signal on 3500 kc. He hooked up W6IB and W6CZR by telephone through his station by throwing the output on his receiver into the lines. W6EIB's signals came through to W6CZR six miles away from W6EDK about QSA5, and an enjoyable QSO was had. W6ATT did yeoman service during the dairy show. He operated at W6SS, copied at W6OT, and then pounded out the left-over traffic through his own station. W6ALX, who won the cup in the L.A.-East Bay traffic contest as the high man in the East Bay Section, took time off this month to look after affairs at his radio school. W6EOO at Pope Valley, after returning from the

convention, pounded out a sizeable total. W6BZU gets a bit of traffic now and then. W6RJ says the rainstorms of the past month have killed his pet power leak. W6BIW is trying to catch up on the sleep he lost during the traffic competition. W6EJA at Pt. Richmond has been having difficulties, owing to the fact that his rectifying tubes went soft. W6EW works everything he hears. W6CGG has constructed a low power fone *à la* September QST. W6BMS got a report from W1TL on 3500 kc. while using 3 watts. W6CZR is back on the air with W6DCZ's TPTG and has been QSO east coast and Hawaii. W6BEF is still doing his bit of traffic work. W6BI says he is too QRL for skeds and traffic. W6ASH has been practically off the air, due to school work. W6EY wants to know where all the E. B. fellows were at the convention. W6EDR can't make his set perk. W6BYS at Napa says 14 mc. is great for DX. He is leaving on a Naval Reserve cruise to South America February 14. W6CUO has a new job with a fone company, and is leaving on the first of the year. W6CZN has finished his screen-grid receiver. W6AUT paid a visit to W6EDO while on a quail hunt, and says all he got was "wet." W7NL, operating for Beeing at the Oakland Airport, won one of the prizes in the code contest at the convention. W6IT has resigned as president of the Oakland Radio Club because he is moving to San Francisco, and new officers are going in on the first of the year. S. G. Culver, who has been acting as secretary-treasurer of the section, expects a new call soon as he has just passed his examination. The Oakland Radio Club is planning a class to get extra first licenses for the gang. FB.

Traffic: W6AMW 498, W6ETA 474, W6AWF 474, W6ATT 438, W6SS 365, W6OT 362, W6EIB 349, W6EDK 289, W6ALX 92, W6EDO 70, W6BZU 53, W6RJ 39, W6BIW 31, W6EJA 30, W6BMS 28, W6CZR 25, W6BHF 24, W6VI 20, W6ASH 19, W6EY 2, W6EDR 1.

SANTA FRANCISCO — SCM, C. F. Bane, W6WB — Things are beginning to look as if we are finally getting into the running in the Pacific Division traffic fest. Fifteen men report this month with five of them in the BPL. W6AD leads the parade as usual with an enormous total, and that boy Schmidt sure deserves all the credit in the world. On two occasions he arranged a reunion of mother and daughter, mother at W6AD and daughter at KA1CM. Splendid work, OB! The monthly W6ERK-W6BIP traffic race finds the latter on the short end this time. W6BIP says that graduation from high school cramped his style. W6AYC surprises us all this month and makes the BPL with a bang. Let's keep up the good work, Martin, OB. Being elected president of the S.F.R.C. evidently did W6AMP lots of good, as he reports a very nice total for the first time. Jack Stevens, W6PW, was elected president of the A.R.A. of S.F., succeeding yours truly. Luck, Jack. W6AVH makes the BPL the first time up and says that it's going to continue. Life is getting to be one amplifier after the other with W6WN, but he always manages to get some traffic. W6DZZ is out after an ORS and is slowly climbing up in his totals. W6DFR is pounding away with A-A work. W6DBD, the RM, has had a session of night work, so no traffic this month. He is Vice-President A.R.A. W6ERS is only using a UV201A in the transmitter. W6AVQ sandwiches in some traffic between bursts of FB DX. W6ATI is just recovering from the effects of the convention. W6DEE reports for the first time, and has been having lots of grief with parting filaments in his fifties. W6DFS reports having excellent results with his xtal layout. Stations in the northern part of the section are urged to report their traffic to the SCM. We can use some good ORS. We hear that W6BIA, former RM, is getting back on the air. W6FJ is still dynamiting 14 mc. W6WV takes out an ORS so as to be eligible for SCM. Hi. The A.R.A. of S.F. were honored by the presence of Jim Lamb of headquarters, and all join in thanking Mr. Lamb for his splendid talk. W6WB nearly froze Jim to death out at the shack after the meeting. Hi. We are darn glad to see the rapid increase of xtals and MO-PAs in this section and decrease of RAC, AC, etc., *ad nauseam*. FB, men. W6CIS is running skeds with W1MK and AC8HM.

Traffic: W6AD 1586, W6ERK 450, W6BIP 434, W6AYC 304, W6AMP 88, W6AVH 75, W6WN 46, W6DZZ 43, W6DFR 19, W6ERS 22, W6AVQ 9, W6WB 5, W6ATI 3, W6DEE 9, W6DFS 12, W6CIS 12.

SANTA CLARA VALLEY — SCM, F. J. Quemant, W6NX — W6YG, Santa Cruz High School, restricted to day-time operation, tops the list of traffic handlers with 128. W6JU, San Mateo Junior College, was a close second with daily skeds with W6DHM and W6ETA. W6HM maintained his trans-Pacific communications which placed him

in the BPL. W6HM will soon be crystal controlled 500 watts. W6ALW moved down to 14,000 kc. where DX FB but traffic light. W6ALW is a postman. W6DQH on 3500 kcs. maintains daily skeds, moving plenty of traffic. He is the newly appointed RM, and all San Joaquin Valley stations should get in touch with him for skeds, etc. W6BYH, a consistent traffic station, operating on 3160 and 7200 kcs., wants skeds with L.A., S.F., Salt Lake and Portland. W6DCP is thinking about organizing a radio club at Santa Cruz, as amateur interest is increasing there. W6BMW attended the L.A. Convention during the month as delegate. W6BNH is on 7000-kc. band with a 210 in TPTG circuit. W6AME also attended the L.A. Convention and copped one of the prizes. W6NX is building a new receiver. The interest in the section is increasing each month, and inactive stations are being weeded out. The San Jose and Modesto Radio Clubs are especially active. The Tri-Section meeting of the San Francisco, East Bay and Santa Clara Valley Sections was held on January 13 with a large attendance present. W6BAX is QSO South America regularly. W6BVG got a letter from the Secretary of the Navy congratulating him on submitting one of the twenty most perfect copies of the Navy Day broadcasts.

Traffic: W6YG 128, W6JU 111, W6HM 180, W6ALW 82, W6DQH 77, W6BYH 50, W6DCP 32, W6BNH 3, W6AME 2, W6BMW 38, W6NX 4, W6BVG 105, W6BAX 12.

SACRAMENTO VALLEY — SCM, Everett Davies, W6DON — W6TM is still at the top with a wonderful report, due to his trans-pacific work and some real daily schedules. He sent the first definite news of the destruction of the yacht *Carnegie* to the Carnegie Institute in Australia. W6BSQ made the BPL with five good local schedules, and wants a reliable schedule in the Middle West. W6BDX is a telephone repeater man. W6AIM reports his business engagements take up most of his time. W6AFU says Hi and Merry Xmas. The Sacramento Valley Radio Club is going strong with a bunch of new officers. Sacramento went to the Los Angeles A.R.R.L. Convention and brought it back with them. W6JB is the new YL operator in Sacramento. She is young, free, and white and can really pound brass besides being W6ESZ's sister. W6BSN, the high-speed brass pounder at KRJ, works them on 14 mc. if they are far enough away. W6DQG's wife has been sick so he is on very little. Some one said W6DD was back on the air.

Traffic: W6TM 853, W6BSQ 256, W6AIM 12, W6BDX 10, W6AFU 2.

ARIZONA — Acting SCM, Louis Barrett, W6EAA — W6BWS is working day and night on a new BC station in Phoenix. W6DYG, W6BWS and W9LK are planning on consolidating and putting in xtal control. FB, OMs. W6BJF was heard in New Zealand on 3500 kc. W6EAA has been experimenting with new circuits, but could not find anything better than the old push-pull Hartley. W6AWD reported direct to HQs, W6DIE had to take his antenna down. W6DRE is getting out FB on both 7000 kc. and 14,000 kc. W6DTU blew up the works and is now on with a 201A. Come on, fellows! Let's get some action and run up those traffic totals.

Traffic: W6DRE 55, W6BJF 24, W6EAA 3, W6AWD 9. SAN DIEGO — SCM, H. A. Ambler, W6EOP — W6EPZ leads the section this month, and again makes the BPL. W6ACJ has four skeds and also handles lots of traffic for the Naval Reserve. He wants to thank the A.R.R.L. Convention and the Thordarson Electric for the three transformers that he won at the Los Angeles Convention. W6EOS has a FB note and is getting PDC and xtal control reports. W6BGL is on with a portable while he is rebuilding. W6EPF, the new RM, is getting the ORS lined up. If you want any skeds, get in touch with him. W6CPT is still working DX with the 112A. W6BAM reports two stations. W6LH and W6AXU, of Santa Ana are back on the air and thinking of applying for ORS. W6BAS is back with us again. W6DNS and W6DGW have been very ORL with school. W6BFE is now on with a 50-wattter. A big bunch from San Diego attended the convention in Los Angeles, and all reported a fine time. W6BXI has renewed his ORS.

Traffic: W6EPZ 177, W6ACJ 174, W6BGL 26, W6EOP 26, W6DGW 10, W6EPF 5, W6CTP 5, W6BAM 4, W6BAS 4, W6DNS 3.

ROANOKE DIVISION

NORTH CAROLINA — SCM, Hal S. Justice, W4TS — Route Manager W4AEW is offering a prize of one Cunningham CX310 tube to the station handling the most traffic between January 16th and April

15th. Go to it, fellows; let's have a little competition for this bottle. Due to lagging interest among the ORS, all certificates issued prior to August 1, 1929, are being cancelled, and new certificates will be issued only to stations showing sufficient interest in traffic work and reporting. The new certificates will be issued only for a period of one year, and a condition requiring the holder to handle at least one hundred messages during a three-month period is under consideration. W4ABV, our newest ORS, is the high traffic man for this month. W4AEW suggests a 3500-kc. QSO party some night. W4AA-W4ACA has been busy making improvements at WNRG the last month. W4TY has a fine new shack. W4AB is back on the air. W4DW is changing to 3500 kc. and building a new receiver. W4AFW has a sked with VK6FH on Wednesdays. W4WE, U.N.C. station, is looking forward eagerly to the February DX contest. W4AHH blew three 50-wattters and is going to the 28,000-kc. band with his UX852. W4JR is on 3500-kc. band consistently.

Traffic: W4ABV 155, W4AEW 89, W4TS 28, W4JR 25, W4WE 16, W4AHH 12, W4AFW 8, W4DW 5.

VIRGINIA — SCM, J. F. Wohlford, W3CA — W3ARU is working 3.5 and 7 mc. now and doing good traffic work. W3AUA, W2ABX and W8AMJ are new operators at W3ARU. W3AHW lost his antenna in high winds. W3AMB is working some DX besides his traffic work. W3HO is another Richmond station handling traffic. W3HY says he's trying to master the antics of a crystal. W3FJ took a trip to New York and looked some of the hams over. W3ALS visited the SCM Thanksgiving and also went up and looked W3CKL over. W3AKZ, a new station at Louisa, Va., just opened up with one 112A. W3ZA is rebuilding his radiophone outfit. W3WO is using a pair of 210s now. W3BDZ threatens to go in for phone. W3CKL is using radiophone in addition to DX work on the 7000-kc. band. The SCM would like to hear from anyone in the section that would like to try out for the SCM work at any time.

Traffic: W3ARU 280, W3AHW 4, W3AMB 15, W3HO 15, W3HY 12, W3FJ 78, W3ALS 22, W3WO 79, W3CA 61.

WEST VIRGINIA — This report is sent in by W8JM and W8HD — W8OK leads the gang with a total of 112. W8JM is planning on putting a TPTG on 3500 kc. W8BCN is getting out well on 14,000 kc. W8CSR is back and going to start all over again. W3UO is in Fairmont operating WMMN. W8BPU has accepted a position with RCA in Chicago. W8VZ is connected with the same firm. W8AYI moved his station to Davis-Elkins College and is coaching prospective hams. W8TI says, "NIL his way at present." W8BR is home for the holidays. W8AEI said, "I'm satisfied," his phone being heard in Connecticut. W8DNN still keeps his W9AZY sked. W8CCN is selling his stuff to W8ALG and will be back on with some kind of new apparatus. W8BOK has his new phone transmitter working FB. W8AMX is still hunting those little bugs known as power leaks. W8BPP is still attending W. V. U. W8CLQ is working in Pittsburgh, leaving the duties of op of W8CLQ to the younger brother. W8BTY is sure knocking the hams cold on 3500. W8OK can be heard on 3500 kc., Mondays, handling A-A traffic. W8HD is doing his stuff on 3500 kc. with a 250. W8CAY is interested in his Naval Reserve messages. W8DPD sure knows how to make a phone station kick out. He is our oldest op, being around 65 years young. W8AIC works Morse by day and international at night. W8ACZ-W8BCN-W3UO and W8JM are planning on getting together and building a big station about three miles out of the city. Well, gang, let's have more reports next month, and you better be thinking about who you want for SCM. Better put a pin in your calendar for the DX contest in February. Let's cop a few prizes.

Traffic: W8ACZ 105, W8JM 90, W8BCN 72, W3UO 68, W8CSR 60, W8DNN 42, W8BTY 39, W8VZ 36, W8DPD 34, W8CAY 30, W8HD 74, W8CLQ 26, W8AYI 25, W8ALG 24, W8BUB 22, W8OK 112, W8CCN 18, W8DPD 10, W8AIC 6, W8BOK 4, W8AMX 2.

ROCKY MOUNTAIN DIVISION

COLORADO — SCM, C. R. Stedman, W9CAA — W9CVE, a non-ORS, leads in traffic again. Let's see some of you give him a little competition. W9CAA handles considerable traffic on schedule. W9EDM says he has been too busy to do very much. W9DTY is getting out a little now. W9EFD hopes to be going strong before long. W9ECP at Limon is getting out in good shape. W9DRV is on a little on week ends. W9CSR is getting interested in crystal phone work now. W9EAM is working on 3500 and 7000 kc. W9DOC at Fitzsimons Hospital says all the fellows

seem to have the idea that he is a doctor, and he wants the world to know he is a patient instead. W9BQO was selling out in our last report. Now it is revealed that he is hanging out to his 250-watter. Three guesses what that means. W9CBQ is rebuilding his outfit. W9CJC gets on now and then on 7000 kc. W9CHK is working nights.

Traffic: W9CYE 71, W9CAA 43, W9EAM 32, W9CSR 13, W9EDM 23.

UTAH-WYOMING — SCM, Parley N. James, W6BAJ — Traffic was almost at a standstill this month because of school QRM. We have two stations from Wyoming reporting this month and look forward to some activity from this part of the section. W6BTX leads the section in traffic. W6DPJ was only able to get on a couple of days. W7AAH is busy building a set for portable use, call is W7ACR. W6EKF and W6DWR were at the Pacific Division Convention. W6DWR won 4 miles of filter for being the smallest ham there. Hi. W7AHR reports for the first time and is working on 14,000 kc. W7ZZB is on 7000 kc. W6BAJ is rebuilding.

Traffic: W6BTX 23, W6DPJ 14, W7AAH 14, W6EKF 9, W7AHR 5.

SOUTHEASTERN DIVISION

ALABAMA — SCM, S. J. Bayne, W4AAQ — W4PAI now has two xmitters, 15 watts on 14 mc. and 150 watts on 7 mc. W4LM has been appointed an Official Broadcasting Station. W4AX has resigned as A-A Birmingham district station. W4LM has taken his place. W4AKM is running 150 watts into his pair of 210s and says they run like a sawmill. W4AJB is getting out well at Dotham and will return to Tuscaloosa in the spring. W4TI is learning to copy code on the typewriter. W4IA has returned to Selma for the holidays, after working the West Coast on fone. W4LT has returned from a trip to Chicago on which he visited many hams en route. W4AHR makes the BPL with 51 deliveries. W4AHP is keeping nine schedules weekly, which accounts for his fine traffic total. W4AJR has the outfit working OK again, but can't find much traffic. W4AKB can tune to three bands without changing the tank coil. W4HB has his new CW outfit completed and is stepping out nicely. W4AJY and W4AIY report considerable DX and lots of snow. It is with regret that W4AAQ finds it necessary to give up the work as SCM, but on account of increasing business QRM his time is becoming more limited for radio work.

Traffic: W4AHR 143, W4AHP 105, W4AKM 48, W4LM 41, W4AAQ 20, W4LT 17, W4PAI 14, W4TI 13, W3AJR 13, W4AJY 14, W4AIY 6.

GEORGIA-SOUTH CAROLINA-CUBA-ISLE OF PINES — SCM, M. S. Alexander, W4RZ — Reports from ORS are coming in better, although it was necessary for me to cancel several for not reporting. W4KV has put in a pair of 281's and shoved the chemical rectifier out the back door. W4RN has been heard in New Zealand on 3500 kc. W4CM is a new ham in Atlanta who is kicking up the air with a 50-watter. Here's luck, OM. W4PM has still got that ztal DC note, and his traffic total gets bigger each month. W4HA is sure doing good work on the Army Amateur Net. W4RZ can't seem to get the 7000-kc. Zepp to work on 3500 kc., but is still trying. Hi. W4BO can't be persuaded to leave a good DC note alone, and it looks like he would rather use AC, as more stations can hear him at the same time. Well, fellows, I have had a few reports from hams that I think should be ORS and, if any of you think you can qualify, please send in your application, as this section sure needs a bunch of good relay stations. CM8UF has just been appointed on ORS and we are looking for some good work from him.

Traffic: W4KV 104, W4PM 37, W4AHA 31, W4YA 30, W4AJH 18, W4RZ 16.

PORTO RICO-VIRGIN ISLANDS — SCM, E. W. Mayer, K4KD — K4AKV is the only reporter this month. He handled traffic for K4KD when K4KD was off the air. K4ACF reports a burned-out 50, but another one on by the time this comes out. K4KD has completed installation of a new Esco double-current MG set and boasts DC note on 7 and 14-mc. band after 30 days off the air. Let's have reports, fellows. I cannot make a decent report if you won't give me news.

Traffic: K4AKV 12.

FLORIDA — SCM, Harvey Chafin, W4AII-W4PAW — The SCM is sending each station owner in Florida a mimeographed copy of some of the activities and contests that we are going to have. W4AGR has been appointed one of the official observers of Florida and on his monthly report he did not report a single Florida station for being off wave.

W4AFC has a baby girl. Congrats, OB. W4AGY keeps a daily schedule with W2CXL. W4SK sends in a fine report. W4MS keeps a daily schedule with his OW while he is away at the U. of Fla. at Gainesville. W4QA is a new station at Gainesville. W4QL has schedule with W8BJO at 6 a.m. daily. W4WT reports with twenty-five messages this month. W4NB and W4SK are applying for ORS. W4NE reports the Miami Radio Club going fine. W4OO reports nine active amateurs in St. Petersburg. W4HY sold his Silver Marshall receiver. W4OZ reports his new QRA at West Palm Beach. W4IG is using two recto-bulbs.

Traffic: W4OO 75, W4AGR 74, W4AGY 70, W4SK 63, W4AII 62, W4QA 36, W4QL 26, W4WT 25, W4NB 21, W4MS 20, W4NE 16, W4HY 11, W4OZ 9, W4TK 7, W4MF 6, W4SY 5, KDV5 121.

WEST GULF DIVISION

SOUTHERN TEXAS — SCM, Robert E. Franklin, W5OX — The New Year is here and, fellows, with your usual unselfish cooperation I know it is going to be a banner one for the South Texas Section. I think I voice the opinion of everybody who attended the Third West Gulf Convention when I say it was a success and a good time was had by all. The next convention will be held in Houston. Better start making arrangements for the time of your life. While visiting the West Coast this past summer, I heard quite a few compliments for the fifth district gang in regard to their good stations and particularly their good operating. That made me feel very proud of the fact that I hailed from the good ole fifth. I want to, with your help, make this the outstanding section of the entire U. S. We can do it, but we have some work to do and improvements to make. I have noticed several stations using ras ac and others using ras that was so rough that it was impossible to work near their wave; on the other hand, I know fellows that have high-power stations but are refraining from using them because of the fact that they have not the equipment at present to bring them up to the present-day standard, and consequently are showing respect and courtesy for the other fellow by using lower power with a good sharp and steady signal instead. I would like also to say a word in regard to good operating. It seems more attention is paid to receiving than to transmitting when, as a matter of fact, if more attention were paid to good sending, receiving would be much easier for all of us. Fellows, let us get at this trouble by paying more attention to our sending. It is a very easy matter to listen to your sending, if necessary, by using a buzzer and relay or with a monitor and split phone arrangement. A word about the much talked of long cq might not be amiss. Do not cq over three times without signing your call, and then not too long. You, yourself, will pass up a station that cq's too long, so do not expect him to wait for you. What do you say, fellows, are we all going to put our shoulders to the wheel and make this section distinctive for its clean-cut signals and good operating, or are we going to be just another station and just another section? W5AHB keeps five daily skeds, making the BPL again. W5AHB is a new OBS. He also won the station prize contest during the convention. W5AJD reports that W5AGI will be operator there, also, from now on. W5MS is back with us again. W5TD offered the OW a police dog if she would learn the code, but as yet nd. W5OX had the pleasure of a visit from W5RH and also W2ALD, and, while driving through the Rice Institute grounds with the latter, raised W51N and W5AGQ with one cq on the auto horn. (Moral: "Why cq a long time?") W5WN worked Australia. W5AQK's OW passed the exams and is now the proud possessor of an amateur first-class ticket. W5GS is a new station in Houston. Glad to have you, OM.

Traffic: W5BBY 196, W5AHB 167, W5AJD 174, W5MS 102, W5TD 39, W5OX 16, W5WN 9.

NORTHERN TEXAS — SCM, J. H. Robinson, W5BG — W5HY is still keeping skeds with W5AQY at 5:00 a.m. W5BBF sends in his traffic report, saying he is going to make the B.P.L. next month also. He is using 14,000 and 7150-kc. fone in the 1750-band and code in the 14,000-kc. band. W5BAM is the official observer for this district. He is very careful in his checking, so if you get a card, better check up, fellows. He says W5GZ's 150-watter caused excessive QRM in the family BCL set, so he uses low power set until old folks hit the bay. In a recent football game, W5BAD found that his opponent on the rival team was old W5AMH. After the game they forgot rivalry and re-

tired to the oscillator and had a big time. W5BG, the SCM, is back on regularly now. W5JA reports: Let's see some reports, fellows. It is hard to read between the lines when there are no lines.

Traffic: W5HY 180, W5AAE 85, W5BAM 29, W5BAD 42, W5BG 15, W5JA 10, W5BBF 121.

NEW MEXICO—SCM, Leavenworth Wheeler, Jr., W5AHI—W5AJL, our newest ORS, is battin' 'em out via five skeds and may make good his boast of making BPL yet. Hi, W5TV, besides servicing BCL sets in his locality and pounding our Morse for eight hours, finds time to absorb a little book learnin' and holds two skeds daily. FB, W5ZM reports a radio club taking shape at the New Mexico Mil. Institute. W5BH says he is still alive and kicking—mostly on 14,000 kc. Hi, W5EF took a Second-Class Commercial ticket from the R. I., and will operate the new BC station being installed at Clovis. The SCM was headed for BPL, but the traffic route east blew up. The old sure-fire sked with W5ACJ still functions smoothly. You fellows who need skeds, drop me a card, stating your operating hours, etc. Remember the 16th, and let us have bigger and better reports.

Traffic: W5AHI 150, W5AJL 117, W5TV 55, W5ZM 9, W5BH 6, W5EF 5.

OKLAHOMA—SCM, W. J. Gentry, W5GF—Activity in Oklahoma has come to the front now. Our fine ORS, W5CB, is the leader in traffic. Who is going to beat W5CB? W5AUV got to going at last. W5ALM is a new traffic man. Welcome, OM. W5DH is also another traffic hound. W5ASQ and W5BEE are the only ones in Tulsa that seem to be going. W5AYF and others are getting xtal. W5GP is getting more time on now. W5APG has plenty of Naval Reserve work. W5GF is all set now for skeds. W5AXM is going fine on 7000 kc. W5AIR ought to be on the air more. Hi, W5AAV is about alive from traffic reports. We have the New Dixie-Land Traffic Route through Oklahoma and room for some more. SCMs, let's hear from you for skeds in Okla. Let's get some real hot news from the gang in general.

Traffic: W5CB 113, W5AUV 69, W5ALM 47, W5DH 28, W5AFH 24, W5GP 22, W5APG 20, W5GF 19, W5ASQ 10, W5BEE 6, W5AXM 6, W5AIR 5, W5AAV 4.

CANADA

ONTARIO DIVISION

ONTARIO—SCM, E. C. C. Thompson, VE3FC—Central District: VE3BC is heading straight for the BPL with a larger traffic total every month. G. A. Coutanche of VE3BO is our new Route Manager and J. H. Reynolds of VE3DA, at Belleville, is acting as his assistant. Both of these stations are active schedule keepers and should help VE3BC set a glorious example for all the rest. VE9BJ is pounding away at every opportunity on 3700 kc., working good DX as well as keeping schedules. VE3CL says the transmitter and receiver are bringing in both DX and traffic. VE9AL now has a 500-watt tetrode type 861, and promises some peppy signals in the contests. VE3FC keeps watch on 14 and 3.5 mc. regularly. VE3CB makes his regulation number of contacts every month and gets traffic, too. VE3EQ has been playing with phone, but says he is bored to extinction with it, so he's going to turn to CW again for his fun. FB, VE3BO reports working ni-RQP at Reykjavik, Iceland, on 14,100 kc., and also thirty stations on the same frequency one day in about seven hours. Some record!

Northern District: VE3ET is working DX on about 3650 kc. and endeavoring to get a trans-continental relay chain in working order. VE3AR and VE3BH are busy on construction work and experimenting. VE3GC, a new station, is getting out well on 3500 kc. VE3GG has been very ill, but has been using 14,000 kc. when he could. VE3ET has now worked 43 states in the U. S. A.

Traffic: VE3BC 71, VE3ET 43, VE3DA 29, VE3CB 10, VE3CL 7, VE3EQ 7, VE9BJ 7, VE9AL 5, VE3FC 5, VE3BH 1.

VANALTA DIVISION

BRITISH COLUMBIA—SCM, King Cavalsky, VE5AL—VE5AK is now on 14,000 kc. VE5BC has a sked with VE4DJ. VE5AN has done some fine work with low power. VE5BM has perfected a key click filter and

can work his set on the same antenna as he uses for the BCL set. VE5AL is rigging up another set. VE5DD is overhauling his pile and getting ready to put things over. The B. C. A. R. A. is going strong and, the way the new members are rolling in, it looks like a bumper crop of hams to start the New Year. Come on in and meet the gang any Tuesday evening. VE5CF says nothing startling around his shack. VE5CO says there's plenty of amateur material around Victoria. VE5CT has things going very nicely on 7000 kc. Westlake, exVE5GO, is leaving for the South to handle an airplane job. Best luck, OM. VE5AW is our most northerly station and has done real fine DX on 7000 kc. He has now worked all continents. VE5BR still continues to handle traffic on 3500 kc. VE5BY is at sea and says he met Chang, exVE5GO in Shanghai. VE5GT has been made R. I. for Prince Rupert.

Traffic: VE5BR 25, VE5AL 9, VE5AK 2.

ALBERTA—SCM, E. J. Taylor, VE4HA—The long expected DX weather has not yet arrived, but most of us are longing for it. VE4CU is still making regular contacts with England. VE4HM is working on a new circuit. VE4EC is still our best bet on message totals. VE4GD is also high up and going strong. VE4AR is on regularly and making a fine showing. VE4EA is rebuilding and promises big things soon. VE4DZ is on right along. VE4GT is on week-ends only. We hear VE4FF on the air once in a while. Before long I expect the announcement of the new SCM, and I hope the boys will support him in as good a manner as they supported me.

Traffic: VE4EC 52, VE4GD 50, VE4HM 3, VE4HA 2.

PRAIRIE DIVISION

SASKATCHEWAN—SCM, W. J. Pickering, VE4FC—VE4HL has not been on much of late, having been busy with 10AB. Our old friend, VE4CP, is back on the air again with a new receiver. VE4HH and VE4IW both expect to be active again shortly. VE4GR turns in a nice traffic report, and so does VE4IH, who says that the Sask. gang is more active lately and it is easier to QSP to any city.

Traffic: VE4IH 18, VE4GR 14, VE4HL 7.

MANITOBA—SCM, A. V. Chase, VE4HR—VE4BU, at Pointe du Bois, is back on the air. He has a splendid location and his station is well equipped on 3.5, 7, 14 and 28 mc. VE4BQ and VE4HR have met with a fair amount of success in experimental work on 28 mc. The press of University work has kept VE4DK off the air. A new station, VE4RL, is on the air pending receipt of his license. VE4GQ is building a phone transmitter for 3.5 mc. A mercury arc rectifier has been added to the equipment of VE4HX, the club transmitter. VE4BD has renewed his schedule with VE4CM. VE4DY, one of the old gang, expects to be pounding the key soon.

Traffic: VE4BQ 26, VE4HR 14, VE4BU 10.

QUEBEC DIVISION

QUEBEC—SCM, Alex Reid, VE2BU—In this report I will try to give an idea on just how things stand in general all over Canada. The Western boys are very much in favor of a Trans-Canada traffic route. Several routes are working between Winnipeg and Vancouver, and VE4IC and VE2BE are doing fairly well with Winnipeg and Montreal. Your General Manager is receiving fine support from all over Canada. We need more OBS in Canada, and I would be glad to hear from a number of stations in our division who would like to become OBS. Traffic is on the increase all over the Dominion, Quebec, Ontario, Vanalta and Prairie are showing fine totals.

Reynolds, VE2DA, deserves congratulations on his fine circular asking for skeds. I would like a letter from all Route Managers giving their views on how they are handling their traffic problems so that these can be forwarded to others to assist them with their work. Let's all pull together for the good of the game and make 1930 a banner year for traffic. I intend to head the divisional reports each month with a little review on what is going on in Canada.

Best wishes to every member in Canada for a Happy and Prosperous New Year.

Traffic: VE2AC 140, VE2BB 19, VE2BE 35, VE2AL 9, VE2AY 13, VE2CA 9, VE2BG 9.