

QST

DEVOTED ENTIRELY TO

AMATEUR RADIO

Published by the American Radio Relay League



July
1927

25¢

Cunningham RADIO TUBES

*Round out the circle
of vacation joys—*

For real summer enjoyment you cannot do without Radio. To increase that pleasure, Cunningham Radio Tubes are most essential to your set.

No matter where you plan to be,—the mountains, the sea-shore or the back country— you can depend upon Cunningham Radio Tubes to bring you the world's best music with song, dance and laughter.

*Your nearest Radio dealer will tell
you the best combination of Cunning-
ham Tubes for your particular set.*

E. T. CUNNINGHAM, Inc.
New York Chicago San Francisco



SILVER-
MARSHALL

652 RESERVOIR B SUPPLY

Uses Vitrohm Resistor 507-64

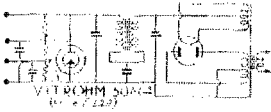

VITROHM RESISTORS

—in power supply units

35 years of research and experience in the manufacture of resistors is incorporated in Vitrohms for radio.

There are available Vitrohms to give you noiseless, dependable service wherever resistance is indicated in a current or power supply circuit.

Vitrohms do not age or change in resistance value after use. Ten, twenty or thirty years of constant use under all conditions are every-day records of Vitrohms.

RAYTHEON A-B-C

350 m.a. CURRENT SUPPLY UNIT

Uses Vitrohm Resistor 507-62*
and Vitrohm Rheostat 507-63

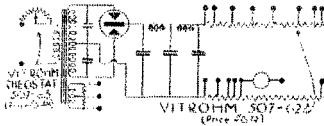

QRS A-B-C

400 m.a. CURRENT SUPPLY UNIT

Uses Vitrohm Resistor 507-62*
and Vitrohm Rheostat 507-63

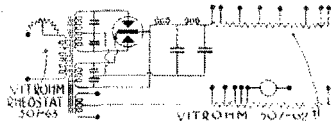

Vitrohms are "pre-aged" wire wound on porcelain tubes and protected by fused-on vitreous enamel for the permanent protection of resistance wire and terminals.

Per square inch of surface, Vitrohms have greater watt dissipation than any other resistor.

Send 15c for "How To Use Resistance in Radio." It contains many circuits of interest to all experimenters. Bulletin 507 describing Vitrohms for radio is sent without charge upon request.

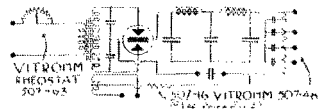

QRS and RAYTHEON

85 m.a. CURRENT SUPPLY UNIT

Uses Vitrohm Resistors
507-16 and 507-48

* Approved by the Raytheon and
Q R S Laboratories.

Ward Leonard Electric Company

37-41 South Street

Mount Vernon, N. Y.

REG. U.S. PAT. OFF.

THE **ELKON**

PRINCIPLE of RECTIFICATION

The Elkon rectifier, invented and developed by Samuel Ruben and the Elkon Works, Inc. is the first to make current rectification possible by means of a "BONE DRY" rectifying medium constructed entirely of SOLID, IMMOVABLE, NON-FRAGILE materials.

Now on the market for more than a year, doing duty in thousands of homes in the ELKON TRICKLE CHARGER, this rectifier, in actual use, has more than lived up to the expectations of those who conceived and developed it.

It has made possible, for the first time, rectification without ACIDS, ALKALIS, TUBES, or MOVING PARTS.

It is economical. It operates noiselessly. It does not cause interference. Short circuiting cannot harm it. It functions equally well in any position and under any extreme of climate.

Now in use in the Elkon Trickle Charger, the Elkon 3 Ampere Charger, and the Elkon "A" Power it is fast supplanting the old methods of current rectification.

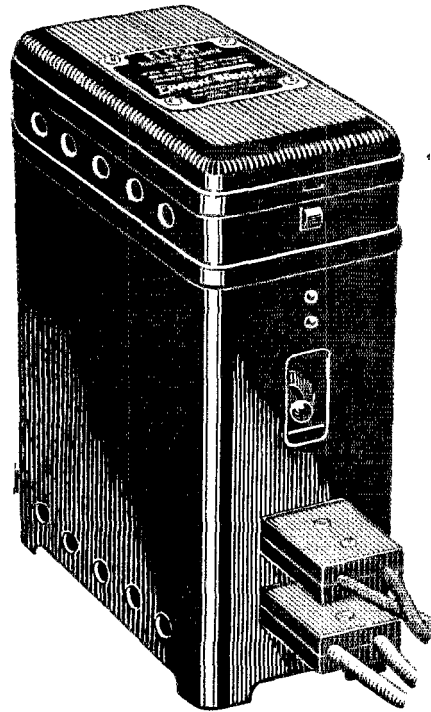

The Elkon Trickle Charger in which the Elkon Rectification principle was first made available to the public Jan. 1, 1920.

ELKON WORKS
Subsidiary of P. R. Mallory & Co., Inc.
Weehawken, N. J. Inc.

Section Communications Managers of THE COMMUNICATIONS DEPARTMENT, A. R. R. L.

| | | | | |
|---|-----------|---------------------|---------------------------------------|-------------------------|
| Eastern Pennsylvania | 8BQ | H. M. Walleze | 597 No. James St. | Hazleton |
| Maryland-Delaware-District of Columbia | 3AB | A. B. Goodall | 1824 Ingleside Terrace | Washington, D. C. |
| Southern New Jersey | 3EH | H. W. Densham | 140 Washington St. | Collingswood |
| Western New York | 3PJ | C. S. Taylor | 598 Masten St. | Buffalo |
| Western Pennsylvania | 3AE | G. L. Crossley | | State College |
| ATLANTIC DIVISION | | | | |
| Illinois | 9AAW | W. E. Schweitzer | 4264 Hazel Ave. | Chicago |
| Indiana | 9CYQ | D. J. Angus | 310 N. Illinois St. | Indianapolis |
| Kentucky | 9ARU | A. A. Downard | 116 No. Longworth Ave. | Louisville |
| Michigan | 8ZZ | C. E. Barr | 137 Hill Ave. | Highland Park, Detroit |
| Ohio | 8BYN | H. C. Storck | 694 Carpenter St. | Columbus |
| Wisconsin | 9VD | C. N. Crapo | 443 Newton Ave. | Milwaukee |
| CENTRAL DIVISION | | | | |
| North Dakota | 9EFN | G. R. Mofr | 618 11th Street, South | Fargo |
| South Dakota | 9BDW | E. J. Beck | | Milbank |
| North Minnesota | 9EGU | C. L. Barker | | Henning |
| South Minnesota | 9BYA | D. F. Cottam | 3538 Third Ave. So. | Minneapolis |
| DAKOTA DIVISION | | | | |
| Arkansas | 5AIP | Leonard Clippard | 2468 North Pierce St. | Little Rock |
| Louisiana | 5UK | C. A. Preflar | 129 Camp St. | New Orleans |
| Mississippi | 5AKP | J. W. Gullett | 1708 22nd Ave. | Meridian |
| Tennessee | 4KM | L. K. Rush | 4 Second St. | Memis |
| HUDSON DIVISION | | | | |
| Eastern New York | 2ADH-ZAXR | Earle Peacock | Box 113 | Yonkers |
| N. Y. C. & Long Island | 2CWR | F. H. Mardon | 117-11 140th St. | So. Ozone Park, L. I. |
| North New Jersey | 2WR | A. G. Wester, Jr. | 50 Princeton St. | Maplewood |
| MIDWEST DIVISION | | | | |
| Iowa | 9BKV | A. W. Keuse | Rt. 6, Box 19 | Akron |
| Kansas | 9DNG | F. S. McKeever | 1317 Mich. St. | Lawrence |
| Missouri | 9RR | L. B. Laizure | 5610 Mercier St. | Kansas City |
| Nebraska | 9RYG | C. B. Deihl | 5695 Cedar St. | Omaha |
| NEW ENGLAND DIVISION | | | | |
| Connecticut | 1BM | H. E. Nichols | 82 Elmwood Ave. | Bridgport |
| Maine | 1BG | Frederick East | 13 E. Crescent St. | Augusta |
| Eastern Massachusetts | 1BYL | R. S. Briggs | 383 Ashmont St. | Dorchester |
| Western Massachusetts | 1DB | A. H. Carr | 30 Vassar St. | Worcester |
| New Hampshire | 1ATJ | V. W. Hodge | 227 Main St. | Claremont |
| Rhode Island | 1BYB | D. B. Fancher | 92 Summer St. | Westerly |
| Vermont | 1AJG | C. T. Kerr | | Foultney |
| NORTHWESTERN DIVISION | | | | |
| Alaska* | 7DE | L. H. Machin | Box 452 | Cordora |
| Idaho | 7ST | Henry Fletcher | 1610 N. 10th St. | Boise |
| Montana* | 7AAT | O. W. Viers | | Red Lodge |
| Oregon | 7PP | R. H. Wright | 510 Ross St. | Portland |
| Washington* | 7FD | Otto Johnson | 4310 30th Ave. W. | Seattle |
| PACIFIC DIVISION | | | | |
| Hawaii | 6BDL | John A. Lucas | Box 1142, Fort Shafter | Oahu |
| Nevada | 6HO | C. R. Newsome | | Yerington |
| Los Angeles | 6AM | T. C. Wallace | 109 W. Third St. | Long Beach Calif. |
| Santa Clara Valley | 6NX | F. J. Quement | 51 Pleasant St. | San Jose |
| East Bay | 6ZX | P. W. Dann | 562 35th St. | Oakland |
| San Francisco | 6VR | J. W. Patterson | 1338 Fell St. | San Francisco |
| Sacramento Valley | 6CRS | C. F. Mason | 2530 N. St. | Sacramento |
| Arizona | 6ANO | D. B. Lamb | 229 W. First St. | Mesa |
| Philippines | 6PAU | Manuel T. Felizardo | 252 Gaiteta St. | Manila |
| San Diego | 6BQ | G. A. Sears | 296 Bonair St. | La Jolla |
| ROANOKE DIVISION | | | | |
| North Carolina | 4JR | R. S. Morris | 418 S. Broad St. | Gastonia |
| Virginia | 3CA | J. F. Wohlford | 118 Cambridge Ave. | Roanoke |
| West Virginia | 4BSU | C. S. Hoffman | 126 Chantal Court | Wheeling |
| ROCKY MOUNTAIN DIVISION | | | | |
| Colorado | 6CAA | C. R. Strohman | 1641 Albion St. | Denver |
| Utah-Wyoming | 6AM | Don C. McKae | 214 Belvedere Apts. | Salt Lake City |
| SOUTHEASTERN DIVISION | | | | |
| Alabama | 5ATP | A. D. Trum | 217 Catoma St. | Montgomery |
| Florida | 4QY | W. F. Grogan | Box 816 | Pt. Myers |
| Georgia-South Carolina-Cuba-Porto Rico-Isle of Pine | 4KU | H. L. Reid | 11 Shadowlawn Ave. | Atlanta |
| WEST GULF DIVISION | | | | |
| Northern Texas | 5AJT | W. B. Forrest, Jr. | 502 Royal St. | Waxahachie |
| Oklahoma | 5APG | K. AL Ehret | 2904 N. Robinson St. | Oklahoma City |
| Southern Texas | 5YK | E. A. Sahn | 146 N. Academy St. | New Braunfels |
| MARITIME DIVISION | | | | |
| Newfoundland | 8AR | Loyal Reid | Avalon House | St. Johns |
| New Brunswick | 1BI | T. B. Lacey | 670 N. B. Power Co. | St. John |
| Nova Scotia | 10U | W. C. Barrett | 14 Simolait St. | Dartmouth |
| Prince Edward Island | 1BZ | F. W. Hyndman | 25 Fitzroy St. | Charlottetown, P. E. I. |
| ONTARIO DIVISION | | | | |
| Ontario | 9BJ | W. Y. Sloan | 167 Close Ave. | Toronto |
| QUEBEC DIVISION | | | | |
| Quebec | 2BE | Alex Reid | 169 Logan Ave. | St. Lambert |
| VANALTA DIVISION | | | | |
| Alberta | 4GT | A. H. Asmussen | 2123 18th St. W. | Calgary |
| British Columbia | 5BJ | E. S. Brooks | 670 Forestry Dept. Radio Court House, | Vancouver |
| PRAIRIE DIVISION | | | | |
| Manitoba | 4DE | F. E. Rutland, Jr. | 452 St. John Ave. | Winnipeg |
| Saskatchewan | 4FC | W. J. Pickering | 514 19th St. W. | Prince Albert |

*Temporary officials appointed to act until the membership of the Section concerned choose permanent SCMs by the nomination and election.

Five-tube set
for aerial
or loop.

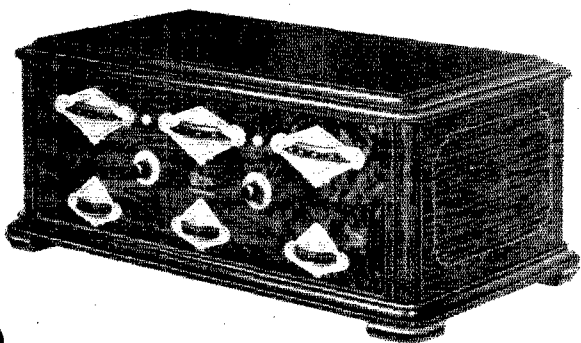

Now Priced at \$95

LARGE sales and consequent lowered manufacturing costs now enable dealers to offer the Grebe Synchronphase at \$95.00.

Only the price is changed. There is the same remarkable tone quality and reception efficiency—the same easy station finding of its *one dial-control*—that have long made the Synchronphase the dominant receiver in the better set field.

Send for Booklet Q. Then have your dealer demonstrate the exclusive Grebe features.

A. H. Grebe & Co., Inc.
109 West 57th St., New York City

Factory: Richmond Hill, N. Y.

Western Branch: 443 So. San Pedro St., Los Angeles, Calif.

The oldest exclusive radio manufacturer.

The **GREBE**
SYNCHROPHASE
TRADE MARK REG. U.S. PAT. OFF.
RADIO

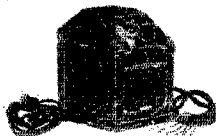

Grebe Socket Power

Dependable "B" and "C" power, ample voltage to operate 180-volt power tube; self-adjusting, quiet. For any 5 and 6-tube receiver and the Synchronphase Seven; 110 volts, 60 cycles A. C. Without BH Raytheon tube, \$50.



QST



The Official Organ of the A.R.R.L.

VOLUME XI

JULY, 1927

NUMBER 7

| | |
|---|--|
| Editorials | 7 |
| Short Wave Radio Transmission and Its Practical Uses—Part 1 | <i>Chester W. Rice</i> 8 |
| The Michigan State Central Division Convention | 14 |
| A Bridge to Measure Capacity, Power-Factor, Resistance and Inductance | <i>J. Katzman</i> 15 |
| That Spirit of Accomplishment | <i>Hiram Percy Maxim</i> 20 |
| Army Amateurs in Joint Army-Navy Maneuvers | <i>David S. Bowden</i> 21 |
| Western and Central New York Atlantic Division Convention | 23 |
| Indiana State Central Division Convention | 23 |
| Some Light on Transmitter Tuning | <i>Ross A. Hull</i> 24 |
| Concerning QST Contributions | 28 |
| An Investigation of the 5-Meter Band | <i>E. M. Guyer and O. C. Austin</i> 29 |
| Hudson Division Convention | 30 |
| Radio Frequency Sparking Distances | <i>Alexander Numan</i> 31 |
| A.R.R.L. Information Service Rules | 32 |
| Keying the Amplifier | <i>A. G. Shafer</i> 33 |
| The "852" Holder | 35 |
| A Constant Frequency Transmitter | <i>W. H. Hoffman</i> 36 |
| Official Wavelength Stations | 40 |
| Another View on Crystal Control | 41 |
| Standard Frequency Transmissions | 42 |
| Amateur Radio Stations <i>3ZI, 6DDO</i> | 43 |
| An A. C. Voltmeter | 45 |
| Calls Heard | 46 |
| The Communications Department | 49 |
| Experimenters' Section Report | 65 |
| I.A.R.U. News | 66 |
| Correspondence | 70 |
| Ham Ads | 92 |
| Index of Advertisers | 94 |

QST is published monthly by The American Radio Relay League, Inc., at Hartford, Conn., U. S. A. Official Organ of the A.R.R.L. and the International Amateur Radio Union

Kenneth B. Warner (Secretary, A.R.R.L.),
Editor-in-Chief and Business Manager

F. Cheyney Beekley,
Managing Editor and Advertising Manager

Robert S. Kruse,
Technical Editor

Harold P. Westman,
Assistant Technical Editor

David H. Houghton,
Circulation Manager

Subscription rate in United States and Possessions, Canada, and all countries in the American Postal Union, \$2.50 per year, postpaid. Single copies, 25 cents. Foreign countries not in American Postal Union, \$3.00 per year, postpaid. Remittances should be by international postal or express money order or bank draft negotiable in the U. S. and for an equivalent amount in U. S. funds. Entered as second-class matter May 29, 1919, at the post office at Hartford, Connecticut, under the act of March 3, 1879. Acceptance for mailing at special rate of postage provided for in section 1103, Act of October 3, 1917, authorized September 8, 1922. Additional entry as second-class matter, acceptable at special rate of postage provided for above, at Springfield, Mass., authorized September 17, 1924.

Copyright 1927 by the American Radio Relay League, Inc. Title registered at United States Patent Office.
Member of the Radio Magazine Publishers' Association.

The American Radio Relay League

The American Radio Relay League, Inc., is a non-commercial association of radio amateurs, bonded for the promotion of interest in amateur radio communication and experimentation, for the relaying of messages by radio, for the advancement of the radio art and of the public welfare, for the representation of the radio amateur in legislative matters, and for the maintenance of fraternalism and a high standard of conduct.

It is an incorporated association without capital stock, chartered under the laws of Connecticut. Its affairs are governed by a Board of Directors, elected every two years by the general membership. The officers are elected or appointed by the Directors. The League is non-commercial and no one commercially engaged in the manufacture, sale or rental of radio apparatus is eligible to membership on its board.

"Of, by and for the amateur", it numbers within its ranks practically every worth-while amateur in the world and has a history of glorious achievement as the standard-bearer in amateur affairs.

Inquiries regarding membership are solicited. A bona fide interest in amateur radio is the only essential qualification; ownership of a transmitting station and knowledge of the code are not prerequisite. Correspondence should be addressed to the Secretary.

Directors

President
HIRAM PERCY MAXIM
Drawer 2102
Hartford, Conn.

Vice-President
CHARLES H. STEWART
St. David's, Pa.

Canadian General Manager
A. H. K. RUSSELL
5 Mail Bldg.
Toronto, Ont.

Atlantic Division
DR. EUGENE C. WOODRUFF
234 W. Fairmount Ave.
State College, Pa.

Central Division
CLYDE E. DARR
137 Hill Ave., Highland Park,

Dakota Division
C. M. JANSKY, JR.
Dept. of Elec. Eng., U. of M.
Minneapolis, Minn.

Delta Division
BENJ. F. PALNTER
424 Hamilton Nat'l Bank Bldg.
Chattanooga, Tenn.

Hudson Division
DR. LAWRENCE J. DUNN
480 East 19th St.
Brooklyn, N. Y.

Midwest Division
PORTER H. QUINBY
1034 Planters' Building,
St. Louis, Mo.

New England Division
DR. ELLIOTT A. WHITE
Dartmouth College
Hanover, N. H.

Northwestern Division
K. W. WEINGARTEN
3219 No. 24th St.,
Tacoma, Wash.

Pacific Division
ALLEN H. BABCOCK
65 Market St.,
Southern Pacific Co.
San Francisco

Peanoke Division
W. TREDWAY GRAVELY
503 Main St.,
Danville, Va.

Rocky Mountain Division
PAUL M. SEGAL
c/o District Attorney
West Side Court Bldg.
Denver, Colo.

Southeastern Division
HARRY F. DOBBS
c/o Dobbs & Wey Co.,
Atlanta, Ga.

West Gulf Division
FRANK M. CORLETT
2515 Catherine St.,
Dallas, Tex.

Officers

President HIRAM PERCY MAXIM, Hartford, Conn.
Vice-President CHAS. H. STEWART, St. David's, Pa.
Secretary KENNETH B. WARNER, Hartford, Conn.
Treasurer ARTHUR A. HEBERT, Hartford, Conn.
Communications Manager . . . F. EDWARD HANDY, Hartford, Conn.

Address General Correspondence to Executive Headquarters, Hartford, Conn.

EDITORIALS

14

ALL of us believe that the accomplishments of a skilled radio amateur are such that he has made a valuable citizen out of himself for his country. A recent letter from Canuck 3GG presents several new slants on this idea, which we think so interesting that we are presenting them on this page.

Amateur radio is unique among hobbies. In its pursuit the radio amateur possesses himself of a knowledge that increases his value to his nation, he trains himself to defend it, and, in order to accomplish these things, he buys all his own equipment! A novel idea for armies, isn't it?

He has perfected a wonderful communication system that is available for public service in time of community peril or national emergency. While nearly every other hobby under the sun is pursued merely for the pleasure it brings, the radio amateur competes with his fellows during emergencies for the honor of working intensely for long watches without rest, often at great discomfort, and for no compensation other than the joy of service and the sense of satisfaction in a hard job well done.

Governments possess in their radio amateurs a self-supported reserve of trained specialists, capable of rapid mobilization, kept in constant training, drawing no pay yet buying all their own equipment with which to train! What other hobby can boast as much value to the government in time of war? To get a better viewpoint of what this really means to the United States one must ask himself of what use twenty-thousand golfers, pinochle players, stamp collectors or pool players would be to the nation some nice fine morning when the sky goes black with enemy aircraft. Ask the Army—they know!

The untiring efforts, perseverance and dogged persistence of the radio amateur have laid the foundations for one of the largest industries in the world—the radio industry—and the chief exhibit of the amateur from that effort is the scars of numer-

ous battles in which he had to engage to insure his existence. Consider the unique position of radio among industries. Thousands of skilled experimenters who buy all their own tools from this industry and receive no wages, are engaged in work which will inevitably be of incalculable value to the very industry which sold them the tools with which to work! Is there a parallel to be found?

Finally, it seems very likely that radio amateurs have done more for world peace and understanding than all the other hobbyists and all the lobbyists that ever existed. In the dismal certainty that war is not ended we must continue to think of armies and of preparedness against unjust aggression, but that cannot lessen anyone's appreciation of the intense value of fostering international good will and understanding by the contact between large bodies of private citizens of different countries. That contact is made possible by the present status of international amateur radio. What a splendid thing it is to have a considerable number of the young men of every country, the leaders of to-morrow, on the air each night learning to know their fellows in every civilized land in the world! Wars there may be but the young man of to-morrow is going to be able to know a just war from a politically-determined one, and no Stuffed Shirt or Brass Hat of the future is going to be able to stampede the youth of his land into an unjust conflict with the youth of another land—not when those young men know and understand each other, as amateur radio is to-day teaching them!

And now doesn't it just appear that the radio amateur is worthy of all the operating privileges that his government can give him? Isn't it clearly the duty of every enlightened government—or, if you please, isn't it clearly to its selfish interest—to see that adequate privileges are given its radio amateurs, in order that these benefits may redound to the State?

K. B. W.

Short-Wave Radio Transmission and Its Practical Uses

Part 1*

By Chester W. Rice**

THE EARTH'S atmosphere is composed of two concentric spherical shells. The inner one is called the Troposphere and is distinguished by the fact that the temperature decreases as we go upwards; the rate of fall being in the neighborhood of 17.° F. per mile (6° C./km.). In this region there is a continual churning motion which keeps the different constituents of the air thoroughly mixed and therefore of constant proportions.

The outer shell is called the Stratosphere and is distinguished by the absence of a temperature gradient and consequently, any

posed of Nitrogen, Oxygen and Argon, with traces of Carbon-Dioxide, Krypton, Xenon, Neon and Helium. This composition remains the same throughout the lower layer, that is, up to about 12½ miles. In the outer layer the mixing ceases and therefore a sort of "setting-out" effect causes the heavier constituents to predominate in the lower levels, leaving the atmosphere composed of the light gas, Helium at great heights.

This state of affairs is represented graphically in Fig. 1 which is taken from a paper by Chapman and Milne.²

At the surface of the earth we start with about 76% Nitrogen, 23% Oxygen and 1% Argon. This composition remains constant up to about 12½ miles (20 km.). At 50 miles (80 km.) the proportion of Nitrogen has increased to 92% and the Oxygen dropped to 8%, the Argon having practically disappeared. Here, Helium is just beginning to reach an appreciable proportion. At 83 miles (133 km.) we find half Nitrogen and half Helium, and at 125 miles (200 km.) the atmosphere is practically all Helium.

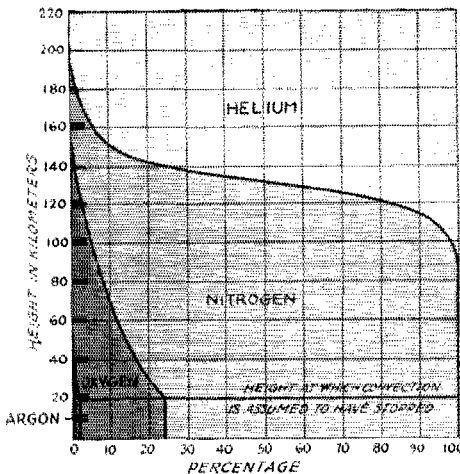

FIG. 1. TO UNDERSTAND RADIO TRANSMISSION THRU THE AIR ONE MUST FIRST KNOW SOMETHING OF THE AIR

This drawing shows how the composition of the air changes with height and how it is therefore possible for radio waves to act differently at different heights.

large-scale mass motion. It is sometimes referred to as the isothermal layer. The boundary between the two layers is of course not sharp, and the thickness of the transition layer, in which the mass motion practically dies out, is not precisely known.

We may assume, however, that mass motion ceases at a height of about 12½ miles (20 km.). Above this the temperature remains practically constant at 65.3° Fahrenheit below zero (-54° C.).

At the surface of the earth the air is com-

AIR PRESSURES

It is now interesting to see what pressures we have at different heights, above the earth. At 12½ miles, (20 km.) which is the top of the inner layer, we find that the pressure is about 1/20 of that at the surface of the earth. In the vicinity of 50 miles (80 km.) it has dropped to approximately 1/160,000th of that at the surface. This pressure is what we would ordinarily call a fair vacuum. At 125 miles (200 km.) the pressure is approximately 1/180,000,000th of an atmosphere which is probably lower than the best vacuum usually obtained in the laboratory. When we reach 1000 to 2000 miles, which we may call the outermost limit of our atmosphere, the pressure has fallen so low that the Helium atoms will travel in elliptic orbits around the earth forming a series of infinitesimal satellites. A few atoms which happen to have acquired very high velocities will describe hyperbolic orbits and be lost to the earth's atmosphere forever.

Table I gives some of the above facts in greater detail. Here the pressure, number of molecules, approximate molecular mean free path and average collision frequency between an electron and gas molecule are given for different heights.

*The second and last part will appear in the next number of QST.

**Research Laboratory, General Electric Co. Schenectady, New York.

2. Quarterly Jour. of the Roy Meteorological Soc. Vol. 46, p. 357, 1920.

IONIZATION IN THE UPPER ATMOSPHERE

The theories of the amorae (diurnal variations in the earth's magnetic field) as well as the familiar magnetic storms which sometimes interrupt telegraph service, are based upon the existence of ionization in the upper atmosphere.

In the early days of radio, Kennelly³ and independently Heaviside⁴, suggested the need of an ionization layer to account for the observed long distance radio transmissions. More recently Watson⁵ has shown that an equation of the Austin-Cohen type, which is known to represent long-wave experience, can be obtained theoretically if a conducting upper atmosphere is assumed.

HOW THE AIR IS IONIZED

The present views appear to favor the hypothesis that the ionization in the upper atmosphere is maintained partly by the "penetrating radiation of cosmic origin"⁶ which has attracted so much recent discussion and partly by the action of high velocity electron streams which reach the earth's atmosphere from the sun.

Milliken's recent results indicate that the penetrating radiation comes at a constant rate, day and night, and fairly equally from all directions of space.

When the high velocity electron streams approach the earth, the earth's magnetic field will concentrate them at the poles and bend them around the earth into the dark hemisphere. On this view the maximum ionization intensity will be expected in the polar regions where the electrons are concentrated by the effect of the earth's magnetic field and on the sunlit hemisphere where they are received by direct impact. Figures 2 and 3 show some of the electron paths as calculated by Störmer⁷.

The tendency of an electron stream to become spread out in space during its long trip from the sun, because of the mutual repulsion of like charges will be partly compensated by the magnetic attraction due to their high velocity. In the limiting case of light velocity, the mutual electrostatic repulsion will be balanced by the mutual magnetic attraction.

Rayleigh⁸ has shown that the green auroral line, which McLennan⁹ proved to be due

to Oxygen, is always present in the night sky and in this way confirmed the existence of strong ionization on the dark side of the earth.

Chapman and Milne² have calculated on certain assumptions the distribution of ionization which would result from the ab-

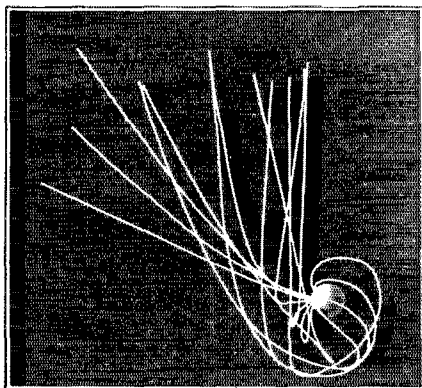

FIG. 2 HOW ELECTRONS COMING FROM THE SUN TO THE EARTH TWIST ABOUT WHEN THEY MEET THE EARTH'S MAGNETIC FIELD

sorption of various types of radiation in the earth's atmosphere. Their calculations show that the ionization should start with a small value near the earth and increase with the height reaching a maximum value somewhere in the upper atmosphere and will then decrease again to a small value at very great heights. A distribution of this sort is shown in Fig. 4 where the height, thickness and maximum ionization values are those required on the present theory of radio transmission to account for the relatively meagre experimental data. This procedure is made necessary since at the present time short wave radio experiments appear to be the most direct method we have of estimating the ionization conditions existing in the inaccessible regions of the outer atmosphere. Sounding balloon experiments have given information concerning the lower atmosphere and possibly someday an ionization gauge in a high velocity shell will give direct evidence about the upper atmosphere.

WHY THERE IS IONIZATION AT NIGHT

In the daytime the electrons arrive directly from the sun and therefore penetrate deep into the atmosphere before being brought to rest by collisions with the gas molecules. At night the electrons have to be bent around the earth by the magnetic field. In so doing, more air is traversed and therefore they will not get so close to the earth before being stopped. Superimposed upon this variable effect, we have the prac-

3. A. E. Kennelly: *Elect. World and Engineer*, March 15, 1902.

4. Oliver Heaviside: *Encyclopedia Britannica*, tenth edition, Vol. 38, Dec. 1902.

5. G. N. Watson: *Proc. Roy. Soc. Lond.*, Vol. 95, pp. 562, 1919.

6. The subject has been extensively investigated during the past fifteen years principally by Hess, Kolhorster, and more recently, Milliken. An excellent review with copious references is given by Birge, *Jour. Opt. Soc. of Am.*, Vol. 14 up pp. 112, 1927.

7. Stormer, *Terr. Mag. and Atmos. Elect.*, March 1917, pp. 22.

8. Lord Rayleigh, *Proc. Roy. Soc. Lond.*, Vol. 109, pp. 428, 1925.

9. McLennan, McLeod and McQuarrie, *Proc. Roy. Soc.*, Vol. 114, pp. 1, 1927.

tically constant ionization distribution due to the penetrating radiation of cosmic origin.

The day value is relatively well fixed by the radio experiments, and it is interesting to note that it is located in the vicinity of

| HEIGHT IN KILOMETERS | PRESSURE DYNES PER SQ. CM | NUMBER OF MOLECULES PER C.C. | MOLECULAR M.F.P. CM | ELECTRON COLLISION FREQUENCY PER SEC |
|----------------------|---------------------------|------------------------------|---------------------|--------------------------------------|
| 0 | 1.01×10^6 | 2.7×10^{19} | 9×10^{-6} | 9.5×10^{11} |
| 12 | 1.92×10^5 | 6.5×10^{18} | 4×10^{-5} | 2.1×10^{11} |
| 20 | 5.53×10^4 | 1.9×10^{18} | 1×10^{-4} | 8.5×10^{10} |
| 40 | 2.55×10^3 | 8.6×10^{16} | 3×10^{-3} | 2.8×10^9 |
| 60 | 1.24×10^2 | 4.2×10^{15} | 6×10^{-2} | 1.4×10^8 |
| 80 | 6.27 | 2.1×10^{14} | 1.0 | 8.5×10^6 |
| 100 | .363 | 1.2×10^{13} | 20. | 4.3×10^5 |
| 150 | 1.49×10^{-2} | 5.0×10^{11} | 500. | 1.7×10^4 |
| 200 | 5.62×10^{-3} | 1.8×10^{11} | 1000. | 8.5×10^3 |
| 300 | 6.99×10^{-4} | 2.4×10^{10} | 1×10^4 | 8.5×10^2 |
| 400 | 1.05×10^{-4} | 3.6×10^9 | 7×10^4 | 1.2×10^2 |
| 600 | 2.59×10^{-6} | 8.8×10^7 | 3×10^6 | 2.8 |
| 800 | 7.97×10^{-8} | 2.7×10^6 | 9×10^7 | .95 |
| 1000 | 2.92×10^{-9} | 9.9×10^4 | 3×10^9 | 2.8×10^{-3} |

TABLE I. THE REALLY IMPORTANT THING ABOUT THE CHANGING PRESSURE AND COMPOSITION OF THE AIR AS ONE GOES UP IS THE EFFECT OF THESE CHANGES ON THE LENGTH OF THE MEAN FREE PATH (M.F.P.) WHICH IT IS POSSIBLE FOR AN ELECTRON TO TRAVEL THRU BEFORE COLLIDING WITH SOMETHING WHICH WILL DEFLECT OR STOP IT

the observed auroral height measurements. The night values may appear rather high and perhaps further experiments will show that they should be brought lower down.

RADIO EXPERIMENTS

Let us now review the available radio propagation data and see how the assumption of an ionization gradient in the upper atmosphere allows us to account for the apparently anomalous behavior of short waves. The meagre experimental "skip distance" data which have been used in the following calculations are now two years old and, therefore, probably require revision. The effect of a revision would be to alter the location and maximum ionization values in the upper atmosphere, and the numerical value of the "short wave limit", etc., but should not affect the general conclusion to which the theory leads.

In Fig. 5 we have attempted to summarize the available data on medium and short wave propagation tests. Most of the data are from the valuable papers by Taylor¹⁰ and Taylor and Hulbert¹¹ with a few check points kindly supplied by Young¹². We have also obtained considerable help in drawing the smooth curves through the few scattered points from the valuable work

published by many amateurs¹³. The large absorption shown in the figure in the vicinity of 214 meters is undoubtedly due to the resonance effect produced on the free electrons by the earth's magnetic field which calculation shows should occur at the frequency which corresponds to this wavelength. This, and other interesting magneto-optic effects, such as rotation of the plane of polarization, double refraction, etc., were recently independently suggested by Appleton¹⁴ in England, and by Nichols and Schelleng¹⁵ in this country. The present discussion will be confined to the propagation phenomena on the short wave side of 214 meters where the effective electron restoring force due to the earth's magnetic field will cease to be important compared with the electron inertia and may, therefore, be neglected as a first approximation.

In recent years, propagation tests on short waves (i.e. below 60 meters) have definitely brought to light many peculiarities which were entirely unexpected from our many years of long-wave experience.

As a typical example of the peculiarities of short-wave transmission, let us describe the results obtained with a 5-Kw. 20-meter transmitter. At this wavelength the signal rapidly decreases as we leave the transmitter, due to spreading and energy absorption by the ground, and reaches the lower useful limit of 10 microvolts per meter at

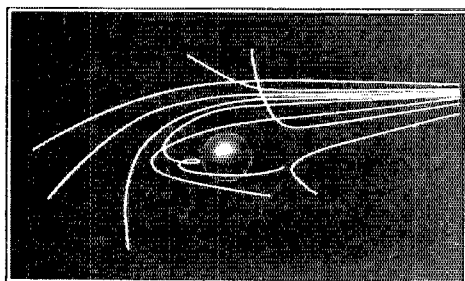

FIG. 3. MORE EXAMPLES OF THE WAY IN WHICH HIGH-SPEED ELECTRONS COMING TO THE EARTH MAY BE CAUSED TO CURVE WHEN ENTERING THE EARTH'S FIELD. THIS AND FIG. 2 ARE FROM CALCULATIONS BY STORMER

about 60 miles. This short range is what might be called the expected value as viewed from our long-wave experience and is rep-

10. A. Hoyt Taylor, *Inst. Radio Eng.*, Vol. 13, pp. 677, 1925.
 11. A. Hoyt Taylor and E. O. Hulbert, *QST* Oct. 1925, pp. 12. Also, *Phy. Rev.*, Vol. 27, p. 189, 1926.
 12. C. J. Young, Unpublished reports on Short Wave Transmission Tests by the General Electric Co. at Schenectady, N. Y.
 13. See for example *QST*, 1924 and 1925.
 14. E. V. Appleton, *Proc. Phys. Soc. Lond.*, Vol. 87, Part 2, pp.16D, 1925.
 15. W. H. Nichols and J. C. Schelleng, *The Bell System Tech. Jour.*, Vol. IV, pp. 215, 1925.

resented in Fig. 5 by passing to the right of the line marked "Limit of Ground Wave." If we now continue to greater distances the signal remains out until we reach approximately 850 miles where the day signal unexpectedly becomes strong again. This is represented in the figure by crossing to the

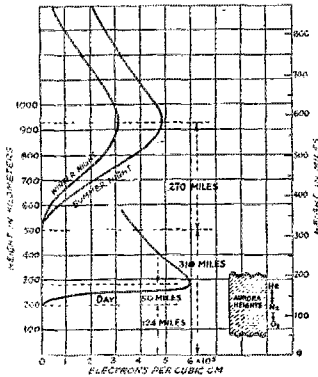

FIG. 4. THE DISTRIBUTION OF IONIZATION IN THE UPPER AIR, AS CALCULATED FROM RADIO TRANSMISSION EXPERIMENTS
Note how much the aurora may carry the ionized layer down.

right of the curve marked "Minimum Range of Sky Wave by Day." Continuing to greater distances we find the signal gradually falling off in intensity and reaching the useful limit of 10 microvolts per meter in the vicinity of 4000 miles by day. This is represented in Fig. 5 by passing to the right of the curve marked "Maximum Day Range." On a summer night the signal does not reappear after the 60-mile extinction until we are approximately 4000 miles from the transmitter, after which the signal falls off gradually to a very low value at 6500 miles.

The unexpected reappearance of the signal beyond 50 miles which we may call the "ground wave" limit, is accounted for by a bending back to earth of a portion of the energy which is radiated towards the sky. This bending or refraction is attributed to the presence of the free electrons in the ionized portion of the upper atmosphere.

A refraction theory of this effect has been proposed by Reinartz¹⁶.

More recently a refraction theory has been developed by Taylor and Hulbert¹⁷. Eccles¹⁸ appears to have been the first to apply the electron theory of optical dispersion, which was developed by Lorentz¹⁸ and Dude¹⁹, etc., to the problems of radio wave propagation. The present investigation was inspired by the work of Lamor²⁰.

HOW WAVES MAY BE BENT

When an electromagnetic wave passes through an electron atmosphere it sets the

electrons in motion, with the result that the effective or phase velocity of the wave is increased above that in free space.

Let the electric field intensity of the wave be

$$E = E_m \sin \omega t \quad (1)$$

The force exerted on an electron carrying a charge e is $e E$ and since for a free electron no elastic restoring or dissipative forces exist, the total applied force is consumed in accelerating the electron mass m , giving

$$m \frac{dv}{dt} = e E_m \sin \omega t \quad (2)$$

Integrating equation (2) and putting the constant of integration equal to zero, since

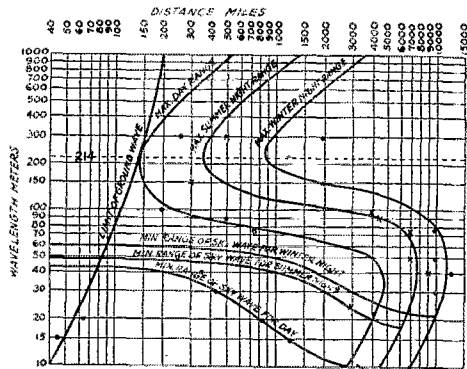

FIG. 5. APPROXIMATE AVERAGE TRANSMISSION PERFORMANCE OF DIFFERENT WAVELENGTHS AT DIFFERENT DISTANCES

It is assumed that the received signal must have commercial strength, which calls for a field-strength of 10 microvolts per meter at the receiving point. The transmitter is assumed to have 5000 watts in the antenna. The chart is rather confusing but may be explained as follows. To the left of the line marked "limit of ground wave" it should be possible to receive at all times. After that, one must pick a pair of curves of the same sort (that is for the same time) and if the distance is between the curves one should hear the signal. Thus, a 30-meter wave should be reliable at all times to 70 miles for the conditions mentioned. From there to 400 miles its daylight performance will probably be uncertain while from 400 on it will gradually die down until at 4600 it will again be below 10 microvolts per meter. There are, of course, numerous exceptions where one does not hear the predicted signal and others where one does hear it when it should be absent. The curves are mainly from data by A. H. Taylor.

16. John I. Reinartz, QST, pp. 9, April, 1925. (In connection with this article there was suggested by F. C. Beekley and myself a refractive bending of the wave in the manner shown in Fig. 7 and 8 of this article and covering the phenomena shown there except the limiting ray path. This appeared as a note signed "Tech. Ed."—R. S. K.

17. W. H. Eccles, Proc. Roy. Soc. Lond., Vol. 87, p. 79, 1912.
18. H. A. Lorentz, The Theory of Electrons, Teubner, 1909.
19. Paul Drude, The Theory of Optics (Engl. Trans. by Mann and Millikan), Longmans, 1917.
20. Joseph Lamor, Phil. Mag., Vol. 48, p. 1025, 1925.

we are not concerned with the *random* velocities, we obtain

$$v = -\frac{e}{m} \frac{E_m}{\omega} \cos \omega t \quad (3)$$

where v = electron velocity due to electric field.

If there are N of these electrons per cu. cm. moving with the velocity v they will con-

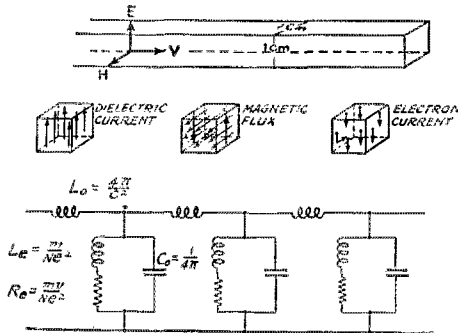

FIG. 6. THE AIR AS AN ELECTRIC FILTER

An electric circuit that will give effects similar to those put on the wave in passing thru ionized air.

stitute a current i_1 per square cm. equal to $N e v$. We thus have from (3)

$$i_1 = -\frac{N e^2 E_m}{m \omega} \cos \omega t \quad (4)$$

In addition to this electron current we have the ordinary condenser charging current flowing across the unit cube. The electric intensity or potential gradient in the wave is E and, therefore, the potential difference between two planes one cm. apart is E times one cm. The capacity of our imaginary condenser which has two plates of one sq. cm. area and one cm. apart is $C = 1/4\pi$ since the dielectric constant is unity. The charging current for this unit condenser is

$$i_2 = \frac{1}{4\pi} \frac{dE}{dt} \quad (5)$$

Differentiating equation (1) with respect to t we have

$$\frac{dE}{dt} = \omega E_m \cos \omega t \quad (6)$$

Substituting this relation in (5) we obtain for the charging current density

$$i_2 = \frac{1}{4\pi} \omega E_m \cos \omega t \quad (7)$$

The total current i , is obviously the sum of the two currents i_1 and i_2 .

$$i = \frac{1}{4\pi} \left\{ 1 - \frac{4\pi N e^2}{m \omega^2} \right\} \omega E_m \cos \omega t \quad (8)$$

By substituting equation (6) in (8) the total current density becomes

$$i = \frac{1}{4\pi} \left\{ 1 - \frac{4\pi N e^2}{m \omega^2} \right\} \frac{dE}{dt} \quad (9)$$

It will be observed that *this becomes the ordinary expression for the charging current of a unit condenser* if we let the bracketed quantity stand for the effective dielectric constant of the material between the plates. In other words, the effective dielectric constant of an electron atmosphere becomes

$$k = 1 - \frac{4\pi N e^2}{m \omega^2} \quad (10)$$

The quantities in the above expression are all in c.g.s. electrostatic units.

N = number of electrons per cu. cm.

e = electron charge = 4.77×10^{-10} e.s.u.

m = 8.97×10^{-28} grams

$\omega = 2\pi f$

f = frequency in cycles per second

$4\pi e^2/m = 3.2 \times 10^9$ e.g.s. (e.s.u.)

We see from equation (10) that the effect of electrons in reducing the apparent dielectric constant of space is, for a given fre-

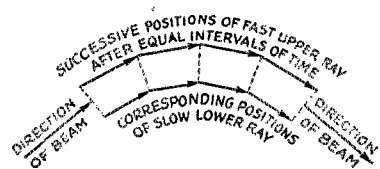

FIG. 7. A SKETCH OF THE MANNER IN WHICH A WAVE IS BENT

quency, proportional to the total number N present per cu. cm., and to the square of their charge and is therefore independent of the sign of the charges, and is inversely proportional to their mass. The lightest gas ion is that of Hydrogen having a mass of approximately 1800 times that of an electron. It is, therefore, evident that for anything like equal numbers the effect of gas ions on the effective dielectric constant can be neglected.

The velocity of an electromagnetic wave in a medium is inversely proportional to the square root of the permeability times the dielectric constant of the medium. For our

case the permeability is unity and the effective dielectric constant that given by equation (10). We may, therefore, write for the velocity

$$c' = \frac{c}{\sqrt{K}} \text{ cm. per sec.} \quad (11)$$

where $c=3 \times 10^{10}$ cm. per sec. velocity of light.

The refractive index of a medium is defined as the ratio of the velocity of light in a vacuum to that in the medium.

From (10), (11) and (12) we obtain

$$\mu = \sqrt{1 - \frac{4\pi N e^2}{m \omega^2}} \quad (13)$$

as the refractive index of our electron atmosphere. The second term under the radical is always positive, and therefore the effect of the electrons is always to reduce the refractive index below unity. This means that the apparent velocity of the radio wave will be increased above that in free space when it enters an ionized medium.

equivalent to shunting the capacity of each unit cube of space by an inductance equal to $m/N e^2$.

THE ATMOSPHERE AS AN ELECTRICAL FILTER

Another way of looking at the problem is to draw the equivalent circuit for the propagation of a wave in an electron atmosphere. This has been done in Fig. 6.

Here $L_o = 4\pi/C^2$ represents the series distributed inductance of space per unit length and unit cross section. $C_o = 1/4\pi$ is the distributed shunt capacity of space and $Le = m/Ne^2$ is the equivalent shunt inductance due to the loading effect of the free elec-

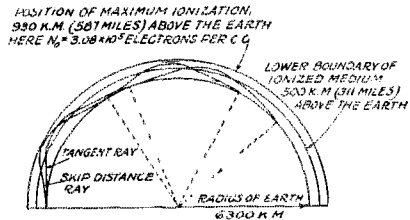

FIG. 9. A PARTICULAR EXAMPLE OF THE GENERAL EFFECT THAT WAS SHOWN IN FIG. 8. This diagram shows the calculated ray paths for a 25-meter transmitter on a winter night.

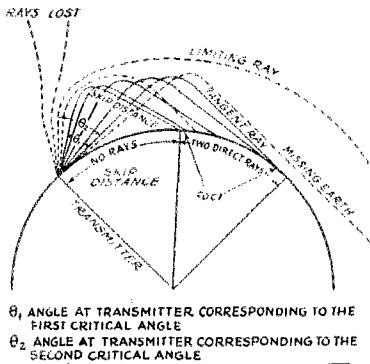

FIG. 8. DIAGRAM SHOWING THE VARIOUS POSSIBLE PATHS OF RADIATION

The vertical and near-vertical rays penetrate the ionized layer and wander away. When one reaches the "limiting angle" the ray just does get bent enough to be kept from wandering away, but it continues to graze the layer and is after all worthless. Below this angle we have progressive reflection (or refraction) and the ray returns to earth. As the angle of departure from the transmitter is chosen flatter and flatter the energy strikes so far away as to miss the earth, possibly going out to the ionized layer again, and perhaps even being reflected down a second time if it has energy enough left.

A comparison of the signs of equations (4) and (7) shows that the electron current is opposite in phase to the condenser charging current. In other words, the inertia due to the to-and-fro motion of the electrons is

trons. The effect of electron collisions with molecules may be represented by the resistance $Re = m\mu/Ne^2$ where μ is the collision frequency between an electron and molecule.

The effect of the electron shunt inductance is to tune out some of the natural capacity of space and therefore raise the apparent velocity of propagation above that of light.

If we now imagine two adjacent rays, Fig. 7, in which the upper ray has a higher velocity than the lower ray, because the upper ray is travelling in a denser electron atmosphere, we see that the front of the upper wave will run ahead of the front of the lower wave and therefore the wave front will bend downward and the beam which started out towards the sky will return to earth at some distant point.

Following out this idea we find that a ray starting out at a low angle will be only slightly bent or refracted and come to earth again at a great distance from the transmitter. For higher angles the rays will return to earth progressively nearer the transmitter. Finally, a critical angle is reached for which the refracted ray comes down at the nearest distance to the transmitter. For higher angles the points of return recede from the transmitter until eventually a second critical angle is reached at which the ray does not return to earth, but instead goes out into space and is lost. This effect is shown diagrammatically in Fig. 8.

"SKIP DISTANCE"

The distance from the transmitter to the nearest point at which the refracted sky

wave returns to earth has been called the "skip distance." For a given wavelength the skip distance is a minimum in the middle of the day and a maximum on a winter night. This follows from the fact that by day we have strong ionization due to the direct impact of the electrons from the sun, while at night the ionization is less.

Experiments show that the skip distances for a given time of day or night decrease with increasing wavelength. This observation is in agreement with the increase in refraction on the longer wavelengths. Calculations show that a concentration of energy or what may be called a "focussing effect" occurs just beyond the skip distance and again inside of the point where the ray leaving the transmitter tangent to the ground, comes back to earth. This effect is illustrated in Fig. 8.

We may expect severe fading right at the skip distance since here too sky waves having traversed different paths are concentrated at the same point, and consequently, interference effects are likely to occur. A little beyond the skip distance the ray of higher initial angle rapidly dies out leaving one ray only and consequently a better chance for a steady signal.

From the above considerations it follows that when we are selecting a wavelength to cover a given distance we should try to have the receiver just beyond the skip distance or just inside of the tangent ray focus. (It is, however, not correct to assume that one can always prophecy exactly where a signal will be heard and where it will not be heard. There is a distinct tendency to regard these transmission rules as absolute. The distances are decidedly anything but absolute.—Tech. Ed.)

Obviously, a portion of the incident energy which strikes the ground will be reflected towards the sky and return to earth again at twice the initial distance from the transmitter as shown in the calculated paths of Fig. 9. Thus, if conditions are unfavorable to locating the receiver just beyond the skip distance or just inside the tangent ray focus, our next choice is to place the receiver at a multiple of one of these distances so as to receive the reflected energy from one of the two foci.

(Editor's Note:—The second part of this paper which will appear in August, will discuss the practical application of the theory to amateur practice.)

The Michigan State Central Division Convention *

WHILE the attendance at this the Sixth Annual Michigan Convention, held at the Hotel Tuller, Detroit, on May 20 and 21, was not as large as last year,

Ralph Thetreau and his committee did everything possible to make the delegates satisfied that their trip was not in vain.

Dr. E. C. Woodruff, professor of electrical engineering, State College, Penna., and Director of the Atlantic Division, is getting to be a regular convention "hound", and is more interesting every time we hear him. His talk on small portable sets, Milliammeter Stunts and Tube Voltmeters showed that he understands his radio. Director Darr gave a lot of information on Crystal Control, based on practical experience. C. G. Williamson, SBRV, spoke on Mercury Arc Rectifiers and certainly has had considerable practical experience and his talk was instructive. Fieldman Hebert explained "skip" distance phenomenon of 20 and 40 meters and Dr. Van Becclaere, SWO, gave valuable information on the operation of Master-Oscillator Power-Amplifier Sets.

The traffic meeting in charge of "Tate" gave the gang their first opportunity to hear Assistant to the Communications Manager Jones, who came from Headquarters to represent Handy. His fine personality and good talk impressed every one. He was followed by some of the route and section managers. Traffic meetings are always interesting as the majority of those attending conventions are "brass pounders" and it gives them an opportunity to become better acquainted and straighten out some of their problems.

Like all well conducted conventions it ended with a very fine dinner and we all enjoyed listening to Capt. Baldwin telling us of his early radio experience on his way to China years ago and Dr. Woodruff of his trip to Paris last year. (We never thought the Doctor was such a "raconteur".) Ole Bill Schweitzer, from Chicago, proved conclusively, after telling us of his trip around the world, that the next national convention should be held in India so as to give us old travellers a chance to see some of the sights.

A convention is never complete without the distribution of prizes for events that have taken place and the Convention Committee gave joy to those present by virtually being able to so arrange the very generous donations of our good friends, the manufacturers who advertise in our QST, as to present practically every one with some remembrance. We were pleased to see that on the back cover of the program the firms who cooperated so unstintedly were inscribed on a roll of honor. Give your patronage to those good friends fellows, and those of you who were fortunate to receive a prize be sure to write the manufacturer and thank him for it.

Our thanks also to the City of Straits Radio Club and the Radio Research Club of Detroit who sponsored this convention.

—A. A. H.

Better Audio Amplification for Short-Wave Receivers

By L. W. Hatry*

WE amateurs pride ourselves on constant improvement. In spite of this, we too frequently get into a rut. It is so easy to copy.

For instance—what does the average amateur use for receiving? Almost invariably, an oscillating detector followed by one single stage of "distortion" audio amplification. The exact arrangement of the oscillating detector circuit is varied a little now and then, but the audio amplifier never seems to improve at all. Why does it always use a distortion transformer? Why does it never have two stages—or three?

When pressed for an answer the owner of the set will answer, "Don't need any more" or, "Too much noise."

These are thin excuses. On weak signals one does need more amplification than one stage can give, while there is the claim that more stages or better transformers are noisy—that is simply an admission. The broadcast listening amateur can and does build affairs having from 2 to 5 stages of audio amplification which (with the antenna disconnected) can be borne by sensitive ears, under good phones. Borne? Why, the affair doesn't make a sound when nothing is fed into it. That is one reason why an inefficient "tuned r.f." (broadcast receiver) will bring in concert after concert with plenty of loud-speaker volume when a headset in the detector circuit strains one's hearing. In radio telegraphy, such a gain is worthwhile on those weak Chilean or Australian signals that one can not quite read.

However, even if the amplifier is not making any noises of its own, the user may still object to the way in which a local signal bursts in while one is straining after a Tasmanian. Many have tried to overcome this by the use of jacks or switches to cut off a stage whenever such a thing happens. Neither is quite satisfactory. A jack gives an abrupt jump-and a click, together with a lapse of time long enough to upset the ear and therefore to introduce an additional lag consequent to readjustment. This is a waste of time that makes poor operating

efficiency. A switch is just as violent but at least is more rapid and thus not so bad, though the click still introduces lag by requiring readjustment of the ear sensitivity. The jack is, from my standpoint, useless. The switch is worthwhile.

THE PRACTICAL MULTI-STAGE ARRANGEMENT

To make two, even three stages of audio bearable on the headset for constant operat-

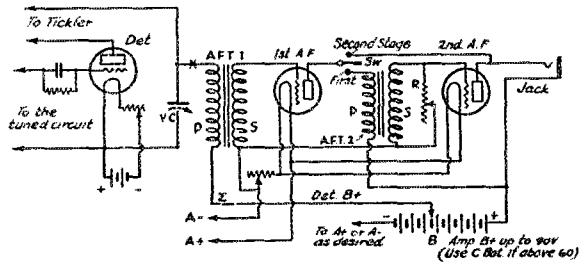

FIG. 1. A TWO-STAGE AUDIO AMPLIFIER WITH RESISTANCE CONTROL OF AMPLIFICATION AT THE INPUT OF THE SECOND TUBE, ALSO SWITCHING ARRANGEMENT FOR CUTTING OFF THE 2ND STAGE

The detector circuit shown need not be used but may be modified into any of the standard arrangements by such changes as adding a variable resistance at Z, fixing the condenser V. C. or putting in a choke at X.

ing use is a simple trick. The circuit is shown in Fig. 1. The assumption in the figure is that the usual throttle control of regeneration is used, but no matter what the control, the amplifier scheme remains the same; the only difference usually being in the lack or presence of an r.f. choke at x

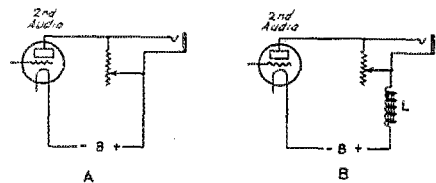

FIG. 2. OUTPUT CONTROLS

A is a resistance shunted across the phones. B is a modification which permits use of the resistance as an audibility meter—provided the resistance is good enough so that it does not change with the weather or use. L is a choke described in the text.

or a variable high resistance at z. Both amplifier tubes are controlled by one rheostat because separate rheostats offer no gain. Filament rheostat control of amplifiers is anything but satisfactory. A rheo-

*Radio Department, Hartford Times, Hartford, Conn., also 10X, same address.

hundred divisions and last one-hundred divisions, the capacity changes very uniformly with each change of setting. In other words it is almost a straight capacity-line condenser between from settings of 300 to 2400. Below 300 and above 2400, the line is not straight due to the edge effects be-

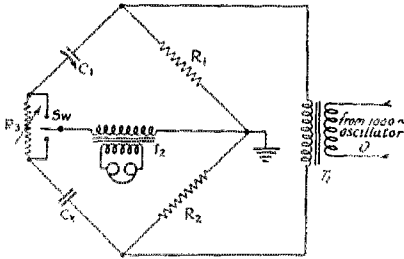

FIG. 1 THE BRIDGE CIRCUIT

T1 and T2 are the input and output transformers which prevent unbalanced effects which would otherwise be caused by direct connections to the oscillator and headphones. R and R₂ are the resistance arms of the bridge while R3 is the decade box as explained in the text. Switch Sw connects this box in the C_x or C_x branch as desired. C₁ is the standard air condenser or sometimes this condenser in parallel with standard fixed condensers.

tween the fixed and moveable plates at the moment of engaging and disengaging of these plates. This condenser should therefore be used only between 300 and 2400, that is between about 160 μfd. and 1450 μfd. It is best to have this condenser accurately calibrated for capacity at points every 100 divisions apart, between 300 and 2400. This can be done by the Bureau of Standards or some other reliable agency. These values may then be plotted on a graph sheet, as shown for part of the scale of a standard in Fig. 2. From this curve the capacity for any reading of the standard condenser may be obtained, or, if the number of measurements to be made warrants it, a table may be constructed as shown in Fig. 3. This table is made up as follows:

As an example, assume the following calibrations:

| Condenser Setting | Capacity |
|-------------------|-------------------------|
| 400 | 200 μfd. (.000220 μfd.) |
| 500 | 282 μfd. (.000282 μfd.) |

Hence the difference between condenser settings = 100 divisions

The difference in capacity = 62 μfd.

Therefore the capacity per division0.62 μfd.

From which, in the table Fig. 3,

| | |
|----------------------|--------|
| 401 on the condenser | =220.6 |
| 402 " " " | =221.2 |

It is interesting to note that the making up of the table is not as laborious as might

at first appear, if the sequence is recognized. Note that the last figures in the vertical columns are constantly recurring, such as 2, 4, 6, 8, 0, or 1, 3, 5, 7, 9, etc. If, therefore, the first row is once found, the rest of the vertical columns may be obtained by adding 6.2 to the figure immediately above the one sought, and checking these values by noting whether there is a break in that series. Of course, a legitimate break should occur where the calibration changes from 62 μfd. per 100 divisions to some other value.

Now as to the bridge itself. After the connections have been properly made, as shown in Fig. 1, the bridge is ready for the measurement of capacity, but is not quite ready for the measurement of power factor. Regardless of the care taken in the construction of this bridge, the same power factor will not be obtained if C_x and C₁ of Fig. 1 are interchanged. This is due to the slight unevenness of the losses occurring in the connections and necessary insulation that is incorporated in the various arms of the bridge. To overcome this difficulty, either two measurements must be made with C_x first on one side and then on the other side of the bridge, and the average of

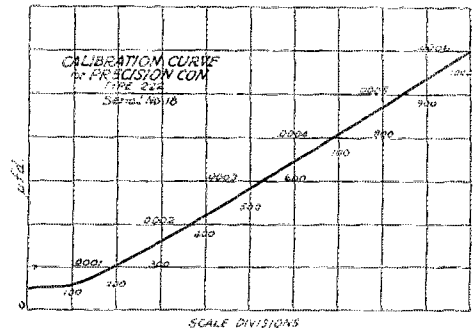

FIG. 2 CALIBRATION CURVE OF A GENERAL RADIO PRECISION VARIABLE CONDENSER LIKE THAT SHOWN IN THE PHOTOGRAPH

On the original large curve sheet the cross-hatching is 10 times as close to permit accurate reading but in a small reproduction these lines tend to run together and are therefore omitted.

the two results taken, or else a correction for the bridge can be made. Fig. 4 shows such a correction curve. To get this curve, C_x is replaced by any variable condenser. It is then adjusted to balance the standard condenser set at 300. The final adjustment for balance of capacity is then made with the standard condenser, and balance of resistance by means of R₂, Fig. 1. The two condensers are then interchanged and the bridge is rebalanced for both capacity and resistance. The difference between the two

readings of resistance divided by two, is the correction for that setting of the standard condenser. The same is repeated for other settings of the standard condenser and a curve is then plotted with these resistance corrections on one axis, and corresponding setting of standard condenser on the other axis. For the first point on curve Fig. 4, for example the standard condenser produced a capacity balance when in the upper arm, and set on 313, and R_s (Fig. 1) was in the same arm and read 1400 ohms. On interchanging the two condensers, R_s was again in the arm containing the standard, but now read 180. The difference is therefore 1220 ohms, and half of that is 610 ohms. If it decided that the standard will always be kept on the upper left hand side of the bridge, then 610 ohms has to be subtracted from every resistance reading obtained for a condenser of a capacity represented by 313 on the standard. Having a complete correction curve, correction for resistance for any capacity can be obtained. As can be seen from Fig. 4, the correction becomes negligible for large capacities. A new correction curve may be needed every three months or even more often. The user of such a bridge should, therefore, make frequent checks of one or two points to detect any change in losses that may occur and that may vitiate his accurate measurements of power factor.

MEASUREMENT OF CAPACITY

Two methods of measuring capacity need to be employed. One is for the measuring of large capacities, and the other for the measuring of small capacities. For large capacities (160 μ fd. and above), condensers are compared directly with a standard. For capacities between 160 μ fd. and 1450 μ fd. the standard air condenser alone is used. For larger capacities, proper mica standards are added in parallel with the air condenser. Referring to Fig. 1, since the resistance arms are equal, the capacity C_x is equal to the capacity of the standard C_s . When a mica standard has to be used, it should be of a smaller capacity than that of the condenser under tests, and the balance obtained by adjusting the variable air condenser. By the use of the standard variable air condenser in parallel, it is possible to obtain an accuracy equal to the accuracy of the mica standard since the variable air condenser may be set to an accuracy comparable to that of the mica

standard. The capacity of the unknown, is of course the sum of all the capacities of the standards used in parallel. From what was said, it is obvious that the mica standards must be well constructed so that they will maintain their calibrations for a long time and thus serve as dependable standards. By means of the substitution method,

400-859

| | 0 | 1 | 2 | 3 | 4 | 5 | 6 | 7 | 8 | 9 |
|----|-------|-------|-------|-------|-------|-------|-------|-------|-------|-------|
| 40 | 220.0 | 220.6 | 221.2 | 221.8 | 222.4 | 223.1 | 223.7 | 224.3 | 225.0 | 225.6 |
| 41 | 226.2 | 226.8 | 227.4 | 228.1 | 228.7 | 229.3 | 229.9 | 230.5 | 231.2 | 231.8 |
| 42 | 232.4 | 233.0 | 233.6 | 234.3 | 234.9 | 235.5 | 236.1 | 236.7 | 237.4 | 238.0 |
| 43 | 238.6 | 239.2 | 239.8 | 240.4 | 241.1 | 241.7 | 242.3 | 242.9 | 243.6 | 244.2 |
| 44 | 244.8 | 245.4 | 246.0 | 246.7 | 247.3 | 247.9 | 248.5 | 249.1 | 249.8 | 250.4 |
| 45 | 251.0 | 251.6 | 252.2 | 252.9 | 253.4 | 254.1 | 254.7 | 255.3 | 256.0 | 256.6 |
| 46 | 257.2 | 257.8 | 258.4 | 259.1 | 259.7 | 260.3 | 260.9 | 261.5 | 262.2 | 262.8 |
| 47 | 263.4 | 264.0 | 264.6 | 265.3 | 265.9 | 266.5 | 267.1 | 267.7 | 268.4 | 269.0 |
| 48 | 269.6 | 270.2 | 270.8 | 271.4 | 272.1 | 272.7 | 273.3 | 273.9 | 274.6 | 275.2 |
| 49 | 275.8 | 276.4 | 277.0 | 277.7 | 278.3 | 278.9 | 279.5 | 280.1 | 280.8 | 281.4 |
| 50 | 282.0 | 282.6 | 283.2 | 283.9 | 284.4 | 285.1 | 285.7 | 286.3 | 287.0 | 287.6 |
| 51 | 288.2 | 288.8 | 289.4 | 290.0 | 290.7 | 291.3 | 291.9 | 292.5 | 293.2 | 293.8 |
| 52 | 294.4 | 295.0 | 295.6 | 296.3 | 296.9 | 297.5 | 298.1 | 298.7 | 299.3 | 299.9 |
| 53 | 300.6 | 301.2 | 301.8 | 302.4 | 303.1 | 303.7 | 304.3 | 304.9 | 305.6 | 306.2 |
| 54 | 306.8 | 307.4 | 308.0 | 308.7 | 309.3 | 309.9 | 310.5 | 311.1 | 311.8 | 312.4 |
| 55 | 315.0 | 315.6 | 316.2 | 316.9 | 317.5 | 318.1 | 318.7 | 319.3 | 319.9 | 320.6 |
| 56 | 319.2 | 319.8 | 320.4 | 321.0 | 321.7 | 322.3 | 322.9 | 323.5 | 324.1 | 324.8 |
| 57 | 325.4 | 326.0 | 326.6 | 327.3 | 327.9 | 328.5 | 329.1 | 329.7 | 330.4 | 331.0 |
| 58 | 331.6 | 332.2 | 332.8 | 333.5 | 334.1 | 334.7 | 335.3 | 335.9 | 336.6 | 337.2 |
| 59 | 337.8 | 338.4 | 339.0 | 339.7 | 340.3 | 340.9 | 341.6 | 342.2 | 342.8 | 343.4 |
| 60 | 344.0 | 344.6 | 345.2 | 345.9 | 346.4 | 347.1 | 347.7 | 348.3 | 348.9 | 349.6 |
| 61 | 350.8 | 351.4 | 352.0 | 352.7 | 353.3 | 353.9 | 354.5 | 355.2 | 355.8 | |
| 62 | 356.4 | 357.0 | 357.6 | 358.3 | 358.9 | 359.5 | 360.1 | 360.7 | 361.4 | 362.0 |
| 63 | 362.6 | 363.2 | 363.8 | 364.5 | 365.1 | 365.7 | 366.3 | 366.9 | 367.6 | 368.2 |
| 64 | 368.8 | 369.4 | 370.0 | 370.7 | 371.3 | 371.9 | 372.6 | 373.1 | 373.8 | 374.4 |
| 65 | 375.0 | 375.6 | 376.2 | 376.8 | 377.4 | 378.1 | 378.7 | 379.3 | 380.0 | 380.6 |
| 66 | 381.2 | 381.8 | 382.4 | 383.0 | 383.7 | 384.3 | 384.9 | 385.5 | 386.2 | 386.8 |
| 67 | 387.4 | 388.0 | 388.6 | 389.3 | 389.9 | 390.5 | 391.1 | 391.7 | 392.4 | 393.0 |
| 68 | 393.6 | 394.2 | 394.8 | 395.5 | 396.1 | 396.7 | 397.3 | 397.9 | 398.6 | 399.2 |
| 69 | 399.8 | 400.4 | 401.0 | 401.7 | 402.3 | 402.9 | 403.6 | 404.1 | 404.8 | 405.4 |
| 70 | 406.0 | 406.6 | 407.2 | 407.9 | 408.4 | 409.1 | 409.7 | 410.3 | 411.0 | 411.6 |
| 71 | 412.2 | 412.8 | 413.4 | 414.0 | 414.7 | 415.3 | 415.9 | 416.5 | 417.2 | 417.8 |
| 72 | 418.4 | 419.0 | 419.6 | 420.3 | 420.9 | 421.5 | 422.1 | 422.7 | 423.4 | 424.0 |
| 73 | 424.6 | 425.2 | 425.8 | 426.5 | 427.1 | 427.7 | 428.3 | 428.9 | 429.6 | 430.2 |
| 74 | 430.8 | 431.4 | 432.0 | 432.7 | 433.3 | 433.9 | 434.6 | 435.1 | 435.8 | 436.4 |
| 75 | 437.0 | 437.6 | 438.2 | 438.9 | 439.4 | 440.1 | 440.7 | 441.3 | 442.0 | 442.6 |
| 76 | 443.2 | 443.8 | 444.4 | 445.0 | 445.7 | 446.3 | 446.9 | 447.5 | 448.2 | 448.8 |
| 77 | 449.4 | 450.0 | 450.6 | 451.3 | 451.9 | 452.5 | 453.1 | 453.7 | 454.4 | 455.0 |
| 78 | 455.6 | 456.2 | 456.8 | 457.5 | 458.1 | 458.7 | 459.3 | 459.9 | 460.6 | 461.2 |
| 79 | 461.8 | 462.4 | 463.0 | 463.7 | 464.3 | 464.9 | 465.5 | 466.1 | 466.8 | 467.4 |
| 80 | 468.0 | 468.6 | 469.2 | 469.9 | 470.4 | 471.1 | 471.7 | 472.3 | 473.0 | 473.6 |
| 81 | 474.2 | 474.8 | 475.4 | 476.1 | 476.7 | 477.3 | 477.9 | 478.5 | 479.2 | 480.2 |
| 82 | 480.8 | 481.4 | 482.0 | 482.7 | 483.3 | 484.0 | 484.6 | 485.3 | 485.9 | 486.6 |
| 83 | 487.2 | 487.8 | 488.4 | 489.1 | 489.7 | 490.4 | 491.1 | 491.7 | 492.3 | 492.9 |
| 84 | 493.6 | 494.2 | 494.9 | 495.6 | 496.2 | 496.8 | 497.4 | 498.1 | 498.7 | 499.3 |
| 85 | 500.0 | 500.6 | 501.3 | 501.9 | 502.6 | 503.2 | 503.8 | 504.5 | 505.1 | 505.8 |

NOTE: Results are in μ fd. for No. 18 Condenser ^{3/31/25}
By J.K.

FIG. 3. CHART FOR RAPID READING OF CAPACITY FROM SETTINGS OF THE PRECISION VARIABLE CONDENSER

This chart is one of a series, this particular one covering the range from 400 to 859 on the condenser scale of 2500 divisions. Such a chart is an advantage when many hundreds of readings are to be made, as the use of the curve-sheet then becomes a burden.

capacities smaller than 160 μ fd. can be measured accurately. This method is illustrated diagrammatically in Fig. 5, which also shows the tuned amplifier. The standard condenser C_s is first adjusted to balance any condenser C_x . C_x need not be known, as long

as it "stays put." The condenser C_s , the capacity of which we wish to find, is then connected in parallel with C_s , and C_s is reduced till a balance is again obtained. The difference of capacities between the two readings of this standard condenser, is the capacity of the condenser C_x . During the whole test, the leads connecting to C_x should remain as fixed in one posi-

tion as is possible. While in both these measurements of capacity nothing was mentioned about the adjustment of resistance R_s , it is important that this resistance be adjusted simultaneously with the variable condenser in order to obtain a perfect balance. The more closely the two are set to produce perfect balance, the more accurate become the results.

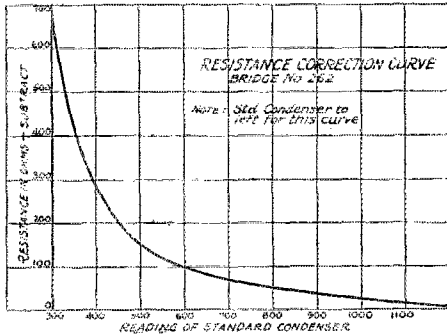

FIG. 4 RESISTANCE CORRECTION CURVE

With the standard condenser thrown to the left the readings are made and from the setting of the standard and the curve sheet the resistance correction is found. This correction is then subtracted from the previous result, as explained in the text.

MEASUREMENT OF POWER FACTOR AND RESISTANCE

The resistance of condensers of equal goodness depends on their capacity, therefore it is convenient to express the goodness of a condenser in terms of its power factor which automatically includes both these factors. Power factors of condensers are usually specified in percent. A one-percent power factor means that the losses of energy is one percent of all the energy supplied to the condenser. Often power factor is also designated by an angle of a certain number of degrees, minutes, and seconds. This angle is known as the Angle of Phase Difference and is that angle whose sine is equal to the power factor expressed as a decimal. In measuring power factor neither of these is directly obtained. Instead, an equivalent series resistance (which we ordinarily speak of as the condenser resistance) is first obtained, from which the power factor is computed. The equivalent

resistance is that resistance which if placed in series with a perfect condenser, a condenser that has no losses, will introduce the same losses in the circuit, as would another imperfect condenser or the same capacity and whose power factor is to be found.

If R is this equivalent series resistance and C is the capacity of the condenser in microfarad and P.F. is the power factor expressed as a decimal

$$(1) \text{ The P.F.} = \frac{CR}{159}$$

To get P.F. in percent, this value is multiplied by a hundred. The angle of phase difference may be obtained from a table of sines or tangents, the values of sines and tangents being equal for small angles.

When measuring capacities of condensers by the comparison method as above explained and as illustrated in Fig. 1, the value of resistance of R_s , when corrected by means of the correction curve, Fig. 4, may be assumed to be the equivalent series resistance of the condenser under test if the variable standard condenser alone is used. An error is here introduced due to the equivalent resistance of the standard, but it is negligibly small for the good standard at the larger capacities for which it is used in the comparison method. For the smaller values, (that is below 160 μ fd.) it is by no means negligible. But even this error may be corrected for, by obtaining a curve of the equivalent series resistance of the standard, as will be explained later, and adding this equivalent resistance to the correction value of R_s . If additional mica standards are used in the measurement of capacities above the maximum of the air condenser, the effective resistance of all condensers in parallel should be added to the corrected value of R_s .

Let R_s = the effective resistance of this parallel arrangement.

C_1, C_2, C_3, C_4 = the respective capacities of the condensers used in parallel.

R_1, R_2, R_3, R_4 = the effective resistance of the respective condensers.

C_s = the capacity of the parallel condensers combination.

$$(2) \text{ Then } R_s = \frac{C_1^2 R_1 + C_2^2 R_2 + C_3^2 R_3 + C_4^2 R_4}{C_s^2}$$

The standard mica condensers when calibrated for capacity can at the same time be calibrated for power factor, and from formula (1) the resistance required for formula (2) can be computed.

By the substitution method of measuring small capacities, as shown in Fig. 5, in the first balancing of capacities, a definite reading for R_s is obtained. When the test condenser is introduced and the capacity re-balanced, a different R_s results. This difference of resistances, multiplied by the square of the ratio of capacities, gives the effective resistance of the test condenser.

Let the initial resistance be presented by R_{s1}

The final resistance be presented by R_{s2}

The initial capacity of the variable

condenser = C_1

the final capacity of the variable

condenser = C_2

The capacity of the test condenser

then = $C_1 - C_2$

and the difference in resistance = $R_{s1} - R_{s2}$

Let the resistance of the test

condenser = R_x

$$(3) \text{ Then: } R_x = (R_{s1} - R_{s2}) \left(\frac{C_1}{C_1 - C_2} \right)^2$$

The power factor can be calculated from formula 1.

This same method may be used to obtain the effective resistance of the variable

ohms, two condensers are first balanced, and the resistance to be measured is then inserted into one of the arms, as is shown by R_x in Fig. 6 and R_s and C_s are again adjusted to produce a balance. The difference between the two values of R_s is the value of the resistance R_x . The condensers are necessary to prevent overloading of the os-

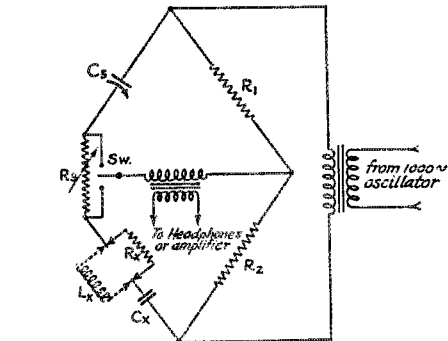

FIG. 6 THE CIRCUIT AS USED FOR MEASUREMENTS OF INDUCTANCE OR RESISTANCE.

With everything else remaining as before the unknown inductance L_x or the unknown resistance R_x is connected in as shown. Naturally the values obtained are those corresponding to 1000 cycles with a small current flowing. All inductances and most resistances change somewhat with frequency and current, therefore the results are not necessarily applicable to other conditions. The same statement of course applies to any resistance or inductance measurement, especially to the latter. As a particular example, the inductance of an iron-cored choke with a small 60-cycle current flowing is one thing; the inductance of the same choke with 40 or 50 mils of d.c. plus 2 mils of a.c. flowing thru it is likely to be quite another and much smaller amount. Failure to understand this prevented many of the early rectifier-filter combinations from working.

illator when small resistances are used, and to balance out any inductance or capacity of R_x . Of course if a larger resistance than the total resistance of R_s is to be measured, an additional standard resistance box has to be used in series with R_s .

MEASUREMENT OF INDUCTANCE

The method of measuring inductances is based upon the principle that if the inductive reactance is smaller than the capacitive reactance, and the two are connected in series, the combined result is the same as would be obtained by one condenser of larger capacity. If therefore, the capacity of any condenser is first balanced on the bridge, and then the inductance coil, of which the value of inductance is desired, is placed in series with this condenser and the bridge again is balanced, the standard will show a larger capacity. From this increase of capacity, the value of inductance can be found. Referring to Fig. 6, C_x is balanced on the bridge with the standard condenser C_s . The inductance L_x is then connected

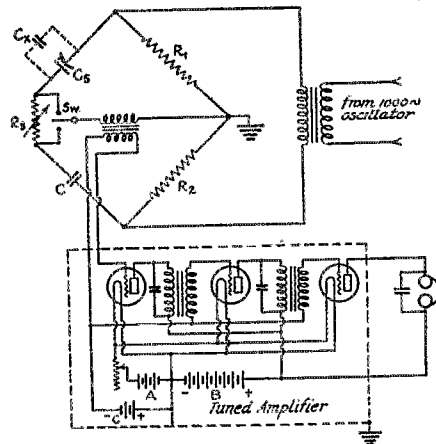

FIG. 5 THE BRIDGE SET-UP FOR USE WITH A TUNED AUDIO AMPLIFIER

Except for the amplifier the connections are the same as before. The amplifier improves the sensitivity and also thereby the accuracy. The bridge is shown as used to measure small capacities shunted across the standard variable capacity.

standard, provided two such standards are available, or one additional good variable condenser. This additional condenser is then used in place of C_s , while the standard is used in place of C_x .

MEASUREMENT OF RESISTANCE

To measure resistance at 1000 cycles between values of 1 ohm and about 10,000

in series with C_2 , just as R_x formerly was connected, and R_3 increased to produce a balance again.

Let initial capacity of the standard be represented by C_1 in microfarads.

Final capacity of the standard be represented by C_2 in microfarads.

$$\text{Then } L_x = \frac{C_2 - C_1}{39.5 C_2 C_1}$$

Thus if $C_1 = .0010 \mu\text{fd.}$ and $C_2 = .0011 \mu\text{fd.}$

$$L_x = \frac{.0011 - .0010}{39.5 \times .001 \times .0011} = \frac{.0001}{39.5 \times .001 \times .0011} = 2.3 \text{ henrys}$$

To use this method successfully, a proper choice of capacity is necessary. The capacity must not be too large. If it is too large, the net reactance in the lower arm, Fig. 6, will become inductive and therefore will not be balanced by *any* condenser in the upper arm. If it is too small, $C_2 - C_1$ will become very small and the results ob-

tained will not be accurate. As can be seen from the above illustrative problem, .001 $\mu\text{fd.}$ is a very good capacity for 2 henry. No fine choice of capacity is however required, and it will be found that .001 $\mu\text{fd.}$ will be suitable for inductances ranging between about .4 henry and 4. henrys.

For smaller inductances, larger capacities should be used, and of course small capacities should be used for larger inductances. If one thinks of the values of capacity or inductive reactance instead of the values of C and L this becomes obvious. When uncertain of the approximate inductance, it is best to start with a small capacity such as .0002 $\mu\text{fd.}$ (which is suitable for about 25 henrys) and if the difference in capacity is small, increase the capacity. The increase in capacity may be made in large jumps such as .0002 $\mu\text{fd.}$, .001 $\mu\text{fd.}$, .01 $\mu\text{fd.}$ and .1 $\mu\text{fd.}$ The last value will be suitable for inductances as low as a fraction of a millihenry.

All these tests may be made easily, and (with a little experience) both quickly and accurately.

That Spirit of Accomplishment

By Hiram Percy Maxim, President A.R.R.L.

I SUPPOSE all of us get a certain question asked every so often. It usually comes from the type of person who wonders why Columbus ever went to the inconvenience of discovering America, or why Peary risked a chill by going to the North Pole or why Charlie Lindbergh risked a perfectly good life in a non-stop solo flight across the North Atlantic from New York to Paris. The question asked of us is why we study and work so hard and sit up so late at night just to hear a faint little whistling sound?

There is no answer to such questions—at least to the kind of person who would ask them. But there is an answer. The answer is, because of the tremendous satisfaction that comes from successfully accomplishing the extremely difficult or the extremely dangerous.

In our case it is the extremely difficult. Human standards are still such that it is considered wonderful to be able to sit in one's home in America and communicate back and forth with a fellow amateur on the other side of the earth. And to be able to do this with apparatus that has been built and installed with one's own hands brings a feeling of exalted satisfaction.

The ordinary mortal cannot do it. It is too difficult. But we can do it. When it becomes easy to do we shall lose our interest in it, however. Witness our record during the past ten years. We struggled with "the useless" 200-meter spark transmission until we mastered it and disclosed its limitations. We took up 200-meter continuous wave because it was better and more difficult. We went down to 100 meters because it was still more difficult, and better for our purpose. We left this for 80 meters. Thence we went to 40, thence to 20 and now we insist that 5 meters shall give up its secrets. And one of us is going to make 5 meters do it, because no one has ever been able to. Who wants to say that one of us amateurs is not going to achieve honors in ultra short wave work that will place his name beside those of Maxwell, Hertz and Marconi? It can easily be that one of us will wake up some morning and find we are another Charlie Lindbergh, with the whole world striving to do us honor.

Army Amateurs in Joint Army-Navy Maneuvers

By David S. Boyden*

THE general scheme of exercises provided that the Black Force, represented by the United States Fleet, had secured command of the North Atlantic and was advancing on the New England coast with an expeditionary force of some 75,000 men in transports. By the limitations of the problem, the area of operations was confined to the coast and adjacent islands extending from the eastern elbow of Cape Cod to the mouth of the Connecticut River.

The defense, or Blue Force, included the

air attack and bombardment by battleships on the Harbor defenses of New Bedford and Narragansett Bay on the afternoon of the 18th. It seized Block Island and raided the Harbor of New London on the night of the 18th and made a land attack along the coast, extending from Sakonnet Point to Salters Point at daybreak on the 19th.

While the official decision of the Chief Umpire has not been made public, it is the consensus of opinion that the Blues withstood the attack and that the Blacks were unable to advance and secure the objective.

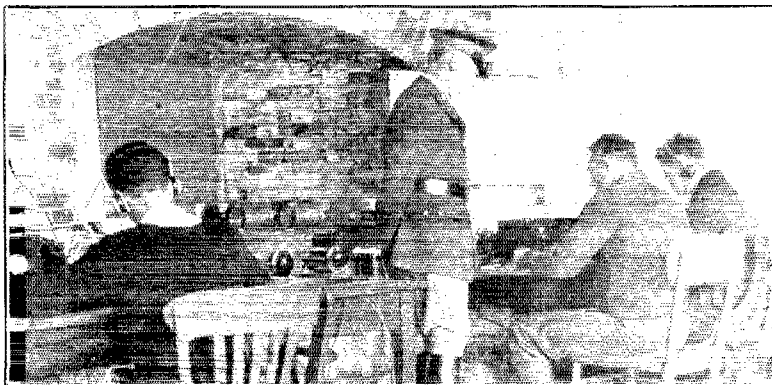

THE NET CONTROL STATION, 1WF
Left to right: Chief operator, E. L. Deslauries, 1AWB; 1st Lieut. D. S. Boyden, 1SL; S. B. Waring, 1AZZ; Jefferson Borden IV, 1CMX.

land forces harbor defenses and a small Naval Fleet.

The objective was to make a landing of sufficient force to advance on and make a Bridge Head for protection of a large force to land later. The Blue Forces were organized as follows:

The First Coastal Sector included the shore line of New England with its Command Post at Worcester, Massachusetts. It included four sub-coastal sectors of which only the third was involved in the problem of the Blue Forces.

The problem started at 12:01 a.m., May 17, and was concluded by order of the Chief Umpire at 12:20 p.m., May 19.

The Black Fleet made a general reconnaissance on the evening of the 17th, and an

*1st. Lieut. Sig-Res., Radio Adviser on Amateur Matters to the First Corps Area Signal Officer, nu1SL.

With this picture before you, we will proceed with the Army Amateurs' activities in these objective.

In accordance with instructions received from the Signal Officer, First Corps Area, the Radio Advisor on Amateur Matters organizes the Army Amateurs within the theatre of operations into three groups:

Group 1—Intercept.

Group 2—Coastal Observation.

Group 3—Net Control Station at Headquarters.

Group 1. The "Intercept" group was located in Attleboro, Massachusetts, and vicinity; as at this location there was an Army Goniometric Station which had a direct telephone connection with the Headquarters of the Third Sub-Coastal Sector at Fort Adams, Newport, Rhode Island.

A telephone connected to the local exchange was installed at the Goniometric

Station for prompt relaying of messages intercepted by this group.

The intercept work required a constant listening-in on all frequencies allocated to Government use from 200 kilocycles (133 meters) to 18100 kilocycles (16.6 meters) and to report all messages intercepted except those which were positively identified as being commercial or of a friendly nature. The operators at the Goniometric Station scrutinized all relayed intercepts, filling incomplete messages where possible. ISE and IPM were in charge of schedules of listening periods for the various stations, so that as far as possible a continuous service would be maintained in the several intercept bands.

The group was composed of amateurs 1ABT, 1ACI, 1ADM, 1AMD, 1AUG, 1AWB, 1BQQ, 1CMP, 1EX, 1MV, 1NT, 1OW, 1PM, 1SE and 1UW.

The radio silence maintained by the enemy during the first forty-eight hours of the maneuvers made intercept work rather monotonous, but on the third day, enemy

These observers were to report the approach of enemy forces either by air, water or land by radio to the "Headquarters" Group of the Third Sub-Coastal Sector. All observed information was enciphered by the amateur before transmitting to Headquarters. The work of this group was made very difficult by the weather conditions; fog and rain being encountered during much of the time.

No one except the Blacks knew when and where the attack would be made upon the coast defended by the Blues, therefore, every amateur was on the alert to secure the first information of the enemy's approach. Several stations reported occasional enemy scouting aircraft, and on the second day of maneuvers, the Blacks were discovered off the coast of Buzzards Bay.

1AOM and 1BHS located respectively at South Harwich and South Dartmouth found themselves within the area of active operations. Each of these amateurs was at his key keeping hourly schedules with the Net Control Station Headquarters. On the

third day the Black forces attacked the Harbor defense of New Bedford, and vicinity, to effect a landing on the shores between Sakonnet Point and Salters Point. 1BHS was then in constant touch with New Control Station Headquarters, sending in reports as fast as they could be enciphered and transmitted. At 6:50 a. m. on the 19th (E.S.T.) 1BHS reported "things happening so fast cannot report them in

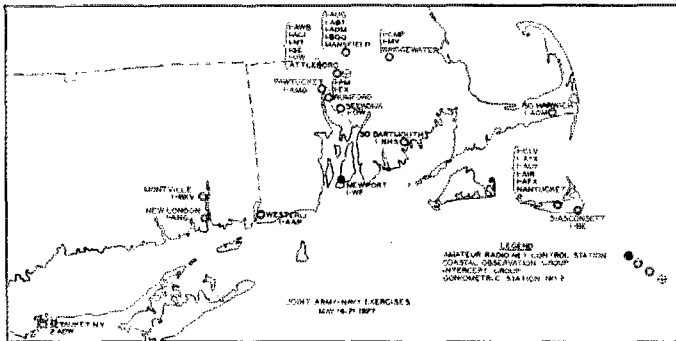

messages were reported. The majority of these messages were in Cypher Code and were forwarded to the cryptanalysts of the Intelligence Division for decoding.

A few enemy messages were sent in the clear. These were between ships and aircraft and of minor importance. *Nine messages of major importance* were intercepted and reported by this group.

Group 2. This was known as the "Coastal Observation" group. It was composed of Army Amateur Stations located on the New England Coast between Chatham, Massachusetts, New London, Connecticut, the Island of Nantucket and Long Island, as follows: 1APP, 1AFX, 1AIR, 1AOM, 1ANG, 1AUY, 1AYX, 1BE, 1BHS, 1BXV, 1CLV and 2ADW.

Each station secured the assistance of as many scouts as possible so located as to command a view of the waterfront in their vicinity, so that observation would be as continuous as possible.

cipher code". Upon receipt of this message, the Signal Officer, First Coastal Sector, authorized observation reports transmitted in the clear. And for the next two hours 1BHS reports were received amid great interest and excitement at Headquarters of the Blue Forces.¹

Group 3. The "Net Control" Station was located at Fort Adams, Newport, Rhode Island, Headquarters of the Third Sub-Coastal Sector. A fifty-watt transmitter was used in an inductively coupled Hartley circuit, using 1100 volts, "S" tube, rectified a.c. on the plates. The transmitter was operated at approximately 800 kilocycles (77 meters) using the call n1WF. This station was manned by Army Amateur operators from Newport and vicinity, the

1. For their exceptionally excellent and unremitting work during the exercises, 1AOM and 1BHS have received special commendation in the report made by Major Evans, First Corps Area Signal Officer.

volunteer personnel being: 1AQQ, 1AUG, 1AWB, 1AWG, 1AVM, 1AZZ, 1BQD and 1CMX.

During the maneuvers, the operators worked in pairs four hours on and eight off, maintaining a constant listening-in for reports from stations of the Coastal Observation Group.

The first visual contact with any of the Black Fleet by land observers was obtained by an Army Amateur Station. At the close of the exercises, Commanding General of the Blue Forces, Major General Preston Brown, and Signal Officer First Corps Area, Major P. W. Evans, commented favorably on the part the Army Amateurs performed in these maneuvers. A commendatory letter was sent to each by the Signal Officers.

The result of the Army Amateur activities in these exercises proves the Amateur Radio operator to be a potential factor who can be relied upon as an aid to our armed forces in the event of an emergency.

The amateurs participating were selected by their geographic location without consideration of their operating ability. From an analysis of these operators and applying the percentages to the licensed amateurs of the United States, it would appear that there are 14,000 amateurs having a speed of over fifteen words per minute and 1400 amateurs having a speed of more than twenty words per minute. In addition, the majority of amateurs are familiar with the technique of radio communication apparatus.

It is hoped that Army Amateur personnel² will be utilized in the future on every possible occasion of this character that they become familiar with Army methods and radio procedure. Attention is invited to the excellent work performed by all cooperating amateurs.

2. If interested in participating in the Army Amateur Nets that have been formed in various parts of the country, send your application for appointment as Army-Amateur Radio Station to A.R.E.L. Headquarters and it will be forwarded to the attention of the proper Corps Area Signal Officer via the Army Amateur Representative of that Corps Area. It is not necessary to enroll in the Signal Corps to get in on the interesting Army-Amateur activities.

1BIG, 1KL, 1BMS and a number of other amateurs enrolled in the Naval Reserve (the number is not definitely known at this writing) were with the Black Forces making the attack on the New England Coast.—F. E. H.

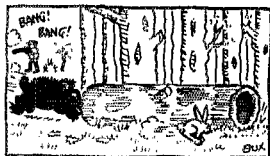

MAKING A LOG ENTRY

Western and Central New York Atlantic Division Convention

PLACE: Powers Hotel, Rochester, N. Y. Date: Friday and Saturday, August 5th and 6th. Price: \$4.50 will buy Convention ticket which includes everything. No extra fees.

This convention will be put on by the Society of Rochester Transmitting Amateurs, and is the sequel to the one held at Utica last year.

The program consists of Traffic and Technical sessions, trips to Stromberg Carlson and Bausch and Lomb, (where QTZ crystals are ground), plenty of sports, and finally the Banquet, for which we have some good speakers lined up. A long list of prizes will also be awarded for stunts and contests.

Get your ticket now from R. H. Lucia, Secretary Convention Committee, 109 W. Chestnut St., East Rochester, N. Y.

Indiana State Central Division Convention

COME to the Elks Auditorium, fellows, where this year's convention will take place. The Radio Traffic Association is the sponsor and *entertainment* will be the keynote for the two days.

The committee informs that an initiation into the Imperial Order of the Yellow Dog will take place. There will be prizes for everyone and the fee for the whole convention is \$5.00.

It will help the committee if you write Fred W. Fischer, 1114 Crescent Ave., Fort Wayne, Ind., and tell him that you will be there.

~~Strays~~

It is claimed by 9MM that a 200-A detector tube will improve matters if you are using a 201-A and are bothered with an audio-frequency hum from the power line.

4NE says he has been having a lot of trouble with spider webs. They are spun from the lead-in to the side of the house and when covered with rain or dew, partially short the antenna system. Perhaps the fact that his name is John H. Webb has something to do with it and perhaps not.

We are told by 3CNR that the use of Xmas tree bulbs across the filaments may be considered as good insurance against burn-out from high plate overload. He blew his lamps three times preventing his CG1162 from continuing a Westward journey.

Some Light on Transmitter Tuning

By Ross A. Hull*

A GREAT deal may have been written during the last few years in explanation on transmitter adjustment. Much more information may comprise the general knowledge of even the relatively inexperienced amateurs. However, after listening for an hour or two on any of the amateur wave bands, one would never think so. One is tempted to believe instead that the typical amateur of these days thinks of tuning as a means to but one end; the end being on the far side of the antenna meter scale.

And in case you imagine that I exaggerate, reach over right now and switch on the old 40-meter noise box, with your mind rearranged along critical lines. Drift slowly from one station to another and make a list of only those signals to which you would be proud to tack your call. If you have the power to differentiate between the

antenna before his next parade of CQ's. "Jimminy", you'll think, "must be an awful dumb-bell, that chap—careless bozo to put out such a noise". And in all probability you'll be quite wrong. The fellow behind the signal will be, perhaps, just as much of a genuine amateur as you are, with just the same pride in his station and the same desire to own a really fine signal. No doubt he thinks he has one. The over-enthusiastic guy that he worked last night is certain to have told him that his QSB was "veri FB," his wave "veri FB" and his keying not a scrap less than "veri FB". And our wabby-note friend probably has eaten it all up!

And, while we're on the subject, what sort of a signal have you? Have you ever heard it with your own pair of "cans" or do you rely solely on the dizzy "FB's" of others?

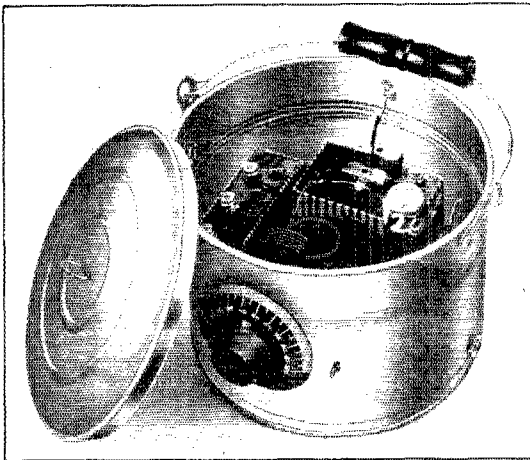

THE MONITOR-BOX USED TO CHECK THE CHARACTER OF THE SIGNAL

clean-cut snappiness of worthwhile signals and wabby chirps or raspy rattles your list will be small, dismally small. And now, in the same critical frame of mind, try to visualize the fellow behind one of those snappy signals. It should not be difficult. Try in contrast one of those silly sloppy signals. Listen to the key chirps, the shaky wave, the crazy rattle, and, if you are quick enough, follow the thing as it slides out of audibility when the "op" leans over to squeeze that final point into the

Taking into consideration the curiosities to be heard on the amateur bands it has not been surprising to find that very few amateurs realize that it is possible to know exactly what their own signals sound like. They will take great trouble to rig an elaborate antenna and a splendid receiver; they will fuss with the wiring and the appearance of the gear, but the *signal*—that part of the station that exhibits itself over the whole globe—they *will disregard entirely*. Is it any wonder that the amateur bands are filled with weird and horrible noises?

So, let us delve into the work of adjusting the transmitter, not with any hope of expounding new or original principles but simply with the idea of explaining the method of obtaining a truly readable signal, irrespective of whether it is "a.c." "r.a.c." or "d.c."—the sort of a signal that will be described in glowing terms by even the truthful DX man.

DO YOU KNOW THIS?

The essential first requirement is a means of listening to the signal right at the transmitter, and, lest you forget it, I will whisper a little known truth. It is thoroughly and completely impossible to adjust the transmitter satisfactorily unless one can hear it and twiddle the knobs at the same time.

Obviously, it is impractical to tune the receiver to the fundamental of the transmitter, but often when tuned to some odd harmonic, the receiver will serve to make the transmitted signals audible. More often

* A.R.R.L. Information Service and Experimenters' Section.

the harmonic will be submerged in a background of noise caused by the plate supply machine or by radio-frequency energy arriving through power-supply wiring. Often, too, the harmonics will not be similar in character to the fundamental, nor will they

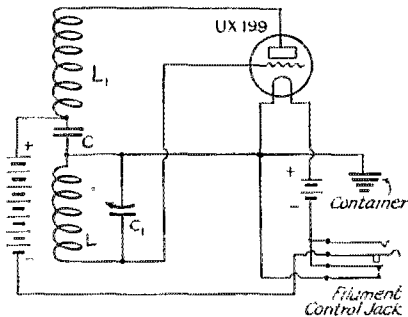

FIG. 1. THE WIRING OF THE "GROWLER" OSCILLATOR

L and L1 = 5 and 9 turns of 22 gauge for 20 meters.
 12 and 15 turns of 22 gauge for 40 meters.
 26 and 26 turns of 30 gauge for 80 meters.
 Coils wound on a bakelite tube socket.
 C—1000 micro microfarads.

By connecting an antenna to the grid through a "Midget" condenser, placing a 50,000 ohm variable resistance in the "B" battery lead for regeneration control and adding a grid leak and condenser the oscillator can be converted into a particularly appropriate portable receiver for camping expeditions this summer.

bear much resemblance to each other. The desirable arrangement is a simple screened oscillator tuned to the fundamental of the transmitter and located in such a position that the head phones can be worn conveniently as adjustments are being made. Such an oscillator can be assembled from the junk box of most stations in the space of a few hours, and is quite certain that if every amateur station was equipped with one, many of them would close down from sheer shame, and the amateur bands would no longer sound like the playground of painfully indifferent and irresponsible ether-busters.

There is nothing complex, curious or costly about the oscillator, so let us proceed.

A "GROWLER" OSCILLATOR

Clasping the right hand securely around one quarter and striding firmly into the nearest hardware store, negotiate for the purchase of one shielded container (variously styled "Billy Can", "Billy", "Bucket" or "Growler"). This will provide an oscillator housing of both esthetic and electrical merit.

The remaining equipment includes a UX-199 with the essential rubber suspension, a variable condenser of about 150

1. An American coin often referred to as "two bits".

micro-microfarads, an inductance built according to the details given below the wiring diagram, and filament and plate supply batteries. The filament supply can well consist of a 4½-volt C battery whilst the plate supply can be obtained from a miniature 22½-volt B battery of the type designed for loads of less than 10 m.a. If the jack (to be seen mounted on the side of the can) is arranged to switch the filament circuit, matters will be simplified since it will be possible to plug the head phones from the receiver to the oscillator without the need of any other operation. Should the transmitter be arranged to operate on more than one band the inductances can be wound on a bakelite tube base and plugged into a tube socket or can be of the more usual type hitched to four binding posts mounted in a row on a narrow strip of bakelite. The wiring should present little difficulty though care should be taken to see that other than grounded leads do not make contact with the surface of the container. The need for care even in this regard has been reduced in this oscillator by connecting the negative side of the plate battery to the grounded side of the filament. Therefore, in order to avoid a filament eruption it is only necessary to keep the positive filament lead well insulated. The tuning condenser is connected across the grid coil only so as to allow the grounding of its frame. If the condenser is wired

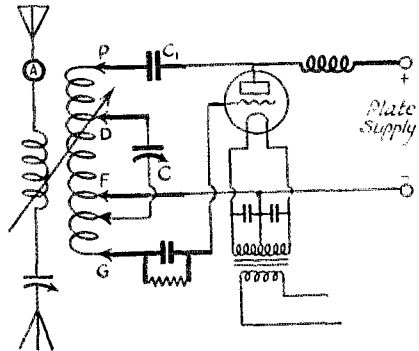

FIG. 2. THE CHIEF ADJUSTMENTS INFLUENCING THE EFFICIENCY OF THE TRANSMITTER ARE SHOWN IN HEAVY LINE

This is contrary to the usual QST practise, which is to use heavy lines to indicate wires carrying radio frequency currents.

across both grid and plate circuits, as is so often done, it will be very difficult if not impossible to avoid "hand-capacity" effects. The exact arrangement of the apparatus in the "Growler" is a matter of little importance, or wires associated with it, do not "shimmy" since the slightest vibration will destroy the truthfulness of the resultant signal. It will be hard enough to check and eliminate "shimmies" in the transmitter

without having to make allowance for one in the oscillator.

And now, with a 199 plunged into the socket, the "Growler" monitor-box should oscillate in readiness for the grand show-down.

POWER SUPPLY REQUIREMENTS

In order to tune even the simplest transmitter, it is necessary or at least highly desirable, to know the purpose of each of the knobs and clips provided. In the modern amateur station apparatus, controls and adjustments have been reduced to something closely approaching the absolute minimum and, as a result, it is impossible to expect the transmitter to make its best performance unless each one of them receives careful and intelligent attention. In every tube transmitting circuit, there is provided a source of plate supply and a source of filament supply. Apart altogether from the character of this supply, there are considerations of the greatest importance in the work in hand. The plate supply, for instance, irrespective of whether it is "a.c." "r.a.c." or "d.c." must

maximum capacity, and filter chokes of low resistance are absolute necessities.

Of equal importance is the constancy of the filament supply. In many cases where the high voltage transformer serves in the dual role of plate and filament supply the filament voltage is dropped whenever the load is placed on the high voltage windings. Key-chirps are the result. In the low-powered transmitter a separate filament transformer is the cure, but even this provision is not sufficient in a high-powered outfit operating from an over-worked 110-volt line. In such a case, some form of compensating winding on the filament-transformer is often used.

Troubles from either of these sources can be detected very simply, of course, with the aid of voltmeters. They can be detected with equal ease and with less expense, however, by listening to the transmitter with the "Growler" oscillator.

If it happens that a "d.c." note is desired, the filtering of the plate supply is a matter of prime importance. It would be quite useless, however, to attempt to add anything useful to the material on this subject to be found in recent issues of *QST* or in the Handbook.

WHAT THE KNOBS DO

To proceed to the transmitter proper we find that provision is made in it to tune the plate circuit of the tube to the required wavelength, to tune the antenna circuit to resonance with the plate circuit and to vary the amount of energy fed into the grid circuit from the plate circuit (the grid excitation). Other means are provided to adjust the grid bias, to match the impedance of the plate circuit with the output impedance of the tube, and to adjust the antenna load to that value which will allow the most efficient transfer of energy from the plate circuit. Some method of making all of these adjustments is to be found in every satisfactory circuit. In fact a circuit is nothing more than a combination of the necessities for making such adjustments. Trouble is ahead when the time comes to twiddle all of these adjustments in order to get the largest possible output, without exceeding the limits of the tube, and always maintaining a steady clean-cut signal. One would never believe this to be so after reading of the process in any good text book. It would seem that so long as a couple of elaborate equations were satisfied nothing could result except an output of the highest character, and an efficiency to be envied. One cannot help

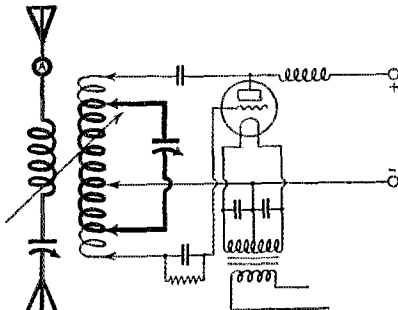

FIG. 3. IN THIS CASE THE HEAVY LINES INDICATE THE FACTORS TO WHICH PARTICULAR ATTENTION MUST BE GIVEN WHEN AIMING AT A STEADY WAVE

be constant. Further, the plate supply must have good regulation. In other words, the voltage must remain fairly constant even though the output load is varied over wide limits. If the voltage delivered by the plate supply drops to 75 or 50 percent of its no-load value when the load is on—as is so often the case—it will be possible to avoid key-chirps only by using some system of keying which allows the tube to take full power during both characters and spaces. This arrangement is usually most undesirable.

A transformer of ample rating, a rectifier system—if one is used—working below its

2. "Amateur Filter Problems", Dec., 1925; "Key Thump Filters", Nov., 1925; "Filtering the Synchronous Rectifier", Feb., 1926; "Electrolytic Filter Condensers", April, 1927.

of the bus. They are just large enough to hold two wood screws which screw into the wooden baseboard and hold the whole unit in place.

The transmitter inductance has twelve and a half turns. Three taps are taken out at the sixth, seventh and eighth turns respectively. The filament lead is connected to the one that gives best results. The coupling circuit winding has eighteen turns and the distance between the two windings is approximately one-quarter of an inch. This coil is mounted by means of two pieces of heavy bus which are fastened to the two condensers used for tuning the transmitter. They are also used as the leads to the condensers.

The variable condensers used in the set are all General Radio type 368, 50 μ fd. ones which are of the "midget" variety, having a single hole mounting arrangement. The two in the transmitting circuits are put on the panel in the normal manner but the one for the receiver tuning control is mounted a bit differently. This is due to the use of a National 'Velvet Vernier' dial, a very smooth running one that has about the right ratio for the size condenser used. The dial itself is fastened to the panel by means of four screws which extend through it and are held by nuts. There is a short hollow shaft on the dial assembly that extends through the panel and into which the shaft of the condenser fits. This requires that the condenser be mounted about an inch and a half from the panel. As the dial assembly is plenty strong enough to support the condenser, it is only necessary to get an arrangement to keep the entire condenser from rotating with the dial and also to keep the correct amount of tension on the rotor section to insure good contact at the bearings. This is done by bending a piece of bus wire so that it will be gripped by the mounting nuts on the condenser and its ends will be held by the same screws that hold the dial in place.

The batteries are connected to the set through a four-wire cable. The key is placed in the positive B battery lead. It is impractical to put it in the negative lead as this is connected to the A positive lead at the battery box to save the running of an extra lead. However, the radio frequency choke does its work and no reaction is had due to the hand coming in contact with this lead. The voltage at this point is not high enough to cause any trouble.

The battery box is divided into three compartments. Two of these hold the batteries (this is really one compartment with a shelf so that the batteries will pack better and keep out of each other's way) and the other holds the antenna wire, phones, tubes, etcetera.

Tuning is simplified to a considerable degree by having the phones in the plate circuit of the tubes. In order to find the proper tap for the filament lead, throw the switches for transmission and light the tubes up. Put the filament lead on the

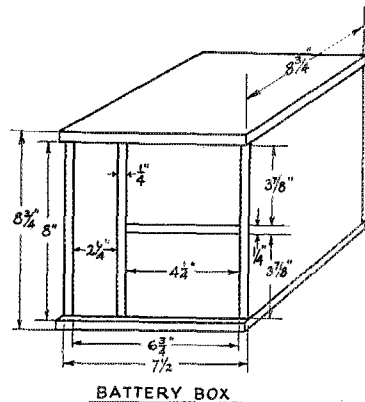
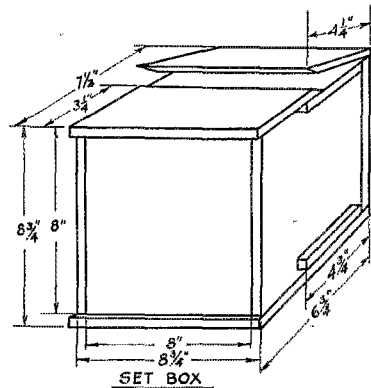

FIG. 3

tap nearest the grid end of the coil. Rotate the condenser across the primary coil and keep touching the metal pointer on the condenser. This is equivalent to touching either the grid or plate lead and will stop the tube from oscillating. As it stops and also as it starts when the finger is removed, a click will be heard in the phones. The condenser should be rotated over its whole scale and it may be noted that the set doesn't oscillate over that entire range. Try the filament lead at the next tap and test for oscillation. This will probably be all right. If not, try the tap farthest from the grid. If that doesn't work, there is probably something wrong in the connections or a defective piece of apparatus. Check everything over carefully and be sure that all soldered joints are making

denser—say 500 micro-microfarads on 40 meters—the most striking stability can be obtained even with fluctuating supply voltages and a shaky antenna system. Heavy conductors and a very excellent condenser in the oscillatory circuit are essential, and some power may be sacrificed. At the same time, the result is decidedly worthwhile.

And lest it be forgotten, I will insist that all of these adjustments can be made satisfactorily only with the aid of the "Growler" or some similar oscillator.

THE NOTE AND KEYING

And now take a look at Fig. 4. Neglecting the filter system entirely, and apart altogether from the keying method used, it will be found that the note and the keying are tied hand in hand with filament voltage, grid leak resistance, grid condenser capacity, grid excitation, antenna coupling and antenna tuning.

When "bright" (tungsten) filament tubes are used, filament voltage is of great importance. Sometimes it will be found that the rated voltage is sufficient, but unfortunately it is often impossible to clean up the signals unless the normal rating is exceeded. The alternative is to increase the grid leak resistance, when the desirable condition will be reached with lower filament brilliancy. The modern "dull" (oxide coated or "XL") filaments are not nearly as critical in this regard.

Passing over the grid excitation and adjustments in the grid circuit, to which reference has already been made, emphasis must be placed on the matter of antenna coupling. Aside from considerations of efficiency it will be found that this coupling has the most marked effect over key chirps, key thumps and the note. By varying the coupling and antenna tuning, points will be found where the note clears, where chirps disappear, and where thumps are greatly reduced. It is often difficult and sometimes impossible to combine all the necessities in one adjustment but the "Growler" will serve to indicate a practical mean. Antenna tuning also must be observed with particular care. In some cases severe chirps or a mushy note found on one side of the resonance point will disappear when resonance is approached from the other side!

Of course the conditions in all transmitters will differ very greatly and consequently it is quite impossible to give detailed instructions that will hold good in all cases. The entire purpose of this article will have been fulfilled, however, if it has indicated the relatively unknown field for the improvement of amateur stations provided by the ordinary knobs and clips. And it surely is relatively unknown! Out of four-hundred queries received by the In-

formation Service relative to this very matter during the last five months not more than two inquirers indicated any knowledge of the fact that the note and keying are influenced by factors other than the filter and keying system. What a display of clean cut, worthwhile signals the amateur bands would be if all the world's amateurs listened to their own signals and studied them!

Concerning QST Contributions

OCCASIONALLY a contributor does not understand the peculiar situation of *QST* and therefore it seems wise to explain that this magazine is, as the latter part of its title says, "devoted exclusively to amateur radio." It is not required to pay dividends to stockholders as most magazines are. The income which could be used in that way is, instead, used to operate an Information Service and to support the American Radio Relay League which has no other income. Since each subscriber to *QST* is also a member of the A.R.R.L. the profits of the magazine are in the end all returned as service to the subscriber, either thru the Information Service or else thru one of the League's activities—the Communications Department, the work of the Field Man, the participation of A.R.R.L. in expeditions, emergency work, military networks or transmission experiments with commercial firms or government departments and finally thru the less easily defined kinds of work such as the representation of the amateur in his dealings with the government or his contact with international radio and in the experimental investigation of the new things in radio. In all these the A.R.R.L. has an honorable history.

QST is therefore a magazine serving those who support it. For that reason articles are not paid for but are regarded as contributions from the author to the international art of radio. Under this policy this magazine has received every article printed during its history.

—R. S. K.



An Investigation of the 5-Meter Band

By E. M. Guyer and O. C. Austin*

THE ORIGINAL objective was in an entirely different direction when the high frequency work was undertaken. An immediate need of a high frequency generator compelled us to investigate the use of a vacuum tube in obtaining the desired frequency. With the common type of tubes such as the 201-A, the 20-meter band was easily reached. At a wavelength of 18 meters, using the series fed Hartley circuit, we experienced our first difficulty. In measuring the frequency, we had been using a two-turn coil shunting a 50- μ fd. variable condenser which had been roughly calibrated to 50 meters. Below that, we had been merely guessing at it. The two-turn coil was now abandoned and a one-turn coil substituted. We roughly computed its range as being from 1 to 10 meters. We were able to tune this tank circuit to that of the transmitter and we felt reasonably sure that our transmitter was oscillating in the neighborhood of 5 meters. A two-wire Lecher system was set up and we endeavored to measure our wave by this means. The ends of the two-wire system were connected to a coupling coil which in turn was coupled quite closely to the inductance of the transmitter. In locating the nodal points, it was found that after locating two with a shunt of wire the space between the shunts could in turn be divided, indicating that the system was rich in harmonics. As our two-wire system was only about 8 meters long we could not be sure of our exact wavelength. By computing the inductance of the one-turn coil across our condenser, it was found that we had the transmitter tuned to approximately 17 meters. Loosening the coupling remedied the situation. No further trouble was henceforth experienced and 201-A tubes were made to oscillate down to about 1.3 meters. About this same time, Kruse came out in the 1924, October issue of *QST* (Vol. 8) with details of a 5-meter transmitter and plans for communication on this amateur band. A new transmitter, No. 1, (the original being a "hay-wire" set up), was built, also a receiver to match it, and put on the air with no results. A transmitter had also been built at 9EK, the same set being

used for receiving, and an attempt made to communicate with 9AKR. Although the two stations were only about three miles apart, nothing was heard at either station. This was probably due to a difference in frequency as the transmitter at 9AKR was very crude, very little attention being given to the problem of tuning the transmitter, faults in receiver design, etcetera. In the course of events, four transmitters and two receivers operating on the 5-meter band were constructed. No actual communica-

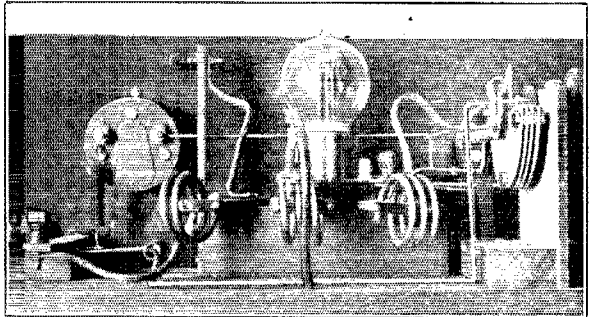

5-METER TRANSMITTER NO. 1

In the photo may be seen the following:

- Milliammeter—0-50
- Antenna coupling coil consisting of 2 turns of No. 4 bare copper wire.
- Plate coil consisting of 3 turns of No. 4 bare copper wire with movable tap.
- Grid coil consisting of 3 turns of No. 4 bare copper wire.
- V.T. is a W.E. No. 216-A.
- Plate stopping condenser is a 3-plate variable condenser.
- Radio frequency chokes are wound on a $\frac{1}{2}$ -inch diameter and have 20 turns. They are put in all filament and plate leads.
- Plate source was from about 200 volts of Burgess "B's".
- Tuning was done by changing number of turns on plate and grid coil. Antenna current was about .4 amp. This set was the result of the "hay-wire" laboratory set.
- The circuit was a series fed Hartley.

tion was carried on and that phase of it was dropped. Stability of the No. 3 transmitter was then investigated. The transmitter was set up in a large room and filament and plate current supplied. Another transmitter, No. 4, was put along side and tuned to beat with No. 3. A crystal detector was used to pick up the beat note. It was found that both temperature and humidity varying from day to day seriously affected calibration. An additional body or mass introduced into the room also shifted the frequency. An attempt was made to shield the transmitter, and this helped some, the shield having to be made "watertight" before any degree of steadiness could be obtained. The frequency variation by temperature and humidity was proved by placing one of the transmitters under a glass

* 9AKR, 206 N. Orchard St., Madison, Wisconsin.

jar and introducing a small amount of H_2SO_4 (sulphuric acid). Lack of time prevented any additional characteristics being worked out.

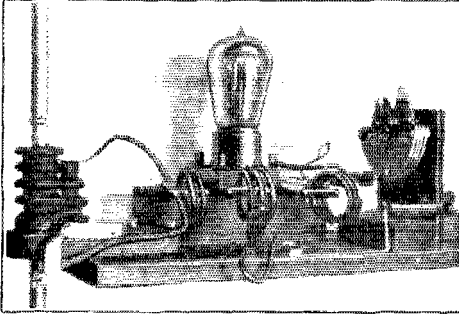

5-METER TRANSMITTER NO. 3

Very similar to No. 1 with the exception of the antenna system. Hertzian system used consisting of 2 brass tubes, each 762 cms. long.

Antenna tuning condenser and ammeter have been removed from set. Antenna current of No. 3 was about .7 amp. using a 5-watt RCA tube with 350 volts on the plate.

The circuit was the series fed Hartley.

A magnatron type of tube would be much more suitable for waves around 2 meters

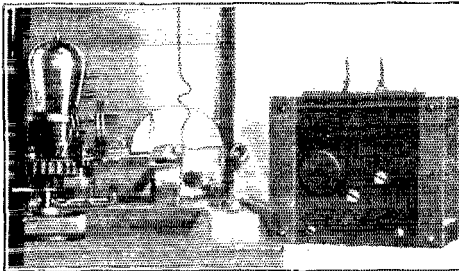

5 METER TRANSMITTER AT 9AKR NO. 4

Circuit series fed Hartley tuned with a two-plate condenser across the grid and plate of the tube. Picture shows set shielded with copper screening. This had very little effect on stabilizing the frequency. The two-plate mounted condenser with an extension knob shown alongside of the set was used as a wavemeter. One turn of No. 9 copper wire connected to the two terminals.

as a current of a few amperes would control the tube's electron emission. A tube of this type is now being constructed, and I hope to be able to continue high frequency work below one meter.

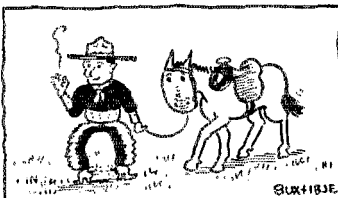

CHARACTERISTIC CURVE

The Hudson Division Convention

A SECOND annual convention of the Hudson Division of A.R.R.L. was held at the Hotel Pennsylvania in New York City on June 3d and 4th.

The usual meetings, contests and banquet were held, talks being made by Army representatives, the Directors of the Hudson and Atlantic divisions and by members of the Communications Dept. organization of the Division, also by President Maxim and by members of the headquarters organization of A.R.R.L. The technical program consisted of a very excellent antenna demonstration by R. B. Bourne of IANA and some talks by several men from A.R.R.L. headquarters. Mr. Bourne's talk unfortunately cannot be reproduced on paper but other talks will appear in *QST*, one being found in this issue. The $\frac{3}{4}$ -meter amateur band was formally opened for A.R.R.L. use by a demonstration message at the Saturday afternoon meeting, staged by Kruse from *QST* and Boyd Phelps of 2EB. The banquet that night, with President Maxim as principal speaker, concluded the affair.

Strays

Here is a suggestion from 9KB for those who are trying to adjust the position of the feeder in a single wire feed line. The biggest obstacle in this work is the lack of communication between the man at the set and the one on the roof and this may be overcome in a simple manner. Two ordinary head sets are connected together with a piece of lamp cord or any other double conductor that is long enough to reach from the set to the roof. One phone of the head set is taken out of its holder and used as a "transmitter" and the other is worn in the normal fashion. If necessary, a 4.5 volt "C" battery may be placed in the circuit to boost the signal strength but good results will be obtained without this. It certainly helps in this sort of a job.

If you are using the new 852 transmitting tube, be sure to twist together the double leads from the plate and grid. Otherwise, if only one of these leads is used, there is apt to be considerable heating that may prove disastrous. The twisting should extend right to the glass seal but be sure you don't get too enthusiastic and break both off short.

The Radio Engineering Labs have strayed from their old quarters in N. Y. C. and are now located at 100 Wilbur Avenue, Long Island City, N. Y.

Radio Frequency Sparking Distances

By Alexander Nyman*

OF the different means for measuring radio frequency voltage the spark gap is probably the simplest, and most satisfactory means when the voltage is anywhere in excess of 1000 volts. Its main advantages are that it can be operated at any frequency and that the current it draws from the line is entirely negligible, even at the highest frequencies, running into several thousand kilocycles, and that the simplicity of construction and cheapness can place it in the hands of most of the experimenters.

Figure 1 shows an experimental spark gap which has been used with much satisfaction in measuring the voltage, for tests on insulators, condensers and other high frequency transmitting appliances.

It will be seen that it consists of a micrometer type sphere gap, where the two gaps are separated by long pyrex glass tubes and shielded with a cylindrical copper shield connected to one of the terminals (this shield is shown in a raised position to expose the sphere gap).

It is of course necessary to supply specially good insulation at radio frequency, as any dielectric strain is liable to cause rapid deterioration in any such insulating materials as wood, bakelite or hard rubber. It is for this reason that pyrex glass was chosen as the main supporting element. It is also evident that long rods of this nature would give very low capacity to the instrument.

Although this is not shown clearly in the picture, the metallic parts on the top which are exposed are carefully rounded off to prevent corona.

The sheet copper clamps holding the glass tubes are all turned with their sharp edges inwards, so that there is no corona on these edges. In use the lower terminal is generally rounded and the micrometer screw is operated by means of a long glass rod with a piece of rubber tube at the end.

One way of operating the device is to set it for a certain spacing which has been determined experimentally as the setting for a definite voltage, and then raising the voltage of the supply until it sparks across the terminals. The other way to use the device is to measure the voltage in the circuit by turning the micrometer screw very slowly until a spark occurs.

Repeated sparks on the same sphere gaps would gradually occur at lower voltages because burning or pitting occurs on the spheres if the voltage is not discon-

nected immediately. However, if the surface of the spheres is cleaned with fine emery cloth before every discharge, the sparking distance remains consistent.

To overcome this difficulty it is possible to arrange a small air blast next to the gap, conducting the air by means of a glass tube and blowing out the little arc that follows the spark. With such an arrange-

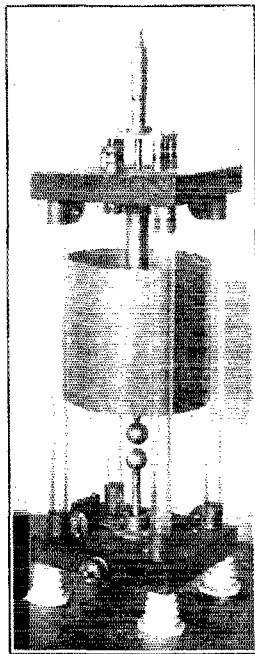

FIG. 1.—SPHERE-GAP VOLTMETER FOR HIGH VOLTAGES AT LOW OR HIGH FREQUENCIES

The upper sphere is carried by a rod operated by a micrometer head which may be taken from an ordinary "mike" or purchased separately. The lower sphere is mounted solidly. One or the other must be screwed on its rod so that the micrometer head can be made to read zero when the balls just touch. The size of the apparatus may be judged from the fact that the balls are 2cm. in diameter and the micrometer head is standard. The copper shield is normally dropped down to the base and connected to the lower ball.

ment the sparking distance was maintained constant for an indefinite number of discharges.

It was soon found that the d.c. or 60-cycle calibration of sphere gap were *entirely inaccurate* at radio frequency and considerable effort was exercised to secure correct calibration at radio frequency. For

*Dunhill Condenser Corporation, 4877 Bronx Boulevard, New York City.

Reducing Static at Short Waves

ONE reads a good bit these days of various methods for reducing static. Peculiarly enough the ones that get the most attention are not at all the ones that transmitting amateurs have found to be most successful. The loop is constantly being set up as being a great device for reducing static. Now in point of fact, the ordinary loop picks up just about as much energy from a signal as does a ten-foot antenna, and between the two the 10-foot antenna is decidedly easier to handle, gives just as good signals, and gives no more static. However, the 10-foot an-

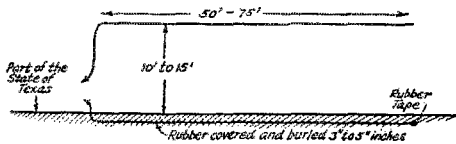

FIG. 1. THE UNDERGROUND "ANTENNA" SYSTEM AT 3HS

tenna only does give "just as good" signals, and that isn't very good. Neither one of the two devices strikes me as being worth while for serious long distance receiving during difficult weather.

GROUND WIRE.

Mr. Cecil Patterson of 5VU at Frost, Texas, some time ago recalled to my attention the very great usefulness of a buried wire for receiving during the summer. There is nothing new about this; work was done on it many years ago by Wien in Germany and subsequently by Rogers in this country but as far as I know it was not applied to amateur work until 1920 at which time it was used by Kral of 3HS at Washington, D. C., the detailed results being reported in a Washington Radio Club bulletin. It was found possible to receive consistently at this station through conditions that made reception with an antenna absolutely impossible, no matter how small the antenna was. In this case the pick-up wire was about 35 feet long and made of ordinary rubber covered house-wire with the end put in a bottle of asphalt. It was buried as shown in figure 1. There was very little possibility of any fake effect because the station itself was below the ground level and the antenna had to go down to get to it. The ground lead was only a few inches long and went immediately back into the earth in the same yard where the pick-up wire was buried. There was an antenna on the premises but the results were not changed in the slightest

degree by grounding, ungrounding, or even removing this antenna. Since space at 3ABI, the writer's station at the time, did not permit checking the results we went into a vacant lot and ran tests with various members of the Washington Radio Club on one particularly hot Fourth of July when local thunderstorms were scurrying around the District of Columbia. Our transmission results were poor enough. We could transmit with the buried wire but the range was low for the power and some bad directional effects were encountered. The receiving was very satisfactory and in consequence the wire was buried at 3ABI in the small space available. It did not prove successful, probably because of the very long lead in which had to go up to the third story.

At 5VU a buried wire was also used but serves as a counterpoise and therefore belongs in the next paragraph.

RECEIVING COUNTERPOISES

A great deal can be done towards removal of static by simply lowering the antenna to a point less than 20 feet above the

| Test | Antenna | Result |
|--|--------------------|---|
| A | 100' Buried 6" | Reception good at 200 and 600 meters. Transmission fair to S.W. and N.E. only. On 180, 250 and 300 meters. |
| B | 50' buried 6" | Reception good at 200 but poor at 600 meters. Transmission poor at all three waves. |
| C | 100' buried 12" | Results all thru same as in test A. |
| D | 100' top of ground | All reception very weak. Transmission tried only at 250 where very weak. |
| E | 100' 4' off ground | Reception weaker than others. Static stronger. Transmission very poor 300, fair 250, and about equal to A for 180 meters. |
| Earth a dry clay of very high resistance, results probably different for other soils. Observation stations from 1 to 6 miles away. | | |

FIG. 2. WASHINGTON RADIO CLUB TESTS ON RECEPTION AND TRANSMISSION WITH UNDERGROUND WIRES

All tests made with one ground connection to a hydrant and with other terminal of set to various wires all laid to the southeast of the set. Buried wires rubber covered No. 14 house wire.

earth and then dispensing with the ground connection in favor of the counterpoise. The counterpoise may be several wires spanned out and suspended about three feet above the ground. If the family owns a garden this process seldom meets with very great favor and one must resort to the device used at 5VU. This is to use a receiving counterpoise very much like the buried receiving antenna at 3HS. Mr. Patterson recommends an antenna fifteen feet

Keying the Amplifier

By A. G. Shafer*

A GREAT deal of material has been published in the past, regarding keying systems, so much so, that the subject would appear to be well nigh exhausted. Inasmuch as this article has to do with crystal-controlled transmitters in particular and oscillator-amplifier systems in general, it would seem to be "just another of those things". However the method to be described is really different from those previously expounded and the success has been so gratifying that it would be selfish, if nothing more, not to pass the information along. Whereas this method has been worked out for crystal transmitters it is also applicable to oscillator-amplifier systems without crystal control. In using it with straight oscillators the writer has had no great success. But more of that later.

Many of the articles on crystal transmitters have circuits showing the key placed in the high voltage lead of one of the intermediate amplifiers, or in some other position where a key-thump filter is a positive necessity. Now a key-thump filter is a highly effective piece of apparatus after it is once adjusted to the load it has to carry but let that particular load vary to an appreciable extent and the filter becomes a detriment rather than an aid to stopping the BCLs from sending a round-robin to the Radio Inspector. The load on an intermediate amplifier, while fairly constant during an extended period of transmission is subject to some variation during the time when things are warming up, to say nothing of the changes made by the operator himself.

To give an example of a representative case: At the Lansdowne Radio Association's station, 3BQJ, the radiating system consists of a vertical 30-foot antenna and a horizontal 30-foot counterpoise. Suspended from the same pole as the antenna is the aerial of a BCL receiver. The ends of the two antennas are about fifteen feet apart. (It should be explained here that the BCL is the owner of the club house and is not a transmitting amateur himself. Enough said!) The club transmitter is, briefly, a 250-watt amplifier fed from a cascade frequency-doubling system using three UX-210's and a 164-meter crystal, putting 41-meter power into the antenna. A diagram of the transmitter is shown, which with the data under it, is self-explanatory. The meters and the connections of the filaments are left out for the sake of clarity. It should be pointed out, however, that the

filaments are heated by a.c. from center-tapped transformers and these center-taps are connected together, the negative high voltage and positive grid biasing voltage being also connected to these center-taps. Suitable by-pass condensers are also included in the filament circuits. Plate voltage is supplied by two high-voltage transformers. One has 750 volts each side of center-tap and the other has 1100 volts each side. These are connected to two chemical rectifiers. One consists of thirty jars and the other of forty-six jars. The output of these rectifiers is connected in series and the 500-volt supply for the intermediate amplifiers as well as the 350 volts for the

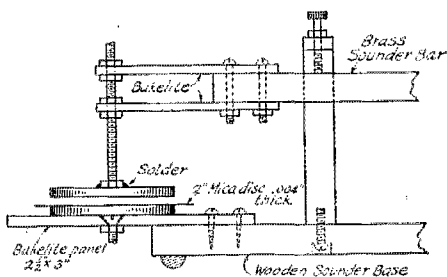

oscillator tube is obtained thru resistances in series with the tap from the 750-volt output. Grid bias is obtained from a group of Diamond "B" Batteries. Various filters have been tried on the plate supply but the note obtained with the unfiltered d.c. is more satisfactory to copy.

Every known system of keying (and a few unknown systems) was tried and the result was the same. The anvil chorus was in the BCL receiver. The condition was thought hopeless; until the writer recalled a conversation with Dr. Woodruff, the Atlantic Division Director, some time ago, concerning the keying system in use at one of the commercial stations. This consisted in raising and lowering the top plate of the crystal holder and was said to work beautifully. As can readily be seen this would require an extremely accurate job of machine work to limit the travel of the top plate so as not to hammer the crystal. The idea, however, seemed promising; for all that was needed was to vary the output of the crystal or one of the intermediate stages without actually breaking any circuit.

Previously, some work had been done by the writer in determining how small the feed

* President, Lansdowne Radio Association and operator of 3ACF, 4410 Bond Ave., Upper Darby, Pa.

condensers C_4 and C_5 could be in the various stages and it was found that for 80-meter work, 200 μ fd. was sufficient while for 40-meter work 80 or 90 μ fd. was plenty. A decrease in these values naturally resulted in a decrease in output. Why not key the transmitter by varying the capacity of one of these condensers in accordance with the well known "dots-and-dashes"?

Consequently, an old telegraph sounder was dissected and an insulated arm about three inches long was secured to the brass sounder bar making, in effect, an extended bar. As the drawing shows, this insulated arm is really two pieces of $\frac{1}{8}$ " bakelite

adjusted rather strongly to balance the weight of the added disc. It was not thought necessary to show the complete sounder as practically everyone knows what one looks like. Incidentally the capacity of this condenser-relay when depressed is about 400 μ fd. and when in the "up" position is less than 25 μ fd. At the first trial, the relay was connected between the grid of the 250-wattter and the 2nd amplifier. This position is marked by K_2 . The set was adjusted with the relay down and when the key was operated, all trace of thump or click was removed not only from the BCL receiver but from a 40-meter receiver located about five feet from the transmitter. A blanketing effect was present in the BCL receiver on distant stations but this was removed by placing a 41-meter wave trap in the BCL antenna lead to his set. Of course the 40-meter club receiver is blanketed with the key depressed, but due to the absence of the terrific thump it is possible to work break-in without discomfort of any kind—an impossibility heretofore.

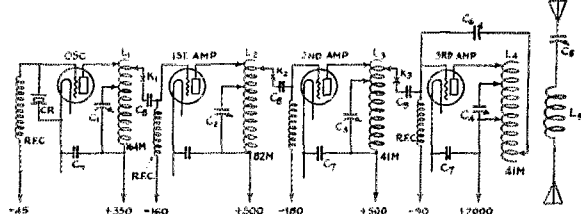

EXPLANATION OF SYMBOLS IN CIRCUIT DIAGRAM

- C_1, C_2, C_3 —500 μ fd. variable condensers
 C_4, C_5 —200 μ fd. variable condensers
 C_6 —125 μ fd. neutralizing condenser
 C_7 —2000 μ fd. fixed mica condensers
 C_8 —500 μ fd. fixed mica condensers (feed condensers)
 C_9 —90 μ fd. fixed air feed condenser
 L_1 —14 turns No. 22 Enameled Space wound $\frac{1}{4}$ " apart on 3" Bakelite Form
 L_2 —10 turns 1 32" x $\frac{1}{4}$ " H. D. copper strip edgewise wound 3/16" spacing. C_2 across six turns
 L_3 —10 turns same as L_2 . C_3 across three turns
 L_4 —12 turns $\frac{1}{4}$ " copper tubing 4" diameter spaced $\frac{1}{4}$ " apart. C_4 across five turns. Neutralizing portion about four turns
 L_5 —Four turns same as L_4
 RFC—In Oscillator grid circuit three spider-web wound coils of forty turns each mounted in series aiding about $\frac{3}{4}$ " apart on glass tube. Other RFC's are of 150 turns No. 24 D.C.C. on 1" dia. cardboard tube
 CR—Crystal, 164 meters, and holder
 OSC, 1st amp., and 2nd amp.—UX-210's. 3rd amp.—UV-204

The figures, such as 164 M, at the lower right side of the inductances refer to the wave to which the respective circuit is tuned

$\frac{3}{8}$ " wide bolted one above and the other below the bar. To the outer end of this arm is secured a long screw which carries on its lower end a disc of aluminum or other metal. This disc is $1\frac{1}{2}$ " in diameter and the disc below it is the same size. This lower disc is fastened to the insulating base by a flat headed screw soldered to its under side in the center. On the top surface of the lower disc is glued or cemented a 2" disc of mica .004" thick. As may be seen, the two metal discs with the mica between will be pressed tightly together when the sounder windings are energized. The upward travel of the sounder bar is limited by the adjustment of the thumb screw shown on the right side of the drawing. The spring which is a part of the sounder is of course left on the sounder and has to be

adjusted rather strongly to balance the weight of the added disc. It was not thought necessary to show the complete sounder as practically everyone knows what one looks like. Incidentally the capacity of this condenser-relay when depressed is about 400 μ fd. and when in the "up" position is less than 25 μ fd. At the first trial, the relay was connected between the grid of the 250-wattter and the 2nd amplifier. This position is marked by K_2 . The set was adjusted with the relay down and when the key was operated, all trace of thump or click was removed not only from the BCL receiver but from a 40-meter receiver located about five feet from the transmitter. A blanketing effect was present in the BCL receiver on distant stations but this was removed by placing a 41-meter wave trap in the BCL antenna lead to his set. Of course the 40-meter club receiver is blanketed with the key depressed, but due to the absence of the terrific thump it is possible to work break-in without discomfort of any kind—an impossibility heretofore.

With the relay in this position a rise in plate current was experienced in the 2nd amplifier whenever the key was up which caused this tube to run unduly warm. The relay was then tried in the K_1 position where it functioned perfectly but with a rise in plate current in the 1st amplifier. Then the relay was placed in the K_2 position where it still worked quite nicely and where it caused no undesirable plate current variations. It will be seen that with the relay in this last position the effect, besides that of keying the set, is to vary the effective capacity across the inductance L. This naturally changes the tuning of the circuit L C_1 but with crystal control does not affect the frequency of the oscillator. The oscillator circuit is tuned with the relay depressed and it may be tuned to the very "peak" or position for maximum output and then when the key is released the tuning of this circuit automatically drops back to a point where the danger of the crystal stopping oscillation is less. This will be appreciated by those who have had experience with crystal transmitters.

As to the capacity-relay's application to

1. It is quite possible to key directly in these r. f. feeder lines. It may be of help to shunt the keying contacts with a small condenser (25 μ fd.) which should give a condition almost similar to the use of a "capacitive relay" as described above.

Since calibrating the wavemeter in the 20 m. band, as described in the foregoing, by harmonics from signals of longer wavelengths, we have had an opportunity to check it against 9XL from 25 to 15 m. inclusive, and have found it to be as correct as the coarseness of its readings will permit its determination, certainly closer than 0.2 m. in the band mentioned.

Aluminum Frames

THERE are many times when one would like to have an all-metal cabinet for a receiver or transmitter. This is particularly true of the man who is putting in a crystal or other amplifier-oscillator arrangement.

If you have ever collected together six metal plates with the intention of soldering them together in the form of a box, you will appreciate the extent of the job as well as the distorted product that usually re-

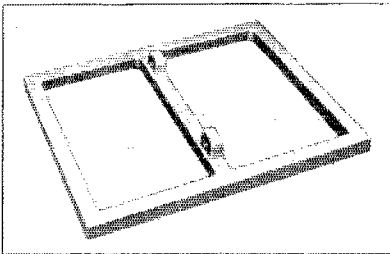

sults. Your troubles are materially reduced though, if you are able to get some sort of a skeleton frame to start with. The illustration shows a cast aluminum frame that should prove of great help.

The cross section is 5/8" square. The outside dimensions are 10 inches by 12 inches and there is a dividing column located almost in the center. This has two raised portions to which may be screwed a plate of metal to make two separate compartments. They may be obtained from the Radio Engineering Laboratories of 100 Wilbur Street, Long Island City, N. Y.

—H. P. W.

Concerning Those "Phone" Articles

THERE has been some excitement because of our statement that *QST* will consider the use of some material on radiophones.

Let us make our position perfectly clear.

We believe that with few exceptions, the American amateur radiophone is very poor in all its parts, oscillator, plate supply, modulator and microphone. We think that such stations are not desirable and that we should give no space to information about them.

On the other hand, we feel that if there is to be amateur radiotelephony it is better to have good stations than bad ones and that it is proper for *QST* to give some space to high grade amateur radiophones in which many A.R.R.L. members are showing an interest.

It is our view that a good radiophone is a thing that must be built with much more care than a c.w. station and that one must begin by understanding this and also being ready to spend at least as much for the speech end as for the rest of the station apparatus. A good radiophone must have an oscillator better than we are used to, must have an almost perfect power supply for the plate, must have a first-rate microphone and a speech amplifier that compares favorably with the ones used to work loudspeakers in broadcast reception. The percentage of modulation must be reasonably high, therefore the system used must be a sound one and not of the "freak" variety.

From this one can see that good low-power phone seems a better thing than the large mediocre phone.

This means that while we are interested in actual high grade radiophone stations to a degree we are of the opinion that more good will be done by discussions of the things that go to make a radiophone station: "the radiophone oscillator, how it must differ from the c.w. oscillator"; "plate supply and filter systems for radiophones"; "modulation systems"; "what ails your speech amplifier?" and "adjusting the radiophone."

If such material can be obtained—if any reader knows where to get it—then it seems entitled to be considered with *QST*'s other material and to be allowed space in the magazine in case it is able to stand the test of comparison with other contributions. If it cannot stand that test it does not belong in the magazine, just as the phone itself will deserve more space in the ether only if it can prove itself the equal of c.w. in effectiveness without an undue creation of undesirable situations.

—R. S. K.

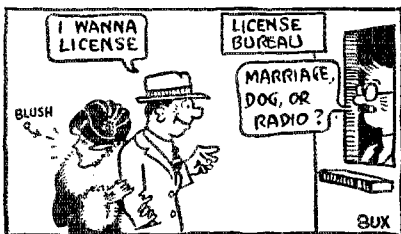

APPLYING FOR A LICENSE

A Constant Frequency Transmitter

By W. H. Hoffman *

PROBABLY the hardest problem with which the amateur and experimenter has to struggle in connection with low wave (or high frequency) transmission is that of maintaining his transmitter at a constant frequency as long as desired while still retaining the ability to shift rapidly to another (and equally steady) frequency. If, after choosing a suitable frequency, the transmitter will maintain this frequency to a high degree of accuracy, regardless of a swinging antenna, a vibrating building or a fluctuating power supply, then, a big step forward toward the ideal arrangement will have been made. None the less, one must be able to shift at times.

Where dozens of transmitters are placed into operation within given limits or bands as assigned to the amateur, it is often a

THE TRANSMITTER DEVELOPMENT

Taking a birds-eye-view of tube transmitters, as they have entered the field, we see first, the tube oscillator which employs the capacity and the inductance of the antenna circuit to form a portion of the oscillating circuit itself. We used to call such an arrangement "directly coupled." However, this sort of set is now obsolete and deserves no further mention.

In Figure 1A, we have a tube oscillator which has a tuned primary circuit $L_1 C_1$ made of coils and condensers, this circuit being "loosely coupled" to the antenna circuit. This is the way most of our stations are made today.

In Figure 1B, the tube oscillator has a tuned circuit $L_1 C_1$ of coils and condensers as in case "A" but the energy from this tuned circuit is put through a radio frequency amplifier before going to the antenna.

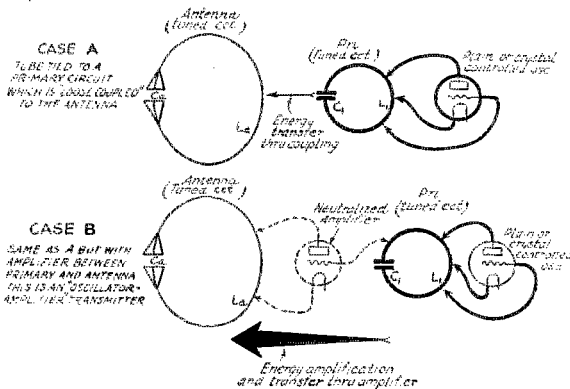

FIG. 1. THE TYPES OF SENDING SETS USED TODAY

Case A represents most of the sets in use. Case B simply puts an amplifier between the primary and antenna circuits. One may look at the two sets as differing only because the case B set gets its coupling thru an amplifier. Such a coupling makes it possible to create a very steady signal.

decided advantage, where interference conditions exist, to be able to shift a transmitter from one definite frequency value to that of another value.

The crystal controlled transmitter seems to be the nearest approach to the ideal today. There is a tendency to overlook the fact that other oscillator arrangements are capable of maintaining frequency constant to a surprising degree of accuracy if properly designed and assembled. This paper will describe such a non-crystal device.

* 9EK-9XH, C. F. Burgess Laboratories Inc., Madison, Wis.

STEADYING THE OSCILLATOR

Ordinary oscillators shift frequency whenever there is a change in:

The load (this means a swinging antenna or feed line).

The plate voltage (change in line voltage or key surges).

The filament voltage (from keying or other causes).

Tube vibration also causes wobbles in the note.

It is necessary to build an oscillator which does not suffer from any of these effects. A crystal oscillator is generally considered to be the best. For the government and the commercial needs, this may be true, however, for experimental and amateur use, this type of transmitter has its disadvantages. Some of these are as follows.

- (1) Cost.
- (2) Does not allow of wave shift or QSY.

Our real problem then is to make a non-crystal-control oscillator which either does not suffer from the changes in load and voltage or else is protected from them.

THE NEUTRALIZED AMPLIFIER

To protect the oscillator from the changes of load caused by swinging antennas, etc., one may use the arrangement of Figure 1, case B. Here we come rather

close to having a "one-way" coupling, which allows power to flow through to the antenna but does not allow antenna

power from oscillating and it reduces "back coupling" between the antenna circuit and the oscillator circuit to a value that approaches zero. The exact circuit used for the neutralizing does not matter, though ordinarily it is convenient to use an arrangement akin to the Rice or Hazeltine systems.

The neutralized amplifier, fortunately, retains all its advantages when used follow-

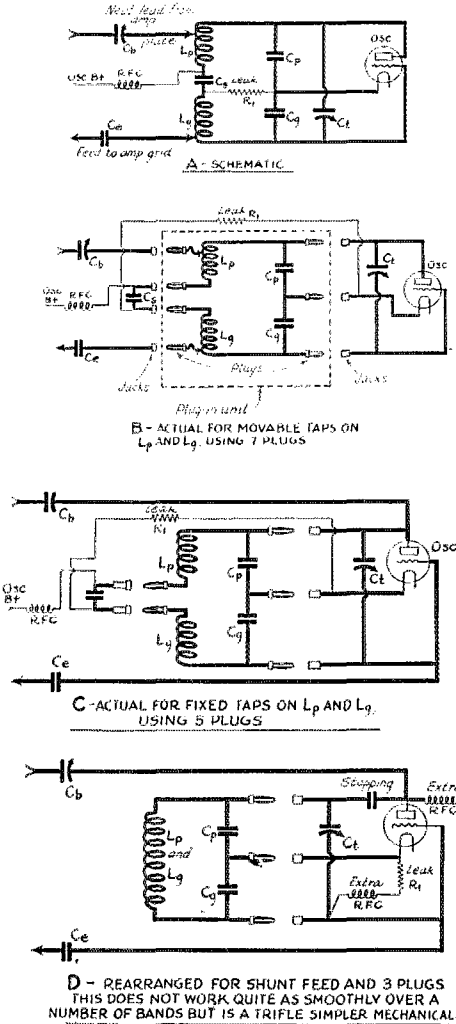
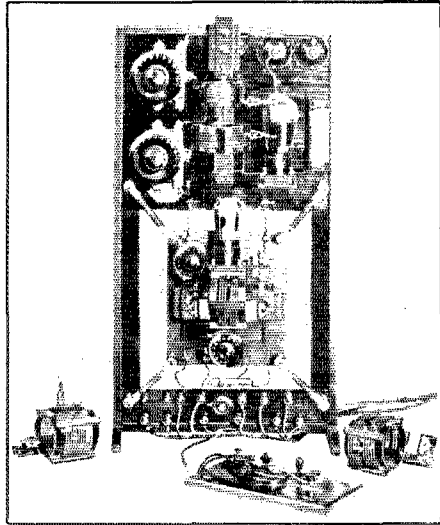

FIG. 2. WIRING DIAGRAMS OF THE PLUG-IN TUNED CIRCUITS

Diagram C is the one used in the present set. The heavy lines show the circuits carrying r.f. Some of these carry both r.f. and d.c., others carry r.f. only. The thin lines show circuits carrying d.c. only.

changes to work back and change the capacity and inductance of the amplifier plate circuit.

In this type of amplifier the coupling between the input and output circuits due to the capacity between the elements of the tube, is neutralized or balanced out. This is important for it prevents the ampli-



FRONT VIEW OF THE TRANSMITTER

The upper wooden panel carries the amplifier, and the spring-suspended rubber panel carries the oscillator. Nothing is mounted on the rear of the panel except a plate choke on the back of the oscillator panel.

The lower small panel is a terminal strip and also supports a filament rheostat for the oscillator tube. The power supply leads are cabled together.

The coils in position are those for the 40-meter band. Those shown at either side of the transmitter are for the 80-meter band. The 20-meter coils are not shown.

ing oscillators of the usual form, such as the Hartley or the Colpitts, as well as when used following the crystal oscillator.

THE OSCILLATOR

In order to approximate the stable frequency characteristics of the crystal controlled transmitter it is imperative first to produce a *stable oscillator*. Although not matching the frequency constancy of a crystal oscillator, it can be shown that the ordinary form of tube oscillator can, when connected in a proper arrangement, with suitable constants, be depended upon to maintain a constancy of frequency that is surprising and remarkable.

Some of the conditions that are desir-

able for obtaining oscillator stability are as follows:—

(1) Battery supply for source of plate and filament energy. Although uni-directional current may be obtained from rec-

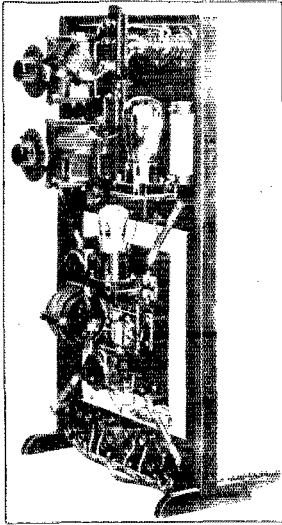

SIDE VIEW OF THE TRANSMITTER

Two porcelain, standoff insulators mounted at the top right-hand corner of the panel provides support for the antenna and the counterpoise terminals. Just to the left of them is the hinge and the slide support for the antenna coil. The amplifier plate choke is mounted beside the amplifier tube. The upper variable condenser tunes the antenna circuit while the one just below it provides tuning for the amplifier plate circuit. Of the two variable condensers on the suspended panel, the upper one is the neutralizing condenser and the lower one is the vernier tuning condenser.

tified a.c. and from a d.c. generator, it is found to be difficult to remove all of the ripple even with elaborate filter systems, when such sources are used to supply an oscillator at frequencies greater than 3000 kilocycles. Battery supply will give d.c. note characteristics that are difficult to obtain from any other source.

(2) The tube should not be "forced" or worked at an overload. The working of a tube so that its plate shows a difference in heating when the load is thrown on and off causes changes in the tubes characteristics such as will give unstable action.

(3) An oscillator circuit arrangement which includes relatively large capacities across the elements of the tube especially from the grid to the filament has been found desirable for obtaining stability.

(4) A high value of grid leak resistance has been found effective in reducing frequency changes caused by changes in plate and filament voltage supplies to a tube, working as an oscillator.

A TRANSMITTER WITH BATTERY DRIVEN OSCILLATOR

The transmitter described in the following paragraphs is one of low power. It is designed to use a tube of the UX-210 type as an amplifier and a receiving tube of the UX-201-A type as an oscillator. Such an oscillator with a 180-volt plate supply will furnish sufficient excitation to the grid of a UX-210 amplifier tube and as the drain from the oscillator source is only about 15 milliamperes, dry cells such as used on the ordinary radio receivers, are quite satisfactory and will give service over long periods.

THE SPECIAL OSCILLATOR

The oscillator is arranged in a series Colpitts circuit which automatically brings about the condition of relatively large capacities connected across the tube elements which is favorable for maintaining stability. The coils and condensers making up the circuit are closely grouped on the front of a small hard-rubber panel eight inches high and seven inches wide. The tuned circuit consisting of two fixed mica condensers C_p and C_r in series and the split coil L_p - L_s are mounted together on a small hard rubber strip measuring $1\frac{1}{2}$ " by $5\frac{1}{4}$ ". Connections terminate in spring plugs. This tuned circuit, as a unit, plugs into jacks on the main oscillator panel. In this manner, different condenser-coil arrangements, suitable for tuning at the different amateur wave bands, can quickly be plugged into or removed from the oscillator panel. Figure 2 indicates the connections. A 50 μ fd. variable condenser C is mounted on the main panel and connected across the fixed condensers. It acts as a "vernier" and provides for the exact adjustment to a given wavelength in the band covered by that coil system. In addition, the oscillator panel carries a fixed feed condenser C_a connected to the center panel of the inductance of the series Colpitts arrangement. This main panel also carries the amplifier feed condenser C_s and the amplifier neutralizing condenser C_n . The whole oscillator unit is hung from spring supports in order to absorb shocks and vibrations that would otherwise affect the stability. Connections to the unit are made by means of flexible leads.

THE AMPLIFIER

The amplifier grid or input circuit is supplied from the oscillator circuit. The amplifier is mounted on a hard wood panel which forms the upper part of the frame that supports the oscillator unit. The plate

1. A UX-171 may be used here. It will have a longer life and give greater output but will require more plate current which will reduce the life of the plate battery.—Asst. Tech. Ed.

method is obviously costly of space in the ether and should not be resorted to except for important work and where the necessary diversity factor cannot be obtained by one of the other schemes. The several transmitters may all be located at a convenient central point for it does not seem as though spreading out over a moderate area would add greatly to the diversity factor.

SEVERAL WAVE PATHS

Case IV. Here we select the next most favorable wavelength band and repeat the above schemes. For our example Figure 11 indicates the 18-meter band. In this way, use is made of a widely different path in the lower and upper atmosphere as well as different reflection points.

Before complicating things too much in an effort to obtain direct communication, we should of course consider the use of one or more relay stations. In this case, one at Panama or Pernambuco would probably be sufficient.

The numerical wavelength values deduced in the above examples are of course uncertain, due to our present lack of accurate data on the ionization conditions in the upper atmosphere. It is also clear that a great deal of systematic experimental work will be required before the relative merits of the various ways of increasing the diversity factor on short waves can be determined.

MAKING WAVE ACTION VISIBLE

The following optical experiment illustrates very beautifully the bending of radio waves in the upper atmosphere. The idea and necessary information for the experiment was obtained from the description of a similar experiment by Wood²³. Some difficulty was experienced at first in making the experiment work and therefore a rather detailed description is given below for those who wish to try it. The effect is very striking, and well worth the trouble of personal observation. Fig. 13 shows a general view of the apparatus used.

The plate glass trough about 18" long by 4" high by 2" wide is filled about one quarter full with the following solution which has previously been mixed up in a bottle:

Solution No. 1.—

400 c.c. of 95% grain alcohol (see note 24).

2000 c.c. of water.

200 c.c. of concentrated sulphate of quinine solution.

10 drops of concentrated H₂SO₄.

The sulphate of quinine solution which renders the solutions fluorescent, was made by stirring an excess of the powder in water and then filtering off the clear solution. It is very important to have all the solutions very nice and clear. A second heavier solution is then allowed to flow slowly under the first solution from the flask shown in the photograph. The second solution is fed in parallel to the bottom of the trough through a tube which has a small right

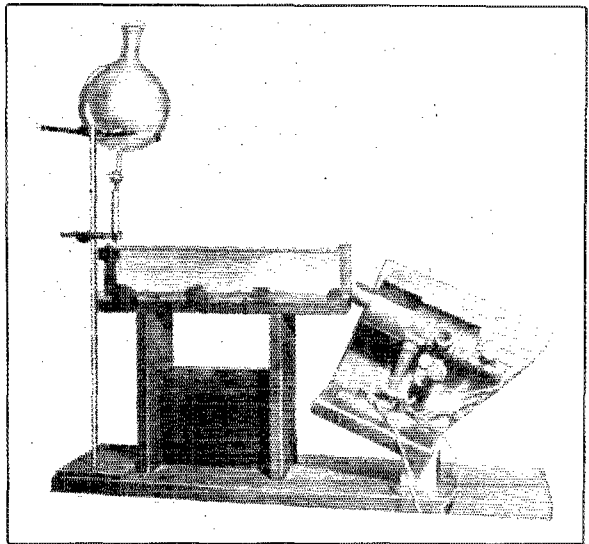

FIG. 13. OPTICAL APPARATUS TO ILLUSTRATE THE THEORY OF REFLECTION WHICH IS BEING DISCUSSED

The lantern at the right represents the transmitter and throws a ray of light, angling upward thru the end of the glass trough into a liquid which is to represent the air. This liquid is of two layers of which the upper is lighter and represents the thin ionized upper air. The two liquids are slightly diffused into each other where they meet, thus representing the diffused reflection condition of the Heaviside layer. The effect of putting the light ray in at different angles is shown in Fig. 14.

angled capillary at the bottom. The hole in the capillary is about the diameter of a pin. The flow is regulated by the stop cock shown on the flask. This second solution was from a bottle containing:

Solution No. 2.—

1500 c.c. clear pure glycerine.

900 c.c. 95% grain alcohol.

100 c.c. sulphate of quinine solution.

10 drops concentrated H₂SO₄.

24. A denatured alcohol was first tried and found to give milky solutions which are not suitable. Further trials would probably have shown that some of the various denaturing agents yield clear solutions which is all that is necessary.

23. R. W. Wood, Phil. Mag., Vol. 47, pp. 349, 1899.

rating. Form a single turn of fairly heavy wire about the same diameter as the amplifier plate coil. Connect the two ends of the single turn to the two terminals of the flashlight bulb. This may be done by using a miniature socket or by soldering directly to the bulb. Couple the single turn closely to the top of the amplifier plate coil. (Keep

depending on the method of feeding the antenna.

The set can be used in any of the standard arrangements operating any sort of an antenna on either its fundamental or a harmonic and feeding either by a "current feed" or a "voltage feed" method. Naturally also, a one-or two-wire feed line may be used if desirable or convenient.

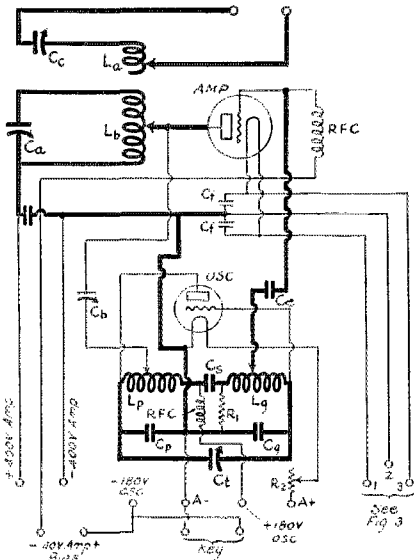

THE "UNSCRAMBLED" SCHEMATIC DIAGRAM IS SHOWN IN FIG. 3. THE HEAVY LINES SHOW THE R.F. CIRCUITS

Although voltages are marked on some of the terminals these may be changed, especially if a different tube combination is used.

the "plus 400" amplifier plate supply lead open.) With the key closed, turn the amplifier plate tuning condenser C_a until the flashlight bulb lights. Then, adjust the condenser C_b until the bulb goes out. Slight readjustment of C_a may be necessary due to slight detuning when C_b is changed. The proper adjustment has been found when the lamps stays dark while C_a is turned slowly across the resonance point, meaning resonance between this circuit and the oscillator. The amplifier tube is now neutralized. The "plus 400" lead may now be connected and the amplifier plate tap adjusted for best output. In the transmitter shown it was found that variable taps on the oscillator coils L_p and L_c were not necessary. The taps were permanently connected to the outside ends of the oscillator inductance. (See Figure 2.) The antenna circuit is tuned to resonance in the usual manner, the exact way of going about this naturally

Official Wavelength Stations

THE Official Wavelength System furnishes a service cooperative with, but differing from, that of the Standard Frequency Stations 9XL and 1XM, which are also operated in accordance with plans made with the O.W.L.S. Committee. Contact with the O.W.L.S. is through Mr. D. C. Wallace, 6AM, who is also chairman of the committee. Mr. Wallace is at present checking up all O.W.L.S. to make sure that they are really indicating their wavelength (or frequency) at the end of each transmission—and are doing so with proper accuracy; which is to say 2%. They do this in the course of regular operation and do not send calibration schedules as do the S.F. stations.

The list is as follows:

- 1AAC, 1AVW, 1AWW, 1BHW, 1BZQ, 1CCW, 1CK, 1KP-NRRC, 1ZL, 1ZO, 2CLA, 2DS, 2MU, 2SZ, 2XI, 3APV, 3BE, 3XW, 4LK, 5AGN, 5AKN, 5EW, 5MN, 5OX, 5PH, 5SP, 5XBH, 5ZAV, 6AKW, 6AM, 6BB, 6BCP, 6BGM, 6QB, 6CAE, 6CDN, 6CDY, 6CVO, 6LJ, 6SX, 6TI, 6TS, 6XAG, 6XAO, 6ZE, 6ZZH, 6ZV, 7AGL, 7BE, 7BU, 7CQ, 7NX, 7QK, 7XF, 7ZX, 8AA, 8APZ, 8BAU, 8BZT, 8EQ, 8GU, 8GZ, 8XC, 8ZG, 9AXQ, 9BCH, 9BGK, 9BMR, 9CPM, 9CXU, 9DXN, 9EGU, 9ELB, 9FF, 9IG, 9WI, nc1AE, nc2BE, nc3CO, nc3NI, nc3FC, nc4BT, nc4FV, nc9AL, eg2OD, eg2SE, Ireland 5NJ, oa2CM and oz2AC. Crystal Controlled O.W.L.S.: NKF, 1AXA, 2BO, 2BRB, 2EF, 2WC, 4BY, 4XE, 6AOI, 6DLL, 8CMM, 8DAJ, 9AUG, 9BVH, 9UZ-NRRL, 9ZA, eg2NM, eg5LF and oa5BG.
- Standard Frequency Stations: 1XM and 9XL.



Another View on Crystal Control

THERE have been many arguments here of late as to the possibility of crystal controlling a quarter-kilowatt tube by putting a UX-210 ahead of it and operating the grid of the 210 under crystal control. The question is, "If the quarter-kilowatt tube operates at full power is it under crystal control, or is it practically self-oscillating?"

It seems possible that one might have the amplifier highly regenerative and yet to have it under some degree of control though probably not as perfectly so as when its grid power is all supplied by the crystal oscillator. Under these circumstances it would be a trifle more easy for the tube to operate at the crystal frequency since there the normal regeneration in the amplifier would be assisted by the power from the crystal oscillator.

Although a crystal oscillator was not available, a test of this notion was made with a plain oscillator constructed with

diagram and it can be seen that by disconnecting at X the amplifier could be made into an Armstrong circuit oscillator while disconnecting at Y would leave the oscillator alone operating in the same circuit.

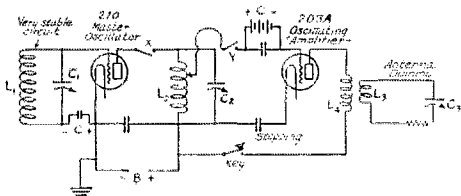

TEST CIRCUIT

TEST CIRCUIT TO TRY POSSIBILITY OF STEADYING AN UNSTABLE OSCILLATOR BY SUPPLYING A PART OF THE GRID ENERGY FROM A VERY STABLE OSCILLATOR

C1 is comparatively large while C2 and C3 are comparatively small. Circuit L1-C1 is comparatively stable and the other two circuits are the reverse. In a crystal control set the crystal would take the place of L1 and C1.

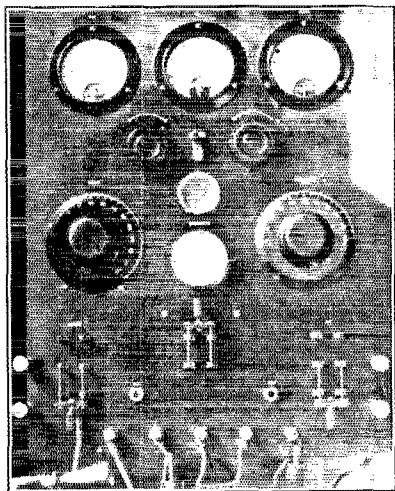

THE OSCILLATING AMPLIFIER SET AT 5AJJ

The circuit arrangement is similar to that of the diagram. A switching system permits insertion of various degrees of filtration so that the stabilizing effect of the master oscillator can be noted.

high capacity, low inductance and so adjusted as to secure stability of frequency. The amplifier was connected to an artificial antenna variably coupled to the amplifier, this coupling being varied during test transmission. The amplifier was not neutralized and could be made to oscillate. The circuit arrangement was that shown in the

The test was made as follows. Using a low capacity and fairly high inductance in the antenna dummy and with the circuit broken at X we have a sort of Armstrong oscillator as mentioned before. It is not very steady and when the key is operated the wave jumps around rather badly, also changes in the antenna coupling or tuning change the wave badly.

The circuit at X is now closed so that the oscillator goes to work. By adjustment of the condenser C1 the oscillator is put on the same wave as that on which the "amplifier" previously operated. Because part of the grid power of the amplifier is now supplied from the oscillator the output is increased somewhat and because the frequency is now partly under control of the very stiff circuit L1-C1 the steadiness is improved. Keying does not make the wave jump around nearly as badly.

The test was rather hasty and of course one may argue that the circuit L1-C1 changes its function somewhat when both switches are closed but the whole thing will be found to have a good resemblance to the usual crystal circuits with amplifiers and creates at least a suspicion that some of the crystal control stations above referred to operate in this fashion.

The photographs herewith show a station of several years ago (5AJJ) as it was then operated by Mr. Bernard S. Shields at 3704 Oak Lawn Ave., Dallas, Texas. The circuit used resembled very closely the test circuits described above and it is important to note that at the lowest wavelength setting used there was still being employed

half of the capacity of the rather large variable condenser nearest the reader in the rear view of the set. This was the condenser in the oscillator circuit and other dimensions show it to have been a very

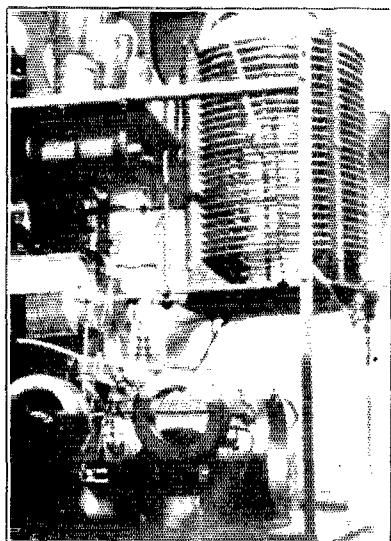

THE WORKING PARTS OF THE SET AT 5AJJ

Note particularly the large condenser at the left center. This is the tuning capacity of the master oscillator.

stable and stiff circuit. The arrangement was operated for several years and Mr. Shields says of it, "The amplifier circuit is a reversed 'feedback' (tuned grid with untuned plate closely coupled to the antenna as in the test circuit) with 45-watt tubes in parallel but added to this is a master oscillator. The grid to the oscillator inductance is first disconnected while the amplifier circuit is being tuned. (This is the oscillating amplifier of the diagram.) The oscillator is then put on the same wavelength by using the variable condenser across the inductance and there is an increase in antenna current also the wave emitted becomes very steady."

—R. S. K.

Standard Frequency Transmission

THE Official Wavelength Station Committee of the Experimenters' Section, A.R.R.L. announces the following standard frequency schedules. The frequency values at 1XM and 9XL are based on the standards of the Bureau of Standards and have been checked by the Cruft

Laboratory at Harvard University and by the Communications Laboratory of the Massachusetts Institute of Technology. While an accuracy of 1/10 of 1% is to be expected, no guarantee is made. Station 1XM has suspended for the summer. Details on 30th 1XM and 9XL may be found on page 8 of the June issue.

In the following, "f" is the frequency in MEGACYCLES and the approximate wavelength in meters follows.

SCHEDULES

(Figures are frequencies in MEGACYCLES per sec.; approx. wavelengths in parentheses.)

| Friday Evening Schedules | | | | Sunday Afternoon Schedules | | | |
|-------------------------------|-------------------|-------------------------------|-----------|-------------------------------|-----------|-------------------------------|--|
| Eastern Standard Time for 1XM | | Central Standard Time for 9XL | | Eastern Standard Time for 1XM | | Central Standard Time for 9XL | |
| Time (PM) | Schedule A f λ | Schedule B f λ | Time (PM) | Schedule C f λ | Time (PM) | Schedule D f λ | |
| 8:30 | 3.50 (85.7) | 6.50 (46.1) | 3:00 | 10.0 (30.0) | 3:12 | 12.0 (25.0) | |
| 8:42 | 3.60 (83.3) | 6.75 (44.4) | 3:24 | 14.0 (21.4) | 3:36 | 14.5 (20.7) | |
| 8:54 | 3.75 (80.0) | 7.00 (42.8) | 3:48 | 15.0 (20.0) | 4:12 | 16.0 (18.7) | |
| 9:06 | 3.90 (76.9) | 7.25 (41.3) | 4:00 | 15.5 (19.3) | 4:24 | 18.0 (16.7) | |
| 9:18 | 4.00 (75.0) | 7.50 (40.0) | 4:36 | 20.0 (15.0) | | | |
| 9:30 | 5.70 (52.6) | 7.75 (38.7) | | | | | |
| 9:42 | 6.50 (46.1) | 8.00 (37.5) | | | | | |
| 9:54 | 7.00 (42.8) | 8.25 (36.3) | | | | | |
| 10:06 | 7.50 (40.0) | 8.50 (35.3) | | | | | |
| 10:18 | 8.00 (37.5) | 8.75 (34.3) | | | | | |
| 10:30 | 8.50 (35.3) | 9.00 (33.3) | | | | | |

| | | |
|------------|---|-----|
| July 1, | A | 9XL |
| July 10, | C | 9XL |
| July 15, | B | 9XL |
| July 29, | A | 9XL |
| August 5, | B | 9XL |
| August 14, | A | 9XL |
| August 19, | C | 9XL |

The August schedules are subject to change. See August QST.

DIVISION OF TIME

- 3 minutes—QST QST QST nu (Station call letters)
- 3 minutes—5 sec. dashes broken by station call letters every half minute.
- 1 minute—announcement of frequency in megacycles per second (8.75 megacycles per sec. is sent as "8 r 75 MC.")
- 1 minute—announcement of next frequency in megacycles per second.

Special Notice—The continuation and possible extension of these transmissions depends entirely upon the response of the A.R.R.L. If you use the transmissions send a note to Experimenters' Section, A.R.R.L., Hartford, Conn.

—R. S. K.

Strays

Taken from the log of 1ARE on contact with 4CK.

| | |
|--------------------------------|-----------|
| Getting contact | 2 minutes |
| His report my sigs | 4 " |
| My report his sigs | 4 " |
| His wx report (very complete) | 10 " |
| My wx report (very complete) | 10 " |
| Description of his YL | 9 " |
| Description of his OW | 1 " |
| Change to Daylight Saving Time | 80 " |

3LD asks, "If a man interested in baseball is called a baseball fan, can a student of electricity be called an electric fan?"

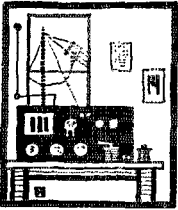

Amateur Radio Stations

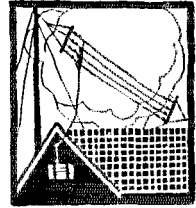

3ZI, Trenton, N. J.

IN the pre-license days, Edward G. Raser was bitten by the amateur radio bug and almost immediately put up what was then a high class outfit. This consisted of

fashion and uses a Western Electric 211-A. fifty watt in a Hartley circuit. The tube used is four years old which speaks well for the care taken in the adjustment of the circuit. It is always run with a conservative input.

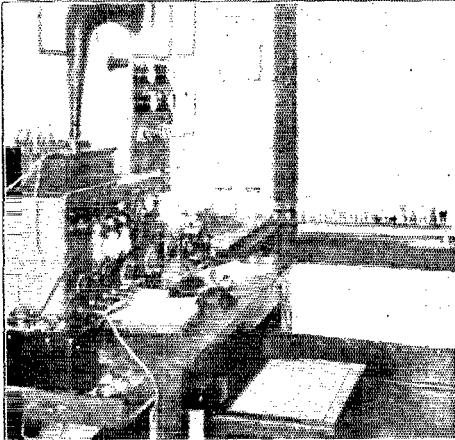

The plate supply is taken care of by an Acme 500-watt transformer, the output of which is rectified by a pair of "S" tubes. These have never been overloaded or otherwise abused and have been in operation for five years. No attempt is made to filter the plate supply, as a good r.a.c. note is considered to be the most practical for handling traffic. The filament is supplied from a separate transformer.

The power supply units are located in the operating room and are wired up through a panel with all the necessary meters so that the operator can see at a glance just what is happening in the circuits. All the controls for varying the plate and filament voltages are on this panel and within reach of the operator. The power supply is fed to the transmitter thru BX cable which runs from the operating room thru the ceiling to the attic. Radio frequency chokes are inserted in all these leads.

a crystal detector and spark-coil transmitter. Later, when licenses became necessary adjuncts to a station, one was obtained and the call of 3NG was assigned. In spite of the obvious interpretation that could be made of the call, the station prospered right through until the war, at which time it was dismantled.

After getting out of the Navy, at the close of the war, a new station was put in operation drawing the call of 3CS. The rock-crusher then employed did its stuff until the spark died a natural death. In 1922 when the phone craze sprang up, a phone was put in but did not hold its own for very long. In 1923, the present call of 3ZI was assigned and the station completely remodeled. Various changes have been made since then.

The transmitter proper is located in the attic and is remotely controlled from the operating room. It is built up bread-board

The antenna is a single wire, 60 feet long,

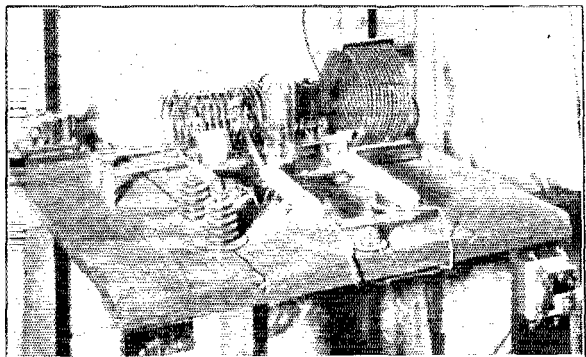

rising semi-vertically from the house top to the 48 foot "rain spout" mast. A three foot cone top serves to put the capacity

where it belongs and helps to steady the wave here. The counterpoise is similar and comes within five feet of the earth. The insulators are of plate glass cut from old windshields. A separate antenna is used for reception which allows the use of break-in. This receiving antenna is 200 feet long but only 20 feet high.

The short-wave receiver is located below the power panel and covers a range of from 20 to 110 meters. A 600-meter receiver stands next to the short-wave job and is used for the sole purpose of standing by for "SOS" calls when the BC stations shut down, and for listening to the ship-to-shore traffic now and then as fancy calls.

Mr. Raser has been a member of the

League since its inception in 1915 and has held a First Grade Commercial License since 1914. He has been in the Navy and has operated aboard several ships. 3ZI is one of the original ORS appointed and still holds that title. RM and OO appointments are also held as well as being the Alternate Net Control Station for N. J. in the Army-Amateur scheme of things. Various other appointments have been held in the past.

Mrs. Raser is also a licensed operator and holds an Amateur First Class License and has had assigned to her the call letters of 3AEC. She is not now on the air as a Junior op takes most of her time. As Edward Jr. is very much interested in radio, it makes a complete radio family.

6DDO, Los Angeles, Cal.

THIS station is located at 200 West 42nd Place, Los Angeles, California. It is owned and operated by H. G. Pearce.

When 6DDO was first built, it started like a good many others by installing a receiving tube and shoving about 500 volts on its plate. This was soon discarded for the five

were substituted. At the present time, a 203-A is being used.

The plate voltage is obtained from an Acme 1100-volt transformer, rectified by a soup rectifier consisting of 32 pint jars. The elements have about four square inches of active area in the borax solution. White oil is kept on the solution which is changed every two months or so. It requires practically no attention. The filter consists of a six-henry choke which is capable of passing 150 mils. A two-mike condenser is shunted across the line each side of the choke. The output amounts to about 300 volts which allows the tube to be run cold. This helps to keep a steady note which does not climb. Reports are always "good, steady d.c."

The present transmitter uses a loose-coupled Hartley circuit. The cabinet is closed in and the window through which the tube may be seen is covered with a piece of quarter-inch plate glass. The coils are edgewise-wound copper ribbon, 5 inches in diameter. Six turns are used in the secondary and seven in the primary. They are suspended from the top of the frame and are held by three glass rods. The lower rod is fastened to the base by rubber bands and prevents any excessive vibration.

The plate condenser has a capacity of 2000 μ fd. The grid one is of 900 μ fd. Both are rated at 3,000 volts. The grid leak is 5,000 ohms. The antenna series condenser has a 500- μ fd. capacity and the primary one is 120 μ fd. Keying is done by means of a relay in the center tap lead and it is controlled by either a straight key or Vibroplex. The Vibroplex is slowed down. A 1- μ fd. condenser is in series with

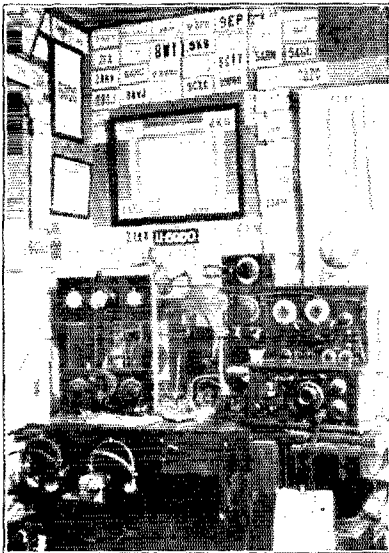

watter and later a 7½ watter. Four of these went West due to overloading and after getting acquainted with the short waves, a 203 was put in. After blowing up several of the receiving condensers, better insulated ones

a 30-ohm resistor and placed across the key to keep down the sparking. A green pilot light indicates when the 110-volt line to the set is alive and a red one tells when the set is in an operating condition.

The receiver is of the "Schnell" type and after being rebuilt five times is the equal of anything that has been tried so far. The secondary condenser is about 100 μ fds. and the throttle condenser about 350 μ fds. The antenna condenser consists of two 2 $\frac{3}{4}$ " round plates, one of which is fastened to a screw which allows the capacity to be adjusted by means of a long bakelite rod reaching outside of the panel. There is also a two-plate midget condenser shunted across the tuning one and used as a vernier. It is excellent to hold weak signals without disturbing the main tuning condenser. The coils are of the Lorenz-type, wound three inches in diameter of 14 d.c.c. wire. They are held in place by four binding posts mounted on a piece of bakelite which is fastened to the base on two stand-off insulators. A 112 with 22 volts on the plate is used as detector and a 201-A is used as an audio amplifier tube. A 10-to-1 transformer is the coupling device. It has been found that by turning down the filaments, the local and near DX signals seem to be weaker but the long DX pounds in fully as strong as with them turned up full. The advantage of this is that the usual noise is muchly diminished.

The antenna is 33 feet long and is a vertical wire with a cage top and the counterpoise is a single wire 26 feet long. Its fundamental is about 42 meters.

Excellent work has been done and most of the U. S. has been worked as well as Honolulu, Philippines, Australia, Tasmania, New Zealand, Japan, Canada, Argentina, Mexico, Chile, Singapore, Borneo, Tahiti and ships in three oceans. 6DDO is an Official Relay Station and handles approximately 60 or 70 messages per month. All traffic is cleared within 12 hours when possible. Traffic is not the only aim as experimenting and rag-chewing is just as popular.

An A. C. Voltmeter

THE Weston Electrical Instrument Corporation of Newark, N. J., have just announced a new series of alternating current meters. These may be obtained in various ranges as either milliammeters, ammeters or voltmeters.

The movement is of the iron-vane type and is enclosed in a fan-shaped bakelite housing. This prevents dust from working into the movement and protects it from any mechanical injury. The housing can be seen in the illustration showing the inside of the case. This part of the instrument

carries all the moving parts. The other section has mounted upon it the actuating coil, the multiplier and terminals. As will be noted, the actuating coil is shaped so that it will fit closely over the housing in which the vane is mounted.

This meter has the same face dimensions as the Model 301 meters and therefore, fills

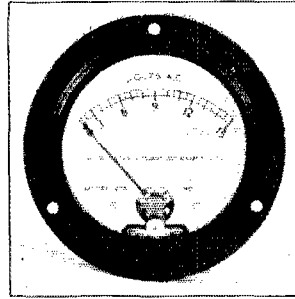

a gap in the line of small switch-board instruments commonly used in radio work. It is slightly deeper than the 301 instruments and measures 1 $\frac{5}{8}$ " from the back of the flange to the back of the meter. The terminals extend a bit beyond this. This should not be particularly damaging as the average transmitter has plenty of space directly behind the meters.

The instrument shown in the cut is the 0-to-15-volt one. It is possible to get good readings as far down as three volts which

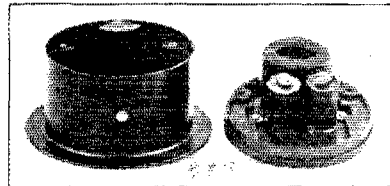

makes it useful for all of our common transmitting tubes as well as for receiving tubes when they are run from a.c. However, this is not the only range that may be had as there are several; one of which should fit your case. They may also be obtained in a variety of ranges as ammeters and milliammeters.

—H. P. W.

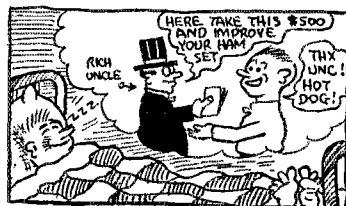

A SWELL DREAM

Calls Heard



eg-2BWZ, H. E. Smith, 31, Wandie Road,
Hackbridge, Surrey, England
(Heard from Apr. 1 to Apr. 10 to 20 meters)

lalf labt lbhm laba lro lka lry lzz
lcc ladm laur lasu lajm luw lbvl lcdp lpm lvc
lfo lbyu lbxk lcaw lkk lsw lbhs iakz 2amm 2aqw
2jn 2fc 2wc 2ahm 2aiu 2bg 2mu 2ie 2qf 2bsl 2aer
2bur 2ads 2aym 2akw 2mv 2ech 2bwt 2ag 2aks
2mw 4bl 4tv 4jr 4wh 4tn 4im 4dm 4ok 4ac 4agq 4ajs
6hb 8hoy 8sar 8bct 8ic 8oq 8ar 8afq 8cdv 8qh 8anc
8axa 8xe 8box 8cdd 8bc 8aul 8cl 8aly 8dix 8ex
8ahc 8haj 8drj 8dix 8bpd 8ded 8bau 8cfr 8acy 8auh
8eyo 8clp 8dgr 8dij 8ash 8awh 8dga 8dh 8adr 8bmx
8aib 8en 8ari 8dbw 8ib 8kv 8bpm 8aji 8es 8ara 8cca
8anz 8dbw 8emb 8aol 8enc 8agq 8bht 8edy 8dlc
8dkc 8cip 8afb 8ef 8axb nc-1of nc-1bo nc-1co nc-1dq
nc-2ax nc-2be nc-3mp nc-3fc nc-4cn.

eg-2HJ, K. E. B. Jay, 19 Elm Close, Amersham, Bucks,
England

laal laao labz lach lacl ladd ladm laer lafy laha
lair laif lajg lakm lair laon larv lasa lasy laub
lauc lavf lavl lawe laxa lxxx lbdc lbdm lbez lbhi
lbhs lbms lbve lbol lbym lbz lehr lejs lcmx lepb
lera lcua lcx ldee ldi ldl lfn lga lgp lhe lbi
lis liy lka lkk lmv on lql lqv lrv lrf lrn lro
lrp lrx lsw lvs lwoj lxaw lxm lxi lzd lzw 2ahy
2ajv 2agn 2ags 2ahe 2ahf 2ahv 2ah 2am 2ame 2amf
2amj 2amp 2apq 2aqw 2arr 2atk 2atu 2atv 2avg
2avk 2aw 2awu 2ayj 2azb 2blm 2bsj 2bud 2buv 2cdm
2eds 2cep 2es 2ean 2est 2euc 2evj 2evs 2exd 2eyq
2dc 2dg 2fc 2iz 2kr 2kx 2le lma 2am 2ox 2pv 2qf
2qh 2sz 2to 2tp 2ym 2ab 2acm 2am 2aw 2axi 2axj
2any 2auv 2av 2av 2ba 2bhp 2bn 2bqj 2bva 2cbl 2cfs
2cdv 2cjm 2ckj 2cp 2fi 2gp 2jm 2jo 2jt 2la 2ld 2lg
2ow 2pf 2qw 2sh 2tu 2su 2sw 2wm 2adl 2bco 2bgg
2bga 2cbv 2ech 2hu 2ku 2qp 2qa 2sj 2tn 2vc 2wf
2ee 2db 2fu 2io 2oc 2oy 2ab 2ak 2cu 2ev 2fa 2hl 2iz
2jm 2ll 2nn 2ob 2pk 2rr 2ry 2sp 2st 2ta 2ae 2aj
2aj 2kj 2ke 2oa 2qj 2ql 2rh 2rr 2sv 2sh 2sja 2aky 2df 2fd
2ki 2rr 2va 2vu 2zav 2bjl 2bm 2nw 2ta 2am 2amm
2dp 2df 2fo 2ek 2fv 2ag 2af 2afq 2aj 2ajk 2arg
2auc 2aya 2ayf 2bj 2bce 2ben 2bhz 2bja 2bni 2bt
2bth 2bvw 2bcm 2ces 2cjp 2cen 2dan 2dcm 2ded 2djp
2dnh 2dwp 2diz 2gl 2gf 2if 2in 2ip 2isg 2ix 2aek 2aim
2am 2auu 2au 2bc 2bf 2by 2bnp 2bqc 2bu 2cei 2cet 2cn
2cpq 2cun 2cwm 2dad 2do 2dij 2dr 2efk 2egu 2ek 2elb
2ek 2il 2ir 2jv 2xi 2adg 2ara 2axh 2bcz 2bhu 2bom
2btx 2cia 2em 2eos 2epa 2etr 2edg 2dga 2dwa 2dyu 2ee
2efe 2ekf 2emh 2kd 2sa af-1b fm-8mar fm-8st fo-a8z
fo-a41 ne-1ad ne-1dq ne-1br ne-1ap ne-2al ne-2dn
ne-9bz nj-2zd nm-1j nm-1k nm-5e nm-9a nm-m3y nr-2fz
nr-cto oa-2bh oa-2tm oa-3xo oa-5bg oa-7ew oa-7dx
oa-7hl od-pk9f oz-2bg oz-2xa oz-3ai oz-4aa oz-4ac oz-4ae
oz-4am oz-2ae oz-4am oz-2ae oz-3aj oz-4ob sa-cb8
sa-hd4 sa-hg1 sa-fc6 sb-1aj sb-1al sb-1bk sb-1bu
sb-1ca sb-2ab sb-2ax sb-2ig sb-sb sb-scl sb-2bl se-1if
su-1br su-2ak arcx and giky gay hva jx lpl nar nldk
nkf shv spw ved wiz fq-pm ardi dcz aa7 hbc ngd whv
wby.

eg-2KK Radio House, Wilson Road, Smethwick, Staffs,
England
(Heard during March, April and May)

laa lcax lch las lpy lql lafn lahv lbvx lbhs 2tm
2ar 2dh 2arv 2ahm 2im 2qv 2eyx 2euv 2bv 2jo 2ic
2bke 2gp 2ua 2ak 2ab 2ba 2ajc 2agz 2aoh 2afn 2ro
2hz 2sp 2hn 2km 2si 2fa 2cz 2qj 2ahh 2rn 2ak 2io
2apo 2ags 2afu 2ap 2agv 2ah 2ao 2im 2ar 2dd 2hv
2avs 2ke 2bg 2auf 2iv 2arg 2df 2acp 2ad 2ajm 2av
2ww 2sh 2au 2ajs 2df 2ef 2eep 2aat 2abm 2aej 2am
2aod 2apa 2ate 2auk 2ax 2bgb 2bh 2bhh 2bkj 2bsd
2bvm 2bwc 2bxd 2bzf 2gzm 2cak 2cc 2cdw 2dam

6dan 6dck 6der 6dgy 6dp 6ek 6ew 6fg 6gc 6kl 6oi 6ba
7adw 7aij 7ek 7gb 7ic 7wb 8axa 8anb 8avb 8amy
8bfa 8evg 8dew 8dse 8day 8abc 8ocx 8ahm 8any 8anz
8aol 8ara 8awq 8haf 8bhh 8bbl 8btt 8bhi 8brh 8bri 8bl
8bna 8bak 8bwl 8bvl 8bz 8ca 8ca 8caj 8cey 8ohs 8eib
8ejq 8cuj 8cuj 8cmj 8en 8ent 8ep 8epq 8eri 8ctw 8cwy
8exx 8eyb 8dax 8dce 8dbw 8des 8dga 8dij 8dip 8dkm
8dlr 8dny 8dol 8dol 8dra 8drh 8drv 8dvy 8dyl 8eae
8eas 8edi 8ef 8eff 8efh 8ein 8eir 8ek 8ey 8ik 8kq
8kv 8bl 8bl 8bz 8mh 8nm 8ph 8qe 8rf 8um 8vy 8xm
9xx.

BRS30, P. H. B. Trasier, 37 York Road, Northampton,
England
(Heard on April 3d)

labt lafn lahb laix lair laot latx lavf lbhc
lbdw lbfx lbke lbmm lbxx lcrn lemx lif lga lid
lij lkf lhc lij lmv lnl lnt lrd lrm lsq lsv lww lxaw
2aer 2akj 2akz 2alj 2apd 2agw 2atk 2atx 2aub 2avk 2awq
2awx 2axt 2ayz 2fc 2gk 2gg 2oi 2zh 2zv 2acm 2aew
2ahl 2ajh 2bcd 2bpl 2bwt 2la 2ld 2ge 2sk 2tm 2tn
2ut 2w 2aj 4av 4et 4ea 4ec 4fv 4im 4mi 4ob 4rn 4we
4wg 5oa 5abv 5ac 5adg 5ajg 5aj 5agh 5ave 5ct
5cpl 5dei 5dne 5dod 5wt 5adk 5cia 5uz 5vi nc-1ad nc-1br
nd-hik sh-vpa su-led su-loa sb-lar sb-lav sb-lie
sb-zag sb-zq.

eg-BRS63, G. G. E. Bennett, 26, Blenheim Park Road,
Croydon, Surrey, England
(Heard during March and April)

laao laas laba labz ladd lach lacl laey lacy ladd
ladm lads laif laf lafn lair lajm lake lakz lair
lamu lani lanz lapv laqa lasu latv lauk laur lav
lavr lave lawu laxa lxxx lbak lbwv lbca lbek
lben lber lbdx lbe 1bgg lbhm lbix lbkp lbky lbl
lbb lbm lbnr lbdq lbq lbux lbxx lbvy leaa leaw
led lecw lejh lemx lene ida ifi lfn lfo lgwh lhh
lhk lke lid lka lkk lli lmr lmv lnl lnw lom 100
lue lql lrd lyp lvt lwbj lxaw lxe xm lzw 2aan
2aby 2ac 2aer 2aes 2afb 2ags 2agz 2agu 2ahe 2aiu 2aw
2akj 2akr 2aky 2alm 2amj 2amp 2amw 2ane 2aoj
2aol 2apd 2aqw 2ard 2ase 2asz 2ate 2aua 2avb 2avk
2avw 2awx 2axd 2axy 2ayj 2ad 2bbx 2bdm 2bem
2ber 2bg 2bz 2bow 2bz 2bur 2bu 2bvd 2ea 2ebk
2ec 2ddm 2edr 2egr 2eh 2ein 2ens 2es 2est 2eaz
2euc 2ouz 2oz 2oyq 2eyz 2da 2dq 2ek 2gr 2hc 2hp
2hk 2ih 2iz 2jn 2kr 2ma 2md 2me 2or 2pn 2qf 2qu 2uf
2uo 2vd 2wa 2wc 2wj 2wr 2xad 2xaf 2axi 2abl 2abr
2acb 2add 2aen 2afw 2agm 2ahl 2ais 2ajx 2akw
2al 2am 2anv 2aav 2abv 2bbo 2bco 2bfg 2bn 2bho 2bjo
2bqz 2bwt 2cbh 2cg 2ek 2cju 2cp 2ef 2fi 2gp 2hu
2iu 2jm 2ld 2mh 2mv 2ow 2pe 2ps 2py 2qf 2aw 2sh
2su 2sz 2wh 2wm 2w 2xk 2bl 2bw 2ee 2ef 2ei 2cu
2cy 2ea 2et 2fu 2fv 2iz 2jm 2jr 2km 2ld 2ll 2lm
2mn 2nh 2ok 4on 4oy 4qb 4rm 4rp 4rr 4ry 4sp 4th
4tn 4tu 4ux 4apa 4bhp 4ads 4akn 4ao 4api 4ao 4eb
5ew 5jf 5ij 5ke 5ki 5oa 5oe 5ql 5ry 5uk 5va 5vu 5wz
5zav 5az 5bh 5bz 5ca 5em 5hm 5jn 5rn 5ta 7dl 7kf
7rl 7tm 7vq 8ac 8acu 8adg 8ae 8afq 8agn 8ahc 8ahd
8aj 8aks 8alg 8alm 8aly 8ask 8axa 8auc 8aua 8avl
8bag 8baj 8bau 8bet 8bde 8ben 8bja 8bk 8bou 8bpq
8bqi 8bt 8bo 8bwa 8bww 8bxr 8cau 8ccq 8ced 8ces
8cfr 8eko 8eln 8clp 8cl 8ent 8enz 8coa 8cpl 8erj 8ese
8evj 8eyd 8dce 8dd 8db 8dcm 8der 8dij 8djp 8dpx
8dia 8diq 8dia 8dkh 8dod 8dpa 8dqk 8dqz 8drj 8eq 8es
8ex 8fp 8gk 8im 8if 8it 8re 8ut 8vj 8zg 8aek 8arm
8awz 8axq 8bl 8bc 8bm 8bpm 8bpl 8bpm 8buc 8bui
8br 8bu 8bv 8bw 8bw 8bw 8caj 8cev 8ce 8ce 8cet
8cja 8ek 8eki 8cmv 8cn 8cpm 8cpq 8etg 8er 8ey
8ewe 8exx 8du 8dga 8dgm 8dju 8djp 8dr 8eas
8ebj 8ebp 8ee 8ee 8efk 8efo 8egh 8ei 8eiz 8ek
8ekf 8hd 8jr 8lc 8ed 8aj 8et 8xi.

Frank Pemberton, 115 Cambridge Road, Wimbledon, London, S.W. 20, England
 (Heard from Apr. 21 to Apr. 22 on 20 meters)

lauk lbhv 1bf lbgw 1edp 1cpb 1yd 2alm 2bal 2bj 2ch 3akw 4dm 8ahd 8alg 8baj 8bde 8bau 8bdp 8csr 8cil 8cmb 8dij 8ily 9alm 9aex 9bmx 9brw 9bq 9cst 9cib 9cqq 9ef.

40 meters (Heard from Jan. 1 to Apr. 23)
 lasf lale laof lamu lair lasy laud lazz lakz laadm lazd lavl lamp larn labz latg laxx laao laur lair lapu lasa lavf lazw lanx lads lbkp lbhm lbux lbdw lbxl lckp lcez lcz lcmf lcnz lera lcv lcki lcd lcmx ldi lei lga lgp lgh lhj lii lin lid lkk llc lmv lmy lmq lro lpa lqu lql lrd lsw luz lvc lwe lvd lyl lzd 2agn 2awu 2aas 2ahm 2avr 2azk 2ayj 2aqw 2arm 2apd 2aev 2atk 2aby 2avk 2ags 2aib 2awq 2ahe 2ate 2amj 2avt 2bad 2bsl 2bvk 2ags 2aib 2awq 2ahe 2ate 2amj 2avt 2bad 2bsl 2bvk 2ags 2aib 2awq 2bho 2bir 2bbx 2cxy 2cu 2ced 2ch 2edr 2es 2eib 2cep 2dh 2de 2fo 2fc 2gp 2eg 2kw 2md 2nz 2nn 2od 2pv 2rs 2tp 2uo 2zo 3ajc 3aj 3any 3ahl 3afw 3aw 3acm 3akw 3bwt 3bhv 3ekj 3vkl 3eds 3eah 3ef 3gp 3pg 3jo 3ku 3ld 3pf 3qe 3qf 3sk 3tn 3zo 4ak 4aa 4aa 4bn 4cv 4dd 4ft 4gz 4hm 4hy 4iz 4io 4it 4ll 4nh 4ob 4rr 4rm 4ry 4tu 4tk 4he 4ew 4zav 6oi 6bzf 8ade 8aly 8afq 8anc 8avj 8elf 8aad 8aj 8bth 8bja 8bpl 8bjb 8baj 8cwt 8cfr 8cjm 8cau 8drj 8day 8dan 8gz 8im 8lt 8rh 8vx 8zae 9adm 9aao 9aek 9arn 9be 9btz 9bre 9cpm 9cn 9cwy 9cwn 9dqw 9dar 9dvq 9dr 9dih 9nm.

B. & F. Smith, 101 Highfield Rd., Sattley, Binghampton, England
 (Heard during April on 20 meters)

laba laei lajm lakz lamu laqa lasu laxx lbhm lbky lbqt lbvy lbux lbvl lca lcaw lcaz lcfq lco lfm lcpb lera ldf lio lka lmy lom lok lpm lsw lue luw lzc 2aer 2ahm 2alm 2amj 2ann 2bat 2bg 2cmx 2in 2nm 2or 2qu 2rc 2tp 2wv 3ade 3akw 3bwt 3cch 3cfq 3gj 4fa 4dm 4km 4od 5dq 6als 8ade 8adg 8ahc 8aks 8alg 8aly 8ask 8avh 8axa 8axd 8bau 8bd 8bde 8bde 8bdp 8bna 8odb 8cil 8elp 8emb 8ese 8sr 8dxx 8dxx 8dij 8dm 8drj 8dsv 8og 8wt 8zr 8z 9anz 9bhh 9bki 9bmx 9bpm 9bq 9ca 9eci 9ek 9en 9evn 9avr 9dga 9dgi 9dj 9eas 9eho 9ec 9emb na-7mm np-4je ne-lar ne-3fc ne-3gg ne-3kp ne-3mp fo-5x sb-lad sb-law sb-2ab era.

30 to 50 meters
 lair laur lavf lavl lbfx lbym lcej lcpb leng ldee lgh lhh lmv lmq lsd luw lxm 2ags 2ahm 2amh 2avw 2bur 2bxu 2cef 2nm 2uo 3adl 3ahl 3eah 3gp 3id 3qw 3us 3vf 4aao 4ef 4km 4ll 4ok 6hm 8ba 8bxn 8box 8cdv 8cfr 8cin 8cnv 8dan 8ddm 8nt 8oq 9amo 9buw 9dr 9xe 9xl ne-lad ne-lad lc-lp ai-2kx oa-2ak oa-2no oa-2sh oa-3bq oa-4bd oa-7cw oz-4aa af-1b af-hva fo-5ft fo-a6n fo-aga su-1fb su-1na su-1oa su-2ak sa-cb8 sa-tb2 sa-de3 sa-en8 sa-ha2 sb-1aj sb-1ab sb-1ba sb-1b sb-1br sb-1ck sb-1ib sb-1ic sb-1ld sb-2aa sb-2ad sb-2aj sb-2ar sb-2av sb-2ax sb-5aa sb-7ab sb-2ar sb-2as sb-2bl.

Miss B. Dunn, Stock, Essex, England
 (Heard during April)

lads laur laxx lbfx lbhm lbms lbng ldee lix 2apd 2ase 2ayj 2bqh 2euz 2evj 2vd 2xaf 3of 4ee 4gp ne-lad nm-cyy nn-m3y ni-ffh sb-lad sb-laj sb-laq sb-law sb-lax sb-lib sb-2ag sb-2ap sb-2ar sb-2id sb-5aa su-lbr su-1ed ac-lmdz ar-ocby ed-2yd ed-oid ed-oiuk eh-9oc eh-oso em-8gl em-5bj em-smsh em-smtn em-smv em-smxy et-tpsa et-tpai fi-lew fm-8gat fm-8jo fm-8ju fm-8rit fm-tun2 fq-pm ed-anf kdr naa nivd wik wuby wvc 2xt 8xa 9pz 9wj ci xm f9c sok.

HRS-64, R. G. R. Lyon, 37 High St., Aberystwyth, Wales, Great Britain
 (Heard during April)

lasa lgh lafa lcpb lcej lair lga lafn lii lcej laud laum lcd lcl lasy lejv laxx lmv laf laac laxa lbkk laur lckz lbm lasu lamu lwl lcms lrn lnl lcpk llx laf lajm lkk lmv llw lmg llh lia lamx 2bm 2oe 2ags 2kr 2oh 2am 2ahm 2as 2amp 2ae 2aog 2egr 2vh 2awz 2evj 2bxu 2pd 2axa 2rs 2zc 2ar 2axx 2atz 2za 2tp 2apa 2nm 2ahm 2bm 2awz 2aon 2ayj 2ek 2agj 2bv 2avk 2awx 2qu 2awu 2bbe 2edr 3bwt 3of 3oq 3abr 3iu 3ekl 3anx 3akw 3ads 3be 3cfq 3adh 4ce 4iz 4fa 4ei 4dd 4du 4sn 8dij 8bes 8csr 8alg 8bau 8dij 8adm 8aj 8bpg 8cfr 8axa 8aks 8boy 8don 9aex 9ek 9eki ne-lad ne-2fo ne-3fc fi-lew su-1by su-2ak sb-2ib sb-2ia sb-2aa sb-2ag sb-2aj sb-2ig sb-2ic sb-2ar sb-2ar sb-2ab sb-2id sb-lad sb-laj sb-ld

sb-1ck sb-1ar sb-1aw sb-1br sb-1id sb-1ib sb-1ic sb-1ak sb-1hf sb-1bo sb-1ca sb-1aq sb-5aa sa-hgg sa-hgc sa-hgl sa-db2 eu-1ua eu-lbra se-2bl se-2as ai-2kx as-llra np-ck4 np-4oi fx-fm oz-3ar oa-2mh fe-egz fe-f2.

S. Jamieson, 2/23 Russell St., Brixton, London, S. W. 9, England
 (Heard during April on 30-45 meters)

laae laau labz lach laei laum lafn lahv lajf lair lamu lapv lasa lasy laur lbak lber lbez lbfx lbqg lbhm lbke lbms lbux lcej lckj lckp lcpb lcsr lde lgh lid lii llc llj llk llx lmdz lmv lmy lnl lql lrd lrf lrn lso lwbj lwe lyb zabp zagt zahm 2amj 2amp 2apd 2api 2apq 2atx 2avb 2avz 2awv 2awx 2axr 2bbx 2bir 2bow 2buw 2bxu 2egr 2eib 2euz 2evj 2exl 2ezr 2dg 2gk 2hc 2tf 2tp 3ahl 3bco 3ce 3cin 3ckl 3ef 3gp 3hg 3kr 3ld 3pf 3py 3qf 3ow 3sh 4bn 4ce 4fv 4hy 4ll 4nh 4ok 4oy 4si 4tu 4hm 6rn 7tm 8adg 8afv 8aks 8auc 8bre 8cfr 8ero 8drj 8li 8lj 8vx 8db 9eli 9vo se-2bl sb-1ao sb-1ap sb-1at sb-1aw sb-1ib sb-2ab sb-2ar ne-lbr ne-lcx ne-2bg ne-2fo fm-nal et-tpai eagr eake eaw3 wuby jx wgy (tel).

ef-8FT, R. Aroussohn, 2 bis rue J. Deville, Colombes, Seine, France
 (Heard from Mar. 1 to Apr. 26)

lbbm labn lga labr lmy lgr lakg laif laei lbke lcep lbfl laif lcmx lair lasa lapp lii laic luu ladm lbkv lxf leau lmr lpcr lbez lckp lmv lic lcmp lrd 2evj 2agn 2bug 2bm 2auc 2ahm 2azr 2bj 2bur 2gk 2vd 2fo 2apf 2uo 2amp 2euz 2agi 2ayj 2bem 2agj 3iu 3gf 3ahl 3ev 3bu 3egg 3hav 3ll 3bwt 3ti 3sh 3acm 3hm 4io 4te 4za 4zkl 4hy 4sz 4tr 4it 4qy 4ft 6hm 6bix 7ek 8xe 8zm 8bo 8rt 8cnx 8dsv 8aj 8adm 8gz 8aly 9ep 9aya 9eev 9bh sb-1ib sb-2id sb-2af sb-2ag sb-2ag sb-1eo sb-1aw sb-1ak sb-1ar sb-1ag sb-1ac sb-2ab sb-5ae sb-1ck sb-1d sb-1ex sb-1az su-lcd ne-2bg ne-lad ne-law ne-2fo nb-2pm ni-2pz ns-ua7 nd-hik xawp x123 x5fmb se-2ar se-2ar se-2m se-2ah se-hgl sa-hd4 ar-8ha af-1b oz-lar hva fapm fo-a8p oz-4aa arex wuby.

ef-RO91, C Conte, 24, Allee du Rocher, Clichy-sous-Bois (S-et-O), France

lacc lacy laix lakm lasa lasy laur laxx lawe lchw ldd lga lgh lhc lhc lis llx llq lpy lrn lxm lzw lkk lwbj 2aan 2abp 2axd 2ahh 2ahz 2amp 2aon 2ary 2as 2aub 2avk 2az 2ad 2axe 2axh 2ayj 2awx 2bbl 2bow 2buw 2cdd 2edr 2egr 2euz 2hr 2ir 2iz 2kl 2me 2pw 2uf 2um 2vd 2vj 3afa 3ahl 3avj 3ajx 3kl 3bco 3bv 3bwt 3ef 3gp 3hc 3hg 3id 3mn 3nz 3pf 3qw 3ow 3sh 3sz 3uo 3mk 3py 4cj 4ey 4db 4dd 4fa 4jm 4ll 4nn 4on 4ox 4ok 4qq 4rr 4st 5ax 5iy 5ry 5uk 6hm 7df 8adg 8aef 8aj 8alt 8arx 8aym 8baj 8bet 8bhx 8bou 8buj 8bw 8bxw 8bt 8ccs 8es 8cmp 8cfr 8cpl 8cpq 8evd 8ewd 8dds 8dbl 8dem 8djm 8dli 8dpa 8ddl 8dsm 8kf 8lt 8wsw 9ak 9arn 9bav 9be 9ceb 9cet 9cmv 9eue 9dxm 9sa 9uz 9vv ne-2bb ne-3bt nm-1j nt-cto.

S. W. Hecker, Camp St. Temora, N. S. W., Australia

2es 2euz 2kx 2fj 4js 5fj 5va 6avf 6ta 6bkd 6bkj 6zat 6cmq 6im 6ngg 6hzy 6cmf 6gdq 6or 6amm 7df 7lr 7adg 8drq 8gz 8nt 9ev 9hp 9ak 9xi 9day 9dul 9adk 9eci 9efk oh-6dda oh-6buc oh-6agc oh-6bvy oh-6cxy ef-8yor ef-8el ef-8ca ef-8qr ef-8aqm ef-8fj ne-5aj ne-4hh ne-5ya ne-4du aj-isk aj-ikzb aj-lsm aj-1fm oz-1fb oz-1fe oz-1fs oz-2bp oz-2gg oz-3ec oz-3ae oz-3xb oz-4ao oo-dgk ey-lhw eg-5xy am-2se op-lbd ni-2pz eb-4zz et-1xla af-hva ei-lav whr gbk glq bxy and kft 8st oet ngy ml.

C. Harrison, Rokeby Rd., Bellriver, Tasmania, Australia

laao laap laum laga laid lakz lair laim laud laue laux lbai lbez lbke lbms lbqg lcmf lcmp lcxm lcpb lid lga lii lij lja lip lmv lnt loa lrd lrf lro lraw lxl lya lzb 2agp 2ags 2avj 2auh 2buw 2adl 2ase 2aub 2avm 2ayj 2eka 2ela 2ens 2eyh 2ced 2gk 2hr 2mk 2or 2qh 2uo 2zo 3ade 3ahl 3al 3bt 3ckl 3se 3hg 3gw 3te 3ue 3vf 4iz 4ll 4nh 4ob 4rr 4rt 5aq 5aqe 5aua 5dq 5fm 5rg 5rh 5uk 5ux 5wz 5zai 5zav 6acz

6adh 6adp 6agr 6alv 6aix 6akw 6am 6aoi 6avb 6bgt
 6bia 6bif 6bkh 6blh 6bux 6bvb 6bvy 6bvx 6bzf
 6byz 6cgv 6cgn 6cmu 6cnk 6cnm 6cnu 6czk 6dba
 6dey 6dgy 6dfr 6dhu 6dhw 6dij 6dik 6dja 6dkq 6dki
 6dta 6dt 7abf 7abg 7abm 7adf 7ae 7il 7ly 7lz 7mp 7no
 7pu 7tj 7xf 8ahw 8ade 8adg 8adm 8aip 8aj 8aly 8asb
 8baj 8bcv 8ben 8bo 8bww 8cau 8ccq 8chz 8cw 8dbl
 8dds 8djp 8dme 8drg 8dl 8ll 8sh 8vx 8xa 8adk 8ahq
 9asd 9axz 9agq 9bht 9bkq 9cel 9cia 9cmj 9cn 9cnd 9cv
 9day 9doe 9dyz 9efk 9eli 9eme 9ezi 9kv 9mo 9mr 9nk 9ov
 9ux ea-gp eb-k44 eb-w1 eb-4rs eb-h5 eb-4ax eb-4an eb-4zz
 eb-4ar eb-k6 eb-4ar eb-4ww eb-4au eb-4eb ef-8yor ef-8jr
 ef-8ix ef-8fk ef-8fr ef-8ca ef-8br ef-8jf ef-8jn ef-8fz
 ef-8et ef-8ei ef-8px ef-8ep ef-8sm ef-8zb ef-8mm
 ef-8jnc ef-8fn ef-8yec ef-8dl ef-8el ef-8fj ef-8rdi
 ef-8udi ef-8gi ee-ar44 eg-2ao eg-2od eg-2sz eg-2lz
 eg-5xy eg-5uw eg-6qw eg-2ec eg-6ww eg-2gy eg-2vx
 eg-2wj eg-2om eg-2kf eg-5ma eg-2dr eg-2nh eg-2j
 eg-2db eg-5hk eg-5yx eg-5kz eg-5up eg-2xy eg-6jw
 eg-6vj eg-6qh eg-6yv eg-6vp eg-5nw eg-6ko eg-5ni
 eg-6mu eg-2it ei-lay ei-lgw ei-lma ei-ler ei-lno
 ek-4uah ek-4ya ek-4dba ek-1x el-1f en-opm ep-lae
 es-2ao es-2nm ac-8em ac-2ff af-1b aq-ges as-1a03
 na-7aam ne-1ad ne-2bg ne-4bn ne-4du ne-5et ne-5go
 ne-5hp ne-5ya ne-9bz nm-5b pr-cto sa-hb5 sa-hd4
 sb-2aj sc-2aa sc-2bl su-2ak tk-ktc to-a4l fo-a3b fo-a3x
 fo-8at oh-6nl oh-6brk op-1au od-pkg skl sk2 hva
 ahl wpa nezp gfr gfy wi8 5fs ved kfzh acs aue
 ardl arcx.

su-1CG, W. Figuera, 1070 Magallanes St.,
 Montevideo, Uruguay

1aa0 1cmx 1hj 1mv 1zs 2amj 2arm 2eka 2es 2uo
 3iz 3ll 3bk 3el 3cm 3ahn 3buc 3bzo 3cky 3csw 3sad
 3bau 3bkd 3dgp 3epm 3ni ac-lcn ac-2ff ac-2ss ac-8fo
 ac-8em ac-8xx aj-1ab aj-1pp aj-1km aj-1ko aj-1sh
 ap-1am ap-1zb aj-8aa aj-8az aj-3rw aj-3yz ef-8gi
 ef-8ij eg-5dh en-oro fm-1fm fo-a3e fo-a3w fo-a4l
 fo-a4v ne-3bl oa-2sa oa-2sh oa-2yi oa-3wm oa-4bd
 oa-7hl op-1au op-1hr op-3ac oz-1af oz-1an oz-1fb
 oz-1fe oz-1fq oz-2ae oz-2ak oz-2at oz-2bd oz-2bg oz-2br
 oz-2bx oz-2ga oz-2gc oz-3ai oz-3aj oz-3ar oz-4aa oz-4ac
 oz-4ai oz-4am oz-4ao flip ikzb nuqg.

eb-4XE, Roger J. Parent, 183 Chaussee de Heusy,
 Verviers, Belgium

1aev 1ajf 1ax 1amu 1abi 1aff 1aci 1aah 1air 1ciff
 1cfx 1ehs 1gr 1mdz 1mv 1ne 1ng 1ie 1py 1rd 2amp
 2avl 2ahu 2afu 2apd 2azm 2bn 2ckp 2evj 2ood 2eug
 2he 2mb 2md 2ra 3add 3eah 4hm 4hl 4cv 4du 4eu 4ll
 4md 4gkk 6jn 8aly 8arg 8enh 8epf 8xe 9ect nj-2pz
 ns-sop nr-8jc sb-1ib sb-2ag sb-2ar sb-2ax sb-5aa
 sb-5ak sc-2as su-2ak su-1cd oa-7hp oz-4aa oh-6kkn
 oh-6bgl fo-a4x fo-a9a fl-lew fl-ta.

nm-1E, M. Veramendi, Sor Juana, 119 Mexico, D. F.
 ler 2ar 4rc 5av 5uk 5atf 8jf 9ln 9da 9ti.

1BUX, Touisset, Mass.
 20 Meters

nc-4bt ne-4fv ne-5fk nd-hik ne-8af nj-2pz nl-1p
 np-4sa sb-1ad sc-3ag su-2ak su-1cd eb-4au eb-4ax
 eb-4bc eb-4ww eb-4zz ef-7cz ef-8aro ef-8bf ef-8ct
 ef-8gi ef-8gm ef-8jn ef-8di ef-8yor eg-2ao eg-2ec
 eg-2kf eg-2od eg-5yb eg-5hs eg-6ku eg-5mq eg-5yz
 eg-6bd eg-6yq eg-6yv eg-6mu ei-ler en-owe fo-a3z
 fo-a4f fo-a5x fo-a6n oh-6ag oh-6bd.

40 Meters

oa-2ay oa-2bb oa-2cg oa-2cm oa-2ds oa-2dy oa-2ga
 oa-2gw oa-2ij oa-2jy oa-2mh oa-2ms oa-2no oa-2rc
 oa-2rj oa-2rt oa-2rx oa-2sh oa-2sa oa-2tm oa-2wb
 oa-2wc oa-2yh oa-2yi oa-2yj oa-3bd oa-3em oa-3es
 oa-3ls oa-3wm oa-4bd oa-4nw oa-4rb oa-5bg oa-5bv
 oa-5by oa-5dx oa-5hs oa-5ja oa-5sa oa-5wh oa-5xo
 oa-6mu oa-7cw oa-7ox oa-7hl oz-1an oz-1fq oz-2bg
 oz-3aj oz-3aa oz-3ac ea-gp eb-n33 eb-4au eb-4rs eb-4ww
 eb-4yz ee-ear18 ee-ear44 ef-8cs ef-8fr ef-8iz ef-8gi
 ef-8ix ef-8jf ef-8max ef-8ng ef-8udi ef-8yor ef-8sw
 ef-8ez eg-2ec eg-2xy eg-5xy eg-6mu eg-6td ei-lau ei-leo
 ei-lno ei-lpi ek-4dba ek-4oa ek-4uah ek-4uu ek-4ya
 el-1a el-1w el-1x em-smtm em-smuk en-oga en-ocmx
 ep-lae ep-3fz es-2co es-2nd fm-8st fm-ocb fo-a3b
 fo-a3c fo-a3e fo-a3m fo-a3p fo-a3w fo-a3x fo-a3z
 fo-a4e fo-a4q fo-a4y fo-a4x fo-a4z fo-a5o fo-a5t fo-a5x

fo-a5z fo-a6l fo-a6n fo-a8p fo-a8s fo-lar fo-pm sa-cbb
 sa-fc6 sb-1ai sb-1ap sb-1aw sb-1ib sb-1ld sb-1br sb-2af
 sb-2aj sb-2ag sb-2aa sb-2as sb-7ab sc-2ar sc-2as sc-3ag
 sh-bzl su-1am su-1bu su-1cd su-1fb su-2ak sv-ayre
 nl-4x nn-8yn nr-cto.

1SZ, Clark C. Rodimon, c/o A. R. R. L. Hq.,
 Hartford, Conn.
 (40 meters during International Test)

ea-gp eb-4ac eb-4af eb-4ar eb-4au eb-4ax eb-4rs
 eb-4ww ef-8px ef-8gi ef-8fr ef-8et ef-8sm ef-8eo ef-8jf
 ef-8cc ef-8ku ef-8fz ef-8art ef-8tis ef-8pel ef-8ddh
 ef-8eo ef-8ft ef-8eo eg-5ls eg-6hy eg-6xy ei-lno ei-ler
 ei-lgw ei-luu ei-ler ei-lay ek-4oa ek-4sar ek-4uah
 ek-4uu en-oga ee-car10 ep-lae ep-3fz er-5aa es-2co
 et-tpai nm-1aa nm-1j nm-1n nm-8y nm-1nic nq-8kp
 nr-2fj nr-2gph nz-ez5 sa-cb3 sa-fc6 sb-1ic sb-1aw
 sb-1ar sb-1ck sb-2af sb-1ax sb-1br sb-1ca sb-7ab sb-1ld
 sb-1aq sc-2bl sc-2as sc-3ag se-1ek sb-2ar su-2ak su-1oa
 sv-ayre fm-8ma fo-pm fz-lap oa-2rt oa-2sh oa-2ri
 oa-5hg oa-3bq oa-6mu oa-2wc oa-7cw oa-3hl oa-2rc
 oz-4aa oz-3ar oz-4ac oz-2ga oz-2me oz-1fs oz-1fq oz-2ae
 oz-4av imm ardi aqe ppu nau nna nidk wbyu.

2CMX, S. G. Meyer, 240 Washington Ave., Rutherford,
 N. J.
 (Heard on 20 meters during April)

4dd 4dm 4fa 4fl 4km 4ok 4rm 4si 4xe 5bh 5qs 5tt
 5uk 5vu 5wz 5ado 5age 5arf 5ata 6ar 6ir 6ig 6km 6lh
 6rn 6aod 6bhq 6bil 6bpg 6bux 6bxg 6cay 6cck 7cz 7ek
 7mh 7io 9cn 9db 9ec 9ar 9jl 9kv 9ll 9mz 9ax 9ahu
 9amq 9anu 9anz 9aok 9arl 9atg 9avg 9bad 9bht 9big
 9bkn 9bmx 9bqg 9brm 9bwo 9bvl 9caa 9caj 9cbt 9cis
 9cuj 9cki 9cmj 9cpq 9csl 9cux 9dea 9ddz 9dpb 9dov
 9drw 9dsg 9duh 9dwd 9ecz 9ece 9efe 9epe 9a-7mn
 ne-lap ne-lar ne-1co ne-1dx ne-3gg ne-4ek ne-4fv
 ne-8af np-4sa eb-4ax eb-4gh eb-5yx eg-6mu ez-8ct
 ef-8yor sb-1ad sb-1ak sb-1aw oh-6bd.

6ZT, 247 East 7th South St., Salt Lake City, Utah

8bt 8lt 8dms 9cit 9cxe 9dge 9dli 9to ne-5ef na-7jd
 nj-2pz ef-8if ef-8jn oa-2hg oa-2hx oa-2rc oa-2rt oa-2as
 oa-2uk oa-2yi oa-3ai oa-3aj oa-3dc oa-4ak oa-4bd
 oa-5dx oa-7bq oa-7dx oa-7hl oh-6cfq oh-6cxy oz-lan
 aqe arex ardi bam iio jx lgn ocl ved xc6l xc50.

8BAU, F. R. Gibb, 2639 Neil Ave., Columbus, Ohio
 (20 meters)

1aba 1abl 1auff 1ahi 1asf 1axs 1axx 1bhm 1boe 1byv
 1ev 1cfo 1ia 1ib 1ry 1sw 1uw 1zz 2ag 2agp 2apa 2apb
 2awz 2brb 2bsh 2est 2etg 2cck 2hj 2ow 2xhc 2xg
 3ekg 3eka 4bl 4om 4gs 4hv 4hx 4io 4iz 4ou 5abp 5acl 5agb
 5ahg 5ahk 5ain 5api 5apj 5aqc 5ass 5bd 5bh 5am 5ann
 5aou 6awk 6bau 6bjb 6jl 6hzm 6caw 6cca 6ccl 6czw
 6che 6ciw 6ekv 6cls 6cuc 6dhw 6ddw 6gj 6ql 6rn 6zat
 7aae 7ca 7da 9ah 9anb 9ano 9aon 9awb 9bad 9bhl 9be
 9bjp 9blu 9bmx 9bqg 9byc 9cae 9cal 9caw 9cho
 9ciw 9cjr 9ckv 9csi 9hcc 9des 9dgr 9djb 9dmb 9dsy
 9dvl 9ae 9eno 9efs 9el 9jk 9kq 9kw 9lb 9lz 9mh
 9au 9fr 9ob 9vk 9xm 9xx ne-lar ne-1cg ne-lap ne-3ec
 ne-4dw ne-4fv ne-5bk ne-5fk nd-hik nj-2pz np-4sr
 eb-4ac eb-4au eb-4zz ef-8ct ef-8gm ef-8j ef-8yor
 eg-5hs eg-1od eg-2lf eb-8vj ei-ler ei-1ad se-1cd se-2ak
 sc-3ag su-1ak su-lag sb-1ao sb-1ab oa-2vi oa-4ac
 oa-5hg oa-5lf oh-6ag oh-6cxy oz-lan oz-2ae oz-2rc
 vs-lab fo-a5x wiy lw wik derr sut kogt.

8CFL, Charles Justice, 433 S. 17th St.,
 Columbus, Ohio
 (20 meters)

1abz 1adm 1air 1ai 1act 1awe 1aun 1bhs 1bis 1ay 1yv
 1cfo 1cm 1df 1mk 1ka 1bkv 1bsg 1sw 1by 1ue 1rw
 1se 1zz 2ahm 2awk 2gk 4fa 4iz 4qb 4xe 5af 5ako 5amt
 5agp 5avs 5bd 5uk 5wz 6am 6aod 6bau 6bc 6bl 6dfe
 6det 6ekv 6fr 6kg 6nc 7aj 7jl 7ne 8aly 8ac 9ari 9am
 9amq 9brh 9ax 9bc 9by 9bf 9dgr 9dkl 9dfr 9ct 9dcm
 9dbz 9dwn 9dpb 9cxi 9cde 9duh 9cjs 9cpw 9kv 9qy
 9cki 9had ne-1ad ne-1ak ne-lap ne-lar ne-1co ne-1dx
 ne-4dp ne-4dw ne-4ek ne-4fv ne-5bf np-4je np-4sa
 eb-4ax ef-8ct ef-8yor eg-2nh sb-1ad sc-3ag su-1cd
 su-2ak perr.

The Communications Department

F. E. Handy, Communications Manager
1711 Park St., Hartford, Conn.

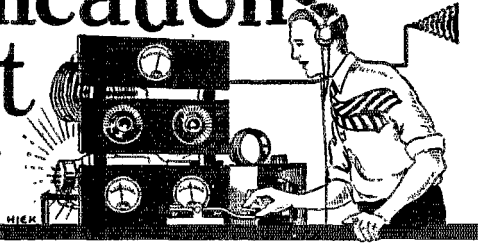

Expeditions

The *Putnam Baffin Island Expedition* sailed north from Rye, New York again, Saturday June 1 and will probably be gone for about four months. This expedition will explore and chart the central portion of the western coast of Baffin Island, a spot probably unvisited since Luke was there in 1681. Trips inland will be made in an attempt to locate an ice-cap and to chart lakes and territory never previously explored, crossing the island to Cumberland Sound. A radio transmitting station will probably be used at a location nearer the earth's magnetic pole than ever before and any unusual performance investigated.

Ed Manley (8FJ) is the chief operator on the *Morrissey*, VOQ, and Munroe Banard will assist in handling the base station when Manley is out with the low-power field set (an 852 supplied by Eveready B-bats) which will be taken inland. VOQ will handle press with 2UO and all general traffic by amateur radio just as last year. Look for VOQ on 33 meters. 500-cycles will be used most of the time on the 500-watt set though DC is available, too. The set will be operating on "20" after the expedition is far enough north, so keep an ear open there also. Remember the narwhal tusk awarded to Miller of 9CP last year for best work with VOQ? More valuable and interesting souvenirs will be collected this time and there will again be an unusual award for the station-owner doing best work for the expedition. On your toes for work with VOQ, gang, and let the reports for Manley come via Hq. so we can follow progress regularly thru these columns.

The communications arrangements of the *Wilkins Arctic Expedition* are working out very successfully according to latest reports from Mason at KFZG (Point Barrow). Besides amusing the matter-of-fact natives with short-wave broadcasting from PCGG and WGY (to which the Eskimos say "Ahdegah," meaning FB), weather, news, and messages are handled on schedule with KFZH at Fairbanks, Alaska. Hemrich of KFZH keeps a regular Monday and Friday 33.5 meter schedule with the States, nu7BM being the lucky station. ne4DU reports KFZH as putting a good crystal-controlled signal into his part of the country. nu9DNG was also QSO late in May and oh6BWV worked KFZH and took some traffic with the help of oh6AXW. From the northern-most tip of Alaska, Mason of 7BU sends a list of calls heard during April for the gang. Here they are:

1avh 1ber 1bma 1bms 2bl 2fj 2mu 2uo 3xt 2axr
2cbr 2xbc 4ll 4ok 4pd 4si 5em 5fs 5of 5atf 6ad 6dp
6gw 6hm 6ja 6xi 6aak 6aat 6ajj 6alt 6aye 6bdc 6bjl
6bjv 6bhw 6bxi 6byz 6bzf 6cfq 6coa 6csc 6csw 6cxy
7am 7bm 7br 7df 7eb 7ek 7er 7fh 7is 7gz 7mn 7qb
7tj 7uh 7abb 7abe 7abk 7ac 7ad 7ac 7ac 8aly 8at
8bau 8ben 8bjk 8cjb 8cve 8dcb 8dcm 8dhs 9be 9bf
9by 9ek 9af 9rk 9uu 9wi 9xi 9adk 9ahm 9alw 9apm
9arn 9aau 9avh 9bfm 9bvy 9btr 9cel 9cet 9efu 9eos
9epm 9epn 9evy 9cya 9cye 9cxw 9dcd 9dce 9eft
nc-5aw ne-1dq ne-5fs aj-igs eb-4ar eb-4rs eg-5bg
eg-5xy el-1alx eu-1nn ef-8bf ef-8cl ef-8jf ef-8jj ei-1no
en-6ga es-2co oa-2jt oa-2jy oa-2nj oa-2rb oa-2rt
oa-2sa oa-2uk oa-2vw oa-2ve oa-2xi oa-2bz oa-2dc
oa-3jk oa-3lg oa-3vp oa-4bd oa-4bl oa-5bg oa-5lt
oa-5wp oa-7ew oa-7gh oz-1af oz-1bd oz-2bg oz-2ga
oz-3ar oz-4aa oz-4ae oz-4ak oz-4am oz-4ar oz-5cl (fone)
nu-2xg nu-2xs kdka dfkx wgy pcrg (Misc.) at agb
agc agw arex b2 bam boia c2a cdo ido iri jkzb jna jps
kdfu kel kft kfim knux naa nba npa npc npg npm

nbn npo pea pepp ra08 sfv sgl sok wik wiz wut
wux wvc wvy wvaj.

The *University of Michigan Greenland Expedition*, nx1XL, uses a 250-watter on 25, 35, or 45 meters wavelength. Operator Paul Oscaunyan, Jr., (2AZA) advises that schedules may be arranged via radio and that nx1XL will probably be on the air on or before August 1, 1927. The outfit will be operated Mon., Wed. and Friday from 8pm EST to conclusion of traffic. Sunday operation will be from noon to 1pm EST on 25 meters. Outside the 9 to 9:30pm schedule with 8AXZ all time will be filled with schedules made by radio excepting from 8 to 9pm daily for general QSO and traffic work. Better listen for nx1XL and make your schedules early before all the time is filled, OMA.

Both a portable outfit for field contact with the base station and a more powerful set (mentioned above) are going along. The portable will operate from Burgess B-bats while an Escoc generator run from Exide storage batteries which in turn are charged from a 32-volt Delco outfit provides power for the "250." Some 210's, H-tubes, and a spark-coil are carried for any emergencies that may arise. The expedition will study meteorological conditions and the radio whims of the arctic. A base camp on the inland ice will first be established. Bamboo sectional masts will be used. A CR18 short wave and the new RCA IP501A medium wave receivers (with a 503 long-wave coil unit) are being taken along. The expedition will go further north and base at a higher elevation this year.

The *Borden-Field Museum Arctic Expedition* (KGEK) working nightly on 37.5 meters and daily on 23 meters sailed North from Oakland, Calif., April 30. The schooner-yacht *Northern Light* will collect live and mountable museum specimens for the Field Zoo and Museum at Chicago after outfitting at Vancouver, B. C., QRD Kodiak island, Pribilofs, Nome and the Arctic Sea.

We are indebted to Mr. A. Binneweg, Jr., 6BX-ex6XAA for a description of the radio equipment. A 600-meter transmitter and receiver in addition to the 100-watt short wave outfit is located in a two-by-four radio room right under the main mast. A tuned-plate tuned-grid circuit is used in the transmitter the coils being of silvered copper tubing of the plug in variety to make a quick QSY possible. The outfit was built by R. W. Hart (Chief operator of KGEK) and Binneweg (6BX). W. E. tubes with .0006 μ f grid and plate blocking condenser are used. A 1000-volt M. G. supplies power, keying the high voltage being accomplished with a Leach relay. A short vertical antenna is used against ground. Operator Hart requests all amateurs to listen for him and help QSR Chicago. All cards sent to him at 80 Grand Ave., Oakland, Calif., will be acknowledged. Look for KGEK on 23 and 37.5 meters, gang!

The *Marshall-Field Expedition* in Alaska has an outfit on 37 meters (WMBE) and 9AXZ tells us to QSL the sigs via Sears Roebuck (WLS) Chicago, Ill.

3AHL (908 Hanover Ave., Norfolk, Va.) gives us the QRA of xCBZ as a ship on an around the world cruise via Panama, Australia, India and the Mediterranean Sea—at this writing between Australia and India. During the 5 months cruise xCBZ is using a UX210 with 750 volts dynamotor supply. Cards may be sent thru 3AHL.

Real Amateur Cooperation

By Charles N. S. Ballou, op3AB

THIS is offered apropos an article by F. Johnson Elser appearing in *QST* for December, 1926, entitled, "As Others See Us." May I invite your attention to a transmitting amateur who practices all that he preaches? I refer to this same Elser, who is also the proprietor and brass pounder in chief of op3AA and op1ZA.

Now I was once a transmitting amateur, and I rejoiced in my ability to copy 25 words a minute and send with a good clean fist. That was thirteen years ago. From 1915 to 1926 I was out of it, having spent the intervening years in acquiring a degree or two, a commission in the Army as my father did before me, a wife, and a pair of noisy progeny. Then I encountered Mitey Doran (of KUDG) who after spending most of his day handling ship traffic for the West Jester, spent the rest of it throwing signals about the world with a Japanese 20 watter on 40 meters.

Sez I to myself, "Verily this darn glass bottle is some different from my old one Kw., but if all these cards are to be believed, it produces the goods. Verily, I will investigate." So before Doran sailed from Zamboanga, where I was hibernating at the time, I secured from him a diagram and much good advice. Now Zambo sits down below the seventh parallel near the far end of nowhere, and radio stores are not, so much junk went into my set.

Try sometime and build yourself a set with condensers cut from scraps of zinc and aluminum with a pair of tinsnips. Just try and make those condensers variable. Open up your wife's electric iron and make a grid leak of its innards. Hold down the job you're being paid for, spend your spare time with a company of native troops chasing renegade Moros in the hills, shove the thermometer up to 120 in the shade, solve your own problems, because there will be no one to answer questions, and when you get through, you will either be crazy or have a radio set. I had a set of sorts. It worked after a fashion, but not often enough to give me a real thrill—furthermore, it had made me most unpopular with my wife. She was very much "again' it," so I decided radio was not for me.

Then a mosquito bit me and a kind headquarters sent me to the mountain country to get the malaria bugs out of my system. I rambled about the hills and in the course of my wanderings, came upon a small shack between two tall lattice-work masts. "Here" said I, "is the den of a radio bug." The bug was at home and he showed me the works.

"This is op3AA," sez he. "With a 5 watter this station has worked England, and with a pair of fifties, I have made myself a member of the WAC Club. Look it over." I did. There were no loose wires. All was laid out with care and precision. Connections were made with heavy copper tubing, and that tubing was polished till it glistened. Much pyrex was in evidence, and all four walls were plastered with cards which said, not "tnx fer card, om" but "ur station wkcd" or "ur station hrd wrking".

"So," I sed to myself, "I have come to the right place, but will this egg deign to notice me when he hears that I can no longer handle 25 per, nor yet even 5 per—that I have a fist like a truck, and that most of this layout means nothing to me. However, I will give it a try." So I sed, "I would have a radio station, and I have tried hard, cussed much, and burned my fingers many times with high voltage DC and with soldering irons, yet still I have no radio station. What is all this about, and what are all these pretty glass and copper dinguses for?"

Then this ham (he does not like that word) took me in hand and introduced me to the mysteries of the Hartley circuit, and the Tuned Grid and Plate and, after struggling mightily with the density of my ignorance, dug down into the depths of his junk box and presented me with many dingbats which I carried proudly home to the despair of my wife.

Now 3AA is a busy man, and he went away to Manila for two weeks. When he came back I was in bed, having been laid low again by the black water fever I had acquired in the swamps of the Southlands; and in bed with me were wire, and solder and dingbats galore. So he hied him away to his station and returned shortly with his own soldering iron and a vernier dial, and we put the finishing touches to a receiver. That night we tried it out and it worked, and great was my joy as I had expended many hours and some pesos on its construction. "Now," sez 3AA, "you need a transmitter, and while my own

ambitions run to one Kw. water-cooled tubes, I think a pair of UX210's self rectified, will be about right for you to start with. Tubes are expensive, but a friend of mine is a friend of a friend, etc., etc.—so we will get those tubes cheap." We did, also condensers and things, some that he bought and some that 3AA donated out of the kindness of his heart and his hope that another good ham might be born. And meanwhile this busy ham brought out an ancient buzzer and key, and endeavored to delve into the recesses of my rusty brain and revive a ready understanding of the mysteries of dah-dit-dah.

So well did he do all this that in due time the authorities invested me with beautiful certificates, two of them, attesting my right to own a radio station and to run one. Then came the great day when a carefully measured length of No. 12 enamel was raised for all to see, and with a wavemeter (3AA's, of course) in hand, we pressed the key, while Elser tinkered with the clips and dials. The needle slowly crawled up the dial and finally rested on 9/10 amp. The wavemeter said 33 flat.

"'Tis well," sez 3AA, "we will now communicate." We did. Op1HR came back at the first call "7 steady smooth rac", sez he. HR has become an old story since then, traffic runs smoothly to stations on the Pacific Coast, Australia, South Africa and Europe have admitted that 3AB is on the air, and great is the peace of my mind and the content of my soul. And also—Elser and op3AA can have my shirt or my wavemeter or anything else that I have any time he wants it.

In his article, he attempted to describe the wrong kind of ham. This is my attempt to tell you of his kind and of the manner in which he practices the creed he preaches, and to express my own appreciation of the assistance and friendship of a real "Transmitting Amateur". He taught me the why and wherefore of my set and helped me build it. When I've been disgusted because I had such a rotten fist and because I had to say QTA and QSZ so often, he has said, "Sure you are an awful ham, but so are we all at first. Here let me take that key and shift some of your traffic, you'll feel better after awhile."

Next year he will be in Boston Tech, splitting the ether with a pair of crystal controlled 1Kw. water-cooled babies. Listen for him and when he comes on the air, you will meet an amateur who can and will handle traffic with the best, with a fist as smooth as cream, and one who will be always ready to help some poor devil like myself who wants to be a ham and doesn't know how. He's a real transmitting amateur and he knows his stuff.

A Friendly Challenge from 6BJX

Say, gang, since 1BIG copped that traffic trophy, the traffic figures in that bit of collym in our dear ol' *QST* have been getting awfully—QRZ, shall we say? Let's have a little competition here. Yours truly is going to give a few figures, and he's issuing a friendly challenge to any of you to equal them for consistency, at any time, past or future, for a like period of time. In fact, he'll give a genuine "Baguio Set" (Philippine linen, made by the natives) to whoever can prove to have equalled this record. They're all the rage om, and very scarce in this part of the world. Will one of 'em make the YL open her eyes? Oh, boy! This competition is for operators, not stations.

Here are the figures to shoot at, ob. In the summer of 1924, "KH" of 6BJX adopted the slogan "6BJX for a real qsr". He's tried to live up to it, and here's what he's done, from January, 1926, to May, 1927—17 months. He was in the BPL 15 times. One miss because he was sick, and one because the report was lost in the mail—and these figures are from *QST*, so we can't count that one. He handled 4849 messages, and delivered 1875. This is an average of 323 a month, and 91 a month delivered. The total only dropped below 225 twice. 6BJX was third or under on the list on six different occasions, and held the starred rectangle once. The daily schedule with op1HR is in its 19th month, and going strong. About 80% of all messages are handled with the Philippines. These average 33 words each.

To simplify matters, all we'll ask for is a like percentage of times in the BPL, with an average of 300 or over a month, and a sked—over any distance—of like duration. 6BJX has done it. Who wants that "Baguio Set"?

Some Considerations in Organizing a Radio Club

By J. Walter Frates, 6CZR

DURING January a group of amateurs from the East Bay Section met at the home of J. H. MacLafferty, Jr., 6RJ appointed him as Temporary Chairman, designated ourselves charter members and organized the Oakland Radio Club.

Our object, to quote from our new constitution, "shall be the bringing together of licensed transmitting amateurs and those interested in the art of radio telegraphy.....and further..... to encourage good operating procedure in accordance with Government regulations and the creation of a body of skilled operators whose services and abilities will further the general knowledge of the art of radio." In other words, we took the tried and true A.R.R.L. principles—or what we conceived them to be—and applied them to our own case.

Our next move was to elect officers and draw up a constitution.* Those elected as officers of the Oakland Radio Club were 6ZX, president; 6RJ, vice-president; 6AEA, secretary; 6OC, treasurer; 6CZE, publicity manager, and 6RJ, 6APA, 6CCT, and 6AMO, members of the advisory board. The third step was to apply for affiliation with the A.R.R.L.

We divided our membership into three classes: full, associate and honorary. Full members** are those who hold Government licenses. Associates are those broadcast listeners who are interested in radio telegraphy and express a desire to enter the club. Honorary members include outstanding figures in the radio game, and amateurs of other cities who would like to come in with us occasionally and sit by the fire. The inspectors of the Sixth District and 6CJ of Santa Barbara. 6RJ, 6JS and 6ANE were appointed a committee to draft the constitution and by-laws of our new organization. 6APA, 6CCT, 6BBK and 6CCK were present at the first meeting.

Some of our rulings are a little arbitrary, we admit, but we made them so to protect ourselves and keep the standards of the club and amateur radio high. We will solicit no members, but we do invite applications from those interested who will abide by the ideals associated with the A.R.R.L. and transmitting amateurs. In addition, we reserve the right by vote of the entire club, to decide whether or not we want a man for a member, or, after being admitted, to compel him for just cause at an announced general meeting of the whole club to cancel his membership, even if he is an officer. Neither the president nor the vice president nor the members of the advisory board may hold consecutive terms of office. There will be no politics and no group can ever gain control of the club; we have arranged everything to the best of our modest abilities so that the organization will always remain democratic and controlled by the wishes of the entire membership. In addition, we have pledged ourselves for everything which will benefit amateur radio, or increase our own knowledge of the art of brasspounding.

As soon as we get straightened out in a parliamentary way, we have many plans. We're going to have a shack with a stove (not the QRM kind), a transmitter, talks by experts,*** hamlets, meetings with other clubs, discussions, code classes for beginners, banquets,—anything and everything that a good club should have.

But, while doing all this, we're not going to forget that there are other fellows both inside and outside of amateur radio worth knowing and that while enter-

tainment is pleasant, the only reason for the existence of the art is education, instruction, operation and experimentation. And, as far as we are concerned, that's the way its going to be, or they can't play in our backyard!

With the Route Managers

By Lawrence A. Jones*

WHAT seems to be the main difficulty, fellows? Here the number of Route Managers is increasing all the time, and yet the number of letters is decreasing. That isn't at all according to Hoyie. By rights we should be snowed under with epistles from you.

Summer wx and summer traffic are with us for sure now. Messages are scarcer than hen's teeth, and many stations have canceled their heretofore reliable schedules. It's too bad, but that's what we have to contend with every summer. Perhaps it's just human nature to want to drop all winter activities in this weather, and get out in the fresh air. We all feel that way, but surely there isn't any reason why one evening a week—or even part of it—cannot be devoted to schedule work right through the hot months.

1AAL, RM of Western Mass., says, "This sure has been a tough month for QRN. At times it was next to impossible to work on eighty meters. It did not bother me so much though, as I put one over on it by going down to twenty meters." Have handled a good deal of traffic down there." He's right, fellows. When the static gets too bad on eighty, just try popping down to twenty for a time. Brown also tells us about the official opening of the message box system in his city. The Mayor of Worcester was induced to post the first message, which was addressed to the Mayor of Hartford, Conn. The message was relayed immediately through Brown's station 1AAL to 1MK, phoned to the Mayor of Hartford, and a reply immediately relayed back to Worcester. The whole business occupied less than half an hour, and was a fitting opening for the box system. EB work, OMs! 1APL in Springfield has been appointed as Brown's assistant in RM work, and we are sure he will do a good job. Good luck to you, OM.

9CWN, the new RM of Northern Minn., is getting off to a fine start in his work. He has gotten out a multigraphed letter to all his ORS, asking for their cooperation in keeping him advised of schedules, etc. Among other things this letter contains spaces to fill in giving wavelengths, times, direction of easiest QSO, etc. That's the stuff, old boy, keep at 'em. Let's hear how the thing works out.

4FI, our worker from Tennessee, says, "I have a number of stations who say they will be active 'a little later', but it looks like this 'little later' is never coming to pass, so I'm going to 'ride 'em Cowboy' until I see some active stations in Tenn." With a spirit like that, results just can't help coming. 4FI also tells us that since Tennessee has a comparatively small number of ORS, he is going after the non-ORS and trying to get them to apply for an ORS ticket and handle more traffic. We expect to hear great things from Tenn. with that kind of work going on. Congratulations OM, and keep up the good work.

We have another comment on the QRN situation from F. J. Beck, the SCM of South Dakota. He says that QRN has sure been knocking things in his section, and he suggests a remedy in maintaining skeds on twenty meters plus forty and eighty short distance daylight schedules to clear local traffic. Beck tells us that twenty meter traffic is improving FB. It won't be long before the gang as a whole will realize the excellent traffic handling possibilities on twenty and begin to make use of them. As we have told you many times before, static is practically nil down there on nights when it is knocking your heads off on eighty and forty. (Give it a try some day, by starting some messages on their way.

Our old friend 9CZC of Iowa, says that although the ORS do not seem very active, there is some traffic being handled on the sly. Hi! Appearances are often deceiving! Anyhow whadda we care just so long as it's being handled? He also tells us that many stations are sticking to eighty meters, and can be heard

* Asst. to the Communications Manager.

*Any one interested in organizing a radio club may obtain a sample club constitution by requesting the same from A.R.R.L. Headquarters to help the committee appointed in drafting a satisfactory set of by-laws.—F. E. H.

**By restricting full membership and voting privileges to qualified transmitting amateurs, the founders of the club can rest assured that its government and objectives will always be devoted to amateur two-way communication in accordance with the Constitution and By-Laws. This is an important provision which should be carefully considered when a club is being organized.—F. E. H.

***A program committee arrangement that has worked very successfully with several clubs is that of making the committee consist of two men plus the president. The two men divide their duties clearly and are required to report a definite date each month (to the president) on the program that has been prepared. When the men on the committee are changed but one goes out of office at a time.—F. E. H.

and worked nightly even in this warm weather. So you see fellows, that it can be done. The static is bad, but we should not give up the ghost until it becomes absolutely impossible to work through.

Lookit gang, we're squeezed into half a page of QST this month, and it's all your fault. If you are interested in reading this stuff, you'll have to contribute some yourself. Depending on the other fellow will work for a while, but not forever. So every one of you write in this month, and we'll see if we can't get back our full page next time. Incidentally we would be mighty interested to know how many of you read this page, and whether or not you like it. Drop a QSL card in the mail box as soon as you finish reading this and tell us all about it.

That's all there is now. Best of luck for another month. 73 de "LJ".

Reports on 20-Meter Work

WHILE early May reports indicated generally poor conditions for a few days, most of those received during late May and early June showed a return to the previous fine conditions. During the international tests a whole new bunch of foreign stations were heard and worked on "20". The most successful stations in the tests used 20-meters in addition to other wavelengths. Many good logs of work on "20" alone were received. Of course stations capable of a quick QSY had a material advantage in that they could make best use of all available operating time. Lots of operators found relief from 40-meter QRN and QRM by working the large number of 20-meter brass-pounders who were "QRV test msg". Low-power stations found themselves under no handicap at all using "20".

From 1AJM, "Out of 23 countries heard on 20, I have worked 22. Traffic is now better, too. Took a msg from nu6VZ for e1AY, gave it to him an hour later and had answer for 6VZ same night. xLWJ can't give full QRA but he is operating under cover from some point in India. QRH 19.8 meters, DC note, and will QSL those worked when possible."

20-meter calls heard by 8AXA (Syracuse, N. Y.) May 9-22: eb 4AA 4AU 4BC 4WW 4ZZ, ef 2BF 8CT 8EO 8FJ 8GM 8LJ 8JM 8JN 8NOX 8TUV 8YOR, eg 2AO 2CC 2IT 2XJ 2XY 2BY 5GQ 5HS 5LS 5WQ 5YK 5YX 6BD 6MU 6VX, ei 1CO 1CR 1NO, em SMUK SMWS, en PB6, fm XN2, fo 2UK 7GW, oh 6BDL, oz 2AG, sb 1AC 1AD 1AK, sc 2AH 2AR 3AG, su 1GD 2AK.

6CKV (San Jose, Calif.) reports, "20-meter work is increasing out here. All continents have been worked on that band. Stations dead to Europe on 40-meters are getting R-8 and R-9 reports from there on 20... honestly it can't be beat. Am keeping daily schedule with amVSIAB (Singapore, Malaya) and we work single from 1500 to about 1630 Greenwich. amVSIAB is just below WIK with a deep RAO note and very steady. It's great to send away single and know the fellow 3,000 miles away is getting it perfect, and then look out the window and see a bright sun (it's mid-morning)!" A message from amVSIAB to Hq via 6CKV and 4FA made good time on 20-meters. Tnx. OMs.

From 8AVB via 1LU and 1BHW, "Have been on twenty meters for over three months. Have worked about 65 different sixes and about 15 different sevens and ne, np, oh, ef, and WY on UX210. Have found 20 both peculiar and FB at times." From 3CVQ, "Worked eg5HS from 5 to 5.30 pm EST May 14... our sigs R5."

A word from 1BYV (Framingham Center, Mass.), fmTUN2 at Tunis, Africa, has been worked five times lately between 2000 and 2400 Greenwich, sometimes later. He uses AC plate supply, 30-watts input on 23-meters, and asks the gang to look for him. The 20-band is perking fine now, as I can figure over 25 countries represented. Worked 6HM the other night when he had but 9 watts input in his set, also worked eg5YX ten times and he generally uses less than 10 watts. FB!"

From ne3FC (Toronto, Ont.), "Wholly from choice I used 19.85 meters with T.P.T.G. circuit, operating from eleven pm until one am daily during the Contest. A Sunday schedule with eg5HS has been in effect for many months and his signals are remarkably steady and R6 or better. The time has gradually been set ahead from 1800 to 2130 Greenwich. What I regard as most outstanding on this wave is the work with oz2AC night after night begun last March and

carried out regularly ever since. oa7CW, oh6AXW, oh6BDL, eg5BY, eg2IT and ef8CT put good signals through during the tests." record time on 20-meters, being relayed via oh6BDL, nu5WZ, and nu1BCZ. A shorter message from the same station of origin was received through nu6BIIH, "20-meters sure is the DX-wave. May 28 0700 hooked with eb4AU position here 12.07 S. 142.10 W. QRB 9360 miles."

A radiogram from CR10 to Headquarters made egBRS83 "finds 20 meters FB and logged oh6AXW, oh6BDL, na7MN, nu6ZAT, nu6FR, nu6UR and many others in other districts during the first week of May. 20-meter work is jolly interesting because there is so much to be found out."

nu6VZ (Santa Monica, Calif.), "...was QSO e1AY on 20 meters at 10.40 pm PST May 29, 1927. Is this the first Italy to Calif. QSO on 20-meters?" It's the only one ever reported to us. OM. 6BQ, 6AJM 6BAM, 6AXU, 6CNK and 6LH are now on 20-meters and 6SB expects to QSY soon. 6ZAT (Bill Eitel, Los Gatos, Cal.) has worked 19 countries to date on "20". His station is one of the best points for So. African contact at present and has been QSO 114 times since last Sept. 12 (about every other day!). Not always on 20-meters of course though the latest QSO reported is contact with foA4F on "20" April 29. 6ZAT says that the South African fellows are bashful about coming down to 20-meters for some reason and passes along the rumor that A5O is planning to move to Bermuda. Sec'y Raymond Coombs of the South African Radio Relay League sends news that a 20-meter contest with English hams is being planned.

8CLP reports his best DX the sixth district until he dropped from 40 to 20-meters. Now he has worked nm, np, nj, nr, sb, ef, ei and oa, the latter QSO being with 4BD. He says, "oh, oa, and oz stations are good until about 3.00 am EST, then fade gradually out. All the Toledo, Ohio gang are now on "20" exclusively. The strongest and most consistent are as follows: ef8CT, SBF, eg2IT, oh6ACG, 6AXW, 6BDL, sb1AK, su2AK, sc8AG, oz2AC."

Fred Westervelt, 8VE (Pittsburgh, Pa.), "I tried to raise So. America for a long time and never succeeded until 20-meters came to the rescue. That band is a GOOD band for EVERYTHING. Herewith a list of 20-m calls heard (Apr. 15-May 15 in spare moments):

1CJ, 4FA, 4SI, 5AFB, 5AKO, 5AMW, 5API, 5APZ, 5AQB, 5AQU, 5QJ, 5SK, 5UK, 5WZ, 6AGS, 6AHS, 6AEY, 6BAM, 6BUX, 6CHE, 6CKV, 6CUC, 6DCK, 6DFE, 6DGG, 6EA, 6EW, 6RN, 6TX, 6VZ, 6ZAT, 7BM, 7DA, 7EK, 7GR, 7LX, 7JF, 7MH, 8AEX, 8AOK, 9AYW, 9BCN, 9BGH, 9BOC, 9BYC, 9BYL, 9CAA, 9CKT, 9CVN, 9DBV, 9DKR, 9EK, 9KV, eb-4AU, eb-4AX, eb-4WW, ef-8BF, ef-8CT, ef-8YOR, ef-2IT, eg-2LZ, eg-2NH, eg-5BY, eg-5HS, eg-5YK, ei-1CA, nc-1AR, nc-1BY, nc-8GG, nc-4DU, nc-4FV, nc-5BF, ni-2PZ, nm-1AA, np-4SA, oz-2AC, sb-1AD, sb-1AK, sb-1AW, sb-1AX, sc-8AG."

Bill Duffield, ne4DU, (Winnipeg, Can.), "On 20-meters I have been QSO eg5YX, oh6BDL, sc8AG, oa, oz and CHAM (the S.S. Seaham when 100 miles west of Ireland) to whom cards may be forwarded via ne2CG. I beg to differ with nu8CCQ's statement in last QST. For a year I have been using both WE211D's and 212D's on 20-meters having worked the latter tube as low as 15 meters with inputs up to 400 watts. I find that smaller grid and plate blocking condensers are better with the WE212D when used below 25 meters (.0003 pf.). Have logged eg2LZ 20Z 20NM 8BT 5YX 5HS 2IT, eb 4AU 4AX 4WW 4ZZ, ef 8YOR 8CT 8JN 8JZ, sc 2AH, 3AG, oh 6BDL 6AYW, oz2AC, oa4BD, CR10, CHAM, GLGY, NIDE."

Mr. J. C. Haban, Columbus, Ohio (8BJF) is studying 20-meter polarization effects by making daily observations on GLQ, FW, and AGB (26 meters and approx. 4,000 miles distant) and on 2XT (17 meters - 500 miles) with a vertical and a horizontal antenna at certain hours. Between seven and eight pm EST signals from stations in the first group pick up strength rapidly using a horizontal receiving antenna while 2XT's strength is unchanged. Audibility is nearly constant from all stations observed using a long high antenna with quite great vertical length. More volunteer observers are wanted on this problem. All that's necessary is a good receiver and horizontal and vertical antennas of about the same over all dimensions with switches for quick changeover. Observations over a period of several days should be averaged. PCUU and WIK right in the vicinity of

20-meters are a couple more good stations on which to make observations.

TBM finds twenty meters "the berries" as he worked all districts but the third in two hours time. WEF says. "I have worked five continents in one night on "20". fmTUN2 has been worked twice... QRA Radio Club of Bizerte, P. O. Box 72, Bizerte, Tunis, Africa. A Spanish whaler X2R has been worked by 9BSK and myself when about 2000 miles southeast of Cape Ste. Marie, Madagascar QRD the antarctic. X2R asks all the gang to look for him on "20". 1AKZ is having good luck with So. America on 20. GFR says. "It seems to be the best wave for both European and Australian QSO's. I.AAL says there is plenty of traffic on 20. 9EAY handles most of his traffic there now. 1AJM is on 20 to stay. Victor Gramich, Murnau, Oberbayern, Germany (ek4UAH) says in speaking of 20-meters. "Tests I have made till now persuaded me the work is very satisfying and this band is the coming band for DX work. The May 23 and 24 I have worked on "20" in a few hours the following stations: nu1RF (the first nu-ek QSO on "20"), nu4RR, nu2TP, nu1AJM, nu2CH, nc3MP, nc9BZ, sc2AH. The last one reported me R5 though using but 20-watts input on this wave. On my first test on April 10 I picked up immediately foA5X."

Notice

During the past month three Section Managers have taken office. They are as follows: In the Oregon Section of the Northwestern Division, R. H. Wright, 7PP, 310 Ross St., Portland, Ore. In the San Francisco Section of the Pacific Division, J. W. Patterson, 6VR, 1338 Fell St., San Francisco, Cal. In the Sacramento Valley Section of the Pacific Division, C. F. Mason, 6CBS, 2530 N. St., Sacramento, Cal. Give them your cooperation in all they are attempting for these Sections of A.R.R.L. please.

This month we are sorry to be obliged to record the resignation of S. C. Ms in the Eastern New York Section of the Hudson Division, in the Michigan Section of the Central Division and in the Florida Section of the Southeastern Division. To OMs Peacox, Darr, and Grogan go all good wishes from the gang. Probably when they are relieved of the load we will hear them on the air more than was possible when busy with Section affairs.

Due to these resignations and to vacancies in our line-up previously existing, nominating petitions for Section Communications Managers are hereby solicited from the following Sections:

| Section | Petitions to be valid must be filed on or before |
|------------------|--|
| Eastern New York | Noon, Aug. 2, 1927 |
| Michigan | Noon, Aug. 2, 1927 |
| Florida | Noon, Aug. 2, 1927 |
| Alaska | Noon, Aug. 2, 1927 |
| Montana | Noon, Aug. 2, 1927 |
| Washington | Noon, Aug. 2, 1927 |
| New Mexico | Noon, Aug. 2, 1927 |

The closing dates for receipt of nominating petitions in the Sections listed is given above either as previously announced or extended when necessary due to the failure of members in filing petitions in certain Sections. Petition must be filed at A.R.R.L. Headquarters on or before the time announced to be valid. The proper form for nomination was shown on page 45 of April 1926 QST. The candidate and five signers of a nominating petition for Section Communications Manager must be members of the A.R.R.L. in good standing and the signatures on the petition must be authentic or the petition will be thrown out as invalid. Members are urged to take initiative immediately, filing petitions for the officials of each Section now operating under temporary officials, so that the work of organization can go forward everywhere without further delay.

—F. E. HANDY, Communications Manager.

OFFICIAL BROADCASTING STATIONS

Changes and Additions
(Local Standard Time)

9JU (41.5) 10:15 pm Tues., Fri.
3ZL-3CS (81) 7:00 pm Mon., Thurs., Sun.
5ADA (41) 7:00 pm Sun.

BRASS POUNDERS' LEAGUE

| Call | Orig. | Def. | Ref. | Total |
|---------|-------|------|------|-------|
| 8BAU | 41 | 27 | 339 | 407 |
| 9CPM | 15 | 147 | 218 | 380 |
| 6AMM | 69 | 140 | 140 | 349 |
| 6BJX | 86 | 120 | 77 | 283 |
| 8XE | 37 | 34 | 207 | 278 |
| op1HR | — | — | — | 226 |
| 3BLP | 1 | 6 | 210 | 217 |
| 2APD | 34 | 36 | 142 | 212 |
| 8CWT | 18 | 42 | 138 | 198 |
| 8EU | 41 | 36 | 114 | 191 |
| 8GI | 2 | 50 | 124 | 176 |
| op1AU | — | — | — | 175 |
| 6DAU | 40 | 36 | 86 | 162 |
| 9CMY | 85 | 26 | 40 | 151 |
| 8CGZ | 2 | 3 | 146 | 151 |
| 6AGG | 53 | 2 | 88 | 143 |
| 5AMO | 30 | 15 | 90 | 135 |
| 6CMQ | 16 | 11 | 106 | 133 |
| 8CXL | — | — | 131 | 131 |
| 8AVK | 26 | 20 | 84 | 130 |
| 7UL | 112 | 1 | 16 | 129 |
| 1APL | 4 | 16 | 107 | 127 |
| 9BWN | 30 | 20 | 74 | 124 |
| 1BQD | 27 | — | 97 | 124 |
| 1AOX | 19 | 7 | 98 | 124 |
| 2ALP | 27 | 34 | 62 | 123 |
| 5EW-5PK | 96 | 16 | 11 | 123 |
| 6ZBJ | 11 | 7 | 104 | 122 |
| 5FJ | 43 | 17 | 58 | 118 |
| 6RJ | 19 | 29 | 66 | 114 |
| 6BWW | 7 | 7 | 96 | 110 |
| 6BYH | 12 | 11 | 86 | 109 |
| 9DOE | 27 | 19 | 60 | 106 |
| 9ZK | 21 | 6 | 78 | 105 |
| 1BFZ | 32 | 10 | 62 | 104 |
| 6BVY | 49 | 53 | — | 102 |
| 6AJQ | 37 | 24 | 40 | 101 |
| 8ADQ | 75 | 13 | 12 | 100 |
| 8BNW | 25 | 21 | 54 | 100 |

Some stations took time out for participation in the International Relay Tests; others let summer QRM their message handling activities. The B. P. L. shows the effect of these things this month, giving credit to the stations that in spite of all obstacles handed quantities of good messages. 8BAU, 9CPM, and 6AMM are the top-notchers with old 6BJX and 8XE in fourth and fifth place. Nearly forty stations are keeping up membership in the B. P. L. during the summer months. Others can do the same with a little more effort in making and keeping schedules with the right stations. Hw?

ARMY AMATEUR NOTES

SECOND CORPS AREA—At the Army Amateur meeting held during the recent Hudson Division Convention, Capt. A. C. Stanford and Capt. J. A. Autrey, in charge of A-A work in the Second Corps Area, Lt. D. S. Boyden, A-A Representative for the First CA, and Lt. David Talley, A-A Representative for the Second CA, were present. Interesting talks were given by each, and the value of A-A stations was officially recognized by the commanding general. The officially recognized by the commanding general. Stations keeping schedules with 2SC are: 2OU, 8HJ, 2ASE, 2AVB, 2CVJ, 2PF, 3HW, and 2EV. A-A stations 2APD, 2AVR, 2ARM, 2CBC, 8DME, 8CVJ, 2ALS, and 2CZR continue to be active.

THIRD CORPS AREA—Station 8AGO has been in communication with Captain R. C. Hildreth, S.C., who is to represent the Third Corps Area at the Atlantic Division Convention. Station 3BQJ has been doing satisfactory work in keeping schedules with 3SN. More A.R.R.L. members are desired in this Area. Amateurs interested are requested to communicate with the Signal Officer, Headquarters Third Corps Area, Baltimore, Md., for details.

FOURTH CORPS AREA—Certificate has been issued to 4BZ of Atlanta, Ga., to serve as principle of the 122nd Infantry, Georgia National Guard. 4SI has been acting as Corps Area Control Station, and will continue to do so, meeting all schedules with 2CXL, indefinitely.

EIGHTH CORPS AREA—Station 5AIN, the N. C. S., has been operating satisfactorily. Tests have been carried on from this station for the benefit of A-A stations in Arizona, with satisfactory results.

Club Activities

ALBERTA—The Alberta Radio Experimenters' Association at Calgary, is doing good work. They hope to have a new station in operation shortly, and expect to handle traffic. FB!

BRITISH COLUMBIA—The British Columbia Amateur Radio Association, Inc., has held its first hamfest. Being in Canada, trips to the liquor store were not infrequent. Hi! The members donated enough apparatus of various kinds so that the club will be enabled to get on the air with a real high-powered station before long. FB. More of these meetings will be held in the near future.

CALIFORNIA—The Central California Radio Club have engaged their new club rooms, and expect to hold open house soon. They propose to have code classes and general instruction in amateur work as soon as they get located.

The Oakland Radio Club has been making several attempts to QSO Sokoloff of na7KK, in response to a request from Headquarters. FB!

The Santa Clara Amateur Radio Association is starting construction of their new high power transmitter. Visiting amateurs are always welcome to the clubrooms.

The Silver Gate Radio Amateur Association are having very interesting meetings, and the club now numbers fifty. They held a very enjoyable banquet a while ago.

The Whittier Union High School Radio Club put over a hamfest attended by 100 Southern Calif. hams. 6CSS, 6BMA, 6AM, 6BUR, 6DDO, and 6BKA were on the program. 6ALZ was the manager. YLs 6EI and 6BXA both graced the gathering with their presence. Of course everyone had a peach of a time.

CONNECTICUT—The Twin City Radio Club of West Haven elected 1ATH as their new president, to succeed 1BAU, who resigned.

GEORGIA—The Chattahoochee Valley Radio Club has just been organized for the purpose of helping local amateurs and BCLs by giving them the opportunity of getting together with their problems.

IDAHO—The Idaho Key Pushers, known as the IKP, is a new organization started to promote and uphold interest in amateur radio in the state of Idaho, and to help the A.R.R.L. put across any worthwhile proposition. Any interested Idaho amateurs are asked to communicate with SCM Fletcher, 7ST.

ILLINOIS—The Chicago Radio Traffic Association plans to continue activities right through the summer. They are organizing an indoor baseball team, which will get into action as soon as the rainy season passes. FB!

The Aurora Amateur Radio Club is a new organization which has 9EHF as its president, and 9NE as its Secretary-Treasurer. The main purpose of the club is to protect the amateur, and to give some instruction in theory and code.

INDIANA—The Purdue Lafayette Radio Association has been organized at West Lafayette to further the interests of the amateurs at the University. A hamfest was held recently, and was so enjoyable that more are to come darned soon!

The Indianapolis Radio Club is starting a code school for beginners. The vice-president, 9DSC, has an iron brand with which he intends to mark all chairs, etc., in the club room, so that said chairs will not walk away when left alone. Hi!

The Mahoning Valley Amateur Radio Club holds contests for code efficiency for the young members every three months. The first one to pass license exam gets a UX 210. That's an FB idea!

The Society of Rochester Transmitting Amateurs is busy arranging for the big annual western and central New York Convention at Rochester August fifth and sixth.

KANSAS—The Imperial Brass Pounders Club of Independence, of which 9BUY and 9JU are the officers is going along in fine shape. Meetings are only held about every four months, due to the large area covered by the club's membership. The purpose of the club is to promote better friendship among the hams of southeastern Kansas.

MAINE—The Queen City Radio Club is deriving a great deal of enjoyment from bi-weekly gatherings at various members' homes. Plans are under way for a week-end trip to the sea shore in the latter part of June, and it is hoped that the Bar Harbor gang will ring in on this with the Queen City bunch.

MASSACHUSETTS—The Eastern Massachusetts Amateur Radio Association meets the first and third Tuesdays of each month, at 72 Gardner St., Allston, Mass. Interesting technical talks and discussions are held at the meetings. New hams are always welcome.

MISSOURI—Chapter 3 of the O.B.P. has been founded at this city. The order of O.B.P. is a semi-secret body working along the lines of college fraternities, and composed of bonafide active operators. 9ZD, 9ADR, 9ACA, and 9DRD are the officers of Chapter 3. The aim of the O.B.P. is to foster a fraternal spirit among amateurs in a way that stimulates attendance and interest at each meeting. It might be interesting to other cities to investigate the order of O.B.P. with the possibility of organizing additional chapters. Chapter 1 is affiliated with the A.R.R.L.

NEW YORK—The Queens Radio Club will be on the air shortly with two 210's. The club's operators will take turns at keeping schedules with reliable stations.

OHIO—On April 22, the Cleveland Amateur Radio Association visited the local telephone company, and heard an interesting talk on "The Dangers and Effects of High Frequency."

ONTARIO—The Telephone City Radio Association of Brantford has installed a couple of receiving outfits in a local sanitorium, equipping them with three loudspeakers and about 55 headsets. The club is also active in clearing up interference sources. FB, fellows. Such work is bound to be appreciated, and it would be well if more clubs would undertake such work.

PENNSYLVANIA—The Golden Triangle Radio Association has an idea that may be useful to some of the clubs. They have no regular elected president. They nominate a member at each meeting to preside, thereby being the acting president for the evening. This is done so that no one can say it is a one man club.

SASKATCHEWAN—The Moose Jaw Radio Association has been affiliated with the A.R.R.L. They operate a broadcasting station under the call 10-AB, and intend to preach ham gospel over the air. At present they are conducting a drive to secure sufficient funds in order that a good radio set with phones for every bed may be installed in the general hospital, and are having good success. That's a fine idea, and the club is to be congratulated.

WEST VIRGINIA—On May 2, the Gamma chapter of the Pi Alpha Tau Amateur Fraternity held a meeting, at which 4KF was initiated. 8BSU, 8ASE, 8CDV, 8DOH, and 4KF were present.

WISCONSIN—The Milwaukee Radio Amateurs' Club publishes an interesting paper called the "Badger News." It is edited by 9VD.

TRAFFIC BRIEFS

8BFA says that a 100-watt toy transformer makes a good plate transformer for a transmitting outfit, that is, when one has 500 cycle ac available. He feeds about 150 volts of 500 cycle stuff into the 25-volt (60 cycle) winding of the transformer, and gets enough out of the 110-volt winding to make a UX 210 blush. Of course, the insulation of such a transformer will hardly be good enough to stand more than five or six hundred volts. It looks like a peach of an idea for low power tubes, though.

9DCX says, "There are only two men that got a crystal oscillating within a half hour—One is dead, and the other went crazy.—QTK."

While the yacht *Fortuna* was cruising in the Gulf of Mexico, the Atlantic Coast Line RR tried in vain to get in touch with the owner in order to advise him that the departing time of the train on which he was to leave Ft. Myers had been changed. Finally, the General Agent of the RR came to 4QY and asked if he could help out. Since 4QY had a schedule with the boat it became a simple matter. Good work! Incidentally, 4QY tells us that the General Agent is sold completely on amateur radio. Hi!

6ABN says that twenty meters and the checker plan of 6DEG described in QST are both the berries. He played an entire game of checkers on twenty with 4JI, and has worked lots of DX besides.

9ADB says, "My Chev. has a low frequency note cuz I can count the cycles.—QTK."

DIVISIONAL REPORTS

ATLANTIC DIVISION

DELAWARE*—MARYLAND—DIST. OF COLUMBIA—SCM. A. B. Goodall, 3AB—Maryland: 3CGC is active on 20 and 40 meters. 3HI has been heard fairly regularly with good signal strength. 3LL is putting in crystal control. 3HG is still working the foreign fellows and getting a kick out of it. 3RF, who has been consistent in the ham game, has had to close down. 3BCK is "somewhere in 200". 3CFX is operating a very low power set with battery supply but is doing nicely with traffic work. 3CV is a new station on the air with schedules and getting out in fine shape.

Dist. of Columbia: 3BWT, RM, has cut down with his schedules and taking a partial vacation from the strenuous work he has done in the past. 3GP is still pounding away consistently with a crystal controlled station in the 40 meter band. 3ASO, another crystal control station, has at last dropped down to 80 meters and is heard evenings. 3ALF is on 40 meters with low power. 3AB is only on the job for short schedules in the early evening. 3CAB is on the air regularly when at home.

Traffic: 3CAB 16, 3AB 15, 3BWT 25, 3GP 41, 3CGC 6.

EASTERN PENNSYLVANIA—SCM. H. M. Wallace, 3BQ—The traffic figures are poor this month. Practically every report is late. QRN is blamed by many for the low totals. Others had other work. 20 meters is taking its toll. Early morning hours seem infested with beginners who don't QSR. The man with regular skeds handles the real ttc.

3EU tops the list, handling a lot of convention ttc. 3CW is busy on 20 but says ttc is poor. The R.I. fixed 3BFE up with a new license. 3CMO is DXing on 40 but did fast QSRing with KPZG to NYC, 20 hours. 3CHZ continues with EB work. Tubes left for 3AIY. Ttc. was good for 3AVK. A new Hertz steps FB for 3BLP. 3ADQ is on 40 for a change. 3ADE is working three bands with success. These fellows are always on top. They find traffic anywhere. A new cage is giving 3HD trouble. Local QRM gave 3CDS trouble. A new op at 3LM's shack gummed the total. 3ZM flopped to 40 again. Power leaks played thunder with 3NP. 3AVL has an 852 on 19 m. 40 m. has 3PY for the summer. 3BUV sticks to 40. 3EH is working for an ORS appointment and is doing nice traffic work on 80. 3CJN hit it up nicely this month. 3ABX is out for an ORS, also. 3RQP is overworked at work. 3AKW has a new 852 but wasn't home to use it much. The R. I. visited Hazleton this month. 3RQ has a poor location. 3WJ is QSO his brother, 2WC, regularly. 3BQ 'lunched' the Inspectors. HI!

Traffic: 3BLP 217, 3EU 191, 3CGZ 151, 3AVK 130, 3ADQ 100, 3ADE 65, 3CMO 39, 3ABX 29, 3CJN 21, 3RQ 20, 3BFE 19, 3HH 16, 3AIY 14, 3HD 13, 3CW 12, 3CDS 11, 3NP 11, 3AVL 11, 3AKW 5, 3BQP 5, 3PY 5, 3LM 4, 3ZM 3, 3BUV 1.

SOUTHERN NEW JERSEY—SCM. H. W. Denshom, 3EH—Despite recent discoveries and developments in the .77, 5 and 20 meter bands, in television, etc., it seems the old annual slump is with us again. Looking back over the past few months form reports, the experimental interest in amateur radio is conspicuously absent from the items of general interest. What do you say, if on future form 1 reports we include a report of what we have been playing around with for the last month. Give this dobe to the SCM on your monthly reports, if the form one is not big enough use a separate sheet. 3CO thought he could give up ham radio. It can't be done. 3ZI has his antenna in the air again. This time on a copper spout mast and is perking away on 75 meters. 3CPG is running skeds with 1PE, 2AFV and 3AVK. 3SJ has been feeding his antenna on 20 meters on a voltage point and wondering why no DX. HI! 3KJ is all set to come back on the air with a W.E. 50 and M.G. 3UT has been getting good DX on twenty with a vertical antenna. 3AAL sold his automobile for fifteen dollars so he could buy a new UX210.

Traffic: 3CPG 70, 3SJ 21, 3KJ 1, 3UT 32.

WESTERN PENNA.—SCM. G. L. Crossley, 3XE—Reports this month are very small. 3BRM will be off the air for a while because of special circumstances that happen to most of us. It is reported that he is to be married soon and the better half is not an opr. 3DKS, 3AYH and 3CRK are QRW. 3ABW will be inactive for the summer. 3AGO and 3CEO report the Atlantic Division is going to be a good one and they are very busy with that work. 3CES has been in

continuous operation since 1922 and still going strong. 3DOQ and 3AKI are on the air again. 3CES has been sick but will be on soon. 3AXM has been having transformer trouble, but is back on the air now. 3DOB is making a few changes in his set. 3CFR has been having some transformer trouble. 3DBL is putting in higher power. 3AWR and 3VE are on 20 meters. 3VE needs Asia yet to make the W.A.C. 3GI has schedules and as a result handles traffic. 3ZD is going to a new location and is going to put in a 5 and 20 meter set. 3CWT has a mercury arc on 20 meters. 3GK is on 40 meters. 3CYP wants several schedules for early evening. 3DFY mourns the loss of a 50 watter. 3BIN and 3BVG have new chemical rectifiers. 3GU is back home at Erie again. 3AMA is the new call of the Erie Radio Club. Out of 30 ORS in the section, there were only 20 who reported this month. Can't we have all of the ORS report some month?

Traffic: 3XE 278, 3CWT 198, 3GI 176, 3AGO 86, 3CEO 85, 3ABW 25, 3AKI 22, 3DBL 21, 3CFR 20, 3DFY 18, 3CYP 17, 3DKS 15, 3VE 10, 3DOQ 10, 3AGQ 6, 3GK 4, 3ARC 3, 3CES 3, 3CRK 2.

WESTERN NEW YORK—SCM. C. S. Taylor, 3PJ—We can be proud of 3ADG who hooked up with 26 foreign stations during the inter-relay tests, on both 20 and 40 meters. 3AHC also worked many foreigners. 3ANX has handled some. 3APK has handled skeds with 1DV and handled traffic. 3ARG has been handling traffic until he blew his 50 watter 3AYJ is off for the summer. 3AVR has applied for portable license as he expects to go West for the summer. 3AYU has been busy with skeds with 3DKY, 3AC, 1ASD, 2ADZ, 3APK, 3CRF and 3BMJ. 3BAG has been keeping skeds with 1AJF, 1QB and managed to handle some traffic. 3BCM kept skeds with 3NF and 1APL. 3DKX received a msg from 3DKX and got a return answer back in 5 minutes. 3BGF has been worked by 7DA. 3BPL has built a new transmitter and wants skeds with Aussies and Zedders on 40 meters. 3BMJ has two foreigners and all U. S. A. Dists. to his credit. 3BQK's YL has gone on her vacation so he would like skeds with anyone on Long Island, N. Y. 3BYE says traffic is poor. 3CDB says the gang should get on 20 with traffic. 3CNT has been handling traffic. 3CVJ broke the news of Lindbergh's trans-Atlantic success into the flooded Southern districts. 3CYK has been operating at 3CHY and 3ARS in Ohio while working there. 3DDL has handled quite a bit of newspaper traffic on the Lindbergh trans-Atlantic success. 3MU will be on the air soon at Canadaga. 3DHX was preparing for the International Tests when his power transformer blew. 3DNE got news of Lindbergh's flight from France ten minutes before cable to U. S. A. Press, etc. 3DNE has been off the air on account of illness. 3DRJ handled quite a bit of traffic and worked oa-NM. 3HJ is with the Army Test Stations and kept skeds with 2SC, 3DME, 3CVJ, 3CPG and 3BMN. 3QB worked oa2RT. 3UL has just finished his crystal control transmitter and is handling traffic again. 3AYB of West New York is on 75 and 80 meters for schedules only.

Traffic: 3CDB 29, 3DDL 39, 3CNT 23, 3DNE 18, 3CVJ 8, 3ARG 7, 3ANX 4, 3CYK 1, 3DRJ 52, 3AHC 37, 3BQK 19, 3UL 9, 3AYU 8, 3BAG 7, 3BGN 3, 3CDB 45, 3APK 24, 3BMJ 18, 3BFG 9, 3HJ 7, 3ADG 6, 3AVJ 2.

CENTRAL DIVISION

INDIANA—SCM. D. J. Angus, 9CYQ—9BUZ worked Aussies regularly until the station was torn down for the school year. 9CIZ is operating on low power with Hertz antenna on 20 and 40 meters. 9AKK gets on once in a while on the 40 meter band with low power. 9CHC uses a 7½ watter with an indoor antenna and works all over the country with this combination. 9IY is inactive at present due to experimentation. 9CMV is the most active station near here. Twelve operators keep two fifty watt sets busy on 20 and 40 meters. 9BK and 9CEY are not very active. 9EF is doing fine work, working oa, oz, ei and many others. He just needs Asia now to become a WAC. 9DLJ is having just about as good luck with a 7½, getting R6 from France. 9BSK isn't on as much as he used to be but works out fine when he is on. 9CP will be going strong on 20 any day now. Too busy with school work since Apr. 1. 9OG expects to go to France with the American Legion. 9BBJ thinks he can get the gang going again as soon as he gets home from school. 9DLM is working

on 40 meters, even tho he got married recently. 9DUZ works fair. 9ASX is on 40 with low power occasionally. 9AUX just bought a new 50. 9ABP is moving to a different part of the city and is off temporarily. 9DHM is on the road and off the air for some time. 9AEB is on when he can find time. 9DDZ is busy with railroad work. 9BOH is the only really active station in Elkhart. 9BYI was on for only 8 days during the past month. 9DVE is getting good results with his mercury arc rectifier. 9EF made 26 points in the I.R.P. 9DUK has finished his new home. It has a radio room and he will be on the air as soon as he gets an antenna up. 9AGR with 100 watts (RAC) on 80 m. reports 4 msgs. relayed. 9EG is on 41 m. with 50 watts and works flocks of hams. 9EJU has his 7 1/2 watt on 30 m. and says it's FB. 9BEF and 9DDA have not been heard from and could not be located in this huxie city.

Traffic: 9CRV 33, 9CYQ 19, 9DSC 16, 9CVX 10, 9DPJ 21, 9EJU 18, 9AXH 4, 9CUD 2, 9CLO 2, 9BKJ 5, 9CMJ 11, 9CNC 14, 9ASX 3, 9EGE 10, 9AIN 13, 9BK 6, 9EF 33, 9BBJ 12, 9AEB 10, 9AUX 6, 9BQH 4, 9BYI 4, 9DDZ 2, 9BOX 9, 9BUZ 30, 9CMV 151, 9AXO 5.

OHIO—SCM, H. C. Storek, 8BYN—Reporting was not so good this month, and some ORS have the idea they don't need to report when not actively on the air. This is a mistake as missing reports for two consecutive months is grounds for cancellation now as always. Notify your SCM that you will be off the air, so that he can know what is going on and put you on a temporarily inactive list instead of being obliged to turn in a cancellation. Traffic has taken a slump, which was expected, but the SCM expects some activity all thru the summer. Plenty is going on on 20 now, and those keeping schedules down there are reporting it FB for traffic. Let's get down to 20 and keep things humming thru the summer. What say? 3 stations handled 100 or more while 16 got above 10 messages, rather a poor showing for OHIO. 8BAU takes high honors again with 407 messages, 8 of which concerned Lindbergh. 8CXL (a non-ORS, by the way) comes next with 181. FBI 8BNW handled 100, 8GZ 84, 8CXL did good work handling messages during the flood period. He also announces a Jr. Op. 8BYV, has passed into the great beyond, and his key is silent forever. We will miss his sigs on the air. 8DTH wants more stations on 80 in the early AMs for schedule work. A good idea. 8DSY has been QRW with finals, and has spent most of his time on 20 with fine results. 8AKO is still working mostly from the "crib" on the lake, and the call is 8HB. 8ALU reports no news. 8BEV is installing a UX852. 8CMB got his First Commercial License, and is only 16 years old. Eb. Om. 8AYO has given up Xtal control, temporarily using TPTG. 8AEU remodelled and made a panel job out of it. 8CFL awaits his low total also very active. Better luck next time. 8DFP a 201-A can only work 8BEV, but handled 11 messages just the same. We hope he gets connection to the power mains soon. FB. Om and keep up the good work. 8CNL is off the air with a defunct tube. 8CVE is on the air some. 8BZT is busy with married life. 8AXS also QRW. 8DIA has been having trouble with his S tubes, but has new ones now. 8ARW says 8BOW wasn't notified for license examination, and to notify the R. I. because they can't use 2nd grade licenses in Greenville. HI! 8AYJ will be off the air all summer. 8DDQ's battery charger was stolen. The SCM said something about 8ALW and the YLs last time. SALW says he nearly got in bad with his O.W. HI! and sorry error, Om. 8AWX reports 8DRX leaving Ohio and going to California. Sorry to lose you, Om. 8RN is aboard W.P.U. Str. Yosemite, having a lot of fun with the spark set. SGL now has a chemical rectifier, instead of the old AC note. 8PL has been rebuilding. 8CCG moved QRA to Warren, Ohio. 8DQZ will be in Pittsburgh all summer. 8AVB has been on 20 mostly. 8AHH tried to drop radio, but once a ham, always a ham, and he is back again. 8ADH is very irregular and says he should have more time as soon as school is out, but as he has had the same YL since January, he won't make any promises. HI! 8CBI is another ham about to enter the 5th stage. If his activity in radio is any sign. He *does* get on once in a while. 8BOP is using two fivers for Kenotrons. 8CLR says his pole came down twice. Busy with work and YLs too. 8DHS was at the Detroit convention, got a temporary license, so expects to be all right soon again.

Any of 20 meters is mighty FB compared to 40 and 80, altho the SCM wishes to impress the idea to 40 and 80, altho the SCM wishes to impress the idea of more early morning (just before and after dawn)

work on these bands. The QRN is least then of any time of the 24 hours. Let's not give up the ship gang. Keep going. And, don't fail to come across with any suggestions you may have at any time. Good luck and 73.

Traffic: 8BAU 407, 8CXL 131, 8BNW 100, 8GZ 84, 8CPQ 47, 8DTH 44, 8DSY 42, 8AKO 39, 8ALU 36, 8BEV 33, 8CMB 32, 8ARS 26, 8BAD 24, 8AYO 15, 8AEU 14, 8CFL 11, 8DPF 11, 8CBI 10, 8AXS 10, 8DIA 8, 8ARW 8, 8AYJ 6, 8DDQ 5, 8ALW 5, 8AWX 4, 8BKJ 3, 8RN 3, 8GL 3, 8PL 3, 8CCG 2, 8KC 2, 8DQZ 1, 8AVB 1.

MICHIGAN—SCM, C. E. Darr, 8ZZ—8AUB is working hard to get the fellows organized there. 9CYU is putting in a 250 watt on 20, 40 and 80 meters. 9ANT is on 20 meters for keeps. 9CSI reports traffic in upper Michigan very light. 8DED says now that the DX contest is over, he can settle down to traffic. Don't forget to make schedules with him. 8DED is RM for western Mich. 8ZF and 8KN of Lansing are closed for the school vacation. 8CAU and 8DOJ are active again, probably for the summer vacation tourists. 9CE has a schedule in 8CPM and 9EGG and 9AYR daily. 8PF is trying to get an H tube to work on 20 crystal controlled. 8ZZ on 20 meters part of time, has worked many European stations. He cleared a message from Capt. Lindbergh's mother to Capt. Lindbergh in France thru nulsZ. 9EAY has a new set with TP-TG on 20, 40 and 80.

Traffic: 9CM 10, 9CSI 11, 9CE 13, 8ZF 8, 8DED 42, 8MM 3, 8PF 5, 8DAG 6, 8ZH 3, 8ZZ 13, 8AUB 41, 9EAY 16.

ILLINOIS—SCM, W. E. Schweitzer, 9AAW—The Chicago Radio Traffic Assn. trophy is not won yet and this time, 9APY has won a leg. However, he must win it the next two times in a row or he'll not keep it permanently. The terrific wind storm of May 9 carried away many a good mast—and many not so good, mostly the latter. As summer is now with us, let's all try to send in some constructive information on conditions noted at your station. Pay particular attention as to what you hear and when you hear it. Let's keep the traffic ball rolling and set a record for summer work. 9AAE is trying out 5 meters. 9AAW attended the Michigan Radio Convention in Detroit. 9AEG is a new Chicago ham and promises to become a reliable station. 9ALZ likes 40 meters better than 20. 9AMO wants schedules with Iowa or Missouri. 9APY won the traffic cup this month. 9AWX, a new ham in Joliet, sent in his first report. 9AXZ is using one of the new 75 watters. 9AYB is going after the traffic trophy when school is out. 9BHM finishes school this month. 9BPX is going to put in a 50 watt. 9BVP wants schedules for checker playing. 9BWL was on a two weeks trip to Asheville, N. C. 9CIA lost his antenna in the recent storm. 9CNC is going to use an H tube. 9CPQ has gone to Linden, Texas working Australia, N. Z., Madera, Portugal, Ind. for the summer. 9CSB was on during the DX Hawaii. FB. 9CWC is keeping schedules with 9SK, 9EAI and 9DMG. 9DZL has trouble controlling his set on 20 meters. 9DAF is going to increase power to a UX210. 9DBI has put in a new UX352. 9DDE is finishing exams for the summer. He worked nr-2FG. 9DGA complains of poor weather conditions. 9DKK is another station reporting. 9DXG worked nr-2PZ. 9DYD also lost his tower in the storm. 9EAI wants to be appointed an ORS. 9EGG is building a station for Senn High School. 9ELR is another whose aerial is on the "fritz." 9BL reports 9AM to be a real old ham returning to the game from 1908. 9IZ reports having calibrated his receiver. 9KA blew his H tube. He reports 9BA working FB on a 202. The Sr. op of 9MR will be home soon. 9NE uses 20 meters for DX and 40 meters for traffic. 9UX received as a present a 1500 volt motor-generator. 9VO worked four oa's and one OZ this morning. He also worked sc-3AG, sr-2AR, of8GL, gi6MU. 9AGG and 9UB built a stage of RF on 9AGG's SW receiver. 9AGG has the honorary titles Owner, Operator, Builder, Designer and Janitor of the radio station.

Traffic: 9APY 62, 9CPQ 60, 9DDE 58, 9CZL 53, 9CIA 51, 9AFB 39, 9VO 38, 9BTX 37, 9AMO 28, 9AWR 23, 9UX 23, 9EAI 16, 9IZ 13, 9BPX 14, 9CSB 14, 9BL 12, 9AXZ 12, 9DKK 9, 9ALK 10, 9NE 10, 9RWL 9, 9DQZ 7, 9DGA 7, 9BHM 6, 9DAF 6, 9KA 5, 9AEG 6, 9BVP 4, 9BNA 3, 9AHJ 3, 9AWX 2, 9AFP 1, 9DYD 1, 9CWC 1.

KENTUCKY—SCM, D. A. Downard, 9ARU—QRN during May was R9 plus. The SCM could draw an inch spark off his antenna and counterpoise almost any time during the day or night. 9MN has again

changed locations but still hangs on to 40 meters. 9ABR is getting his 250 ready to perk with DC on the plate. 9CMW will be back from school and on the air again soon. 9BAZ blamed it on QRN but when he replaced his old "B's" he said the QRN was nil. Hi! 9BWJ has a new 50 foot latticed mast and is experimenting with voltage feed antennas. 9EI and 9BPB have arc sets going. 9BIQ has a 210 perking on 40 meters. 9CRD is on 40 with a 210 and worked Costa Rica right off the bat. FBI 9CJW, a Missouri boy attending Centre College, is leaving for home but says he will keep a sked with the fellows "back home." 9BPB worked six countries in four nights during the recent tests. 9ATV, 9ARU, 9OX and 9WR are out temporarily.

Traffic: 9BAZ 41; 9ABR 23; 9BWJ 10.

WISCONSIN, SCM, C. N. Crapo, 9VD—9DTK reports traffic the past few weeks slowing up, probably due to the heavy QRN. 9EK-KH reports 4DM is closed for the summer but has sked with 4LK on Mon., Wed., and Friday nights at 8.30 P. M. 9DLG is not pounding the kite quite so hard now due to cut in range. 9EEF keeps schedules with 9CZH daily. 9BPW has been trying 20 meters. 9EHM dropped down to 20 meters and was QSO 6TX, 7NY and others at noon. 9SO has been keeping schedules with SAMC and NR-2FG weekly. 9AZN's antenna is higher now with better results. 9BIB has been away at school for a few weeks at Ft. Wayne, Ind. 9CAV has installed a mercury arc and it is surely FB. 9ABM keeps schedules with 9EMD, Monday, Thursday, Saturday at 5.30 P. M. 9DZV and 6BLX operated at 9BWO some last month. 9CDT put up a Hertz antenna and is getting out much better. 9EAN reports not much doing this month. 9COI schedules were discontinued while operating 9EGH in International Relay Tests. Schedules will be continued with 9EOC, 9CQY and 9EMD. 9BWZ is having trouble getting his generator to work properly but keeps traffic moving in his direction.

Traffic: 9DTK 72; 9EK-KH 64; 9DLG 88; 9EEF 37; 9BPW 22; 9EHM 20; 9SO 68; 9AZN 15; 9BIB 11; 9CAV 11; 9AHM 10; 9BWO 8; 9CDT 8; 9EAN 3; 9COI 2; 9BWZ 2.

DAKOTA DIVISION

NORTHERN MINNESOTA—SCM, C. L. Barker, 9EGU—Is the old "warm weather damper" going to stop us any this summer, gang? I say NOT. How about it? 9DKR and 9AOG are leaving for Calif. the first part of June to look for work and see the country. 9EMR has got going again, after a lapse of a few weeks. 9BMX says "20 meters is getting better" and he works the globe. 9EHO is doing fine work on low power on 20 meters. 9GZ is moving to Tenney and keeps his 250 going. 9BVH is building a crystal controlled 5 meter transmitter to use in the 5 meter CQ party. 9ABV fell off a bit this month. 9EGF had to originate all his traffic this month. Hi. 9BTW is a new station at Howard Lake, stepping right out with low power. 9CIY is a new station at Hibbing that is very promising and started right out with a good supply of schedules. 9CTW is putting in a new UX852 with DC and voltage feed Hertz. 9AOK is going on the road with a portable set of 20 and 40 meters and wants the gang to listen for him. He handled a RUSH message from Chile. 9CKI is going "crazy" on 20 meters and finds plenty of traffic down there. 9EGU finds the Reinartz transmitting circuit very FB in every way. Business QRM was the reason for a 3 day rebuilding job lasting 3 weeks. Hi. 9KV has been QRW. International tests and also trying to get the R.L. to come to Duluth to give exams. 9EGN has a new 50 and is praying already. Hi. 9BJD finally got located in his new shack and is on regularly. 9CWA has a new UX852 and a new transmitter going good. 9AKM built a plate transformer that gives 800 volts but can't find time to use it. 9MF is about ready to start the "life grind" as he calls it.

Traffic: 9EGN 56, 9KV 49, 9CKI 29, 9AOK 25, 9CTW 23, 9CIY 16, 9BTW 15, 9EGF 8, 9ABV 8, 9BVH 7, 9EGU 7, 9BJD 5, 9CWA 5, 9DKR 5, 9BMR 5, 9BMX 4, 9EHO 4, 9GZ 4.

SOUTHERN MINNESOTA—SCM, D. F. Cottam, 9BYA—Traffic was better than expected this month. A number of stations are keeping on with the good work. There are neither new appointments nor cancellations this month. Due to the warm weather and beautiful Minnesota, it is pretty hard to stay at the junk as much as when the snow is flying in the winter. Minnesota is a great tourist state and the Minnesota gang welcome hams at their homes and stations. In case out of town amateurs are in Minnea-

polis, please give us a ring and we will try to make your visit to the city a little more pleasant. School is putting the damper on high totals, also track, baseball, etc. QRN will be bad this summer, no doubt, so why not do some engineering and experimenting all your own. You may find some very interesting results. These are just suggestions you know but what do you think of them?

9CPM is the most active station again this month. 9DBW is on 20 and does good short distance work at night with it. He holds one sked and was QSO Australia. 9DWO is rebuilding his station and 9WL for 20 meter work. 9BN holds two skeds with 4 ops. 9DH is a new op at 9BN. 9EFK holds a number of skeds and works his DX from 4:30 AM on. 9CAJ is on the road and is only home on Sat. and Sun. 9XI is not very active and is only on occasionally. 9IG is going once more. 9AKT uses a complete remote control xmitter. 9COS is looking for more apparatus to complete an elaborate transmitter. 9BHZ is QRW and is oping whenever he can. 9GI got married. Congrats, OM, from the gang. 9EYA has had the delightful job of housecleaning. 9DBC has been busy with track and won every dash event in the state meet. 9EFO is very QRW with school and as soon as school is out, will rebuild everything and arrange skeds. 9CIX put up a new stick and looks for better results. 9DEQ is on 20 and likes it. 9CCX works OZ, OA and altho QRW at WCCO, manages to pound anyway. 9DWO is rebuilding for 20 meters. 9DGE is a cook on the "Lawrence J. Palmer" on the Lakes. He gets his eats free. Hi.

Traffic: 9CPM 380, 9DBW 68, 9BN 44, 9EFK 34, 9CAJ 32, 9XI 24, 9IG 22, 9AKT 18, 9COS 18, 9BHZ 15, 9EYA 16, 9DBC 12, 9EFO 12, 9CIX 11, 9DEQ 8, 9CCX 4.

NORTH DAKOTA—SCM, G. R. Moir, 9EFN—9RRR leads the Section this month by some fine relay work and finds a UX210 with tuned-plate tuned-grid on 20 meters FB for work with oh6BDD. 9DYA wants a sked with a nearby 80 meter station. 9BJV worked nq2RO with his two UX210's. 9DM lost his pole in a wind-storm but worked all districts on "40".

Traffic: 9RRR 26, 9BJV 5, 9DM 10.

SOUTH DAKOTA—SCM, F. J. Beck, 9BDW—Nearly half of the active stations in the section operate on 20 meters. Examinations and graduating QRM together with QRN on 40 and 80 cut traffic badly. RM, 9DWN, reports new S. D. University skeds so he's on 20 now with a new 210. 9RKB handles several skeds. 9DB worked several foreigners on 20 meters during tests. 9DLY, a new ORS, keeps early morning skeds on 80 meters. 9CZG has good delivery of his messages. 9AJF is trying 20 meters and likes it very much. 9BBF, the O-O, is rebuilding after keeping skeds with some oa's for over a month. 9AGL is going to sea again this summer but will be back on in the fall. 9BGL suggests starting a "new ham month". 9DBZ reports school QRM. 9DIY has little time to operate. The Sioux Falls Club held a picnic this month. 9CJS is building a Scotch receiver. a la 9DXY. 9NM had trouble with the charging outfit but did some DX on 20. 9BOT has farm QRM. 9DYX is a new station at Rapid City and 9BXV at Bryant. 9TI gets RAC reports on 20 from a B battery xmitter. Some audio fading. Hi!

Traffic: 9DWN 70, 9BOW 48, 9RKB 46, 9DB 20, 9DLY 10, 9CZG 12, 9AJV 10, 9BBF 8, 9AGL 8.

DELTA DIVISION

LOUISIANA—SCM, C. A. Freitag, 4UK. The only L station now handling any flood work is 5PM, New Orleans, who has schedules with 5TC and 5AIQ, both in the badly flooded districts. 5UK's emergency transmitter has been installed on the roof of the A. T. & T. Building, making numerous tests on schedule with 4RE, Atlanta, Ga. In case of emergency the station will be operated under the call letters 5UK. In the meantime, the regular station of 5UK is being operated with a 7½-watt transmitter, and is getting out fairly well. 5ASE is a new 7½-watt station at New Orleans. 5IE is on both 20 and 40 meters with much success. 5QJ has been doing some nice DX on the 20 meter band, working several foreign countries. He says on 40 meters he is unable to work anything but oa's and oz's (not even nu's). Hi. 5AEN has been assisting in the flooded area, and will be on again full force when the excitement is over. 5UT is doing well with his 2-7½-watt tubes and planning to install a 50 watt.

Traffic: 5PM 31, 5EB 25, 5UK 9, 5IE 9, 5NS 7.

ARKANSAS—SCM, Wm. L. Clippard, Jr.—5AIP.

Arkansas amateurs had a fine month of msg handling, and from our report one can see that OM static is not going to retard the work here this summer. 5CK and 5ABI are two new ORs. Look 'em over fellows and see their totals. 5CK has the highest total made in the state for some time. How about the BPL next month, OM? 5ABI handled a bunch of flood Red Cross traffic. 5AW has a new 75 watter. 5CJ will be on soon with a new set. 5SI is still going PB as usual. 5JK reports 40 meters better than 80 for msg. handling. He has been trying 20. 5JB and 5FF are going away for the summer, but we all hope to see them again next fall. 5AKF has his Delco now and will be on soon. 5SI says 5ER has a wireless Hertz ant. It has no lead-in (that one can see). Hi. Hi. 5AIP has been having trouble with a msg. Come on fellows, let's put Arkansas on top in amateur radio.

Traffic: 5CK 82, 5SI 35, 5ABI 35, 5AW 23, 5JK 18, 5AIP 6, 5JB 4.

MISSISSIPPI, SCM, J. W. Gullett, 5 AKP—9QZ, 5PJ, 5ARB and 5ANP failed to report. Ferrell at Greenwood sprained his ankle and this will keep him off the air as he can't erect his antenna and counterpoise until he is able to get around again. 5QQ has come down to 40 meters and worked lots of stations. 5AUB is rebuilding again, despite YLs. He threatens to have a real transmitter. 5API says no news and no DX. 5AGS was QRW exams, due to going to camp. 5QZ is trying to sell out. 5AQU is working with two little 7¹/₂ wattors on 20 meters and reports it FB. His 20 meter DX so far is c8YOK, nrlUR and ca4BD. He is having some trouble with his present receiver. 5AKP is doing manual labor trying to get his heap to perk on 20 meters which it refuses to do although rebuilt several times. Gang, please cooperate with the RM and SCM by sending reports regularly.

Traffic: 5AKP 33; 5API 23; 5QQ 11; 5AQU 2; 5PQ 14.

HUDSON DIVISION

NORTHERN NEW JERSEY—A. G. Wester, Jr., SCM, 2WR. Traffic has fallen off, however the percentage of ORS reporting in the past month was FB and the SCM thanks you for your fine reports. 2KS has requested that his ORS be cancelled due to leaving amateur for some time. 2CJX, an old time spark station, is now in operation and desires an ORS. 2ABE has filed application for ORS. 2CO in communication with NIDK of the Ice-2AW5 6, 2ALS 6. Richmond: 2AYH 2, 2ABO 13, patrol. 2AT has been making a business trip which kept that station silent during the tests. 2CP's better half is confined to the hospital and we all wish her a speedy recovery. 2CW is keeping amateur radio in Caldwell on the move. 2DX when next heard will have a mercury arc running his new 20-40-80 meter crystal controlled transmitter. 2EY has hard time getting on the air. 2JC not on, due to transmitter being dismantled. 2FC is on nightly six to seven P.M. Eastern Standard Time. 2KA finds it hard to keep schedules. 2ALM is going along fine on 20 meters. 2ANB is very QRW school work. 2BQU is finding it hard to find time to operate. 2CGK is still QRW BCL work. 2CQZ is the proud possessor of a new flyver. 2CTQ has been QSO 15 countries on 20 meters. 2CYV hopes to handle the summer traffic for the Mich. Greenland Expedition NX-1XL which 2AZA is operator. 2GV has a new QRA of which is 8 Sunnyside Terrace, E. Orange. 2CDB reports that sbTAB is a YL. 2EBR is experimenting with Hertz Antennas. 2IS is putting all effort experimenting with low power transmitters. 2AVK shut down to neighbors kicking about key clicks. 2QI had the misfortune of blowing the complete rectifier including kenotrons and transformer. 2ADL had installed the TGP Circuit. 2BAL was QRW helping getting the Hudson Division Convention working. 2AOP has filed application for an ORS. 2CJD has a new antenna as he claims the old Hertz did not Hertz.

Traffic: 2WR 1, 2AT 2, 2CP 7, 2CW 3, 2FC 1, 2KA 4, 2ALM 32, 2CPD 6, 2CQZ 4, 2CTQ 46, 2GV 1, 2CDB 11, 2EBR 6, 2IS 8, 2AVK 6, 2ADL 34, 2BAL 6, 2CO 26, 2AOP 37, 2CJX 10, 2CJD 23, 2ASZ 13.

New York City & Long Island.—F. H. Mardon, SCM, 2CWR—There is a noticeable drop in reports this month, several being among the missing. Watch your stop. Three non-reports and your ORS is automatically cancelled. Don't get Spring Fever—the Spring hasn't started here yet. And besides, the

Spring and Summer are the *best* time for DX on the higher frequencies. Several requests have been coming to the SCM for appointment as ORS. I have not answered all due to pressure of business elsewhere so let me again state thru these columns that it is necessary for a station desiring to become an ORS to send three consecutive reports after filing his application with the SCM before his application can be considered. The application is then forwarded to the Route Manager of his Borough for investigation and if Oked the appointment is put thru.

Manhattan:—2EV is busy overhauling his station and getting it ready for the summer rush. 2ANX also rebuilding, now is remote controlled, break-in system reports, FB. 2BCB is building a new receiver and as he works at night again he is after some afternoon scheds. 2AMJ is now using crystal but can't report on it yet until he gives it a better trial, says it seems FB.

Bronx:—2BNL says nit at his station but that 2IH has moved to the top of Ft. George Hill and 2EH is installing 2-250 wattors on 80 meters. 2ALL has his mercury arc going full blast now. He recently handled a msg. New Zealand and Summit, N. J., that was originated and delivered within 24 hours. FB. 2ALP wasn't on much this month but has a good t/c total due to some reliable scheds. He reports 2ARD and 2AWU are rebuilding for 50 wattors. 2ALW reports nit t/c on 20. 2BBX reports working ca5BW for one hour and 25 mins. with same old lowpower set. Daylight all thru. QSO R5 at Australian end. How's that? That fellow BBX sure knows his red and white onions. Congratulations, OM, 37.7 was the wave. 2GYX is rebuilding for T.P.T.G. circuit. Ready soon.

Brooklyn:—2AWX now uses T.P.T.G. in place of the old Hartly handling HQ traffic with effect. 2AMI is doing his stuff in great style now that he is an ORS. 2AVR is keeping some good scheds and going along great. 2ADZ has been ill but is better now and is getting some new scheds and everything is FB. 2ABP made a good start in his first report. What's the use of saying anything about 2FF, he is always busy and at the present time more so on account of the convention. 2BRB took the 1st Commercial Examination. Not on the air much just now. 2APB-CCD was out of town but managed to get in a report. He reports things OK. 2APD was also out of town but was busy with tests he has 70 points in tests, and so far is sixth.

Long Island:—2ALS is now in Astoria and says DX will be fine there. He is going to use X'tal. 2AWQ reports all OK. 2AGU has been QSO lots of foreigners lately and all report R4 to R6. 2BSL says very little t/c on 20 but lots of DX. 2AJE almost forgot to report but got it in time. 2AVB hopes to lead B.P.L. next month.

Richmond:—2ABH was only on two weeks but managed to handle traffic when he was on. Richmond is certainly getting life and I want to congratulate the RM and all who are behind him out there. Keep it up. 2AKK nil to report. Just working that's all. 2AKR reports things about the same. 2ABO the Sec'y of the Staten Island Radio Club had the misfortune to blow his receiver tubes. He has new and larger ones now. The Staten Island RC is now on the air under the call of 2CPG, and going strong. Reports the best season ever and getting better. 2AYH reports t/c had "Only two" better two real ones, OM than rubber stamp ones. Keep up the good work.

Traffic: Manhattan: 2EV 12, 2ANX 23, 2AMJ 48, 2BCB 16, Bronx: 2BBX 49, 2ALP 126, 2ALL 21, 2BNI 6, Brooklyn: 2APD 212, 2APB 14, 2PF 14, 2ABP 28, 2ADZ 20, 2AVR 40, 2AMI 18, 2AWQ 7, Long Island: 2AJE 4, 2AVB 48, 2BSL 1, 2AGU 26, 2AWQ 3, 2AJS 6. Richmond: 2AYH 2, 2ABO 13, 2AKR 7, 2AKK 4, 2ABH 10.

EASTERN NEW YORK—SCM, Earle Porcox 2ADH—Rosenthal, 2QU, takes the honors as most consistent traffic station in this Section. FB. OM! Several msgs for Europe were handled. 2PV kept sicks with 5CK and 3BCD and had some good QSO's within the Section on 40. 2CNS will be off for a few months if he rents his place for summer. 2ANV handled a few despite a bad power leak. The SCM has found it necessary to resign due to his new work and urges cooperation with the new leader as soon as you have chosen him by nomination and election.

Traffic: 2 QU 54, 2PV 15, 2 ANV 4, 2CNS 4.

MIDWEST DIVISION

NEBRASKA—SCM, C. B. Diehl, 9BYG—9AI, is rebuilding. 9CJT is tinkering with 20 meters. 9CNN is busy with his work. 9EEW is rushed to death with his railroad at this season. 9AWS and 9BYG are rebuilding. 9ASD is putting a fifty. 9DI and 9DAC are graduating. 9BOQ is busy on the farm. 9DUH is in his busiest season. 9BBS is back on the railroad again and this is his last good report for a while. 9BQR is still fighting 40 and 20 meters.

The Route MRR reports business very light throughout the Section and very little traffic noted outside this Section.

Fetterman is having a busy time at his work and expects it will be late June or July before he can do much radio work. Craft and Williams are having their busy season. 9QY is right in the center of planting his corn so the report is light. 9CJT is having a lot of fun with 20 meters but "sings" because not more traffic there. Badgerow is rebuilding his outfit from the outside in and says that if it doesn't work better than before he might say something. 9BYG will be on the air this month after a year's silence. Bamer is so busy graduating that he hasn't time to go near his "pet". Magnuson is also very QRW and plans now to increase his power by fall. Miller says that he hopes he never has to graduate again as it takes too much time away from his hobby. Hi. Jones is very busy but found time to work in the foreign tests a bit. Larimore has to QRT himself for a while on account of going back on the road. Chesley still has the usual hard time trying to get down. Sisler, formerly of Omaha, has been issued a portable license under the call 5ADV and will tour the middle states this summer in his Essex, looking for data on portables, etc.

Traffic: 9CNN 6, 9QY 18, 9EEW 3, 9CJT 1, 9ASD 12, 9DI 9, 9DAC 3, 9DUH 10, 9BBS 51.

KANSAS—Fergus McKeever, SCM, 9DNG—9JU turns in a very interesting and complete report. He is getting under way as an official observer and is also keeping up his traffic in fine shape. 9BUY is busy arranging for the Brass Pounders Club meeting this month, but handled some messages to England and Australia. 9COR worked EN and NR despite of school QRM. 9BII is co-operating with BCL's and hopes to convert a few. 9DNG is trying the same thing. His new 250 watt is working fine and R9 in Australia. 9BYQ, 9OFN, and 9CKV all are moving good traffic. 9CFN is also doing a little DX on the side. "The big three", 9AEK, 9CET and 9CV, are still bringing home the bacon at Topeka. All three took part in the international tests with good results. ex-9DSR is now in Ohio. We were sorry to lose him. Our loss will be the 8th district's gain. 9BGX leads the state in traffic. He also took part in the relay party. For consistency, 9CNT is THERE, being on several hours daily and doing splendid traffic work. 9CVL returns from college and will be at the old key this summer. 9DPW put in a Hertz and thinks it's FB. 9HL is setting the pace in schedules. He has half a dozen good ones and is coming along. 9LN and 9CLR of Lawrence are on regularly both going in more for DX than traffic. The latter is to be a ship operator this summer.

Traffic: 9DNG 16, 9BII 4, 9CKV 15, 9BYQ 28, 9AEK 18, 9BUY 10, 9HL 27, 9COR 4, 9CVL 2, 9CNT 25, 9CET 9, 9CFN 52, 9DPW 32, 9BGX 88, 9CV 7, 9JU 19, 9LN 25.

IOWA—A. W. Kruse, SCM, 9BKV—Traffic is still dropping and as usual QRN is to blame for the low totals. The RM is working hard to keep the state line up with good reliable routes, and those of you who are going to be active this summer please cooperate with the RM. 9BWN is handling traffic hot and heavy and is keeping schedules on 20, 40 and 80. 9CZC lost his mast with a resultant drop in his usual high total. 9DVG is busy building a new 500 watt transmitter at KWCR. 9DAU is hearing a lot of DX on his new Grebe. 9EFS is keeping his 50 hot with 1600 volts RAC from a mercury arc rectifier. 9CGY is using a fiver and a 201-A and says he don't know which one is working. Hi! 9CS is using a 2 feeder wire Hertz on 40 meters. 9EHN continues to pound away on all bands. 9DEA is trying 20 and 40 but hasn't had any results yet. 9CZC, the RM, wants to hear from you fellows who are going to be active this summer and if you are interested in working reliable schedules drop him a line.

Traffic: 9BWN 124, 9CZC 22, 9DVG 19, 9DAU 14, 9EFS 13, 9CGY 12, 9CS 11, 9EHN 8, 9DEA 8.

MISSOURI—SCM, L. B. Laizure, 9RR—St. Louis ham activity well sustained during QRN season by two stations, 9ZK and 9DOE hitting the BPL with several others handling good totals.—9BEQ, 9BHI and 9DUD. 9ZK has four transmitters going. 9DOE is spending the summer on Great Lakes and expects to pound brass either on a commercial vessel or on a lighthouse tender. 9BHI reports skeds fell down due to QRN and he is working mostly daylight stuff. 9DUD has worked mostly foreign DX this month. 9BGO handled a good total and kept several early morning skeds with 9CZZ, 9CTS, 9NW and 5FS. 9DMT was put out on 80 meters by QRN and is changing to 40. 9HY lost his antenna in hail and windstorm and he moved and rebuilt twice. 9BZM is doing some experimenting. 9DTQ closed up for QRN. 9DIX is still visiting Chicago hams. 9CYC lacked only 99 messages short of the BPL. 9AJW is having good luck with the new bottle. 9DKG was unable to handle tie due to school but promises some action in June. 9DAE dropped all skeds due to QRN. Traffic in Kansas City was nil this month. 9ZD is on the most so far as reported. 9RR closed down indefinitely due to financial QRM and will not be on again before winter if at all. 9ACA is still off the air following a move. 9DQN is doing some experimenting but DX not very great. 9ADR and 9ACA have held some reorganization meetings for the amateur club but not much enthusiasm at present due to short funds on all sides. The R. I. has been over this territory lately and a number took the exams at Kansas City and Joplin. 9BMS and 9HY passed in Joplin and a number passed the commercial test in Kansas City.

Traffic: 9ZK 105, 9DOE 106, 9BEQ 45, 9BHI 49, 9DUD 12, 9DAE 3, 9AJW 23, 9CYC 1, 9HY 10, 9BGO 85.

NEW ENGLAND DIVISION

RHODE ISLAND—SCM, D. B. Fancher, 1BVB—With the help of Army traffic, 1BQD hit the BPL. Both he and 1AAP have been appointed Army stations and took active part in the recent war game between the Army and Navy. Next month is going to see a bunch of cancellations if necessary to get rid of dead-wood, and prove ourselves "small but active".

1BIL is sailing on the KTB but will be back in July. 1CKB has been off this month putting the Xmitter back of a panel. 1AID is going full blast on 20, nu8JQ who just returned from the Orient called on her recently. 1MO is still trying to get parts for his filter. Should be a pip if he ever gets it going.

Westerly: 1AAP has ICD's MOPA Xmitter going on 80 with a tone like an Xtal set and is reaching out well. He handled a great deal of traffic during the war game. 1BVB moved quite a bit of traffic due to schedules.

Newport: 1BQD is the star man this month and doing excellent DX as well. FB!

Pawtucket: 1AMU kept schedules, rolled up a good traffic total, made some DX records using 20 meters and is now putting in a mercury arc rectifier. He certainly keeps Pawtucket on the map in fine shape.

Traffic: 1BQD 124, 1AMU 74, 1BVB 68, 1BIL 24, 1AID 20.

EASTERN MASSACHUSETTS—SCM, R. S. Briggs, 1BVL—The message totals for this month were quite low due to the usual summer slump. A lot of us have been bothered by school QRM and others have shifted their activities to working DX on 20 meters. It is easy to handle traffic with the West Coast and Europe on 20 meters. 1FL is a new ORS in Hudson and sure puts some snappy signals on the air. 1SL, who is an officer in the Army Radio Net, was at Fort Adams operating 1WF during the recent Army-Navy maneuvers. 1AWB also operated there. 1CRA handled messages for Lindbergh and also some for the recent flood. 1ACH has been QRW hunting for a power leak. 1BKV, 1RF, 1ADM and 1ABA have been active on 20 meters, handling International Relay messages. 1BYV says he has now worked 20 countries and five continents. Mr. Kolster, the R.I. and Mr. McCarthy, who is also well known to us hams, paid 1BYO a visit to investigate some BCL trouble, but everything turned out OK. 1ON was busy on 38 meters with the relay contest using a 208A. He also has become a "wacker". FB. OM! 1BVL has been off the air due to school QRM, but watch his smoke this summer. Hi. 1ALP gets on the air occasionally, but we are sorry to say that he is

now an EX-ORS. IAVR claims that he has a 201-A that works better than a 202, 210, or an H tube. 1OG and 1GP have been moving so have not had the chance to do their stuff. 1APK was on 88.5 meters handling Army Amateur traffic. 1PB is beginning to reach out on 80 meters. 1KR handled quite a few. The Eastern Massachusetts Radio Association held their second annual banquet on May 20th. From various reports it appears that the gang enjoyed themselves as usual. 1XM has the honor to be represented in the coming MacMillan expedition by one of the star operators, Mr. C. E. Himoe, ex9AOG-9ZE, who is to be operator on the Bowdoin. We can hardly wait to hear him sign WNP. 1AAY, also from Tech., is to be operator on the supply ship, "Radio". 1AXA arranged his Xtal set so as to use both 40 and 20 meters. 1NQ is going to change his QRA. 1BDV and 1CJR have been inactive due to school QRM. 1AHV is still on with crystal-control and expects to be on at his summer station 1QZ. We are very sorry to lose one of our ORS, 1OU, who is moving his outfit to Providence. 1AYX is off the air until fall.

1LM handled a few messages. 1ACA is on 80 meters during the afternoon and finds 20 meters a relief from QRN during the evening. 1NV has just got started again on 20 meters. 1UE has been fooling some with fone on 80 meters.

Traffic: 1CRA 66, 1FL 60, 1AGA 51, 1ACH 48, 1KY 46, 1BYV 86, 1LM 80, 1GP 22, 1PB 17, 1AHV 14, 1AVY 10, 1YC 8, 1ADM 8, 1APK 6, 1AWB 6, 1ON 4, 1NQ 4, 1RF 2, 1AXA 3, 1BKV 1.

VERMONT—SCM, C. T. Kerr. 1AJG—Sure glad to see how you fellows keep sending in those reports. Thanks, and let's step on it and double that traffic total. Notice we rolled most a hundred for three stations which is going some for Vermont in the good old summer time. 1AJG sighting up 20 meters but hasn't got there as yet. 1IT is high man and is vY QRW bizness. 1BBJ is also QRW office. Sorri, OM. 1BD sez he isn't dead but QRW wid Pontiac and YL. 1BEB on 20 and 80 meters now and just one msg under 1IT. He is sure sailing on 20. 1BJP shut down moving but on soon again.

Traffic: 1BEB 42, 1IT 43, 1BBJ 13.

CONNECTICUT—SCM, H. E. Nichols. 1BM—The summer season is fast approaching and the static is increasing but there still remain the old faithfuls who never give up. It is as much of a thrill to copy a message through intense QRN as it is work DX when everything is favorable. This indicates an increase in quality operating instead of quantity and any amateur who makes a practice of doing it deserves real praise. 1AOX, our Army Amateur station, leads the traffic list this month and makes the BPL as well. 1AOS will be with us soon as he intends to install his set at his shore cottage this summer. 1BHM has appointed 1CTI and 1AOX as his assistants in their counties and is looking for other good ops to line up the other sections of the state. 1MK is working on both 40 and 80 now. The 80-meter band is getting to be the sister wave to the old 200-meter one and there is more real A.R.R.L. sociability on it than ever before. Does anyone else feel this way or is it imaginary on your SCM's part?

1BDI, our CM, handled traffic with nnMSY-1NIC (U. S. Marines at Nicaragua). Sure fb. OM. 1BEZ reports having arranged a schedule with an op at Honduras but due to little rouble with rectifier has been handicapped temporarily. 1ZL has swung from the Hartly to the tuned plate and grid circuit, and reports better records than ever. 1VB, 1BJK, 1AOX have been doing very noticeable traffic work in their vicinities and your SCM has originated quite a little traffic to test the outlet in this direction and feels it is quite satisfactory. The SCM hopes to increase his power so that all ORS in his section will be able to copy him. 1OS, our Danbury YL station, reports handling a message on its way to India, which didn't seem to her a bit from the ordinary.

Traffic: 1BGC 6, 1ROH 7, 1CTI 10, 1BYM 11, 1BLF 12, 1TD 13, 1ZL 16, 1BEZ 20, 1BHM 21, 1ATG 24, 1MK 67, 1BJK 45, 1AOX 124, 1BDI 20, 1OS 16, 1ASD 29, 1BCG 40, 1VB 41.

NEW HAMPSHIRE—V. W. Hodge. SCM, 1-ATJ—The "Summer-slump" has apparently hit this Section as only 6 stations reported. Please send your Form 1 cards to me even though you have no traffic to report. 1IP and 1AOQ have been rebuilding. Our R-M, 1OC, is at Riverhill, N. H., for the summer, on a well earned vacation. 1JN says the Manchester gang are ready for traffic. 1ASR neglected to send any news with his report. The SCM will be off the 80 band

until a new transmitter can be assembled. The new "OW" swiped the glass towel bars out of the old set. HI!

Traffic: 1IP 69, 1JN 28, 1BFT 26, 1AOQ 16, 1ASR 8, 1ATJ 1.

WESTERN MASSACHUSETTS—SCM, A. H. Carr. 1DB—Good weather is having its telling effect again and our traffic has dropped some this month. Fifteen stations failed to report at all. We have made up for all this in a way by the inauguration of the amateur free message service. Much thanks is due to Dr. Tessmer, 1UM Pres of the local radio Assn. and Brownie our RM for this new scheme of getting messages and we are all putting our shoulders to the wheel and look forward to it going over big. It was certainly fine of the Mayors of Worcester and Hartford to cooperate with us the way they did. 1AAE has kept schedule with NIDK nearly every night at 6 pm. 1AAL did himself proud by operating his station with the message from the Mayor of Worcester to Mayor of Hartford. 1AJK had two weeks of active radio duty with the Naval Reserve. 1AJM is on 20 meters and handled some of the relay contest reports from Chile. 1AKZ is also on 20 and says he is having good luck QSO with South America. 1AMZ will be on the air regularly again in a month. 1APL makes the BPL again for the fourth consecutive time. 1ARE says he is away from home most of the time now so that is why it is so quiet in his direction. 1BIV's new QRA is 10 Emerson Rd., Worcester, Mass. 1BYR says he will be on the air the last part of June. 1KZ is shutting down for the summer. 1WQ is a new ORS and wants to know if any of the gang is going down to Fort Monmouth, N. J., for the CMTC, he wants company.

Traffic: 1AAE 35, 1AAL 55, 1AJM 37, 1AKZ 10, 1AMZ 1, 1APL 127, 1EO 9, 1DB 8, 1WQ 8, 1AGA 90.

MAINE—SCM, Fred Best. 1BIG—1BFZ leads the Maine Brass Pounders, and his work is certainly appreciated by the SCM. 1AIT says it has been impossible to relay east or south in Maine because of punk weather. 1FP is striving to get a good contact station located at Bar Harbor, Eastport and Houlton, but as yet has had rather poor luck. Come on fellows, let's hear from active hams in these places. 1AUR has a new UX-852 which is already perking on twenty meters. 1COM reports school QRM has bothered his traffic total. He has been able to get his transmitter working on 20, 40 and 80 meters. He reports that 1DCX is moving to Norway after school closes. 1ACV still keeps Houlton on the map. Perhaps 1CZ also of Houlton will be with us another month. 1BNL reported, but handled no traffic. 1BIG, 1KL and 1BMS spent a delightful (???) 15 days on the USS Mohave and USS Wandank, participating in the Joint Army-Navy War Maneuvers down around Newport, R. I.

Traffic: 1BFZ 104, 1AIT 61, 1BIG 25, 1FP 23, 1AUR 22, 1COM 6, 1ACV 1.

NORTHWESTERN DIVISION

MONTANA—SCM, O. W. Viers. 7AAT-7QT—7PU has his station all packed and ready for shipment and he hopes to see the gang via "6???" soon. 7AFM, the new ORS at Nasauha, says things are held up on account of rainy weather. 7QV is still very busy but works the key when he can spare the time. 7EL is very busy on the ranch. 7AAQ is getting things shined up and will soon be on with 200 watts. 7AAT-QT is very busy with the new YL but hopes to have the station back on the air in a few weeks.

Traffic: 7PU 24, 7AAT 12, 7AFM 4.

WASHINGTON—SCM, Otto Johnson, 7FD—7UL at W. S. college takes traffic honors this month, crashing into the BPL. They handled messages from the WSC Engineers Show. 7EK takes DX honors working ei, em, es, uz, en, oo, and others. 7DF is now a WAC thru working fo8BZ and ac8HB. 7UQ worked eg-5HF. 7ACB worked eb4WW. Both use 210's, 20 meters, of course. 7VL took a lot of traffic using a new 852. 7GP worked many countries in the tests. 7AG is going again in the new QRA. 7AIY is also. 7MZ, 7NH and many others are coming on for the summer. 7AAB and 7EH keep things moving in Tacoma. 7AM is trying 20. 7FD had his vacation during the tests and

didn't get time to get on the air. 7AES, 7AET and 7JS are newcomers. 7TJ is fishing for DX. 7QB and 7MP have taken to the woods for the summer. 7GO is coming back with an 852. 7AW has a new xtal control xmitter. 7TX is doing good work on 20.

Traffic: 7UL 129, 7VL 80, 7DF 55, 7UQ 52, 7ACB 39, 7AM 29, 7AAE 28, 7EH 18, 7EK 12, 7AG 9, 7AIX 4, 7FD 8, 7TX 8.

OREGON—SCM, A. C. Dixon, 7IT—R. W. Wright, 7PP, 310 Ross St., Portland, has been officially elected SCM of the Oregon Section and will take the place of Ashley Dixon, Jr., who was acting SCM until one should be formally elected. All reports and communications should be addressed to 7PP after this.

The ORS turned in a good total this time. 7SY has kissed ham radio goodbye for a time but went off with a good report. 7AEK showed up well with the sync. 7EO works Hawaii and KFZH. 7ABH has a weekly schedule with oh-6AJL and keeps it consistently. 7ACG in Lexington graduated from high school on the 20th so was QRW. 7AV is on just enough to be sure that his xmitter will oscillate. The weather in Oregon is very pleasant this time of year and no doubt the fellows are answering the call of the wild instead of DX calls.

Traffic: 7SY 38, 7AEK 42, 7AV 2, 7EO 16, 7JO 6, 7ABH 15, 7ACG 10.

IDAHO—SCM, H. H. Fletcher, 7ST—There are several ORS certificates that are going to be cancelled next month if you fellows don't snap out of it. Of course, it's up to you to make the state what it is going to be but I want you to know that the SCM is pulling for the betterment of radio. 7GW is the new RM and says he is going to do his best. 7YA is on nearly every day but isn't hitting par. 7QC comes next but he is QRW with business. 7ACN rebuilt his xmitter. 7ACK is just finishing up his year of school teaching. 7ABB has been QRW school but piled up six points in the I.R.P. 7GW operates every night but has been doing experimental work. 7EJ is on a trip east. He is taking notes on everything he sees.

Traffic: 7YA 24, 7QC 22, 7ACN 4, 7ACK 2, 7ABB 2, 7GW 1.

PACIFIC DIVISION

EAST BAY—SCM, P. W. Dann, 6ZX—Acting SCM, J. H. MacLafferty, 6RJ—Activities in this Section during the past month show an increase instead of the usual summer slump. Interest in 20-meter work and the fact that the East Bay hams are getting together more than they have in the past is the cause of the good reports received this month. 6AYC and 6IT operate as guide posts on the lower and upper ends of the 40-meter band, keeping 6th District stations in their own wavebands. 6APA, 6ANE and 6CTX, our Route Managers, are QRW lining up schedules and setting an example in moving traffic. 6AYC is back on the air due to postponement of the cruise of the yacht "Idalia". 6BER is a new ORS operating every evening on 80 meters and is QRV for traffic anywhere. Jack Ward (Kacy), owner, operator, janitor, etc., of 6CKC, is QRW publishing the "Ham-meter" but manages to find time to handle traffic. He leaves June 15th to tour the east in a Chevy with 6CLS. 6RJ was appointed Assistant SCM and wants the support of every East Bay amateur in making this Section what it should be. 6CZR says he is ready for traffic all the time. 6IM is our star performer on 20 meters. 6CCT is QRW in the Television Department of the Telephone Company every night but Saturday. 6ANE has also been QRW with night work. 6AFT was R6 at se8AG and says plenty of traffic on 20 meters. 6CTH says his new location in Berkeley is FB, judging by R8 reports from the East Coast and OH. 6ALX sent the ORC code class a course of study and advises use of 2-cent stamped envelope for delivery of messages by mail with return address. Messages with wrong address will then be returned to sender and proper address can be obtained from station of origin. 6APA has arranged schedules for several ORS this month and reports business is good on 20 meters.

Traffic: 6RJ 114, 6IM 60, 6AYC 38, 6CZR 24, 6APA 22, 6ALX 12, 6BER 12, 6AFT 10, 6CTH 9, 6CKC 2, 6ANE 2.

HAWAII—SCM, John A. Lucas, oh6BDL—Most every one seems to be doing DX along with traffic

work. The first E-OH QSO was reported by 6AXW who worked ef8YOR on 20 meters. 6B4WW reported hearing them R7. 6BWV worked sa8CB and also made the BPL again this month. 6ACG worked fo8SR and A3X. 6DCU QSOd fo8SR and got an R7. 6CFQ will visit California till mid September. Says his code class at 6BUC is coming along fine and that he'll have them taking tricks shortly. 6BDL worked CR10, then 2100 miles from Panama bound Brisbane, on 20 and took 9 messages without a stop from start to finish. No break-in and sent single. 6ACG and 6CXY are now ORS.

Traffic: 6BWV 110, 6ACG 86, 6AXW 81, 6CXY 67, 6BUC 37, 6DCU 37, 6BDL 38, 6CFQ 8.

LOS ANGELES—SCM, Don C. Wallace, 6AM—This is the first report submitted to the new SCM, so be at ease. We note with pleasure the high total of 6BJX and guess this is to be expected with the able direction of 6BXA. 6AGG in spite of school QRM does nobly. 6CMQ acts as YL headquarters for 2AMQ in a weekly schedule with 2AMQ's girl. 6ZBJ is arranging champion chess matches over the air. 6AJQ makes the BPL with 6ALZ, 6AM, 6BXD, 6AGR, all showing substantial totals.

6BUX, the DX hound, QSOd Australia 20 times during the month, working 5 countries on 20. 6AWQ is moving to Lake Arrowhead. He is a new assistant route manager. 6CDY is applying for ORS. 6CQP is changing circuits. 6CZJ, 6PY and 6NW all show their value to the section with good prompt reports. 6AKW continues to QST Aust like local with 39 QSOs there. 6CHT, 6RF are both showing good DX with foreigners. 6DEG has a phone on 180 as well as 42 and 84 meter waves. 6BRO wants to know the QRA of XC55. 6CLK finds 20 much better for DX and rag chewing. 6AIO has a new plug-in transmitting going, and we need more of these. 6DAQ finds 20 much better than 40 but lacking in traffic. 6BER and 6CGK come through with a report as usual.

6AM worked every continent last week, but has to kiss the set goodbye and go to Chicago, New York and Boston for a month. The office here at Long Beach will take care of the report as usual, and we plan on keeping the LA section on the map as well.

Traffic: 6BJX 288, 6AGG 148, 6CMQ 138, 6ZBJ 122, 6AJQ 101, 6ALZ 76, 6AM 72, 6BXD 50, 6AGR 46, 6BUX 39, 6AWQ 34, 6CDY 28, 6CQP 27, 6CZT 18, 6PY 20, 6NW 20, 6AKW 19, 6CHT 14, 6RF 9, 6DEG 6, 6BRO 6, 6CLK 5, 6AIO 8.

SAN FRANCISCO—SCM, J. W. Patterson, 6VR—6BGB leads the Section this month for traffic. 6BIA has been QRW the YLs and has found little time for brass pounding. 6PW has also been QRW working overtime with the telephone company. 6KW showed up after his vacation all tanned up and itching to pound brass again. 6CAK is installing a WE50 and has visions of RIO reports in Australia. 6CCR has gone back to 40 meters deserting 20 after QSOing ef8YOR. 6VR is still on 20 meters and has installed a 75 watt bottle primarily for this wave. 6DEK will QRP to one 210. He has been handling press for WUX. 6HJ is trying to put S.F. on the map as the champion checker player. He has challenged 6DEG to a game over the air and needs help. 6ADM received a report from England on his sigs and when last seen he was offing his heap up so things could slide off easier on their journey. 6PN is rebuilding now and will be on soon with a 210 in a TP-TG transmitter.

Traffic: 6BGB 72, 6VR 49, 6DEK 34, 6CCR 32, 6KW 29, 6BIA 26, 6ADM 24, 6PW 24, 6CAK 20, 6HJ 12, 6PN 4.

NEVADA—SCM, C. B. Newcombe, 6UO—6ABM has moved to a new location and is getting out much better. 6GA, using an H tube, has worked Hawaii and aj-1AK. 6CHG had to lay off for a few days on account of the arrival of his first grandchild. He says the kid's QRK is RIO, pure DC. 6UO has a UX352 and getting fine results.

Traffic: 6ABM 56, 6UO 18, 6GA 4, 6CHG 34.

SACRAMENTO VALLEY—SCM, C. F. Mason, 6CBS—The SCM has a new UX352. 6FR reports 20 meters to be the best DX wave. 6CGM is kept off the air by railroading most of the time. 6AVB is using a Hertz antenna. 6CDK still sticks to 40 meters.

Traffic: 6FR 15, 6CGM 22, 6AVB 36, 6CDK 90.

SAN DIEGO—SCM, G. A. Sears, 6BQ—6DAU is leaving to join the Navy. His report is a dandy and we are sorry to lose Frank in the S. D. Section. Best wishes, OM. 6AJM, Route Manager, has moved to

1821 Altura Place, San Diego, and is again on the air. 6HU and 6CTP are still QRW school. 6LH likes 20 meters and has his xmitter there regularly. 6BAM rebuilt now using Colpits and piles up nice traffic totals. 6AXU is on a vacation for about three weeks. 6BFE is rebuilding both xmitter and receiver. 6SB has been sick but expects to be back on the air soon. 6CNK reports hearing of 8JF and eb4WW. 6OX wants a couple of skeds. 6SJ has another good traffic total, a result of regular operating and skeds. 6FP is in new quarters, 4030 Goldfish St., San Diego. 6MB has all night for the now. 6ANC says getting hot in Imperial Valley and signs not very good. 6BXN has a new transmitter going good now.

Traffic: 6DAU 162, 6SJ 74, 6BAM 55, 6AJM 55, 6AXU 43, 6BXN 39, 6FP 19, 6CNK 18, 6CTP 12, 6LH 12, 6ANC 12, 6BQ 5, 6SB 5, 6OX 5, 6MB 3, 6HU 2.

ARIZONA—SCM, D. B. Lamb, 6ANO—6BJF is working on 20 meters. 6DCQ worked phone FB on 20. 6DWS had YL op on air once. 6CDU has been working 6RXU on schedule playing checkers. Hi! 6AZM hasn't been able to do a thing on account of local QRW—QRM. 6ANO works on 20-40 getting out FB. 6DIE is perking good. 6DIB uses 600 V. M.G. 6CUW is active yet so the YLs didn't get him after all. Hi!

Traffic: 6BJF 37, 6CDU 57, 6BWS 20, 6DCQ 11, 6ANO 26.

SANTA CLARA VALLEY—SCM, Frank Quement, 6NX—6CKV acting SCM—The SCM—6NX has zone and done it. He has taken unto himself an OW, and is now happily honeymooning in northern parts. Congrats OI Timer. 6AMM comes through with high traffic honors and a real report. Made 15 points in relay contest and is still best contact with Philippines. 6BYH is still on job as an OO and reports 17 points in the contest—FB. 6BVY hits the BPL once again and is fighting QRN at the Philippine end of his schedule. Also very active in Naval Reserve work. 6ACQ says things are going fairly well now. 6BCH has a job we don't envy. He has to hit his 250 watter to get it going as the grid is warped and touches the filament. Hi! Hi! 6BMW has been QRW trying to crystal control his quarter k.w. bottle. 6CSX is, as usual, handling traffic with the OH stations. 6DDN has worked OH and is on every Sunday. 6CTE has fallen off in traffic but has one schedule. 6CLP has been QRW but found time to handle a couple. 6CJD is another one that is busy at College. 6CKV is on both 20 and 40. He scored 54 points in the relay contest.

Traffic: 6AMM 349, 6BYH 109, 6BVY 102, 6ACQ 25, 6BCH 20, 6BNW 20, 6CKV 18, 6CSX 11, 6DDN 8, 6CTE 7, 6CLP 2.

PHILIPPINE ISLANDS: SCM, M. I. Felizardo, op-1AU—This report received by radio via op-1AU and nu-6BVY—Due to QRN setting in and making QSO with U. S. A. different after 10 P.M. local time traffic has slumped a bit. Op-1HR keeps battling a high average through, the traffic originating from Army folk at Fort McKinley. Op-1DL is off the air most of the time but still has some traffic. Op-1AT QSY'd to 20 and worked am-VSLAB, first P. I. Malay contact on the 20 meter band. FB, OM! Op-1AH is sure lining up for an ORS. Just look at his tfe this month. Op-1AU handled messages for Vienna, Austria QSR'd via el-LAZX. Old al-1ZQ lately of JKXB visited Manila enroute to Schenectady, N. Y. via Europe.

Traffic: op1HR 226, op1AU 175, op1AH 150, op1AT 39, op1DL 6.

ROANOKE DIVISION

NORTH CAROLINA—SCM, R. S. Morris, 4JR—Due to the resignation of 4ML, the position of RM is again open. Anyone who desires this job please write 4JR at once. Drop a card in the box on the 26th, OM. You don't have to be an ORS to get credit and every little helps. 4RY has graduated from Davidson and will be on from Montreat during summer vacation. 4DB has been QRW exams. 4OC is getting fair results from his crystal controlled set now. 4NJ is using plug-in coils to work on 20, 40 and 80 meters. 4 PP has at last got his license renewed. 4TS has been handling signal corps traffic with 5DL. 4EC has trouble too—shot tube, lost mast. BCL QRM etc. 4SJ seems to be on afflully, perhaps he will get his set going steadily soon. 4OH has been QRW YLs. 4FV worked DCZ. 4BX is rebuilding the station arrangement.

62

4JR lost a game of checkers to 6 ABN on twenty. Traffic: 4TS 7, 4SJ 4, 4EC 3, 4DB 2, 4JR 1, 4BX 7, 4NJ 4, 4RY 3, 4OH 2, 4FV 1.

VIRGINIA—SCM, J. F. Wohlford, 3CA—3KU, 8JT and 3WM have been trying local phones. 3MU rebuilt xmitr. and filter system. 3WM worked ex6BY, his first foreign contact. 3CEB has skeds with 3NR 7.30 PM daily. Has changed to 40 meters for summer work. 3AHL was in relay contest but only made 15 points. He was QSO NM, EI, EB, OA, OZ, NR, EF, NQ. 3CKK will not have much time for work during the summer. He has joined the Naval Reserves, and will instruct recruits in radio, on the sub-chaser. 3UX blew a fifty watter but is putting in a 250-watter now. 3NM-3DL is very QRW school but has maintained sked with 3NR expects to have five point system after school. 3IE is going to Washington for the summer but will be on in full force in September. 3BGS says nothing extra to report although he handled a few messages. 3KG has done nothing but is on the air some. 3BMN is running a BC station now but we hope he will be back on the air soon. 3RX-3SR is doing some experimental work now, so no traffic handled. 3CA expects to get that long-looked-for and much-talked-of crystal control on the air by middle June. 3BDZ has connected with ex3VO of Richmond in California. 3CKL has been visiting hams this spring and early summer with the track team from VPI so not much work reported at the station.

Traffic: 3CEB 24, 3KU 30, 3BGS 9, 3NM 7, 3UX 33, 3AHL 36.

WEST VIRGINIA—SCM, C. S. Hoffman, Jr., 8BSU—During the last month, there was considerable drop in traffic, due to school exams and general overhauling in transmitters. 8VZ reports being busy at WSAZ. 8WK is adjusting his crystal set. 8DOI is a new ORS. 8BBM is experimenting. 8BJB is putting in Mercury arc. 8AUL, 8QH, 8CEK, 8CDV are 20 meter stations, all doing excellent DX. 8DPO reports good DX with two 210s. 8BSU and 8AWM spent several days in Huntington at 8WK where a hamfest was held by 30 hams. The SCM congratulates Huntington for having such a splendid organization and wishes to thank the hams for their courtesies.

8VZ got in some nice traffic relaying for flood relief work with 9BWJ and 8DVT in Kentucky, handling 48 flood emergency messages in five hours. FB. 8CDV worked a couple of S's.

Traffic: 8VZ 48, 8CDV 2, 8BJB 8, 8AUL 6, 8BSU 1.

ROCKY MOUNTAIN DIVISION

COLORADO—SCM, C. R. Stedman, 9CAA—Denver: The ORS of 9DQG and 9BJN have been cancelled. 9DKM has resigned his position as RM of Colorado as he says he is quitting the game. We understand that a certain YL plus several other YLs has brought this on. The OM at 9BDF will soon sign a 7 call. The YL remains in Denver, however, and will be on with a new call, the old one having expired. 9CAA blew himself to a new 75 watter. 9DGJ and 9EAM are still doing their stuff. 9OO came thru with a delayed report this time. 9BQO is going on a 3 months trip thru the midwest and central divisions and expects to see lots of hams. 9CDW is going to join 9CAA in going 9DKM one better. They are going to mix YLs and Radio. 9QL, 9EEA and 9DED report as usual. 9CAW says 9BQO is a "two timer". 9DWZ has a much improved note lately. He is doing good work as official observer.

9BYC has given up hope of ever hearing from the SCM regarding some 5 meter tests. Hi. (Have patience, OM). 9CDE will not be on much this summer. Keep up the reports, OM. You are the only station in the Section who has never missed a report since you got the ORS and the record stands for 4 years back. This is an example of what the SCM wishes all ORS could be. 9DSU has applied for ORS and turns in a good report.

Traffic: 9CAA 91, 9OO 62, 9DSU 28, 9DWZ 27, 9EAM 18, 9EAA 18, 9CDE 17, 9BYC 11, 9QL 11, 9CDW 7, 9CAW 1, 9DGJ 1.

UTAH—WYOMING—SCM, Don C. McRae, 6RM—Traffic took a big drop this month and only about half the usual number of reports were turned in. A great number of the gang were busy with school and in getting ready to go on vacations so that only a few did any brass pounding. 6GLQ still continues the good work this month keeping schedules every A.M.

Q S T FOR JULY, 1927

except Sunday. 6BAJ reports using a 210 with good results since his H tube went west. 7DA has been working on 20 with splendid results but had very little time this month to push many thru. 7RX blew his 50 but is operating with lower power at present. A couple more new stations are being lined up in Wyo. and let's hope to see some more going good before long. The SCM is leaving June 10 for his vacation and hopes to visit some of the gang down in Calif. while he is gone.

Traffic: 6CLQ 91, 7DA 25, 6BAJ 15, 7RX 4.

SOUTHEASTERN DIVISION

FLORIDA—W. F. Grogan, SCM, 4QY—4NE sends in a list of schedules that looks like a R.R. time table. FB, OM, 4VS is working 18 hours a day but handled some traffic in the six hours left, FB, 4DD has been doing good DX on 20. This is the time for 20-meter work while the QRN is bad on 40. 4CK is going all the way to Indiana just to see how his sigs sound. 4HY sez his 50 went west and didn't even advise him of the trip. 4OB and 2TK are exploring the 20 band and hooking up a 250 tube. Great stuff, boys. 4JZ is still with us. Twelve ORS were cancelled this month so better remember to mail that little card gang, or the rest will be cancelled. 4QY is on 20 for the summer and also going down to 5 meters soon.

Traffic: 4IZ 63, 4NE 62, 4VS 25, 4DD 23, 4CK 23, 4HY 4, 4OB 4, 4JZ 2, 4TK 1, 4QY 18.

ALABAMA—SCM, A. D. Trum, 5AJP—Summer time is with us now for a few months and we cannot expect any too much. Let's do the best we can. You fellows that complain of not getting mentioned in QST, try and send in a report and see what happens. The SCM regrets that he hasn't a vivid imagination concerning your activities. Birmingham is thriving with amateur activity again with some new stations. Let's have some reports, gang. 5ADA is planning to buy a motor-generator and do away with the chem-rectifier. 5YJ's junior thought he would be a second op and got tangled up in the xmitter and JY cussed the old set so much it felt ashamed and started perking as it never had perked before. 5AJP has been working at 5JY this month. 5ATP has returned from Georgia Tech. where he was chief op at 4AV. John Andrews is looking for his six letter call, having sent in papers for his license this month. 5AFS has dismantled for the summer. 5NL has been on consistently and has a good sig. 5ABS is very sorry for his showing this month but was out of town a good deal which accounts for it. 6JP got his ORS this month and feels like a king with a crown. 5FI wants traffic. He handled some very important two way traffic in record time. 5AX sent his report via 5JY by air. Is still alive with a good DC note. Chris Englehart is on the air with the call 5VX. 5DJ is on with four 201A's with 350 DC. 5AV is going strong. 5DI has returned from Auburn and is on the air again. Bewig is going to have classes this summer for code practice for beginners. Harrison has been sick and his being the backbone of the hams there, it paralyzed the others from reporting.

Traffic: 5ARS 6, 5ADA 24, 5AJP 11, 5FT 19, 5AX 28, 5JP 14, 5NL 44, 5DL 56, 5DF 3, 5AV 11, 5JY 60.

GEORGIA—SOUTH CAROLINA—CUBA—PORTO RICO—ISLE OF PINES—SCM, H. L. Reid, 4KU*—Porto Rico: It seems that the gang on the Island are going to come out if it and show us real stuff. 4KD has written to all the fellows asking their support in putting PR back in the lineup and he's making good headway. 4KT is installing a Mercury arc. 4KD is keeping skeds with HKK, AYRE, 6KO and np4AAG.

Cuba: Mr. L. B. Foster, U. S. Naval reserve station at Guantanamo Bay, Cuba, has written in for the Handbook and is going to try to get the Cubans lined up so we can get their regular monthly report.

South Carolina: 4AAM is on 38 meters at 9:30 am and 12 midnight. 4EI has rebuilt his station and is putting 2.5 amps into the antenna with input of 140 watts. "4EI gets married June 29th, second attempt". Congrats, OM. 4IK has recovered from a double operation and the Sawbones have left his pocket book in such shape that Claude says the old 201s looks good to him now. 4WA is on the air under high pressure as the YLs are giving him QRM. 4KZ has a fifty going (working, of course).

Georgia: 4TU is doing nice work still carrying on skeds with his father at Santiago, Chile. 4KU is doing good work on 20 and likes it FR. 4IO has a new 852 coming and 4RM has a new 204A enroute. 4AAH is on again after a temporary leave and is ex-

perimenting with Heriz antennas. 4TU got an RS report from ek4AUH and took a message from him for a YL in NYC.

Traffic: 4EI 22, 4AAM 12, 4KD 5, 4AAH 4, 4TU 17, 4KZ 1, 4JK 6.

WEST GULF DIVISION

OKLAHOMA—K. M. Ehret, SCM, 5APG—5FJ, RM for Western Oklahoma, sends in his last report from Norman for the summer but will report from Enid for the balance of the vacation. He expects to hold a ham reunion for Northwest Oklahoma in Enid this summer. With 5AMO leaving the University for the oil fields to dress tools, traffic seems to be doomed at Norman for the summer. 5AMO did good work in the International tests with a total of 16 points. 5VH is going back on as soon as he can raise enough money to get a 7 1/2 watter. Hail ruined 5APC's wheat crop and guess he'll have to mortgage the farm to keep up brass pounding. 5ANT is on the job every morning from six to eight. 5FJ has a permit to construct a BC station so traffic will suffer. 5VT is new Op in 5FJ's family. Mebbe grand dad next. Hi! 5ABQ and 5DQ are QRW school exams. 5ANL has rebuilt his 80 meter transmitter and is on the air with a great wallop and getting fine reports. 5APG is still constructing his crystal controlled transmitter. 5SW is working steadily but won't be satisfied until he tries a Zepp antenna. 5AKA is getting out fine with a WE 50 watter. 5AFX is getting back in the game after an absence of several years. 5QL has his big brute safely installed in its new location and is pushing a Zeppelin so successfully that to date he reports QSO 100% with all foreign DX called. 5AAV is suffering a University complex but we hope that a summer's sojourn in Denver will restore his radio pep. 5AJ has a pair of 75-watt jugs amplifying the output of his 15 watt master oscillator.

It appears that traffic will be light in this Section during the summer due to hot weather inertia but after the University hams get settled down at home, we anticipate some activity. Several 200 meter fone sets are in operation in the State but the operators do not seem to be sufficiently interested to report their traffic totals and news. How cum?

Traffic: 5APG 8, 5SW 8, 5AJ 1, 5AKA 9, 5ANL 12, 5AGN 2, 5AMO 135, 5FJ 118.

SOUTHERN TEXAS—SCM, E. A. Sahn, 5YK—Activity seems to be as great as ever although summer is now advancing rapidly. One evidence of summer, however, is that an epidemic of rebuilding has again broken out. 5ABQ is rebuilding his set and for that reason has not handled much traffic. 5RR, a prospective ORS, had handled some. 6HS has handled considerable traffic but says he has been forced to mail six messages. 5EW-5PK, who have recently combined, have handled considerable traffic and maintained schedules with nine different stations. E. W. Wilkins, formerly of Miranda and now of Refugio, says he will see the gang soon with 1KW crystal control. Tennant, our old stand by at Lynchburg, was in the relay contest and handled traffic with nearly every country on the globe. Tell the Houston and Goose Creek hams that visit you, OM, that we need a few good ORS in that neighborhood. Houston should be large enough to have a few. Joe Wright of Miranda reports that he will be back with us next month after an absence for a while. 5ARQ is on the air for the first time using a 201-A.

Traffic: 5EW-5PK 123, 5HS 14, 5RR 2, 5AHP 21, 5ABQ 5.

NORTHERN TEXAS—SCM, W. B. Forrest, 5AJT—With the coming of the summer months the SCM urgently requests that all stations try to be prompt with reports in order that the showing for this section may be as good as possible. 5OK is back on the air again and doing some nice work in traffic handling. 5AJJ has moved to New Orleans. The gang loses a good man and friend, but wish him every success in his new location. 5HY maintains schedules with 5PK and 5KK. 5WW is doing some experimental work, but still manages to get in a traffic report each month. FB, OM. 5AKN handled some nice traffic with KFSK, a ship from Shanghai to New York. 5RG adds his endorsement to the new UX-852 transmitter tubes. He is getting excellent results with his. 5AHU is handling traffic on 40 meters. 5RO is moving to Las Vegas, New Mexico, and will be on there shortly. 5AYD and 5AXQ are new stations in Comanche.

Traffic: 5RG 21, 5AHU 23, 5WW 22, 5HY 16, 5OK 85.

CANADA MARITIME DIVISION

NEW BRUNSWICK—SCM, T. B. Lacey, 1E1—Activities are a little below par in this Section, owing to good weather conditions and the gang finding the call of the great outdoors too much for them. 1AD again appears to be the leading station for the month having several DX records to his credit. 1AM is working on both 20 and 40, moving traffic with commercial speed. 1AI is on the air occasionally and is getting excellent results with his new power supply. 1AX claims his sigs do not get out of his own back yard, but we have seen several cards that testify they are roaming at large in Europe, both on 20 and 40. 1AQ is busy studying for final exams and is gradually raising both the price and output of his H tube. 1AN is now operating a broadcasting station at Fredericton. 1AK has been busy erecting new antennae and has concluded that third harmonic gives him best results. 1CB is on the air regularly and though only a newcomer, has had several good QSO's with NU first, second, and third districts. 1EI has received several reports from Europe, operating a set owned by Thorne 10-BO.

Traffic: 1AD 15, 1AM 17, 1AI 15, 1AX 30, 1AQ 6, 1AK 31.

PRINCE EDWARD ISLAND—SCM, F. W. Hyndman. 1BZ—1AP has done exceptionally good work for being a new man.

Traffic: 1AP 5.

NOVA SCOTIA—SCM, W. C. Borrett, 1DD—Nova Scotia boasts of two new stations on 40 this month, 1CC of Dartmouth and 1BM of Liverpool. While we have gained two new stations, we regret very much the loss to Ontario of 1CX of Glace Bay, one of the most consistent stations of the Province. 1DD has received a card from fq-PM at Eholowa, Cameroun, Africa asking for QRA of ne-1CDP. Can anyone supply? Since 1CX has left Cape Breton, will all stations there please report direct to 1DD each month. 1AE of Wolfville suggests Dominion Day Trans-Canada relay. This will probably take place on 40 or 20 meters. Any stations willing to take part please notify 1DD at once.

QUEBEC DIVISION

QUEBEC—SCM, Alex Reid, 2BE—Interest in our great pastime is still holding, even though the boys are planning to depart on their vacations. It was too bad that none of the gang were able to take part in the recent tests. Three stations were forced out on account of moving to new QRAs, and others just did not seem to have the ambition. 2DN and 2AV are the star stations for this month. 2DN has a station in operation at his store, then goes home and pounds brass during the evening. 2EV has his crystal set working and is getting good results. 2HT has a beautiful new transmitter, also a new car. 2AL is doing most of his DX on 20 meters and invites the gang to get down there with him. 2BG had a visit from Capt. Fuller (enough said). 2BE is getting fine results at his new QRA. 2BM is having antenna troubles. 2BN has been heard (what's the matter, John, did the bug bite again?). 2AX is still experimenting with crystal. 2FO has his set working beautifully on 20 meters. 2EQ is our star fone station.

Traffic: 2DN 19, 2AV 13, 2AL 7, 2BB 9, 2BE 3, 2BV 5, 2AK 3, 2BG 9.

ONTARIO DIVISION

ONTARIO—SCM, W. Y. Sloan, 9BJ—Stations throughout the Division have been very active this month with the International Tests. In Toronto, the competition has been keen and the results are being eagerly awaited. Eastern Dist.: 3AEL has been off the air since February but is going to install an 862 this fall on 20 and 40 meters. 3VS has moved to a new QRA and reports the DX much improved. 3AFZ and 3AEL are planning some interesting experiments with two portable sets this summer. 3HE is the latest to appear in the marriage column. Congrats, OM.

Southern Dist.:—3CS, is, as usual, far in the lead in the activities in this district. 3CB and 3IA took in the convention in Detroit. Two new fellows have made their appearance, 3DD in Woodstock and 3DL in Courtright. A new junior op has arrived at 3UD. We suppose by this time, 3UD has him well grounded in the Q signals.

Central Dist.: 3BT reports things there are rather dead, as most of the stations use 80 meters and the by eg-5HS while using very low power on an ex-

static has driven them off. 3BT was heard on 20 perimental 852 and a very small antenna system of the most rudimentary nature. 3AZ has departed for Northern Ontario to operate a short-wave station for the Ontario Forestry Service at Women Lake. 3DY has been doing experimental work at extremely short-wavelengths around one meter and less and also continues to use 42.7 and 21.8 meter waves with excellent results on low power. 3UR is still using a single 202 and uses both 40 and 80 meters. 3CJ is also a station using but a single 202 which gets out with but 500 volts on the plate. 3DW is on the air but failed to report this month. 3BK is active in all else save reporting. 3EL has been in operation occasionally on 41 and 20 meters, handling one very important death message successfully on 20. 3BR is also very QRW at school and radio has had to suffer. 3BL has appeared occasionally on 20 to test an oscillator. 9AL has apparently decided to eschew crystal control that won't control and is now doing excellent DX consistently on 20 meters with an ordinary oscillator. 3FC has also been using 19.8 meters exclusively. 9BJ has not been in operation as Bill is moving to his summer home at Toronto Island and everything had to be dismantled and stowed away. 3DB has been active as usual using a single 202 and working successfully both on 40 and 20 meters. 9BZ has been very active this month on both 20 and 40 meters. 3CC says that the old 202 continues to perk and the same old DX is accomplished. 3JM, a pioneer station from the old spark days, is again on the air using the modern CW this time. 2CO is now in Toronto pounding brass on 40 meters under the call 3CO. 3GG is going strong on 20, piling up DX on low power. 3HP is also on 20 and 40 doing good DX.

Traffic: 9AL 12, 9BZ 22, 3EL 6, 3CC 4, 3CJ 3, 3UR 10, 3DY 5, 3BT 3, 3HP 26, 3FC 20.

VANALTA DIVISION

BRITISH COLUMBIA—SCM, E. S. Brooks, 5BJ—(March-April) The report from Victoria arrived too late to be sent in with the last report so here it is: 5HO, a new station, steps out and works op's and oa's. 5CO wants to QSO stns. 5AJ still puts R7 sigs to oz and oa with 20 watts input. (April-May) 5AJ reports only 16 QSO's with oz and 22 with oa this month. 5CO blew a 5'er and replaced it with a 201A. 5AR's new set is perking FB. 5HO worked a Brazilian. 5CT is too busy fishing to pound brass. 5AM has closed down. 5AV is waiting for a new tube. 5AC reports good DX. 5GF is housecleaning. 5GO has a new sync and is out to break records. 5HB installed a chem. rectifier with fair results. 5AD and 5AU took a trip to Victoria, visited the gang there and returned with a raft of new ideas. Have some cards for ne-5FS—please send your QRA, OM (SCM).

Traffic: Mch-Apr.: 5AJ 92; Apr.-May: 5AJ 94, 5AC 17, 5CO 14, 5AV 1.

ALBERTA—SCM, A. H. Asmussen, 4GT—4DG holds the record for traffic and wish we had more like him. FB—keep it up, OM! 4CL holds the record for DX and is next in line for the WAC, having worked three continents. 4CU is working hard for a WAC and there is a good chance of Alberta having two and maybe three WAC's. Calgary has a live bunch with a number of new hams on the air. The AREA now have a club room and enough junk to put a station on the air. 4IO with the help of some of the new converts will build the club station, while 4AX and 4AG keep up the good Spirits of the club and 4DA and 4GF the code practise for beginners. 4DQ has made some real DX records for which the credit goes to the OW. 4DI is doing good work. 4AH is rebuilding. 4AL is resting on his laurels. 4HM has rebuilt and sure has a neat outfit having at the same time worked his first DX. 4BZ is getting out better every day. 4GT will be off the air for a while moving to Edmonton.

Traffic: 4DQ 4, 4DG 42, 4DI 3, 4CU 6, 4GT 5, 4IO 7.

SASKATCHEWAN—SCM, W. J. Pickering, 4FC—Very few reports this month—apparently due to the spring weather and ORS are liable to be cancelled if they fail to report. Say it with cards. 4AA is busy with a BC station but will be on again soon. 4AC is busy and hasn't much time for brass-pounding. 4CB has gone on his vacation. 4FA is on 20 but reports no traffic and is QRW with farm work. 4FC was QSO oz-3AU for 1½ hours. 4CM is a new station at Humboldt, and is working hard for an ORS as is 4CP. There is very little activity on the Canadian band at present.

Traffic: 4AC 11, 4FC 2.

Experimenters' Section Report

THE report must be almost completely omitted this month because the time of both of us here at headquarters has been completely occupied by duties which developed very suddenly and unavoidably in connection with the Hudson Division Convention, which is reported elsewhere.

TRANSMITTER TESTING

For this convention and also for QST, Mr. Hull devised and constructed a shielded oscillator of simple construction for testing certain things about a transmitter which

on practically no notice the attempt was made. By working day and night (somewhat to the neglect of QST) the apparatus was gotten into shape and a demonstration message transmitted a short distance to the receiver in the meeting room, formally opening "Three Quarters" as an A.R.R.L. transmission wavelength. The details of the story will appear in the next issue of QST. The date of the formal opening was Saturday, June 4. The time was about 4 P. M.—unfortunately both of us were too tired to note the exact time.

REGARDING R.F. CHOKES

It seems that this section has at last developed enough material on radio frequency chokes so that we will be able to run an article on the subject in the next issue, wherein there will also be a more complete section report.

GENERAL REPORT AND BARCLAY CHART

Before this magazine arrives, there will reach all members a general letter from Mr. Hull and also a radio calculation chart. The letter will explain itself while the chart is to be regarded as a gift from Mr. R. H. Barclay of 194 Crafts Street, Newtonville, Mass. It is requested that members of the section acknowledge the chart to Mr. Barclay directly.

—R. S. K.

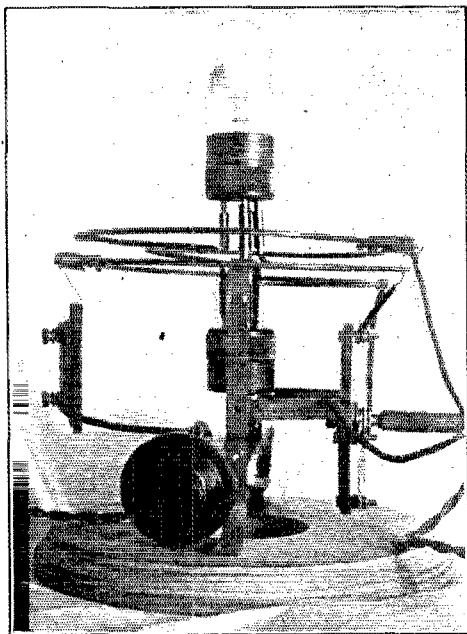

THE 5-METER PUSH-PULL OSCILLATING RECEIVER AT ITALIAN 1BR

are ordinarily neglected. The work on this device and the trip to the convention used up all the spare time of the preceding week—plus that ordinarily devoted to this section.

THE 3/4-METER BAND IS FORMALLY OPENED

It developed that there was a bare possibility that at the Hudson Convention we might be able to open the 3/4-meter band formally and before witnesses as part of a proper League meeting. Mr. Boyd Phelps and the writer had both operated tubes in this neighborhood and Phelps had constructed a variety of very short-wave oscillators as described in the last issue. We therefore seemed the logical candidates and

Strays

1HN tells us that as an acknowledgment of working 6AVJ, he not only received a QSL card but a list of the "International Intermediates" and a photo of that station. This is some different from the usual remarks we get about stations failing to QSL at all.

Remember, fellows, that the Hydrographic Office publication No. 205, "Radio Aids to Navigation," is obtainable from the Hydrographic Office, Navy Department, Washington, D. C. The price is only 90 cents and it is well worth while if you are a seagoing op.

The International Resistance Company will send to anyone interested, copies of their leaflets giving information concerning resistances and their use in radio. They may be addressed at the Perry Bldg., Philadelphia, Penna.

W. L. Jepson of Beverly Hills, Calif., says it would take a tuner capable of performing like one of these sliding ladders in a shoe store to copy some of the short wave artists who swing in and out like the moon in a cloudy sky.



I.A.R.U. NEWS

BELGIUM

SINCE licenses have been granted, our amateurs have been working very hard and DX communications are taking place quite regularly. The most active stations are 4WW, 4AX, 4CK, 4CB, 4AU, 4AC and 4BC.

"Practically all of our stations interested in intercontinental work are using the so-called Levy aerial. This is a Hertz antenna with a two-wire, current feed. This gave very excellent results at ef-8JN and most of our stations proclaim it to be a decided advantage over all other types they have tried. (This type of antenna was described on page 12 of the July, 1926, QST. —Asst. Tech. Ed.)

"4WW has been keeping a daily schedule with the Norwegian whaler, AQE since she left New Zealand waters bound home via the Panama Canal. Good signal reports are obtained and a good deal of traffic is handled.

"4ZZ is reported R-9 by afIB in Saigon and works him easily, besides making

bourne. He works on low-power with only 30 volts on the plate of his tube. It would be hard to believe this report except that he has received a QSL card which checks with his log book.

"4UU is putting up a Hertz antenna, Zeppelin type feed for operation on 20-meters during the summer. He will use a maximum power of 20 watts.

"Kindly note that all QSL cards to Belgian amateurs are to be sent to the Reseau Belge, 11 Rue du Congress, Brussels."

—eb4UU, General Manager, Reseau Belge.

BRITISH GUIANA

There is a low-powered transmitter with call VPA operated by Stanley I. Comach at Mabaruma, North West District, British Guiana. He has been working some of the "nu" stations although his equipment is rather meagre and old.

A receiving tube is used for transmission and the plate supply obtained from a hand generator which (so Comach says) was built for Noah. It has been lying idle for centuries and has only just been resurrected for this job. It has to be wound up rather strenuously to get enough juice for operation with the result that whoever is doing the winding gets muscle-bound in short order. As the station is located about 150 miles from civilization on the British Guiana-Venezuela border, there is no power available for this work.

There is little opportunity of obtaining materials and although a steamer comes from Georgetown each week, they invariably bring the wrong material when any is ordered.

Reception is good and it is hoped that many QSOs will be made.

MEXICO

The Union de Radio Experimentadores Mexicanos, held its elections for officers for the next two years at station CYB, Mexico City. The new officers are: President, Fernando J. Ramirez, nmJH; Secretary, T. Hinojosa; Treasurer, M. Veramendi, nm1C.

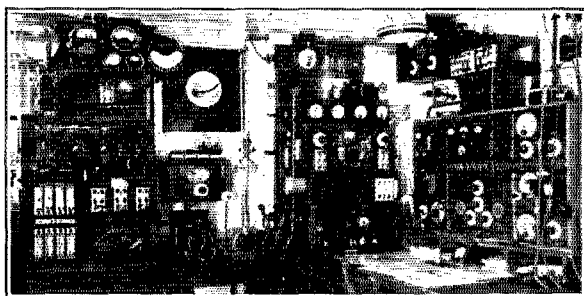

THE OUTFIT AT foA3X, DURBAN, SOUTH AFRICA

From left to right the main panels are power unit 200-watt transmitter, and universal receiver (8 to 23,000 meters). The meter on the table in front of the receiver is a microammeter for measuring received signal strength.

numerous contacts with other countries outside of Europe.

"4AU keeps schedules on both the 40- and 20-meter bands with Saigon, Chile and Brisbane; contacts being almost certain on all sides.

"ebK5 has been reported R2 in Mel-

The new officers are going to make a very strong effort to get as many new short-wave transmitters on the air in the coming years as possible. They will endeavor to convert and educate the BCLs to this phase of radio. Instruction in code, electricity and radio is given free at the club-house and printed instructions are being distributed all over the country. These instruction sheets may be had for the asking.

The meeting hall, light and other necessities for the club's meetings are supplied by station CYB of the Buen Tono Company which is Mexico's largest cigarette manufacturing factory. All the members of the club are issued beautifully engraved certificates of membership. These are somewhat similar to the A.R.R.L. certificates although the motif is decidedly Aztec. All stations that are members of the U.R.E.M. are authorized by the government to handle traffic. The club also acts as an interference committee to keep the air free from illegal operation, power leaks etcetera.

FRANCE

We have the following report on French activities forwarded to us by Prof J. Reyt, ef8YOR.

"On the 32-meter band, the conditions during January, February and March were very good and distant stations were received well. Static was heard but rarely. Many contacts were established with the New Zealand and Australian stations and daily reception of oz2AC, oz4AC and oz4AE was possible.

"The French boat, Caniopée, FBIO, was worked by 8YOR when between New Zealand and Australia. af8FOK in Hanoi, Indo-China was QSO ef8QRT although the amount of power used was very small.

"The S.S. San Francisco, RXY, when located near Panama was QSO 8JF, this being the first contact between France and Panama. The stations nj2PZ and nrCTO are heard each morning in France and have held communication with 8JF, 8JN, 8YOR and 8QRT. During February, work with the U. S. A. was excellent and in the mornings numerous 5's and 9's and also a few 6's and 7's were worked. Several contacts with Californian stations have been made. 6TK, 6OI, and 6UA having been worked by ef8QRT; 6OI and 6UW by ef8YOR and 6HM by ef8JF. ef8YOR has also been in contact with nu7EK and nu7VH.

"English 32-meter transmitters are heard very well during the day. A new African station fKTC of Kartown, Sudan was worked by 8IX and 8YOR. The first contact between France and the Belgian Congo was made on the 11th of March when ef8YOR was QSO fo8HSD in Elizabethville. The "fo" stations are heard regularly at night and many QSOs have been made by 8JF, 8CT, 8YOR and 8GM.

"More and more French stations are working on the 20-meter band. The most active ones are 8CT, 8YOR, 8JN, 8BF, 8GM and 8IX. Tests between nu1RD and ef8YOR show that it is possible to communicate during the whole day on this wave. Contact has been established between these two stations at 10.00 G. C. T. and also at various hours in the afternoon. Work in this band at night is also excellent and the "nu," "nc," "sb," "sc," and "sz" stations are heard regularly with good signal strength. ef8CT and ef8YOR have had numerous contacts with stations in all but the fifth, sixth and seventh U. S. districts.

"There has been organized a series of daylight trial transmissions by ef8JN between nu6VZ and 8JN, 8YOR, 8CT and 8GM. The signals of nu6VZ are being heard in France with remarkable regularity and the most favorable hours have been 15.00, 16.00 and 17.00 G. C. T. Signal strengths as great as R6 were had and 8YOR succeeded in making the first daylight contact between France and California."

We have also received the information from R. Audureau, ef8CA, Secretary of the Resau des Emetteurs Francais, that this organization now has a membership of 333. This is certainly a fine showing and the organization is to be congratulated for the excellent work it is doing.

DCZ

Have you heard DCZ? There is an interesting story to be told of her trip from New York to San Francisco.

She is the German peace boat "Vaterland," property of Count Felix Von Luckner who made quite a reputation during the war and who is now on a lecture tour. He is traveling across the continent and the "Vaterland" left New York in early April for her trip through the Canal. The Count was to meet her in San Francisco and she was then to continue on a cruise of some two years duration.

Some of the Second District amateurs decided that she should not leave port without a short-wave set and 2ABT very generously presented her with a 50-watt transmitter and a receiver which were installed and adjusted by 2CUQ.

2CUQ was to keep in contact with her but after she got below Haiti, communication was very unsuccessful. 2APD, 2BZO and 2UO helped 2CUQ immensely by perfectly splendid coöperation. When she reached the Canal, her signals were not readable and 9EKF stepped in to fill the gap.

Next, we find 6HM on the job. He first picked up a CQ from DCZ on April 22nd

when she was starting up the Mexican Coast from Panama. The operator, Fritz Jonske, said that they had had no news for two weeks and could not copy press because of the bad QRM on 600 meters. They had been out of all contact with shore. A schedule was arranged to handle some messages and give them news.

The very next day she had a break-down in the engine room and it was only due to this short wave contact that the operator was able to get off a long cable to Germany ordering the necessary parts needed for repair. It was also possible to notify the Count who was lecturing in Chicago, of these conditions.

She next ran into a big storm from the north and two schedules a day were kept instead of one. The storm drove her off the coast faster than she could make headway north and according to position reports which were being forwarded to San Francisco every day by 6HM, it looked as if she were QRD Honolulu. If it had not been for the excellent work of 2ABT, 2CUQ and the West Coast hams, no reports would have been had of this boat and probably there would have been many ships scouring the Pacific for her.

After the storm let up, the wind was from the wrong quarter and not much use could be had of her sails. (Primarily she is a sailing vessel with auxiliary power.) To make matters worse, the supply of fuel oil ran low and only one engine was being run. The generator was used only at night.

There seems little doubt but that she shall reach port safely having such excellent contact with land. When she does arrive, a big reception is to be given for the Captain and crew but we feel quite sure that the radio operator will be missing, having been kidnapped by the West Coast hams.

JAPAN

The Japanese amateur has not been having a particularly good time although he certainly has been active, in a way.

There were more than 40 enthusiastic amateurs and although they were using very low power most of them were making remarkable records. The average station consisted of one or two 301-A tubes while a few were using 202s. A very few "high power" stations employing 50 watters were in operation. Despite this low power most of the stations were in contact with New Zealand, Australia, South America, China, Philippines and Africa.

On January 25th, it was found that the Government officials were going to construct a portable short-wave transmitter and receiver with which they intended to make contact with the transmitting stations

and in that way catch them in the very act of carrying on illegal transmissions.

Immediately upon getting this information, all amateurs were told to QRT and to dismantle their transmitters at once. Due to this action, none were caught by the officials.

On March 7th, the situation became a bit worse as an official rule was made which confined the wavelength of receiving apparatus to be between 430 and 170 meters. It is, therefore, prohibited to listen in on short wave signals.

At the end of March, a conductor of a BCL magazine, deceiving one of the amateurs, obtained a complete list of the QRAs of all the amateurs. Up to the present time the amateurs in the Third District have been visited by Government officials and each has been forced to give a detailed account and explanation of his conduct. Stations in the other divisions have not as yet been so visited.

While it is theoretically possible to get a license for a transmitter, it is practically impossible to obtain one. Although it is expressly stated in the law that such licenses may be obtained, the qualifications necessary are such that one must be at least a professional in order to get one. A movement by the amateurs to make the obtaining of licenses for general transmission possible is under way and looks rather promising at the present time. Perhaps they may, some day, be officially licensed but until that time arrives all QSL cards should be sent "under cover" to prevent the authorities from obtaining information concerning QRAs of these stations.

NEW ZEALAND

nu9ARN has passed us a message from oz4AK to the effect that Mr. Gibbs, Chief Engineer of the New Zealand Telegraph Department will be traveling in America and Europe for the next six months. He will attend the International Radio Conference while in America. He is already keenly interested in amateur radio and intends visiting a number of U. S. amateur stations through which he hopes to keep in contact with New Zealand. The American amateurs are asked to look out for him and any assistance they can give him will be appreciated. The message is signed by oz4AG, who is a junior engineer in the New Zealand Telegraph Department.

PHILIPPINES

We understand that the local broadcast station has succeeded in having a law passed taxing all radio receivers in order to pay for broadcasting. All of the local amateurs are protesting and it is expected that the ship owners will follow suit. 20 per cent. of the tax goes to the Government and the rest goes to the broadcast station, in spite of the fact that they are still ex-

perimenting with the station. Its present modulation is very poor but the fees are being collected just the same.

SALVADOR

ns1FMH has been appointed by the President of the Republic of Salvador as Chief of the Radio Communications Service. This means that from now on, the amateur will be encouraged rather than discouraged in his short-wave work. Although 1FMH has been the only licensed amateur station, there are two other hams who are getting transmitters rigged up and these will be given temporary permits to operate until the present regulations which were drawn up by men having insufficient knowledge of the subject have been changed so as to allow general amateur work.

Amateur transmission, will be allowed in all the popular short-wave bands now used for this work and there will be no bars on the handling of messages. Up to 500 watts may be used although only c.w. will be permitted. We may expect some action from these folks soon! FB!

ns1FMH tells us that he has heard from Federico Gonzales that he is to put a transmitter on the air in Costa Rica, using the call of nr2FG. The radio population of Central America is growing slowly but steadily.

U. S. S. R.

Carl Madsen, nu9EEO, is on his way to Khabarovsk, in Siberia to install a 20 Kw. transmitter for the Westinghouse Electric and Manufacturing Company. This outfit is crystal controlled and will work on a wave of 30 meters.

He is taking with him a smaller set using a fifty or a two-hundred fifty watt with which he expects to do a considerable amount of ham work. He will use the call of 9EEO or EEO with the intermediate of "as." His wave will always be 30 meters although he will listen in both the 20 and 40-meter bands. He has a schedule to work 2DY who will be on 41.9 meters from 6.00 to 6.30 a. m. and with 9ANZ from 7.00 to 7.30 a. m. This is E.S.T. These tests will be run on all dates of the month which are divisible by five and will run for several months starting in June.

Reports on his signal would be appreciated as they will help considerably in showing just what hours will give best results for these QSOs. Address your cards to Carl Madsen, Westinghouse Radio Engineer, Khabarovsk, Siberia, U. S. S. R. Here's a chance to work Asia for that WAC certificate, OMs.

QSL SECTIONS

QSL cards to amateurs in those foreign countries listed below should be sent directly to the address given. Do not send them

to A.R.R.L. Headquarters for forwarding.

Help us and help yourself by sending cards to the proper QSL Section.

Belgium—Reseau Belge, QSL Section, 11 Rue du Congress, Bruxelles.

England—QSL Section, R. S. G. B., 53 Victoria Street, Westminster, London, S.W.1 England.

France—Robert Larcher, 17 Rue Fessart, Boulogne-Billancourt (Seine) France. This is the QSL and QRA Section of the Reseau des Emetteurs Francais.

India—R. J. Drudge-Coates, Cambridge Barracks, Rawalpindi (India).

Ireland—Irish Radio Transmitters Society Solent Villa, Kimmage Road, Terenure Co., Dublin, Ireland.

Italy—Traffic Manager of Radiofonia, Cassella Postale 420, Roma, Italy.

Portugal—Rede Emissors Portugezes, Tenente Eugenio de Avillez, 15 Costa do Castello, Libson, Portugal.

Spain—Association EAR, Mejia Lequerica 4, Madrid, Spain.

It would be appreciated if all other organizations maintaining QSL Sections would drop us a card giving the address of the Section for insertion in this department.

SOME MORE NEW ONES

ac2FF—G. W. Fisk, 303 Victoria Road, Tientsin, China.

acBRJ—12 Kashmir Place, Villa No. 8, Hong Lusk, China.

acZX2—Thibet, China. Complete QRA not known.

ar8LHA—Lambert, Box 86, Beirut, Syria, Asia.

ek4DBA—Fagien, Koenigsberg, Kalthof, Germany. Appeared incorrectly in May.

er5AA—P. Popescu, 143 Carol Davila, Bucarest, Roumania. (Cards under cover.)

enJA—c/o Radio Wereld, 250 NZ Voorburgwal, Amsterdam, Holland.

fm8VX—Alphonse Bautie, Ain-Tedeles, Algeria.

nfBAT—Nassau, Bahama Islands.

nmCYY—Martinez Canton Hnos, Merida, Yucatan, Mexico.

oc8XZ—Radio Centre de Noumea, New Caledonia.

vGLQ—Boat believed off Tierra del Fuago. Any more dope?

xef8FMB—French steamer in harbor of Beiru, Syria.

xen1NL—Dutch steamer "Kinderdyk" QSL c/o Royal Mail Steam Packet Co., Glasgow, Scotland.

These lists are possible only because those who run across new QRAs send them in to us. We want to thank every one of you for your contributions. Any additions or corrections will be appreciated.

Correspondence

The Publishers of QST assume no responsibility for statements made herein by correspondents



Help

49 Harvard Street,
Whitman, Mass.

Editor, QST:

I've got to get this load off my chest right away or bust. I've been musing over it for some time and have arrived at the stage where I must spill it.

Some time ago, I answered a CQ from 4— and after the preliminaries he asked me to QRS and QSZ as he was new at the game. I did as he requested and about three minutes later, the family called me to supper. So, necessarily, I had to cut the QSO short. I explained to him that I must go eat and would QSU later. The lad took it that I did not care to work him simply because he was a new man and could not copy as fast as I. We have straightened it all out now and he knows that I told him the truth. He told me that I was the fifty-second station who had been QSO him and that I was the fiftieth to quit him because he was a new man. Fellows, that doesn't sound very good, does it? That episode started me to wondering and I made it a point to listen for and work some new men. After numerous QSO's, I came to the conclusion that there were a bunch of fellows, who, seemingly, will *not* help the new man at all. I don't think they really mean to refuse help to the new man but rather that they have completely forgotten that they would have welcomed a little themselves at one time.

4— said that all but two of the fifty two he was QSO cut him short with 73 and CUL, as soon as they found him to be a new man. I think most of us know that to be only too true, not only as regards 4— but as a general practice among some of the gang. *It isn't right, gang.* We were all new at one time. We all had to start in slowly, so why not do all we can to help the new ham?

We are not all so balmy about foreign DX that we forget our own country entirely. How are the ever increasing ranks of BCLs who are becoming short-wave fans, going to get a start without the cooperation of the gang? If we are lax and don't give our help to the new men, what impression of the amateur radio fraternal spirit are they going to get? It's reasonable to suppose that it won't be very complimentary. The

ultimate result will not be good to contemplate if we don't snap out of it. Why, one lad who started in after getting his license three months ago, confided to me that he was just about discouraged and about to give it all up. He could rarely get a QSO that lasted more than five minutes at the most. Fellows, that's what will happen with a lot of them if there is not more cooperative spirit shown.

There have been a few communications regarding this subject but they seem to come from new men entirely. Why should they have cause to write in and tell us about the help they don't get? I think that there is a lot of us who are alive to the fact that there *are* so many new men coming into the game.

So, think it over, gang, and remember that you all had to start once yourself. Don't wait until you are asked to help, *offer* it.

—T. S. Brown, 1BFX
ex1JV and ex1CN.

(Ed's note—This seems to be the case with all stations and does not come about because 4— is a newcomer. This "QRU, 73" brevity is more noticeable on 40 meters.)

Saving Calls

2168-77th Street,
Brooklyn, N. Y.

Editor, QST:

In the past issue of QST, I find the Correspondence Column containing many letters pertaining to QSOs with stations. However, little has been said about the preliminary calling of a station which has just CQed. It is taken for granted that the calls should be as short as possible. A long call is unnecessary and makes for needless QRM and waste of time.

QST has suggested the "three and three" call. This call, many stations find, is not long enough to enable them to QSO. In consequence, we find stations calling for minutes at a time. With the large number of stations on any one band that we now have, it is impossible for an operator to tune thru an entire band in the space that it takes to send a "three and three" call. QST states that a CQing station should tune around the band for five minutes after an answer. Yet, why should the station tune for five minutes when the operator knows

that those calling him only call for less than a minute?

Surely, there must be some way by which we can at the same time give a short call and be sure that the other station has had time enough to come to our part of the band. At 2ARM we use the following system that has worked perfectly. We all know that the operator tuning around after a CQ starts from one end of the band and goes right thru. If our wave is in the middle of the band, it will take him quite some time until he reaches our wave. Therefore, why start to call him immediately? If it takes him one minute to reach our wave, why not start to call him about fifty seconds after he has signed off? This would save about one whole minute of calling.

The question now is, "How do I know how long to wait before I start to call? Suppose he should pass over my wave before I begin?" There are several ways to find the proper interval. Upon testing out the following ones, the resulting time was found to be almost exactly the same. If you have "break-in", the thing is very simple. Just begin to call immediately after the CQing station has signed off, meanwhile keeping your eye on your watch. When the station being called breaks, notice how long it took him to get to your wave. Do this several times and average the resulting figures. You will be surprised at how much time you can cut off your calls and still have them do the trick.

If you haven't "break-in", the procedure is somewhat different. Send out a CQ yourself. Let us assume that your wave may be picked up at 48 on your receiver dial. After your CQ, find out how much time it takes you to tune to 48 while looking for an answer. Try this several times and average these figures also. You can allow ten seconds difference; i.e. begin calling about ten seconds before the time it takes to come to your wavelength.

Using this system, we have found the "three and three" call is more than long enough. We also find that the percentage of stations who do not come back presumably because they passed over us before we started calling is very small.

This system is only a suggestion. It is a practical one. Give it a try and lessen the QRM.

—Maurice Apstein, 2ARM.

Kind Words

La Cotte,
La Moye, Jersey,
Channel Islands.

Editor, QST:

Just two words of appreciation.

I have read the "Radio Amateur's Handbook" carefully and am going to re-read and digest it. Speaking personally, it is one of

the best radio handbooks I have ever come across, especially from a ham point of view.

I wonder how many hams have had new interest put into radio by the article in the April QST on "How Far Is It?" A couple of days illness which kept me off the key were passed most pleasantly thanks to this article and a book of "Trig Tables." It, incidentally, opened my eyes as regards the distances in "fact" rather than in "fancy" of some of my QSOs.

In QST for April, eg6YQ and eg5MQ's letter on "Cut 'Em Down" is sound sense.

—A. M. Houston Fergus, eg2ZC

QRP

59 Marlborough Park, North Belfast,
Northern Ireland

Editor, QST:

Although I hesitate as a QRP man, to put my views forward in your columns, I do want to support the pleas of eg6YQ and eg5MQ in your April number and to add a few extra remarks on my account. These remarks do not solely apply to "nu" stations and I hope other stations will consider them.

Many "nu" stations and others give a "CQ Europe" call and after listening for about thirty seconds give another CQ call. It is obvious that they only wish to work high-power stations and do not carefully sift the foreign band. I find that to go carefully thru the 40-meter "nu" band, takes at least six minutes and I think the offending stations might search a little more carefully.

Please remember, the majority of our stations are limited to ten watts input and only a very few are on 32 meters. I know of several DX stations that only listen for British stations on 32 meters and thus, after a CQ call, leave many of us calling them uselessly on 45 meters. Please indicate the band you expect to receive a reply in e.g. "CQ Europe nu 9ZZZ—QRX 32 ar."

There is no doubt that our QRP signals often get thru to "nu" stations with fair strength. This was obvious in the recent QRP tests when no QRO stations in Britain were transmitting and I was able to work four "nu" stations and one "nc" station in an all-night sitting with five watts input, receiving average reports of R-4. On ordinary nights, one gets the impression that DX stations will not reply to a rather weak signal but call and call again till they get a QSA reply.

At the same time, I wish to thank those stations who have carefully sifted the 45-meter band and given many of us QRP stations the pleasure of a QSO; I wish there were more of you!

More power to your excellent journal—
it's great!

—T. P. Allen, Owner eg6YW,
Operator eg2BX.

ORS Bulletins

1554 Marion Street
Denver, Colorado

Editor, QST:

Just a line to tell you how much I like the ORS Bulletin that arrives here every so often. It certainly contains a good bit of news, ideas and advice.

More of the fellows should seek the ORS appointments, not only because they would receive the Bulletins but they would feel more responsibility in the handling of traffic and they would also get better acquainted with Headquarters and their fellow hams.

When you next need QSL cards, why not visit your local Chamber of Commerce or Traveler's Bureau and see if you can't get them to print your cards for you if you allow them to place an advertisement of the city on it.

—Willard Wright, 9BQO

The Thrill of First Contact

(Editor's Note: The ordinary run of amateur work has been phenomenal for so long that nothing is phenomenal any more, if you know what we mean. So many contacts have been made between opposite ends of the earth that we are very likely to think that every possible contact has been made. But contact between Australasia and South Africa has been singularly difficult, it appears. The Australians succeeded in doing it some time early last year but only after a schedule had been kept for several months, and it will be a surprise to many amateurs to learn that the QSO between New Zealand and South Africa was not made until a few months ago. The following letters from Miss Brenda Bell, the YL at Zedder AAA and sister of the illustrious Frank Bell, tell the story of one of the biggest thrills that can come to a radio amateur.)

Palmerston South, N. Z.
March 14, 1927.

Editor, QST:

".....We still continue to fail with South Africa, though there have been several reports of hearing them in the last few weeks, mostly around four to six in the morning. Crept out in stockinged feet myself before the dawn to-day and was rewarded with what sounded like a perfectly good Yank until it occurred to me that it was late for Yanks. Awakening still further I copied "foA5Z" and sat up. It might be someone calling him—I'd heard a similar noise on that mark before—but perhaps..... He began again: "CQ DX foA5Z", and signed "Macgregor, Caledon, S. Africa", which is OK in the callbook, so.....anway I let fly. Battery down;

pushed in an extra cell. N.D. Again.... A faint noise....Was it? And then the washing-machine motor started up! Out across the wet yard in the rain and shoeless, cut off the motor while a maid gasped, back again, but no..... Anyway I have spent six dollars on a cable and we propose to camp on Mr. Macgregor's wave from now on. Dawn is 5:20 and I heard A5Z first at 6:12 N.Z.T. He was then R2 but at 6:15 he was R3-4 and up to 6:30 was a steady readable R4.

We are going to Dunedin to help swell the crowd and cheer the Duke and Duchess of York this week, but I'd rather catch that African. I trust I shan't disgrace myself and murmur "73 OM CUL" if I'm presented. Here's hoping.

Brenda Bell.

Palmerston South, N. Z.,
March 16, 1927.

Editor, QST:

Hurray, we've done it! Yesterday I rose with the dawn once more and sat in still excitement, but N.D. Then appeared ac8EM, an old friend in Shanghai who was kind enough to say he would listen. Back he came and said "No sign of A5Z. Can't be on, as conditions good here and would certainly hear him. If you are trying again tomorrow will listen again and let you know. What time is sked?"

"0630 GMT", says I. "What?" says he. "0630 GMT", says I. WHAT?.....0630 GMT.....Lord, I've been and cabled that when it ought to be 1830. What a fool!

Could have wept with rage but hid me to the telegraph and spent another 15/6 confessing my sins in six words: "Meant eighteen thirty".

Meant to arise at four this morning to make sure, sked being six N.Z. Time, but forgot to turn on the alarm, having thoughtfully put it "silent" yesterday when I beat it. Awoke at five and out. Rain, pitch dark. No sigs except commercials. Called CQ Africa at intervals, and at six, A5Z. N.D. Again. What do I hear a bit below A5Z's wave?? "4AA ozfo A5Z". Damn this static! "RRR OK". Wow! Too excited to copy and R1-R2 and static frightful. Still I'm sure he said RR OK. Call again. Hurray, it's all right. "Hi.... Gracie, ring up Mr. Frank at once and ask him to come down and speak to a gentleman in South Africa". But Gracie slept on. Finally I rushed to the telephone and did it myself. He certainly arrived double-quick! Mr. Macgregor of A5Z asked if we were excited. We were! It was a vile morning and very hard to copy thru static, so it looks a bit patchy, but parts of it were excellent.

And now I must go and dress for the Duke! Thank heaven television is not yet or Mr. Macgregor would have died of shock.

Somehow I never look my best in my early morning sked outfit. Both stations suffered from QSS but he would be R4 on a decent day. Anyway, cheers loud and prolonged, and we are delighted to have done it on low power. Borrowed a 50-watter for the sked and it arrived smashed, so an aged, aged Gamage did the trick.

Yours, Brenda Bell.

IN R.F. by-pass circuits



SANGAMO Mica Condensers

A HIGH self inductance in condensers used in R. F. by-pass circuits means a *loss in capacity* at the lower wave lengths.

In many by-pass condensers the inductive reactance below 300 meters is appreciable. They become choke evils!

Use the large capacities of Sangamo Mica Condensers in all R. F. circuits. Self inductance is negligible and direct current resistance more than 35,000-megohms! Sangamo Mica Condensers are *all capacity*.

SANGAMO ELECTRIC COMPANY
6336-2 SPRINGFIELD, ILLINOIS

AN EFFICIENCY OF 98%

A rectifier that delivers as D.C. 98% of the A.C. Hi-Voltage input. Gives a clear clean-cut note that may be varied from pure D.C. to any desired degree of modulation. A D.C. plate supply built to handle any tube from a 210 to 2 204A's at the price of some rectifiers alone. 8,000 volt brand new mercury arc rectifier bulb. 1500 watt tapped surge-proof power transformer with keeplive windings, tuner bulbs and choke. Send us your rectifier problems.—We'll solve them.

RECTIFIER ENGINEERING SERVICE
RADIO 8ML, 4837 Rockwood Road, Cleveland, Ohio.

Send the EASY Way
With The Improved Martin
VIBROPLEX
For Continental or Morse Code
Any speed from 10 words per minute up to 90 words per minute-up

Reg. Trade Marks
Vibroplex Bug
Lightning Bug

Japaned Base, \$17
Nickel-Plated, 19

Easy to learn and easy to operate. Simply press the lever—the Vibroplex does the rest. Adjustable to any speed from 10 words per minute up. Saves the arm, prevents cramp and improves sending 50 to 100%. Over 100,000 users. No station complete without this up-to-date BUG. Can be used in majority of DX circuits without relay.

Special Radio Model
Equipped with Extra Heavy, Specially Constructed Contact Points to break high current without use of relay. Sent anywhere on receipt of price. Money order or registered mail. **\$25** Liberal allowance on old Vibroplex.

Insist on the Genuine Improved Martin Vibroplex. The Vibroplex Nameplate is YOUR protection. Order NOW!

THE VIBROPLEX CO., Inc.
825 BROADWAY NEW YORK
Cable Address: "VIBROPLEX" New York

Kenotron Rectifying Tubes
(Type T. B. I.)
MFD. BY GENERAL ELEC. CO.

These rectifying tubes operate on a filament voltage from 8 to 10 Volts and draw 1½ amps. They will safely stand an A.C. input voltage up to 750 Volts and pass plenty of current and voltage for the plate of the Transmitting Tubes.

They are also very efficient rectifiers for use in "B" Battery Eliminators.

**STANDARD BASE
NEW IN ORIGINAL CONTAINS
PRICE ONLY \$1.25 Ea.**

AMERICAN SALES COMPANY, 21 Warren St., N.Y.C.

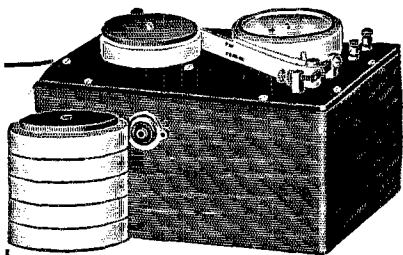

With or without Key and Sounder or Buzzer—

DEALERS

Write for Attractive Proposition

LEARN Morse or Continental CODE The EASY Way

With the **TELEPLEX** In Half the Time

Not necessary to memorize the code. The Teleplex teaches you to read by sound in half the time. Easy as A. B. C. Fascinating as any game. The only instrument that REPRODUCES actual sending of EXPERT operators. Sends messages, radiograms, newspaper matter, etc. at any speed from 5 to over 80 words per minute. Sends FIVE times as many words with one roll of tape as any other instrument, and SIX rolls are furnished. Furnishes unlimited practise. No waiting. Improves ability of the best operators. A recent purchaser writes "The Teleplex has already improved my ability 100% and increased my salary 25%." Write NOW—at once for particulars of this amazing instrument. A post card will do. Practical Course in Morse for ship operators without extra cost.

TELEPLEX CO., 76 Cortlandt St., New York

"B" Eliminator TESTING Problem Solved by Sterling

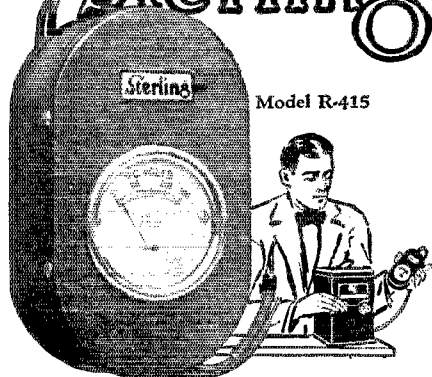

Model R-415

TO GET full value from your "B" Eliminator you must *know* that your "B" Power is delivering the *right* amount of voltage to detector, amplifier and power tube.

Low resistance voltmeters suitable for testing batteries are worthless for testing "B" Eliminators. This specially designed High Resistance Sterling is accurate for both.

Whether this voltmeter is used in your business or for your own set, it is *essential* if you want the facts about any "B" Eliminator.

**It is the Universal Voltmeter
for the Amateur
R-415**

Sterling voltmeter meets the special needs of the amateur in a variety of ways—for testing the output of D. C. Generators, and for every other purpose calling for a *high resistance* voltmeter.

Never before has a laboratory instrument been available at a price so reasonable.

Sterling

R-415 VOLTMETER

A laboratory meter at the remarkably low price of **\$8.50**

Also Model R-417. A New 150v. Sterling A. C. Meter for Testing A. C. line current and all A. C. Circuits \$7.50

THE STERLING MFG. CO.

2831 Prospect Ave.

Cleveland, O.

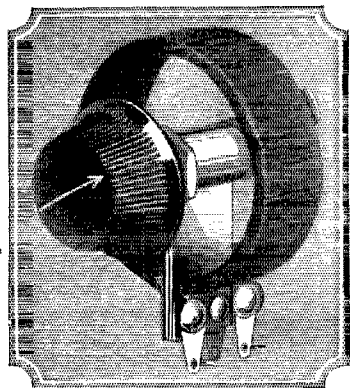

HEAVY DUTY WIRE WOUND RHEOSTATS--POTENTIOMETERS

Designed especially for heavy current control. Impossible to break down under high temperatures. Limiting factor is the fusion point of the Nichrome or Advance Wire used. These units dissipate over 50 watts at 182° Fahrenheit. Diameter—2 inches, single hole mounting.

500 ohm Centralab Power Rheostat \$1.75
150 ohm Centralab Power Potentiometer 1.75

At your dealer's, or mailed direct.

CENTRAL RADIO LABORATORIES
20 KEEFE AVE. MILWAUKEE, WIS



15,000 OHM GRIDLEAK

Tapped at 5,000 and 10,000 ohms with 85 watt capacity Price, \$1.50
5,000 ohm 85 watts \$1.00

50 Watt Lowloss Socket

Maple treated base with brass airgap shell and heavy phosphor bronze springs. For UV 203A UV 217 and similar tubes. Price \$1.25

UX210 TRANSFORMERS FILTER CHOKES

200 Watt Size—Plate winding for full wave rectification, supplying 1100 volts with center tap at 550 volts. Has two 7.5 volt center tapped filament windings for UX210 and UX216 B tubes. Price \$12.50

100 Watt Size—Plate winding for half wave rectification, supplying 750 volts. With 100 henry choke system gives smooth RAC note. Has two center tapped 7.5 volt filament windings for UX210 and UX216 B tubes. Price \$9.50

50 henry 100 milliamperere filter choke \$5.50
100 henry 50 milliamperere filter choke \$5.00

UTILITY RADIO CO.

80 LESLIE STREET EAST ORANGE, N. J.

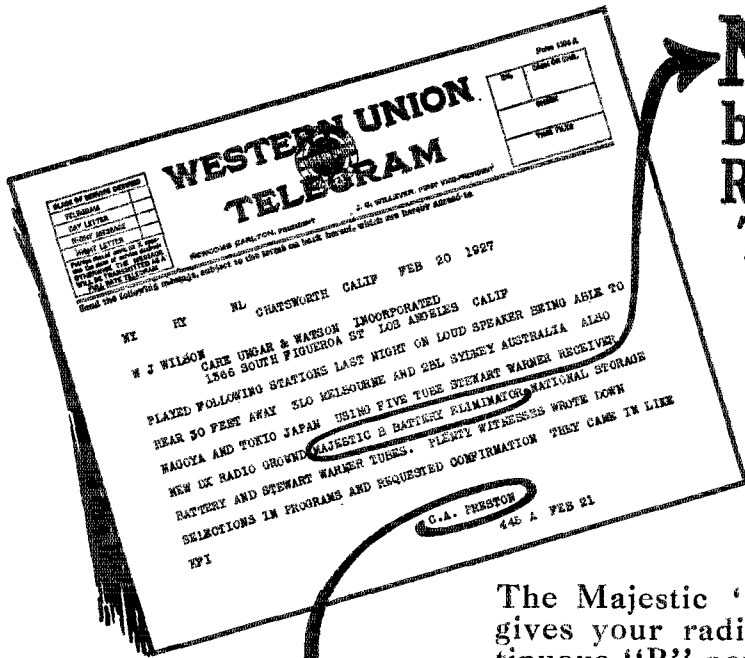

**Majestic
brings better
Radio Reception
To any Set**

*Read this
Telegram*

The Majestic "B" Current supply gives your radio full strength, continuous "B" power from the electric light socket. It does improve reception.

No acids or liquids—no hum. It is the best "B" unit, regardless of price. Ask your dealer for a demonstration.

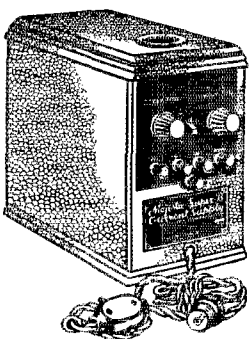

Majestic Standard-B
Capacity Nine 201-A Tubes or equivalent. 45 milliamperes at 135 volts.

\$26.50
Raytheon Tube \$4.50 extra

Majestic Super-B
Capacity 1 to 12 tubes including the use of power tubes. 45 mils. at 150 volts.

\$29.00
(As Illustrated)
Raytheon Tube \$4.50 extra

Majestic Master-B
Positive control of all output voltage taps. For sets having high current draw or heavy biasing batteries. 60 mils. at 150 volts.

\$31.50
Raytheon Tube \$4.50 extra

This Majestic Owner and hundreds of thousands of others all over the country are boosting **Majestic-"B"**

GRIGSBY-GRUNOW-HINDS-CO., 4562 Armitage Ave., Chicago, Ill.



Jewell Instruments

Radio set manufacturers, who are completing their new set designs for the coming season, are urged to investigate the Jewell line of small panel mounting instruments suitable for radio set use.

A decided sales advantage is enjoyed by the set having an instrument, over the set having none. Prospective buyers are quickly sold on a set having as definite a means of control.

Jewell instruments add greatly to the appearance of a set and, in addition, they are of decided worth in detecting battery failure or set trouble, and reduce dealer service through increased owner knowledge of set operation.

Jewell Instruments are substantial, good-looking and accurate, and are backed by twenty-seven years' experience in instrument manufacture.

Let Jewell Instruments make your set more desirable.

Write for information and ask for a copy of our radio instrument catalog No. 15-C

Jewell Electrical Instrument Co.

1650 WALNUT ST., - - CHICAGO

"27 YEARS MAKING GOOD INSTRUMENTS"

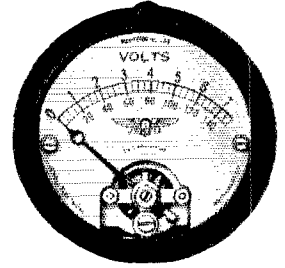

Pattern No. 135-B
Two in. Diameter
Double Scale Voltmeter



WHAT THE NEW SETS WILL INCLUDE!

No. 3591 Transformer and No. 3584 Double Choke are used with the new Raytheon B A 350 m.a. rectifier tube. A unit built up with these parts does away with all batteries and other power accessories. Better and much more satisfactory radio reception can be had now by plugging into a light socket for A and B power.

You can modernize your own set at slight cost and an eventual saving. The Raytheon B A 350 m.a. tube at \$7.50 list as well as Dongan No. 3591 Transformer \$15 list, and Dongan Double Choke, \$15 list can be shipped at once by sending check or money order.

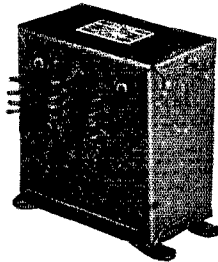
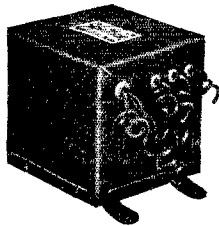

Dongan Electric Manufacturing Co.
2999-3001 Franklin St., Detroit, Mich.

TRANSFORMERS of MERIT for FIFTEEN YEARS

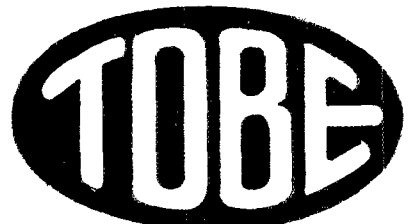

Trade Mark Reg. U. S. Pat. Office

One object only, to make and sell only the best Condensers and other Technical Apparatus.

Tobe Deutschmann Co.

Engineers and Manufacturers of
Technical Apparatus
Cambridge, Massachusetts

Have You Your A.R.R.L. Auto Emblem?

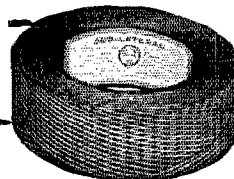

We carry a complete line of Duolateral Inductance Coils, together with mountings, especially designed for experimenters, engineers and laboratories.

Write for information and prices.

PACENT ELECTRIC CO.
91 Seventh Ave New York



TRANSMITTING KITS



Peerless Construction and Performing Quality!

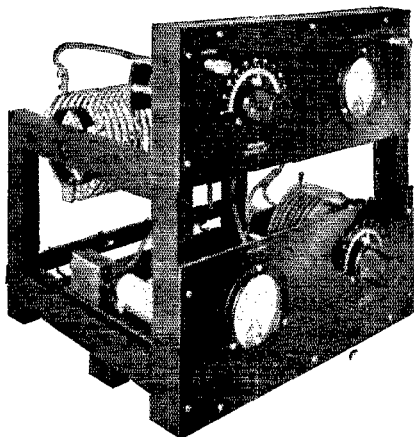

THE 50 WATT LOOSE COUPLED HARTLEY

This is the simplest type of transmitter and will be found extremely easy to place in operation. An excellent crystal amplifier stage is obtained by using the series feed circuit with this set. Power supply can be obtained by motor generator, rectified A.C. or "B" batteries.

| Cat. 157-Type | Tube Used | Price |
|---------------|-----------|-------|
| TR-5 | UX210 | \$56. |
| TR-15 | DeF-D | 56. |
| TR-50 | UV203A | 63. |
| TR-65 | DeF-H | 63. |
| TR-75 | UX852 | 63. |
| TR-250 | UV204A | 79. |

TUNED PLATE TUNED GRID

This is one of the most popular present day transmitters. A large majority of short wave stations are employing this circuit.

| Cat. 139 Type | Tube Used | Kit Price |
|---------------|-----------|-----------|
| TR-5 | UX210 | \$71. |
| TR-15 | DeF-D | 71. |
| TR-50 | UV203A | 80. |
| TR-65 | DeF-H | 80. |
| TR-75 | UX852 | 80. |
| TR-250 | UV204A | 96. |

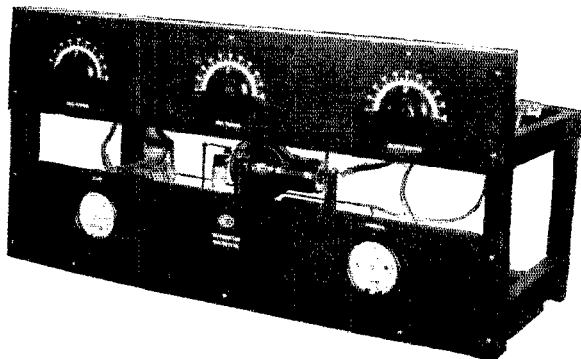

THE transmitting kits manufactured and sold by REL have been subjected to every test to determine their efficiency. Only those which are perfect pass. All units of like power have the same dimensions, allowing symmetrical arrangements in all sets.

REL also manufactures a complete line of short wave apparatus; transmitting inductances, special coil kits, tube holders, sockets, wavemeters, etc. All are examples of masterful workmanship. A handy sheet of REL products, priced and illustrated, is available for the asking.

A complete handbook of short wave dope, invaluable to every ham, and including pages describing every type of transmitter and power supply for Ham work will be mailed to you on receipt of two bits in cash or P. O. money order. (It's worth it, too!)

Radio Engineering Laboratories



100 Wilbur Avenue, Long Island City, N. Y.



YAXLEY

APPROVED RADIO PRODUCTS

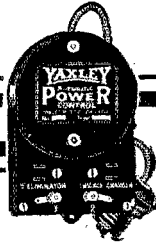

AUTOMATIC POWER CONTROL

Use the Automatic Power Control and Yaxley Radio Convenience Outlets and make this a perfect Radio Summer. The Power Control automatically takes care of the switching of your set. When you turn the set on the trickle charger is cut off and the B eliminator cut in. The reverse takes place when you turn off the set. With the Convenience Outlets you can place the set on front porch and keep your batteries in the basement or any convenient out-of-the-way place.

- No. 445—Automatic Power Control—Multiple Type, for any set\$6.00
- No. 137—Convenience Outlet for Battery Connections 2.50
- No. 135—For Loud Speaker 1.00
- No. 136—For Aerial and Ground 1.00

At your dealer's or jobber's. If he cannot supply you, send his name with your order to

YAXLEY MFG. CO.,
Dept. S 9 So. Clinton St.,
CHICAGO, ILL.

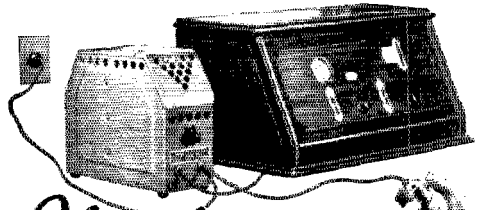

No batteries

Run this radio direct from house current outlet. Ordinary 110 volt 60 cycle domestic electricity transformed mechanically into smooth, quiet radio A, B and C power, as you use it. No more batteries to fuss with! No trickle chargers! Price \$50.00
Crosley receivers designed for use with this marvelous power supply, are the AC-7 (pictured above) a 6 tube table model at \$70 and the AC-7-C, a 6 tube console at \$95.00.

Write Dept. 18 for descriptive literature.
THE CROSLY RADIO CORPORATION
Powel Crosley, Jr., Pres. Cincinnati, Ohio
Prices slightly higher west of the Rocky Mountains.

CROSLY RADIO

Crosley manufactures radio receiving sets, which are licensed under Armstrong U. S. Patent, No. 1,113,149 or under patent applications of Radio Frequency Laboratories, Inc., and other patents issued and pending.

FROST-RADIO FROST-RADIO FROST-RADIO FROST-RADIO FROST-RADIO

FROST-RADIO

FOR FINE CONTROL
of TONE and VOLUME

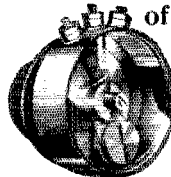

Frost-Radio Super Variable High Resistance Units give remarkably fine control of tone and volume through their smooth and noiseless operation. They are far ahead of wire wound types. Roller contact arm eliminates wear on resistance strip and insures long service. Furnished in two and three

terminal types and in resistances from 50,000 to 500,000 ohms List: \$1.25.

WONDERFULLY BETTER FOR EVERY SET

Frost Radio Metal Frame and Bakelite Rheostats are not only the smallest and most compact rheostats made, but they have velvety-smooth action and windings of finest Nichrome or Chromel A wire. Due to number of turns used these rheostats will keep cool under the heaviest load for which they are designed. Complete with Bakelite pointer knob. Resistances from 2 1/2 to 75 ohms. List: Metal Frame, 50c; Bakelite, 75c.

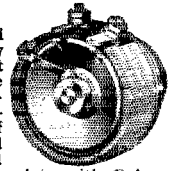

HERBERT H. FROST, Inc.
MAIN OFFICE and FACTORY
ELKHART, IND.

Chicago Philadelphia St. Paul
New York Pittsburgh New Orleans
Boston Washington, D. C. Los Angeles Buenos Aires
Argentina

FROST-RADIO FROST-RADIO FROST-RADIO FROST-RADIO FROST-RADIO

Amer Tran Radio Products

Carry This Guarantee

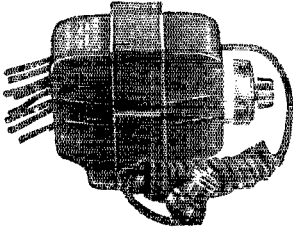

The AmerTran power transformer type PF52, \$18.00, is designed for use with 1X-216B and 1X-210 tubes at their correct voltages, supplying A, B, and C to the last audio, and B and C to the other tubes.

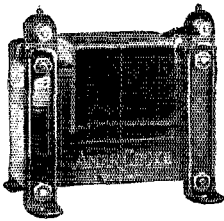

The AmerChoke is an impedance or choke of general utility, primarily for use in filter circuits. It is recommended in conjunction with AmerTran transformers for construction of the Power Pack plate supply and power amplifier. \$6.00 each.



AmerTran DeLuxe audio transformers are guaranteed to amplify at 80% of their peak at 40 cycles, and their peak is above 10,000 cycles. Made for first and second stages. Either type \$10.00.

“**A** MERTRAN audio transformers, regardless of type, are fully guaranteed against defects for a period of one year from the date of purchase, and will be replaced free of charge either through your authorized AmerTran dealer or direct, if defective for any cause other than misuse. The individual parts are each carefully tested and inspected before assembly and the complete transformer receives a most rigid inspection and test before being packed for shipment.”

This is the way the American Transformer Company stands behind its products. AmerTran DeLuxe audio transformers are recognized as reliable efficient units for improving the tone quality and tone range of present sets and as the indispensable choice for new sets. Other AmerTran products have been adopted for power supply apparatus that on performance stand in the front rank of modern development.

Send for booklet, "Improving the Audio Amplifier," and other useful data, free.

The American Transformer Co.

178 Emmet Street

Newark, N. J.

"Transformer Builders for Over 26 Years"

SOLD ONLY AT AUTHORIZED AMER TRAN DEALERS

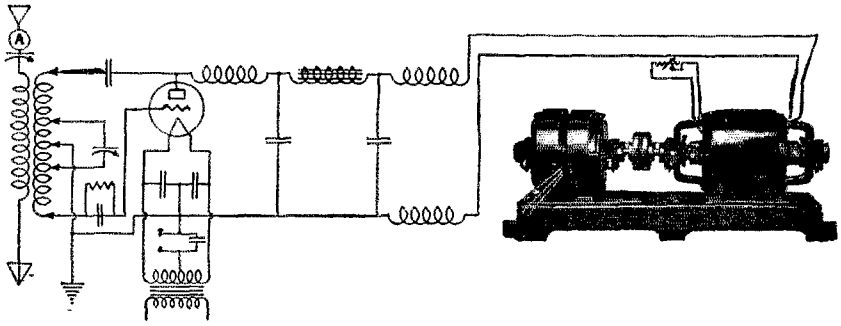

This is Item #26 used as a Plate Power Supply for a 204-A Tube.

Bulletin 237 lists over 300 other Generators, Motor-Generators and Dynamotors for Radio purpose. If you haven't your copy, write for it today!

ELECTRIC SPECIALTY COMPANY

Mark "ESCO" Trade

225 South Street

Stamford, Conn., U. S. A.

Manufacturers of Motors, Generators, Motor-Generators

Dynamotors and Rotary Converters, for Radio and Other Purposes

RADIO OPERATORS WANTED

THE EASTERN RADIO INSTITUTE can train you quickly and thoroughly because:

MODERN AND EFFICIENT METHODS
THOROUGH INSTRUCTION under staff of
LICENSED COMMERCIAL OPERATORS
MODERN APPARATUS including SHORT WAVE
TRANSMITTER

FOURTEEN years a RADIO SCHOOL
THE OLDEST, LARGEST and MOST SUCCESSFUL
school in New England. RECOMMENDED BY THE
A. R. R. L.

Day or Evening Classes Start Every Monday.

SPECIAL CODE CLASSES

Write for Illustrated Prospectus

EASTERN RADIO INSTITUTE

899 BOYLSTON STREET BOSTON, MASS.

SEND FOR THIS BOOK

Amateurs who know Browning-Drake can safely recommend the new Official Kit Set. Complete constructional booklets will be mailed immediately on receipt of twenty-five cents.

BROWNING-DRAKE CORPORATION
BRIGHTON MASS.



RADIO CONDENSER CORPORATION, Peoria, Illinois

Seventh Edition Just Off the Press

ROBISON'S MANUAL OF RADIO TELEGRAPHY AND TELEPHONY

Completely Revised and Up-to-Date

Of the 6th edition of this book reviewed by QST it was said this is perhaps

"The Best Radio Book That Ever Came To This Desk"

The standard Navy book on radio originally prepared in 1907 by Lieutenant (last year Admiral and C-in-C of U. S. Fleet) S. S. Robison. The 6th edition and the present edition revised by Commander S. C. Hooper, U. S. Navy, late Radio Officer, U. S. Fleet.

Price \$5.50 postpaid (former edition sold for \$8.00)

Address: Secretary-Treasurer, U. S. Naval Institute, Annapolis, Md., U. S. A.

An accurately calibrated 5 meter wavemeter

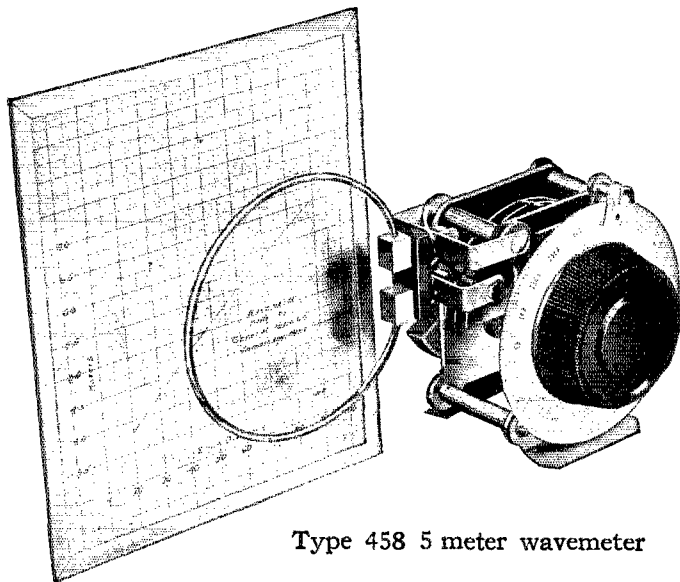

Type 458 5 meter wavemeter

The recent developments in transmission at 5 meters (60,000 k.c.) have made it imperative to use an accurate wavemeter.

The Type 458 wavemeter is supplied unmounted, having only brackets to support the condenser in an upright position. The condenser is of the usual soldered plate, metal end plate type, having a maximum capacitance of 50 MMF.

The coil consists of a single turn of 1/8" copper tubing, and is connected to the condenser by means of the convenient General Radio plugs. The coil is silver plated.

A four inch dial and indicator completes the wavemeter. It is found that the metal end plates so completely shield the condenser that hand capacity is not at all troublesome.

An individual calibration chart is supplied with each Type 458 Wavemeter.

Price, complete with calibration chart\$8.00

The Type 458 5-meter wavemeter as described above is obtainable from the General Radio factory only upon receipt of \$8.00 net, delivered post paid anywhere in the United States.

GENERAL RADIO CO.,

CAMBRIDGE, MASS.

GENERAL RADIO

A. R. R. L. MEMBERS ATTENTION!

You are not all located within shopping distance of a dealer stocking General Radio parts. Remember that we will deliver, post paid, anywhere in the United States, any of our radio parts on receipt of current catalog price.

Also if we can be of help to you in supplying technical information, we will welcome your correspondence. Have you a Bulletin No. 927 in your file? If not, a post card will bring it.

Gross Receivers & Transmitter Kits

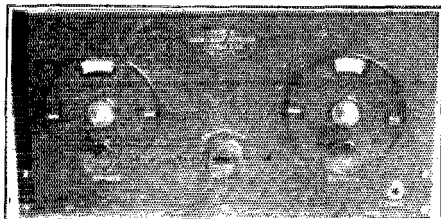

RECEIVERS

2 Tube Kit

\$15.75

Wired to order
\$1.50 extra

3 Tube Kit

\$19.75

Wired to order
\$2.00 extra

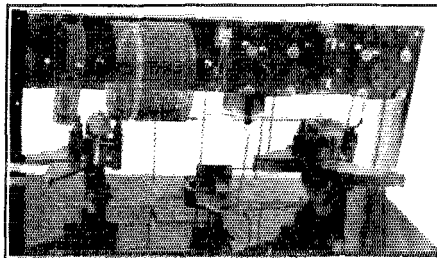

Please note the prices on Receiver Kits are special, same will be advanced shortly.

Gross short wave receiver Kits are composed of high grade parts such as Gross plug-in coils, Hammarlund middle condensers, vernier dials and other high grade parts necessary to complete the receiver. Supplied with plug-in coil for any band you specify, 20, 40, 80 or 200 meters. Extra coils\$3.00 each

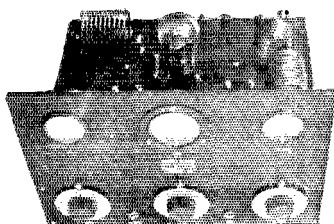

No C. O. D. Shipments

Transmitter Kits as illustrated composed of highest grade parts available, thoroughly metered, not revamped receivers.

Tuned Grid,

Tuned Plate Type

7 1/2 w\$47.50

75 w\$65.00

Coupled Hartley Type

7 1/2 w\$43.50

75 w\$65.00

Frequency Meters for Broadcast Stations, \$75.00.

J. GROSS & COMPANY,

30 Park Place, N. Y. City

The New Federal Power Tube Coupler

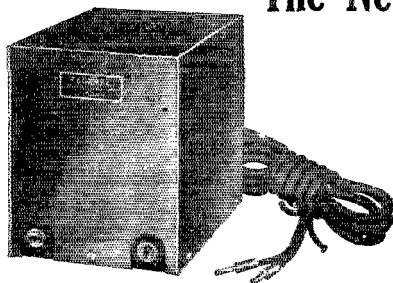

Another great advance toward positive perfection of radio tone quality.

A superior type of speaker coupler—easily installed—neatly finished—positively efficient.

Sold by designated Federal Ortho-sonic Retailers.

FEDERAL RADIO CORPORATION
BUFFALO, N. Y.

Keep Lightning Out

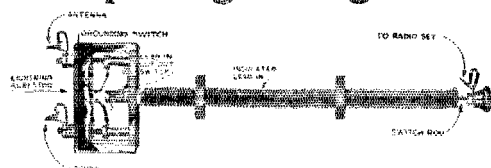

A PUSH AND PULL SWITCH
Operated from inside the house

RADIO RAY Inc. Walkerton, Ind.

Four-In-One Radio Protector

1. Antenna Grounding Switch
2. Lead-In Cut-Out Switch
3. Insulated Lead-In
4. Lightning Arrestor

Disconnects Radio Set from Antenna
Connects Antenna Direct to Ground
Safety for your set all in one device
Absolute Protection Easily Installed

Price \$2.50 postpaid



Unlimited Power IN A CONSTANT FLOW

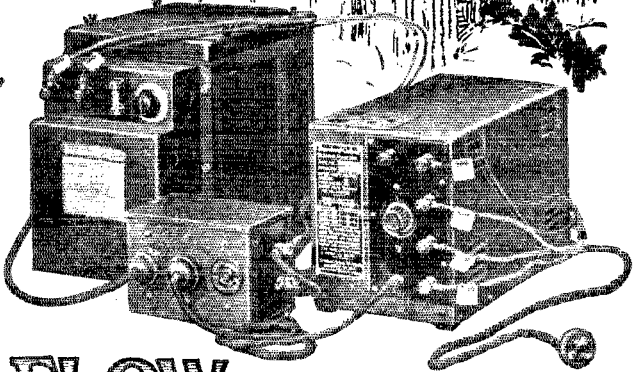

Stromberg-Carlson owners, and others who possess Receivers using the same tubes, similarly arranged, may greatly increase the efficiency of their Receivers through the use of the new Stromberg-Carlson Socket-Power Equipment.

These Power Accessories—the “A” Socket-Power Unit, the “B” Socket-Power Unit and the Power Switching Relay, give more uniform, more convenient and more economical operation than any other form of power supply.

Simple to install, these units furnish noiseless power at all times. And it is also “peak” power. It is never low and never runs down, but is always exactly what is required by your Receiver.

With these units your Receiver is always ready to operate at full strength.

Stromberg-Carlson Telephone Mfg. Co.
Rochester, N. Y.

The “A” Socket-Power Unit (Gould Unipower)—built to Stromberg-Carlson specifications. A reliable source of filament current, operating from alternating current house lighting mains. Price, East of Rockies \$38.00; Rockies and West \$43.00; Canada \$51.00.

Stromberg-Carlson No. 401 “B” Socket-Power Unit. Eliminates “B” batteries by substituting silent power from alternating house current. Designed to meet Underwriters requirements. UX-213 Rectron tube furnished with unit. Price, East of Rockies \$63.00; Rockies and West \$69.00; Canada \$87.50.

Stromberg-Carlson No. 301 Power Switching Relay—a relay of the bridging type. Gives single switch control when socket-power units or external superpower amplifier is used. Price, East of Rockies \$11.00; Rockies and West \$11.75; Canada \$15.00.

Stromberg-Carlson

Makers of voice transmission and voice reception apparatus for more than 30 years

SAY YOU SAW IT IN Q S T—IT IDENTIFIES YOU AND HELPS Q S T

for
REAL RECEPTION!

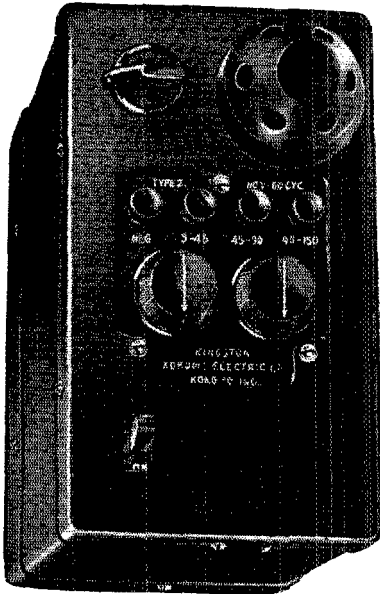

KINGSTON

"B" Current Supply Unit

Guaranteed to remove the battery nuisance and deliver clearer tone and increased volume. Provides three different voltages at the same time. Each tap adjustable over a wide range, making possible any desired voltage from 5 to 150, absolutely harmonizing "B" current supply to your set. Raytheon tube used as rectifier. No noise or vibration. Contains no acid or solution and will not get out of order. Operating cost negligible.

At Your Dealer's

Price, complete with Raytheon tube **\$35.00**

KOKOMO ELECTRIC COMPANY
KOKOMO, INDIANA

Hoyt B ELIMINATOR VOLTMETER

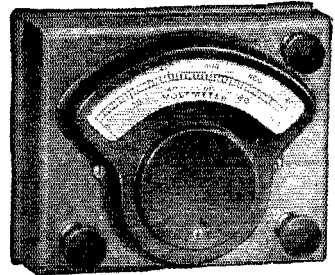

A new sensitive voltmeter, for regular Dealers' service work as well as for laboratory and precision measurements. Resistance 1,000 ohms per volt. Provided with two scales,—0-100 volts and 0-500 volts, covering the entire range of ordinary B-Eliminator and Power-Amplifier work. Prices, HOYT Standard B-Eliminator Voltmeter, 0-100 and 0-500 volts—\$28.00.

Supplied on special order with additional scale, either: —0-10 volts or 0-100 ma. at \$32.50.

Send for Price list Q-6

BURTON-ROGERS CO.

Sales Dept. for Hoyt Electrical Instrument Works
BOSTON, MASS.

SUMMER DX SPECIALS

Transmitting Inductances

R.E.L. 20-40 or 40-80 inductances with clips and rods complete\$8.95
Aero transmitting inductances 20-40, 40-80 new type special \$9.65
Argo pancake inductances 20 meter 40 & 80 meter sizes \$4.25
No. 12 enamelled copper antenna wire 100 ft.\$.79
Pyrex 7" insulators\$1.20

Power Transformers

Thordarson combined plate and filament transformer * 4 few left\$6.25
Above has plate winding of 650 volts and filament 7 1/2 volts with mid-tap. Thordarson 100 watt plate transf. \$10.95, 450 watt plate transf. \$16.45. Thordarson 80 watt filament transf. \$5.95—150 watt filament transf. \$7.95. Acme 75 watt power transf. \$13.25. Acme 200 watt power transf. \$18.25.
Meters * Voltmeters * Milliammeters and Antenna Ammeters Jewell 3" flush mounting milliammeters. Any scale reading desired \$6.00. Jewell 3" flush mounting A.C. & D.C. voltmeters (up to 50 volts) \$6.00. Jewell 3" flush mounting thermo-couple antenna ammeters any scale reading \$9.75. Weston model 301 milliammeters and D.C. voltmeters any scale reading \$6.95. Weston model 301 thermo-couple antenna ammeters. Scale readings any size \$11.65.

Variable Transmitting Condensers

Cardwell new type T-199 & T-183B special transmitting .00015 & .00035 \$8.95. Cardwell type 147B .00045 \$6.95. Cardwell .00025 164B trans. cond. \$5.95. Hammarlund new type brass plate .00045 mfd. \$8.95. .00025 \$6.45. General radio .00005, type 334V \$3.25. G. R. .0001 type 334T \$3.65. National 23 plate .0001 mfd. 6000 volt \$9.45. National .0005 mfd. \$12.95. National 23 plate .00025 mfd. \$8.65. National .00015 special \$4.75. Rebuilt Cardwell 23 plate .00022 mfd., 3000 volt transm. condensers \$3.20.

Grid Leaks

New Ward Leonard 5000 ohm center-tapped for 250s large type \$2.45. New Ward Leonard 5000 ohm center-tapped-for 5s and 50s \$1.80. Crescent Lavite Transmitting Leak, 5000 ohm \$2.20 (for 50s) \$3.15. General electric heavy duty grid leak for 5s and 50s special \$1.45. Enormous stock on hand makes possible immediate mail order delivery all parts sold on a money back guarantee* your money back if you are not entirely satisfied. All parts brand new and guaranteed. No CODs.

A. HASS—RADIO "2MA"
"Your Brother Ham"

168 Washington Street,

New York City

AERO COIL

SUPER-SENSITIVE INDUCTANCE UNITS

The Perfect Inductances for All Low Wave Work

**FOR
RECEIVING**

AERO LOW WAVE TUNER KIT

Price \$12.50

Completely interchangeable. Adopted by experts and amateurs everywhere. Range 15 to 130 meters. Includes 3 coils and base mounting, covering U.S. bands, 20, 40 and 80 meters. You can increase or decrease the range of this

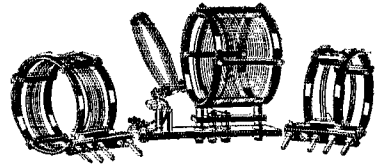

PRICE \$12.50

short wave tuner by securing the AERO Interchangeable Coils described below. All coils fit the same base and use the same condensers. Use Code No. INT-125 in ordering.



INTERCHANGEABLE Coil No. 0

Range 13 to 29.4 meters. This is the most efficient inductance for this low band. Code number INT-0.

Price \$4.00

INTERCHANGEABLE Coil No. 4

Range 125 to 250 meters. Fits same base supplied with low tuner kit. Code number INT-No. 4.

Price \$4.00

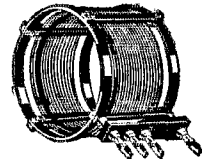

THE NEW AERO INTERCHANGEABLE COIL No. 5

Normal range 235 to 550 meters. However, by using .0001 Sangamo fixed condenser across the rotor and stator of the .00014 variable condenser, the maximum wave band of this coil is increased to 725 meters. This gives you coverage of the following bands: Airplane to Airplane, Land to Airplane, Ship to Shore (Great Lakes) Ship to Shore (Atlantic and Pacific Oceans). Code number INT-No. 5.

Price \$4.00

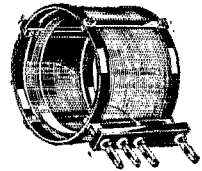

**FOR
TRANSMIT-
TING**

KEY 2040 KIT Price \$12.00

Kit contains 2 AERO Coils, 17 to 50 meters each, 1 AERO Antenna Coil Mounting Base, 1 AERO Grid Coil Mounting Base, 2 AERO Essential Choke Coils.

KEY 4080 KIT Price \$12.00

Kit contains 2 AERO Coils, 36 to 90 meters each, 1 AERO Antenna Coil Mounting Base, 1 AERO Grid Coil Mounting Base, 2 AERO Essential Choke Coils.

If you desire to have this set tune also 20 meters, simply buy two AERO 20 to 40 meter transmitting coils, which plug in the same mounting bases, and work efficiently with the above items.

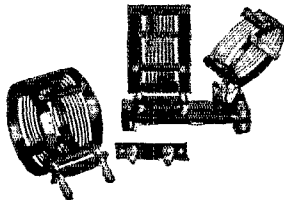
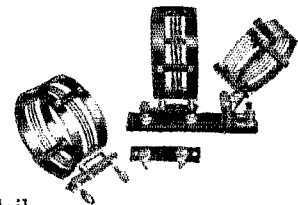

AERO PARTS

Transmitter coils (17 to 50 meters, Key 2040C and 36 to 90 meters, Key 4080C) \$4.00 ea.
Antenna Base, Key PRI-800, \$3.00 ea.
Grid Coil Base, Key GRID-100, \$1.00 ea.
Choke Coils, \$1.50 ea.

PLAN FOR D. X. RECORDS NOW!

Order these coils direct from us if your dealer hasn't them and start now for wonderful records. Specify code or key numbers when ordering. Or write at once for complete descriptive literature.

AERO PRODUCTS, Inc.

Dept. 16

1772 WILSON AVE., CHICAGO, ILL.



CARTER

New
Complete Line of
**Molded Mica
By-Pass
Filter
Buffer
CONDENSERS**



(Half Size)

A complete line of fixed condensers that are not only made accurately but are unaffected by climatic conditions and stay accurate.

Carter reputation for quality parts is your strongest guarantee. You will find these condensers fulfill every expectation.

See them at your dealers

In Canada: Carter Radio Co., Ltd.,
Toronto

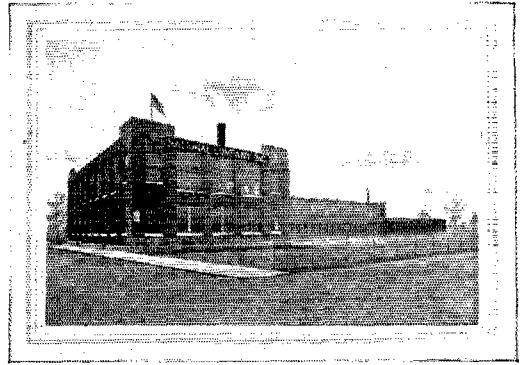

New Factory of National Company, Malden, Mass.

THE NATIONAL COMPANY, INC., having outgrown its quarters in Cambridge, announces its removal to a new plant at Sherman, Abbott and Jackson Streets, Malden, Mass. Here in a modern factory with three times the floor area of its former buildings,—with ample room on the property for further expansion, its steadily growing business in Radio and Engineering Products can be carried on without crowding for some years to come.

The new plant is near Malden Square, and is easily reached by elevated train and surface-car connection from the central part of Boston in less than one-half hour. Visitors are most welcome at any time.

NATIONAL
COMPANY INC., W. A. READY, PRES., MALDEN, MASS

Again Balkite has it

First noiseless battery charging. Then successful light socket "B" power. Then trickle charging. Balkite has always been not only the leader but the pioneer in the radio power field. And now Balkite has a greater development than any of them. It will be announced soon. Look for it.

FANSTEEL PRODUCTS CO., Inc.
North Chicago, Ill.

FANSTEEL
Balkite
Radio Power Units

S. W. TRANSMITTER

wired and tested \$15.00

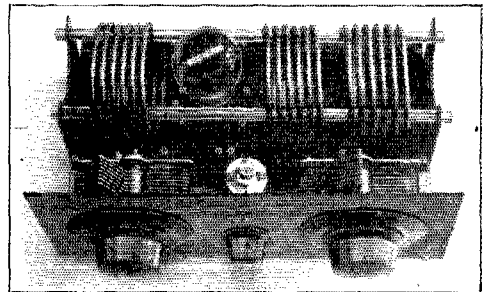

This transmitter comes delivered to you completely wired and tested under actual transmitting conditions. It is designed to use the popular 7½ watt tube and to operate in the 40 meter band. Being entirely controlled by condensers and with no clips or critical adjustments makes this the ideal transmitter for the beginner. The transmitter comes packed with full set of instructions, and when used after our directions will perform in a satisfactory manner.

Shipped prepaid if M. O. comes with order.

Order now!

PARMATER PRODUCTS CO.

Merrill

Michigan

ANNOUNCING

6-EX's

New **RECTOBULB**

for plate supply
50 to 250 watt
XMITTERS



Filament end fits 5-watt socket.
Plate end has terminal post.
Tungsten filament.

Plate current - - 250 M.A.
Plate voltage - - 3000 Max.
Filament current - 6.25 A.
Filament voltage - 10
Volts drop at full load—200

Price \$15.00 Each

Sold and shipped direct C.O.D. or on receipt of money order.

Your tubes repaired and guaranteed perfect. We guarantee safe delivery.

| | | |
|--------------------------------------|--|---------|
| 203 | • • • • • | \$15.00 |
| | Guaranteed against stem puncture on 100% overload. | |
| 203-A with Tungsten Filament | • • • • • | 19.00 |
| | Guaranteed against stem puncture on 100% overload. | |
| 204 and 204-A with Tungsten Filament | • • • • • | 50.00 |
| | Extra Heavy Grid and Plate Leads | |

NATIONAL RADIO TUBE COMPANY
(A HAM INSTITUTION)
748 14th Street, San Francisco, Calif.

New "Ham" Inductances

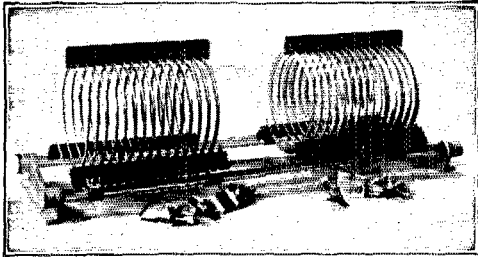

Designed to give peak efficiency on amateur wavelengths. Single coils and coupled types, with glass rods and end castings.

| | Single Coil | Coupled Unit |
|-------------------------------|-------------|--------------|
| Type 154 for 40-80-160 meters | \$5.50 | \$12.50 |
| Type 123 for 20-40-80 meters | \$4.75 | \$11.00 |
| Inductance clips EXTRA, each | \$.20 | |

Other types listed in our free catalog, the famous HAMALOG. Get your copy now. It's the best complete "Ham Catalog" to be had.

We are distributors for DeForest Transmitting Tubes.

| | | | |
|--------------------------------|---------|---------------------|--------|
| Type "D" 10 watts | \$9.00 | Type "DR" Rectifier | \$7.50 |
| Type "H" 18.00 | | Type "HR" Rectifier | 16.00 |
| Type "P" 250 watts | 110.00 | Type "PR" Rectifier | 90.00 |
| NEW UX-852 RADIOTRONS IN STOCK | \$32.50 | | |
| Sockets | \$.250 | | |

E. F. JOHNSON COMPANY

9 ALD - - Waseca, Minnesota

Ad. Auriema, Inc.
Manufacturers' Export Managers
116 Broad Street, New York, N.Y.
Scientifically equipped to economically export dependable receiving and transmitting radio apparatus.

WARD LEONARD VITROHM RESISTORS

Rated to Carry 60 Watts Continuous Duty

1100 Ohms with taps of 400, 400 and 300 Ohms. 2600 Ohms. 7000 Ohms.

All of these Ward Leonard, heavy duty Vitrohm (vitreous enamel) Resistors are Brand New. Size 4x1".

They are absolutely permanent and accurate in value, and are for use in Transmitters, Eliminators or Electrical Control work.

Your choice of any of the three sizes at

EXTRA SPECIAL PRICE OF 85c Each

AMERICAN SALES CO., 21 WARREN ST., NEW YORK CITY

Model "N"
Vario Denser

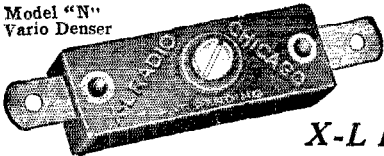

**Pep Up
Your Set
With
X-L Products**

Easier tuning—correct tube oscillation—more volume and clearness with an X-L VARIO DENSER in your circuit.

Suggested and endorsed by foremost Radio Authorities in all leading circuits.

MODEL "N"—Capacity range 1.8 to 20 micro-micro farads. Micrometer adjustment assures correct oscillation control in all tuned radio frequency circuits. Neutrodyne, Roberts 2-tube, Browning-Drake, Silver's Knockout, Interflex circuit, Quadformer, World's Record Super-9, B. T. Power-6, R. B. Lab. Circuit, etc. Price 1.00.

MODEL "G"—For Cockaday, Oliver Lodge N. Loftin-White, Nankin Ultra-5 circuits, filter and intermediate frequency tuning in super-heterodyne and positive grid bias in all sets. Capacity range, Model G-1 .00002 to .0001 Mfd. Model G-5 .0001 to .0005 Mfd. Model G-10 .0003 to .001 Mfd. Price each with grid leak clips \$1.50.

X-L PUSH POST—Push it down with your thumb, insert wire, remove pressure, wire is firmly held. Vibrations will not loosen, releases instantly. Price 15c.

Also in strips of 7 on black panel marked in white. Price \$1.50 FREE wiring diagrams showing use of X-L units in the new LOFTIN-WHITE constant coupled radio frequency circuit, and in other popular hook-ups. Send for yours today.

**PUSH
POST
PANEL**



X-L RADIO LABORATORIES, 2428 N. Lincoln Ave., CHICAGO, ILL.

88

SAY YOU SAW IT IN Q S T—IT IDENTIFIES YOU AND HELPS Q S T

**Make any Good Receiver
BETTER**



**C. E. Mfg. Co., Inc.
PROVIDENCE,
R. I.**



QST Oscillating Crystals

Prices for grinding POWER crystals for the various Amateur bands as follows:

| | |
|----------------------|---------|
| 150-170 Meter band | \$15.00 |
| 75-86 Meter band | \$25.00 |
| 37.5-42.5 Meter band | \$40.00 |

We will state the frequency of the crystal accurate to better than a tenth of one per-cent. All crystals guaranteed.

BROADCAST BAND

We will grind for you a crystal accurate to plus or minus 500 cycles of your assigned frequency for \$30.00 unmounted, or \$50.00 mounted. This crystal is our POWER type and is absolutely guaranteed. PROMPT DELIVERIES.

We grind crystals to any frequency between 40 and 10,000 kilocycles. Let us quote prices for your particular requirement.

"The Crystal Specialists"
SCIENTIFIC RADIO SERVICE

P. O. Box 86 Dept. L Mount Rainier, Maryland

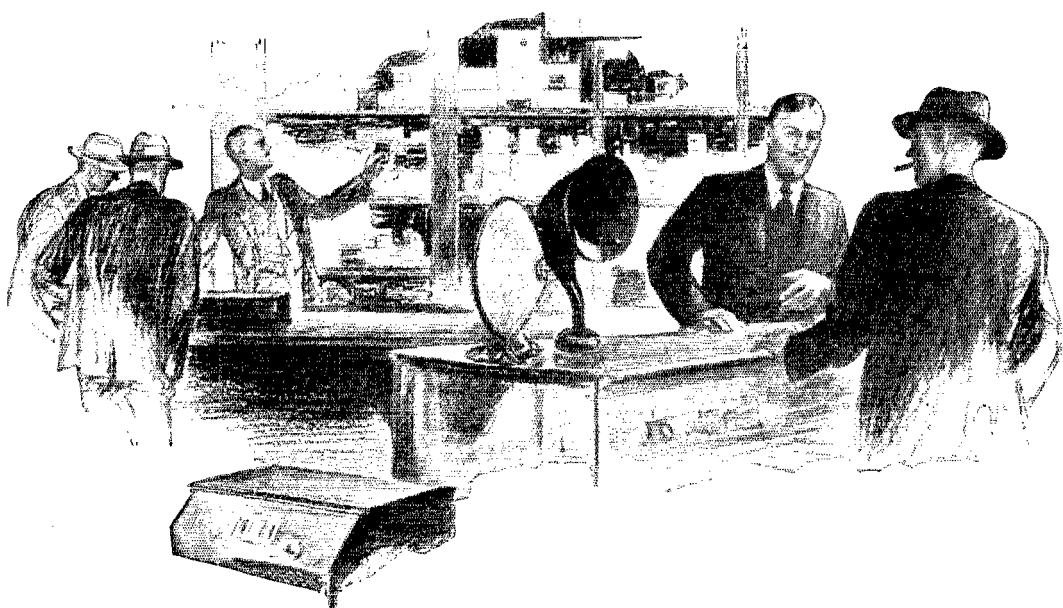

The expert can recommend Faradon equipped sets — with confidence

Faradon value is the result of twenty years of manufacturing to high standards.

It is logical that makers of fine equipment include Faradon Capacitors in their specifications.

Most experts know from personal experience that the equipment of Faradon quality results in satisfactory, long-lived service.

WIRELESS SPECIALTY
APPARATUS COMPANY
Jamaica Plain : Boston, Mass., U.S.A.

Established 1907

Faradon

951

Electrostatic Condensers for all Purposes

FILTER CONDENSERS

Manufactured by Dubilier Condenser & Radio Corp.

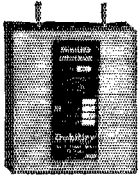

1 $\frac{3}{4}$ mfd. 1000 volts rated D.C. Working Voltage
 7 mfd. 600 volts rated D.C. Working Voltage

Extra Special at **\$1.35** each
 Extra Special at **\$3.50** each

Manufactured by Stromberg-Carlson Tel. Mfg. Co.

3 $\frac{1}{2}$ mfd. 600 volts rated D.C. Working Voltage

Extra Special at **\$1.75** each

All of these High Quality Filter Condensers, are brand new,
 and guaranteed as rated. They are excellent for use in your Trans-
 mitter, Eliminator or Experimental Work.

AMERICAN SALES CO.

21 Warren St. N.Y.C.

Laboratory Product



**CRESCENT
 LAVITE
 RESISTANCES**

for Distortionless Amplification

Used in 50 big broadcasting stations, 12,000
 18,000, 50,000 and 100,000 ohms. For distortionless
 amplification. Order a Crescent today at \$1.50. Special
 sizes made to order. Discounts to dealers.

Stromberg-Carlson Radio Corp., 166-32 Jamaica Ave., Jamaica, N. Y.

Why is the Karas Equamatic the
 most efficient receiver ever designed?
 Write us for full information.

KARAS ELECTRIC CO.,
 4030-G North Rockwell Street, Chicago, Ill.

To Our Readers Who Are Not A. R. R. L. Members

Wouldn't you like to become a member of the American Radio Relay League? We need you in this big organization of radio amateurs, the only amateur association that does things. From your reading of *QST* you have gained a knowledge of the nature of the League and what it does, and you have read its purposes as set forth on page 6 of every issue. We would like to have you become a full-fledged member and add your strength to ours in the things we are undertaking for Amateur Radio, and incidentally you will have the membership edition of *QST* delivered at your door each month. A convenient application form is printed below—clip it out and mail it today.

.....1927

American Radio Relay League,
 Hartford, Conn., U. S. A.

Being genuinely interested in Amateur Radio, I hereby apply for membership in the American Radio Relay League, and enclose \$2.50 (\$3 in foreign countries) in payment of one year's dues. This entitles me to receive *QST* for the same period. Please begin my subscription with the issue. Mail my Certificate of Membership and send *QST* to the following name and address.

.....

Station call, if any

Grade Operator's license, if any

Radio Clubs of which a member

Do you know a friend who is also interested in Amateur Radio, whose name you might give us so we may send him a sample copy of *QST*?.....

..... Thanks!

RESISTANCE

1000 Ohms per Volt

WESTON Model 489 Battery Eliminator Voltmeter is made in double range combinations of 200/8 and 250/50 volts; the latter range can be supplied with an external multiplier to increase it to 500 volts. Handsomely enclosed in Bakelite, supplied with a pair of 30-inch flexible cables.

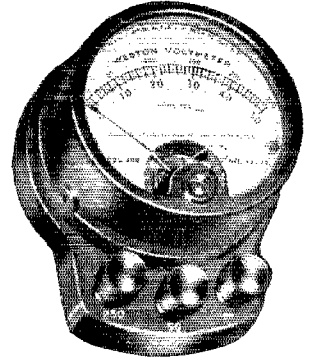

Weston Electrical Instrument Corporation

158 Weston Avenue Newark, N. J.

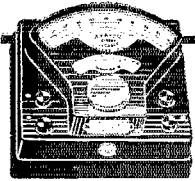

STANDARD THE WORLD OVER.

WESTON

Pioneers since 1888

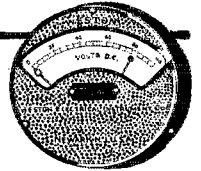

THE SUPER SYNC

The Synchronous Rectifier That Can Be Filtered

The Super Sync is the only synchronous rectifier that can be filtered with ordinary type of filter and deliver a pure direct current.

The construction of the commutator enables this rectifier to rectify practically the full wave thus making the R.A.C. delivered much easier to filter. It is impossible for the voltage to jump between the conducting segments as the insulating ridge between them

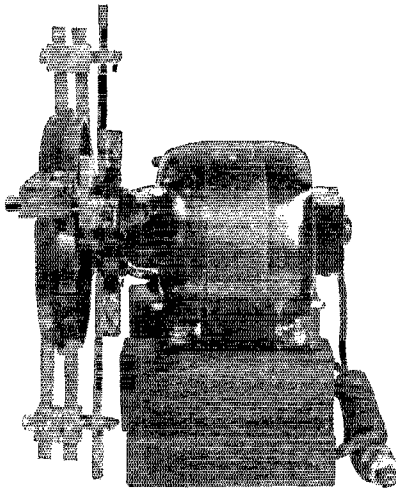

prevents break-down at this point.

The brushes on this rectifier are made of copper leaf and make a clean sliding contact. There are no air gaps in the commutator to cause the brushes to vibrate and make poor contact.

The synchronous motor can be supplied for either 110 or 220 Volts 50 or 60 Cy. Other name plate ratings can also be supplied but will require a slight delay in shipment.

PAT. PENDING

PRICE \$75.00 F.O.B. ST. LOUIS, MO.

MARLO ELECTRIC CO., 5241 Botanical Ave., St. Louis, Mo., U.S.A.

HAM-ADS NOTICE

This department of *QST* is conducted as a service to members of the American Radio Relay League. Advertisements can be accepted only under the following conditions.

- (1) "Ham Ad" advertising will be accepted only from members of the American Radio Relay League.
- (2) The signature of the advertisement must be the name of the individual member or his officially assigned call.
- (3) Only one advertisement from an individual can be accepted for any issue of *QST*, and the advertisement must not exceed 100 words.
- (4) Advertising shall be of a nature of interest to radio amateurs or experimenters in their pursuance of the art.
- (5) No display of any character will be accepted, nor can any typographical arrangement, such as all or part capital letters, be used which would tend to make one advertisement stand out from the others.
- (6) The "Ham Ad" rate is 7c per word. Remittance for full amount must accompany copy.
- (7) Closing date: the 20th of second month preceding publication date.

THE life blood of your set—plate power. Powerful, permanent, infinitely superior to dry cells, lead-acid, Bs, B eliminators. Trouble-free, rugged, abuse proof, that's an Edison Steel-Alkaline Storage, B-Battery. Upset electrically welded pure nickel connectors insure absolute quiet. Lithium-Potassium solution (that's no lye). Complete, knock-down kits, parts, chargers. Glass tubes, shock-proof jars, peppy elements, pure nickel, anything you need. No. 12 solid copper enameled permanently perfect aerial wire \$1.00, 100 ft. Silicon steel laminations for that transformer 15c lb. Details, full price list. Frank Murphy, Radio 8ML, 4837 Rockwood Rd., Cleveland, Ohio.

TO licensed hams only—\$12.50 Aero Kit \$8.18. Ferranti 12 audios \$7.80. \$25 Browning-Drake kits \$18.25. \$35.10 Loftin White kits \$51.06. \$10.00 Ensco Cone 36" kits \$7.00. \$22.50 modern compact B eliminators with Raytheon \$19.50. Latest original packages. Discounts on Cardwell type E, Karas, Hammarlund, AmerIran, Aero, Jewell, Thordarson, Benjamin, Samson, Perryman, Ward Leonard 35%. On Sangamo, Lynch, Daven, Marco, Bodine, Yaxley, Paent, Ceco 40%. All prepaid. Our weekly data sheets give more dope than all radio magazines together. 20 weeks trial \$1.00. 52 weeks \$2.50. Over two pounds data, circuits, catalog, prepaid 25c. Fred Luther Kline, Kent, Ohio.

PURE aluminum and lead rectifier elements holes drilled brass screws and nuts, pair 1/16", 1"x4" 13c, 1"x6" 15c, 1 1/2"x6" 17c, 1 1/2"x6" 19c. Sheet aluminum 1/16" \$1.00, lead \$1.00 square foot all prepaid. Silicon transformer steel cut to order .014" 10 lb. 25c, 5 lb. 30c, less than 5 lb. 35c per lb.. .022" thick 5c less per lb. Postage extra. Edgewood wound copper ribbon, 7 sizes, see Jan. *QST*. 1 1/2" square copper wire better than copper tubing 50c lb. postage extra. Air pocket insulators blue glazed porcelain 8" leakage path fine for transmitting, 4 for \$1.00 prepaid. Geo. Schulz, Calumet, Michigan.

"POWER transformers—for 7.5 watters. Filament, 7.5V., Plate, 600V., center-tapped, \$5.75. For fifties. Filament, 15V., Plate, 1100V., center-tapped, \$8.00. Milliamperes, 0-100, \$2.00. Rectifier Elements, Aluminum, Lead, pair, 1"x4", 7c; 1"x6", 10c. Wavemeters, calibrated, 15-170 Meters, Complete, \$4.00. QSL cards, \$1 per 100, highest quality, free samples. Orders filled immediately. Terms, C. O. D. or cash. Complete Radio Catalogue upon request. William Green, 207 Cathedral Parkway, NYC."

WANTED: Used 208a or 208A, Elmer Gunther, Ft. Dodge, Iowa.

2GUZ has for sale: Eleven Cunningham, six Magnatron brand new UX201As \$1.25. Bradley transmitting leak \$2.50. Brand new VTL, \$2.00. Two W.E. fifties \$15.00 each. Everything guaranteed perfect.

EDISON element storage "B" battery power units will deliver a pure "B" current of low internal resistance. Superior to dry "Bs" or eliminators. Highest quality, lowest price. 90 volt unit \$10.95. 135 volt \$15.00. Complete with battery, charger, cord, plug, etc. Rechargeable hundreds of times and guaranteed. Headquarters for Edison elements, parts and supplies. Also special batteries. Send for list. J. Zied, 904 N. 5th Street, Philadelphia, Penn.

700 WATT transformers 1000-1500 each side \$14.00. 250 watt transformers 550-700 each side \$10.00. 200 watt filament transformers for fifty watters mid tapped \$12.00.

40 watt mid tapped filament transformers for 7 1/2 watters \$7.00 C.O.D. or cash. 9CES. F. Greben, 1927 S. Peoria St., Chicago, Ill.

PYREX 7 1/4 inch amateur transmission insulators, Pyrex stand-off insulators, also radio parts. Write for best prices. F. I. Ellert, 693 Mission Street, San Francisco.

SAVE your hands! Pure aluminum and lead elements, complete, holes drilled, screws, nuts, pair 1/16", 1"x4" 12c. 1 1/2"x6" 17c. Square foot \$1.00. Ammonium phosphate "beats borax", 50c lb. prepaid. J. J. Jacobsen, 400 West 150 St., New York City, 2AHE.

DODGE Radio Shortkut fixes signals in mind to stick. Kills hesitation. Cultivates speed. Produces results. 7AAD Nelms "did not expect Shortkut to teach code as if by magic but has—almost. Four hours study increased speed from four to twelve per". Very surprising my previous experience considered". Quarter coupon and reports progress made by 200 users (all licensed) 25 cents. Specimen reports each district on request. Shortkut with Appendix and Better Key Work \$3.50 U. S. and Canada. Elsewhere \$4.00 reg. mail. None C.O.D. Send money order. Check may delay. C. K. Dodge, Mamaroneck, N. Y.

WILL pay five bucks for one burned out 204. Write 4AA.

WANTED 1/2 kw fully mounted Packard transformer. In writing advise name plate specifications or give dimensions. 6BBH.

CROCKER-WHEELER 450 watt 24/150 volt dynamotors \$45.00. 1/2 KW 500 cycle transformers \$12.50. Motor generators 500 cycle half to five KW Crocker-Wheeler; Complete gasoline engine driven power units 500 cycle and dc outputs. Complete Navy transmitters any capacity. Navy portable transmitters complete with power unit. Sangamo Watthour meters designed for battery use \$10.00. Govt. wavemeters, leather case, current squared meter, interchangeable coils 125-2500 meters \$45.00. SE 1012 receivers range 50-1000 meters used \$35.00. Navy Blinker Keys heavy silver contacts \$2.00. Henry Kienzie, 501 East 84th Street, New York.

FOR SALE—Advance Sync. S tube, fifty watter, radiation hamster and Acme plate transformer, 250 watts. Wilfred Hardman, 116 Lincoln St., Lowell, Mass.

FOR sale: 1 Acme plate transformer with 1500-1100-750 and 550 volt taps. In perfect condition. Price \$20.00. Bruce Quackenbush, 3 Park Place, Herkimer, N. Y. 8BLI.

WANTED—Kellogg or Western Electric broadcasting microphone. State price and condition in first letter. E. L. Benton, 1627 State St., LaCrosse, Wisconsin. 9ZY.

SHACK furniture. Rigid transmitter or receiver table 30x60 birch top and legs mahogany stained aprons priced at \$16.50. Cash with order. Anything in furniture for the home or shack on at prices that can not be beat. Will you give us a trial? W. Ryder, Jr., Hibbing, Minn. 9OY.

FOR Sale: Acme 500 plate transformer \$16.00. E.C.A. UL1008-OT \$6.00. Acme 1 1/2, H-500 mil choke, \$3.00. Complete factory built REL short-wave receiver \$12.00, complete 50 watt transmitter with REL OT (2) power and 211A tube, panel mounted with 3 meters \$65.00. Everything for the "ham". Send for list. Wm. H. Brunt, 44 Whittier St., Rahway, N. J.

400 V. 100 W. Esco coupled to 220 V. 3 ph. A C motor \$25.00. 1000 V. 300 Watt Esco motor 110 V. single phase \$95.00. 2000 V. 1000 Watt Westinghouse double commutator \$275.00. 2500 V. 2 kilowatt Generator double commutator, coupled to three phase 220 V. 1750 Speed motor, 2500 Volt 600 W. double commutator generator coupled to 110-220 V. 60 cycle single phase motor 1750 speed. Also many others, Inafd Western Electric condensers 50c. New 1/4 H. P. 110 Volt 3500 speed Robbins & Myers alternating current motors \$4.50. Prices f.o.b. Chicago. James J. Smat, 1734 Grand Av., Chicago, Ill.

METERS: Three 0-2 1/2", two 0-3 Roller Smith hot wire ammeters, new, \$4.00 postpaid. 5AD.

HAMS: Get our samples and prices on printed Call Cards made to order as you want them. 9APY, Hinds, 19 S. Wells St., Chicago, Ill.

THE Ensall Radio Laboratory six tube short wave receiver. Range 15 to 210 meters. Inductances, list at \$18.50 with circuit drawing. Operates on loop or outside antenna. Parts list on request. We also are distributors of practically all types of radio apparatus. We also build transmitters, receivers, wavemeters, inductances, etc. Prices on application. We employ your parts in any apparatus desired. Blue prints and drawings furnished for any type of radio station, amateur, broadcast, or commercial. Special apparatus constructed to order. Quotations on application. Thos. Ensall (8BDN), 1208 Grandview Ave., Warren, Ohio.

BRADLEY amplifier cost \$15 going cheap. \$10.50. SCVV.

NEW 1kw transformers, continuous rating, shell type, Silicon steel core, suitable voltage for large or small power tubes. Bakelite terminal board. Primary 110 volts—50-60 cycle secondary volts. 4400-3300-2200-1650-1100—all voltages have center tap. Exciting current 13 watts—110 v 50 cycles, weight 40 lbs. Price \$19.00 F.O.B. Los Angeles, Carl Schwenden, 7427 Alameda Blvd.

QSL cards—two color—government post cards \$1.90 per 100. White cards \$1.00. Real ham stationary at \$1.40 per 100 sheets and envelopes. Postage 10c. Free samples. 3DTY, 257 Parker Ave., Buffalo, N. Y.

TRANSMITTING chokes 30H-125MA, \$5.75. 30H-85MA for Raytheon \$2.75. 30H-60MA \$2.25. 20H-25MA \$1.00. General Radio 174-B wavemeter \$25.00. 3"x4" .93 watt loss Silicon core 1" thick .014 \$1.50. 429-6-110 volt transformer, with midtaps \$4.00. 1/30 H.P. Universal motors \$2.50. Write for list of meters, transformers, condensers, etc. M. Leitch, Park Drive, West Orange, N. J.

WANTED new 204A and sync. W. B. Michael, Caldwell, Ohio.

FOR sale—complete fifty watt station with tube, meters and everything. S tubes and perfect filter. Shortwave receiver with one step. Strictly high grade equipment and only slightly used. Sacrificing this splendid outfit for \$100. Also Western Electric amplifier \$25. Write 9DSK, Fred V. Hines, Owensboro, Ky.

DYNAMOTOR wanted 2000 volt, have Esco 32-359 for sale. 8DOA.

FILAMENT transformers 8 volt center tapped (unmounted) \$3.50. One plate transformer 525 volt center tapped \$4.75 (unmounted), one Jewell 54 D.C. ammeter 0-1 amp. \$5.00. All postpaid. Clarence Barnett, Corinth, Miss.

AERO short wave kits, complete three tubes, nothing else to buy, \$40.75. Aero short wave coil kit, \$9.50. Marco Browning & Drake kits, \$45.50 Prepaid. Quality parts only. Write for description. Lowell Mast, 615 S. Clinton St., South Bend, Indiana.

"S" tubes, omnigraphs, vibroplexes, teleplexes, transmitters, receivers, 50 watters, chokes, meters, transformers, motor generators, all wave receivers. Bought, sold, exchanged. L. J. Ryan, 9CNS, Hannibal, Mo.

WANTED:—"S" tubes, Griffith, 1109 Eighth Avenue, Fort Worth.

HEADQUARTERS for Hams:—Immediate deliveries on Mueller 150-watt input tubes \$15.00. RCA 5-wattors \$3.15. To be 2000-volt 5-mfd condensers \$13.75. Aerovox —1-mfd 1500-volt tested condensers \$1.75. 15-dial Omnigraphs \$25.00. "Ham-List" 4c. Romanyl Curtis, 1109 Eighth Avenue, Fort Worth, Texas.

CURTIS-Griffith 250-watt power-filament transformers 350-550 each side \$12.50. Thordarson power-filament transformers for 7.5-wattors \$6.90. Thordarson power transformers 350-550 each side \$11.00; 1000-1500 each side \$16.00. Edgewound Inductance 6-inch turn 12c; 4-inch turn 10c; 3-inch turns 7c. Aluminum square foot 85c; lead square foot 85c. Curtis-Griffith 30-hyrie 150-milli-ampere chokes \$11.00. "Ham-List" 4c. James Radio Curtis, 5-A-Q-C, 1109 Eighth Avenue, Fort Worth, Texas.

500 CYCLE 1/2 kw self-excited generators \$65, with gas engine \$100. 1/2 kw motor-generators 120 volts dc drive new with spare armature \$60. 1 to 5 kw motor-generators. 500 cycle transformers. 1/2 kw 500 cycle generator with propeller for airplane radio \$40. 275 volt new dc generators \$8. 6 volt dynamotors 400 volts at 200 watts output \$15. 200 watt 500 and 900 cycle generators \$10. 900 cycle dynamotor output 120 volt input 16 volts dc \$15. R. Wood, 46-20, 102 St., Corona, N. Y.

SUPER-sync rectifier. Almost new. \$48. F.O.B. Tacoma. H. J. Holt, 806 S. Sheridan Ave., Tacoma, Washington.

POSTPAID and guaranteed brand new R.E.L. Transmitting Inductances, double unit with glass coupling rods and clips, \$8.90. Single, \$4.85. R.E.L. mountings for "H" tubes, \$1.89. H.E.L. 50 watt sockets, \$1.89. R.E.L. Radio Frequency chokes \$1.00. R.E.L. Short Wave Coil Kits, \$3.75. Allen-Bradley "Radiostats", the big Primary rheostat, \$6.25. Allen-Bradley "Radioleaks", 2000-30,000 ohm variable transmitting gridleaks, \$4.89. General Radio Wavemeters, Type 358, \$19.25. 3BMS, G. F. Hall, 535 West Horter St., Philadelphia, Pa.

GREBE CR-18, full set of coils, used one month, \$75.00 takes it. Cox, P. H. Adams, 1632 Torrey Road, La Jolla, California.

NEW power amplifier transformers, 200 watt, 1000 volt secondary with center tap, 2-7 1/2 volt filament windings. Price, without case, \$9.50. Other transformers and chokes at equally low prices. Radio 1NZ, 26 Sterling Road, Waltham, Mass.

EVERYTHING for the ham: We carry a full stock of parts for the amateur. Ham radio is our business. Everything in stock for the short wave transmitter and receiver. Jewell meters, Acme chokes and transformers, Thordarson transformers, Aero, Allen-Bradley, General Radio, Ward-Leonard, etc. No. 12 solid copper enameled wire 1c ft. No. 10, 1 1/4 ct. Send for our catalogue, "Dy-nex for Dx", E. J. Nicholson, 1407 First North St., Syracuse, N. Y.

RESOLVE now to make that needed improvement in your station. If you haven't it, by all means get 9ALD's free Hamalog, the original and best ham catalog, pick out the things you want, and we'll ship them quick. See our ad elsewhere for some wonderful new inductances, also listing DeForest tubes. New Citizens Amateur Call Books, \$7.5, A.R.R.L. Handbooks \$1.00, both postpaid; Sangamo filter condensers, 1000 volts, 1mfd, \$1.95, 2 mfd. \$2.50, 4 mfd. \$4.00; REL products, No. 125 wavemeter \$22.00. No. 127 Inductances \$11.00, No. 130 Short Wave Kit \$36.00; Special, some General Radio Wavemeters only \$7.50. E. F. Johnson, 9ALD, Waseca, Minnesota.

9DPL selling out. Over \$200 worth of stuff for \$75.00. Complete 20-40-80 transmitter, ham receiver, dynamotor 380 AH-battery, extra tubes, meters, other stuff, Gross 10 watt frame type transmitter, all A-1 stuff and cheap. Will sell all or part. Write for list with descriptions. Howard O. Severide, Huxley, Iowa.

NEW line of transformers and chokes for eliminator and transmission purposes. 200 watt power transformers at special price. 2APJ, 643-5 West 171st Street, New York City.

0-1500 WESTON voltmeter panel mounting \$18. RUX carton drawn to order for your DX cards, \$1. Don Hoffman, 50 South Balch St., Akron, Ohio.

R13—1000 cycle, All American audio transformers. The ideal 1000 cycle transformer. Limited number available specially priced postpaid anywhere in the U. S. at \$1.87 each. Brand new stock fully guaranteed by All-American. Replace your present transformers and make that DX QSA. Curve sent on request. 9DEM, 1942 N. Lowell Ave., Chicago, Illinois.

Q R A SECTION

50c straight with copy in following address form only:

1AUN—Gordon Wiley, 48 Pearl Street, Gardner, Mass.

1BBT—Raymond E. Lewis, 9 Carter St., Newburyport, Massachusetts.

1BJE—Philip F. Taylor, Care Western Union Tel. Company, Nantucket, Mass.

1KH—George W. Bailey, Webster Road, Weston, Mass.

1LC—Herman Sanborn, Beacon St., Shrewsbury, Mass.

1LX—Randolph B. Reed, 398 Westford St., Lowell, Mass.

2DBJ—Walter H. Werth, 417 W. 150th St., New York City.

2XAI-WAQ Westinghouse Electric & Mfg. Company Radio Test Station, Newark, N. J.

3AG—Willard F. Hinton, Falls Church, Virginia.

3KP 4828 N. W. 16th St., Washington, D. C.

4DP—49 West 4th St., Atlanta, Ga.

4ES—465 N. E. 28th St., Miami, Fla.

4JW—Mark R. Bowling, Jr., Box 145, Louisville, Ga.

5MN—Horace E. Biddy, 1330 Rigsby Ave., San Antonio, Texas.

5RR—Vir N. James, 105 Carolina St., San Antonio, Texas.

6DIA—Archie W. Karvonen, Box 96, Fort Bragg, California.

6DIG—Joe A. Bowers, Box 37, El Centro, California.

6DJA—C. E. Saunders, 392 View St., Mountain View, Calif.

6IP—H. Y. Ballou, 1434 1/2 Loma Drive, Los Angeles, Calif.

6SM—A. E. Ekdale, 159 S. El Molino Ave., Pasadena, Calif.

8AYU—Walter V. Turner, 3 Bell Ave., RFD 1, Glens Falls, N. Y.

8CSR—W. F. Kisner, Watson, West Virginia.

8DEI—Geo. M. Benas, 1801 Genesee St., Utica, N. Y.

9HW—Rob-Roy Phillips, 412 Post Court, N. W., Canton, Ohio.

9IN—M. Malmer, 754 N. Walnut St., Youngstown, Ohio.

9ANQ—Albert Herrmann, Jr., 653 Mill Court, Waukegan, Ill.

9BAV—W. L. McNamara, Y.M.C.A. Building, Grand Island, Nebraska.

9C'TT—F. A. Nichols, R.R. 4, Pana, Ill.

9DZJ—H. A. Wakely, 770 Main St., Oshkosh, Wisconsin.

964YZ—Andre Courtois, Hodimont-Verviers, Belgium.

9a5WH—W. H. Barber, 50 Somerset Ave., Cumberland, South Australia.

9a6RY—Jouir, R. Whitburn, Box 320 G.P.O., Adelaide, South Australia.

The following stations belong to members of the A.R.R.L. Headquarters gang. Mail for them should be addressed care A.R.R.L., Hartford, Conn. When operating 1MK they use personal signs as indicated.
 1MK Headquarters IES A. A. Hebert "ah"
 1AL H. P. Westman "ws" 1GO L. A. Jones "lj"
 1BAO R. S. Kruse "lq" 1KP - NRRG F. Cheyney
 1BBI F. E. Handy "fh" Beckley "beek"
 1BHW K. B. Warner "kb" 1OA R. S. Kruse "lq"
 1BUD A. L. Budong "bud" 1SZ C. C. Rodimon "cr"

Become a Radio Operator

See The World. Earn a Good Income. Avoid Hard Work.
Learn in the Second Port U. S. A.

Radio Inspector located here. Opportunities for employment second to no other port. Most logical location in the U. S. A. to come for training.

Practically 100% of radio operators graduating on the Gulf during past four years trained by MR. CLEMMONS, Supervisor of instruction. All graduates placed in jobs.
 Day and Night Classes, enroll anytime. Write for Circular.

Gulf Radio School 844 Howard Avenue, New Orleans, La.

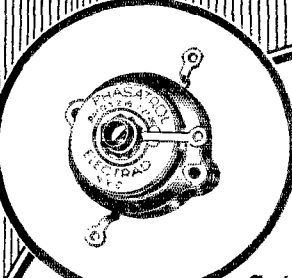

Licensed by Ruder Radio Corporation
 Pats. Pending
 Patented 5-2-'16
 Patented 7-27-'26

Does Your Set Oscillate?

PHASATROLS

In every corner of the country, set builders and owners are improving their receivers by installing Phasatrols.

A True Balancing Device for Radio Frequency Amplifiers.
 Price \$2.75.

Phasatrols stop the squeals and disturbances caused by oscillations. Don't be satisfied with ordinary reception—get Phasatrols from your dealer and marvel at the results.

Write for free hook-up circular.

Dept. 67, 175 Varick Street, New York, N. Y.

ELECTRAD

FOR YOUR CONVENIENCE QST'S INDEX OF ADVERTISERS IN THIS ISSUE

| | |
|--|------------|
| Aera Products, Inc. | 85 |
| American Sales Company | 73, 88, 90 |
| American Transformer Company | 79 |
| A. R. R. L. Application Blank | 90 |
| A. R. R. L. Auto Emblem | 76 |
| A. R. R. L. Handbook and QST Combination | 3rd cover |
| Aurisma, Inc., Ad. | 88 |
| Browning-Drake Corp. | 80 |
| Burgess Battery Company | 4th cover |
| Burton-Rogers Company | 81 |
| Cardwell Mfg. Corp., Allen D. | 96 |
| Carter Radio Company | 86 |
| C. E. Mfg. Company | 88 |
| Central Radio Laboratories | 71 |
| Cresradio Corporation | 96 |
| Crosley Radio Corporation | 78 |
| Cunningham, Inc., E. T. | 2nd cover |
| Deutshmann Company, Tobe | 76 |
| Dongan Electric Mfg. Co. | 76 |
| Eastern Radio Institute | 80 |
| Electrad, Inc. | 94 |
| Electric Specialty Company | 80 |
| Elkon Works, Inc. | 2 |
| Fansteel Products Co. | 86 |
| Federal Radio Corp. | 82 |
| Frost, Inc., Herbert H. | 78 |
| General Radio Company | 81 |
| Grebe & Company, A. H. | 4 |
| Grisby-Grunow-Hinds Co. | 75 |
| Gross & Company, J. | 82 |
| Gulf Radio School | 94 |
| Hellcon Radio Condenser Corp. | 86 |
| Jewell Electrical Instrument Co. | 76 |
| Johnson Company, E. F. | 88 |
| Karas Electric Company | 90 |
| Kokomo Electric Company | 84 |
| Marlo Electric Company | 91 |
| National Company, Inc. | 86 |
| National Radio Tube Co. | 87 |
| Pacent Electric Company | 76 |
| Parmater Products Co. | 86 |
| Radio Engineering Labs. | 77 |
| Radio Ray, Inc. | 82 |
| Sangamo Electric Company | 73 |
| Scientific Radio Service | 88 |
| Sterling Mfg. Company | 74 |
| Stromberg-Carlson Telephone Mfg. Co. | 82 |
| Teleplex Company | 73 |
| Thordarson Electric Mfg. Co. | 95 |
| U. S. Naval Institute | 80 |
| Trifty Radio Company | 74 |
| Vibroplex Company | 73 |
| Ward-Leonard Electric Co. | 1 |
| Weston Electrical Instrument Corp. | 91 |
| Wireless Specialty Apparatus Co. | 89 |
| X-T. Radio Labs. | 88 |
| Yakley Mfg. Company | 78 |
| ZMA | 84 |
| ZML | 73 |



New!

*You don't have to be
water boy to this
battery charger*

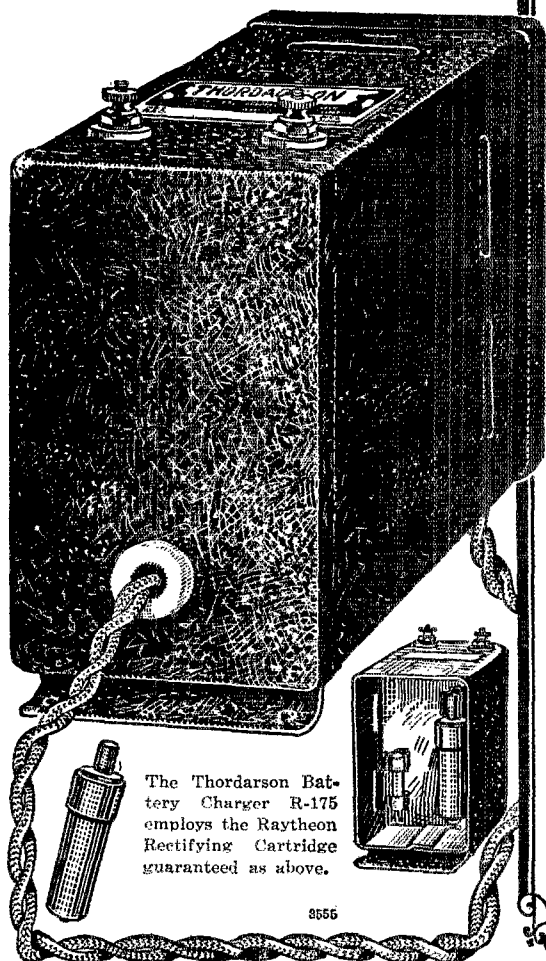

The Thordarson Battery Charger R-175 employs the Raytheon Rectifying Cartridge guaranteed as above.

8556

THORDARSON BATTERY CHARGER R-175

Radically new,—sound in principle,—proven in performance.

The Thordarson Battery Charger makes its bow as a welcome relief to the army of butlers to thirsty battery chargers.

DRY—As dry as they make 'em. In fact, the rectifying element is contained in a moisture proof cartridge.

SILENT—No vibrating parts. Current is rectified through a patented electrochemical process.

SAFE—There is no hazard to rugs or woodwork for there is no acid to spill. The tubes of the set are safe even if turned on when charger is in operation.

COMPACT—Fits into battery compartment easily. Only 2 3/4" wide, 5 3/4" long and 4 3/4" high, overall.

EFFICIENT—This charger is always ready for service. No overhauling required. Rectifying element can be replaced in thirty seconds.

GUARANTEED—The rectifying unit is guaranteed for 1,000 hours full load operation, or approximately one year's normal service. The Transformer will last indefinitely.

Charging Rate—2 amperes

*For Sale at Good Dealers Everywhere
or direct from the factory*

Price Complete \$12.50

THORDARSON ELECTRIC MANUFACTURING CO.
Transformer Specialists Since 1895
WORLD'S OLDEST AND LARGEST EXCLUSIVE TRANSFORMER MAKERS
Huron and Kingsbury Streets — Chicago, Ill. U.S.A.

Cardwell

THE OAK TREE OR THE MUSHROOM

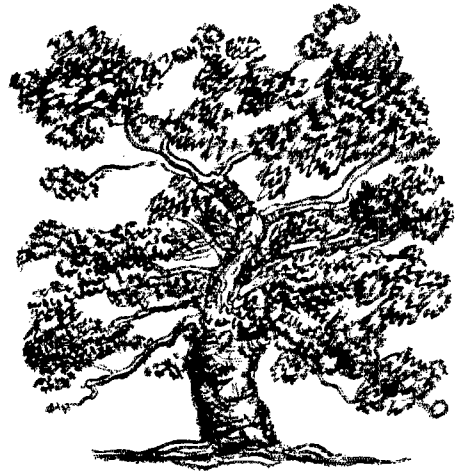

AN Oak Tree is a noble example of nature's handiwork, defying the decaying forces of the elements for hundreds of years.

A Mushroom springs into being over night and reaches maturity in a few days, fading into decay equally soon. Cardwell Condensers are long lived, like the Oak Tree. The first Cardwell Condensers are still doing duty, and will continue—useful long after the other parts have been consigned to the junk pile.

Don't use mushroom parts—they may be shinier or cheaper—but Cardwell Condensers will work better and last longer.

Cardwell Taper Plate Receiving Condensers take up less space, have less losses and hold their calibration. The 167-E, illustrated at the right, has a maximum capacity of .00014 and is particularly good for short wave reception.

Cardwell Transmitting Condensers are built with a rating for each Xmitting tube and voltage—send for a table that shows which to use. Prices are lower, and two new Xmitting Condensers, with heavier plates and wider spacing improve the line.

"We have a very limited number of reprints of the 20A Transmitter booklet. Send 25c for your copy."

TRANSMITTING CONDENSERS

| Type | Price | Capacity (Mmfd.s.) | Airgap (Inches) | Spacing between adjacent rotor plates | Plate Thickness | Length (Back of panel) |
|-------|--------|--------------------|-----------------|---------------------------------------|-----------------|------------------------|
| 141-B | \$4.25 | 245 | .030 | .085 | .025 | 2.375 |
| 123-B | 5.00 | 480 | .030 | .085 | .025 | 2.875 |
| 137-B | 6.00 | 954 | .030 | .085 | .025 | 4.000 |
| 164-B | 7.00 | 217 | .070 | .165 | .025 | 4.000 |
| 147-B | 10.00 | 440 | .070 | .165 | .025 | 5.875 |
| 157-B | 12.00 | 217* | .070 | .165 | .025 | 5.875 |
| T-199 | 10.00 | 330 | .084 | .208 | .040 | 6.500 |
| T-183 | 10.00 | 110 | .171 | .382 | .040 | 6.500 |
| 166-B | 70.00 | 297 | .219 | .502 | .064 | 10.250 |

*—Double stator, capacity of each section.

The Allen D. Cardwell Mfg. Corporation
81 Prospect Street
Brooklyn, N. Y.

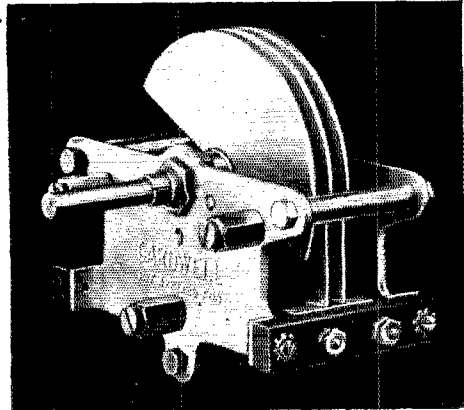

Taper Plate Receiving Condensers

| Type | Capacity Mmfd.s. | Price |
|------|------------------|--------|
| 191E | 75 | \$3.75 |
| 167E | 140 | 4.00 |
| 168E | 220 | 4.25 |
| 169E | 340 | 4.75 |
| 192E | 500 | 5.00 |

Condensers

"THE STANDARD OF COMPARISON"

SPECIAL OFFER!

QST and The Radio Amateur's Handbook

THE RADIO AMATEUR'S HANDBOOK meets and fills the long-felt need. It is at once a manual of approved procedure for the most advanced of "old-timers", a text book on station construction and operation for the average amateur, and the finest introduction to amateur radio for the beginning amateur that has ever been published anywhere. It paints the whole picture of the greatest of modern hobbies, covering everything from so elementary a start as the explanation of what amateur radio is and how to become an amateur, up to the details of construction and operation of the most up-to-date type of amateur transmitter, and the most elusive and complex of traffic-handling procedures. Communications Department questionnaires have shown that the amateur has little idea of how his apparatus works. The Handbook explains it, in "theory" made understandable. Data and complete constructional information on the building of many pieces of apparatus are given.

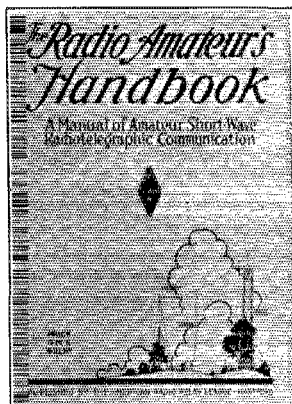

DURING JULY and AUGUST

**Special offer on the Handbook, a year's
subscription to QST and membership
in the A. R. R. L.**

All for \$3.00

Even if you are already a member of the League and a subscriber to QST, you may take advantage of this offer. Simply mention that fact and instead of entering it as a new subscription we will extend your present subscription for another year.

American Radio Relay League, Inc.

1711 Park Street, Hartford, Conn.



*When
you
buy*

BURGESS *batteries*

you buy more than just batteries. You buy a guarantee—
a record of satisfactory service as old as radio and attested
by users in every part of the world.

We don't ask you to take our word for this. Go into
the Ham Shacks!—ask the "amateur" what batteries he
uses and see how often the answer is—

BURGESS RADIO BATTERIES

