

QST

DEVOTED ENTIRELY TO

AMATEUR RADIO

Published by the American Radio Relay League

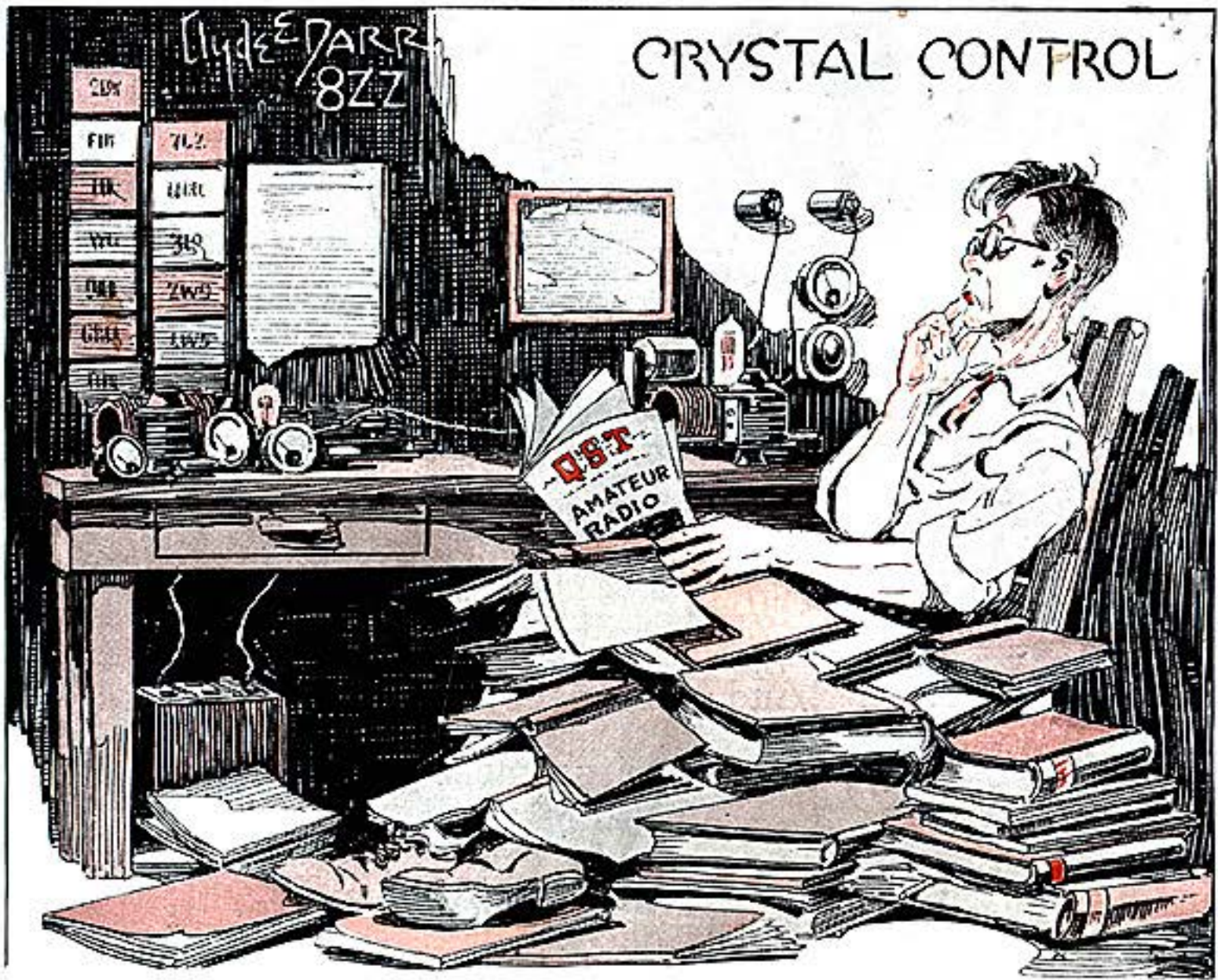

MAY
1927

25¢

The New Cunningham

HI-MU Amplifier type CX340



Price
\$2.25

*Five Volt
¼ amp. Filament
Mu of Thirty*

The development of radio centers around the radio tube. In offering this new type we take another step forward in fulfilling the obligation of leadership.

With the advent of the CX-340, heights of efficiency heretofore unattainable in resistance and impedance coupled audio circuits are placed within easy reach of the radio world. This new Cunningham Radio Tube is especially designed for use in receiving sets employing resistance or impedance coupled audio frequency amplification.

Consult your dealer as to its proper installation or write us for the special CX-340 Bulletin.

Sixteen Types all in the Orange and Blue Carton

E. T. CUNNINGHAM, Inc.

NEW YORK

CHICAGO

SAN FRANCISCO

Manufactured and sold under rights, patents and inventions owned and / or controlled by Radio Corporation of America.

RCA ANNOUNCES

RADIOTRON UX-852

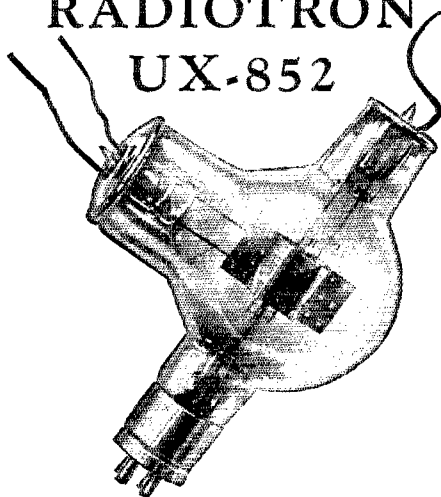

*A rugged 75 watt, low internal-capacity tube
for short wave work*

THIS is RCA's latest contribution to Amateur Radio. A rugged, dependable 75 watt Radiotron, that will stand the gaff of day-in, day-out operation on short waves, at the same time that it establishes new standards of stability for the amateur transmitter.

Radiotron UX-852 has been made to oscillate at $\frac{7}{8}$ of a meter in the designing laboratories. Its use for four and five meter work is entirely practicable, and on 20 meter operation its stability and efficiency will be a source of genuine pleas-

ure to the amateur who wants to clean his hook on the long haul stuff without having to worry about what is happening to the precious "bottle." Long life is a "built in" feature of this Radiotron.

If your dealer cannot supply you, the nearest RCA District Office listed below will be glad to send you Radiotron UX-852 postpaid, on receipt of money order and call letters of your station.

Filament Volts	10
Filament Amperes	3.25
Plate Volts (normal)	2000
Plate Current Osc. (milliamperes)	75
Safe Power Dissipation (watts)	100
Out-put (watts)	75
Price	\$32.50

Radio Corporation of America
233 Broadway, New York, N.Y.

28 Geary Street
San Francisco, Calif.
100 W. Monroe Street
Chicago, Ill.

RCA Radiotron

MADE BY THE MAKERS OF THE RADIOLA

*“We’re equipping with
Faradon again this year”*

New specifications, new equipment and new policies are now under discussion. But, for the manufacturer or amateur who recognizes the value of capacitor durability, there is one certain answer to his condenser problems—*Faradon*.

Recognized generally as standard quality equipment by radio manufacturers, *Faradon* Capacitors have also been specified for other exacting work—Automatic Train Control Systems and Marine Direction Finders.

Manufacturers are urged to avail themselves of the *Faradon* engineering co-operation covering all types of fixed electrostatic condenser equipment.

**Wireless Specialty
Apparatus Company**

Jamaica Plain, Boston, Mass., U. S. A.
Established 1907



Faradon

782

Electrostatic Condensers for all Purposes

Section Communications Managers of THE COMMUNICATIONS DEPARTMENT, A. R. R. L.

		ATLANTIC DIVISION		
Eastern Pennsylvania	8BQ	H. M. Walleze	597 No. James St.	Hazleton
Maryland-Delaware-District of Columbia	3AB	A. B. Goodall	1824 Ingleside Terrace	Washington, D. C.
Southern New Jersey	3EH	H. W. Densham	149 Washington St.	Collingswood
Western New York	8P4	C. S. Taylor	598 Masten St.	Buffalo
Western Pennsylvania	SXE	G. L. Crossley		State College
		CENTRAL DIVISION		
Illinois	9AAW	W. E. Schweitzer	4264 Hazel Ave.	Chicago
Indiana	9CYQ	D. J. Angus	310 N. Illinois St.	Indianapolis
Kentucky	9ARU	D. A. Downard	116 No. Longworth Ave.	Louisville
Michigan	8ZZ	C. E. Darr	137 Hill Ave.	Highland Park, Detroit
Ohio	8BYN	H. C. Storck	694 Carpenter St.	Columbus
Wisconsin	9VD	C. N. Crapo	443 Newton Ave.	Milwaukee
		DAKOTA DIVISION		
North Dakota	9EFN	G. R. Moir	618 11th Street, South	Fargo
South Dakota	9BDW	R. J. Beck		Milbank
North Minnesota	98GU	C. E. Barker		Henning
South Minnesota	98YA	D. E. Cottam	3538 Third Ave. So.	Minneapolis
		DELTA DIVISION		
Arkansas	5AIP	Leonard Clippard	2408 North Pierce St.	Little Rock
Louisiana	5UK	C. A. Freitag	129 Camp St.	New Orleans
Mississippi	5AKP	J. W. Gullett	1708 23rd Ave.	Meridian
Tennessee	4KM	L. K. Rush	4 Second St.	Memphis
		HUDSON DIVISION		
Eastern New York	2ADH-2AXR	Earle Peacock	Box 113	Yonkers
N. Y. C. & Long Island	2CWB	W. H. Mardon	117-11 140th St.	No. Ozono Park, L. I.
North New Jersey	2WB	A. G. Wester, Jr.	39 Princeton St.	Hilton
		MIDWEST DIVISION		
Iowa	9BKV	A. W. Kruse		Akron
Kansas	9DNG	P. S. McKeever	1817 Mich. St.	Lawrence
Missouri	9RH	L. B. Lutzke	8910 Mercier St.	Kansas City
Nebraska	9BYG	C. B. Deihl	5605 Cedar St.	Omaha
		NEW ENGLAND DIVISION		
Connecticut	1BM	H. E. Nichols	82 Elmwood Ave.	Bridgewater
Maine	1B1Q	Friederick Rest	13 E. Crescent St.	Augusta
Eastern Massachusetts	1B7V	A. S. Briggs	293 Ashmont St.	Dorchester
Western Massachusetts	1B4	H. C. Carr	20 Vassar St.	Worcester
New Hampshire	1ATJ	V. W. Hodge	227 Main St.	Claremont
Rhode Island	1RVB	D. B. Fancher	22 Summer St.	Westerly
Vermont	1AJG	C. T. Kerr		Poultney
		NORTHWESTERN DIVISION		
Alaska*	7DE	L. H. Maehin	Box 452	Cordova
Idaho	7ST	Henry Fletcher	1619 N. 10 St.	Boise
Montana*	7AAT	O. W. Myers		Red Lodge
Oregon*	7IT	A. C. Dixon, Jr.	1350 East 36th St.	Portland
Washington*	7FD	Otto Johnson	4340 30th Ave. W.	Seattle
		PACIFIC DIVISION		
Hawaii	6BDL	John A. Lucas	Box 1142, Fort Shafter	Oahu
Nevada	6TQ	C. B. Newcombe		Yerington
Los Angeles	6BUR	L. E. Smith	340 No. Painter Ave.	Whittier
Santa Clara Valley	6NX	P. J. Quement	51 Pleasant St.	San Jose
East Bay	6ZX	P. W. Dann	562 25th St.	Oakland
San Francisco*	6VR	J. W. Patterson	1338 Kell St.	San Francisco
Sacramento Valley*	6VBS	C. F. Mason	2530 N. St.	Sacramento
Arizona	6ANO	D. B. Lamb	229 W. First St.	Mesa
Philippines	6P4U	Manuel I. Feltzardo	252 Galicia St.	Manila
San Diego	6BQ	G. A. Sears	250 Bonair St.	La Jolla
		ROANOKE DIVISION		
North Carolina	4TR	R. S. Morris	418 S. Broad St.	Gastonia
Virginia	3CA	J. P. Wohlford	118 Cambridge Ave.	Roanoke
West Virginia	4BSU	C. S. Hoffman	126 Chantal Court	Wheeling
		ROCKY MOUNTAIN DIVISION		
Colorado	9CAA	C. R. Stedman	1841 Albion St.	Denver
Utah-Wyoming	9KM	Don C. McRae	211 Belvedere Apts.	Salt Lake City
		SOUTHEASTERN DIVISION		
Alabama	5AJP	A. D. Trum	217 Catoma St.	Montgomery
Florida	4QY	W. E. Grouen	Box 816	Pt. Myers
Georgia-South Carolina-Cuba-Porto Rico-Isle of Pine	4KU	H. L. Reid	11 Shadowlawn Ave.	Atlanta
		WEST GULF DIVISION		
Northern Texas	5AJT	W. B. Forrest, Jr.	502 Royal St.	Waxahatchie
Oklahoma	5APG	K. M. Ehret	2904 N. Robinson St.	Oklahoma City
Southern Texas	5YK	E. A. Sahn	146 N. Academy St.	New Braunfels
		MARITIME DIVISION		
Newfoundland	5AR	Leval Reid	Avalon House	St. Johns
New Brunswick	1B1	T. B. Lacey	7 N. B. Power Co.	St. John
Nova Scotia	1DD	W. C. Borrett	14 Sinclair St.	Dartmouth
Prince Edward Island	1BZ	P. W. Hyndman	25 Fitzroy St.	Charlottetown, P. E. I.
		ONTARIO DIVISION		
Ontario	9BJ	W. Y. Sloan	167 Close Ave.	Toronto
		QUEBEC DIVISION		
Quebec	2BE	Alex Reid	202 Birch Ave.	St. Lambert
		VANALTA DIVISION		
Alberta	4GT	A. H. Asmussen	2133 18th St. W.	Calgary
British Columbia	5BJ	E. S. Brooks	c/o Forestry Dept. Radio Court House,	Vancouver
		PRAIRIE DIVISION		
Manitoba	4BE	F. E. Rutland, Jr.	452 St. John Ave.	Winnipeg
Saskatchewan	4PC	W. J. Pickering	514 19th St. W.	Prince Albert

*Temporary officials appointed to act until the membership of the Section concerned choose permanent SCMs by the nomination and election.



Tone Quality

so intangible, so difficult to describe, is the very foundation stone of radio enjoyment.

There are very definite and tangible reasons why the tone of the Grebe Synchronphase is so superior.

Booklet Q explains them.

Send for it.

A. H. Grebe & Company, Incorporated
109 West 57th Street New York City

Western Branch:

443 South San Pedro St., Los Angeles, Calif.

Factory: Richmond Hill, New York

The oldest exclusive radio manufacturer

The **GREBE**
Synchronphase
RADIO



TRADE MARK
REGISTERED
The Synchronphase
is also supplied in
five console models.



Frank B. Rowland



QST



The Official Organ of the A.R.R.L.

VOLUME XI

MAY, 1927

NUMBER 5

Editorials	7
A.R.R.L. Policies	Hiram Percy Maxim 8
A Complete Inexpensive Transmitter	Harold P. Westman 9
2nd Annual Atlantic Division Convention	14
Fixed Resistors	14
Radio Regulation Returns	15
Some Tests With R.F. Below 200 Meters	Joseph Deckendorf 18
Statement of Ownership	19
The UX-852 Transmitting Tube	Robert S. Kruse 20
A Method of Grinding Quartz Plates	Paul Mueller 21
Some Convenient Relays	Robert S. Kruse 27
Michigan State Central Division Convention	31
A.R.R.L. Information Service Rules	31
The Air Pirate	32
Successful Electrolytic Rectifiers	S. E. Hall 33
Emergency Transmitters	Rufus P. Turner 36
A Portable Antenna Tester	A. E. Teachman 38
Official Wavelength Stations	40
Amateur Radio and Drafting	Milton A. Ausman 41
The South Dakota Convention	42
A Short-Wave Loop Receiver	R. Prece Jr. 43
Another CQ Party—This Time on 5 Meters	44
The Vertical Antenna at 8BMW	V. W. Sherman 45
Your Wave From a Broadcast Receiver	Roy L. Gale 46
An R.F. Amplifier of Uniform Sensitivity	J. O. Mesa 47
A Tube Characteristic Chart	48
Standard Frequency Transmissions	50
Experimenters' Section Report	51
Amateur Radio Stations 9DMJ, 1NF	55
Calls Heard	57
L. A. BR. U. News	61
Correspondence	65
Hamads	92
QRAs	93
Index of Advertisers	94

QST is published monthly by The American Radio Relay League, Inc., at Hartford, Conn., U. S. A.
Official Organ of the A.R.R.L. and the International Amateur Radio Union

Kenneth B. Warner (Secretary, A.R.R.L.),
Editor-in-Chief and Business Manager

F. Cheyney Beekley,
Managing Editor and Advertising Manager

Robert S. Kruse,
Technical Editor

Harold P. Westman,
Assistant Technical Editor

David H. Houghton,
Circulation Manager

Subscription rate in United States and Possessions, Canada, and all countries in the American Postal Union, \$2.50 per year, postpaid. Single copies, 25 cents. Foreign countries not in American Postal Union, \$3.00 per year, postpaid. Remittances should be by international postal or express money order or bank draft negotiable in the U. S. and for an equivalent amount in U. S. funds. Entered as second-class matter May 23, 1919, at the post office at Hartford, Connecticut, under the act of March 3, 1879. Acceptance for mailing at special rate of postage provided for in section 1103, Act of October 3, 1917, authorized September 8, 1922. Additional entry as second-class matter, acceptable at special rate of postage provided for above, at Springfield, Mass., authorized September 17, 1924.

Copyright 1927 by the American Radio Relay League, Inc. Title registered at United States Patent Office.
Member of the Radio Magazine Publishers' Association.

The American Radio Relay League

The American Radio Relay League, Inc., is a non-commercial association of radio amateurs, bonded for the promotion of interest in amateur radio communication and experimentation, for the relaying of messages by radio, for the advancement of the radio art and of the public welfare, for the representation of the radio amateur in legislative matters, and for the maintenance of fraternalism and a high standard of conduct.

It is an incorporated association without capital stock, chartered under the laws of Connecticut. Its affairs are governed by a Board of Directors, elected every two years by the general membership. The officers are elected or appointed by the Directors. The League is non-commercial and no one commercially engaged in the manufacture, sale or rental of radio apparatus is eligible to membership on its board.

"Of, by and for the amateur", it numbers within its ranks practically every worth-while amateur in the world and has a history of glorious achievement as the standard-bearer in amateur affairs.

Inquiries regarding membership are solicited. A bona fide interest in amateur radio is the only essential qualification; ownership of a transmitting station and knowledge of the code are not prerequisite. Correspondence should be addressed to the Secretary.

Directors

- | | | |
|--|--|---|
| <p><i>President</i>
 HIRAM PERCY MAXIM
 Drawer 2102
 Hartford, Conn.</p> <p><i>Vice-President</i>
 CHARLES H. STEWART
 St. David's, Pa.</p> <p><i>Canadian General Manager</i>
 A. H. K. RUSSELL
 5 Mail Bldg.
 Toronto, Ont.</p> <p><i>Atlantic Division</i>
 Dr. EUGENE C. WOODRUFF
 234 W. Fairmount Ave.
 State College, Pa.</p> <p><i>Central Division</i>
 GLYDE E. DARR
 137 Hill Ave., Highland Park,
 Detroit, Mich.</p> | <p><i>Dakota Division</i>
 C. M. JANSKY, JR.
 Dept. of Elec. Eng., U. of M.
 Minneapolis, Minn.</p> <p><i>Delta Division</i>
 BENJ. F. PAINTER
 424 Hamilton Nat'l Bank Bldg.
 Chattanooga, Tenn.</p> <p><i>Hudson Division</i>
 DR. LAWRENCE J. DUNN
 480 East 19th St.
 Brooklyn, N. Y.</p> <p><i>Midwest Division</i>
 PORTER H. QUINBY
 Box 134A, Route 6,
 Omaha, Neb.</p> <p><i>New England Division</i>
 DR. ELLIOTT A. WHITE
 Dartmouth College
 Hanover, N. H.</p> <p><i>Northwestern Division</i>
 K. W. WEINGARTEN
 3219 No. 24th St.,
 Tacoma, Wash.</p> | <p><i>Pacific Division</i>
 ALLEN H. BABCOCK
 65 Market St.,
 Southern Pacific Co.
 San Francisco</p> <p><i>Roanoke Division</i>
 W. TREDWAY GRAVELY
 503 Main St.,
 Danville, Va.</p> <p><i>Rocky Mountain Division</i>
 PAUL M. SEGAL
 c/o District Attorney
 West Side Court Bldg.
 Denver, Colo.</p> <p><i>Southeastern Division</i>
 HARRY F. DOBBS
 c/o Dobbs & Wey Co.,
 Atlanta, Ga.</p> <p><i>West Gulf Division</i>
 FRANK M. CORLETT
 2515 Catherine St.,
 Dallas, Tex.</p> |
|--|--|---|

Officers

- President* **HIRAM PERCY MAXIM**, Hartford, Conn.
Vice-President **CHAS. H. STEWART**, St. David's, Pa.
Secretary **KENNETH B. WARNER**, Hartford, Conn.
Treasurer **ARTHUR A. HEBERT**, Hartford, Conn.
Communications Manager . . . **F. EDWARD HANDY**, Hartford, Conn.

Address General Correspondence to Executive Headquarters, Hartford, Conn.

EDITORIALS

RADIO regulation is rapidly stabilizing. Each new pronouncement of the Federal Radio Commission fixes a regulation that governs some branch of radio and takes that branch out of the realm of chaos and freedom of individual action into a position where law and order again obtain. As a result, there is a very distinct change in the conditions governing amateur radio, and it is important that every amateur operator get the situation clearly in mind.

When radio regulation broke down with the decision of the Attorney-General last year, an amateur theoretically was free to operate on any wavelength below 200 meters. That day is now gone forever. When the new law was passed in February, it gave the Commission the power to make regulations which had the force of law. When on March 15th the Commission extended all amateur licenses as having the same force and effect as though it had issued new licenses, it made these wavelengths legal and binding upon all of the stations concerned. As reported in detail elsewhere in this issue, the Federal Radio Commission until further notice is observing for amateurs the same wavelength assignments that have been ours since the Fourth National Radio Conference—the familiar 150-, 80-, 40-, 20-, 5- and $\frac{3}{4}$ -meter bands.

Whereas in recent months there has been some doubt about the legality of any effort to compel amateur observation of these wavelengths, there is none now—they are again binding and with the full force of law. Some amateurs, we fear, grew careless in that period when law enforcement was lax, and much off-wave operation resulted. This situation must be corrected immediately, and each of us must do his part. Most of this sloppiness has occurred on the 40-meter band where, for many reasons, it is most important that it not occur. Off-wave operation has been sufficiently extensive to cause severe interference over the entire area from 33 meters to 45 meters. As a result, our own stations have been operating in the band where our foreign brothers are to be heard, pretty completely spoiling our DX possibilities. We have badly interfered with other shortwave interests, particularly our own Navy which is an extensive user of short waves in that region; and whereas the Navy has been patient in the knowledge that this sloppiness was not an actual

breach of law, it cannot be expected that it will be patient much longer if we continue to operate on their waves.

Much more important than the spoiling of our own DX by this rambling off-wave is the fact that it spoils our record for staying where we promised to stay. If an amateur has any group pride for his game, let him get immediately within the amateur bands; and if he has no group pride, let him get there anyway, as quickly as he can, for fear of certain punishment, for be it known that the law has teeth again and "the Supervisor"ll get you if you don't watch out!"

May 1st is moving day, and it is time to clean house, fellows. Make it a point to check your wavelength and be sure you are within one of the amateur bands, and thereby you will save all of us, but particularly yourself, a lot of trouble. As concerns the 40-meter band, where most of the trouble is occurring, it is so simple a matter to observe the law that there can be no excuse. NAA at the bottom of the band and WIZ at the top are beacons that clearly indicate the limits of the band for everyone. These stations are crystal controlled and never vary in their frequency. Any amateur heard below NAA and any heard above WIZ are outside of the authorized band. Every amateur in the country can hear these two stations. Even if you haven't a reliable wave-meter, log these two stations on your tuner dial and then if you make sure that your transmitter comes between the two you will be inside the band—and safe!

IN some quite unfathomable fashion a rumor has been drifting about that the A.R.R.L. Board of Directors and A.R.R.L. Headquarters were not interested in the 150-200-meter amateur band, that they intended to turn it over to broadcasting and that they didn't care whether any provision was made for the amateurs whose interest lay in radio telephony or not. Ridiculous though such an idea is, it caused us plenty of hard work answering letters before we could overcome it. It seems desirable to make the plain statement in *QST* that the League Board of Directors has instructed the officials of the League to prepare a thoroughgoing defense of all of the presently-assigned bands, including the 150-200-meter band, and that the Executive

Committee of the League and Headquarters are doing this. We are pledged to support all of the amateur bands, and we certainly believe in it. We would like to call the attention of the gang, particularly that of the phone brethren, to the League's statement before the Federal Radio Commission when it was holding hearings on the subject of widening the broadcast band. The statement is published elsewhere in this issue.

That we were so eminently successful in preserving the 150-200-meter band from the encroachment of broadcasting is attributable to the fact that broadcasters and set builders themselves were opposed to the proposal. We did not want to lose the band and we were prepared to make the best possible defense of it, but we fear that if the radio industry had been united in its demand for it, the result would have been a different story in spite of our best efforts. There is all too little use now made of this band by amateurs. It represents twelve and one-half percent of our allotted useful frequencies and probably not more than five percent of the amateurs of the

country are equipped to-day to use it. It deserves better consideration. It is an ideal band for short-range telegraphy. It is by long odds the best band for amateur telephony. Those of us who are exclusively telegraphers have reason to be grateful to the phone men for their occupancy of this band. There is a growing feeling that telephony on the 80-meter band is a mistake and that all of our amateur telephony should be concentrated on the upper band which is so much better suited to it. There is reason to hope that the portion of this upper band made available for telephony will be materially increased soon, and the definite exit of I.C.W. from the amateur picture is indicated just as clearly as that of the spark.

Let the phone men feel that the League is behind them in the preservation of ample wavelengths and operating regulations, but let them make the fullest possible justification of the representations we have made, by utilizing the 150-200-meter band to the fullest possible extent.

K. B. W.

A.R.R.L. Policies

By Hiram Percy Maxim, President

IT has not always been easy in the past for us to carry through policies which were sound and sure. Looking back over the years I can recall several instances where great pressure has been exerted by one part of the country or another, to follow certain radical tendencies. Every time these matters have come up I have shuddered at the consequences. But, somehow or other, our Directors have always decided upon the sound and sensible course to pursue. It only shows the value of a large Board of Directors representing widely separated sections of the country. They can be counted upon to average things up.

The reward for following sound policies for several years in succession is absolutely certain. It never fails. Our A.R.R.L. reward is coming to us in chunks at this time. These are the days of the most hectic sort of radio regulation. Congress, all the Departments in Washington and the country at large are all engaged in a wild scramble for radio privileges. The influence being brought to bear to secure special consideration is nothing short of appalling. And yet, at least up to this writing, we amateurs stand firmly entrenched. We have the enthusiastic backing of every influence that counts. When we speak we are listened to. Our opinions on matters entirely out of our particular radio field are sought, and they carry weight.

The reason for this is well worth the careful consideration of every A.R.R.L. member. The position of dignity and respect and confidence which we occupy is the result of being on the right side of big questions as far back as anyone can remember. It takes years and years of careful management and right thinking to build up this good will. It could be wrecked in thirty days. But as long as we carry on our A.R.R.L. on the standards that have prevailed in the past, there will be no wrecking and we will go on and build still bigger and more powerful good will.

A Complete Inexpensive Transmitter

By Harold P. Westman, Assistant Technical Editor

THERE are quite a number of folks who would like to get into the short-wave transmitting game but who do not feel competent to overcome the technical difficulties which they believe must be encountered in the construction and adjustment of such a transmitter. There are also those who refrain purely from a financial standpoint. The transmitter which is to be described will be found to be no more complicated to build than a regenerative detector and audio amplifier receiving set and as there are but three adjustments which are fairly independent of each other, no difficulty should be encountered from this angle of the case. The cost of the complete set including material for the antenna should not exceed forty or forty-five dollars. This includes everything that is necessary to put the set on the air and start operation. The plate and filament supply is covered as are the tubes and telegraph key.

The set consists of two UX-171 power amplifier tubes used in a back-to-back or self-rectified Hartley circuit. This circuit is a very popular one in that no rectifier is required, the tubes working in alternate order so that there is at any instant only one tube in actual operation. However, as each tube is working only half the time, it is possible to make the tube do a bit more work during that time than it will normally

raw a.c. on the plate of a single tube or two tubes connected in parallel, in that it does not cause nearly as much local interference. The note obtained with it is double the frequency of that obtained from raw a.c., which makes it easier to read and more pleasing to the ear. On the whole, this circuit gives a method of obtaining a smooth-toned output with a minimum of

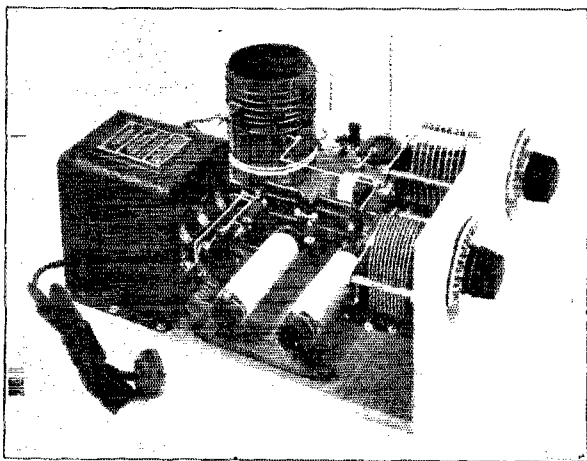

A SIDE VIEW OF THE COMPLETED TRANSMITTER

equipment and a corresponding lack of complications.

Before a man builds a transmitter, he usually puts a receiver together to see what is doing on the air and to get acquainted with the code. Looking at Fig. 1A, we find the circuit of a short-wave receiver with which you will be somewhat familiar. The batteries and phones have been omitted for simplicity. At 1B, we have the Hartley transmitting circuit which at first glance seems to bear no resemblance to the receiver. However, in examining the two we find they have very much in common. The relative positions of the tickler coil and throttle control condenser have been reversed, putting the two ends of the inductances together. This allows us to use one coil with a tap taken out at the point where the filament connects.

As the circuit is to be used in an oscillating condition, it is not necessary to use a variable throttle control condenser and this is substituted for a fixed one. Were it not for the fact that the plate supply system would be short-circuited, even this could be eliminated. Instead of putting the

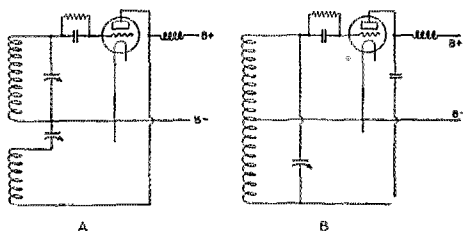
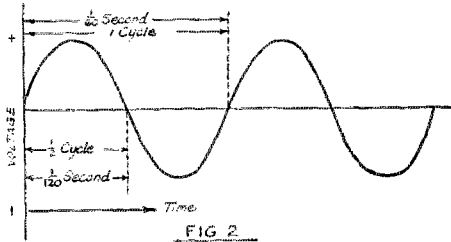

FIG. 1

do when working constantly and therefore the output under these conditions is not only half of what can be obtained with direct current on the tubes but somewhat more than half. The real reason for this circuit's extreme popularity is that the character of the emitted wave is similar to that obtained from rectified but unfiltered a.c. It differs radically from the use of

secondary tuning condenser across the grid coil alone, it may be placed across both the grid and plate coil. In this position, it is used for tuning the circuit just as in the



receiver. In both arrangements, the radio frequency choke, R.F.C. is used to keep the radio frequency current from getting into the B-battery or other plate supply system where it is of no use and may cause trouble.

In order to understand how tubes work in a "back-to-back" circuit, it is necessary to have some understanding of what an "alternating current" or "alternating voltage" is. Let us assume that we have a direct current voltmeter that will follow rapid voltage changes and also that we are able to see these rapid changes. Being a direct current instrument, it will show a deflection toward the right when the current flowing through it is in the proper direction and toward the left, or off scale, when the current is reversed. The direction in which the current will flow, depends upon whether the positive wire is connected to the positive terminal of the meter or to the negative terminal. When connected to the positive terminal the meter will read toward the right (as it should).

If this meter is connected across the 110-volt, 60-cycle line, we will find that the meter moves away from zero to the right and then returns to zero again. The next time it moves away from zero, it will move in the opposite direction or "off scale". If the "off scale" space of the meter is large enough and there is no stop to prevent, the needle will move just as far "off scale" as it moved to the right showing that the maximum voltage was the same in both cases but that the big difference was in the direction in which the current flowed. If we could count the number of times the needle moved toward the right or as it might be termed "on scale" and the number of times it moved "off scale", we would find that in one second there were 60 movements "off scale" and the same number "on scale".

One of these trips of the needle from zero to the maximum "on scale" point and

back through zero to the maximum "off scale" point returning to zero again constitutes a complete "round of events" and is termed a cycle. When there are 60 of them in a second, the supply frequency is "60 cycles" or "60 \sim ". Figure 2 shows what a diagram or picture of the variations in the voltage of such a circuit would look like. The plus and minus signs each side of the zero voltage line indicate the polarity of one wire in respect to the other one of the pair. It should be remembered that no wire is positive or negative when considered alone. It assumes a definite polarity only in respect to some other part of the same circuit. Notice Figure 3 which shows the plate and filament circuits of a tube. The plus and minus signs above the batteries designate the polarities of the ends of the batteries in respect to their other terminals, having nothing to do with their positions in the circuit. The indications would be correct if the battery were taken out of the circuit entirely. "Point 1" when taken alone cannot be considered as either positive or negative and when considered in respect to "point 2" it is positive while in respect to "point 3" it is negative. Therefore, a terminal cannot be spoken of as

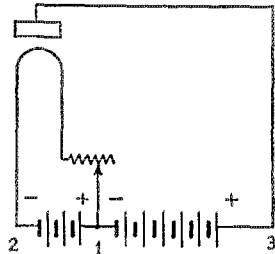

FIG. 3

being either positive or negative unless the other point of the circuit is designated or else is so obvious as not to require being pointed out. In the case of a battery standing alone, we state a terminal as being negative and understand that we mean in respect to the other terminal on it.

The use of a transformer to step up the voltage to a value more suitable for the operation of a tube does not change these characteristics and the transformer, T, shown in Figure 4, will have the same voltage changes taking place across the secondary winding as take place across the 110-volt line. However, in this case, we have another tap that is taken out at a point midway between the two outside terminals. This center tap may be con-

sidered as a pivot point, remaining at zero voltage while the two outer points, A and B, vary both in voltage and polarity in respect to this fixed zero point. When the end A, is positive, the end, B, must be negative in respect to the center and vice versa. The end, A, is positive for one half of the cycle and is negative for the other half so that its polarity is changing in accordance with the changes in the supply voltage.

If we assume that A is positive when the supply voltage is on the darkened half of the cycle in Figure 4a, the tube, X, will be in an operative condition as the plate will have a positive potential applied to it. The other tube, Y, will have a negative voltage on the plate and cannot operate. Now, after that half-cycle has passed and the lower half is being used, the conditions will be reversed as shown in Figure 5. The lower darkened portion of the cycle is being used and the end of the transformer, B, is positive while A is negative. This allows only tube Y, to operate. We therefore, have a condition where for each alternate 1/120th second, tube X is working and for the periods in which it is inoperative, tube Y will be working. This gives a condition where there is a tube always in operation although any one tube operates only each other 1/120th second.

The photo shows the general lay-out of the parts. The condenser on the left is a Cardwell 500- μ fd. type and is used to tune the antenna circuit. The other one has a capacity of 250 μ fd. This one is double-spaced but this is not at all necessary and a regular single-spaced one will do excellently. The only reason for using the double-spaced one is that it was at hand while no single-spaced one was available at the time. It is used to tune the primary or oscillating circuit. The complete circuit diagram appears in Figure 6.

The inductance is wound on a piece of Radion ribbed tubing. A length of about five inches will do nicely. Six turns of No. 14 bare copper wire are wound around the tube. Hard drawn wire may be used and will hold its shape much better than the softer material. The proper length of wire should be cut and wound tightly around a form about two-thirds the size of the tube. The wire upon being released will spring out and if the correct size form has been used, will have a diameter about a quarter inch smaller than the tube. By springing slightly, it can be worked over onto the tube, turn by turn. Small machine screws pass through holes in the tube and the ends of the wire are anchored to them. The loops of wire that the leads to the coil are soldered to, have another reason for existence. After the wire

is anchored at both ends, these loops may be squeezed between the jaws of a pair of pliers and the winding tightened so that there will be no tendency of its slipping. This saves a lot of trouble as anyone who has tried to pull the end of a coil tight and then bind it before it starts to loosen, will admit. The spacing between turns may be adjusted by eye as an exact value is not critical. The winding takes up a space of about one and three-quarters inches. The antenna coupling coil consists of three

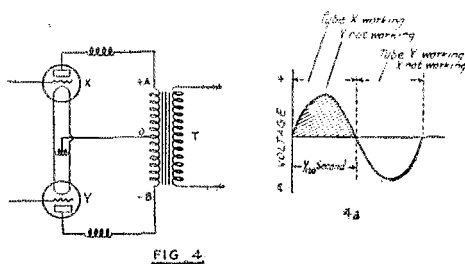

turns of No. 14 d.c.c. wire. It must be capable of being moved up and down on the form to vary the amount of coupling between it and the primary. It must also be able to hold any position without shifting. The arrangement for obtaining this condition is quite simple and consists of making one turn shy by about an inch. The ends of the wire are bent a bit sharper than a right angle and over the hooks thus formed a rubber band is slipped. The band should be of such a size or so doubled that it exerts a fair amount of pull tending to draw the wires together. This arrangement tends to tighten itself on the form and will not slip. It is flexible enough though, to allow it to be shifted along the tube without much trouble. Flexible leads are soldered to the ends of the coil so that it can be shifted without breaking them off. Due to the ribs on the tubing, the wire stands away from the coil form proper and this spacing allows a clip to be attached without much trouble. The clip may be one of the Eureka test clips or any similar one with its jaws flattened out so they will grip the wire firmly. The coil is fastened down to the baseboard by means of two brass angles.

The radio frequency choke coils consist of 125 turns of No. 24 or 26 d.c.c. wire on a one-inch form. The construction is quite obvious from the picture. The size of the wire and tube is not extremely critical and smaller wires and other size tubes may be employed. The wire may be as small as No. 30, although it gets rather troublesome to wind when it is that small. There is another choke that is connected between the

grids of the two tubes. It is most naturally called a grid choke and is inserted to prevent ultra high frequency oscillations from being generated. These oscillations occur at a frequency controlled by the grid to plate capacity of the two tubes in series and the inductance of the connecting leads. The choke raises the wavelength of this circuit to a point where these oscillations are not so likely to occur. It does not interfere with the normal action of the cir-

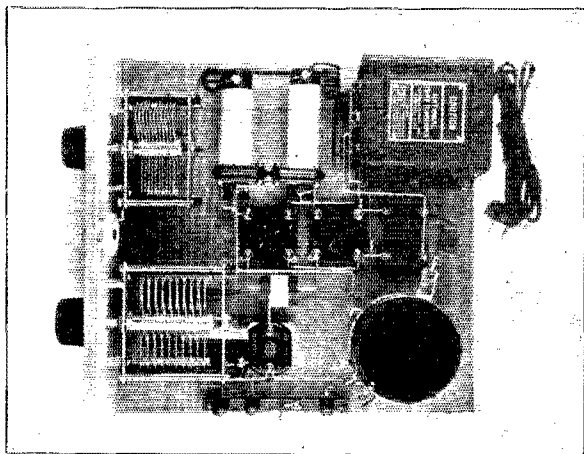

A DOWNWARD GLANCE AT THE LOW-POWERED TRANSMITTER

cuit because it is too small to be effective at the wavelength at which the tube is oscillating. It may consist of about twenty-five turns of the same size wire you use on the plate chokes and is tapped at the center.

The transformer is made by the National Company and supplies both the plate and filament voltages. It is so designed as to allow various combinations to be used. The plate winding gives 300 volts each side of the center tap with taps so that 230 volts each side may be used if desired. It has two separate filament windings. One of these will take care of two UX-210 filaments in parallel and the other is for 201-A, UX-171 or other tubes requiring five volts across their filaments. The voltage works out to be just about right when using two UX-171s. It is recommended for obtaining full life from the tubes, that the lower plate voltage be used although a greater output will be had when using the full 300 volts on 171s. Whether or not you desire full output or full tube life is entirely up to you as you may obtain either according to your tastes. If 201-As are used, the 300 volts will break them up in short order and it is strongly recommended that only 230 volts

be used on them. Even this will not allow the full life to be obtained. UX-210s may be used with the 300-volt tap without doing anything in the way of shorting their life at all. The filaments should be put across the 7.5 volt windings. In general, the UX-171 seems to be the most logical tube of them all for this particular job and is therefore recommended. Caution: To get the transformer (when ordering) that has the 220-volt tap, you must specify same or you will get the regular type with only the 350-volt tap.

All the fixed condensers used except the one across the key are of the .002- μ fd. Sangamo receiving variety. The one across the key is of .01- μ fd.

Grid leak keying is used. This system may be either quite effective or else very ineffective, depending upon the position of the filament tap on the inductance.

What happens, is that under normal conditions the grid tends to collect electrons which are piled up on the grid condenser. The grid leak which is shunted across it allows them to continually leak off the condenser and if the values of these two instruments are correct there will be a mean number of electrons on the grid condenser at all times. This quantity of electrons supplies a definite negative bias to the grid. If the resistance of the leak is decreased, the

negative bias will decrease, as more of the electrons will have leaked off the condenser. If, however, the value is increased, the bias will increase but if the resistance is made too high or is opened completely, the electrons cannot leak off the condenser and the bias rises to a value that completely shuts off all plate current. This, of course, assumes the leakage across the condenser to be negligible. In practise, the system works out quite well and it will be found that another condenser shunted across the key will help matters somewhat. The size of this condenser is somewhat critical. If it is too small, it has very little or no effect and if too large, it will cause bad arcing at the key contacts and may even encourage a key thump. The value stated in a previous paragraph will be found to be about right.

The adjustment of the transmitter will be found to be simple if done in a systematic manner. Always use the lowest plate voltage tap for the preliminary adjustments. This saves the tubes when misadjustments are made. The transformer is connected to the 110-volt, 60-cycle line through a switch which should be located in a convenient

position as you will use it quite a deal. When using 171s, the filament tap should be placed on the center turn of the coil. The switch may then be closed and with the receiver working, the key may be depressed. Tune over the receiver dial until you hear the transmitter. It should have a low-pitched note. After you pick it up, you can get an approximate idea of the wavelength from your past experience with the receiver. The limits of the 40-meter band which are 37.5 and 42.5 meters can be obtained from logging WIZ whose transmission is on 43.02 meters and NKF on 37.34 meters. NKF transmits on several wave bands so be sure you are using the right one. These two stations will allow a fair approximation of the limits of the amateur band on the receiver to be had in the 40-meter amateur band.

The primary may be shifted until the note is heard loudest at a point within the U. S. amateur band. The antenna series condenser should then be adjusted until the flashlight bulb used as a current indicator shows maximum brilliancy. It is quite possible that you will have a condition where the lamp gets bright and then as the condenser is rotated farther, the lamp suddenly drops its brilliancy. This indicates that the coupling between the antenna and primary circuit is too close and

condition where there is no hash to be heard when the key is up, is more to be desired than the condition giving maximum output. If there are too many turns between the grid and filament connections, keying will not be complete and the key may show no effect whatever, the circuit oscillating, merrily, regardless of whether or not it is closed or open. If too few turns are between these points, the circuit will not

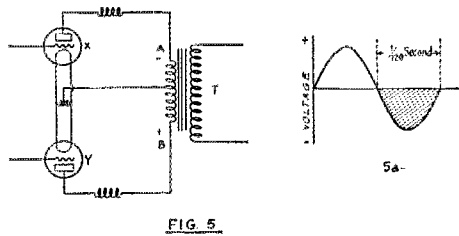
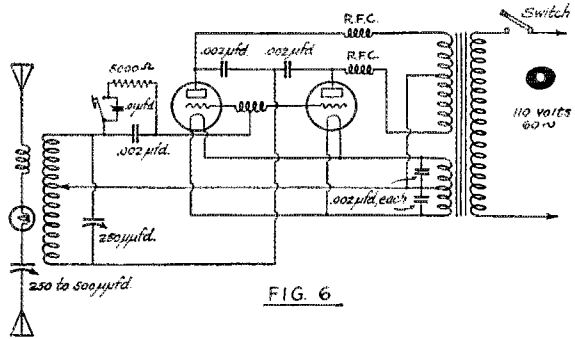

the antenna coil should be moved farther from the primary one. If, when the antenna coil is as far away as it can readily be and the same effect is the same, the antenna condenser should be adjusted so as to get maximum brilliancy with the note remaining smooth. When the coupling is made too tight, the note will break up and get very rough. It is good policy to keep a constant check on the note as adjustments are being made.

After you have a condition giving some antenna current, you can adjust the position of the filament tap so as to obtain greatest output and clean keying. The clean keying

oscillate at all or you may get a condition where it will oscillate when the key is open and quit on you when it is closed. Under normal good keying conditions, there should be a complete stopping of oscillations when the key is open although there will be heard a series of clicks which may occur at the rate of one each two or three seconds. This is due to the grid condenser having collected a large number of electrons which raises the voltage across the condenser to a point that allows a partial discharge of them across it. Such a discharge materially reduces the charge on the condenser and it takes a couple of seconds to build it up to the discharging point again. If the condenser across the key is made larger, the frequency of these discharges will decrease as it will take a correspondingly longer time to build up the necessary voltage. In practice, this series of clicks take place at such a slow rate that they do not occur between words in transmission and as far as this is concerned they may not even exist. They will be heard only when the key is up for more than a couple of seconds at a time.

The simplest and most easily adjusted antenna for this set is a simple antenna-counterpoise system, the fundamental wavelength of which is a bit higher than the working wave. While it is probable that surrounding conditions will influence your particular antenna, it is also probable that if it is in a fairly open space that a length of 35 feet from the far end to where it connects to the set for the antenna and a

similar length for the counterpoise will be about correct. This should give a system having a fundamental of approximately 45 meters which will be about right for operation in the 40-meter band.

The following parts and materials are needed for the set.

1 National Power Transformer	\$16.50
2 UX-171 vacuum tubes	9.00
2 Cardwell .00025- μ fd. receiving condensers	1.50
5 Sangamo .002- μ fd. condensers	2.50
1 Sangamo .01- μ fd. condenser	1.15
2 Benjamin UX-type sockets	1.50
1 Lynch 5,000-ohm heavy duty resistor	1.50
2 3" Dials	.50
1 Telegraph Key	2.00
1 Flashlight bulb and socket	.25
Tubing and wire for r. f. chokes	1.50
5" piece of Radion tubing (ribbed)	1.00
100 feet aerial wire (No. 12 enameled)	1.00
4 3" or 4" glass insulators	2.00
Terminal strip and three posts	.60
Panel and baseboard	1.25
Miscellaneous wire, screws, etc.	1.00

Total \$44.75

It must be remembered that no transmitter may be operated until a station and operator's license is obtained. As this subject may be revised considerably by the time this article appears in print, no information concerning it will be given herewith. Such changes as may be made will appear, no doubt, in other parts of the magazine.

2ND ANNUAL ATLANTIC DIVISION CONVENTION

Hotel Fort Pitt, Pittsburgh, Pa.

June 23-24-25.

The biggest event of the year.

Watch for details in June QST.

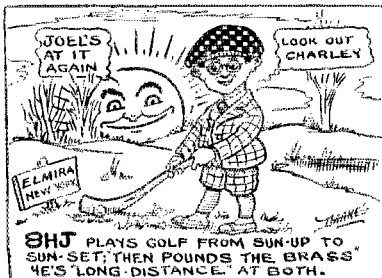

(—pounds the brassie all day and the brass all night.—Ed.)

Fixed Resistors

WE usually try and reduce the amount of resistance which is present in our circuits as it is considered as being a loss that is not desirable. However, there are times and places where a certain amount is not only of advantage but is necessary for the action of the equipment being used. Resistances to be used in such circuits should have a definite value

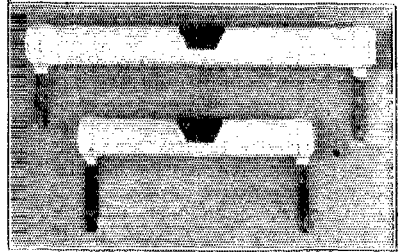

and should maintain this value throughout the life of the unit. They should also be capable of dissipating the amount of heat that will be generated in them due to the current flowing through them.

The illustration shows two units which are of the wire wound type and which may be obtained in 2-, 5-, 10-, 25-, 50- and 100-ohm sizes.

The manufacturer's rating on them covers the amount of energy that can be dissipated in them without the temperature raising to a point of noticeable warmth. This is quite different from the maximum safe dissipation allowable with the unit running warm. The 2,000- and 5,000-ohm 18 units are rated at a cold dissipation of 7 watts and will handle up to 40 watts when running warm. Likewise, those having higher resistances are rated at 12 watts and will handle up to 50 watts. The manufacturer's ratings are, therefore, extremely conservative. The units may be obtained from Arthur H. Lynch, Inc., of New York City.

—H. P. W.

Strays

For those who have too few milliammeters (meaning about 99 44/100 percent. of us) the following suggestion is given. It is due to 2DC who needed a few extra ones for his C.C. outfit. Regular receiving circuit jacks are placed in the plate circuits of the various tubes just back of the by-pass condensers and the meter connected to a plug which can then be inserted in any of these circuits. Double circuit jacks should be used and the inner terminals connected together.

Radio Regulation Returns

THE Federal Radio Commission named by President Coolidge on March 1st, as mentioned in our editorial last month, at once went actively to work and already has made tremendous progress towards the restoration of radio regulation. Rear Admiral Bullard, the Chairman, has been absent from the country up to this writing but wired authorization to the remaining members to organize and proceed in their work, whereupon Judge Sykes, the Commissioner from the Third Zone, was chosen Vice Chairman, and the Commission got to work. Congress adjourned without appropriating funds for the Commission to carry on its work and for a time this threatened to be a most serious inconvenience, but other government agencies cooperated and the Commission borrowed personnel and office equipment and got into action in a surprising short time.

On March 8th the Department of Commerce removed radio administration from under its Bureau of Navigation, where it had been since 1912, and established it as a separate organization, known as the Radio Division, operating directly under Secretary Hoover and with Mr. W. D. Terrell, formerly Chief Radio Supervisor, as the new Chief of the Division. The Bureau of Navigation was moved out of the Department of Commerce building and its quarters given over to the new Radio Division and the Federal Radio Commission.

AMATEUR STATION LICENSES EXTENDED

At its first official meeting on March 15th, the Commission indefinitely extended the station licenses of all amateur and ship stations by the following order:

"The Federal Radio Commission under authority of the Act of February 23, 1927, hereby extends the force and effect of all radio amateur and ship licenses issued by the Department of Commerce from and after this date until further orders from this Commission, this extension to be of the same force and effect as though new licenses had been issued by this Commission, subject to such general regulations as this Commission may from time to time issue."

This means that every unexpired amateur station license in existence on March 15th is extended until further notice, *regardless of its expiration date*. It may be some time before the Commission can get around to a consideration of amateur regulations, and in the meanwhile every licensed amateur is authorized to continue, provided only that he had a license on March 15.

NEW AMATEUR STATION LICENSES

The above action did not take care of new applicants who on March 15th did not have an amateur station license, and on March 26th the Commission took care of this need by ordering the Department of Commerce to arrange through its Supervisors to issue temporary amateur station licenses, pending the review and issuance of new amateur regulations. Application blanks and forms for this temporary station license are being printed as this is written, and by the time this issue of *QST* reaches the readers the various Supervisors should be in position to receive and act upon applications for new amateur station licenses, as in the past. It is to be emphasized that this applies only to stations that did not have a license on March 15th, as all licenses valid on that date are extended indefinitely. The new forms are very simple and it is believed that the new station license will simply state the authorized wavelength bands and the assigned call. These licenses will be valid only until such time as new regulations governing amateur station operation are promulgated.

OPERATOR'S LICENSES EXTENDED

Under the new law the matter of operator's licenses is exclusively a function of the Secretary of Commerce. On March 16th the Department of Commerce issued the following order:

"All radio operator licenses valid at the passage of the Radio Act of 1927, (February 23, 1927), are hereby extended for the unexpired period of such licenses."

At the same time, new regulations governing the issuance of operator's licenses were issued, changing the Amateur First Grade to "Radio Operator, Amateur Class" and the Amateur Second Grade to "Temporary Amateur License", and also eliminating the Amateur Extra First Grade, Cargo Grade, Commercial Grade Four, and the Experimental and Instruction Grade. We were very disappointed to learn that since the inauguration of the Amateur Extra First Grade Operator's license some years ago, but six of them have been issued, two of which were renewals, so that it seems unnecessary to continue that grade.

REGULATIONS FOR NEW OPERATOR'S LICENSES

The regulations governing commercial operator's licenses remain very much as before, except that there are now to be but three types, the Commercial Extra First Class, Commercial First Class and Commercial Second Class. The Supervisors are now prepared to issue amateur operator's licenses to all applicants who qualify, and it is to be noted that a renewal must be

applied for when the existing operator's license expires—this indefinite extension until further notice applies only to *station* licenses. The new regulations have the following to say about amateur licenses:

"RADIO OPERATOR, AMATEUR CLASS. Applicants for this grade of license must pass a code test in transmission and reception at a speed of at least ten words per minute in Continental Morse Code (five characters to the word).

"An applicant must pass an examination which will develop knowledge of the adjustment and operation of the apparatus which he desires to use and of the International Regulations and Acts of Congress insofar as they relate to interference with other radio communications and impose duty on all classes of operators.

"A percentage of seventy will constitute a passing mark.

"This license is valid for the operation of licensed amateur radio stations only.

"TEMPORARY AMATEUR LICENSE. Amateurs who cannot be examined at time of application may be given temporary licenses valid for the operation of a particular station until such time as examination for a regular license can be held, but not to exceed a period of one year."

Amateur licenses may be renewed without examination provided the operator has had three months satisfactory service during the last six months of the license term, or, at the discretion of the examining officer, one year satisfactory service out of two years of the license term. We understand that the examination for temporary amateur license will be similar to that used in the past for the old Amateur Second Grade license, and that this temporary license will be in the form of a letter written by the Supervisor. It is to be noted that this temporary license will authorize its holder to operate only a particular station.

The old Amateur First and Amateur Second Grades have never been actual grades—the practical effect of the Second Grade has been that of a temporary license pending actual examination—so that it is to be hoped that these changes will eliminate some of the confusion that has heretofore been evident in this connection.

THE COMMISSION'S HEARINGS

When the Commission extended amateur and ship station licenses it decided to call for new applications from broadcasting, point-to-point and coastal public service stations, and with particular respect to broadcasting it decided to hold hearings at Washington between March 29th and April 1st to obtain the opinions of the various branches of the art on the following subjects: widening the broadcast band; limitation of power; reducing frequency separa-

tion; simultaneous broadcasting with same frequency; time division; consolidation of broadcasting service; limitation of number of stations.

Naturally we amateurs were very much interested in this first item of widening the band. Prior to the hearings, Commissioner H. A. Bellows discussed some of the difficulties of extending the broadcasting band downward, and added: "Moreover, there would be instantaneous and well-founded protests from the 17,000 or so amateur radio operators who have been using the 150-200-meter band for their experimental and long-distance code communication. These operators, largely youths, have done a valuable service to radio in the past and their consideration is important."

Commissioner Bellows was quite right and at that very time the amateurs were preparing for the defense of their 150-200 meter band. Our Board of Directors at its Annual Meeting in February instructed our Executive Committee to spare no effort in defending amateur privileges. When the hearings were called our Executive Committee had a long session to lay our plans, and it was decided that our Vice-President, Mr. Charles H. Stewart of St. David's, Pa., (also the Chairman of our Legislative Committee) and Secretary Warner should represent us at Washington. They prepared our defense of our upper band and went to Washington, where several hundred representatives of all branches of the radio art were present for the hearings. The first question considered was this matter of widening the broadcast band and, just as we had expected, the broadcasters themselves and the manufacturers of sets were as much opposed to the proposal as we amateurs were. Every speaker was opposed to widening the band and there was no one to be heard in favor of doing it. As a result, it is assured that the broadcast band will not be extended to take away from us amateurs our 150-200-meter band.

Unfortunately, we are obliged to close our forms while the hearings are still in progress and the outcome respecting the major aspects of broadcast regulation is unknown at this writing. A comprehensive plan for the rehabilitation of the entire structure of broadcasting has been presented by the American Engineering Council, signed by many eminent engineers, which with possible modification seems very likely to be the basis of future broadcast regulation. These matters, however, do not further concern amateur operation.

NEW AMATEUR REGULATIONS

As soon as the Commission conveniently can get around to it, it is probable that new amateur regulations will be considered. It is with this in mind that amateur station licenses are now on a "till further notice" basis. The Commission must first clear up

the more important matters of broadcasting and, in fact, considering the forthcoming International Radio Conference at Washington in October, it is likely that they may let amateur regulations stand without further consideration until after that time. The Commissioners have been most courteous to the amateur representatives and we are assured of a hearing at the time amateur regulations are considered. There is room for considerable uneasiness about the outcome of this October International Conference, as we have pointed out editorially in *QST* before, but that will be something to worry about when the time comes.

THE AMATEUR STATEMENT

The amateur representatives received many compliments on their presentation of the amateur position made at the hearings, and in the belief that our members will be interested in knowing what was said in defense of our 150-200-meter band, the statement is published in full herewith:

STATEMENT OF K. B. WARNER

Secretary, American Radio Relay League Headquarters, Hartford, Conn.

Mr. Chairman and Gentlemen of the Commission:

Representing the American Radio Relay League, the national association of transmitting amateurs, I come before you to present what I hope can be considered a broad general view of the American amateur on this question of widening the broadcast band. We amateurs have had a long and varied experience with almost all of the branches of radio. In this respect our experience has been unique. We are acquainted by observation and experimentation and oftentimes by direct participation, with almost all of the kinds of radio for which provision has been made by American radio law. We have experience with telegraphy and with telephony and even with such things as the radio transmission of pictures. We have observed long waves, short waves and intermediate waves. We know something about commercial radio, government radio, amateur radio and even perhaps something about broadcasting. Our experience starts back in the days of spark stations long before there was any radio law in this country and comes right down to the present through all of the successive inventions and developments which have made radio what it is to-day.

It is from this broad viewpoint of the entire art, based upon this general observation of all of the forms of radio, that we desire to say to you that in the amateur's opinion there are ample channels for all necessary and desirable broadcasting that the country needs between the presently assigned limits of 200 meters and 545 meters (550 to 1500 kc.).

Now the territory above 545 meters is occupied by marine services which cannot conceivably be displaced, so that we are aware that any discussion of widening the present broadcast band must necessarily mean a consideration of extending the lower wavelength limit downward. The band immediately below the broadcasting band is the exclusively amateur band of 150 to 200 meters (1500 to 2000 kc.). We wish also to say to you that from this same broad amateur view of the radio situation it is our belief that there is ample justification for the retention of the presently assigned amateur bands. We want you to know that we are employing this 150-to-200 meter band and that we do value it. We have heard that it has been rumored that the amateur is no longer using these wavelengths and is not interested in them and would willingly give them up, but these things are not true.

If you gentlemen could have seen the correspondence that came to our headquarters from our members when these rumors were first circulated, you would have known that the reverse was true. Our Board of Directors, a nationally representative body elected by our amateur membership, at its annual meeting just a few weeks ago unanimously reaffirmed this position and instructed its representatives to appear before you to defend this band. It is true that practically all of our long-distance international amateur communication is carried on on shorter waves, but amateur radio in this country, with some 16,000 licensed transmitting stations, is itself a greatly diversified organization having activities that run in a great number of directions. Some of our amateurs are interested solely in maintaining a stable station which may be used for reliable communication with their fellows, while others are primarily interested in experimentation with apparatus, resulting in useful contributions to the art; some are interested in friendly conversation and the development of human contact with their acquaintances around the earth, thereby indubitably advancing world understanding; while others concentrate chiefly upon the handling of amateur message traffic and become most expert operators.

Many of us employ radio-telegraphy primarily in this work but some of us are more interested in radiotelephony. Now it is our amateur radiotelephone stations that are chiefly concerned when the 150-to-200 meter amateur band is discussed. Of course this band is also used for short-range amateur telegraphy where, because of the skip-distance effect, it is superior to our shorter-wave bands, but primarily we value it for telephony. This is the only amateur band in which really successful amateur telephony is possible, because all of our shorter waves are subject to technical difficulties such as audio-frequency fading which, while they do not adversely affect telegraphy, do make it extremely difficult to carry on successful telephony. Our telephony, too, is generally shorter-range work than our telegraphy, and for these ranges our shorter waves are not suitable because of the skip-distance effect. There are many hundreds of amateurs licensed for amateur telephony in this band and although the public rarely hears of them they are carrying on an active amateur work. As an indication of the scope of this activity, a prominent Detroit amateur, Mr. Henry B. Joy, who may be known to some of you gentlemen of the Commission, recently wrote me that this winter he has been hearing amateur phone stations in every State east of the Rocky Mountains and from his own amateur phone station has been in communication with many of them. These amateurs are carrying on a useful and valuable work, developing apparatus and methods and obtaining experience and transmission data in the performance of these wavelengths that are bound to advance the world's knowledge of this branch of the art.

This work would be stopped and these amateurs would be deprived of their only useful band for amateur radiotelephony if broadcasting were extended downward to 150 meters.

We say that we believe the present broadcast band of 200 to 545 meters ample for all needed broadcasting. We base this on our understanding that the fundamental need in broadcast administration now is to take care of broadcasting, not necessarily of broadcasters—to see that the public is well served rather than that everyone who may desire to run a broadcasting station is accorded the opportunity to do so. The fundamental needs of the situation therefore do not seem to indicate a necessity for more channels. The only basis on which we can see that consideration might be given the subject of widening the band by invasion of amateur territory would be in the event it is feared that broadcasters, by virtue of a previous station license, have been given a right to use their apparatus which cannot now be denied them, so that some provision must be made for them whether their operation is now held to be in the public interest or not. But we respectfully point out that if this view of a right to use apparatus is held, the same view must apply to the thousands of amateur stations, who have been licensed in this territory since ever there

(Continued on Page 26)

Some Tests With R. F. Amplifiers Below 200 Meters

By Joseph Deckendorf*

HAVING enrolled for Experimenters' Section problem R-15, I began to think over the various possibilities and to wonder if special circuits were really needed. It seemed worth while to make sure that the simplest method of all had a fair trial. Before building any sort of r.f. set, I outlined my plan of attack so that I could use what little time I had, and to finally arrive at some worthwhile conclusion. To make comparisons as to signal strength, selectivity, and sensitivity, I made a set on two panels—one with the tuner and the other with the amplifier. The arrangement was such that the r.f. stage could be cut in or out easily.

Plug-in coils were used throughout and although homemade were very rigid and good connections were provided. The circuit of the tuner alone is shown in Figure 1.

The antenna was a 30-foot wire suspended 25 ft. high; A ground system covering several blocks was used. It was an old spark ground used by station 5ZN. The

noticed except that I personally prefer the 199. The RFC consists of 120 turns of No. 30 D.C.C. wire wound on a porcelain lead-in bushing. The grid leak was variable from $\frac{1}{4}$ to 10 megs. Several fixed ones

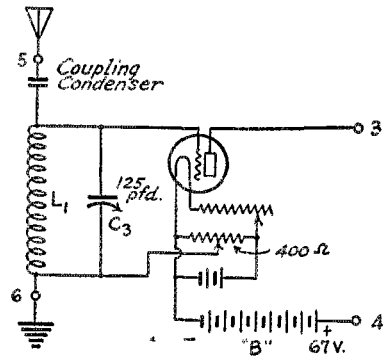

FIG. 2 THE R. F. AMPLIFIER

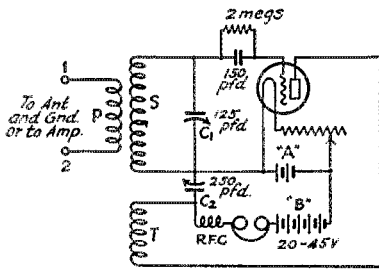

FIG. 1 THE REGULAR SHORT-WAVE RECEIVER

primary coil P had six turns for the 40- and 80-meter bands and 9 turns for the 150- to 200-meter band. The secondary S was wound on a form 2½ in. in diameter. A 9-turn coil served for the 40-meter band, a 14-turn coil for the 60-110 and a 30-turn coil for 150- to 200-meter band. A 5-turn tickler wound on a 1½ in. form serves for 40 meters, 8 turns for 80 and 15 turns for the 150-meter band. A Bremer-Tully 125-pfd. condenser serves to tune the secondary, and a 250 pfd. for the regeneration or feedback. Both UX-201-A and UX-199 tubes were used and very little difference

were substituted from time to time for comparison. I started out with a 250-pfd. grid condenser but later on got better results with 150 pfd. The 250 pfd. was o.k. on broadcast waves but was sadly out of place on the lower waves. The plate voltage was kept constant at 45.

On this tuner, as is the case with most of those in use today, there is really only one control, namely, the tuning condenser. The feedback condenser is usually set for each band and rarely needs changing.

The circuit of the r.f. amplifier is shown in Fig. 2. The coil L-1 corresponds to the coil used on the tuner for a particular band. For example, the coil L-1 had 9 turns the same as the coil S on the tuner for the 40-meter band. The condenser C-3 was a 125-pfd. B-T. The aerial was electrostatically coupled by means of two ½" copper sheets separated ¼". A 400-ohm potentiometer seemed to control oscillations and once it was set for a particular tube, needed no further attention. I have also tried a 200,000-ohm Centralab "Modulator" resistance in the B plus lead. There seems to be very little difference in results. The same type of tube was used in the r.f. amplifier as was used in the tuner. A B-voltage of 67 was used. The two posts marked 1 and 2 on the output of the tube are connected to the input posts on the tuner marked 1 and 2.

*Eagle Pass, Texas. Member A.R.R.L. Experimenters' Section.

Now for the test itself. I tune in a station on the tuner alone. Then I add the amplifier by means of a double-pole double-throw switch. In every case the signals seemed to come back with more power. Signals of just comfortable intensity were too

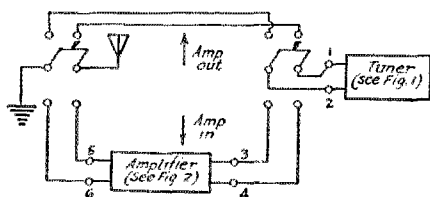

FIG. 3 THE SWITCHING ARRANGEMENT USED. NO SPECIAL CLAIMS ARE MADE FOR IT

loud when the amplifier was added to the tuner. Foreign stations which were hard to copy on the tuner alone, and whose audibility was an R-3 came in with an R-8 on the amplifier. The selectivity of the set seemed to remain the same but no trouble had previously been experienced so I made no further tests with that as my goal.

The whole set seemed to remain a single dial affair as there seemed to be one setting for each band and once adjusted needed no further attention. I have run up against the same thing in home-made neutrodynes but traced the trouble to high circuit resistance. I do not think that this could be my trouble as everything in and about the set is rigid, well soldered, well spaced and up in the air. The r.f. condenser had a setting of 40 for most work.

Now for a few tests or experiments that I performed. I tried using a UX-200-A detector tube in the set and on strong signals it failed to give any better results, and I could substitute a 201-A without any great difference. On weak signals it was a different story especially when the r.f. was cut out.

While I had the outfit up and was experimenting I proceeded to digest everything I could find on toroids, and as a result wound several "doughnut" coils and gave them a trial on waves above 60 meters. They seemed to allow for easier control of oscillations, smoother control on all waves, and a neater arrangement. I could not see where they are otherwise worth any more than ordinary space-wound coils. I would like to hear of the results obtained by others with toroids.

There seems little else to add except that I am sorry that I have no photos of the whole arrangement and I am too busy to have time to draw a diagram. By the time you get this there will probably be some other set on my table—in fact I am plan-

ning on another set. I am sure that if any one builds an r.f. set and takes care to mount all parts rigidly he will certainly be amply repaid for his trouble. Meanwhile I am anxious to try short-wave r.f. further, not only in the tuned form but also superheterodyne and super-regenerator.

STATEMENT OF THE OWNERSHIP, MANAGEMENT, CIRCULATION, ETC., REQUIRED BY THE ACT OF CONGRESS OF AUGUST 24, 1912.

Of QST, published monthly at Hartford, Conn., for April 1, 1927.

County of Hartford }
State of Connecticut } ss:

Before me, a Notary Public in and for the State and county aforesaid, personally appeared K. B. Warner, who, having been duly sworn according to law, deposes and says that he is the business manager of QST and that the following is, to the best of his knowledge and belief, a true statement of the ownership, management (and if a daily paper, the circulation), etc., of the aforesaid publication for the date shown in the above caption, required by the Act of August 24, 1912, embodied in section 443, Postal Laws and Regulations, printed on the reverse of this form, to wit:

1. That the names and addresses of the publisher, editor, managing editor, and business managers are: Publisher, The American Radio Relay League, Inc., Hartford, Conn.; Editor, Kenneth B. Warner, Hartford, Conn.; Managing Editor, F. C. Beekley, Hartford, Conn.; Business Manager, Kenneth B. Warner, Hartford, Conn.

2. That the owners are: (Give names and addresses of the individual owners, or if a corporation, give its name and the names and addresses of stockholders owning or holding 1 per cent. or more of the total amount of stock.) The American Radio Relay League, Inc., an association without capital stock, incorporated under the laws of the State of Connecticut. President, Hiram Percy Maxim, Hartford, Conn.; Vice-President, Chas. H. Stewart, St. David's Pa.; Treasurer, A. A. Hebert, Hartford, Conn.; Communications Manager, F. E. Handy, Hartford, Conn.; Secretary, K. B. Warner, Hartford, Conn.

3. That the known bondholders, mortgagees, and other security holders owning or holding 1 per cent. or more of total amount of bonds, mortgages, or other securities are: (If there are none, so state.) None.

4. That the two paragraphs next above, giving the names of the owners, stockholders, and security holders, if any, contain not only the list of stockholders and security holders as they appear on the books of the company but also, in cases where the stockholder or security holder appears upon the books of the company as trustee or in any other fiduciary relation, the name of the person or corporation for whom such trustee is acting, is given; also that the said two paragraphs contain statements, embracing affiant's full knowledge and belief as to the circumstances and conditions under which stockholders and security holders who do not appear upon the books of the company as trustees, hold stock and securities in a capacity other than that of a bona fide owner; and this affiant has no reason to believe that any other person, association or corporation has any interest direct, or indirect in the said stock, bonds, or other securities than as so stated by him.

5. That the average number of copies of each issue of this publication sold or distributed, through the mails or otherwise, to paid subscribers during the six months preceding the date shown above is (This information is required from daily publications only.)

K. B. WARNER.

Sworn to and subscribed before me this 8th day of March, 1927.

Caroline S. Crisman, Notary Public.
(My commission expires February, 1931.)

The UX-852 Transmitting Tube

By Robert S. Kruse, Technical Editor

THE whole long trail of amateur c.w. is littered with dead vacuum tubes that "went west" by some sort of break-down in the "stem", that troublesome part of the tube where all the wires come together for no reason except to permit a quick exchange of tubes—of which the ordinary amateur buys *one* in a good many months. This "quick exchange" idea with a standardized 4-prong base was fine for the Army or the Navy; a blown vacuum tube does not mean much to the United States and the main thing is to get the corpse out of the way and a new one into the set.

Now with the amateur it is another matter. A blown tube is a calamity, and he would very much like to have some sort of construction which would make base flashes impossible. On the other hand, an extra ten minutes to exchange tubes isn't particularly serious.

In 1923 or thereabouts, when amateur radio first began to work down towards 50 meters, stem-flashes and break-downs became more and more troublesome. Not because we were the only ones; only because I *know* about us is it interesting to recollect that Boyd Phelps and I blew up over 30 of the 50-watt tubes (203 and 203-A) before they were improved to their present state. Reinartz and others must have done as well—or as badly. The tube laboratories saw clearly enough that the cure for this was to follow European practice, abandon the single-ended tube and make a double-ended or T-shaped tube with the leads coming out far apart to prevent trouble. Unfortunately, it is one thing to work out a tube in the laboratory and quite another to put it on the market. The factory and the selling end of the outfit have to be convinced that, in cash or goodwill, the new tube will pay for the changeover from the old model, or else that the old model has become obsolete because radio has changed again. In the case of the American transmitting tube,

this transition was a slow and rather painful process. For quite a while the commercial folks seemed convinced that nobody outside the governmental radio services had any use for tubes. During this time the radio amateur imported his vacuum tubes in peculiar manners or else "snaffled" them—which, by the way, isn't in the dictionary with that meaning but will be understood by any Navy radio or Signal Corps man—and most amateurs.

Finally we did get tubes—meant for rather long wave work where base troubles didn't bother the designers. When these tubes began to blow up by base puncture, the folks that sold them over the counter were dead sure that the tube had been abused. It wasn't until most stations were below 100 meters that it became possible to convince these people that a 203 run at $\frac{3}{4}$ rated voltage may have a stem puncture at such a wavelength as 40 meters.

The laboratory folks—being still tied to the single-ended construction by manufacturing considerations—then did what they could to improve the single-ended tube, and they did a first rate job too. There is an amazing difference between the original 203 and 202 on one hand and the present 210 and 203-A on the other. The spacings have been improved, the plates made more solid, thin wires replaced by heavier ones, glass tubes put around the leads in the stem and so on. At 160 meters, at 80 meters—and even at 40 meters, they are quite excellent, though it would be handy if the capacity of the 203-A were smaller than it is, so that one could use more condenser in the tuned circuit, and thereby make the wave a bit steadier—but more of that later.

OUR NEXT MOVE

That isn't the end of the story. Amateur radio has been almost as slow to make full use of the 20-meter band as it was in

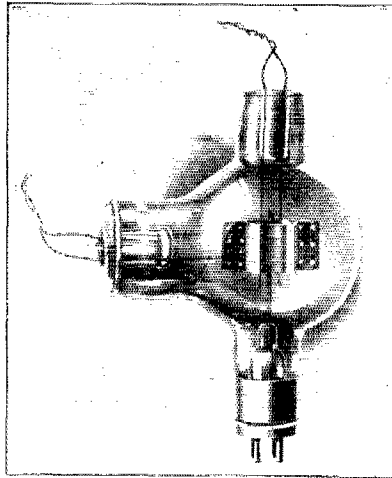

THE UX-852 TUBE

Extremely high insulation, and very low tube capacity make it an excellent short-wave tube. It may be operated at 5 meters more easily than the standard 50-watt tube at 40 meters. At 40 meters it may be used with a larger condenser in the tuned circuit, tending to steady the wave.

(Photo Courtesy R. C. A.)

getting down to 200 meters or 100 meters, 80 meters or even 40 meters; all of which have been thoroughly worth-while moves. About 8% of the ORSs have been converted now and are finding it easier to work at 20 than to fight QRM at 40 or 80—and are finding that the “skip distance” isn’t half as much of a handicap as they had been led to suppose. There will be many more active on 20 soon. Besides this, it looks as if the 5-meter band will be more in use this year than before.

At 40 meters one has to be a bit careful with tubes of the single-ended variety—and the wave isn’t any too steady. At 20 meters one has to be VERY careful and the

somewhere between this and the 204-A?” Very well—we have it, the UX-852.

THE 852'S PERFORMANCE

The 852 is rated at 75 watts output, and after the manner of the Radiotrons, the

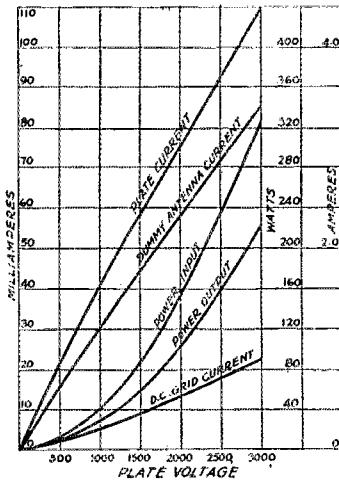

FIGURE 1. OSCILLATION CHARACTERISTICS OF UX-852 WITH NORMAL FILAMENT AND PLATE VOLTAGES. THAT IS 10 VOLTS FILAMENT AND 2000 VOLTS PLATE

wave is likely to be quite wobbly, and at 5 meters; just try to operate a 203-A at 5 meters with full output for a few hundred hours.

All of these things suggest that we need a double-ended tube or a T-shaped tube. Of course there is the 204-A—but we are not all rich. For several years we have been asking for multiple-terminal tubes and a while ago we got the first one on the American market—the De-Forest “H” tube. The contrast between that tube and single-ended tubes of otherwise similar nature at any wave below 40 meters is very gratifying. Those of us who have used the “H” tube have experienced our first real freedom from the stem-puncture and the tube-capacity nuisance.

Naturally, we thought, “Now would it not be fine if we had a tube of the T-type

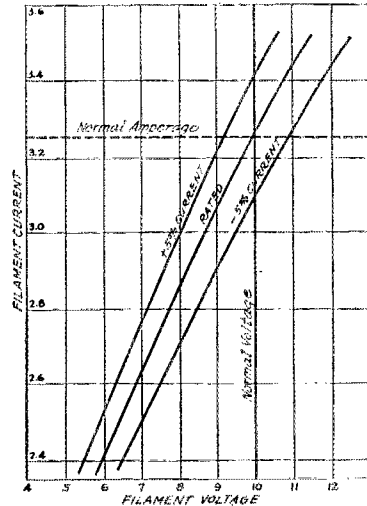

FIGURE 2. FILAMENT CURVES, SHOWING THE IMPORTANCE OF CORRECT FILAMENT VOLTAGE

rating is conservative. The tube plate is large and so rugged that 100 watts can be left on it without the least possibility of

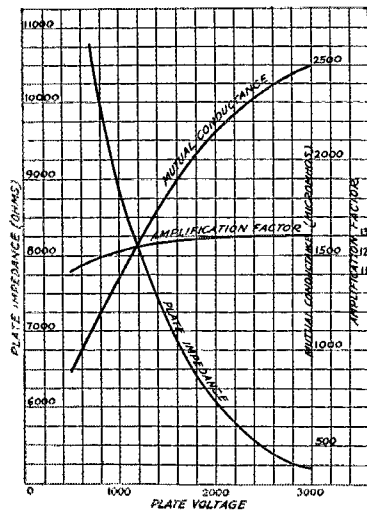

FIGURE 3. EFFECT OF PLATE VOLTAGE UPON AMPLIFICATION FACTOR, PLATE IMPEDANCE AND MUTUAL CONDUCTANCE

trouble. The insulation between leads is excellent so there is exactly no chance of trouble from flashes over any of the glass parts. The capacity of the tube is very small; it gets down to 3 meters *more easily* than the 203-A gets down to 30. The leads from the plate and grid are double and the two should be twisted together and the connection to the circuit made from the ends of this twisted pair. In doing this, some care should be taken not to break a lead off.

This *can* be done and the stubs are not

both 20 and 5 meters. The input was kept normal at 20 meters while at 5 it was first kept normal and then raised to 100 milliamperes at 3000 volts—which is of course deliberate abuse to get an idea of the performance of the tube when mistreated. Nothing in particular happened, though the plate was very much too warm. It should not run above a cherry red, which happens when about 100 watts are being left on it. If properly adjusted with normal input, the tube will show very little color on the plate, and even that cannot be seen until the filament is turned off.

Another sample tube has been used to test the insulation between filament and plate or grid. With the filament cold, 5,000 volts could be applied between it and the plate without any fuss of any sort—nothing happened. It was not judged wise to try such a test between grid and plate or grid and filament but these stood 750 volts without disturbance. With the filament burning, the tube would block the plate current whenever the grid was left "open", even

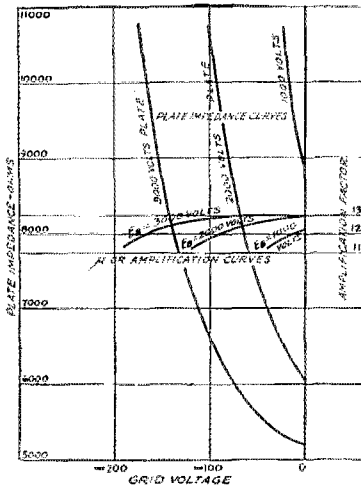

FIGURE 4. EFFECT OF GRID VOLTAGE UPON PLATE IMPEDANCE AND AMPLIFICATION FACTOR

easy to get at since they are down inside the stem, next to the mash. It seems that the plate and grid stems might be equipped with some sort of metal cap but it is possible that the heat of the tube would then start cracks. It does not matter much—a chance on a broken lead is made up for by the satisfaction of using a tube that does not make poor contact in the socket, flash-over inside or crack open because of a brush discharge.

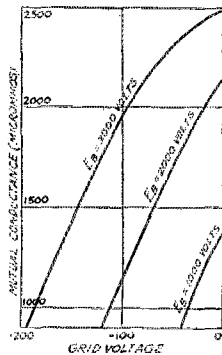

FIG. 5. EFFECT OF GRID VOLTAGE UPON MUTUAL CONDUCTANCE

A sample tube used here has operated on an automatic key for several hundred hours at

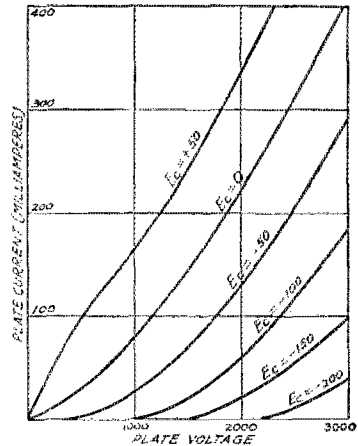

FIGURE 6. STATIC PLATE VOLTAGE-PLATE CURRENT CURVES WITH DIFFERENT GRID VOLTAGES

with voltages as high as 3500, showing that the grid insulation is excellent. Single-ended tubes seldom show such margin over normal requirements.

CIRCUITS AND SENDING RANGES

Just why anyone wants to show circuits or talk about the transmitting ranges of a tube, I do not know. Any good tube should work in any standard circuit, though it is more convenient to use shunt plate feed on low impedance tubes and series feed on high impedance tubes. A low-capacity tube will

allow the use of more tuning condenser and that is good, for the condenser capacity is steady but the tube capacity is wobbly and tends to wobble the wave.

The sending range naturally depends on the antenna and the number of watts in it, not forgetting the plate supply. Whether the 100 watts in the antenna happen to come from a 204-A, a 203-A, an 852 or a group of 210s, does not matter in the least.

0 and then at *plus* 100. The tube is required to have a low secondary emission. If the grid current reverses when the grid is positive, that tube is rejected.

CONSTANTS AND CURVES

Most of the necessary data about the tube can be gleaned from the curves, though it is well to remember that the antenna currents shown apply only to one particular dummy antenna at one particular wavelength. It is of course not possible to prophecy your antenna current with the 852 any more than it is with other tubes.

The constants of the tubes are as follows. Filament: 3.25 amperes at 10 volts.

Plate: 75 milliamperes at 2000 volts.

Largest safe plate dissipation 100 watts, equal to cherry red.

Rated output: 100 watts under the conditions listed.

Amplification constant: 12.

Internal capacities: With the plate grounded.

Filament-grid: 1.8 picofarad.

Filament-plate: 1.6 picofarad.

Grid-Plate: 3.3 picofarad.

The very low capacities are quite impressive and show why the 852 can be used at all amateur waves, down to and including 1 meter, with some fixed condenser to steady the wave.

The variable "constants" are as follows, with normal plate and filament voltage.

	With grid at 0	With minus 100 grid volts
Plate impedance	6000	9000
Mutual conductance (Mhos)	2.0	1.3

That provides about all of the information needed and we will have a better start with the 852 than with any new tube ever presented to us.

Strays

The regular run of QSL cards bear as much resemblance to each other as do the grains of sand found along the seashore. (I suppose someone will take us up on this and tell us of all the various related families of sand there may be.) We have recently run across a couple that gave promise of being somewhat different in that the usual blagh was camouflaged by appropriate drawings, etcetera. If your card is *different* send one in to Harold P. Westman, 1711 Park Street, Hartford, Conn. Maybe a few samples of these will help us to get away from the terrible monotony.

1BJE, who uses a "Talking Tape" antenna on his S.W. receiver, noticed a discrepancy in its length and a search showed about fifteen feet of it sewed on Mrs. 1BJE's new dress for gold trimming.

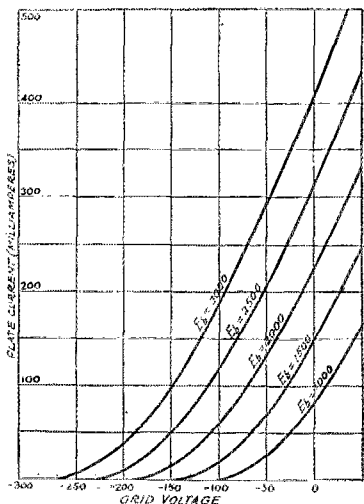

FIGURE 7. STATIC GRID VOLTAGE-PLATE CURRENT CURVES WITH DIFFERENT PLATE VOLTAGES

That the 100 watts happen to reach Hong Kong or Johannesburg does not prove that either is good or bad—the signal would have been the same if the 100 watts had come from any other sort of tube. The main business of the tube is to manufacture r.f. watts. If it does that steadily it is a good tube, even though it never has a chance to work for a good operator in a good location. As it happens, the 852 has some nice work to its credit—but that isn't what makes the tube good—nice long-range work has been done with a UV-199, which does not make it a sending tube.

TESTING

In addition to the usual tests that are given to a sending tube during and after manufacture, the 852 is tested in a 5-meter sending circuit and is required to keep on oscillating when the filament voltage is reduced to 2.

A secondary emission test is made with 750 volts plus on the plate; the filament a bit below normal and with the grid first at

A Method of Grinding Quartz Plates

By Paul Mueller*

QST has explained in previous issues how a suitable quartz crystal can be chosen and at what angles the rough slabs or "blanks" for oscillator plates may be cut. The method of doing that cutting and also the method of grinding the blanks down to actual oscillators of the desired thickness afterward deserves some discussion.

CUTTING THE "BLANKS"

The "blanks" may be cut from the crystal by means of a "muck saw". This may be a disc of copper or soft iron about 10" in diameter and 1/32" or 3/64" thick. It is driven at about 150 r.p.m. while the crystal is clamped in a slide at the desired angle

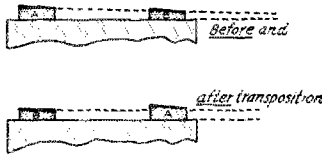
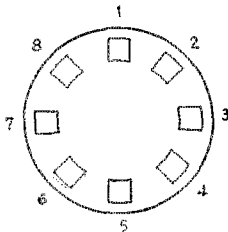

WHY TRANSPOSITION CAUSES THE PLATES TO APPROACH PARALLELISM

FIG. 1

and pulled against the revolving disc by means of a cord, a pulley and a weight of 2 or 3 pounds. Since the disc itself will not cut it is provided with teeth by spoon-feeding it with 150 emery and water. A pan underneath catches the drippings which may be used over and over.

GRINDING THE "BLANKS"

Since we are interested in making plates to be used as radio frequency oscillators it will be necessary to grind the rough blanks to an exact flat surface and to get the two faces as nearly parallel as possible. If the crystal is to work at one particular frequency it is further necessary to do this by

a method which will keep the crystal flat, parallel and smooth all during the latter part of the grinding since one does not know just when one is to stop, except by making frequent tests in a tube circuit. It is of course possible to do the grinding by hand and to work "free hand", but it is a practical certainty that this procedure will cause the formation of various "zones" and pits and will also tend to make the sides non-parallel in various ways during the process. It follows that the crystal will refuse to oscillate at various times during the process and one of these times is quite likely to be the one at which the crystal has attained the desired frequency—in other words, one may have to "grind past" the desired spot before the thing goes to work again.

Even if an exact frequency is not desired it is still easier to work by a method which has more of a tendency to produce plane-parallel surfaces than does the ordinary hand method. Now it is rather hopeless to do this thing by mechanical exactness—that is to say by attempting to construct a very accurate surface grinder. One will have better success by using a method which depends on allowing errors to come in and then making them cancel each other.

THE METHOD

It is necessary to grind at least 9 of the little plates at once so they may as well all be quartz, tho the method can be worked as well by using one quartz plate and 8 glass "dummys".

The first step is to cut (with the muck saw) a square slug of quartz from the whole crystal and to rough-grind this slug and to chamfer the corners. The slug is then sawed up into slabs somewhat thicker than the final oscillators are to be (.1 inch larger).

Next these slabs are ground fairly flat with 150 emery and water, holding the crystals in the fingers and working as carefully as possible because an error is easy to make but hard to grind out again.

ROUGH PARALLEL GRINDING

There are now prepared three cast iron "laps", which is to say plates of cast iron planed flat. One is a foot square and the

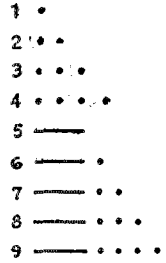

FIG. 2

* Hartford Machine Screw Co., Hartford, Conn.

other two are 8" discs, all being about 1" thick.

The rough quartz "blanks" are now cemented to one of the 8" discs with a mixture of beeswax and rosin in the pattern shown in Figure 1. Depending on the particular rosin and wax that you have, different proportions will be needed to secure a cement that will hold without being too brittle when cold. The cementing is done by heating the 8" disc until it will just melt the cement which is then applied as evenly as possible and allowed to "flatten down", after which the quartz blanks are set into place, each one being pressed down firmly. If good results are to be gotten the blanks should be located carefully and none of them should have any bad "fins" left from the first rough grinding.

Now put on the 12" square lap a supply of the grit that was left from the muck saw and invert the 8" disc with the quartz blanks on this. Start grinding by pushing

First Transpose	1 and 5	3 and 7
2nd	"	2 and 6
3rd	"	3 and 1
4th	"	6 and 2

FIG. 3

the disc to and fro with short strokes, always shifting the hold on the disc. The pressure should be very light and as even as possible, allowing the weight of the disc to do most of the work. When the slabs have been ground to the same plane so that all parts of the surface have been ground wash off the grit, heat the slab gently and slide off the blanks which must then be washed free of all cement, using benzine. The plate also must be cleaned carefully. Now heat the plate gently, brush on a thin coating of the cement, press the slabs down again with the freshly-ground faces down, cool and repeat the grinding process.

We now have both faces of all the crystal flat but they are neither true or parallel.

PARALLEL GRINDING

To get the faces parallel the slabs are removed as before and replaced at random without making any attempt to get them in the same positions or to have the same side up. Grind for a time, remove and shuffle them again and repeat the operation until the slabs are only .03" oversize.

The scheme of random transposition will serve well enough to get the faces roughly parallel; to get them more exactly parallel a systematic transposition and great exactness is required.

FINE PARALLEL GRINDING

The three cast iron laps are taken to a good machine shop and ground flat on a

surface grinder until they are true enough so that (when they are cool and dry) no light can pass between their surfaces and a good straight edge set on the surface.

The cementing, grinding and transposing is then continued as before with the following changes:

a. When cementing keep everything spotlessly clean and use almost no wax at all. While the wax is cooling press the plate down by using the second iron disc as a weight.

b. Mark the slabs on their edges with white paint so that they can be identified during the systematic transposition that is to follow. Figure 2 suggests a code for marking.

c. Use flour emery until all the scratches are removed and the slabs are within .005 inches of the desired thickness.

d. When transpositions are made they should be done in accord with the system explained in Fig. 3.

FINAL GRINDING WITH "4-MINUTE" EMERY

The final color of the plates is ground on with "4-minute" emery. When ready for this the 3 iron laps are cleaned and then worked together (use all 3 of the possible combinations) until the previous grit is broken down and the plates are dead flat again. This is done with "4-minute" emery, the preparation of which will be explained later.

Now clean the iron laps, cement, grind and transpose as before but use the "4-

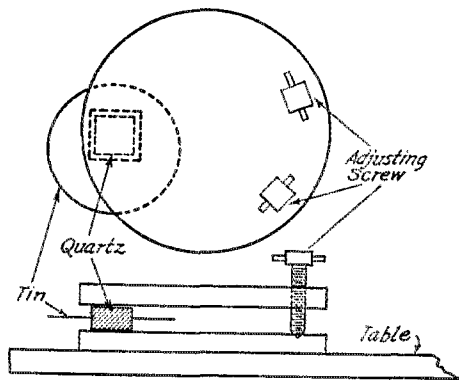

RIG FOR TUNING GRINDING
FIG 4

minute" emery until the crystals are ground to the same even color. Only experience will tell how far each of these stages is to be carried. In general the processes are slower and slower as one goes along, therefore each step should accomplish as much grinding as possible without danger of creating errors or scratches that cannot be taken out by the next step.

PREPARATION OF "4-MINUTE" EMERY

Take all the drip from the fine grinding or procure some emery of the grade SF 10 X Washington Mills. Place about 3 tablespoonfuls in a 2-quart Mason jar of clean water and shake thoroughly. Allow this to stand for 2 minutes and then siphon (not pour) the top 3 pints off. The pint that is left contains the heavy grit which will not do for this work. Shake up the pint left in the jar with an additional 3 pints of fresh water, allow to settle and again siphon off the top 3 pints.

The 6 pints of water that have been siphoned off contain the light grit that is wanted. This should be shaken up and strained thru 4 or 5 layers of cheesecloth to remove scum and then allowed to stand for 3 or 4 hours, after which all but a pint may be siphoned off. This remaining pint contains the desired fine grit.

TUNING

If the crystal is to be worked to a definite frequency it must be touched up separately. Drill and tap two pointed adjusting screws into one of the 8" discs, spotting the holes lightly in the other plate. Grind the plates flat against each other with "4-minute" emery and then put in the screws and adjust so that the plates are separated by the thickness of the slab (crystal) which is to be ground. The crystal is now put in and becomes the third point of support. Slide the crystal back and forth with a piece of tin having a hole that fits the crystal *loosely*. The position of the pin and the direction of the stroke must be changed constantly. Use almost no loose emery but let that embedded in the iron plate do the work. If the embedded emery stops cutting take the whole affair apart and recharge the iron laps by rubbing them together with "4-minute" emery and water.

GENERAL

As was suggested before, the whole thing can be done with one quartz plate in the central position surrounded by nine plate glass dummies which are transposed as one goes along. As a matter of fact it might be a good idea to try the whole process on plate glass before spoiling any quartz. One learns just as much and it is cheaper.

EDITOR'S NOTE

At the author's request the foregoing article was submitted to Mr. Russell W. Porter of Springfield, Vt., who is well known as an authority in the grinding of telescope reflectors and the like. He comments as follows.

"I assume that the oscillator plates are not polished and therefore cannot be checked by the methods of light interference.

"In general I should say that the method here described would hold the plates flat

to the order of a few hundred thousandths of an inch and parallel to something under a minute arc, the accuracy of parallelism being governed by the number of transpositions and the care with which the plates are cement to the base block.

"A few moment's polishing on a pitch lap would permit fringes to be seen in monochromatic light and the actual conditions of the plate to be determined readily. This would be my only suggestion."

Radio Regulation Returns

(Continued from Page 17)

was a radio law in this country, and to whom all previous national radio conferences have made this 150/200-meter band an exclusive assignment.

Because useful amateur work would be stopped and amateurs would be deprived of their only useful phone waves, and because we believe that the improvement of broadcasting conditions requires regulation of the number of and the operation of broadcasting stations rather than an increase in the band assigned for broadcasting, we respectfully urge that the broadcasting band be not extended in such a fashion as to deprive the amateur of this territory which is so valuable to him.

At some more favorable opportunity when your body is in position to entertain the subject, we shall be pleased to have an opportunity to discuss with you some of the details of amateur regulations. Unlike most classes of radio users to-day, however, the amateur in general is quite content with his existing situation and is not asking for additional privileges; at this time he is asking only that broadcasting be not permitted to take away from him his own telephony band.

—K. B. W.

Strays

Want some more maps like the ones the Burgess gang sent out some time ago? They tell us they have some maps of both the U. S. and the World and also some log books which may be had by any amateur asking for them. It is necessary to include your call when writing. Address your request to the QRM Department, Burgess Battery Company, Madison, Wisc.

A budding neophyte writes in and says that his transmitter is causing interference to the neighbor's BC receiver. He takes the antenna-counterpoise off of his transmitting set and the QRM stops. What he wants to know is if there is something wrong with the antenna. We'll say the only "trouble" with it is that the danged thing must be radiating.

50E tells us that it is possible to repair burnt out audio transformers and loud speakers by putting the open winding across the high voltage end of the plate supply transformer. The key is pressed for an instant and the arc that takes place should weld the broken wires together.

Some Convenient Relays

By Robert S. Kruse, Technical Editor

As has been said in a number of recent *QST*'s, relays can make a number of jobs easier about the amateur radio station. Amateurs seem to be worried by the problem of constructing relays, therefore it seems worth while to mention a few of the easily obtained types that can be diverted to uses the maker did not think of.

In the last few months there has been a good crop of the so-called "Automatic

turned on the antenna is automatically taken off the receiver and transferred to the transmitter while at the same time the plate voltage is taken off the detector. The B-battery is left connected to the audio tube of the receiver which picks up enough of the transmitter energy to make a readable signal to guide one in sending. The connections are shown in Fig. 2. The reason for choosing the Jewell relay in this case was very simple—I happened to have it first, by reason of meeting John Miller at the New York Radio Show. The same thing can be done with any relay that does not have too much capacity between the parts and has the springs insulated from the armature. The choke L is a circuit trick to steady

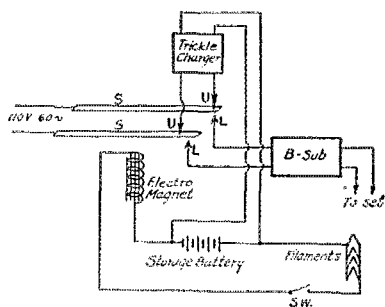

FIG. 1

ONE OF THE COMMONEST USES OF THE A-B RELAY, CONTROLLING A BROADCAST RECEIVER, THE BATTERY CHARGER AND THE B-SUB, FROM THE SWITCH ON THE SET. THE ACTION IS EXPLAINED ELSEWHERE

Controls" or "A-B relays". These amount to the arrangement shown in Fig. 1. The 110-volt supply is connected to the two springs S-S which operate between a pair of upper contacts U-U and a pair of lower contacts L-L. When the broadcast receiver is turned on by means of the switch sw, the filament current flows thru the magnet windings and pulls down an armature (not shown in the diagram) which is connected to the springs S-S by a strip of insulation. The springs are thus pulled down onto the contacts L-L, which connects the 110-volt supply to the B substitute. When the switch sw is turned off the springs rise and touch the contacts U-U, starting up the trickle charger.

OTHER USES

These relays come in a big variety of forms at various prices ranging from \$7 down to \$2.50 or thereabouts. Since they are expected to work without adjustment they are usually rather well made and suited to a variety of uses. For instance, I have been using a type 595 Jewell A-B relay as a combination antenna switch and ear-protector at 10A. The filament current of the transmitter is run thru the magnet windings and whenever the transmitter is

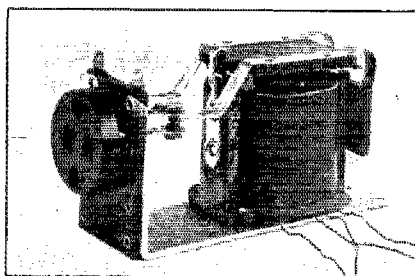
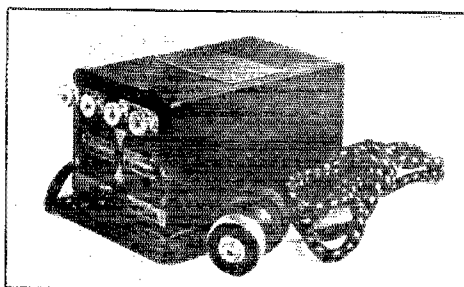

INNER AND OUTER VIEWS OF THE BRACH MODEL RU "CONTROLIT"

This relay has a rather slow magnetic circuit, large armature and long springs making it rather easy to get solid contact on a.c. or partly filtered d.c. The one tested operated with currents in the neighborhood of .5 ampere for the series connection of the two windings and about 1.1 ampere for the parallel connection. The release was at about .4 and .9 respectively. The contacts are of German silver and carbon and performed satisfactorily with a 600-watt load.

the pull on the armature which otherwise would be pretty unsteady as the transmitter filament current (as usual) is a. c. The idea is approximately that L has a much higher inductance and lower resistance than

the relay armature, therefore it takes most of the current and also has a different phase than the magnet. The result is that during the low spots in the a. c. this choke supplies a momentary "kick" to the magnet and holds it up, which prevents

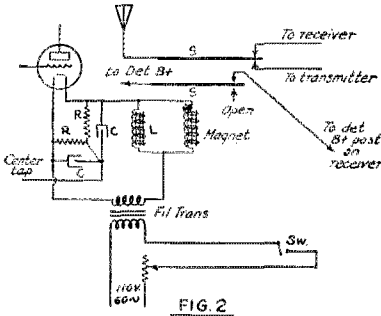
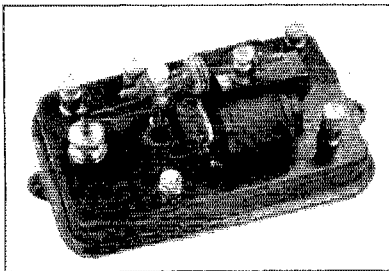

FIG. 2

AN ADAPTION TO TRANSMITTING STATIONS OF LOW POWER

Turning on the transmitter filaments transfers the antenna and cuts off the plate battery of the detector. CC & RR are a center-tap arrangement necessary because the usual center type of the transformer cannot be used with the connection shown.

chattering of the contacts. The exact size of the choke does not matter. I happen to use the secondary of a 150-watt transformer meant to step down from 110 volts to 3 volts. Naturally it would not be a



THE NON-FLICKER KEY AT 1KP-NRRC

This is a Manhattan (MESCO) 20-ohm telegraph relay supplied with large silver contacts made of dimes. It is used in the circuit of Fig. 4 to control a pair of UV-204-A tubes and a dummy load of 200 feet of No. 22 stove pipe wire.

very good idea to use this antenna switching arrangement with very much power in the antenna; it is recommended for "baby" transmitters only.

KEYING

It seemed likely that a keying relay might be gotten from one or the other of the makes of set control relays and several were tried with that in view. The performance of the contacts was surprisingly good in all cases. The Brach "controlit" for instance keyed a 600-watt load at 15 words per minute (110 volts, 60 cycles) without

any apparent distress after 15 minutes of steady operation when the magnet was being operated on d. c. obtained from a No. 6 dry cell. The response at this voltage was as good as with a greater direct voltage. This is natural since all of these devices are designed to operate at less than 1 volt.

With none of the relays was it possible to obtain especially good operation with a. c. to the magnet, even when a variety of stunts was tried to steady up the ragged pull on the armature. The stunt of Fig. 2 was o. k. for simple transfer switching but did not answer for keying. This was given up as a bad proposition with no regrets, dry cells only cost 40c apiece.

The "snappyness" of the keying seemed to depend mainly on the shortness of the armature and springs. Types such as the

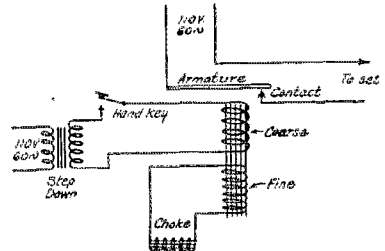

FIG. 3. USING A FORD GENERATOR CUTOUT AS A MAGNETIC KEY

The connections shown are for a.c. operation of the key but a battery may be used. The right value of the choke depends on the current and the condition of the contacts.

Yaxley Automatic Power Control responded promptly and cleanly even at high speeds (as amateur speeds go) while those with the longer armatures did not follow a "bug". It would be nice if we could compel a lot of our operators to install a relay that refuses to follow fast, "light" sending. By the way—the stunt of Fig. 2 works *worst* with the "snappy" sort of relay and best with the rather slower ones.

One of the best of the makeshift keying relays was suggested by 1KP. It is the ordinary Ford generator cutout—price from 90c both ways. The creature comes inside a stamped steel shell which is welded on very firmly, the theory being that one never repairs these affairs but throws them away. For radio purposes this shell must be taken off by grinding the welded spots out with an emery wheel, after which the shell can be thrown away or used to hold powdered rosin for soldering. The magnet has two windings—a fine wire one and a coarse wire one. These should be disconnected from the frame and contacts which leaves one with a magnetically operated single-pole single-throw switch or else a magnetic key. Like most of the other fast relays this one will

not work well on a. c. "as is" but its performance in that direction can be improved by putting the working current thru the coarse winding and connecting a good big inductance to the fine winding as shown in Fig. 3 Here again one seems to be working hard to save a 40c dry cell but it may be worth while where the keying line is long or where the set is used intermittently so that the batteries tend to die overly-soon. If one does use batteries the fine winding is the correct one since the coarse one calls for a very large operating current. Of course the affair can be re-wound but it is hardly worth the trouble.

AN ANTI-FLICKER RELAY

In many places the regulation of the 110-or 220-volt line is not good and a radio transmitter is unpopular because the lights go up and down whenever the key is operated. Of course if the load is within ordinary household limits (say 250 watts or so) the flicker should not be serious and a bad flicker indicates that something is not as it should be. The pole (or manhole) transformers are probably too small or spaced too far apart. Generally the question isn't worth arguing with the light company—it is simpler to install an arrangement such as shown in Fig. 4. When the key is down the set is connected to the line—when it is up the load R is connected to the line. Thus the lights go down and *stay down* when the changeover switch is thrown to the sending side. They come up again when the switch is put back on the receiv-

relay shown in one of the photos acted very well on a single 50-watt tube which was drawing its normal 125 watts, the balance load being a rather scrambled assortment of lamps, Ward-Leonard resistors and carbon

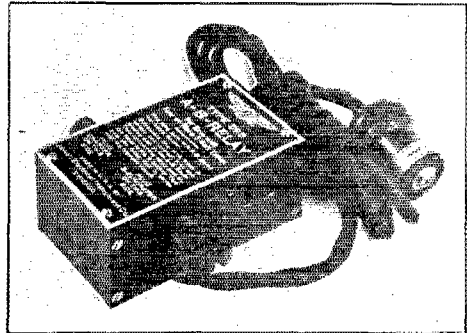
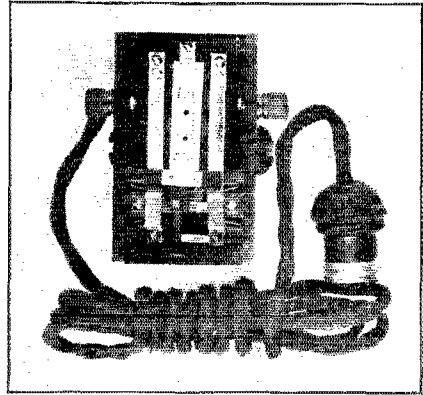

OUTER AND INNER VIEWS OF TYPE 595
JEWELL A-B-RELAY

The capacity between parts is unusually low in this relay though the construction would not lead one to suspect this. This of no importance unless used as suggested in Fig. 2. The one tested operated at .35 amperes and released at .1 ampere. Another type is furnished with a fine wire winding to be connected across a five-volt circuit.

rods—anything to waste enough power to cut down the "blink". Since the armature is long and the spring not very "snappy" this relay will not follow a bug. That does not bother an "18-word-per" chap like myself—and I suspect that a great many of those I hear *ought* to be held down to that speed.

At 1KP-NRRC, Beekley is using a similar arrangement but in much better form. His relay is shown in one of the photographs. The circuit arrangement is the same as that shown in Fig. 4. A pair of 204-A tubes, working at 3000 volts with an input of 200 milliamperes is handled with this rig without much damage to the lights which used to dive and swoop wildly.

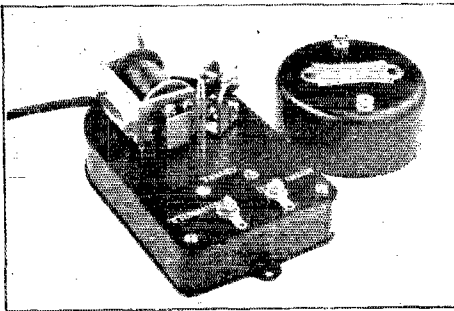

THE YAXLEY NO. 444 AUTOMATIC POWER CONTROL

A short armature quick action relay with silver contacts. In the one tested the relay closed at .45 ampere and opened at .07 ampere. This relay follows the key very well but must not be expected to handle a very large load.

ing side. This means that there is only one "blink" for a transmission period instead of several hundred of the same.

Such a keying system may be worked with any relay that provides a back contact and is willing to follow the speed of keying that is desired. The "Reliable Parts"

MODIFICATIONS

In any of the schemes where a constant load is wanted the same general scheme can be put in at some other point in the transmitter circuit, remembering that it is gen-

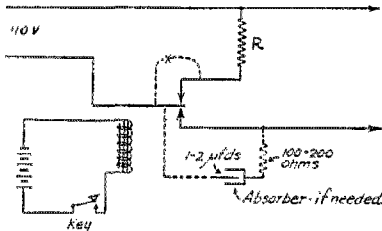
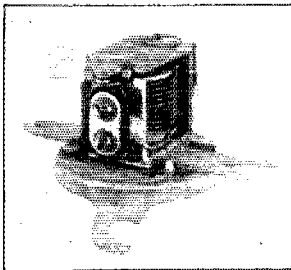

FIG. 4. AN ANTI-FLICKER KEYING SYSTEM USING A MAGNETIC KEY WITH A BACK CONTACT AND A DUMMY LOAD R

If the dummy is a choke another absorption circuit may be needed at X.

erally harder to devise a good dummy resistance for a higher voltage. About the best bet is a series of 15-or 25-watt tungsten lamps if one must have such a resistance. Since their resistance varies all over the lot as the filaments warm up one may as well forget all about arithmetic and just go at it cut-and-try. Usually when trying to



FORD GENERATOR CUT-OUT WITH HOUSING REMOVED

key a plate load one needs a disgusting number of the 15-watt lamps and the 25-watt ones turn out to be too large. Probably in your case these rules are both wrong.

If an a. c. load is to be keyed (either a rectifier input or a 110 or other low-voltage input to the set) one can save quite a lot on the light bill by making the dummy load an inductance instead of a resistance. The anti-flicker condition is that the current drawn from the line in the two key positions must be the same; the power can be widely different. If, therefore, you can rig up something in the way of a choke with an adjustable airgap or a tapped winding so that the thing will draw 3 amperes at 110 volts (with a nice rotten power factor) the anti-flicker effect will be the same as if you were using a resistance drawing 3

amperes. The difference is that the resistance will be drawing 330 watts—and charging you for it on the meter—while the choke may be using up only 75 watts or so. It is no good at all to give rules as to laying out the choke unless one has a reasonably good description of both the station and the line conditions. Again cut-and-try is the rule, starting out with the things you happen to have.

Incidentally—these steady-load affairs all must be snappy in action and the contacts must be set closely, otherwise there will be time for a poor line to cut up while

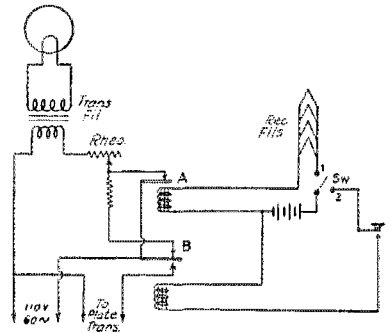

FIG. 5. A CIRCUIT TO KEEP THE A. C. CIRCUITS OFF THE OPERATING TABLE AND TO KEEP THE TRANSMITTING TUBES WARM

When the switch Sw is on contact 1 (receiving position) the relay A is down and the relay B is up. This supplies the filament transformer thru the resistance R. When the switch is on contact 2 (transmitting position) the relay A is up, supplying the filament transformer at full voltage except as reduced by the rheostat. Relay B is either up or down depending upon the key position. Plate power cannot be supplied to the transmitting tubes except when the filaments are at full brilliancy.

the armature is going across. If there is trouble with arcing an absorption circuit may be connected as shown in Fig. 4 (dotted lines).

A TUBE SAVER

In at least two amateur stations the arrangement of Fig. 5 is used. The idea is that when the operator is receiving, the tubes are lighted dimly, keeping them warm. As soon as the receiver filaments are turned off the transmitter tubes come up to full brilliancy without delay, also the note does not take so long to settle down. The scheme is also supposed to have the advantage of keeping the 110-volt circuits off the operating table so as to keep things a bit quieter. I would rather leave the receiver filaments burning, cut off the plate current by an automatic switch and work some such combination as shown in Fig. 6. These schemes (of Fig. 5 & 6) assume the use of separate antennas for sending and receiving which is good practice. Frankly, I do not think

a great deal of the scheme described in Fig. 2, because the antenna does go thru the relay.

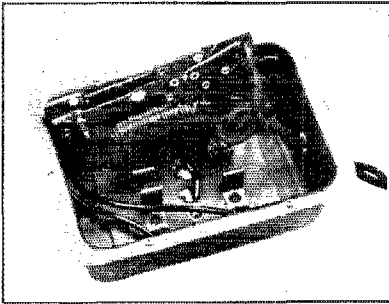

**RELIABLE PARTS MANUFACTURING COMPANY
AUTOMATIC CONTROL SWITCH**

Unfortunately this relay had to be partly disassembled to expose the armature and magnet. This is a single-pole double-throw arrangement. The exact operating limits are not known but a 250-watt load was handled and fairly good operation gotten with a.c. to the magnet without any steadying inductance. A similar relay by the same makers operated at .5 ampere and released at .1.

All of this has been written from such uses of standard relays as have happened to come to my notice. Other uses will

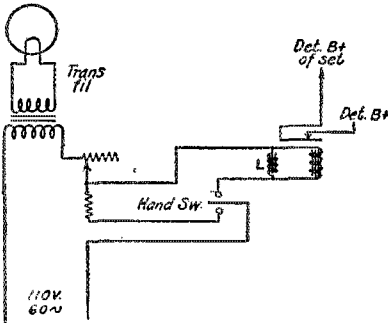

FIG. 6. ARRANGEMENT FOR CONTROLLING DETECTOR B BATTERY AND RECEIVER FILAMENTS WITH ONE SWITCH

The inductance L is used more to cut down chattering noise from the relay than for any electrical reason since the relay contacts work only when no current is flowing thru the relay.

suggest themselves as the need arises. The intention here is not to cover all the possibilities but simply to suggest that the relay is a useful thing for the radio amateur.

**Michigan State Central Division
Convention**

May 20-21st, Hotel Tuller, Detroit, Michigan

FOR the sixth time, Michigan will stage its annual convention, this time in Detroit. Look at the dates above, fellows, and put two big red crosses on the calendar.

Ralph Thetreau, convention secretary, tells us it is going to be bigger than ever, and the affair is being sponsored by the City of the Straits Radio Club and the Radio Research Club. There will be so many things to see and hear that space does not permit us to print the details, but the high lights of the program will be: visits to outstanding local amateur and broadcasting stations; technical talks on crystal control; master-oscillator power-amplifier operation; mercury-arc rectification, etc. You know the Michigan fellows; enuff sed.

\$5.00 is the total cost. Just write R. P. Thetreau, 5012 Sheridan Ave., Detroit, Mich., and tell him you will be there.

We almost forgot; Larry A. Jones, Assistant Communications Manager, and O. M. Hebert from A.R.R.L. Headquarters will be with us.

**A.R.R.L. Information Service
Rules**

Please help us by observing the following rules:

1. Keep a copy of your questions and diagrams and mention that you did so.
2. Number the questions and make a paragraph of each one.
3. Make diagrams on separate sheets and fasten them to the letter.
4. Print your name and address (not merely your radio call) on your letter. Don't depend on the return address on the envelope as this is destroyed when the letter is opened.
5. Don't ask for a comparison of the various manufacturers' products.
6. Before writing, search your files of QST—the answer probably is there.
7. Address all questions to Information Service, American Radio Relay League, Inc., 1711 Park Street, Hartford, Conn.
8. It is not essential to enclose an envelope as long as you supply postage and **PRINT CLEARLY** your name and address on your letter.



The Air Pirate

SHORTLY after last Thanksgiving day, the broadcast listeners of Lancaster, Pa., became the object of the wrath, or whatever else it may have been, of a misguided individual who apparently took extreme delight in breaking up their concerts. His method was quite simple and he used a spark coil with a gap connected directly in the antenna circuit. The results were excellent as far as the manufacture of interference was concerned. The towns-folk not only admitted this but actually asserted it in the newspaper as well as via the "grape vine telegraph".

Reception anywhere from 20 meters to above 5,000 was impossible and public opinion of "those amateurs" ran somewhat above the tepid point. This seems to be the usual reaction to interference and it was practically impossible to make anyone be-

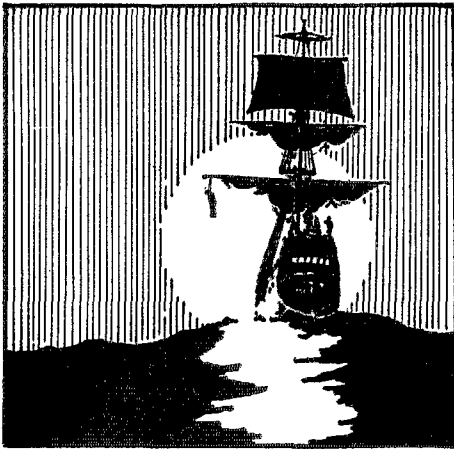

lieve that the amateurs themselves were just as much interfered with and could do no work through the rumpus.

The interference was on about one night each week and seemed to be for the benefit of the local BC station. This saved the hunting party much time as they could make all their preparations in advance and could tell just about when they should start out on the hunt.

S. E. Fraim, 3BIT, gives us the following report on the proceedings. "In company with E. W. Fohl, 3VB, and John A. Roehm, 3ADM, I started out and, in the course of the next few weeks, we spent many nights driving around the streets of Lancaster in the writer's car with a superhet BCL loop set.

"After many guarded inquiries and many nights of such waiting, we finally made some headway. On the night of

January 28th during the course of the opera broadcast by WJZ and its chain, the interferer did his worst. He broke up the entire opera program from start to finish by playing with his key, imitating the starting of a train and by alternately keeping time with the opera as it was broadcast.

"While all this was going on, we were working fast and after getting several different readings on him, we located his house and station in one of the toughest and worst sections of the city. We found the source of the disturbance to be in a chicken coop in the rear of the dwelling. We kept very quiet and did not go in as we were not sure but that he had some confederate watching and that it might go hard with us if we were discovered.

"After talking things over, we got into immediate touch with the U. S. Radio Supervisor at Philadelphia. He came up to Lancaster on Thursday of the following week and although we sat around waiting, the "Pirate" did not again come on the air. The inspector wanted to catch him at it but after waiting till after 10:30 on Friday night and not hearing him, he decided to end the matter there and then and went into the house. We found part of his apparatus and the Inspector did the rest. The "Air Pirate" is no more.

"There were several other would-be and well meaning investigators working on the case, who by the leadership of a certain chap unwittingly balked almost all of our moves by his inappropriate actions. We did the whole thing secretly and to this day, there are only five of us, including the R.I., who really know who the "Air Pirate" was. It is for this reason and partly to keep the "Pirate" from bodily injury after the R.I. gets done with him, that the whole matter has been kept secret. The present feeling in some quarters of the town is to tar and feather him.

"No names were published in the newspaper but our work was terminated in a notice that the "Air Pirate" was no more. We, as amateurs, have performed our duty to clear the air and this, being finished, we will simply sit back unannounced and forget about it, chalking it up as another radio amateur's service to his community."

These men deserve a great deal of thanks for their splendid, unselfish work and we would like to say that this account was sent at the request of headquarters for our information, but we feel that such actions should be brought to the attention of the rest of the membership as well as the broadcast listener to help promote a more brotherly feeling between these two neighboring groups of radio enthusiasts.

—H. P. W.

Successful Electrolytic Rectifiers

By S. E. Hall*

THE operation of a lead-aluminum cell as a rectifier depends upon the formation of a thin film on the surface of the aluminum. This film (which seems to be some hydroxide of aluminum) allows current to flow in one direction only, that is from the electrolyte to electrode. Various theories have been advanced as to the exact part the film plays in the operation of the cell, but no definite information is available. Hydrogen gas is given off at the aluminum and oxygen at the lead, or positive electrode, whatever material is used. If lead is used, lead peroxide is formed on the surface and appears as a chocolate-brown coating. These actions always take place, regardless of the solution used, but the breaking down and reforming of the compounds in solution depends upon the composition of the salts themselves, and if several salts are used, especially organic compounds, the reactions may be very complex, so will not be discussed here.

ELECTROLYTES

In practical operation there is a considerable difference in electrolytes as to temperature characteristics, their creeping, forming and moulding tendencies, etc. Some electrolytes operate satisfactorily with lead or iron as negative electrodes, others do not.

Electrolytes can be divided into two general classes; organic and inorganic. Inorganic solutions generally are not as efficient as organic solutions in actual DC/AC ratio except in very dilute solutions. Solutions of phosphates, citrates and acetates, for instance give more efficient results than borax or baking soda. From the results of numerous tests it seems that the greater the molecular weight of the salt in solution, the more efficient the operation. Small dilute inorganic solutions, however, have a very high break-down voltage, possibly 400 to 500 volts, but the solution has to be so dilute that the useful life is shortened.

Electrolytes of the organic class also have their disadvantages. Usually they are much more expensive, and besides, lead or iron are not very satisfactory in combination with them. Lead, and lead salts generally, are soluble in acetic and citric acids. If the rectifier is left idle for a few days, some of the lead dissolves and deposits on the aluminum electrode as metallic lead. This deposit sometimes gets quite thick and appears as a black film on the surface of the

aluminum. It can usually be removed electrolytically, but this requires considerable time and no rectification is going on while any of the deposit remains. It has been found that the lead does not deposit on the aluminum as long as any of the aluminum hydroxide film remains. If a black deposit is in evidence, you may be sure that the film is all gone, and the rectifier will have to be put through the forming process again. If the rectifier is in continual operation, lead or iron can be used with good results. In case the rectifier is to be left idle any length of time, the elements should be removed from the solution. Much better results can be obtained from a solution of this class by using carbon instead of lead or iron. Ordinary dry cell carbon is all right, but arc light carbon is better, as it is less porous. The carbon will finally disintegrate, however, and have to be replaced. The life of the carbon can be lengthened by boiling it in paraffine, then scraping the layer of paraffine off the surface. Solutions of this class also have a tendency to mold, and to foam while in operation. The mold is the result of the citric or acetic acid content. The foaming is the result of the gassing of the cell causing bubbles on the surface of the solution. The bubbles do not readily burst because of the syrupy nature of the solution. A layer of oil will help to prevent the molding. If a solution of this class is to be used, plenty of room must be left at the top for foaming. These solutions are not so troublesome about creeping as some of the inorganic solutions.

Borax solution is not as good as many others of its class. It evaporates very readily, creeps worse than most any other solution, and is not very satisfactory in dilute solution. A saturated or nearly saturated solution seems to be best for this salt. Lead or iron can be used with it to good advantage.

Sodium bi-carbonate seems to be a very good salt of the inorganic class. It is very satisfactory in dilute solution (about $\frac{1}{2}$ oz. to a gallon of water). It is very cheap, has no molding or foaming tendency, is not bad about creeping, and iron or lead can be used with it.

Possibly ammonium salts are a little better to use than sodium or potassium salts, as the hydroxide of the metal is formed at the aluminum electrode, and aluminum is slightly soluble in alkaline solutions. Ammonium hydroxide is not so active chemically as potassium or sodium hydroxide.

Ammonium phosphate and sodium-potas-

* Engineering Department, The Prestolite Co., Inc., Indianapolis, Indiana.

sium tartarate are very good salts, but are more expensive.

Chromates, dichromates or ferric iron compounds added to a solution in very small amounts tend to stabilize the film of the aluminum. A small quantity of a bi-carbonate added to an organic solution will tend to precipitate insoluble lead carbonate, as lead goes into solution.

Solutions or tannates and oxalates are not as good as the phosphates, acetates and tartarates, as they are less stable in operation, usually breaking down and forming complex salts, which do not help the operation of the cell.

EFFECT OF COUNTER E. M. F.

Results of tests seem to indicate that one of the big factors governing the life of the rectifier is the potential difference between the aluminum electrode and the electrolyte, with the valve closed that is not passing current, the film of the surface of the aluminum acting as the dielectric. There seems to be a breaking down of the salts in the solution, taking place at the aluminum electrode and the rapidity of this action is proportional to the potential difference. An instance of this follows: 100 c.c. of a certain solution were used, and when charging a 48-volt battery, at a given rate, the life was 67 ampere-hours. The input was at 110 volts A.C. With another 100 c.c. sample of the same solution a 6-volt battery was charged at the same rate, using 20 volts A.C. input. To date the second rectifier has delivered 380 ampere hours and is still in good condition. In the first instance we have, roughly, a total of 160 volts potential difference between the aluminum electrode and the electrolyte, with the valve closed, and in the second instance only about 26 volts. Just what action is taking place is not definitely known. Of course, only in battery charging will a counter E.M.F. like this be encountered.¹ For reasonable life and good rectification, 30 to 40 volts per cell seems to be enough.

Generally speaking, the life of a rectifier is directly proportional to the weight of salt in solution. However, the more con-

centrated the solution, the lower will be the break-down voltage.

FORMING

Special care must be exercised in the initial formation of a rectifier, if a number of cells are being formed in series, using a high voltage transformer. When the circuit is first closed it is practically a dead short across the transformer secondary, and the current will be quite high until the film is partially formed. At first, close the primary circuit of the transformer for one or two seconds at a time, for about twenty times, or until the current drawn from the transformer is not over its rated capacity.

If an old solution which has not been entirely exhausted is at hand, the initial forming of new electrodes can be done in it. If sodium bi-carbonate is used, there is a heavy, white, flocculent precipitate formed at the aluminum electrode, which rapidly settles to the bottom. Very little is formed after the film is on the surface of the aluminum, and after formation is complete, the elements can be transferred to a fresh solution. Considerable of the material making up the solution is used up in the initial forming, therefore, by doing this in an old solution, the accumulation of sediment in the fresh solution is practically eliminated, and considerable gain has been made in the life.

The character of the surface of the aluminum is more or less responsible for the length of time required for formation.

The maximum current density used in forming should not be higher than normal operating density, about 50 mils per square inch. If sparking occurs, the rate must be reduced, as the film is being destroyed as fast as it is made.

A well formed aluminum electrode should appear very smooth, and look as though it were covered with a thin layer of white paint, having no gloss.

HEATING

It has been found that there is a critical temperature above which it is unsafe to operate a rectifier. The critical temperature varies somewhat with different solutions, but generally it is well not to operate above 120° F. When the critical point is reached the film on the aluminum begins to break down. This allows an increase in leakage current which in turn causes a further increase in temperature, until the rectifier is ruined. The decomposition of the aluminum is usually the result.

Most of the heat is generated at the aluminum electrode and can be radiated more or less successfully by several methods. The volume of the electrolyte can be increased, fins or flanges can be attached to or incorporated with the electrode, (that

1. When a rectifier supplies a tube circuit (either receiving or transmitting) WITHOUT A FILTER the back voltage on the rectifier is only the transformer. When a filter is used the back voltage consists of the transformer voltage plus the voltage that is left in the filter — and the better the filter the bigger this left-over voltage, which accounts for the fact that a better filter sometimes results in a worse tone because the voltage-per-jar has been made too high and the rectifier has begun to break down, sparkle and generally make "hash" that cannot be filtered out. A few more jars will cure the trouble. When charging a battery the back voltage is that of the transformer plus that of the battery, counting the gassing voltage of the battery. In all of the above the transformer voltage to be considered is that at the peak of the cycle — roughly 1.4 times the rated voltage. Tech. Ed.

part which is not submerged), or the whole thing can be put in a water bath. Operating with sparking at the electrode will increase heating, besides producing poor rectification. In case sparking occurs, the voltage per jar should be reduced, unless it is a defective cell. Possibly the best thing to do is to add more cells, and with the same input voltage this will automatically reduce the current density, by increasing the ohmic resistance. There is very little heat generated at the negative electrode and current density there makes very little difference.

INSTALLATION AT 9ASJ

The installation at 9ASJ is a forty-eight cell rectifier, using bridge connection, and a very dilute solution of sodium bi-carbonate for electrolyte. The jars and assembly racks are the remains of two 48-volt, type LRR, Prest-O-Lite storage "B" batteries. These jars have a volume of about ten cubic inches and are filled up to about $\frac{3}{4}$ inch of the top. About $\frac{3}{4}$ inch of transformer oil is poured on top to reduce evaporation. Lead strip, 1/16" by $\frac{1}{2}$ " was used as negative electrodes.

The first rectifier put in operation at this station had a rather short life, due to a poor grade of aluminum. The electrodes became streaked and badly pitted, and were very thin near the bottom toward the end of life. The first two conditions are good indications of poor aluminum. This was discarded, and new aluminum substituted, using new solution, and the old lead electrodes. The second set of aluminum electrodes are $\frac{1}{2}$ " wide by .008 inch thick, and have been in operation about three months. There is no evidence yet, of pitting or streaking. They are kept immersed about 2". The plate current varies from 150 to 180 mils, with no sparking. The temperature rise in two hours operation is negligible. Keying is done in the negative lead, between rectifier and filter, so the full transformer voltage is across the rectifier when the key is up. Slight sparking occurs at the instant the key makes contact. Input is 1100 volts, 60 cycles². The voltage across the rectifier terminals with the key closed is 520 volts, with the key up 600 volts². The transmitter uses two UX-210 tubes, and they handle 75 to 90 mils at that voltage without the least bit of coloring of the plates. The filter at present is only a 1 microfarad, 1750 volt, condenser². When operating four or five nights a week, for about three hours a night, it uses about a quart of water, in that time.

CURRENT DENSITY

Reports of different investigators concerning the maximum safe current density, per unit area, do not check very well. The shape of the electrode has a direct bearing on the results, that is, the area exposed compared to the volume of the electrodes and the natural cooling facilities. There seems to be little limit to the current density that can be used, *if the temperature is kept down*. However, densities of over 50 mils per square inch can only be used with difficulty, unless some special cooling method is used.

LEAKAGE AND CAPACITY CURRENTS

When the valve is closed, A.C. may come through in two different ways. One is as a leakage current coming directly through the film, and the other is as a capacity current, flowing through the condenser formed by the electrode and the electrolyte, the film being the dielectric. In both cases the current flow is directly proportional to the area submerged. This is the best reason for submerging the smallest surface of the aluminum that will carry the current without abnormal heating. Usually, leakage current amounts to very little, and if the efficiency is fairly high, a small filter is all that will be necessary. However, a mixture of pulsating D.C. and A.C. with all sorts of wave forms, is almost incapable of being filtered.

CONCLUSIONS

For good results combined with low cost, the writer is partial to a dilute solution of sodium bi-carbonate. (baking soda) possibly it is no better than sodium-ammonium phosphate, Rochelle Salts, or several other salts, or mixtures of them, but it is very much superior to the old stand-by, borax.

Remember that the more concentrated the solution the lower the break-down voltage. Don't saturate the solution.

If one or more cells spark, and submerging more aluminum surface does not help matters, discard the cell, or at least, that particular piece of aluminum. If it does help, don't submerge any more aluminum than necessary.

When figuring the aluminum surface necessary for the 50 mils per square inch, don't forget to figure *both sides of the strip*.

When you pay a big price for material for a solution, for which extravagant claims are made, take the claims with a grain of salt. Such claims as the following: "This solution will not pit the aluminum," should not be accepted, as pitting is nearly always caused by impurities in the electrode.

2. It, of course, varies with the plate current.
Author.

3. The voltmeter drew 35 m.a. at 600 volts.
Author.

Emergency Transmitters

By Rufus P. Turner*

ALL ships are required by law to carry not only emergency power supply devices but also extra transmitters which may be put into operation at any time such use is warranted. This is the most logical means of insuring continuous operation. It would be well if Official Relay Stations should also have emergency plate-filament supply.

On shipboard, the emergency installation is referred to as the "auxiliary apparatus" and the writer can see no reasons why this term should not be used in amateur radio to designate emergency plate-filament power units. Hence, the term will be used throughout this article for that purpose.

That amateur auxiliary apparatus is needed, particularly in Official Relay Sta-

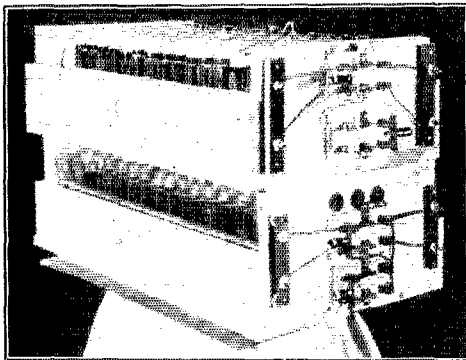

AN EXCELLENT EXAMPLE OF AN EMERGENCY POWER SUPPLY

At station 1AWW, operated by T. Frank Cushing of 78 College St., Springfield, Mass., there is used a plate power supply consisting of 18 trays of Edison storage batteries of which two are shown here. By means of gang switches the trays are connected in parallel for charging, which takes 7 hours when a special Tungar is used. With the switches thrown to the series position the trays become a 1200-volt d. c. source which will operate the 50 watt oscillator thru a week of ordinary traffic. The filament supply is obtained from a 12-volt storage battery. The battery power has been found so satisfactory that it is used exclusively and power-line interruptions of a day or two mean nothing at 1AWW.

tions, is a fact long since presented. Continuity of operation is preferred to freak DX transmissions by the well thinking and progressive amateurs of today. There is nothing better for amateur radio than continuous operation which carries with it the faithful keeping of schedules.

*1AY, 11 Wellington St., Boston, Mass.

It is rather common to read in the divisional reports such sentences as; "Station 3——is off the air for a time pending repairs" or "9——is holding funeral ceremonies over his only tube——will be back on air as soon as new bottle arrives". Let's put an end to this interrupted operation by keeping efficient auxiliary apparatus in the station.

Amateur auxiliary apparatus varies in design with the likes and dislikes and financial standing of the owner of the station. Some prefer and can afford an elaborate dry B-battery arrangement. Some have a soft spot for a small battery-driven dynamotor while still others hook in a spark coil. Each accomplishes the purpose though one may do it in a more pleasing way than the other.

The neatest and most efficient installation the writer can recall was seen in the third district. By means of a d.p.d.t. cam-switch mounted on the transmitter panel, the operator was able to throw into use either the regular transformer-rectifier or a high-voltage bank of batteries. Only one motion was necessary—a simple upward flip of the switch handle. On one occasion when the main fuses blew, the operator was forwarding a message to a "9". When the lights went out, he throw the switch and the message went on with a break so small as to be practically unobserved at the other end.

In Rochester another installation was found which is deserving of mention. The auxiliary apparatus consisted of a Navy dynamotor driven by a 24-volt storage battery so connected that a single throw of a switch started the dynamotor and cut in a tube. In one position, the switch would send the full 24 volts into the machine causing it to deliver 1500 to a fifty-watter. In the other, it caused the dynamotor to be driven on a 6-volt section of the battery and deliver 500 volts to a five-watter which was also cut in by the same switch. The switch was a four-pole double-throw device and the battery supplied filament current as well as driving current to the dynamotor.

The regular power unit at this station was a transformer-rectifier ("S" tubes).

The clever operator had considered not only the possible failure of his regular power unit but also his tubes. The idea is certainly worth trying by all of us who can afford it. Such unique arrangements are praiseworthy and commendable.

Many other stations were visited in view of finding the approximate number of those

equipped with auxiliary apparatus and to obtain some worthwhile data for this article but it seemed that the general practice is to have a bank of batteries or a "B" eliminator so arranged that it may be switched into the circuit.

In attempting to determine the "best" piece of amateur auxiliary apparatus, the writer placed the names of the devices in

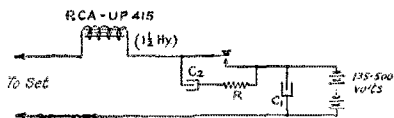

FIG. 1. KEY THUMP FILTERS

The resistance R may not be necessary but if used should be adjustable from 1,000 ohms on down. C1 and C2 are condensers with a capacity from 2 to 4 microfarads. C1 is not always necessary. If the battery voltage is above 350, better key with a relay so that the plate voltage does not reach the key.

question on separate sheets of paper and under each name, the good qualities were placed in one column and the bad ones in an opposite one. These qualities were determined by faithful experimentation with the device. Concluding was a matter of "weighing the data in the balance". (Apologies to the originator of this system—one Thomas A. Edison.)

The experiments proved to be exceedingly interesting and the writer has boiled the data from the sheets down into paragraphs which follow.

BATTERIES

One of the simplest and most popular pieces of amateur auxiliary apparatus is the common B-battery, used to supply the plate potential, and a suitable high-capacity storage battery for the filament. At more than a score of stations equipped with auxiliary units, batteries were found arranged in some convenient corner.

The only real continuous current anyone has ever heard of is delivered by batteries. A generator is good if one can find a good filter but it lacks the smoothness of batteries at best.

Either dry or storage B-batteries may be used to energize the plate of the transmitting tube. So much has appeared in other issues concerning the cost, upkeep and results that it is hardly necessary to delve into those topics.

The clear, bell-like note produced by a battery-operated transmitter is often mistaken for crystal control if the antenna is steady, the leads taut and motionless and the tubes in good condition. The note cuts through the worst of QRM and QRN. A source of annoyance resulting from the

use of battery operated transmitters is bad keying. At best, key clicks may not be eliminated "right off the bat" but a little experimentation with key thump filters will bring the desired results. An excellent filter is shown in Fig. 1. The choke is a Radio Corporation UP 415 plate reactor made to use for Heising modulation and the condensers were salvaged from a Bell telephone. This arrangement of condensers and choke coil was found to be very good. Back issues of QST carry a number of other key click filters which, like the variety of oscillating circuits, are worth our while trying.

The Burgess battery people have in print several engineering circulars which have to do with B-batteries and their efficiency in radio transmission. These circulars may be obtained for the asking by addressing the Burgess Battery Co., Madison, Wisconsin. The most interesting publication is the one describing fully the Arctic transmitter and receiver run entirely by Burgess batteries (both "A" and "B" being dry).

STORAGE BATTERY DYNAMOTORS

Very popular also as a piece of amateur auxiliary apparatus are the small motor generators driven by storage batteries. These machines may be obtained at ridiculously low prices from many QST advertisers who are selling Government surplus stock. The writer subjected two of the dynamotors to tests. The first was a 12-350 machine and the second a 24-1500 device.

The first machine was driven by a twelve-volt battery and drew fourteen amperes.

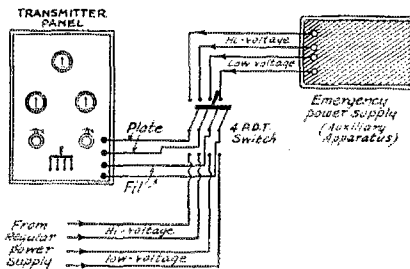

FIG. 2. ONE WAY OF CONNECTING THE MAIN AND AUXILIARY POWER SUPPLIES TO THE TRANSMITTER

It delivered 350 volts d.c. and 143 milliamperes. Its input power was 168 watts and output approximately fifty watts. This machine is very neat, being less than a foot in length and about seven inches in diameter.

The second dynamotor was driven by 24 volts and ten amperes, its d.c. output of 1500 volts (233 milliamperes) was so

(Continued on Page 49)

A Portable Antenna Tester

By A. E. Teachman*

OUR little friend (or enemy) the compact Radiola III regenerative receiver makes a very practical portable antenna tester and trouble shooter. It readily finds faults in broadcast receiving antennas though the faults are not visible. The method of making such tests will be described as if a Radiola III were being used but the entire scheme is thoroughly adaptable to short-wave practice.

Such a portable tester is particularly valuable to the radio service man and the experimenter. It can be made conveniently portable by constructing a case just large enough to hold the set, two small 22½-volt B blocks, the headset, and one dry cell which is enough for portable work. Since audio quality is no object the C-battery is left out and the -C post connected to the -A post by means of a jumper as shown in the circuit diagram of Figure 1. Two good long leads with clips should be included to facilitate connections to the antenna and ground, which are to be tested. In all of these tests the only one of the four antenna posts used is number 3.

D. C. LEAKAGE TESTS

To detect a grounded antenna or a leak (even of high resistance) between antenna and ground simply remove the antenna wire and touch it to the tip jack which is connected to the plate. As the set is ordinarily turned this is the jack nearest the operator. This method of test simply connects the B-battery, phones, and antenna

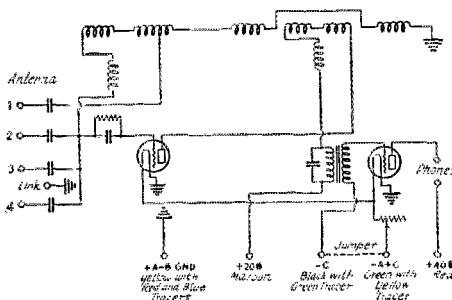

FIG 1
CIRCUIT DIAGRAM OF RADIOLA III

system in series. The phones are very sensitive and will readily detect a leak of 50,000 ohms. Even if there is no leak or short a slight click will be heard when the contact is made because the antenna acts

as a condenser and receives a charge. If the antenna is good no click will be heard when the contact is broken. Poorly insulated and defective lead-ins and lightning arresters are common sources of leakage.

OPEN CIRCUITS

For this test the receiver should be connected in the usual manner with the antenna wire on post number 3. Advance the tickler far enough to cause oscillation. To test for a break in the ground wire touch the ground post of the receiver with a moistened finger. If the receiver stops oscillating there is a break in the ground wire. When the ground wire is covered with insulation and the break is therefore invisible the easiest stunt is to have an assistant follow the length of the wire and make contact with it at intervals by pushing a knife edge thru the insulation. The receiver will stop oscillating every time the wire is touched until the break is passed. If the ground wire is complete and o.k. there should be little or no effect when it is touched, unless the ground wire is extremely long and that is in itself a bad condition.

When there is a break in the antenna the effect is to shorten it and therefore to cause the set to howl very easily with only moderate settings of the regeneration control. In the case of a long lead-in whose upper end has broken loose from the antenna, reception will be possible but familiar stations will be found too high on the tuning scale. This would not be detected easily except with a single circuit tuner. Breaks in the antenna can be located in the same manner as described for the ground wire. If the lead-in and the antenna are o.k. throughout their length the receiver should stop oscillating when the wire is cut at any point.

HIGH RESISTANCE IN THE ANTENNA SYSTEM

All that has been said thus far has been only in the nature of pointing out a different way to find troubles which anyone could discover by the more tedious method of passing a direct current through the wires. We must next deal with antenna system or more especially ground resistance.

It must be admitted that good judgment and good workmanship go a long way toward the making of a good antenna, but the best of judgment cannot tell us the effectiveness of a ground connection.

To say that one can operate without a ground connection is correct, but it is nonsense to believe that one can operate with an aerial only. The best aerial wire that can be put up cannot possibly be any more

*Union Village, Woonsocket, R. I.

efficient than its other half (it might well be called its "better half"). There must be a "ground side", somehow, be it a counterpoise, direct connection, or via capacity of the receiver to the earth. It behooves one then to know what kind of a ground connection he is using. This has been out of the question for the average experimenter, because of the apparatus required. The fol-

Now the set is ready for the test. The curves of Figures 2 and 3 show the results of some tests made in this way.

In Fig. 2, the curves A, B, and C were made on an antenna of 85 ft. total length. The length of the curve is the wave-band covered by a complete swing of the tuning dial. The ordinates represent the regeneration setting that is just sufficient to produce oscillation with the different grounds. It is well to point out here, that ohmic resistance is the chief factor in controlling the shape of the curve. It seems that radiation resistance does not enter largely into the problem, because operation at the fundamental of the antenna is far below the range of the receiver, when the antenna is connected. Dielectric losses, of a serious nature, could effect the shape of the curve, but losses, of this kind (practically speaking) can be seen with the eye and good judgment in the location of the antenna will correct them.

In curve A, Fig. 2, a badly corroded gas pipe was used as a ground. It can be plainly seen that it took considerable feedback to produce oscillation on any point of the curve. In actual practice, one would not have to travel far to find grounds worse than this. In fact, some will be found that refuse to oscillate at all! Curve B illustrates the results obtained with a good water pipe ground. (Connection made at the water meter.) A ground of this resistance will yield very satisfactory results. By the way

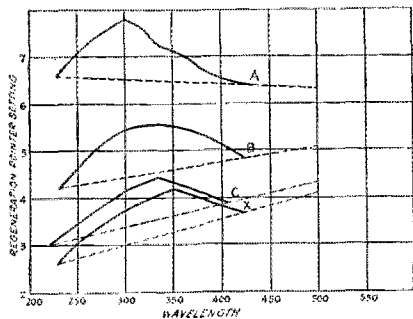

FIG 2

TESTS ON AN 85-FOOT ANTENNA

- A Against bad ground
- B Against good ground
- C Against counterpoise so large as to have very little tuning effect
- X Check measurement with low-loss dummy circuit replacing antenna and ground

lowing simple method has been used very successfully for some time by the writer and co-workers, and suits the purpose excellently.

Before attempting to run the following test, several simple precautions should be observed. To follow them will insure a reliable test.

Connect the antenna to post No. 3 only. If you are in doubt as to the capacity of the condenser under this post, replace it with a good grade of mica condenser, of 250 picofarad capacity. Use 22½ volts on the detector; no more, no less.

Be sure to have two good tubes. The detector tube especially should be o.k. in every way. Avoid tubes which give freakish high test and choose one in which the grid and the plate are concentric about the filament. The filament should have good emission at low temperatures. When the tubes are put into action, the filament rheostat should be adjusted to give the filament the color of iron when it is malleable.

As a check on the operation of the apparatus, connect a low-loss condenser of 250 picofarads, or slightly less, in series with an inductance of about a half-dozen turns and substitute this for an antenna and ground. With this arrangement, it should not be necessary to turn the tickler beyond 5, to produce oscillation at any point on the tuning scale.¹

1. A good test for any oscillating receiver, especially those of the "single circuit" type.—Tech. Ed.

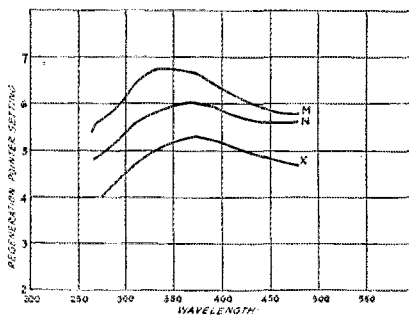

FIG 3

TESTS ON 170-FOOT ANTENNA

- M Against water pipe ground
- N Against water pipe ground plus several hundred feet
- No. 4 insulated wire laid on the earth
- X Check measurement with low-loss dummy circuit replacing antenna and ground

of experiment, a very large counterpoise was erected and substituted for a ground. Curve C shows that the resistance was materially reduced. Curve X was made with a low-loss artificial antenna that possessed the same constants as the antenna under

measurement and proved that the counterpoise arrangement was lacking but little in efficiency.

In Fig. 3, the antenna used was 170 ft. over all. Curve M was taken with the water pipe ground. Curve N, was made with the same ground, but aided by several hundred feet of insulated No. 14 wire laid on the surface of the earth sand connected with the water pipe ground. Curve X shows the practical limit of resistance reduction as gauged with a low-loss artificial antenna.

A casual examination of these curves will show several things to be true. First of all, an antenna of 80 to 150 feet in length, should not have a ground resistance that would prevent oscillation on any part of the tuning scale, with the regeneration pointer set at 6. It will also be noted that, the better the ground, the steeper will be the line drawn between the ends of the curve.

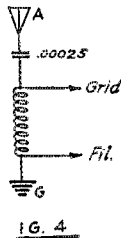

FIG. 4

See dotted lines Fig. 2. The best ground, on the average, will be a wire run direct to the water meter and too much emphasis cannot be laid on the firmness of the contact. If a driven pipe *must* be used, make it long, put a point on it, and drive it out under the antenna and *not up against the cellar wall*. This will shorten the earth-return path and cut out resistance. The ground wire to the house can be buried, if it is well insulated. A counterpoise should be well worthwhile for the "distance bug". A long antenna is seldom as effective as it might be, because of the long earth return path. A shorter antenna composed of several wires will, in many cases, be more effective. Avoid, if possible, running the antenna in one direction and the ground lead in the other. In general, keep the earth return path as short as possible.

The writer knows of no other type of receiver that is quite so satisfactory for making these tests. At the present time, Radiola III's can be obtained for a very small sum. These same tests can also be made with a Radiola III-A. (The writer does not have any for sale!) Almost any type of receiver can be used for the antenna short-circuit test. The open circuit test can be made with any type of regenerative set, which has the antenna coupled to the secondary as in Fig. 4.

The ground resistance test is not so practical with all types of regenerative receivers, but if the antenna coupling is the same as Fig. 4, then the reduction of resistance can be detected by freer oscillations.

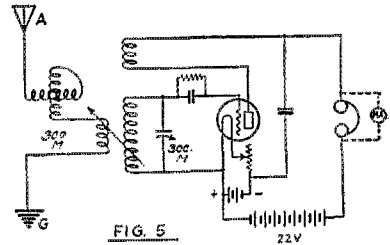

FIG. 5

For the experimenter, an alternative method of resistance detection is suggested in Fig. 5. The oscillator can be adjusted to 300 meters and the antenna tuned to the same wavelength. The coupling should be varied until the oscillations are just suppressed. The lesser the coupling at which this occurs, the smaller is the antenna and ground resistance. The coupling device should have some sort of a readable scale.

Official Wavelength Stations

THE Official Wavelength System furnishes a service cooperative with, but differing from, that of the Standard Frequency Stations 9XL and 1XM, which are also operated in accordance with plans made with the O.W.L.S. committee. Contact with the O.W.L.S. is through Mr. D. C. Wallace, 6AM, who is also chairman of the committee. Mr. Wallace is at present checking up all O.W.L.S. to make sure that they are really indicating their wavelength (or frequency) at the end of each transmission—and are doing so with proper accuracy; which is to say 2%. They do this in the course of regular operation and do not send calibration schedules as do the S.F. stations.

The list partially revised is as follows:
 1AAC, 1AVW, 1AWW, 1BHW, 1BZQ, 1CCW, 1CK, 1KP-NRRC, 1ZL, 1ZO, 2CLA, 2DS, 2MU, 2SZ, 2XI, 3APV, 3BE, 3XW, 4LK, 5AGN, 5AKN, 5EW, 5MN, 5OX, 5PH, 5SP, 5XBH, 5ZAV, 6AM, 6BB, 6BCP, 6BGM, 6BQB, 6CAE, 6CDN, 6CVO, 6LJ, 6SX, 6TI, 6TS, 6XAG, 6XAO, 6ZE, 6ZZH, 6ZV, 7AGI, 7BE, 7BU, 7GQ, 7NX, 7QK, 7ZX, 8AA, 8APZ, 8BAU, 8BZT, 8EQ, 8GU, 8GZ, 8XC, 8ZG, 9AXQ, 9BCH, 9BGK, 9BMR, 9CPM, 9CXU, 9DXN, 9EGU, 9ELB, 9FF, 9IG, nc1AE, nc2BE, nc3CO, nc3NI, nc3FC, nc4BT, nc4FV, nc9AL, eg2OD, eg2SE, Ireland 5NJ, oa2CM and oz2AC. Crystal Controlled O.W.L.S.: NKF, 1AXA, 2BO, 2BRB, 2WC, 4BY, 4XE, 6AOI, 6DLL, 8CMM, 8DAJ, 9AUG, 9BVH, 9UZ-NRRL, 9ZA, eg2NM, eg5LF and oa5BG.
 Standard Frequency Stations: 1XM and 9XL.

Amateur Radio and Drafting

By Milton A. Ausman*

ONCE, everyone in my town thought that because I was associated with radio my fortune was made and that I was a superior being. I almost got to believe it myself until after working very diligently on an idea I found the same thing exactly in a book that was copyrighted in 1892. This only goes to prove the old adage, "The more you know you know you know, the less you know you know." We radio amateurs very often get into the habit of believing that we know all about radio—and we do not help radio by that. There is only one way to do the most for the advancement of amateur radio and that is by acquainting yourself with modern engineering methods of research and investigation and—drafting.

I can assure anyone that the time spent in learning to draft will not be wasted. Those who intend to pursue engineering careers will find themselves at sea without its aid. *It is the one language that is universal among engineers.* The fundamentals of American drafting are laid in Indian picture writing and find their most complicated form in the draftings of a modern telephone exchange. It would be impossible to express literally in many pages the simple message a sheet of drafting paper can carry. Drafting has still another great strength—its amazing ability to expose the weak spots of a design that seemed good, when seen only as a mental picture.

After being more or less in touch with the amateur world for the past ten years I have come to the conclusion that one or two hundred amateurs have carried the principal weight of the advance of the radio art upon their shoulders. Of these I am sure 95% make sketches and often accurate drawings of their work, before one step is realized in the construction of their apparatus. Efficient design without a drawing of some sort is either unsatisfactory or outright impossible.

The methods of design you can find in the texts and in *QST*. I propose to speak of the use of mechanical drawing in radio work, principally of its advantages and the necessity of understanding it to be recognized as one of the aristocracy of radio.

In forming one's preliminary ideas a rough drawing is very useful but no rough drawing can entirely take the place of an accurate mechanical drawing, when one begins to build a good piece of apparatus. Our practice here is to make up a drawing of the devices which we have decided to build and (after carefully checking it over)

we make a tracing (drawing on transparent paper for making blueprints) of the corrected drawing. We have several blueprints made from this tracing. We then bend all wires and solder lugs

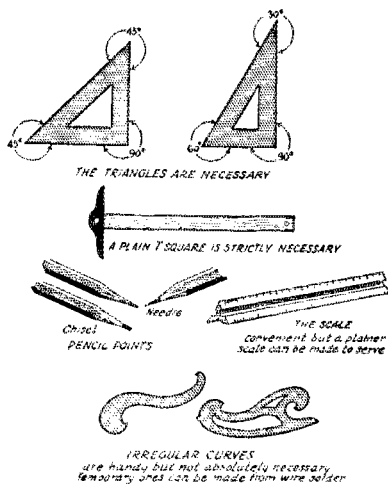

on them, according to our drawing. In the meantime we have our panel and sub-panel drilled and engraved. We buy the screws necessary for assembling and when all the material arrives we assemble the entire set without so much as changing one part. What a distinct advantage this is over shoving parts around on the panel until we find that they all will go on, then drilling holes in the panel and finding perhaps one of them wrong, then assembling the set only to find that after all of this is done things aren't just the way you wanted them and that the wires are all bunched and half the binding posts inaccessible.

To take up this great time saver and money saver we require first a good text book. (Kruse says that "French's 'Engineering Drafting' is excellent." I believe that it is a trifle technical for the beginner but is without a doubt one of the most comprehensive texts I have seen on the subject.)

Next we will have to have a drafting table or board. There are a great many drafting tables on the market, some of them are expensive and others are very cheap. I have one that is made by the Hamilton Mfg. Co., Two Rivers, Wisconsin, and I find it entirely satisfactory. This table in ques-

*Spencerport, N. Y.

tion cost me twenty-two dollars. Drawing boards are less expensive and the price scale is very extensive. My first drawing board was a moulding board planed true on one edge so that no light could be seen under my T square when the edge was set against the planed surface of the board.

The T square is next in importance. The texts, to which you refer, will tell you the requirements of a good T square and you will find it easy to make a T square to meet these requirements. The T square is used in drawing horizontal lines across the paper and as a horizontal base-line for the use of triangles in constructing angles as most angles are reckoned from the horizontal.

Next in importance are the triangles. There should be two triangles, one whose angles are $45^\circ \times 45^\circ \times 90^\circ$ and another whose angles are $90^\circ \times 60^\circ \times 30^\circ$. These are usually laid along the T square in drawing all lines excepting horizontals.

Regular drafting paper can be purchased in rolls or sheets and the grade can be regulated by the size of your pocketbook. The better grades of paper will stand erasing better and also take ink better. A cheap substitute is found in a smooth-surfaced cardboard.

The irregular curve is another handy drafting instrument but it is not as important as those which have preceded it. It is used in filling in curves which are not parts of a circle and is made of either celluloid or maple.

The butterfly and protractor are both instruments to measure or construct angles and are treated fully in all drafting texts.

Two kind of erasers are necessary for good drafting work. The "soap" eraser is made of soft rubber and does not "touch" ink marks but cleans the dirt and pencil marks from the drawing. The other should be a fine sand eraser for erasing ink. The sand eraser should always be used through an erasing shield, as this prevents a bulge in the paper. All erasures with the ink eraser should be made *slowly* so as not to heat the paper by the friction of erasing.

There are plenty of drawing inks on the market and a large number of them are good. I always buy Higgin's Waterproof Ink.

The proper pencil for drafting work is a 3H or 4H according to the paper that you are working on. One of your pencils should be sharpened to a wedge-like point. This can be readily done by the use of a strip of sandpaper glued on a piece of cigar box. One pencil should be sharpened to a needle point for use in dimensioning (or else a needle may be inserted in the end of a piece of wood the shape of a pencil) for making tiny holes in the paper to locate the termination of lines.

The only kind of thumb tacks to use are those which lie very close to the paper so

that they will not interfere with the T square. These are so cheap and common that further discussion is unnecessary.

There is one point which you will notice I have left out and that is one of drafting instruments. The texts treat these fully but one word to the wise, a few good ones are better than a whole carload of poor ones. Drafting instruments aren't what they look like any more than some of these beautifully mounted sets that you see.

I will be glad to give anyone information if the inquiries are sent to me with a stamped envelope. Please do not send questions until you have done a little research on your own part. I am acquainted with some good drafting supply houses in various parts of the country and will willingly inform anyone who is interested.

I hope this article will help a little toward better amateur apparatus and save a great many of you both money and trouble.

The South Dakota Convention

THERE is an old saying that good things come in small packages. This may well apply to the Sixth Annual South Dakota Convention held at Huron on February 25 and 26. While small in number as compared with the more populous divisions, it has never failed to "put it over" in fine style. And this year's convention was no exception. The Hotel Marvin Hughitt just buzzed with good things staged by Maurel Ohman, 9DBZ; Dwight Pasek, 9DGR, and Charles Kuhn, 9DKL.

Lloyd V. Berkner, 9AWM-9XI, of Hawaiian Relay fame, was the big attraction as he represented A.R.R.L. Headquarters and Director Jansky. Besides being a real ham, Berkner gave us a good technical talk on receiving apparatus and circuits. Mr. Crothers, Dean of Electrical Engineering, South Dakota State College, gave an interesting lecture on "Inductance in Coupled Circuits".

F. J. Beck, SCM, and John Berg, Jr., Route Manager, held the platform on Saturday afternoon and discussed amateur work and problems. The efficient organization of South Dakota is due to the hard work of these two men.

Sightseeing trips were made and "Paradise for Two" at the show house was enjoyed, but unfortunately it was only a moving picture, so Nick Jensen says.

The convention closed Saturday evening with a big Banquet and the awarding of prizes; some \$500. worth of apparatus having been donated by QST advertisers. Thanks to all of them. As in the days of old, we can say, "WELL DONE, FELLOWS!"

—N. H. J. & A. A. H.

A Short-Wave Loop Receiver

By R. Prece, Jr.*

THE constructor of a short-wave receiver has considerably more latitude in which to work than has the constructor of a medium- or long-wave receiver. In long-wave receivers especially, space must be considered because they use such large numbers of turns to gain the necessary inductance. In the short-wave receiver it is not necessary to wind many turns of wire side by side to gain the small inductance required. A single turn of wire will do. In this way we gain several things; the distributed capacity is minimized easily and effectively, the inductance (being reasonably large) permits the receiver to be used without an antenna or ground and finally, since the inductance has but a single turn it will be possible to make this turn of copper strip or rod or of any material having a low value of r.f. resistance. With condenser plates connected properly, as shown in the diagram of Fig. 1, hand capacity is absent. Fig. 1 shows the familiar Armstrong circuit (tuned-grid and tuned-plate) but any of the familiar short-wave circuits may be used.

A square inductance eighteen inches to

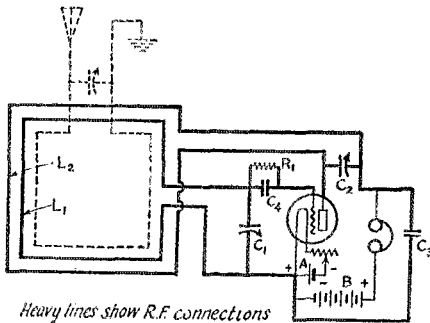

FIG. 1 CIRCUIT DIAGRAM. THE AUDIO AMPLIFIER HAS BEEN OMITTED

- The constants are for the 40- and 80-meter bands.
- L1 18 inches to the side.
 - L2 20 inches to the side.
 - C4 Usual grid condenser, about 250 mfd.
 - C3 2000 to 6000 mfd to pass super-regeneration frequency as well as r. f.
 - C1 & C2 560- μ fd variable condensers.
 - R1 Adjust as explained in text.

the side works well at both 40 and 80 meters, while on 12 inches on a side or a little less will function well at twenty meters. Grid and plate coil should be separated by an inch or more, depending on the type of tube and the plate voltage. 500-micromicrofarad tuning condensers are recommended to cover

the 40- and 80-meter bands with the same coils.¹

A stage of audio frequency amplification is practically a necessity. In addition the set is operated in a condition of super-

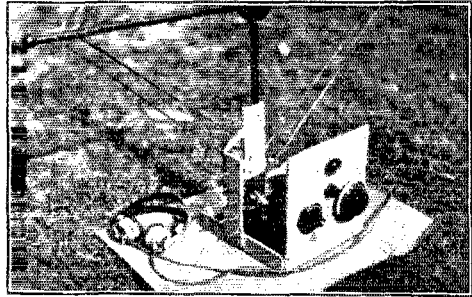

FIRST MODEL OF THE SET. THE LATER ONE IS IN A CASE WHICH ALSO CONTAINS THE BATTERIES, MAKING AN EASILY PORTABLE SET

regeneration which will increase weak signals until they are audible 10 feet from the phones. To obtain this effect the receiver is first placed in operation and a signal of about R4 intensity tuned in. If the signal is in the 40-meter band the plate condenser should be near its minimum setting.

The detector filament current is now increased until an audio oscillation (note) appears in the receivers. If the note is a low pitched rumble it should be changed to a high whistle by changing the grid-leak resistance. A resistance of $2\frac{1}{2}$ megohms will be found nearly correct for the average UX-199 tube.

Finally the signal is carefully returned and will be found to be greatly increased intensity. The operator should secure and maintain an audio note which is of high enough pitch so as not to interfere with reception. The easiest way to do this is by adjustment of the grid leak although the B-battery voltage is also important.

At the writer's station, European, South American and Australian stations are copied regularly without antenna or ground. The directional effects are still a matter of considerable need for experiment. Many peculiar effects have been noted, probably

1. The high ratio of L/C will undoubtedly be complained of at once. One must recollect that this set is operating on the intermittent-blocking type of super-regeneration, the laws of which are not very well understood. It is possible that the L/C ratio is of small importance in this case. Certainly the performance of sets like this one and the one of Oliver Wright is impressive.—Tech. Ed.

*c/o The Brunswick-Balke-Collender Co., 35 South Forsyth St., Atlanta Georgia.

Another CQ Party—This Time on 5 Meters

DO you recollect our famous 100-meter CQ party with which we opened the old 100-meter band in March of 1923? Nobody believed in it until afterwards but it was the start of world-wide amateur radio. International radio, daylight radio, the skip distance discoveries and many other advances followed after it.

Today we are farther along with 5-meter work than we were with the 100-meter work in March, 1923. East coast U. S. 5-meter signals have been copied across the U. S. A. and we have heard—though not read—foreign signals that have come across a major ocean.

Perhaps we are on the edge of another change. Let's try it and see.

5.0- TO 5.1-METER CQ PARTY

Each group sends for 10 minutes only, on each schedule. This schedule runs 4 times as follows:

- a. Exactly as shown—June 11-12.
- b. Repeat, 12 hours later to give other countries the best light.
- c. Repetition of "a" one week later.
- d. Repetition of "b" one week later, i. e., 12 hours after "c".

The rules of the game are as follows:

1 Prizes will be given for the best DX in the way of reception, provided that the reception is fully confirmed by some copy of what was said and all other details that can possibly be thought of.

2 For the best two-way contact arising from these tests there will be a separate award, providing the distance is over 600 miles. "Best" here means both distance and goodness of communication.

3 If there is any doubt on the awards a committee will be chosen to decide.

4 Be sure to operate your transmitter between 5 and 5.1 meters, using the best standards you have.

5 Call CQ *once*, put your intermediate in *once*, then sign *three* times and repeat. If any code letters are added think them over to be sure they will not be confusing.

6 When you copy anything notify A.R.R.L. headquarters at once by radio and wire, confirming fully and in detail by mail.

Hint—Better check up by taking the receiver a ways out in the country and listening to your own sending. Then fix both the sender and the receiver. We are having fine results from an autodyne detector followed by 2 stages of audio—or else followed by an i.f. amplifier with controllable regeneration (potentiometer) a second detector and a stage of audio—5 tubes.

Good luck. —RSK and BP

	Time and Date*		
	Local	London	New York City
New Zealand and Oceania	9.30 a.m. Sunday 12 Wellington	10 p.m. Sat. 11	5 p.m. Sat. 11
Australia	8.10 a.m. Sunday 12th Melbourne	10.10 p.m. Sat. 11	5.10 p.m. Sat. 11
Asia	1.20 to 6.20 a.m. Note †	10.20 p.m. Sat. 11	6.20 p.m. Sat. 11
Africa and Asia Minor	10.30 p.m. 11th to 1.30 a.m. 12th Note †	10.30 p.m. Sat. 11	5.30 p.m. Sat. 11
Central and Eastern Europe	11.40 p.m. 11th 12.10 a.m. 12th Note †	10.40 p.m. Sat. 11	5.40 p.m. Sat. 11
France, British Isles, Spain, Portugal, Holland, Belgium	11.50 p.m. 11th or 10.50 p.m. Note †	10.50 p.m. Sat. 11	5.50 p.m. Sat. 11
South America East of Longitude 60 and all stations on Atlantic intercolonial time	7 p.m. Sat. 11	11.00 p.m. Sat. 11	6.00 p.m. Sat. 11
South America west of Longitude 60 and all U. S. and Canadian stations using New York Time.	6.10 p.m. Sat. 11 New York	11.10 p.m. Sat. 11	6.10 p.m. Sat. 11
Central America and all U. S. and Canadian stations on Central Standard (Chicago) time	5.20 p.m. Sat. 11 Chicago	11.20 p.m. Sat. 11	6.20 p.m. Sat. 11
Mexico and all other Canadian and U. S. stations (including Alaska)	5.30 p.m. 11th Sat. Francisco 4.30 p.m. 11th Denver	11.30 p.m. Sat. 11	6.30 p.m. Sat. 11

*Approximately correct; if in doubt figure from London or New York.
 †Depending on location in the area.

Strays

We wish that operators sending in skeds on short-wave work (below 30 meters) would send them in at least six weeks before they are to be run. It is practically impossible for us to get such notices in *QST* so that they will do any good in less time and if it is desired that European listeners be notified, the dope should be in our hands two full months in advance. We have received several such schedules from folks who seem to think that we can get out a special issue for them. Better be safe and give us enough time, OMs.



The Vertical Antenna at 8BMW

By V. W. Sherman*

IN many cases amateurs are content to pump precious power into whatever type of antenna happens to fit the backyard best. We dig up a stack of old QST's and then after finding a station whose description seems to apply to us we proceed to try out this antenna. Consequently in the course of a few years we will have strung up several thousand feet of wire in a dozen styles, plus as many more variations. The result is that you are familiar with the usual types; you know their characteristics; you have discovered that type which works best for you. I shall therefore limit myself to a rather unusual antenna which was recently put into service at 8BMW.

My old twin cage antenna system, which had given faithful service for about two years, was hanging on a couple of dilapidated poles, both of which were waiting for an excuse to collapse. I was fed upon steel poles and re-radiating guy wires, so after the usual financial considerations were reviewed I tried following stunt.

A twenty-two foot tower was constructed from four straight 2x4s and was rigidly braced with 2" x 1" strips. The top was formed by the junction of the four main members so that a 4½" square opening existed. Two feet down from the top, arrangements were made so that a piece of plank could be slid across to support a metal pole.

The pole is the antenna and in this case is 30 feet long. It is composed of three 10-foot lengths of copper gutter pipe with suitable reduced couplings between the 3-inch bottom section and the 2-inch top section. I chose these dimensions as a compromise between wind resistance and mechanical strength. A small copper ball is soldered on top to keep the rain out and for the sake of appearances. The guying is done with four 5/16" Manilla ropes, thoroughly soaked in linseed oil, and fastened thru strain insulators to a point 10 feet from the top of the pole. A tinner made the pole from 16 oz. cold rolled, corrugated, copper gutter pipe for ten dollars. The critical part of the job is the reducing coupling which he must make and solder in between the bottom 3-inch and

the middle 2-inch section. This point and the point where the guys are attached bear the greatest strain during a storm. The best way is to reinforce this point with an inner coupling of galvanized sheet metal. Up to date two forty-mile winds have failed to cause any damage.

Putting the pole on top of the tower is just as simple as it sounds. The pole with guy ropes attached, had been set up inside the tower before the front tower braces were put on, and, with an attendant at each guy rope and another to slide the pole base

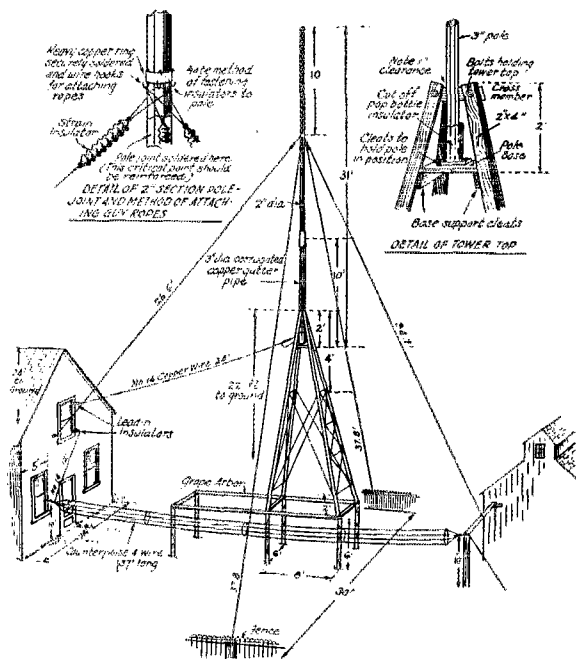

into place, the pole was easily hoisted into position by a single man.

Now you want to know about the counterpoise. That's easy; it is a 37-foot 4-wire cage strung up on glass, 10 feet above the ground. Its center is located at the tower base. That is; the radiating system is like an inverted "T" with the tower forming a break between the horizontal and the vertical numbers. (Incidentally when I tried this pole antenna with the cage counterpoise I found it to have practically the same fundamental as the old twin cage system.)

*8BMW Army-Amateur Radio Station, 5080 Harding Ave., Detroit, Mich.

A word about the method of insulating
(Continued on Page 68)

Your Wave From a Broadcast Receiver

By Roy L. Gale*

A RECENT census of Official Relay Stations showed that many operators do not own a good wavemeter, and those who do have one are never quite sure as to the accuracy of its reading. Nearly every issue of this, the amateur's favorite magazine, has some reference to the construction of wavemeters, but very little is said about calibrating them. Possibly it is taken for granted that the amateur knows exactly how to proceed with this work. The writer listened faithfully each Friday night for the standard frequency transmissions but never heard a sound. The location here was bad for them, I suppose. The only way left seemed to be to ask other amateurs what my transmitting wave was. There were various answers, ranging from 37 to above 41 meters! Later, the wave was found to be 36.1, which is not a legitimate wave for United States' amateurs to use at any time.

During the past few months the same question has been asked many times, and in not a single instance could the other operator do more than give a rough guess as to my wave or his own either.

The purpose of this paper is to show the amateur how he may either calibrate a wavemeter by means of his broadcast receiver, or determine his wave directly from the receiver, no wavemeter being required. The only condition is that the receiver must be of the regenerative type.

Let us assume that the amateur already knows where certain well-known broadcast stations come in on his receiver tuning dial. In the writer's case WGY, which operates on a wave-length of 379.5 meters, is to be found at 30 on the dial. At some time when this station is *not* broadcasting, set the dial very near this point and put the receiver into oscillation. Then depress the key of the transmitter and tune the latter until it beats with the receiver. The transmitter is thus tuned to some harmonic of 379.5 meters. In the vicinity of the 40-meter band the possible harmonics are 34.5, 37.95 and 42.2 meters. These waves are the eleventh, tenth and ninth harmonics of the original wave of 379.5 meters. The operator must know his wavelength roughly in order to know which harmonic is being used. Now leave the transmitter tuned as above and turn the receiver dial thru its range carefully logging the points on the dial where beat notes or harmonics are found. Bear in mind that it is not necessary that any broadcast station be operating at the time. On the contrary, it is far

better that none be on the air as their beat notes would only cause confusion. However, if a station is operating, make a note of it and disregard those beat notes caused by such stations known to be operating.

In the middle of the broadcast band the harmonics of 37.95 meters are 345, 379.5, 414 and 449 meters. Using these points, carefully calibrate the receiver, and draw up a chart which shows the wavelength corresponding to each degree on the dial. The calibration will be easy if the receiver is provided with SLF condensers. Otherwise it will be best to obtain other points on the dial, by selecting the wavelength of some other station and repeating the process. The known points will then lie within a few degrees of each other, and it will be easy to calculate the wavelengths corresponding to the intervening points.

Having calibrated the receiver, you wish to determine the wavelength of your transmitter at any given instant. Very well; press the key of your transmitter, and with the receiver in oscillation, turn the dial of the receiver until you hear the beat note between the transmitter and the tenth harmonic of the receiver. Note the reading of the dial, refer to the same reading on your calibration chart, divide the corresponding wavelength by ten, and you have your wavelength to one-tenth of a meter.

Please note that though the wavelength of the original broadcasting station with which you started to calibrate your receiver, was a trifle off its rated wave, you are dividing the error by ten, which reduces the given error greatly.

If the operator wishes to calibrate a wavemeter, this can be done against the transmitter, tuning the latter to the tenth harmonic of various waves directly from the broadcast receiver.

Amateurs living in the middle-west could use WEBH, which operates on 370.2 meters, while those still farther west could make use of the wavelength of KGO on 361.2 meters. It is essential, or at least desirable, that only those stations which are known to maintain their given wavelengths within very small limits of error, be used. After the receiver or wavemeter, or both, are calibrated, the amateur makes no further use of the broadcasting station's wavelength.

Thus far, mention has been made only of the 40-meter band, but the method is just as applicable to any of the amateur bands. If working in the 80-meter band, the only difference would be in using the fifth harmonic instead of the tenth. Of

*1BD, Plainfield, Vt.

An R. F. Amplifier of Uniform Sensitivity

By J. O. Mesa*

THE ORDINARY tuned radio frequency type and neutrodyne type receiver has greater sensitivity at the high frequencies than at the low frequencies even when every precaution, including complete shielding is taken to reduce the causes of feed-back. The reason for this is evident from the formula for feed-back, which is;

$$r = K \frac{L}{RC}$$

in which r represents the feed-back amplification, K is a constant, L the inductance of the circuit, R its resistance and C its capacity.

This shows that as the tuning capacity C is decreased the amount of regeneration is

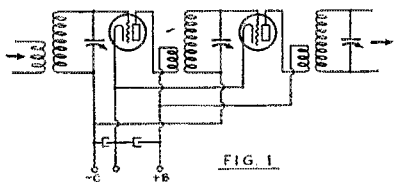

FIG. 1

increased. This increase in regeneration is somewhat offset by the fact that the resistance R of the circuit is greater at the higher frequencies. Usually, however, this increase is not sufficient to compensate for the decrease of capacity, with the result that the entire amplifier has considerably less sensitivity at the higher wavelengths than at the lower. To overcome this fundamental difficulty a regeneration

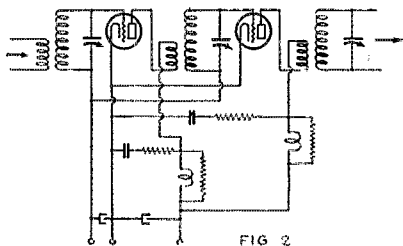

FIG. 2

control has been added to certain receivers. This complicates tuning beyond what is advisable for general use.

One method which has been used in the past to compensate for the increase in regeneration at the higher frequencies has been that of decreasing the inductance by having an inductance control coupled mechanically to the tuning condenser. While

this method gives a uniform sensitivity, it limits the flexibility of the system in that the inductance is predetermined, and the value of ratio of primary to secondary required to give the desired selectivity characteristic, cannot be chosen.

Another method which is free from this difficulty and permits the selection of an inductance which gives sufficient selectivity without "cutting into" the side bands is described hereafter. It consists effectively in changing the resistance R , shown in the previous formula, so as to compensate for the capacity change. Telephone engineers are familiar with the combination of inductance, capacity and resistance which they call equalizing net works.¹ These networks are so designed that they attenuate certain frequencies more than other. By using a structure of this type in the radio frequency amplifier, it is possible to compensate for the greater response at the high frequencies and obtain a uniform

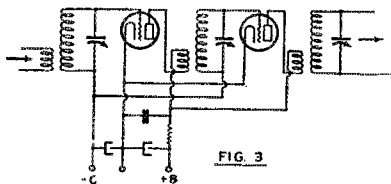

FIG. 3

sensitivity over the entire broadcast band.

Figure 1 shows the schematic wiring diagram of an r.f. amplifier with the necessary provision for C batteries and by-pass condenser to insure its working as a proper amplifier. In Figure 2 is shown the same circuit with equalizing networks added in the plate circuits of the tubes. These networks will have a higher resistance at the higher frequencies, with the result that the effective resistance of the tuned circuits is a function of frequency and is larger at the higher frequencies. These networks can be simplified in the usual r.f. amplifier by the omission of inductances and the resistance in series with the shunt condenser. Under these circumstances, the equalizer becomes merely shunt capacity and a shunt resistance. In radio frequency circuits the series resistance will be comparatively small in the order of magnitude of 200 to 300 Ohms, while the shunt capacity will be comparatively large of the magnitude of several thousand micromicrofarads.

1. J. B. Johnson—"Transmission circuits for Telephonic Communication," page 229. R. S. Hoyt—"Loaded Lines and Compensating Networks," Bell System Technical Journal, July, 1924, Volume 3, No. 3.

*M. E. Laboratory Chief, Chas. Freshman Co., Inc.

(Continued on Page 49)

A Tube Characteristic Chart

THROUGH the courtesy of Mr. D. C. Wilkerson of Washington, D. C., and East Orange, N. J. there is presented herewith an ingenious chart for the rapid non-mathematical determination

of plate resistance, amplification constant and mutual conductance. The chart is so designed that all three constants can be read off when one has made three simple measurements as follows:—

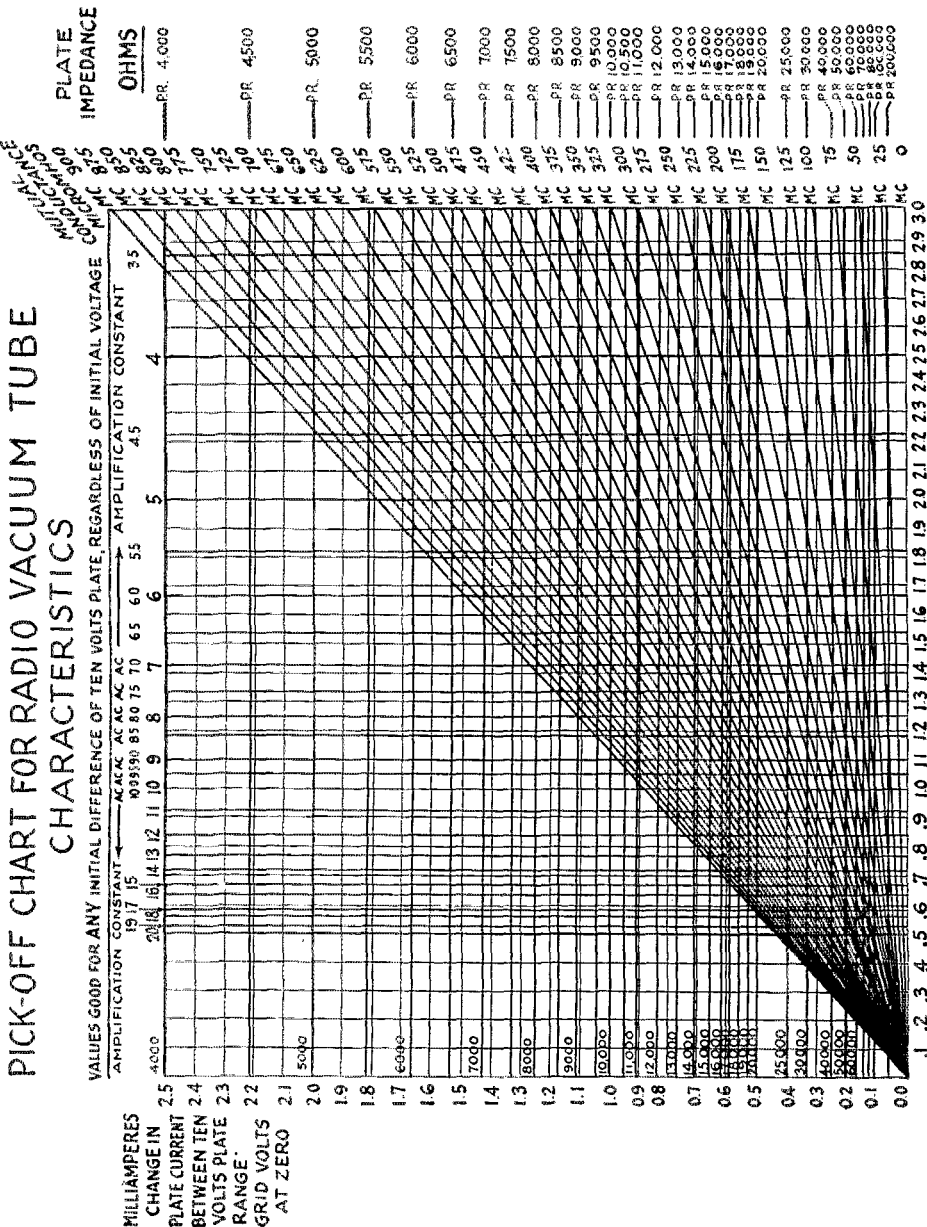

Copyrighted 1924 by D.C. Wilkerson

- A—Plate current at any voltage E_p and zero grid volts.
- B—Plate current at any voltage $E_p + 10$ and zero grid volts.
- C—Plate current at any voltage $E_p + 10$ with grid biased negative to depress plate current to value A again.

The first voltage may be anything which will give a readable plate current. It happens to be 40 in the following example but any convenient value will do.

EXAMPLE

With 40 volts in plate circuit of tube, and zero grid volts, read plate current in milliamperes, say you get 1.4; then with grid volts still at zero, raise the plate volts to 50 or, in other words, by 10. Read plate current again in milliamperes, say you get 2.1

$$\begin{array}{r} 2.1 \\ 1.4 \\ \hline \text{Subtract:} \\ \hline .7 \end{array}$$

which represents the milliamperes change of plate current for a corresponding change of 10 volts plate voltage. Now, bias the grid negatively and increase the bias until the plate current is the same as before that is, 1.4, then read grid volts required to produce this change, say 1.25 volts was required. Enter left vertical column with .7 and enter bottom horizontal line with 1.25. From their point of intersection (marked for this example with a small circle) read up to top margin. Here you find 8. This is the *amplification constant*. From the same small circle read diagonally up and to the right, and you find that the *mutual conductance* is midway between 550 and 575, which is 562. Now read straight right from original intersection and you find that the *plate resistance* is between 14,000 and 15,000, or about 14,250 ohms.

An R. F. Amplifier of Uniform Sensitivity

(Continued from Page 47)

It will be seen that the series resistance is small enough so that a single equalizer can be used for two stages without this resistance being the cause of undue feed-back.

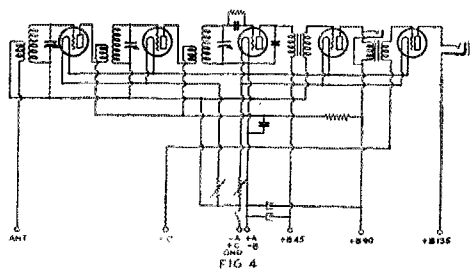

A circuit using this idea is shown in Figure 3. A complete schematic wiring diagram of a receiver using an equalizer of this type is shown in Figure 4. This receiver is being manufactured on a large quantity production basis with an exceedingly small variation in the factory output. By proper selection of resistance and capacity, such a receiver is made to operate just below the point of oscillation with constant voltages applied to all the r.f. tubes and without making use of any additional regeneration control.

Emergency Transmitters

(Continued from Page 37)

smooth that no filter was needed with a radiophone set. This machine operated on lower driving voltages delivering lower output voltages.

Connecting either of these battery driven dynamotors is a task so simple that it requires no mention whatever.

MISCELLANEOUS DEVICES

Under this head may be classed "B" eliminators and spark coils. The former may be found to measure up to each of the requirements given for dry or storage B-batteries. A good instrument should be picked out.

It goes without saying however, that a "B" eliminator holds a low place in the list of amateur auxiliary devices since that instrument is dependent upon the commercial a.c. or d.c. electric power mains. Should there be any accidents to these lines, the "B" eliminator would automatically become worthless as an emergency power supply device.

The spark coil has for a time been used to energize the plates of transmitting tubes. Its connection in the circuit is simple—the primary being connected to the storage battery and key (the battery, incidentally, is used also to heat the filament). The secondary is connected to the high-voltage leads of the transmitter. As the high-voltage current delivered by the spark coil is a pulsating direct current (no, not an alternating current), it has definite and noticeable polarity. Hence, the secondary must be so connected that the positive is hooked to the plates of the tubes.

A little experimentation with the adjustment of the vibrator of the coil will enable the experimenter to find a high-pitched note resembling pure c.w.

It must be borne in mind that a spark coil delivers a pulsating direct current to the transmitter and the wave radiated is of the i.c.w. variety. This means that the transmitter must be operated in the band allowed i.c.w. transmitters. From time to time,

(Continued on Page 36)

Standard Frequency Transmissions

THE Official Wavelength Station Committee of the Experimenters' Section, A.R.R.L., announces the following standard frequency schedules for 1XM and 9XL. The actual transmissions are based on crystal-controlled oscillators and precision wavemeters and an accuracy of better than 1/10% is to be expected.

The frequency values are based on the standards of the Bureau of Standards and have been checked by the Cruft Laboratory and by the Communications Laboratory of the Massachusetts Institute of Technology. While the accuracy mentioned above is to be expected, no guaranty is made other than the one that transmission will be suspended if errors are found by the O.W.L.S. Committee.

Station 1XM is operated by the Communications Division, Massachusetts Institute of Technology and the M.I.T. Radio Society, Cambridge, Mass.

Station 9XL is connected with, and a part of, the "Gold Medal Station" at Anoka, Minnesota.

SCHEDULES

In the following "f" is the frequency in MEGACYCLES and the *approximate* wavelength in meters follows.

(Figures are frequencies in MEGACYCLES per sec.; approx. wavelengths in parentheses)

Friday Evening Schedules				Sunday Afternoon Schedules			
Eastern Standard Time for 1XM		Central Standard Time for 9XL		Eastern Standard Time for 1XM		Central Standard Time for 9XL	
Time (PM)	Schedule	Schedule	Time (PM)	Schedule	Schedule	Time (PM)	Schedule
	f λ	f λ		f λ	f λ		f λ
8:30	3.50 (85.7)	6.50 (46.1)	3:00	10.0 (30.0)			
8:42	3.60 (83.3)	6.75 (44.4)	3:12	12.0 (25.0)			
8:54	3.75 (80.0)	7.00 (42.8)	3:24	14.0 (21.4)			
9:06	3.90 (76.9)	7.25 (41.3)	3:36	14.5 (20.7)			
9:18	4.00 (75.0)	7.50 (40.0)	3:48	15.0 (20.0)			
9:30	5.70 (52.6)	7.75 (38.7)	4:00	15.5 (19.3)			
9:42	6.50 (46.1)	8.00 (37.5)	4:12	16.0 (18.7)			
9:54	7.00 (42.8)	8.25 (36.3)	4:24	18.0 (16.7)			
10:06	7.50 (40.0)	8.50 (35.3)	4:36	20.0 (15.0)			
10:18	8.00 (37.5)	8.75 (34.3)					
10:30	8.50 (35.3)	9.00 (33.3)					

Date	Schedule	Station
May 1.	C	1XM
May 6.	A	9XL
May 8.	C	9XL
May 13.	A	1XM
May 20.	B	9XL
June 3.	A	9XL
June 12.	C	9XL
June 17.	B	9XL

DIVISION OF TIME FOR 9XL & 1XM

- 3 minutes—QST QST QST nu (Station call letters)
- 3 minutes—5 sec. dashes broken by (station call letters) every half minute
- 1 minute—announcement of frequency in megacycles per second (8.75 megacycles per sec. is sent as "8 r 75 MC")
- 1 minute—announcement of next frequency in megacycles per second.

Special Notice—The continuation and possible extension of these transmissions depends entirely upon the response of the A.R.R.L. If you use the transmissions send a note to Experimenters' Section, A.R.R.L., Hartford, Conn.

WWV SCHEDULES

The Bureau of Standard's Station, WWV, at Washington, D. C., will transmit the following schedules during May and June. Note that some of the frequencies have been changed from former practice.

The transmission is by continuous waves with a slight modulation at high pitch to aid in identifying the signals.

The transmitting scheme differs from that of the 9XL-1XM scheme and is as follows.

DIVISION OF TIME FOR WWV

- 2 minutes; QST QST QST WWV WWV WWV etc.
- 4 minutes; long dashes broken by WWV WWV.
- 2 minutes; announcement of next frequency to be sent.
- 4 minutes; for readjustment to the next frequency.

Information on the use of the signals for calibrations is given in Letter Circular No. 171 which may be had on application from the Radio Section, Bureau of Standards, Washington, D. C. Even though only a few points are received a complete calibration can be made by use of harmonics; information on the methods of doing this being given in the circular.

SCHEDULE OF FREQUENCIES IN KILOCYCLES
(Approximate wavelengths in parentheses)

Eastern Standard Time	May 20	June 20
10:00 to 10:08 p.m.	1500 (200)	3000 (100)
10:12 to 10:20 p.m.	1650 (182)	3300 (91)
10:24 to 10:32 p.m.	1825 (164)	3600 (83)
10:36 to 10:44 p.m.	2025 (148)	4000 (75)
10:48 to 10:56 p.m.	2225 (135)	4400 (68)
11:00 to 11:08 p.m.	2450 (122)	4900 (61)
11:12 to 11:20 p.m.	2700 (111)	5400 (58)
11:24 to 11:32 p.m.	3000 (100)	6000 (50)

(Speaking for the Experimenters' Section and also as Technical Editor, it seems to me that such fine work as has been done at 1XM and 9XL deserves much more hearty thanks than we are giving. Every A.R.R.L. man has benefited directly or indirectly from the transmissions of these stations and of WWV. The least that can be asked is that a note of acknowledgment be sent to the Experimenters' Section which will take especial care to see that it is forwarded and also noted in QST.

To the scores who have acknowledged during February and March our thanks are hereby extended.

—Robert S. Kruse.)

Experimenters' Section Report

B EING short of time and space we will omit the details of the organization of this section and refer everyone to the last issue of *QST*. It is unfortunately not possible to cover all problems in this report which will be given mainly to the 5-meter tests.

THE MARCH 5-METER TESTS

The reports for the March 5-meter tests have not yet arrived as this is being written just after they closed and our Australian report cannot be obtained until next Sunday when Ross Hull keeps his weekly Australian schedule. During this test transmissions were made by the following stations at wavelengths near 5 meters. The figures are antenna watts.

ACD	Adriano Ducati, Bologna, Italy,	300
3ZN	Morris Israel, Sydney, Australia,	50
10A	Robert S. Kruse, West Hartford,	
	U. S. A.,	500
2EB	Boyd Phelps, Jamaica, N. Y.,	
	U. S. A.,	500
2CSM	C. H. West, Stapelton, N.Y.,	
	U. S. A.,	15
2XM	A. H. Turner, Schenectady,	
	N. Y., U. S. A.,	
9EHT	Norvell Douglas, Lawrence,	
	Kansas, U. S. A.,	60
9EK-9XH	Burgess Lab., Madison,	
	Wisconsin,	100
9BVC	Herbert Clark, Lutesville,	
	Mo., U. S. A.,	75
	Harry Lyman, San Francisco,	250

There were almost certainly additional transmissions of which we do not know definitely.

Considering the number of transmissions it seems that we should obtain some reports even though the actual duration of the tests was short, running from the 25th

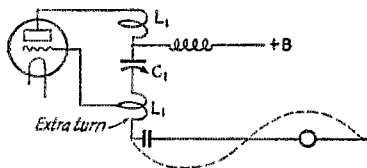

FIG 1

to the 31st inclusive only. The series was decided upon suddenly, there was no time to use *QST* and it was necessary to make contact by mail and by radio—which is a story.

SOME REAL RELAYING

The Experimenters' Section in the U. S. A. and Canada was notified by circular letter that a test was about to be run at the request of the Wireless Institute of

Australia. Radiograms were then started out to the more distant points. Thru experience in the February tests we knew that this sort of thing works—that A.R.R.L.'s traffic system really has become internationally effective. The February message had gotten into Italy, South Africa, Brazil, Australia, New Zealand, Holland, Belgium, England and Germany but we had lacked confidence and had routed each message thru 4 different stations. As a result most of the addressees got from 3 to 6 copies delivered to them—and some of them objected and said that it wasn't funny. That piece of work had been done by stations chosen by Communications Manager Handy. They were evidently well chosen and we

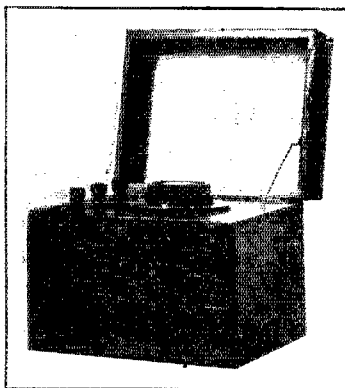

THIS IS NOT THE G.R. 5-METER WAVEMETER

By an accident of magazine makeup it was shown on page 45, of March, *QST*; inside a paragraph referring to the G.R. 458 meter which is actually a very nicely built unmounted meter. The picture here shown is that of Raymond C. Shlorf's laboratory condenser, described in the last paragraph of the page referred to. This is in response to numerous inquiries.

are thankful to all of them—for the message was a great lubberly thing with well over a hundred words in it.

For March it seemed safe to use fewer stations. As all had been equally effective the other time, these were chosen simply by chance with no special intention to indicate that the others would not have been as good. Accordingly the March message went to 9DNG at Lawrence, Kansas, to various Washington, D. C. stations thru Miss E. M. Zandonini of 3CDQ, to C. P. Goetz of Cincinnati and to G. A. Hinkley of 1GA at Roslindale, Mass. All of these got the message at the last moment—some less than 36 hours before the test—but the message was on time in England, South America (several countries), Italy, and

Belgium, though it was another hundred-word affair rather clumsy for long-distance work. The Australian contact was thru the "private-wire" of this section—which is to say Ross Hull's weekly schedule between Australian 3BQ, operated by Maxwell Howden and 1BHW (K. B. Warner's station) operated by Hull. Of course the circuit does not belong to the section at all but did start working as a result of Hull's desire to make a go of the February test. It now works so well that he "holds the line" while Howden calls up the Hull family and asks for

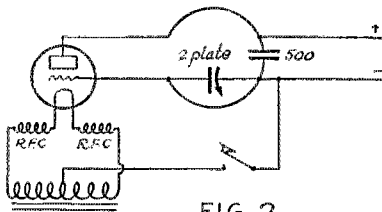

FIG. 2

news and messages. Right in this same connection must be mentioned the fine co-operation of Frank Jones of Berkeley, and Harry Lyman of San Francisco in gathering California observers.

FEBRUARY FINAL REPORT

The reports on the February tests are now reasonably complete. There is not a great deal to add to that which was first said, except confirmation. The signals of 2EB at Jamaica were copied (not merely heard) several times at 9EHT, Lawrence, Kansas. They were heard and copied with good intensity at 9BVC, Lutesville, Mo. In both cases the receiver was one employing an oscillating detector and an audio amplifier, also the reception was during the evening schedule and at a time when 2EB was using "raw a.c." on the plate of the tube. The logs of these stations are at hand and agree as to matter sent, wavelength, tone and irregularities. 2EB was also heard at Seattle, Washington, by E. R. Stevens of 7BB. This remains the maximum distance over which the signal has been identified positively. Unreadable signals were heard by Adriano Ducati at Bologna, Italy, and though they corresponded as to wavelength, plate supply and time there is no positive proof as to their origin—although 2EB and 10A seem to fit the description—probably 2EB which was using materially more power than 10A in the February test. 2EB has not been heard as far since adopting rectified plate supply but this may be coincidence.

Unreadable signals of the right wavelength, modulation and time for ACD were heard at West Hartford by the writer, who also heard 2EB a number of times with wide variations in signal strength and in addi-

tion twice heard another station using approximately d.c. plate supply but with a wave so unsteady that only occasional letters could be copied.

SOME SPECULATION

The February contacts are therefore small in number although made at 35, 60, 100, 800, 1000 and 1800 miles with a possible transatlantic reception. These are to be added to the previous 900-mile contact between George Washington's 2AUZ at New York and J. K. K. Grindle's 9BSK at Hammond, Indiana, also to the contact between Italian 1ER and a receiving point in Tripoli over a distance of 1800 miles.

That we have had really good contacts over these varying distances and yet at the same time have had many total failures seems to indicate one of several possible things; principally, that our tests have been badly planned, that our apparatus is poor or else that there are some factors with regard to time and weather that we have not yet considered enough—or are totally ignorant of.

THOSE G. R. WAVEMETERS

In the class of unsati factory apparatus we must first think of our home-grown wavemeters. In EVERY case of actual reception there has been a first rate wavemeter at both ends. For that reason two of the General Radio special wavemeters

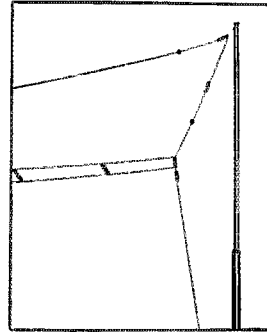

FIG. 3

were shipped to the Wireless Institute of Australia and to several other points where it seemed that this might be the difficulty. This wavemeter was a job made up at the writer's insistence in a "limited edition" of 15; G.R. doing its usual gilt-edged work. The demand for the meter has been sufficient so that it is now regularly stocked and anyone having any work to do between 4 meters and 6½ meters should by all means obtain a meter. The type number is 458.

THE TRANSMITTERS AND RECEIVERS

The shortcomings of our receivers and transmitters continue, except in a few cases. At 2XM there is a crystal-controlled 5-meter transmitter which will be described in an early issue of QST and at 2BCK there

is a non-crystal set using direct current plate supply with enough steadiness to permit reception—if the receiver is good enough.

The receiver is in most cases much more troublesome than the transmitter, because the latter can be cushioned and left alone, thereby allowing it to operate evenly, while the receiver is constantly being vibrated by the dial movements. Two more super-regenerative receivers at 10A have been given up and at 2XM the same thing was done.

Superheterodynes show a tendency for the intermediate frequency amplifier to oscillate more easily (and less controllably) than normal when receiving 5-meter signals. This thing has happened at 2XM and also 10A. It seems to me that possibly the superheterodyne may have an advantage in quietness but that we cannot hope for much better performance than from a good oscillating detector in which all of the amplification is at a.f. In any case, it seems that at 5 meters the first detector should by all means be autodyne—that is to say

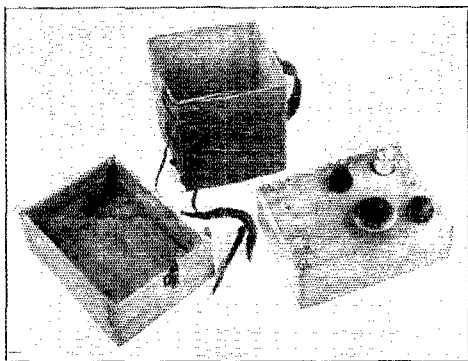

A PORTABLE RECEIVER MADE BY L. H. HUBER, OF TIPTON, IOWA

The box at the right is the receiver proper and contains a UX-199 operating in a Hartley circuit with resistance control of regeneration. The tube is usually operated in a semi-howling condition (audio-blocking variety of super-regeneration). This condition is reached by means of a variable grid leak. The tuning dial is notched to receive a thin wooden handle which takes the place of a vernier dial and saves space. The batteries, antenna and phones are separate but the coils may be kept in the lid. The box is waterproofed and when wrapped in its leather jacket is almost armored. The performance is very good.

self-heterodyning, which removes one tuning control. It is imperative that there be good control of the intensity of oscillation. Therefore this set will simply be the usual 5-meter receiver with the oscillating detector and audio amplifier pulled apart to permit inserting two stages of i.f. of which the second is made to oscillate so as to produce a beat note. This makes a 2-control set which has some chance of being good.

TIME AND WEATHER

With so few contacts at any distance it is hard to tell just how time and weather enter in. From our limited information it seems that clear sunlight coincides with good signals between Jamaica and Hartford, also between Jamaica and the center of the country (Lutesville and Lawrence). For that reason, the March test hours were chosen to give us a chance at part daylight

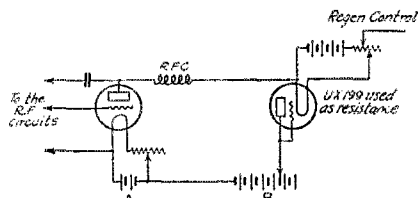

FIG 4

when it was just leaving Australia and again when it was just leaving the eastern U. S. An additional schedule was thrown in to make up for uncertainties.

We may be quite wrong on this whole thing and it must be remembered that 2EB has been heard at Hartford and at intermediate distances with good strength on very gloomy days and has utterly failed to appear on some that were bright at one end.

C. H. West, of 2CSM, states that in some local tests over a 7-mile region he finds a strong daylight effect but fails to state if light brings improvement or the reverse.

It is hoped that we will be able to arrange some tests with a limited group during late April to clear this point enough so as to permit a better possibility of running tests at the right hours. At the present time many short and medium two-point tests are being run with both fixed and automotive receiver stations. Unfortunately it is not possible to list all of the pairs of men working on this but their work is thoroughly appreciated, as is that of the many who are cooperating by providing communication, material and information.

Whether it is eventually found that 5 meters is a good communication wave, or only that it does certain unusual things making it unfit for such purposes, we are still sure that a nice piece of cooperative work will have been done and that the results will be worthwhile for some purpose.

5-METER APPARATUS SUGGESTIONS

The transmitters continue to be in the main variations of the Ultraudion. At 10A we have used a Hartley circuit with a 1-turn "helix" of heavy brass ribbon and a 55-picofarad condenser. This operated very steadily with a UX-852 tube but was not especially efficient and tended to de-activate the filament very fast. I do not understand this last effect.

The circuit now in use is shown in Fig. 1. The arrangement of the Ultraudion induct-

ances in two coils is a matter of convenience only. L1 has 2 turns and L1 has one turn. C2 is a feed condenser made of two brass strips 2" long and 1/16" thick placed edge-on. This capacity must be adjustable and is moderately critical. The antenna is straight and one wavelength long with the meter 50 inches from the end, the voltage being distributed as dotted. The antenna current is 2 amperes with a tube input of 200 watts. With full power, the meter must be shunted and the reading is only a "current indication".

Figure 2 shows the variation of the common "plate tickler" circuit which is used for transmission at 9BSK, by J. K. K.

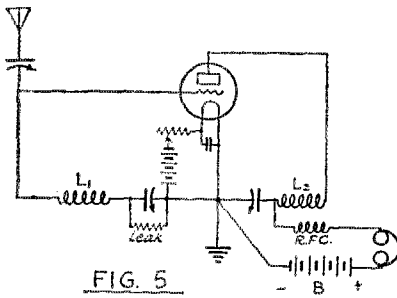

Grindle. The single turn is of 4" diameter. The antenna systems used at 2EB are shown in Fig. 3. The "Zeppelin" system has been dropped temporarily as it did not give good field strengths within any distance under 60 miles and it seemed unlikely that it would show up better at a distance. The circuit is Ultradion and the feed from one end thru voltage applied direct to the wire (no feed condenser) which operates at the 7th harmonic. The sending set itself was shown on page 58 of the April issue.

There is no reason at all for thinking that some other antenna will do less excellent work; in fact, the low-power 2AUZ-9BSK contact was done with a horizontal antenna of moderate height fed by a horizontal 2-wire line in the "Zeppelin" arrangement.

RECEIVER SUGGESTIONS

Austin Lidbury has built an oscillating detector receiver in which the regeneration is controlled by means of a resistance in the plate supply. This is ordinarily a mean job because the resistance tends to be very noisy. Lidbury gets around this by using a UX-199 as the variable resistance; connections being made as in Fig. 4. The filament rheostat of the 199 controls the detector plate current. Of course, the filament battery of the 199 is "up in the air" but a C-battery can be used and no harm is done.

Figure 5 is the circuit used at 2XM by A. H. Turner. L1 and L2 are wound on the

same G.R. form and plug in, the ranges being 4.8-5.2, 5.1-5.5 and 5.4-5.9. The tuning condensers have a max of 45 pfd. The action is naturally somewhat interlocking but the control is easy and the plate voltage need not be raised above 45. Inductive antenna coupling is used at times.

FURTHER TEST ANNOUNCEMENTS

All desiring to take part in any future tests should by all means look thru other parts of this issue as there may be a last-minute announcement of a June test.

STANDARD FREQUENCY OBSERVATIONS

The returns from the observation blanks on stations 1XM and 9XL are very gratifying. These two stations are perhaps the only ones in amateur radio which are operated on a sliding wave schedule with steady inputs and most valuable information on transmission at different waves will gradually accumulate. In those gotten to date there are striking exceptions to the present theory, also quite a bit of confirmation. All those who wish more blanks should write to this section asking for them.

THE RECTIFIER PROBLEM

The various entrants in the aluminum rectifier problem are assured that their various material has now really gotten under way and that before this reaches them there should be material on hand so that work may begin.

NEXT MONTH

As was said at the start of this report, the 5-meter matter is current and it seemed advisable to make a reasonably complete

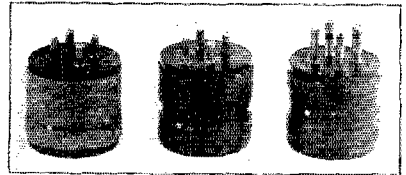

THE SCOTTISH RECEIVER

Director Porter Quinby of the Midwest Division uses plug-in receiver coils of the most economical sort possible. They are wound on tube bases and used in a tube socket with a 1-turn antenna coil put around the base of the socket. The coils shown are for the 20-, 40- and 80-meter bands. The number of turns used naturally depends on the waveband to be covered and the size of the tuning condenser used while the tickler turns depend on that and some other things also. It is a very small job to determine the right arrangement for any one job.

The coils have compact fields and permit compact set construction.

report. This does not in any way represent an intention to ignore the more continuous problems of the section whose usual status will not be changed by the seeming concentration on a single problem.

—R. S. K.

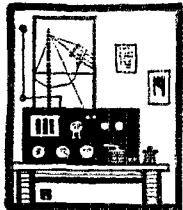

Amateur Radio Stations



9DMJ, St. Louis, Mo.

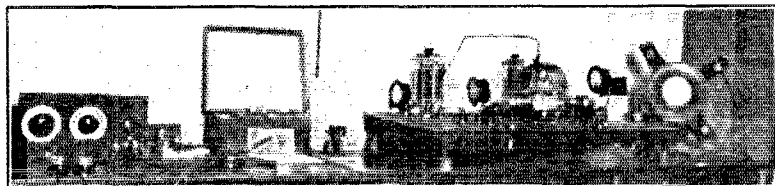

THIS station is owned and operated by D. W. Fowler and has been actively operated since 1919. Of course it started with the usual Ford coil but quickly graduated to a 1-Kw. "rock crusher". This transmitter was quite consistent and on several occasions Hewitt of 2RK-2PF was worked without difficulty.

With the advent of c.w., a fiver was installed. This was followed by a pair of fifties and these in turn supplanted by a 250-watter in December of 1924. This is still in use. As may be seen in the photo, the tube is mounted breadboard-style and the whole board mounted on porcelain insulators.

The shunt-feed Hartley circuit is used and is capacitively-coupled to a Hertz antenna operating on its third harmonic for 40 meters. The antenna is a single No. 6 solid copper wire with an overall length of approximately 95 feet. It is suspended between two wooden masts, one being fifty feet and the other sixty-five feet high. No counterpoise or ground is used. With an input of 750 watts which is the normal input, the antenna current at 41.5 meters is 2.5 amperes.

The plate supply system in use at this station is the result of numerous tests through which it has been developed to a satisfactory operating condition. In an effort to secure a synchronous rectifier that could be easily and successfully filtered, exhaustive tests on existing types were made. For filtering the rectifier's output, two iron core chokes are used. One is of fifteen and the other of thirty henries' inductance.

The smaller one is inserted in the positive lead directly after the spark filter which consists of two 1- μ f. condensers in series and a 6000-ohm resistor. It is connected right across the output leads of the rectifier. From there on the filter is of the usual brute force type using 2 mikes across the line both sides of the thirty-henry choke. Four r.f. chokes are used and are very helpful in securing a good note. They are spaced-wound on 2-inch pickle bottles to approximately double the working wave.

The receiver as seen at the left is of the conventional Hartley type with one stage of high ratio, audio amplification. Plug-in-coils are used to cover the various bands. Due to the interference from concrete mixers and line hums of various varieties, an underground antenna is used for receiving. It consists of a coil of number 14 rubber covered wire two feet in diameter buried approximately four feet in the earth. Another coil of similar dimensions located five feet away is used as a counterpoise. Local interference, while not entirely eliminated, is considerably reduced and the signal to static ratio is increased considerably above that obtained with the usual elevated wires.

Practically all the wavebands allotted to the amateurs, with the exception of the 5-meter one, have been used at some time or other and while the DX on none have been exceptional, it was possible during the winter of 1924 to maintain a schedule with g2NM on 80 meters each week for about six weeks. The 40- and 20-meter tests were participated in and CBS reported overhearing 9DMJ's end of a conversation with 6CGW. This constitutes the best daylight work.

The usual number of oa, oz, sb and nm stations have been worked.

Due to the fact that this is a one-man station and carries on a great deal of ex-

perimental work, it is impossible to be on the air a great deal of the time. However, it is an O.R.S. and always QRV for traffic.

1NF, Beverley, Mass.

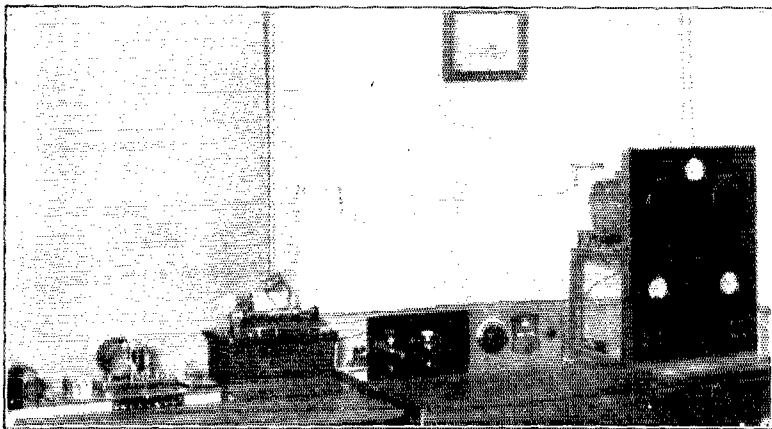

THIS station has been in operation for quite a few years and signed "ZZ" from 1905 to 1912. It was then licensed to use the call of 1RD. After Arthur E. Ericson, its owner and operator, came out of the Navy, the station was dusted off for duty and the call of 1NF allotted to it.

The transmitter is only a low-powered affair but is neatly constructed as will be seen from the photograph. A UX-210 is used in a Hartley circuit. 650 volts of raw a.c. are applied to the plate but due to the use of very loose coupling to the antenna the signals are reported steady.

A bent antenna, 60 feet long and 35 feet high and a counterpoise 30 feet long and 15 feet high are operated at a wavelength of 42 meters. The normal antenna current is about five-tenths of an ampere. A wavemeter covering all bands and made up in an aluminum case for shielding is placed near the counterpoise lead and by means of the hot-wire galvanometer in it, the wavelength can be readily checked. The wavelength is always 42 meters.

Two receivers are installed and both may be used when two operators are on hand. This allows a much finer combing of the band than is possible when only one operator is on duty. Both receivers use the throttle condenser control of regeneration and give excellent results.

A considerable amount of experimental work is done and a picture machine and tape recorder which may be switched to the output of either receiver, is always in operation.

Ericson is a charter member of the Institute of Radio Engineers and is greatly interested in experimenting. He would like to hear from any fellows who have tried the Jenkins picture transmitting equipment. 1NF is always glad to QSO and QSR and also to swap QSL cards with stations worked.

Your Wave from a Broadcast Receiver

(Continued from Page 46)

course any other harmonic could be used, the tenth being used in the illustration merely as it is easier to divide by ten than by the other harmonics.

No claim is made that this method will be as accurate as the standard frequency transmissions, but when the operator is not able to hear the above-mentioned transmissions, this offers a valuable substitute, as the wavelength may be ascertained to one tenth or, at the most, two-tenths of a meter; which is surely close enough for the average amateur.

Emergency Transmitters

(Continued from Page 49)

circuits have been published showing spark coils connected to forty- and even five-meter transmitters. Only pure c.w. is allowed in the lower bands and the spark coil i.e.w. transmitters should be kept far above that locality.

In future, we hope to read of many more additions of "auxiliary apparatus".

Calls Heard



ALL lists of calls should be prepared in exactly the same form as they appear below. It is preferable that they be typed although they will be accepted when printed in ink. They must be double-spaced and no punctuation or indicators designating stations worked or best DX should be used. There is no excuse for incorrectly made up lists as each QST carries several pages showing the proper arrangement.

1BHW, Warner and Hull, c/o A.R.R.L. Hq., Hartford, Conn.

oa-2ak oa-2bh oa-2bv oa-2zj oa-2me oa-2mh oa-2no
oa-2rc oa-2rx oa-2rt oa-2ss oa-2tm oa-2xi oa-2yi
oa-2yx oa-3ag oa-3al oa-3am oa-3bc oa-3bq oa-3bl
oa-3dc oa-3es oa-3hl oa-3jk oa-3lg oa-3wm oa-3xo
oa-4an oa-4bd oa-4cg oa-4nw oa-4rb oa-4sb oa-4wb
oa-5da oa-5hg oa-5wh oa-5yu oa-7cs oa-7cw oa-7bq
oa-7dx oz-1aa oz-1af oz-2ab oz-2ac oz-2ae oz-2ap
oz-2ak oz-2bg oz-2br oz-2rc oz-2xa oz-3ai oz-3ax oz-4ac
oz-4ai oz-4av ef-8acy ef-8bf ef-8ctn ef-8eo ef-8fi ef-8gi
ef-8ix ef-8jf ef-8jrk ef-8krt ef-8udi ef-8tis ef-8xix
ef-8zc ef-2nh ef-2zg ef-2xy ef-5dh ef-5fi ef-5mq
ef-5sz ef-5xy ef-6oo ef-6yq ef-6zc ef-4rs ef-v33
eb-7h eb-2l ei-1ce ei-1cr ei-1pl ei-1rc ef-4da es-2co
eo-amstn en-onf en-ong fo-a3b fo-a3m fo-a3x fo-a4x
fo-a4z fo-pm nl-2t nj-2pz pr-nau sa-2sr sb-2aj sb-2ag
sc-2ag sc-8ag.

1BSU, 25 Birch St., Chittendale, Mass. (From Feb. 5 to Mar. 5)

eb-b1 eb-4ac eb-n33 eb-o8 eb-4aa eb-v33 eb-h5
eb-4au eb-w1 eb-4cb eb-2bl eb-4qg eb-y2 eb-4yz eb-lar
eb-3uu ef-8af ef-8ger ef-8zet ef-8akl ef-8gfi ef-8jz
ef-8ep ef-8ix ef-8yaa ef-8dl ef-8ud ef-8xix ef-8eo
ef-8dui ef-1hp ef-8fr ef-8xv ef-8ux ef-8yx ef-8yor
eg-1eg eg-2xy eg-5oc eg-5kz eg-6mu eg-2cc eg-2jp
eg-5is eg-5uu eg-6ts eg-6yd eg-2nh eg-5jw eg-5vl
eg-6bd eg-6yv eg-2oj eg-5ku eg-5wq eg-6da eg-2am
eg-5ma eg-5yx eg-6fa eg-2vq eg-5mm eg-5kl eg-6qv
ef-1ay ef-2ce ef-1en ef-1cr ei-1da ei-1gw ei-1no ek-4ua
ek-4auh ek-4oba ek-4ya en-pjff en-lopf eo-3lr ep-1ac
ep-1aj ep-3fz em-smvr ne-lae ne-lak ne-lap ne-lax
ne-1lx ne-1dm ne-1ku ne-2bb ne-2fo ne-3bt ne-3gg
ne-3kt ne-3jl ne-3jw ne-3mv ne-4al ne-4d ne-5af
ne-5hp ne-8af ne-8aw ne-8azw nj-2pz nl-4x nm-1j
nm-5b nm-cyy nq-8kp nr-cto nr-rxy sb-1be sb-1ib
sb-1ig sb-2af sa-dh5 sb-1aw sb-1aq sg-5vl sb-bzl
su-2ak sv-ayre sb-2aj sc-2as sc-2ah fo-olg op-1ib
oz-4am ar-8lha fq-pm fo-a4x fb-lyaa a7 ab1 bzq erid
cri-10 err frw kel ee-aar4 1m mpt octu ono oxua
pdd ptr ptq rxy sbj sfv sgl sjb spw vgjl xchh zro.

1BYV, W. W. Smith, 300 Edgell Road, Framingham, Ct., Mass. (20 meters)

5auz 5dw 6adp 6ako 6am 6ann 6bxi 6bxr 6cln 6clp
6dck 6ea 6fj 6hm 6lj 6vz ef-8bf ef-8et ef-8gm ef-8ij
ef-8jn ef-8yor eg-5hs eg-6yq sc-1ed sc-3ag su-2ah
su-2ak nd-hik np-4sa oh-6acg ssi ab1 kdgl xlg.

1HN, Harold S. Johnson, 92 Brookline Ave., Hartford, Conn.

6am 6bd 6ea 6hj 6ip 6kg 6oe 6ta 6ua 6xs 6za
6ag 6ala 6aqx 6auk 6avj 6ay 6bz 6bhi 6bhv 6bhz
6bvj 6hya 6cer 6eik 6evy 6exy 6zbe 7if 7je
7ob 7us 7vl 7zn 7adb 7aib eb-4rz eb-4za eb-5uw
eb-a2 eb-b7 eb-k6 eb-n33 eb-u3 eb-z2 ed-7dx ee-ear6
ef-8ba ef-8du ef-8fi ef-8fk ef-8fy ef-8gi ef-8ix ef-8jx
ef-8qa ef-8ri ef-8sm ef-8tu ef-8zb ef-8zv ef-8zw ef-8dx
ef-8akl ef-8aro ef-8cax ef-8clu ef-8ger ef-8frk ef-8nox

ef-8yrt ef-8ssw ef-8udi ef-8ynd ef-8yor ef-8zet eg-2cc
eg-2cz eg-2dl eg-2it eg-2jp eg-2nh eg-2nm eg-2od
eg-2oq eg-2qv eg-2aw eg-2vq eg-2zc eg-5ad eg-5at
eg-5by eg-5df eg-5hx eg-5ku eg-5lf eg-5ma eg-5mq
eg-5mz eg-5nw eg-5sz eg-5tz eg-5ul eg-5vl eg-5yk
eg-5yv eg-6bd eg-6br eg-6dh eg-6fa eg-6mu eg-6nx
eg-6oo eg-6pu eg-6ry eg-6td eg-6ty eg-6vp ei-1ce
ei-1gw ei-1ad ek-4dba ek-4raf ek-4uah en-onf en-ofp
ep-1af ep-3fz ep-3gb fm-8ay fm-8jo fm-8st fm-8yx
fo-a3b fo-a3r ne-4dq ne-4du ne-4dw ne-4gt ne-5ef
ne-5go nl-4x nm-1j 'nm-1n nm-1r nq-2jt nj-8kp
nj-2pz oa-2bb oa-2jr oa-2rw oa-2sh oa-2yi oa-3bq
oa-3fr oa-3gl oa-3wm oa-5bw oa-5dx oa-5hv oa-7dx
oa-7hl oa-9lr oz-1fq oz-2ac oz-2ae oz-2br oz-2bg
oz-2xa oz-3ar oz-4am sa-aal sa-f8 sb-h4 sb-1af
sb-1aw sb-1ax sb-1ib sb-2as sb-5aa sc-2ah sc-2ar sc-2as
sc-2bl sc-2c su-1bu su-1ed su-1na su-2ak su-3yz.

2AXR, Box 113, Yonkers, N. Y.

6aak 6acg 6adk 6adp 6ahn 6ajj 6akh 6akn 6air
6am 6aur 6avb 6axd 6axu 6axw 6bam 6bgb 6bgs
6bd1 6bb 6bk 6bh 6bj 6bjj 6bjh 6bl 6bkh 6bbn
6blg 6bmw 6bfe 6bsn 6bqt 6boy 6bq 6buc 6bxc 6bxi
6bxn 6bxr 6bt 6bz 6ca 6cb 6cbz 6cbz 6bzy 6cel
6ege 6els 6eng 6ehd 6chn 6eh 6ea 6eub 6ecy 6eij 6dag
6det 6deq 6dp 6gr 6gz 6hb 6ha 6h 6j 6jz 6kj 6oe 6pw
6rs 6rv 6zat 6zbe 6zbd 7aae 7acc 7acf 7bl 7iz 7ju
7ll 7lz 7ol Tum 7vg 7adz ne-4ch ne-4fz ne-5au nq-8kp
nj-2pz nm-1n nm-9a eg-2sz eg-2lz eg-2xy eg-2dh
eg-6td ef-qrt ef-8yor ef-8ssw fm-8st fm-8jo es-2co
ea-ohk sb-law sb-1ib sb-1ak sb-2ag su-1ed su-1eg
su-1ak oa-2rt oa-2zg oa-2jr oa-2su oa-2ss oa-2sh
oa-2mh oa-2no oa-2yi oa-2yj oa-3wa oa-3vp oa-3ef
oa-4an oa-4bd oa-4is oa-5da oa-5om oa-5ix oa-5wh
oa-7cs oa-7cw oa-7dx oa-7hl oa-7qg oa-2br oz-2xc
oz-2xa oz-3aj oz-4ac oz-4am oz-4ak oz-4vb oo-gco
es-ear26 nn-xc51 nn-xc55 nm-xc66 ardi ur rxy xs
sd jl utm 4q2 kdcl kdgl kumt tony 6b-1 mars.

2CTQ, R. H. Davis, 36 East Gouverneur Ave., Rutherford, N. J.

(Heard on 20 meters during February)

4az 4bx 4cu 4ev 4lm 4rm 4sp 5ael 5aec 5ak 5ar
5atf 5aua 5auc 5dq 5dt 5du 5oa 5qj 5ql 5rh 5ru
5wz 6aat 6adp 6ahp 6ako 6ann 6arv 6bac 6bha 6bhq
6bil 6bjd 6bjj 6bjv 6bux 6bye 6bwx 6bxi 6bxr 6bzy
6cer 6edw 6eln 6elp 6elt 6et 6ey 6eze 6dek 6ea 6eb
6fr 6gg 6gj 6jn 6jo 6kv 6lh 6rm 6rv 6zat 7abx 7adw
7aif 7ay 7ek 7gb 7jc 7wb 7anb 7avb 7axv 7baf 7bfa
7cvg 7dew 7dse 7dsv 7eb 7ec 7ea 7eay 7anz 7aol
7ara 7awq 7baf 7bbh 7bbj 7btt 7bhi 7bhr 7bi 7bl
7bna 7bvk 7bw 7byl 7bzq 7ca 7caj 7cey 7chs 7cib
7cjj 7cjk 7ckj 7cmj 7cn 7ent 7ep 7epq 7eri 7etw
7ewv 7exx 7eyb 7dax 7dcb 7dcb 7des 7dga 7dlj 7dip
7dkm 7dlr 7dvn 7dod 7dol 7dra 7drh 7drw 7dsv
7dvl 7eae 7eas 7edi 7ef 7ef 7efh 7ein 7eir 7ek 7eky
7ik 7jk 7kv 7lb 7ll 7lr 7m 7nm 7nh 7oe 7rf 7ub
7vm 7vy 7xm 7xx ne-1r ne-1cg ne-3ni ne-4dw ne-5fk
np-4sa nq-2co eg-5hs ef-8udi sc-3ag su-1bu su-2ak
oh-6acg oh-6ash xq xlg agb.

2GP, Don Sayer, St. Ann's Ave., Richmond Hill, L. I., N. Y.

(Heard on 20 meters during February)

4bx 4fx 4jk 4km 4it 4lm 4pp 4sl 4we 5ael 5ado
5asu 5dq 5dw 5nj 5ql 5sk 5tt 5wz 6adp 6ahp 6ako
6ann 6bau 6bac 6bhq 6bjv 6bxr 6bux 6cer 6cei 6cln
6ctr 6ct 6ea 6gj 6fr 6jn 6ko 6ow 6rv 6rw 6zaf
7adw 7aif 7ek 7aly 7adk 7aul 7aya 7anb 7avx 7bvc
7ces 7ebi 7el 7egu 7ero 7exw 7df 7dch 7dpl 7dse
7dsy 7aah 7aaf 7aim 7acx 7aeb 7baz 7awb 7baf

9bes 9be 9b1q 9bna 9ont 9bsk 9bnl 9bzs 9byd 9caw
 9cei 9caj 9chs 9cib 9ck 9cjr 9cn 9cpq 9cpl 9csh 9cye
 9cwe 9cki 9exl 9eyb 9exl 9dad 9dad 9dbc 9dee 9des
 9dbw 9dij 9doe 9don 9dny 9dwl 9dzn 9dzy 9ef 9eai 9eas
 9ein 9eir 9eez 9eli 9ek 9eky 9fk 9jr 9ny 9kv 9mi 9qe
 9rf 9rk 9ru 9uu 9xi 9xx nc-lar nc-lad nc-lco nc-3fc
 nc-3gg nc-3ni nc-4du nc-4dw nc-4fy nc-4k nc-5fk eg-2ao
 eg-2or eg-2ot eg-2xy eg-2hs eg-5ku ef-8ct ef-8jn
 ef-8yd ef-ler su-lcd su-2ak sa-3ag sa-3ag np-4sa nd-hik
 oh-6aac glo glky nite oiq x-1qx.

4DK. M. I. Hull, 653 Rozelle St., Memphis, Tenn.
 (Heard between Dec. 20, 1926, and Feb. 20, 1927)

sa-bal sa-cb8 sa-db2 sb-lad sb-lak sb-lam sb-lar
 sb-law sb-lbr sb-lfb sb-2af sb-2aj sb-2aa sc-2ab
 sc-2as sc-2bl sc-2ld sc-3ag su-lcd su-2ak nc-lam
 nc-3cc nc-3gg nc-3jl nc-3mv nc-4al nc-4gt nc-5fk
 nc-5hp nc-9ai nj-2ae nj-2pz nm-1n nq-2jt nq-8kj
 nu-bb3 ny-rxy fo-a3b oa-2rb oa-2rg oa-2ij oa-2ij
 oa-2mh oa-2no oa-2pt oa-2rv oa-2rt oa-2rx oa-2sh
 oa-2ss oa-2tm oa-2ty oa-2uk oa-2xi oa-2yi oa-3bc
 oa-3bq oa-3ig oa-3my oa-3vp oa-3wm oa-4an oa-4bd
 oa-4cg oa-4nw oa-4rb oa-5bg oa-5bv oa-5da oa-5hg
 oa-5hs oa-5lf oa-5wh oa-6sa oa-7bq oa-7es oa-7ew
 oa-7dx oa-7hl oa-7lj oz-1fe oz-2ae oz-2xa oz-3ar
 oz-4aa oz-4ac oz-4ak nau ex b-fb2 xam nupg oedy
 ayre.

5JK. Norman Willis, De Queen, Ark.

iaae iaao ibtq icmp iea imk iabp iaan iaww iaxw
 idy idt icpd iab 3bit 3gp 3wf iaah iaar iay 4bt
 4bk 4bu 4ct 4dd 4ec 4fx 4jk 4il 4le 4of 4pp 6am
 6bj 6bq 6rj 6xr 7abb 7a 7ek 7rl 7ld 7pu 7uw 8av
 8au 8bp 8by 8cc 8ex 8scu 8ema 8cmb 8ec 8jb
 8adk 9ais 9apy 9br 9bf 9ct 9fn 9eky 9or 9czh
 9e1 9day 9dli 9dl 9dk 9dmt 9dtk 9dvw 9eez 9ek
 9el 9hh 9kd 9ln 9as 9d 9uz 9wk 9xi 9za 9zd bh-4qg
 eg-2mn eg-2lz eg-5by eg-6yd ef-8jn oa-5bg oz-2ac
 sc-2ar sc-2ld xc51 nm-9a nm-1n ex6.

6BZR, Bill Breuer, 1720 So. Catalina St., Los Angeles, Calif.

nc-3el nc-3mv nc-3aq nc-4ah nc-4rt nc-4bz nc-4hs
 nc-4dq nc-4dw nc-4bl nc-4fd nc-4du nc-5am nc-5ad
 nc-5bn nc-5hp nc-5go nc-5ef nc-3ar nm-9a nm-ix
 nm-5c nm-1n nm-1j nm-5b nm-1o fo-a3b fo-a4z fo-a6n
 fo-a4v fo-a5t fo-a7h sb-laa sb-lam sb-2az sb-2as sb-2ad
 sb-6qa sc-2ah sc-2ar sc-2as sc-2ah sc-2bl sc-2ld sc-4aq
 sa-bal sa-cb8 sa-bd4 sa-fc6 sa-hgl oz-1fe oz-2ae oz-2gc
 oz-2br oz-2xa oz-2bg oz-3ai oz-3ar oz-3xb oz-4aa
 oz-4 m oz-4ay oz-4ac oz-4ak oz-4wr su-lbu su-lcg
 su-2ak su-2ac oh-6axw oh-6ddl oh-6aff oh-6dcf oh-6tr
 oh-fxl oh-dme2 oh-dgo oh-1fl oh-ba5 ef-8em ef-8ij
 ef-8gm ef-8em an-1fg nj-2pz fo-pm oh-4pu dez
 rxy wudo 2yt jat hig aque nite m6n ag6 kfqz rjm hm
 lw nupg sda 6z ch ska qnp pic knt voq ev8 r5e
 aa7 wvr ay7 abl bb3 fr5 eef kfn dx8 sme fer.

6CETE, John Taylor, Sunnyvale, Calif.

iaa icxx ich las lny lol lafn lahy lbyx lrhs 2tm
 2ar 2dh 2ah 2ahm 2fm 2qv 2eyx 2eug 3jo 3fc 3ble
 3cp 3ua 3ak 3al 3ba 3ajc 3agg 3eah 3afw 3ro 4kz
 4ep 4m 4km 4si 4fa 4ez 4qj 4ahh 4rn 4ak 4io 5apo
 5aqs 5afu 5apr 5aah 5ql 5ao 5mn 5ar 5dq 5hv 5avs
 5ke 5bg 5auf 5uh 5ag 5df 5ap 5ad 5ajm 5av 5vw
 5sh 5rg 5au 5ajs 5dl 5ef 5ad 5oa 5efq 5la 5avs 5ban
 5dan 5day 5daj 5aou 5wk 5dem 5bbe 5daw 5bre 5da
 5dba 5aju 5dqi 5zw 5bnf 5aat 5efq 5bna 5eli 5dsv
 5dem 5ecu 5dea 5ash 5dhp 5gz 5bjz 5cwk nm-9a
 ef-8am oa-2rg oa-2no oa-2rt oa-2hb oa-2bv oa-2as
 oa-2ss oa-3ot oa-3ca oa-4nw oa-4bl oa-5atw oa-5hg
 oa-5ay oa-5wh oa-5bc oa-7dx oa-7hl sb-lap sb-laj sb-lar
 oa-8ax oa-8wh oa-8hg oa-8x oa-7hl sb-lap sb-laj sb-lar
 sb-5og oz-3ar oz-4ak sa-2ar sa-2as sa-2ab sa-2bl sa-3ag
 sa-4al sa-af2 sa-bgl sa-dw4 sa-hd4 sa-fc6 sa-dm7
 nj-2pn nc-2dn nc-3ni nc-4dw nc-4fv nc-4bn nc-5ar
 nc-5bn nc-5ef nc-5ct oh-6dl oh-6bzm oh-6cxv oh-6ddl
 oh-6buu glkd kel agb pk9 ch8 dez nos.

6DCU, R. Blanchard, 1435 Thurston Ave., Honolulu, T. H.
 (Heard from Feb. 5 to Feb. 16)

ladm lamp laul laxa lbhs lia lrn lsw lvc 2aan
 2ahm 2apd 2avl 2ac 2dz 2ev 2kg 2nz 2uk 2va 2zk

3bms 3bqj 3ef 3gp 3lw 3ow 4aah 4ea 4ry 4io 4km
 4ab 4m 4jz 5aaq 5akn 5ain 5apo 5amn 5ard 5ajj 5atf
 5bf 5aq 5e 5hn 5mr 5rh 5oo 5jf 5sg 5uk 5kk 5rg
 5zai 8acy 8ac 8bjz 8dd 8dni 8lt 8je 8xe 9aaa 9aan
 9arn 9bht 9bwo 9bvp 9bjn 9bqc 9bge 9bpi 9bpu 9bud 9caa
 9ca 9dqt 9crg 9cwn 9cnn 9csh 9cft 9cet 9eya 9dbf
 9dl 9ed 9day 9dwn 9dr 9eca 9elb 9eli 9ehp 9et
 9ln 9sd 9sx 9xm 9fn 9xe 9uu 9xi 9za 9pi ne-4fo
 sc-2as sc-2ar sc-2bl sa-hd4 sa-hd5 nm-lo aa-4z fo-a3b
 fo-a5r oa-4bd oa-4rb oa-3dc oa-3bl oa-2ty oa-2yj
 oz-1fb oz-lfe oz-ifs oz-2ac oj-1km oj-jkzb abl rxy knt.

6KQ. S. O. Halls, 86 Puiwa Road, Honolulu, T. H.
 (Heard during February, 1927)

3mm 4rn 5afg 5api 5auz 5dl 5if 6aat 6abm 6aej
 6am 6aod 6apa 6arc 6auk 6ax 6bg 6bh 6bhv 6bkj
 6bsd 6bvm 6bwc 6bre 6bxd 6bz 6bzm 6eak 6ec 6edw
 6elh 6ell 6epv 6ex 6exk 6eua 6euc 6ey 6ez 6ezk
 6dam 6daa 6dek 6der 6dgy 6dp 6ek 6ew 6fj 6ge 6jp
 6jq 6kb 6ld 6nw 6o 6ta 7ace 7acz 7adg 7aw 7im 7vp
 7ry 7tm 7vy 7efq 8ka 8rc 9arn 9bi 9bu 9dng 9dol 9xi
 aj-1km aj-lsk aj-lsm nm-5b nm-9a oa-2ay oa-2bg
 oa-2ly oa-2mh oa-2rw oa-2sa oa-2ty oa-2xi oa-2yj
 oa-3fd oa-4cg oa-4do oa-4nw oa-5bw oa-5rm oz-lfe
 oz-lfs oz-3ai sa-dd4 sa-hd4 su-1fb.

John Brucker, 1552 East 32nd St., Cleveland, Ohio

ladn lahb lahr laip lajm lakz iall lari lauk
 laxa lbs lbyy led lcke loo 2abu 2agn 2ane 2ann
 2auq 2ao 2apb 2aq 2au 2aub 2ec 2dy 2ox 2xao 3ad
 3agg 3cc 3vj 3wa 4ai 4ao 4cs 4dk 4ec 4ht 4iq 4ll 4lr 4pn
 4rm 4ti 4ie 5akk 5dt 5oa 5pi 5al 5br 6mu 6aca
 6acf 6adg 6adm 6agw 6ahj 6ak 6alm 6ams 6ani
 6ao 6aq 6arn 6as 6auw 6aw 6bas 6bct 6bho 6bhu 6biv
 6biw 6biv 6biz 6bid 6bnu 6bq 6br 6bz 6br 6brd
 6bv 6ca 6cen 6ed 6ef 6eg 6eh 6ci 6cl 6clu 6cm 6cmb
 6emt 6eni 6eo 6er 6erg 6ero 6ez 6da 6dae 6dew
 6do 6dpl 6dl 6dkl 6dlm 6dmz 6dne 6dol 6dqk 6drb
 6du 6giz 6hiu 6hj 6iv 6lai 6mz 6mj 6uz 6wf 6xao 6adk
 6afx 6ahb 6aj 6ak 6akg 6am 6amy 6anz 6aww 6awn
 6ba 6baq 6bbi 6bc 6bd 6be 6bg 6brg 6buc 6bm 6bzm 6bna
 6bnd 6bnd 6bng 6boe 6bz 6br 6br 6bv 6bwi 6bz 6bz
 6bv 6ed 6efw 6emi 6emq 6end 6emp 6eow 6ep 6et 6ew
 6ey 6ezz 6dbu 6dgg 6dq 6dr 6dm 6dhd 6drt 6dr
 6dte 6dvg 6dwe 6du 6ey car-o ed-8ko en-8dm fo-9cm
 fo-dll k-8al na-9aa nc-5a nc-9bc nc-9bq nc-9nz nm-rze
 nm-5c nm-9ll oa-9gl oz-2xa oz-4cz oz-5br oz-6c
 sa-5e 7) sh6d agh an8 ba-3 baw gky jaap lp-1 lw nek
 nimn qik rr-5e 5nnl ss-3 ze-8 znn waj wbf wsw wvv
 wdr.

ef-ROGL, C. Conte, 24, Alee du Rocher, Clichy-sous-Bois (S-et-O), France

(Heard between Jan. 28 and Feb. 23)

luac laao laap laem ladm laen laga lahv lair
 lait laif laki lakm laox lapf laqa laqm lare laru
 lary laaa laar lasu latr laur lavl lazw lbdw lbel
 lbes lbef lbfx lbhm lbhs lbhw lbkz lbqt lbpx lbvl
 lbvy lbvc lbym lbyx leje leh lemz lemp lemt
 lemx leng leue leg lid lfn lga lhh lih lidz lin lia
 lja lkk lkp loz lql lrd lro lry luw lvy lwl
 lxm lye lyx lzk lzy lva 2ac 2aba 2abp 2abe
 2ad 2adl 2ae 2ae 2ahp 2agn 2aky 2amp 2ams
 2ane 2apa 2apd 2arp 2atk 2aue 2aul 2aut 2ave
 2awf 2axy 2ayj 2ayw 2ays 2azk 2azu 2bae 2bbi
 2bc 2bi 2bkr 2blm 2bsl 2buy 2bzo 2bwa 2edr 2ei
 2eka 2exl 2eff 2em 2evj 2evs 2eyh 2eyz 2ez 2db
 2dg 2dh 2dy 2ev 2fo 2gz 2hc 2hr 2isu 2kk 2lm 2ux
 2ot 2sz 2uh 2uo 2wr 2vm 2abq 2acm 3adz 3afz 3afw
 3akv 3ait 3anq 3auv 3bms 3bz 3bqj 3bwt 3cbv 3cc
 3cdq 3cdy 3ce 3ehg 3ekl 3ej 3en 3dh 3eb 3ep 3eb
 3gp 3iu 3jo 3kr 3ld 3pf 3oo 3ps 3qv 3fh 3ql 3arw
 3sz 3te 3vf 3wr 3zs 4aac 4aah 4aar 4ay 4ez 4dd 4ft
 4go 4gz 4to 4jz 4jq 4km 4ld 4mw 4ob 4ov 4rp 4rm 4si
 4tn 4tu 4ajs 4atf 4eb 5if 5kc 5oa 5va 5vu 5ws 5wz
 5zai 6cqa 6abw 6ac 6ade 6ahl 6aky 6alo 6aly 6amu
 6anc 6aol 6ard 6avs 6aw 6awt 6ayf 6bau 6bbe 6hez
 6bhj 6bjz 6bpq 6brf 6bzu 6byn 6bvw 6eca 6eer 6ec
 6eck 6eef 6erp 6evi 6dbl 6dem 6dij 6dkx 6dhu 6ef 6ef
 6fg 6la 6li 6tl 6sf 6uy 6xe 6xf 6yv 6agz 6adg 6agw
 6arn 6anu 6btr 6cpm 6cv 6exl 6dr 6eev 6ef 6eb 6rd
 6uy 6qt 6zk 6zky 6xi nj-2pz nm-5c ne-lbr ne-lap
 ne-2be ne-2fo wll.

A. S. Williamson, 106 Rushdale Road, Meersbrook, Sheffield, England (Heard during February)

lcnr lbux laah laik laqi lavr lavf lair lauc laur laew lbhm leic leij lcyq leen lbqd lavr laix lbfx lbfl laen laao laxa laci lamp lshz laur lbdx iall lafn lais lbpx lbhm lakm laxx lafm larc lenp ladm laac lxam lcxh lbhs lbft lajf laue lest laff lbw lbew lage ladi lptw laga lbeo lahv lomx lbez labz lair laur lawe lcmf lbgs lbdw labn inl lxm lmp lch idi lkk lve ldd lkf lrn lcb lyb lie lav lrf lrd lcx lmv lbz lab lql lgp lhu lga lau lro lmr llj ldl les lqi lhj lww 2ie 2um 2bm 2md 2sw 2nz 2eb 2ec 2uc 2aa 2ha 2sb 2dy 2er 2kx 2dh 2fc 2xa 2tb 2uk 2lt 2tp 2sf 2iz 2ga 2yg 2gk 2pv 2ch 2ava 2ayw 2eyx 2beo 2akz 2buy 2auw 2avr 2ast 2ahm 2ary 2odr 2evp 2bhs 2aas 2ayk 2ago 2aul 2ann 2evj 2aev 2eyn 2auq 2arm 2euc 2agu 2eah 2ejd 2xaj 2amj 2edq 2bur 2ahe 2bur 2exl 2aen 2ahp 2avw 2epc 2apq 2ebi 2blm 2azk 2evs 2boz 2aub 2ase 2ens 2apm 2bbx 2baa 3ax 3rw 3jt 3pf 3eb 3ue 3ps 3dw 3gp 3ut 3jn 3jo 3bn 3kr 3ql 3hg 3ik 3rf 3aw 3dh 3ld 3zw 3hx 3mk 3cc 3ee 3gz 3iq 3ok 3og 3py 3tn 3nc 3bhv 3any 3bva 3ajt 3ahl 3add 3ebv 3bwt 3bms 3cen 3afw 3eki 3eah 3anr 4jo 4oy 4km 4nr 4gp 4gz 4we 4ab 4ll 4ac 4ft 4iz 4ek 4if 4hy 4wj 4nh 4ry 4ob 4dd 4rn 4rm 4aae 5va 5vl 5ke 5zai 7ua 8aiy 8afq 8bja 8enh 8bau 8bwu 8don 8boj 8abz 8rhk 8bzu 8cot 8acz 8alg 8adg 8dan 8dei 8bbw 8ane 8bbe 8xeu 8akv 8aul 8auc 8ut 8kj 8ew 8rh 8vx 8lj 8li 8dg 8xe 8ac 8eyx 9btr 8aql 9bpb 9ebt 9bht 9axb 9cys 9dxz 9bxz 9day 9dko 9dog 9arn 9cpm 9eev 9nk 9be 9sa 9xi 9ev 9cn ne-1da ne-1dd ne-2be ne-2bg ne-3kp ne-8rg ni-3kg nj-2pz nj-2ac nm-cy nm-hw nm-llj nq-5az nq-8kp nr-cto sa-bal sa-hd4 sa-bg8 sa-fc6 sa-en8 sa-db2 sb-1tm sb-lag sb-law sb-lib sb-lbr sb-lar sb-lak sb-lad sb-lal sb-lay sb-lie sb-laf sb-2ag sb-2am sb-2ig sb-2av sb-2ak sb-2ax sb-2id sb-5aa sa-2as sa-2bl sa-enw1 su-2ak su-lcd su-lak su-1fh oa-3dc oa-5wa oa-7cw oa-7dx od-pk9 op-lau oz-2ac oz-2br oz-2xa oz-3ac oz-3ar oz-4aa oz-4am oz-4ao oz-4ar af-1o af-hva ai-dcr fm-8at fm-8os fm-8vx fm-8jo fm-8mv fm-8pmr fo-a4z p-9ab s-ktz pkn sl-la xo kef vps wjl vbgi 98x tg5u ohk kfzq rsy dxs.

BRS10, W. H. Talbot Smith, 16 Farman Rd., Coventry, England

laff lauc lasf lakz lach ladm law laeo lair laul laac lbke lbkp leue lech lauw ler lce ldg ldi ldm lga lbe lhj lli lia lie lif lij lmy lme lon lry lrf lrd lsw lvz lve lwl lyaw lz1 2ahm 2agt 2amj 2apd 2ajv 2as 2ey 2ef 2ema 2dh 2tp 3arm 3ay 3ahl 3bhv 3en 3gp 3ka 3jo 3oo 3rs 3hg 4ak 4hy 4iz 4tk 8am 8az 8afq 8adg 8hx 8lt sb-laf sb-lao sb-lag sb-laa sb-law sb-lag sb-lbr sb-ldd sb-lbc sb-lgw sb-lib sb-2ad sb-2ar sb-2am sb-2ig sb-2ax sb-4aa sb-5aa sa-dw4 sa-hd4 sa-bg8 sa-dh5 sa-ch8 su-lcd su-2ak sa-2as ef-8abc ef-8ag ef-8adg ef-8en ef-8eaz ef-8et ef-8dl ef-8ddh ef-8dd ef-8ix ef-8jf ef-8jj ef-8ku ef-8kz ef-8ufe ef-8muz ef-8pri ef-8oqp ef-8ri ef-8rid ef-8sm ef-8tis ef-8vx ef-8xu ef-8xix ek-4ab ek-4ey ek-4mca ek-4sa ek-4wd ek-4vah es-2nm es-1vv es-2co es-1cr eb-2i eb-4yz eb-08 eb-4rs eb-k6 en-oco en-odg en-opm eb-epue en-owr ei-lgw ei-lvbg ee-ear50 ee-ear28 ee-ear42 fm-8dd fm-8st fm-8t fm-8u fa-8vx fa-8jo em-ssmw em-smuk em-smvg em-sgt lo-1x la-1f uia-oda einu eapg eapmr ef-1bla ar-8ha nj-2pz ne-2xt nn-4we pi-1xr p-1bk p-2af oa6n ank anf pea 8axg wll bda kzk chik gily xyz zwf viz tpal.

Miss B. Dunn, Lilystone Hall, Stock, Essex, England (Heard during January and February)

laal ladm lajx lavl laxa lcaw lch lenz lcx lga lie lkk lrd lro lsw lxm 2ybv 2nz 2tp 2xaf 3kr 4iz 8ada 8ajn 8aly 8dys 8lt ee-2yd ed-7fp ed-7zg ed-oxz el-1x el-5b el-ardl el-ign es-1pn es-1ee es-2cx eu-rau eu-rerl fe-suc2 ne-2fo nj-2pz ns-1bhv nz-1rx sb-lad sb-lap sb-lar sb-lib sb-2ab sb-2af sb-2ib sb-5ab sb-sq1 sc-2as fe-f2 fm-8st oa-7cw oa-7dx od-anf od-pki oz-3ar oz-4ac ap4 az4 bv4 cb3 dk ds dv3 f8z lv ptg ptr spr spw 4ca 9tf naw wss.

oa-3WM, W. J. M. McAuley, "Mia Mia", Union St., Brunswick, Victoria, Australia

ac-8fo ac-8em af-1b af-8fok aj-ish aj-1sk am-2sd am-2se ef-8bf ef-8ed ef-8eo ef-8fj ef-8ku ef-8max

ef-8qrt ef-8xz es-2co ne-3fc nz-2pz se-2ab sp-5oa su-lbr fe-f2 fm-8mb fo-a3z fo-a4f fo-a5x fo-alo fw-la oo-dgk oh-6acg oh-6bdl oe-hvv oa-3wm.

C. Harrison, Bellerive, Tasmania (Heard during January 1927)

ladl lama lasf lawe laxa lazd lbes lbhs lch lemf lhn lkk lkp llj lql lve 2adh 2agn 2ahm 2amr 2akv 2avr 2eka 2ctn 2euc 2yc 2agb 3bms 3bwt 3ekl 3dh 3ef 3gp 3kr 3ld 3lw 4bk 4km 4px 4tp 5ard 5aur 5auz 5aq 5ek 5ek 5km 5rh 5ww 5abg 6ach 6adh 6adt 6ajj 6akw 6ala 6amm 6anc 6ann 6auk 6ax 6bch 6bfl 6bhx 6ble 6bpm 6hq 6bvy 6bxe 6bxi 6bzm 6bzn 6cjj 6cm1 6eng 6ctx 6eux 6cz 6ezz 6ew 6fr 6hm 6jp 6kb 6mu 6w 6rj 7dd 7lx 7ou 8aip 8alu 8baj 8bau 8bf 8bgn 8bac 8cau 8ecs 8gp 8gz 8kc 8xf 8adn 9aex 9aim 9arn 9bjj 9bmm 9caj 9ckf 9ent 9ebv 9ead 9cvn 9cx 9dol 9dbw 9dr 9eev 9kb 9pn 9xi 9za nc-3wab nc-4fz ne-5aj fe-f2 ed-oxz od-pk9 ef-8bf ef-8eo ef-8gm ef-8jj ef-8kz ef-qrt ac-8em ac-8hb fm-ain af-8fok af-1b eg-2ao eg-2bm eg-2dx eg-2rg eg-5by eg-6dh eg-5tz eg-6al eg-6bd eg-6lr eg-6nh eg-6pa eg-6td eg-6uz eg-6yv eg-5nw oh-6acg oh-6axw oh-6bdl oh-6bc oh-6bcv oh-6bww oh-6clj oh-6cxy oh-6def oh-6oa oh-6xk oh-fxl oh-gdl aj-lab aj-lsk aj-lsm aj-kzb nj-2pz en-ohb fo-a3e fo-a3z fo-a4f fo-a4v fo-a5x op-1dl op-lhr op-3ac su-2bg su-dcr voc eog bam rxy ardi aye wxz dgk wuaj wucc ohk vps.

W. V. Macaulay, 122 Harbour Terrace, Dunedin, New Zealand

lad ladm lase lavm lba lbes lbhs lfq lgo lrd 2ag 2ab 2amd 2bak 2bt 2cdn 2cv 2axx 2gc 2nz 2pz 2xg 2xaf 3bs 3awt 3ds 3ng 4ao 4dd 4gp 4ht 4rm 4st 5aj 5ajj 5ap 5atj 5eq 5ig 5kc 5knh 5ohb 5ql 5uk 6anc 6ans 6adp 6aix 6azs 6ak 6bju 6bep 6bnv 6bqt 6btz 6hm 6bzm 6bx1 6cng 6cqw 6eaj 6ecn 6cso 6clj 6cl 6car 6ctg 6elt 6dia 6dp 6daa 6de 6den 6phj 6ta 6udb 7mh 8ad 8bjz 8bz 8bwv 8boi 8aju 8ccq 8ecx 8dxy 8ec 8jv 8no 8nt 8qb 8rt 9arn 9axb 9bqe 9bzi 9bbi 9bwb 9cwn 9crz 9ec 9cvg 9ecs 9dke 9dba 9dju 9efo 9dwx 9hp 9kax 9li 9pk 9sj 9uw 9xa oa-2uk oa-2xa oa-2kn oa-2ng oa-2ss oa-2sh oa-2ya oa-2rg oa-2aj oa-2ei oa-2lj oa-2rc oa-2sm oa-2ca oa-2ah oa-2wp oa-2ms oa-2eb oa-2sa oa-2uk oa-2kl oa-2nw oa-2xl oa-2fe oa-3eb oa-3wm oa-3ef oa-3es oa-2kr oa-3aa oa-4aw oa-4an oa-4cg oa-4nw oa-4rb oa-4lf oa-4lj oa-5ja oa-5ak oa-5lf oa-5ng oa-5wh oa-6ag oa-7cw oa-saz ne-2ak ef-8qrt ef-8rot ef-8fok eg-2ah eg-2nm oh-6buc oh-6kb oh-6bx1 ei-1gw nz-2pz nm-9a sa-cb8 sa-bg8 sa-hd4 es-2hi dac bhm pcs asb.



A General Radio Company 156 tube socket makes an excellent 50-watt socket by removing the metal shell. A piece of celluloid should be cut in a circle slightly larger than the base of the tube and pushed up over the prongs. This is to prevent the metal base of the tube from touching the mounting screws on the bakelite ring. In some cases, it may be necessary to bend one or more of the springs. This arrangement makes a good universal mount for the 201-A, 210 or 203-A but care should be taken with the fifty as the prong arrangement is different. Suggested by H. S. Dawson of the S.S. Canadian Fisher. He signs CR10 when hamming it and QSLs should be addressed to him at 22 Selkirk Ave., Montreal, Que., Can.



BELGIUM

Mr. Paul de Neck, president of the Reseau Belge, sends us this information concerning the recent governmental announcement of the issuance of amateur licenses and also of the annual meeting of the Reseau Belge.

"Belgian amateurs are now fully recognized by their government and licenses are granted covering installations up to 100 watts input. The official call letters consist of a 4 with two letters after it.

"Some good work has been done by our hams lately. Contacts with the U. S. A. have been both numerous and easy. eb4QQ, ex ebQ2, is working the states regularly

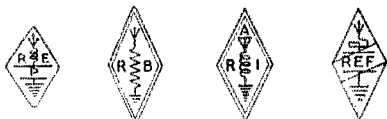

FOUR MORE DIAMONDS

They are the emblems of the Rede Emissora Portuguesa, the Reseau Belge, the Associazione Radiotecnica Italiana and the Reseau Emetteurs Francais.

with only 440 volts d.c. from the mains. eb4ZZ, ex ebZI, at Liège, dropped down to 20 meters and brings in "nu" stations with reports varying from R5 to S. eb4FT established the first Belgium-Alaska contact when he worked WWDO.

"In brief, everyone now being allowed to work in the open will make the best of his set and doubtlessly there will be many fine records made in the near future."

The Reseau Belge council has now the following officers: President, Paul de Neck, eb4UU, ex ebU3, 312 rue Royale, Brussels; Secretary-Treasurer, M. Ocreman, ebU8, 8 Ave Mahillon, Brussels; Traffic Manager, G. Noelemans, ebO8, 15 rue du Luxembourg, Brussels and Technical Manager, J. Musche, ebC2, 53 Boulevard Poincare, Brussels. The councillors are R. Deloor, ebP2, 26 Ave du Mt. Kemmel, Brussels and L. Hunninck, ebU2, 108 rue d'Anderlecht, Brussels.

Besides the elaboration of statutes which are being handled by a special commission, the situation is being closely studied with the view of creating ORSs and the development of the home traffic.

All members, both Belgian and foreign will receive the monthly organ "QSO", which is now inserted in the Belgian review, "Radio-Science". Subscription price is one dollar.

Strong endeavors are being made to have the government change the 4 of the call to a 3 so as to differentiate between the Belgian and the German calls as they are already using the 4. The new emblem is pictured with the others appearing later in these notes.

Roger Parent informs us that the wavelengths assigned to the Belgian amateur are: 15-20 meters, 43-47 meters, 95-105 meters and 135-145 meters. While a large majority of the stations work in the 43-to 47-meter band, there are some that are testing in the 18-to 17-meter region. Among these are 4ZZ and 4XS, who are working each Sunday from 14.00 to 16.00 GCT.

ebP2, the late president of the Reseau Belge, is in daily contact with the Belgian Congo and he has been getting excellent reports from Boma and Elizabethville. Receiving conditions are good but about a month ago they were very poor. The "nu" stations are covering a very large band, their signals being copied from 31 meters to about 47 meters.

According to the new licenses, old ebY8 is now eb4AC and ebB1 is eb4BC.

CHINA

Robert K. W. Suez sends us this news as an indication of the activities in China.

"There was an exhibition held in Shanghai at which the various colleges of the city had displays. The St. John's University students of the Radio Society gave a most excellent exhibition which was the only scientific one to be seen. There were all sorts of transmitters from the old spark coil sets to a real modern crystal set (quartz oscillator and not receiver).

"The receiving portion of the exhibit covered everything from a simple crystal and phone connected to the antenna and ground up to a ten-tube super."

This was certainly a fine thing and we hope it will indicate to the "powers that be" the advisability of encouraging amateur work.

CHILE

During the past few months, conditions have not been favorable for DX. QRN has been very heavy except for a few nights. This is on the 40-meter band and in contrast to this, the conditions on the 20-meter band are good early each evening. European stations are heard occasionally on the 30-to 35-meter band and it is expected that during this winter work with them will be just as easy as was the case last winter.

In the mornings, conditions are good for working New Zealand, Australia and Asian amateurs. Second district amateurs are still doing fine work. 2AB has worked HVW, Mr. F. H. Harvey at the Hebrides Islands. 2AS has worked all continents and is waiting for his WAC certificate. 1AH and 2AR are regularly on the air and are QRV for traffic or tests. 2AK is dismantled as he has changed his QRA. 3AG, who is better known as 2LD, is the only Chilean amateur at present working in the 20-meter region. He is using 50 watts with r.a.c. on 19.5 meters almost every night from 6.30 to 8.00 p.m. E.S.T. His signal on this wave is reported as being very QSA in the U. S. A.

FRANCE

There have recently been established some new stations in French Africa, QSLs for which may be sent to Robert Larcher, 17 Rue Fessart, Boulogne-Billancourt (Seine), France. These stations are OCBA at Bamako, OCRU at Rufisque, OCZI at Zuider and OCDA at Dakar. All other QSL and

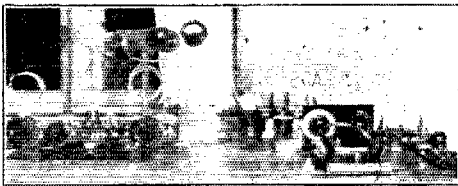

0z2GA AT WELLINGTON, N. Z.

QRA requests for French amateurs should be sent to the same address as this is now the official Réseau des Emetteurs Français, QRA and QSL section.

The correct QRA of ef8CL is Pavillon de Moisson, La Roche-Guyon (S&O), France. The owner is Madame Lebaudy and the operator A. Marquet deVasselot.

AUSTRALIA

We have been informed that the amateurs of Australia will not be allowed to transmit on any wavelength between 20 and 38 meters from 17.00 to 19.00 G.C.T. during the voyage of the *Renown*. This ban will not be raised until she is back in England. The present allowable waves for

transmission are: 8-10, 23, 32-33, 36-37 and 85-95 meters.

NEW ZEALAND

We are showing a picture of the outfit at 0z2GA. The transmitter uses 500 volts of c.r.a.c. on a five-watt tube. The circuit is the tuned grid-plate one.

The receiver is of the "Weagant" type with plug-in coils. As 2GA is in the State Forest Service, he is away from home quite a bit and on these trips carries a portable outfit.

MADEIRA ISLANDS

In regard to the misleading reports on BBT that we have been receiving, this letter from Alberto C. de Oliveira, ep3CO, should clear things up as far as that QRA is concerned.

"I want to draw your attention to the report on the Madeira Islands. I can assure you that this station BBT, is not located here and although the name, Vincenti Camba sounds like Italian as does also Venecio, the rest of the QRA seems to be Spanish! It may be anything but Portuguese!

"All of our amateur stations use the prefix "ep" followed by the figure 3. As you know, the prefix "ep" has been assigned to Portugal, Azores and Maderia Islands. We have arranged matters as follows: ep1 for Portugal, ep2 for the Azores and ep3 for Madeira. We all stick to this scheme. Therefore, Mr. Vincenti Camba must be Italian or Spanish but more probably Italian, and perhaps Venecio stands for Venice, the well-known city of gondolas.

"We have a league of our own, solely for transmitting amateurs, called Rede Emissors Portuguezes (R.E.P.), the head office being at 15 Costa do Castello, Lisbon, Portugal."

ARGENTINA

In the recent election for a president of the Argentina Section of the I.A.R.U., Mr. Enrique L. Repetto, of Buenos Aires, has been elected for a period of two years. Mr. Repetto will be remembered as being the Argentine delegate to the first International Amateur Congress at Paris, two years ago.

FINLAND

We see that Finland has recently passed a law stating that all radio reception and transmission will hereafter be under State control. This law seems to be aimed at the broadcast field and we do not know if the amateur has been mentioned in it.

U. S. S. R.

"The government has been issuing licenses more freely of late. There are now about one hundred short-wave transmitters although a large percent. of them are unlicensed. As the outlook for the erection

of more of these stations is promising, there is under consideration the printing of an amateur bulletin which will be called RA-QSO-RK. The first number is expected to be printed in March.

"Owing to the fact that the present method of issuing call letters has resulted in a considerable amount of confusion, a new arrangement of calls has been submitted to the Commissariat of Posts and

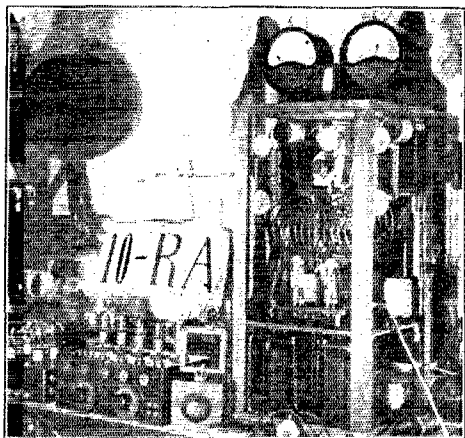

10RA

Telegraphs and it is hoped that it will be acceptable. It calls for the dividing up of the country into various sections, such as in the U. S. A. with each section being designated by a number and the call consisting of two letters following it. The problem of wavelengths will also be taken up. The present regulations allow waves from 10 to 110 meters to be used in amateur work.

"The photo shows one of our new stations, 10RA, who has done some very nice low-powered work."

—R1WX

FEDERATED MALAY STATES

It seems that about every so often the authorities in charge of radio in this part of the world have nothing else to do so they either change the wavelengths, call letters or anything else that may be thought of at the moment. Their latest attempt at "straightening things out" has been to bar the use of the new international intermediates, assign an intermediate of their own and change the old call letters more or less completely. They seem to have the opinion that the intermediate is an integral part of the call whereas it is only an abbreviation adopted by the amateurs of the world which is used instead of the operator having to spell out the name of his country. Such intermediates are *not* part of the call but are sent before the call as standard procedure, this being considered the most logical place for it. It is done in order that

time may be saved and less confusion result than if it were sent in the text of a transmission or alone either before or after the complete call and sign has been sent. There is no reason in the world why any government should feel obliged to dictate what abbreviations should or should not be used in amateur radio.

According to this latest ruling, the following is the "intermediate" and number which precedes the two letter call for stations in the various states.

vs1 for Straits Settlements.

vs2 for Federated Malay States.

vs3 for Un-Federated Malay States including Brunei.

vs4 for North Borneo.

vs5 for Sarawak.

ss2SE who later became am2SE is now vs1AB. am3AB in Lajore, Malaya now signs vs3AB. We hope the old saying, "A rose under any appellation—" still holds.

SOUTH AFRICA

"Conditions for DX are now spasmodic toward the east and west. Contact with the U. S. A. is still FB, though. The new intermediates are working out excellently. We appreciate this new form and consider it FB for all concerned.

"The "ef" stations are coming in well, in particular 8JJ, Mr. Belin. eg2OD, 5JN and 2LZ are fine on 32 meters but there has been ND on the 45-meter wave. "ek" and other "e" stations are occasionally QSO but the Asian and "oa" stations are not being worked as easily as in midsummer. We anticipate a complete wipe-out east and west for about three months starting in May. This occurred last year.

"There is a great deal of low-power work going on.

"The second annual conference of the S.A.R.R.L. is going to be held in Capetown during the Easter holidays in April. We expect a good turnout."

—Oxenham, A4L

SWEDEN

We are showing herewith, a picture of SMUK. The transmitter is a capacitively coupled Hartley circuit with an input which

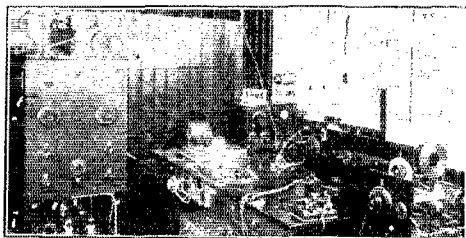

SMUK, NEAR STOCKHOLM, SWEDEN

may be varied from 25 to 200 watts. Communication has been held with most parts

of the world and is in operation every night from 22.00 G.C.T. on a wavelength between 32 and 33 meters. On Sundays, when broadcast stations are not operating, the station is on the air between 12.00 and 14.00 G.C.T. on a wave between 20 and 23 meters. The QSB is r.a.c.

The QRA is H. Francke, Hasselbo, Nellinge, Saltsjöbaden (Sweden).

QSL

There are a number of radio organizations in foreign countries that will forward QSL cards to amateur stations in their country when the QRAs of these amateurs are not known. We are listing some of them and would appreciate receiving word from all others who are prepared to render this service to the amateurs of the world.

England—QSL Section, R. S. G. B., 53 Victoria Street, Westminster, London S.W.1, England.

France—Robert Larcher, 17 Rue Fessart, Boulogne-Billancourt (Seine), France. This is the QSL and QRA section of the Réseau des Emetteurs Francais.

India—R. J. Drudge-Coates, Cambridge Barracks, Rawalpindi (India).

Ireland—Irish Radio Transmitters Society, Solent Villa, Kimmage Road, Terenure, Co., Dublin, Ireland.

Portugal—Rede Emissors Portuguezes, Tenente Eugenio de Avillez, 15 Costa do Castello, Lisbon, Portugal.

Spain—Association EAR, Mejia Lequerica 4, Madrid, Spain.

These organizations are in a much more intimate contact with the amateurs in their countries and are, therefore, better fitted to handle your cards than is A.R.R.L. headquarters. Remember, in many countries, the price of postage is an important consideration and the cost of mailing should be included with the cards whenever this is known or even suspected.

CANADA

Effective April first, the Canadian stations will be allowed to use the 52.51- to 52.6-meter band for all communication. Previously, this band was reserved for communication between only those stations in the British Empire.

We have a few "new" QRAs this month. aiACS—L. E. P. J nes, A Corps, Signals, Karachi, Ind. Wave 38.8.

Y-DCR—R. J. Drudge-Coates, Cambridge Barracks, Rawalpindi (India). Uses between 38 and 41.5 meters. (Intermediate should be "ai".)

ae1BK—Bangkok, Siam. Complete QRA not known.

ae2FF—Tientsin, China. Complete QRA not known.

ek4UAH—Victor Gramich, Murnau, Oberbayern, Germany.

ek4DBA—Fagien Kenigsberg, Kathof, Prussia, Germany. 34 meters, r.a.c.

ch4AR—Switzerland? ? ?

caJZ—Julius Zwirina, Wien IV, Favoritenstrasse 64, Austria.

ej7WW—Orehov, Petrovaradiu, Jugo Slavia, 44 meters, d.c.

SAD—Naval station at Stockholm, Sweden, 31 meters, 500 cycles.

ep1AE—Tenente Eugenio de Avillez, 15 Costa Costello, Lisbon, Portugal.

ep1AF—A. Faria, operator, Praca Marquez de Pombal 3, Lisbon, Portugal.

clLA1X—Stavanger, Norway.

ei1CR—Ing. Quasimodo, Gorizia, Italy.

ebW1—G. Regnier, 17 Ave Frere, Orban, Liege, Belgium.

fb1YA—Box 47, Ugandainya, Madagascar.

fa4A—W. Falk, Box MS 2, Abed, Abyssinia.

fqPM—Edwin Cozzins, Ebolowa, Cameroun, West Africa. Previously used foPM.

fm8ST—Lieut. Pelletier, Quezzan, Morocco.

foA4X—H. Rieder, "Hilmont", St. Johns Rd., Seapoint, Capetown, S. Africa.

naQRP—Siginaka Island, Alaska.

ubBEM—Ian C. Morgan, "Southlands", Warwick East, Bermuda Islands.

nbHIK—Cuban Dominican Sugar Co., Barahona, Dominican Republic, Island of Haiti, West Indies.

nrCTO—Box 115, Cartago, Costa Rica, C.A.

caJRK—Given as Cayenne Island near French Guiana. This doubtful and probably is Cayenne, the capital of French Guiana. If so, the intermediate should be "sf".

svAYRE—Harry C. Given Jr., Apartelo 288, Caracas, Venezuela, S.A. Given is ex nu3BC and is running AYRE which is a BC station.

shBZL—Arthur Gagan, Radio Station BZL, Demerara, British Guiana.

su1YD—Box 37, Montevideo, Uruguay, S.A.

su2AK—Box 37, Montevideo, Uruguay, S.A.

ni4X—Island of Antigua, Lesser Antilles.

SHIPS

VGJL—Canadian Commander, QSL to Harold W. Turner, c/o Canadian Marconi Co., Marconi Bldg., Montreal, Canada.

NITC—U.S.S. *Tampa*, Ice Patrol, runs between Boston and Halifax. QSL to Navy Yard, Boston, Mass.

BV8—S.S. *Lamariano*.

ZRO—Private yacht, Minnie.

SJB—Swedish *M.S. Laponia*, QSL to Wireless Operator, Laponia. Box 236, Stockholm, Sweden.



Correspondence

The Publishers of QST assume no responsibility for statements made herein by correspondents



A Real Welcome

1131 West Indiana Avenue
Philadelphia, Penna.

Editor QST:

I suppose that you receive letters of praise every day but here is one that I think might be a least bit different from the rest.

Upon the request of Mr. E. Maneval, 8EU, I visited Williamsport on Sunday, March 6th. I do not think anyone could have treated me better, had I been the king of England or the president. Of course, this may seem a bit strong but it is the real truth! I was met at the station at 6.08 a.m. and that is a dreadful time for a real ham, as 8EU is, to get up. After breakfast, he called up all the hams that were active in that town and in a short while they were all assembled to honor me. Believe me, I have been welcomed before but never have I even seen a reception as they gave me. To tell the truth, it made me feel proud to be an amateur and even those whom I have never even heard on the air talked to me as though I had known them all my life. What more can anyone want?

The thing that made the greatest impression on me was that they actually fought each other for the right to take me to their station first. The fellows were 8EU, 8AVK, 8BFE, 8CCQ, 8CGZ and 8CMO. They are real, red-blooded hams in every word. The day was over entirely too soon and when I had to leave at 5.50 p.m., the entire bunch was there to see me off and *I was asked to come again.*

The real A.R.R.L. spirit is right there in that town and I want to compliment you for having such a fine bunch of ORSs and as 8EU is RM of the district, no better man could have been picked for the job.

Now, that this letter is off my mind, I can go ahead and make arrangements for my next trip. 73.

Yours in amateur radio,

—Charles W. Hackenyos Jr., 3AIY

Crystals

2222 Avenue O
Brooklyn, N. Y.

Editor QST:

In regard to this crystal control business; I must get something off my chest, as the

saying goes. Why is so much publicity given to the crystals having a frequency in the 150- to 200- meter band and hardly anything said about the 80-meter fundamental crystals? You know, of course, that a 150- to 200-meter crystal makes it necessary to use one intermediate stage amplifier in order to get down to the 80-meter band and two stages for the 40-meter harmonic. While the cost of these crystals is about fifteen dollars, the price of the extra tubes, sockets, condensers, wire, etc. will be more than ten dollars. Therefore since you can procure a crystal in the 80-meter band for about twenty-five dollars, it is false economy to buy a fifteen dollar high-wave one and use extra apparatus in order to make it work in the 80- or 40-meter bands.

But that is not all. At 2BRB, 2PF, 2CLA and 2WC; using an 80-meter crystal, with an oscillator and a fifty watt tube amplifier, it is possible to transmit on either the 80-meter (fundamental), 40- (second harmonic) or the 20- (fourth harmonic) meter wave with the aid of three plug-in-coils for the amplifier. 2BRB originally got it working with the help of 2PF and it worked so nicely that all the other C.C. stations in Brooklyn are following suit. There is no secret at all, just the proper design of the coils and chokes. In addition, it is necessary to use about 200 volts on the grid of the amplifier to prevent self-oscillation on the 40- and 20-meter bands. Yes, as soon as we get some time, it will be written up for QST.

I hope, therefore, that these facts will be pointed out in QST so that the other amateurs can see how uneconomical it is to pay fifteen dollars for a crystal and about fifteen or twenty more for the necessary apparatus for transmission on the 40-, 20- or even the 80-meter band when, for about ten dollars more, an 80-meter fundamental crystal can be procured which does not necessitate this extra equipment.

Very truly yours,

—David Talley, 2PF.

Balance

318 Hamilton Street
Bound Brook, N. J.

Editor QST:

Commenting on the "Amateur—His Code" which appeared in the Communications Section of the February issue by Paul M.

Segal, I think that it is an excellent code and if lived up to would make the radio amateur a person to take example from.

One of the hardest rules to follow, however, seems to be Rule V, "The Amateur is balanced." I think this rule is the most abused one of all. Every amateur I ever knew has been in the habit of staying up late nights, losing sleep for the sake of DX. Everyone admits that it is the "bunque" on the morning after and mothers will call their little "Tommies" to meals and never get a QSL until T.O.M. comes up to the shack and threatens to throw all the junk out the window. It has happened to me and, no doubt, has happened to all of us at some time or other.

At least, this is a time when we can mend our ways because there is excellent DX to be heard at a sensible hour. There is no longer an excuse for all-night sessions unless they will not interfere with any of the other members of the house. The hours from 7 p.m. until midnight are the hours when the average human being is at leisure and this is the time to pound the brass. Saturday is a great day for the school boys but they can get all the QSO they want without pounding straight through meal time. Sunday is a free-for-all day as a listen in on the 40-meter band will show. For the average human, and most of the gang are average, although quite a few would put us as being "a little off" due to some of our actions; 80 meters is the best wave to stay on where there is little time for experimenting.

There have been trophies awarded for about everything in hamdom but never has there been one awarded for the "most sensible amateur". As the comics put it, "Something ought to be done about this."

If it were considered an honor or a greater feat to be a consistent operator and do good DX at a sensible hour, it would tend to make the gang more anxious to do all their DX and excellent operating at a time when they can do so without impairing their health.

The men who win the cups and do all of the great things in amateur radio are generally the ones who have a regular time for operating at a reasonable hour.

When any of the gang becomes so greedy for DX or stays up at unreasonable hours in hopes of doing some exceptional work, amateur radio at once loses its meaning and the fellow on the outside looking in, brands us as a bunch of dumb-bells. Everything I have mentioned is taken from personal experience and I am not original as I can name at least fifty fellows with whom I am acquainted who have all fallen down sorely on this rule.

I think it would do the bunch a great deal

of good to give this rule a little thought. The only change I should suggest in Mr. Segal's code is to make the Rule V, Rule 1.

73,

—John J. Long Jr.

They Got There

Schooner Yacht "Fisherman"
Anchored in Bay of Islands
Near Russell, New Zealand

Editor QST:

In contrast to the many letters published in the correspondence columns of QST, bewailing the fact that only five or ten percent of the traffic handled by amateur radio is delivered, I wish to say that during the voyage of the "Fisherman" from Los Angeles to Auckland, New Zealand, practically all of our traffic sent by amateur radio was delivered. In some cases there were as many as eight to ten amateurs delivering the same message. I think that this is a real indication of the wonderful spirit of amateur radio.

Mr. Zane Grey joins me in thanking the many amateurs who have handled our traffic, and the splendid spirit of coöperation has been deeply appreciated by all who have been in touch with the "Fisherman" by amateur radio.

Sincerely yours,

—Karl E. Zint, Radio Operator,
Schooner Yacht "Fisherman"

Getting Down

949 Ogden Avenue,
New York City.

Editor QST:

How about getting a few more fellows to get perking on the 20-meter band? It's FB, OMs, with lots of low-power DX in daylight, and anyone who doubts it can just listen in on 20 meters some Sunday afternoon and hear those Pacific coast stations come rolling in with a fine kick even though all are using low power. I am writing this because I think the band too unpopulated and believe that with the help of a few more hams, the band can be made as good, if not better than, the 40-meter band. Just give it a try!

—J. H. Gullans, 2AWU.

Cause For DX

624 Chester Street
Zanesville, Ohio

Editor QST:

Does the world have to turn upside down these days before a fellow can do any DX work?

The morning before the earthquake, snowslides, cyclones, thunderstorms and whatnots, I worked eight Californian stations between midnight and 4 a.m., E.S.T. I can't understand the "high hat" disposition of my 7½ watter as this is the first time I have been able to get into that section of the country. I was given an R-9 by one station and the rest gave me R-5 and 6, steady.

Another thing I might mention is that I didn't hear any other stations except those worked during this period of time. Also, we had an unusual electric and hail storm in this section on the same date.

I would like to think that this is honest-to-goodness DX but believe there is a "nigger in the wood pile" some place. I am not claiming that the above-mentioned uproar is the cause, yet, it gives some food for thought.

73

—A. L. Gatwood, SCHZ.

Standard Frequency

1108 Florida Avenue
Tampa, Fla.

Editor *QST*:

This is not meant as a complaint but rather as a suggestion. Why not ask the bunch to shut down during the standard frequency transmissions of the various stations that are sending such transmissions. It would widen the scope of this excellent service, in that stations at greater distances would be able to take advantage of the signals to calibrate their wavemeters.

Three times, now, I have tried to calibrate my wavemeter but without much success. On the 80-meter band, the QRM is not so bad and 1XM's signals come in about R-9 but on the 40-meter band, QRM is very bad and 1XM comes in only about R-4 to 5. While the skip may have a lot to do with the transmission, QRM has more effect as far as being able to use the signal is concerned.

This would mean that we must QRT for about an hour or so and as the transmissions are not made so very often, this would not cause us to miss enough operating to worry about. It would let many of the fellows get their wavemeters calibrated so that they could stay in their prescribed band.

—Le Roy B. Weitzel, 4AK.

He Hopes Handbook Helps Him

1301 Queen Anne Avenue
Seattle, Washn.

Editor *QST*:

Have heard how Handy's handbook helps handicapped hams. Have heretofore hesi-

tated. Hereafter, Handy's handy ham's handbook hobbles hesitancy here. Hence, hasten Handy's helpful handbook hither. Hustle!

Hurriedly,

—F. T. McAllister

QSL Again

Belden, Nebr.

Editor *QST*:

QSL cards have been quite a bone of contention. Nobody seems to think they are of any use except to show how the old fiver works and to make wall paper. Station walls are a mass of cards with those from greatest distances in the prominent places. No wonder the fad comes in for malediction.

I think we will all agree that, if every operator knew the exact location of every station he heard and whether or not it was a desirable station to attempt to QSR through, we could easily double our traffic in the hours we put in. Now, by simply trying to get a card from every station I work and arranging them alphabetically by districts around the wall, I have a very satisfactory substitute for a super memory. It is also a good CQ eliminator.

When clearing traffic, one glance at the wall tells me whether to answer the station I hear signing or not. I felt like stopping my subscription to *QST* some time ago when they advised against sending cards to stations in your own district. Those are the ones we need most for QSR. We know the general direction of stations in other districts but in our own, it is the old, time consuming QRA business.

—O. A. Kilbourn, 9EGJ.

73

Frankfort, Mich.

Editor *QST*:

After looking over some of the cards we have received, I am wondering where the 73's and es originated.

73's evidently came from the old Morse abbreviation, 73, meaning "best regards", but where the apostrophe "S" was added seems to be a mystery. The expression is already pluralized so I can see no reason for adding an apostrophe "S". The es, undoubtedly has been handed down from Morse but, if so, it is not es. A dot, space and three dots in Morse is written by making the characteristic symbol for and, "&". Those of you who have ever worked Morse have probably never seen it in a message as es. This symbol is used in Morse as an abbreviation for "and" when sending or copying car initials; such as, B&O and it is not written BesO.

This mistake is not only prevalent among amateurs but quite a few commercial operators use es for & and 73's for 73 and think it is perfectly correct.

Yours very truly,
—C. O. Slyfield

Cooperation

Editor QST:

A lot has been said in our beloved QST on the subject of "Ham coöperation" and maybe it would be just as well if I kept my peace on it. However, as I don the "cans" every night, I am more and more convinced that ham coöperation isn't all that it might be.

First, there is the chap who will not QSR. He is out for DX and cares very little for traffic. I had some traffic for Massachusetts the other night and hooked up with a fellow in the very city the traffic was for. I asked him to QSR but he came back with a "nil hr om, gl'd wkd u, cul". Now! I ask you, "Is that coöperation?" I don't see it that way.

Then there is the man who pushes the brass at 25 per, little thinking or caring about the fellow who has trouble in copying his ten.

No, I think hamdom has a long way to go before we have real coöperation. Let's get together and help make Hamdom what we like other folks to think it is.

Yours,
—J. W. Singleton, 1CDX.

A Short-Wave Loop Receiver

(Continued from Page 43)

due to the house wiring and to capacity pickup.

Several sketches are appended. Since

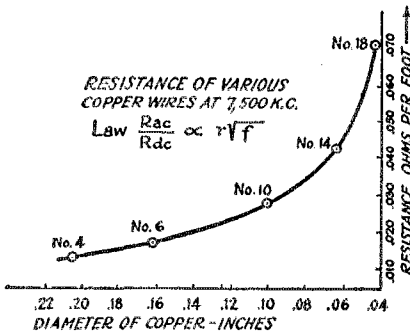

FIG. 2

the coils have but a single turn each the choice of the proper wire size for the coils

is little concerned with the distributed capacity effects and eddy losses which limit

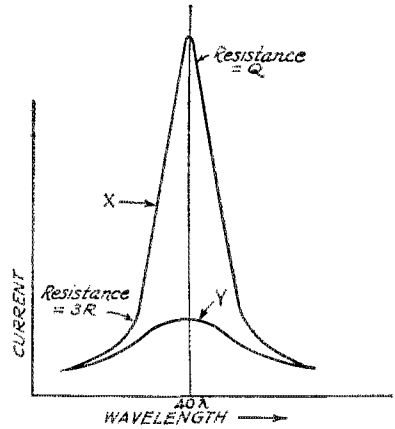

FIG. 3

the size of wire that can be used in coils for longer waves. Instead one approaches the conditions for straight wire and the curve of Fig. 2 is calculated on the basis of a straight wire. The calculations are based on Morecroft and circulars of the Bureau of Standards. Fig. 3 shows the increase in response that is to be expected if one manages to decrease the resistance of the tuned circuit to 1/3 of its former value. Curve Y is for a circuit with resistance 3R and curve X for a circuit with resistance R—one third as much.²

2. This automatically raises the old question—does the grid-circuit resistance matter when the tube is oscillating. Both sides of the argument have proved their cases to their own satisfaction. Here the question is complicated by the method of operating the tube. In any case, the heavy wire probably improves the ruggedness of the set.—Tech. Ed.

The Vertical Antenna at 8BMW

(Continued from Page 45)

the pole may be of interest. I did this with the bottom of a large pop bottle. You can cut the top off by binding a turn or two of cord around the bottle at the desired place—soak the cord in alcohol, light it, revolve the bottle until the flame dies out, then plunge it into cold water. Better practice on another thick bottle first. I set the pole into this bottle-bottom and then filled the remaining space around the sides with paraffin so that water could not get in to break the insulator in the winter time. The pole is kept from sliding off its base by four wooden cleats nailed to the base and forming a box around the bottle bottom insulator. The opening in the tower top clears

the pole on all sides by about an inch, so further insulation is unnecessary.

There is one more point which might cause trouble and that is the lead in. My back yard has two pairs of light lines in it, running parallel to the horizontal lead from the pole base. Of course having just completed a strong arm job, I was still very practical and reasoned that since I would use current feed I would be a smart baby and do it thru cute little cages. Logical enough wasn't it? Well, I strung up a 24-foot run to the antenna and a 12-foot one to the counterpoise; then of course I dashed up and tried the new antenna. Antenna current was good but I couldn't seem to QSO. I gave the outfit a few hours rest and tried it again that night. A bedroom light, four front room lights and a basement light glowed in sympathy with the key. What could be sweeter! The cage lead to the antenna was guilty without a doubt. I detuned those lights with .002 μ f condensers and changed the cage to a single wire. The counterpoise lead was also made single wire just on general principles. (Practical dope covering this phase may be found in the article "Feeding the Antenna," by Kruse in July QST.—Author's note.) Then results resulted. Two UX-210s in a Hartley circuit coupled to this antenna have given beautiful results. I have been comparing the reports given by eastern coast stations with old reports from the same section and I am certainly satisfied. It was something of a surprise that I discovered the antenna worked well at 174 meters.

I don't believe any further data on the tower is necessary—the photos show the proportions quite well. Use your own ideas. My tower was made extra solid so that, had the antenna experiment been NG, I could have put up a regular 2" by 4" mast. I claim to be the first amateur to build this type of antenna for c.w. service. Am I right?

You Need This BUG!

Reg. Trade Marks
Vibroplex
Bug
Lightning Bug

Genuine Improved Martin

VIBROPLEX

For Continental or Morse Code

Adjustable to 10 words
per minute
or less.

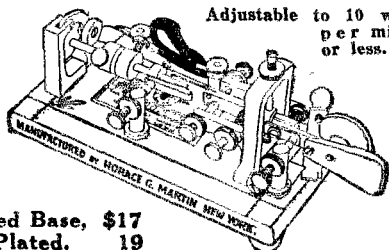

Japanned Base, \$17
Nickel-Plated, 19

Nothing can compare with the VIBROPLEX in EASE and PERFECTION of sending. Experienced operators KNOW this—that's why over 100,000 use and recommend it. Easy to learn. You simply press the lever—the Vibroplex does the rest. Saves the arm, prevents cramp and makes you a good, strong sender. Latest Improved Model Illustrated. Can be used in majority of DX circuits without relay.

Special Radio Model

Furnished with Extra Heavy, Specially Constructed Contact Points for direct use in any circuit without relay. Sent anywhere on receipt of price. Money order or registered mail. Liberal allowance **\$25** on old Vibroplex.

Be sure you get the Genuine Improved Martin Vibroplex. The Vibroplex Nameplate is YOUR protection. ORDER NOW!

THE VIBROPLEX CO., Inc.
825 BROADWAY NEW YORK

See that screw

A SCREW DRIVER
ADJUSTS AN X-L
IN CROWDED
PLACES

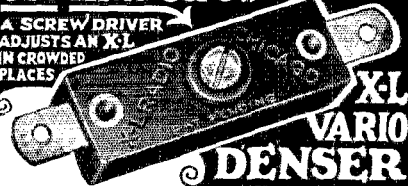

**X-L
VARIO
DENSER**

Quick, easy tuning—more volume, clearness, stability, with X-L VARIO DENSER.

Specified in all latest and best hook-ups.
MODEL "N" Correct tube oscillation on all tuned radio frequency circuits with slight turn. Neutrodyne, Browning-Drake, etc. capacity range 1.8 to 20 MFD. PRICE \$1.00.
MODEL "G" Proper grid capacity on Cookaday circuits with grid clips, filter and intermediate frequency tuning in heterodyne, positive grid bias in all sets.



Capacity range
Model G-1 .0002 to .0001 MFD
Model G-5 .001 to .0005 MFD
Model G-10 .0003 to .001 MFD
PRICE \$1.50.

X-L PUSH POST. Push it down with your thumb—insert wire, remove pressure and wire is firmly held—vibrations will not loosen—releases instantly. PRICE 15c.

PUSH POST PANEL. Furnished in strip of seven, marked in white on black insulating panel, with seven standard markings. PRICE \$1.50.

X-L RADIO LABORATORIES, 2428 N. Lincoln Ave., Chicago, Ill.

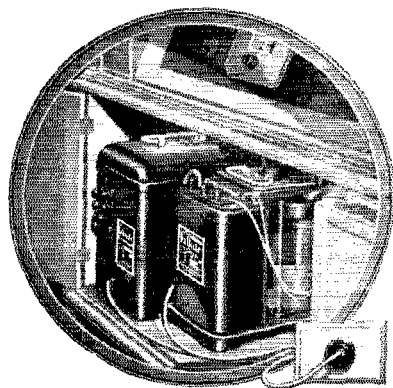

Now make your radio set
a light socket receiver with
Balkite "B" and the
new Balkite Trickle and
High-Rate Charger

Ask your radio dealer

FANSTEEL PRODUCTS CO., INC.
North Chicago, Ill.

Battery Eliminator Voltmeter

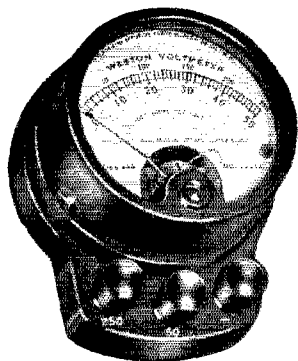

THIS Weston instrument is especially designed to measure the output of battery eliminators. The ordinary type of low resistance voltmeter cannot be used for this service. ¶ Model 489 Battery Eliminator Voltmeter has a high self-contained resistance of 1,000 ohms per volt, hence requires a current of only one milliamperere to produce full scale deflection. It may be obtained in two range combinations—200/8 and 200/50 volts. The latter instrument can be supplied with an external multiplier to increase it to 500 volts. ¶ For complete information address—

WESTON ELECTRICAL INSTRUMENT CORPORATION
158 Weston Avenue, Newark, N. J.

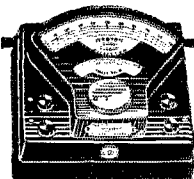

STANDARD THE WORLD OVER
WESTON
Pioneers since 1888

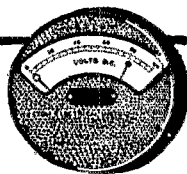

The New Federal Power Tube Coupler

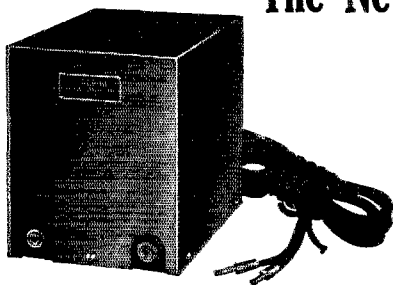

Another great advance toward positive perfection of radio tone quality. A superior type of speaker coupler—easily installed—neatly finished—positively efficient. Sold by designated Federal Ortho-sonic Retailers.

FEDERAL RADIO CORPORATION
BUFFALO, N. Y.

UX210 TRANSFORMERS FILTER CHOKES

200 Watt Size—Plate winding for full wave rectification, supplying 1100 volts, with center tap at 550 volts. Has two 7.5 volt filament windings for UX210 and UX216 B tubes. Price \$12.50

100 Watt Size—Plate winding for half wave rectification, supplying 750 volts. With 100 henry choke system gives smooth RAC note. Has two 7.5 volt filament windings for UX210 and UX216 B tubes. Price \$9.50

50 henry 100 milliamperere filter choke \$9.50
100 henry 50 milliamperere filter choke \$7.50

UTILITY RADIO CO.
80 LESLIE STREET EAST ORANGE, N. J.

Make any Good Receiver BETTER

CC
TUBES

G. E. Mfg. Co., Inc.
PROVIDENCE,
R. I.



PACENT TRANSFORMERS

Used and specified by the leading radio engineers of the country.

PACENT Electric Co., Inc.
81 Seventh Ave., New York

Amplification per dollar

*5-Tube Stromberg-Carlson
with TUNED ANTENNA
and DUAL CONTROL*

*Total Amplification=
768,000
Price \$180*

*768,000 ÷ 180 = 4266 =
amplification per dollar*

*Specimen 6-Tube Receiver
with UNTUNED ANTENNA
and SINGLE DIAL CONTROL*

*Total Amplification
55,296
Price taken as \$100*

*55,296 ÷ 100 = 552 =
amplification per dollar*

$$4266 \div 552 = 7+$$

*This means that a Stromberg-Carlson gives more
than 7 times the amplification per dollar*

What is the REAL VALUE of a Radio Receiver?



Above everything else amplification determines the reception quality of a receiver.

AMPLIFICATION DETERMINES VOLUME. Powerful amplification builds up the energy of weak incoming signals through succeeding stages until they can be reproduced with pleasing audibility.

AMPLIFICATION DETERMINES RANGE. The more distant the station the weaker the incoming signal; therefore, the greater the receiver's amplification the farther the receiver's range.

AMPLIFICATION DETERMINES CLARITY. All radio receiving systems depend upon converting electrical energy to sound by means of a vibrating diaphragm. The greater the receiver's possibilities to give tremendous and accurate amplification to the energy of the weak incoming signal, the greater is the available energy for overcoming the inertia of the diaphragm and the more natural will be the tone quality.

AMPLIFICATION DETERMINES SELECTIVITY. The ability to amplify only the signal to which the receiver is tuned is selectivity. The more powerful the amplification the more marked is the selectivity. Thus it is seen that the real value of a receiver should be gauged by its power of amplification—not by the number of tubes.

The chart above illustrated compares the amplification of a Stromberg-Carlson 5-tube No. 501 Receiver with a specimen 6-tube, single control receiver. This comparison shows that a Stromberg-Carlson should be the ultimate choice of those who demand results.

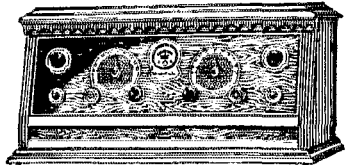

No. 501 Receiver, Treasure Chest, 5-tube; coils shielded; operates off either house current or batteries.
Price less accessories, east of
Rockies \$180.00
Rockies and West \$192.50
Canada \$225.00

STROMBERG-CARLSON TEL. MFG. CO., Rochester, N. Y.



Stromberg-Carlson

Makers of voice transmission and voice reception apparatus for more than 30 years

SAY YOU SAW IT IN Q S T—IT IDENTIFIES YOU AND HELPS Q S T

for
REAL RECEPTION!



KINGSTON

"B" Battery Eliminator

Guaranteed to remove the battery nuisance and deliver clearer tone and increased volume. Provides three different voltages at the same time. Each tap adjustable over a wide range, making possible any desired voltage from 5 to 150, absolutely harmonizing "B" current supply to your set. Raytheon tube used as rectifier. No noise or vibration. Contains no acid or solution and will not get out of order. Operating cost negligible.

At Your Dealer's

Price, complete **\$35.00**
with Raytheon tube

KOKOMO ELECTRIC COMPANY
KOKOMO, INDIANA

Hoyt

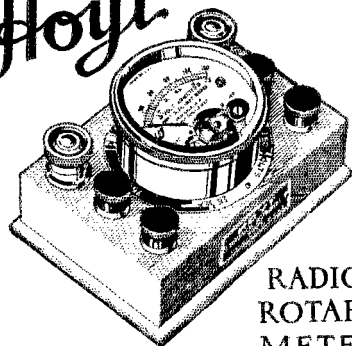

RADIO
ROTARY
METER

The Radio Dealer who services his customers' sets the most quickly and thoroughly, gains the most good will and profit. This HOYT Radio Rotary Meter gives him in one rugged, compact and accurate instrument, all the necessary 5 meter scales required for prompt and sure Radio service,—by a simple rotation of the meter case.

Send for 8-page book describing 20 Radio service tests with the HOYT Radio Rotary Meter.

BURTON-ROGERS CO.,

Sales Dept. for HOYT Electrical Instrument Works
857 Boylston Street, Boston, Mass.

Send for booklet "Hoyt Meters for Radio"

New Transmitting CONDENSERS

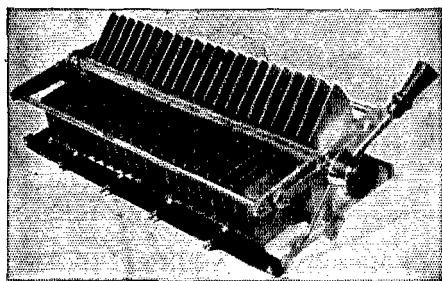

TYPE B, illustrated, has 6" diam. rotor plates, $\frac{1}{4}$ " plate clearance, breakdown voltage 8,000, etched scale, polished handle, pointer and locking device.

100 mmf. \$36.00	200 mmf. \$48.00
150 mmf. 42.00	300 mmf. 60.00
Counterweight extra	4.50
Panel Mounting Brackets	3.00

TYPE A is similar, but with 10" diam. rotor plates and with plate spacings of $\frac{1}{4}$ ", $\frac{3}{8}$ ", and $\frac{1}{2}$ " for breakdown voltages of 8,000, 12,000, and 16,000. Either type may be ordered any capacity.

New Inductances also now ready. Ask for our free catalog containing full information.

E. F. JOHNSON COMPANY
9ALD Waseca, Minn.

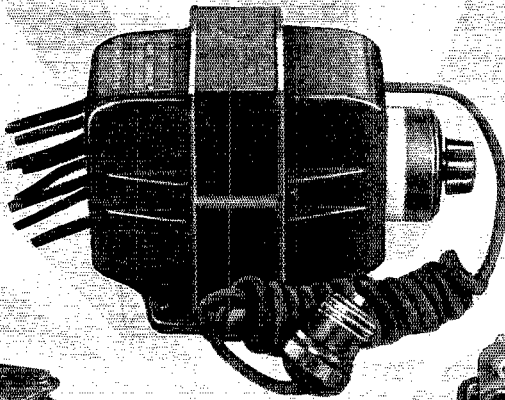

AmerTran Power Transformer
[Type PF 52—\$18.00 Each

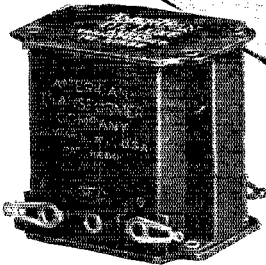

AmerTran
De Luxe Audio
Transformer
\$10.00 Each

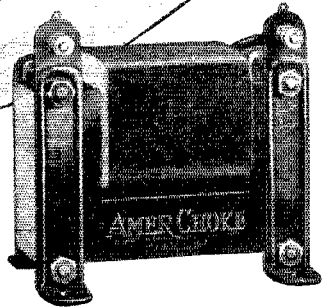

AmerChoke
Type 854
\$6.00 Each

BASS NOTE ENERGY

The production of deep bass notes at the source requires the expenditure of energy beyond that of sounds with higher tones and frequencies.

This greater energy is radiated by the best broadcast stations. When received and amplified uniformly by high grade transformers such as the AmerTran DeLuxe, it has a tendency to overload the last tube. The reason is not the volume of sound, but the relative increase in energy required to produce the sound naturally.

Prevention of overloading in the last stage lies in the choice of a tube which will permit the use of a high plate voltage and current. There are power tubes now on the market that will utilize these higher voltages. In obtaining these voltages economically, the ordinary 110 volt alternating house current can be stepped up and rectified with the proper apparatus and delivered to this tube.

Observing this principle you will obtain finer and more real reception through the use of AmerTran DeLuxes in your circuit.

Literature will be sent gladly on request describing the use of AmerTran Radio Products in the best of high voltage plate supplies.

The American Transformer Company
178 Emmet Street Newark, N. J.

*"Transformer Builders for
Over 26 Years"*

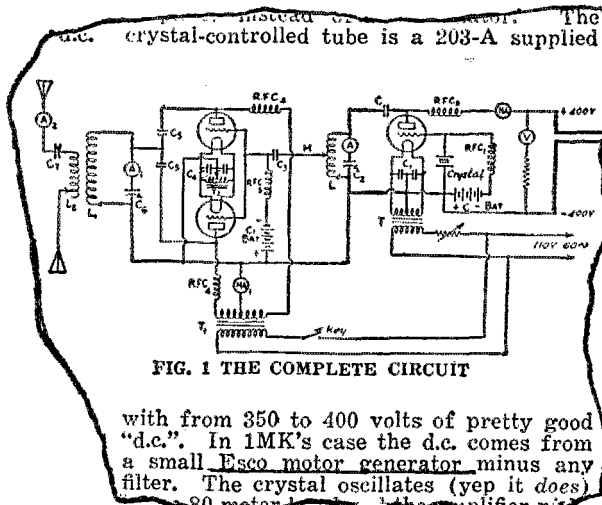

Clipped from March 1927 Q. S. T.

This is item 4--It is a very good set for crystal control.

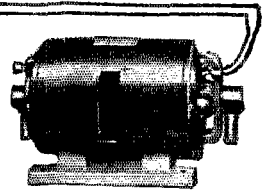

Bulletin 237E List over 500 combinations of generators, motor generators and dynamotors for Radio. If you have not a copy write for one.

P.S.--Have you a copy of Filter Facts?

ELECTRIC SPECIALTY COMPANY

Mark "ESCO" Trade

225 South Street

Stamford, Conn., U. S. A.

Manufacturers of Motors, Generators, Motor-Generators
Dynamotors and Rotary Converters, for Radio and Other Purposes

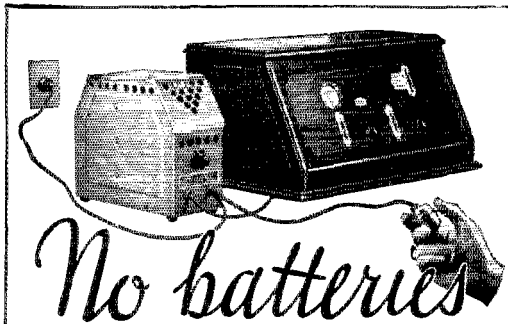

No batteries

Run this radio direct from house current outlet. Ordinary 110 volt 60 cycle domestic electricity transformed mechanically into smooth, quiet radio A, B and C power, as you use it.

No more batteries to fuss with! No trickle chargers! Price \$50.00

Crosley receivers designed for use with this marvelous power supply, are the AC-7 (pictured above) a 6 tube table model at \$70 and the AC-7-C, a 6 tube console at \$95.00.

Write Dept. 18 for descriptive literature.

THE CROSLY RADIO CORPORATION
Powel Crosley, Jr., Pres. Cincinnati, Ohio

CROSLY RADIO

Crosley manufactures radio receiving sets, which are licensed under Armstrong U. S. Patent, No. 1,113,149 or under patent applications of Radio Frequency Laboratories, Inc. and other patents issued and pending.

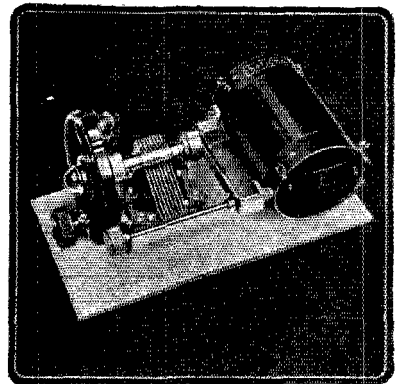

New Type
Designed and Officially Approved
by Glenn H. Browning

These new National Tuning Units comprise the Official Browning-Drake Coils and R.F. Transformers, mounted on the New National Equitune Variable Condensers with their light, rigid Girdler-Frames. Each Tuning-Unit is fitted with

NATIONAL TUNING UNITS COVER THE BROADCAST BAND

Price BD-1E, with Genuine BD Antenna Coil and .0005 Condenser \$10.75.

a National Illuminated Velvet-Vernier Dial--Type C, with variable ratio and smoothest action. Each tuning unit is packed mounted as shown so that it may be used without change for experimental work or easily installed on a panel.

Price BD-2E, with Genuine BD Transformer and .00025 Condenser \$14.25.

NATIONAL Tuning Units are standard for good Radio sets. So are NATIONAL Impedance Transformers, for quality audio, NATIONAL Tone-Filters, for power tube output connection.



NATIONAL CO. makes heavy-duty B Supply Units and 3-stage Power Amplifiers. Write National Company, Inc., W. A. Ready, Pres., Cambridge, Mass., for Bulletin 116-2-5.

Reliable

LONG DISTANCE COMMUNICATION

on
1 meter to 200 meters

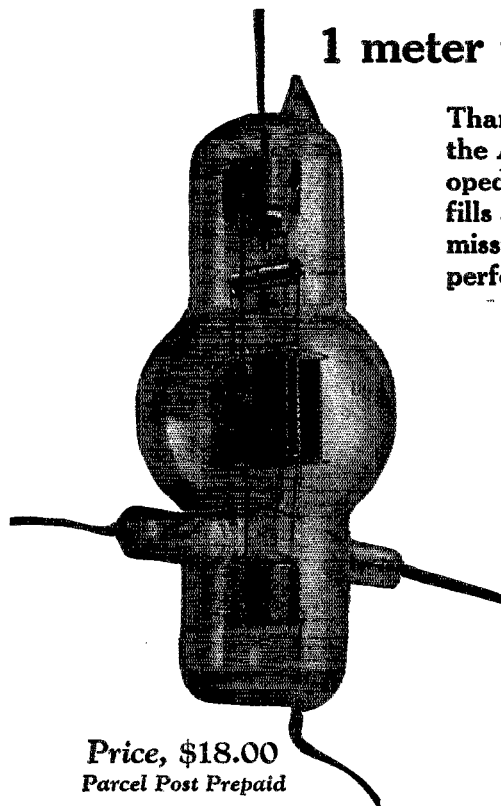

Price, \$18.00
Parcel Post Prepaid

Thanks to the co-operation of members of the A-R-R-L, De Forest has further developed the Type-H tube to a point where it fills *all* the requirements of amateur transmission. The result is still more uniform performance with extended filament life.

Technical Data

INPUT RATING 150 WATTS

Plate Voltage 500—2000
Plate Current 50-100 MA.
Fil. Voltage 10
Fil. Current 2.35A



HR Thermionic Rectifiers

Will Operate Two H Tubes

Fil. Voltage	10
Fil. Amperes	2.35
Plate Voltage A. C.	2000
Plate Mill Amps.	200 Max
Voltage Drop	300 at 200 Ma

PRICE

\$16.00

Sold and Shipped Direct
Upon Receipt of Money Order

DE FOREST

TYPE-H

TRANSMITTING TUBE

139 Franklin St.

DE FOREST RADIO CO.

Jersey City, N. J.

SAY YOU SAW IT IN QST—IT IDENTIFIES YOU AND HELPS QST.

demand AEROVOX

FILTER CONDENSER BLOCKS

For Working Voltages of 200, 300,
400, 600 and 1000 Volts D. C.

Flexible leads for connections eli-
minate all possibilities of leakage
from soldering.

AEROVOX WIRELESS CORPORATION
60-72 Washington Street
Brooklyn, N. Y.

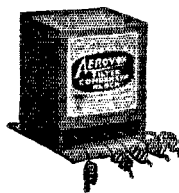

CARTER

NEW
Midget Rheostat

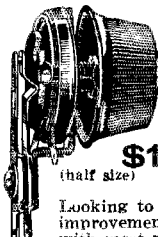

\$1
(half size)

with
**Filament
Switch**

Furnished in
eleven resistances
2-75 ohms

Looking to Carter for the latest
improvements has become a habit
with most radio fans.

This new midget rheostat and
filament switch combined has
been at once appreciated.

Its simple, sturdy construc-
tion, compactness, the elimination of
moulded parts, the all metal frame with re-
sistance element clamped in, all appeal to
the radio constructor.

As you know, Carter parts are specified
in the popular circuits.

See them at your dealers

In Canada: Carter Radio Co., Ltd.

CARTER RADIO CO.

MEMBER
RMA CHICAGO

90 Volt Power Unit \$12.75

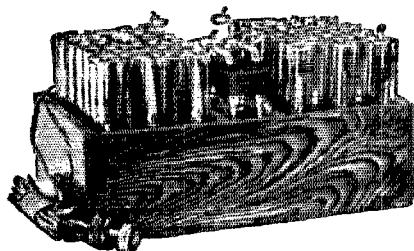

Hums, line noises, etc., positively impossible with
this new advanced unit. Plug in and forget. Non-
acid and noiseless. All detector and intermediate
voltages plainly marked. Simpler to hook-up than
dry cells. Operates any type set 1 to 12 tubes.

Greater volume and clearness guaranteed. If not
thoroughly satisfied return after using 30 days for
complete refund. Guaranteed further 2 years. For
110-120 volts A. C. 25 to 60 cycle current, 90 volts,
\$12.75; 112½, \$15.25; 135, \$17.50; 157½, \$19.50;
180, \$24.00; 202½, \$26.00.

Also built for D. C. current 110 and 32 volts at
only \$3.00 additional, any size above. Ample
stocks—same day shipments. Simply say—ship C.O.D.
or write for my interesting literature, testimonials,
etc.

B. HAWLEY SMITH, 332 Washington Ave., Danbury, Conn., U. S. A.

A FLOOD OF COMMENT



LOOK for the TRADE MARK

has been pouring in from all sections of the country.

The DIAL

A genuine black-bake-lite dial, four inches in diameter, with special indicator, whose movement is governed by a spiral groove in the rear of the dial, gives the HELICON movement needed for registering the five complete turns which the condenser makes. A special chuck-type clamp grips the shaft of the condenser eliminating the objectionable set-screw to hold the shaft. The indicator is remarkably simple and positive in operation. It eliminates any and all types of vernier dials, yet accomplishes what is so essential in tuning; namely, FINE ADJUSTMENT. Price

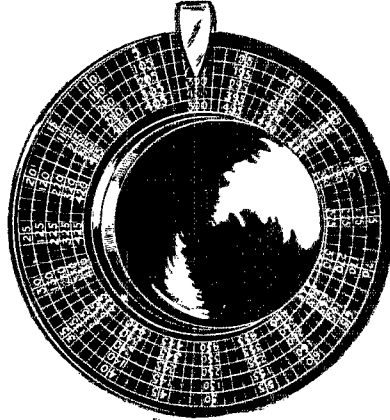

..... **\$1.45**

PATENT PENDING

RADIO FANS soon saw that with this new and practical HELICON condenser marked improvements in radio reception were made possible, especially on SHORT WAVES. There's a reason.

The CONDENSER

The new HELICON has a "tuning range" ten times longer than any 180 degree dial now employed, insuring exceedingly fine setting of the dial positions with comparative ease, especially on the higher frequencies (short waves). The variation is microscopic rather than micrometric, the vernier being found in the condenser rather than in the dial, thus permitting direct connection to the shaft of the condenser. No gears, pulleys, or other reducing devices. Each instrument is individually tested on a "wave-meter" circuit. It will replace any make or

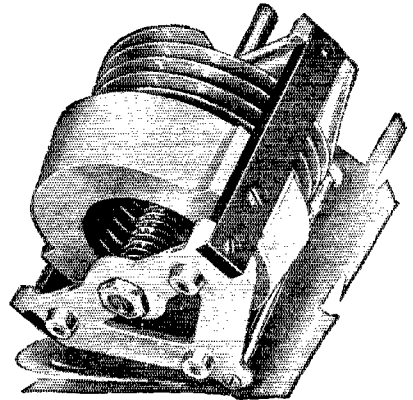

type of condenser of equal capacity. Guaranteed to give satisfaction. .000340 microfarad

\$6.25

Patent under
O. Meirowsky Patent
No. 1538487
E. Shalkhauser Patent
No. 1612473

AS ONE RADIO FAN SAYS: "We have been waiting for it for years."
If not obtainable from your dealer get them direct.

HELICON RADIO CONDENSER CORPORATION

PEORIA ILLINOIS

SAY YOU SAW IT IN QST—IT IDENTIFIES YOU AND HELPS QST

THE SUPER SYNC

The Synchronous Rectifier That Can Be Filtered

The Super is the only synchronous rectifier that can be filtered with ordinary type of filter circuit. Due to the fact that the Super rectifies practically the full wave it requires much less filtering apparatus to obtain the direct current which you desire. The commutator is so constructed that it is possible to rectify 99% of the full wave without danger of break down be-

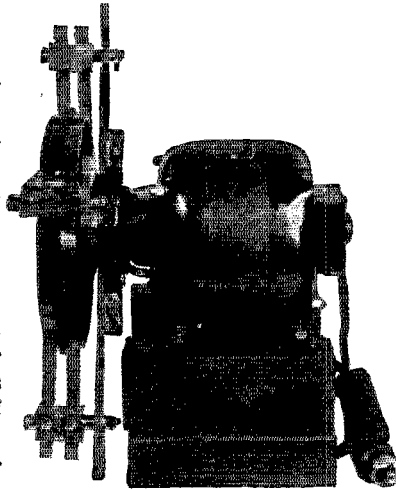

tween the conducting segments.

This rectifier is rated at 4000 volts and will rectify any voltage up to this amount.

The commutator is turned at a synchronous speed by a $\frac{1}{4}$ H.P. 1800 r.p.m. Synchronous motor and can be supplied for any standard line voltage and frequency.

PAT. PENDING

PRICE \$75.00 F.O.B. ST. LOUIS, MO.

MARLO ELECTRIC CO., 5241 Botanical Ave., St. Louis, Mo., U.S.A.

QST Oscillating Crystals

Attention Owners of Broadcasting Stations

We are at your service to grind for you your oscillating crystal. We will grind you a crystal for either use to serve as a frequency check on your emitted wave, or, we can grind you a POWER crystal which will be suitable for use to actually control the frequency of your transmitter.

Crystals ground accurate to BETTER than a tenth of 1% of your assigned frequency. Price for grinding such a crystal \$50.00 unmounted, \$60.00 mounted. Prompt deliveries.

Attention Owners of Amateur Stations
See our prices for grinding crystals for use in your hands, POWER crystals as usual, and the frequency given accurate to better than a tenth of 1% in the April issue of QST.

SCIENTIFIC RADIO SERVICE

THE CRYSTAL SPECIALISTS

P. O. Box 86 Dept. J Mount Rainier, Maryland

RADIO OPERATORS WANTED

THE EASTERN RADIO INSTITUTE can train you quickly and thoroughly because:

MODERN AND EFFICIENT METHODS
THOROUGH INSTRUCTION under staff of
LICENSED COMMERCIAL OPERATORS
MODERN APPARATUS including SHORT WAVE
TRANSMITTER

FOURTEEN years a RADIO SCHOOL
THE OLDEST, LARGEST and MOST SUCCESSFUL
school in New England. RECOMMENDED BY THE

A. R. R. L.

Day or Evening Classes Start Every Monday.

SPECIAL CODE CLASSES

Write for Illustrated Prospectus

EASTERN RADIO INSTITUTE

899 BOYLSTON STREET BOSTON, MASS.

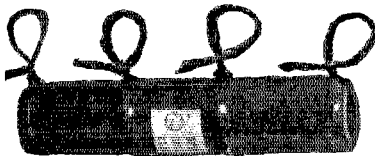

15,000 ohm Gridleak

Tapped at 5,000 and 10,000 ohms with 85 watt capacity. Price \$1.50.

5,000 ohm 85 watts	\$1.00
5,000 ohm W. L., 20 watt,	.75
10,000 ohm 150 watt,	1.50



UC 1015 Condenser

7,500 volts tested, sulphur and mica insulated, eleven capacities, .0002 to .001 mfd, for grid and plate blocking.

Price \$1.25

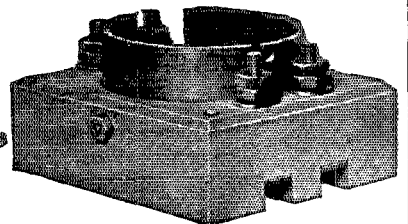

50 Watt Lowloss Socket

Maple treated base with brass airgap shell and heavy phosphor bronze springs. For UV 203A UV 217 and similar tubes. Price \$1.25

Utility Radio Co., 80 Leslie Street, East Orange, N. J.

"My set is all right, but....."

my "B" Batteries are just about gone?
 How often have you had to embarrass yourself by explaining that run-down "B" Batteries and not your radio set were the cause of all those reception "noises"—or worse, no reception at all?

Put an end to such "embarrassing moments." Do away with the annoyance and expense of constantly replacing wasteful "B" Batteries. Go to your nearest dealer and ask for a Majestic "B" Current Supply Unit to try on your set. Then, your "B" power troubles are over. You will have permanent, "full strength" "B" current direct from your light socket every time you turn on your set.

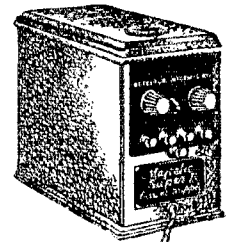

Majestic "B" Current Supply

The best "B"-Unit regardless of price

Majestic Standard - B
 Capacity Nine
 201-A tubes or
 equivalent. 45 mil-
 liamperes at 135
 volts.

\$26.50

West of Rocky Mts., \$29.
 Raytheon Tube \$6.00 extra

Majestic Super - B
 Capacity 1 to 12 tubes,
 including the use of
 power tubes. 45 mills. at
 150 volts.
\$29.00
 (as illustrated)
 West of Rocky Mts. \$31.50
 Raytheon Tube \$6.00 extra

Majestic Master - B
 Positive control of
 all output voltage
 taps. For sets hav-
 ing high current
 draw or heavy bias-
 ing batteries. 60
 mills. at 150 volts.

\$31.50

West of Rocky Mts. \$34.00
 Raytheon Tube \$6.00 extra

[CAN BE PURCHASED ON DEFERRED PAYMENTS]

No acids or liquids. No hum. Uses Raytheon tube. No filament to burn out. G.-G.-H. double sealed moisture proof condensers positively prevent breakdown, the cause of 95% of B-eliminator troubles.

GRIGSBY ~ GRUNOW ~ HINDS ~ CO.
 4562 ARMITAGE AVE. CHICAGO-ILL.

Majestic "B" is best

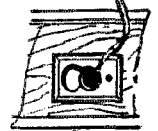

Ideal for the new HI-MU tubes

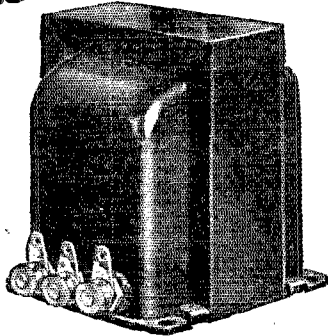

THORDARSON Autoformer

Trade-Mark Registered

All Frequency Amplifier

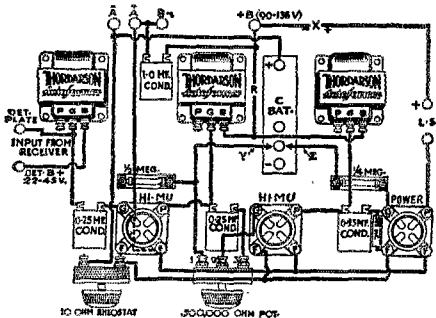

The Thordarson Autoformer used as a straight impedance makes an ideal coupling medium for the new Hi Mu tubes UX-240 and CX-340.

The excellent tonal reproduction of the Autoformer combined with the high amplification of the Hi Mu tubes plus a power tube on the output will transform your receiver into a real musical instrument.

The Autoformer is available at all good dealers at a price of \$5.00.

Thordarson Electric Manufacturing Company
World's Oldest and Largest Transformer Makers

Huron and Kingsbury Streets - Chicago

THE "WINDHAM" Type S.S.O. Condenser

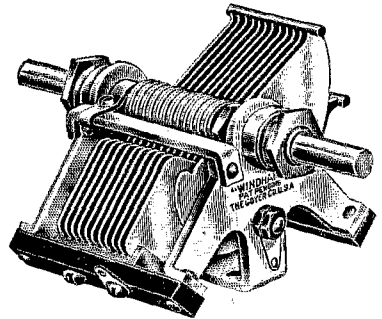

Satisfies Every Condition

Removable $\frac{1}{4}$ " shaft, hollow spindle, uniform station separation, easily mounted on panel or table, the best of materials and workmanship. You have often paid twice as much for a condenser half as good.

Send for Catalog

THE GOYER COMPANY, Willimantic, Conn.

Kenotron Rectifying Tubes

(Type T.B.I.)

MFD. BY GENERAL ELEC. CO.

These rectifying tubes operate on a filament voltage from 8 to 10 Volts and draw $1\frac{1}{2}$ amps. They will safely stand an A.C. input voltage up to 750 Volts and pass plenty of current and voltage for the plate of the Transmitting Tubes.

They are also very efficient rectifiers for use in "B" Battery Eliminators.

STANDARD BASE
NEW IN ORIGINAL CARTONS

PRICE ONLY \$1.25 Ea.

AMERICAN SALES COMPANY, 21 Warren St., N.Y.C.

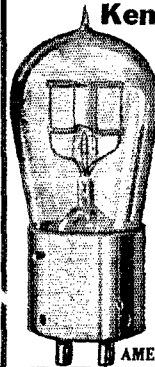

FOR EVERY BEGINNER

THE SIGNAL PRACTICE SET

Complete in every detail with high grade key, true tone adjustable high pitch buzzer and brass code plate. R68 \$8.40



SIGNAL WIRELESS KEYS



Strongly made with coin silver contacts. Brass parts polished and lacquered. Very reliable units.

R48- $\frac{1}{4}$ in. K. W. \$2.80 R62- $\frac{1}{4}$ in. contact \$2.50
R63- $\frac{1}{4}$ in. " \$3.70
R64- $\frac{1}{4}$ in. " \$3.90

Signal Buzzer



Small neat high frequency type. Has standard resistance of 5 ohms. Black crystallized lacquer finish. Special resistances on quantity orders.

R60 \$1.25

We manufacture a complete line of telegraph instruments.

SIGNAL ELECTRIC MFG. CO., Menominee, Mich.

REG. U.S. PAT. OFF.

THE **ELKON**

PRINCIPLE of RECTIFICATION

The Elkon rectifier, invented and developed by Samuel Ruben and the Elkon Works, Inc. is the first to make current rectification possible by means of a "BONE DRY" rectifying medium constructed entirely of **SOLID, IMMOVABLE, NON-FRAGILE** materials.

Now on the market for more than a year, doing duty in thousands of homes in the **ELKON TRICKLE CHARGER**, this rectifier, in actual use, has more than lived up to the expectations of those who conceived and developed it.

It has made possible, for the first time, rectification without **ACIDS, ALKALIS, TUBES, or MOVING PARTS.**

It is economical. It operates noiselessly. It does not cause interference. Short circuiting cannot harm it. It functions equally well in any position and under any extreme of climate.

Now in use in the Elkon Trickle Charger, the Elkon 3 Ampere Charger, and the Elkon "A" Power it is fast supplanting the old methods of current rectification.

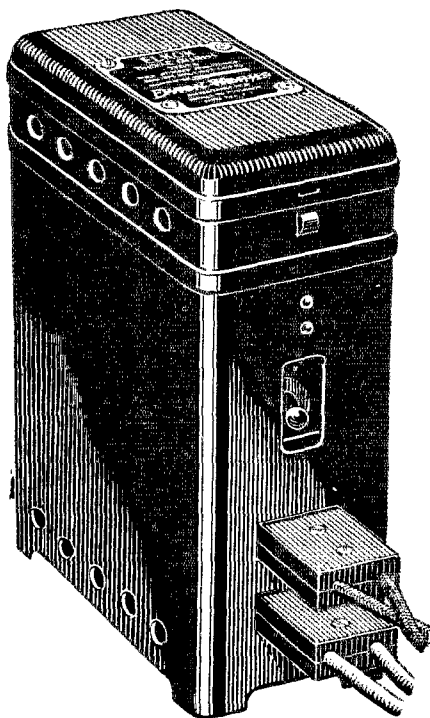

The Elkon Trickle Charger in which the Elkon Rectification principle was first made available to the public Jan. 1, 1926.

ELKON WORKS
Subsidiary of P. R. Mallory & Co. Inc.
ELKON WORKS Inc.
Weehawken, N. J.



Pattern No. 54 Voltmeter

When measurements of high voltages are necessary such as in the plate circuit of transmitting sets or in special laboratory test service, the Jewell Pattern No. 54 is the ideal instrument to use because of its high standard of accuracy and dependability, and also because of its adaptability to small panel board space.

Full scale ranges of 0-5 to 0-3000 volts are available.

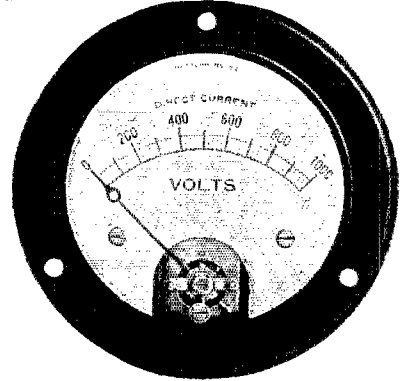

Pattern No. 54

Pattern No. 54 three-inch flush type instrument is an instrument of the best type. Bearings are natural sapphires. Movement is of the moving coil type. Movement parts are all silvered, and the scale is silver etched with black characters. It is equipped with zero adjuster, standard with all Jewell instruments. Case is finished in black enamel.

WRITE FOR RADIO INSTRUMENT
CATALOG No. 15-C

Jewell Electrical Instrument Co.

1650 WALNUT ST. - - CHICAGO

"27 YEARS MAKING GOOD INSTRUMENTS"

CRESRADIO CORPORATION

FORMERLY

CRESCENT RADIO SUPPLY CO.

Announce their removal to

166-32 Jamaica Ave., Jamaica, N. Y.

Your patronage has required us to double our floor space twice in three years.

Laboratory
Product



CRESCENT LAVITE RESISTANCES

for Distortionless Amplification

Dual resistances for DeForest "H" tube or one or two fifty watters, \$5.50. Special Grid leaks for any tube to order. Let us solve your voltage drop problems. Use all tubes in a circuit controlled transmitter on main generator. Our resistances will take care of the different voltage requirements.

PORTABLE S. W. TRANSMITTERS

Complete portable 7½ Watt Xmitters with Power Supply and accessories for your summer trip or as emergency standby, \$85.

Just out a Compact Xtal Oscillator Unit, \$70.

P. A. and Freq. Doubler 7½ Watt, \$45; 50 Watt, \$55.

We furnish full instructions how to adapt these Units to your present Xmitters.

Write for Quotations on complete Ham and Commercial Transmitters and Power Installations.

TRANSMITTING EQUIPMENT LABORATORIES, 3982 Woodlawn Ave., Los Angeles, Calif.

Look! O.M. Short Wave Coils \$6.00

Four coils, spawound, complete with mountings, 20 to 200 meters \$8.00 Complete kit including coils, drilled and engraved bakelite panel, SLF condensers etc. \$20.00. Write for descriptive literature.

ROONEY & WEHMAN

3410a 118th Street,

Richmond Hill, N. Y.



Never Before At This Sacrifice Price HIGH VOLTAGE KENOTRON RECTIFYING TUBES MODEL U. V. 217



A. C. Plate Voltage 1500 volts. Filament Voltage 10 volts.

Used with U. P. 1016 Power Transformer or similar Transformer.

These Genuine R.C.A. U. V. 217 Tubes are very efficient Rectifiers and they will pass plenty of current and voltage for 50 watters and H Tubes and also can be used for 250 watters. Every tube is brand new and packed in original carton.

List Price \$26.50 ea.

EXTRA SPECIAL, \$12.50 EA.

AMERICAN SALES COMPANY

21 WARREN STREET, NEW YORK CITY

Cardwell

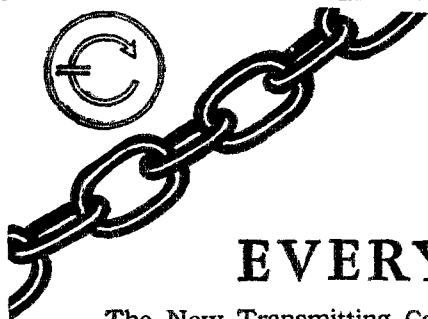

The Only Complete CHAIN

of condensers with a link for

EVERY AMATEUR USE!

The New Transmitting Condensers, with heavier plates, greater spacing, and more accurate construction, have proven extremely popular. Air dielectric fixed condensers offer grid and plate blocking capacities without losses. Receiving condensers of every style satisfy the most exacting, and insulators, inductance strip and choke coils supply the final needs for the Transmitter.

CONSULT THIS CHART

to be sure that you are getting the right condenser for your purpose.

Excepting the 156-B and 157-B, the maximum price is \$10.00

Plate Voltage	Use	U X 171 or smaller	U X 210 U V 202 VT2	"H" Tube	U V 203 U V 203A 211-D	U X 852 1/2 K W	1/2 K W 1 K W	Higher Power
200 Volts	C. W. or Phone	192-E 169-E 168-E	192-E 169-E 168-E					
500 Volts	C. W. or Phone		187-B 123-B 141-B	187-B 123-B 141-B	187-B 123-B 141-B			
800 Volts	C. W.		147-B 164-B 157-B	147-B 164-B 157-B	147-B 164-B 157-B			
800 Volts	C. W.			147-B 157-B	147-B 157-B			
1000 Volts	Phone			164-B	164-B	T-199	T-199	
1000 Volts	Phone			T-199	T-199	T-183	T-183	
1500 Volts	C. W.			T-199	T-199	T-183	T-183	
1500 Volts	Phone			T-199	T-183	166-B	166-B	Special
2000 Volts	C. W.			T-199	T-199	166-B	166-B	Special
2000 Volts	Phone					166-B	Special	Special
3000 Volts	C. W.					166-B	166-B	Special
Higher Voltages						Special	Special	Special

An Announcement

CARDWELL CONDENSERS
ARE NOW PROTECTED
BY PATENT 1626391

Send for copy of specifications of
new Transmitting Condensers

The Allen D. Cardwell Mfg. Corp.
81 Prospect Street, Brooklyn, N. Y.

Condensers

"THE STANDARD OF COMPARISON"

SAY YOU SAW IT IN QST—IT IDENTIFIES YOU AND HELPS QST

GROSS QUALITY APPARATUS

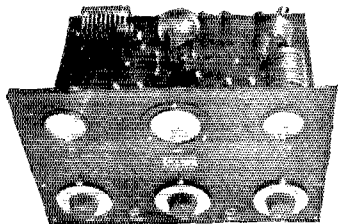

TRANSMITTER KITS FOR FONE OR C. W.

Transmitter kits illustrated above employ the tuned grid tuned plate circuit. They are composed of the finest parts available and are real transmitters, thoroughly metered, etc.

- 7 1/2 Watt kit complete \$47.50
- 75 Watt kit for use with the new UX-852 short wave tube \$65.00
- UX-852 tubes on hand for immediate delivery, price \$32.50
- Rated at 75 Watts can be used with voltages up to 3000 volts.

- GROSS PLUG-IN RECEIVER COILS**
- Base and coil for any band \$5.50
 - Complete kit, 15 to 130 meters \$11.50



PLUG-IN TRANSMITTER COILS

Gross plug-in transmitting coils are the last word in efficient plug-in transmitting inductances. Very compact in size and wound with heavy copper tubing. Can be used on any power up to 150 watts.

- Kit for tuned grid tuned plate circuit for 20 and 40 meters ... \$8.75
- Kit for tuned grid tuned plate circuit for 40 and 80 meters ... \$8.75

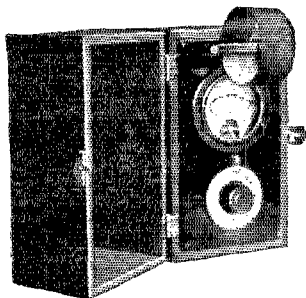

GROSS WAVEMETER

A high grade precision instrument at 1/3 the usual market price. Built into compact carrying case of genuine solid oak, leather handle on top with removable cover. Coils extremely low loss making a very low resistance wavemeter either the flash lamp or galvanometer type will easily respond to an oscillator using 50 volts or less on the plate of the tube. Coils fit into cover, when not in use. Calibration meter than 1% guaranteed. Checked against Piezo oscillator using a minimum of 10 points for each curve, no imaginary curves drawn from 3 or 4 points. Separate curve furnished with each coil.

- Type 1-F—with flash lamp indicator for 20, 40, 80 meter bands \$15.00
- Type 2-F—with flash lamp indicator for 20, 40, 80 and 200 meter bands 18.75
- Type 1-G—with galvanometer indicator for 20, 40, 80 meter bands 30.00
- Type 2-G—with galvanometer indicator for 20, 40, 80 and 200 meter bands 33.75

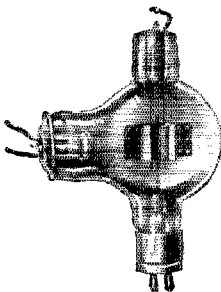

J. GROSS & CO., Manufacturers,

30 Park Place, New York



AUTOMATIC POWER CONTROL

Here is the way to control the switching of your B eliminator and trickle charger or either automatically.

No more needless burning of lamps which reduces their usefulness, and runs down your battery. You know that when you turn the switch on your set, the trickle charger is off, the B eliminator is on. You know that when you turn the set off, the Power Control is working automatically, surely and without fail, turning off the B eliminator and the trickle charger on.

No. 444—Automatic Power Control, Series Type—for use with sets having tubes with a current draw equal to or greater than 6 U.V.-199 type of tubes. Each \$5.00

At your dealer's. If he cannot supply you send his name with your order to

YAXLEY MFG. CO.

Dept. S, 9 So. Clinton Street Chicago, Ill.



Centralab Station Selector



BIGGEST Dollar's Worth in Radio. Tunes out short wave interference, increasing selectivity of any set (not using loop) on stations close to local, except same wave length stations. Not a wave trap. No adjustments. At dealer's or send us dollar bill. Money-Back Guarantee. Satisfaction guaranteed.

Central Radio Laboratories
20 Keefe Ave. Milwaukee, Wis.
Parts manufacturers for 69 makers of leading standard sets.





"BREAKING IN"



WITH Q. S. T.'S LOW POWER TRANSMITTER

Built in accordance with specifications given in the April, 1926, issue of Q. S. T. and also in the April handbook.

REDESIGNED-GREATLY IMPROVED

Due to the enormous demand for this popular kit REL has redesigned a neater and more flexible set which readily adapts itself to all UX Base Tubes—Any Type Power Supply—Wavelength range 15 to 90 meters. Large detail blue print with each kit. Dealer inquiries welcomed and promptly answered.

THE BEGINNERS IDEAL !

Complete Kit Includes

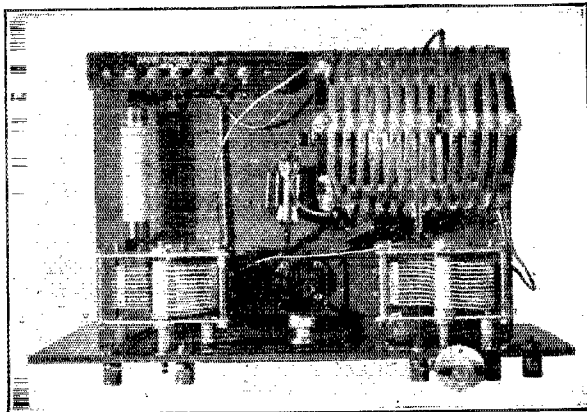

- 1-drilled and neatly engraved "Radion" front panel.
- 1-five ply veneer base board.
- 1-Special REL Inductance with supporting brackets.
- 5-REL Inductance Clips.
- 2-Special Cardwell transmitting variable condensers.
- 2-Three inch bakelite dials.
- 1-UX tube socket.
- 1-REL Choke Coil.
- 1-flament switch.
- 1-grid condenser with grid leak mountings.
- 1-7000 ohm grid leak.
- 1-Plate blocking condenser.
- 1-complete rear binding post connection strip.
- 5-large binding posts for front panel.

Necessary bus-bar, spaghetti, flexible rubber covered wire and all mounting screws.

(CAT. No. 175)

Price \$30

(We're doing a little "breaking in" here ourselves to say that it's high time to get your copy of our catalogue—if you haven't already. Price. .two bits and well worth it.)

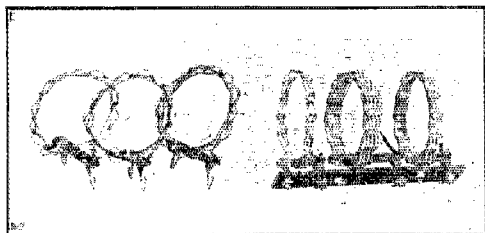

Special Short Wave Coil Kit—designed specially for those short wave circuits that require separate primary, secondary and tickler coils. Wavelength range of three secondary coils, 15-100 meters when tuned with .0001 mfd. condenser.

Six Coils (3 Secondaries, 3 Primaries or Ticklers) with base mounting

PRICE \$6.00 PER SET

REL Owns and Operates Experimental Station 2XV on 15.1 Meters, 19867 Kilocycles, Crystal Controlled.

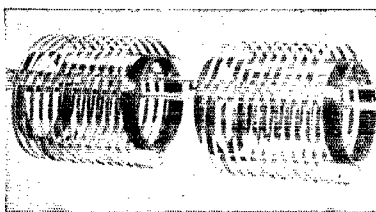

REL Transmitting Inductances—Flat-wound on glass. The inductance that you must eventually use.

Type L—(40, 80, 150 meters wavelengths)

Type S—(20 meters and less)

Single Unit, either type, with three clips \$5.50

Double Unit, either type, with six clips \$11.00



Radio Engineering Laboratories

100 WILBUR AVENUE
LONG ISLAND CITY, N. Y.



U. X. 852 TUBE HOLDER

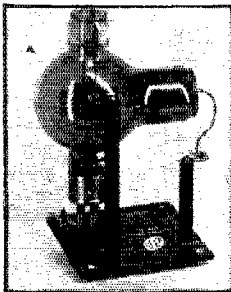

SPECIALLY designed for the new Short Wave Transmitting Tube.

Holds tube absolutely rigid. Connections for grid and plate leads. Provisions for mounting of grid and plate condensers.

Insures short, direct leads in the transmitter.

A necessity in every efficiently constructed short wave transmitter. Price \$2.50

RADIO ENGINEERING LABORATORIES

100 WILBUR AVE. - - LONG ISLAND CITY, N. Y.

Edison Storage Batteries, 10 volts, 8 twin cells in case, type L-4, for \$5.00; U. S. Signal Corps. Field Telephone, model 1917, maker Western Electric Co. Price \$2.50; Lower Half SE 100 Receiving Set, \$1.50; Marconi Transformers, 2 kw. 500 cycle Pri Rate 140 volts 18 amps. sec. 12,500 volts .45 amps. oil immersed, \$10.00; Thompson & Levering Co. Government standard Decade Test Set, Price \$50.00; U. S. Signal Corps. 8 line Portable Telephone Switchboard complete without battery. Cam switch operated. Maker Western Elec. Co. \$25.00; Largest stock Government Radio Transmitting & Receiving material in U. S. Send 2c stamp for our new and latest price list. WEIL'S CURIOSITY SHOP, 20 South 2nd St., Philadelphia, Pa.

Become a Radio Operator
 See The World. Earn a Good Income. Avoid Hard Work.
Learn in the Second Port U. S. A.
 Radio Inspector located here. Opportunities for employment second to no other port. Most logical location in the U. S. A. to come for training.
 Practically 100% of radio operators graduating on the Gulf during past four years trained by MR. CLEMMONS, Supervisor of Instruction. All graduates placed to date.
 Day and Night Classes, enroll anytime. Write for Circular.
Gulf Radio School 844 Howard Avenue, New Orleans, La.

To Our Readers Who Are Not A. R. R. L. Members

Wouldn't you like to become a member of the American Radio Relay League? We need you in this big organization of radio amateurs, the only amateur association that does things. From your reading of *QST* you have gained a knowledge of the nature of the League and what it does, and you have read its purposes as set forth on page 6 of every issue. We would like to have you become a full-fledged member and add your strength to ours in the things we are undertaking for Amateur Radio, and incidentally you will have the membership edition of *QST* delivered at your door each month. A convenient application form is printed below—clip it out and mail it today.

American Radio Relay League,
 Hartford, Conn., U. S. A.

.....1927

Being genuinely interested in Amateur Radio, I hereby apply for membership in the American Radio Relay League, and enclose \$2.50 (\$3 in foreign countries) in payment of one year's dues. This entitles me to receive *QST* for the same period. Please begin my subscription with the.....issue. Mail my Certificate of Membership and send *QST* to the following name and address.

.....
 Station call, if any
 Grade Operator's license, if any
 Radio Clubs of which a member
 Do you know a friend who is also interested in Amateur Radio, whose name you might give us so we may send him a sample copy of *QST*?.....

..... Thanks!

SAY YOU SAW IT IN QST—IT IDENTIFIES YOU AND HELPS QST

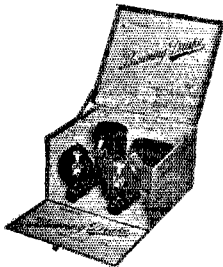

BROWNING DRAKE KIT

Antenna system — One Browning-Drake space wound antenna coil mounted on .0005 condenser, with velvet vernier illuminated dial.
 Regenaformer system — One Browning-Drake transformer; slot wound primary, space wound secondary, mounted on one .00025 condenser with velvet vernier illuminated dial. Complete with instructions. List price \$25.00.

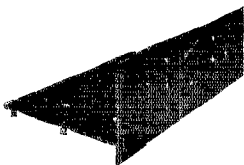

B-D FOUNDATION UNIT

Consists of front and base panels drilled and engraved; with sockets resistor clips, soldering lugs, machine screws and wire. List price \$15.00.

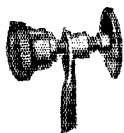

NEUTRALIZER

The Browning-Drake balancing or neutralizing device lists for \$1.00. This system of neutralization is recommended by Browning and Drake.



CARTRIDGE RESISTANCE

The cartridge resistance — another Browning-Drake Corporation product. Lists for 75c.

Engineering Features

of the New Official
BROWNING-DRAKE

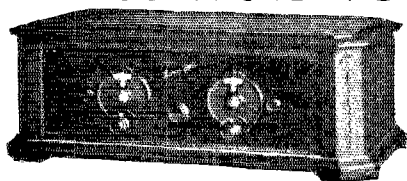

Kit Set

SEVERAL interesting engineering features enter into the increased selectivity of the new Browning-Drake assembly and its adaptation to the popular new power supply units and "B" eliminators. First, the audio units have been placed well back away from the coils, because when large masses of metal are in the main field of the coil, maximum selectivity cannot be obtained. Second, the new girder frame condensers give unusual strength with a minimum of metal in the coil fields. Third, a new method of neutralization helps to make the tuning sharper. Fourth, a tone filter eliminates the danger of damaging speaker or affecting tone quality where high voltages are used with power tubes. Five, the motorboating which occurs when "B" eliminators are used with impedance and resistance coupled amplification has been banished.

Booklets containing complete constructional data are available for twenty-five cents, or the booklet with five full size blueprints for one dollar. Get your parts TODAY and build the new "Official" Browning-Drake Kit Set.

[Dealers:—Some of you amateurs are dealers.
 If so, we invite you to write for information on
 the new Browning-Drake opportunities.]

BROWNING-DRAKE CORPORATION
 BRIGHTON :: MASS.

BROWNING-DRAKE RADIO

Here You Are! -- PLUG-IN COILS

THESE ARE THE FAMOUS TECO PRODUCT

Coil No.	Wavelength	Megacycles	Price
1	8.5-18	16.6-35	\$2.50
2	15.8-31	9.7-19	\$2.50
3	29-62	4.85-10.3	\$2.50
4	56-112	2.68-5.35	\$2.50
5	107-216	1.38-2.8	\$3.00

Bottom Mounting strip, \$1.50
Antenna Coil, \$1.50

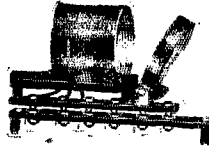

COMPLETE SET
In Polished Cabinet

With Antenna Coil and Bottom Mounting Strip **\$7.50**
Formerly \$12

Short Wave Receiver with the Famous Teco Plug-In Coils \$27.50



Kellogg Diamond-Wound Tuner Coil

Honeycomb type, for wavelengths up to 25,000 meters. **\$1.00**

50 - Watt Socket

Cast-aluminum frame, phosphor-bronze springs, Dielectro insulation. **\$1.50**



Mag-navox
2-Stage Amplifier

Complete with a 14 in. speaker. This combination outfit formerly sold for \$35

\$9.75

INCLUDE POSTAGE WITH YOUR ORDER

2 MFD Condensers 85c
Telegraph Keys 49c
Electric Soldering Irons 95c

Hard Rubber PANELS

7x6, 7x9, 7x10, 7x12
TWO FOR 25c

Kellogg Transmitting Condenser
Factory double spaced. Capacity .00025. Stands 300 volts. **\$2.95**

18-inch Insulators, 55c

TOROID Doughnut R. F. COILS

For .00035 Condensers Accurately Matched

\$1 PER SET OF 2
Worth \$4

New Low Price



Globe Wireless Company

7 STUART STREET BOSTON, MASS.

Transmitting Apparatus At Rock Bottom Prices

PROMPT — RELIABLE — MAIL ORDER SERVICE — WITH THE 2MA MONEY BACK GUARANTEE

No. 12 Cooper enameled antenna wire \$.90, Pyrex 7 1/2 inch strain insulators \$1.19, 12 inch Pyrex \$2.79, R.E.L. Transmitting inductances double units with coupling rods 40-80 meters \$8.95, Single unit \$4.65, New Aero Transmitting Coil Kit 40-80 or 20-50 Meter Coil Kits \$9.85, RCA UC-1803 10,000 volt condensers (for tuned grid and plate transmitters) \$.95, New Ward Leonard Center-tapped with mountings 5000 ohms for 5 and 50s \$1.75, up to 250 watts sets \$2.59, Crescent lavite 5000 ohm leaks \$2.19, Heavy duty G.E. 5000 ohm leaks \$1.49, Sangamo .002 condensers \$4.48 Paragon 3000 volt .002 \$2.29, All sizes of Jewell 3 inch Flush Mount Jewell Thermo-couple antenna ammeters \$9.69, Jewell Milliammeters, A.C. Voltmeters, D. C. Voltmeters \$6.00 each, Filter Condensers, Eectime 2MFD 2000 volt \$5.19, 4 MFD 2000 volt \$8.60, Sangamo 1 MFD 1000 volt, \$1.60, 2 MFD \$2.15, 4 MFD \$3.65, A Few Left Thordarson Combined Plate & Filament Transformer for 7 1/2 watt set 650 volt plate winding 7 1/2 volt filament with center-tap, Special \$6.19, Thordarson Filament Transformers—Mounted with mid-tap, 80 watt (for 4 7 1/2 watters) \$6.05, 150 watt (for 3, 50 watt tubes) \$7.90, 300 watt (for 250 watters) \$13.15, Thordarson Plate Transformers, 100 watt plate \$10.90, 450 watt plate \$14.90, R.E. Chokes \$4.90, Short Wave Receiver Specials Aero Short Wave Coil Kit \$9.45, R.E.L. \$3.69, Cardwell 7 plate S.L.W. \$2.45, 11 plate \$2.45, Special On Cardwell Transmitting Condensers 22 plate \$3.25, 48 plate \$3.95, Special T. Types, T-199, T-183B, \$2.95 each, Hammarlund Transmitting Condensers 22 plate \$5.75, 48 plate \$8.25, Any Other Parts Not Listed Here in Stock At Reduced-Low Prices.

RADIO 2MA

168 Washington St.

New York City

FROST-RADIO FROST-RADIO FROST-RADIO FROST-RADIO FROST-RADIO

FROST-RADIO

VARIABLE HIGH RESISTANCE UNITS

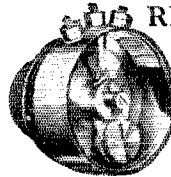

For fine control of tone and volume you should install **FROST-RADIO** Super-Variable High Resistance Units as indicated in our free booklet. Far superior to wire wound types. Operation is smooth and noiseless because of the exclusive roller contact arm.

Nickel plated brass case. Single hole mounting. Supplied in resistances from 50,000 to 500,000 ohms. List \$1.25.

BAKELITE and METAL FRAME RHEOSTATS

The neatest, most compact and most serviceable rheostats made. Have smooth-working contact, bakelite pointer knob, single hole mounting, "Finest nichrome or chromel A" wire; wide resistance strip keeps rheostat cool under heaviest load. A type to suit every requirement from 2 1/2 to 75 ohms. Bakelite Type, list 75c. Metal Frame Type, list 50c. Your dealer has them.

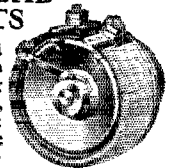

HERBERT H. FROST, Inc.

160 N. La Salle St. CHICAGO



New York Los Angeles

FROST-RADIO FROST-RADIO FROST-RADIO FROST-RADIO FROST-RADIO



A.R.R.L. APPARATUS

Essential equipment for every live amateur station

AMERICAN RADIO RELAY LEAGUE LOG OF STATION								SHEET NO.
DATE	CALLER	CALLED BY	JOB	OPERATOR	FIELD	REMARKS		

A. R. R. L. Log Sheets

Designed by hams for hams. 8½ x 11 bond paper, punched for standard three-ring loose-leaf binder. 125 sheets postpaid for \$1.00 or 500 for \$3.50.

Members' Correspondence Stationery

Write your radio letters on League letter-heads—it identifies you with the biggest radio organization in the world. *Lithographed* on 8½ x 11 heavy bond paper. 100 sheets postpaid for 75c or 250 sheets for \$1.70. Sold to members only.

THE AMERICAN RADIO RELAY LEAGUE
MEMBER'S CORRESPONDENCE

THE AMERICAN RADIO RELAY LEAGUE
HARTFORD, CONN., U. S. A.
RADIOGRAM

TO: _____

FROM: _____

DATE: _____

RE: _____

RECEIVED _____

SENT _____

Official A. R. R. L. Message Blanks

Most convenient form. Designed by the Communications Department of the A.R.R.L. Well printed on good bond paper. Size 8½ x 7¼. Put up in pads of 100 sheets. One pad postpaid for 35c or three pads for \$1.00.

Message Delivery Cards

Neatest, simplest way to deliver a message to a near-by town. On U. S. stamped postals 2c each. On plain cards (for Canada, etc.) 1c each post-paid.

RADIOGRAM
AMERICAN RADIO RELAY LEAGUE

From: _____ Date: _____

To: _____

Address: _____

Phone: _____

American Radio Relay League

1711 Park Street

Hartford, Conn.

TOBE

Trade Mark Reg'd U. S. Pat. Office



TINYTOBES

Shown here actual size, complete the TOBE line,—keep up recognized quality. Good for use on voltages up to 100 volts D.C. they will have been tested to 2300 volts A.C. before breakdown. Phase-angle is very low.

TINYTOBES are recommended in re-resistance-coupled-amplifiers using the New UX-240 and CX-340 HIGH MU TUBES.

TINYTOBES are used in the OFFICIAL BROWNING-DRAKE KIT-SET and Matched TINYTOBE-TWINS are used in the SAMSON Band-Pass Filter. Individually packed in transparent envelopes. Prices .0007 Mfd.—.005 Mfd.—35c each, .001 and .002 Mfd.—40c, .005 and .006 Mfd.—45c, .01 Mfd.—55c, .02 Mfd.—50c.

MATCHED TINYTOBE TWINS—.001 Mfd. each, per pair \$1.40.

Tobe Deutschmann Co.

Engineers and Manufacturers of
Technical Apparatus
Cambridge, Massachusetts

QUALITY **DONGAN** PRODUCTS

Specialization Has Its Reward
Dongan, for years, has maintained complete experimental laboratories. Many of the advancements in design, have found their origin in the Dongan plant. All this time, Dongan has specialized in one thing—the manufacture of transformers and chokes.

Today—manufacturers of receiving sets, power amplifiers and eliminators, look to Dongan as the logical source of supply on standard and special transformers.

Dongan Electric Manufacturing Co.

2999-3001 Franklin St., Detroit, Mich.

TRANSFORMERS of MERIT for FIFTEEN YEARS

For Sale—Radio Equipment—Second Hand

- 7—500 Cycle motor generators—Crocker-Wheeler Motor 120 volts, D. C., amperes 6.6—R. P. M. 2500 Generator 125 volts, A C amperes 5, cycles 500 for use with transformer.
 - 7—Rheostats—Ward Leonard Ohms 250—Amps 5
 - 7— $\frac{1}{2}$ KW Quenched Multiple spark radio transmitters without spark gap
 - 1—2 KW Transformer—open core
 - 1—Reactance coil—for spark transmitter
 - 1—Antenna switch—Navy type 5 K.W.
 - 2—Jar Racks—capacity 10 jars each, type wireless specialty.
 - 1—Wave Change switch
 - 1—Rheostat—Ward Leonard, 10 ohms, 5 amps.
- Will accept bid on all or part of this equipment. Mail bids to Pere Marquette Railway Company, Mr. W. C. Atherton, Purchasing Agent, Room 234 Union Depot, Detroit, Mich.

Why is the Karas Equamatic the most efficient receiver ever designed? Write us for full information.

KARAS ELECTRIC CO.,
1031 Association Bldg., CHICAGO

Hey, THE BEST \$1 YOU EVER SPENT!
Am—
Have u ordered ur copy of
Andy's
Andy
Handbook?
PUBLISHED BY
AMERICAN RADIO RELAY LEAGUE
1711 PARK ST, HARTFORD, CONN.

Hey, THE BEST \$1 YOU EVER SPENT!
Am—
Have u ordered ur copy of
Andy's
Andy
Handbook?
PUBLISHED BY
AMERICAN RADIO RELAY LEAGUE
1711 PARK ST, HARTFORD, CONN.

Specially Prepared for SCMs and ORSs



*Have You Ordered
Yours?*

Special Colored Official League Emblems for Section Communications Managers and Official Relay Stations

Red Background (for SCMs only)
Blue Background (for ORSs only)

Small (1/2 inch) size

\$1.00 each
post paid

These emblems are smaller than the regular black emblems and are particularly neat in appearance. They can be supplied in either pin (brooch) or button style for ORSs. Pin style only for SCMs.

American Radio Relay League, Inc.,
1711 Park Street - Hartford, Conn.

Bound Volume X of QST

There still is a limited number of copies of Bound Volume X of *QST*. Vol. X comprises the entire 1926 series of *QST*. This volume is made up of two books or sections, each containing six issues of *QST*. This volume is handsomely bound in red cloth and with gold imprint. The complete volume is priced at \$5.00, postpaid.

QST, 1711 Park St., Hartford, Ct.

"B" Eliminator TESTING Problem Solved by



Model R-415

TO GET full value from your "B" Eliminator you must *know* that your "B" Power is delivering the *right* amount of voltage to detector, amplifier and power tube.

Low resistance voltmeters suitable for testing batteries are worthless for testing "B" Eliminators. This specially designed High Resistance Sterling is accurate for both.

Whether this voltmeter is used in your business or for your own set, it is *essential* if you want the facts about any "B" Eliminator.

It is the Universal Voltmeter for the Amateur R-415

Sterling voltmeter meets the special needs of the amateur in a variety of ways—for testing the output of D. C. Generators, and for every other purpose calling for a *high resistance* voltmeter.

Never before has a laboratory instrument been available at a price so reasonable.

Sterling

R-415 VOLTMETER

A laboratory meter at the remarkably low price of **\$8.50**

Also Model R-417. A New 150v. Sterling A. C. Meter for Testing A. C. line current and all A. C. Circuits\$7.50

THE STERLING MFG. CO.
2831 Prospect Ave. Cleveland, O.

HAM-ADS NOTICE

This department of QST is conducted as a service to members of the American Radio Relay League. Advertisements can be accepted only under the following conditions:

- (1) "Ham Ad" advertising will be accepted only from members of the American Radio Relay League.
- (2) The signature of the advertisement must be the name of the individual member or his officially assigned call.
- (3) Only one advertisement from an individual can be accepted for any issue of QST, and the advertisement must not exceed 100 words.
- (4) Advertising shall be of a nature of interest to radio amateurs or experimenters in their pursuit of the art.
- (5) No display of any character will be accepted, nor can any typographical arrangement, such as all or part capital letters, be used which would tend to make one advertisement stand out from the others.
- (6) The "Ham Ad" rate is 7c per word. Remittance for full amount must accompany copy.
- (7) Closing date: the 25th of second month preceding publication date.

THE life blood of your set—plate power. Powerful, permanent, infinitely superior to dry cells, lead-acid B's, B eliminators. Trouble-free, rugged, abuse proof, that's an Edison Steel-Alkaline Storage, B-Battery. Upset electrically welded pure nickel connectors insure absolute quiet. Lithium-Potassium solution (that's no lye). Complete, knock-down kits, parts, chargers. Glass tubes, shock-proof jars, peppy elements, pure nickel, anything you need. No. 12 solid copper enameled permanently perfect aerial wire \$1.00, 100 ft. Silicon steel laminations for that transformer 15c lb. Details, full price list. Frank Murphy, Radio 8ML, 4837 Rockwood Rd., Cleveland, Ohio.

25% to 35% discount to amateurs on receiving parts, no sets. Our weekly data sheets give you more dope than all the radio magazines together. 20 weeks' trial \$1.00, 52 weeks \$2.50. Over two pounds data, circuits, catalog, prepaid 25c. Fred Luther Kline, Kent, Ohio.

PURE aluminum and lead rectifier elements holes drilled brass screws and nuts, pair 1/16", 1"x4" 13c, 1"x6" 15c, 1 1/2"x6" 17c, 1 1/2"x6" 19c. Sheet aluminum 1/16" \$1.00, lead \$1.00 square foot all prepaid. Silicon transformer steel cut to order .014" 10 lb. 25c, 5 lb. 30c, less than 5 lb. 35c per lb., .022" thick 5c less per lb. Postage extra. Edgewise wound copper ribbon, 7 sizes, see Jan. QST 1/2" square copper wire better than copper tubing 50c lb. postage extra. Air pocket insulators blue glazed porcelain 8" leakage path fine for transmitting, 4 for \$1.00 prepaid. Geo. Schulz, Calumet, Michigan.

QSL Hams: Reasonable rates on neat QSL cards. Samples on request. INQ, 180 Cornell St., Roslindale, Mass.

THE BWJ laboratory offers secondary control inductance rheostats in addition to primary control type, with double winding inductively balanced, thus permitting balanced center-tap by single control; an adjustable iron plunger. Prices: Primary \$3.00; Secondary \$2.50 postpaid. Edwin Hare, 9BWJ, Paintsville, Kentucky.

PERFECT reproductions, any write-up from any past issue of QST or any other radio magazine—I have 'em all from 1908 to date. Send red stamp for price on write-up you want, or send 20 cents for sample "Rotten Old Man" pre-war QST story. 6LM, Box 177, El Monte, Los Angeles, California.

BARGAINS 10" leadin insulators, adjustable, threaded rod through center 55c. Second hand parts; 1 pr. Frost Navy Type Phones \$1.00, Manhattan Variocoupler List \$3.00, Price \$1.00, B-T Tuner \$1.00, Kellogg 43 plate condenser with dial and 5 plate vernier \$1.00, 2 Bradleystats \$1.00. Postage extra for Second Hand Parts. Write for Bargain List. Frank A. DeLaMater, 311 East Adams, McAlester, Okla.

DODGE Radio Shortcut Fixes signals in mind to stick. Kills hesitation. Cultivates speed. Produces results. 9CSK Crafts "Raised speed from 12 to 20 in two hours". 9BRB Garland "Raised speed from 6 to 12 in one evening". 1COB Damon, "Memorized code your way in 15 minutes". Quarter coupon and reports rapid progress made by 200 users (all licensed) 25 cents. Specimen reports each district on request. Shortcut with Appendix and Better Key Work \$3.50 U. S. and Canada. Elsewhere \$4.00 reg. mail. None C. O. D. Send money order. Check may delay. C. K. Dodge, Mamaroneck, N. Y.

VT18 FIFTY watters new \$10 prepaid; Westinghouse up to 2KW mercury rectifier bulbs \$15. Makes a real rectifier. Express only. 8AFR.

WANTED—volumes 7 and 8 QST also Omnigraph, QTC gang? Send lists. Jack Holmes, operator C.F.Y.C.

SELL—trade, phone or key transmitter cheap. Write for particulars. Orville Crossland, Jefferson, Kansas.

GENUINE new R.C.A. UV202 five watters in original cartons \$2.50. No C.O.D.'s. James Marinell, 725 Oak Street, Youngstown, Ohio, 8BEP.

OMNIGRAPHs, vibroplexes, transmitters, tubes, "S" tubes, receivers, chokes, meters, transformers. "Synes", motor-generators, supers, Grebe CR18s. Bought, sold, exchanged. QSO. 40 meters. L. J. Ryan, 9CNS, Hannibal, Mo.

QSL cards, 100, one color, \$2.50, two colors \$3.00, as you want them, printed on Government postal cards. Your station call on 4x7 card free. Fred E. Church, Millington, Michigan.

WANTED—1000 or 1500 volt M.G. with motor. What have you? 8BXC.

THE Ensall radio laboratory six tube short wave receiver. Range 15 to 210 Meters. Operates on Loop Antenna. Excellent for summer reception with unusual DX. List price of inductances with circuit drawing, \$18.50. Parts list on request. Wiring charge on request. This popular receiver now being used by many amateur stations. We also are distributors for practically every make of radio apparatus. Build, also transmitters, receivers, wave-meters, inductances, etc. We employ your parts in any apparatus if desired. Quotations on request. Thos Ensall. (8BDN) 1208 Grandview Ave., Warren, Ohio.

I am not selling out. But I have a lot of stuff I don't need and want to sell. Write for list. 5ASU, Box 205, Montgomery, Ala.

FOR Sale: 100 watt transmitter complete. Also Westinghouse motor-generator set. Must sell at once. All letters answered. L. S. Kidd, 289 Broadway, Lawrence, Mass.

NEW Ham Inductances now available. Small edgewise strip construction, hard rubber insulation, far superior to any other type. Built along recommendations of Kruse of ARRL Headquarters. Send for complete information. See our ad elsewhere on variable condensers for high voltages. New Spring Citizens Amateur Call Books, 75c postpaid; A.R.R.L. Radio Amateurs Handbook \$1.00; Sangamo filter condensers, 1500 volt test, 1000 volts working; 1 mfd. \$1.95, 2 mfd. \$2.50, 4 mfd. \$4.00; DeForest "T" Tubes \$18.00, "DR" Rectifiers \$16.00, "D" Tubes (10 watts) \$9.00, "DR" Rectifiers \$7.50. Be sure to get the new free Hamalog and Supplement. E. F. Johnson, 9ALD, Waseca, Minnesota.

ALL Western Electric and guaranteed o.k. 50 watt (211-A) tube \$17.50. Parts for 7-A amplifier (three 216-A tubes and three transformers) \$25. Parts for 2-A current supply set (supplies 3 amperes filament, 120 volts plate) \$25. A. M. Elliott, c/o L. L. Nolan, Bayside, I.I.N.Y.

WANTED—UP1868 transformer. Must be in good condition. 2AWK, Riverhead, N. Y.

SELL—two Rauland Lyric A.F. transformers. Cost \$9.00 apiece. \$16. takes 'em. C. Schrotel, 2366 Minto Ave., Cincinnati, Ohio.

BEFORE buying the stuff for that new set drop us a line for a copy of our new catalogue. It is yours for the asking. We carry everything in stock for the short wave transmitter and receiver. All the leading makes such as Aero Cardwell, National, General Radio, Acme, Thordarson, Jewell, Pyrex, Etc., 1.16" lead acid aluminum, \$1.00 per sq. ft. No. 12 solid copper enameled wire, 1c ft. No. 10, 1 1/2c ft. New edition Citizens Radio Call Books 75c. "Everything for the Ham". "Dyrex for DX". 8BIN, E. J. Nicholson, 1407 First North St., Syracuse, N. Y.

FOR sale—New Signal Corps forty foot sectional masts with guys and fittings ready for erection sent by express collect upon receipt your money order for eighteen dollars. 2BIO, Box 66, Wall Street Station, New York City.

UNMOUNTED chokes 80H, 50MA, \$1.75, 50H, 60MA, \$2.00. C.R.L. rheostats \$1.00. 5" Jewell O-50 voltmeter \$4.50. Music Master phonograph attachment, \$2.50. I can quote price on all material for the outfit you're building. Write for list. M. Leitch, 34 Park Drive, West Orange, N. J.

ALL Postpaid. Sangamo filter condensers 1000 volt working voltage, 2 mfd. \$2.15; 4 mfd. \$3.65, R.E.L. Transmitting Inductances, type L, Double unit, \$3.90; Single, \$4.85. R.E.L. radio frequency chokes, \$1.00.

Q R A SECTION

50c straight, with copy in following address form only:
CALL—NAME—ADDRESS.

R.E.L. 50 watt sockets, \$1.89. R.E.L. mountings for De Forest "H" Tube, \$1.89. Allen-Bradley 2000—30,000 ohm variable transmitting grid leaks, \$4.89. Allen-Bradley "Radiostats", the big primary rheostat, \$6.29. General Radio Wavemeters, Type 358, \$19.25. Other prices on request. 3BMS, G. F. Hall, 133 East Gorgas Lane, Philadelphia, Pa.

SPECIALS—new: Warren speaker, \$5.00; Konite B Eliminator \$15.00; E. Z. Toon Vernier Dials, \$1.00; 30 watt transmitter \$40.00; R.E.L. coils short wave set \$25.00. Used: Shortwave set \$15.00; Crosley Four \$15.00; Apco charger \$7.00. Dime brings bargain list. Roger Curran, Dundee, N. Y.

SUPER Sync Rectifier. New \$45. F.O.B. Detroit. A. Smith, 78 Worcester Place, Detroit, Michigan. 5HG.

ARRL sweater emblems should be worn by all League members. They are diamond shaped 5"x8" and made of best quality yellow and black felt. Only \$1.00. No C.O.D.s. Eric Robinson, Jefferson Road, Webster Groves, Missouri.

WANTED—General Electric ET3619 transmitter; ET3620 rectifier; several "3" tubes; 30 H 150 Milliampere choke; have new UV203 also UV208A slightly used. Will trade. James M. Boyer, 6116 Howe Street, Pittsburgh, Penn.

SELLING out everything cheap. Write for list. 4DK.

SELLING out—Write for list—Edward W. Wilkins, Miranda City, Texas.

EDISON "B" battery parts 100 volt knocked down units \$8.75. 140 volt \$11.00. Large size elements already connected 5 cents per pair. All parts carried in stock. Send for literature. M. Rhine, 146 W. 68th St., New York City.

50 VOLT Edison Element Storage "B" Battery complete with charger, \$10.95. Rechargeable hundreds of times. Superior to dry batteries or eliminators. 135 volt, \$15.00. 180 volt \$19.00. 1500 milli-amp capacity. Your money back if not satisfied. Parts and supplies in stock. Send for complete list. J. Zied, 904 N. 5th Street, Philadelphia, Penn.

FELLOW hams. You need our price list. It's free for the asking, and will solve your problem of "Where to get it". Varied assortment of choke coils in stock. Filament heating transformers, also power and plate. A "HE" grid leak for \$2.00, that will not burn out. Tubes, keys, filter condensers, short wave coils, General Radio wavemeters, transmitting variable, sheet lead, aluminum, ammonium phosphate, Jewell meters, etc. Write today to Harris, 5RM, 104 East Tenth St., Fort Worth, Texas.

CURTIS—Griffith 250-watt power-filament transformers 350-550 each side \$12.50. Thordarson power-filament transformers for 7.5-watters \$6.90. Thordarson power transformers 350-550 each side \$11.00; 1000-1500 each side \$16.00. Edgewound inductance 6-inch, turn 12c; 4-inch, turn 10c. Aluminum square foot 85c; lead square foot 85c. Curtis-Griffith 30-henry 150-mila chokes \$12.00. National 23-plate 3000-volt transmitting condensers \$9.50. 1x24x1/4 Bakelite panel \$10.00. New "Ham-List" 4c. James Radio Curtis, 5-A-Q-C, 1109 Eighth Avenue, Fort Worth, Texas.

HEADQUARTERS for hams:—Immediate deliveries on Mueller 150-watt input tubes \$15.00. RCA 5-watters \$3.15. Tube 5-mfd. 2000-volt condensers \$17.00. Aerovox 1-mfd. 1500-volt condensers \$1.75. Potter 2000-volt 1-mfd. condenser \$2.50; 1-mfd. 2500-volt \$3.25. Used 50-watters \$15.00. Federal 4/1 Audio Transformers \$1.50. "Ham-List" 4c. Romanyel Curtis, 1109 Eighth Avenue, Fort Worth, Texas.

COMPLETE 250-watt 40-meter Transmitter: UV204A tube; Jewell meters; Cardwell Condensers; Thordarson Transformers; Mounted; KFTH Circuit. Price Complete \$125.00. Price Griffith, 1109 Eighth Avenue, Fort Worth, Texas.

GENERATORS 275 volts, 120 watts gives up to 500 volts, \$8. UC1831 variable transmitting condensers \$1. Kenetrons RCA \$2. 202s \$3. Used generators 30 volts dc input, output 300 volts dc, \$8. 200 watt 900 cycle generators \$10. 1/2 kw 500 cycle \$15. 200 watt 500 cycle \$10. 500 cycle motor-generators 110 dc drive. Navy wavemeters 150 to 3000. 1803 RCA condensers 50c. Honey-comb geared mountings \$1.60. 200 ohm RCA potentiometers 50c. Postage extra on all. R. Wood, 46-20 102nd Street, Corona, New York.

FEW new Western Electric fifty watters, \$26. each. 2BYJ, Levy, 144 Taylor St., Brooklyn, N. Y.

SAY YOU SAW IT IN Q S T—IT IDENTIFIES YOU AND HELPS Q S T

1ACV—Rulof H. Fowler, Box 199, Houlton, Maine.

1LC—Herman Sanborn, Beacon St., Shrewsbury, Mass.

2ATB—Henry N. Whitney, P. O. Box 867, Glen Cove, N. Y.

2MB—Lester Spangenberg, 420 Lakeview Ave., Clifton, N. J.

2MK—E. F. Reynolds, Central Valley, Orange County, New York.

3EF—Wendell H. Hosteley, 101 Upland Terrace, Collingdale, Penn.

3KP—4828 N. W. 16th St., Washington, D. C.

3NN—Robert R. Achey, Quakertown, Penn.

3TM—F. D. Smith, 226 E. 27th St., Norfolk, Virginia.

4DP—49 West 4th St., Atlanta, Ga.

4ES—456 N. E. 28th St., Miami, Fla.

5AFG—Dr. Elmer J. White, 2476 North St., Beaumont, Texas.

5LF—L. J. Arnold, Crossett, Arkansas.

6DIG—Lester Anderson, Box 255, Fort Bragg, California.

6DIG—Joe A. Bowers, Box 37, El Centro, California.

8DEI—Geo. M. Benas, 1801 Genesee St., Utica, N. Y.

8DTI—Alexander H. Buchman, 1869 Alvason Road, East Cleveland, Ohio.

8EZ—T. M. Hale, 170 N. Front Street, Cuyahoga Falls, Ohio.

8LD—Joseph A. Roell, 2313 15th St., Niagara Falls, N. Y.

9PI—Philip R. Sears, Trumansburg, N. Y.

9CUX—R. C. Baughman, Blairsburg, Iowa.

9DEF—A. Maitland, Jr., 204 Walsix Bldg., Kansas City, Missouri.

9MZ—Edw. C. Crossett, 1200 Lake Shore Drive, Chicago, Illinois.

oa2RX—Henry Clive St. John, 82 Gibbies St., Rockdale, New South Wales, Australia.

The following stations belong to members of the A.R.R.L. Headquarters gang. Mail for them should be addressed care A.R.R.L., Hartford, Conn. When operating 1MK they use personal sines as indicated.

1MK Headquarters IES A. A. Hebert "ah"

1AL H. P. Westman "ws" 1GO L. A. Jones "lj"

1BAO R. S. Kruse "lq" 1KP - NRRC F. Cheyney

1BDI F. E. Handy "fh" Beekley "beek"

1BHW K. B. Warner "kb" 1OA R. S. Kruse "lq"

1BUD A. L. Budlong "bud" 1SZ C. C. Rodimon "er"



**WARRANTED FIXED RESISTORS
HEAVY-DUTY TYPE**

THE new Lynch wire-wound heavy duty resistors for eliminator and power work are now ready. These units are ideal for use in Raytheon and all other power circuits.

EQUALIZORS

For perfect filament control use the Lynch Equalizers. There is a type for every type of tube and for any combination of tubes. A Lynch Equalizer will take the place of your filament rheostats. Complete, with mounting, \$1.00.

Lynch Suppressors and Low-loss mountings mean better radio.

At All Good Dealers

**ARTHUR H.
LYNCH, Inc.**



Gen. Motors Bldg.,
E' way, and 58th St.
New York, N. Y.

At Last! **TELEPLEX**

The famous
Sends Morse or Continental

With only
a screw to
turn

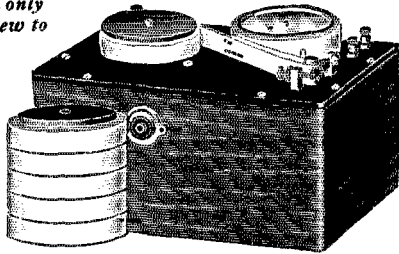

CUTS LEARNING TIME IN HALF

Think of it! Expert operators to send to you—5 to 80 words per minute, right in your own home or office—with only a screw to turn. No longer is it necessary to waste months in useless practice—the TELEPLEX will teach you in half the time. Improves the ability of the best operators. The TELEPLEX is the only instrument that reproduces actual sending of expert operators. Not short, simple words, but exact messages, radiograms, train orders, car reports, and newspaper matter. It sends five times as many words with one roll of tape as any other instrument, and six rolls are furnished. Enclosed in handsome, dust-proof cabinet. With or without key and sounder, or buzzer. Complete course in Morse or Continental FREE. Nothing else to buy. Write to-day—NOW for particulars of this amazing instrument. A post card will do.

TELEPLEX COMPANY
76 Cortlandt Street, NEW YORK CITY.

A New, Improved **ADVANCE** “Sync” RECTIFIER

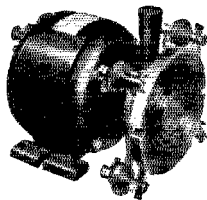

For years the Advance Sync Rectifier has been recognized by amateurs all over the world as far superior in quality in spite of being lower in price. This accounts for its prevailing use in international transmitting. NOW several important improvements have been made in this rectifier which gives it still further superiority.

The Advance Sync Rectifier meets all requirements for heaviest duty. Improves all transmission—giving clearer tone and better volume. Can be easily and quickly filtered. Speedy starting because of Advance Bakelite wheel. Requires no attention—always ready.

Revolving disk is moulded bakelite six inches in diameter. Nickel plated brush holders with adjustable gauze copper brushes. Convenient control handle. Disk, aluminum brush arm support and brush holders perfectly insulated.

Price complete with Westinghouse ¼ H. P. Synchronous Motor

Rectifying wheel with complete brush assembly and mounting ring to fit your own motor

\$35 \$20

We Pay All Transportation Charges in U. S. A.

ADVANCE ELECTRIC COMPANY
1260-1262 West Second St., Los Angeles, Calif.

FOR YOUR CONVENIENCE QST'S INDEX OF ADVERTISERS IN THIS ISSUE

Advance Electric Co.	94
Aero Products, Inc.	95
Aerovox Wireless Corp.	76
American Sales Company	80, 82
American Transformer Co.	75
A.R.R.L. Apparatus	89, 91
A.R.R.L. Application Blank	86
A.R.R.L. Handbook	90
Browning-Drake Corp.	87
Burgess Battery Company	4th cover
Burton-Rogers Company	72
Cardwell Mfg. Corp., Allen D.	83
Carter Radio Company	78
C. E. Mfg. Company	70
Central Radio Labs.	84
Cresradio Corporation	82
Crosley Radio Corporation	74
Cunningham, Inc., E. T.	2nd cover
Deutchmann Company, Tobe	90
DeForest Radio Company	75
Dongan Electric Mfg. Co.	90
Eastern Radio Institute	78
Electric Specialty Company	74
Elkon Works, Inc.	81
Fansiel Products Co.	69
Federal Radio Corp.	70
Frost, Inc., Herbert H.	88
General Radio Company	96
Globe Wireless Co.	88
Goyer Company	80
Grebe & Company, Inc., A. H.	4
Grigsby-Grunow-Hinds Co.	79
Gross & Co., J.	84
Gulf Radio School	86
Helicon Radio Condenser Corp.	77
Jewell Electrical Instrument Co.	82
Johnson Co., E. E.	72
Karas Electric Company	90
Kokomo Electric Company	72
Lynch, Inc., Arthur H.	83
Mario Electric Co.	78
National Company	74
Pacent Electric Company	70
Pere Marquette Railway Co.	90
QST Bound Volumes	91
Radio Corporation of America	1
Radio Engineering Labs.	85, 86
Rooney & Wehman	82
Scientific Radio Service	78
Signal Electric Mfg. Co.	80
Smith, B. Hawley	76
Sterling Mfg. Company	91
Stromberg-Carlson Tel. Mfg. Co.	71
Teleplex Company	94
Thordarson Electric Mfg. Co.	80
Transmitting Equipment Labs.	82
Utility Radio Company	70, 78
Vibroplex Company	69
Well's Curiosity Shop	86
Weston Electrical Instrument Corp.	70
Wireless Specialty Apparatus Co.	2
X-L Radio Labs.	69
Taxley Mfg. Company	84
ZMA	88

AERO COIL

Super-sensitive Inductance Units

The PERFECT INDUCTANCES for LOW WAVE RECEIVING

**THE AERO
SHORT WAVE
RECEIVER**

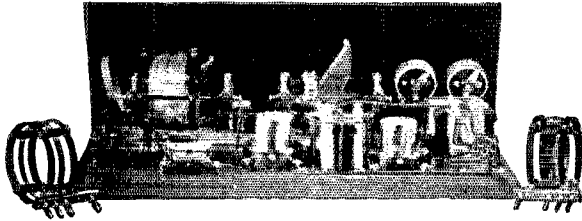

A short wave receiver built around the famous interchangeable AERO Low Wave Tuner Kit is sure to give splendid results, as thousands of radio experts and amateurs have proved. These wonderful inductances are of special patented construction that reduces high frequency resistance to a minimum. AERO Coils are wound without dope, and are capable of greater volume without distortion. Every amateur should use these super-sensitive coils for perfect short wave reception.

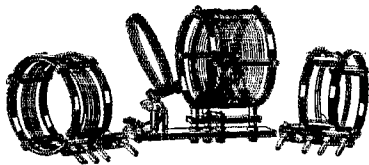

PRICE \$12.50

LOW WAVE TUNER KIT Price \$12.50

Completely interchangeable. Adopted by experts and amateurs everywhere. Range 15 to 130 meters. Includes 3 coils and base mounting, covering U. S. bands, 20, 40 and 80 meters. You can increase or decrease the range of this short wave tuner by securing the AERO Interchangeable Coils described below. All coils fit the same base and use the same condensers. Use code No. INT-125 in ordering.



INTERCHANGEABLE COIL No. 0

Range 13 to 29.4 meters. This is the most efficient inductance for this low band. Code number INT-0. Price\$4.00

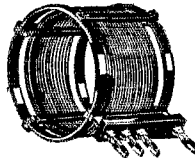

INTERCHANGEABLE COIL No. 4

Range 125 to 250 meters. Fits same base supplied with low tuner kit. Code number INT-No. 4. Price\$4.00

THE NEW AERO INTERCHANGEABLE COIL No. 5

Normal range 235 to 550 meters. However, by using .0011 Sangamo fixed condenser across the rotor and stator of the .00014 variable condenser, the maximum wave band of this coil is increased to 725 meters. This gives you coverage of the following bands: Airplane to Airplane, Land to Airplane, Ship to Shore (Great Lakes) Ship to Shore (Atlantic and Pacific Oceans). Code number INT-No. 5. Price \$4.00

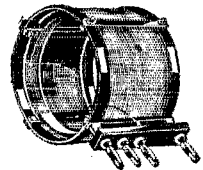

**AERO COIL
BASE**
Fits all INT. Coils.
Code Number INT.
Base.
Price\$4.00

PLAN FOR D. X. RECORDS NOW

Order any of the coils on this page direct from us if your dealer hasn't them, and start now for wonderful records. Specify code or key numbers when ordering. Or write at once for descriptive literature.

AERO PRODUCTS, Inc.

DEPT. 16

1772 WILSON AVE.

CHICAGO, ILL.

Type 358 Amateur Wavemeter

Price \$22

Complete with Calibration Chart

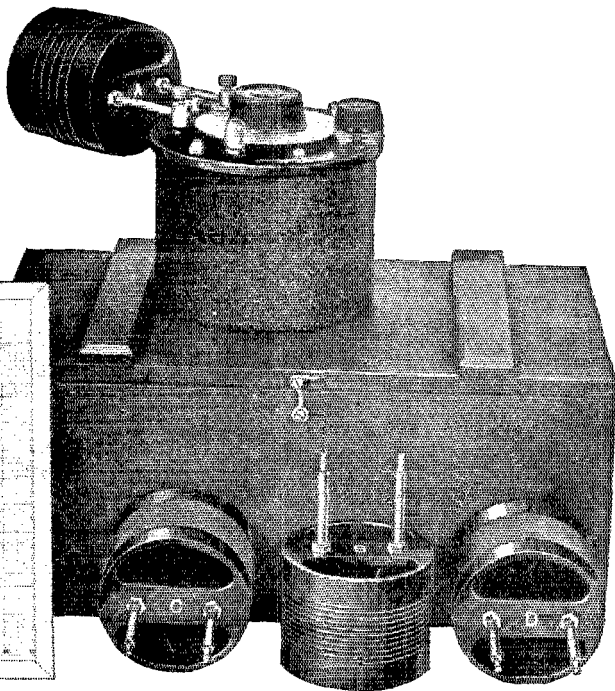
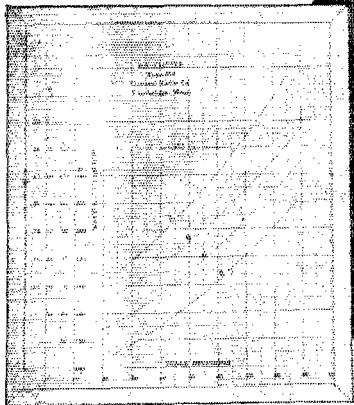

Individually Calibrated with an accuracy of 1%

The type 358 wavemeter is especially designed for amateur use in checking wavelengths. It covers a range from 15 to 220 meters, by interchanging four coils of low loss construction. These coils are carefully wound on threaded Bakelite forms, thereby insuring accuracy and permanence of calibration. Coil ranges are as follows:

Coil A 15 to 28 meters

Coil B 26 to 56 meters

Coil C 54 to 114 meters

Coil D 105 to 220 meters

Price, complete with Calibration Chart, \$22

Write for descriptive folder Q. R. H.

GENERAL RADIO CO.,

CAMBRIDGE, MASS.

GENERAL RADIO

A. R. R. L. MEMBERS ATTENTION!

You are not all located within shopping distance of a dealer stocking General Radio parts. Remember that we will deliver, post paid, anywhere in the United States, any of our radio parts on receipt of current catalog price.

Also if we can be of help to you in supplying technical information, we will welcome your correspondence. Have you a Bulletin No. 926 in your file? If not, a post card will bring it.

To the Man Who Would Like to be an Amateur and Doesn't Know How to Start—to the New Recruit to Short-Wave Radio.

Here is a book written to order for you, to tell you how to do these things

It starts at the beginning and tells

what an amateur is,
what the League is,
what amateur radio is,
how to be an amateur,
how to learn the code,
how to understand what you hear,
how to get your licenses,
how to build a simple station,
how to build a better station,
how to operate your station,
how the A. R. L. works,
how to handle traffic,

and it winds up with an appendix filled with enough extra dope to keep you busy for the next ten years.

It has twice as many words as the average book, all of them directed right at you and your case.

The name of this book is
THE RADIO AMATEUR'S HANDBOOK
and the price is only \$1, postpaid

American Radio Relay League
1711 Park Street, Hartford, Conn.



WHENEVER you visit an amateur station with an envious record of achievement, look for **BURGESS RADIO BATTERIES**

BURGESS BATTERY COMPANY
The Home of 9EK-9XH-NRRL

GENERAL SALES OFFICE: CHICAGO

Canadian Factories and Offices: Niagara Falls and Winnipeg

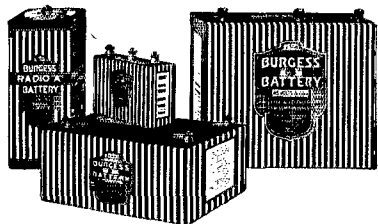

The Communications Department

F. E. Handy, Communications Manager
1711 Park St., Hartford, Conn.

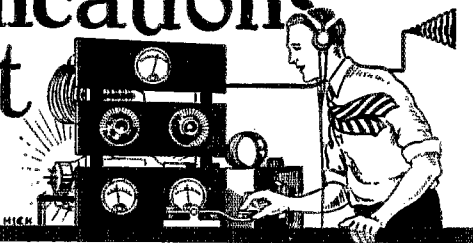

Checker Games by Amateur Radio

By Jim Kirk, 6DEG

MY first attempts at reviving the sport of radio checker-playing in Los Angeles were failures due to inaccuracies in transmission, too-long calls each time, lack of a short snappy system, and because there was no break-in system. Just as the games would get interesting I would get, "Hey! u can't move there, my man is there already," then "sa! u can't jump backwards." The OW voted the whole business the wooden medal, all of which made me secretly vow that I would try it again with a top-notch operator.

Accordingly I picked on OM Day, 6BXC, a prince of a fellow and a good op who made the B.P.L. by wiggling a bug many, many times. Under questioning he broke down and confessed that he couldn't play checkers (must have been raised in the city, b'gosh). However, he secured the promise of the "checker-champ of Hollywood" to manipulate the dominoes at 6BXC and the date for the contest was set. I told all my friends and the OW invited company but luck was against me again. The "champ" failed to arrive, cowed no doubt by my "rep" as a checker-slicker. The party was a flop as usual. About this time 6BXC moved away so that it became necessary to make further arrangements. At last I found a real enthusiast willing to go all the way in the person of 6AIJ. I hope to convert others now that successful methods have been tested out and proved useful. I should like to turn the local ether into a bedlam of mysterious checker-chatter.

The method of lettering the two boards is shown in the diagram. The checker boards must be lettered in the same way at each station and kept checked

and also makes it possible to drop comments such as "Move if you can now, HI HI."

The first game between 6DEG and 6AIJ took one hour and 45 minutes which was fairly good time considering some of the interruptions. ("OW says, 'QRT and do dishes.' Pse QRX game.") Break-in is important and brevity in transmission helps also in reducing the time required in playing. My OW won from 6AIJ so now she is in favor of playing often. I have a checker-schedule with 6AIJ and he is strongly in favor of organizing a checker-radio-club. It's great fun and good practise in snappy accurate transmission. Try it, OM.

6DEG is on 39 meters at seven pm P.S.T. every Monday evening, for radio checker games. All you checker wizards watch for him, and give him a buzz some Monday.

8DDQ, the Norwalk Amateur Radio Association at Norwalk, Ohio, has been keeping schedules with 9CNV, at Angola, Indiana, and through him has played eleven games of checkers with a friend in Angola.

On 20-Meters

ARE YOU looking for a new and thrilling experience with your outfit—something a little bit different? In trouble with QRN? Well that's not unavoidable you know. Even though no one has yet devised a simple and wholly successful static eliminator, there are ways around the difficulty. If you are tired of the increasing QRN evenings, if you are one of those who complain bitterly about 40-meter QRM and the DX-hounds who inhabit the 40-meter region, it is earnestly suggested that you try a new and higher frequency band.

Since the last 20-meter reports in QST, a number of additional countries have jumped into the swim and are now represented on 20-meters. The first Europe-South Africa QSO on "20" took place March 13 when eg2NH (New Malden, Eng. worked foA5X (Johannesburg, S. A.), using 35-watts input. Australian and New Zealand amateurs are now using "20" successfully in increasing numbers.

Despite the impression that seems to have gotten about that 20-meters is chiefly good for daylight work it has been proven time and again by consistent performance on 20-meters that this wave is better than any longer wavelength for use in the daytime and fully as good as 40-meters at night, too. nuIAJM (Leominster, Mass.) recently worked oz2AC (L. H. O'Meara, 209 Harris St., Gisborne, N. Z.) from 10.15 pm to 1.05 am EST and the signals were steady and R6 at both ends of the contact. A radiogram from nc8PC through nc9AI (Toronto, Ont.) says he works oz2AC on schedule at 1 am daily. A letter from 1BYV (Framingham Center, Mass.) reports oz2AC rolling in all over the U. S. between 1 and 2 am EST daily. 2GX (Newark, N. J.) worked oz2AC for 1/4-hour Mar. 26 using a 210 tube with 20 watts input. 1BYV, 9BMX, 9BVI, 9DKC, and 6EA are among those who have been QSO and oz2AC is reported at various times between 19.2 and 20.5 meters wavelength. 9DFR heard him working 9AT March 19.

When QRN on an evening gets increasingly worse on 80-meters and on 200-meters and is noticed in but slightly lessened intensity on 40-meters one can drop to the shorter 20-meter wavelength and be assured of relief due in part to the looser coupling made possible at the higher frequency and in part to the use of a short antenna that is F6 for 20-meters

	A		B		C		D
E		F		G		H	
	I		J		K		L
M		N		O		P	
	Q		R		S		T
U		V		W		X	
	Y		Z		AA		BB
CC		DD		EE		FF	

up constantly during the game. Letters are used instead of numbers because we can get speedier transmission that way. If break-in is used and the operator at each end does not do all of the actual playing, the game does not drag but instead becomes intensely interesting, especially if a group of people watching the progress of events are present at each amateur radio station.

Suppose I start off by moving from L to P. I say simply, "LP K" and the op at the enemy's key says "R LP" or if he missed it "ND PSE QTA". Whatever the trouble is, the idea to be kept in mind is to OK for each move for a single mistake will spoil the game.

Break-in is very valuable for this sort of thing

but which is a poorer collector of static than the usual antenna. "20" isn't entirely free of QRN—we don't mean that—but we do mean to say that the signal to static ratio can be considerably improved by using the shorter wavelength.

Our 20-meter band is 2,000 kilocycles wide including as much territory as our three upper wavelength bands put together. There is very little interference between stations as compared with the situation at the present time on 40 and 80 meters. At the same time a good bunch of operators are working on "20" ready for your traffic or for a friendly gab-fest.

Recent experiments with horizontal and vertical reception of 20-meter signals seem to shatter some of the theories advanced regarding definite skip-distances for 20-meter signals at certain times of day and night. More information from a greater number of observers is needed to make it possible for us to draw any general conclusions that are of value about 20-meter transmission phenomena. The polarization of short-wave signals has been subject to some investigation (see Feb. 1926 QST pps. 9-16). During the coming season with the increasing use of 20-meters, it seems reasonable to believe that horizontal reception will become more popular than it has ever been on the higher wavelengths.

Rig up a 30-foot horizontal wire (with the set at the center) in addition to the usual vertical antenna used against ground. Then connect a D. P. D. T. switch so that a quick comparison of antennas can be made. You will probably find times when the horizontal wire is much the best of the two combinations—and other times when it is inferior to the usual arrangement. At times when 20-meter signals may have dropped out altogether using the vertical collector, they may be found strong and steady on a horizontal antenna.

Logs kept for several days comparing results on signals received from various distances over a 24-hour period should enable one to draw some definite conclusions for a given arrangement. A further comparison of many such logs and arrangements is necessary to lead to general conclusions. If the arrangements of the transmitting antennas can be compared with many observations on each new fact in connection with both, polarization and the angle of radiation may be discovered. Wide use of the 20-meter band coupled with frequent reports of results to QST will bring some of the interesting and valuable things about 20-meters to light more quickly than anything else. Whatever you do, don't forget to drop us a line about it so that we can tell the rest of the fellows anything of general interest brought to light by a comparison of results.

To the DX man, to the traffic worker, and to the experimenter also, 20-meters offers a fertile field for activity during the coming season. It offers almost every advantage that one can think of—and no disadvantages at all unless one considers the difficulty of obtaining a steady signal at this frequency a disadvantage. As a matter of fact a steady signal is important at any wavelength and attention to the right proportioning of C/L ratios and good mechanical design—perhaps the use of crystal control if you can afford it—is sure to pay in any case.

For the information of all concerned we are going to quote from a number of interesting observations that have been received showing who is active and also serving to put you in touch with the good results and contagious enthusiasm of those who have made the necessary changes in their outfits so that a quick QSY to 20-meters is possible. When you see what those who have tried and used "20" think we are sure that you will agree that you can't afford to be missing something any longer and that you will want to jump into the swim too.

From 2AFR (Red Bank, N. J.), "This a. m., about 7.45, I picked up foA5X on 21 meters—a record of 17,000 miles by the night route or 7500 miles in broad daylight. 20 meters is the most pleasant wave to work on I've tried yet. Good DX and no QRM. Stations heard in France, England, Portugal, Germany, Belgium, Holland, Costa Rica, Dominican Rep., St. Martin Is., Jamaica, Argentina, Chile, Uruguay, Hawaii, New Zealand and So. Africa. That stuff about 20-meters being good only in daylight is the bunk."

4BL (Lakeland, Fla.) reports, "20 sure is fine. Have worked ef, eg, oh, nj, oz and all U. S. and Canada except the fifth. 1MK as loud as on 80 after dark. oz2AC is good here from 10 p.m. until 1 a.m. and oz2AE is the same except for a little higher

wave and a pure DC note unusually steady and easy to copy for 20-meters. Worked e8LL with 5 watts input. I recently helped hook nu4WH up with eg2NH by asking the latter to QRX a few minutes while 4WH got things lined up."

8BAU (Columbus, Ohio) says, "20 meters forever!!!! Have worked ef, eg, ei, oh, oa, oz, nj, nu, su, and se." 2CTQ (Rutherford, N. J.) similarly, "QSO on 20: nu, ne, ne, eg, ef, oh, se." 7FU (Portland, Ore.), "In one week have worked 28 states with one 210 on 20 meters. Have schedule with oh6ACG daily." 1ACA (Roxbury, Mass.), "Find 20 vj FB. Worked 5 districts the first day down there with 2 201A and am staying on 20." 9SF (Redwood Falls, Minn.), "Have worked both coasts on 20. FB." 1ABA (Boston, Mass.), "20 seems to be the coming band. Many Europeans and So. Americans worked."

9RVH (St. Paul, Minn.) has a 20.2 meter crystal-controlled set using one UX210. He lost one good night's sleep to find out if anyone could be worked on 20 meters after dark. nj2PZ was worked from 10 to 10.30 p.m. CST, oz2AC was worked from 10.30 to 11.30 and oh6BDL at 11 p.m. 9BVH worked se3AG and heard sb1AD at 1.30 a.m. CST.

8KC says, "Twenty is the berries. Schedule se3AG weekly." 8BEV reports ndHJK, se3AR, su2AK coming in well. He continues to work egBVJ.

1AYJ (West Baldwin, Me), "Now that the 20-meter and 5-meter bands are working out to good advantage communication on very lower power over longer distances will do wonders. In my experience on 20, found it possible to cover much greater distance in either daylight or dark than on the other bands."

8AHG (Union Springs, N. Y.), "Since the last of February I have worked the following: su1CD, su1BU, su2AK, ef8CT, ef8GL, eg2NH, eg5YK, eg3CC, eg5BY, eg6YV, eb4ZZ, oh6BDL, oh6ACG, nj2PZ, ndHJK, ne8AF, about 20 sixes and ten sevens all on 20 meters. 20 is just the QRH for long distance traffic. One can put a message into California either night or day with equal facility. The same with foreign countries, oz2AC starts up late every night on 20 and every time he does there are about 500 (more or less) nu stations calling him. Some folks doubtless get a good laugh listening to the stations that don't QSO successfully. Yes, I'm in this class but haven't given up hope. As Briggs says, 'It May Be Comedy for Some Folks but It's Tragedy for Me.'"

1AMU (Pawtucket, R. I.), "Have worked eg6HS, eg2AO, ef5YOR, ef8UT, ne5GF, ne4DW, ne4AF, ne4IO, ne5FK, ne1AE, 47 9th dist. stations, eleven 8's, four 7's, twenty-five 6's, four 5's, five 4's, one 3 and 3, three 1's. I worked oh6ACG Feb. 4 at 12.15 p.m. Honolulu time and believe I am one of the first if not the first East coast station to work "oh" on 20."

oh6ACG, oh6AXW and oh6BDL have been doing a lot of 20-meter work. The latter with one 204-A and working his antenna on fifth harmonic worked 1ADM, 2TP, 2GX, 2AWX, 8AHC and 7AAE. nu1AJM has found 20 FB night and day. He worked 20 stations outside the U. S., had 40 West Coast QSO's etc. The following stations have been heard in Hartford recently on "20": 4FL, 4LL, 9CTO, 9AEX, 5EK, 4MI, 4JK, 9BYL, 6ZAT, 4EK, 9CZW, 6BJL, 6CIW, 9XX, 9QB, 4HX, WLL, 9ACF, se3AG, 9EAG, oh6BDL, 4BP, su2AK, 4QQ, 6BJL, 5AKP, 6BAV, 6CLS, 9BBT, and 9CVY, 5AGO, 5TK, and 4CJ were all worked at 1MK after 11 p.m. EST. 3CFJ (Cranbury, N. J.) reports working WYI (a ship 700 miles south of Cuba) on 21.5 meters. 6AJM on "20" worked all U. S. districts in two hours one Sunday morning. 8CCQ on 20 meters Mar. 5 and 6 worked: 4LM, 9BBL, 9CDE, 9EIR, 9SD, ef5YOR. Heard: 4DY, 4MI, 6EA, 6OI, 6PUX, 9AFZ, 9CEI, 9DWI, eb4ZZ and NAA—all QST's answered. Worked at 4QY Mar. 16 to 20: 2AIV, 9EB, 8AYL, 5AGQ, 8BAU, 5NL, 1ZZ, 6ARV, 3DS, 1CAW, 5MI, 4IO 8QJ 2VA, 8AYA. Heard only: 3DE, 6BZM, 2IE, 1BKV, ne3CS, 9ELI, 9BUD, 1ALD, 8OQ, 9XX, ne3NI, oz2AC, 6CGW and 5AKK. Copied in just one hour at 4JR: 5akn, 6ku, 6bxl, 9bmj, 9dip, 9bpm, 7ne, 6lh, 7if, 6ahp, 6hb, 6cer, 7zm, 7bb, 6bpm, 9dsy, 3chd, 9bau, 6bzd, 7de, 6tt, 6asi, 7ek, and ne-4ek.

Calls Heard on "20" by 8BEH: 1BYM, 2GP, 3AKS, 4IO, 5UK, 6CCR, 7JC, ne4DW, nj2PZ, np4SA, nq8KP, se2AB, se3AG, su2AK, su1CD and efGAY. Just above "20": eg5DH, nq2JT, sb2AB, M9A, sb2SS, oh6ACG, ne4HS, ne4FV, KDGO, NST, FW, AGB, GBH, NPJ, SPW, XAH, NPM, GLQ, 2XT, NEZB, NITC and D8Q.

1CAW says, "20-meter DX FB here! 15 foreign contacts on 20 this week. Suggest the So. American stations go up to 21.5-23.5 meters instead of using our

band." 6NX is working on 22 meters daily between 6 and 7 pm PST. 1UE is on "20" with 600 volts on one 210 tube. He voices the majority sentiment when he says, "That band is certainly great!"

1ON, 1ADM and a number of other stations turn in the following information received by radio from eb4BC via eb4AC: eb4BC is transmitting daily on 20-meter band just above WIK. He runs daily schedule calling at 1630 Greenwich and 1800 Greenwich. All are requested to QSO and send reports.

9EMB speaking of his first day on 20-meter says, "Called 20 stations and worked 17 of 'em. FB!" A radiogram just received from sc3AG via nu1CAW reports that sc3AG will look for the gang on "20" during the International Relay Party. We have the same from other countries, too. 2AMJ has been QSO su2AK, su1CD and eff3JN often.

Mr. G. G. E. Bennett egBRS63 (26 Blenheim Park Road, Croydon, England) wants a schedule with a 1st or 2nd district "nu" on 20-meters in order to check 20-m conditions against weather, temperature and barometer at each end. A time is preferred between 1700 and 2000 GMT. Please write him.

There is little to be added on the subject that has not been covered in our past reports on 20-meter work. All we can say is, therefore, "See you on 20-meters OM."

—F. E. H.

The International Relay Party!

Full details appeared in March QST (pages 28 and 29) and in April QST (pages 8 and 71). Don't forget the dates—May 9 to 22 inclusive.



ONE OF THE CERTIFICATES OF MERIT THAT WILL BE AWARDED TO THE LEADERS IN THE CONTEST.

A similar certificate with slightly different wording has been prepared for participants located outside the mainland U. S. and Canada. There are still a few days in which U. S. and Canadian amateur stations may enter and receive material for use in the contest. If you haven't sent a QSL-entry card to the International Contest Editor before and if you are going to be able to operate during the period of the contest get busy and do the necessary RIGHT NOW.

NOTICE!

Nominating petitions for Section Communications Managers are hereby solicited from the following Sections.

Section	Petitions to be valid must be filed on or before
Alaska	Noon, July 2, 1927
Montana	Noon, June 2, 1927
Oregon	Noon, June 2, 1927
Washington	Noon, June 2, 1927
Sacramento Valley	Noon, May 6, 1927
San Francisco	Noon, June 2, 1927
New Mexico	Noon, June 2, 1927

The closing dates for receipt of nominating petitions in the Sections listed is given above either as previously announced or extended when necessary due to the failure of members in filing petitions in certain Sections. Petitions must be filed at A.R.R.L. Headquarters on or before the time announced to be valid. The proper form for nomination was shown on page 45 of April 1926 QST. The candidate and five signers of a nominating petition for Section Communications Manager must be members of the A.R.R.L. in good standing and the signatures on the petition must be authentic or the petition will be thrown out as invalid. Members are urged to take initiative immediately, filing petitions for the officials of each Section now operating under temporary officials, so that the work of organization can go forward everywhere without further delay.

—F. E. HANDY, Communications Manager.

BRASS POUNDERS' LEAGUE

Call	Orig.	Del.	Rel.	Total
9DXB	52	19	347	418
1OC	130	45	174	349
1MK	57	135	145	337
3CBT	107	9	202	318
8ANX	5	73	215	293
8BAU	14	7	281	292
5FJ	40	100	144	284
9BWN	30	25	218	273
8XE	45	38	284	267
9DTK	35	44	182	261
9EK-XH	84	93	76	253
6BYH	36	10	206	252
6AYC	52	4	191	247
8CMO	17	15	210	242
8CDB	124	62	96	242
8EU	31	45	158	234
8BMJ	21	11	200	232
3BWT	32	43	156	231
8CNX	36	26	168	230
9DWN	9	18	203	230
9HKV	45	16	166	227
6RIX	54	81	82	227
3BLP	5	3	210	218
5AMO	60	57	100	217
1CRA	61	12	139	212
1IP	10	22	180	212
6AMM	42	116	44	202

9CZC 198, 7JF 185, 1AEF 185, 8CEO 179, 2APD 167, 8GI 187, 8SX 183, 6CTX 161, 1BFZ 161, 1CJX 161, 8AVK 160, 2CYX 159, 7LZ 157, 6AJM 156, 1ATJ 155, 1APL 149, 6RJ 147, 9XI 146, 9CAA 146, 6BVI 144, 6BUX 142, 3CEB 140, 2CSX 139, 9DGR 136, 6CCT 135, 6ACG 135, 9CBT 134, 8DEX 131, 6ABM 131, 1BIG 125, 9BYI 124, 1PE 124, 6BXC 123, 8CWT 122, 6AXW 121, 6ZBJ 119, 9RR 118, 9DAE 118, 3AWT 117, 9DYD 117, 6DAU 115, 5DF 115, 9DDZ 114, 3AHL 114, 6CDZ 113, 3CFG 112, 1YB 111, 9DLI 110, 9BBS, 110, 4AV 108, 9DOE 107, 8CNT 106, 6CLQ 106, 1IT 106, 7UO 105, 1AUR 105, 5VM 105, 6CTE 104, 6BJR 104, 9AIN 103, 8DED 103, 9DBC 103, 8RN 103, 8DII 102, 8AVJ 102, 1LM 102, 1COM 101, 8DEA 101, SAGO 101.

The 25 highest stations are listed first. 9DXB rates at the top in view of having relayed a big bunch of traffic. 1OC dropped to second place this time. The number of DELIVERED messages was very high at the following stations who deserve special mention for their good work: 6AMM, 6BUX, 8ANX, 9EK, 9DTK, 8EU and 3BWT. The number of stations making the B. P. L. is FB but the lower totals of the high men show that the season is having a little of the old effect in reducing the total number of messages that are put on the air.

OFFICIAL BROADCASTING STATIONS

Changes and Additions
(Local Standard Time)

4SJ (40) 12:30 pm Mon. Fri.; 6APA (38.6) 7:45 pm Mon. Thurs.; 3DME (20.3) 7 pm Wed. (84.8) 7 pm Fri.; ne4CU (40.20) 8 and 10 pm Sun. 5QL (38.2) 9 pm Wed., 10:30 pm Sat.

With the Route Managers

By Lawrence A. Jones*

OUR NUMBERS are growing. Every month we have a few more fellows to introduce to the gang. There are just an even dozen this time, and here they are:

Arkansas: E. R. Ariedge, 5SI.
Indiana: F. R. Einchout, 9CLO.
Jacob Worley, 9CMQ.
L. B. Wilcox, 9DPJ.
J. R. Miller, 9CF.
C. A. Luigs, 9EBW.

San Diego: Wendell Jones, 6BYZ.

Vermont: Forrest Drew, 1BJP.
George Wallstrom, 1BBJ.
Charles Kibling, 1BIQ.
Forrest Adams, 1FN.
Ralph Colvin, 1AC.

For the information of the rest of you fellows, 6DDO, RM of the Los Angeles section has changed his address to 608 West 57th St., Los Angeles.

There's something funny about this page isn't there? Yes, that's right, we haven't any traffic map for you this month. On looking over the reports, we found that the schedules were so nearly the same that we decided it would hardly be worthwhile printing another one. So the space will be filled up with more of this chatter.

In spite of our appeal for suggestions last month, very few have found their way in here. Surely you fellows must have some idea what sort of dope you would prefer seeing on this page each month, haven't you? We want to make it as interesting as possible to you, and your suggestions are the only things that will enable us to do that. If you like it the way it is, tell us about it, and if you don't like it at all, tell us about it.

How many of you have noticed the slump in traffic this month? Just take a glimpse at the BPL list in this issue. The old spring fever seems to be hitting us more suddenly than usual this year, and it is up to us to try to keep up interest. Many good stations are cancelling their schedules, and you know as well as we do that nothing will drop our message totals more rapidly than this.

QRN has been pretty bad of late, and undoubtedly this is one of the discouraging factors to many. Here's a thought. For some reason or other, old man QRN seems to be afraid of twenty meters! Doesn't that give you some good ideas? With QRN nil, and QRM almost nil, that band ought to be great for traffic handling all during the summer. Signals seem to have practically the same strength day or night, and therefore consistent schedule work should be most satisfactory. For further information on twenty meter work, read the writeup to be found elsewhere in this Department.

Many of our good ORS have dropped down to twenty during the past month, but have not endeavored to introduce traffic down there, with the result that their monthly total has suffered. In this respect, 1AAL, the RM of Western Massachusetts says, "This 20-meter experimenting has undoubtedly been a factor in the low total of some of the former good traffic stations. But I think this will be only temporary. We all enjoy working DX, and all this experimenting is of course very valuable to the game, but I don't think it is necessary to neglect the important part, i. e.; traffic relaying." That's good dope, but why can't we combine experimenting, DX and relaying all in one. Twenty is an ideal place for this, and it rates the attention of all the gang. Try to get some of your fellows to try it. We have 1MK on twenty at times, and are going to shove out some messages. What think?

We have another idea on getting around the summer static nuisance, and it comes from 9CZC, the RM of Iowa. He says: "The success of the 7:30-8:30 A.M. schedules kept by 9CGY, 9EJQ, and 9RBS show that the eighty meter band need not be abandoned this summer if the stations will change their schedules to operate mornings instead of evenings." This is an excellent suggestion for those of you who are in a position to keep early morning schedules. The QRN is nearly always a great

deal lighter at that time, and QRM is also much less. There is no reason why a good bit of fairly DX traffic couldn't be handled then, as well as local. Remember, eighty meters used to be a wonderful DX band, and it is just as good now as it ever was.

Now you have two suggestions for cheating the static evil. One or both of these will surely help immeasurably, and if you fellows can get a bunch ORS to adopt something along these lines, we will surely be able to keep the summer slump from being as great as formerly.

Incidentally, one of the nicest things in the world for a traffic man is a transmitter that will QSY quickly, to all amateur bands. If QRM or QRN is very bad on the wave being used at the moment, it's a great help to be able to QSY to one of the other bands and continue without difficulty.

RM Brown, 1AAL with the aid of the radio club of which he is Traffic Chairman, is posting collection boxes in radio stores and other public places. These boxes will have information regarding amateur message handling, and it is hoped that a nice bunch of good traffic can be secured in this manner. FB!

Now we come to that message delivery question again. There hasn't been any marked improvement in the percentage delivery this month. 2QU, RM of Eastern New York says, "My experience has been that very few of the ORS want to go to the trouble or expense of mailing messages, with the result that a message is passed back and forth between stations within fifty miles of the destination until some big hearted chap digs up a stamp and mails it. I have doped out an entirely new system of traffic handling which in my opinion ought to give the hundred per cent. delivery aimed at by the A.R.R.L. It is based on the commercial method of handling radiograms between ship and shore, and would be very simple to put into operation. I will make it the subject of a special report in the near future." Let us have a look-see, OM. Anything that will really improve our delivery will be mighty welcome. Why don't the rest of you get busy and dope out some ideas along this line, too?

Have any of you tried some of the suggested activities in last month's QST? We've only heard from a couple of you in this line. If you haven't, why not get busy, and shoot us the dope as soon as any results are obtained.

The number of RM reports received this month hits a new peak. Fine work, gang, and keep it up. Just one little suggestion. Instead of sending just a report and nothing else, why not, as we have asked you so many times, drop us a line along with the report giving any information you may think of that will be of benefit to other RMs. We would like to have these to consider, and the best ones will be put before the rest of our gang on this page each month.

Well, fellows, there are sixty-three of us on the roll now. Growing pretty fast, aren't we? Let's all pull together on our problems, and we'll soon show the hams at large that we can do more toward improving general traffic conditions in a few months than they could do in a couple of years. It's just a matter of observing conditions in our own sections, and doing what seems to us to be things that will do most to improve these conditions. Various suggestions have been given you through QST and in letters, and some of these will probably be useful in your particular difficulties.

That's all there is for now. It's too bad we have to be scattered all over the country. It would be nice if we could all get together and talk over these things, but we'll just have to make this page take the place of a meeting each month. Good luck until next time. 73.

ARMY-AMATEUR CONTEST RESULTS

IN THE contest conducted from 2CXL, and described in February, QST, 6BUF made the highest score in the United States.

The contest consisted in the sending of messages at various speeds and at different times of day. Two evenings were used, the first consisting of entirely eighty meter transmission, and the second consisting of forty-meter work. Various observations were made at the close of the contest regarding the effi-

*Assistant to Communications Manager, "LJ" at 1MK.

ciency of the two waves. Following is a quotation from the comments of the officer in charge of the contests, Capt. A. C. Stanford, of Fort Monmouth, N. J.

"There seems to be no comparison between the results obtained with the eighty meter transmissions as compared with the forty meter messages. The signal strength of the eighty meter messages diminished gradually as they spread westward, reaching the Pacific coast with a strength of R4 to R6. The forty meter transmissions were very erratic, not being heard near Fort Monmouth, and having different signal strengths throughout the country. In general, transmission at this wavelength on this particular test was a failure.

"It is felt that contests of this type, if they cause competition between corps area amateurs, are very valuable. The lessons learned from the first will be most valuable in arranging future contests. It is contemplated using only the eighty meter band in the next contest, giving a correction factor to make up for the high attenuation of the wave."

Robert E. Ewing, 6BUF, of San Francisco, made a wonderful showing, with 600 points out of a possible 600—100 per cent. He is to be congratulated on his excellent work.

Here are the rest of the high scores: First Corps Area: 1ATJ (80), 293 in 300; 1BYV (40), 219 in 300; 1CAK (40-80), 509 in 600. Second Corps Area: 8DME (80), 292 in 300; 2PF (40), 300 in 300; 2CYX (40-80), 577 in 600. Third Corps Area: 3SN (80), 256 in 300; 3SN and 3AYI (40-80), 286 in 600. Fourth Corps Area: 4JR (80), 235 in 300; 4JR (40), 129 in 300; 4JR (40-80), 471 in 600. Fifth Corps Area: 9BXO (80), 276 in 300; 9NM (40), 243 in 300; 9ANB (40-80), 471 in 600. Sixth Corps Area: 9DTK (80), 238 in 300; 9DXZ (40), 268 in 300; 9DXZ (40-80), 546 in 600. Seventh Corps Area: 9DWV (80), 300 in 300; 9COS (40), 255 in 300; 9COS (40-80), 555 in 600. Eighth Corps Area: 9BYC (80), 300 in 300; 5AL (40), 244 in 300; 5AL (40-80), 531 in 600. Ninth Corps Area: 6BIF took the honors with the highest score in the country: (80), 300 in 300; (40), 300 in 300; (40-80), 600 in 600.

That's all there is. Be on the watch for future tests, and see if we can't boast some of these scores.

ARMY-AMATEUR NOTES

FIRST CORPS AREA—The Massachusetts National Guard Army Radio Net became effective in early April. 1JC is Net Control Stations, owned by the 26th Signal Co., Mass. Nat. Guard, located at Commonwealth Armory, Allston, Mass. Two 50 watters are used on 79 meters. The Adjutant General has issued a bulletin to all commanding officers, placing the net in operation, and it is expected traffic will follow in volume. The new Monitor stations are 1WF, 1KZ, 1ACH, 9OKS (ops), 1BBJ, 1QY, 1AFO, 1FF, 1APK, 1AWW, 1AAL, and 1BFT, and all are lined up ready for work.

All New England Division Amateurs desiring to cooperate in similar nets should send a QSL card to the Army Amateur Representative, and one to Capt. J. P. Ferriter, Liaison Officer, Army Base, Boston, Mass.

SECOND CORPS AREA—In the Western N. Y. Net, consistent schedules have been kept by 8HJ, 8AX, 8DME, 8ANX, 8BMN, 8CVJ, 8CPG, 8BHM, and 8VW. 2SC, the N. C. S. of the Eastern N. Y. Net has kept all schedules with 2SC, but has had difficulty in keeping contact with his Net stations due to "skip-distance" on 40m. 2CVS has been keeping the Bronx Net schedules while 2CYX is rebuilding his transmitter. 2EV has returned as the N. C. S. of the Manhattan Net, and good activity is expected soon. 2ARM, 2APD, and 2AVR have been keeping schedules in the Brooklyn-Staten Island Net. 2BGI has applied for appointment. In the Long Island Net, 2BAA succeeds 2AUE as alternate N. C. S. 2AVB has difficulty keeping his schedules with 2SC. 2AXT is a new addition to this net. 3HW, the N. C. S. of New Jersey, was on the job during the recent storm which put down all telephone and telegraph wires in and around Trenton. FBI

THIRD CORPS AREA—Fourteen new appointments have been made, among whom is 8AKI of Altoona. 2AAL, 2AGO, and 2CEL have been keeping their regular schedules with 3SN, the N. C. S. Amateurs are desired from Harrisburg, Pa., and Annapolis, Md. in this Net. Those interested should get in touch with the Signal Officer, Hq. Third Corps Area, Baltimore, Md.

FOURTH CORPS AREA—4SB, 6ADF, 5ARJ, and 5ALE are new stations in this area. National Guard Nets are being organized for the states of Alabama and North Carolina.

SEVENTH CORPS AREA—This area gave an excellent account of itself in the recent test reception of signals from 2CXL. 9AWS, the N. C. S. would be glad to receive applications for membership in the auxiliary net in this area.

EIGHTH CORPS AREA—The Governor's Net in Arizona is in operation, with 6AXN, 6AZM, 6AAM, 6BJF, 6CDU, 6CBI as its members. Amateurs in Casa Grande, Mesa, and Tempe are needed to complete this Net. 5ABQ has been appointed to the Texas Net, and 5ATT to the New Mexico one. 5AIN, the N. C. S., has maintained regular schedules with 2CXL.

Anyone in the country desiring to apply for A-A appointment should communicate with his A-A representative. The names and addresses of all representatives are given in the following table:

Corps Area	Call	Name	Address
First	1SL	D. S. Boyden	72 Gardner St. Allston, Mass.
Second	2PF	David Talley	2222 Avenue O. Brooklyn, N. Y.
Third	3WF	C. A. Miller	405 N. Curley St. E. Baltimore, Md.
Fourth	4IO	J. Morris	58 Frederica St., Atlanta, Ga.
Fifth	5BYN	H. C. Storck	694 Carpenter St., Columbus, O.
Sixth	9AAW	W. E. Schweitzer	4264 Hazel Ave., Chicago, Ill.
Seventh	9BYG-DR	C. B. Diehl	5605 Cedar St., Omaha, Nebr.
Eighth	5ZAE	L. D. Wall	1025 So. Presa St., San Antonio, Tex.
Ninth	6MC	D. B. McGowan	Route B, Box 341, San Jose, Calif.

TRAFFIC BRIEFS

6AYC, of Berkeley, Calif., is sailing May fifteenth as operator of KFVM, the yacht *Idalia*. The radio installation has been under way for some time, and will consist of a MO-PA arrangement using fifty watts for the oscillator, and 100 watts for the amplifier. The set will work on 20, 40, and 80 meters.

F. F. Pniest and C. B. Knight Jr. of station 3AHL write us that the correct name of the whaler ARUX, mentioned in these columns last month, is the *T. Nelson Alonzo*. Last fall the ops at 3AHL visited ARCX when she was in port at Norfolk, also keeping a nightly schedule for some time during her trip southward. The last reports received from ARCX indicate that she is expected back from the South Seas during the latter part of May. A. F. Prescott, R. H. Culver, and Alfred Freeman of 8DLL worked ARCX Feb. 24 and report the sigs from her 50-watt outfit on about 33 meters, R6 500-cycles.

8DLL also reports handling traffic for the U. S. Coast Guard Cutter *Mojave*, NIKB, on patrol off the New England coast. March 11 ARDI (SS C. J. Larsen) was heard testing on 20, 25 meters.

KFZG AND KFZH

Operator Howard Mason of the Wilkins Arctic Expedition reports the March weather warm at Fairbanks, Alaska. It was -30° when the expedition arrived there but the mercury hovered around zero for most of the month. Mason pushed on to Point Barrow in mid-March to put KFZG on the air. The set using this call works normally on 6490 kc's (46.3 m), using 4173 kc's (72. m) as alternate frequency when necessary. Operator Hemrich at 18-mile roadhouse (near Fairbanks) has been on the air with KFZH regularly since March 10. KFZH normally uses 6703 kc's (44.7 m) but will shift to 5913 kc's (50.7 m) if by any chance the first crystal cracks.

The best time for working KFZG and KFZH is probably 4 to 6 p.m. just before sunset. It must be remembered, too, that Fairbanks time is two hours ahead of P.S.T. Hemrich is going to try whenever possible to work the States direct with messages and coded press for the Detroit News. So please listen and lend whatever help you can fellows, reporting hearing or working these stations to A.R.E.L. Hq. 5AGQ recently worked 1MK on 20 meters asking the gang to listen for ex5AIJ who will be on the air in

Singapore, Dutch West Indies after April 15 using two 210's on 31.5 meters with the call od1GR.

9BPM reports working nc5FS March 24. nc5FS is located at Aklavik N.W.T. on the delta of the Mackenzie River. QRH 33 meters and he wants to QSO the bunch.

2APD kept schedules for a time with DCZ, the *Vaterland*, and FFJP. He handled quite a number of messages from both these ships. oh6BDL also reports working FFJP.

On February 26th, oh6BDL worked ohHVW, the station of F. M. Harvey, in New Hebrides. This was HVW's first QSO with Hawaii.

1BFZ reports working KAH (the S.S. Conrad) which was off Nova Scotia at the time. KAH is working on 78 meters with RAC plate supply.

6CGM reports that the station signing ac(xef)8FLO is the French cruiser *Julie Michélet* located at Isanga, China. 8FLO is using fifty watts with a.c. plate supply on 33.5 meters.

The International Ice Patrol is now off the Grand Banks, both the Coast Guard Cutters *Tampa* and *Modoc* (NIDK) being active. NIDK has a 500 watt crystal controlled transmitter on 35.03 meters. Amateurs can be worked nightly between 10:15 PM and 1:00 AM EST whenever the hook is clear of the great amount of official traffic which must be handled.

DCZ is the call of the S.S. *Vaterland* which started south from New York on a tour around the world. DCZ has a 500-cycle note and operates on about 33 meters.

Here are three "Don'ts" for traffic handlers:

1. Don't sacrifice accuracy for speed.
2. Don't guess when taking messages.
3. Don't hesitate to ask for repetitions when necessary.

ACCURACY COUNTS!!!!!!

opXC3 is the station of Alfred Keip, care Insular Lumber Co., Fabrica Negros, P. I. He keeps a daily schedule with 6BXC, which, by the way, offers a good point through which to enroute your Philippine Island traffic. Incidentally, 6AMM's schedule with op1BD, and 6BVY's schedule with op1AU, also furnish reliable clearance points for P. I. traffic.

The Chicago Radio Traffic Association announces a Silver Cup Trophy to be given to the Illinois amateur handling the most messages for three consecutive months. The rules for the contest are the same as those in the recent Traffic Trophy contest, except that only amateurs in Illinois may compete. The judges will be 9AAW, 9DXZ, and 9QD.

Here we have it,—the only one of its kind! 9BRD's QSL card has on it the following description of his station: "Transmitter—'Improves with use.' Receiver—'Aged in the wood.' Antenna—'No metal can touch you.' Our QRH—'57 varieties.' Antenna Current—'Good to the last drop.' Plate Current—'Delicious and refreshing.' Transmitting Tubes—'Keep that Schoolgirl complexion.' DX—'That's the insidious thing about it,—not even your closest friends will tell you.' Quick Watson, the hypodermic!!"

eg6CJ says that he has heard many nuf's this season, but has not been able to get their call completely, simply because they used ac or unsteady waves. 'Nuff sed!

Here's a good one! An extract from the text of a recently originated message reads as follows: "Cold much better. Will go to Northampton next week. Studies coming along ok." Simple enough, but look at the way it arrived: "Cold March weather here. Will go to Norchurch on next week end. Sanders coming along ok." Unique, what? And only one QSR along the line, too.

nc5AW is a station at Whitehorse Yukon. Watch for him gang. He is using a pair of 201-A's on 42

and 39 meters. He has already QSO'd a couple of U. S. stations. A UX 210 is expected to take the place of the little tubes very shortly.

CLUB ACTIVITIES

CALIFORNIA—The Oakland has grown to twenty nine members 6ZX has resigned owing to business activities. His successor has not as yet been named.

The Santa Clara County Amateur Radio Association recently elected 6DFE, 6BKT, 6ARV, and 6UF as its officers. 6NX, 6KG, 6BEU, 6ARV, and 6HC are on the Executive Board.

The short Wave Club of Pasadena is a new club, and membership is open to all persons interested in transmission and reception below 200 meters. All communications should be addressed to the Secretary, 6CMQ. The club hopes to affiliate with the A.R.R.L.

The Silvergate Amateur Radio Association of San Diego publishes an interesting paper called "The Static Sheet".

CONNECTICUT—The Twin City Radio Club of West Haven announces the resignation of its president, 1BAU. The club put on an interesting act at the recent New England Division Convention. They have an interesting little mimeographed sheet called "QRM".

ILLINOIS—Last month an error was made regarding the meeting place of the Chicago Radio Traffic Association. This Club meets in the County Building, rather than at the member's homes. The newly elected officers of the Association are 9LY, 9RK, 9AAW, 9QD, and 9DYD. The club's Traffic Cup Contest is now in full swing. FB!

The New Trier High School Radio Club is still busy constructing its new transmitter and receiver. A few stations in the club are going in for the International Relay Party in May.

INDIANA—The Indianapolis Radio Club is holding regular meetings with technical programs every Monday night. They are putting in a 109 watt 500 cycle station for the Naval Reserve at Indianapolis. This station will be operated jointly by the Naval Reserve and the club.

NEBRASKA—The Cornhusker Radio Club tells of a very enjoyable get-together at Lincoln on the occasion of the presentation of the "Nebraska Week" trophy. 9CEF was the toastmaster, and talks were given by 9DXY, 9BYG, 9DUO, and 9ECS. A good portion of the state was represented, and a good time was had by all.

NEW YORK—The Fulton Radio Club has an interference committee which is very active in locating power leaks and cleaning up such receiving difficulties. They have the cooperation of the local lighting company. FB!

The Society of Rochester Transmitting Amateurs has recently been affiliated with the A.R.R.L. The club is on the air every night with the call 8AC, using a 250 watt on the forty meter band.

OHIO—The Radio Club at Ohio Northern University, in Ada, suggests the forming of a College Relay Route. Nearly every student in college has a friend in some other school, and such a scheme would also be handy during interscholastic contests. It sounds FB. What do the rest of the college clubs think about this?

The Norwalk Amateur Radio Association (8DDQ), wants to correspond with other clubs in Ohio and elsewhere. Address D. J. Young, Sec'y., 55 W. Main St., Norwalk, Ohio.

OREGON—The Benson Tech Radio Club of Portland is on the air with the call 7YK. They are using one UX210. The club has been quite active in ham affairs.

PENNSYLVANIA—The Amateur Transmitters Association of Western Pennsylvania has started a membership campaign. The club's code classes are showing good progress.

The North Philadelphia Radio Association holds its meetings every other Monday in the Library Hall. At a recent meeting a talk was given on the coming International Relay Party.

SOUTH DAKOTA—The Y.M.C.A. Radio Club of Sioux Falls is holding a contest which it hopes will bring in some new members. An electrical discussion is being carried on by a representative of Northern States Power Company, which is proving very interesting.

DIVISIONAL REPORTS

ATLANTIC DIVISION

DELAWARE—MD. D. OF C.—SCM. A. B. Goodall, 3AB—3A1S has been heard occasionally on 40 meters.

MARYLAND—3PU has been in communication with South America with a five watt. 3RF reports that he will leave town shortly. 3ACW is reported as getting out consistently. 3GGC is still heard occasionally on 40 and 80. 3CJ discovered that he had been working for some time on 40 meters when he thought he was still on the old 80 band and as a result worked a bunch of foreigners before he knew it. 3PS is doing some work on 20 meters for the first time.

DISTRICT OF COLUMBIA—3BWT reports the addition of Sutherland of ex-8CME as another addition to the operating staff at that station. 3NR works on 40 and 80 meters. 3GP, the well-balanced crystal-controlled station, reports a slow-motion—too much QRN. 3GP has replaced his old antenna with a Zeppelin and finds the experiment successful. 3CAB has been out of town on one of his many excursions but got in a little work.

Traffic: 3PS 37, 3CJ 3, 3CGC 22, 3PU 4, 3ASO 10, 3AIE 47, 3CAB 12, 3GP 39, 3NR 36, 3BWT 231.

WESTERN NEW YORK—SCM. C. S. Taylor, 3PJ—Reports this month show every indication of a larger Western New York Section of the Atlantic Division. More stations are on and reporting regularly and message traffic and schedules are increasing two-fold. 3AYB is working hard to have those handling schedules get in communication with him. There has been quite a bunch of Dead ORS wiped off the list this month. Now is your chance to sign up with the U.S.N.R.F. the Army Net, etc., and in case of trouble you will be all set. 3ABG is handling traffic. 3ADE handles traffic and is now playing with 20 meters. 3ADG was reported in Central West Africa. 3AHC, on 20 meters has worked France, Belgium, Uruguay, Dominican Republic, Hawaii, Jamaica and New Foundland. 3AIL works Belgium with a UX210. 3AKC handled a 5 meter msg. for Headquarters. 3Aly paid a visit to the R.A.W. Ny. at Buffalo and gave the gang here a treat with his Rochester bunch of Brass Pounders. 3ANX has heavy traffic this month on 76.6 meters. 3APK has rebuilt his transmitter with break in system. 3ARG worked ni-2PZ and 6AXW. 3AYJ handled msgs. from the convention at Gloversville. 3AVR is experimenting with fone on 80 meters. 3AYS is keeping schedules with 1AFY, 1IM, 1GEX, 1DV, 1CDX, 1MT, 3AC and 3BNS. 3BAG has doubled his traffic report this month. 3BCZ works 6's and handles quite a bit of traffic. 3BFG is after ORS and working hard handling traffic to get it. 3BGN is off until a new UX 252 arrives. 3BLP has a new 50 watt bottle. 3BMJ is now an ORS and has quite a traffic report. 3BQJ sez he's met the sweetest Girl in the World and traffic at his station is nil. 3BRD is handling traffic with his new 50 watt on a Hertz antenna. 3BYE has been off on account of A Battery going west. 3BZP sez his plate voltage is good but the tube won't perk well so he only handled a few messages. 3CDB has schedules with 8CCR, 1CUP, 9DLD, 9BYI, 8CEG, 3AYB. 3BLF works sb-2AC with his phone on the 80 band. 3CEG works 5QQ on a 201A. 3CIV is rebuilding the set now for a 50 watt bottle. 3CNI handles traffic. 3CNT has rebuilt his set. 3CNX is going full blast again on 20 meters. 3CVJ works Jamaica and had schedules with 8DME, 8HJ, 3BFG. 8DEX states west coast reports his station steady. 8DME works 6DOW in dalite and Uruguay. 8DNE has no schedules as yet. 3DRJ states DX great and traffic fair. 8DX handles traffic from the Boy Scout Exposition. 8HJ reports no schedules but from reports of others he must have quite a list. 8NT works Europe often. 8QB has handled every PRR test. 8YW has two transmitters and is off with one for rebuilding.

Western New York loses a good ham when 8BEM moves into Ohio.

Traffic: 8ABG 8; 8ADE 5; 8ADG 5; 8AHC 96; 8AIL 12; 8AKC 20; 8ALY 19; 8AVR 4; 8AYU 293; 8APK 26; 8ARG 4; 8AVJ 102; 8AVR 4; 8AYU 11; 8BAG 50; 8BCZ 19; 8BFG 30; 8BLP 2; 8BMJ 232; 8BQK 5; 3BRD 24; 8BZP 10; 8CDB 242; 8CUC 99; 8CUG 22; 8CIV 12; 8CNI 16; 8CNT 106; 8CNX 230; 8CVJ 6; 8DHX 131; 8CME 21; 8DNE 77; 8DRS 19; 8DX 46; 8HJ 32; 8QB 18; 8NT 12; 8YW 19.

EASTERN PENNA.—SCM. H. M. Walleze, 3BQ—Traffic figures for this month seem improved. Some of you fellows still lag below the 10 per month limit. How cum? Any of you passing this way enroute to the Pittsburgh Convention are invited to stop off and see me. 3EU wants the westbound gang to assemble in Williamsport and swarm in from there. How about it? 8CMO tops the BPL this time. 3EU is very busy, too. 3BLP staged a nice comeback. New 500es put 8AVK back in the BPL. 3AWT continues to bat em out. 3CGZ is working the three lower bands. 3ADE leads the Harrisburg bunch again. 3BQP is going strong with CC. Skeds helped 3CNJ along. 3CDS may QSY to 80 at last. QRN sure worries 3AY. 3NP is fussing with CC. 80 don't step for 3BLC. 3BCQ tries to keep Wilkes-Barre alive. The CBL's stormed 3BUV. (Me too, Hi). A new Zep antenna works FB for 3BIR. 3CW couldn't get on much. Merc are bottles don't stay with 3RT long. 3HD needs aid in putting up a 60-footer. 3BFE lost his license, but no one knows why. Tic picked up for 3ZM. FB. 3Aly has a terrible time keeping in tune. Hi. 3VF is going in for skeds strong. 3BSZ's shack is warming up now. 3PY pounds 40 a lot. 3BFL likes 20 OK. 3ABX telegraphed his report—who ever he is. Gess the sig was garbled. 3ADE cleared a nice bunch of em.

Traffic: 3CBT 318; 8CMO 242; 3EU 234; 3BLP 218; 8AVK 160; 3AWT 117; 3ADI 92; 3ADE 67; 3CGZ 67; 3BQP 32; 8BQ 31; 3CDS 23; 3ABX 27; 3CJN 22; 3HD 10; 3JJ 15; 3VF 14; 3ZM 14; 3BFL 13; 3BFE 13; 3RT 13; 3BLC 13; 8BCU 11; 3NP 11; 8BSZ 10; 3BIR 10; 3AY 8; 3CW 8; 3PY 6; 3Aly 4; 3BUV 2; 8AVL 5.

SOUTHERN NEW JERSEY—SCM. H. W. Denham, 3EH—Traffic took a decided drop this month with the failure of a number of the gang to report. Let's do all we can, gang, to keep up the records that we have been making for the past few months. 3RTQ is back on the job again after a busy winter. 3CO has gone back to 80 meters. 3BWJ is another coming up to 80. 3SJ has been saving up his pennies to put in xtal control and just when he had enough in the bank, some YL talked him into buying an Essex Sedan. 3UT reports a new ham in Atlantic City, in the person of 3ACX. 3CFG comes through this month with a good traffic total. 3KJ reports that a short wave outfit is to be installed at WPG and that the ops are going to start a club. The last sleet storm in Trenton wrecked 3ZI's 48 ft mast and brought down the entire antenna system. 3ALX and 3BAY reported from 8XE where they are each working a shift. Will be back at their own QRA as soon as college closes for the summer. Traffic: 3CFG 112, 3UT 36, 3SJ 34, 3BWJ 20, 3CO 8, 3BTQ 5.

WESTERN PENNSYLVANIA—SCM. G. L. Crossley, 8XE—More stations are reporting this month than usual and the average messages handled is also higher than it has been for some time. There are several stations who have not reported more than 3 messages for over 10 months. Let's get going, gang, and handle traffic in the Section and show the rest of the Division what the ORS stands for in the Western Penna. Section.

3AGO and 8CEO report activities for the Atlantic Division Convention to be held in the latter part of June at Pittsburgh. 3AGU, 8CVZ, and 8CJQ are new stations and seem to be very active. 8BDJ is off the air due to YL QRM. 8ZD and 8DNO report QRW. 8CLV just got married and hence no traffic. Hi. 3ARC and 8GI have been keeping schedules with several good stations. 8CKM built a new receiver. 3BRB is operating on KDO and if you hear a station signing KDOI that's he with his short wave set on board. 3CWT is installing a mercury arc. 8GK is putting in an 80 meter traffic set. 8CYP is now using an MG set. 8DOQ has a new kenotron set. 3AYH is busy trying to get BCL's interested in amateur work. 3CRK has trouble with local work but OK on DX. 3BRC says that 8HXE is the only amateur around his locality that has nerve enough to operate when the BCL's threaten him. 3BRC reports activity and promises more very soon. 3CFY is active on 20 and 40. 3DFY will soon be on with xtal control. 8XE is working regularly on the 40 and 80 band. 8DOB reported for the Erie gang. 8BVK, 3HN, 8AOS and 3VF are working the East coast on phone using 210s. 8CAE is on with a WE 5 water. 3CXG has a new TG transmitter. 8TS is now at Erie. 8BGB has a 50-watt transmitter

going. 8BDT has just moved and will be on again soon. 8DOB is also moving but will soon install a transmitter with two 202s. The SCM wants to call the attention of the gang to the coming Atlantic Division Convention to be held at Pittsburgh in late June. He has had opportunity to see a prospective program and it looks very interesting. 8ARC reported this month via Radio and sent a confirmation copy by mail. That is a suggestion, gang.

Traffic: 8XE 267, 8CEO 179, 8GI 167, 8CWT 122, 8AGO 101, 8DOQ 86, 8DBL 79, 8CFR 62, 8ABW 61, 8DFY 36, 8CRK 28, 8ARC 18, 8VE 14, 8CYP 12, 8GK 10, 8DNO 10, 8BRB 9, 8AYH 3, 8BRC 2.

CENTRAL DIVISION

KENTUCKY—SCM, D. A. Downard, 9ARU—Let's hear from you fellows that hold O.R.S. certificates and are not mentioned in the traffic figures below. Do you remember the clause in your application for ORS regarding your monthly report to the SCM and what would happen when you fail to report? If you want to keep that ticket you HAVE to report. 9ABR reports having worked ARDI (the "Larsen" at the South Pole) for an hour March 10th handling two messages. FB OM! 9BWJ is QRW ponding bits at a drilling rig. 9GC is still waiting on power. 9MN says he can't get his tube to perk on 20 meters. 9BAZ was CQing for traffic the other nite and someone gave him one for Italy. Hi! He hasn't CQed since! 9EI and 9ATV have consolidated. 9ALM is working good DX on 20 meters. 9ARU is rebuilding and will be back again soon on 20-40 and 80 meters. 9OX reported via radio this month.

Traffic: 9WR 81, 9MN 53, 9ALM 35, 9BWJ 35, 9ATV 25, 9BAZ 20, 9ABR 17, 9ARU 12, 9OX 85.

OHIO—SCM, H. C. Storck, 8BYN—The SCM is very much pleased with the way the ORS in OHIO are reporting now. FB gang, keep it up. The ones who were late this time, please remember next month. 8BAU takes high honors for traffic. He keeps 10 or 12 schedules. 8RN comes next but will be leaving us soon to pound brass commercially again. 8DIH comes a close third and a flock of schedules. 8KA has the wanderlust again, and is leaving again, not to return until July or later. 8GZ, O-O, is sending daily schedule on 5.2 meters, with 300 watts input. The other O.O. for Ohio are:—8BAU, 8PL and 8APZ. 8BNW blew two five waters in a week. 8DPF turns in a nice total, but will be off the air for several weeks, due to moving to another town. 8AYJ is good schedule man. 8ALU turns in a nice score, but is too modest to say anything about himself. Hi! 8DJG was only on the air 10 days but got 39 messages. Vy FB om. 8EQ keeps a schedule with OH-6AXW for traffic. 8DSY sends his dope pretty faithfully, altho he says QRN has been terrible. 8BEV worked EG-BVJ first time he pushed the kep on 20. 8ACY sends his report card with a black border around it, in memoriam of the demise of his pet 250, which passed to its reward. 8ACY is going on the Lakes again. 8CQU was on only five days due to not having tubes. 8AVB turns in a nice total all handled on 20 meters. FB, OM. 8CFL says the way to get traffic is to use a 201-A. 8AVX is keeping schedules, especially with 8DSY. 8CMB blew some tubes and is now rebuilding. 8DDQ is QRW playing checkers via radio. The Norwalk Amateur Radio Assn. (8DDQ) wants correspondence with other clubs. 8PL is still DXing, altho he does handle a few messages. 8PP is on 40 and 80, and always ready for traffic. 8BWW has built a new panel mounted master oscillator-power amplifier set. The SCM received a radiogram from 8AQU saying that he handled 14 messages. 8AYO is going on the air with Xtal control on 41 and 20.5 meters. 8AEU is on 20-40 and 80 meters. 8GL says radio is going to the dogs, QRN is bad, QRM worse, and power leaks worse. 8DQZ is going good now, but anticipates trouble because school work is heavy now. 8CLR says his DX is no good, so he has to get traffic to feel good. Hi! 8BKM reports his MG is FB but no traffic on 20 and 40 and is going back to 80. 8DHS is trying a Hertz antenna but says he is not satisfied with R4 in Kansas, when he is using a 250. 8RJ moved to new QRA. 8CCG has had trouble getting from 80 to 40. 8APZ has not had much time for traffic due to O.O. work. 8AU, the RM for OHIO, says his work is getting under way nicely now. 8ADH is going to get a Xtal soon. 8DIA is still too busy to do much with radio. 8KC thinks 20 meters is "the berries". 8DCF

and 8DEM are still QRW school. 8BOP absolutely will be on the air by April 3rd with DC. He sure has been working hard enough to get there. The reports this month showed increased activity on 20 meters. Don't let the hot WX knock you out altogether, let's try to beat a path thru the "ether" this summer and have the satisfaction of finding out whether when QRN gets bad, amateur radio has to QRX.

Traffic: 8BAU 292, 8RN 103, 8DIH 102, 8KA 87, 8GZ 76, 8BYN 74, 8BNW 74, 8DPF 67, 8AYJ 69, 8ALU 39, 8DJG 39, 8EQ 38, 8DSY 38, 8BEV 34, 8ACY 33, 8CQU 30, 8AVB 25, 8CFL 24, 8AVX 22, 8CMB 21, 8DDQ 18, 8PL 18, 8BWW 15, 8AQU 14, 8DMX 11, 8AYO 10, 8AEU 10, 8GL 8, 8DQZ 8, 8CLR 8, 8BKM 6, 8DHS 6, 8RJ 5, 8CCG 5, 8APZ 4, 8AU 2, 8ADH 1, 8BKQ 1, 8DIA 1, 8KC 1.

WISCONSIN—SCM, C. N. Crapo, 9ZD—9DTK lends this month, probably due to keeping 12 schedules. 9EK-XH handled 15 Naval Reserve msgs and has schedules with eleven different stations. 9DLL handled 98% of his traffic on 80 meters but sez he will drop to 40 and 20 for the summer months. 9CXK did good work this month but blew a couple of kenotrons. 9CFT has been off the air for a few weeks due to a death in the family. 9JM is a new station at Sturgeon Bay that is improving in traffic every month. 9AGV maintains six schedules and is working his head off for an ORS. 9EMD is kept busy with his four schedules and getting out route maps. 9COI is busy at school but ground out 29 this month. 9BJY is changing to crystal control and making a wave meter. 9VD expects to get the vertical Hertz perking soon with the aid of suggestions from 9XM. 9AZN keeps three schedules on Mon. Wed. and Friday nights. 9BWO worked a couple more Australians this work. 9AZY gets an ORS this month for his good work. 9AZY is on daily at 12:30 PM on 38.5 meters and will be on occasionally. 9BPW had a fire which damaged his equipment badly so he will not be on again for some time. 9EHM worked Cuba and has daily schedules at 6-3 PM and 11 PM 1AM. 9EIH an old timer back on the air on 40 meters and on schedule. 9BIB has a new antenna that is working fine. 9CIT is a new station at Eagle River which we expect will have a lot of traffic on his hands when the tourist traffic starts moving. 9CAV has a new 100 watt going into a Zeppelin antenna.

Traffic: 9DTK 261, 9EH-XH 253, 9DLL 110, 9CXK 53, 9CFT 49, 9JM 45, 9COI 30, 9BJY 25, 9VD 22, 9AZN 22, 9BWO 21, 9EEF 19, 9AZY 19, 9BPW 17, 9EIM 15, 9EIH 50, 9BIB 10, 9CIT 7, 9CAV 6, 9EEM 2.

ILLINOIS—SCM, W. E. Schweitzer, 9AAW The Chicago Radio Traffic Assn. is donating a silver trophy to the amateur station handling the most messages for three consecutive months. The stations must be in Illinois and the rules for the award are similar to the rules of the trophy won by 118IG. The contest started the 25th of March. The SCM congratulates the Ill. gang. For the past three months, we have been near the top of all Sections in the number of stations reporting and messages handled. The action of the Board in voting against further national conventions is meeting with great disfavor here. So much so in fact that petitions are being circulated asking the gang what they really think. Never has any action by the Board been so resented as this action taken at the last board meeting, saying that there would be no more national conventions.

9AAE expects to get a mercury arc rectifier. 9AAW held a ham blowout Sat., Mar. 26th. A good time was enjoyed by all. 9AHJ is on 40 with a 210. 9AFF is working FB with the Army traffic. 9AJM was off the air all month. 9ALJ was also off but not because of YLs. 9AFB likes 20 meters for daytime. 9AFX gets his exercise roller skating instead of pounding brass. 9ALK blew his plate transformer. 9ALW is out of town. 9ALZ reported for the first time. 9APY is doing some three corner work with England and Belgium. 9ARM asked about station licenses which are expiring—the S. of R. says GA until the radio commissioners make new rules for amateur stations. 9AXZ is working some fine DX. 9BHM has been logging some real DX. 9BHT reports several new stations ready to open up in Canton, Ill. 9BIZ is working with a 204 and reports 9BYW working on 40—says 9CHF does not like the chirp of CC. 9BKD is on 20 meters. 9BTX is keeping a good bunch of schedules. 9BRX bought a new car. 9BWL has been off because of cleaning. 9CDX is a new ham, starting off right

by reporting. 9CEC blew his 50 watter. 9CEH has been QRW with work and YLS. 9CBL works 6's and 7's with a 210. 9CIA is out to make the WAC. 9CNE is troubled with a bad power-leak. 9CNP reports traffic on the decided increase. 9CSB is organizing a club for North Shore Chicago hams. 9CSL reports little activity. 9CWC is planning to put in a 250 watter. 9CXC, pres. of the Chi-Nines club, is looking for games for the baseball team. 9CYN just finished building his transmitter. 9CZL gets very little QRM on 20 meters. 9DBI keeps busy at the U. of Illinois. 9DDE was on only the first part of the month. 9DGA is working all the continents. 9DOX is signing off for an indefinite time because of sickness. Old Paxton will be back soon, we feel sure. 9DXB is working for a commercial ticket. 9DYD made the BPL as he promised he would. 9EIA has moved to a new QRA. 9EGC is going to the Dakota Convention. 9EIR is a new station sending in a dandy report. Chicago's YL. 9BA is transmitting with a 201-A. 9BL uses remote control and break-in. 9CN is doing his usual good work. 9GE handles regular business with Detroit via radio. 9IZ, another new station, is working with a Hertz. 9KA has a new transmitter working. 9MR is at present inactive, the ops at 9NV are all busy studying. 9PU is waiting for the time that he can get back on after school closes. 9QD had a slump in traffic because of the loss of his schedules with 9DXY. 9RK says break-in is FB for traffic work. 9SK slipped up on his total, too. 9UX blew his 250 watter.

Traffic: 9DXB 418, 9DYD 117, 9CIA 98, 9RK 94, 9SK 88, 9QD 66, 9GE 64, 9CNE 68, 9CZU 55, 9BHM 54, 9DOX 51, 9NV 48, 9AFB 48, 9CZL 46, 9CN 46, 9CSB 45, 9APY 43, 9AXZ 39, 9CPQ 36, 9CNP 32, 9CEH 32, 9BVP 32, 9LY 30, 9CYN 26, 9BTX 22, 9ALK 20, 9BWL 20, 9EHH 18, 9BPX 31, 9CWC 17, 9BL 16, 9AAW 15, 9AAF 15, 9BHT 14, 9UX 18, 9CEL 11, 9EAI 11, 9BIZ 10, 9PU-9MI 8, 9DDE 8, 9AHJ 6, 9IZ 5, 9DGA 4, 9BRX 4, 9ELR 3, 9EGC 3, 9CXC 2, 9BKD 2, 9CSL 2, 9AFX 2, 9ALZ 1, 9CPD 1, 9BA 1.

INDIANA—SCM. D. J. Angus. 9CYQ—There does not seem to be any slackening of interest in Indiana. Things are pointing toward increased activity—a considerable number are rebuilding. 9BKJ blew all his filter condensers so has pure a.c. now. 9BCM has changed to 80 meters for his traffic. 9DRS has just rebuilt, putting in kenotrons. 9BYO is on 40 and 80. 9CNC is still on 20 meters. 9EGE's 7 1/2 watter bought on Fri. the 13th still perks. 9ABW has the blews. He blew all of them. Hi. 9EJU is still on 80 and 176 meters regularly. 9CVX is rebuilding for crystal. 9CEY, a new ORS, is experimenting with 20 meters. 9BK handles a little traffic when business is not rushing. 9DELJ is leaving to operate on the lakes. 9CNV plays radio checkers with 9DDQ. 9CMJ is using a new Hertz with fine success. 9AIN's generator armature went west. 9DDZ is using a Tobe tube for his 20-meter work. 9BQH uses baking soda rectifiers. 9AUX is repairing schedules on 80. 9ABP still operates, also repairs BCL sets. 9AHT is getting out better than ever now. 9CEM is getting started again. 9AEB is the super-DX bird of Elkhart. 9DHM is nursing a radiation blister from leaning on 9BQW's choke. 9BYI turns in a good total. 9DVE is using tuned plate-tuned grid and getting out good. 9BBJ is on occasionally. 9BMV, at Purdue, owned jointly by 9BBJ, 9DMC, 9DGG, 9BBQ blew a 50 and two 5's and is on a 210 now. 9ASX works schedules with low power. 9BUI just put in a new 50 watter. 9DLM is QRW with the mumps. 9BSK is working foreigners now. 9EF is QSO Hawaii regularly now. 9DIJ and 9CP had their 204A's go soft. 9AXO is on but handles no traffic. 9BBL is going good on 20. 9ES and 9BDT are on phone on 85 meters getting out well. 9DBA is going again on 80. 9BJR is going to rebuild for 40 as well as 80. 9CBT handled a good number. 9CLO is going good with the crystal-controlled set. 9CRV now uses a 7 1/2 watter and gets out fine. 9DSC does all his work on 40. 9APG is still on but BCL repairs cramp his style. 9AXH operates a lot in spite of his motorcycle. 9ACR peddles papers when he is not at the key, which isn't often. 9CUD just completed a 40-meter set. 9CJQ had his motor generator rewound so is perking OK again.

Traffic: 9CBT 134, 9BYI 124, 9DDZ 114, 9BJR 104, 9EF 80, 9AIN 103, 9CMJ 58, 9CNC 68, 9DHEJ 11, 9CP 7, 9BK 4, 9CEY 2, 9CVX 15, 9EJU 10, 9ABW 7, 9EGE 30, 9CNC 26, 9BYO 3, 9BCM 31, 9BKJ 32, 9ASX 20, 9BBJ 8, 9AUX 7, 9ABP 7, 9AHT

1, 9AEB 4, 9BQH 57, 9CMV 10, 9RDA 13, 9CLO 52, 9CRV 40, 9DSC 32, 9APG 8, 9AXH 7, 9ACR 6, 9DWE 3, 9CUD 2.

MICHIGAN—SCM. C. E. Darr, 8ZZ—Two stations made the BPL this month. 8SX is the leader with 163 and 8DED comes second with 103. Good work, fellows. Why can't the rest of you do as well? Incidentally, 8SX has been busy lining up some good traffic routes for Michigan. FB!

Traffic: 8PF 2, 8DIV 1, 8CEP 62, 8ZF 5, 8MM 5, 8BYJ 7, 8BEH 23, 8AUB 42, 8SX 163, 8JG 3, 8DED 103, 8ACU 3, 8CWK 74, 9CSI 14.

DAKOTA DIVISION

SOUTHERN MINNESOTA—SCM. D. F. Cottam, 9BYA—There have been fifteen cancellations for various reasons since last month. Better check up and see that you are not violating any rules or you may be the next one to be cancelled. You are getting a fair warning that an ORS must have a traffic total of at least 10 messages or else be dropped an ORS. You have two months of grace in order to get scheds for the purpose of traffic handling. Drop 9CAJ or his assistant, 9EPK, a line for scheds. They are at your service.

9XI has been QSO a new country (fq) ANM. 9DBC is QRW with school but made the BPL. 9EFK has a new 50 in a 4 coil Meissner that works FB. 9CIX, a new ORS, keeps 3 skeds. 9BHZ is considering a mercury arc. 9DGE is again in town and ready for business. 9COS wants skeds. (Get in touch with 9CAJ, OM) 9BYA raised oa-7BQ on a two minute CQ on the 28th. 9EFO is QRW at school but is on, anyway. 9AIR's mast blew down but he has a new one up. 9DBW is QRW with YLS. 9SF QSO's any place on 20 with no antenna. 9BTZ made a new DX record for himself by working fa-4A. 9DHP did fine work reporting the basket ball tourney to the towns that had teams playing in Minneapolis. 9GH has a new Zep up and it is OK. 9DEQ complains of no traffic. (Write 9CAJ, OM) 9DMA is at school and ops at 9XI.

Traffic: 9XI 146, 9DBC 103, 9EFK 34, 9CIX 45, 9BHZ 41, 9DGE 56, 9COS 21, 9BYA 20, 9EFO 21, 9AIR 16, 9DBW 16, 9SF 15, 9BHB 10, 9BZT 6, 9DHP 6, 9BKX 6, 9GH 4, 9DEQ 4.

NORTHERN MINNESOTA—SCM. C. L. Barker, 9EGU—By the number of new stations that are starting up, and by the number of Official Relay Station appointment applications that are, and have been, coming in, the SCM wonders where all the stations really come from. Hi. By the looks of things we'll have to make our section larger to take care of all the stations, but then, maybe we'll get by with it as it is, eh, gang? Reports were much better this month, and out of 29 ORS, only 7 reports were missing. FB, and let's make it much better than this, next month! The gang is all enthused about the big convention next month, and everything points to a record-breaking attendance.

9AOK deserves lots of credit—being high man with traffic this month, and a brand new ORS. (Ata spirit, OM, SCM). He works every morning, noon, and night, and all day Sundays, and KEEPS incidentally, doing nice DX work on the side. Incidentally, his QRA is Elk River, Minn. 9ABV follows in second place for traffic totals. 9CWN works on both 40 and 20 meter bands, and he says 20 is fine. 9AKM, our "northern-most ORS", was off for over a week, so think of what his traffic totals would have been if he could have been on regularly! He reports having started two new hams at Hallock, and they will be on as soon as they get their licenses. 9BHY is leaving for Minneapolis, but we hope he will be with us again shortly. 9CTW has a new set on both 40 and 80 meters, and a second set for 20, all going fine. 9EGF reports 2 old-timers back in Virginia, indicating that "the range is opening up again". 9EHO is all set for a QSY to any band in one minute's time, and does lots of 20 meter work, getting CC reports on his storage battery supply. 9KV says that Duluth is 100% tuned-plate 'n' grid now. 9CKI works on 80 meters with a new H tube in TP-TG. 9BJD is a brand new ORS at Duluth. 9BBT has been too busy to do much radio work. 9EFP casually remarks that he hates to pay \$25.00 for an 80 meter crystal, but what we want to know is: who don't? Hi. 9CWA has been on the sick list, but had a few visiting hams. 9MF says he operates only during "weak ends" now, though he takes regular tricks

at 9X1. 9GZ is off the sick list now, though QRW. 9BVH put up a 200 foot receiving antenna and gets 100% better reception. (Perhaps that will start a new argument over long and short receiving antennas, hi. SCM) 9BMX is on 20 meters "for good" yet, and reports DX fine with his UX210. 9DRK and 9AOG are installing a transmitter at the local Armory for traffic work. 9DRK rebuilt his set but it wouldn't perk, so he is trying it again. 9AOG is on with "15 watts" fed with a.c. 9EGU has been off a little and on a little, doing not much in general, but finally succeeded in getting the 2-year-old 50 water to push out a mean signal again. He walks carefully when in the radio room so that the darned thing won't get out of adjustment again. hi.

Traffic: 9AOK 90, 9ABV 74, 9CWN 47, 9AKM 44, 9BHY 44, 9CTW 38, 9EGF 62, 9EHO 35, 9KV 31, 9BAY 27, 9CKI 19, 9BJD 19, 9BTT 15, 9EFP 14, 9CWA 12, 9MF 11, 9GZ 4, 9EGU 3, 9BVH 3, 9BMX 2, 9DKR 6.

SOUTH DAKOTA—SCM, F. J. Beck, 9BDW—9DWN, RM, continues to be high man and wins the prize given by 9NM for high traffic man this quarter. The number of stations handling traffic and the reliability of our traffic routes is improving and we have several stations on transcontinental relay routes. 9DGR handled a rush msg. to Chicago and back when W.U. closed. 9BOW has more power all of 8 watts now and handles lots of traffic. 9BOT, another mouse power set. 9DLY worked mornings on 80 and is a reliable station. 9ALN has lost his pole again but is going with a zep antenna. 9BKB is starting up with skeds and handled some messages this month. 9DB has been experimenting with antennas. 9DNS has a power leak on 80. 9CZG likes 80 better than 40. 9NM has had QRM from jury duty but started up some new stns. in his locality. 9DBZ works Hawaii regularly on 20. 9DIY had the usual BCL QRM. 9DYA is leaving the state. 9AJP wants skeds on 40. 9CFK also handles traffic on 80. 9CJS is working on portable xmitters. 9BBF is leaving us and will take a small xmitter with him. 9ABX is on 40 meters. 9EGL works on 180 and 80 meters now. 9CMG uses spk coil cw. 9AZR found the jinx on his xmitter. 9DES, 9BQV and 9AJP are putting Sioux Falls on the map. 9TI working 80 meter fone.

Traffic: 9DWN 230, 9DGR 136, 9BOW 53, 9BOT 35, 9DLY 29, 9ALN 22, 9BKB 20, 9BDW 14, 9DNS 13, 9CZG 11, 9NM 8, 9DBZ 7, 9DIX 3, 9DXA 1, 9AJP 20, 9CKF 25.

NORTH DAKOTA—SCM, G. R. Moir, 9EFN—9DM has been quite active during the month and informs us of a three month old Junior operator in his family. Congratulations! 9BJV and 9DKQ have been rebuilding. 9BVF, 9DYV and 9EFN have been on but little.

Traffic: 9EFN 4, 9BYF 24, 9DKQ 4, 9BJV 2, 9DM 20.

DELTA DIVISION

ARKANSAS—SCM, W. L. Clippard, Jr., 5AIP—Activities are gradually picking up in Arkansas. Our RM is getting things lined up and we hope to more than double our record this month. Please do your share, OMs, in pushing our state forward. We have two new additions to our gang this month. 6SY and 5QV. Welcome, OMs. 5ANN works FB when he gets time. 5AFR, 5ABD and 5PX are still tinkering. Hi. 5LV blew his 210s and uses 201A tubes. 5AW is back on the air with a 100 watt crystal. 5HN and 5BI are also putting in crystal. 5CK and 5LV report a dull month. They weren't in the storm then. Hi. 5ER moved to Pine Bluff. 5IR's business has taken him to Washington and he will soon be a 7.

Traffic: 5ABI 23, 5AW 20, 5SI 17, 5HN 12, 5LV 11, 5CK 10, 5NI 8, 5AIP 7, 5CJ 6.

LOUISIANA—SCM, C. A. Freitag, 5UK—5QJ is obliged to resign his ORS due to the pressure of business. 5PM is very enthusiastic in regard to amateur radio and traffic handling and will make an excellent relay station in a very short time. 5ANC has been off for some time due to illness. He will be back shortly, tho. 5AEN has a new transmitter working FB. 5WB is working good DX on 80 meters. Shreveport reports two more BCLs interested in amateur radio who will soon take out licenses. 5AKI

is using phone on 180 meters. 5OP and 5BB are temporarily dismantled. 5KZ's Christmas present (AWE50) went west while he was drawing a huge arc from the inductance. 5ML has a phone on 180 meters. He is building a small 20 meter transmitter and receiver for this summer. 5MQ is selling Kelvinators and Grebe sets. 5EB reports regular news is sent daily to the operator on SS Roanoke. A new station 5IE is on the air here with 2 CX310 tubes. Seems to be getting out pretty well. 5NS will be on as soon as he gets a plate transformer.

Traffic: 5ANC 22, 5EB 19, 5UK 16, 5PM 13, 5WF 6, 5WY 5, 5KC 5.

MISSISSIPPI—SCM, J. W. Gullett, 5AKP—We have a new station, 5IB, at Long Beach. 5ANP has schedules with 5QQ and 5AJS. 5AUB is getting better and says he will be going strong now that his foot is better. 5QQ reports schedules with 5ANP every night at 7 pm. 5AGS, our RM, reports ND on account of sickness in his family. 5API reports a new transmitter at his shack on 20 and 40. 5AKP has hard luck as the cook dropped a stove eye lifter into his transmitter and busted two glass towel bars that supported his inductances, but thank goodness, she missed the two wee 7 1/2 watters. 5PJ is going strong and promises to be a real traffic handler soon. 5ARB had better watch his step or the SCM will have to jar him loose from his ORS certificate. How about reporting regularly?

Traffic: 5AKP 39, 5AGS 22, 5QQ 28, 5ANP 54, 5FQ 12, 5API 24, 5AQU 25, 5PJ 9.

HUDSON DIVISION

NEW YORK CITY & LONG ISLAND—SCM, F. H. Mardon, 2CWR—Bronx: 2APV and 2CYX will soon be on with tuned plate tuned grid. 2BUK delivers all messages he gets. 2ALL, 2ALW, 2ARD and 2AWU have been quite active.

Brooklyn: 2APD and 2AVR have been doing some DX. 2BRB, 2PF and 2WC still going strong on crystal control. 2BO handles a bunch of South African traffic. 2CCD is the portable call of 2APB. 2ADZ is a new station and is hot after traffic. 2AMI plans to add a 20 and 80 meter outfit to his present 40 one.

Richmond: 2AYH is back again and QRV for Interborough traffic. 2AKR has been QRW school but is on 20 every Sunday.

Long Island: 2AJE has been working DX on 20. 2AGU was off for a while with generator trouble. 2AVB working a number of schedules. 2AV, 2AIZ, 2BSL and 2CLG have been QRW outside activities. 2AYJ works plenty of foreigners. 2AUE and 2AWQ have been on most of the time. 2AWX and 2CSX handled quite a bit of traffic.

Manhattan: 2EV is working DX and is NCS of the Manhattan A-A Net. 2ANX and 2BCB have been QRW so their operation was irregular. 2ALP handled 2ALS has a new UX852 and says it's FB.

Traffic: Manhattan: 2ANX 43, 2ALS 23, 2EV 24, 2ALP 53, 2BCB 41. Bronx: 2ALW 4, 2ALL 8, 2BRB 59, 2CYX 159, 2AWU 17. Brooklyn: 2APD 167, 2BRB 5, 2PF 22, 2BO 64, 2AVR 20, 2WC 11, 2APB 16, 2ADZ 6, 2AMI 8. Richmond: 2AKR 2, 2AYH 4. Long Island: 2AUE 4, 2AGU 44, 2AV 4, 2CSX 139, 2AJE 2, 2BSL 2, 2AYJ 24, 2AWQ 6, 2AWX 33, 2AVB 40, 2CLG 5, 2AIZ 2.

NORTHERN NEW JERSEY—SCM, A. G. Wester, 2WR—All ORS certificates have been issued and those who did not receive any know theirs are cancelled because of failure to report. We welcome 2AVK, 2QI and 2ADL as new ORS which makes 30 ORS in this section. 2ALW has moved to New York and will continue as an ORS in that Section. Any station in this Section that can handle the duties of R-M is requested to write the SCM. 2AT has been off due to a business trip. 2CW reports that the amateurs on Montclair are forming a radio club. 2FG is experimenting with outdoor Hertz antennas. 2MB has a good signal on 80 with 4 UX210s. The Bloomfield Radio Club had a ham get-together for the purpose of acquainting hams with one another which was a fine success, under the leadership of 2EY. 2FC still maintains his Tues. schedules with eg-5UW. 2KA is on 80 meters. 2KS is having trouble getting started. 2ALM was QSO Australia this month with a 7 1/2 watt. 2ARC is having luck with European QSO's. 2BLM is going down to 20 meters. 2BQQ is in the rebuilding stage. 2CGK lost his 2ND fifty wattter this season and his an-

tenna in the gale. 2CPD having trouble getting his Xtal set perking. 2OQZ is building a 40 meter master oscillator with a 250 watt. 2CTQ is QSO all European countries on 20. 2OYV handled some long traffic messages from the American Legion at Ala. thru 4JR. 2BAL, 2ASZ, 2CJD, 2ATV and 2AQE have made application for ORS. 2AMB is able to work on any of the amateur bands with from 5 to 250 watts. 2AUX is building a 250 watt master oscillator for 40 and 80 meters. 2BR is back on the air again after replacing a blown 50 watt. 2CDR is QRW working for a N. Y. BCL paper.

Traffic: 2AT 50, 2CW 19, 2EY 2, 2JC 1, 2FC 1, 2KA 2, 2KS 4, 2ALM 35, 2ANB 5, 2ARC 3, 2CPD 6, 2CQZ 14, 2CTQ 35, 2CYV 2, 2ADL 2, 2BAL 3, 2AVK 20, 2QI 6, 2CJD 31, 2IS 31, 2ASZ 36.

MIDWEST DIVISION

NEBRASKA, SCM. C. B. Diehl, 9BYG—9AL reports good traffic and three schedules. 9CJT has good traffic on 20 meters. 9CWN turns in excellent total for the first time. 9EEN let up a bit for a change. 9AWS is busy with Army work. 9DFR is trying out 20 meter schedules. 9BYG is still tinkering. 9EHW is not on much on account of business. 9ASD is hitting the Army work hard. 9DI rolls up a fine total with schedules. 9BOQ has his farm to take care and cannot give radio much time now. 9DAC is busy at school. 9DUH has gone back to 80. 9BBS knocked em dead this time. 9QR is still at it. 9EBL has been moving and has been sick in bed, but is at it again.

Route Manager's Report: Several requests are on file for schedules, but none to take them; otherwise things moving along in satisfactory manner, not much activities in this branch only usual routines.

Badgerow is sure after his Army net and will give an account of himself in short order. Henry has canned the YL and back to radio and reports a great deal more satisfaction with the results. Crozier has a BCL business and is kept pretty busy telling them why they can't hear Hong-Kong with a crystal. Williams has his Army work well in hand now. Bamer holds QSO with his father in Philippines via ham radio. Magnuson is putting in his corps now and is QRX for a short while. Miller is having his Exams now and had to let up for a short time. Jones works on 80 mostly but goes to 40 at times. Larimore is sure hitting the breeze these days and his totals prove it. Chesley is resting for a short while after a rush in the P. O. Slim Cumming has been sick in bed but expects to be with us soon.

Traffic: 9AI 34, 9CJT 6, 9CWN 20, 9EEW 12, 9AWS 6, 9DFR 21, 9BYG 1, 9EHW 0, 9ASD 40, 9DI 73, 9DAC 11; 9DUH 29, 9BBS 110, 9BQR 0, 9CBL 11, 9ANZ 14.

KANSAS, SCM. F. S. McKeever, 9DNG—Everyone in Kansas seems to be either QRW or off the air because of blown down aerial, or burnt out tube. 9BHR has requested to hand his ORS cancelled because of QRW. We are certainly sorry to lose him. 9CET worked England, France, Italy and Uruguay on 18 meters. FB. He handled good traffic, too. 9CV and 9AEK were on less than usual. 9AEK reports a string of DX, but little traffic. 9CKU lost his aerial so dropped down in traffic, but ought to be on again very soon. There are two new hams in Lawrence who are getting under way and will be going soon. 9LN and 9CLR have new rectifiers and are stepping right out. 9EHT and 9DNG are busy with 5 meter work. 9EHT is both sending and listening on that wave, while 9DNG is spreading the dope to foreign countries on 40. 9CET and 9DNG will attend the Ames Convention together in April.

Traffic: 9HL 43, 9LN 10, 9CLR 3, 9DNG 43, 9DSR 1, 9COR 10, 9CKU 14, 9CV 8, 9AEK 1, 9CET 34, 9DEP 4.

IOWA—SCM. A. W. Kruse, 9BKR—9BWN is the star traffic man this month and his high total is due to RELIABLE schedules. 9BKV has a raft of fine schedules. A new transmitter using Aero coils is perking FB at 9DEA. 9DGW now has a schedule with 9DAE four nights a week at 10 PM. 9EJQ got a job and had to discontinue his schedules. The pole at 9CGY took a tumble during the recent ice storm. 9DRA reports that ham radio is picking up in Linn County. Not much doing at 9DAU and 9EFS this month. The plate transformer at 9DVG blew up, but they borrowed one and the old set is perking as usual. 9DWV has a new M. G. 9CS plugs away on 41 meters. 9DSL still complains of school QRM. 9AMG is using a UX-210 on 40.

Traffic: 9BWN 273, 9BKV 227, 9CZC 198, 9DEA 101, 9DGW 95, 9EJQ 62, 9CGY 51, 9DRA 55, 9DAU 45, 9EFS 19, 9DVG 16, 9DWV 14, 9CS 10, 9DSL 6, 9AMG 4, 9DLR 63.

MISSOURI—SCM. L. B. Laizure, 9RR—9DOE led the traffic handlers in St. Louis continuing his noon sked with 9EK. 9SO is a new Naval Reserve station. QRA, Albert Konefsky Radioman 1st class, USNRF, Foot of Ferry St., St. Louis. 9BEQ worked fm-SST. 8DLB was not on much. 9DUD reports mostly DX and no traffic. 9BHI kept a sked with 4AV at 1 am for traffic. 9BAO is a new station heard on the air often handling traffic. Report has it that the Director of the Midwest Division is now hailing from St. Louis but we have not yet heard the new address.

9BQS reports no traffic on account of school. 9DKG kept skeds with 9BR. 9NW, 9CYC and 9HY applied for ORS. 9BWR-9AJW-9UI sent to a mail order house for a tube and it never came—and then when the Kansas City hams tried to send one thru the mail, it arrived broken. 9DIX is still visiting in Chicago. 9DVF was QRMed in rebuilding the set by business QRM. 9CDF umped again and is back in Butler and will be heard from 9ARA when occasion permits. 9DMT kept skeds with 9EAN and 9BHR. 9CYC dropped to 20 and says his traffic quit and DX started. 9CXU says he couldn't get the set to perk. 9ARA took a message for 1MK from KNT. 9BUE kept A.M. skeds with 5ES and 5ACE. 9LJ is back after a long absence and is set up for 40 and 80 meters. 9BSE resigned his ORS appointment on account of rotten QSR by stations to whom he gave traffic. 9DAE hit the BPL again in spite of QRM. 9RR dropped some skeds on account of QRM but handled some traffic. 9ACA moved to a better radio location and will be on again as soon as possible. 9BWN writes for skeds on 40 or 80 with Mo. stations as his Mo. traffic now goes by mail. 9CEY of Whiting, Ind. also requests schedules. 9ZD reports DX fine on small set.

Traffic: 9DKG 7, 9CDF 20, 9DMT 6, 9CYC 3, 9CXU 2, 9RUE 9, 9ARA 22, 9BSE 8, 9DAE 118, 9DOE 107, 9BEQ 46, 9DLB 4, 9BHI 29, 9ZD 1, 9RR 118.

NEW ENGLAND DIVISION

EASTERN MASSACHUSETTS—SCM. R. S. Briggs, 1BVL—A large portion of the gang is down on 20 meters. Many of them are beginning to realize what real use can be made of all the bands and are rebuilding their transmitters so that they may shift from one band to another easily. This practice should facilitate traffic handling. 1AXA is QSO Australia Saturday and Sunday afternoons. 1YC had schedules with 2CXL. 1ON gave up his Xtal control and handled quite a bit of foreign traffic. 1BVL has temporarily given up his 50 watt Xtal set and is on 20 meters most of the time with a UX210. 1SL has been QRW with Army-Amateur work. It seems that 1RR is always having tough luck with his Xtal outfit. School QRM is keeping 1RF and 1AWB silent. 1BKV, 1ABA, 1UE, 1ACA, 1BVL, 1ALP, 1ADM, 1BYV, 1ADL and 1BMS are on 20 meters. 1KY says she kept quite a few schedules but traffic was scarce. 1BZQ gets out in fine shape on 78 meters and worked 6ABM and 7ACP. 1AYX says he has not acquired an OW as some think. Every month, 1LM says he is "just rolling along". When do you expect to get there, OM? Hi! He was one of the few to make the BPL. 1OG is trying for an ORS. 1BDV is a new Army-Amateur Station and expects to be on the air more this summer. 1ADM reports DX very good on both 40 and 20 meters. 1NK was reported R8 in England. He has BCL trouble when on 80 meters. 1ACA finds 20 meters great and worked five districts the first day he went down there. 1NQ handled an important message concerning the fire-meter tests. 1ABA says that 20 meters is becoming the best band for foreign QSO. 1UE is on 20, 40 and 80 meters. He handled a message from 1UN at Pinkham Notch, N. H., to Jackson, N. H., when party was snowed in and averted a search party. Three cheers for 1UE and 1UN!

1BKV finds the 20 meter band the berries. As soon as possible, 1XM will get a distinctive note. Plans are being made to install a three-phase rectifier to feed the 250 watt. 1ORA again leads this month with 212 messages. 1GP is planning an Xtal controlled transmitter. 1BYV was very active on 20

meters. 1ACH has been stepping out and has five continents worked to his credit. 1APK has been appointed Asst. Monitor station for Greater Boston in the new Army Network. 1AGS lights up the lights in his house when he sends on the lower part of the 40 meter band. 1AHV is still battling out with crystal-control.

Don't forget gang, 1UE the Route Manager, is the one to write for information on traffic schedules.

Traffic: 1CRA 212, 1LM 102, 1ACH 58, 1UE 72, 1ACA 49, 1BZQ 47, 1KY 44, 1NK 42, 1AHV 42, 1ADL 37, 1AYX 34, 1XM 34, 1AGS 33, 1YC 32, 1ADM 32, 1SL 24, 1BVI 17, 1ABA 16, 1GP 16, 1ON 15, 1APK 15, 1NQ 13, 1BYV 11, 1BKV 10, 1AXA 7, 1RR 4, 1OG 4, 1BDV 3, 1OU 2, 1RF 1, 1AWB 1.

RHODE ISLAND—SCM, D. B. Fancher, 1BVB—Things have taken an awful slump in this state this month. Only one or two stations handled any traffic to amount to anything. Come on fellows! What's the trouble? One ORS was cancelled this month and another put on the inactive list. If things keep on there won't be any need of an SCM in this Section. G. M. Mathewson, 1BQD, has been appointed Route Manager for this state. Cooperate with him, fellows, and we can show them that things are not as dead as they seem. He is getting out a circular letter to all of the ORS and then things should start to hum.

Providence & Pawtucket: 1AMU advertised for messages and got quite a bunch of them. 1AID is rebuilding her transmitter to the tuned plate tuned grid circuit.

Westerly: 1BVB has a schedule with 1AAC and quite a bunch of traffic has been moved. 1AAP has sold his complete station to a new ham in Jewett City, Conn., and will be off the air for a while.

Newport: 1BQD, our new RM, has been busy moving to a new QRA and at this writing, is getting things whipped into shape for some good routes and schedules.

Traffic: 1BVB 56, 1AMU 38, 1AID 14, 1BQD 14, 1AEI 9, 1AWE 4, 1AAP 4, 1MO 2, 1EI 2.

MAINE—SCM, Fred Best, 1BIG—The Maine Section had four members in the BPL this month. FB, OMS, Let's get back our average of eight and if possible let every ORS who reports become a member of the BPL. I maintain that if a ham has time for traffic at all, he can make the BPL without extra effort, and let's prove this to our own satisfaction, gang!

Two RMs have been appointed—1FP has accepted the appointment for the east and 1COM for the west. 1BFZ made 1BIG take his dust this month and as a result leads the Maine Section. 1BIG has a new rectifier and a pure DC note. 1AUR, a real old timer, stepped on it this month and made the BPL. 1COM, our RM for western Maine, gained the BPL this month. 1HB used his Vibroplex to advantage and handled a nice total. 1BNL has bought a new Ford but managed to be on enough to handle an impressive total, just the same. 1APF is now on the air and promises to show some of the Maine ORS how traffic should be handled. 1FP is getting things lined up in eastern Maine. 1AQI was absent from Brewer nearly the whole month, in connection with his work. 1AIT is back with us using a 201A. He can give any of the Maine gang a run for their money when he has a set going and we look for one of his old time reports next month. 1CFO handled a few in spite of the fact that he has been down on 20 nearly the entire month. 1ADI sent in his usual meagre report. What's the trouble, Harry?

Traffic: 1BFZ 161, 1BIG 125, 1AUR 105, 1COM 101, 1HB 68, 1BNL 65, 1APF 25, 1FP 7, 1AQI 4, 1AIT 4, 1CFO 3, 1ADI 2.

NEW HAMPSHIRE—SCM, V. W. Hodge, 1ATJ—A number of new stations sent in reports this month. We have plenty of material for ORS. 1JN applied for ORS. 1YB had two big tubes go bad but are on with $\frac{1}{4}$ kw and would like reports on their sigs. 1AER sent in a good total. 1ASR had trouble with their MG. 1IP handled a bunch of traffic and is working 5 skeds. 1AOQ reports traffic dead on 40. Plenty on 80, OM. 1OC has been appointed O-O so watch your waves, gang. Hi! He worked the USS Tampa. Two new stations in Manchester, 1HK and 1MS, sent in good reports. 1IP and 1YB handled important traffic for the Dartmouth Outing Club. 1AEF reported by radio. A few stations failed to report, probably caused by "spring fever". Hi!

Traffic: 1OC 349, 1IP 212, 1ATJ 155, 1AEF 185, 1YB 111, 1AOQ 98, 1AER 92, 1HK 51, 1JN 50, 1ASR 23, 1MS 6.

VERMONT—SCM, C. T. Kerr, 1AJG—Wow, fellows, will you look at the traffic totals rolled up by 6

active stations. Read them and realize what our new RMs are doing. The star goes to 1IT the GRM who almost made the SCM weep with joy when his report came in. The new RMs appointed are 1FN, 1AC, 1BIQ, 1BBJ, 1BJP, 1BEB is on 80 for traffic. 1BJP is keeping a regular line of schedules shoot him traffic for northern Vt. and Canada. 1BBJ has three separate stations operating on 20, 40 and 80 meters. 1IT's supervision of the whole traffic system of the State is sure putting a pile of work out. 1ATZ reports more tough luck as his tubes blow out too often. 1FN hitting out FB as usual. 1BDX has arrived. He blew his 50 but has got a new one coming. 1AC on the air but changing back to 80 meters for traffic. 1AJG on regular schedule.

Traffic: 1IT 106, 1BBJ 46, 1BJP 51, 1BEB 6, 1ATZ 8, 1AJG 61.

WESTERN MASSACHUSETTS—SCM, A. H. Carr, 1DB—1AAC kept two schedules and says there is plenty of DX. 1AAL, our RM, has been appointed Monitor Station for the Army. 1AJM is still on the 20 band and reports working many foreigners. 1AMZ is still busy at college but will be on the air during the Easter vacation. 1APL reached the BPL again and kept quite a few schedules. 1AWW kept up some good schedule work and handled some Army traffic. 1EO is looking for some more schedules and has been busy with messages for the past month. 1JV reports working a lot of DX and we hear him on quite a bit. 1VC is on 20 meters and has been QSO a bunch of Europeans. 1XZ has but one licensed operator and has not been operating much.

Traffic: 1AAC 47, 1AAL 85, 1AJK 18, 1AJM 2, 1AKZ 4, 1APL 149, 1AQM 13, 1AWW 27, 1BV 61, 1BKQ 46, 1DR 5, 1EO 31, 1JV 21, 1VC 21, 1AZD 34, 1AUO 6, 1AGA 22.

CONNECTICUT—SCM, H. E. Nichols, 1BM—At this writing, our annual New England Div. Convention is the topic of interest and we are looking forward to having a real enjoyable gathering and renewal of friendships through our meeting with each other. Your SCM will have the thrill of a lifetime and feels that many others will have the same. It is particularly noticeable how many new amateurs are in the making and probably at no time since the end of the war has there been such evidences of new activity. Let's encourage them in every way possible, fellows. 1MK with its corps of reliable ops leads our state in traffic total this month which certainly shows that schedules make fine totals. 1CJX is handling considerable traffic on schedule and helps to keep our southern outlet in active shape. 1EL reports working Chile direct and had the pleasure of handling some traffic for Headquarters from there. 1ZL and 1MY have given their transmitters new locations. 1ZL chose the back porch and 1MY goes back to the "ole cornfield". 1ATG reports working 4-BM who said his input was only $\frac{1}{4}$ kwatts which is sure some DX for the power. 1BHM reports schedule activity for this Section and has quite a few lined up so that there is no delay in getting traffic through his city. 1BJK and 1BM have schedules and dependable QSO has been maintained for over a month.

There are quite a few prospective ORS who are reporting each month and your SCM surely appreciates their interest and will attend to their appointment as quickly as possible. Your reports are the best evidence of fitness for an appointment and is used as a guide in many cases. 1OS, our new YL op at Danbury, reports handling quite a little traffic as well as saying that she has a possible prospect of another YL operator who is a friend.

Traffic: 1MK 337, 1CJX 161, 1BEZ 66, 1BHM 51, 1CTI 38, 1BMG 33, 1HJ 32, 1ADW 25, 1TD 22, 1BM 19, 1MY 15, 1ATG 14, 1BGC 11, 1BQH 10, 1AVX 8, 1AOX 7, 1ZL 4, 1BLF 6, 1FD 2.

NORTHWESTERN DIVISION

IDAHO—SCM, H. H. Fletcher, 7ST—7JF led the whole state in traffic and DX. TYA received basketball results from the state tournament, via 7JF. 7ABB has been on 20 meters some. 7ZN still perks on 20, 40 and 80. 7QC is on 40-80 but is busy. 7GW, the new O-O, has lots of fivers now. 7ACN is on 40 but expects to go up to 80. 7KJ is using 201-As. 7CW has a 210 in TG-TP circuit. 7ACK moved his set into the other room and is getting better results. 7HK has a couple of 20's and is on 40 and 80. 7CJ is perking with a 201-A. 7QA has a portable on 40 and 80.

Traffic: 7JF 185, 7YA 65, 7ABB 30, 7ZN 16, 7QC 12, 7GW 8, 7ACN 8, 7KJ 7, 7CW 3, 7ACK 2, 7HK 1.

WASHINGTON—SCM, Otto Johnson, 7FD—7LZ takes traffic honors this month. 7UO also makes the BPL this month. 7MP, 7ACB, 7VI and 7DF are keeping the hook cleared. 7EK is reported to have worked France and England but is too modest to report it himself. 7ACA is doing well with a 201-A. 7EH is working for an ORS ticket. 7TX has dropped to 20 meters. 7ED is QRW. (Married men always are!) 7NO, 7SJ, 7BM and 7TK keep the Grays Harbor Section on the air. 7RY and 7IZ are pepping up the Walla Walla-Attalia district. The Spokane bunch are busy at the convention, which will probably be held around Labor Day. 7TJ and 7TZ are in mourning for departed 50s but 210s are doing their bit now. 7QB and 7UH are troubled with YLs, altho 7UH's YL is a budding hammette. 7AAE threatens to show them all up (referring to traffic work, not YLs)! 7AW is working on a xtal controlled set. 7BO is still on. 7GO will be on again soon. 7AM is trying 20. The gang is requested to send in more news of other stations so we can have a fine report in QST. Be sure to send your reports on time. Many fellows kicked about the failure of one report to appear in QST, yet only THREE stations sent their reports thru on time that month and one of the three missed the next one by a week. Your SCM is doing the best he can, but for the luvvamide, help him out by reporting on time. Suggestions and criticisms may help make these reports worthwhile, so let's cooperate!

Traffic: 7LZ 157, 7UO 105, 7MP 63, 7ACB 48, 7VL 44, 7DF 43, 7ACA 26, 7EH 22, 7TX 18, 7FD 4.

MONTANA—SCM, O. W. Viers, 7AAT—7PU has been doing his usual good work and DX on a pair of UX-210A tubes. 7EL blew his trust river but kicked out good with a single UV-201. 7DD is earnestly working on an 80-meter crystal transmitter. 7FL is very busy with school work but pounds the key when he gets spare time. 7QV is getting interested in ORS work and will soon have his ticket. 7AFM had some trouble with his power transformer. 7AFP is back again after several months silence. 7CK, will soon be going with a M.G. 7AAW has his crystal set going now. 7AAT-2T raised his input from 22 watts to 80 and worked Hawaii.

Traffic: 7AAT-QT 112, 7PU 110, 7FL 86, 7DD 85, 7EL 17.

OREGON—SCM, (acting), A. C. Dixon, 7IT—Stations reporting this month were: 7AAY, 7EO, 7SY, 7ACG, 7AEK, 7PP, 7AV, 7ABM, 7ABH and 7IT. 7ACG at Lexington works a schedule with 7AAC on break-in. 7RJ at Pendleton has power QRW. 7SY handled traffic. 7AAY uses a 201A with 110 volts getting fair DX. 7AEK's new "sync" sounds like the old spark days in Portland. 7AAC has his H tube going on nicely. 7ABH worked nc, na and most US districts. 7ABM is changing from 5 to 50 watts. 7TM gets Europe R3 evenings.

Traffic: 7AEK 6, 7IT 4, 7AV 4, 7PP 5, 7SY 33, 7AAC 8, 7ABM 12, 7ABH 8, 7AAY 2.

PACIFIC DIVISION

EAST BAY SECTION—SCM, P. W. Dann, 6ZX—There are certain ORS in this Sect. who are padding their message reports sent in on Form 1. I am sorry to hear this and hope that it is not true as the SCM can check up on your message file. 6AYC is still the leader with 6CTX and 6RJ running second and third in order named. FB. The SCM will be glad to check your wavelengths as he has a good wavemeter. Chief RM MacLafferty reports all stations are cooperating 100%. He has the schedules kept by other Sections of the P.D. so if you want any information, Mac will be glad to help. 6AYC is leaving for the South Seas as Operator on KFVM, the Yacht Idalia, on May 15. He wants the gang to watch for him. 6CTX has a schedule with ac-8FM at 6 am PST daily. 6RJ says a ham with a wife and two kids has no business overloading his tubes. H11 6BHM has a 50 watter now and works Aussies, etc. 6AFT's antenna blew down so is crippled for a while. 6BRQ's 7½ watter went west. 6CLZ is also trying the Zep antenna, as well as 6RJ and 6APA. 6CTH has been ill with the Flu and unable to keep skeds. 6ZX has taken down all his junk preparatory to migrating to Alameda, San Leandro, Hayward, Berkeley, Albany or Richmond but where, don't know just yet. Hi.

Traffic: 6AYC 247, 6CTX 161, 6RJ 147, 6CCT 185, 6ALV 37, 6IM 35, 6GU 28, 6APA 22, 6BHM 20, 6BER 18, 6AFT 15, 6BRQ 12, 6AMI 10, 6CLZ 2.

ARIZONA—SCM, D. B. Lamb, 6ANO—if all ORS would report on time, you would have no trouble in getting mentioned in QST. 6BJF traded 2 storage bats for 2 pairs of boxing gloves. 9EH is the 2nd operator at this station now. 6DIB is a new station in Phoenix. 6DIE uses a 210 with RAC. 6ANO has YL QRM but got on the air quite a bit. 6CDU also has QRM from YLs and spring fever. 6CAP was sick for about 2 weeks and didn't get on much. 6CBJ has been handling messages for the local theater to the First National Pictures, Inc. 6AZM is changing to crystal control this summer. 6BJI is a power plant operator and will be changed to a new location so will be off for a while until he is settled again. 6BWS is building a 20 meter set and if results are good, he is going to put a 50 on 40 and a 210 on 20. 6DCQ worked op-XC3 on phone with very good results.

Traffic: 6CDU 17, 6CBJ 21, 6CAP 23, 6BJF 66, 6DCQ 15, 6BWS 39, 6BJI 24, 6AZM 1, 6ANO 72.

PHILIPPINE ISLANDS—SCM, M. I. Felizardo, op-1AU—This report by radio to QST from Manila, P. I. op-1AU via 6BVY. Op-1AT worked es-2NM of Helsinki, Finland, and reports working nu-6AM. op-IDL's sked with nu-6BVY was cancelled Mar. 1 but he now has skeds with 6ZV and 6BUX. Reporting new QRA op-XC3 at Fabrica Occidental Negros P. I. and says he was heard in New York and Washington, D. C. op-1HR piled up a lot of traffic again. He worked NKF, also ac-2LD and sa-AA8. op-1AU with ac-1CRS and nu-6BVY completed wedding arrangements for a lady in the U. S. who came to Manila to marry her fiance. He reports traffic from Shanghai thickening. His skeds are with ac-1CRS and nu-6BVY and es-2NM.

Traffic: 1AU 244, 1HR 211, 1DL 71, 1AT 30.

HAWAII—SCM, J. A. Lucas, 6BDL—This report to QST by radio on 20 METERS Fort Shafter, Hawaii on-6BDL via nu-6BJL and nu-8AHC (FB 20-meter work everyone—CM). 6ACG working on 20 and 40 is working all over the states day and night. 6AXW tried 20 meters and expects to do much more work in that band. 6BWV took a few days vacation. 6BDL did most of his work on 20 but managed to work India and New Hebrides on 40. Using full 250 now. 6DCU with new tube and transformer is strutting his stuff again; all he wants to make him happy is a chemical rectifier.

Traffic: 6ACG 185, 6AXW 121, 6BWV 60, 6BDL 41, 6DCU 31, 6BUC 17, 6CH 8.

SACRAMENTO VALLEY—SCM, C. F. Mason, 6CBS—Four stations reported excellent traffic work and are in line for ORS appointment. All active station-owners in the Section are cordially requested to get in touch with the SCM reporting monthly (by postal on the 26th) and boosting our Section in every possible way.

Traffic: 6CKA 39, 6FR 25, 6AVB 26, 6CDK 90, 6BYZ 42.

SANTA CLARA VALLEY SECTION—SCM, F. J. Quement, 6NX—if your station call did not appear in QST last month, it was due to lack of space. All calls are listed this month. 6BYH took the lead this month while 6AMM and 6BVY continued to handle their important traffic with the Philippines and the Orient. Route your P. I. traffic to these stations. 6CTE made the BPL again this month. 6CLP and 6BCH both lost a tube this month and their traffic suffered. RM 6BMW is hearing the French stations and hopes to QSO. 6CUL and 6BDR handled their usual amount of traffic. 6CSX continues his sked with Honolulu whereas 6DDN had a sked with WYA. 6NX used a UX-852 this month. 6DFE, new Pres. SCCARA, got on the air this month. 6AZS is QRW college. 6ACQ wants QSLs hearing his 2 watts input set. 6BTJ is on 20 meters. Many stations are using 20 meters now and traffic seems to be moving in fine style. The east coast has been worked as late as 10:30 p.m. PST.

Traffic: 6RYH 252, 6AMM 202, 6BVY 144, 6CTE 104, 6CLP 38, 6BMW 36, 6CUL 24, 6BDR 12, 6CSX 19, 6BCH 8, 6DDN 5, 6NX 5, 6DFE 5, 6AXS 4, 6ACQ 2, 6BTJ 2.

NEVADA—SCM, C. B. Newcombe, 6UO—6ABM is doing some work on 20 and is trying out the 5-meter band. 6CDZ is also working on 20 meters and conducting tests with 6ABM on 5 meters. He worked KDGL while 2100 miles southeast of San Pedro and handled a rush message for them. 6CHG spent an evening at the S. F. Radio Club while on a trip

to the coast and says the hams there are a live bunch.

Traffic: 6ABM 131, 6CDZ 113, 6CHG 50, 6UO 6. LOS ANGELES SECTION—SCM, L. E. Smith, 6BUR—By the time this report is published, the new SCM for the Los Angeles Section will be in office. Here's wishing him every success in building a stronger and better Section.

6BXJ leads this month in traffic as usual. And all the time, he rates a YL. 6BXA. 6BRUX takes second place and says "skeds are sure the berries for traffic." 6BXC also made the BPL. 6ZBJ had sickness in the family and apologizes for reporting only 119. 6CLK and 6AGD made a trip to San Diego, bringing back favorable reports. 6CT and 6DAJ are busy on 20 meters. Pasadena has organized a real radio club. All the gang are still on 80 but handle as much traffic as is done on 40. 6BXD and 6CMQ keep a good bunch of skeds. 6CCO is moving to Whittier. The SCM has been oping there lately. 6AIQ reports a good bunch of skeds. 6BVM has schedules with 6DEG at 7 a.m. daily except Sat. and Sun. We are sorry to hear that 6DAQ had the flu but he is back and going now. 6AGC complains of no traffic on 20 but he seems to have found a good bit on 40. 6RF says he wants to give 20 meters a whirl soon. 6CMT is doing good consistent work. 6CHT says there's not as much going in Hollywood as usual. Wonder how he means that. 6BHR says, "heavily engaged in school now". Hl. 6DEG finds less QRM on 80 than on 40. 6AHP finds a 7 1/2 watter almost keeps up with his 250 on 20 meters. 6BGC promises big traffic for April. 6AE is going to open up on 20 soon. 6DDO, the RM, has moved to 603 West 57th St. He has a good QRA now and hopes to get out better.

6BTM is rebuilding. 6AIO has been handling traffic for Glendale High School. 6CMY is busy keeping KFGR going in Santa Barbara, but handled his share of traffic. 6ALH is now President of the American Commercial Operators Union. Congrats. OM. 6AKW has been QSO all over the map on a very few watts. 6CSW is tickled with his new WE 50 watter. 6AHS is fighting a power leak. 6AM gets only 4 European cards in one day. 6CCI reports good traffic but no luck on 20 meters.

Traffic: 6AIO 5, 6AHS 27, 6AM 53, 6CSW 13, 6AKW 7, 6ALH 66, 6CMY 28, 6BTX 13, 6DDO 45, 6AE 32, 6BGC 7, 6AHP 28, 6DFG 29, 6BHR 6, 6CHT 38, 6CMT 29, 6RF 14, 6CCL 19, 6AGG 9, 6AJQ 32, 6CT 3, 6CMQ 33, 6BXD 37, 6AWQ 88, 6DAJ 3, 6CLK 14, 6ZBJ 119, 6BUX 142, 6BXC 123, 6BJX 197, 6BVM 48.

SAN DIEGO—SCM, G. A. Sears. 6BQ—The SCM recently visited most of the ORS in Orange County and expects to visit those he was unable to see on his last trip in the near future. The new section seems to have the support of all visited. Evidences of increased activity were noted at nearly all stations. 6AJM leads traffic this month. Cracked his crystal but is back with the old reliable. 6DAU takes second place—4 skeds does the trick. 6BXI is installing a mercury arc. 6BAM is a new ORS who hopes to make the BPL soon. 6FP is QRW hunting causes of QRM, being official R. I. for local power company. 6BYZ is a new R-M for Orange County. Give him dope on your skeds or he can help arrange new ones. 6CGC, R-M of San Diego, is trying out Zep antennas. 6SB is unable to do much on account of power leaks. 6BAS, President SGRC, is busy at NPL. 6BFE is back to Hartley after trying TP-TG. 6CTP was QSO San Diego with 18 volts B bats and a 201-A. 6AOY was a 1/2 Kw. set on 40 now. 6AKZ expects to start going soon. 6MB has helped get two hams going.

Traffic: 6AJM 156, 6DAU 115, 6BXI 69, 6BQ 63, 6BAM 46, 6FP 34, 6SJ 30, 6CGC 20, 6SB 11, 6BAS 4, 6BFE 3, 6CNK 3, 6CTP 1.

SAN FRANCISCO—SCM (acting), J. W. Patterson. 6VR—for traffic schedules on 20 meters, write 6CLS, 6CCR or 6VR. All three stations are now permanently located on this band. 6BIA has more BCL troubles—he lights up all the receiving tubes in the neighborhood whether the batteries are off or not. 6PN-x2CHK has changed his QRA again to 1075 Calif. St. 6GW has things perking at last, working everything he hears. 6CHE dropped down to 20 but says its NG. Our RM, 6EJ, has been QRW so has little time for brass pounding. 6DAW blew the works so is silent at present but expects to be on in a week. 6CIS is now at sea as operator on a freighter to Alaska. Everyone misses his familiar fist and ether buster.

Traffic: 6PW 110, 6VR 65, 6CLS 47, 6CHE 12, 6BIA 30, 6PN 10, 6CCR 14, 6EJ 20.

ROANOKE DIVISION

VIRGINIA—SCM, J. F. Wohlford, 3CA—The SCM would be very glad if every station would report promptly on the 25th of each month and designate the messages in the proper form that they may be reported.

3CEB handled PRR emergency traffic when the storm put their telegraph lines out of commission. 3UP is a new station at Norfolk. 3AHL has a 250 watter on 40 and a 50 watter on 80. 3KU is on every day and has schedules with 9PO and 4AAM-PG. 3WM increased his power from a 201A to a 210. 3II is back on the air again—had bad QRM from YLs. 3TN changes his transmitting circuit daily. 3MK reports that the dinner given Mr. Herbert at Norfolk Feb. 1st created new interest, 32 hams being present. 3MK has installed a new antenna working fundamental on 40 meters. 3CKK reports handling a message from 4LP for Norfolk and delivered same and answer back at 4LP in less than ten minutes. 3GX has worked lots of foreign DX. Claims QRM from school work. YLs and plenty of 'em. 3AEV works consistently and does some DX. 3BMN is on the air again testing 3SA's transmitter. 3RX reports no traffic on account of bad QRM. 3BGS has much QRM from young chickens—the feathered kind. Hl! 3KG is going on the air again with B battery supply. 3NM claims QRM from exams but handled some traffic. 3CKL is working n-2PZ, oh-6BDH and 7WC on 20 meters. 3HZ is working on crystal now with low power. 3CA is waiting for crystal. 3BDZ is also talking crystal.

Traffic: 3CKK 11, 3MK 31, 3KU 81, 3JT 26, 3TN 48, 3WM 15, 3AHL 114, 3CEB 130, 3NM 17.

NORTH CAROLINA—SCM, R. S. Morris. 4JR—4MI is trying his luck on 20 meters. 4RY has been off some on account of glee club trips. 4NJ is back with us again until next winter. 4JR is doing experimental work with xmitters. 4OH has QRM from school work. 4EC is stepping out with a 210. 4ET is also beginning to raise a few on his 210.

4DB has put in a 50, 4TS is tuning up a 100 watt MO-PA set. 4PP is still off waiting for license renewal. 4TO has changed from Hartley to tuned grid and plate. 4SJ blew a plate transformer but re-wound it without delay. 4BX visited 4WE. 4VQ has applied for O.R.S. appointment. 4QK is contemplating 20 meters. 4OC has at last got his crystal going but is not satisfied yet. 4RI isn't on much.

Traffic: 4MI 89, 4SJ 54, 4DB 52, 4JR 48, 4RY 42, 4EC 30, 4VQ 30, 4OH 23, 4BX 15, 4TO 14, 4QK 7, 4NR 6.

West VIRGINIA—SCM, C. S. Hoffman, Jr., 8BSU—Although there was a slump on traffic for the month, activity in general has been exceedingly good. Several stations report going down to 20-meters and others rebuilding. 8AUL reports working Europe on the 20-meter band. 8CDV and 8CEK report PRR messages being handled by them. 8DPO and 8ADI are new Wheeling stations. 8ASE couldn't stay away any longer so opened up his station on low waves. 8WK put up an 80-foot mast. 8IT is sailing as operator aboard a ship bound for Australia. 8VZ is getting a 204-A, and promises better traffic figures. 8QH moved his station. 8DCM has schedules with 8DAU, 8AD and 8OXZ. 8AWV is getting over a sick spell. 8BBM is on at 3RX-3SR. 8BJB is also on 20-meters and in four days worked every district. 8SV is QRW work, but on at 8WK Sundays.

Traffic: 8WK 54, 8CDV 21, 8DCM 31, 8BSU 11, 8AUL 10, 8CEK 15, 8QH 8, 8BJB 8.

ROCKY MOUNTAIN DIVISION

COLORADO—SCM, C. R. Stedman, 9CAA—9CAA leads the traffic handlers this month with 9CNL and 9DKM following. He has a new stick up now and a steadier wave. 9CNL also rebuilt the first of the month and says it was well worth the trouble. 9EAM is on 40 and 80 and getting out well. 9DKM is on 20 meters. 9CJY took down an old aerial that he figured was absorbing a lot of juice and now he can't get out worth a darn. Hl. 9BXQ has been cancelled. 9DWZ is going to raise his aerial a bit. 9CAW is getting tired of the "NM JUL 73" biz and so now he goes to bed and reads bedtime stories. 9BQO is also rebuilding. 9DGJ didn't handle very much traffic but all of it was important stuff. 9DSY can't raise foreign stations but covers the U. S. in fine shape. 9DED and 9QL didn't get much traffic thru this month due to other activities. 9EEA has been out of town on League business. 9AOI is

opping at KFXE now. 9BYC is still busy experimenting but hopes to be thru soon. 9ADI says he will be 50 years old soon but enjoys his radio as much as the younger fellows. 9DUI expects to leave the state soon to go to a radio school. 9CDE has been sick but expects to be OK PDQ now.

Please try to get your reports in a little earlier, gang. Some of them hardly made this report.

Traffic: 9CAA 146, 9CNL 65, 9DKM 74, 9ADI 36, 9EAM 81, 9CJY 28, 9DWZ 25, 9CAW 21, 9BQO 18, 9DGJ 7, 9CDE 20, 9BYC 9, 9DSY 8, 9AOI 8, 9DED 1.

UTAH—WYOMING—SCM. D. C. McRae, 6RM—Activity in this Section has taken a jump this month with nearly double the usual number of reports. FB gang—let's keep growing! 7DA put through a bunch this month and has made application for an ORS. 7RX also turns in his initial report. We have needed stations in Wyoming for a long time so any information as to any other stations there will be greatly appreciated by the SCM. 6ZT breaks thru this month with a few. 6BTX still continues to be the only station on 80 meters. 6BAJ is operating on the 40 band with an H tube. 6RM was off 20 meters during the month but did some work on 40.

Traffic: 6CLQ 106, 6CVA 53, 6BTX 18, 6RM 17, 6CNX 15, 6ZT 4, 6BAJ 4, 6AIK 2, 7DA 87, 7RX 5.

SOUTHEASTERN DIVISION

FLORIDA—SCM. W. F. Grogan, 4QY—4NE is still confined to bed but is on the air. 4HZ loaned him a transmitter and 4DU a receiver. 4HY reports a good DX month but not very much traffic. 4BL is keeping a schedule with 8AKX on 20 meters FB. Most of the Fla. boys are getting down on 20 now and it should result in good traffic reports for the summer. 4IG is at last on the air and is keeping a schedule with 4NE. 4AAO and 4CJ are also on the air now. 4JZ is now using Hertz and is getting out very good. 4CK, a new ORS, sends in a good report and reports schedules with several stations. 4VS reports things going very good. 4DD is using a 210 after blowing his 50. 4LK says he will soon be on 20 and 80 meters. 4LG reports good DX on 20 but very little traffic. 8CUG is now in Fla. as 4LM and sends in a good report. Glad to have you with us. OM. 4MS, 4BR, 4QA, 4AO and 4UW are attending the Naval Aviation Radio course which will last twenty weeks. FB, OM!

Traffic: 4BL 66, 4NE 60, 4LK 39, 4QY 34, 4DD 82, 4CK 29, 4VS 22, 4LG 15, 4IG 4, 4JZ 3, 4OO 18, 4TK 3, 4OB 8, 4HY 8, 4LM 57.

ALABAMA—SCM. A. D. Trum, 5AJP—Chirp. Chirp, Spring is here and the hams in Alabama are either thinking of their YLs or spring fever is here. Anyway, we can't complain for we had a good month. Spring cleaning and remodeling is just starting.

5AV has been keeping prompt schedules with 5EK and has handled quite a bit of traffic. 5AV reports plenty of new material in the Selma Dist. but getting their support is like pulling hen's teeth. 5TP says he is a hot potatoe with a new 210 and a Hertz. 5FI is still on the veteran handling job of traffic moving and doing fine. 5ZAE-WEAP and several others on the job. 5AC is on again—we are sure glad to have you back. 5AC proposed to his YL and she told him she would consent when he invented a static eliminator. 5ADA had the pleasure of a visit by 4MN formerly 5ABT of this city. ADA handled good traffic and worked South America quite often during the month. 5AJP has been stepping out with a fifty and handled service between New York and Montgomery this month. 5JY is on consistently working most everywhere. 5AFS is often heard lately. 5NL is coming back fast and strong. WYK ops are still working on their short wave set.

Traffic: 5ADA 20, 5AJP 23, 5AV 44, 5AFS 14, 5JY 69, 5JP 8, 5FI 37, 5DF 115, 5AC 4, 5DL 22, 5AX 28, 5AKK 36, 5NL 48.

GEORGIA—SO. CAROLINA—CUBA—SCM. H. L. Reid, 4KU-4TU being a coop student at Ga. Tech., reports that he has been working this month and has no report in the way of traffic. 4AAM sends in the reports for a few of the fellows which is FB. 4PG and 4KI are on 80 meters daily from 7 p.m.

until midnight. 4AAM has been carrying on a schedule with 4NE and 4JK. 4AV is doing fine work. This station is the most consistent in Atlanta. 4OY sends in a nice report. 4KU is on the air on 38 meters. We hear old Phil Bangs from Atlanta is about to get on as soon as the Jr. op gets in tune. 4IT dropped his inductance on his 50 watter and by gently shaking the tube, the filament welded itself back.

Traffic: 4AV 108, 4OY 52, 4AAM 21, 4KU 9.

WEST GULF DIVISION

OKLAHOMA—SCM. K. M. Ehret, 5APG—5ATU has purchased a 50-watter, the set of 5GS. 5GS has quit the game. 5FS has 7½ watter phone station on 80 and 7½ watt CW on 40. 5ATA putting in a pair of big "Jugs" when he has time off from "The Amateur Transmitter".

The Cushing "gang" off the air this month with the exception of 5ANL who is still trying to get his set going good on 40 meters at night. Guess that home brewing activities have been QRMMing the bunch at Cushing.

5AAV back on the air with a MOPA set after several months of inactivity. 5APG working sum 40 meter DX and fooling around on 20. 5SW hooked up with a SR station and is getting the dx fever bad. 5QL has been appointed OBS for Oklahoma. 5AKA having good luck with the Aussies and Zeppers. 5AGN finished a good wave meter and is QRV now.

Ex-4MV was QSO the ADM and advises that he will be in line for an ORS as soon as he receives his new call. Welcome to our Gang, 4MV.

Norman stations saved our rep this month. Alpha Sigma Delta with the call 5VM got a 250 watter hooked up and handled a gang of messages during St. Pat's day at the University. 5FJ rustling some good traffic material and is lining up the gang at Alva and Fairview. 5ADX new ham at Norman going strong. 5VH QSO all districts with a 201-a. 5APC is rebuilding and 5ALT has moved to California. 5FJ is handling Traffic fast since the erection of Zeppelin antenna. 5AMO has a German 20 going and helped 5VM with the open house messages. 5VM is rapidly regaining its old prestige and has lined up skeds with 9CFN and 9AGK daily. FB! 5CE on the air occasionally.

Traffic: 5APG 17, 5AGN 6, 5AAV 2, 5AMO 217, 5FJ 284, 5ATA 24, 5VM 105, 5ZAV 31, 5AKA 3, 5SW 6, 5QL 6.

5VU is on 39.5 meters at 10 pm and 5 am daily. 5AJJ made a trip to Arizona this month. He is always qso Mexico for lfc anytime. 5ALH is not to be with the gang again until next winter. 5SX, 5AIV, 5PN, 5ABR, and 5AHX are new stations in our section. 5APO is experimenting with master oscillator circuits and herzian antenna. He wants traffic schedules with anyone. 5AVS is a new station in Fort Worth.

Traffic: 5ALH, 35; 5AJJ, 68; 5VU, 51; 5RG, 16; 5SP, 22; 5ACL, 20; 5AKN, 14; 5APO, 102.

Traffic Summary: Originated, 38; Delivered, 32; Relayed, 258; GRAND TOTAL, 323 msgs.

SOUTHERN TEXAS—SCM. E. A. Sahn, 5YK—Section has done excellent work this month. Our RM has gotten busy and lined up traffic schedules. From all indications, there is a very promising summer ahead. The Bexar County Radio Assn. have already planned their annual banquet and have a very promising program.

5AHP sent in his report by Western Union so as to get it in time. 5PK advises that he is now permanently located at his home in Brownsville. 5EW has installed remote control. 3RR burned out his 50, paralyzed his five but handled three messages with a 201A. 5ALA says he must renew his operator's license before he gets back on. He reports a new ham 5AAF in Mirando. 5MU is a new station applying for an ORS. 5WP says his brother has turned the shack into a machine shop and that they will have to do some readjusting to take care of both it and the radio set. 5ABQ has been on the job pretty well this month.

Traffic: 5ABQ, 10, 5RR 3, 5EW 2, 5PK 1, 5AHP 12.

CANADA

MARITIME DIVISION

NEW BRUNSWICK—SCM, T. L. Lacey, 1E1—We seem to be having excellent DX and good reception tho there has been considerable difficulty experienced on account of heavy QRN in this Section. More schedules are being arranged and traffic is moving with minimum delay. Some stations are using the 20 band and report it very fine for mid-afternoon QSO with Europeans. N.B. stations may be found on wavelengths of 42 to 42.5 any day between 12 noon and 2 pm for traffic.

1AK has worked his tenth British station for this month—also Belgium and Sweden. 1AM reports working of 8YOR and British stations on 20 meters. 1AQ is too busy at school to be on much. 1AX has been QSO a number of foreigners. 1AD is rebuilding his station but is on intermittently. 1EI has been on very little this month but is thinking of dropping down to 20. 1AD, 1AQ and 1AX now hold ORS certificates.

Traffic: 1AD 22, 1AK 62, 1AM 5, 1AX 13.

PRINCE EDWARD ISLAND—SCM, F. W. Hyndman, 1BZ—1CO worked eh-4CM at 7 pm on 40 meters. 1BD is again on the air. 1AP is on 20 meters. The SCM will appoint some new ORS this month.

Traffic: 1CO 8.

NOVA SCOTIA—SCM, W. C. Borrett, 1DD—1BR and 1BT have gotten on the air this month. 1BT is an old timer and should make a good addition to the NS gang. Other Cape Breton stations working are 1DA, 1DM and 1CX. 1AE and 1AC are other active NS hams. 1AC will soon have the biggest station in the Maritimes. Reports are coming in as they should from the gang and unless some interest is shown by the gang in general, the Nova Scotia Section of the Maritime Division will have to look for a new SCM. Please report each month, even if you have to state ND at your station. The Maritime Convention will not be held until some time during the summer when the NB gang can use their cars to attend. The award for the Murphy Cup has been decided and the winner will be announced next month.

QUEBEC DIVISION

QUEBEC—SCM, Alex Reid, 2BE—The ham spirit is very much alive if the enthusiasm shown by the boys at the last two hamfests is any indication. There was a good turnout at 2AX's station Feb. 27th and at 2AD's Mar. 19. 8RG has been in the city for the past two weeks and with 2CG visited many of the local ham stations. 2DN reports that he has a portable set working at the store and is surprised at the results he is getting in daylight. 2AV is looking for old batteries—wants more plate current. 2DN reports a new station will soon be on in his division. 2CG, 2FO and 2AX are trying out Zep antennas, and are getting fine results. 2BV and 2AL have been very active. 2HV is using UX-216 tubes for rectifying. 2HG entertained some of the South Shore gang to a Red Ink party. 2AD and 2EV will be on with crystal control shortly. 2HT is rebuilding for 40 meters. 2BM has a new antenna which gives much better results. 2BB reports splendid results, especially daylight traffic.

Traffic: 2DN 5, 2AV 7, 2AL 19, 2BV 15, 2BB 8, 2BM 4, 2BE 9, 2BG 11, 2CU 8.

ONTARIO DIVISION

ONTARIO—SCM, W. Y. Sloan, 9RJ—Probably the most outstanding achievement during the month was the first 20 meter contact from Canada to New Zealand which was pulled off by the old reliable, 3FC. Congrats, Ernie! It is also encouraging to note the increasing attendance on 52.5 meters, Wednesday nights.

Southern Dist.: 3FU has done some nice receiving work with a small portable set. 3CS is having trouble with the BCLs since putting the big bottle on the air. 3CB, with the help of 9AL, is doing fine work in revising the callbook and bringing the Canadian lists up-to-date. 3LW, 3CA, 3CN and 3CM are carrying out some 5 meter experiments. 3UD has moved his QRA again. 3IA and some more of the gang are rebuilding for the May tests. 3BB is another new station.

Eastern Dist.: 3DO and 3JL are heard banging away steadily and handling lots of traffic. 3BN is returning to the air after an absence of several months.

Central Dist.: The Toronto stations have been on the air regularly during the last month. 3BL has been on the air regularly. 3AZ has kept a couple of regular schedules. 3BR keeps weekly schedules on 40 and 52.5 meters. 3EL has rebuilt his transmitter and is getting out very well. 3EL lent a hand to 3CY, a new station now on the air. 3CJ is another new station. 9BJ worked ef-8YOR. 9AL is still wrestling with crystal controlled sets and circuits. 3FC has been steady on the job and has managed to save his reputation by working 3 New Zealanders. 3CK is back on the air again on 20 meters. 3JM has a 250 and 50 watter working together. 3CR is regularly on on 40 meters. 3CC is getting out very well with a 201A. 3AI is trying a KFUH transmitter on 40 and 80 meters. 3CT is getting much better reports with a new 210. 3BZ has been keeping schedules. 3DC has the first crystal-controlled set on the air in Hamilton on 80 meters. 3PG is now on 40 meters and 300 volts H batteries. 3HR has improved everything by putting glass insulators in his antenna. 3DW is coming back on the air soon after several years' silence. 3BT has worked lots of real DX with his new 50. 3BT has been awarded the Central Ontario Merit Shield in recognition of his energetic work in organization.

Northern Dist.: 3HP has been spasmodically active on 20 and 40. 3NI says traffic has jumped this month because of closely kept schedules on 20 meters.

Traffic: 3NI 48, 3FC 25, 3CC 26, 3JL 25, 3HP 24, 3CS 23, 3BL 21, 3CJ 18, 3BT 17, 9AL 16, 3FU 16, 9BJ 14, 3BZ 7, 3AZ 6, 9BZ 6, 3CR 5, 3EL 4, 3BR 3, 3CT 2.

VALNTA DIVISION

BRITISH COLUMBIA—SCM, E. S. Brooks, 5BJ—5GT, 5BM, 5CR and 5AS's ORS certificates are cancelled for failure to report. 5AJ is the star station again—reports working oz-3AI on schedule and never missed a night. 5CT is using a ground now and wants schedules for traffic. 5AV blew his 5 watter and is now off the air. Hi. 5BN is keeping schedule with oh-6BWV. The B. C. Amateur Radio Assn. will have a set going soon using the call nc-5HB temporarily. 5AM has moved to Victoria.

Traffic: 5AJ 60, 5AV 25, 5BN 23.

ALBERTA—SCM, A. H. Asmussen, 4GT—Spring is here with several new stations and ORS. 4AF has taken second place in traffic totals—he is QSO the continent in daylight. 4AH tests with all the new hams showing the A.R.R.L. spirit. 4AL worked ARDI but forgot to report. 4BN is now in Calgary with a good QSB on 40. 4BZ is holding up the south half of the Province. 4CL has broken the ice for the Igloo Hut gang by working Australia. 4CU tops the message list FB for a new ham. 4DA is open for traffic this way. 4DG is now an ORS. 4DQ is back on shift but the OW works all the DX. 4GF has a real xmitter and wants to QSO the gang. 4GL and 4JJ are beginning to step out FB. 4GT works mostly Sunday afternoons. 4HM is a dependable station to handle traffic. 4IG, an old timer, is rejuvenated at Retlaw. 4IO is doing his stuff on 20 and wants more local company there. 4AU is now building up. 4AX is still in cold storage. 4EB does his stuff but forgets the report card.

Traffic: 4AF 14, 4AH 8, 4CU 28, 4DG 2, 4DQ 3, 4GT 3.

PRAIRIE DIVISION

SASKATCHEWAN—SCM, W. J. Pickering, 4FC—Will the Saskatchewan gang please let the SCM have their reports not later than the 20th of each month. 4AQ and 4FA are still getting out fine. 4AA is inactive at present. 4HZ expects to be on the air soon. 4FC is back on the air on 40-52.5 and 80 meters. 4CP has a 50 watter now. 4CB complains of backwash on 52.5 meters from Toronto stations.

Traffic: 4AQ 17, 4FA 5.

