

QST

DEVOTED ENTIRELY TO
**AMATEUR
RADIO**

*The One Control
Superheterodyne!* *in this
issue*



*Complete constructional details of the most important
Superheterodyne development of recent years*

NOVEMBER
1924

20¢



The Whistle! *The Kick-Off!*

Z-o-o-m-i-n-g High, the ball arcs down the field and drops into eager arms. Around the runner interference rallies. One tackler misses. . . . Another nails him . . . The big game is under way . . . Next to watching from a stadium seat, the direct radio story gives the utmost in thrill, excitement and satisfaction Why experiment when Cunningham Tubes are the certain answer to clear Radio reception?

Quality plus Service
Since 1915

PATENT NOTICE —
Cunningham Tubes are
covered by patents dated
2-18-08, 3-18-12, 12-20-
13, 10-23-17 and others
issued and pending. Li-
censed for amateur, ex-
perimental and entertain-
ment use in radio com-
munication. Any other
use will be an infringe-
ment.

Cunningham 40-page Da-
ta Book fully explaining
care and operation of
Radio Tubes now avail-
able by sending the in-
Stamps to San Francisco
office.

PRICES THE SAME ON ALL FIVE TYPES
C 301 A
C 300
C 299
C 11
C 12

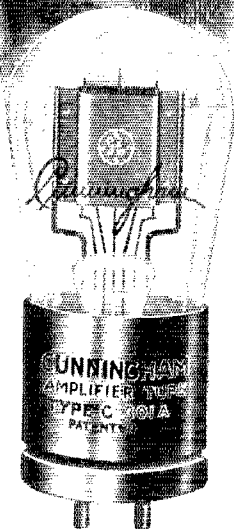

Cunningham **RADIO TUBES**

E. J. Cunningham Inc.

Branch
CHICAGO

Home Office:
182 Second Street, SAN FRANCISCO

Branch
NEW YORK

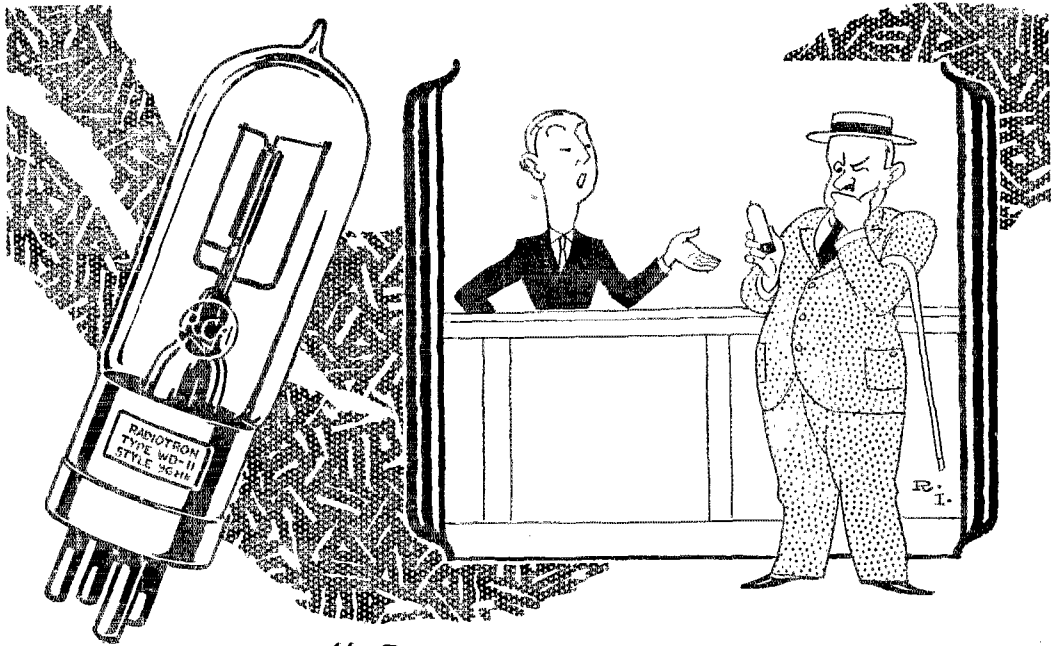

"Are those Tubes Genuine?"

The question is heard at every radio counter: "Is it a genuine Radiotron?" Almost every dependable manufacturer uses genuine Radiotrons in his sets. Everyone who builds his own knows enough about radio to know that nothing else but the genuine will do. And the man who replaces used-up tubes in his set knows that to get the same performance, he must have the same tubes—genuine Radiotrons only. So everybody asks "Is it genuine?" And asks to see the marks that prove it—the name "Radiotron" and the "RCA" mark.

All Radiotrons Now
Reduced to \$4.00

It isn't a genuine WD-11 unless it's a Radiotron.

It isn't a genuine WD-12 unless it's a Radiotron.

It isn't a genuine UV-199 unless it's a Radiotron.

It isn't a genuine UV-200 unless it's a Radiotron.

It isn't a genuine UV-201-a unless it's a Radiotron.



This symbol of
quality is your
protection

Radio Corporation of America

SALES OFFICE, SUITE NO. 2911

233 Broadway, New York 10 So. La Salle St., Chicago, Ill. 433 California St., San Francisco, Cal.

Radiotrons

REG. U. S. PAT. OFF.

ALWAYS MENTION Q S T WHEN WRITING TO ADVERTISERS

Which one is your tuning circuit?

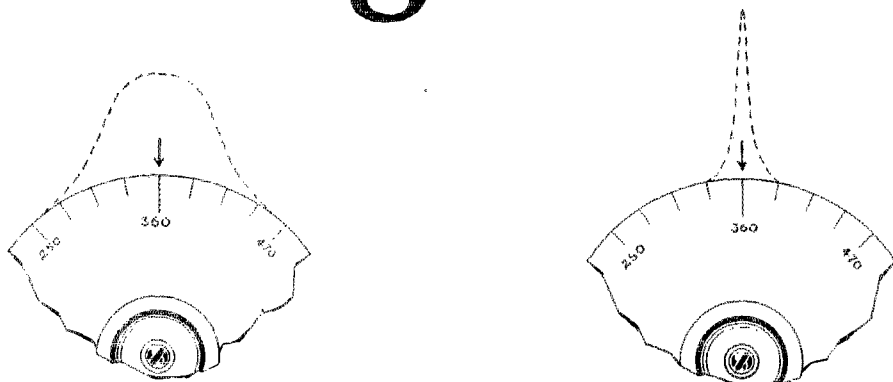

The hump or the peak?

HERE are the curves of two tuning circuits. The hump has a high loss condenser and the peak a low loss condenser. Both receive broadcasting, but the peak receives local and distant stations without interference, while the hump receives only the nearby stations with interference. The New Acme Condenser will change your tuning circuit from a hump to a peak.

The Acme Engineers have been working for two years to bring out a condenser which would give to radio experimenters sharp tuning and minimum losses. The

new Acme Condenser has these fundamental advantages and also has many new improvements in structure and equipment.

Write to us for booklet, "Amplification without Distortion," which contains many diagrams and helpful hints on how to build and get the most out of a set. Enclose 10 cents in stamps. If you have any difficulty in getting Acme Transmitting Apparatus, write either to the Acme Apparatus Company, New York Office, 1270 Broadway, or to the factory, Cambridge, Mass., and you will be taken care of promptly.

ACME APPARATUS COMPANY.

Transformer and Radio Engineers and Manufacturers

Dept. 32, Cambridge, Mass.

ACME ~for amplification

THE TRAFFIC DEPARTMENT, A.R.R.L.

ATLANTIC DIVISION

Manager	C. H. Stewart	St. Davids, Pa.
A.D.M. D. of C.	A. B. Goodall	Washington
A.D.M. Maryland	G. L. Deichmann, Jr.	Baltimore
A.D.M. So. N. J.	H. W. Densham	Collingswood
A.D.M. West. N. Y.	C. S. Taylor	Buffalo
A.D.M. East. Penna.	J. F. Rau	Philadelphia
A.D.M. West. Penna.	P. E. Wiggin	Wilkesburg
A.D.M. Delaware	H. H. Layton	Wilmington

CENTRAL DIVISION

Manager	R. H. G. Mathews	Chicago, Ill.
A.D.M. Michigan	C. E. Darr	Detroit
A.D.M. Ohio	C. E. Nichols	Lima
A.D.M. Illinois	G. M. Bergman	Dwight
A.D.M. Wisconsin	C. N. Crapo	Milwaukee
A.D.M. No. Ind.	M. W. Hutchinson	Middlebury
A.D.M. So. Indiana	D. J. Angus	Indianapolis
A.D.M. Kentucky	J. C. Anderson	Lexington

DAKOTA DIVISION

Manager	D. C. Wallace	Minneapolis
A.D.M. Minnesota	M. G. Goldberg	St. Paul
A.D.M. So. Dakota	Orville Wheelon	Pierre
A.D.M. No. Dakota	Bert Wick	Devils Lake

DELTA DIVISION

Manager	W. W. Rodgers	Memphis, Tenn.
A.D.M. Louisiana	V. L. Rosso	Plaquemine
A.D.M. Mississippi	W. L. Kennon	Mississippi
A.D.M. Tennessee	W. C. Hutcheson	Wind Rock
A.D.M. Arkansas	Dr. L. M. Hunter	Little Rock

HUDSON DIVISION

Manager	E. M. Glaser	Brooklyn, N. Y.
A.D.M. New York City	F. H. Mardon	Bronx
A.D.M. No. New Jersey	A. G. Wester, Jr.	Irvington
A.D.M. East. New Jersey	G. Kastenmayer	Schenectady

MIDWEST DIVISION

Manager	P. H. Quinby	Omaha, Nebr.
A.D.M. Iowa	D. E. Watts	Ames
A.D.M. Missouri	L. B. Laizure	Kansas City
A.D.M. Kansas	C. M. Lewis	Yates Center
A.D.M. Nebraska	H. A. Nielsen	Omaha

NEW ENGLAND DIVISION

Manager	I. Vermilya	Mattapoisett, Mass.
A.D.M. Rhode Island	D. B. Fancher	Westerly
A.D.M. New Hampshire	C. P. Sawyer	Manchester
A.D.M. Vermont	W. W. Hall	Burlington
A.D.M. Maine	Dick Chase	West Baldwin
A.D.M. West. Mass.	T. F. Cushing	Springfield
A.D.M. East. Mass.	B. H. Chase	Winthrop
A.D.M. Connecticut	D. C. S. Comstock	E. Hartford

NORTHWESTERN DIVISION

Manager	Glenn E. West	Polytechnic, Mont.
A.D.M. Montana	H. E. Cutting	Bozeman
A.D.M. Washington	Everett Kick	Everett
A.D.M. Oregon	P. R. Hoppe	Eugene
A.D.M. Alaska	Geo. Sturley	Vancouver, Wash.

PACIFIC DIVISION

Manager	M. E. McCreery	Los Angeles, Calif.
A.D.M. Arizona	H. L. Gooding	Douglas
A.D.M. Nevada	G. M. Lewis	Reno
A.D.M. So. Calif.	D. M. Brockway	Los Angeles, Calif.
A.D.M. Central Calif.	P. W. Dann	Oakland
A.D.M. No. Calif.	Stanley Runyon	Walnut Grove
A.D.M. Hawaii	K. A. Cantin	Honolulu, T. H.

ROANOKE DIVISION

Manager	W. T. Gravely	Danville, Va.
A.D.M. West. Va.	J. L. Rock	Farmington
A.D.M. Virginia	J. F. Wohlford	Roanoke
A.D.M. No. Carolina	T. M. Simpson	Winston-Salem

ROCKY MOUNTAIN DIVISION

Manager	N. R. Hood	Casper, Wyo.
A.D.M. Colorado	P. M. Segal	Denver
A.D.M. Utah	Art Johnson	Salt Lake City

SOUTHEASTERN DIVISION

Manager	H. L. Reid	Atlanta, Ga.
A.D.M. So. Carolina	A. DuPre	Spartanburg
A.D.M. Alabama	H. S. Brownell	Box 2165 Birmingham
A.D.M. Florida	C. F. Clark	Jacksonville
A.D.M. Georgia	J. M. Keith	Atlanta
A.D.M. Porto Rico	Luis Rexach	San Juan

WEST GULF DIVISION

Manager	F. M. Corlett	Dallas, Texas
A.D.M. New Mexico	Louis Falconi	Roswell
A.D.M. Oklahoma	C. E. Whartenby	Enid
A.D.M. So. Texas	E. A. Sahn	Waxahachie
A.D.M. No. Texas	W. B. Forrest, Jr.	New Braunfels

MARITIME DIVISION

Manager	W. C. Borrett	Dartmouth, N. S.
A.D.M. P. E. I.	W. Hyudman	Charlottetown
A.D.M. New Brunswick	T. B. Lacey	St. John

ONTARIO DIVISION

Manager	C. H. Langford	London, Ont.
A.D.M. Central Ont.	W. Y. Sloan	Toronto

QUEBEC DIVISION

Manager	J. V. Argyle	Montreal
----------------	--------------	----------

WINNIPEG DIVISION

Manager	J. E. Brickett	Moose Jaw, Sask.
A.D.M. Saskatchewan	E. L. Maynard	Morse
A.D.M. Manitoba	E. Nicholson	Winnipeg

VANCOUVER DIVISION

Manager	A. J. Ober	Vulcan, Alberta
----------------	------------	-----------------

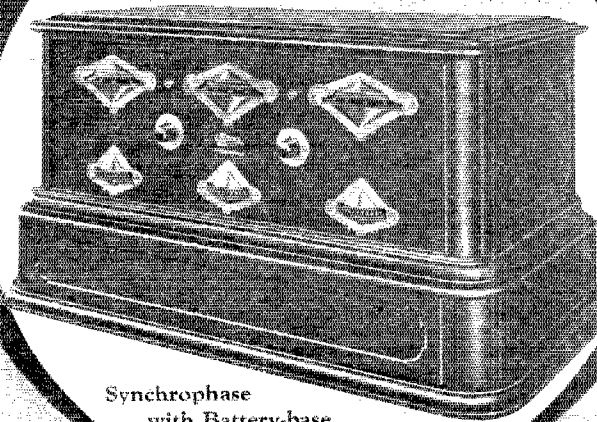

Synchronphase
with Battery-base

GREBE SYNCHROPHASE

TRADE MARK



"Of what use is cleverness
of speech?"

—Confucius

Words, even though select-
ed and phrased with the
greatest deliberation, can-
not do full justice to the
Grebe Synchronphase—and
its performance.

Doctor Thru



TRADE MARK
REG. U.S. PAT. OFF.

IN THIS outstanding triumph of fif-
teen years of radio development,
a new type of fieldless "Binocular"
coil transformer—unaffected by
local interference—is used for tun-
ing the detector and two stages of
Balanced tuned radio frequency.

The settings for the various broad-
cast stations are equally spaced over
the dials. The S-L-F (straight line
frequency) condensers accomplish
this.

Write for literature

A. H. GREBE & COMPANY, INC.

Van Wyck Blvd., Richmond Hill, N.Y.

Western Branch: 443 So. San Pedro St., Los Angeles, Cal.

All Grebe apparatus is covered
by patents granted and pending.

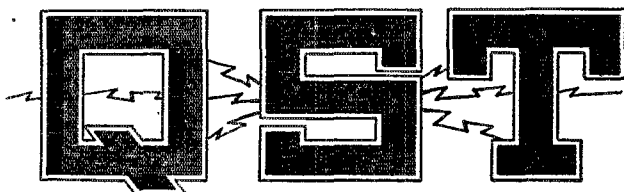

The Official Organ of the A.R.R.L.

VOLUME VIII

NOVEMBER, 1924

NUMBER 4

Editorials	7
Short Wave Daylight Transcons	8
The One-Control Superheterodyne	9
Communication With New Zealand	15
The "Bowdoin" Returns	16
My Radio Experiences in the Far North	17
Parallel Operation of Power Tubes	24
Attention Superheterodyne Owners	27
Hassel's Super-Zenith Circuit	28
Coming: Dakota Division Convention	30
Antennas for Short Waves	31
Statement of Ownership	32
Secondary Circuits for Broadcast Receivers	33
Helium Tubes	34
Experimenters Section	35
Atmospheric Electricity	37
Bum Relaying	40
Be Careful, Gang	42
Sixth District Convention	42
A Beautiful Antenna	43
Practical Short Wave Transmitters	44
20 Meter Tests	47
Unscrambling Things	48
The Receiving Experimenter	49
The Ohio State Convention	50
Extension of Standard Radio Frequency Transmissions—WWV Schedules	51
Amateur Radio Stations	52
The Amateur Builder	55
Who's Who in Amateur Wireless	59
International Amateur Radio	61
"Strays"	64
Radio Communications by the Amateurs	67
QST's Directory of Advertisers	127

QST is published monthly by The American Radio Relay League, Inc., at Hartford, Conn.

S. Kruse,
Technical Editor

Kenneth R. Warner (Secretary, A.R.R.L.),
Editor and Business Manager

Edwin C. Adams,
Advertising Manager

L. W. Hatry,
Department Editor

F. C. Beekley,
Assistant Editor

David H. Houghton,
Circulation Manager

Subscription rate in United States and Possessions, Canada, and all countries in the American Postal Union, \$2.00 per year, postpaid. Single copies, 20 cents. Foreign countries not in American Postal Union, \$2.50 per year, postpaid. Remittances should be by international postal or express money order or bank draft negotiable in the U. S. and for an equivalent amount in U. S. funds.

Entered as second-class matter May 29, 1919, at the post office at Hartford, Connecticut, under the act of March 3, 1879. Acceptance for mailing at special rate of postage provided for in section 1103, Act of October 3, 1917, authorized September 8, 1922. Additional entry as second-class matter, acceptable at special rate of postage provided for above, at Springfield, Mass., authorized September 17, 1924.

Copyrighted, 1924, by the American Radio Relay League, Inc., Title registered at United States Patent Office.

THE AMERICAN RADIO RELAY LEAGUE

The American Radio Relay League, Inc., is a national non-commercial association of radio amateurs, bonded for the more effective relaying of friendly messages between their stations, for legislative protection, for orderly operating, and for the practical improvement of short-wave two-way radio telegraphic communication.

It is an incorporated association without capital stock, chartered under the laws of Connecticut. Its affairs are governed by a board of Directors, elected every two years by the general membership. The officers are elected or appointed by the Directors. The League is non-commercial and no one commercially engaged in the manufacture, sale or rental of radio apparatus is eligible to membership on its Board.

"Of, by and for the amateur," it numbers within its ranks practically every worth-while amateur in America and has a history of glorious achievement as the standard bearer in amateur affairs.

Inquiries regarding membership are solicited. Ownership of a transmitting station, while very desirable, is not a prerequisite to membership; a bona-fide interest in amateur radio is the only essential. Correspondence should be addressed to the Secretary.

OFFICERS

President
HIRAM PERCY MAXIM
Hartford, Conn.

Vice-President
CHAS. H. STEWART
St. David's, Pa.

Traffic Manager
F. H. SCHNELL
1045 Main St.
Hartford, Conn.

Canadian Gen. Manager
A. H. K. RUSSELL
6 Mail Bldg.,
Toronto, Ont.

Treasurer
A. A. HEBERT
Hartford, Conn.

Secretary
K. B. WARNER
Hartford, Conn.

DIRECTORS

President
HIRAM PERCY MAXIM
Drawer 4,
Hartford, Conn.

Vice-President
CHAS. H. STEWART
St. David's Pa.

Canada
A. H. K. RUSSELL
Toronto, Ont.

Atlantic Division
GEO. L. BIDWELL
1245 Everts St., N. E.,
Washington, D. C.

Central Division
CLYDE E. DARR
137 Hill Ave., Highland Park,
Detroit, Mich.

Dakota Division
CYRIL M. JANSKY, JR.
Dept. of Elec. Eng., U. of M.,
Minneapolis, Minn.

Delta Division
BENJ. F. PAINTER
424 Hamilton Nat'l Bank Bldg.,
Chattanooga, Tenn.

Midwest Division
L. BOYD LAIZURE
30th & Mercier Sts., R. F. D. 1,
Kansas City, Mo.

New England Division
GEO. H. PINNEY
84 Prospect St.,
So. Manchester, Conn.

Northwestern Division
K. W. WEINGARTEN
3219 No. 24th St.,
Tacoma, Wash.

Pacific Division
ALLEN H. BABCOCK
65 Market St.,
San Francisco

Roanoke Division
W. TREDWAY GRAVELY
508 Main St.,
Danville, Va.

Rocky Mountain Division
PAUL M. SEGAL
404 Equitable Bldg.,
Denver, Colo.

Southeastern Division
HARRY F. DOBBS
c/o Dobbs & Wey Co.,
Atlanta, Ga.

West Gulf Division
FRANK M. CORLETT
2515 Catherine St.,
Dallas, Tex.

Address General Correspondence to Executive Headquarters, Hartford, Conn.

EDITORIALS

de AMERICAN RADIO RELAY LEAGUE



The Winter Season

ALL signs point to a winter of unusual achievement now opening to us. It is good to be alive, and to have a good short-wave set, and have all the world at one's fingertips, isn't it?

Transocean amateur signals dropped out during the peak of the static season but with the first few days of cool weather they came back. English and French amateurs have been worked again, and never an eyebrow flickered. Italian ACD aboard the "Ecuador" of the Royal Italian Navy on a visit to South America, has worked many American amateurs while off the Brazilian coast, signing IHT. And there is the wonderful work of u6BCP and u6CGW and z4AA in linking this country and New Zealand.

The summer extension of quiet hours on the waves above 150 meters was cancelled when Daylight Saving Time gave way to standard time, and this is a big help. The foreign amateurs are as industriously remodeling as we are, and there are several new European countries waiting for somebody to be the "first" to work. With an early DX season and a degree of activity the whole amateur world over never approached before, we expect many wonderful things to happen before next spring.

This is a good sign for the success of the First Congress of the International Amateur Radio Union in Paris next Easter, too. Every little international contact between now and then will help to increase interest in the I. A. R. U. Hop to it, fellows!

Our Bigger Circulation

WITH this number, *QST*'s newsstand distribution has been coolly tripled, which means that twice as many copies of this issue are being printed as are usually distributed. Let this soak in for a moment and we'll explain the large idea.

For a long time folks have been telling us that *QST* ought to have a wider distribution, that we are publishing perfectly splendid articles that would be of very wide interest if only they were made more commonly available. We believe that is true, and so we're trying it.

QST is distinctively an amateur periodical. There are two kinds of radio amateurs. First there is the telegraphing amateur, the kind the 1912 radio law has in

mind when it says "amateur". But there is another and growing class equally entitled to be called amateurs, for they follow the hobby of radio with a love therefore no less genuine than that of us telegraphing amateurs. We refer to the amateur whose interest is in telephony instead of code, in 400 meters instead of 100 meters. He is an outgrowth of the B. C. L., but not a B. C. L. in the commonly accepted meaning of that term. It is to these two types of amateurs that *QST* caters. It is to reach the second class in greater numbers that we are increasing our distribution. This marks no change whatever in *QST*'s editorial policy; we have published articles for this kind of amateur regularly in the past, and we shall simply continue to do so.

We want to reach these "phone amateurs" because they are among the highest class of experimenters, because they are blood-brothers of the transmitting amateur, and because they will make excellent relayers as soon as they become interested in radio-telegraphy and realize the boundless opportunities for world-exploration that lie in being an active A. R. R. L. member. To them the League extends a hand of welcome.

And of the A. R. R. L. membership *QST* has a request to make: tell your many friends in the big phone-experimenter-amateur class about our magazine. It will help them, for it has the kind of information they need and want to get. And it will help you, for it will enable Headquarters to put out an increasingly bigger and better *QST*. And it will help amateur radio, for it will eventually bring into the game many thousands of amateur operators of the right sort. *QST* will now be found in greater quantity, on more newsstands, and in places where it never was before. A few minutes of missionary work by each A. R. R. L. member will do a world of good all around.

Tnx, O. M.

The Third Conference

WHAT'S coming off at this Third Washington Radio Conference? Frankly, we do not know at this writing, but there are plenty of rumors floating around. It seems pretty well established that somebody is going to disclose himself as gunning for the amateur's hide. Some of the big commercial com-

panies, we hear, are much put out that Uncle Sam has given us the use of some short waves, especially without consulting them, and we are told that they will be present at Washington to protest this. These short waves are much too valuable to let amateurs have them; mustn't let these amateurs entrench themselves in their use or we'll have a hard job dislodging them; right now is the time to kick them out. Etc., etc. And somebody else is said to have acquired the gorgeous idea that broadcasting needs more cyclage and that the place to find the cycles is in the amateur's band—hammer the amateur down to 176, 150 to 176 meters is enough for him.

Let's see, are we worried or not? We are not! The functions of this conference committee are advisory to the Department of Commerce. If its recommendations go contrary to the law of 1912, how are they

possible of execution? And doesn't the law of 1912 give the amateur rights to the use of all waves below 200 meters? The amateur representatives at the conference will enter the affair with the spirit of co-operation uppermost in their minds, and they will be just and reasonable, but they will know that they have no right, either moral or legal, to sacrifice the minimum privileges of the American amateur under the existing radio law.

But say, isn't it funny how the cupidity of commercial interests is always being attracted by amateur development? The history of amateur radio in this country has largely been one of guarding our cherished right to existence from the designs of somebody who would like to have something of ours, generally because they think they can make some money out of it.

Ho, hum

Short Wave Daylight Transcons.

75 to 80 Meters—November 9th and 16th

ONCE again we shall endeavor to beat the sun across the continent with another series of Daylight Transcontinental Tests, the first test on November 9th and the second on November 16th. Both dates fall on Sunday and we expect a good turnout for the events. The only difference between these tests and the previous ones is that we will use short waves (75 to 80 meters) instead of the higher bands.

In order to prevent any possible "flukes" no messages will be started until the sun is up over both the Atlantic and Pacific Oceans. No message will be transmitted until 7:00 A. M., P. S. T., or 10:00 A. M., E. S. T. Messages from the West coast must reach the East coast before sunset, and messages from the East coast must reach the West coast before sunset, if we are to call the tests successful. The tests are relay tests and one jump across the country will not count. Each message must be handled by three or more stations, not more than two of which shall be what may be considered coastal stations.

Unknown stations will start messages from each end, with some from a central point—there will be sufficient messages for all stations to participate; and if you don't get in on the fun, it's your fault.

In your logs, do not include any information that does not apply strictly to the Transcon Messages—we haven't time to wade through piles of stuff that don't concern us. All logs must be in Hartford not later than November 25th for credit in QST.

The dates are November 9th and 16th. The wave band is 75 to 80 meters. The starting time is 7:00 A. M., P. S. T., or 10:00 A. M., E. S. T. Just be on the job and you will have some fun, because we can work several hundreds of miles in daylight now.

—F. H. S.

The One-Control Superheterodyne

By James L. McLaughlin

Research Engineer, Precise Manufacturing Corporation

Following closely on his recent article in *QST* describing the One-Control Neurodyne, Mr. McLaughlin has produced a superheterodyne operated by but one control which we take great pleasure in presenting to our readers in this article. We consider it the outstanding development in recent "superhet" progress, as it provides the simplest imaginable control for what is admittedly the best reception arrangement known today. Although this article describes a set for the broadcast wavelengths, Mr. McLaughlin's control idea of course is applicable to superheterodynes designed for any other bands.—Editor.

WHEN the public first became interested in radio broadcasting several years ago it was introduced to receiving apparatus having numerous controls. It was taken for granted that such apparatus had to have several controls to be of any consequence, and if a person had a set with more knobs than his next-door neighbor's it was generally considered that his was the superior set. In fact it gave the impression that he had mastered a great

the novelty stage to a status similar to that of the automobile—it has become a modern convenience. And therefore it is necessary that receiving devices be designed with such simplicity that the layman may operate them with little knowledge of the principles involved.

Besides being simple in operation a receiving set must be sensitive and selective or it will be useless. The two most sensitive and selective types of Super receivers at the present time are the Superheterodyne and

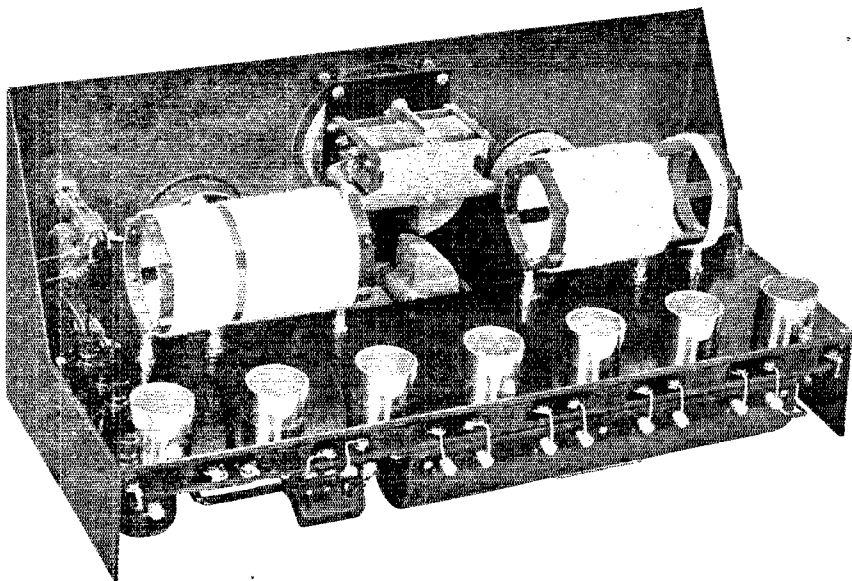

FIG. 1—A REAR VIEW OF THE SET THAT DOES THE TRICK, showing particularly the location of the two geared condensers and the inductances for the oscillator and tuner. Incidentally, note how the front panel and the sides are formed from one piece of sheet metal, the sides supporting the horizontal panel which carries the sockets.

deal of radio engineering to be able to operate such a tuner. This novelty has now worn off and the tendency is towards sets with the minimum number of controls. This is a very healthy state of affairs because it shows that radio has passed from

those sets employing "neutralized" radio-frequency amplification. The measure of sensitivity and selectivity depends entirely upon how well made the sets are and not upon how many tubes they use. I have seen some of both type that tuned as

broadly as a single-circuit receiver and were about as sensitive as a one-tube set.

In the Neutrodyne type of receiver we can simplify the filament control to one rheostat but beyond that we can do nothing

the circuits are tuned simultaneously to the same wavelength. The set being electrically all right, the success of such an arrangement depends upon how well the mechanical work is done. Such a receiver

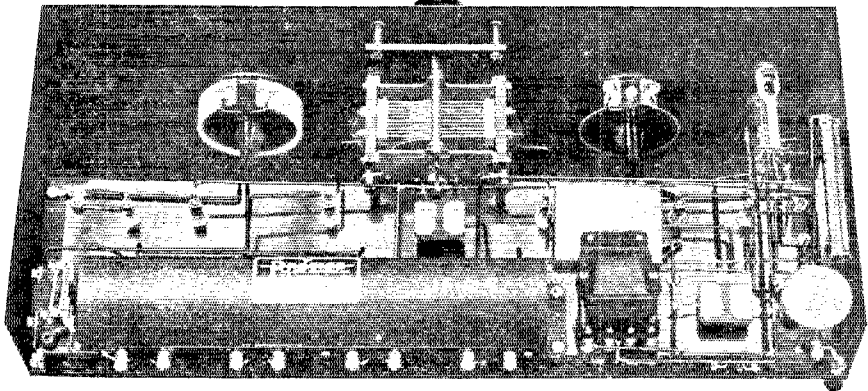

FIG. 2—THE BOTTOM OF THE SET, showing location of the transformers, fixed condensers, etc. The long black case in the left foreground is a "Super-Multiformer", a multiple transformer serving all the intermediate-frequency stages.

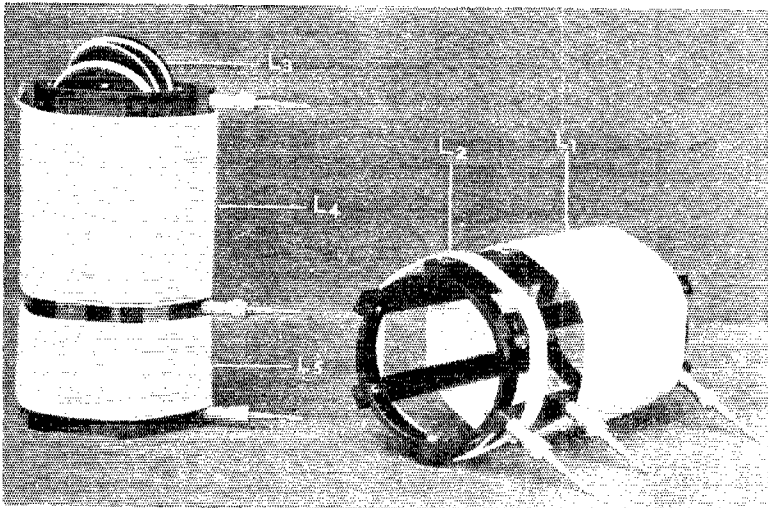

FIG. 3—THE INDUCTANCES. The left-hand one is for the oscillator, the right-hand for the tuner. Note the very efficient low-loss construction, the windings being carried by a light frame of narrow hard-rubber strips. The plug-in connectors make it possible to substitute other inductances for different wavelength bands. The success of one-control superheterodynes built from this article will depend largely upon the fidelity with which these inductances are duplicated electrically, so they should be carefully studied. See also the dimensional drawing, and consult the hook-up for the winding data.

ing electrically that will simplify its operation. We still have three or more tuning controls, depending on how many stages of tuned radio-frequency amplification are used. But by means of gears or some other mechanical device we can connect these several controls in such a manner that all

was described by the present author in the August (1924) issue of *QST*.*

Examining the Superheterodyne

Let us now look into the possibilities of simplifying the control of the superhetero-

*Available from *QST*'s Circulation Department.

dyne. We can control the filaments of the tubes as in the Neutrodyne. This leaves us with one tuning control and one oscillator control. We may also have a stabilizing control for the intermediate-frequency amplifier but this may be eliminated by neutralizing the amplifier as described by this author in the June issue of *QST*.^{*} Even if the tube capacity is not neutralized, this control may be made very stable by careful and proper design of the transformers used in the intermediate-frequency amplifier, so that it may be ignored here.

The first thought that occurs is to couple the two remaining controls as was done in the One-Control Neutrodyne, but this will not work because these two circuits are not to be tuned to the same frequency but to a constant *difference* in frequency which must equal the frequency of the intermediate-wave amplifier. It is quite a different problem and much more complex. Let us imagine the tuner of our superheterodyne has a range from 200 to 600 meters, and that the intermediate-frequency amplifier is tuned to 40 kilocycles. If the tuner is set, say, at 200 meters or 1500 kilocycles, the oscillator must be tuned to 205 meters (1460 k. c.) or else to 195 meters (1540 k. c.), either of which will produce a beat frequency of 40 k. c. We will not go into the reason for this or into the theory of superheterodyne operation, as this has been very fully covered in recent issues of *QST*.¹ Now let us change our tuner to 600 meters or 500 k. c., which we will call the maximum wavelength. To give the same beat frequency of 40 k. c. our oscillator now will have to be set at 650 meters (460 k. c.) or at 550 meters (540 k. c.)

From this we see that the wavelength ratio between tuner and oscillator does not remain constant but varies more or less directly with the dial setting; that is, as we go from minimum wavelength towards the maximum wavelength we have to change the wavelength of the oscillator more rapidly than we do that of the tuner. If only we had straight-line-frequency variable condensers the problem would be simple, for then if we had identical inductances in the first detector and in the oscillator we could gear the condensers of these two circuits together at a frequency difference of 40 kilocycles and the beat frequency would be the same over the whole range; but such condensers cannot be obtained on the market and we will have to look for some other solution.

A Way Out

Looking at Figure 5 we see how the tuning curves of the first-detector circuit and oscillator circuit must look when plotted to produce a constant difference of 40 kilocycles over the whole tuning range, if the tuning condensers of the two circuits are identical. A study of these curves suggests that we design the inductances of both these circuits so that such tuning curves may be produced. Right there is our solution. When the proper ratio of inductance, capacity and distributed capacity in both of these circuits is found it becomes a simple matter to make a one-control superheterodyne. In the following description all

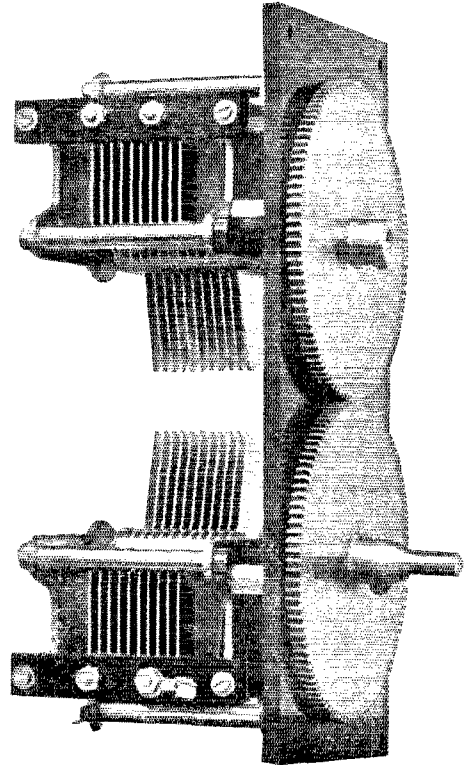

FIG. 4—THE SUB-PANEL carrying the two 23-plate Cardwell condensers and their gears. The control knob goes on the extension shaft of the bottom gear. Data on the gears are given in one of the drawings.

the specifications of the inductances are given so that the reader of average skill may duplicate the results.

The Construction

Two .0005- μ fd. (500 μ fd.) Cardwell condensers are used to tune the two circuits and are geared together so as to be operated by one control. Figure 4 shows

¹ See particularly "Building Superheterodynes That Work," a series edited by S. Kruse, appearing in *QST* for June, July and August, 1924.

the gear construction, and dimensions and details are given in one of the drawings.

The cover of this number of *QST* illustrates the front of the receiver and shows the indicating arrangement that is used. The control knob, in the center of the panel, was taken from an Accuratune dial and is connected to the lower condenser

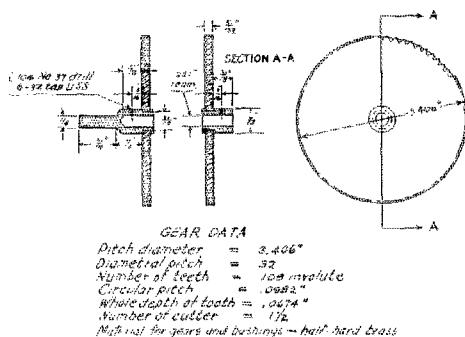

and gear. The two glass windows above this dial show the indicator, the left-hand one being used for calibration and the listing of important stations while the right-hand one indicates condenser settings so that stations that are not listed may be logged. (See also Fig. 6.) The small left-hand knob is the rheostat which controls all the tube filaments. This could be replaced if desired by a fixed resistance, as the filament temperature is not critical in any of the tubes. The small right-hand knob is a potentiometer and controls the grids of the amplifying tubes. This was found not at all critical, due to the design of the amplifying unit, and once set one could tune over the whole range and have the amplifier remain stable and still work at maximum amplification. Two jacks are shown on the right-hand side of the panel for the head-phones and loud-speaker, while between them is the filament control switch. The panel itself is 1-16" brass, with a baked crystal finish; working dimensions and layout are shown in one of the drawings.

The Inductances

Figure 3 shows the construction of the oscillator and tuning inductances. Their physical dimensions are given in a separate drawing, and the number of turns in each winding is shown under the wiring diagram. They were made so they could be removed readily from the circuit and others placed in to cover another wavelength range. In the photograph the left-hand coil is the oscillator inductance. The lower winding is the plate coil; the upper one is the grid coil; and the small coil inside at the top is in series with the grid

coil, forming a small variometer, and is used to balance the circuit. The right-hand inductance is the first-detector tuner. The smaller winding is the antenna coil, the larger one the grid coil.

Figure 1 is a rear view of the receiver and gives a good idea of the position of these inductances in the completed set. The coils are kept over 2" away from everything except at their extreme ends. The seven sockets are arranged at the rear edge of the set. Beneath the sockets is a sub-panel which supports the intermediate-frequency amplifying unit, which is a Precise "Super-Multiformer", the audio-frequency transformer, bypass condensers, etc. This view clearly shows the short grid and plate leads required to make connections between transformers and sockets.

Figure 2 shows the underside of the layout and gives a clear idea of the "Super-Multiformer", which really is the heart of the outfit and is chiefly responsible for the sensitivity and stability of this set. Alongside of this, to the right, is the Precise audio transformer. At the right-hand lower side is shown a 200-M.H. choke coil, which is required in the oscillator plate feed. Above this is the 1/2- μ f. by-pass condenser which shunts the

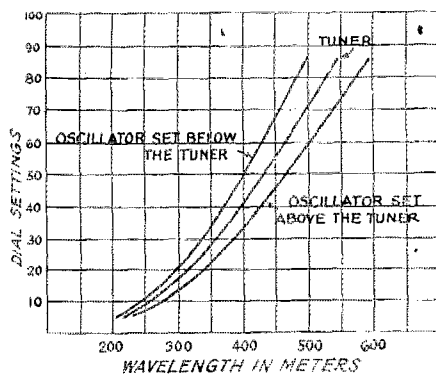

FIG. 5, showing how a constant frequency difference between tuner and oscillator involves an increasing difference in wavelength as the tuning wavelength is increased.

batteries, while above the audio transformer the C-battery of the audio stage may be seen. The layout of sockets is such that the first tube looking from the antenna end of the set (left-hand end in Fig.

² The "Super-Multiformer" is a multiple transformer for superheterodynes developed by the Precise Mfg. Corp., of Rochester, and takes the place of the four separate intermediate-frequency transformers that otherwise would be used. Although the basis of the set described in this article, Mr. McLaughlin's one-control idea is applicable to sets using other good makes of intermediate-frequency transformers.—Ed.

2, right hand end in Fig. 1) is the first detector; the next three are for the r.f. amplifier, the next is the second detector, then the audio amplifier, while the last one is the oscillator. This arrangement keeps the length of leads between oscillator circuit and oscillator socket approximately the same as between tuner circuit and tuner socket. The only coupling between these circuits is through

results were obtained using no plate voltage other than that supplied from the filament battery when the plate return was connected to the positive side of the A-battery as was done with the first detector, but 45 volts was found to be sufficient to bring in the loud signals to the best advantage as well as the weak.

In the second detector no grid condenser or leak is used, as generally the voltage

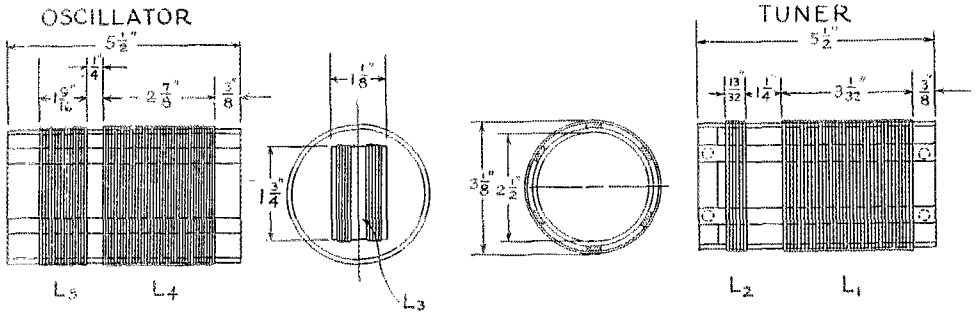

DIMENSIONS OF THE INDUCTANCES—Care should be taken to duplicate these as nearly exactly as possible. See Fig. 3 also. The end rings are sawn from bakelite tubing of $2\frac{1}{2}$ " inside diameter and having a $3/32$ " wall. The longitudinal hard-rubber strips are $3/8$ " x $3/16$ ". The wire is No. 18 D.C.C. throughout.

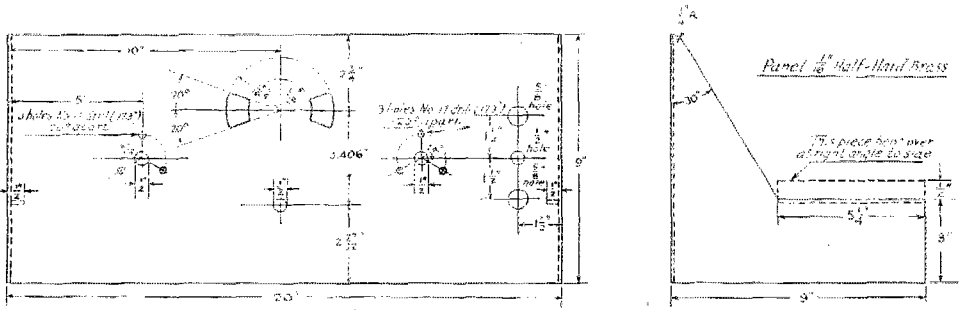

LAYOUT DIMENSIONS FOR THE METAL PANEL

the battery leads and stray coupling between the coils themselves (the separation is 6"). This was found much superior to the customary arrangement of choking the first detector with energy from the oscillator.

The Circuit

No plate voltage was used on the first detector other than that supplied by the A-battery. (See wiring diagram.) This improved reception greatly and was of big help on weak signals. The oscillator was supplied by a 45-volt B-battery, instead of the customary 90 volts. In fact excellent

applied to the grid of this tube is sufficient to shift the operating point to the bend in the characteristic curve and thus obtain detection.

Adjusting the Set

After all the parts are mounted and wired up and both condensers set to exactly the same capacity, the small coil in the grid circuit of the oscillator is adjusted until the oscillator and tuner circuits are correctly balanced. This adjustment can be found readily. Connect antenna and ground to the set, and set the potentiometer over to the negative side so that the

long-wave amplifier is in a state of oscillation. Set the condensers at, say, minimum or five or ten degrees, and move the potentiometer back until the amplifier is just barely oscillating. Then adjust the

the "rushing" sound should be of approximately the same intensity. If it is not, readjust the small coil and note how much variation is required to compensate for this change in tune. Then set the con-

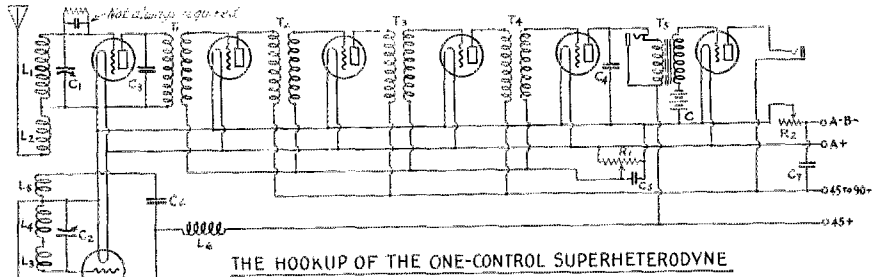

THE HOOKUP OF THE ONE-CONTROL SUPERHETERODYNE

- T₁ - 54½ turns No. 18 D.C.C. wire on 3½" frame
- T₂ - 30 " " " " " " 1½" from L₄
- T₃ - 200 M.H. choke coil
- T₄ - Precise "Super-Multiformer"
- T₅ - Precise audio transformer
- R₁ - 400 ohm GRCo potentiometer
- R₂ - 7 ohm GRCo rheostat
- L₁ - 50 turns No. 18 D.C.C. wire on 3½" frame
- L₂ - 8 " " " " " " 1½" from L₁
- L₃ - 5 " " " " " " 1½" cube mounted inside L₄
- L₄ - 54½ turns No. 18 D.C.C. wire on 3½" frame
- L₅ - 30 " " " " " " 1½" from L₄
- L₆ - 200 M.H. choke coil
- C - Negative bias battery for audio amplifier grid
- C₁ and C₂ - 300 µfd. Cardwell variable condensers
- C₃ - 300 µfd. Micadon (fixed)
- C₄, C₅, C₆ - .006 µfd. Micadons (fixed)
- C₇ - 0.6 µfd. Federal condenser (fixed)

small coil in the oscillator grid inductance until the "rushing" sound that is heard is at its loudest. This will indicate that both

condensers at maximum or nearly so. If the coils have been made correctly the noise will still be heard. If it is necessary to change the small coil again, it is clear evidence that the condensers and coils are out of balance and that sufficient care has not been taken in building and adjusting them, because when both condensers are set at exactly the same capacity and coils built as specified it is only necessary to set this small coil once, at any condenser setting, and the circuit will be balanced for all settings in its range.

When the proper setting of this coil is found it is advisable to lock it in some manner. In our case we soldered it securely, so there would be no chance of its becoming loose and throwing the circuits out of balance.

Results Obtained

It is certainly a strange sensation to turn one knob and hear station after station come in without any further adjustment. With the calibrated scale on this set it is a very simple matter to find the desired station.

As to results—at Rochester, New York, we have been able to bring in Pacific Coast stations on a loud-speaker on an average of three nights a week in the middle of August, which is not the best time of the year to obtain good reception, so you can imagine what it will do in the good radio season.

circuits are set at the proper frequency to produce the beat-frequency required for the amplifier. Then move the knob which controls the condensers to, say, fifty degrees;

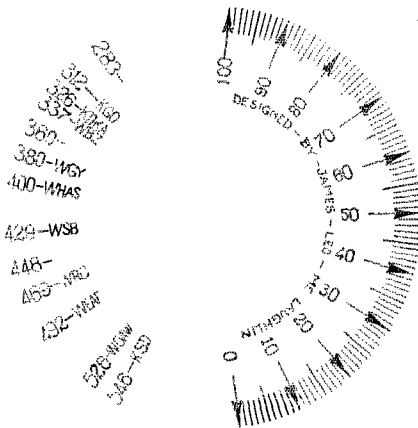

FIG. 4—THE TUNING CHART of Mr. McLaughlin's set illustrated in this article. These are the scales that show through the two little windows that may be seen in the photograph on our cover. The set has a wavelength range from 180 to 580 meters, although only a little more than 90 degrees of the condensers are actually used for the interesting waves between 300 and 550 meters.

Communication With New Zealand

6BCP and 6CGW Shatter All DX Records When They Work Z4AA;

Former Wins the A.R.R.L. Boomerang

ANOTHER continent was added to the list of far-distant places linked to amateur radio signals, and the American end of the world's record for two-way amateur distance was brought back to the U. S. A., when two California amateurs on September 21st were in communication with Mr. Frank D. Bell, 4AA, at Waihemo, Palmerston South, New Zealand. We make the distance right at 6,900 miles.

On the night of Sept. 20-21 Mr. W. B. Magner, 6BCP of San Pedro, Calif., was calling Australia and New Zealand in the tests arranged by the A.R.R.L. at the request of the Australian Radio Relay

The establishment of these splendid records, while not with the benefit of a schedule, was by no means accidental, but rather the result of hard plugging for months on the part of all these stations. Our Australasian friends have been "riding" us a bit about our inability to hear them and the Traffic Manager recently called for a determined effort to get QSO before the end of the year. The determined effort was productive! QST congratulates the successful stations.

New Zealand is rapidly "showing the world". The previous DX record was between z2AC in Gisborne, N. Z., and CB8



THE BEAUTIFUL TOWER and surroundings of New Zealand 4AA. The antenna has twin cages in a 30-ft. flat-topped T, 85 feet high, and under it is a 6-wire counterpoise. The 90-ft. wooden tower was built by Mr. Bell.

League, when he was answered by z4AA. Two-way communication was established immediately and lasted from 12:20 a. m. to about 1:40 a. m. P.S.T. z4AA is reported QSA, some QSS. 6CGW, Mr. K. L. Riedman, of Long Beach, Calif., tied up with 4AA immediately thereafter, and worked him until 2:20 a. m., handling one message in each direction, the first amateur traffic between these countries. The received message was to

ARRL

HARTFORD

GREETINGS FROM NEW ZEALAND HAMS
Z4AA

(now DA8) in Bernal, Argentina, a distance of about 6,400 miles. This communication took place on May 22nd, which is a measure of how far the South Americans beat us to connecting with New Zealand. The Anzacs, be it noted, have had one end of both records.

This work was not done on short waves. Bell, 4AA, is reported to have been on 130 meters, 6BCP used 157, and 6CGW was on 150. To our mind that makes the work all the more remarkable.

Some information on the station equipment that did this work may be interesting.

(Concluded on Page 66)

The "Bowdoin" Returns

THE "Bowdoin" is back and Donald Mix is home, after a year within a few hundred miles of the North Pole. Our readers will recall that in June of 1923 the MacMillan Arctic Expedition sailed from Wiscasset, Me., in the 80-foot auxiliary schooner "Bowdoin", carrying the first short-wave radio installation ever taken north by an explorer. The apparatus was designed and installed by

A.R.R.L. officials at Wiscasset when the little vessel came in. He stated that radio had been of immense assistance to them, giving them the news of the world daily and sending word back home from day to day how things were going, and he paid a glowing tribute to the A.R.R.L. operator, Don Mix.

The "Bowdoin" came home at 1 p. m. on September 20th, being met by a crowd of

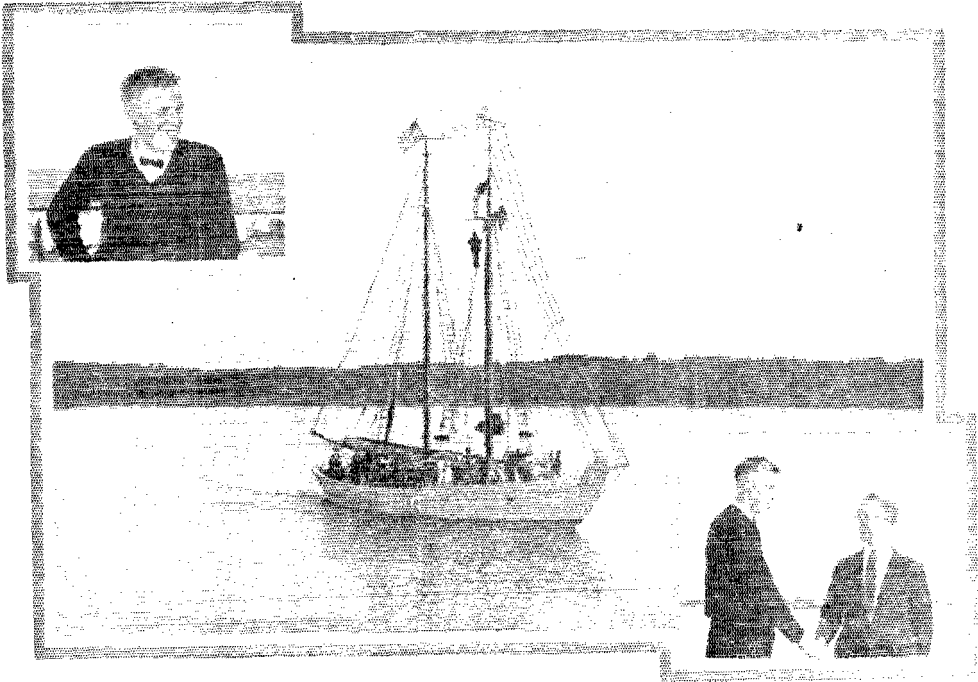

BACK HOME AGAIN!

The doughty little "Bowdoin" coming up to her anchorage at Wiscasset after fourteen months in the Arctic, her contact with the outside world being via amateur radio. (Photo by McDougall & Keefe.) Upper corner: A.R.R.L. operator Don Mix and his famous grin. Lower corner: Mix receiving the congratulations of the Traffic Manager upon a good job well done. (Photo by 1KX.)

the Zenith Radio Corporation, of Chicago, and was operated by Donald H. Mix, ITS of Bristol, Conn., who was selected and sent by the American Radio Relay League from a large field of candidates. The expedition's communication with civilization and home has been exclusively thru amateur stations of the A.R.R.L. as has been related monthly in *QST*.

"Great work you fellows of the League have done for us", were the first words spoken by Capt. MacMillan upon greeting

several thousand people and the whistles of a variety of Maine locomotives backed onto side-tracks for that special purpose. There was Don Mix, big as life and looking as if he had enjoyed every minute of it. The pretty little village of Wiscasset was filled to overflowing, as the MacMillan party was escorted ashore and to the steps of the Congregational Church on the village green, where simple but impressive ceremonies of welcome were staged. Radio has been one of the greatest factors in the success of the

expedition, and among the speakers was our own president, Hiram Percy Maxim, who told how proud we amateurs are to have been the help we have.

Our brother amateur Mix is back home in Bristol now, covered with glory, and guarding a WNP log about six inches thick.

He has much to relate that is of interest and importance, for he is the first amateur ever to operate a 200-meter set in the frozen reaches of the Far North. With which, ladies and gents, we take much pleasure in presenting the intimate ham story of the "Bowdoin's" voyage, as related by Don Mix himself.

My Radio Experience in the Far North

By Donald H. Mix, 1TS, WNP.

THE majority of *QST's* readers are by this time no doubt acquainted with the purposes of the MacMillan North Greenland Expedition of 1923-4 and the part which the A.R.R.L. took in this expedition.

Leaving Wiscasset, Maine, on June 23, 1923, we made a fine run without incident to Sydney, N. S., where we remained three days. While we were under way the crew with the exception of the engineer and cook was divided into two deck watches. I was appointed to the port watch which was on deck from 12 noon to 6 P. M. and from 12 midnight to 6 A. M., and until we reached Refuge Harbor I stood this watch in conjunction with the regular radio watch, standing six hours of the twenty-four at the wheel.

There were two French battle cruisers anchored at Sydney for the Dominion Day celebrations and I had a chance to get a peek at the sets aboard them. They were still equipped with the antiquated non-sink spark sets and the radio officers were much impressed with the small power of our transmitter.

Leaving Sydney on July 3rd we ran up the western coast of Newfoundland through the Straits of Belle Isle to Battle Harbor, making emergency anchorages at Greenly Island, Red Bay and Henley Harbor due to heavy heads, fog, and unusually heavy field ice in the Straits.

The Marconi Station at Battle Harbor is equipped with a fine 2 K. W. 300-cycle synchronous spark transmitter. They still use a crystal detector but have a one-stage English tube amplifier. Stretching northward along the Labrador coast is a string

of quarter-kilowatt induction coil sets at intervals of about 40 miles, with receivers equipped with crystal detectors and also a Marconi magnetic detector for emergency use. The most northern of these stations is located at Mokkaovik in latitude 59 north. The traffic, which is surprisingly heavy for the population of the country, is relayed by these small stations to the big station at Battle Harbor, from which it is sent to FOGO, Newfoundland. The station at Battle Harbor is open during the winter months. The antennae at all of these stations are two-wire affairs practically vertical, using single masts from 150 to 200 feet high.

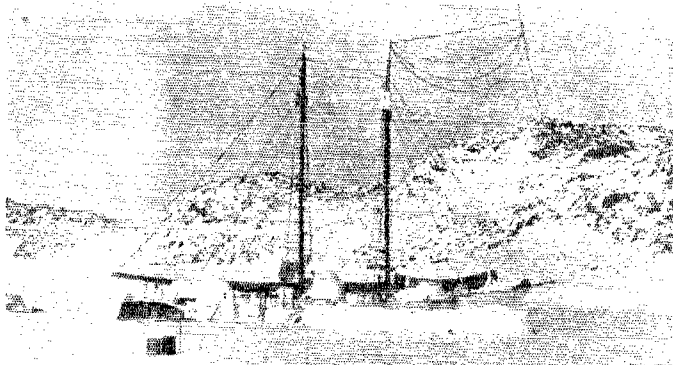

THE "BOWDOIN" in winter quarters at Refuge Harbor, North Greenland, frozen in the ice. The experimental fan aerial erected by Mix can be seen, stretching from a spreader on the foretopmast to a long cable stretched across the tops of the cliffs on either side of the small harbor. (Photo by Mix.)

Leaving Battle Harbor on the 13th of July we ran northward along the coast of Labrador, making stops at Boulter Rock, Greedy, Indian Harbor, Cape Harrison, Turnivik, Hopedale and Jack Lane's Bay, the stop at the latter place being made to pick up Mr. Abram Bromfield as our interpreter.

During the run from the coast of Maine to our most northern point in Labrador the work of our old friend Vermilya, 1ZE of

Marion, and of Bourne of 1ANA, Chatham, Mass., stood out above all others. These two men kept a constant ear out for our signals and while we tried night after night to raise other stations these seemed to be the only ones able to copy our signals consistently. 1ZE took two press stories of over 500 words each, one of them in code. The first one was cleared while we were anchored at Monhegan Island, Maine, and the second one under most difficult conditions while we were going up the west coast of Newfoundland. While anchored at the western entrance to the Straits of Belle Isle, 2CQZ made pretty work of a two hundred word press dispatch. From this point 1ANA took up the harness and kept in practically constant communication with us until we were in North Greenland, a truly remarkable record. He copied coded press dispatches from Henley Harbor, Greedy, and Jack Lane's Bay. Practically all work on the run up the Labrador coast was done through the heaviest kind of QRN, which seems to prevail in this section. Reception at Red Bay and Henley Harbor was unusually poor, due, no doubt, to the fact that both harbors are surrounded by high hills. While clearing the press dispatch from Jack Lane's Bay I was nearly killed by mosquitos.

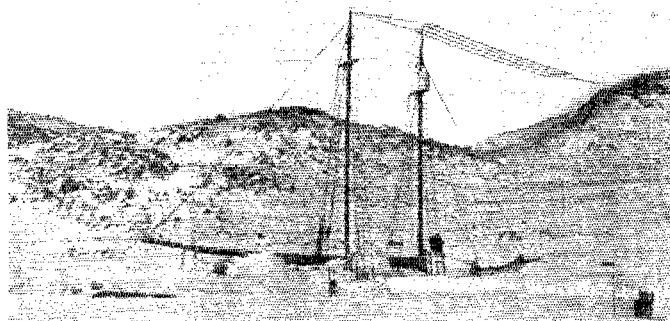

MIX'S FLAT-TOP AERIAL, running about 60 ft. from the foremast spreader to another spreader supported by a long cable running about 500 yards to a boulder on the hillside 200 ft. above sea-level. Note the snow igloos over the hatches. (Photo by Mix.)

Only those who have been on the Labrador can imagine the misery that these pests can cause. I covered all hatches with mosquito netting and bandaged my face and hands with it, but it was useless. I looked like a boiled beet in the morning.

Leaving Jack Lane's Bay on the morning of July 25 we ran through a belt of field ice for about ten miles, after which we emerged into clear water and struck out for South Greenland. On the morning of July 27th when about half way across, 5ACJ came bumping in and the next A. M. a short time after sighting the Greenland coast 6PL

and 6CMR broke through, and for a few minutes 1ANA exchanged signals with us. We remained at Godthaab three days. While anchored there signals from all districts except 5th, 6th, and 7th were logged, altho the Danish authorities informed us that the "Islands Falk", the Danish coast patrol ship, has never been able to hear anything while anchored in the harbor.

We left Godthaab at noon on the 31st of July and that night worked 1ZE and 1ANA, but signals both ways were poor and uncertain. The next day we ran into rough weather and in the afternoon the "Bowdoin" nosed under and a sea carried the bowsprit away completely, wrecking the antenna and making it necessary to put into Simiutak for repairs. Mr. McCue, our mate, very ingeniously improvised a new bowsprit of a couple of "two by four's" and we were able to be off again the morning of August 2nd. That night 1ANA once more came through and took the last press dispatch cleared through a station east of the Mississippi. The sun was below the horizon for only an hour—from 11:30 P. M. to 12:30 A. M.—while we worked on the press dispatch from 11:30 to 1:15 A. M.

From the time we sighted South Greenland until we anchored in Refuge Harbor, the signals from stations east of the Mississippi seemed to decrease in strength while the signals from those stations west of the Mississippi seemed to increase, a phenomenon for which no satisfactory explanation as yet has been found.

We continued pushing northward without stopping until we had crossed Melville Bay and reached Cape York, where we made a brief anchorage to a large flat berg from the surface of which we filled our water tanks. After making a few brief stops

on Whale Sound we finally anchored in Etah Harbor on August 8th. Since August 4th the sun had not set and during these last four nights amateur signals, though rather weak, were logged every night between 11 P. M. and 2 A. M. while there was absolutely nothing doing on phone carrier waves or on 600-meter commercial stuff. Ever since leaving Nova Scotia it had been impossible to copy press from NSS on account of the absolute absence of signal strength and constant QRN from the European long-wave stations and it was only

under the most favorable conditions that time signals were heard. On the afternoon of the 8th the Canadian steamer "Arctic" came into Etah and from her we learned of President Harding's death. The operator aboard the "Arctic" gave me a schedule on which POZ sends press in English and from that time until late spring in 1924 we had practically daily news service. The operator told us that they had been unable to work VAS on their 1-K.W. tube set since leaving the Gulf of St. Lawrence, and expressed confidence that we would not be able to work back to the States on short waves. The next day we made an attempt to get to Cape Sabine, but a solid pack extending ten miles off the Cape kept us off and we put back into Etah to await a possible change in ice conditions. The "Arctic" also made an attempt to break through the pack but she became jammed and we watched her drift about helplessly for two days and then head back southward towards Baffin Land.

On August 12th we ran into Pandora Harbor, a few miles south of Etah, to look it over as a possible wintering place in case we found it impossible to make Cape Sabine or Flagler Fiord. On the 13th we again attempted to cross to Cape Sabine but ice conditions were worse than on the previous attempt and we turned back to an anchorage between Littleton and McGary Islands. We remained there until August 16th when we headed north again, arriving at Refuge Harbor, 78:32 north latitude, on the 17th of August. From this date signals grew steadily better, as the sun was sinking nearer and nearer the horizon. On August 23rd Mexican JH came in very strongly, calling 4EB, and 5's, 6's, 7's, and 9's began coming in in large numbers. On August 23rd the sun dipped below the horizon for the first time since leaving South Greenland. 6CMR was readable three feet from the fones on this date. On the 25th of August we left for a three-day trip to Etah to pick up a cache of rather ripe walrus for our sledge dogs. We ran into Etah again on the 27th and early on the morning of the 28th worked LANA for the last time, being able to give him only our TR and "All's well", altho we copied two messages from him without difficulty. From this date to September 8th we were unable to raise anyone, altho signals, especially those from west of the Mississippi, came in unusually well. The sun at this time was below the horizon from about 10:30 P. M. to 1:30 A. M. and signals were good usually for about a half hour on each side of this period. Sixth and 7th district stations were beginning to come in in great numbers, as well as scores of 9's.

Finally on September 8th, 7DC, J. A. Ruggedge of Bremerton, Washington, succeeded in hearing us but was able to copy only our "All's well". We tried for nearly an hour

but he reported "QRN heavy and U QRZ N.D.", so I had to give him up. On tuning around Canadian 9BP, Jack Barnsley, Prince Rupert, B. C., came booming in calling us and saying "GA U QSA vy". He took our TR and three messages without a repeat, and gave us an account of the Japanese earthquake. For the rest of 1923 Barnsley was our main and often our only connection with the outside world. Enough praise cannot be given to this man for his untiring efforts night after night, bad weather and good weather, early and late without fail. It is one thing to sit pounding out the stuff but an entirely different thing to copy weak, fading signals through constant QRM and most of the time bad QRN. Barnsley did wonderful work. Of the 16,000 words cleared, 8,000 were cleared through 9BP; and of the 13,000 received, 9,000 came through him. On one night he worked nearly two hours copying thirty words under conditions where an ordinary operator would have given up. During September we were in communication with the outside world 15 times, all through 9BP with the one exception of 7DC. He also gave us news dispatches at frequent intervals.

QRN was moderate during this month and there were quite a few good clear nights. On the 17th, 6CEU in Hawaii came banging in for the first time and he was with us for the rest of the winter at quite frequent intervals. Stations in every U. S. district and the 3rd, 4th and 5th Canadian districts, and Mexican JH, were logged. We began to hear a few phones at this time, the first one being WOC, Davenport, Iowa, who was heard signing off very faintly. On the 13th WLAG, Minneapolis and KHJ, Los Angeles, came in very well and nearly their entire programs were heard on the loud-speaker. The number and strength of phone stations increased as winter approached and some of the programs, especially from WOAW, CFCN, WJAZ, KHJ, KFI and WLAG, came in unusually well at frequent intervals during the winter. We were surprised one night to hear CFCN call out "Hello WNP somewhere in the Arctic. Hope you are getting this." On November 25th a broadcasting station in Glasgow, Scotland, came in quite well. This was the only European broadcasting station heard. Also on the morning of the 17th we copied 6CEU about three feet from the phones while working 6ARB, who could not copy him on account of "QSS".

During the last week in September, as the ice had frozen around the ship sufficiently to hold it in a permanent position, we took the original antenna down and put up a cage inverted-L of 6 wires, 6 inches in diameter, running it in a southerly direction. While putting this antenna up I absent-mindedly walked on a soft spot in the

ice alongside the ship and fell thru, taking a rather cool bath. We tried this antenna during the greater part of October but until we shifted it so as to make it lie in the same plane as the old antenna its operation was noticeably inferior; and while the transmitter showed more antenna current with less input, 9BP reported signals weaker there. During the winter we tried other types of antennae and all worked noticeably better while running towards the mouth of the harbor, which was approximately west, than in any other direction.

Communication during October was not as satisfactory as we had hoped for. For the first two weeks conditions were unusually poor, signals being very weak and swinging badly. During this period NSS was so weak that it was necessary to resort to NPL, who came in fine, for time signals. We were in communication but 11 times during October, although the dark period had increased to about 12 hours daily. 9BP handled all our traffic for this month also, with the exception of one message cleared thru 9EBT. Stations in all districts were logged again during this month, despite the poor conditions. On the 24th we changed the antenna to a flat-top inverted L. There was a spreader mounted about two feet above the deck, through which four wires ran practically vertically to the spreader on the foretopmast and thence to a spreader suspended by a rope several hundred yards in length whose end was fastened to a large

tions, up to this time, 9BP had been the only station we could reach with the exception of exchanging with 7AHB in Alaska, 7DC, and 9EBT. During October signals from the 6th, 7th and 9th districts predominated in strength and numbers.

November was the best month for traffic. We were QSO 51 times. Jack Barnsley as usual handled the greater part of the traffic but was assisted admirably by Canadian 4CL and 6XAD. On the 20th 9BP cleared over 1,000 words. On November 16th, I CQ'd and nearly fainted when 6CEU (Hawaii) came back. We worked for about 15 minutes. He said he was using three 5-watters MIM! We hooked up again on the 21st. During this month we succeeded in exchanging signals with several 7's and 9's. On the 20th we worked Can. 3NI, the most eastern Canadian worked from winter quarters; exchanged signals with 2AGB, the most eastern station in the United States worked from winter quarters; and 8BXX, the only 8th district station to be worked while in Refuge Harbor. On November 26th all speed records for relays were broken by the 1HX-6XAD-WNP relay, the account of which appeared in QST for January, 1924, of five minutes and six seconds. After making this speed record everything was set for the Thanksgiving Relay. We heard 6XAD OK the message from 1HX and call WNP, but he evidently could not hear my GA. Later I heard him broadcast it to us and copied it OK but was unable to get the QSL or answer to him or anyone else that morning. On November 23rd 9BZI, 9MZ, 8ZZ, 5ZAV, 6AWT, 6CGW and 7ABB started broadcasting American press daily, which we copied quite regularly throughout the winter and which was of considerable interest to all members of the crew.

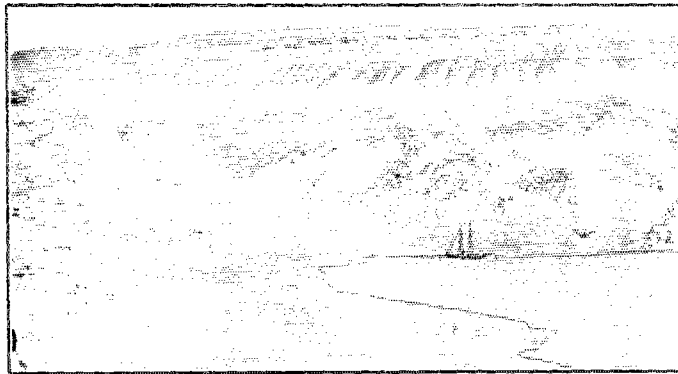

REFUGE HARBOR, showing how the "Bowdoin" was landlocked by towering cliffs. The hills in the center of the picture are 1400 feet high. This photo was taken looking towards the southeast. (Photo by Mix.)

boulder high up on the hill at the head of the harbor. The length of bunched lead was but three feet. This antenna worked noticeably better and early on the morning of October 24th we raised 9BP again, and cleared the first press dispatch in over two weeks. It is a peculiar fact that altho we tried again and again to raise other sta-

7's and 9's formed the majority of the calls heard but were well sprinkled with 5's and 8's.

During December 9BP was closed down and 9DKB, Leonard Weeks of Minot, North Dakota, came forward and did flawless work in filling in the gap left by 9BP's absence. Weeks proved to be another member of that

gang which held on so faithfully during the winter months trying to help us at every opportunity. He certainly stuck to it and cleared a bunch of traffic through heavy QRN. On December 9th, altho QRN was terrific, he copied 1600 words, the greater part without repeat. I shifted to low power after the first 100 words. It certainly was great to hear him come back time after time with his invariable "dit-dah-dit, dah-dit-dah." Canadian 4HH of Moose Jaw, Saskatchewan, and 6XAD also did wonderful work during December. Canadian 4HH took 14 messages on the 16th and 17 more on the 18th. During December we were QSO 25 times. Signals from west of the Mississippi formed the greater part, as always. Signals from east of the Mississippi were much fewer than during November.

Starting December 21st, the opening date of the European transcontinentals, several Europeans were heard nightly until the end of the tests. The list of Europeans heard was sent back via 9DKB and published in QST. The signals from these stations were as a rule weak in comparison with those from the States, although Dutch PA-9 could be heard outside the ship on the harbor ice on the loud speaker.

On December 29th we heard LWZ, Amundsen's ship "Maud," which is drifting in the polar sea, working Spitzbergen on 600 meters, and from that date until late in February we heard her sending meteorological reports and position reports almost nightly. We could also hear Spitzbergen relaying the reports to North Cape, Norway.

Conditions during December, especially the first week, were poor. It was about this time that we began to have trouble with a phenomenon which we noted in the log as "QRN storms". This was a roaring or hissing like escaping steam—something like the noise the old audiotrons used to make when the filament was turned up too high. These storms would come on without warning and last anywhere from an hour to a couple of days. They seemed to come mostly when a strong northeast wind was blowing, drifting snow over the harbor. An instrument in the magnetic observatory operated by Mr. Richard H. Goddard, of the Department of Terrestrial Magnetism of the Carnegie Institution of Washington, recorded the fluctuations in the voltage of the atmosphere. On comparing the records obtained from this observatory with our radio log we found that as a rule the atmospheric voltages were running high when the air was perfectly clear of storms. These storms occurred at uncertain intervals from early December until late winter or early spring when the sun was well on its return trip. The interference varied considerably in intensity from time to time. It was often so bad that it was impossible to copy even the strongest signals. It was of equal intensity

on long waves and short waves. QRN of the usual type was also bad during the greater part of the winter.

During the month of January we were in communication 35 times. Canadian 9BP was back on the job again and he and 9DKB shared most of the traffic. Canadian 4HH also handled a bunch. Conditions were very poor, QRN storms occurring almost nightly, and signals on an average were weak and fading badly, altho there were one or two nights when the signals came bumping in fine. Signals were exchanged with 7OM and 7OB, both using 2 five-watters, and with 7DJ, who was using but one 5-watter. The signals from these stations were much stronger than many $\frac{1}{4}$ K.W. sets.

The return of the sun in February was accompanied by an abrupt decrease in signal strength, so we were able to work but 8 times. Altho 9BP and 9DKB were on and tried to get thru to us, we were not able to work Barnsley at all and 9DKB but twice. 7DJ, Everett Sutton, of Port Angeles, Washington, with his little five-watter handled most of the small amount of traffic despatched during this month. On the 19th we worked 6CEU for the last time, exchanging 73's. QRN storms were frequent during the first part of the month but disappeared entirely during the last half of the month, as did most of the type of QRN to which we are accustomed in lower latitudes.

Signals diminished rapidly in number and strength as the sun swung higher and higher. During March we were able to reach civilization but once, which was on the 3rd, thru Can. 4HH, who took one and gave us three messages.

During the first week in April in a last effort toward a possible improvement in our antenna, we ran a rope about a half mile long across the harbor above the ship, from a hill top on one side to one on the other side, and from this rope which passed over the ship at a height of about 125 feet dropped four wires to the deck, making a four-wire vertical fan antenna which was used until the ice broke up. Nearly all rope of any description which was available was used, from the ship's halliards to dog traces.

The next date on which we were able to break thru was April 14th, when, after over a month of vain attempts to raise someone, 7DJ answered a CQ and reported "QSA". We worked for an hour without trouble, his signals being heard a couple of feet from the phones and 7DJ copying our signals with only an occasional repeat. He answered our CQ at 12:34 E. S. T., which was 9:34 his time. It must have been still twilight there, while the sun was above the horizon at Refuge Harbor. 7DJ was the last station we were able to raise, altho nightly watch was kept for about a month after this date. Signals grew steadily weaker and weaker until within less than

two weeks after working 7DJ no signals could be heard on short waves at all, and those of long wave high-powered commercial stations were weakened until it was impossible to copy press from POZ.

In the middle of May I reported radio conditions to Capt. MacMillan and told him that as the supply of oil was rapidly diminishing, I thought it inadvisable to run the transmitter regularly, as the possibility of raising anyone was extremely improbable except under very freak conditions. As a result, regular watch was abandoned until we started home on August 1, 1924. As soon as the ice broke up around the ship about the first of June and she was free to shift with the wind and tide, it was necessary to abandon the aerial support on land and return to the original ship's antenna which we had used until the "Bowdoin" froze in.

We left Refuge Harbor on August 1st and made a fine run down the coast of Greenland, making several stops enroute, one stop being made at Godhavn on Disko Island. Here we saw the concrete foundations of a radio station which is being installed as one of three or four to be built on the west coast of South Greenland, to work on the same scheme used on the Labrador coast, with one high-powered station at

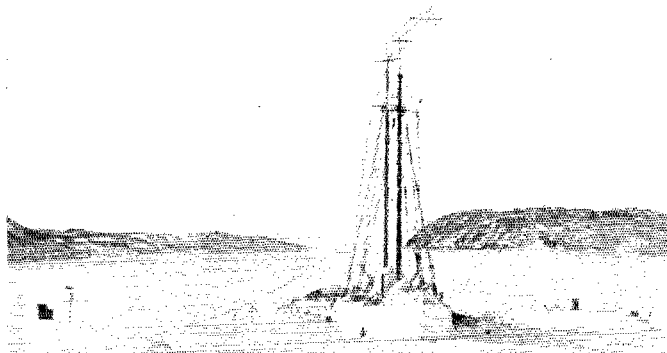

A VIEW of REFUGE HARBOR looking slightly south of west, the entrance to the harbor being almost directly behind the "Bowdoin". The free end of WNP's antenna pointed a little north of east. Note also the snow wall around the ship, built for winter protection. (Photo by Mix.)

Juliannehaab, which will communicate with Copenhagen direct.

While stopping at Godthaab a Danish civil engineer who was working on the radio installation there asked us to get a message to Copenhagen for him. We had not the slightest idea how we were to do this, but on listening in that night heard LWQ, a Norwegian whaler, working TFA, Reykjavik, Iceland. We called him on our longest wave of 300 meters and luckily suc-

ceeded in raising him. He took the message and QSR'd it to TFA, who was QSO Copenhagen.

Signals increased in strength as we went south and finally on the 26th we succeeded in raising 9CDV in East Grand Forks, Minn., and in giving him our TR. From this date until our arrival at Wiscasset on the 20th of September signals increased tremendously and we were in practically constant communication with the States. The fellows surely did hang on. IRV of South Hamilton, Mass., handled most of our traffic until we reached Newfoundland, when IMO's special station came on and handled the remainder of the traffic, in all about 300 messages, until we docked.

Several "freaks" occurred during the winter at Refuge Harbor. 9BZI while broadcasting press to us one night said that a heavy snowstorm had covered his lead-in with slush and that his antenna current had diminished to practically nothing, so he would not send any more. His signals were still strong when he signed off. 5ZAV while broadcasting press to us blew one of his two fifty-watters and continued on one. His signals were fully twice as strong as when using the two. 9DKB while working us one night blew his fifty-watter and substituted a five-watter. His signals were so increased in strength that there was no comparison between the two.

On December 9th signals at Refuge Harbor were very weak and QRN exceptionally bad, but 9DKB copied 1600 words in three hours on our low power. Aside from this instance and possibly a few others, all traffic was cleared with greatest difficulty, repeat after repeat being necessary, and enough credit cannot be given to those fellows who stuck at the job and copied our weak and fading signals. The majority of

the time the signals from the stations we worked were quite consistent and there were many nights when Can. 9BP and 9DKB sent a long string of messages which were copied without a miss, but often under these circumstances they were unable to get even our QSL until several nights later when we swung in again.

Very little aurora was seen while we were in winter quarters, but on our way home down the coasts of South Greenland

and Labrador the sky was at times covered with the displays, but they in no way affected the reception of signals on any wavelength.

Commercial spark signals on 600 meters were generally lacking thruout the winter, but on favorable nights we logged WNU, New Orleans; NAY, Port Isabel, Texas; FFU in France, and several English stations, as well as hearing the commercial stations all along the Pacific coast of North America. Signals from those on the Atlantic seaboard with the exception of WIM's I.C.W. set were practically never heard. Long-wave alternator stations on the Atlantic coast were strong but those on the Pacific coast and in Europe were much stronger. It was possible to copy NSS press on only three or four occasions under very favorable conditions.

Amateur spark stations both in the 6th district and 9th district were logged, but of course could not compare in strength or consistency with C.W. signals from the same locality.

According to observations made during the winter, a fairly well rectified 60-cycle plate supply seemed to give the most consistent signal. D.C. signals were perhaps easier to copy thru heavy QRN but they had a tendency to swing badly. 500-cycle supply seemed to be the poorest proposition. The signals seemed to swing badly and were easily broken up by QRM and QRN and did not have the kick of a rectified 60-cycle signal. While on our way up the Labrador coast 8AWP shifted from 500-cycle supply to rectified 60-cycle and his signal strength was fully doubled. 9MC also used both and his 60-cycle supply was much superior.

During the winter we copied scraps here and there to the effect that experiments were being made on waves below 200 meters but we had no idea that they had been so successful. During the winter we had an available wave of 175 meters but the stations we worked invariably reported N.D. on this wave and requested QSY back to 220. There is no doubt but that if we had been able to get down to one hundred meters or lower we would have been able to keep in constant communication during the light period as well as the dark period.

During the entire trip every detail of the apparatus stood up wonderfully. Both

transmitter and receiver worked faultlessly without attention. It was not necessary to replace a single tube nor even a B battery, during the entire trip of 15 months.

Several false reports have been issued by stations who reported working WNP.* The following is the correct list of stations worked while en route to and from Refuge Harbor and while there. From points

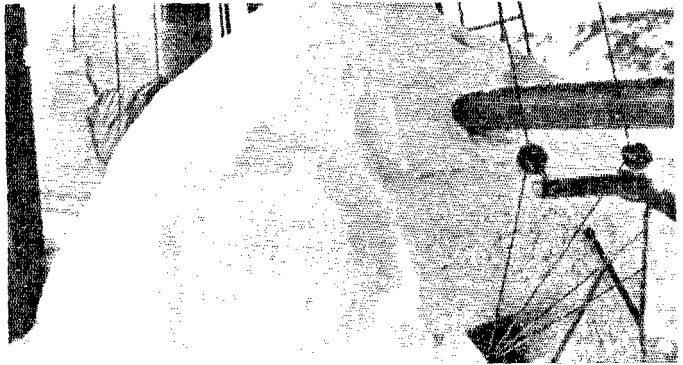

THE WINTERTIME LEAD-IN arrangement on WNP. An igloo was erected over the foreccastle hatch, and in this a port was cut for the wires to enter. The four wires of the antenna dropped vertically from the foretopmast to a short spreader mounted on the winch, and thence to the lead-in insulator within the igloo. (Photo by Mix.)

south of Jack Lane's Bay, Labrador: 1CKP, 1CRW, 1FM, 1UJ, 1FB, 2CQZ, 1CPI, Can. 1AR, 1DD. From South Greenland: 1ZE. From Refuge Harbor: 1ANA, 2AGB, 6AKW, 6BCL, 6CEU, 6XAD, 7ABB, 7AHB, 7AIB, 7CO, 7CX, 7DC, 7DJ, 7KS, 7OB, 7OM, 7SC, 7SF, 7ZU, 8BXX, 9ACK, 9APF, 9AVZ, 9BTT, 9DKB, 9EBT, 9ZT, Can. 3NI, 4CL, 4DQ, 4FN, 4HH, 5CT, 5GO, 9BP. On the return trip the following were worked. From South Greenland: 2CBG, 9CDV, VDM. From the Labrador coast: 1AGO, 1RV, 1TS. From points south of Labrador: 1ASR, 1AZT, 1BDV, 1CST, 1MO, 1MY, 1RA, 2BRB, 2CQZ, 3CJN, 3DU, 8AQ, Canadian 1DD.

* We are surprised to learn from Mix that he never worked 1BVR, as reported in September QST and overheard by several other stations, and that the message received by 9FB, as reported in August QST, was likewise a fake. Someone with a distorted sense of humor victimized these amateurs and represented himself as WNP.—Editor.

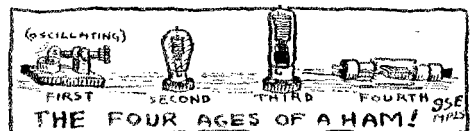

Parallel Operation of Power Tubes

By James H. Turnbull*

THE problem as originally outlined by the vacuum tube section of the General Electric Research Laboratory was to find the cause of the ultrahigh frequency oscillations commonly met with when a number of tubes are operated in parallel. The efficiency of such multiple oscillators was also to be investigated. As the work progressed it was found that several factors contributed to the losses in multitube sets and each was in some measure investigated. In this report, conclusions with supporting experimental facts have been given rather than to include all data and observations.

Thanks are due Dr. W. C. White, Dr. John C. Warner, Dr. A. W. Hull and Mr. E. W. Kellogg, all of the Research Laboratory of the General Electric Company.

The Problem

When we attempt to operate several tubes in parallel as oscillators we almost never get an output per tube as large as if we were using a signal tube. A typical case is given in **Table 1**.

TABLE 1

Fifty watt thoriated filament tubes in Hartley circuit. (A constant dissipation of about 60-70 watts per tube was controlled by means of an optical pyrometer—Circuit adjusted for this value with maximum output. Separate grid leaks).

No. of tubes oscillating	1	2	3	4
Plate current	200 ma.	380 ma.	550 ma.	725 ma.
Grid current	8 ma.	15 ma.	24 ma.	31 ma.
Antenna current	3.5 amp.	4.5 amp.	5.1 amp.	5.6 amp.
Approx. antenna resistance.	9 ohms	9 ohms	9 ohms	9 ohms
Watts input	110 w.	185 w.	240 w.	290 w.
Ratio of watts output to input milliamperes.	1.55	.49	.44	.40

(Supply A.C. at constant voltage.)

The Difficulties

There are several separate and distinct

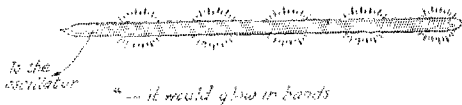

FIG 1

effects to be considered. The most obvious of these is the ultrahigh frequency oscilla-

tions (ordinarily called parasitics) which vary in wavelength from one to ten meters. The cause of these will be discussed in detail later and the remedy suggested.

When tubes are put in parallel their capacities are also in parallel, as are those of the sockets. After a certain number are connected this capacity has become so high that efficient operation is impossible. This trouble is more prevalent at the higher frequencies. About a certain value of capacity the tubes entirely refuse to oscillate. In one of my circuits with 800 volts D.C. applied the apparent limiting value of oscillation for the tube was approximately as follows:

One tube,	15 meters.
Two tubes,	23 meters.
Three tubes,	28 meters.
Four tubes,	32 meters.

These tubes had an approximate grid-plate capacity of 18 to 24 micromicrofarads. I do not maintain that these are the lowest possible wavelengths at which these tubes will oscillate but merely wish to show how in one particular circuit arrangement the lowest wavelength is changed by the number of tubes.

Obviously there is a drop in the plate impedance and what appears to be a decrease in the amplification constant.

There was encountered a condition of cross current much like that gotten in the paralleling of 60-cycle transformers. This will be discussed in detail later.

The tubes used in these tests were of low impedance, low amplification constant, and with thoriated filament. Some trouble had been experienced in connection with parasitic oscillations in these tubes. For the most part the tests were conducted with a conductively coupled artley circuit, although the Meissner and tuned grid were also employed.

The tubes are not available on the market and were chosen for the experiment solely because it was known that they exaggerated the effects which were being investigated. Many measurements were attempted but the difficulties were so numerous that no great accuracy could be obtained. None of the values given here should be regarded as of greater accuracy than 10%.

Ultrahigh Frequency (parasitic) Oscillations

At times, for no reason, a multitube oscillator will work at two independent frequencies, the frequency of transmission

*Late of Union College, Schenectady. Experimenters section A.R.R.L.

(and its harmonics) as well as a second frequency which is much higher and usually from 200,000 to 20,000 kilocycles. $1\frac{1}{2}$ to 15 meters.)

The wavelengths of these extra oscillations were measured in several ways. The familiar standing waves in parallel wires (Lecher wires) were used as a standard. Greatest sensitivity was found at the current loops, where a hot wire galvanometer was used shunted with a short copper bar. This method was not rapid and was inconvenient for a single person. Hence a glass tube one centimeter in diameter was space wound with fine copper wire varnished into place. This tube was about one and one-half meters in length. The tube was evacuated and a very little gas put into it. Now when the tube was brought near to an oscillator it would glow in bands. Fig. 1. The tube was calibrated against the standing waves on the parallel wires and after that served as a very useful measuring device for shorter waves. In this way the short waves could be measured conveniently.

The currents at these short waves were more difficult to measure because any meter had a certain amount of resistance and this frequently stopped the high frequency oscillation. Finally a special thermo-couple was sealed into a notched piece of nichrome ribbon and the presence of parasitics determined by nothing whether there was a change in the galvanometer deflection when the current was sent thru the strip. If I suspected that the heating effect was due to the longer wavelength and to the direct current I would put 10 or 15 ohm resistance in series and arrange a key to short circuit this extra resistance as in Fig. 2. In the main circuit the working-frequency-current would not be changed much by operating this key but a quite small parasitic current would be strongly affected, hence its presence could be detected by watching the galvanometer carefully while operating the key.

Energy Loss By Parasitics

Due to the low impedances at these high frequencies the currents flowing are some-

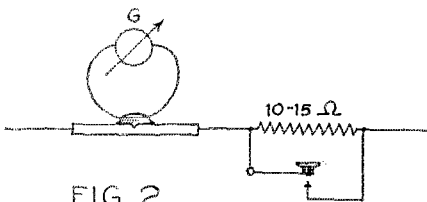

FIG. 2

times very large and consume considerable energy uselessly. With 50-watt tubes parasitics as large as 11 amperes were measured with a hot wire ammeter of .04 ohms resistance. Now this is not a true test since we introduced an appreciable resistance

(.04 ohms) in the circuit. *Probably the currents were larger before that.*

In every case moving the leads connecting the plates and grids in parallel (Fig. 3) will either change the wavelength of the parasitics or cause them to stop. When the wavelength of the Hartley circuit was changed by varying the number of turns in the antenna coil no change in the wave-

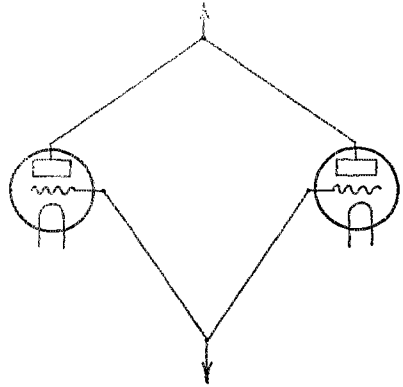

FIG. 3

lengths of the parasitics could be detected. In a tuned grid, tuned plate circuit (Meissner) the parasitics were found to be the worst. This was when the tuning was accomplished by condensers. When tuning was done by variometers the parasitics greatly decreased. In an inductively tuned circuit the wavelengths of the parasitic oscillation was decreased.

Curing Parasitics

It has been pointed out that these could be eliminated by resistance in the grid or plate circuit or by means of chokes. These remedies all reduce the currents of parasitic frequency. Other devices were also tried. When a small low-loss coil is put in the plate circuit of each tube near the plate binding post, Fig. 4a, the current at the main wavelength falls off very slightly and the wavelength is raised a trifle. By shunting a small condenser from the grid to the plate of each tube, Fig. 4b, it was found possible to get them into oscillation at various waves up to 28 meters without effecting the main wavelength of 200 meters at all. If two tubes were used in parallel and the condensers on one set at maximum while the other was set at minimum it was not possible by any juggling to generate parasitics. So long as the nodes lie in the inductances, we continue to have oscillations but when we shift either of the nodes into the condensers, the oscillations cease immediately. Placing resistance close up to the plate terminals of each tube, Fig. 4d, will abolish parasitics. This agrees with

theory for we find that with a given resistance oscillations will cease.

The useful effect of chokes in stopping parasitics is also probably caused by the resistance; that is the effective A.C. resistance of the coil at the parasitic frequency is really what stops these ultrahigh oscillations. In order to check this fact small low resistance chokes were tried in the circuit and it was found that oscillations at the parasitic frequencies stopped immediately when a small iron bolt or nail was put in the choke so as to increase the resistance. (This should not increase the inductance much at the very high frequency because of the low permeability of the iron at such frequencies.—Tech. Ed.)

A circuit with high ratio of inductance to capacity was not as badly troubled with parasitics as one with large capacity. The oscillations never occur when a single tube is operated but are frequently found in the amplifier of a master oscillator and have even been detected in parallel oscillators for speech frequencies.

The Real Cause of Parasitics

It is evident that there is no simple connection between the main frequency of oscillation and the parasitic frequency. *Only one conclusion can be drawn; that there is present somewhere in the set a circuit which is definitely resonant to the parasitic frequency.* It is also evident that in this circuit the tube capacities are not operating in parallel for if they were, a single length of wire 5 centimeters long would produce the necessary inductance and the actual wire length is greater than this. In addition it can be shown that with such a ratio of capacity to inductance oscillation could not be maintained. Since both tubes are obviously taking in the oscillation there remains only one possible conclusion, *that the tube capacities are acting in series.* This arrangement is shown in Fig. 5, first,

compares with those that are actually present. In addition the ratio of C/L is such that oscillations would be sustained. A sample calculation is tabulated below.

CALCULATION OF THE NATURAL PERIOD OF PARASITIC CIRCUIT

Measurements:

- Internal tube capacities 13-14x10⁻¹² farads.
- Connecting leads 1 mm. in diameter. 15 cm. long. 10 cm. average separation.
- Inductance of leads.
- L/cm. len. = 2 ln d/r + .5 abhenries
- L = 30 x 2 x 6.9 + .5
- L = 430 x 10⁻⁹ henries

Internal capacity of tubes in series = 7 x 10⁻¹² farads. This gives a natural period of 103,000 kilocycles or about 3.0 meters. In practice the wavelength was less than this, being for this case about 3.5 meters.

During the war attempts were made by the French under Prof. Gutton to employ this property to generate very short waves, which could be detected by the rays of a searchlight. They eliminated the higher frequency and utilized only the very short waves which we are now regarding as a "parasitic". It is possible to get about the same amount of energy as on the longer waves. The great difficulty is in coupling this into a radiating system.

Equalizing Loads

The comparison between a tube and a motor generator set has long been used to clarify certain things about tube operation. It is but one step further to think of the similarity of a pilotron to a step-up transformer where the grid-filament corresponds to the low side of the transformer and the plate-filament corresponds to the high side. Suppose we take two or more transformers of slightly different ratio and

try to operate them with the primaries connected in parallel and the secondaries connected in parallel. One will take a major portion of the load because it has a higher secondary voltage. This will result in circulating current between the transformer secondaries. We have a similar condition in the pilotron. The difference in amplification constant corresponds to the difference

in ratio of transformation. The difference in the grid plate capacity corresponds to the difference in leakage of transformers. The first condition (difference in amplification constant) is independent of fre-

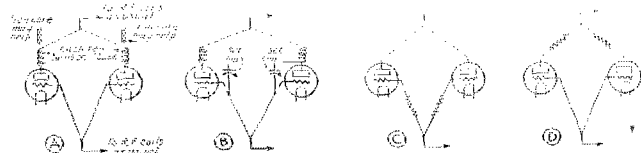

FIG 4 REDUCING PARASITICS

NOTES: Filament wiring omitted to simplify diagram. In Case D it will not do to use a big spread-out resistance. Use a curved lead which may be wound with small resistance wire.

as encountered in the actual tube and second, diagrammatically.

This theory can be checked. Calculating the tube capacities in series and taking a probable value of the tube connection we arrive at a resonant frequency which com-

quency but the second (difference in grid plate capacity) is a direct function of frequency and accordingly very troublesome at short waves. The first condition may be handled mathematically in a way similar to the treatment of losses in the parallel operation of oscillators. For this see Proceedings I.R.E. of September, 1920. The second does not lend itself to symbol analysis.

In practice tubes which do not differ by more than 5% will operate satisfactorily above 50 meters.

If it is desired to make all tubes take even load no matter how widely their characteristics may vary this can be done by using separate variable grid leaks and grid condensers. Attention must be paid to the fact that each of these resistances carries the grid current of a single tube and that if only a single grid resistance and condenser are being used, they should have a much lower resistance in proportion to the number of tubes being used. Putting it differently, if four tubes are being used in parallel with a single grid leak which serves all of them this leak should have about one quarter of the resistance that would be used for a single tube. This is often overlooked. For maximum efficiency a corresponding change will have to be made in the grid condenser, that is to say it would have four times the capacity. A grid meter assists in making these adjustments when we remember that the grid current should be proportional to the number of tubes. These facts are commonly neglected in otherwise carefully constructed and designed oscillators.

"Double Frequency"?

One of the popular magazines definitely attributes most of the undesirable interference to the use of multiple oscillators. It maintains that these tubes are oscillating close together. This is not correct. If independently at separate frequencies very we use common grid leaks and condensers it is quite impossible for the tubes to oscillate except in synchronism. We may think of our inductances as a lump inductance and our capacities as a single capacity which determine the frequency. Even two oscillating circuits independent from each other excepting through coupling will tend to oscillate at the same frequency. An illustration of this lies in the fact that with a fairly powerful oscillator coupled very loosely to a heterodyne wavemeter it is quite impossible to get beat notes lower than about 100 cycles because from that point onward the large oscillator forcibly drags the smaller one into synchronism. This effect will be much increased in a parallel tube transmitter where the coupling is so much closer. Further proof lies in the fact

that in listening to C.W. stations we are never troubled with a beat note unless we are using an oscillating receiver or another oscillating receiver is being used nearby. The transmitter itself does not transmit beat notes and therefore evidently did not

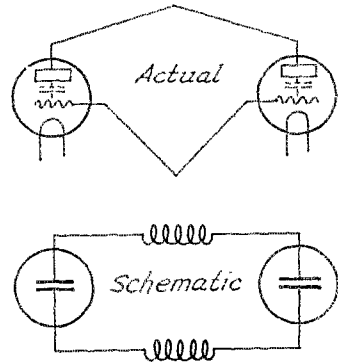

FIG. 5 WHERE PARASITICS BEGIN

generate them. Furthermore it will be noticed that with all strong incoming signals the zero beat tuning will extend over some little portion of the range showing that there positively is *not* a double frequency present.

Attention Superheterodyne Owners

Since the appearance of "Superheterodyne Trouble Shooting" (August QST), Captain H. J. Adams has been besieged with requests for filters to be used in all manners of superheterodyne receivers.

Captain Adams wishes to call attention to the fact that each kind of set requires a *different filter* and that it is a laboratory job to determine what will fit any particular set. Of course one can scrap the existing transformers and put in a new set clear thru, together with a suitable filter, but that amounts to building a new set.

The alternative is to run curves on the existing transformers and then to fit a filter to them. Captain Adams' Signal Corps duties do not permit him to do such work. However, he suggests that if anyone is seriously enough interested to send the set to Philadelphia he can see to it that a proper job is done. The owner of the set may use his own discretion as to what he wants—a complete new set of transformers or measurements on the old ones from which a special filter can be built.

Hassel's Super-Zenith Circuit

By Healdon R. Starkey*

FOR the past two years radio-frequency amplification at the broadcast and amateur waves has been approved and rejected, knocked and boosted, canned and re-instated until the average person has come to the conclusion that "radio-frequency amplifiers are all right when they work, but they only work when they feel like it," whereas the real trouble all along has been that the radio-frequency amplifier was only partly developed. If the writer's memory hasn't gone back on him, the front rank of the radio-frequency army consisted of a horde of transformer-coupled potentiometer-controlled circuits which put up quite a battle but presently retired in disorder before the counter-attack of the old standby regenerative circuits.

Then came the second wave, a doughty army of impedance-coupled amplifiers, most of which used variometers for the tuned impedance and the same old potentiometer control, with a division of recruits from the scattered front rank reorganized in the form of "tuned transformers". The term transformer is here used in its popular sense, to mean a coupling device into which sufficient losses have been introduced to make it cover a wide band of frequen-

detector, and finally we had the reversed tickler and neutrodyne types with their various hybrids.

In beginning his efforts to build a radio-frequency amplifier that would have all of the advantages and none of the disadvantages of the types which had gone before, Hassel started his experiments logically with a few of the better ones, and by the process of elimination arrived at a simple circuit which represented the accumulation of the best points in the circuits which had gone before, having sensitivity and selectivity and being well adapted to the "logging" of stations. The circuits also had the following weaknesses which he then proceeded to overcome.

Difficulties

The first disadvantage to be overcome was the marked decrease in the transfer of energy from one stage to the next with the increase of wavelength. This means that the circuit would give maximum sensitivity on only one wave. This had been perhaps the biggest stumbling block in the path of previous experimenters, and Hassel's solution of this problem forms the basis of a patent application, which promises to be one of considerable importance in the field of radio reception.

The second disadvantage was that the circuit shown in Fig. 1, had no means for adaptation to the wide difference present in even the best makes of tubes at present on the market. In fact no thoroughly satisfactory means of doing this had been found in any of the circuits tried.

The third disadvantage was that a man would need *three hands* in order to tune the set in comfort.

The fourth disadvantage was the difference in energy transfer from the antenna to the first tube at different frequencies, the solution of this problem being the same as that of the first.

The Cures

Going to the root of the matter, Hassel decided that before it would be possible to build a really satisfactory r. f. amplifier it would be necessary completely to overcome the first and biggest difficulty. Other experimenters had puzzled over finding a way to equalize the transfer of en-

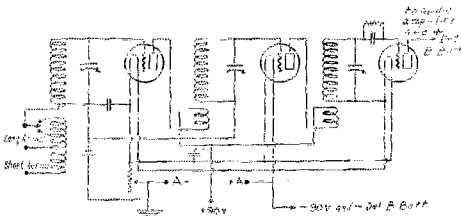

FIG. 1 THE CIRCUIT FROM WHICH THE START WAS MADE

cies. The so-called "tuned transformers" simply have a hump at the lower end of the scale which is shifted along the scale by a variable condenser in the case of the fixed transformer and by variometer action in the case of the variotransformer.

Then there came that marvellous destroyer of religion which has been called a "cascaded regenerative receiver," inasmuch as both grid and plate were tuned in both the r. f. amplifier and detector with loose coupling between the plate circuit of the r. f. tube and the grid circuit of the

1—K. E. Hassel, Chicago Radio Laboratory, also Zenith Radio Corp. Author "Short-Wave Tuner Design" and "SF" at 9ZN.

* Research Department, Zenith Radio Corporation.

ergy at different frequencies, some of them partially solving it by introducing lossers into the field of the coils which caused higher losses at the higher frequencies, thereby effecting a partial balance. But can you imagine "Low-Loss" Hassel even giving a second thought to such means?" He calmly did the thing which is so obviously the simplest and most efficient way of meeting the difficulty that everyone who sees it either says "Why didn't I think of that!" or "I thought of doing that but didn't have the patience to work it out." He simply took a portion of the plate coil and mounted it on the condenser shaft so that it rotates inside the grid coil of the succeeding stage, in such manner that the rotating portion of the plate coil *opposes* the coupling from the fixed portion at the low waves and *adds* to the coupling at the high waves, rotating with the condenser thru its 180° of revolution. The circuit arrangement is shown in Fig. 2.

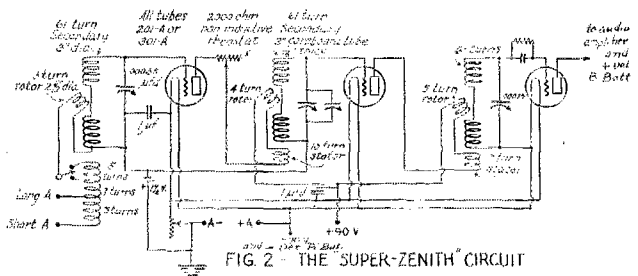

the plate circuit of the first tube (the critical one) having a sufficient range of resistance to compensate for all reasonable variations in tubes. This is shown in Figure 2.

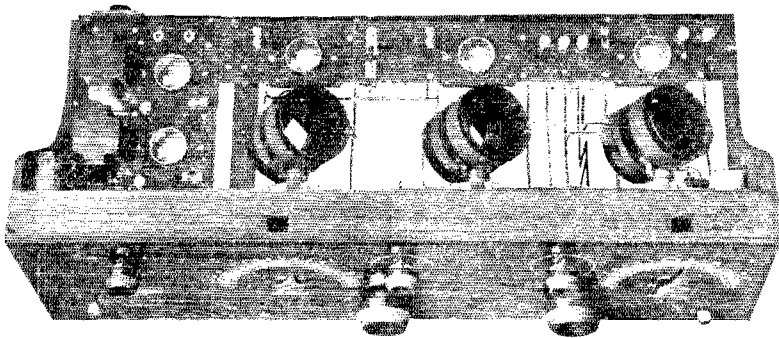

Fig. 3—LABORATORY MODEL OF THE SUPER-ZENITH. At the back of the set is the strip carrying the r.f. tubes and the detector, also the filament resistances in the shape of small cartridges which can be changed to fit the type of tubes used. The longer cartridge is the grid leak. The transformers with the rotating plate coils are located just ahead of the tubes, but the variable condensers cannot be seen. At the left is a three-stage audio amplifier with a stage-control switch. The large knobs at the lower edge of the panel are on the vernier shafts—there are no knobs on the main shafts.

Having thus conquered the first and biggest obstacle, the second in importance was adaptation to the differences in tubes. In hunting for the solution of this problem, Dr. Spaeth (well known as the inventor of the electric arc system of nitrogen re-

The third problem was a mechanical one, the tuning of two sharply resonant circuits simultaneously with one knob, so as to make it possible to tune the set in comfort with the normal human allotment of two hands. While purely mechanical, this was by far the most intricate problem of the three, and merits treatment as a separate subject. Suffice it to say this time that it was solved by Mr. H. Perlesz, the manager of the Research Division.

2—The point being that the whole "low-loss" agitation started with the famous Hassel article "Short-wave Tuner Design" which appeared in December 1923 issue of QST.

Figure 3 is a photo of one of the more recent models and Fig. 4 is a photo of the set dressed up in its best clothes.

The "Super-Zenith," as this circuit has been named, has some rather astonishing records to its credit, having tuned in stations when all that could be heard on the same waves on ordinary sets was static. On at least one occasion during the summer it put KDKA on the loud speaker with

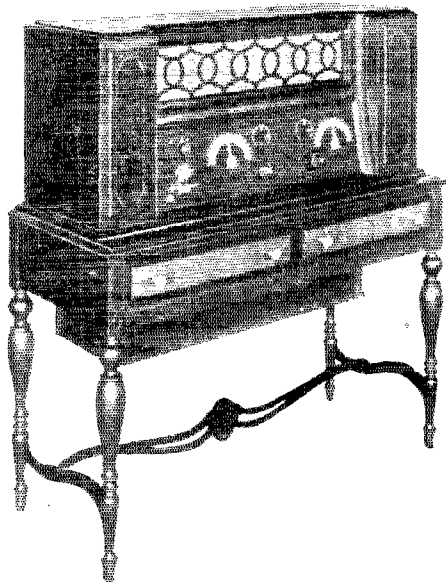

Fig. 4—

The Super-Zenith "All Dressed Up In Its Best Clothes."

dancing volume without any kind of aerial or ground. And also during summer it put Pacific Coast stations on the loud speaker with a 25-ft. wire on the floor for aerial. Another feat was to cut out WLS (Chicago) and get KGC (Oakland, Cal.) 19 meters apart, at my room which is exactly 2 blocks from WLS. One hot summer night I happened to pick up a 6th district ham while making some tests using a small U. V. 199 oscillator and I was so surprised I went fishing for others and in about twenty minutes heard several districts, using the 199 tube oscillator as a separate heterodyne, and this was on a night when static put the regenerative sets right out of business.

The circuit has not been tried very far below 200 meters but there is no apparent reason why it should not work down on the shorter waves, at least to 100 meters.

In closing let me say a few words for the benefit of any who wish to build one of

these sets. Do not be fooled by the simplicity of the circuit into thinking you can buy a bunch of parts Saturday afternoon and be ready to receive by Monday night. I am not saying this to discourage anyone, but to make the builders realize that they must use all their skill in designing a set of this type, or they will be as much disappointed as they have been with other r. f. amplifiers. It is literally true that carelessness in placing a single wire may completely ruin the operation of the set. Also do not expect to use the same number of plate turns as shown in the diagram. The kind and arrangement of parts and wiring affect the number of turns greatly; better put plenty of turns on both stators and rotors and tear off one at a time until you get the proper balance, and be prepared to start in and wind them all over again. The angle of the coils must also be determined experimentally. If the spacing of your coils is seven inches from center to center, try 56 degrees to start with. Above all don't try to run two of the condensers on one knob unless you are a bear-cat mechanic. If you do want to try it the second and third condensers are the ones to team up, and don't forget a separate 3-plate vernier to bring the two circuits exactly into resonance with each other before starting to tune. This circuit has given me more thrills than any other I have handled and I feel quite justified in saying that those who build it right will be well repaid for their efforts.

Coming:

Dakota Division Convention

Fellows, put these dates down:

FRIDAY, NOVEMBER 28th.

SATURDAY, NOVEMBER 29th.

Two days so full of interesting events that it is impossible to give the complete details in this notice, but for all the stunts planned including Dinner, Wouf Hong and Rides it will cost only

\$4.00, just \$4.00; that's all.

The meetings will be held in the Electrical and Engineering Building, University of Minnesota, MINNEAPOLIS.

Write H. D. Jones, 9GT; L. C. Smedy, 9AUL or G. W. Volkenant, 9IG-9VL, for details.

—A. A. H.

Thomas Ensall of 1208 Grandview Avenue, Warren, Ohio, offers to take your old spark junk in trade on new apparatus. This, at least, prevents the obsolete stuff from being a total loss and ought to be interesting to some of us.

Antennas for Short Waves

By H. F. Mason, ex 7BK

EVERY amateur now has a splendid chance to try out his pet theories on antennas. There has not in the past month been much experimentation along this line as there might have been because most amateurs were not blessed with the room to try different antenna systems, nor the high masts that were usually called for. On the short wave amateur bands, however, antennas can be made small enough to be easily built and changed without much trouble. Working an antenna on a harmonic, explained by Mr. F. Dawson Bliley on page 12 of the August QST, is not now being considered.

To have a vertical cage antenna has been the pet ambition of most every amateur for years. This ambition can now be realized on the short wave bands. What is more, the supports for the vertical antenna need not be so high as to require elaborate guying.

An example of an antenna especially for the short wave bands is shown in the sketch. The insulators are eighteen inch glass towel bars obtained for ten cents each at a dime store; the cages are each about eight inches across but may be tapered if desired. The top spreader is a piece of clear 2 by 2 spruce, 12 feet in length. The spring in this top piece keeps the cages taut.

The above antenna, when used in conjunction with a 15 foot ground lead to salt water was found to have a fundamental wavelength of 93 meters; making it almost ideal for use on the 75-80 meter band with a series condenser. When used in conjunction with a counterpoise of one wire 25 feet long and one foot high, the fundamental wavelength was lowered to 40 meters. This great decrease in the fundamental is caused by the capacity between the counterpoise and the ground acting as a series condenser. A multiple wire fan counterpoise would raise the fundamental wavelength of the system because it would be equivalent to using a larger series condenser.

The antenna just described can be used in another way. One cage can be used as the antenna and the other as the counterpoise in any of the standard inductively coupled circuits. The action here is similar to that of the familiar Hertzian oscillator, except that the two parts of the system have been brought around closer together, increasing the natural wavelength, the cap-

acity and the current flow. When used as a Hertzian oscillator the downleads should be separated several feet or more.

Loop transmission becomes very effective on short waves. A good transmitter loop, though not rotatable, can be made by modifying the antenna shown in the sketch. Bring the downleads from the two cages into the station separately and connect a small coupling coil between them. This coil is in turn coupled to the sending set. Now at the top of the mast, connect the two cages together through an insulator. The capacity through this insulator serves as the loop tuning condenser, so the insulator should be a good one. An Ohio Brass porcelain insulator or a Pyrex insulator will serve. Maybe the capacity through the insulator itself will not be sufficient to allow the loop circuit to oscillate at the desired wavelength. If more

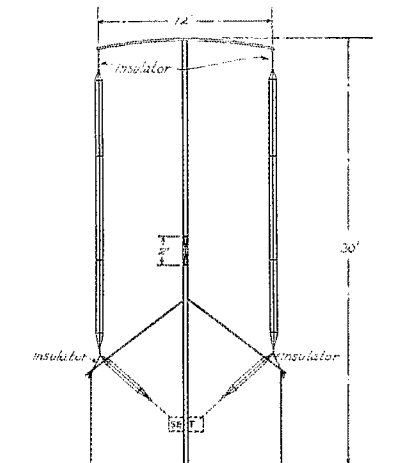

An experimental Short Wave Antenna

Antenna used at 1AKI, Eastern Summer Headquarters of the 7th District—a thing unique in amateur radio history. Erected and operated by 7BK, H. F. Mason (Dept. Editor of QST and former N. W. Division manager.), 7BG, K. W. Weingarten (Northwestern Director A.R.R.L.), 7ZQ, W. E. Slauson (of Washington and Wyoming and now operating on the Luckenbach line) and 7OE, Lieutenant Commander S. M. Mathes, U.S.N., (former N. W. director A.R.R.L. and now stationed at Gloucester with N.S. Shawmut).

capacity at the top is needed, fasten a tin piepan to each end of the insulator, run-

ning the wires through the center of the pie-pans so as to support them in a parallel position like the plates of a condenser. If less capacity at the top is needed, use a longer insulator, such as an 18 inch towel bar. By having a wavemeter equipped with a flash lamp at hand for frequently measuring the transmitted wave during the experiments you can soon arrive at the right top capacity for about the wavelength you wish to use.

The final adjustment can then be made by varying the number of turns in the

tenna so the signals would slide off easier, is not so much of a joke after all!

STATEMENT OF THE OWNERSHIP, MANAGEMENT, CIRCULATION, ETC., REQUIRED BY THE ACT OF CONGRESS OF AUGUST 24, 1912.

Of QST, published monthly at Hartford, Conn., for October 1, 1924.

State of Connecticut
County of Hartford

58.

Before me a Notary Public in and for the State and county aforesaid personally appeared K. E. Warner, who, having been duly sworn according to law, deposes and says that he is the business manager of QST and that the following is, to the best of his knowledge and belief, a true statement of the ownership, management (and if a daily paper, the circulation), etc., of the aforesaid publication for the date shown in the above caption, required by the Act of August 24, 1912, embodied in section 443. Postal Laws and Regulations, printed on the reverse of this form, to wit:

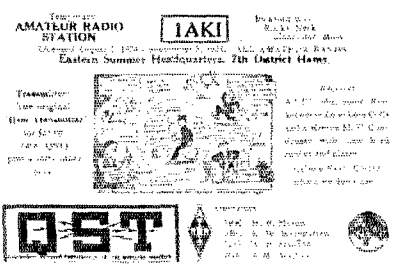

The Eastern calling card of the 7th District

coupling coil. In general, the fewer turns in the coupling coil the better. Two or three will be sufficient in most cases.

The time worn question of counterpoise vs. ground has been opened anew in connection with work on the short wave bands. It is your local conditions that determine what is best for you to use. If you can get a good ground, as by running a short and direct lead to a copper tank or a series of copper sheets buried in permanently moist earth, it may give you better results on some wavelengths than a counterpoise—and then again it may not. No experiments have been made the results of which will apply to your particular case.

The effect of imperfect dielectrics in the field of the antenna or poor antenna insulation is very deleterious to short wave work. Ground leads, counterpoise leads, and antenna leads should be rigidly supported at least one or two feet from all solid materials.

The black oxide coating that appears on copper wire a few days after an antenna has been erected has a very bad effect at short waves. There are two solutions to this difficulty. One of them is to use enameled wire. The other is to build the antenna and mast so it can be hinged down daily and the wires polished. Indeed, they might even be greased to keep the corrosion from setting in so rapidly. Thus the old sea-going joke about the green operator who was ordered aloft to grease the an-

1. That the names and addresses of the publisher, editor, managing editor, and business managers are: Publisher, The American Radio Relay League, Inc., Hartford, Conn.; Editor, Kenneth B. Warner, Hartford, Conn.; Managing Editor, (none); Business Manager, Kenneth B. Warner, Hartford, Conn.

2. That the owners are: (Give names and addresses of the individual owners, or, if a corporation, give its names and the names and addresses of stockholders owning or holding 1 per cent. or more of the total amount of stock.) The American Radio Relay League, Inc., an association without capital stock, incorporated under the laws of the State of Connecticut. President, Hiram Percy Maxim, Hartford, Conn.; Vice-President, Chas. H. Stewart, St. David's, Pa.; Treasurer, A. A. Hebert, Hartford, Conn.; Traffic Manager, F. H. Schnell, Hartford, Conn.; Secretary, K. E. Warner, Hartford, Conn.

3. That the known bondholders, mortgagees, and other security holders owning or holding 1 per cent. or more of total amount of bonds, mortgages, or other securities are. (If there are none, so state.) None.

4. That the two paragraphs next above, giving the names of the owners, stockholders, and security holders, if any, contain not only the list of stockholders and security holders as they appear on the books of the company but also, in cases where the stockholder or security holder appeared upon the books of the company as trustee or in any other fiduciary relation, the name of the person or corporation for whom such trustee is acting, is given; also that the said two paragraphs contain statements embracing affiant's full knowledge and belief as to the circumstances and conditions under which stockholders and security holders who do not appear upon the books of the company as trustees, hold stock and securities in a capacity other than that of a bona fide owner; and this affiant has no reason to believe that any other person, association or corporation has any interest direct or indirect in the said stock, bonds, or other securities than as so stated by him.

5. That the average number of copies each issue of this publication sold or distributed, through the mails or otherwise, to paid subscribers during the six months preceding the date shown above is(This information is required from daily publications only.)

K. E. Warner.

Sworn to and subscribed before me this 19th day of September, 1924.

Frederick L. Pratt, Notary Public.
(My commission expires February 1, 1929.)

Secondary Circuits for Broadcast Receivers

By Philip G. Schermerhorn

PAGES 46 and 47 of the July issue of *QST* remind us of the lack of standardization in tickler coil and antenna condenser size and design. This is very trite, but it seems to me that far worse conditions are to be found concerning the best and most efficient proportions for secondary coils and shunt condensers for broadcast reception.

When I glance over back numbers of our numerous radio magazines and supplements, I indeed pity the embryo enthusiast when he seeks to design broadcast tuners; for no two articles are in the least likely to agree concerning the proper number of turns, size of wire, diameter of tube, method of winding, or any other factor which goes into the construction of the important secondary circuit.

Let us assume that the broadcast range covers from two hundred to six hundred meters, and that it is desired to construct the most efficient tuner for this class of reception. By "efficient" is meant that which will render selectivity, quality and volume. Now is this not quite obviously a purely technical problem which many electrical research laboratories are fully competent and equipped to solve? After examining many circuits the writer is of the opinion that the constants most often met with are about 60 turns of No. 26 wire upon a 3" form, and shunted by a variable condenser of 500 μfd (.0005 μfd .) capacity. However, the result of months of experimental work upon this subject leads the writer to believe that such proportions are by no means the most efficient.

I believe it is pretty generally conceded that it is undesirable to employ excessive capacity in the secondary or grid circuit, and that for most efficient reception the value of L should be reasonably high as compared with C. It is also obviously desirable to so proportion the relationship between inductance and capacity that about 70% to 80% of condenser dial may be utilized for tuning purposes. That is to say, so that stations broadcasting upon around 240 meters come in at about 10 or 15 on dial, while those transmitting around 500 meters and over come in at, say, 70 to 85.

Bearing both these desirable features in mind I decided to employ a Cardwell condenser of 250 μfd . (.00025 μfd .) capacity, as secondary shunt condenser, and by experiment to determine the best proportions of an inductance which would most nearly fulfill such conditions. After many rather tedious windings and rewindings, I ultimately chose a 4" tube wound with 57 turns of No. 22 D.S.C. wire, since such a coil, used

with my 250 μfd . (.00025 μfd .) condenser admirably satisfied my requirements. I found that with this combination, and using the entire condenser scale, it was possible to cover the entire range from 197 to 600 meters.

According to the formulae I used, the inductance of said secondary coil was .473 millihenrys. In the same manner I found that should it be desired to use a shunt condenser of 500 μfd (.0005 μfd .) capacity (instead of .00025) and yet bring in stations at the same points on dial, this could easily be accomplished by reducing the inductance of coil to .18 millihenrys—or, for example, 35 turns No. 22 D.S.C. wire on a 4" tube.

Experiments were then carried further, and a "Superdyne" receiver constructed wherein the secondary coil was as above, of .473 millihenrys, shunted by a 250 μfd . (.00025 μfd .) condenser; and the tuned plate coil was of .18 millihenrys, shunted by a 500- μfd . (.005 μfd .) condenser. This set proved to be unusually satisfactory, and was remarkably easy to tune since both dials logged exactly alike for any station throughout the entire range.

Coils of smaller diameter and of smaller size wire were subsequently wound to .18 and .473 millihenrys inductance respectively, but—regardless of theory—failed to produce as loud signals.

Referring to the article in *QST* for August, 1924, describing the "Compact Superheterodyne" circuit and constants, I note that a secondary coil of 60 turns No. 26 S.C.C. wire on a tube 2 3/4" diameter, shunted by a 500 μfd . (.0005 μfd .) condenser, is specified. The inductance of their coil is .224 millihenrys, which is considerably higher than my preferred value of .18. It would appear, therefore, that with such a coil stations could be crowded toward the lower end of dial, and this is exactly what I find is the case, for station KYW (336 m.) tunes in at 59 upon the dial. Not liking such a position, I juggled a few figures and wound 52 turns No. 22 D.S.C. wire upon a tube 2 3/4" diameter and substituted same for the coil shown in the "Compact" superheterodyne circuit, and found KYW's tuning point had moved up to 82, where I wanted it.

This all goes to show that there is pressing need of standardization of secondary circuits. I certainly do not claim my values are the best, but I do trust that my experiments will induce others, more able than I, to give us a standard, and once for all stop this endless and most confusing variety of coils. Every BCL would be exceedingly grateful . . . and less likely to become discouraged.

Helium Tubes

By F. S. McCullough

HELIUM tubes are now playing a great part in the high frequency art today. Seventeen of the largest broadcasting stations use these tubes each evening. These are the first stations in the world to use the helium atom as a carrier of radio frequency currents. It has been practically impossible to separate the helium atom heretofore from other gases. The helium in these tubes is by far the purest in existence. There is practically no other gas mixed with it, otherwise the tube would become inoperative. These little carriers also cool the tube.

A great many experiments have been carried out in connection with emission of electrons from hot bodies using filaments and plates within a glass bulb, which could be exhausted of air by means of a vacuum pump. The filaments were heated by a battery and means were provided for the measurement of the electrical charge on the plate. With the air inside the bulb at normal atmospheric pressure, the temperature of the filament was gradually

increased by increasing the current passing through it. It was found that the plate received a positive charge of electricity, which increased until the filament was at a yellow heat. When the temperature was raised above the value the charge decreased, until at white heat, the charge became small. The pressure of the air inside the bulb was then reduced gradually. The charge diminished still further until it reversed and went negative, and this negative charge gradually increased as the exhaustion of the bulb continued. Later it was found that the

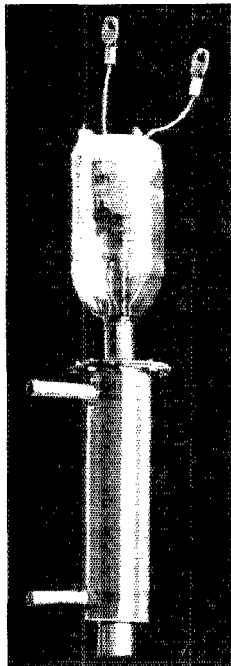

degree of electrification of the plate and also its sign depended largely on the nature of the gas inside the bulb. It was noticed

that the presence of oxygen tended to reduce the charge received by the plate.

The electron theory assumes that an atom of an element consists of a positive nucleus or core, around which revolves a number

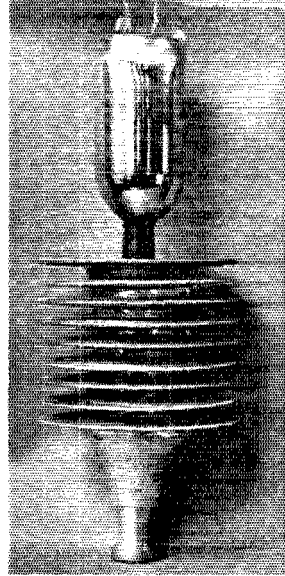

of electrons. Little is known of the positive core, although its mass is great compared to that of the electron. Thus, a difference between gold and lead is probably that there are more electrons per atom in one than in the other. If we could alter the number of electrons in an atom, we could probably active substances, examples of atoms emitting some of their electrons and therefore changing their character.

Tungsten plays a very important factor in electron tubes. Take for example a tungsten filament at low temperature. No electrons are emitted. As the filament becomes red hot, about 1000°C ., a very small number of electrons is emitted, which increases further as the filament is heated. The maximum currents are obtained just before the filament melts, which is about 3270° . Gases have been used in tubes. Hydrogen for instance has a great cooling effect but it decreases the electron current. The writer, however, found that by putting pure gases in tubes and keeping them in a free state, entirely different results occurred. All of the known gases have been

used in a pure state and it was found that there were a number of factors to contend with. First, the cooling effect was always kept in mind, so a metal air-cooled tube was built and used to carry out extensive experiments. During these experiments, it was found that when the tube containing

the gas kept cool, the gas itself was able to retain it in equilibrium and not become inactive. Helium proved the best because it was capable of excellent cooling and gave a great deal more space current. These helium tubes have been used for six months without any failures.

Experimenters Section

20 Meter Tests, November 22nd and 30th

MEMBERSHIP in the Section is open to anyone interested in radio experimentation in company with others.

It is not necessary to have a radio laboratory, most of the work can be done with the equipment of an ordinary amateur station plus the willingness to stick to it.

Joining the Section

The business of joining the section is extremely simple—just address a request to Experimenter's Section, A.R.R.L., 1045 Main Street, Hartford, Conn.

The Service of the Section

The Experimenter's Section offers the following services:

A list of men who are interested in your problem.

A list of problems that are in need of work at present.

Outlines suggesting the best way of attacking your problem.

All of these are kept up to date and are available on request of those who have enrolled their names in the Section.

Laboratory Sheets

Several additional laboratory sheets have been made out. They will be mimeographed and sent to the members who signed up for them.

Observers for NAA

Careful observers who can receive 15 words per minute are wanted for some observations to be made on the transmission of NAA and possibly some other stations. The wavelength is 2650 meters, the signal I. C. W.

Please communicate direct with this section in the regular form indicated below.

Power Line Interference

Our item on page 38 of the May issue has brought immediate response. The New Bedford Gas & Edison Light Company of New Bedford, Mass., has stated that they will be very glad to receive the cooperation of any amateur in their neighborhood. They will welcome any practical ideas on the location of line interferences and will be

glad to try the methods out and report upon them. We also have a letter from W. R. G. Baker of the Radio Engineering Department of the General Electric Company stating that they are doing work of this kind and will be very glad to receive additional information of any kind. Several residents along the line of the electrified portion of the New Haven railroad have written us statements that any town along this line offers a good field for experimental work on line interference. In addition to this we have letters from various portions of the country where Cottrell precipitators are used in depositing soot and smelter dusts. It appears that these precipitators at times cause very severe interference.

At the present time we are therefore long on experimental fields and short on suggestions as to the method of attack. Assistance is invited.

The Hartley Circuit

Mr. E. B. Redington of 2XQ at Union College, Schenectady, N. Y., raises the

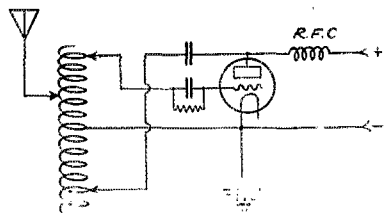
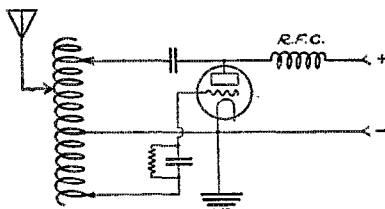

question of whether there is any advantage in favor of one of the two clip arrangements shown here. The Editor has en-

countered violent individual opinions on this but no one seems to have any actual knowledge.

Correspondence

It has become absolutely necessary to insist that letters to this section be made



separate and that they be kept free of matters relating to QST, the Information Service and the Traffic Department. Please put such things in another letter addressed to the proper department. Neglect of this causes great delay.

Please address your communication to "Experimenters Section, A. R. R. L., 1045 Main Street, Hartford, Connecticut," and enclose a stamped and self addressed envelope for reply. Foreign members in particular are requested to supply the return envelope but the stamp is not necessary in such cases.

20 Meter Tests

On November 22nd and 30th a series of 20 meter tests will be held. These tests are arranged to give all districts a chance and provide for both dark and daylight work.

By all means take part, either sending or else receiving. If possible, do both.

Many of the members of this section have wavemeters that work down to 40 meters and can help other stations to get down; it is a short jump from 40 meters to 20 meters.

If your regular set will not go down throw together a temporary small set—but get into the test.

What It's About

100 meter work was almost ancient history before we were able to make it popular. Then our "100 Meter CQ Party" started things going.

In the same way—plenty of 20 meter work is being done today but we need the help of hundreds to explore that wavelength properly.

This is to be a public demonstration that 20 meter work is useful—especially in the daytime.

The Schedule

The night and day tests are all arranged so that the Atlantic time belt stations (Eastern Canada) send first for a quarter of an hour. They are followed by the Eastern time belt, then the Central, then

the Mountain and finally the Pacific. Please stay on the schedule.

In each test send as follows—

"QST, QST, QST U (Your own call three times) 20 METER TEST."

Repeat this during your test period. It is best to send slowly and clearly (fading is often bad at 20 meters) and above all to make many short calls signing only 3 times after each.

Night of November 22-23

	Pacific Standard Time
All Stations in Atlantic Intercolonial time belt send	10:00 to 10:15 P. M. Nov. 22
All stations in Eastern Standard time belt send	10:15 to 10:30 P. M. Nov. 22
All stations in Central Standard time belt send	10:30 to 10:45 P. M. Nov. 22
All stations in Mountain Standard time belt send	10:45 to 11:00 P. M. Nov. 22
All stations in Pacific Standard time belt send	11:00 to 11:15 P. M. Nov. 22

Daylight Test, November 30

	Pacific Standard Time
All Stations in Atlantic Intercolonial time belt send	noon to 12:15 P. M.
All stations in Eastern Standard time belt send	12:15 to 12:30 P. M.
All stations in Central Standard time belt send	12:30 to 12:45 P. M.
All stations in Mountain Standard time belt send	12:45 to 1:00 P. M.
All stations in Pacific Standard time belt send	1:00 to 1:15 P. M.

Reports

Please make your log as complete as possible and mail it to "Experimenter's Section, A.R.R.L., 1045 Main St., Hartford, Conn."

The one for the test of Nov. 22-23 should be mailed on the morning of Monday, Nov. 24. The one for the test of the 30th should be mailed on the morning of Monday, December 1st.

Atmospheric Electricity

By Dr. S. J. Mauchly*

FRANKLIN'S proof that lightning and electricity are one and the same is so generally known and accepted that when a flash of lightning is seen it

place continuously, even during the fairest of weather. Although these conditions and changes make no direct appeal to our senses, we are able by the aid of suitable instru-

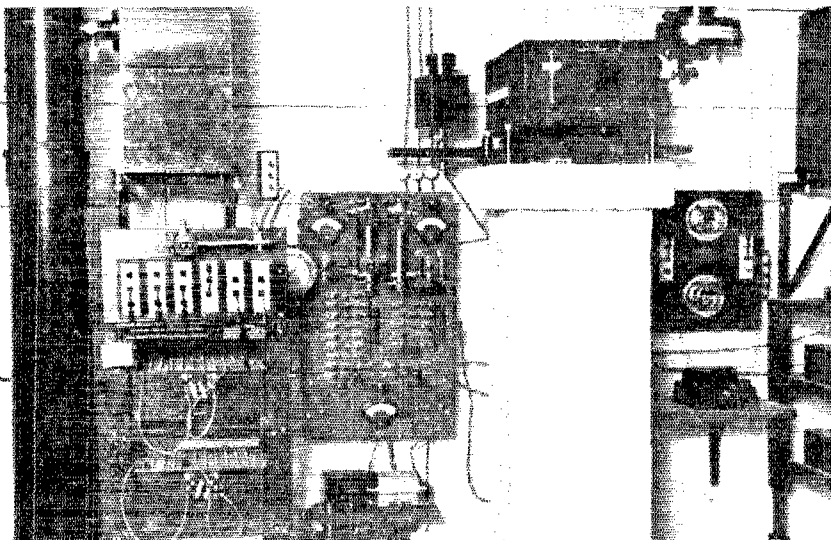

Inside view of Atmospheric-Electric Building at the Huancayo Magnetic Observatory, Huancayo, Peru, showing in part an apparatus for recording the conductivity of the air.

immediately suggests the existence of electricity in the air or at least in the clouds. In fact, lightning and the attendant thunder impress themselves so vigorously on our senses that to many persons the term "atmospheric electricity" suggests nothing else. Similarly aurorae or polar lights, silent but none the less impressive, have in these days of familiarity with man-controlled electric displays come to be rather generally considered by the layman as of electric origin. But northern lights occur so rarely in the latitude of Washington that doubtless many of my readers have never had the opportunity of seeing this most beautiful of Nature's displays; and even lightning, although it is much more common than aurorae and no doubt occurs altogether too often to suit many of us, must still be regarded as of rather infrequent occurrence.

There are, however, in addition to the foregoing, certain important electric phenomena in our atmosphere which are taking

ments to learn much concerning them; also, some information regarding atmospheric electricity is obtained indirectly through studies of the records of radio reception under various meteorological, electrical, and magnetic conditions. Time will not permit me to deal with each of these different phases of atmospheric electricity, and my remarks will be confined chiefly to the so-called fair-weather electricity, partly because this is less familiar to most people than the more spectacular phases, and because it represents the normal conditions which prevail throughout much the greater part of our lives. I shall endeavor to give briefly some of the most interesting and important of the known facts and occasionally a bit of theory regarding them.

For example, in the space surrounding the Earth and occupied by the air there is an electric condition called potential which somewhat resembles the pressure in a water main. However, this force differs from ordinary pressures in water or air in that it affects only bodies which are electrically charged; that is, it acts as a motion-produc-

* Chief, Section of Terrestrial Electricity, Department of Terrestrial Magnetism, Carnegie Institution of Washington.

ing force on particles of air, dust, drops of water, etc., which are electrified but does not affect those which are neutral or uncharged. Technically this property of the space surrounding the Earth is referred to as the Earth's electric field, and the volt with which everyone is more or less familiar is the unit used in measuring its strength or intensity. Since air-potential normally increases with height above ground, the Earth's field is usually expressed in volts per meter or in volts per foot to show the amount of change in potential for a meter or for a foot of change in height. For our present purpose, however, we shall in most cases be concerned only with the potential at a given point.

The strength of the Earth's electric field under average fair-weather conditions is such that the electric potential of the air at the height of a man's head is from one hundred to several hundred volts greater than that of the ground beneath his feet. Or, in other words, out in the open, away from buildings and trees, the difference in electrical potential between the ground and a point 5 feet above ground is usually somewhat greater than the difference of potential between the lead wires of the ordinary house-lighting circuit. Combining this experimental result with well-established

point again later but for the present I may say that, electrically speaking, our bodies really form a part of the Earth and our position is somewhat similar in this respect to that of birds sitting without harm upon a high-tension electric wire. Our observations also show that at a distance of say 10 feet above ground the potential of the air is twice as great as at the 5-foot height, etc., and that a free balloon at an elevation of a mile may be at a potential 50,000 or more volts greater than at the ground.

At many observatories in various parts of the world the electric potential of the air is continuously recorded by automatic instruments. Three such observatories are maintained by the Carnegie Institution of Washington, one being in the District of Columbia, another at Watheroo on the plains of Western Australia, and a third at Huancayo in the Peruvian Andes. Records so obtained show, in all cases, that the electric potential of the air where the instrument is placed changes continuously throughout the day although the daily change, at any given locality and time of year, is very similar from day to day. In some regions the daily change is much the same regardless of time of year, but in most localities the nature of the average daily change varies considerably with time of year.

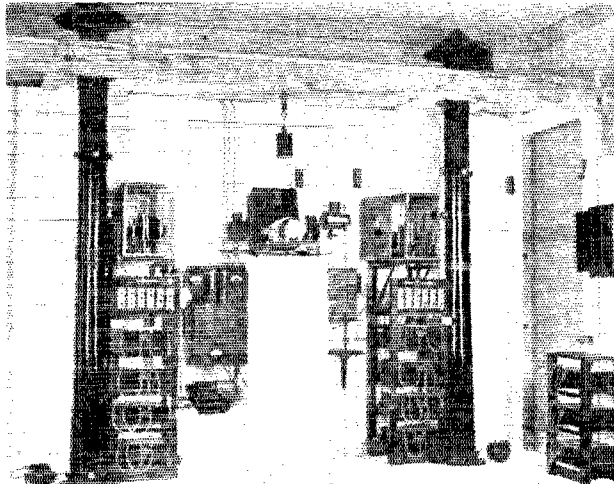

Apparatus for recording both the positive-ion conductivity and the negative-ion conductivity of the air as set up for test at Washington.

electrical theory leads us to the startling conclusion that the entire Earth is electrically charged to a potential of many millions of volts. This at once raises a question as to why we are not subject to injury or discomfort as a result of living in such a strong electric field. I will return to this

the months from October to March, inclusive, than during the remainder of the year, although there are several regions where the reverse seems to be true.

The origin of the electric charge on the Earth and of the resulting electric field is not known. And, as if to add to the inter-

The Department of Terrestrial Magnetism of the Carnegie Institution is making careful studies of changes in the Earth's field during the day, during the year, and from year to year, based on continuous air-potential observations in all parts of the world. One of the most striking results thus far obtained is that the chief daily maximum or high point tends to occur everywhere at approximately before noon in Washington, in the late afternoon or evening in most parts of Europe, and between midnight and morning in Western Australia and Eastern Asia.

It is further found that, in both the northern and southern hemispheres, the average value of the atmospheric potential is greater during

est and to the difficulty of finding a suitable explanation, it appears that there are gradual changes from year to year in the atmospheric potential which are in close relation with observed sun-spot changes. Thus in trying to explain the existence and variability of the Earth's electric field we must take into account not only the entire Earth but also conditions on the Sun.

Another matter of great importance in atmospheric electricity is the electric conductivity of the air, or its ability to carry an electric current. For, although the air is one of the best-known insulators, it is far from being a perfect insulator. As is well known, air consists almost entirely of small particles, called molecules, of nitrogen and oxygen. While most of these molecules are electrically neutral, there are always a few—only a small fraction of a per cent of the total number—which are charged, some positively and some negatively. Those positively charged are called positive ions and those negatively charged, negative ions. While these ions are constantly disappearing, new ones are being formed at such a rate that a cubic centimeter of air under ordinary conditions usually contains about 1,000 positive ions and roughly the same number of negative ions, that is, about 16,000 of each kind to the cubic inch. The process by which these ions or charged particles are produced is somewhat too complex for description here. In brief, it may be said that the small amounts of radium and thorium naturally present in the air and the direct action of sunlight are largely responsible for their continued formation. From observations over the oceans and in balloons it appears that a so-called "penetrating radiation" may also be one of the important causes of the ionization of the air, although the nature of this radiation is not well understood.

Under the action of the Earth's electric field the positive ions of the air normally travel toward the ground and the negative ions in the opposite direction. Consequently, under normal conditions, there is everywhere an electric current passing from the air into the Earth. However, we need not fear electrocution from this cause, for despite the large potential difference between the ground and the air at any considerable altitude the current from this source passing through the body of a single person is exceedingly small. In fact, if the entire human race were collected out in the open at one time the total flow of current from the air to the ground through the assembled bodies would be less than that required to operate an ordinary reading lamp. Nevertheless, small as this current is at any one place, its total amount over the entire Earth is by no means negligible, and is estimated to be at least 1,000 amperes. Moreover, al-

though the Earth is, as already stated, charged to a potential of many millions of volts, 90 per cent. of its charge would be neutralized within ten minutes by this air-to-Earth current if there were no source of replenishment.

Many investigators believe that the Sun is the source of this replenishment, and various experiments have been made to test this point. However, no proof has yet been found that electricity from the Sun actually gets down into the Earth.

It has been suggested also that lightning discharges may be the source of replenishment since such discharges, while comparatively infrequent in a given locality, are probably taking place almost continuously if we consider the whole world. However, some lightning discharges bring positive electricity to the Earth while others bring negative, and it has not yet been shown that the negative discharges are in excess of the positive by an amount sufficient to satisfy observed conditions.

All our direct knowledge of the ionization of the air is necessarily limited to those parts of the atmosphere which have been reached by balloons. However, from purely theoretical reasoning, investigators have long thought that there probably exists at some very high level a layer of air which

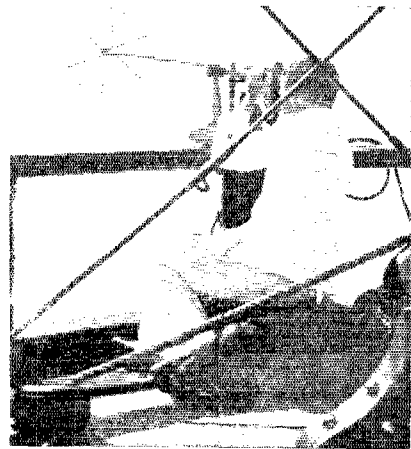

Observing the electric potential of the air at sea. (Survey yacht "Carnegie" of the Carnegie Institution of Washington.)

is highly ionized and which has an electrical conductivity enormously greater than that of the air in which we live. Observations in balloons and on high mountains do indeed show that the air gradually becomes a better conductor of electricity as higher levels are reached.

During the past year many of us have watched with great interest for the reports

by radio from Captain MacMillan's schooner *Bowdoin*, now frozen in the ice at Refuge Harbor, North Greenland, and from Captain Amundsen's ship *Maud*, now drifting in the Arctic. As we all know, during the winter months, messages were exchanged without difficulty, especially with the *Bowdoin*. For the past two or three months, however, such communication has been impossible and probably will be until autumn. It is also well known that transatlantic radio transmission is better in winter than in summer, and that distant stations can be picked up at night more readily than during the day. In their attempts to reach even an approximate explanation of these facts and the universally-experienced fading of radio messages, radio investigators, too, have found it necessary to assume the existence in the upper air of a layer in which the conductivity and ionization are much greater than have been found even in the highest balloon observations.

Consequently, the most vital point of contact between atmospheric electricity and radio communication appears to lie in this

assumed conducting layer of the upper air. Does it really exist, and if so, at what height? Although a height of about 30 miles or 50 kilometers has been suggested, higher and lower estimates are also given. Is its height the same the world over, and from day to day, and at different times of year, or does it vary? What is the thickness of the layer and what is the nature of its lower boundary? How great is the conductivity and how does this vary with place and time? These are only a few of the many interesting questions which are stimulating the best efforts of investigators in this field of research.

While we have at present no observational means for directly exploring the region of this assumed conducting layer, there are promising indications of future progress along this line. Meanwhile, correlation of effort between workers interested primarily in the study of atmospheric electricity and those who are interested mainly in radio transmission will doubtless continue to contribute to the solution of outstanding problems.

Bum Relaying

A Night With The Old Man and Some Good Reasons For Wrath

By George Sturley, 7BJ

THE night at last had crawled on to nearly ten-thirty. I looked at my watch and noted with joy that DX was close to hand. I was the guest of T.O.M. himself tonight, with the

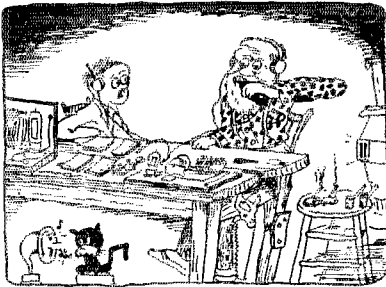

privilege of sitting in with him at his set. We straightened out the papers about the table. T.O.M. opened the log-book and dated a page for the evening. He took his message hook down from the wall and looked thru the stack of QTC. I asked him why it was he hung the msgs on the wall backsideout.

"Why, son, don't you read the radio laws? Didn't you ever read in them anything about the secrecy of messages? I hang them up that way so visitors can't read them. Some day when you go to sea to operate you will be razzed by your first operator for this same thing."

I realized he was right, and my head felt like pure ivory.

Meanwhile T.O.M. sorted his eastbound msgs in one pile, westbound in another, and the same way with the rest, passed me a pair of cans and lit up his one little tube in a low-loss tuner. We listened a few minutes and he logged a few long-distance CQ's out west. Sigs seemed to be coming thru fine and right away we decided it was going to be a good night. But something seemed to be jarring on T.O.M.'s nerves. His feet were scratching around under the table and he mumbled to himself. I copied the stuff coming in:

HR HR NR 1 TO A R LANG PORTLAND. PSE RITE SN SIG JIM 7-- U 7--

"Why, lessee", says I, "both those sevens are in Portland".

"Yes", roars the Old Man. "That's the worst of it. And tomorrow night the other one of them will pass the message back

to the fellow he got it from the night before".

I know how it goes, and by this time the Old Man takes a vicious chew off a plug of tobacco lying on the tuner, and pretty soon he swings around in the chair and looks for Kitty. But Kitty had seen T.O.M. take said chew and had faded under the stove, so he had to take it out in specially-selected phrases. Jabbing a thumb at a message on the table, he says:

"Just take a lamp at that message. Where, oh where, it it from? That reminds me when I was a commercial brass-pounder and was away off in the Pacific sending a message to a station in Hong Kong. Somehow, absent-mindedly in sending the message I forgot to transmit the name of the city where it was going. It happened to be Yokohama. The coastal op came back with 'Where to? London or Paris?' Wow! He handed me a little slam and an interrogation at once. Those two 7's we heard ought to be five hundred miles out in the drink someplace and deliver a phony message to their skipper like that. He would fix them plenty and tell 'em what was the style on his ship."

Then the O.M. returns to that message again and says to me:

"Just look at the address. No street or number. I tell you, son, It's this kind of stuff that drives directory clerks nutty, this being a detective trying to forward letters with bum addresses. Let me relate another little seagoing comparison.

"One time a passenger filed a message in my radio room for an address in Seattle. My second op sent it but omitted a simple little letter 'N' on the Seattle street number. The Canadian coastal station that took the message came back an hour later with a service stating it was undelivered. The words he used were UNDELD NSN. That meant 'Undelivered; no such number', and was signed 'Western Union, Seattle'. Then what? Well, we two ops got together and discovered it was our fault, and to make things right and effect delivery of that passenger's message we sent a paid service message to the Canadian telling him the correct address. It cost us the price of a 10-word message.

"So you see, son, this address business as we hear it on the ham air is awful. For whole nights I can't sleep when I think how those messages are chewed up. Some day some of those hams are going to get an awful change in climate when they try some of this irresponsible careless stuff absent-mindedly in the commercial game. It'll mean the green green carpet or maybe the ash-can for a lot of them. Or maybe some of the old-timers with a wicked 500-cycle kick will pipe in with a 'Back to the ham factory', or 'Listen to the gumboot' or 'Now try the other foot, OM, only take ur

shoe off this time', all of which is very nice to hear on the air".

By this time the O.M. had cooled off a bit and pushed the cans over his ears again. We both listened. Now someone was calling CQ and his QSB altho DC was swinging like dancing lightbeams. He signed 8-something and again T.O.M. showed signs of uneasiness. Kitty took a shy peep from behind a stove-leg but vanished out of sight again. The O.M. commented on how rotten it is to copy and still more rotten why some hams can have the nerve to come on the air with things haywire like that. He tuned in a 9. We had a message in that direction and so called him the first time he CQ'ed. Back he came and proceeded to shoot us a msg.

"Well, of all....."

But T.O.M. picks up a pencil and copies it. As the 9 sigs off, wham! he lights into him and says:

SA OM I DIDNT SAY QRV YET I CALLED U AND HAD A MSG FOR U.

The 9 comes back with SORRY OM 73 EUL SK. Gosh, I didn't know if I was safe or not. T.O.M. was real sore now. Here a fresh young nine had sent him a msg., ignored his announcement of QTC, and signed off without clearing the O.M.'s msg. T.O.M. slammed the ear-muffs on the table. Again a bulls-eye on the spittoon.

"That reminds me", he says. One night I heard a Jap call KPH while KPH was very QRW. The Jap was only a couple hundred miles out and very QSA and QRM. When KPH finished with some tanker the Jap started right in and called KPH and sent him a 30-word paid message off the bat without any howdedo at all, and signed off. Wow, you should have heard PH! PH says to the Jap, 'Don't try to rush this station.....QRM Now QTA ur nr 1'. Without much doubt old PH had a complete copy of the message but just for good deserts he made the Jap QTA and take his proper procedure".

Again we listened in. Some 8 was calling another 8. A long call, yes, very.

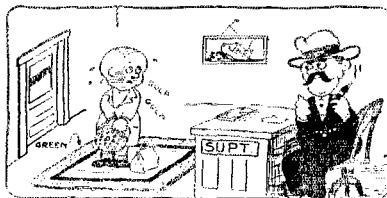

Finally, after eleven minutes had elapsed, the calling 8 signed off.

"What's the idea, WHAT'S the idea", roared the O.M. The other 8 comes back. But listen! He says:

HRD U THE FIRST TIME OM PLS DONT CALL SO LONG QTC?

This seemed to please the O.M. Guess he would have liked to say the same thing himself. Again he returned to seagoing commercial days.

"You know, this long-call stuff would be the certain axe for an op in the commercial game. Just imagine coming into San Francisco harbor and calling KPH for eleven minutes! O Boy, they'd have sent out the harbor patrol and a firing squad and got you before you signed off. Yessir, my boy, well I remember the first trip I made into that port. The first op was very particular and said to me, 'Now remember, when we get into the Bay, call KPH to clear before we dock, but for the luvvamike just say PH.' I did this. All I did was start up the set and throw over the switch and just make one little snappy PH. Immediate comeback from KPH with an I K. Then PH DE (ship call) QTC? NIL. Back he came with a NIL. All done. And believe me, any gumboot that did any more than that had a two-page letter to listen to on the carpet up in the office after arrival."

So with his chest unburdened once more T.O.M. decided to get to work. He started right in and raised a 7 and gave him a message for Tacoma. The 7 came back

RR RR ND OM U VY QSA

The O.M. had started to write down on the blank the time and station call to whom transmitted, when that ND strikes his diaphragms.

"Blast the blankety-blank. Ain't that just like em. Wouldn't that jar you. He says OK, then ND. Say, I'd just like to have that bird here just for.... Shhh!He says PLS QTA."

The O.M. repeated the message carefully and with a good fist we listened for the comeback. And there was the said 7 calling some 2-station.

"Blast the..." T.O.M. gave up in disgust. "Just listen to that. That ham didn't want any message and left me cold. Oh, if Wouff Hongs could only travel 186,000 miles per second! Make a fellow QTA like that and they go after some 2 because it's nice DX. Why the samhill didn't he work DX at first instead of kidding me he was QRV for QTC?"

The O.M.'s chair banged around and the crumpled QTC blank flopped into the wastebasket, while T.O.M. started looking for Kitty again. "No wonder such rotten QSR tonight. Where's that cat? We gotta find Kitty!"

At last Kitty is hauled from under the stove, has her ears soundly boxed, and T.O.M. indicates threateningly that the proper place for her to park is right alongside the table leg. She settles down, curls tail alongside and licks tongue all around,

QST's a rotten look, and curls up for sleep. Now we can try again.

This time we raise a 6 and it's getting pretty late. At last we get an OK on our message and the op adds QRV K K, showing us he is sticking until we clear. Each message was OK'd and the seventh found the western pin empty.

"Nice Kitty", says T.O.M., looking over the edge of the table. "Now let's try the south!"

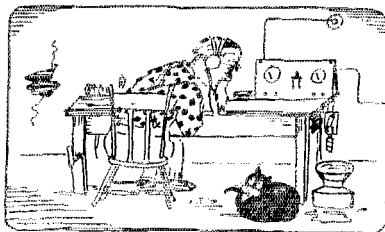

Be Careful, Gang

THE new regulations of the Department of Commerce permit operation on 75-80, 40-43, 20-22 and 4-5 meters *only* if:

- 1—Your license has been changed to permit such operation.
- 2—You are using an inductively coupled sending set.

Many do not seem at all clear on the second point—there must be absolutely *no electrical connection of any sort* between the antenna and the tubes. For legal circuits see page 13 of September QST.

Remember that you don't necessarily have an inductively coupled set just because it happens to use two or three coils. The usual "IDH" and shunt-feed reversed feed-back circuits, for instance, use two coils but are not loose-coupled and therefore are not legal on short waves.

LAST CALL
BIGGEST AND BEST
SIXTH DISTRICT CONVENTION
ever held

MODESTO, CALIFORNIA
NOV. 7-8-9

General amateur sessions, hamfests, technical meetings, stunts, tours, Wouff-Hong Contest. See page 33, October QST.

Send in your reservation now, to L. J. Wren, 6BDS, 911 Thirteenth St., Modesto, Calif.

CU TR OM!

A Beautiful Antenna

A Good Radiating System in a Small Yard

By G. Wiley Bergman, 9CA

WHEN it was finally decided to build a real antenna at 9CA the aid of 9PQ was sought and I am very thankful for his many helpful suggestions.

We started in by remembering what little theory we knew and said that a vertical wire was the best radiator, so right there we decided that the aerial would be vertical. In fact we *had* to believe in the vertical antenna because there was not

foot apart on a 5 foot radius. One of the cypress strips was bent around this line of stakes and fastened by means of clamps. At one-third of the length of this strip another one was fastened on and in this way the circle was completed so that all joints were the same distance apart and no two opposite. Our neighbor is a good friend and as a result the completed hoop cost me \$1.20—and he furnished the material. When making such a hoop hot water may have to be poured on the strips if they are very dry.

After the hoop was done 10 holes were drilled through it at equal distances and a three-pound copper band was bolted to the outside. This connects all of the wires and makes uniform distribution of the voltage, while at the same time it keeps the hoop in shape. In addition a network of wires is woven across the hoop, this can be seen in the picture.

The bottom of the cone is spaced by a 15-inch ring of one-quarter-inch copper tubing. The tubing was bent on the same type of machine that a tinner uses to bend sheet iron into stovepipes. The joints were made by inserting a piece of No. 6 copper wire into the two ends of the tubing, leaving a small gap for the solder to take hold on. If this is done well the solder will

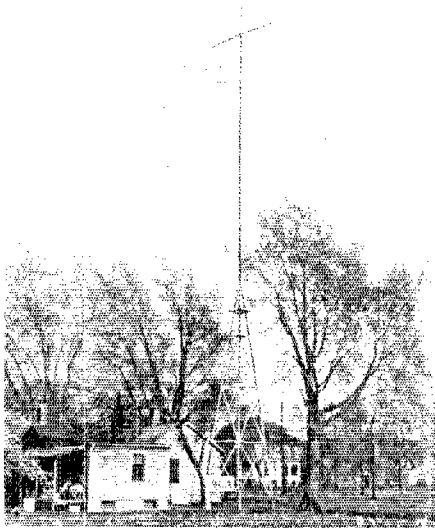

room in our yard to put up anything else.

A fan at once suggested itself. However it would need two supports and we did not have room for them; besides, the wires nearest the steel tower would carry a little more current than the ones in the center of the fan, partly because of capacity to the tower and partly because of the "edge effect".

A cage was the next thing in line and that is what we used.

To increase the top capacity the upper end of the cage was spread out by a large hoop. The hoop was made by a neighbor who is one of the best carpenters in Dwight. Six strips of good clear cypress were obtained. They were 16 feet long, an inch wide and three eighths of an inch thick.

Then stakes were driven in the ground one



run in so easily that after filing you cannot find the joint except for the color of the metal.

There are ten wires in the antenna.

They are all enameled and they are soldered wherever two wires cross each other or cross one of the copper rings. All ten wires in the aerial come together three feet above the center of the 10-foot hoop. Leaving the 10-foot hoop they come down to the 15-inch one and then come together in a soldered cable for several inches at the long insulator as shown in one of the photographs.

The lead-in cage continues the same wires horizontally, spacing first on a 10-inch hoop, then on a 5-inch one and finally entering the operating room through separate holes drilled in a Radion panel. This Radion panel is set in place of one of the window panes and the holes in it are drilled on a 1½ inch circle. The wires are finally all brought together to the antenna switch. In the old days when the spark was the only thing at 9CA the antenna went directly to the inductance in the fashion of 8BDA.

The 101-Foot Mast

By measurements the top of the mast is 101 feet off the ground. The windmill tower is a little better than 41 feet high and is raised slightly off the ground by being mounted on wooden posts which insulate it partly. The steel pole is insulated from the tower by two oil-soaked blocks of wood that fit snugly around the pipe. The pole rests on two thick pieces of plank which have been oiled to make them waterproof.

In a test the pole was connected to the tower and the tower grounded but a distant receiving station could not detect any difference. It was possible to get a small spark between the ground and the

tower but the current was too small to light a flash bulb.

When the guy wires were made I had the idea that if all the wires were of a different length there would not be very much current absorbed on any one wave. Whether I am right or not I do not know. It took a lot of figuring and maybe the whole thing was for naught. The aerial hangs half-way between two sets of guys.

A Test for Swinging

Because the antenna is not far from the tower and the guy wires it seemed that the swinging caused by the wind might change the wavelength badly. It was tested by the following method which is a stunt worth knowing.

A receiving set is connected to the antenna in the usual fashion and put into oscillation¹. Another receiving set is placed in the station without any antenna or ground connected to it. This second set is provided with three stages of audio amplifier and a loud speaker. With both receiving sets oscillating, tune them until the beat note is strong enough so that you can hear it out in the yard. Now swing the aerial around with a rope or a pole. If the wave changes you can tell by the changes in the tone. I found that at 9CA swinging the aerial did not change the wave enough to notice but if you pushed two wires together the tone "blooped" up and down. So in the near future I will have another copper hoop 15 feet up to keep the wires where they belong.

¹This set should be of the "single-circuit" variety so that changes in antenna capacity will affect its tuning.

Practical Short Wave Transmitters

THE PROBLEM of the proper grid and plate coils for an oscillator designed to operate in the neighborhood of ten meters is, as we have consistently tried to put over, no particularly great one. Don't ask us to give you the size of turns and spacing of a helix to run on 11.44 meters—it can't be done; at the same time, all you do have to do is to reduce turns, and cut down the diameter of *any* kind of coil until you get low enough. Outside of this you will probably have no problems that you wouldn't encounter in every 150-meter set.

Coupling such a transmitter to an antenna, however, is another matter. There is very little dope on this phase, and in view of this fact, the following notes will be of special interest. The experiments in question were carried on by two groups of Washington amateurs: B. J. Kroger, 3APV,

working with P. M. Hargis, 5AIJ; and H. A. Wadsworth, old 3JJ, cooperating with W. A. Parks, 3BE-3ZW.

The Krogers-Hargis Set

Figure 1 is the 50-watt lay-out used in the experiments carried on by Kroger and Hargis. Before this set was built, however, a transmitter was built which consisted of the following arrangement: A Meissner circuit was used in conjunction with a 50-watt tube, using a two-turn 2" coil for the grid coil, and the same thing for the plate. These coils were fastened directly to the tube socket, neither grid nor plate condensers being used. This outfit was found to oscillate on 12 meters, and when coupled by means of another 2" two-turn coil to an antenna with a 140-meter fundamental put fair signals into a receiver 3½ miles away.

The success of this first undertaking led

to the construction of the transmitter shown in the photograph. The inductance for the 11-meter oscillator used one 2" grid turn, and two turns of the same size for the plate coil. No. 14 D.C.C. wire, spaced $\frac{1}{4}$ of an inch, was used. With seven turns in both grid and plate, oscillation was secured at 22 meter. As may be seen, the grid and plate condensers are so mounted as to

A direct-coupled Hartley, using a pancake coil (dimensions not stated) gave about the same results.

The Wadsworth-Parks Set

In Fig. 3 is shown the lay-out at 3ZW-3BE as constructed by Wadsworth and Parks.

A "1DH" circuit was used in conjunction

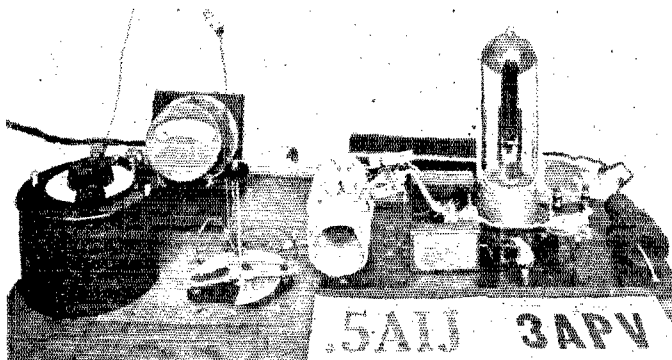

Fig. 1

The Kroger-Hargis 11-Meter Transmitter
From left to right: Antenna series condenser, antenna ammeter, two-plate counterpoise series condenser, inductance, grid and plate condensers, 50-watt tube.

necessitate the minimum amount of wiring for connection purposes. The antenna coupling coil for both waves consisted of five turns wound between the plate and grid coils.

When coupled to the 140-meter antenna, fair results were secured but it was decided to reduce the size of the antenna so that the fundamental would lie near the working wave. To this end two 10' three-wire cages were erected, as shown in Fig. 2. One was used as the antenna, and the other as the counterpoise. Vertical dimensions were omitted from the dope sent us, but the distance between antenna and counterpoise appears to be about 15 feet.

This antenna system had a fundamental of about 31 meters, which could be reduced to approximately 19 meters by setting the two series condensers—one a General Radio 247-F and the other a two-plate vernier—at approximately zero dial setting. This antenna was used for the 20-22 meter waves, and with 900 volts on the plate of a W.E. "fifty" the antenna was from .5 to .7 amperes.

Eleven-meter transmission was accomplished by working on the second harmonic, tuning the antenna to 22 meters, and the set to 11 meters.* Antenna current was approximately .5 of an ampere under these conditions.

*It is probable that somewhat better results would be secured by working on the odd harmonic; that is, tuning the antenna to 33 meters, and the set to 11.

with a fifty-watt bottle. The small white coil nearest the front of the assembly is the grid coil, and consists of three spaced turns of No. 8 D.C.C. wire 2" in diameter, and shunted by a "10-cent high-loss condenser triple-spaced." This condenser can



Fig 2

The Ten-Foot Cage Antenna and Counterpoise at 3APV.

be observed mounted just to the right of the inductance.

Next to the grid coil is the plate coil, made of four turns of No. 8 bare wire 3" in diameter, supported on a hard-rubber strip, and shunted by a large Cardwell condenser, which may be seen to the right and rear of the 50-watt tube. About $\frac{3}{4}$ " to the rear of the plate coil is the antenna coupling coil, consisting of three turns of

the same No. 8 bare wire about three inches in diameter.

With "the large antenna" (fundamental

inside of the shack was substituted. Using this with the "full-size" counterpoise and the antenna condenser shown at the left,

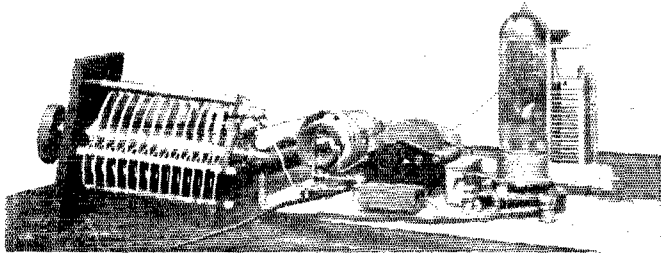
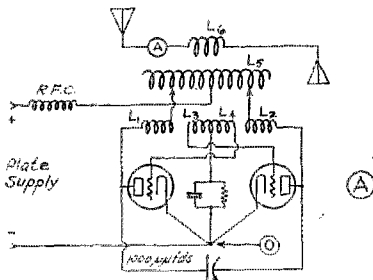

Fig. 3
The Wadsworth-Parks Transmitter
 From left to right: Antenna series condenser, grid, plate and antenna coupling coils, "10-cent" triple-spaced condenser shunted across grid coil, grid and plate fixed condensers, 50-watt socket and tube, behind which are the grid leak and Cardwell condenser shunted across the plate coil.

not mentioned) there was no visible indication of output energy even with 1500 volts on the tube when the set was working on

the fundamental of the system was brought down to 33 meters.

Working on this antenna on 33 meters (tuning the set to the fundamental) it was noticed that when a wave-meter was moved back and forth along the antenna wire the indicator lamp stayed the same brilliancy



LOGWOOD-MEISSNER CIRCUIT ORIGINALLY USED BY SUPERVISOR BEANE
 NOTE - The point "O" is the center tap of the filament transformer secondary which is omitted for simplicity.

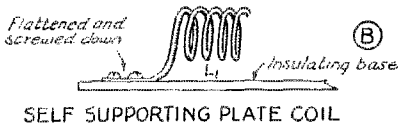

SELF SUPPORTING PLATE COIL

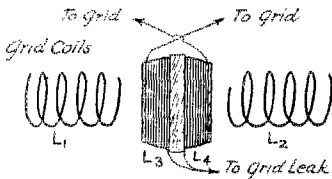

FIG. 4

12 meters. The regular antenna was disconnected, and a substitute in the form of 15 feet of lamp-cord strung around the

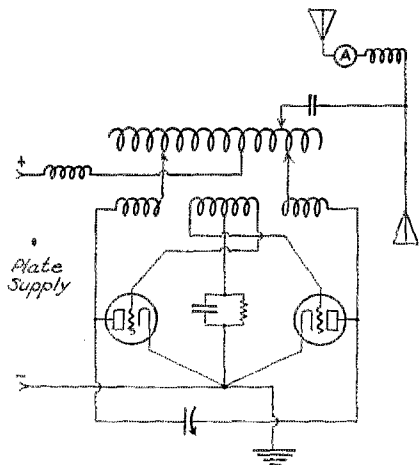

FIG. 5 CAPACITY COUPLED SYSTEM USED BY CHICAGO STATIONS AT PRESENT

the whole length of the wire until within a foot of the free end.

No further experiments were performed with this set in time to enable the information to get put into print.

"Push-pull" Oscillators

At the second National A.R.R.L. convention, Supervisor E. A. Beane told us about a

"push-pull" oscillator that had done fine work at short waves. Unfortunately we were not permitted to work below 150 meters at that time and we have been compelled to keep the circuit on ice, considerably against our will.

Supervisor Beane speaks of the circuit as the "Logwood-Meissner circuit" and inspection will show that it is actually made up of those two circuits. At first sight one is inclined to think (see Fig. 4) that this is nothing but our usual arrangement with "a tube on each side of the cycle." In a way that is correct—but the tubes are on the two sides of the radio frequency cycle. Instead of working alternately 60 times a second, because of a 60 cycle plate supply, they are working at the radio frequency, which depends entirely on the tuning of the circuit.

The circuit seems complex, but as a matter of fact it is simple to operate and is about the only one with which two tubes can be used at very short waves to any real advantage. The nicest thing about the whole business is that the positive plate-power lead goes to the nodal point of the plate coil, practically assuring that there will be little tendency for R.F. trouble in the plate supply.

Supervisor Beane has personally used the circuit successfully from 45-96 meters with both C-302 tubes and C-304 tubes. In addition to this he has suggested the circuit to a number of 9th district men who are now using it successfully on a variety of short waves with various tube equipments. They find that it operates with good stability as far down as 3 meters.

Construction and Operation

When the voltage is run up there is a strong tendency for one tube to take the load and overheat. To prevent this the two grid coils are wound on the same wooden ball and by adjusting the position of this ball the tubes are made to "pull together."

The set originally used by Mr. Beane was for 45-96 meter work, therefore it will fit the 40-45 and the 75-80 meter band with little change. Referring to Fig. 4a the coils L_1 and L_2 were wound of trolley wire and had 4 turns each spaced $\frac{1}{2}$ " apart. To keep all needless material out of the argument they were arranged as shown in Fig. 4b, only one end of the coil touching anything at all. The two plate coils, L_3 and L_4 , should be wound as if they were intended to make a continuous coil. The two grid coils, L_5 and L_6 , were wound on a 4" wooden ball, mounted between the plate coils. Each grid coil had 10 turns of No. 10 D.C.C. wire. The helices L_7 and L_8 can be of any kind.

There is nothing unusual about the R.F. choke, as usual it should not be on too large a tube and should be wound with

small wire. For waves below 25 meters it had better not be on a tube at all but should be self-supporting and have many turns of very small D.C.C. wire.

For these short waves—and the ones on down to 4 meters—the plate coils, the helix

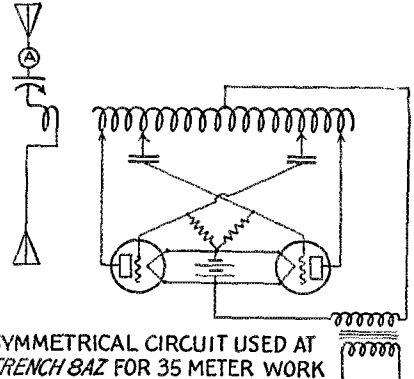

SYMMETRICAL CIRCUIT USED AT FRENCH 8AZ FOR 35 METER WORK

This circuit is described by M.A. Vuibert, (French 8AZ,) July, 1924, issue of "L'Onde Electrique"

The inductance has 18 turns, 30 cms. in diameter and spaced 1 cm. 14 turns are used at 35 meters when working with two French tubes of 50 watt input rating. At times there is used a separate grid coil which consists of 4 turns with a diameter of 12 cms spaced 13 mm. and shunted by a tuning condenser with a variable condenser. When working at 35 meters this condenser is set at 70 μ fd. As American tubes have larger base-capacity and may even be used with sockets the values given cannot be used directly but must serve as starting points only.

etc. must of course be smaller but the general scheme does not change. The tubes will probably need to have their bases taken off tho, especially if they are of the 50-watt sort.

—A.L.B and S.K.

20 METER TESTS

Our historic 100 meter tests are to be followed up by some 20 meter tests. The dates are November 22 and 30, full details are given in the Experimenters Section on page 36.

Don't miss these tests, nor the 5 meter ones to be held in December.

UNSCRAMBLING THINGS

This Word "Efficiency"

While we are fighting words it might be as well to call "efficiency" up for a hearing. Efficiency does *not* mean "this thing is giving the results I want", yet that is the way it seems to be getting used in most radio literature. It does not seem to matter how much a set costs, how much power it uses, how mean it is to operate—if the results are good the owner says "This is a very efficient set." But it isn't true—it is *effective* but it is not *efficient*. In the electrical world a thing is efficient only when it gives you back again most of the power that you put into it—or when it accomplishes the results with a very small investment of money—or space—or work.

"My Radiation is——" (See Fig. 3.)

The entire amateur world seems to be firmly convinced that radiation can be measured with an ammeter. Almost every station card says "Radiation 5 amps." or some such thing as that.

Now radiation is *power* and *you cannot measure power in amperes*. It can be measured in watts, but we do not have such a thing as an antenna wattmeter—yet. Of course it is possible to run a re-

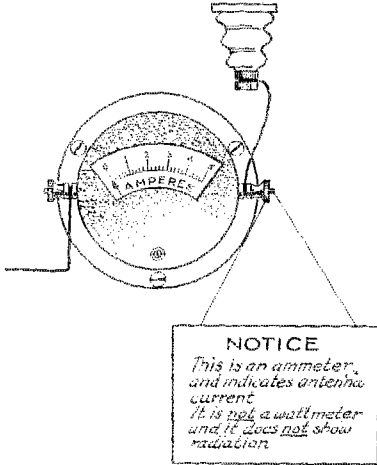

Fig. 3 — What the ammeter shows.

sistance curve of the antenna and to estimate the part of it that stands for radiation resistance and then to multiply the results by the square of the antenna current, but most of us do not do it. We keep waiting for a wattmeter instead.

In the meantime let's stop this nonsense of putting down "radiation 4 amperes"

when we mean "Antenna current 4 amps." or "Antenna amps 4". (Please look at Fig. 3 again.)

"Balancing"

We have just answered a letter from a member who is rather disgusted because this desk doesn't know what he means by "balancing" a sending or receiving set. Now according to Webster the word means "to arrange so that opposing forces neutra-

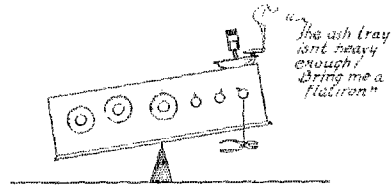
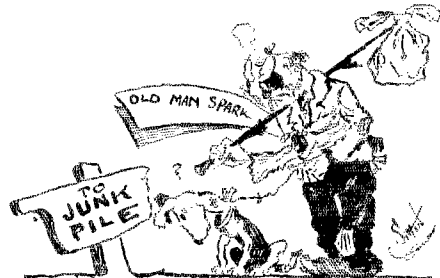

FIG 4 BALANCING A RECEIVING SET— AS WE IMAGINE IT MUST BE DONE.

lize each other". This sounds all right and might mean something if we were talking about Neutrodynes or Superdynes, but what on earth is it supposed to mean when we are talking about antennas and Reinartz tuners? (P.S.—Does Fig. 4 seem right?)

"Zero Beat"

Several years ago someone was guilty of spreading the idea that radiophone reception could be carried on with an oscillating tube if one set it at "zero beat"—in other words made it oscillate at the same frequency as the incoming signal. The fact that this does not work worries many of our members. It would really work if the carrier waves of the sending stations stayed perfectly stationary. However, most modulating systems also wobble the wave a little, giving what E. S. Purington calls "wobulation". The result is an awful hash when the oscillating receiving tube is being used. This is lucky—there are too many oscillating receivers in this world now.



The Receiving Experimenter



CONDUCTED BY S. KRUSE, TECH. ED.

Interference References

The following references on inductive interference were selected for us by the well-known John Crerar Industrial Library at Chicago, Illinois.

Inductive interference as seen by the American Railway Association. Abstract of report in *Electrical World*, vol 98, 1921, p. 767-769.

Valensi, G.—Interference between electrified railways and telephone and telegraph lines (In French) In *Am. des Postes Télég. et Téléphonie* vol. 8, 1919 p. 24-59. Abstract in *Elec. Review*, vol. 85, 1919 p. 428-9.

Parry E.—Interference of power circuits with telephone circuits. In *New Zealand Journ. of Science* vol. 2, 1919 p. 308-314.

Smith, B.M.—Reduction of inductive interference by insertion of resistance. In *Elec. Review*, (Chicago) vol. 75, 1919 p. 117-118.

Le Corleceiller,—Precautions against interference from traction systems in United States of America (In French) In *Soc. France. Elec. Bull.* vol. 10, 1920, p. 39-55. Abstract in *Science Abstracts* vol. 23B p. 327-328.

Phelps, H.S.—Experience in correcting interference of power lines with telephone circuits. In *Elec. World*, vol. 75, 1920, p. 833-834.

Warren, H.S.—Inductive effects of A.C. railways on communication circuits. In *Amer. Institute of Elec. Engineers Proceedings*, vol. 37, 1918 p. 1019-48.

Crawford, W.W.—Elimination of interference from telephone circuits.. In *Amer. Inst. of Elec. Engineers Proceedings*, vol. 38, 1919, p. 377-405.

Doping Coils

No matter how coils are wound or what varnish is used on them it is a good idea to keep the amount of varnish down. A good idea is to use the varnish thin and to drain it off forcibly by whirling the coil on the end of a string. This can be done especially well when the entire coil has been dipped in thin varnish.

Variable Condenser Noises

Whenever the receiving set develops horrible noises as you turn the tuning condenser, take a look at

- a—The vernier.
- b—The bearings.
- c—The plates.

If the vernier has metal gears it is hard to get completely quiet operation. No two metal gears should mesh together.

If the condenser makes contact through the bearings, make sure that it really is getting contact. Oil in the bearings almost invariably makes trouble and a flexible "pigtail" from the shaft to the wiring of the set will usually cure the trouble. Make sure though that the pigtail has an insulating covering so the turns do not rub together.

Finally take a look at the plates and if they don't actually touch double up a pipe cleaner and run it between the plates to get out the dust.

Controlling Amplifiers

Mr. D. A. Griffin of 2AGB makes the following suggestion regarding amplifiers used in superheterodynes and otherwise.

"Oscillation of the I.F. amplifiers is most easily prevented by regulating the "B" battery voltage on the amplifier plates. This may be done by means of a series of resistances which may be cut in or out by means of a switch. This makes a beautiful "gain control" in the bargain. About three 48,000 ohm and one 12,000 ohm resistances will do the trick nicely with a 90-volt "B" battery. Each resistance should be shunted

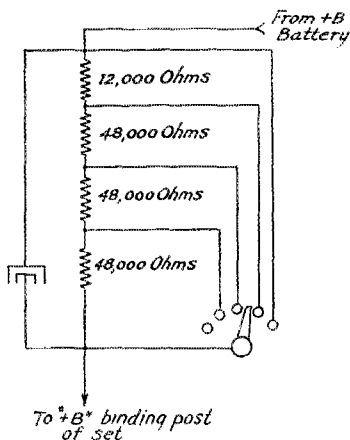

by a condenser of one microfarad or so capacity. (Lavite or Daven resistances are suggested. A Bradleyohm can be used without a switch.)

"This saves the battery while the potentiometer in the grid circuit wastes it by making the grid positive."

Keeping the Antenna Out of the Argument

When using a set with a fixed tune primary it will be found convenient to change the tuning of the antenna enough so that it will not come in the range of the tuner. The idea is to prevent a "blank space" in the tuner. We have before shown how it is possible to move a blank place around by means of a small series condenser and a switch. Perhaps a better scheme is to move

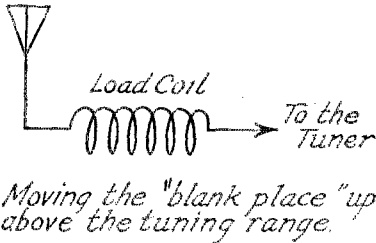

it outside of the tuning range permanently by means of a loading coil as shown in the diagram. The coil is just big enough to tune the antenna a little above the longest wave at which the tuner works. For broadcast work 600 had better be avoided as ships will otherwise come in, therefore 550 is suggested. For amateur work anything above 200 is O.K.

Have we said before that a primary which is fixed tune is most decidedly not "aperiodic"?

How To Ruin Telephone Jacks

An absolutely certain way to spoil telephone jacks so that they will *never* get well again is to solder connections on them with something besides rosin. This has been said many times but seems to make no impression on anyone at all, *especially not on the radio manufacturers*. As nearly as we can make out about three-quarters of them are handicapping their sets with jacks partly short-circuited by corrosive fluxes.

Some recent tests came out as follows: Representative telephone jacks of various makes were measured up with a "megger" to make sure that they were good to begin with. All but one of them were insulated with bakelite-dilecto or other material of that sort. These all tested "infinite resistance" on the 500-volt "megger", the fibre insulated one tested a trifle lower but still perfectly satisfactory.

All of them were then put in a steam bath and tested again after drying out. They tested up well as before.

Next some wires were soldered on in the usual fashion, using plenty of solder and paste and a hot iron so that the compound fumed. Immediately all three of the jacks tested less than half a megohm and shortly after one of them dropped down to a "short

circuit". Anyone of these put across a pair of telephone receivers reduces the strength of the signals about one-half.

The jacks have now been allowed to lie around for about a month. The springs on all of them are green and corroded.

If your set isn't working right tear out those jacks and solder the new ones in with rosin; it is one of the cheapest ways of improving a set.

The Ohio State Convention

THE old time comedians Weber and Field often asked their audiences: Vas you ever in Cincinnati? No! Vell you missed someding." Those of you fellows in the State of Ohio and within a hundred-mile radius of Cincinnati who played hooky and stayed at home missed one of the best conventions. On the morning of September 26th, bright and early, "Hams" from Massachusetts to California and from Michigan to Texas began to arrive and by evening more than 50% of the total attendance had registered, and then it was learned that DON MIX of WNP fame was at the hotel (that executive convention committee did put one over by being able to get Mix to come, when he had just gotten off the boat) and the way he had to autograph programs during the day and a half he was with us it must have given him the glass arm.

Friday afternoon several automobiles took the gang to see WSAI one of the broadcasting stations. In the evening was the official B. C. L. meeting and was fully covered by Herbert from headquarters, Fred Smith of WLW, Green of WSAI and as there were a number of Amateurs the evening was closed by Angus of 9CYQ.

Saturday morning the gang, altho a number had worked at some of the stations all night, gathered bright and early and loaded up two big busses and a number of automobiles and visited the three plants of the Crosley Mfg. Co., and watched the operation of turning out radio sets in large quantities. Right here we must mention a word about that live wire Mr. Plough, of the Crosley Mfg. Co., through whose efforts our visitors were so well entertained. Thanks to you, Mr. Plough. The afternoon was taken up by good technical talks; for instance Gano, SAYU, described a low loss receiver that seemed like good stuff, and then Schnell, A. R. R. L. Traffic Manager, said so many things about what he knew or suspected about low loss receiving and transmitting. The speed, liars, and "guess the radiation" contest were held and proved most interesting. Windom, 8GZ-ZG, of Columbus, must have

had a rabbit's foot in his pocket for he landed three prizes.

And last but not least the day was ended by a banquet, the food from which is still a fond memory. The whole banquet program was broadcasted thru WLW, courtesy of the Crosley Mfg. Co., and several telegrams were received during the festivities reporting perfect reception of what was going on, notably from Laizure of Kansas City, Painter of Chattanooga and Strong of Hartford. Director Darr, 8ZZ, gave a secret away; we now know that his subject for the cartoon, "The Main Guy" was 8BYN. Some "Guy" he is too. Schnell was asked to explain the new circuit he developed on the table cloth, but he refused to commit himself; and no one could explain why Herbert should get away with eating fourteen biscuits or why 9CYQ should smoke his pipe between courses. We were glad to see those Y. L's with the Kentucky delegates; actually we were envious. Following the speeches, balloting for the 1925 convention took place and Dayton was chosen.

The Convention closed Sunday afternoon with the conferring of the degree of the R. O. W. H. by the boys from across the river and it was well done. Three cheers for Elmer H. Schubert, his committee and the Union Central Radio Association for the complete success of it all.

8COJ + A.A.H.

Extension of Standard Radio Frequency Transmissions

FOR the past two years the Bureau of Standards has been transmitting at stated times, radio signals of standard frequency from Bureau of Standards radio laboratory at Washington, D. C. These signals are transmitted approximately twice a month and have been utilized throughout the eastern half of the country. In order to extend the territory covered, transmitting equipment and standards have been installed at Stanford University, California, with the cooperation of that institution. The station thus established at Stanford University on September 5 inaugurated the transmission of similar signals of standard frequency, thus duplicating in the West the service rendered by the Bureau of Standards in the East.

The frequencies included in the past transmission have been from 125 to 2000 kilocycles (2400 to 150 meters). In order to make the transmissions of still greater service, they will be extended to include frequencies up to 6000 kilocycles. The future transmitting schedules which have been definitely arranged are given below.

These special signals of standard frequency are of use to testing laboratories, transmitting station operators and others in standardizing wavemeters and adjusting transmitting and receiving apparatus. The accuracy of the frequencies is better than three-tenths of 1 per cent. Information on how to receive and utilize them is given in Bureau of Standards Letter Circular No. 92, which may be obtained on application from the Bureau.

All transmissions are by unmodulated continuous-wave telegraphy. A complete frequency transmission includes a "general call," a "standard frequency signal," and "announcements." The "general call" is given at the beginning of the 8-minute period and continues for about 2 minutes. This includes a statement of the frequency. The "standard frequency signal" is a series of very long dashes with the call letters (WWV or 6XBM) intervening. This signal continues for about 4 minutes. The "announcements" are on the same frequency as the "standard frequency signal" just transmitted and contain a statement of the measured frequency. An announcement of the next frequency to be transmitted is then given. There is then a 4-minute interval while the transmitting set is adjusted for the next frequency.

The schedule of standard frequency signals from both the Bureau of Standards and Stanford University is as follows: Attention is called to the change in time, previously announced schedules having begun at 11 instead of 10 p. m.

Schedule of Frequencies in Kilocycles (Approximate wave lengths in meters in parentheses)

Time*	Nov 5**	Nov. 20	Dec. 5
10:00 to 10:08 p. m.	3,000 (100)	125 (2400)	300 (1000)
10:12 to 10:20 p. m.	3,400 (88)	133 (2254)	315 (952)
10:24 to 10:32 p. m.	3,800 (79)	143 (2097)	345 (869)
10:36 to 10:44 p. m.	4,200 (71)	155 (1934)	375 (800)
10:48 to 10:56 p. m.	4,600 (65)	166.5 (1800)	425 (705)
11:00 to 11:08 p. m.	5,000 (60)	205 (1463)	500 (600)
11:12 to 11:20 p. m.	5,500 (55)	260 (1153)	600 (500)
11:24 to 11:32 p. m.	6,000 (50)	315 (952)	666 (450)

*Eastern standard time for WWV, Washington, D. C. Pacific standard time for 6XBM, Stanford University, California

**The schedule for Nov. 5 is tentative for station 6XBM, Stanford University; later announcement will be made if there is any change.

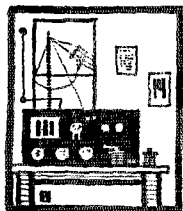

Amateur Radio Stations

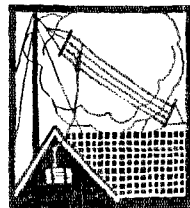

1CMP, Bridgewater, Mass.

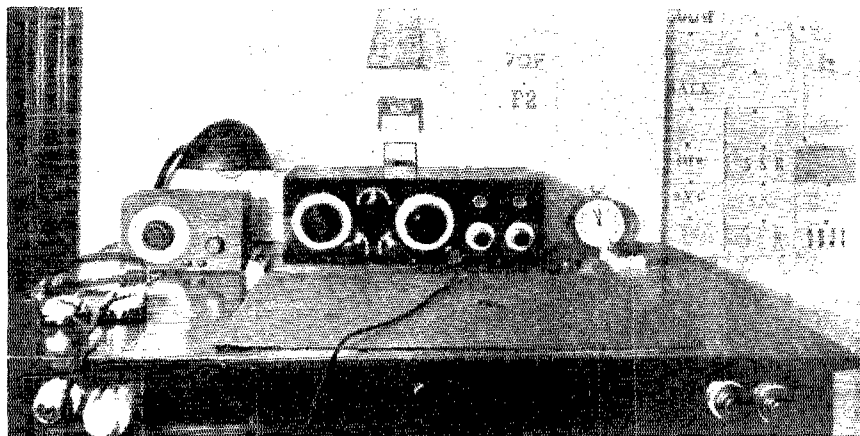

Station 1CMP is owned and operated by two brothers, Clance and William Jackson. It is located at Bridgewater, Mass., thirty miles south of Boston.

The receiver, shown above, is simply a one tube regenerative of the inductively coupled type. The transmitter, shown in the other photograph, is a Hartley arrangement. The single really unusual feature of the station is a relay arrangement controlling the transmitter power and filament transformers. This is illustrated in the diagram herewith. The relays are controlled by an anti-capacity switch which is next to the key. The key controls a relay in the negative lead of the high voltage plate supply.

The original antenna in use at the station was supported by a hundred-foot mast which was removed by a passing storm last March. That antenna was a fan fifteen feet wide at its upper end, on a 45 degree angle, tapering to a vertical four inch cage which was 28 feet long. The fan portion of the antenna was 85 feet long and made up of six wires. The counterpoise con-

sisted of four wires 68 feet long and 18 feet above the ground, in the shape of a fan. Special attention has been paid to antenna and counterpoise insulation, twenty inch porcelain insulators being used. A 250-watt tube was used the majority of the time. It put 5 amperes into the antenna.

After the storm, two temporary sixty-foot masts were erected and a single wire antenna stretched between them. A two-wire counterpoise eight feet high replaced the original one. Practically ever since the use of the temporary antenna system, a ten-watt set has been used with .9 amperes in the antenna; this representing about 40 antenna watts.

Several types of antenna series condensers were tried. The final one, with widely spaced plates, was built recently.

The rectifier consists of a hundred and sixty rectifier jars. The aluminum necessary was purchased direct from the Aluminum Company of America. It was found that Borax worked O. K. but soon ruined the plates so Sodium Phosphate was placed

in use instead and proved much superior. Transil oil is placed in the tops of the jars to prevent creeping of the electrolyte.

The receiving antenna is a single wire 120 feet long and thirty feet high run at right angles to the transmitting antenna.

All states except Nevada have been worked by 1CMP and all Canadian districts. Reports have been received from Alaska, Mexico, Panama, Cuba, Porto

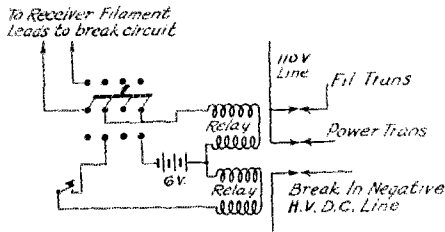

Rico, England, France, Holland, Portugal, Sweden, Scotland, Denmark, New Zealand and Australia. About sixteen different foreign stations have been worked. In addition to DX the station runs up a traffic total of around 125 messages a month, and answers all cards. 1CMP is on the air consistently, too.

8JY, Cleveland, Ohio

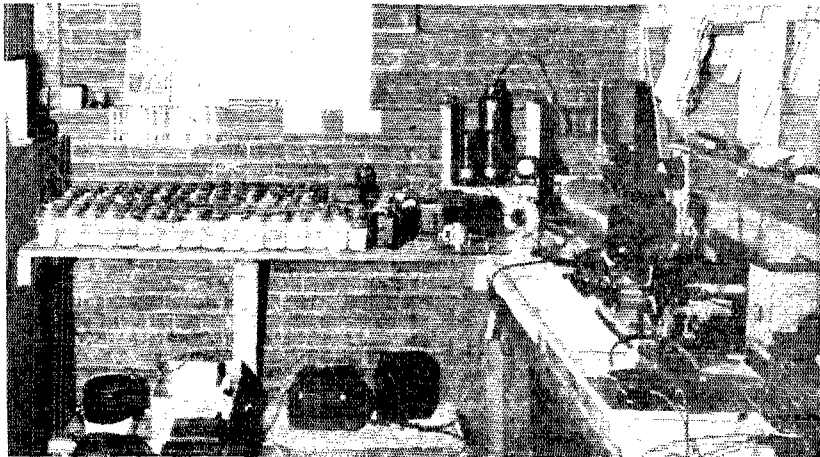

8JY is the station of S. B. Browne, 1757 Eastham St., East Cleveland, Ohio. It has been heard over all of the country and made some excellent DX records as well as

having one of the highest powered transmitters in the country.

The transmitter employs the Hartley circuit with a single 1000 watt (nominal rat-

ing) transmitting tube. 7000 volts, effective, from a 180-jar chemical rectifier, is applied to the plate of this tube. The plate supply transformer has a 9100-volt secondary potential, no load. Series-parallel arrangement of filter condensers partially solves the filter problem. The large tube has cooling flanges and was designed by Mr. F. S. McCulloh who loaned the tube to 8JY. The filament consumes, at 9 volts approximately 20 amperes. The plate current is 200 milliamperes and the tube runs cool, according to 8JY. The set puts ten to eighteen amperes into his antenna.

The antenna is a four wire slanting flat-top, forty feet high at the lead-in end and eighty-five feet high at the free end, with a caged tapered lead-in. The counterpoise is radial, covering nearly all of the antenna field and with a concentrated cage

counterpoise additional, directly under the antenna. The antenna is surrounded by trees as well as having the branches of one directly under it and between it and the counterpoise. Surrounding houses, buildings, and other structures effectually help to reduce the efficiency of the system.

The receiver is a simple inductively coupled tickler arrangement, made bread-board fashion, and is giving the satisfaction usual to this type of receiver.

8JY has been heard in every district, 4150 miles S. W. of Panama, in British Columbia, Cuba, and near the Falkland Islands. A careful and complete log is kept in spite of the fact that, due to the press of business, the station is only operated about two nights a week.

8JY claims that he answers his mail. FB.

4IU-4XE, Jacksonville, Florida

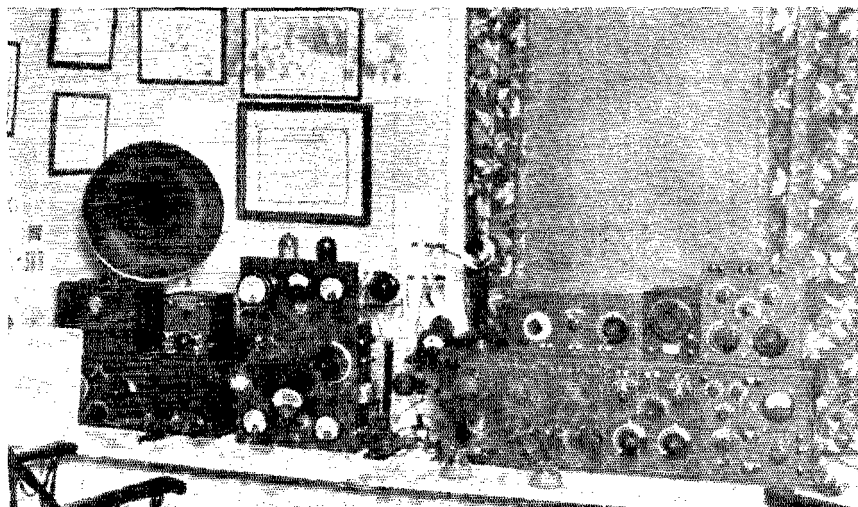

4XE, the station of William Justice Lee, has served its own introduction to the gang on the air so effectively that anything that we could say would be redundant.

Two antenna systems are used for waves from 30 meters up. One system consisting of two 6-inch 4 wire, cages, 43 feet long. The cages are on an 80 degree angle to the earth and about 100 degrees angle to each other. They are used as antenna and counterpoise at a 30 meter minimum, and look like a very effective system. The second system, used on waves from 80 up, uses

a flat-top L type with a fan counterpoise. No dimensions were given but the DX records of the station vouch for its excellence. (4XE had an awful kick in Texas.)

In the photograph, from left to right, are the following apparatus: a special short wave tuner, 40 to 150 meters, with one stage power amplifier, and a neon tube wavemeter of it on top a hundred-watt Hartley circuit transmitter of panel type; a special tuner of DeForest panels, 130 to 450 meters, with a Colpitts circuit trans-

(Concluded on page 58)

THE AMATEUR BUILDER

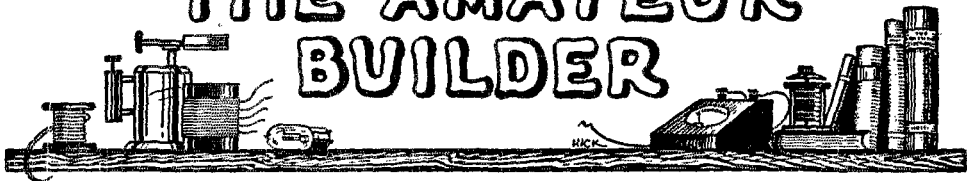

Some Antenna Pointers

By H. F. Mason

EVEN the best of sending sets will not work well unless connected to a good radiating system. It is only too often that the lack of good transmitting results is blamed on the sending set itself when the antenna and counterpoise system is really at fault. The present article tells some of the things that should be taken into consideration when putting up an antenna and counterpoise so that the radiating system can do its share in producing good results from the station.

In the Amateur Builder department of the past two issues of *QST*, we have described a simple C.W. transmitter using one five-watt tube. It is only logical that this should be followed by a description of a good radiating system to be used with the above set. A good radiating system, however, is so important a part of any station that it is well worth a special article. There are few amateurs who cannot get better results by paying more attention to this part of their equipment.

There apparently is no such thing as an ideal antenna that is at the same time practicable for the amateur to build. For this reason every amateur's antenna is different and is built according to his individual views, likes and experiences. There are, however, a few well-tried rules regarding antennas and counterpoises for transmission that should be followed. Make your radiating system conform to as many of these rules, which it is the purpose of this article to explain, as you conveniently can.

Picking a Location

About the first step is to pick a location for your masts and to draw some rough pencil sketches or form a mental picture of how the completed antenna system will look. There will always be several ways to arrange an antenna at a given location. In some cases one way will be by far the best; in others one arrangement may prove to be as good as another. The only sure way of finding the best arrangement where you

have several ideas in mind is to actually build the different antennas and give each a thorough trial.

The placing of the antenna and the run of the downlead is important. The free end of the antenna (the end opposite from that where the down-lead is attached) should always be made the higher. If your choice rests between erecting two equal masts of medium height or one high mast, by all means erect the one high mast. Of course it would be better yet if both ends can be made high, but this cannot always be done. Place the antenna so the top will be well above surrounding buildings and trees if this is at all possible. In planning how the lead-in is to be run, avoid bends of less than about one hundred degrees. It is much better to tie the down-lead off in space with long thin insulators than to have it trail over the building, separated from it only by a few inches, and supported by small insulators of doubtful insulating quality. Some good and also some poor arrangements are shown in Fig. 1.

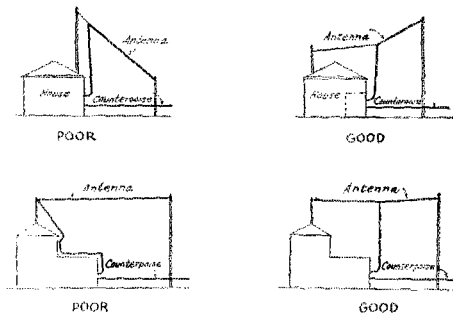

FIGURE 1

As for masts, articles in past issues of *QST* have described the construction of several kinds. The plaster lath lattice mast described on page 39 of the June, 1924, *QST* in the article, "An Eighty Foot Lattice Mast" by Gordon Hammond, 3CEL, is proving especially popular. Irrespective of the form of mast you build, however, always provide a sufficient number of guy wires:

placed so as to effectively hold the mast in position. Under no circumstances should the anchors for these guy wires be placed nearer than a distance of one third of the mast height from the base unless king trussing or other special bracing is used. The

terpoise is off to one side or not wholly under the antenna. There are cases where poor transmission in some directions has been traced to an unsymmetrical arrangement of the antenna and counterpoise, however.

There are two beliefs concerning counterpoise. One faction believes that the counterpoise should be an exact duplicate of the antenna and suspended directly beneath it; the other group believes in a counterpoise of the radial type that is fanned out to cover as much territory as possible. Neither side has proven conclusively that they are right and that their opponents are wrong. There are good stations that employ one type, and good stations that employ the other. Our advice to the beginner is to put up whichever type suits his particular location. If there is any doubt as to which kind to use; put up one kind, give it several weeks trial, then try the other.

Independent of the exact shape of the counterpoise, it is well to make it parallel to the surface of the ground, and to make all of the wires of equal length if practicable. Another good rule is to keep all counterpoise wires at least three feet from trees, fences, buildings, and so forth. The counterpoise insulation should be as good if not better than that of the antenna.

What Kind of Wire to Use

In the past season there has been a great increase in the number of amateur stations using No. 12 enameled copper wire for their antennas and counterpoises. Formerly No. 14 hard drawn copper wire could be taken as the standard for amateur use, but with the coming of real short wave work more interest has been taken in the various

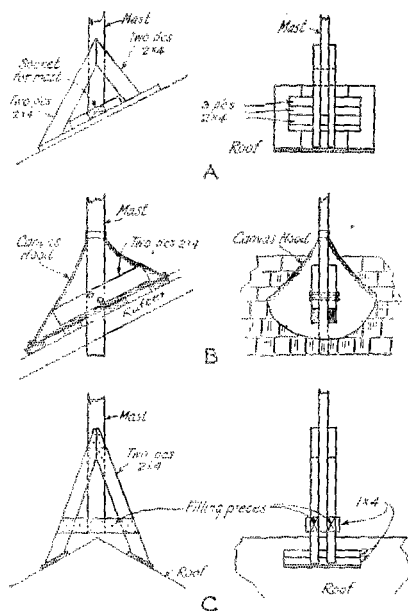

FIG. 2

Several ways of securing the base of a mast that is located on the roof of a dwelling

best all-around wire for guys on the average mast is No. 12 galvanized iron wire, obtainable at most hardware stores. The back guy from the top of the mast should be made especially strong because, when using C.W., it is desirable to pull the antenna up taut to minimize swinging in the wind, which is often accompanied by a swing in the received signal. Arrange the guy wires so they will not interfere with the putting up or taking down of the antenna or counterpoise.

When putting a mast on top of a house, do not tie it to the chimney. If you do, and the mast comes down next winter you will not only need a new mast, but a new chimney as well. Masts placed on top of the average frame house should not be too heavy, nor too high. A piece of two-by-three or two-by-four inch stock twenty feet long should be about the limit. Several ways of mounting the mast on the roof are shown in Fig. 2.

The counterpoise should be under the antenna. However, it is not an ironclad rule; your station will still work if the coun-

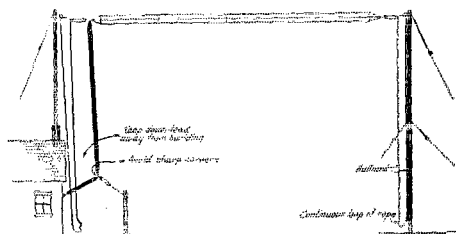

FIG. 3
Construction of a cage antenna

antenna losses and an effort has been made to use what is theoretically best. High frequency current travels mostly on the surface of the wire and it is the oxide that collects on the outside surface of a wire and turns it black that raises its resistance. Coating the wire with enamel will keep the air

from getting at the copper, thus preventing corrosion. Stranded or braided antenna wire has no place in an amateur's antenna or counterpoise. There are no benefits from its use.

Antenna Construction

The old questions of cage vs. flat-top for the upper section of the antenna, and cage vs. cabled-lead for the down-lead will need to be decided on. Put up which ever you like the best and which ever will be the most convenient. No one has proven that there is a noticeable difference between the operation of a cage and a flat top that can be directly attributed to the antenna. The cage should be quite large, however, and may be tapered. In the case of the down-lead there is no question but what a small cage has less high frequency resistance than the same wires cabled. The cage may be anywhere from two to twelve inches in diameter; six inches is a good size to use.

The insulators for the antenna and counterpoise should be carefully chosen. It is well to use only insulators made of Pyrex, glass, or porcelain, unless you have some other kind that you know positively are good for C.W. work on short waves. A long skinny insulator is much better for C.W. work than a short fat one. All insulators that are correct electrically are not usable from a mechanical standpoint, however. If you question the strength of an insulator, string it up to one of the beams in the basement of your house and suspend various weights from it to see what it will stand. To really be on the safe side, should an insulator break and let the antenna down, it is a good stunt to have a rope in place for pulling the remaining parts of the antenna down in addition to the halliard for raising the antenna. This is shown in Fig. 3. By this method there will be no danger of the rope's end sticking at the top of the mast if an insulator or the antenna breaks.

Fig. 3 shows also the details of construction of an antenna of the cage type. There is nothing unusual about it; it represents almost standard practice. The general construction is the same if a flat-top upper section is used, but extra guys from the ends of the spreaders would be required to keep the spreaders horizontal.

In any antenna or counterpoise use just as few good insulators as you can, placing them where they will do the most good. It is better practice to put one good insulator in the wire that holds the antenna at each end than to put an insulator in each of the wires of the cage or flat top. The same applies to the counterpoise, as will be exemplified in Fig. 4 later.

Counterpoise Construction

If you are building a fan type or radial counterpoise the details shown in Fig. 4

will apply. Of course you need not build your counterpoise exactly as shown; the drawing shows only a suggested arrangement and construction.

The counterpoise supports must be strong, for if the counterpoise sags it will be in the way. The usual practice is to suspend the counterpoise about eight feet above the earth. Four by four inch posts, set in concrete if necessary, depending on the character of the soil, should make satisfactory supports if there are no buildings or trees that happen to be in the right place. The bonding wire along the end of the counterpoise should also be strong for the counterpoise wires are all fastened to it. This bonding wire should always be larger and stronger than the counterpoise wires themselves. Some like to make this heavy end wire of galvanized iron, for strength, and then run a copper wire along with it for a good connection. It is not known whether

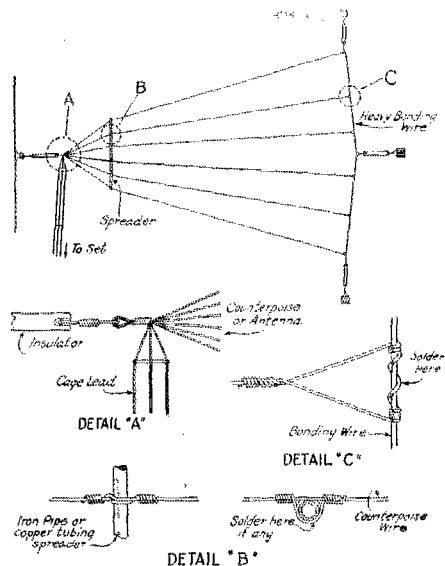
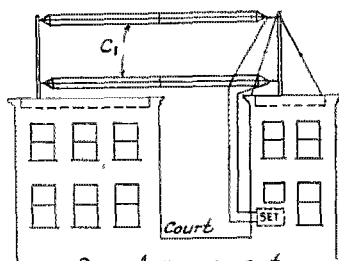

FIG. 4 TYPICAL COUNTERPOISE CONSTRUCTION

any actual benefit results from such an arrangement however. The reason for adopting the connection to the bonding wire shown in detail "C" of Fig. 4, is to prevent the wire from crystallizing and breaking from frequent bending in the wind, which would occur to a greater extent if the counterpoise wire were simply twisted a few times around the bonding wire.

Housetop Antennas

There are some amateurs, notably residing in the second district, who are not blessed with nice open back yards and who must be content with an antenna arrange-



Door Arrangement

Leads to antenna and counterpoise parallel and too close together. Much of the energy may never reach the flat top

A

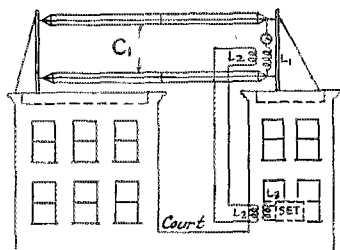

Feeding the antenna system through an untuned link circuit

B

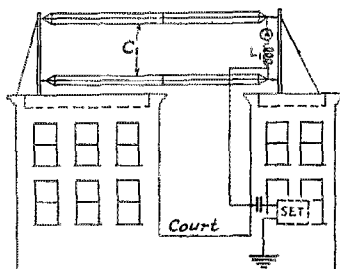

Feeding the antenna system by capacity coupling

C

FIG. 5

are not widely separated as they should always be.

Two much better methods of getting the energy from the sending set to the radiating system are shown in Figs. 5B and 5C. In Fig. 5B the antenna circuit is fed through an untuned link circuit. This is not as complicated as it first appears. The radiated wave is determined as usual by the inductance and capacity of the radiating system. The radiating circuit consists essentially of the antenna-counterpoise capacity $C-1$ and the loading or coupling inductance $L-1$. A series condenser in this circuit may or may not be necessary, depending on the size of the antenna and counterpoise, the vertical distance between them, and the wavelength used. The link circuit consists of two wires, say No. 14 copper, supported a short distance apart and well insulated. There is a coupling coil at each end. These coupling coils may each consist of about a dozen or so turns of wire, closely coupled to their corresponding circuits. It may be necessary to connect a loading coil in each of the long leads between the coupling coils to bring a current antinode somewhere near the center of each of the coupling coils, but of course this depends on the wavelength used, the length of the leads, and the size of coils $L-2$. The spacing of the two wires makes no difference. A spacing of one foot will be satisfactory.

The method shown in Fig. 5C was fully described in the article "Capacity Coupling to Operate an Antenna at its Fundamental" on page 22, 23, 24 of the June, 1923, QST. Only one lead from the set is necessary here. It is essential that this lead connect to the antenna system at some point several feet to one side of the current antinode.

'AMATEUR RADIO STATIONS'

(Concluded from Page 54)

mitter in the same cabinet makes the long set to the right; on top of the last is a wave trap, a 28 to 82 meter tuner, and a 600 to 3500 meter tuner. The receiver-transmitter (five watts) is used for local work entirely.

Mr. Lee is owner and operator of the station and did all of the installation and wiring alone. It is undoubtedly the type of station whose appearance and operation are deservedly commendable as a model.

"The installation has worked," writes Mr. Lee, "further than any other station in the fourth district, having worked PCII in Holland. This station was also the first in the fourth district to work across the Atlantic, as advised by Supervisor Van Nostrand."

ment somewhat like that shown in Fig. 5A. The natural inclination here is to connect the set to the radiating system by two long leads as is done in the sketch. This is a poor arrangement, however, because the leads are parallel for quite a distance and

Who's Who

in AMATEUR WIRELESS



PORTER H. QUINBY, 9DXY



DONALD C. WALLACE, 9ZT-9XAX

Porter H. Quinby, beloved manager of the Midwest Division of the Traffic Department, and old time amateur, was born in 1896 and raised in the city of Omaha, Nebraska. His interest in radio was away back in 1910 when he built a crystal set out of a rolling pin, a 75 ohm receiver, and some E.L. Co., parts. His first DX record was the hearing of a five-kilowatt straight-gap outfit installed as a part of the Naval exhibit at a fair about one block from his house. He had to close the windows so the noise direct from the gap did not drown out The signals coming from the ether! A few days later, with the help and advice of the operator at the fair station, Porter hooked up a one inch spark coil and under the call of "NI" worked with the three other amateurs there were in Omaha at that time. In August of 1912 the present radio law was passed requiring all operators and stations

to be licensed, and NI then became 9AY. Porter's amateur license bore the serial number 52.

9AY then progressed through the several cycles of evolution of amateur radio, from spark coil to transformer, from straight gap to quenched, and later to rotary. In receiving, the needle and carbon detector gave way to the silicon detector, then to the galena, and finally to the vacuum tube or audion as it was then called. Regeneration in those days was accomplished by placing the tube at certain various and critical angles with respect to the field of a large horseshoe magnet. 9AY was inactive while its operator was away at school and during the war the license was of course cancelled. After the war the old junk was hooked up again under the present call of 9DXY. However, the handwriting on the wall was soon read, the spark set was junk-

ed, and two five-watt tubes oscillated at 9DXY, beginning on New Year's day, 1922.

In October of the same year Mr. Quinby was appointed City Manager of Omaha, and, as such, succeeded in maintaining peace between the amateurs and BCL's during the period of strife. He has since successfully held the appointments of Official Relay Station, Official Broadcasting Station, and Assistant Division Manager of the Midwest Division.

He attended the Second National A.R.R.L. Convention at Chicago and won the first and twelfth prizes out of a list of 75 of them. The first prize was won in the loop contest with Turner, the Midwest's late Division Manager, as team-mate. Their previous experience in "looping" recalcitrant amateurs while City Manager of Omaha was undoubtedly a material aid in this contest. The prize was a 50-watt transformer, which is now in operation at 9DXY. As for DX records, this set boasts of being heard in the Azores to the East, by WNP to the North, Hawaii to the West, and by Mexican BX to the south.

Mr. Quinby founded and presided over the first radio club ever organized in Omaha, and has taken an active part in all of its successors. He now holds office of president of the Citizen Radio Club of Omaha, which is 100% A.R.R.L. and affiliated. He is also Manager of the Midwest Division of the Traffic Department.

Mr. Quinby was educated at the University of Nebraska and is a structural engineer by profession, at present with the Concrete Engineering Company of Omaha.

Donald Claire Wallace, 1923 Hoover Cup winner, was born in 1898, about the time Marconi was in the spark coil stage. After being allowed to grow up for a few years, Don was taken to California in 1905. The California air evidently made him grow for he now stands six foot three in his stocking feet. At the age of eleven, electricity came into his life in the shape of some old college physics books belonging to his father. He soon found out how doorbells work and then made a motor, a buzzer, a telegraph sounder, and a key. The telegraph line later made a good antenna for his first crystal receiving set.

The call 60C was soon secured, homemade transformers constructed, and then came a glorious rotary gap for Christmas and life was sweet. San Diego was worked from Long Beach in daylight (100 miles) and then old 6BJ and 6BY in San Francisco were also worked. A crystal receiver was of course used. Then Don heard of the A.R.R.L., just beginning, and joined.

Old KPJ's spark was only six miles away from his California home so QRM and 9ZT grew up together. Soon he worked his passage to San Francisco, 500 miles, and got a commercial operator's license at the age of 15. KPJ became more interesting to him and finally he did relief work there in cases of mumps or baseball games. He also took a few short runs on ships.

Donald Wallace graduated from High School in 1916 and went to the Hamlin University at St. Paul, Minnesota, from there, where he played center, weight 200 pounds, and forgot radio until after the final game. Then a one-kilowatt Thor with its tongue out broke the stillness of the Minnesota air and crashed the call 9BU as far as Texas. This kept up all winter.

Spring came with static, studies, and war, so Don joined the Navy. He was first sent to push the key at some of the big Western stations; NPG arc, KSS arc, and KET, the 300-kilowatt spark at Bolinas. The mill and key buzzed merrily along so Don reached the rating of Chief Electrician, Radio, at the age of 19 and was sent to sea aboard the U.S. Submarine O-16. Here he enjoyed every minute of his sea radio experience but lost fifteen pounds and gained a slight stoop and a dented head. Submarines are a nuisance to a tall man anyway.

From there he joined the patrol looking for 100-meter submarines and bumped into another submarine, and an American too, by heck. They lost some time getting the dents out of their ship but continued. Mr. Wallace then joined the ship on which our Traffic Manager, Fred Schnell, was pounding brass, the U.S.S. Geo. Washington. Arc sets, spark sets, C.W. sets, radio telephone sets, and L.C.W. sets were their playthings. Their ship made so many records in the next few months for duplex working, DX, consistency, and simultaneous transmission that the rest of the ocean thought there were ten George Washingtons instead of only one.

A year later the first C.W. set at 9XI saw our hero at the key and C.W. came into its own. Mr. Wallace graduated that year and set up station 9DR in an apartment house. Then came a home of his own and station 9ZT-9XAX. Mrs. Wallace and a two year old Billy now require some attention but the key and four inch dial get the rest.

Mr. Wallace ably held the office of Assistant Manager of the Dakota Division for a year before receiving his present appointment as Division Manager about six months ago. His present "job" is manager of the radio department of the Peerless Electric Company, a Minneapolis concern. As operator of 9ZT-9XAX, Mr. Wallace is too well known for comment. "Radio for me until 90 years old," Don says!

INTERNATIONAL Amateur Radio

A Neat French Station

One of the nicest things we have ever seen in the way of a foreign station is French 8AÉ. This station, which belongs to one of France's foremost radio magazines, *La T.S.F. Moderne* (Modern Wireless), is a fine example of a well-laid-out and neatly constructed installation. It was built with a view towards making a station that would be the last word in French short wave radio practice.

The station took part in last winter's transatlantic tests, and has been used since that time for experimental and other transmissions on behalf of *La T.S.F. Moderne* and the radio societies it represents. The results have been entirely satisfactory. These regular transmissions have been made with 100 watts in the aerial and this gives readable signals throughout France and at considerable distances beyond.

A description of the masts at 8AÉ appeared in the September, 1923, *QST*, shortly after they were put up. There were two originally, but one was demolished due to an accident, and was never replaced because there was no further need for two masts. The remaining mast, as was the other one, is a guyed mast of wooden latticed construction. It is 115 feet high, triangular in section and about 5 feet on a side at the center. The mast appears at both ends and the lower end rests on a special ball and socket joint.

The present antenna is a cage 90 feet long and 3 feet in diameter, strung from the remaining mast to a stub mast at the station house. There are four counterpoise cages, arranged radially, 13 feet above the ground. They are each about 3 feet in diameter and 45 feet long. All four are used on waves above 180 meters, while only one is used on wavelengths around 150 meters. There is also a ground connection, consisting of a buried network, to which the negative high voltage lead is connected as a protective measure.

The photograph shows how neatly the station is arranged inside. The transmitting apparatus is installed on the far table while a portion of the receiving apparatus may be seen on the table in the foreground. Local power mains supply

current for the station at 220 volts, 2 phase, 50 cycles. Unfortunately the set is supplied from a long supply lead, with the result that the voltage varies widely. This trouble eventually led to the installation of a storage battery for heating the filaments of the transmitting tubes. The photograph shows

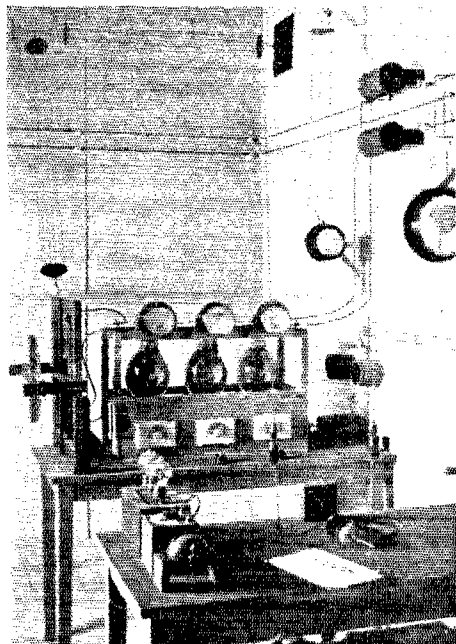

THE TRANSMITTER AT 8AÉ. Note the neatly caged leads to the counterpoises and antenna, the radio frequency choke coils mounted on the wall, and the pleasant accessibility of every part. Quite different from some of our "junk layouts," isn't it?

the filament transformer, formerly used, however, and on the wall may be seen the two radio-frequency choke coils connected in the primary leads to this transformer. Three Mullard 500-watt (input) tubes are used, mounted in a special rack. Small panels below each tube carry separate rheostats in series with the filament of

tube. The normal filament current is 5 amperes at 17 volts. Reading from left to right the meters above the tubes indicate values of grid current, filament voltage and plate current. Antenna current and plate voltage meters are mounted on the wall to the right.

A motor-generator is now installed in another room which supplies 2,000 volts D.C. to the plates of the three tubes, with 500 milliamperes as the maximum plate current. The generator is separately excited and the output can be varied from 500 to 2,000 volts.

The reversed feedback circuit with parallel supply is employed and the inductances may be seen at the left. The antenna and plate coil are combined in a copper strip inductance. The grid coil is a spider-web wound with heavy cord and arranged for variable coupling with the former coil. The negative high voltage lead is brought to a clip on the copper strip inductance, instead of being secured to one end of it, as this clip must be properly placed at the nodal point of the radiating system. Antenna tuning is done mostly by a variable condenser. The grid condenser is also a variable air condenser, shunted by a variable resistance of 8,000 ohms, maximum. The transmitting key, at the same time it controls the transmitter, operates a little buzzer that serves as a guide for the operator to tell what he is sending.

More News on IHT-ACD Tests

THE Italian naval vessel San Marco, IHT, of which we told you in the August, QST, is being heard with some degree of regularity at this time. At the time of most of these receptions, the ship was scheduled to be near Montevideo, Uruguay and Bahia, Brazil; which proves to be the case. The further schedule of its itinerary is of no use because the time that this reaches our readers will find the vessels back in its native waters.

Italian ACD is the operator on the vessel as was mentioned before, and has surprised some of those whom he has worked with his ham vocabulary.

Reports of reception of IHT-ACD should be forwarded to A.R.R.L. headquarters, and a copy to the Naval Attaché, Royal Italian Embassy, Washington, D. C.

ACD writes about Argentina where he visited some amateurs in Buenos Aires, "the radio bug is in full efficiency here and there are many with years of radio experience. Several are A.R.R.L. men and have their transmitters on the short waves. A. C. C. W. is nearly unknown. I was heard on 115 meters in Rome; and in B. A. while yet at Gibraltar.

"I transmit always from 2200, 2400, 0200, and 0400 G.M.T for fifteen minutes

calling IDO on waves near 100 meters and probably from 115 to 120 at times. I will listen at 2300, 0100, 0300, and 0500 G.M.T for fifteen minutes for IDO, Rome, on 105 meters. After this period IDO transmits with a new station on 125 meters. The gang should listen for IDO on these transmissions and should transmit for my reception at 2315, 0115, 0315, and 0515. Thus I ought to hear a few as my receiver is O. K. and the distance would be good."

IHT-ACD was worked by 3HS when at Bahia, Brazil, on Sept. 9th., by 5ZAI on Sept. 14th.; by 1XW on the 17th.; and by 4IO on Sept. 23rd. In addition he has been heard in the states of Maine, Massachusetts, Connecticut, New York, Ohio, Florida, Pennsylvania, Michigan, Alabama, South Dakota, Iowa, Illinois, Texas, New Jersey, and by two stations in Ontario, Canada. The single most interesting reception was by Monte Cohen of New York, N. Y., who heard IHT for several nights in succession and on one particularly staticy one, on a bed spring, using detector one step.

ACD in a later letter, mentions hearing an amateur in Tunis, Africa, but does not mention the call used.

Paris, UFT, and Berlin, POZ, are both operating on various short waves, in the vicinity of 50 to 100 meters.

ACD's log now includes 20 American stations, 5 Canadian, 95 English, 92 French, 3 Luxemburg, 2 Swedish, 24 Dutch, 10 Belgian, 3 Danish, 3 Switzerland, 3 Finnish, 1 African. This certainly sounds wonderfully well as to the general spread of American Radio. It also gives us a very excellent idea as to where we might be heard and whom we might hear.

The misunderstanding regarding a clause in the new British amateur regulations, if enforced, would prevent British amateurs from working with stations outside of Britain has at last been cleared. In reply to an objection raised by the Radio Society of Great Britain the British Post Office Department has stated that as in the past special permission would be granted to those desiring to work with stations outside of the country. They admitted a more fortunate wording of the clause in question might have been found, which might have been expressed as, "Except with the special permission of the Postmaster-General, messages shall only be transmitted to places in Great Britain, etc."

The remaining problem outstanding refers to the situation that arises when a British amateur is called by a foreign amateur who wishes to conduct tests. Under present regulations the British station may

not reply unless the calling station happens to be one with whom he has specific authority to work.

Further advises from **Radio Wereld**, regarding Dutch PCII, indicate that the station is unlikely to be on the air again in the near future. Though the previous case against the station was dismissed, the case is to be tried again in a higher court and, pending these proceedings, PCII must remain silent, his apparatus being confiscated. We hope that this active Dutch station will be successful in the new legal contest.

On December 19, 1923, 9EFU heard New Zealand 1AO and has received verification of the reception. 1AO was using a five wattter with 400 volts B battery on the plate and with .9 ampere in the antenna, wavelength 180 meters. On September 6th, 6CW of San Francisco heard New Zealand 2CE on about 175 meters.

G2KF writes in to let us know that the English amateurs are not allowed below 90 meters. He says that the majority are on waves of 100 to 130 and that he is using 104. He also mentions that he is listening for us on waves from 60 up but we are to remember that he must work above 90. He says that he has been calling until he is blue in the face, with no replies, usually, from the amateurs on this side of the pond.

Mr. Erkki Heino of Helsinki, Finland, advises us that he has secured permission to work and to carry on relay communication. The rights are rather limited and no definite law has been passed but he will advise us when these interesting things occur. He is well-informed, having all of the American and English radio magazines of importance, and Finnish magazines too.

The power they are allowed to use, he mentions as being insufficient for two-way communication regularly; but there is a possibility of getting across this winter. At present he can hear the U. S. broadcasts sometimes and all preparations are being made to listen for the amateur work in the coming seasons.

A ship signing ARRL has worked several British amateurs and been heard by others. It is said to be a cable repair ship but absolutely definite information is lacking. Anyone knowing definitely or possessing any information should let us know so that the identification of the call can be final.

New Argentine Radio Regulations

The Argentine government has recently put into effect a complete set of radio regulations that will do much to relieve the

somewhat chaotic conditions existing there heretofore. The new law, which has been pending for some time, provides for the licensing of stations and operators and the assigning of calls and wavelengths. The new regulations are very just and were evidently framed with a view toward allowing Argentine amateurs to carry on their experiments with amateurs of other countries to the fullest extent.

The license examinations for amateurs in the Argentine Republic are very similar to those in the U. S. except that a code speed of only six words per minute is required. Apparently the Argentine amateurs may use any wavelength below 250 meters for the present but as the art progresses this may be changed to suit conditions. In the vicinity of government stations a power of only 5 or 10 watts is permitted.

For the purpose of assigning calls, the country has been divided into 19 zones, each having one or more designating letters. The calls of the broadcasting stations consist simply of the designating letter for the zone in which they are located, followed by a numeral. The amateur calls consist of two letters and a numeral. The second

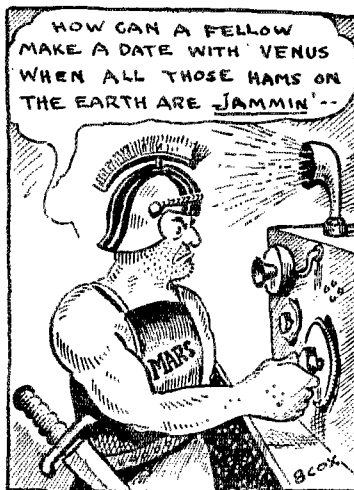

THE ONLY "DX" LEFT
FOR SOME OF US.

letter and numeral is assigned in order as the calls are issued while the first letter denotes the district in which the station is located. At present there are around 150 or 200 licensed amateurs in the republic.

In accordance with these new regulations, the call of the station of Mr. Carlos Braggio at Belgrano 120, Bernal, has been changed from CB8, which was self-assigned, to DA8, the government assigned call.

Strays



We don't understand, with our correspondents, why ham fone conversations run, on either side, much like this: "Hello, old man. No I don't, old man, use 'nother mike, old man. I say old man. . .", ad QRMium. We suggest, as alternatives for the much used OM; old socks, old bean, old kid, old dear, old ham, old cheese, or any other old delicatessen or old haberdashery.

The old boy has suggested that an esthetically pleasing and attractive cover, being also simple, would be a bean rampant on a field of azure.

Joseph Roemisch of 841 Lexington Ave., N. Y. C., says that he has access to the N. Y. University Radio Lab. and that he wishes to cooperate with some other hams on an investigation of the short waves. The farther away from N. Y. the better. Write for schedules, etc.

1PP sends in his calls heard under three headings: spark, C.W., and miscellaneous. We agree with him; some fone stations can only be classed under miscellaneous.

We don't understand some of the squawks that come in about different 'pans' that happen in QST and which are very generally aimed. So many take some of them so seriously to heart that we can't help but feel that they were badly needed.

As a matter of simple courtesy, those of you who write in to QST should advise on your letter whether or not you expect an answer, if you are not asking for information. If you don't expect or need an answer, your making a note of that fact will save us oodles of time. Thanks.

50C wants to know what he ought to do. Everybody that sees his card wants to know what the red 50c is on it for. Guarantee him a jury of Hams and the verdict will be; justifiable homicide, accused not guilty!

Newspaper item says:

"An SOS call from some ship . . . was picked up by a naval station tonight (March

22nd.) but the wavelengths were so long that only fragments of it could be deciphered." The heading was, "Some Ship in Distress" and we are inclined to think that, from the foregoing, the title was more accurate than intentional. The ship must have had indigestion. Or, it's the waves that cause the distress.

"Inclosed you will find a description of my Putrid receiver which has heard all districts, etc. Please publish it in the next issue of QST." Clank! Please, 'nother wastebasket.

8BDR says that a bell attached firmly to your wavemeter and tapped, when the meter is varied nearby the receiver, can be heard as a clear tone when resonance is reached. He says that this trick beats oscillators and buzzers; and, if you have a metal dial on the meter, its vibration will serve the same purpose. Small alarm clock bells screwed to the meter case ought to be fb.

3LM's yi thinks F8AB is a new kind of laundry soap.

"A CQ in the bush is worth two in the air" . . . 3BMN

3BMN also says that these sets with more than one tube and uneven length leads, get so that the right hand tube does not know what the left hand one is doing. This is a case for the direct application of the old saw about removing the hand that offendeth.

8VQ found his receiver changing wave periodically the other night, and was at loss as to the cause. Investigation discovered the fact that a bug was using the condenser plates for stepping stones, thereby detuning the set. We might make a wise-crack about radiobugs but we won't.

We don't use poems in QST ordinarily, and if we do, we have enough now on hand to satisfy the space available for the next

(Concluded on Page 65)

ten or fifty issues. Yes, we don't, you're welcome.

Our correspondents are overflowing with objections to our coupled statements. Be at peace! When we said coupled Hartley we should have said *inductively* coupled Hartley and for the usual Hartley, we should have said *conductively* coupled. Are we happy? Yes!

Do electrolytic rectifiers freeze, and if so, what solution has the lowest freezing point? We know we can keep 'em from freezing by putting a load through them to a couple of lamps and let it run continuously but the family bill payer usually is not inclined to believe our statements of low cost or to have any faith in the economy of the idea. Will someone who knows, give us some facts that are dependable?

Don't send your station description to QST and have them published in some other magazine, too. We won't use them for we have too many others that are available and which will be first run material.

Visitors to the World's Radio Fair held at New York during September took advantage of the short wave amateur transmitter installed in the booth operated by the Executive Radio Council of the Second District and the A.R.R.L. A hundred messages were handled and dispatched for various parts of the world. One being started for as far as Shanghai, China.

Our Treasurer and Fieldman, A. A. Hebert, left on October 14th, on a 12,000 mile trip to visit our traffic officials and affiliated clubs which will take him through most states; excepting the middle states which will be visited in the Spring.

Did you see the article "The Tuner at 9MC" in the September QST on page 48? The boss of the tuner now writes us a vociferous letter to the effect that this tuner won't work with the B battery tail foremost the way we showed it. Alright—we back down and agree to connect the positive to the plate as usual. Incidentally—"Hen" also says that the performance is improved by connecting a 5000 μfd (.005 μfd) condenser from the positive B battery to the rotary plates of the v. e.—in other words shunting it across the B battery and phones.

Before throwing away a dead tube, look to see if some of the wires inside of the stem leading from the terminals are broken or not. Sometimes in transmitting tubes one or more of these wires burns or becomes unsoldered, resulting in an open circuit which may usually be quite easily repaired.

When necessary to use taps in a tuned circuit that you are very particular about, the losses can be reduced by putting slots between the switch points as shown in the attached sketch. These slots go clear through the panel and may be made quite large without seriously weakening the panel. They are cut at the same time that the

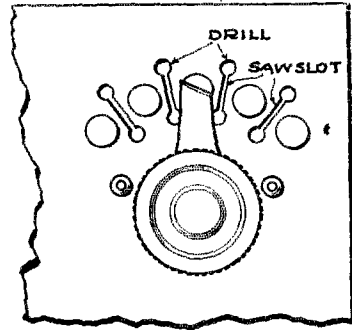

panel is drilled. This excellent idea was submitted by M. H. J. Merwin, Jr., 1801 Danbridge Pike, Knoxville, Tennessee.

Trouble in not being able to filter out the ripple in the high voltage generator of a motor generator set can sometimes be traced to induction between the motor circuits and the generator. This can be prevented in a large measure usually by separating the motor and generator about 18 inches and connecting them by means of an insulating rod coupling. The frames of the machines should also be well insulated from each other.

One of the easiest ways to spoil a pair of phones is to leave them connected in the wrong direction on a one or two stage amplifier. There is a right and wrong way to connect phones, and if they are connected incorrectly they become demagnetized and lose their sensitivity.

The best way to tell which is the correct connection is to plug the phones in the second stage of amplification and tune in a loud signal. The phone caps should then be removed and one edge of the diaphragm should be lifted up about an eighth of an inch with the finger. When the phones are connected in one direction a very much greater pull will be noticed than when connected in the other direction. After this has been determined, some kind of a mark may be placed on the phone terminal that was connected to the plate of the tube when the greater pull was placed upon the diaphragm, and the phones should always be connected with the marked terminal to the plate.

—Radio (Australia)

The radio department of Arthur Rosenberg Co., Inc., Advertising Agents, 110 West 34th Street, New York, is now distributing to radio manufacturers the first issue of the Radio Advertisers' Data Book which it has compiled and published. This fifty-four page book contains the advertising rates, circulation, mechanical requirements and other data regarding all the radio consumer and trade publications, as well as those general magazines which feature radio, also the allied trade papers, covering such fields as the electrical, hardware, talking machine, music trades, and sporting goods in the United States and Canada. The various and important problems that confront the radio manufacturer regarding radio advertising and merchandising are discussed in detail.

"Mr. Jos. L. Roemisch, 2JL of 841 Lexington Ave., New York, advises us that he has obtained the use of the radio laboratory at New York University for short-wave experiments and desires to hear from experimenters who would be interested in conducting special short-wave tests with that station."

Several fellows have commented on the little dah-dit-dit-dit-dah's we have been putting between the "strays" lately. We must admit that it is not our original idea, however. We got it from the snappy little Bulletin put out by the Southern California Radio Association.

To hear a familiar buzz each time the key is pressed helps an operator to send properly. It is even possible that the almost silent operation of a modern C.W. transmitter is responsible for some of the unnecessary operation and "bum fists" that

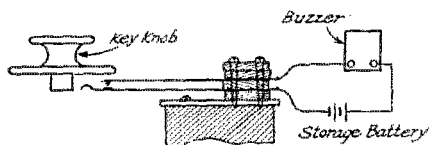

are heard on the air. A good remedy for this is to connect a buzzer so that the operator can hear what he is sending. If it is connected as suggested by H. D. Wilson, Box 6, Phoenix, Ariz., it will not interfere with the regular operation of the set in any way. The parts required are an old telephone jack, a buzzer, and a battery. The front part of the jack is sawed off. The block between the jack and the table must be adjusted to the correct height so the contacts on the jack will close when the key is pressed.

Paul F. Godley is now vice president and general manager of the Farrand Mfg. Co., Inc., with general offices and factory at 28

South Sixth Street, Newark, New Jersey. This company was organized early last spring for the development of the Farrand Super-Pliodyne receiver and has now brought the work to a point where the nine tube receiver is about ready for production.

Famous Sayings

"FB, OM, what pwr U use?"
 "How's my spark?" (Obsolete)
 "All on one five watter."
 "And the plates ice cold."
 "Ur sigs QSA vy, no QSS."
 "QSA vy, OM, but QRM bad hr."
 "All over the shack hr, OM."
 "Have to eat nw, cul."
 "Howrs mow mourduladon, OM?"
 "My tone's perfect DC in my receiver."
 "What circuit U using?"
 "Getting three amps radiation now."
 —9ZG-9APW.

COMMUNICATION WITH NEW ZEALAND

(Continued from page 15)

4AA uses one UV-203 in a series Hartley circuit, 1000 v. on the plate, putting antenna currents varying from 1.2 to 2.5 amperes into the 85-foot-high aerial described in our photograph at wavelengths varying from 120 to 170 meters. 6BCP has a master-oscillator set, using one UV-202 as oscillator and four as amplifiers, 600 volts D. C. from a m. g. This set puts 4 amps. in a 4-wire inverted L, 40 ft. high, used with a counterpoise. His receiver is a short-wave Roberts, as recently described by Zeh Bouck in "Radio Broadcast". 6CGW was described on page 41 of QST for June, but during this work used the high-power set employing one UV-204 in a 4-coil Meissner circuit, 4000 volts C.R.A.C. on the plate, putting 6 amperes in that really beautiful antenna.

6BCP win the boomerang offered by QST to the first North American ham to get QSO Australasia. 6CGW was so close behind him, however, and has tried so hard, that we are offering him a consolation prize of one pair of genuine green suspenders.

z4AA has been working for this for a long time, too. Many and varied have been the incorrect reports of his signals, but he kept a careful log and could always answer positively. Finally on May 19th he was heard on 170 meters by 9AHT, while calling CQ with an input of 80 watts; and on July 13th Mr. Elmer Gabel, of Kennet Square, Pa., heard him calling 6CGW on 120 meters, input 100 watts, both of which were verified by his log. By now, of course, his signals are getting common. Let us hope that this contact is the forerunner of regular communication with Australasia.

—K. B. W.

Radio Communications by the Amateurs

The Publishers of QST assume no responsibility for statements made herein by correspondents



Handling the Key

3 Ord St.
San Francisco, Cal.

Editor, QST:

In your issue for August, Clifford Tunis gives some useful points on handling the common Morse key. At the risk of appearing controversial I would like to heterodyne and possibly amplify said points a little. To begin with Mr. Tunis refers to "key perched on the edge of table", operators "whole arm in midair" and consequent (?) "bum fists" and fatigue. He also italicizes the statement that the method illustrated in QST, July, 1923, is the "only way to handle a key". Well, Sir, I think Mr. Tunis is in error to some extent, and I will do my best to explain why I think so, my ideas being based on observations during several years "wire" and "wireless" work, using the many different types of hand-keys almost "all over the world," to use a common expression.

It should be understood that there are two distinct patterns of Morse key in use to-day. One is the regular light, springy, steel-lever type American key; the other is the rigid heavy, "chunk of brass" European key, which is typified by the British Postal Telegraph key shown in Fig. 1. Some of the French and German keys are even heavier and clumsier in appearance. It is quite obvious that these two fundamental types require two entirely different methods of handling. It is also important to notice that a large number of the keys now used in American radio work approximate the European type but are fitted with a flat American type knob. The consensus of opinion of operators of varied experience and also of the various committees which have been set up by telegraph administrations to study the causes of "telegraphers' cramps" is that the two types should be operated by the following respective methods:

American: Key fixed with knob 15 to 18 inches back from the edge of the table, operator's elbow resting on table, two or three fingers lightly on the knob, towards the back, and thumb touching the edge. Movement must be from the wrist and forearm, not the finger joints, and the elbow should

not "walk" about the table. Generally the fingers should not leave the knob during the transmission of a word, and don't attempt that "nerve-sending" stuff: it is certain to ruin your style and if persisted in for long period results in the affliction known as "Telegraphers' Cramp" (glass arm).

European: Key fixed at edge of table, a little to the right of operator's normal sitting position. Two fingers hooked over the top of the knob, thumb just under its head and third and fourth fingers hanging free. The wrist should be about level with the key knob and the fore-arm absolutely horizontal, the elbow quite a few inches away from the body. In operating the wrist should drop sharply with every signal, but the elbow should be almost stationary in space. The light grip on the knob may be completely released at the termination of each complete letter: this assists in the formation of good spacing. This type of key is generally used with a somewhat stronger spring and larger gap than the American type, but on any key most amateurs attempt to send with far too small a gap and too light a spring for really good sending.

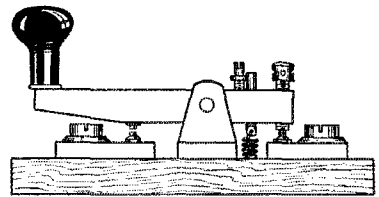

A G.P.O. SINGLE CURRENT KEY
This is a good example of a "European Type" telegraph key

The whole trouble lies in the fact that most amateurs and, unfortunately, a few commercial operators too, have never learnt or been taught how to send in the way it used to be taught in large telegraph schools. The learner should start with an "enormous" gap, say $\frac{1}{8}$ inch and a spring so strong that it requires eight or nine ounces to depress the knob. He should practice with these adjustments until he can send twenty words per minute and then perhaps

commence to reduce the gap, but the spring tension should never be less than about six ounces. An operator who learns in this way can generally send perfectly on any type of key that appears before him. He does not have to spend ten minutes out of every fifteen playing with the adjustment screws, either.

Finally I would say that it is quite a fallacy to suppose that a short gap and light spring are necessary for speed or conducive to good formation and easy working. Some years ago I worked a circuit fitted with European type "double-current" keys, in which the lever strikes softly between rubber buffers, but the knob moves up and down about one-half inch or more. I have put in many a day of continuous sending (no let-ups for receiving as the wire was "duplex") maintaining more than 30 w.p.m. for eight hours without any fatigue whatever, and I was not the "star" operator on that gallery, not by a very long way.

Get down to it boys; learn to send good and steady: a "bum fist" is a nuisance wherever he goes.

Yours Truly,

H. M. Lewis.

Re: Esperanto

97, Rue Royale, 97
Versailles, France

Editor, *QST*:

Thank you very much for so kindly sending me the article on the adoption of Esperanto which is appearing in September *QST* and my most cordial congratulations to the A. R. R. L. for the wise decision it has made.

It gives to the world the finest example of the attitude which should be adopted on the question of an international language.

There is no doubt that radio telegraphy will play a great part in the adoption of an international language and the decision of the A. R. R. L. will certainly carry great weight toward the future of an international radio language. The A. R. R. L. will thus have once more played a most important part in the world and it is most fitting on this account to congratulate it most sincerely.

With very best personal wishes, I am
Dr. Pierre Corret.

Concerning Hot-Wire and Thermo-Couple Ammeters

Chicago, Ill.
September 16th, 1924.

Editor, *QST*:

The writer was much interested in reading the article on Hot Wire versus Thermo

Couple Ammeters by Mr. Richmond on page 45 of the September "*QST*."

The writer agrees with practically all that was said but questions the statement that a thermo couple meter cannot be calibrated on low frequency.

While the thermo couple cannot be checked on direct current as a usual thing, it is perfectly accurate on 60 cycles alternating current, if properly designed. I might say that we have made checks on instruments on 60 cycles and on radio frequency current and these values have been checked by the Bureau of Standards with the net result that the difference in reading between low and high frequency was negligible. In order to get results of this sort, of course, it is necessary to secure proper current distribution in the thermo couple but this is not at all difficult if the peculiarities of radio frequency currents are understood.

If thermo couple meters are wanted for use on direct current they can be calibrated so that they will respond correctly to direct current; it is merely a matter of special calibration.

I would also question the point that thermo couple ammeters are fragile. I really believe they will stand just as much overload as hot wire ammeters and for special work they can be made to stand as much as four or five times normal full scale current.

The thermo couple instruments have been put into such large production in this country that the prices are relatively low and with the many advantages which Mr. Richmond admits, it seems the logical type of instrument to use for measuring radio frequency current.

Yours very truly,

Jewell Electrical Instrument Co.,

John H. Miller
Electrical Engineer.

Newark, N. J.
September 17, 1924.

Editor, *QST*:

My attention has been called to an article in the September number of *QST* by Mr. H. B. Richmond entitled Hot Wire vs. Thermo Couple Ammeters, in which the latter type is illustrated by a Weston Thermo Ammeter.

I have read this with interest, especially so for the reason that the thermo-couple ammeter as known today was originated by the Weston Electrical Instrument Company who own the patents.

The author appears to have intended to be fair in his comparison, yet there are a number of incorrect statements which unless corrected will become very misleading to radio operators.

The author states among other things that the thermo-couple ammeter cannot be checked on direct current, and has a large error when a direct current component exists, and further that it may not be used on low frequency alternating current.

All of these statements are incorrect in the case of the Weston thermo-couple type as illustrated under Mr. Richmond's article. This instrument can be checked with direct current. It is also accurate for alternating currents either low or high frequency, and it also measures the true root-mean-square value of the current when both alternating and direct currents are passed through it at the same time, just as in any other form of thermal ammeter.

These facts are at once evident when the construction of the thermo-couple type is considered. The instrument actually measures the current by measuring the temperature of the conductor heated by the current, just as a hot wire expansion type measures it by measuring the expansion of the conductor resulting from its temperature. It is obvious that the degree of heating of a properly designed strip or conductor is the same whether direct current or low or high frequency alternating current is passed through it, as it depends upon the I²R law.

It is also stated that the thermo-couple type has a small overload capacity. As a matter of fact the Weston type meter will suffer no damage with a 50% overload and will not burn out with a 100% overload.

It is stated that the thermo-couple type is more "fragile" than the hot wire type. That this is not true is evident from the following considerations. The D.C. indicating part of the thermo-couple type ammeter illustrated in the article is the same type as used on the dashboards of trucks and automobiles where a fragile instrument could not be used. The heating strip is several times thicker and therefore much stronger than that in the hot wire type which must be made thin in order to bend for every variation in current.

Further the connection between the pointer and hot wire in the hot wire type is a very fine thread or its equivalent attached to a small pulley connected with the pointer, whereas the connection between the heating strip and indicating instrument in the Weston type is a sturdy rigid thermo-couple and heavy fixed copper wires, welded in place.

It is possible that in writing the article, Mr. Richmond had in mind the small type Weston Thermo-Milliammeter. This operates on the bridge principle which is entirely different from that of the compensated type thermo-ammeter. The bridge type instrument may not be used to measure direct

current, but it is accurate on alternating currents of any frequency. This type of instrument however has a very large overload capacity. It may be used without damage with five (5) times the full scale current.

I trust that the above discussion will correct any misunderstanding that may have been caused inadvertently by Mr. Richmond's article.

Very truly yours,
W. N. Goodwin, Jr.
Chief Electrical Engineer
Weston Electrical Inst. Co.

Cambridge, Mass.
October 2, 1924.

Editor, QST:

You have just read me over the long distance telephone the letters from the Weston Electrical Instrument Co., and the Jewell Instrument Co. Without having the letters before me or without having a few minutes to actually check the points in question it is not possible to make a detailed reply. I would, however, like to emphasize the point that it was not my intention to present a one sided argument but to give fairly the summary of current American and English practices in the use of these two types of meters.

In an article of but one page in length it is not possible to cover many details. The writer *did* intend to convey the idea that a thermo-couple instrument of the types available to amateurs cannot be changed at will from radio frequencies to direct current while a hot wire instrument can be so transferred. As low frequencies are reached, the zero frequency, (or direct current) condition is approached. It is, however, to the great credit of the manufacturers of thermo-couple instruments that they are able to approach high frequency conditions at 60 cycles.

In order that there may not be any misunderstanding in the matter I would like to state that the General Radio Co. uses and recommends the use of a large number of thermo-ammeters annually. We also manufacture and use hot wire ammeters extensively. We believe each type of instrument has its own field and the best instrument to suit each condition should be chosen.

Yours very truly,
—H. B. Richmond.

(The Technical Editor desires to direct particular attention to the fact that the illustrations used in Mr. H. B. Richmond's article were chosen at this office without conference with the author. The intention was to show a good hot-wire meter and a good thermo-couple meter. That the par-

particular makes shown were Weston and General Radio is due to the fact that these were the cuts available at the time.

There was absolutely no intention on our part to indicate a comparison between two particular makes.

The author most certainly had no such intent, for his firm uses both varieties of meters in their apparatus.

The entire discussion must be regarded as having been of profit in that it cleared up the uncertainties surrounding the choice of meters for various uses.)

Regarding the Ultradyne

53 Park Place, Room 902,
New York City, New York.

Editor, QST:

I read with interest your description of the Ultradyne receiver in your article on super-heterodynes in the August issue of QST. However, I wish to point out that my name is not LeCault, but LACAULT, and that it is possible to obtain regeneration in the first tube by connecting a feedback coil between the plate and the first r. f. transformer. In this case a few turns may be used in series with the loop to couple to the plate circuit.

If you can use this information in your next issue and "rectify" my name I should appreciate it. With best wishes for the continued success of QST, I remain.

—R. E. Lacault.

A Good Guy Hint

206 W. 24th St.
Chester, Pa.

Editor, QST:

The other day 3BBN and myself were

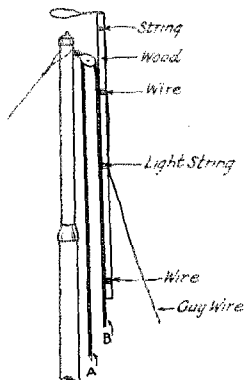

wondering how we were to get two guy wires to the top of his pipe mast. It was

an all-fired long climb and too hot, so, after the fashion of lazy people, we resorted to ye olde beane. Use was made of the ordinary halyard by which the antenna is raised. A piece of wood about one inch square and eight feet long was securely fastened to the rope with wire in two places as shown in the sketch. To the piece of lumber was tied the guy wire, which must be fastened in two places by light string. The whole business is then hoisted to the top and the control rope, B, is used to place the loop over the mast. By letting up on the rope, A, the guy settles neatly in place and there you are. It took us about five minutes to do the job once we got started. A jerk on the rope then breaks the light string and leaves the guy wire where it belongs.

You never can tell, but a little trick like this may add several years to your life.

—E. Everett Miles, 3ADQ.

Radio Revolutionized Again

P. O. Box 204,
Toledo, Ohio.

Dear Sir and Gentlemen:

Since early last Christmas I have been thinking of the vast possibilities of perfecting the radio apparatus as it now stands and have at least been interviewed by several prominent people all of whom are wanting to make a stock company and sell same on a large scale. Many more smart Alex have been here at all hours wanting to get an interview to put in some radio editor's column, but they are all barking up the wrong tree.

You have probably already heard of the Iodyne set of which I am the soul and only inventor; I being me and "dyne" having to do with a Greek restaurant around the corner.

The fundamentals of my Iodyne set of which I am the soul and only inventor can be had in almost any household. I will you just a few of the parts so you won't be quite as dumb as you are. One of the parts is a freshly emptied beer bottle which is wound with eighteen turns of barbed wire for a primary. The plate circuit is made up of old dental work (see my ads for old teeth in most all papers by my agents). In the Iodyne circuit no batteries or tubes are used as it is suspended on three noodle points that supply the necessary current. (Ref. Tech. Ed. QST and article in QST.)

I tried using this set with a ground connection but find that the wire gets so hot it is necessary to put a forced feed oiling system on it. I use a screen door for an aerial and recommend the back door if possible as it works on the back porch best.

I also tried hooking to the garbage can where it now is and am sure you will be pleased to know it works better yet there. I have come to the conclusion that this remarkable new circuit is a crowning glory to the A.R.R.L. and I would be pleased to entertain a responsible committee with the Iodyne set where it now is and answer any prudent questions they may want to know the answer to of which I am the soul and only inventor.

—M. S. Brainerd

P.S. Eddy, will you swap me a years subscription to *QST* for four blown out fifty watters?

Something Better
PYREX TRANSMITTING
Antenna Insulators



Low phase angle difference (0.3°). High Mechanical Strength. No absorption of Water.

Invaluable For the Higher Frequencies
 An important station writes:
 "I'm very well pleased with the PYREX Insulators I am now using, and am glad to be able to report that they have increased radiation about .3 amps. at 77 meters, as well as eliminating a lot of trouble heretofore experienced during rain."

\$1.50 each C. O. D.
CORNING GLASS WORKS
 INDUSTRIAL DIVISION
 CORNING, N. Y., U. S. A.

RADIO MASTS

When you buy a Whittlesey Self-Supporting Standard Steel Mast you buy a mast-head pulley, raising cable, and hoisting reel as well. This is the Whittlesey System. Patents pending. Never climb up except for painting, then "use the elevator." These masts are solid, stiff, rigid and beautiful. 50-75-100-125 feet.

THE WHITTLESEY ENGINEERING CO.
 Cleveland, Ohio



TRADE MARK
 REG. U. S. PAT. OFF.



Radio &
Audio Frequency
TRANSFORMERS

Buy one NOW
You'll buy more later!

MARLE ENGINEERING CO.
ORANGE, NEW JERSEY

WIMCO Announces

Our experimental laboratory is developing instruments for short wave transmitting and receiving.

A real Wave Meter will be ready soon. We know that all hams will be interested.

Send us your name for our mailing list

The Wireless Mfg. Co. Canton, Ohio

The INSIGNIA of RADIO OPERATORS Everywhere

RADIO CALL PINS

Get Yours Now

R. C. BALLARD, 9FZ, 1522 Sunnyside Ave., Chicago. Ill.

Your station call letters in **SOLID GOLD** \$2.00 Check or M. O.

ALWAYS MENTION QST WHEN WRITING TO ADVERTISERS

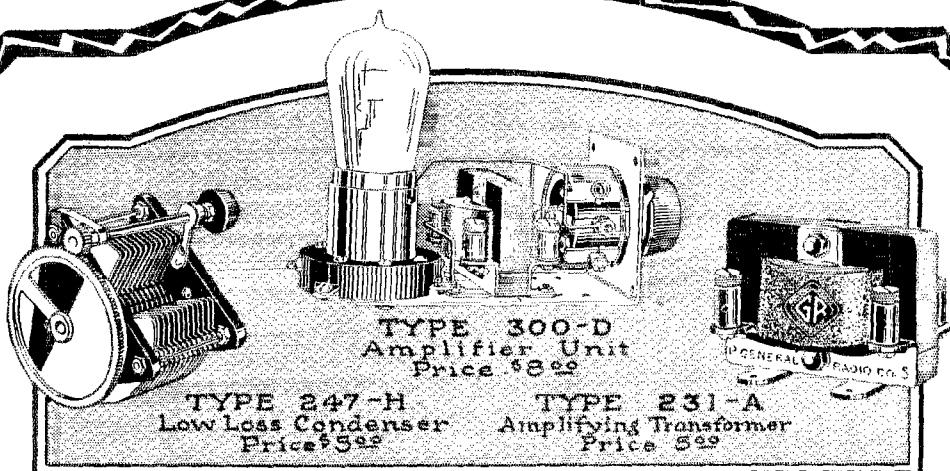

GENERAL RADIO PARTS GIVE SUPER-RECEPTION

Selectivity, distance, clarity and volume are the qualities which constitute *good reception* and are what you may expect from your set if you build with **GENERAL RADIO** parts.

For over a decade **GENERAL RADIO** Condensers have been the *universal favorites* because of their *low losses* and over-all efficiency.

Since 1917 **GENERAL RADIO** Amplifying Transformers have

been the leaders—not only in an historical sense but in *undistorted amplification*.

The type 300D is an amplifying unit designed for the convenience of amateur set builders. It combines the advantages of an efficient transformer, rheostat, and socket compactly assembled and ready for easy installation.

Whatever your circuit—build with **GENERAL RADIO** parts—for *Super-Reception*.

GENERAL RADIO CO.

Cambridge, Mass.



Ask your Dealer or write for our
New Radio Catalogue

Further Adventures of **BURGESS** RADIO BATTERIES

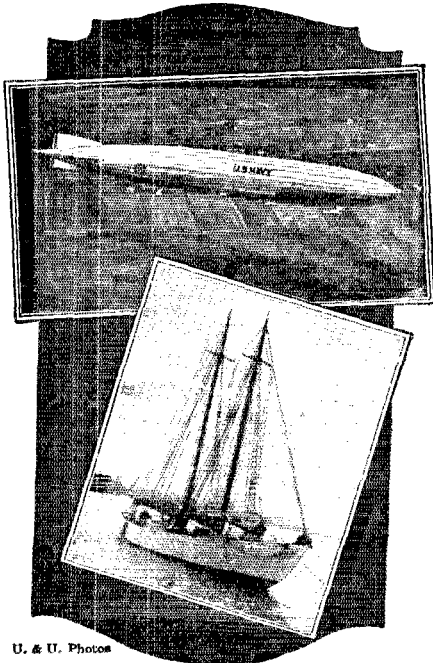

U. & U. Photos

The Shenandoah is Equipped with Burgess Batteries and MacMillan Carried them to the Arctic

If the quality of any product may be judged in part by the standing of its users, surely Burgess quality must be considered unusually high.

Burgess Radio Batteries are found where there's need for the most efficient batteries made—in emergencies where failure brings disaster—with explorers in far-off lands—with the unsung heroes of the air service—beneath the seas with the crew of the submarines.

"ASK ANY RADIO ENGINEER"

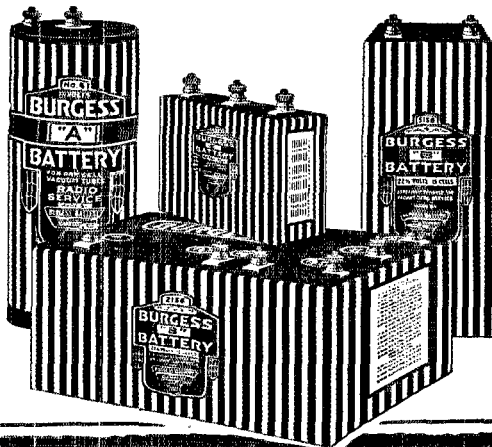

Send for the Burgess Radio Compass. Surprising—amusing and interesting to the entire family. Send free of charge from 195 Burgess Engineering Bldg., Madison, Wisc. Write for it.

BURGESS BATTERY COMPANY

Engineers DRY BATTERIES Manufacturers
FLASHLIGHT - RADIO - IGNITION - TELEPHONE

General Sales Office: Harris Trust Bldg., Chicago
Laboratories and Works: Madison, Wisconsin

In Canada: Niagara Falls and Winnipeg

The mystery of

Prices on De Forest D-12 Radiophones

Including loop, self-contained loud speaker, four De Forest tubes, A and B batteries, and all equipment ready to operate.

With Dry Batteries

In two-tone gray and black
Fabrikoid cabinet . . . \$161.20

In two-tone Mahogany
cabinet 176.20

With Storage Batteries

In two-tone gray and black
Fabrikoid cabinet . . . \$180.00

In two-tone Mahogany
cabinet 195.00

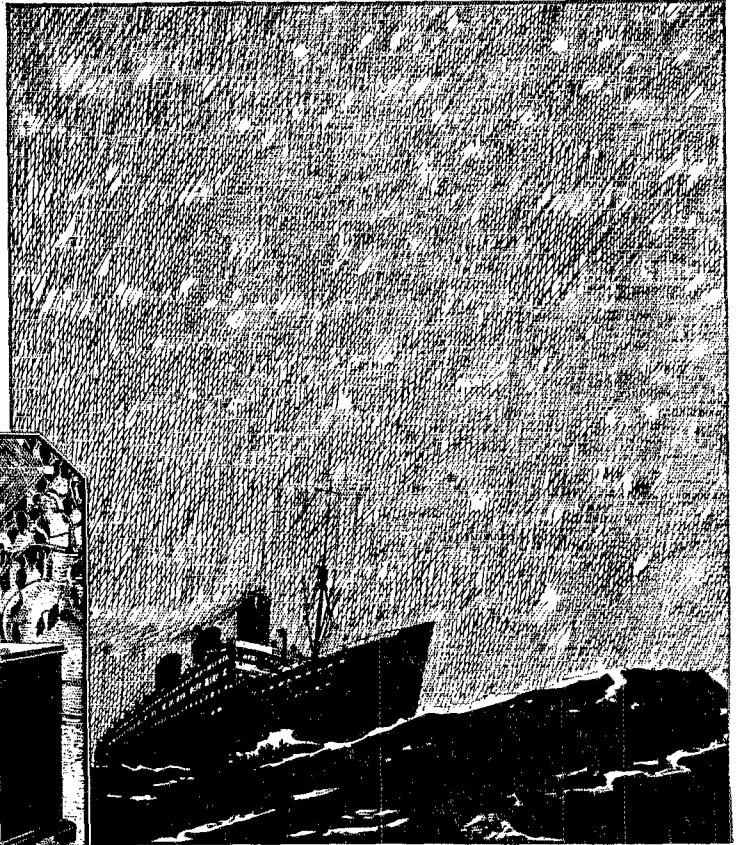
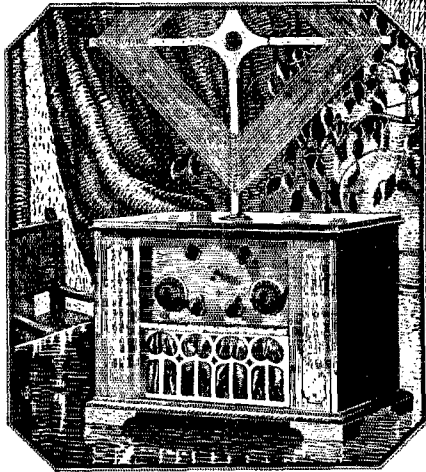

DE FOREST RADIOPHONE

~ D 12 REFLEX ~



FOR BEAUTY AND CLEAR REPRODUCTION

USE the De Forest Loud Speaker. It reproduces naturally, brilliantly, without distortion. The adjustment of the reproducing unit assures uniform response over entire range of audible frequencies. Its horn is shaped to retain the full brilliancy of the original sound,

and also to add volume. The complete unit is free from rattles. No rattles can ever develop. Every De Forest Loud Speaker is thoroughly tested and is guaranteed free from defects. Sold by authorized De Forest dealers only. Price, with 6 feet of cord, \$25.00.

a voice in the night

YOU sit at your new De Forest instrument and you "feel it out" with a dial. Suddenly a voice thrills out at you from the night. Its melody is fresh, as dulcet as when it comes from the singer's throat—how far away?

Whose voice is that? You do not know at first; absorbed, you listen. It is a mystery of the high radioways; and the thrill of that mystery is quick within you till you learn from the announcer whose voice it was.

The De Forest D-12 Radiophone offers you the whole thrill of radio—and in an unequalled way. Here is a complete receiver, ready to operate the moment, practically, it enters your home. *It is the Radiophone ideal for the beginner*—its operation is so simple. *It is the Radiophone for the expert*—it embodies such vast technical skill. Is it any wonder that it is considered to be as standard in its field as is the most famous phonograph, automobile or piano in its own? The De

Forest Radiophone is sponsored by Dr. De Forest himself, whose great invention, the vacuum tube, has made radio broadcasting possible. So this instrument is extremely practical and simple to operate—it is acutely selective and very easy on its batteries. It depends on no outside wire for results, or no ground wire. And its four tubes do the work of seven. Yet it is sold at a four-tube price—which is about $\frac{1}{3}$ less than that of instruments that produce comparable results.

De Forest dealer near you can be useful to you.

De Forest agents are qualified to give you sound and practical advice and help in radio. When you find one you find a man who knows radio—a man who has given us his word that he will see that every machine he sells is properly inspected and properly serviced after the sale. He wants you to get the full benefit and pleasure from your De Forest Radiophone—just as we do.

DE FOREST RADIO COMPANY, Jersey City, N. J.

DE FOREST RADIOPHONE

~ D 12 REFLEX ~

YOUR SET DESERVES DE FOREST TUBES

De Forest
DV-3 Tube
for use with
Dry Cell
Batteries.



THE original De Forest three-electrode vacuum tube was the first of many millions of De Forest tubes that have never been excelled in quality of workmanship, or performance. Today, as in the past, De Forest tubes are unsurpassed for giving volume and beauty of tone.

They are non-microphonic. They can be used with all standard circuits. The DV-3 is for use with dry batteries, the DV-2 with storage batteries. They are guaranteed against defects in material and workmanship. Sold only by authorized De Forest dealers. Price, \$4.00 each.



De Forest
DV-2 Tube
for use with
Storage
Batteries.

The World's Largest Store is

Radio Headquarters

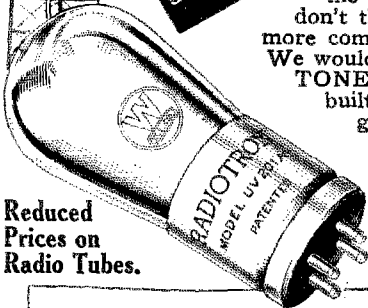
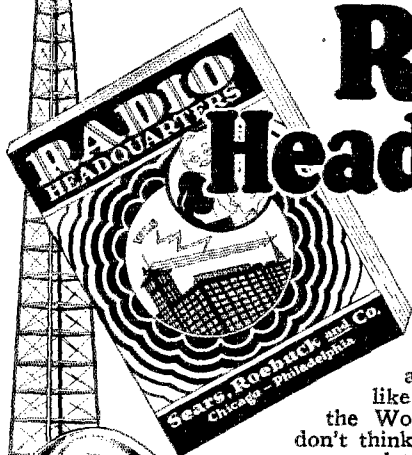

Reduced Prices on Radio Tubes.

Radio tubes—standard equipment—can be had from us at the new low price of \$3.65. This is just an example of the values that our RADIO catalog offers. Get your copy. Mail the coupon TODAY.

No matter what you need for your radio—whether it's a complete set or the smallest part—it can be had from **RADIO HEADQUARTERS** at prices that save you money.

Our new **RADIO Catalog** is ready. Your copy is waiting for you; so fill in and mail the coupon below. We would like you to see the many radio bargains that the World's Largest Store has to offer. We don't think there is a store in America that has a more complete line.

We would like to have you see the famous **SILVERTONE Neutrodyne**, the most perfect radio set yet built. Get all the comfort and enjoyment that a good radio set can deliver. Make sure of your satisfaction. You can do it if you deal with **RADIO HEADQUARTERS**.

Mail the coupon TODAY to the store nearest you.

Sears, Roebuck and Co. 62Q87
 Chicago Philadelphia Dallas Seattle
 Send Latest Radio Catalog.

Name

Postoffice

Rural Route.....Box No.....

State

Street and No.....

Sears Roebuck and Co.

The World's Largest Store owns and operates Broadcasting Station WLS, Wave-length 545 Meters, Tune in.

HICO

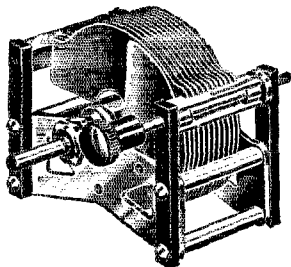

Variable Condenser

The Cam Vernier on Stator Plate does it.

A new and exclusive principle of control that allows minutest adjustments. A low loss condenser that will work well in any circuit. 5 Engineers designed this condenser and incorporated the latest up to the minute features of good condenser construction.

11 Plate	.00025 mfd	\$4.50
17 "	.00038 "	4.75
23 "	.0005 "	5.00
43 "	.001 "	6.00

At all good dealers or sent on receipt of price.

HARTFORD INSTRUMENT CO., 307 Pearl St., Hartford, Conn.

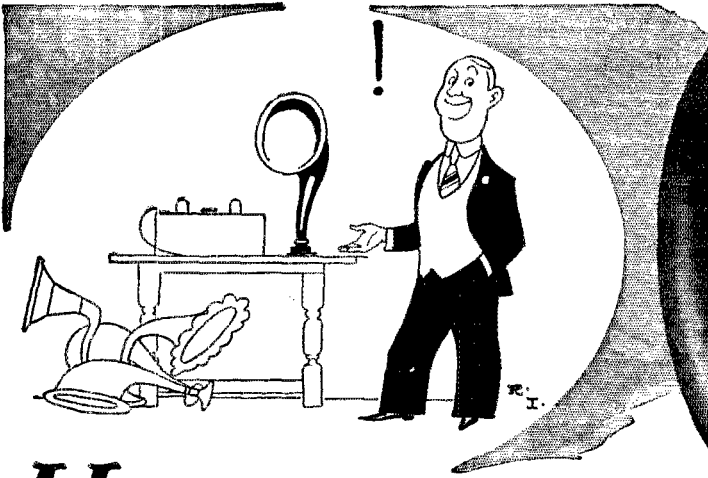

Hear the difference!

A loudspeaker is a critical thing. Any vibration in the horn adds sounds that nature never gave to the speaker's voice. And limited range thins down the tone to flat, unreal quality. Some people think that a near-real voice is the best that radio can give . . . but not after they have heard a Radiola Loudspeaker!

The difference is the result of elaborate experiment and extended scientific study. The Radiola Loudspeaker has an extraordinary range—gets the full richness of tone. And it adds no sound of its own. To know how clear—how mellow—how *real* your music can be—ask to hear a Radiola Loudspeaker.

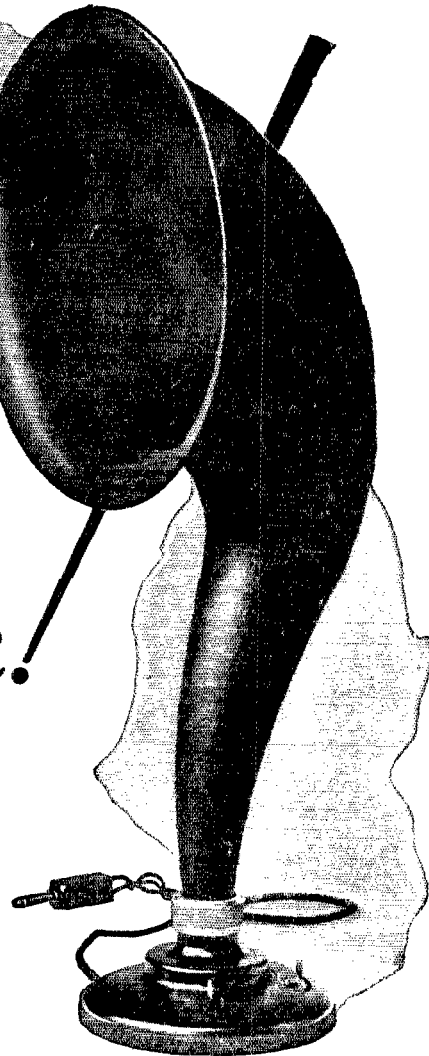

Radiola Loudspeaker
Type UZ-1325
Now \$25.00

This symbol  is your
of quality protection

Radiola

REG. U. S. PAT. OFF.

LOUD SPEAKER

RADIO CORPORATION
OF AMERICA
Sales Offices:
233 Broadway, New York
10 So. La Salle St., Chicago, Ill.
28 Geary St., San Francisco, Cal.

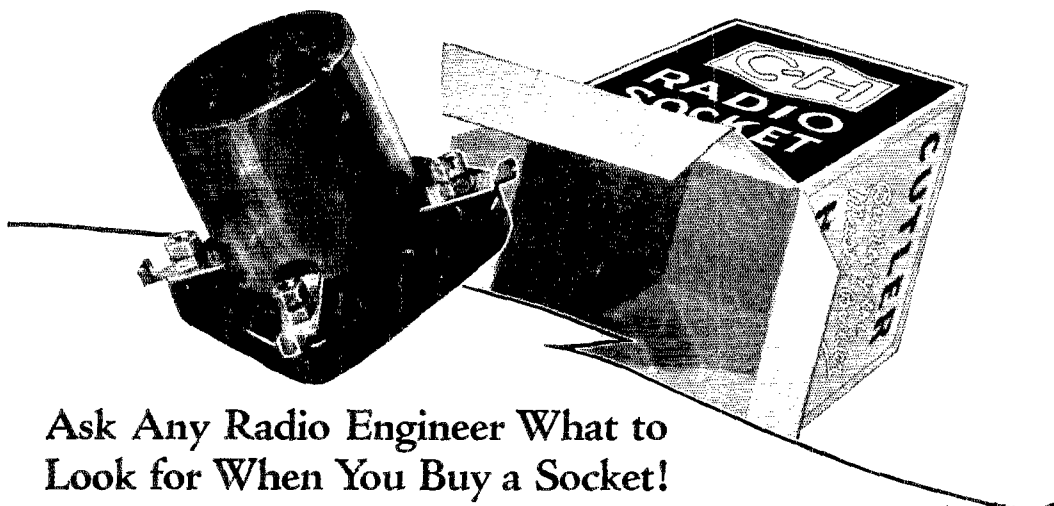

Ask Any Radio Engineer What to Look for When You Buy a Socket!

Radio experts are continually stressing the necessity of using good sockets. In some of the more sensitive circuits such as the Superheterodyne, poor sockets often completely destroy results. In fact, in thousands of sets today, with scores of different circuits, the so called "static" often mentioned, or "battery noises," are in reality merely the result of poor socket contacts—certain proof of dissipation of the feeble currents that we rely on for distant reception.

Minimum Dielectric Capacity

In the Cutler-Hammer Socket, designed by the same engineers whose precision rheostats and other radio current control apparatus have justly become world famous, every effort has been bent toward greatest efficiency. Custom has no consideration—and from its striking color scheme to its novel contact construction, the design is radically new.

It embodies a minimum of both insulation and metal; capacity absolutely minimized without sacrifice of mechanical strength. The insulation materials (shell of thin orange Bakelite and base of genuine Thermoplax) are ideal—high in quality and dielectric strength; low in dielectric capacity and losses. And all metal parts are widely separated, both in the insulation and in air to conserve every last bit of energy received.

Its contacts—the source of losses and noise in most sockets—are of entirely new construction. Each one is a springy clip that clinches the tube prong without strain; yet cleans it bright

Maximum Dielectric Resistance

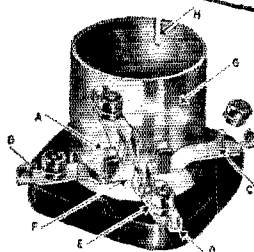

These Exclusive Features Assure Better Reception

- A Perfect contact. Both sides of tube prong cleaned when inserted—no contact or wear on soldered end.
- B All metal parts *silver* plated—perfect contact for the life of the set. Silver may tarnish but its contact resistance does not change.
- C One piece contact construction. The binding post is NOT a part of the circuit—the wire to the socket always touches the contact strip which carries the current direct to the tube prong—no joints to cause losses.
- D Convenient terminals for soldering—full length to allow bending down for under-wiring. Ears hold wire in place for soldering.
- E Extra handy binding posts—tight connections with either wrench or screw-driver. Lock washers hold terminals rigid.
- F Wide spacing of current carrying parts both in air and insulation—true low-loss construction.
- G A minimum of both metal and insulation for low capacity. Shell of thin Bakelite—the base of genuine Thermoplax.
- H The tube is held in place by merely a vertical motion—no twisting to separate bulb from base.

"Built by the



The Perfect

whenever the tube is inserted or removed. These contacts are formed of phosphor bronze and *silver* plated—because the contact resistance of silver does not increase as it stands exposed to air. The area of contact is greater than that found in any other socket; and the construction is such that these feeble currents which mean so much in radio pass directly from the wire to the prong of the tube without meeting a single joint. *(In so many sockets the wiring is attached to a binding post to which the contact strip is in turn attached below. This presents a joint which causes noise and losses. The C-H Socket affords perfect connection even if the screw that holds the contact strip in place is entirely removed.)*

Silver Plated Phosphor Bronze Contacts

No Joints to Cause Noise or Losses

In this socket the tube is inserted and removed without turning—just pushed in and pulled out—to prevent twisting the bulb from its base. And the tube is held tight, absolutely rigid so that any vibration cannot cause contact noises. Its small size and convenient soldering terminals, too, mean a great deal in most sets for space is usually at a premium. The Thermoplax base is only $2\frac{1}{8}$ " square—scarcely more than the diameter of the tube, and the soldering terminals extend out far enough from the rounded corners that they may be turned down for under-wiring when this system is used. These terminals have handy ears which are bent up to hold the wire while the solder is being applied—adding much to the ease with which this work is accomplished. For temporary connection, or where soldering is not used, a slotted hex-nut is provided which securely clamps the wire against the contact spring with either wrench or screw-driver.

Convenient and Efficient Terminals

No Twisting to Damage Tube

In all it is as perfect a socket as engineering skill can devise. It offers maximum efficiency and ease of installation, coupled with an appearance that adds much to any set. And best of all you will like the price, 90c. *This socket that meets the specifications of the most exacting radio engineer costs no more than most of those on the market today!* If your dealer has not been stocked, you can be supplied direct from the factory at list price plus 10c for packing and postage.

THE CUTLER-HAMMER MFG. CO.

Member Radio Section, Associated Manufacturers of Electrical Supplies
MILWAUKEE, WISCONSIN

Master Builder"



Instruments of Guaranteed
Quality Assure Success
in Radio

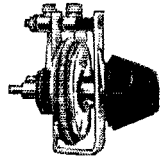

The C-H 4 Ohm Vernier
Rheostat
Perfect detector tube control. Also furnished without vernier for amplifier tube control.



The C-H 30 Ohm Radio
Rheostat
For control of the $\frac{1}{4}$ ampere, "UV-201-A-C301-A" type receiving tubes and the "UV199-C299" type; also made in 125 ohm size.

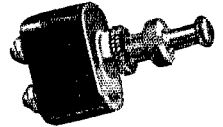

The C-H Radio Switch
The switch with the perfect mechanism for providing easy control of the most delicate circuit without introducing microphonic noises—one hole mounting.

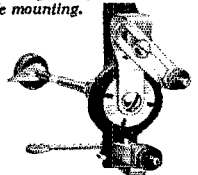

The C-H Variable Grid Leak
Mounted on the tube socket-panel controlled. Adjustable for all grid condensers.

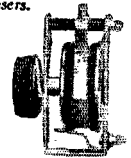

The C-H Radio Potentiometer
The potentiometer with the resistance unit that does not wear and cannot be displaced under constant use.

RADIO SOCKET

To Our Readers Who Are Not A.R.R.L. Members

Wouldn't you like to become a member of the American Radio Relay League? We need you in this big organization of radio amateurs, the only amateur association that does things. From your reading of **QST** you have gained a knowledge of the nature of the League and what it does, and you have read its purposes as set forth on page 6 of every issue. We would like to have you become a full-fledged member and add your strength to ours in the things we are undertaking for Amateur Radio, and incidentally you will have the membership edition of **QST** delivered at your door each month. A convenient application form is printed below—clip it out and mail it today.

.....1924

American Radio Relay League,
Hartford, Conn.

Being genuinely interested in Amateur Radio, I hereby apply for membership in the American Radio Relay League, and enclose \$2 in payment of one year's dues. This entitles me to receive **QST** for the same period. Please begin my subscription with the issue. Mail my Certificate of Membership and send **QST** to the following name and address.

.....
.....
.....

Station call, if any

Grade Operator's license, if any

Radio Clubs of which a member

Do you know a friend who is also interested in Amateur Radio, whose name you might give us so we may write him about the League?

..... Thanks?

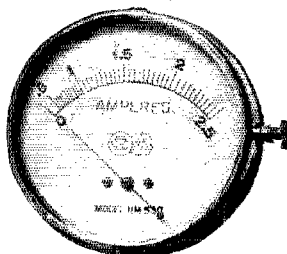

Price \$1.50

Hv U a Little Meter in Ur Home ?

If not, here are some brand new R. C. A. 0-2.5 hot wire ammeters which we have secured at a very low price. Originally listed at \$6.00 each. Our price \$1.50. 3 1/2" in diameter, projecting panel mounting and finished in handsome nickel brass. These ammeters can be used in antenna or closed circuit of transmitters or in filament circuit of W. E. oxide coated tubes.

And Here's Another Bargain

U. C. 1806 R. C. A. mica condenser, capacity .002 mfd., 6000 volts effective. Used principally as grid and plate blocking condensers. \$7.50 value for \$1.50.



The Utility Radio Co., 58 North 6th St., Newark, N. J.



Of Course It's
a CROSLLEY
 Better-Costs Less
Radio

**Crosley's
 Head Phones
 Better—Cost
 Less \$3.75**

To combine the two most desirable things in radio—distant, clear reception at the lowest possible price—there is only one receiver for you. That is a Crosley. During the past twelve months Crosley made and sold more sets than any manufacturer in the world, we believe. This is self-evident proof of Crosley Quality and Crosley Performance.

From the one-tube Armstrong Regenerative Receiver Crosley 50 at \$14.50, the lowest priced regenerative set on the market, to the three tube Armstrong Regenerative and Reflex Trirdyn Regular at \$65—in special mahogany cabinet \$75—Crosley Receivers, each in its own class, assure you as good or better reception than any other instrument of the same number of tubes. At the same time they are the least expensive sets ever offered to the public.

The Trirdyn Regular has especially come through the summer with flying colors. The combination of one stage of tuned radio frequency, with regenerative detector and reflexed amplification, has proven beyond a doubt that the features of selectivity, volume and ease of operation can be obtained with three tubes better than heretofore has been possible with five tubes. We believe no other receiver combines these features so well incorporated in the Trirdyn.

**Before You Buy—Compare Your Choice will be a Crosley
 For Sale by Good Dealers Everywhere**

Send for Complete Catalog

THE CROSLLEY RADIO CORPORATION

Powel Crosley, Jr., President

1118 Alfred Street, Cincinnati, Ohio

Crosley Regenerative receivers are licensed under Armstrong U. S. Patent No. 1,113,149. Prices West of Rockies—add 10%.

Crosley Owns and Operate Broadcasting Station WLW.



Crosley One Tube Model 50, \$14.50
 With tube and Crosley Phones \$22.25



Crosley Two Tube Model 51, \$18.50
 With tubes and Crosley Phones \$30.25



Crosley Three Tube Model 52, \$30.00
 With tubes and Crosley Phones \$45.75

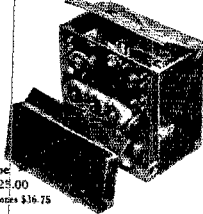

Crosley Two Tube Model 51-P, \$23.00
 With tubes and Crosley Phones \$36.75



Crosley Trirdyn Regular, \$65.00
 With tubes and Crosley Phones \$80.75



Crosley Trirdyn Special, \$75.00
 With tubes and Crosley Phones \$90.75

Mail This Coupon At Once

The Crosley Radio Corp., 1118 Alfred St., Cincinnati, O.

Mail me, free of charge, your catalog of Crosley receivers and parts with booklet entitled "The Simplicity of Radio."

Name _____

Address _____

NATIONAL VELVET CONDENSERS VERNIER and DIALS

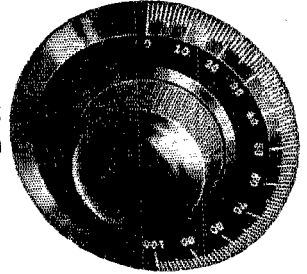
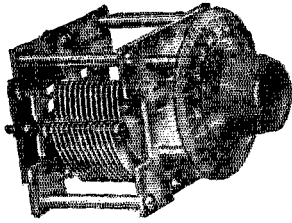

PRICES

Of Condenser

(Including 3-inch Dial)

.001	.0005	.00035	.00025
\$7.00	\$6.00	\$5.75	\$5.50

Price of DIAL Only

4-inch	\$2.50
3-inch	2.00

“Perfect Resonance Control”

That's the way a satisfied purchaser of a NATIONAL VELVET VERNIER DIAL and CONDENSER describes the liquid smoothness and flexibility of this perfect slow-motion dial and low loss condenser. Perfect because of perfection of design

and skilled craftsmanship. No grating—no backlash—no loss. Every part in perfect accord.

Lustrous finish and graceful lines give a “million-dollar-look” to the home-built set.

NATIONAL COMPANY, Cambridge, Mass.

Engineers and Manufacturers. Established 1914

“Rolls Royce” Radio Tubes



Like their name significant of QUALITY. A powerful and durable tube that will greatly improve reception. Increases range and volume with a maximum of clearness. Our direct sales plan enables you to buy “Rolls Royce” at the lowest possible price.

Type 200	5 Volts, 1 Ampere Detector Tube
Type 201A	5 Volts, .25 Ampere Amplifier and Detector
Type 199	3-4 Volts, .06 Ampere Amplifier and Detector
Type 199A	3-4 Volts, .06 Ampere with Standard Base Amplifier and Detector
Type 12	1½ Volts, .25 Ampere Platinum Filament Amplifier and Detector

“The Rolls Royce of Radio Tubes” ALL TYPES **\$2.50**

Type 202.....5 Watt, Transmitters, \$3.00

EVERY TUBE GUARANTEED

to work in Radio Frequency, especially adapted for Neutrodyne, Reflex and Super-Heterodyne Sets.

Shipped parcel post, C.O.D. When ordering mention type.

ROLLS ROYCE TUBE CO.,

21 Norwood St. Dept. S. Newark, N. J.

RADIO

Big, complete stock. Standard prices. And you're sure it's reliable if it comes from Andrae.

Send for our catalog

JULIUS ANDRAE & SONS CO.,

133 Michigan St., Milwaukee, Wis.

ANDRAE In Business Since 1860

**CLEAR
MELLOW
NATURAL
TONE** —



IMPORTED PHONES
Model D
4000 ohms **\$8.50**

An even better "A" battery and at a much lower price

IF you are one of the thousands who have come to rely on the famous six-volt Exide "A" Battery, you will not recognize the new one when you first see it—but you will know it when you hook it up to your set, for it has the same old rugged power, the same constant efficiency, and the same long life.

You will say of this new battery: "Handsome is and handsome does." The composition case (including handles) is moulded in one piece. Beautifully stippled and finished in glossy black, it is an ornament to any room.

Broad inter-cell connectors fit close to the top of the battery. Offset terminal posts make it very easy to hook up. Filling plugs require but a quarter turn to remove. This new Exide is made in five sizes—50, 75, 100, 125, 150 ampere hour capacity.

A complete line of radio batteries

If you use low-voltage tubes you have your choice of those sturdy midgets, the Exide two- and four-volt "A" batteries, weighing but five and six pounds respectively.

In addition to the compact 24-volt Exide rubber case "B" battery of 4000 milliampere hour capacity there is the new Exide for those who desire visibility as well as capacity. This "B" battery is assembled in glass jars and is made in 24 and 48 volt size. Larger plates and greater space for the electrolyte give a capacity of 6000 milliampere hours.



The new Exide six-volt "A" Battery in one-piece case. Price, \$14.60 up, f. o. b. Philadelphia

The Exide Rectifier enables you to recharge your "B" battery from your house current at a cost that is insignificant.

Ask to see the Exide line at any Exide Service Station or Radio Dealers.

Prices Exide Radio Batteries

Battery	Capacity	Voltage	Price F.O.B. Philadelphia	Battery	Capacity	Voltage	Price F.O.B. Philadelphia
3-LXL-5	50 A.H.	6	\$14.60	1-KZR-5	24 A.H.	2	\$ 5.40
3-LXL-7	75 A.H.	6	16.90	2-KZR-3	12 A.H.	4	7.30
3-LXL-9	100 A.H.	6	19.15	12-RB-2	4000 M.A.H.	24	10.00
3-LXL-11	125 A.H.	6	22.10	12-LR-2	6000 M.A.H.	24	12.00
3-LXL-13	150 A.H.	6	25.00	24-LR-2	6000 M.A.H.	48	23.30

Exide Rectifier \$2.00

For better radio reception use storage batteries

Exide

RADIO BATTERIES

THE ELECTRIC STORAGE BATTERY COMPANY, PHILADELPHIA
In Canada, Exide Batteries of Canada, Limited, 153 Dufferin Street, Toronto

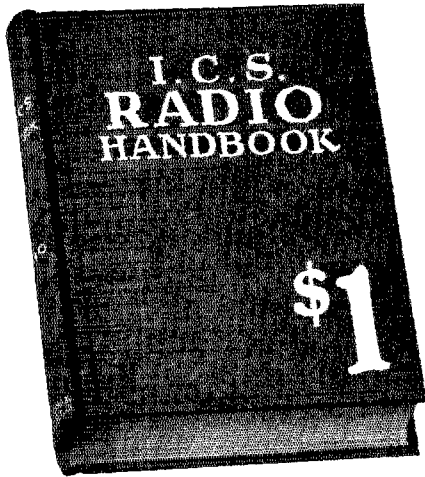

*A practical,
authoritative book on*
RADIO

514 pages. Price only \$1
Compiled by HARRY F. DART, E.E.
Formerly with the Western Electric Co.,
and U. S. Army instructor of Radio
Technically edited by F. H. DOANE

EVERY member of the *American Radio Relay League* should have a copy of this I. C. S. Radio Handbook. Price only \$1. Written, compiled and edited by practical radio experts of national reputation. A handy reference book that will help you improve your sending and receiving apparatus. Explains the operation of dozens of circuits. Filled with interesting experiments. Note this list of contents:

Static strays, dynamic electricity, electron theory, electrical measuring devices, magnetism, circuit effects and co-efficients, condensers, coupling, transformers, aerial systems, wave-length formulae, direction finding, batteries of all types, generators and motors, radio devices, detectors and transmitters, relays, phones and microphones, filters, phonos and receiving sets, formulae, symbols and definitions, regulations, etc.

Send the coupon to-day with \$1 and get this 514-page I. C. S. Radio Handbook.

—TEAR OUT HERE—

INTERNATIONAL CORRESPONDENCE SCHOOLS
Box 6128-C, Scranton, Penna.

I enclose One Dollar. Please send me—post-paid—the 514-page I. C. S. Radio Handbook. It is understood that if I am not entirely satisfied I may return this book within five days and you will refund my money.

Name

Address

Check here and enclose \$1.50 if you wish the deluxe edition, bound in Leatheroid.



Barnes
**LOUD
SPEAKER**
DISTINCTIVE
IN DESIGN
14-INCH BELL

VOLUME, CLARITY, BEAUTY
The loud speaker that will fully satisfy you. Equal to hearing the original tones.
No. 205B—Polished black flare . . . \$22.50
No. 205D—Shell pyralin flare . . . \$25.00
MAKERS OF TELEPHONES FOR 30 YEARS!

American Electric
COMPANY
State and 64th Sts. Chicago, U.S. A.



CELORON
STANDARD RADIO PANEL
Dielectric — easily worked — uniform quality
No. J  Size 7 1/2 x 5 1/2 in.

Manufactured by
DIAMOND STATE FIBRE COMPANY
Developed and Patented in the U.S.A.
BRANCH FACTORIES AND HEADQUARTERS
PHILADELPHIA, PENNSYLVANIA
OFFICES THROUGHOUT THE WORLD
In Canada: Toronto, Ontario

Use a Celoron panel
The high dielectric strength of a Celoron Panel helps you get the best results from your instruments.

Celoron, a bakelite material is approved by the U. S. Navy and Signal Corps. Leading radio manufacturers mount their parts on Celoron bases.

Ask your dealer for a Celoron panel. These panels come in nine standard sizes, in black, mahogany or oak. Other sizes cut to order.

DIAMOND STATE FIBRE COMPANY
Bridgeport, Pennsylvania
Branches in Principal Cities
Toronto, Canada London, England

Have You a Screw Driver?

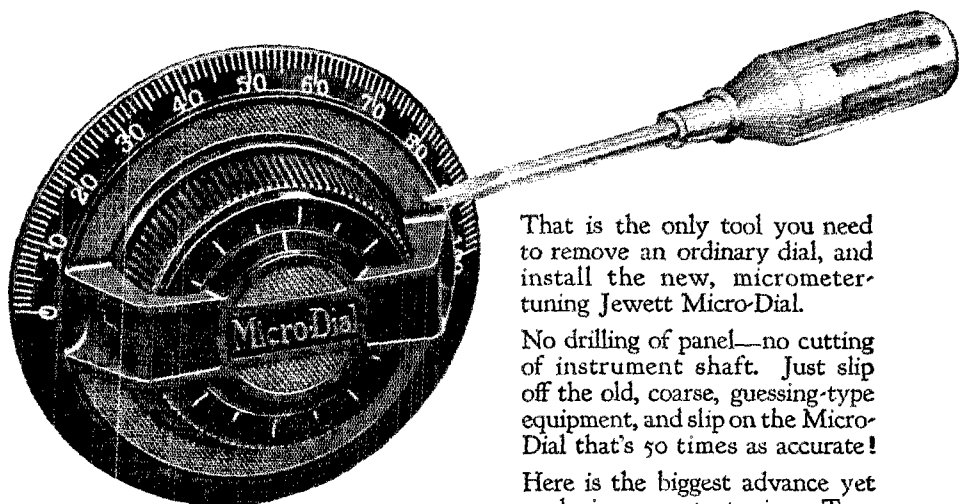

EXCLUSIVE!

Mounts where any four-inch dial will mount—Absolutely self-contained—Nothing to be attached to panel—Slight eccentricity or angularity of instrument shaft of no consequence; Micro-Dial will not bind—Absolutely noiseless—Knob mounted on double cone bearing, self-adjusting and self-aligning—No metal to tarnish or cause body effects; no rubber to deteriorate—Micrometer and coarse adjustments turn complete circle—Calibrations clockwise or anti-clockwise—Mechanism lubricated for life—Lasts forever—Improves with use.



That is the only tool you need to remove an ordinary dial, and install the new, micrometer-tuning Jewett Micro-Dial.

No drilling of panel—no cutting of instrument shaft. Just slip off the old, coarse, guessing-type equipment, and slip on the Micro-Dial that's 50 times as accurate!

Here is the biggest advance yet made in accurate tuning. Two dials in one. Main dial corresponds to your old equipment. Inner dial moves instrument at only one-fiftieth normal speed, permitting accuracy far beyond the former reach of human touch and vision.

More stations—more range—more volume—less interference. Transforms accurate tuning from an accident into a scientific certainty. Especially when coupled with a Jewett Super-speaker ensures the absolute limit of reproductive volume from any set.

Don't confuse the Micro-Dial with any other device for tuning improvement. Its compact neatness, and its complete freedom from wear or deterioration place it in a class all by itself and remember, you need only a screw driver to install.

Rejuvenate your set by Micro-Dial equipment!

If your dealer cannot supply you, we will ship direct to you, charges prepaid, on receipt of list price \$3.50.

JEWETT RADIO &
PHONOGRAPH CO.

5680 Twelfth St., Detroit, Mich.

The Jewett

Micro-Dial

Have You Seen?

The New SIGNAL Vernier Variable Condenser

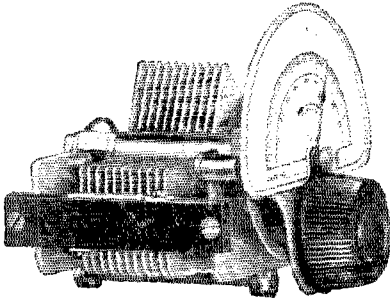

SIGNAL FEATURES

- | | |
|----------------------------|---------------------|
| 1—Soldered Rotor | 6—Ample End Spacing |
| 2—Clock Spring | 7—Unique Clock Hand |
| 3—Pigtail Connection | 8—Main Shaft |
| 4—Locking Dial | 9—Free from Dial |
| 5—Adjustable Stator Plates | 10—Cone Bearings |
| 6—Soldered Stator Plates | 11—Grounded Rotor |
| 7—Easy Mounting of Coils | |

Everything yet developed in Radio has been taken into consideration in the manufacture of this condenser. You will find it of the most advanced design in the field. Go to your dealer today and ask him to show you. The eleven Signal features make it Best in Radio today.

Sizes and Prices

11 plate	\$4.50
17 plate	4.75
23 plate	5.00
43 plate	6.00

Signal Collapsible Loop Aerial will work with any set that can use a loop.

Price \$8.50

SIGNAL Electric Mfg. Co.

Factory and General Offices:

1915 Broadway
Menominee, Mich.

Boston Chicago Seattle Minneapolis Montreal New York Pittsburg
Havana, Cuba St. Louis San Francisco Toronto Philadelphia Los Angeles Winnipeg

You'll find our local address in the Telephone Directory

NOW IS THE TIME, AMATEURS!

To Do Your Experimental Work on Your Receivers in anticipation of Better "DX" This Winter

Parts of every description and at prices that are right to rebuild or add to your present equipment.

You Will Work EUROPE THIS WINTER
With A Good Set—

Look over a few of the items worth while,

Variometers
Variocouplers
Cock-a-day coils

Reinartz coils
Condensers
Rheostats

Farmica Panels
Jacks
Plugs

ROSE RADIO and ELECTRICAL SUPPLIES

129 CAMP STREET,

NEW ORLEANS, LA.

Pioneers in the Radio Field.

German 30 Watters

Are very rugged, filament voltage 10
Plate Voltage 1500

Plate connection brought out at top of tube

SPECIAL \$12.00

Complete line of transmitting parts in stock

TILLEY RADIO CORPN.

Woolworth Bldg.

Providence, R. I.

LIFE OR DEATH

Would you rather have your name engraved on those sets you are building or on your business tomb stone after you crash?

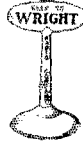

A new Gorton 1-D Engraving Machine stands at attention awaiting your order.

24 hour panel engraving service. Engraving on Bakelite, etc., brass, etc. Dealers send for Engraving Service Display Card.

WRIGHT RADIO COMPANY

Manufacturing Engineers

144 Exchange St., ROCKLAND, MASS.

Ask for Lit. On the Wright LO-LOS LOOP

MAGNAVOX

Receiving Sets which establish an authoritative standard of excellence for the daily enjoyment of radio.

LONG identified with the most efficient radio reproducing and amplifying equipment, Magnavox has developed its new Receiving Sets under conditions insuring superior design, precision of manufacture, and a gratifyingly low cost.

Exacting tests prove that the Magnavox Receiver is not only the simplest to operate but one whose daily performance will satisfy the most discriminating.

Magnavox Radio Receivers, Vacuum Tubes, Reproducers, Power Amplifiers, and Combination Sets are sold by reliable dealers everywhere.

THE **MAGNAVOX** COMPANY, Oakland, California
New York: 350 West 31st Street San Francisco: 274 Brannan Street
Canadian Distributors: Perkins Electric Limited, Toronto, Montreal, Winnipeg

11R

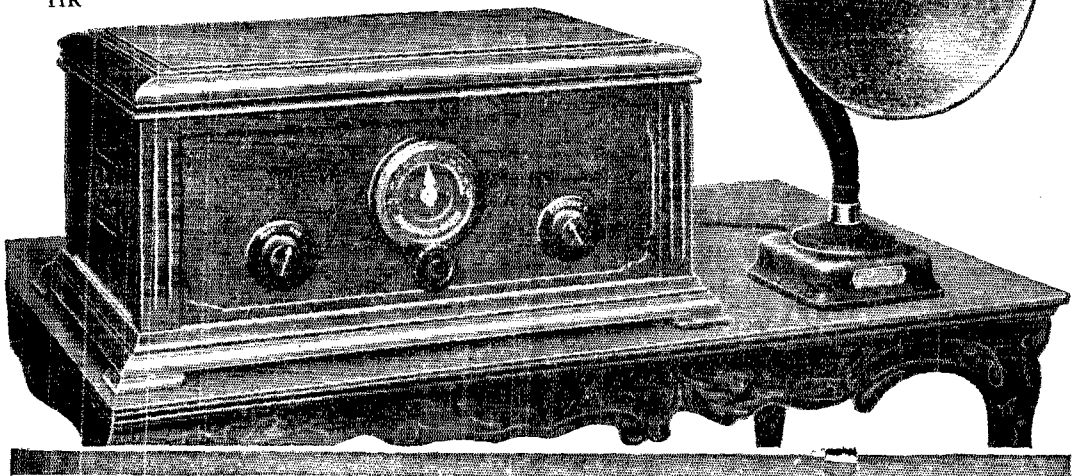

Receiving Set TRF-5

A 5-tube tuned radio frequency receiver encased in handsomely carved cabinet, as illustrated
\$125.00

Reproducer M4

A highly desirable accessory for TRF-5, as illustrated . . . \$25.00

Receiving Set TRF-50

Same as TRF-5 but larger cabinet with carved doors and built-in Reproducer
\$150.00

MODERN RADIO RECEPTION

A New Book

By
Charles R. Leutz

264 PAGES
150 ILLUSTRATIONS
FULLY BOUND

Partial List of Contents:

Radiola Super-Heterodyne Diagram

Western Electric 4B Receiver

Model C Super-Heterodyne

Model C7 Super-Heterodyne

Long Distance Reception

Short Wave Reception

Long Wave Receivers

Pliodynes and Super-Pliodynes

Laboratory Equipment

Broadcast Transmitters

High Efficiency Amateur Transmitters

Model L Super-Heterodyne
and

Everything of importance relating
to Broadcast Reception

Price **\$3.00** Postpaid

EXPERIMENTERS INFORMATION
SERVICE, Inc.

476 Broadway New York City

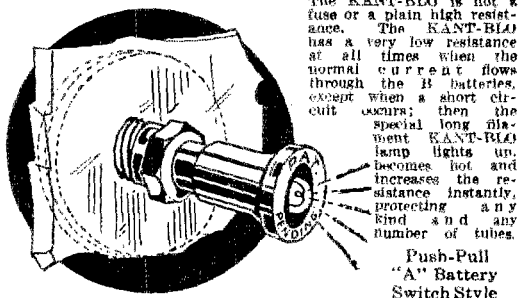

The KANT-BLO is not a fuse or a plain high resistance. The KANT-BLO has a very low resistance at all times when the normal current flows through the filament, except when a short circuit occurs; then the special long filament KANT-BLO lamp lights up, becomes hot and increases the resistance instantly, protecting any kind and any number of tubes.

Push-Pull
"A" Battery
Switch Style

YOUR MONEY BACK IF YOU BLOW A TUBE

When your radio set is equipped with a **KANT-BLO**

Kant-Blo

Only one Kant-Blo needed to protect any number of any kind of radio tubes

SWITCH SIGNAL BINDING POST

"Lights on any Short Circuit"

The Kant-Blo Signal is easily installed. Simply takes the place of either the ordinary push-pull "A" Battery Switch or one "B" Battery Binding Post now on set. Kant-Blo Signals—both Binding Post Style and Switch Style—are at all the best radio stores. If your dealer is out of stock send us \$2 for a Kant-Blo Binding Post Style, or \$3 for the Switch Style, and we will ship any number of KANT-BLOS direct to you, charges prepaid.

Manufactured by
GANIO-KRAMER CO., Inc., New York
Sole Distributors
APEX RADIO CO., Inc., 503 Fifth Ave., New York

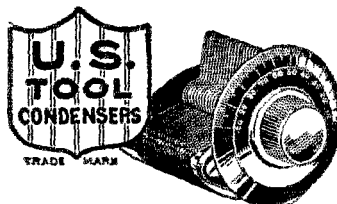

Point
Number
Two

New Hexagon Shaft

The Second of
Five Unique
Features

The rotor blades, stamped with hexagon hole, are gripped tightly by the hexagon shaft, preventing fanning of rotor blades. Found in four new types—types 5 (plain) and 4 (all-vernier), celoron end plates; types 6 (plain) and 6 (all-vernier), low-loss—metal end plates. Ask to see them at your dealer's.

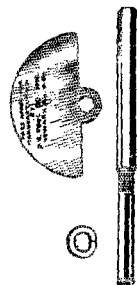

100% GUARANTEED

Write for Literature

U. S. TOOL COMPANY, INC.

112 Mechanic St. Newark, N. J.

Mfgs. of special tools, dies, jigs, automatic machinery and sub presses.

It Tunes Through *Everything* The New SUPER-ZENITH



Super-Zenith X

Super-Zenith VII —Table Model

(Not regenerative)—6 tubes—2 stages tuned frequency amplification—detector and 3 stages audio frequency amplification. Installed in a beautifully finished cabinet of solid mahogany—44½ inches long, 16½ inches wide, 10½ inches high. Door panels inlaid. Slanting panel of sheet bronze, mahogany finish, with scales and indicators in metallic relief. Gold plated pointers, to prevent tarnish. Compartments at either end for dry batteries. Can be operated on either wet or dry batteries. Either inside or outside antenna.

Price (exclusive of tubes and batteries) \$230

Super-Zenith VIII

Same as VII except—built with mahogany legs of well-proportioned appropriate design, converting model into console type.

Price (exclusive of tubes and batteries) \$250

Super-Zenith IX

Same as VII except—built with legs and additional compartments containing built-in Zenith loud speaker on the one side and generous storage battery space on the other.

Price (exclusive of tubes and batteries) \$300

Super-Zenith X

Contains two new features superseding all receivers. 1st—Built-in, patented, Super-Zenith Duo-Loud Speakers, perfectly reproducing both high and low pitch tones otherwise impossible with single-unit speakers. 2nd—Zenith Battery Eliminator. Requires no A or B batteries or charger.

Price (exclusive of tubes) \$550

The new Super-Zenith is NOT regenerative. It is a six-tube set in four different models ranging from \$230 to \$550, with a new, unique and really different patented circuit controlled exclusively by the Zenith Radio Corporation. Amplification is always at a maximum in each stage for any wave-length. The Super-Zenith line is not affected by moisture. For the first time, you have here a set that—

- 1—tunes through everything and selects the station you really want.
- 2—requires only two hands—not three—to operate.
- 3—brings in each station at only one point on the dial.
- 4—affords such mathematical precision and simplicity that you can run over the entire dial in 1½ minutes and pick up more stations with greater clarity and volume than any other set on the market. Direct comparisons invited. The new Super-Zenith was perfected in Zenith's laboratories in the center of the eleven powerful Chicago broadcasting stations. Even under these extremely adverse conditions the new Super-Zenith tunes through everything and "gets the outside" on loop, inside, or outside antenna.
- 5—produces not only the seemingly impossible in perfect selectivity, but also possesses such artistry of design, such finished craftsmanship, that it lends distinction and exclusiveness to any living-room or library.

Write for the name of the nearest dealer from whom you can obtain a demonstration of this outstanding marvel of the radio world.

Dealers and Jobbers: Write or wire for our exclusive territorial franchise.

ZENITH RADIO CORPORATION

Branch Office:
1269 Broadway, NEW YORK

General Offices:
332 So. Michigan Avenue, CHICAGO



The exclusive choice of
MacMillan for his North
Pole Expedition. Holder
of the Berengaria record.

Zenith Radio Corporation

Dept. 11E
332 S. Michigan Ave., Chicago, Ill.

Gentlemen: Please send me illustrated literature giving full details of the Super-Zenith.

Name.....

Address.....

AMMETERS—THERMO COUPLE TYPE vs. EXPANSION HOT WIRE TYPE

The Weston Thermo-Couple Ammeters will be your choice if your instrument requirements demand:

- Accuracy on both A. C. low and high frequencies
- Quick readings
- No zero errors
- No heating errors
- No error when D. C. component exists
- Can be checked on direct current
- Ruggedness
- High overload capacity

It will pay you to purchase an Ammeter that will meet these specifications—one that is accurate and dependable and that will last indefinitely if used with reasonable care.

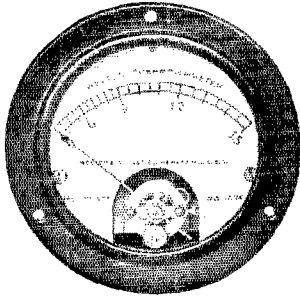

Model 425 Thermo Ammeter

Due to the lack of knowledge and mis-information of the working principle of the Thermo-Couple Ammeter erroneous ideas have resulted.

Both the modern Thermo-Couple type and the old Expansion Hot Wire Type depend for their operation on the heating of a conductor by the current flowing.

The Thermo-Couple Ammeter measures electrically by a D. C. movement and a Thermo-Couple welded to a heating strip, while the expansion Hot Wire Ammeter measures mechanically by the expansion of the hot wire.

The Hot Wire Type is subject to serious errors and zero shift due to the heating of parts, external temperature changes, and is sluggish and fragile.

WESTON ELECTRICAL INSTRUMENT COMPANY
158 WESTON AVENUE, NEWARK, NEW JERSEY

Electrical
Indicating
Instrument
Authorities
Since 1888

WESTON

STANDARD - The World Over

The Model OEM, DAY-FAN Receiving Set

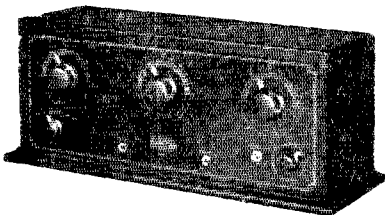

Model OEM-7, Four Tubes—\$98
Model OEM-11, Three Tubes—\$90

This set is worthy of your immediate attention. It has the Duo-plex circuit developed in our laboratories. So perfectly balanced is the OEM that the dial settings on each set are the same EVERYWHERE, EVERYTIME. It has a very low maintenance cost. Write today for full particulars.

The Dayton Fan & Motor Company,
Dayton, Ohio.

Manufacturers of high-grade electrical apparatus for more than 25 years.

CONDENSERS THE RELIABLE "ILLINOIS"

We use no useless metal or dielectric to lessen efficiency. 43 PL. \$3.50, 23 PL. \$2.75, 13 PL. \$2.25. Vernier \$1.50 extra. Without Dials 25c less. Discounts on orders of 2 to 5, 20 per cent; 6 or more, 25 per cent. Prompt Shipment. Send for Bulletin.

G. F. JOHNSON

625 Black Ave. - Springfield, Ill.



There is only one
GENUINE
EBY Binding Post

"With tops which Don't Come Off,"

Eby Posts are scientifically designed, beautifully finished and their price is right.

This is our Ensign post which can be furnished either plain or engraved in twenty-five different markings.

EBYS Are Binding Posts PLUS

H. H. EBY MFG. CO., Phila., Pa.





So little to do—such great results

Never has there been entertainment, so much and so fine, that was so little trouble and expense as with radio.

Good programs without limit when that storage battery of yours is fully charged and ready. Perfectly easy and simple if you have the Tungar, which recharges the radio or auto battery overnight from the house current.

Sold by Electrical, Auto-accessory and Radio dealers.



Tungar is one of the many scientific achievements contributed by the G-E Research Laboratories toward the wonderful development of electricity in America.

Tungar Battery Charger operates on Alternating Current. Prices, east of the Rockies (60 cycle Outfits)—2 ampere complete, \$18.00; 5 ampere complete, \$28.00. Special attachment for charging 12 or 24 cell "B" Storage Battery \$3.00. Special attachment for charging 2 or 4 volt "A" Storage Battery \$1.25. Both attachments fit either Tungar.

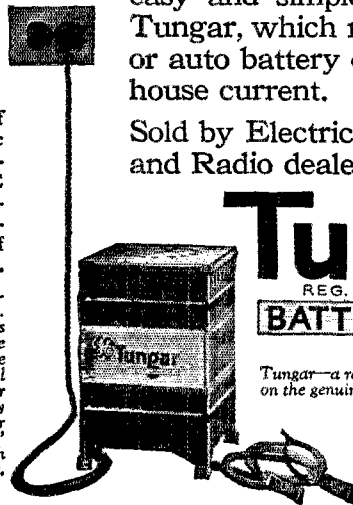

Tungar

REG. U.S. PAT. OFF.

BATTERY CHARGER

Tungar—a registered trade mark—is found only on the genuine. Look for it on the name plate.

Merchandise Department
General Electric Company
Bridgeport, Connecticut

GENERAL ELECTRIC

48E-12

Why the Red Seal Headset is Ideal for "DX" Reception

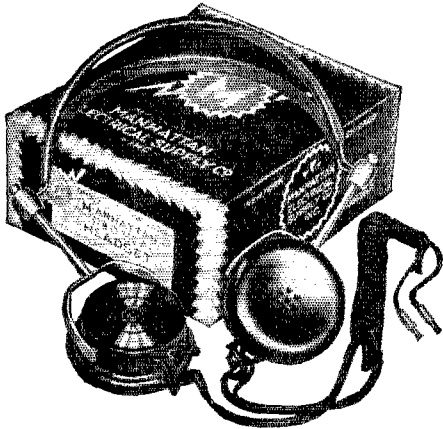

Comfortable!

In the Red Seal Headset maximum comfort is insured through the use of a soft rubber covered head band held in shape by flexible wires which exert just enough pressure to keep the receiver against the ears.

Delivers FULL SIGNAL STRENGTH

The Red Seal Headset has magnets of tungsten steel, with pole pieces of silicon steel. This alone assures all possible signal strength with a minimum of absorption. Red Seals often develop signals not audible with the ordinary headset.

No Distortion

Red Seals produce a full rich tone, free from all natural period. Thus all frequencies are rendered with equal strength and with an absence of all distortion or "chattering."

High Impedance

In the Red Seal the impedance of 25,000 ohms at 1000 cycles, closely matches that of the average vacuum tube,—a necessary requirement for high efficiency.

In addition the case of the Red Seal is a genuine Bakelite, the cord tips are entirely concealed, and the polarity is indicated.

Price \$6.00

MANHATTAN
ELECTRICAL SUPPLY CO., INC.
NEW YORK CHICAGO
ST. LOUIS SAN FRANCISCO

"Makers of the famous Red Seal Dry Batteries, Manhattan and Red Seal Radio Products."

The KIC-O Double Potential Charger

Meets—

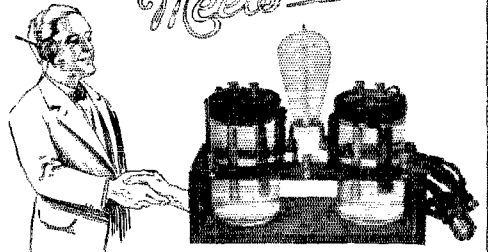

the need of every radio fan—

"Hook Up" our single or double Charger with a KIC-O "B" Storage Battery direct to any electric socket. Then you will have a permanent power plant. No need to worry about "juice" or buying new batteries. Write for literature and prices or ask your dealer.

Kimley Electric Company, Inc.
2666 Main St. Buffalo, N. Y.

Locke Sockets

LOW LOSS SURE CONTACT

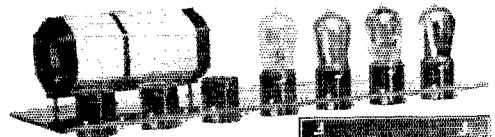

At last a socket with these exclusive features: A phosphor bronze WIRE, silver-plated, Contact Prong—assuring wide spacing of parts, a minimum of both metal and bakelite insulation for low capacity. Self-cleaning; easily shelf or base mounted; makes contact at tube base; direct soldering connections. Seven sockets mounted like cut on 6 x 20 1-2 x 3-16 inch bakelite base panel, designed so as to mount Super Multiformer beneath sockets, making short leads, \$12. 75c each, plus postage

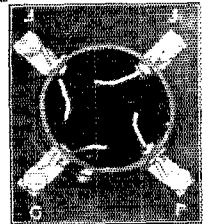

Locke Low-Loss Coils

to match Super Transformer; Tuner 59-T Sec., 8-T Prim., of No. 18 DCC; Oscillator 60 turns-40 turns No. 18 DCC, \$5 ea. Coils mounted free if ordered with panel and sockets.

All articles fully guaranteed—Circular on request

Locke Radio Shop, Victor, N. Y.

EISEMANN

ELECTRICAL EQUIPMENT

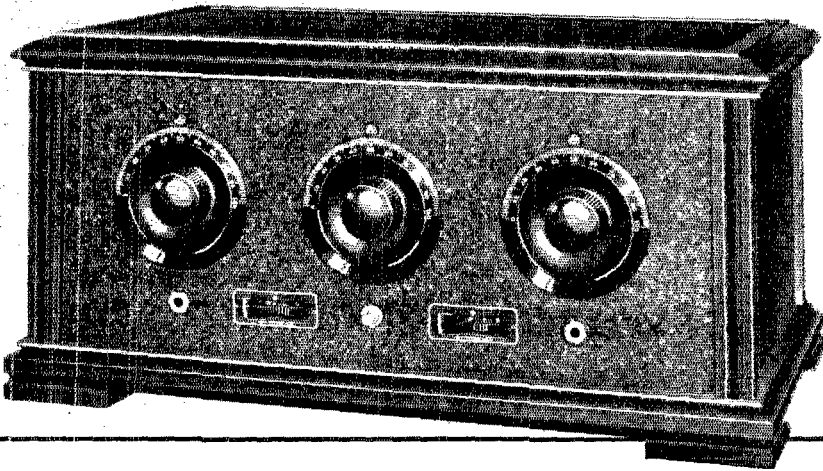

The Measure of True Worth

SPECIFICATIONS

Circuit: Two stages of tuned radio frequency amplification, detector and two stages of audio frequency amplification. Non-oscillating.

Tubes: Five in all. Jacks provided for either five or four tube operation.

Batteries: Either storage or dry cells.

Cables: Complete set supplied for "A" and "B" batteries.

Wave lengths: 250 to 600 meters, with uniform efficiency of reception.

Antennae: 75 to 125 feet, single wire.

Panel: Aluminum, with attractive crystal black finish. A perfect body capacity shield.

Dials: Sunken design. Shaped to fit the hand and permit a natural position in tuning.

Rheostats: Adequate resistance for all standard base commercial tubes.

Condensers: Single bearing, low leakage losses.

Sockets: Suspended on cushion springs which absorb vibrations.

Cabinet: Mahogany, with distinctive lines and high finish. Ample space provided for "B" batteries.

EFFICIENT performance, attractive appearance and moderate price are the three basic elements that comprise value in a receiving set, as in any other article. Trick names and catch phrases, used to designate circuits, mean little and often confuse the buyer. All three essentials are combined in the Type 6-D Receiver.

Performance: Extraordinary selectivity widens the choice of programs. In close proximity to powerful stations, the sharpness of tuning is marked. Far distant points are received with unusual clarity and volume. Tuning is very simple. The three dials are closely matched at all wave lengths, and settings are easily memorized.

Appearance: The substantial mahogany cabinet, with distinctive lines and high finish, is a fitting addition to the living room or library. The symmetrical panel layout and interior construction bear the imprint of advanced thought and skilled workmanship.

Price: \$125.00, without tubes and batteries, creates a new standard of value.



EISEMANN · MAGNETO · CORPORATION

General Offices: 165 Broadway, New York

DETROIT · SAN FRANCISCO · CHICAGO

ALWAYS MENTION QST WHEN WRITING TO ADVERTISERS

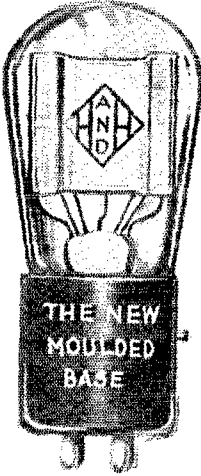

Type 201A

Airtron Radio Tubes

With the new highly developed dielectric moulded bakelite base which eliminates all kinds of electrical losses.

Airtron Tubes

Speak for quality, volume and all other characteristics demanded of a Radio Tube. Designed and manufactured to give the highest efficiency that a tube at the present time can possess.

Type	200	— 6 Volt	1 Amp. Detector
Type	201A	— 5 Volt	.25 Amp. Det. and Ampl.
Type	-12	— 1½ Volt	.25 Amp. Det. and Ampl.
Type	199	— 3-4 Volt	.06 Amp. Det. and Ampl.

Standard Base

Every Tube Guaranteed

List Price \$4.00

Sold by all dealers, or shipped C. O. D. direct by Parcel Post. When ordering mention type

Discount to Dealers

H. & H. RADIO COMPANY

CL. HILL STA. BOX 22

Dept. 108

NEWARK, N. J.

We are still Repairing

ALL TYPES OF RADIO TUBES

\$2.50

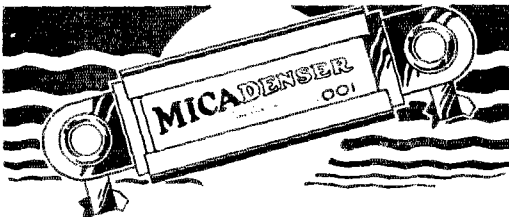

Increased Signals

Gentlemen: Ur MICADENSERS r fb. Oml I have had excellent results since I have been using your condensers. I find your capacities run very accurate.

Your all metal mica construction puts it in a class by itself. The mica you use is of very high grade which would lead me to believe that the power factor of the condenser would be very low. This seems to prove out for when the condensers in a transmitting set were replaced by yours the radiation was increased and the condensers did not heat as the others did.

I have taken other condensers out of receiving sets and put yours in and have in every case increased the signals.

SALY (Signed) H. H. Hurd.

Made in all standard capacities. Most popular capacities priced as follows:

.000135c	.00140c	.00675c
.0002535c	.00240c	.015\$1.75
.000535c	.00540c		
	.00025 with Brackets for Grid Leaks	45c		
	.00025 with Self-contained Grid Leak	50c		
	.00025 in Matched pairs, per pair	95c		

(Both condensers warranted exactly same capacity)

We will furnish any exact capacity value in Micadensers, or duplicate the capacity value of any condenser you send us, at 10c above regular price.

At all good Jobbers and Dealers. If dealer can't supply, Ben Franklin Micadensers will be sent prepaid, on receipt of remittance with order.

The Ben Franklin Radio Manufacturing Company
 Corner E. 27th and Superior Cleveland, Ohio

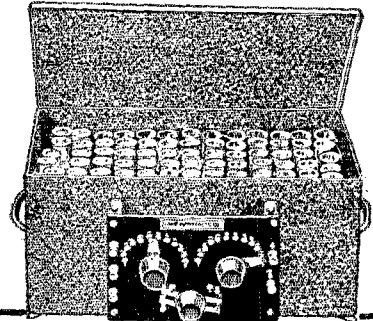

LANE 100 Volt

Non-Acid Storage

"B" BATTERY

NO MUSS NO SPILLING—

CLEAN, ATTRACTIVE
 Makes a wonderful improvement in your radio set. Gives it more life and pep. Makes listening in a real pleasure. Gives a clearer reception than you have ever experienced. Brings in more stations louder and clearer, takes the guesswork out of distance reception.

Life of Battery Unlimited

LITTLE OR NO REPAIRS EVER NECESSARY
 No deterioration—easiest, quickest to charge—will operate a 3 tube set continually for over 50 hrs. Ordinary use one to four months without recharging.

PANEL SWITCHES Gives Instant and Correct Voltage

A great and necessary improvement on batteries. Gives instantly correct voltage at all times and perfect reception. Allows for charging in two equal parts. Comes in handsome **\$25** At your dealer's or indestructible case, direct, 150 v. \$37.50.

Attractive Proposition to Dealers and Jobbers.
LANEMFG. CO., Dept. 11 2941 W. Lake St., CHICAGO

BAKELITE

TRADE MARK U. S. PAT. OFF.

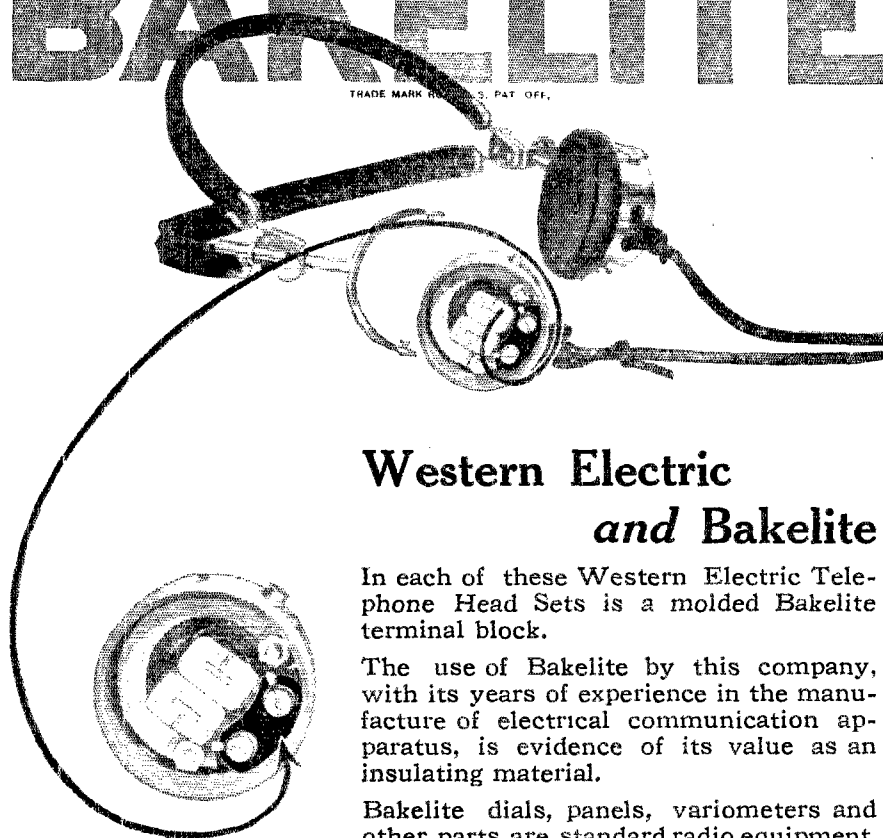

Western Electric and Bakelite

In each of these Western Electric Telephone Head Sets is a molded Bakelite terminal block.

The use of Bakelite by this company, with its years of experience in the manufacture of electrical communication apparatus, is evidence of its value as an insulating material.

Bakelite dials, panels, variometers and other parts are standard radio equipment. Mechanically strong, unaffected by atmospheric changes, and beautiful in appearance, they may be depended upon to render years of good service.

Send for our Booklet C.

Send for our Radio Map

The Bakelite Radio Map lists the call letters, wave length and location of every broadcasting station in the world. Enclose 10 cents to cover the cost and we will send you this map. Address Map Department.



BAKELITE CORPORATION

247 Park Avenue, New York, N. Y.
Chicago Office: 636 West 22d Street.

THE MATERIAL OF A THOUSAND USES

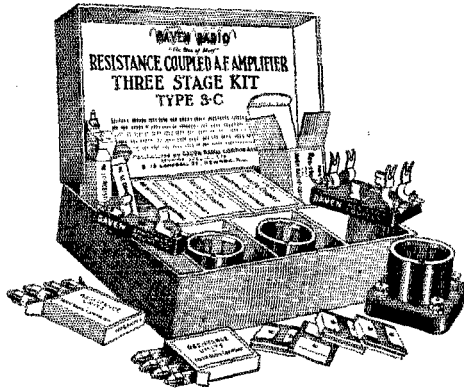

PIONEERS!

Others may follow but we know better than they the way we have blazed

DAVEN engineers designed and built the first Resistance Coupled Amplifier offered to the radiocast fan. Longest before the public, it is natural that they have ATTAINED an excellence that is only approached by other amplifiers.

The Daven Type 3-C Amplifier Kit exactly as illustrated contains all the parts necessary to build a three-stage Resistance Coupled Amplifier. It is packed in a neat compartment box with full directions for assembly and operation with any detector and tuner.

- Price Complete \$12.50
- Type 3-K. Without sockets and condensers \$ 8.00
- Type 4-C Kit complete with sockets and condensers 16.00
- Type 4-K Kit without sockets and condensers 10.50

Purchase from your dealer, the Daven "RESISTOR MANUAL" by Zeh Bouck. This manual contains the how-to-make-it data on Resistance Coupled Amplification.

Price 25 cents.

DAVEN RADIO

"Resistor Specialists"

Newark

New Jersey

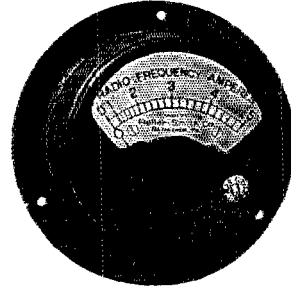

How Many Amperes Are You Radiating ?

A Roller-Smith type TAW Thermal Ammeter will tell you accurately and it will continue doing so. These little 3 1/2" instruments have demonstrated their reliability in the Government service. You can't make a mistake when you use them. Bulletin No. AG-10 is yours for the asking. Send for it. This Bulletin also describes a most complete line of ammeters and voltmeters for all radio work.

ROLLER-SMITH COMPANY

16 Park Place,

New York

Offices in principal cities in U. S. and Canada, also Havana, Cuba.

FREE

Greatest Catalog of Radio Bargains

RADIO
for Everybody
RANDOLPH RADIO CORP.
Satisfaction Guaranteed

Send for It Today

American Bell Loud Speaker

\$3.95 without unit
\$6.95 with unit

With American Adjustable Unit. Wonderful volume, clear reception. Speaks for itself without coaxing. 10-inch bell—made of non-vibrating material.

\$2.45

HEADPHONES "Randolph Special"

2200 Ohm moulded headset, properly designed to give strong and clear reception. Biggest headphone value ever offered.

Hundreds of Other Bargains

Our catalog is filled with bargains like these. Order direct from this ad. We prepay charges. Don't buy anything in radio before you see our catalog. **FREE Service Dept.**

RANDOLPH RADIO CORP.
159 N. UNION AV. Dept. 76 CHICAGO, ILL.

KESTER *Radio* SOLDER

ROSIN-CORE



Oh boy! it sure is
Safe & Simple

Here's the solder that contains the flux recommended by radio engineers! The pure rosin core inside of Kester Radio Solder is a natural flux and can leave no harmful chemical or electrical action on delicate parts or joints.

It requires only heat, and as the solder is used the rosin flux flows out in the proper amount. *Not too much, not too little, but just right.*

In developing radio frequency it proved that all fluxes, except rosin, spatter, fume and run over delicate parts and joints. *This causes high leakage and reduces resistance to like values as grid leaks!*

Solder with Kester Radio Solder. You will have no need to go over and wipe away surplus flux. Leave what rosin may remain—it is a good insulator!

There you have it: Kester Radio Solder is a safe and simple solder with which your set can be quickly, neatly, safely and substantially soldered.

Get a handy can of Kester today from your dealer or send us 25c in stamps—

CHICAGO SOLDER COMPANY

Look for this
carton on your
dealer's counter!



IF YOUR DEALER CANNOT SUPPLY YOU

O. S. T.
Chicago
Solder
Company
4220 Wrightwood
Ave., Chicago, Ill.
Gentlemen: Send me
one can Kester Radio
Solder, for which I en-
close 25c in stamps.
(Postpaid anywhere in U. S. A.)

Name.....
Address.....
City..... State.....
Dealer.....

Why It Is Better

LOOK at this illustration—see for yourself the eleven distinctive features in the construction of the Federal Condenser. Every feature is a distinct point of superiority—essential to clear, sharp tuning and clear reception.

You can get the outstanding advantages of Federal Tone and Federal Selectivity in your pet hook-up **only** by insisting on Federal Parts.

There are over 180 Federal Standard Radio Parts bearing the Federal iron-clad performance guarantee. Use them—for your own protection and enjoyment.

Federal Telephone and Telegraph Co.
Buffalo, N. Y.

Boston New York Philadelphia Pittsburgh
Chicago San Francisco Bridgeburg, Canada



Federal Standard RADIO Products

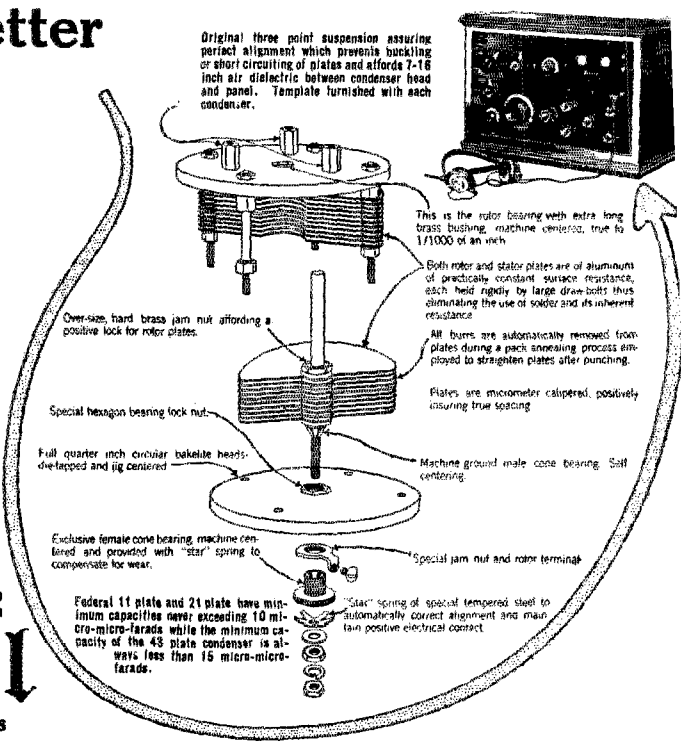

LOG EVERY WORTH WHILE STATION WITH PERFECT EASE

Be able to get the programs you like best any time and with that smoothness and clearness of tone that makes Radio most enjoyable. It's easy with

Stromberg-Carlson

HEAD SETS and LOUD SPEAKERS

Their powerful magnets give extreme sensitivity. The layer wound and layer insulated coils enable these instruments to stand up under the highest voltages and to retain their sensitivity permanently.

Ask your Dealer

STROMBERG-CARLSON TEL. MFG. CO., Rochester, N. Y.



Everything for AMATEURS try these—

A new **Bradleystat** for primary of filament transformer up to 500 Watts, \$6.50 plus postage.

RCA, JEWELL and WESTON meters
Transmitting inductance, \$8.70 like RCA, but lower resistance.

Don't Miss Our HAM-ADS
Ask for our new Ham Catalog

E. F. Johnson
9ALD Waseca, Minn.

TOAZ GRIPFAST TERMINALUGS
Patent Applied For
NOW READY FOR DELIVERY
COPPER — TINNED — \$3.00 M
AMATEURS!

60 Plain Type Lugs	\$0.25
50 Gripfast Lugs	.25
25 Dubblelugs, (1 9-16 centers)	.26
12 feet Bus Wire	.25

Any combination—5 items \$1 Pp.
Discounts to Dealers
Free Pamphlet Practical Soldering

TOAZ Engineering and Sales Co.
11703 Robertson Ave., Cleveland, Ohio

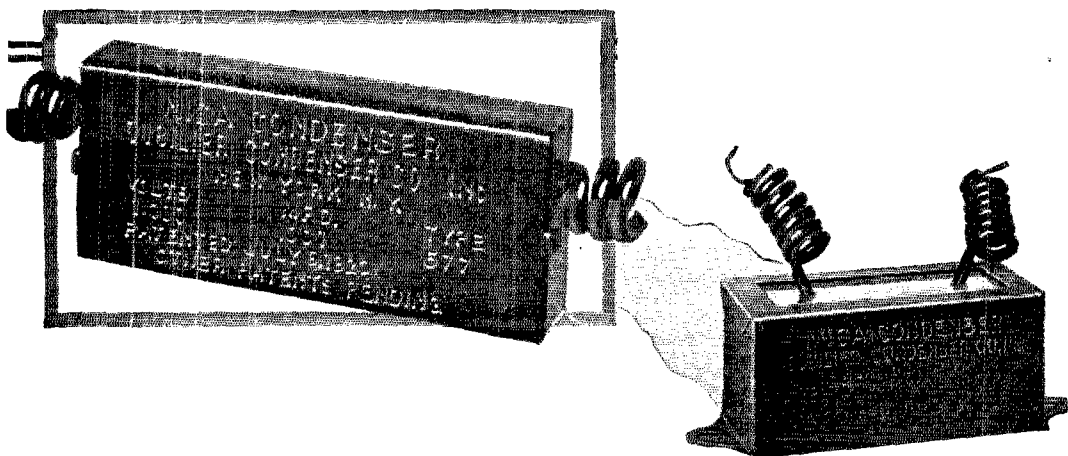

The Army and Navy Equip with **DUBILIER CONDENSERS**

Ships at sea—cut off from the world. Far away regions of the frozen north—miles from civilization. These are the places that literally depend on radio for communication and life. And wherever there are government stations you will find Dubilier condensers. The government knows that they are absolutely dependable for efficient transmission under all conditions.

Types 577 & 580 are efficient condensers of fixed capacity and low loss. They are manufactured under a patented process that maintains permanent capacity and assures steady service. Amateur low power tube transmission with Dubilier Condensers insures the same unfailing service that the government stations achieve with higher power.

*Ask your dealer about them or write us for information at
49-51 West 4th Street, New York, N. Y.*

Dubilier

CONDENSER AND RADIO CORPORATION

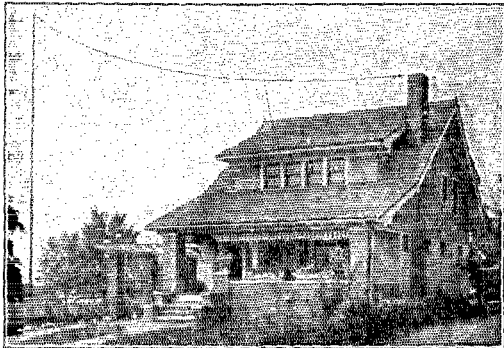

The 40 Ft. HERCULES Mast in yard

The HERCULES AERIAL MAST

This mast is made in sizes to get 20 Ft.; 40 Ft. or 60 Ft. clearance and is the answer to an efficient aerial system. What is more, this graceful mast is an improvement to any property, whether it is installed on the roof or in the back yard. It can be erected in a few minutes. It is shipped knocked down for convenience in handling. All parts are made of steel and are light and strong.

Long Range Radio Reception

It has been said time and again that the best results are obtained only by the intelligent use of the best apparatus procurable. This is an oft repeated statement but the more it is pronounced the truer it becomes and applies not only to the receiving equipment proper, but also to the antenna system. This applies most emphatically to receivers of the crystal detector type and to non-regenerative audion outfits. **THE AERIAL MUST BE EFFICIENT** if the reception of long distance stations theoretically within range of the receiver, is desired.

Proper Aerial Clearance

Very few novices realize the importance of good aerial installation. The feeble currents from long distance stations will never reach the receiving set if the aerial is strung too close to surrounding objects that tend to absorb the energy. It is with this interference that we have experimented for years—and present the answer—**THE HERCULES AERIAL MAST**.

Have Built Radio Towers for Years

For years we have been building radio towers for important broadcasting stations. Included among the names of our customers is the **UNITED STATES GOVERNMENT SIGNAL CORPS**. Only after years of experience and development work have we been able to perfect this wonderful steel aerial mast.



20 Ft. HERCULES Mast on roof

to sell at a price within reach of the amateur.

Give Your Set a Chance

Not only will the proper aerial clearance thus obtained give you the supreme pleasure of long distance radio reception, but the appearance of this beautiful

- 20 Ft. Mast \$10
- 40 Ft. Mast \$25
- 60 Ft. Mast \$45

PREPAID

Order from this "Ad" if you wish

mast on your property will give you a reputation. This reputation will grow as you bring in stations such as you yourself, never hope for.

MAIL POST CARD for full particulars and literature about The HERCULES Aerial Mast.

S. W. HULL & CO.

Department C

2048 EAST 79th ST. CLEVELAND, OHIO





Improve your set with an AmerTran
STANDARD OF EXCELLENCE
for audio amplification

AMERTRAN

TRADE MARK REG. U.S. PAT. OFF.

Made in two types—

AmerTran AF-6 (Turn ratio 5), for use in the first stage of amplification.

AmerTran AF-7 (Turn ratio 3 1/4), the companion transformer for use in further stages when AF-6 is used in the first stage.

Price, either type, \$7, at your Dealer's.

American Transformer Co.

Designers and builders of radio transformers for over 23 years.

176 Emmet Street, Newark, N. J.

LARGEST RADIO STORES IN AMERICA



509 S. State St. CHICAGO, U. S. A. Dept. Q-6

We guarantee RADIO
our new 68 page **Catalog will save you money**

on brand new fully guaranteed, nationally advertised radio apparatus. We buy up manufacturer's and government surplus stocks, jobber and dealer bankrupt stocks, etc. Our enormous buying power permits us to pay spot cash and get rock-bottom prices—even way below manufacturer's costs. That's why our catalog is crammed with thousands of wonderful radio bargains. That's why we **GUARANTEE** to save you money.



Write for your **FREE**

copy today!

WESTINGHOUSE

RADIO

"A," "B" and "C"

BATTERIES

THE COMPLETE LINE

Three types of "B" batteries, all in handsome, one piece crystal glass cases. They are easy to fill and easy to charge. They have long life and ample capacity. Made in three sizes, giving you a wide range of capacities to suit the requirements of your set whatever it may be. They are noiseless, steady, and always reliable. They are rechargeable and, therefore, economical.

"A" batteries in glass cases for 2, 4 and 6 volt tubes enable you to have the advantages of the glass cased "B" batteries for your filament battery also. The Westinghouse line also includes several sizes of 6 volt "A" batteries in one piece composition cases which will not crack, leak or rot like the old time wooden cased batteries. Capacities for every set from a one-tube "bloomer" to the largest "dyne".

The 6 volt "C" battery in a one piece glass case can be tapped off to give you 2, 4 or 6 volts. Small, compact and rechargeable, this little battery gives you storage battery advantages for your "C" batteries also.

Sold by radio dealers and by Westinghouse Battery Service Stations.

WESTINGHOUSE UNION BATTERY COMPANY

SWISSVALE, PA.

CANADIAN DISTRIBUTOR

Canadian Westinghouse Co., Ltd.

Hamilton, Toronto, London, Ottawa, Montreal, Moncton, Halifax, Winnipeg, Calgary, Edmonton and Vancouver

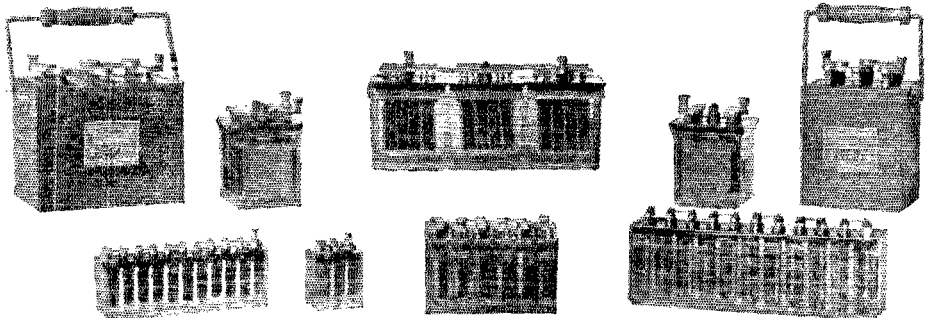

*The Commissioners of Lower Merion Township
Montgomery County, Pennsylvania
Township Building*

W. L. BARKER
HENRY OKLAHLAINE
FRANK J. FLOYD
ALBERT R. GRAY
PETER C. HESS
WILLIAM H. MEMORAN
ANDREW MACDONALD

CLIFFORD MACKAY
CHARLES REIDEL
WILLIAM H. SHERWOOD
JAMES A. STRETCH
FRANK H. BYKES
A. D. WARNOCK

Ardmore, Pa. Gladwyne, Pa.
Sept. 19, 1924

Electric Specialty Company
Stamford, Conn.

Dear Sir:

Upon arrival of your type 80300 generator I immediately coupled it to a Westinghouse 1 Hp. motor. After running it about two hours I connected it to my transmitter which uses three 50 watt tubes. Not only did it work but IT PUT POWERFUL SIGNALS INTO HAMBURG, GERMANY and FLORENCE, ITALY.

I think the above statement shows how much I appreciate the generator.

My card from Italy reads as follows:
Radio 3ETA: Ur sigs hrd hr very very Qss at 5.27
and 5.35 A.M. Both broad day-light. No Qss, Aug. 20
U were one of the loudest of 14 American stns hrd
tt A.M.

Sig.
F.S. Huddy
U lll lzs

Since that time I have worked every district in the U.S. *
one night, also three Canadian provinces.

Very Truly Yours,
Barrie R. Barker
u3bta

P.S. You may use this letter in conjunction with any of your
advertisements as I stand by and for the ESCO generators

A new BATTERY SWITCH

with enclosed,
positive contacts

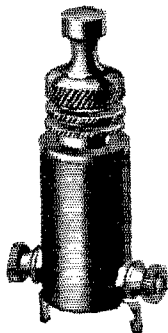

The contacts of the new Centralab Battery Switch are enclosed for protection from dust and mechanical injury, and are firm and positive, of the quick make and break type. The switch is small and compact so as to occupy the minimum of panel space. It has two knurled nuts for adjustment to any thickness of panel. Both binding posts and lugs for permanent soldering are provided. Substantial and neat. Single hole mounting.

No. 300-50c

Centralab

CENTRAL RADIO LABORATORIES
291 Sixteenth St. MILWAUKEE, WIS.

AMERICAN BRAND CONDENSERS

with the

~100 to 1~

Worm Drive Vernier
Finest Condenser Made

and the

Greatest Radio Value
Offered the Public

23 PLATE, only \$5.00 In Canada \$7.00

AMERICAN BRAND CORPORATION
NEWARK, N. J.

CRESCENT LAVITE RESISTANCES

Absolutely non-inductive.

12,000	} Ohms		LIST
48,000			\$1.50
50,000			EACH
100,000			

Special resistances to order \$2.50. When better resistances are made they will bear the Crescent label.

CRESCENT RADIO SUPPLY CO.

13-5 Liberty St., Jamaica, N. Y.



CITIZENS RADIO CALL BOOK

JUST OUT!

A Complete

RADIO-CYCLOPEDIA

CONTAINS

fresh lists of all telephone broadcasting stations in the world, all standard hookups with a complete description of each, how to build thirty and fifty kilocycle Super-Heterodyne, Greene Concert Selector and Low Loss Tuner, complete article on receiver troubles and how to remedy them, maps, log sheets, distance chart and a world of information well worth \$5.00 of any radio fan's money.

Citizens Radio Service Bureau

501 South Dearborn Street

Chicago, Illinois



50c
MAIL COUPON NOW

When ordering direct, include fifteen cents for parcel postage. Dealers, write for our guaranteed plan of sale.

Citizens Radio Service Bureau,
501 S. Dearborn St., Chicago, Ill.

Gentlemen:

Please find enclosed 65c for your latest Call Book.

Name.....

Address.....



PATTERN NO. 95

RADIO TEST SET

- ¶ This radio test set has been designed to meet the demands coming to us from serious experimenters, manufacturers and dealers in radio equipment and supplies, for a complete radio testing outfit.
- ¶ While the various ranges of readings permit making practically every test necessary in connection with radio receiving sets, it has been particularly designed for the taking of characteristic curves on vacuum tubes, the only extra equipment required being the batteries.
- ¶ The several instruments, any of which may be used independently, include a 0-1.2 filament ammeter, a 0-6 filament voltmeter, a 0-120 plate voltmeter, a 0-10 plate milliammeter, and a 10-0-10 grid voltmeter.

Complete with Instructions

Price, \$75.00

Send for Circular

ORDER FROM DEALER

**JEWELL ELECTRICAL
INSTRUMENT CO.**

1650 Walnut St.,
Chicago.

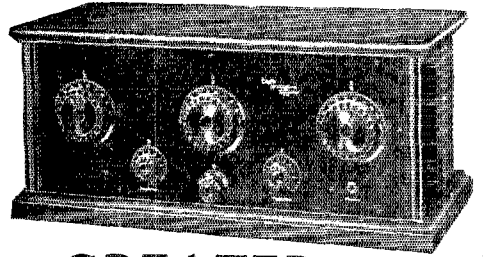

The **GREATER** Neutrodyne

EAGLE Balanced Receiver
Model B, 5 Tubes \$175

THE greatest circuit made greater by epochal refinements. Every instrument that must carry any responsibility for the efficiency of the EAGLE Model B Receiver is made in the EAGLE factory under the supervision of EAGLE engineers.

Licensed by Independent Radio Manufacturers, Inc., under Hazeltine Patent Nos. 1,450,080, dated March 27, 1923, and 1,489,228, dated April 1, 1924. Other patents pending.

Write for Literature

Eagle



Radio Co.

23 Boyden Place, Newark, N. J.

FERBEND

TRADE MARK

Maxmin

All Range Condenser

Here is a new type of low loss condenser embodying exclusive features ranking it supreme among low loss condensers. It is the same condenser used in the Ferbend Wave Trap, and is largely responsible for its remarkable success. So constructed that it is DUSTPROOF and FOOL-PROOF. Absolutely eliminates body capacity. Cannot short-circuit.

Takes place of any condenser from 5 to 48 plate, giving vernier adjustment over whole scale!

May be used in any circuit regardless of capacity specified. Simple in design. Compact. Low internal resistance. Ideal for quiet, clear reception. Can be used for transmitting up to 250 watts power. Sent postpaid for \$2.75. Money back guarantee. Illustrated folder on request.

FERBEND ELECTRIC CO.

23 E. So. Water St.,

Chicago



DEALERS

WE CAN SAVE YOU MONEY!

Standard Guaranteed Lines. Send for latest Discount Book on Quality Radio Apparatus.

RADIO MATERIAL SUPPLY COMPANY
32 N. Wells St. Dept. 106 Chicago

It's Easy to Cut and Drill

RADION PANELS

No special tools are required. Common house tools will turn out a clean hole and a straight edge, with no chipping.

There are 18 stock sizes to select from—literally a size for every set. This means less cutting and little waste, sometimes a definite saving in real money.

Exhaustive research has shown that RADION excels other insulations in the important electrical and mechanical characteristics. It's worth while to ask for RADION Panels and Parts. Be sure to get only the genuine.

Do not accept inferior so-called hard rubber panels that are **not** RADION and that do **not** have the insulating values of RADION.

AMERICAN HARD RUBBER CO., 11 Mercer St., N. Y.



Look for this stamp on every genuine RADION Panel. Beware of substitutes and imitations.

18 Stock Sizes

Mahoganite and Black

3/16 x 6 x 7	3/16 x 7 x 21
3/16 x 6 x 10½	3/16 x 7 x 24
3/16 x 6 x 14	3/16 x 7 x 26
3/16 x 6 x 21	3/16 x 7 x 30
3/16 x 7 x 9	3/16 x 7 x 48
3/16 x 7 x 10	3/16 x 8 x 26
3/16 x 7 x 12	1/4 x 8 x 40
3/16 x 7 x 14	1/4 x 10 x 36
3/16 x 7 x 18	3/16 x 20 x 24

RADION

Panels Dials Knobs Sockets Insulators

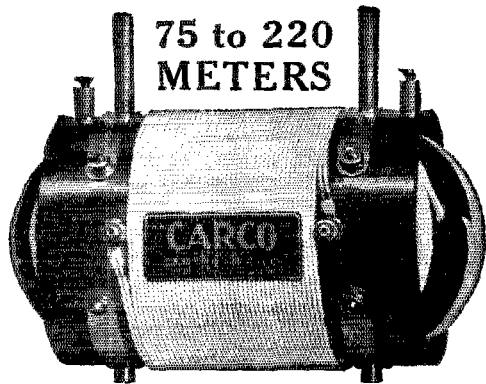

75 to 220 METERS

**“CARCO”
HAM SPECIAL
SHORTWAVE-LOW LOSS
COUPLER**

DESIGNED BY A HAM FOR HAMS
A compact unit in a space of only 3" x 5 1/2".
Antenna Rotor and secondary Stator designed for
"Low Loss" and "Low Resistance."
Our special single layer, multiple wound inductance
does the trick.
A "Low Loss" Condenser for secondary is the only
addition required for a complete tuning unit.
DX work requires a "Low Loss" tuner. Rebuild
your set with a "CARCO" Ham Special. An in-
crease in efficiency will result.

PRICE \$8.00 EACH
SPECIAL PRICE TO HAMS ONLY, \$5.00
This Special Price is NET. No Discount to Dealers
Sent C.O.D. A Postal with name, address will
bring it.

SET MANUFACTURERS and DEALERS:—We
specialize on Couplers and inductances. Let us
know your needs and we will design the tuner
for the desired circuit.
Are you interested in a small variometer (2"
by 3") for crystal sets? We have them.

THE CARTER MANUFACTURING CO.
1728 Coit Ave., East Cleveland, O., U.S.A.

The Carter Manufacturing Co.,
1728 Coit Ave.,
E. Cleveland, Ohio.

Dear Sirs:
Am Greatly surprised at the performance of your
Ham Special Coupler, it certainly surpassed all my
expectations. I hv hrd more Ham DX Stations in 3
nites than I did in 2 years with my old set. It
certainly is the cat's meow for DX stuff.
Thanks vry much for sending me that circular abt
the Coupler that put the idea into my head that I
wanted one for it certainly increases the efficiency
of a fellow's station 100%.

Very Sincerely,
R. H. Wright, 7PP.
310 Ross Street, Portland, Oregon.

40 METERS

A ten turn coil placed in shunt to secondary coil
tunes as low as forty meters; see August Q. S. T.
1924 page forty three for detail.



**America's
Best Phones**

Regardless of Price
\$5

In Canada \$7

Distributed by
Otto Higel Co. Ltd.

On:
Modell

One
Quality!

Toronto, Canada

WE challenge comparison with America's best
known headphones. Globe Phones always
show up best where the opposition is greatest.
And the quality is there to last for years.
There is long experience in making hearing aids
for the deaf behind the amazing tone purity and
reaching qualities of Globe Phones.

As beautiful as they are efficient. Leather
covered head bands, heavily nicked parts, extra
powerful magnets.

If your dealer fails you, write us.

Sales Department
THE ZINKE COMPANY,
1323 S. Michigan Ave., Chicago

Manufactured by

GLOBE PHONE MFG. COMPANY

Reading

Massachusetts

from Coast to Coast
from Gulf to Hudson Bay

BRACH
vacuum arresters
have protected
principal Railway Signal
Systems, Police and
Fire Circuits, and
RADIO
for 18 years

Approved by National Board
Fire Underwriters
No. 3985

SAFETY
demands the
BRACH
vacuum radio arrester

L. S. BRACH-MFG. CO. NEWARK, N. J.

Copper-Brass & Fibre in Sheets, Rods &
Tubes.

Machine Screws, Dies, Taps, and Drills.

ANGIERS, U. S. A.
MONROE STREET PLANT
STREATOR, ILLINOIS.

The

GAROD

PYREX GLASS Low Loss Tube-Socket

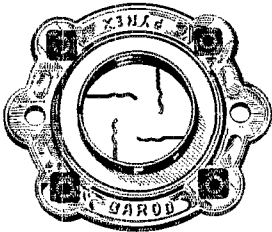

Top View

REPLACE your present sockets with Garod "Pyrex" sockets — or — if you intend building a set — be sure to get Garod "Pyrex". They are solely controlled by the Garod Corporation.

If your dealer cannot supply you — send us \$1.50, plus the parcel postage for each socket wanted.

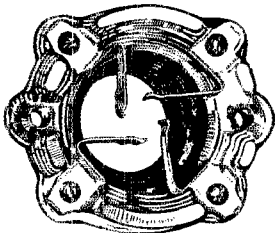

Bottom View

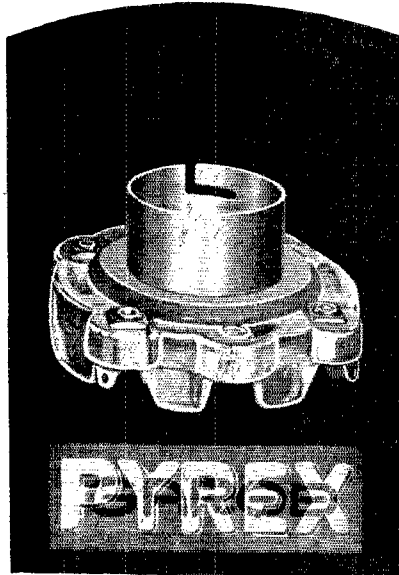

The "Perfect Socket" to complete the Perfect Set!
\$1.50

GAROD Engineers, after intensive research, announce the perfection of the ideal tube-socket. In Pyrex glass they have adapted to use in radio frequency circuits the finest insulating material commercially obtainable, and have placed it in one of the weak spots of the radio circuit: the V. T. socket.

Tests made by the U. S. Bureau of Standards, and the Naval Testing Laboratories, prove "Pyrex" to be the lowest loss insulating material for R. F. C. yet presented, with the exception of quartz. It is strong and heat resisting, and does not absorb moisture. Even the heat of the soldering iron does not affect it. It is entirely free from surface film condensation, and is unaffected by those influences which commonly make rubber, rubber derivatives and compounds, porcelain, phenol products and the ordinary vitreous products so inefficient.

Exclusively a Garod Product

The Powerful **GAROD** Neutrodyne* Receiver

The GAROD Corp.
120 Pacific St. Newark, N. J.

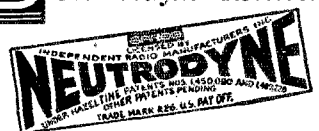

FRESHMAN

*Noiseless Tested
Mica Condensers*

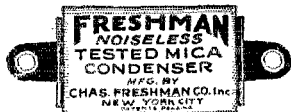

maintain their fixed capacity due to scientific design and construction in which constant equal pressure is exerted on the condenser plates over the entire area; making the Freshman condensers the only ones that avoid noises due to variable pressure on the plates. A metal casing protects the plates and reduces hysteresis losses to a minimum.

Capacity	Each	Capacity	Each
.00005\$0.35	.0025\$0.50
.000135	.00350
.0001535	.003570
.000235	.00475
.0002535	.00575
.000335	.00675
.0003535	.00751.00
.000535	.0081.00
.000640	.0091.00
.000840	.011.00
.00140	.0151.50
.001540	.022.00
.00240	.0252.50

Exclusive Features of Freshman Noiseless Tested Mica Condensers

1. No losses through di-electric hysteresis of fibre covers.
2. No insulating binder to melt at the application of heat and by releasing pressure, change the capacity.
3. Capacity fixed and invariable.
4. Metal case protects against accidental injury.
5. Direct connection to copper plates avoids losses through inefficient eyelet contact.
6. Application of soldering iron does not affect condenser.

At your dealers—otherwise send purchase price and you will be supplied postpaid.

Chas. Freshman Co. Inc.
Radio Condenser Products

106 Seventh Ave., New York

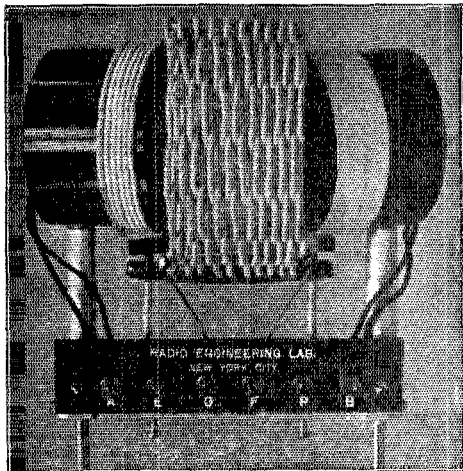

LOW LOSS TUNER UNIT

MOST EFFICIENT TUNER AVAILABLE
REAL DX RECEPTION
EXTREMELY SHARP TUNING TWO TYPES
AMATEUR—45 to 225 METERS WITH TAP
BROADCAST—250 to 550 METERS
Special Types may be furnished for the Very Short Waves

Price \$10 each Write for information

A. C. LOPEZ & CO.

Sole Distributors

334 FIFTH AVENUE, NEW YORK CITY



Telegraph and Radio Instruments

Open circuit Keys are recommended when it is desired to have two way communication between points without the use of closed circuit batteries.

Other types carried in stock.

No. 9037 Legless Key Polished Brass Body ... \$6.00

No. 9035 Leg Key Polished Brass Body 5.00

Send stamps for Telegraph Manual 43-Q

Special Price to Dealers.

J. H. BUNNELL & CO. 32 Park Place, N. Y.

**DEALERS WRITE
FOR QUICK SELLING**

**KITS
RADIO PARTS**

WHOLESALE ONLY

HAROLD M. SCHWAB, INC.

55 VESEY ST., DEPT. STN
NEW YORK CITY, N. Y.

At Last! Radio That Satisfies The Music Critic



THE CHICAGO DAILY NEWS
EDITORIAL ROOMS
August 6, 1924.

My dear Mr. Rauland:
I want to express my great pleasure in witnessing the recent test of amplifying transformers in your laboratory, and in selecting, from different instruments tested, the one which seemed to me to reproduce most exactly the artist's original tones. I was indeed gratified to learn, after the tests, that the instrument which I had repeatedly selected as by far the most successful in reproducing, not alone the melody, but even the very personality of the artist, was none other than your own new "Rauland-Lyric" Transformer.

I feel confident that music lovers everywhere will appreciate the contribution you have made to their enjoyment in the creation of this reproducing instrument.

Very truly yours,
Maurice Rosenfeld
Music Critic,
Chicago Daily News



Price, \$9.00

In placing his mark of approval upon Rauland-Lyric, Mr. Maurice Rosenfeld has invested Radio with a new beauty and dignity. His words carry positive assurance, to music-lovers and trained musicians, that they can now admit Radio to their field of appreciation and enjoyment, with the certainty that all voices and instruments will be reproduced with their original and distinctive Tone Quality.

Mr. Rosenfeld, a veteran among metropolitan music critics, selected Rauland-Lyric, upon the sole basis of Tone

The RADIO KEY BOOK contains the clearest explanation ever given of the nature of audio amplification and equally valuable discussion of many other subjects in Radio. Sent for 10 cents, coin or stamps.

Quality, from a group of the world's best audio transformers.

Karleton Hackett, famous critic of the Chicago Evening Post, pronounced Rauland-Lyric a "distinct advance in the musical quality of radio reproduction."

You can have, in your home, the amplifying instrument which has been commended by eminent critics.

Rauland-Lyric can be installed in your present set, or one that you may buy, to replace any ordinary audio transformer.

Ask your dealer.
RAULAND MANUFACTURING COMPANY
Pioneers in the Industry
2642 Coyne St. Chicago, Ill.



Standard Audio Frequency Transformers
"All-American for Reliability"
Ratio 3 to 2 . . . R-12, \$4.50 Ratio 5 to 1 . . . R-21, \$4.75
Ratio 10 to 1 . . . R-13, \$4.75
Built by precision methods in a modern plant. All-American Standard Audios meet the demand of the public for a dependable, high-quality transformer at a price made possible only by enormous production.

Long Wave Transformer
For highest amplification of intermediate frequencies and perfect reproduction of side bands, 4,000 to 30,000 meters (75 to 15 kilocycles) R-116, \$6.00

Power Transformers
For Tone Quality in a Third Stage, or for Loud Volume with Clearness.
Input type . . . R-30, \$6.00 Output type . . . R-31, \$6.00

Self-Tuned Radio Frequency Transformers
"Wound to Suit the Tube!"
Effectively amplifying all frequencies within the broadcast range. For "190" Tubes R-109, \$5.00
For "01A" Tubes R-101A, \$5.00

10,000 Meter Transformer
(Filter or Input). It gives superior results in beat reception, filtering out a 30 kilocycle frequency with high selectivity and no side-band distortion R-120, \$6.00

Radio Frequency Coupler
(Oscillator Coupler). A uniform output at 150 to 450 meters R-130, \$5.00

Universal Coupler
Sets a new standard of efficiency as an antenna coupler. As a radio frequency transformer in tuned stages it is unsurpassed R-140, \$4.00



Largest Selling Transformers in the World

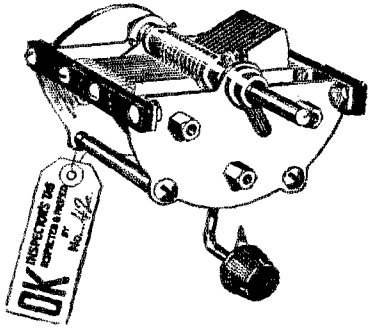

Information Wanted about the **CONTINENTAL** **Lo Loss** **CONDENSER**

We are much interested in the many reports of distance and efficiency that come to our office regularly from enthusiastic users of Continental Lo Loss Condensers.

POZ—GERMANY

is the record of a U. S. Radio Official in Baltimore who hears that station regularly on 75 meters. Others tell of wonderful reception on both long and short wave lengths with every possible kind of hook-ups. Have you got the POZ record beat? Write us.

Continental Lo Loss Condensers are made in the following sizes:
All capacities are exact.

13 plate	Cap. .00025	\$5.50
15 "	" .00035	5.75
25 "	" .0005	6.00
45 "	" .001	7.00

Prices without Vernier are \$1.00 less.

At your dealer's or write us direct.

GARDINER & HEPBURN, Inc.

Sales Dept.: 611 Widener Bldg.

PHILADELPHIA

Factory: 2100 Washington Ave.

'SHEPCO' ALL WAVE Jr.
Non-Radiating DX COUPLER
TRADE MARK PATENTS GRANTED & PENDING

**nabs those elusive
stations and holds 'em!**

Wavelengths from 150 to 1000 meters in single circuits; 150 to 700 meters in triple circuits,—the bankwound and tapped primary and tapped secondary do the trick.

Six efficient hook-ups with each coupler or sent for 10 cents to cover mailing.

At all dealers or sent prepaid on receipt of price.

\$6

Made and fully guaranteed by

SHEPARD-POTTER CO., Inc.

Dept. Q, 35 South River St., Plattsburgh, N. Y.

110

Price
\$8.50

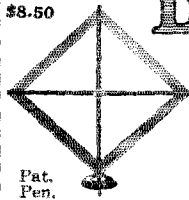

Duo-Spiral Folding Loop

Pat.
Pen.

Famous for its great convenience, handsome appearance and superior performance. Standard loop for super-heterodyne. Has concealed hinge. Rotates on base. Has dial graduated for calibration. Handle permits adjustment without body capacity effects. Fine silver and mahogany finish. We also manufacture **TINY-TURN** the superior vernier control. Write direct, if your dealer cannot supply you.

RADIO UNITS, Inc.

1304 FIRST AVE.,

MAYWOOD, ILL.

PERKINS ELECTRIC, Ltd., MONTREAL

RADIO TUBE EXCHANGE

We Repair All Standard Makes of
Tubes, Including

W.D. 11 or 12
U.V. 199 or C299
U.V. 201A or C301A
C. 11 or 12
D.V. 1 or D.V. 2
U.V. 200 or 201

\$2.00



C 300 or 301 U. V. 202 Repaired. \$3.00.
All tubes guaranteed to do the work.

RADIO TUBE EXCHANGE, 200 Broadway, New York
All Mail Orders Given Prompt Attention
Orders Sent Parcel Post C. O. D.

ALWAYS MENTION QST WHEN WRITING TO ADVERTISERS

A FRANK STATEMENT and Explanation to the Radio Public

From C. H. Thordarson, President
Thordarson Electric Manufacturing Co.

Heretofore, Thordarson Super Transformers have been mainly obtainable only by the manufacturers of quality radio sets. Fans, the world over, have of course noted the use of our transformers in a preponderance of leading makes of receivers.

Quite rightly they concluded that Thordarson Transformers must be decidedly superior. And so they sought to buy the same transformers for replacing unsatisfactory types and for use in home-built sets.

Despite the fact that we lead the field in number of transformers produced, dealers were unable many times to supply Thordarsons to these customers. This led to some feeling that we might be purposely restraining the general sale of our product.

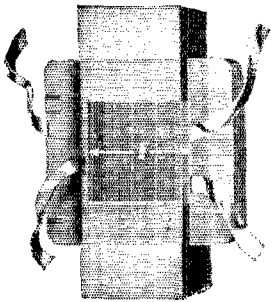

The Exclusive
**Thordarson Square Coil
Leak-Proof Construction**

The Thordarson-made layer-wound SQUARE coil fits snugly around the square core. Coil can't turn--no open circuits due to layers slipping. No air spaces between coil and core (exclusive Thordarson feature!)--no lost energy, no lost volume (especially on low notes), no leaks from primary to cause howls in set. (Thordarsons are quiet, even on the third stage!) Over-size core ($\frac{3}{8}$ " cross section) provides 50% larger magnetic circuit--minimizes core losses, prevents over-saturation. Broad ribbon leads locked in the coil give short, direct and more durable connections to the patented inner-locked terminal posts--no tangled or broken wires inside case (exclusive!). Each Thordarson transformer comes completely protected, shielded and tightly clamped in a stout case. No rivets or screws through the special silicon steel core to cause short circuits or eddy current losses (exclusive!). Do you wonder that Thordarson leads the field in output and produces more transformers for more makers of quality sets than all competitors combined?

Thordarsons, took nearly all we could turn out even though our production was continually multiplied. Not until last summer were we able finally to increase the capacity of our immense six-story factory sufficiently to provide for supplying the needs of the general public in addition to the larger wants of more and more set builders.

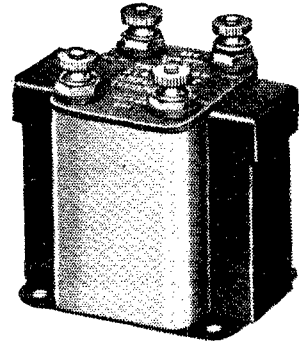

From now on, however, you should experience little if any difficulty in being able to buy Thordarson transformers. My aim is to build enough Thordarson transformers this season to permit every store to handle them.

Thordarson "Super" Audio Frequency Transformers enjoy wider use because of the even volume and freedom from distortion with which they amplify over the entire musical scale and thereby make a good radio set a true musical instrument. Unconditionally guaranteed. Three ratios: 2-1, \$5.00, 3 $\frac{1}{2}$ -1, \$4.00, 6-1, \$3.50. Thordarson Power Amplifying Transformers, which equal our audio frequency types in tonal purity, are \$13 the pair. Write for latest bulletins.

The truth is that the tremendous gains in sales enjoyed by the makers who standardize on

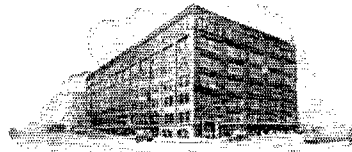

Six Floors
100,000 sq. ft.
Devoted to
Transformers

THORDARSON ELECTRIC MANUFACTURING CO.
Transformer specialists since 1895
WORLD'S OLDEST AND LARGEST EXCLUSIVE TRANSFORMER MAKERS
Chicago, U.S.A.

THORDARSON
Super
AMPLIFYING TRANSFORMERS
Standard on the majority of quality sets

Fleron RADIO SPECIALTIES

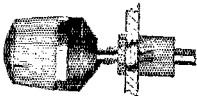

VERNIER ADJUSTER

The best adjuster on the market. Spring holds head away from dial when not in use. With slight adjustment spring can be made to hold head against dial if desired. Patented. 65c.

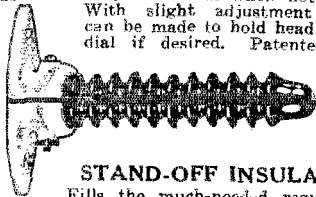

STAND-OFF INSULATOR

Fills the much-needed requirement for a strong, good-looking and practical stand off insulator. Meets every requirement of the Board of Fire Underwriters. \$1.25 ea.

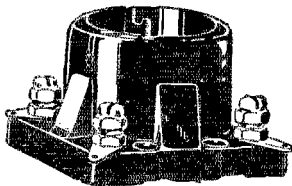

PORCELAIN SOCKETS

Lowest losses of any socket. Very carefully made. Black Body, Black Glaze, Side and bottom contact springs of reinforced phosphor Bronze, Solder Tabs. Cap Nut for screw driver or Spintite Wrench. All parts nickel plated. 65c each.

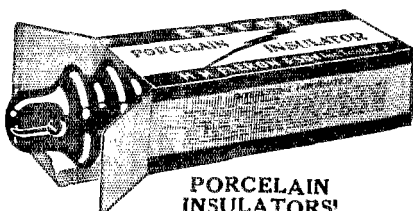

PORCELAIN INSULATORS!

Lowest power losses in the antenna Dielectric absorption reduced to minimum because of very low phase difference of Fleron Porcelain. Very tough body. Solid Black Glaze. Seven sizes. 20c to \$1.00. Each insulator in a separate carton.

For Sale by all Good Jobbers and Dealers

M.M. FLERON & SON, Inc.
TRENTON, N. J.

TURN-IT

ADJUSTABLE
GRID LEAK

Changes the Range of Resistance to Suit the strength of Reception

Constructed along entirely new lines which avoid all use of graphite or carbon and the microphonic noises generally attending the use of these materials. Turn-it greatly increases the volume, secures greater distance and reduces noises in your set. A Turn-it gives constant and undiminished satisfaction. There is nothing to wear out. Absolutely guaranteed.

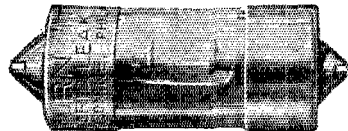

Turn-It Grid Leak Is Only \$1
At Your Dealer or
Direct from Us.

TURN-IT RADIO SALES, Inc.
30 Church Street, N. Y.

Make \$100 Weekly—sell RADIO

Demonstrate once—results mean sure sale. Coast to Coast, lowest prices, attractive four tube instrument \$39.50. Big commission to you. Exclusive territory to proven salesman. Territory going fast. Write today for large illustrated book No. 100. Don't fail to give name of your county.

OZARKA, INC.
821 Washington Blvd., Chicago, Ill.

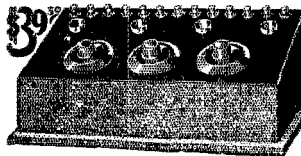

A One-Control Neutrodyne

By James L. McLaughlin

The author of the "One-control Superheterodyne" in this issue of QST has also designed and built a very successful three-stage Neutrodyne having but one control. It was illustrated and described in detail in QST for August, 1924. A three-stage Neutrodyne ordinarily would have four controls and be almost impossible to handle, but by a very ingenious mechanical arrangement Mr. McLaughlin makes it easier than the ordinary Neutrodyne. And a controllable three-stage Neut compares with a Superheterodyne in performance!

Read about this remarkable set in the August QST. Our Circulation Department still has some copies left. Twenty cents, postpaid.

Q S T, 1045 Main St., Hartford, Conn.

Results Alone Are Responsible!

The announcement of the Bremer-Tully "Lifetime" Condenser and Low Loss Tuners brought such an avalanche of business that when this ad is written unfilled orders exceed our entire shipments for the last four months of 1923.

Such record is possible only through **Confidence** — founded alone on past results.

B-T have never put out a product that was not a success. The Low-Loss Condenser is fully worthy of the B-T name, as its use will demonstrate.

Consider the "Lifetime" adjustable, two-step, lubricated, thrust bearing.

Friction is adjustable without variation in capacity, "take-up" for wear makes no change in plate alignment.

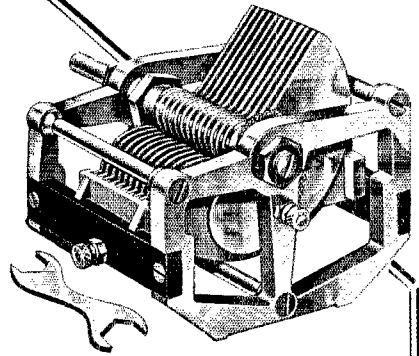

"Lifetime" Condenser

150 M.M.F. 7 plates	\$4.25
250 M.M.F. 11 plates	4.50
520 M.M.F. 23 plates	5.00
800 M.M.F. 35 plates	6.50

"20 Point" folder gives you fuller details.

Write for it

Rotor and Stator assembly die-cast by special exclusive B-T method to within one-thousandth of an inch.

No springs to weaken—no gears to lash or wheels, bevels or counterweights to defeat the purpose for which the low-loss efficiency product is intended.

Compact and rigid construction. Positive connection to rotor. Single hole mounting—with optional screw holes provided. Takes any dial of reasonably correct design.

For this condenser the B-T Low-Loss Tuner is a fit companion. Examine the untuned adjustable primary, the "series-bank" wound coils, the skeleton frame, adjustable double cone bearing—a design which with an 11-plate 250 m.m.f. B-T Condenser covers 200 to 565 meters. Type SW—50 to 150 meters. The price of either model is \$5.00.

Place your order at once so as to insure early delivery.

We shall be glad to send folders giving more details. Write us.

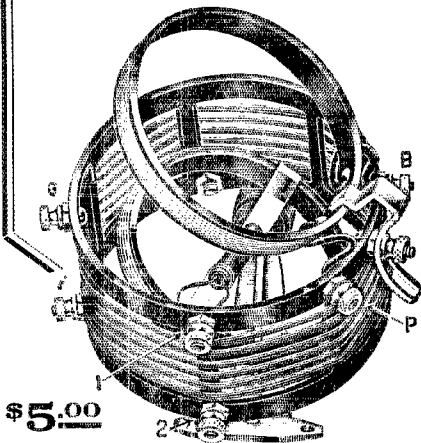

\$5.00

The New
Low Loss Tuner

Two Types Short
Wave 50 to 150
meters Broad-
casting 200 to
565 meters.

Bremer-Tully Mfg. Co.

Pioneers of Better Tuning

531 S. Canal St.

Chicago

TOWER'S

TOWER'S Scientific
 WEIGHS ONLY 8 OZ
 Perfect Tone Mates
\$2.95
 plus a few cents postage



Buy a Headset you'll be proud of



OUR \$200,000.00 COMPANY STANDS SQUARELY BACK OF EVERY HEADSET

WORLD'S GREATEST HEADSET VALUE

now \$2.95, with Notable Improvements
 Longer Cord (full 5 feet), Stronger Magnets, Higher Resistance, Increase of Sensitivity, Perfect Tone Mates
EVERY SET TESTED BY LICENSED RADIO OPERATORS

Send no money - Order on a Post-Card

THE TOWER MFG. CO. : 98 G BROOKLINE AVENUE, BOSTON, MASS.

Scientific

SUPERADIO LOW LOSS KIT



SPEND THE WINTER in New York or California and stop off anywhere between.

"BUY RADIO" for \$38.50

YOU AMATEURS

Know the value of the "The Radio Engineering Laboratory" Low Loss Tuner. "Heath" Radiant condenser. "Superadio Units". Get real DX with the Superadio Low Loss Kit, comes complete in every detail, even the panel and cabinet is included.

NEVER BEFORE

Such Selectivity—Such Volume
 The American Radio Sales Co. Not Inc.
 620-621 Monadnock Bldg., Chicago, Ill.
 Mail Orders Only.

Lowest Minimum Capacity



Greatest Tuning Range Ratio of 1 to .74
 Twelve other features in Premier Crofoot. Electrically and mechanically a real job of engineering. Record low phase angle loss. Made of brass and hard rubber throughout. \$2.75 to \$3.75. Vornier attachment, dial included. 75 cents extra. Send for free Bulletin No. 94 giving all exclusive features and showing full Premier line.

"CROFOOT" PREMIER ELECTRIC COMPANY
Vario Condenser 3811 Ravenswood Avenue CHICAGO
 "with the red stripe" **Quality Radio Parts**

Bakelite Sheets

Fine for Transmitting Panels
 30 x 38 inches, 1/4" thick

Regular Price, \$29.00 per Sheet
Our Price, \$12.50 per Sheet

Standard Transmitting equipment
 Send for our complete bargain price list of

AMERICAN SALES AGENCY
 38 Park Row New York City

It's More Than a Transformer

It's a

Precise

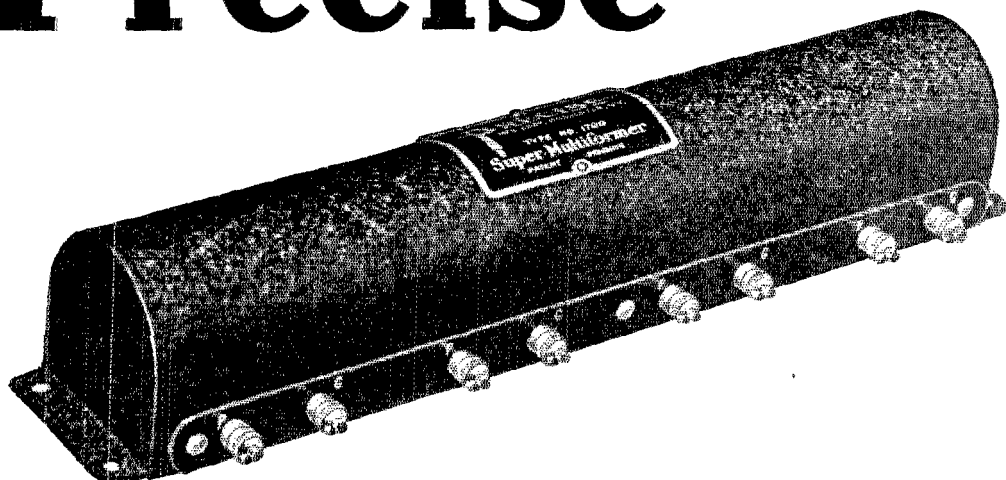

Precise Super-Multiformer

No. 1700 List Price \$20

Designed for perfect long wave and Super-Heterodyne reception. Simplicity of design, maximum amplification, perfect reproduction, and greatest of all, *stability of performance.*

JUST as the one control Neutrodyne was an achievement surpassing commercial practice.

AND the one control Super-heterodyne is a still greater advancement.

SO the **PRECISE Super-Multiformer**, the heart of the one control Super-Heterodyne is the crowning achievement of **J. L. McLaughlin**, our Research Engineer, designer of the three paramount accomplishments in the radio art.

For details communicate at once, direct or to the nearest Sales Office

PRECISE MANUFACTURING CORPORATION
ROCHESTER, NEW YORK

Eastern Sales Office
Niagara Sales Corporation
3-5 Waverly Place, New York, N. Y.

Branches
53 W. Jackson Blvd.
Chicago, Illinois.
821 Market Street
San Francisco, Cal.

Southern Sales Office
Saal Products Sales, Incorporated
Bona Allen Bldg., Atlanta, Ga.
35 Warren St., New York, N. Y.

Canadian Distributor Perkins Electric Limited, Toronto, Montreal, Winnipeg

TRADE MARK
NONE OTHER

DUPLEX

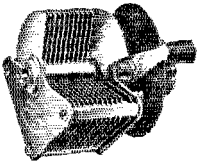

"DR" Series

A low loss precision condenser of High value and unusually low price. Ideal for set builders who can't pay very much for each individual part.

"FR" Series

The highest quality low loss condenser made. Used by foremost set manufacturers. Condenser tests at Yale University in May, 1924, definitely determine its remarkable efficiency.

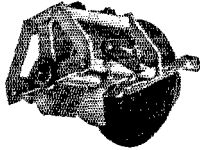

"RK-1"

Supplementary Kit

Necessary for builders of Super-Heterodyne, Ultradyne, and other long wave work. Contains essentials for building to best advantage. You need it.

Write for "Cores and Facts." It's both interesting and free.



The Duplex Engine Corporation, Inc.
32 Flatbush Ave. Extension Brooklyn, N. Y.

In She Comes!

TIP your whisker to almost any point of an NAA Meter tested crystal and the full flow of the impulse instantly hits your phones, clean, clear, steady.

Reason—no guesswork in the test;—every, EVERY crystal meter-tested singly by specially made electrical instruments to a point away beyond normal sensitivity. In addition, the Newman-Stern mounting is new—patents pending—cold assembly, provides for refilling, and avoids damage to crystal by hot alloy; recessed for protection.

Perfect for Reflex

At all good jobbers and dealers, in neat turned wood box, etc. If dealer can't supply, order direct and send dealer's name.

The Newman-Stern Co.

1746 East 12th Street
Cleveland, Ohio

Originators of
tested crystals in 1914.
Oldest and Largest
Producers.
Pioneers in Radio
Equipment in Ohio



PAT. PEND.

New NAA Meter Tested Crystals

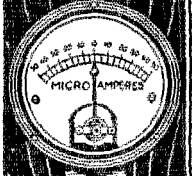

Nuggets of Sensitive-ness



FROST-RADIO

Ask Your Neighbor



THE name **FROST-RADIO** on a piece of apparatus, whether **FROST-FONES**, Plugs, Jacks, Sockets, Rheostats, etc., means highest quality. Your dealer carries complete stocks. See him today.

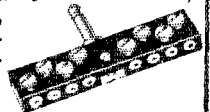

HERBERT H. FROST, Inc., 154 W. Lake Street, Chicago

BRANSTON RADIO

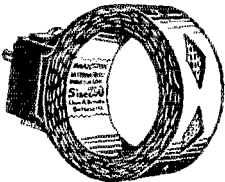

Honeycomb Coils AND MOUNTINGS

Wave Lengths 150 to 21,000 Meters

Send 2c stamp for New Honeycomb Coil Hookups. Compiled by experts and includes five good Honeycomb Coil Hookups and complete catalog of Branston Radio Apparatus. Give us your dealer's name.

CHAS. A. BRANSTON, Inc., 823 Main St., Buffalo, N. Y.
In Canada, Chas. A. Branston, Ltd., Toronto

REPLACE YOUR B BATTERIES with a Kellogg Trans-B-former. Furnishes necessary plate voltages from your 110 A C 60 cycle socket at an enormous saving.

Price \$50.00 At your dealers.

Kellogg Switchboard & Supply Co.

1066 W. Adams St.

Chicago, Ill.



"WARRANTED" RHEOSTATS

6 ohm and 30 ohm
For any type vacuum tubes, 50c. Ten days money back guarantee.

Dealers write

C. C. ENDLY, 22 Sturges Ave.
Mansfield, Ohio

PYREX
AND
ISOLANTITE
INSULATED
VARIABLE CONDENSERS

*Of Rugged Mechanical Construction
Of The Highest Electrical Efficiency
Of Absolute Uniformity
Of Constant Capacity
Suitable for Wave Meters, Decremeters, Wave Filters and Bridge
Measurement Work.
Surely the best for your Radio Receiver.*

For sale at good radio shops at reasonable prices consistent with quality

GENERAL INSTRUMENT CORPORATION
Manufacturers of Laboratory Equipment

423 Broome Street New York

What makes

The biggest little thing in Radio

DURHAM Metallic Grid Leaks — Noiseless?

Fixed or Variable

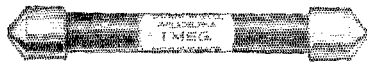

28 Sizes

There's a DURHAM Metallic for every high resistance need. Each marked with guaranteed, tested value.

Prices

Fixed, over 1/4 meg.	• • •	50c
Fixed, under 1/4 meg.	• • •	75c
Variable, to 0.1 meg.	• • •	75c
Variable, 0.1 to 5 megs.	• • •	75c
Variable, 2 to 10 megs.	• • •	75c
Mounts, single leak	• • •	30c
Cond. and leak	• • •	35c
Double, for resis. coupled ampli.	• • •	40c

CIRCUIT noises are caused by uncontrolled resistance changes—unavoidable in the old style leaks. Carbon, graphite, india ink, pencil marks—all vary greatly with temperature and atmospheric changes. Metals alone remain constant.

DURHAM Variable Metallic Grid Leaks—in 3 ranges—have a permanent range of the values marked. Continuous variation is by smooth sliding plunger. For any particular setting, operation is as noiseless as the DURHAM fixed type.

DURHAM Fixed Metallic Grid Leaks are the only truly noiseless. A rare metal deposited on glass has its resistance value fixed for all time. Noise is impossible.

DURHAM Metallic Grid Leaks will fit your present holders. But for new sets, the new DURHAM bases are more convenient—plain, condenser clip, or double for resistance amplifiers.

All about Resistance Amplifiers — 25c

Build a distortionless amplifier. Parts for two stages cost less than one good transformer. Complete detailed instruction booklet, 25c. As your dealer's or postpaid.

At dealers or postpaid

Dealers:— Customers would rather buy DURHAM products at your store. We have a display that helps.

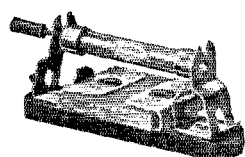

Canadian Distributors De Forrest Radio Corp., Ltd., Toronto

Satisfaction Guaranteed

DURHAM & CO., Inc.
1930 Market St., Philadelphia,

Send NO Money

We trust all amateurs. Call cards: red call, name and address, black printing, high quality, latest design. Radiograms: bond paper, attractive printing. Stationery: letterheads, 8 1/2 x 11 1/2 good quality bond, envelopes 6 1/2 inches, made especially for amateurs. Logs: Columns for call, time, W.K.D. - H.R.D. - Q.S.A. - Q.S.B. - Q.R.H. - Q.T.C. Remarks. ARRL EMBLEM ADDED WHEREVER REQUESTED. Order NOW.



YOUR OWN Name, Address and Station Printed FREE

on any of these. Cards: 100 - \$1.75; 200 - \$2.85; 300 - \$3.50. (Gov. cards 1c each extra). Radiograms: 100 - \$1.35; 200 - \$1.85; 300 - \$2.35. Stationery: 100 env. and 100 letterheads only \$2.25; 200 each \$3.25; 300 each \$4.25. Logs: 100 - \$1.45; 200 - \$2.10; 300 - \$2.75. Don't send one cent. Pay postman when printing service. If you prefer to send check with order we prepay postage. MONEY REFUNDED IF NOT DELIGHTED. Send order today - NOW. A postal will do.

RADIO-PRINTERS, 18 Main St., Mendota, Illinois

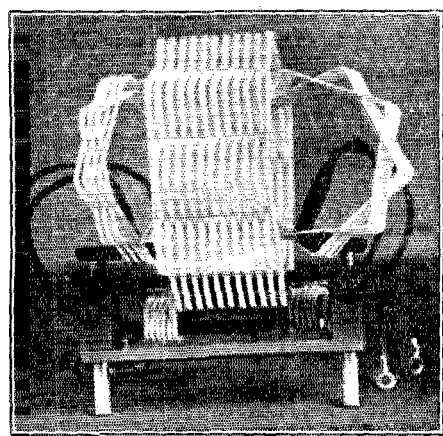

LOW LOSS TUNERS

Amateur 70 to 225 meters \$10.00. Grid coil wound with No. 12 wire. No taps. Broadcast 180-600 meters \$10.00. Broadcast tuner supplied with either fixed, or variable antenna coupling. (No. 16 wire) Tuned R. F. transformers 200-600 meters \$3.00. We pay parcel post and insurance in U. S. (Tuners 4 inches between shafts.)
Davenport Radio Laboratories,
520 Clark St., Davenport, Ia.

OHIO BRASS CO.
ANTENNA INSULATORS
Distributed by
H. M. UMBARGER
65 N. Diamond St., Mansfield, Ohio

HAM-ADS

Six cents per word per insertion in advance. Name and address must be counted. Each initial counts as one word. Copy must be received by the 1st of month for succeeding month's issue. **NOTE NEW CLOSING DATE.**

WHY BUY A NEW SET WHEN AN EDISON B (THE SML KIND) WILL DO JUST THAT FOR YOUR OLD ONE? SURE DOES PUT A SHOVE IN THOSE SIGS. (GET ONE OF THESE: 54 VOLT 42 CELL \$3.75 (A TEAM MATE FOR THAT LOW LOSS TUNER). 100 VOLTS 78 CELLS \$18.00 (MOST POPULAR SIZE). 130 VOLTS 102 CELLS \$30.00. 150 VOLTS 117 CELLS \$23.00; EACH IN A WAX FINISHED FUMED OAK COVERED CABINET WITH RIBBED RUBBER MAT. LARGEST LIVE EDISON ELEMENTS WIRED WITH PURE SOLID (NOT PLATED OR ALLOY) NICKEL WIRE. GENUINE EDISON LITHIUM ELECTROLYTE. (THAT'S NO LYE.) NON-FLOATING PERFORATED HARD RUBBER SEPARATORS. WHITE SEALING OIL. NOT JUST THROWN IN A BOX. BUT CAREFULLY PACKED FOR SAFE SHIPMENT. INDIVIDUAL CELLS 16c. BUILD IT FROM 8ML PARTS. LARGEST CLEAN PEPPY TYPE A EDISON ELEMENTS 6c PAIR, 7c DRILLED, WIRED WITH PURE SOFT NICKEL 10c PAIR. DOUBLE 2000 MILIAMP HOUR UNIT READY TO WIRE 14c. EDISON G ELEMENTS 4c PAIR. 2 POSITIVE 1 NEGATIVE 5c. HICAPACITY 1500 MILIAMP HOUR UNIT READY TO WIRE 10c. PARTS FOR CELL 19c. WITH ELEMENTS DRILLED AND CUT IN UNITS 19c. WITH CELLS WIRED 24c. INCLUDING GENUINE EDISON SOLUTION. GREAT FOR SUPERS, POWER AMPLIFIERS, TRANSMITTERS, THE SUPERCELL—FOR THAT SUPERHET & HIPOWER TRANSMITTERS—3000 MILIAMP HOURS CAPACITY, 30c CELL FOR PARTS READY TO WIRE, WITH SOLUTION 40c WIRED. YOUR B WON'T WORK UNLESS YOU GIVE IT A SQUARE MEAL. FEED IT WITH A WILLARD COLLOID RECTIFIER. \$2.00. JUMBO SIZE \$3. HIVOLTAGE TUNGAR INSTRUCTION SHEET 50c; ANNEALED GLASS TEST TUBES INDIVIDUALLY WRAPPED, 3/4" x 6" 3c, 1" x 6" 4c. FOR A PERMANENT JOB WIRE YOUR EDISON ELEMENTS WITH PURE SOFT SOLID (NOT PLATED OR ALLOY) NO. 20 NICKEL WIRE 1 1/4c FT. PREPAID. PERFORATED HARD RUBBER SEPARATORS 1/2c PREPAID. HAS YOUR EDISON B LOST ITS EDGE? WHIET IT WITH GENUINE EDISON LITHIUM ELECTROLYTE. THAT'S NO LYE. \$1.50 PREPAID MAKES 5 LBS. LIQUID. EVERYTHING FOR THAT EDISON B. FRANK MURPHY, 4837 ROCKWOOD, CLEVELAND, OHIO. DIRECT TELEGRAPH CONNECTIONS.

JUST LIKE THE GOOD OLD DAYS! NO QRX ON 30. BUT YOU NEED A LOWLOSS ABRIAL TO MAKE THE MOST OF THESE LOW WAVES. STRANDED WIRE WON'T DO, AND BARE COPPER BECOMES A GRAPHITE ROD. NO. 12 SOLID COPPER ENAMELED STAYS NEW PERMANENTLY. 1c FOOT PREPAID IN 3rd ZONE. ONE PIECE, BURLAP WRAPPED. MOULDED MUD WILL MELT AT HIFREQUENCIES. TAKES OHIO BRASS CO. PORCELAINS TO HOLD 'EM. 5" 75c, 10" \$1.50 FOR THE HIPOWER SETS. PREPAID TO 3rd ZONE. FLUX DISTRIBUTING SHIELDS ATTACHED \$1.00. ELIMINATE ALL CORONA. PUT YOUR \$\$\$ UP HIGH WHERE THEY DO THE MOST GOOD. THIN SILICON STEEL PUNCHINGS FOR THAT TRANSFORMER AND CHOKE 20c LB., 2 1/4" x 10". FOR THAT LOW LOSS TUNER NO. 12 PURE COPPER DOUBLE COTTON COVERED FOR LOW DISTRIBUTED CAPACITY 100 FT. \$1.25 PREPAID. NO. 16 60c. RADIO 8ML, 4837 ROCKWOOD RD., CLEVELAND, O.

GET THIS, GANG! WET PROCESS PORCELAINS. BROWN GLAZED X INSULATORS. WHERE YOU NEED A RAFT OF 'EM IN THAT COUNTERPOISE. 5" LENGTH 25c IN LOTS OF 10, 75c PAIR. 9" \$1.00 PAIR. 40c EACH IN LOTS OF 10, 13" \$2.00 PAIR. 90c EACH IN LOTS OF 10, 20" \$1.50. GUY WIRE PORCELAINS 2c. LOTS OF 25. RADIO 8ML, 4837 ROCKWOOD RD., CLEVELAND, O.

HIP, HIP, HOORAY—PERMISSION TO USE THE REAL LOW WAVE LENGTHS IS URS FOR THE ASKING. GOTTA USE A REAL CONDENSER THO, BROTHER. THE MUD END-PLATE TYPE JUST WON'T PRODUCE. GOTTA HAVE SOME GOOD TYPE OF INDUCTANCE, TOO, AND HERE'S THE LOW-DOWN ON THE DOWN LOW PARTS. CARDWELL .00025 ORIGINAL LO-LOSS, \$4.25; CARDWELL .0005 ORIGINAL LO-LOSS, \$5.00; GENERAL RADIO GEARED TYPE .00025 \$4.75; CARDWELL RADIO GEARED TYPE .0005 \$5.00; No. 12 DCC MAGNET WIRE per lb. 60c; No. 15 DCC MAGNET WIRE per lb. 65c; No. 18 BELL WIRE 1/2 lb. SPOOLS 35c; UNIVERNIER FOR CARDWELLS, \$1.25. SA OM. HOW ABOUT THAT RECTIFIER? IS SHE IN TIP TOP SHAPE? READY FOR SNAPPY ACTION? IF NOT, BETTER GET SOME OF THE BELOW ITEMS AND BE READY FOR THE FRAY. C. P. SHEET ALUMINUM SQ. FT. 90c; SHEET LEAD SQ. FT. 75c; AMRAD S TUBES, NEW TYPE \$10.00; MOGUL BASES FOR ABOVE 55c. A POST CARD WILL BRING PRICE LIST BY RETURN MAIL, FROM THE ONLY HAM STORE IN THE FIFTH DISTRICT. FT. WORTH RADIO SUPPLY CO., 104 EAST TENTH FT. WORTH, TEXAS.

FOR SALE—The following brand new receiving sets, fully guaranteed, at much below cost prices because our customers are almost entirely BCL's who do not take to amateur receivers: Zenith 1-R Receiver and 2-M Amplifier, \$90.00; Jones No. 508-J detector and 3 step, \$125.00; Kennedy Intermediate with Amplifier, \$100.00. Grebe CR-5 Receiver, \$50.00; Grebe CR-8 Receiver, \$50.00; Grebe CR-12 Receiver \$125.00; Grebe RORN radio frequency amplifier, \$25.00; General Radio Power Amplifier (works off lighting circuit), \$15.00; Federal No. 8 detector and 1 step, \$20.00. The Radio Store, 560 E. Colorado St., Pasadena.

FOR SALE—Eseo 600 watt 1400 volt motor generator set equipped with a 14 volt 2000 watt filament winding motor 110-60 cycle current, cost \$250, sell \$188.00. Panel 200 watt CW transmitter for phone, CW, ICW bargain \$120.00. Western Electric and General Electric 50 watt tubes \$23.00; long wave Navy receiver type CN 240 1000-10000 meters \$75.00. 10/350 volt Westinghouse Signal Corps dynamometers with filters \$20.00; must raise cash, as I am leaving for college. General Electric Army 50 watt tubes same as the UV203 tubes, all new, at \$15. All Grebe and Kennedy receivers at 30% from list, one Western Electric 250 watt tube new \$65.00; one Navy long wave receiver 1000-10000 meters type CN240, perfect condition, \$70.00; No. C.O.D.; remit by cash or M. O. 2AGD.

STORAGE "B" batteries at dry cell prices. Purchase a rechargeable "HAWLEY" storage "B" battery. Non-sulphating or buckling of plates, which means clearer enjoyable reception with unlimited life. Sold in complete knock-down units which requires no former experience to put together. These units contain everything for the actual construction of battery such as large size tested Edison elements, special molded flat bottom glass cells (not ordinary test tubes), punched insulating fibre board for support of cells, pure annealed solid nickel wire Rubber stoppers, perforated hard rubber separators, full strength chemical electrolyte. With all orders there is included free an 8 page illustrated folder showing simple putting together making of charger and charging. Prices of units as above—22 volt \$2.95; 45 volt \$5.75, 90 volt \$8.95; 100 volt \$9.95; 120 volt \$11.60; 135 volt \$12.75; 150 volt \$13.90; 200 volt \$17.50. Special voltage units put up at no increase in price. Complete sample cell, 35c prepaid. Complete non-heating "B" battery charger \$2.75. Extra special 100 volt whitewood cabinet at \$2.75 only. Also "A" batteries at attractive prices. Order direct or write for my literature, 30 days' trial offer and guarantee. Orders ship same day received. No waiting. R. Q. Smith, 31 Washington Ave., Danbury, Conn.

HAVE YOUR BROKEN and burned out Power tubes repaired. 50 watts or over. Send them to us for repair. Charges reasonable. Wm. Baker, 36 W. 20th St., New York City.

WE ARE ADDING to the line constantly. Our acknowledgment and applause cards being used by scores of satisfied amateurs. Get samples free. Wireless Acknowledgment Card Co., 325 Sixth Ave., McKeesport, Pa.

RADIO GENERATORS—500 volt 100 watt \$28.50 Battery Charging Generators \$8.50. High Speed Motors, Motor Generator Sets, all sizes. Motor Specialties Co., Crafton, Penna.

5 A-Q-C PRINTS Q-S-L CARDS. 500 TWO COLOR CARDS \$4.00. ALL CARDS MADE TO ORDER. SAMPLES ALL DISTRICTS 10 CENTS. CURTIS, 1109C EIGHTH AVENUE, FORT WORTH, TEXAS.

KEY AND BUZZER FAILURES have thanked us for License easily obtained. Their reports tell the story, rapid progress quick success—free on request. Method \$2.50. Kills hesitation. Dodge Radio Shortcut, Dept. SC, Mamaroneck, N. Y.

COMPLETE STORY—as to merit cannot be told—is still in the making. Students constantly report more astonishing results from limited study. As told to date free on request. Method \$2.50; kills hesitation. Dodge Radio Shortcut, Dept. SC, Mamaroneck, N. Y.

OLD SCHOOL HAMS—Long anchored at about 15 per have doubled speed in few hours. Their reports tell the story—free on request if mention your call. Method \$2.50. Kills hesitation. Dodge Radio Shortcut, Dept. SC, Mamaroneck, N. Y.

WHAT OTHERS HAVE accomplished—what you may expect to gain—told by qualifying records 150 students now Licensed. Many are ORS A.R.R.L. Some Commercial Ops. Failures by all other methods have succeeded. Old School Hams increased speed; doubled after memorizing Code our way. Qualifying records and detail reports on request. Method \$2.50. Kills hesitation. Dodge Radio Shortcut, Dept. SC, Mamaroneck, N. Y.

REPORTS OF RAPID PROGRESS BY BEGINNER NOW RADIO OPERATOR USS. CLEVELAND YOUNG FOR ASKING. SEE OTHER HAM ADS. DODGE RADIO SHORTKUT, DEPT. SC, MAMARONECK, N. Y.

POWER TUBES repaired, any type or power unconditional, guaranteed. Prices on application. Morsemer Engineering Lab. Research, Grantwood, N. J.

BUILDING EQUIPMENT THAT SATISFIES IS ONE REASON OUR EQUIPMENT IS REPORTED BY F. B. ANOTHER IS OUR "REAL HAM SERVICE". YOU, TOO, O.M., WILL FIND US REAL "HAMS" TO DEAL WITH. OUR SERVICE LINES UP IN SUPER-HETS FOR AMATEURS. BROADCAST DESIGNS IF YOU ENTERTAIN THAT WILL HELP YOU GET N. Z. AND THE AUSSIES. BUILT IN TYPES FROM 6 TO 10 TUBES. PRICED FROM \$65.00 UP. EMPLOYING OUR OWN DESIGN. "AIR FORM" COILS. THESE SUPPLIED FOR ANY TYPE OF COIL. USE NO "DOPE" TO INSULATE. IN THE TRANSMITTING LINE. ANTENNA INDUCTANCES OF SPECIAL DESIGN. DIRECT OR INDUCTIVELY COUPLED. 4 AND 8 COIL INDUCTANCES FOR MEISSNER CIRCUIT, R. F. CHOKES, ETC. SOMETHING NEW TO PUT A KICK INTO THAT C.W. IS OUR OWN DESIGNED CHEMICAL RECTIFIER POWER UNIT COMPLETE WITH CONTROL PANEL. ANY VOLTAGE. ALSO TUBE RECTIFIER UNITS ANY VOLTAGE. TO PUT THAT FONE ACROSS A SPEECH AMPLIFIER WILL BE USEFUL. WE ALSO BUILD ANY TYPE TRANSMITTER OR RECEIVER. WAVEMETERS. WE HAVE AT HAND TRANSMITTERS FROM 10 WATT TO 100 WATT; PRICES ON REQUEST ALL NEW FOR C.W. AND FONE. WHY NOT USE TWO TRANSMITTERS, O.M.? ONE FOR FONE ON THE OLD WAVELENGTH AND ONE FOR C.W. ON THE OTHER. YOU'LL FIND IT'S MIGHTY HANDY WHEN YOU WANT TO CHANGE OVER. WE WILL BUILD YOU A SET AT PRACTICALLY YOUR OWN PRICE. THAT IS ONE REASON FOR OUR GROWING POPULARITY WITH THE GANG. ALL EQUIPMENT BUILT TO ORDER IS BUILT ON THAT BASIS. IF THAT OLD ROCK CRUSHER IS QRX OUR TRADE DEPARTMENT WOULD BE GLAD TO HEAR FROM YOU. "IF IT'S HAM, WE ARE THE HAMS TO GET IT FROM." OUR BUSINESS IS THE AMATEUR LINE. WE INVITE ANY INQUIRIES YOU HAVE TO MAKE. ESTIMATES WILL BE GLADLY GIVEN. QSO. THOS. ENSALL (ENSALL RADIO LAB.), 1208 GRANDVIEW AVE., WARREN, O.

REMLER, GIBLIN and DeForest coils, new mounted only few left as follows—100-150-200-300-400-500-750 turns half list price. Postage extra. Geo. Schulz, Calumet, Mich.

QSL CARDS—Why not give your next order to printers who are HAMS and who know how to print real "Ham Cards"? Samples and prices cheerfully furnished. Numaw and Buzzard, 701 Walnut Ave., Scottdale, Pa. SRJT.

A SECOND DISTRICT CHOICE: "DROSTE FOR DIRECTOR." (Paid adv.)

SALE—Set Victor code records \$2.50. Raymond Ingraham, 406 North 4th St., Clinton, Ia.

BARGAINS—Three U. V. 216 and one 202 \$14.00; 90-210 meter Reinartz with two step and tubes \$45.00; Paragon RA-10 \$25.00; Atwater Kent two step in cabinet \$10. also R. C. transmitting and other receiving parts at low prices. W. C. Haigh, 58 Newfield St., E. Orange, N. J.

\$28—DX 5 watt transmitter. New, complete with tube and high finish mahogany cabinet. Hrd 2000 miles—3BOV.

PURE DC for the plates. GE 12/350 .143 ampere dynamotors with filters \$18.00; Holtzer-Cabot 12/500 .07 ampere \$22.00; GE 21/1500 volt 233 ampere 6000 RPM double 56 segment high voltage commutator. .750 volt tap. Unused \$45.00; adapted for belt drive \$48.00; Can be operated on lower voltage 6V350, 12/750, 16/1050, 18/1200, etc. Crocker-Wheeler 500 cycle self excited and motor generators. Navy Flame Proof key with "blinker light" \$1.50; Postage extra; complete ship 500 cycle spark transmitters. Henry Kienzie, 501 E. 84th St., New York City.

THE OLD MAN SEZ: "A ROTTEN AERIAL MEANS ROTTEN SIGS." BETTER PUT UP UR NEW AERIAL WITH NO. 12 SOLID COPPER ENAMELLED WIRE AND THE NEW PYREX GLASS TRANSMITTING INSULATORS AND "NOTE THE DIFFERENCE". NO. 12 ENAMELED WIRE 1c FT. NO. 10 ENAMELED WIRE (FOR HEAVY DUTY) 1-1/2c FT. PYREX GLASS TRANSMITTING INSULATORS \$1.50. OHIO BRASS CO.'S GLAZED PORCELAIN INSULATORS. 5", 75c. 10", \$1.50; C. P. SHEET ALUMINUM 1/16" THICK. 75c SQ. FT. 1/16" SHEET LEAD 75c SQ. FT. NO. 12 D. C. WIRE 60c LB. NO. 14 D. C. WIRE 65c LB. NO. 16 D. C. WIRE 75c LB. METERS (ALL MAKES, ALL SIZES). CARD-WELL CONDENSERS. 11 PLATE \$4.25. 17 PLATE \$4.75; 21 PLATE \$5.00; 41 PLATE \$6.00; 43 PLATE TRANSMITTING \$15.00. GREBE CR-3 TUNER (NEARLY NEW) \$45. WESTINGHOUSE TYPE MH, 250 WATT, 1000 VOLT MOTOR-GENERATOR (NEW). LISTS AT \$171. SELL FOR \$125. WESTINGHOUSE 100 WATT, 500 VOLT MOTOR-GENERATOR (SLIGHTLY USED) \$60. CAN SUPPLY EVERYTHING IN THE WAY OF HAM STUFF, EVEN TO BLACK CATS. (EACH ONE HAS BEEN OFFICIALLY SPAT UPON BY THE OLD MAN HIMSELF). LETS HEAR UR "TALE OF WOE" ABOUT "THAT HARD TO GET PART". SEND FOR PRICE LIST OF "EVERYTHING FOR THE HAM". E. J. NICHOLSON, 8BIN (THE EIGHT THAT PAYS THE FRIGHT), 1407 First North St., Syracuse, N. Y.

HIGH VOLTAGE from lead type Storage Batteries now within the reach of every ham. Two volts per cell, four ampere hours. NEW plates made in special moulds 1" x 4" x 1/2". One positive and negative WELDED together with lead connector. Can be used in jars or test tubes. Per pair with separators 18c; in other words, any voltage at 9cts a volt. NEW "A" Batteries 6 volts. Exide Rubber Case 150 amp. \$23. WOOD CASE 60 ampere, \$9.80. \$11; 110, \$14.00. Two year guarantee. HOWARD FRAZIER, BOGOTA, N. J.

FOR SALE—Complete 50 watt set. Write for dope. ICBJ.

EXTRA SPECIAL—Brandes Superior phones \$1.75. Radiotron UV 199-201A-200-WD11 or 12 \$2.25; Baldwin type C headsets \$8.00. all new, no seconds. Cash with order or C.O.D. Radio Engineering Co., P. O. Box 197, Berkeley, Cal.

PRIMARY RHEOSTATS for primary of filament transformer. The Bradley "Radiostat" is ideal, varies filament voltage ten volts with perfection. \$6.50 prepaid each. C. R. Smith Radio Company, Port Arthur, Tex.

HIGH VOLTAGE DYNAMOTORS DESIGNED to run off of low voltage DC. Ideal for u hams that have 32v lighting system. Will also run off of any voltage from 8 to 32 volts. These are NEW and UNUSED machines. Write for complete description if u are interested. 9CJW, W. G. Mulks, Whitewater, Wis.

RADIO CARDS—8 special favorites. Large RED call letters 60c per hundred and up. RADIOGRAMS 3 forms

20c per 100. LETTERHEADS and ENVELOPES. Send for our NEW SET of SAMPLES. LOWEST PRICES. THE ARTHUR PRESS, 1453 Arthur Ave., LAKEWOOD, Ohio. BRANCH OFFICE—C. M. Rush, Jr., 855 S. Broad St., MOBILE, ALA. 54P.

\$5.00 NEW United States Aviators' leather Helmet with Head-Phones and Microphone, cost \$25. Postage free. Send at once, limited supply. Other Radio Bargains. WELLS' CURIOSITY SHOP, 20 So. 2nd St., PHILADELPHIA, Pa.

YES, SIREE—HAMS: We've got 'em. Latest type low-loss tuner coils, with 5 interchangeable secondaries. Range 12 to 220 meters, and ABSOLUTELY DO OSCILLATE over entire range. THEY DO GRAB THAT DX. With instructions, blueprints. 2 Per Set, \$4.00. C. O. D. AMES RADIO SHOP, FRANCESVILLE, Ind.

FB NEWS for real Hams. We have the new rheostat for the primary of your filament transformer. Handles up to 500 watt transformer, made by Allen-Bradley, of Bradleystat fame, price \$8.50; we'd like to get \$10.00 but honestly we sell 1000' of highest grade No. 12 enameled solid copper antenna wire for \$6.90. Smaller quantities 75 cents per 100', in 100, 500, or 1000 ft. coils; get some Sure Fire insulators to go with it, 20 inches of finest white glazed high tension porcelain for \$1.15, four or more \$1.00 each; Westinghouse \$5.00 lightning switch \$1.50; New Citizens' Call Book sent prepaid for 50c; No. 16 double cotton covered wire \$.65 per pound; 50 watt sockets \$2.25. new type all porcelain 5 watt socket 65c. side and bottom contact, very low capacity loss, 1b for low loss receiver; series condensers, UC1831 variable \$2.25, UC1015 fixed \$2.00; UC490 filter condensers \$2.50, UC487 85c; Get several UC1006 .002 mfd. 6000 volt condensers for grid, plate, or by-pass at only \$1.50, list price \$7.00; sixteenth inch 99% pure aluminum 75 cents per sq. ft.; lead 4 pounds per sq. ft. 90 cents. UP-1368 power transformer \$14.50, UP-1016 power transformer \$17.50; UP-1626 160 milli-ampere filter reactor \$5.00, UP-1653 160 mill. \$7.25, UP-1654 300 mill. \$10.45; PX-1638 chopper and contact brush \$2.40; S. tubes \$10.00; RCA hot wire meters, now only \$2.00; Jewell TC ammeters \$10.80, AC voltmeters \$6.75, DC milliammeters \$6.75, ask for free Jewell catalog, transmitting inductance similar to RCA \$8.70; a card will bring our newest price list and our complete HAM CATALOG. You can't afford to be without it unless you have everything you want. (H11) E. F. Johnson, 9ALD, Waseca, Minn.

500 Red and Black QSL cards \$3.00. Cash with order. Horace Hart, 309 Seneca Parkway, Rochester, N. Y.

SELL OR TRADE—Power transformer 1000 or 2000 volts output handles four fifties. Wanted power transformer for fivers. What's ur offer? 8BJO, Pietzcker Ave., Massillon, O.

ARRL MEMBERS ONLY. Write for full information on A.R.R.L. pennants. Eric Robinson, Webster Groves, Mo. 9ASX.

DROSTE'S DUB: "HUDSON DIVISION DIRECTOR-SHIP." (Paid adv.)

LOOK! An Esco Motor generator, 250 watt 1000 volts DC Motor is wound for 110 volt 60 cycle; cost \$130, sell \$73 express prepaid. Only used about a month, so is in perfect condition. All inquiries answered. R. B. Andrews, 329 No. 4th St., Olean, N. Y.

WAVEMETERS ACCURATE Permanent 40-190 and other ranges \$12.00; calibrating 9AGL, 708 8th St., Brookings, S. Dak.

MUST SELL AT ONCE TO PAY DEBT. Very cheap. Complete transmitting and receiving station lo-loss short and long wave tuners, tubes, a's and b's, charger, fones, horn, meters, key, transformers microphone filter, Murdock antenna switch, aerial, counterpoise. Fine cabinets, engraved scales on panels. Write for description. Tanner, 1940 Lagonda, Springfield, O.

CHEMICALLY PURE ALUMINUM $\frac{1}{4}$ inch \$1.80, $\frac{1}{16}$ inch 90 cents; sheet lead \$.95 per sq. foot, postage paid. Geo. Schulz, Calumet, Mich.

AMATEURS—10-20% discount on nationally advertised apparatus. Tell us your needs. Fox Instrument Company, 1665 Third Ave., New York.

ALWAYS MENTION QST WHEN WRITING TO ADVERTISERS

SELL—Thordarson transformer \$3.00; Duck Navy type coupler, \$8.00; WD 12, \$2.75; UV200, \$2.75, all good condition. New Crosby Tridynd, \$58.00; Postage extra. Herbert Giffin, Gambier, O.

WESTERN ELECTRIC 522-W phonograph attachment \$5.50; also, three 83-A retard coils (intermediate frequency transformers for WE superheterodyne) \$5.00 each; all new and guaranteed. Allen Edstrom, 2309 South 60th Ave., Cicero, Ill.

ENVELOPES—100 good white envelopes with name and address printed, 50c postpaid. Emblem or call in red \$25 extra. Guy Sherman, Clinton, Ia.

SALE—DeForest Vernier Condenser, .001 mfd. dial \$5.00; Wireless Shop Condenser, .001 mfd. dial \$4.00 UV202 \$2.50; RCA Grid Leak 5000 ohms. \$.75; 2 Brandes Superior Iones \$4.00 each; Reinhartz receiver, 160-395 meters, \$18.00. 9BJI, Denver, Ohio.

25—200 Meter HAM Receiver as described in August QST. Complete with 1 step and tubes. Rest apparatus included—all New. Hrd. over 3000 miles from California, England, France, etc. Only \$30. 3BOV, S. Strobel, 3923 N. 6th St., Philadelphia, Pa.

MOTOR GENERATOR—For sale, new Emerson 500 volt, 200 watt, guaranteed; \$60.00 takes it. 9BLG.

CHEAP—Detector one step with tubes, 2 variable condensers, variocouplers, Somerville 0-15 voltmeter, 5 watt, 200 watt Acme transformer, key, sockets, change-over switch, choke, lightning switch, and loose coupler. Write SWY.

SELL 20 watt set, mounted, 3 meters, RCA equipment Kenotron rectifiers, set ready to operate \$125.00; Marconi type 106 tuner \$30.00. J. L. Sandy, 1928 Washington Blvd., Chicago, Ill.

ALLEN BRADLEY RADIOSTATS for the primary of filament transformers. Recommended by QST. \$6.50. 9CLZ.

THE PERFORMANCE OF YOUR EDISON BATTERY is a revelation when charged at a high rate. Special Bulb Chargers, 20-30 ampere, Full-Wave, High Efficiency, with Weston Meter. Can be used half-wave for low rate, and "B" batteries up to 120 volts. Also, other styles, for "A" and "B" batteries of any description. Photographs and particulars, 8c; stamps. Standard type, 4, 6 and 12 volt "A" and up to 120 volt "B" battery, \$16.00, self-contained. Send for circular. Genuine Western Electric 50-watt tubes, 211-A. Brand New, \$25.00. Only six left. A. R. Spartana, 615 N. Washington St., Baltimore, Md.

COMPLETE 1 tube single circuit set. Louise Parrett, Xenia, Ohio. Price \$25.00.

6.550 MILE RECORD with ten watt set. 5PK complete with two new five watters, new Advance "Sink", power and filament transformers, mounted in cabinet. \$75.00. 50C.

THE ONE REAL SHORT WAVE SET FOR YOU. EMPLOYS OUR SPECIAL DESIGN "AIR FORM" COILS. HAS BUT TWO TUNING CONTROLS GIVING EASE OF OPERATION. GETS DOWN ON THE LOWER ONES. THE PRICE IS \$45.00 WITH TWO STAGE AUDIO AMP. SUCH HIGH EFFICIENCY IN DESIGNS THAT ENABLED US TO COPY 6th DISTRICT STATIONS ON WEST COAST WITH ONE TUBE AND NO ANTENNA IS USED IN THE ABOVE RECEIVER DESIGNS. FOR "DOPE". QSO, ENSALL RADIO LAB., WARREN, O.

WAVEMETERS calibrated and designed, any wave band from 2 meters to 1000, accuracy 1/10 of 1%. Prices on application. Morsemer Engineering Laboratories, Research, Grantwood, N. J.

FOR SALE—DX card and general radio printing business. Owner now at college and will make attractive price. Good profit. 9AVO, 230 Pierce St., West Lafayette, Indiana.

SALE—Timmons "B" Liminator, New, \$30.00; three voltage taps. Raymond Ingraham, 409 North Fourth St., Clinton, Ia.

NEW GENERAL Electric $\frac{1}{2}$ H.P. 110-220 volt 60 cycle 1750 R.P.M. Single phase repulsion induction motors.

These are late type continuous duty motors, all in original boxes. Price \$29.50; each f.o.b. Chicago, 25% with order, balance C.O.D. Quantity limited. Queen City Elec. Co., 1734 Grand Ave., Chicago, Ill.

RADIOLA V detector and 2 stages—audio and crystal detector like new list complete \$142.50; sell for \$55.00; less tubes and batteries; but with 3000 ohm Frost Phone, \$5.00 deposit with express agent, balance C. O. D. subject examination. Geo. Schulz, Calumet, Mich.

ONE HUNDRED FREE CALL CARDS or cigarettes with orders totaling fifteen hundred (not less than 100 to order). Monogram or Call Letter Cigarettes. Send remittance and copy (plate if necessary) of card with order. Solicit your friends. Prices two to four dollars per hundred; eighteen to thirty-five dollars per thousand. Samples, twenty for twenty-five cents. SBSR, L. F. Strobel, 680 Yale St., Akron, O.

DON'T GUESS at that wave, OM. We calibrate wavemeters, and guarantee accuracy. Any type built-to-order. Write for prices. Ames Radio Shop, Francesville, Ind.

FOR SALE—200 watt ACME transformer \$15.00. Reinartz with detector, like new, \$18.00; three tube Cockaday broadcast receiver \$33.00; Jefferson audio transformer \$2.50; Brand new Cardwell 11 plate low loss, reg. \$4.70, for only \$3.00; all stuff guaranteed A-1 condition. R. Groebe, 338 El Mora Ave., Elizabeth, N. J. (2AEY.)

CHICAGO HAMS—A.R.R.L. Emblem engraved on members' panels, 50c. Best Gorton machine engraving. Also larger Emblems with call letters to hang in station. Prompt service on original "50 watt bottle" call pins, \$2.00. A. L. Woody, 20 So. Wells St., Chicago.

TELEFUNKEN Power tubes 50 watt fil. 12 volts, 3 amperes, plate 1000-1500, 30 watt, fil. 10 volts, 2 amps. plate 1000. New genuine R.C.A. apparatus. U. N. 530 and 583 ammeters, \$3.00; Magnetic modulators U. T. 1357, \$6.00; UT 1367, \$7.50. Arthur Beyer, 106 Morningside Drive, New York City.

FOR SALE—Half k.w. Acme spark transformer nine dollars. 75 watt Acme plate filament transformer mounted eight dollars, half inch spark coil two dollars. Stuart Graham, Ionia, Mich.

A REAL Rheostat for a real Tube. An 8DDV 35 ohm rheostat is the slickest on the market—bar none—and sells for only SIXTY CENTS, post paid. Also parts for that transmitter. PROMPT DELIVERY. 8DDV Rensselaer Falls, N. Y.

TRADE—Johnson motor wheel two cylinder with bicycle for transmitting apparatus. W. M. Hansen, Jr., Niles, Mich.

GREBE CR 13 New. First \$45 takes it, or will trade for 50 watt tubes. 1CAB.

SELL Grebe 8 guaranteed gud as new \$30.00. Bob Parsons, 1815 N. 55th St., Seattle, Wash.

SECOND HAND radio goods bought, sold and exchanged. All goods tested and guaranteed. perfect condition. What have you? What do you need? Minnich-Seysse Co., 460 Woodlawn Ave., Buffalo, N. Y.

SELL—Thordarson 100 wstt mounted plate transformer \$8.00. 3BPP.

FOR SALE—Three navy Receiving Sets; CN240, \$50.00 each for 1000 to 10000 meter wave lengths, almost unlimited range. Cost Navy \$475.00. A NO.1 condition. Detailed information on request. Milton Cone, Box 1553, Richmond, Va.

TUBE REPAIRS—HAMS! Look—best prices ever. UV 200, \$1.75; 201, 201A, 199 WD 12, \$2.00; 202, \$3.50. Service and satisfaction guaranteed; include postage. 3BOV, S. Strobel, 3923 N. 6th St., Philadelphia, Pa.

FOR SALE—VT-2, new, \$5.00; .0005 Coto-coil variable, \$3.50. 1AWY.

ANYTHING FOR ANY SIZE TRANSMITTER. ANYTHING, ANYTHING, SUDDEN SERVICE. 9CJU, 675 Knox Court, Denver.

WANTED—20 watt CW transmitter cheap; send photo if possible. Jack Oehler, Millis, Mass.

TEN WATT ACCW, panel mounted, complete with one new five watt and transformers. 1250 miles consistently. \$28.50. 50C.

YOU HUDSON DIVISION MEN: "DROSTE FOR DIRECTOR." (Paid adv.)

MOTOR GENERATORS—New Rob. & Myers 500 volts 150 watts with 110 volt A.C. motor drive \$33.00. Generators without motors \$25.00; motors and generators repaired and rewound 1 year's guarantee. MORTON ELECTRIC CO., 4332 Rice St., Chicago, Ill.

GENUINE SILICON Transformer steel cut to order 25 cents lb. 10 lbs. and over, 4 cubic inches, weight 1 lb. postage extra. Geo. Schulz, Calumet, Mich.

INTRODUCING the new Electric Welding Pencils. Operate from your storage battery. Uses current (2 amps per hour) only when actually touching the article to be soldered. Special introductory price \$1.65. George Voigt, 56 Maiden Lane, Maspeth, N. Y. Dept. N.

FOR SALE—3KW Delco Light plant without batteries. Has only been used about 9 months and is in fine condition. \$200.00 takes it. W. G. Mulks, Whitewater, Wis.

MUST SELL twenty watt CW and fone set immediately. 9CFL.

SELL OR TRADE—UV-206 one KW tube; want a 250. 8UE.

GREBE 13 IN PERFECT MECHANICAL & ELECTRICAL CONDITION. EXCELLENT CONDITION ALL-AROUND. \$45.00 POSTPAID. BERNARD STOTT, 60 PALLISTER AVE., DETROIT, MICH.

LOW LOSS COILS made to order; state maximum capacity of your tuning condenser and maximum wavelength desired, coil will be wound to suit. Fine for wavemeters. One dollar. D. S. Basim, 541 Tennessee Ave., N.E., Washington, D. C.

\$10000 WORTH of Radio Transmitting, Receiving Sets, and Parts, bought from U. S. Government Aircraft Department. We sell at reduced rates. Send 2c stamp for list and prices. Mail Orders Answered. WELL'S CURIOSITY SHOP, 20 South 2nd St., Phila., Pa.

SUPERHET transformers. UV1716's \$4.50; 1714's \$2.50; EIS Model C7 Antenna inductance \$3.00; Model K Antenna Adapter \$15. Mounted HC Coils 200, 300, 400, 750, 1250, 1500, \$1.50 each; other bargains. R. Barrows Columbia Road, Portland, Me.

WANT No. 2 Omnigraph cash or trade u.p. thirteen sixty eight transformer. Sell Grebe CR8. Thirty-five dollars. Rhodes; Butler, Mo.

SELL OR SWAP, for Navy receiver, Paragon ten watt CW set. W. Simpson, 336 Union St., Brooklyn, N. Y.

A NEW MURAD MA 15 six tube receiver for \$150.00; regular price \$180.00; guaranteed good condition or your money back. With loop aerial \$158.00. The above price is without accessories. Money order or COD, 10% for cash on Standard Radio Apparatus. Amateur Radio Supply Shop, 525 Park Ave., Kent, O.

WHY Should Amateurs not make money selling radio supplies? Write quick for our new catalogue and discount sheet. New 5 watt bottles type 202 at \$3.00. Ask for price on anything else in transmission parts. The Radio Club, Inc., LaPorte, Ind. WRAF-9-10.

FOR QUICK SALE—One 10 watt CW and phone set complete with exception of meters. Kenotron rectification \$50.00. Alban Michel, SWC, 116 Benson St., Reading, Ohio.

100 WATT transmitter with tubes, rectifiers, transformer, meters, \$85. Low loss and two step with tubes \$23. table talker \$5.00. 8CGI.

THE "HAM" LAB., THAT IS COMING TO THE FRONT WITH REAL AMATEUR DESIGNING AND BUILDING. ENSALL RADIO LAB., E. R. L.

GREBE 13, new, \$50.00; also 4 Edison cells \$10.00; and 525 volt m.g. \$35.00; please send money order. A. E. Fleming, 2313 Brooklyn Ave., Detroit, Mich. 8UI.

ANTENNA EFFICIENCY. Use Dry-Gap insulators and lightning arresters to keep your aerial constant in all kinds of weather. The only insulator and lightning arrester that has been developed for radio that has a weather cap. They are on the job after the Open-End insulator has broken down in wet weather. They are moulded from black bakelite with a glazed finish. \$1.25 each. Check or money order. The Antenna Insulator Co., 15 Bagley St., Pawtucket, R. I.

"TYPE A" Edison elements, drilled, separators included, pair 5c. Monroe Martin, 3EO, Annville, Pa.

BARGAIN—Reinartz one tube set in mahogany cabinet. Parts cost \$26.00; sell for \$12.00; perfect condition. I will pay postage anywhere. Winston Phelps, 66 Cottage Pl., Ridgewood, N. J.

HUDSON DIVISION MEN: YOUR VOTE WILL PUT DROSTE (2) IN. (Paid adv.)

HAVE SET of three Bremer Tully air core transformers with 23 plate Bremer Tully condensers for Neutrodyne, also 2 Fada Neutrodons. This is practically new goods. Want RCA UL 1008 Oscillation transformer or filament transformer. Amos Reaves, P. O. Box 18, Prosper, Tex.

SELLING CHEAP. CW transmitter, panel mounted, four Jewell meters, Hartley; Copper tubing inductance all radion mounted, four "S" tubes; two UV 208's, Acme filament, Acme plate transformers, Brute force filter four mids RCA cond. with Acme 30 Henry 300 mills choke, kev. bakelite mounted antenna switch, has worked Frab, G2od, WEST coast, etc. City fans invited to inspect, also Paragon RA 10 Det2Step, tubes low loss low wave tuner with Hammarlund cond. one step, "A" battery motor generator mounted, 110AC to 5-8 Amps DC., new. Act quick, need cash. Radio 2JD, 171 Norfolk Str., Manhattan Beach, N. Y. City.

BAKELITE STRIPS—for sub panels and antenna insulation to 5" wide any length 3/16 inches thick 100 square inches \$1.25 prepaid. Geo. Schulz, Calumet, Mich.

HAMS! LEARN ESPERANTO! "Green Star" combination, clothbound Esperanto grammar and double dictionary with detailed instructions in letter of quick method home or group study, with helpful examination later. \$2.00. I will use the above grammar in broadcasting lessons from WBBR this winter. James Denson Savers, Box 223, City Hall Station, New York.

1/4 KW COMPLETE spark transmitter. Best condition with high speed and pitch rotary spark gap. Cost \$55.00. Sell \$25.00. 3BOV.

SEE PAGE 45, July QST. This tuner or condensers for sale. Bare cost of parts \$71.87. Offer? Also three transformers UV 1716, new.

FOR SALE OR SWAP—1 Clapp Eastham 1/2 KW transformer; 1 Murdock Oscillation transformer. 1 Dubilier condenser (transmitting); 1 rotary gap Grebe type; 1 Sterling Battery charger; 1 fifteen dial Omni-graph with Buzzer and key; 1 Bakelite Panel 18 x 24 x 7/16; 3 22 V. Westinghouse Storage Batteries, 1 Shaw 2 1/2 horse power Gas motor. Write Henry Tisserant, Church St., Aqueduct, Long Island.

FOR SALE—Western Elec. loud speaking outfit No. 10 A. good condition. \$100.00. J. M. Abbott, Wapinitia, Oregon.

SELL—Special Acme 30 Henry filter choke—rated at 600 mills but carries 800 easily, \$22.00; RCA chopper wheel with Universal motor, \$9.00; RCA transmitting variable UC 1931, \$3.00; Acme Variable Ratio Audio Transformer—Range 1-1 to 15-1, \$4.50; Genuine Audiotron with adaptor, \$4.00; 4-UV, 201 "A's" (new) at \$3.00. Federal No. 65 Audio Transformer, \$4.00; Pair Como Push Pull transformers, \$8.00; W. E. Desk Telephone Stand, \$8.00; UV 208 (new), \$20.00; Want sync rectifier, UV 208-A's, 1CPV, 33 Emerson St., New Haven, Conn.

MOTOR GENERATOR BARGAINS—G. E. motor 220 volt 60 cycles 3 phase 1750 R.P.M. generator 400 volt 150 watts ring oiled, \$35.00; Esco motor 220 volt direct current generator 500 volts 200 watts, \$35.00. Esco Motor 220 volt 60 cycles single phase A.C. generator 500 volt 200 watts, \$50.00; 1000 volt 300 watt connected to 60 cycle 110 volt A.C. motor \$50.00; 750 volt 200 watt 3400 RPM generator ring oiled, only \$30.00; also others. Queen City Elec. Co., 1734 West Grand Ave., Chicago, Ill.

FIVE WATT TYPE 202 transmitting tubes brand new and guaranteed \$4.00. Smith Radio Co., Locust St., Fayetteville, Ark.

2ADH WILL SELL his 600 watt Acme Power Transformer for first money order for twenty-two salmon. QRP.

2 STAGE AUDIO Frequency amplifier in cabinet, Filament control jacks, \$20.00, 2-stage A.F. amplifier with power transformer, \$20.00. Acme 300 watt power transformer, \$20.00. Paul Shumacker, 22 Harrison St., Pullman, Wash.

WANTED—Synchronous rotary gap or Benwood enclosed rotary with motor Dubilier .007 condenser 25000 volt Packard factory mounted 1 KW transformer. Rufus M. Robbins, Box 77, West Palm Beach, Florida.

NATROMETER for Sale—fair condition. Complete with phone. Price \$5.00. L. Totten, Aberdeen Proving Grounds, Md.

TREAT 'EM ROUGH! THEY LIKE IT! YOU'LL always have a "B" battery if you build an Edison. Large size first class elements, wired with pure nickel wire, electrically welded connections, .07-1/2 per pair, sample .10; Sample 2500 mil-amp transmitter cell, .16; rubber separators, 1/2 cent; pure nickel wire No. 20, .01-1/2 per ft. 225 and 300 amp. hour cells. Everything prepaid except cells. A. Chapelle, Woodburn, Ore.

SELL—Cash or trade Croft 8 volume library electricity, like new. H. M. Lowrie, 3AYQ, Osakis, Minn.

GREAT REVIVAL! Audio transformer revived. Your burnt out transformer brought back to normal activity. The charge is only \$1.50. Satisfaction guaranteed or money refunded. Standard makes only. The Radio Research Laboratories, Box 507, New Bedford, Mass.

SELL—Paragon RA-10. Thirty-five dollars or best offer takes it. Wm. Loeffler, 51 Woodland St., Lawrence, Mass.

A FEW NEW PERFECT W. E. 216 A's at \$4.45. R. Breunig, 2252 Roscoe St., Chicago.

MOTOR GENERATORS—Robbins Myers 600 volt 100 watt \$45. 8BUK.

EDGEWISE WOUND copper ribbon the only really satisfactory antenna inductance 5/16 inch wide, 4 inch diameter 12 cents, 5 inch diameter 13 cents, 6 inch diameter 16 cents, 7 1/4 inch diameter 18 cents per turn prepaid any number turns in one piece. Geo. Schulz, Calumet, Mich.

CARDWELL LO-LOSS .00025 \$3.85. **CARDWELL .0005 \$4.65.** **JEWELL 0-500 MILLIAMMETER \$6.95.** **JEWELL 0-15 AC-VOLTMETER \$6.95.** "S" TUBES **NEW TYPE PAIR \$20.00.** "S" TUBE SOCKETS PAIR \$2.50. Acme 1.5 Henry choke, \$4.25. Hines 500 watt power-filament transformer \$12.00. **JAMES R. CURTIS, 5AQC, 1109 Eighth Ave., Ft. Worth, Tex.**

RAMSEY'S RADIO REVISED—Price \$2.00 postpaid. For review of second edition see July QST page 63. Eighty-four experiments, mimeographed. Note enlarged book brought to date. University Book Store, Bloomington, Ind.

IVORY RADIO PANEL—Grained white "IVORYLITE" makes most beautiful set of all. Guaranteed satisfactory. Any size 3/16" thick sent prepaid 8c per square inch. Sample free. E. P. Halton, Dept. T. 814 Main St., Fort Worth, Texas.

200-20,000 METER receiver including radiotron \$25.00; two step amplifier \$18.00. Smith, 4416 Market, Philadelphia, Pa.

TRANSMITTING AMATEURS Attention—Don't leave those costly tubes and meters lying around to be broken. Mount your transmitter on panel. Looks better, works better. QST says so. It's easy to cut those peep and meter holes with my panel tool. Cuts smooth hole one to five inches in diameter, only \$2.50 postpaid or C.O.D. Homer H. Malcolm, Whitewater, Wisc., 9EKH.

PUREST VIRGIN Aluminum for sale. Particulars upon request. 2EM.

THE MARK TO KNOW IN AMATEUR RADIO,
TRANSMITTING OR RECEIVING. E. R. L.

NEXT NOVEMBER: "DROSTE FOR DIRECTOR",
Hudson Division. (pd. adv.)

WILL SELL 10 watt transmitter at 8BJT, complete
with 500 Volt Esco. Write for description and price.
R. J. Mumaw, 701 Walnut Ave., Scottsdale, Pa.

THE FIRST TWO checks for \$15.00 takes my two Clapp-
Eastham HR receivers, in fine condition. W. G. MULKS,
Whitewater, Wis.

PYREX INSULATORS, the best that money can buy,
39c. Apco Chargers, 7 1/2 Ampere rate \$14.98; Acme
CW inductances \$6.75; Cunningham and R. C. A. tubes
\$3.40; C302-\$6.95; a few Amrad "S" tubes left at our
unusually low price, \$8.00; Everything new and guar-
anteed. George Voigt, 56 Maiden Lane, Maspeth, N.
Y., Dept. N.

MAGNET WIRE ALL KINDS AND SIZES Nr. 10
DCG 50c lb., add 2c lb. for each size up to Nr. 20, 100
ft. No. 12 enameled aerial wire 85c; best grade Silicon
Transformer Steel cut to size 22c lb.; special jappaned
radio frequency transformer steel cut to size 45c lb.
Cash with order. MORTON ELECTRIC CO., 4832
Rice St., Chicago, Ill.

EDISON BATTERY SUPPLIES. LARGEST SIZE
TYPE A ELEMENTS 4c A PAIR, 5c DRILLED, 8c
WIRED IN PAIRS. PURE NICKEL WIRE 1c A FOOT.
PERFORATED RUBBER SEPARATORS 1/4c EACH.
TEST TUBES 1x6", 3c, 1x6", 4c. ENOUGH DRY
CHEMICALS FOR 5 POUNDS OF EDISON SOLUTION.
75c. ALL ARTICLES POSTPAID. BERNARD
STOTT, 60 PALLISTER AVE., DETROIT, MICH.

RADIO CORP TRANSMITTING MATERIAL. BRAND
NEW in original cases. UC1803 .000025 mfd. antenna
series condenser, \$.75; UC1806 .002 mfd. mica condenser,
\$.150; UC1849 double tank circuit condenser double
\$.1; UC1866 filament bypass condenser, double \$.1;
UC1873 filter trap condenser, .05 mfd., \$.1; UC1015
tapped antenna series condenser, \$.2; UM530 2 1/2 amp.
hotwire ammeter, \$1.50; UM533 5 amp. hotwire am-
meter, \$2.00; UM576 0-500 milliammeter, \$4.00; UM578
0-500 DC voltmeter, \$5.50; UC487 1/2 mfd. 750 volt filter
condenser, \$.75; UP1016 750 watt transformer for UV
203A, \$15.00; UP1368 325 watt transformer for UV
202A, \$10.00; UP1626 25 henry chokes, \$6.50; UP1627
40 henry chokes, \$8; UP1653 30 henry chokes, \$7; UP1654
50 henry chokes, \$9; UP1643 1 1/2 amp. magnetic modu-
lators, \$.50; UP1357 3 1/2 amp. magnetic modulators,
\$.75; UT1367 5 amp. magnetic modulators, \$1; PX1688
chopper wheel and brush \$1.50. W. M. Derrick, 58
North 6th St., Newark, N. J.

TRANSMITTING TUBES: all sizes, new and guaranteed
hard. Prices reasonable. Kenotrons rectifying up to
14,000 volts. Special sale UV-204A tubes. 500 cycle
generators and transformers. 1500 volt—500 watt G. E.
self excited generators, new \$15. We have been supplying
most the larger DX stations with tubes for several
years. Get our prices. J. K. Hewitt & Co., 252 Neptune
Ave., Brooklyn, N. Y. 2RK-2FP.

30-350 V DC Westinghouse dynamos \$12.00: Few
new type General Electric 50 watts. Dope on request.
2BYJ.

GREBE CR8 ROKK 2 stage amplifiers like new, fifty
dollars. Howard Eldredge, Sharon Springs, N. Y.

A Zenith regenerator with detector and two step to
match; both units \$50.00. W. E. Van Valkenburg, 1005
So. 17th St., Fort Dodge, Ia.

FOR SALE—2000 volt 1500 watt 1750 R. P. M. double
commutator motor generator set motor end A. C. 50
cycle \$200.00. Also 2000 volt 1000 watt 1750 R. P. M.
motor generator, Motor 110 volt direct current, \$125.00.
Queen City Electric Co., 1734 W. Grand Ave., Chicago,
Ill.

GREBE CR-5 and Grebe 2 step, good as new, \$60.00;
John Dungan, Exeter, Cal.

FOR SALE—Acme 300 watt CW transformer \$13.00;
Omnigraph mounted with buzzer, key, induction coil,
phone, 15 dials, \$16.00; 9AFU, Robbins Foster, 909
Hayes Ave., Racine, Wis.

SEND me your burned out or broken Power tubes—50
watt or over. Will pay liberally. W. Baker, 36 W.
20th St., New York City.

IN CHECKING STOCK we found one 10-watt Paragon-
Radio Telephone No. 2-5-U. Never used. First \$30.00
check gets it with one 5 watt tube never used. Tresco
Sales, Inc., Davenport, Ia.

SUPER-HET Parts: W. E. S-38A Retard Coils, 1-222A
Input Coils, 2-12,000 ohm resistors, 1-50,000 ohm resistor,
entire lot thirty dollars; Grebe RORN Thirty Dollars;
Zenith 4R Receiver Fifty Dollars 3 new UV 1716 RCA
transformers Twenty Dollars. Either lot sent prepaid
on receipt of M.O. or certified check. J. J. Novak, 4031
So. Campbell Ave., Chicago, Ill.

WILL SELL NEW GREBE SETS in original packing
cases. CR-13 \$35.50; CR-8, \$55.00; will ship C.O.D. sub-
ject to inspection. C. L. Tatom, 301 Marshall St., San
Antonio, Tex.

MAKE YOUR NEUT REACH OUT—Same panel, same
layout, fewer parts. Our \$5.00 Kit includes the one
different part, 22 feet real gold sheathed wire, litho-
graphed print of Kladag Coast to Coast Circuit, and
complete, simple instructions. Nothing else to buy.
Gives selectivity with deep, resonant volume. NOT
obtainable elsewhere. We originated this and can
name scores of buyers it has delighted. Satisfaction
guaranteed. Details 10c. Kit prepaid anywhere \$5.00.
New 48 page catalog, thousands of items, many exclu-
sive for stamp. We accept postage stamps same as
cash. KLADAG RADIO LABORATORIES, Kent, O.

TELEGRAPHY—Morse and Wireless—taught at home
in half usual time and at trifling cost. Omnigraph
Automatic Transmitter will send, on Sounder or Buzzer,
unlimited messages, any speed, just as expert operator
would. Adopted by U. S. Govt. and used by leading
Universities, Colleges, Technical and Telegraph Schools
throughout U. S. Catalog free. Omnigraph Mfg. Co.,
150M Hudson St., New York.

FOR SALE—Oldest established and best located going
electrical contractor-dealer and radio business in city of
40,000. Reasons for selling, wholesale interests. Write:
Muskogee Electric Shop, Muskogee, Okla.

AMATEURS! SEND FOR OUR COMPLETE LIST OF
EXTRA SPECIAL BARGAINS IN STANDARD
TRANSMITTING PARTS. AMERICAN SALES
AGENCY, 38 Park Row, N. Y.

158 GENUINE Foreign Stamps, Mexico War Issues,
Venezuela, Salvador and India Service Guatemala,
China, etc., only 5c. Finest approval sheets 50 to 60c.
Agents wanted. Big 72p. Lists Free. We Buy Stamps.
Established 20 years. Hussman Stamps Co., Dept. 151,
St. Louis, Mo.

HAMS—Get our samples and prices on printed call
cards made to order AS YOU WANT THEM. Radio-
grams 25 cents per 100. Hinds & Edgerton, 19 S. Wells
St., Chicago, Ill.

Q R A SECTION

50c straight, with copy in following form
only: CALL — NAME — ADDRESS. Any
other form takes regular HAM-AD rates.

FMH—J. Federico Mejia, 14a Avenida Norte No. 31, San
Salvador, rep. of Salvador, Central America.

1AEU—G. E. Morgan, 44 Summer St., Dover, N. H.

1AYX—Benson Chase, Box 111, Nantucket, Mass.

1CAK-1ZD-1XAX—John M. Wells, 40 Main St., South-
bridge, Mass.

1GV-1ZAB—H. H. Tilley, Woolworth Bldg., Providence,
R. I.

2AEO—Peter Testan, Jr., 2123 Troy Ave., Brooklyn,
N. Y.

2EF—Reassigned to H. W. Bryan, 402 Ocean Ave.,
Brooklyn, N. Y.

3DU—Henry O. Redue, Jr., 723 Reservoir St., Baltimore, Md.

4UC—D. B. Whitmore (ex 2CUZ), 925 Grandview Ave., Seabreeze, Fla.

4XI—Geo. W. Clark, Jr., 1459 Riverside Ave., Jacksonville, Fla.

5AQN—Harry L. Frese, 1614 Louisiana St., Little Rock, Ark.

5WX—A. J. Arnold, 1107 6th Ave., Canyon, Tex.

6BCN—Robert McIlveen, Box 325, Portola, Calif.

6BMW—C. J. Camp, 318 Hawthorne Ave., Palo Alto, Calif.

6CZ—Raleigh W. Whiston, 1808 Buckingham Rd., Los Angeles, Calif.

8BYR—John Cowen, 321 Philadelphia Ave., West, Detroit, Mich.

8DBG—Wm. R. Bell, Jr., 5213 Fifth Ave., East Liberty, Pa.

8HC—East End Y. M. C. A., 2053 E. 105th St., Cleveland, O.

9BIM—Walter B. Roe, 5311 Lakewood Ave., Chicago, Ill.

9BIQ ex 9DEK—William N. Short, 301 Franklin St., North Judson, Ind.

9BJZ—V. W. and J. C. Lotter, Seymour, Wis.

9BM—E. F. Horn, 2017 Hudson St., Denver, Colorado.

9ZB-9DJR—R. W. Groendycke, 3808 Wyoming St., Kansas City, Mo.

CARDWELL

The Original Low Loss Rotor Grounded Condenser

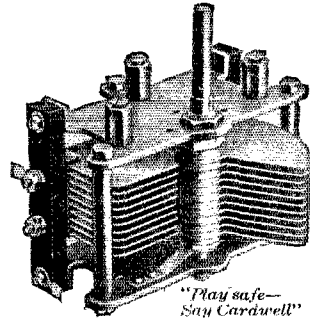

*"Play safe—
Say Cardwell"*

Cardwell is the original Low Loss, rotor grounded condenser. It is a significant fact that of all the various kinds of radio apparatus on the market to-day the CARDWELL CONDENSER is the ONLY unit which is recognized by engineers and technical Editors of National prominence as the ONE best.

*A Post Card Brings you an
Education on Condensers.*

Allen D. Cardwell Mfg. Corp.

81 Prospect St.

Brooklyn, N. Y.

National Electric

Less QRM
More DX

No More

"Break-Downs"

TRANSMISSION CONDENSERS

For Radio Filter Circuits

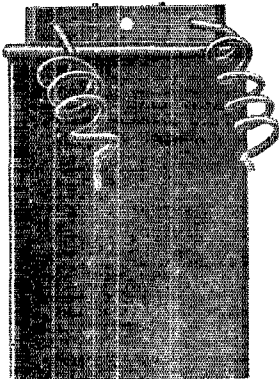

No. 1, 1,000 V. DC Service, per.
2.5 mfd. condenser . . . \$7.00

No. 2, 2,000 V. DC Service per
2. mfd. condenser . . . \$8.00

Order direct by letter or use the coupon.

Are you tired of "break-downs"? Here is a special, high-dielectric, low-loss condenser that will end your troubles. Under tests at double their rated voltage, their phase angle does not exceed 20 minutes—which means a loss of not over 1/2 of 1%—or an efficiency so close to 100% as to be negligible. With National Electric Condensers you send out less QRM and gain the good will of every BCL around you. And you get more DX because a properly designed filter circuit gives a clearer, more understandable note.

COUPON-

**National
Electric
Condenser Co.,**

New Haven, Conn.

Gentlemen: Ship

C. O. D. the following:

..... No. 1 Condens-
ers at \$7 each.

..... No. 2 Condensers
at \$8 each.

**National Electric
Condenser
Company
New Haven
Conn.**

Write your name and address plainly in space above.

EVEREADY Radio Batteries

- they last longer

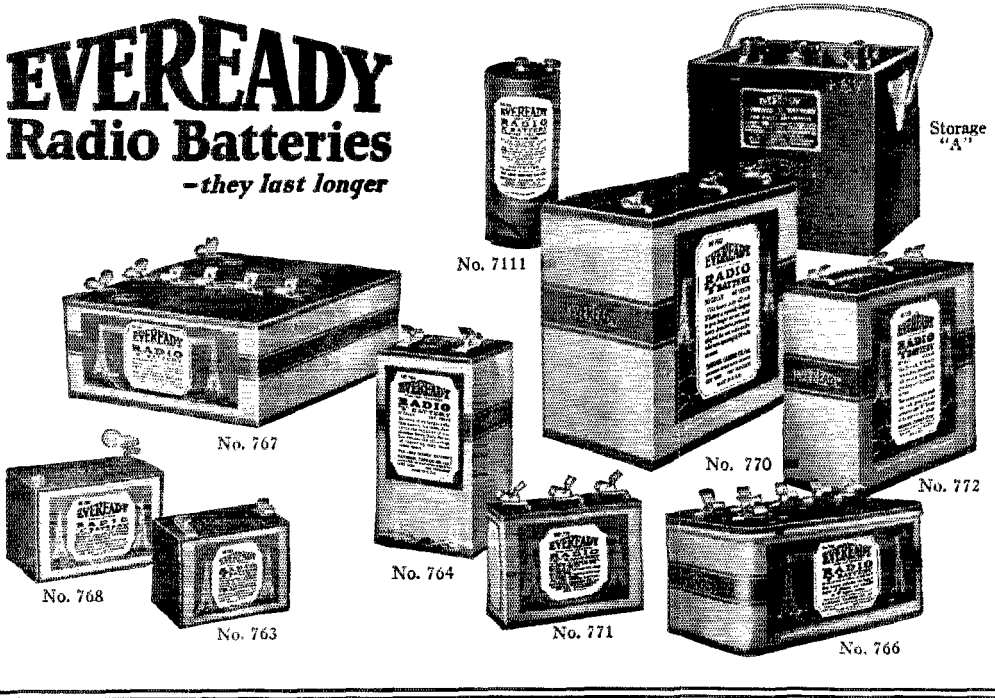

EVEREADY RADIO BATTERIES FOR EVERY RADIO USE

Each one supremely economical and efficient for the use for which it is designed—each one made under the supervision of the world's greatest electro-chemical battery laboratory

Eveready "B" Batteries

THERE are Eveready Batteries for portable sets where small size and light weight are more important than long life. There are Eveready medium size batteries that come between the small and the large sizes. There are Eveready large size "B" Batteries that afford maximum economy and reliability of service when used with average one, two, three or four tube sets. And now there is a newer Eveready heavy duty, extra large size "B" Battery that gives similar economy to owners of multi-tube heavy drain receiv-

ing sets and power amplifiers.

For maximum "B" Battery economy, buy Evereadys, choosing the large sizes (Nos. 766, 767, 772) for average home sets, and the heavy duty, extra large (No. 770) for multi-tube heavy drain receiving sets and power amplifiers. For portable sets choose the Eveready No. 764 medium size, unless space is very limited, in which case choose the Eveready No. 763 small size "B" Battery.

Eveready "C" Battery

Eveready makes a long-lasting "C" Battery with terminals

at 1½, 3 and 4½ volts. May also be used as an "A" Battery in portable sets.

Eveready "A" Batteries

Eveready offers you "A" Batteries for all tubes, both storage and dry cell. For storage battery tubes, use the Eveready Storage "A." For dry cell tubes, use the Eveready Dry Cell Radio "A" Battery, especially built for radio use.

Manufactured and guaranteed by
NATIONAL CARBON CO., INC.
Headquarters for
Radio Battery Information
New York San Francisco
Canadian National Carbon Co., Limited,
Toronto, Ontario

BUY THEM FROM YOUR DEALER

—FOR YOUR CONVENIENCE—

QST'S INDEX OF ADVERTISERS IN THIS ISSUE

Acme Apparatus Co., The.....	2	HAM ADS.....	119-125
Allen-Bradley Co., The, 123.....	3rd Cover	H & H Radio Co.....	94
American Brand Corp.....	102	Hartford Instrument Co., The.....	76
American Elec. Co.....	84	Hull & Co., S. W.....	100
American Hard Rubber Co.....	105	International Correspondence Schools.....	84
American Radio and Research Corp.....	4th Cover	Jewell Elec. Instrument Co.....	104
American Radio Sales Co.....	114	Jewett Radio & Phonograph Co., The.....	85
American Sales Agency.....	114	Johnson, E. F.....	98
American Transformer Co., The.....	100	Johnson, G. F.....	90
Andrae & Sons Co., Julius.....	82	Kellogg Switchboard & Supply Co.....	116
Angiers, U. S. A.....	106	Kimley Electric Co.....	92
Apex Radio Co.....	88	Lane Mfg. Co.....	94
A.R.R.L. Application Blank.....	80	Locke Radio Shop.....	92
Bakelite Corporation.....	95	Lopez & Co., A. C.....	108
Ballard, R. C.....	71	Magnavox Co., Inc.....	87
B-Metal Refining Co.....	118	Manhattan Elec. Supply Co.....	92
Brach Mfg. Co., L. S.....	106	Marie Engineering Co.....	71
Branston, Inc., Chas. A.....	116	National Carbon Co., Inc.....	126
Bremer-Tully Mfg. Co.....	113	National Co., Inc.....	82
Bunnell & Co., J. H.....	108	National Elec. Condenser Co.....	125
Burgess Battery Co.....	73	Newman-Stern Co., The.....	116
Cardwell Corp., Allen D.....	125	Ozarka, Inc.....	112
Carter Mfg. Co.....	106	Precise Mfg. Corp.....	115
Central Radio Laboratories.....	102	Premier Elec. Co.....	114
Chicago Salvage Stock Stores.....	100	QST Back Copies.....	112
Chicago Solder Co.....	97	Radio Corp. of America.....	1, 77
Citizens Radio Service Bureau.....	103	Radio Material Supply Co.....	104
Corning Glass Works.....	71	Radio Printers.....	118
Crescent Radio Supply Co.....	102	Radio Tube Exchange.....	110
Crosley Mfg. Co.....	81	Radio Units, Inc.....	110
Cunningham, E. T., Inc.....	2nd Cover	Randolph Radio Corp.....	96
Cutler-Hammer Mfg. Co., The.....	78-79	Rauland Mfg. Co.....	109
Davenport Radio Laboratories.....	118	"Rolls-Royce" Tube Co.....	82
Daven Radio Corp.....	96	Roller-Smith Co.....	96
Dayton Fan & Motor Co., The.....	90	Rose Radio & Elec. Supplies.....	86
De Forest Radio Co.....	74-75	Schwab, Inc., Harold M.....	108
Diamond State Fibre Co.....	84	Sears, Roebuck & Co.....	76
Dubilier Condenser & Radio Corp.....	99	Shepard-Potter Co., Inc.....	110
Duplex Engine Governor Co., Inc., The.....	116	Signal Elec. Mfg. Co.....	86
Durham & Co., Inc.....	118	Stromberg-Carlson Telephone Mfg. Co.....	98
Eagle Radio Co.....	104	Thordarson Elec. Mfg. Co.....	111
Eby Mfg. Co., H. H.....	90	Toaz Engineering & Sales Co.....	98
Eisemann Magneto Corp.....	98	Tower Mfg. Co.....	114
Electric Specialty Co.....	102	Tilley Radio Corp.....	86
Electric Storage Battery Co., The.....	83	Turn-It Radio Sales, Inc.....	112
Endly, C. C.....	116	Umbarger, N. H.....	118
Experimenters Information Service.....	88	U. S. Tool Co.....	88
Federal Tel. & Tel. Co.....	98	Utility Radio Co., The.....	80
Ferbend Elec. Co.....	104	Westinghouse Union Battery Co.....	101
Fleron & Son, M. M.....	112	Weston Electrical Instrument Co.....	90
Franklin Radio Mfg. Co., The Ben.....	94	Whitlsey Engineering Corp.....	71
Freshman Co., Inc., Charles.....	108	Wireless Mfg. Co., The.....	71
Frost, Herbert H.....	116	Wright Radio Co.....	86
Gardiner & Hepburn, Inc.....	110	Zenith Radio Corp.....	89
Garod Corp.....	107		
General Electric Co.....	91		
General Instrument Corp.....	117		
General Radio Co.....	72		
Globe Phone Mfg. Co.....	106		
Goldschmidt Corp., The.....	82		
Grebe & Co., A. H.....	4		

ALWAYS MENTION Q S T WHEN WRITING TO ADVERTISERS

New

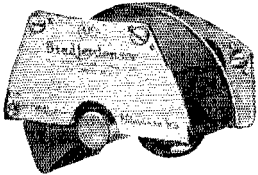
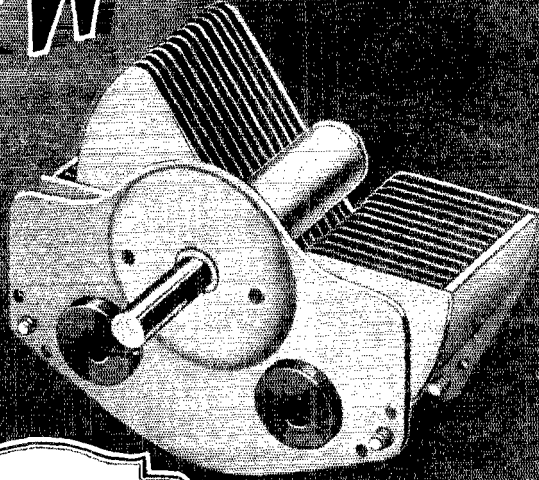

The Bradleydenser
Perfect Variable
Condenser

The Bradleydenser PERFECT VARIABLE CONDENSER

Brass Plates—Grounded Rotor—Low Loss

PERFECTION to the last detail! Even the unique bearing of the new Bradleydenser is a marked improvement over the older types. The rugged brass plates, the grounded rotor construction, and the new detachable dust shield are other details that serve to increase the high-frequency efficiency of the Bradleydenser. Exhaustive laboratory tests reveal exceptional improvements in efficiency. In fact, the Bradleydenser sets a new low record for losses. It tunes the weakest oscillations with the least energy loss, and, therefore, increases the range of any set. There are many other new and striking features of the Bradleydenser. Our new literature explains them, fully. Send for our latest bulletin today.

Standard Capacities

0.00025 M-F . . . \$4.50
0.0005 M-F . . . 5.00
0.001 M-F . . . 6.00

Furnished without vernier plates, only.

Allen-Bradley Co.
Electric Controlling Apparatus

277
Greenfield
Ave.



Milwaukee,
Wis.

Standard Carton

The Bradleydenser is sold in the well-known Allen-Bradley checkered box by all leading radio dealers and jobbers

Baltimore
Birmingham
Boston

Buffalo
Chicago
Cincinnati

Cleveland
Denver
Detroit

Knoxville
Los Angeles
New York

Philadelphia
Pittsburgh
Saint Louis

Saint Paul
San Francisco
Seattle

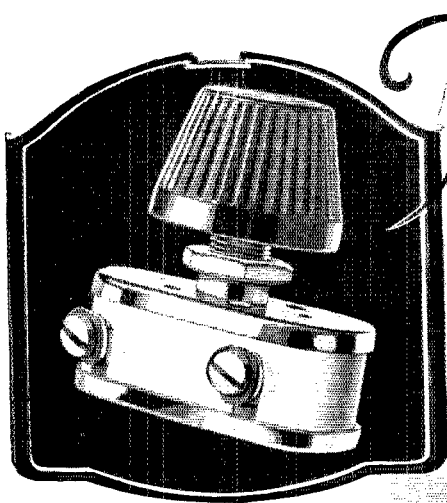

The New Bradleystat

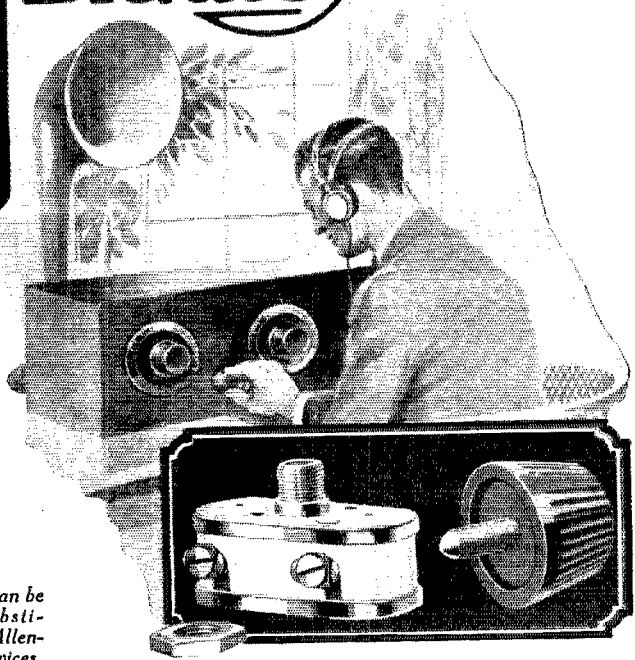

A Remarkable Achievement

Many refinements are embodied in the new Bradleystat. The graphite disc columns are enclosed in a smaller container; two terminals suffice for ALL tubes; a new mounting simplifies installation; the knob is of a daintier pattern. And the noiseless, stepless, control of the old Bradleystat remains, unchanged. Such a combination of advantages can be found in no other filament rheostat.

Every radio set can be improved by substituting the new Allen-Bradley radio devices.

Only One Hole required in Panel

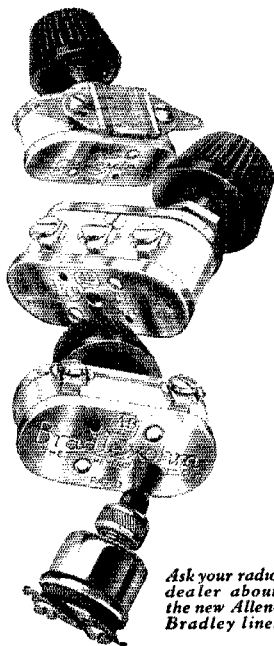

Ask your radio dealer about the new Allen-Bradley line.

A DISTINCTLY new and valuable contribution to radio! That is the verdict of all radio engineers and designers who have seen the new Allen-Bradley radio devices and have witnessed their amazing performance. The new "one-hole mounting," which replaces the older clip mounting, makes for marvelous compactness and simplicity of installation. The new Bradleystat, Bradleyleak and Bradleyohm require only a 11/16-inch space behind panel, and the Bradleyometer only 7/8-inch. Thus, the new models can replace inferior wire rheostats and potentiometers without disturbing the arrangement of the set. Our new literature is ready. Send for it, today!

Allen-Bradley Co.
Electric Controlling Apparatus

277
Greenfield
Ave.



Milwaukee,
Wis.

Baltimore
Birmingham
Boston

Buffalo
Chicago
Cincinnati

Cleveland
Denver
Detroit

Knoxville
Los Angeles
New York

Philadelphia
Pittsburgh
Saint Louis

Saint Paul
San Francisco
Seattle

Type
3650

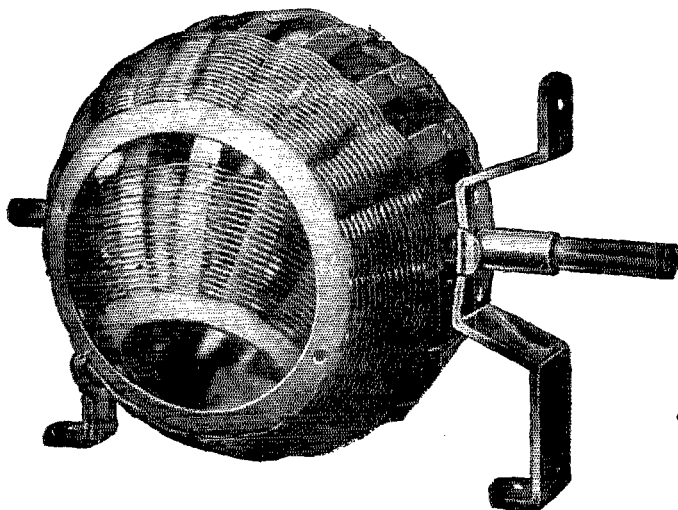

Price
\$3.75

“LOUD SPEAKER ON ONE TUBE”

?????

Do your friends know that the AMRAD “S” TUBE is used not only (1) by the transmitting amateur, and (2) to charge Storage B-Batteries, BUT (3) THAT IT ALSO MAY ELIMINATE YOUR BATTERIES ENTIRELY?

The Basketball Variometer is particularly suited to the BCL who builds his own set. But the amateur can best appreciate its technical features which result in superior efficiency. And the amateur can “steer” his friend to that tuning element giving the best receiving advantages.

Use of molded or other dense material permits loss of high frequency energy. (Every amateur knows this but the average BCL does not. *He buys on looks.*)

We would appreciate your telling BCL friends about the Basketball—how the basketweave windings reduce distributed capacity and electrical losses to the very minimum—how its points of design are approved by leading amateurs and by the testing laboratories maintained by Radio News, Popular Radio, N. Y. World and scores of others.

Order Basketballs from your nearest Dealer. If he is not stocked, place your order with him just the same, and he will fill it promptly. This will help build a convenient source of supply for you and your friends.

Write for Descriptive Bulletin

AMERICAN RADIO AND RESEARCH CORP.
DEPT. Q, MEDFORD HILLSIDE, MASS.

AMRAD

Reg. U. S. Patent Office

The Traffic Department

F. H. Schnell, Traffic Manager
1045 Main St., Hartford Conn.

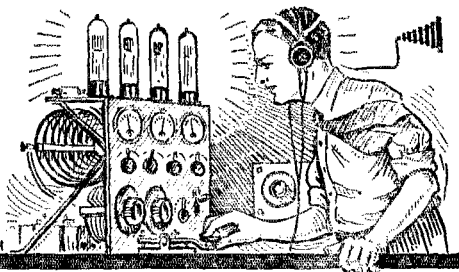

WISH

While our many traffic handling stations are squaring around to the use of short waves, our message traffic is at a standstill. This is only natural, because we are starting out in a brand new field—it is just like breaking into amateur radio, this short wave work. Instead of jumping right in for traffic, we have to go back to the old stuff of “QSA? QSB? QRH?” etc. Remember in the old days how we used to get our set perking a little bit and the first things we used to say was, “how is my spark? are my signals loud?” etc. Well, we have to go through that same process before we can hit the ball on traffic. Nothing we can do will prevent that, it is the routine of amateur radio; there is a certain way of getting down to things more business-like and this testing is one of them. However, we might try cutting down the time limit in order to get to things more valuable to us amateurs and we suggest more attention to traffic.

A complete list, alphabetically by call, of every Official Relay Station has been mailed to each O. R. S. Additions or cancellations will be mailed regularly so the list can be kept up to date. This is one of the moves to expedite message traffic and we won't have to guess or wonder how fast a message is moving to its destination. At the present time, we have about 850 O. R. S., but we have loads of room for hundreds more—write to your Division Manager and file your application for an appointment.

The biggest tests of the value of short waves and the distances that may be covered in daylight will come with the Daylight Transcons, which details have been covered elsewhere in this issue. We must have a big turn-out for the tests as we will need every short wave station operating in the band between 75 and 80 meters.

We want more short wave observers for tests conducted by NKF and other government branches. Just send your card in to the Traffic Manager and we will take care of the rest.

A number of changes have been made in the personnel of the Traffic Department and we call your attention to the names of

the Division Managers and Assistant Division Managers appearing in the front part of this issue of QST. Notice the changes in the Atlantic Division, and the men who are making the new Hudson Division go.

OFFICIAL A. R. R. L. BROADCAST MESSAGES are transmitted every Saturday and Sunday night at 8:00 P. M. on 75 to 80 meters and at 10:30 P. M. on 150 to 200 meters. Listen for these broadcasts if you want to keep posted on the latest schedules from European amateurs this winter.

ATLANTIC DIVISION C. H. Stewart, Mgr.

DISTRICT OF COLUMBIA—Activity in the District is about as has existed during the last few months. Practically all the active stations are definitely down on waves below 100 meters which undoubtedly proves the popularity of the shorter waves. 3BE, the best equipped station by far in the District, is entirely occupied with experimental work. 3BSB, with a 50 watt tube, is consistently heard on 75 meters. 3BWT continues to be the chief traffic handler and has several operators at its disposal. 3JJ of old time fame, will probably not be heard for some time except as operator at 3BE.

Traffic: 3BWT, 29; 3BPP, 11; 3BSB, 15; 3HS, 10.

MARYLAND—Baltimore stations are rapidly getting in line for the season. As yet, only a few have availed themselves of the opportunity of working on low waves: 3AJD has worked the coast on 80 meters. 3LL is also doing excellent work on this wave. 3LG is back on the job with the same old punch. He will undoubtedly uphold his record as Baltimore's star station this season. 3AOJ and 3CDU are using fifties now, and doing FB DX. 3CGC, 3DU, and 3BU are doing good work. 3WF, 3MF and 3DQ are again on the job and kicking out FB. 3APT is installing 150 watts and should do fine DX. 3PH, 3FB and 3SF are doing their usual good work. 3KU hopes to be back on the air soon. 3APV handled only 20 this month and is working plenty of DX with the 5 watter.

Traffic: 3CGC, 28; 3DU, 17; 3LL, 12; 3HG, 8; 3SG, 32.

EASTERN PENNSYLVANIA—Quite a few delinquents came through this month, most all stations being busy with the lower waves. 3QV is back after an extensive tour of the New England states. 3HE's signals penetrated Hawaiian shores. 3ADP is on 78 meters. 3YO is busy tuning up for the short waves. 3CJN has been heard in England, France, Germany and Italy. 3MQ and 3TP are big boosters. Mr. E. T. Denton signs “ED” at 3AUV. Heavy traffic is expected from 3CHG's 250 watter. 3ZO landed their sigs 30 miles from Hamburg, Germany. Wilkes Barre stations please note new C. M.; Mr. J. W.

Eckenrode, 117 Park Ave., Wilkes Barre, Pa. 8BFE and 8EU continue to report for Williamsport.

Traffic: 8QV, 4; 8ZM, 11; 8ADP, 24; 8BNU, 47; 8CHX, 37; 8CJN, 35; 8MQ, 27; 8TP, 9; 8UE, 2; 8AUV, 47; 8SCHG, 35; 8ZO, 70; 8BVA, 84; 8BFE, 3; 8RTU, 16; 8FS, 15; 8EU, 2.

WESTERN PENNSYLVANIA—If you were to take a trip to every amateur station in Pittsburgh, you would see many low wave receiving sets under construction and many new coupled transmitters tuned to 75 meters awaiting the Radio Inspector's permit to operate. This is indeed worth consideration, for with no quiet hours and the way DX comes in on the low waves more traffic is predicted passing through Pittsburgh in the future than ever before. 8AIG has rebuilt his set and expects to handle more traffic next month. 8JQ is a close second, but he failed to give any dope about his activities this month. 8BHJ can be heard nightly working DX stations. 8BHJ is QSO south after much trouble and he has arranged a schedule with 40A. 8SF with two operators at the new station is doing splendidly.

Dist. No. 9: 8CGF reports 7 msgs handled to the 14th. He is now using a 10 watt set. 8BJT complains of QRM from his printing business but still managed to handle 27 msgs on the side. 8CEO turns in a report for not only his own station but for the entire Allegheny Valley. 8CEO is using coupled Hartley and handled 21 msgs in one evening. 8BJI, once op at 8CEO, made us a visit for a few days. He will soon be on the air with a 100 watt set. 8AAG still off the air. The mighty 8BZC is reported to have quit the game. 8AGQ, the station at the Oakmont High School has been on more regularly since the opening of school. 8CKM is rebuilding his set. 8CNW visited Detroit recently and came back with several new ideas. 8BCT has sold out on account of QRM from school work. 8CEO and 8AGQ are prepared to test tubes since they have acquired a Jewell test set. 8DL reports "9" for traffic. 8CDC is to attend the Tome School at Fort Deposit, Md., this year. 8QD, 8LW, 8JW, 8BW, 8CIX, 8BXQ, are still in the ring but due to the recent return of the D. S. the cards did not get out in time. 8VE, 8ZAH can be heard nearly every evening between 7 and 10, E. S. T. on 75-80 meters. 8ZD has been on regularly with two 50 watters self-rectified on 75 meters and gets out well with the single wire aerial. This is the A. D. M's station and he would like to get in touch with all D. S. and C. M. by the air route if possible.

Dist. No. 10: 8ADS and 8BYI have not been on the air the last month on account of QRM from burned out fittings. EX-8BMP is out in California visiting some six stations. 8CCK just returned from an auto trip to Canada. 8KQ says he will be on the air and QRV for traffic. 8BRB has got back from Chicago and is moving a few messages. 8CEJ has a lower total this month than formerly, but he has been busy rebuilding his station. 8CVX will not be on the air for some time since he is getting down on the lower waves. 8AGO-8XAQ has been spending most of his time and money building low wave receivers. His transmitter on 78 meters gets out as good and maybe better than on 150 meters. 8CEI has been doing very good work on 75 meters. He is now experimenting on 40 meters with favorable results.

Dist. No. 12: 8CQL has gone down to short waves and finds them very FB. 8CX5 is still on 195 and says he gets out OK. 8CWW just got going on short waves and works better DX than on the higher waves.

Traffic: 8AEY, 26; 8DAH, 16; 8DIZ, 6; 8AIG, 42; 8JQ, 40; 8BHJ, 20; 8SF, 18; 8CEJ, 13; 8CVX, 13; 8AGO, 11; 8CEL, 7; 8CGF, 7; 8BJT, 27; 8CEO, 21; 8ZAH, 2; 8JW, 19; 8CCK, 8; 8BRB, 15; 8CON, 46; 8CX5, 8; 8CQL, 12; 8CWW, 4.

NEW JERSEY—Dist. No. 6: Traffic seems to have taken quite a jump for the better in this locality at last. 8CS at 8XAN has been trying to establish a good daylight route between New York and Phila. and points south. Have already established good reliable communication with 8KL in Bridgeton, N. J., which heretofore has been considered a "dead spot."

8XAN is now operating on schedule and is doing some very good reliable daylight work having handled the bulk of this month's traffic in about 15 days. 8XAN is on every day between 12:30 and 1:30 P. M., 4:30 and 5:00 P. M. for traffic and often during the afternoon. 8CBX keeps on the air and handles practically all the night traffic through Trenton. He intends to increase to a 50 watt set pretty soon. 8CS swears he will get up a 60 ft. stick this month and hopes to be on the air soon working the gang. 8XAN and 8ZI have both received the new A.R.R.L. O.R.S. certificate. 8BFH and 8OH are still away on their trip to the West coast. 8BLZ is no longer located at the factory but is now working at the Carteret Club of Trenton, using 10 watts straight C. W. and fone on 160 meters. By the way, 8BLZ's antenna system is rather unusual. He uses an indoor antenna 18' long and 2 brass beads as the counterpoise.

Traffic: 8XAN, 22; 8CBX, 11; 8ALH, 24; 8BAY, 34; 8BTQ, 10; 8BWJ, 3.

CENTRAL DIVISION

R. H. G. Mathews, Mgr.

MICHIGAN—The changing over to short waves accounts for Michigan's lower traffic report this month, and many new stations will be heard on the lower bands.

Dist. No. 1: 8AIIH reports he is QRV for traffic. 8ZZ is now working on 42 meters as well as on 80 and 200. 8AMS handled a number of messages for Cincinnati Y.M.C.A. crowd who were at the beach near him. 8BO reports QRV for winter with new aerial and insulators. 8CCW comes through with the information that he is using a 201-A with 1000 volts on the plate. He doesn't say if the filaments are lighted. 8DGO is now an O.R.S. 8ZH is now ready for DX and traffic on the new set—1:00 to 2:00 P.M. schedules open.

Dist. No. 2: 8DFB leads the district this month with 8DEP a close second. Traffic is moving on 78 meters from 8ZF without a hitch.

QRN is much less in the district, but QRM from harmonics is bad, and would suggest that stations calling CQ use some way to indicate the band they are on, and listen on the calling band only—DS.

Dist. No. 3: Everyone seems to have been off the air in this district during the past couple of months. 8AEB seems to be the most active station this month. 8EAS, who is working station 8GE at Douglas, Mich., helped to keep the district going this month. If the bulletin service is to be effective, reports must be sent to the D.S. so that you will get this service. 8BOK reports he is all set now with 50 watts and is QSO east and west with effect. 8CZZ has resigned as C.M. of Kalamazoo, to attend school in Chicago. 8ACO has been elected to replace him (temporarily). 8BOB is on now with a good DX station.

Dist. No. 4: Activity is reported in this district now, and the D.S. looks for an increase of interest in the Upper Peninsula.

Traffic: 8DFR, 42; 8DEP, 41; 8AEB, 29; 8DOO, 24; 8DRO, 22; 8GE, 22; 8CCW, 22; 8CZZ, 18; 8ZZ, 16; 8CAP, 15; 8ZF, 13; 8AMS, 12; 8DB, 11; 8BDR, 7; 8BBL, 6; 8BOK, 3; 8BCR, 1.

KENTUCKY—The Kentucky boys had a little get-together at Louisville Sunday, Sept. 20th, and a big time was had by all. 8BEV, the Kentucky State Fair Stations, was a success. Msgs were sent to all parts of the world. The local hams were ops. 8ARU is going to be in a new shack with an 80' mast. 8ELL has worked over 100 miles with one wire antenna and one wire CP. Master Oscillator ckt. 8WU has shaped from Europe and is getting the station in shape again. 8HAZ is away at school, but will return during the holiday season. 8HP and 8CVR are going strong. 8PRC will soon have a 1000 v MG set. 8CON is on the air again. 8EP has a new ESCO MG on order and expects to be using DC soon. Traffic: 8ELL, 32; 8BAZ, 16; 8WU, 11.

OHIO—Dist. No. 1: Lima is very quiet, due to rebuilding. 8CCI and 8ER are working sixes. 8AVN

will be ready soon. 8DOX is making B batts for his set. 8ZY and 8FU of Defiance will soon be on. 8FU was on 2 nights and was heard on the west coast and in Brazil. 8ANL from Cleveland will be 2nd operator at 8ZY this winter. 9BQI with a 203 A and coupled circuit has a nice report. 8DHS worked two sixes in 45 minutes. 8DCB has a 203A, but no kick yet. 8ARO is getting a W. E. fifty in shape. 8ANN is working DX with tube two years old. 8BFF is off the air on account of moving his station. 8DND hands in a nice report but has QRM from high school work. The Toledo Radio Club will have a station call, 8LO. 8BN and 8BO have good reports of messages but no dope. 8PU is attending Defiance College but hopes to work his station quite often this winter. AW of 8PU is attending Purdue University this year.

Dist. No. 2: 8AAJ was the leading station this month, but he has left for college. 8RY says the four coil Meissner circuit with D.C. note on 155 meters has worked the west coast more times since the first of August than the old Hartley on 185 did

8BN, 29. 8BYN, 29; 8DBM, 28; 8BQI, 27; 8DMX, 27; 8CAB, 25; 8AFP, 25; 8AVX, 24; 8ANB, 21; 8DCB, 17; 9DHS, 15; 8ADA, 14; 8RJ, 11; 8BO, 10; 8DKM, 10; 8MB, 10; 8BGF, 10; 8ALW, 10; 8APR, 10; 8DCF, 9; 8CNR, 14; 8BOQ, 6; 8DOS, 6; 8APZ, 5; 8DND, 4; 8FU, 3; 8GW, 3; 8BNH, 3; 8AWX, 3; 8ALI, 2; 8AHY, 1.

ILLINOIS—Dist. No. 1: We are sorry to state that Mr. J. H. Burke of 9NQ has resigned as D.S. for this district. 9NQ will be working on the Burlington route soon, so will be kept very QRW. Perhaps he can lend us a hand on Railway Emergency work. 9BIZ reports working on 80 meters at the expense of two tubes and several grid leaks. 9AWU will soon be on with a new mast and a 50 watter. 9DGA is moving his set to another part of his house and will be on again soon. 9BWA leaves for Iowa City, and 9VM leaves for Champaign this week to attend the U. of I.

Dist. No. 2: 9HRX has a very nice message total this month of 378 messages, and thinks the shorter waves are the "nuts". He is working every-

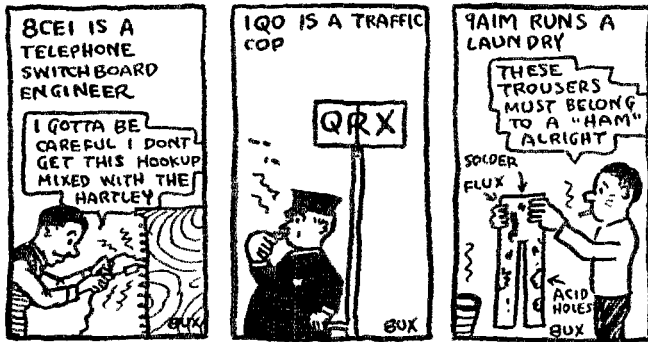

all winter. 8DBM reports traffic scarce at his station. 8ANN is installing four coil Meissner circuit so he can get out better. 8BCE is putting one half amp into the antenna on 78 meters.

Dist. No. 3: 8ALI, 8BNH and 8TT are working all districts. 8ACY and 8ADA are doing fine DX on 80 meters. 8AFP, The Cleveland Boy Scout Station at their summer camp, using two 201A tubes, and 300 volts Edison batteries for plate, handled 25 messages. 8BDV and 8BIE visited many of the 6th and 7th district stations this summer. 9AA visited many Cleveland stations recently. 8BNH is now away in school and will be heard very little. 8TT helped the amateur cause up another notch when he, with the assistance of 8RJ, handled a message to a young man located on a boat in the upper lakes advising him of the death of his mother. The total time for message and return through 8RJ and WTK was 23 minutes. (RB, boys.) 8DMX is now going with 50 watts and doing fine DX. 8TT led in messages handled this month.

Dist. No. 4: 8CTA is doing good work with 10 watts and leads Ohio with 100 messages. 8APR and 8CAB usually get in early in the morning. 8ALW was very busy with the convention. 8CNR operates at night. 8AHY is rebuilding his transmitter. 8GW is changing to 80 meters. 8BGF is going FE. 8CWR has been heard in N. Z. 8CIA left for Cornell Univ. 8AIB recovered his stolen tubes. 8AWN and 8AIB left to attend the University of Cincinnati. Miss 8BI is being flooded with love letters since her photo was in QST.

Dist. No. 5: 8CWP of Lancaster is on full blast and QRMMing Mars. 8PL is on all the time and going strong. 8DEM has an 80 ft. lattice mast and is getting out in fine shape. 8GZ is just back from the National Guard Camp and will be on soon. 8BTT will be back soon, and 8AAP is putting in coupled circuit. 8RYN is using the coupled Meissner as per 8BTT in QST.

Traffic: 8CTA, 100; 8AAJ, 77; 8TT, 44; 8BKM, 41; 8CCL, 40; 8RY, 36; 8UQ, 31; 8CWR, 30; 8CNL, 30;

one on 77 meters with .2 amps. The new mast and CP is very FB. Chief of 9AIC is very QRW and doesn't get to operate the ham set only on Saturday nights. 9BUK has a small message total this month, but he just got started again on 80 meters. 9CTF fell down on us this month and only handled a few msgs. 9CTF's set will be all set for winter work in a few days. 9DXL has just started to rebuild, and while he has been on very consistent he did not handle many messages. 9DLO can't make his set oscillate. The quiet hours put a dent in 9ARM's operating hours. Application is in for O.R.S. for 9DZR. 9PQ has left for Illinois University. 9CA will use the big set that 9PQ had. 9CYH has QRX'd for school and will not be on the air until Xmas. 9BJT, 9BTA and 9ABE are attending Dodge's Institute in Vaipo. 9DDY is coming back on the air again after having been off for about a year.

Dist. No. 3: 8PQ and 9CA drove down to 9MC's. They had dinner at 9ATT's. They are sorry that they didn't see the rest of the boys in Jacksonville but school QRM. 9CMN is raving because he didn't get a copy of the "Oscillator". His was the fifth one mailed. 9AHJ blew his MG, but sez the LC Hartley and low waves are very FB. 9ATT has a very neat station, and it is not Mr. Vail's fault if he doesn't get out. 9TW has been off the air for some time and just got back. 9DJG didn't handle any messages, but reported nevertheless. He is building a new tower. 9CSW mails the report card this month with "Q" for a total. We at least know you are living. That's very fine, OM. 9EFQ reports the same way. No transmitter at 9EFQ now, so ND on signals.

Dist. No. 4: 9DQU will be off the air this year considerably, as he will be taking an EE course at Milliken U. 9VW is coming on the air strong with a couple of fifties, and will give the shorter waves a trial. The new transmitter will be a duplicate of the set 9RP used when QSO WNP. 9ASD has returned from his skeleton hunting trip in S. Dak., and he and 9AQK will pound the same brass this winter.

9DKH is doing splendid work on 80 meters, but shorted his "S" tubes on the high voltage and is now using A.C. 9AP has license for 80 meters and will be going on that wave. 9BGC has made a new cage for the 80 meters and rebuilt the set. 9DZH has license to work on 80 meters, but can't make it percolate down there. 9DQU suggests that he whack off about half of the antenna. 9BEB wants to arrange tests on waves below 80 meters. 9AQA is back in the game again. 9CZL is getting ready for winter traffic by arranging schedules with 9BFB at east Moline and 8ANB, also 8XAB. School 9RM is also bad. 9CLJ also bothered with school 9RM, but hopes to find time for a new antenna. 9DQU cut off half of his aerial and now works on 80 meters.

Dist. No. 5: 9EBQ reports handling 10 messages. 9AYX has been experimenting on the low waves and has worked every district but 6 and 7. 9DZG is working the east coast regularly now. 9AMS lost his job because of failure to report or appoint an assistant to fill his job while he was out of town. 9AYB had the misfortune to blow his tubes. 9BDA pushed three messages through. 9CLZ has moved to Chester and will be closed for school. 9CSK is back on the air again. 9BLO is waiting for a permit to work on 75 meters.

Dist. No. 6: District No. 6 has lost a lot of good stations on account of college. The Rockford gang are experimenting on the lower waves. A recent hamfest at 9AKU's new station was quite a success. The stations that reported are 9CYZ, 9ABB, 9AMR, 9CDB, 9DNP, 9DVV, 9ALW and 9BHD.

Dist. No. 7: Bill Schweitzer is back, but he insisted that his brother "EQ" send in the report. Bill had a fine trip down the "Father of Waters", and is of the opinion that WHU will surpass WNP's record.

9XBD expired and was not renewed, but 9ZW has taken its place. That will no doubt be a trifle easier to send. A counterpoise goes under the aerial at 9AAW, but doesn't seem to make much difference in results. 9AMZ has resigned as CM of Evanston. 9DHQ cracked the base of a 50 watter and is using a 5 watter temporarily. Ex-8DJR is visiting in Evanston, and is pushing the key as on "ER". The QRA of 9DHQ is 2817 Thayer St., Evanston, Ill. 9APK has been on the fence as to whether to use spark or not. The question is now settled in favor of C.W. 9RC is again in shape, and promises an excellent relay center. 9DKK has rebuilt his entire transmitter and will be going soon. Not much news from 9CD-ZA. 9DWX changed his transmitter and is using coupled Hartley now with one 50 watter. The C.M. of Chicago now requires that a copy of all messages handled be sent in with the traffic report. 9ED is closing up for school work. 9APK new QRA is 2304 Park Place. He reports the 80 meter stuff FB, and has heard g2FJ. 9AER will be on soon. 9EDG is on with a 50. 9DBF still leads the town in DX. 9BPH, 9CFS and 9BWP all report good message totals. WTAY is using 9BN's 50, so they are using a 6 watter and seem to get out in great style. 9ASA is closing up for school, but previous to the closing some good message totals grew. 9AXT likes the Illinois Oscillator muchly. 9AXT has been trying to loose couple the 1DH but without much luck. 9EAS is now in Maywood. 9COW is building 110-ft. tower. 9CVF is visiting the 7th district on his vacation. 9CVS is down on 78 meters. Traffic: 9BRX, 378; 9CZL, 249; 9BNA, 74; 9DQU, 38; 9RIZ, 35; 9BHP, 33; 9DWX, 30; 9CFS, 29; 9ASA, 28; 9VM, 24; 9DHQ, 23; 9DGA, 22; 9DZH, 20; 9AIC, 20; 9AAW, 19; 9DZG, 19; 9CVF, 18; 9MC, 18; 9CD-9ZA, 16; 9ABB, 16; 9RC, 14; 9AKU, 14; 9CTX, 12; 9ATT, 12; 9BUC, 12; 9AMR, 11; 9AWU, 11; 9CTE, 10; 9ERQ, 10; 9NQ, 8; 9DXL, 8; 9DLO, 8; 9DKH, 8; 9CDB, 7; 9CIZ, 7; 9REB, 7; 9AHJ, 7; 9CA, 6; 9DKM, 6; 9EAS, 6; 9DNP, 6; 9AKM, 5; 9VV, 4; 9CMM, 4; 9CVS, 4; 9DVV, 4; 9BWP, 3; 9BDA, 3; 9ALW, 2; 9BHD, 1; 9TW, 1.

SOUTHERN INDIANA—9BCC has closed down to go to Purdue. 9EJI is handling the bulk of traffic through Indianapolis. Most of the stations are getting things fixed up for the coming of DX weather. The order from Headquarters limiting the report to the activities of O.R.S. stations has made necessary cutting out most of the report.

Traffic: 9EJI, 64; 9ES, 44; 9BJR, 40; 9BCC, 40; 9BVZ, 11; 9EAQ, 10; 9UT, 7.

NORTHERN INDIANA—Dist. No. 1: 9DRS is going to college and will be on at 9YAD. 9APD reports no messages handled. 9CZB is going good. 9CLN is having trouble with power supply. 9AZX is QSO IHT in Brazilian waters. He is hitting them hard on short waves about three nights a week. 9AZX is also QSO both coasts and South America on 80 meters and with only one third power he formerly used on 180. 9DHD's 200 watter went "Blue" and is using one 50 watt.

Dist. No. 2: 9RIQ, ex-9DEK is using 10 watts on 157 meters with chem rectifier. All reports say D.C. worded 76 stations all over 500 miles in seven nights. He is not going to Purdue this year. 9EFZ has been off the air for a month, and is now back with 100 watts. He is going to the Mayo's hospital for a month. 9DYT had his tube repaired and is doing very good with it. 9EM has a 50 watter now and is working on 78-80 meters. 9DVK says he is not doing much amateur work. 9DHIJ will soon be on with the tube set. He is still using the old spark. 9AKD reports an addition to the family (8 lb. baby girl), but he managed to get in a report. 9EB has put up a new mast and will be on most every night from 4:30 until 7. He will be on short waves soon. 9CTE is dismantled but will be on soon. 9AKD is getting 3.7 amps. rad. on 2 fifties in a loose coupled Hartley circuit using eight inch coupling. 9CP is getting the big generator lined up and into service. Traffic: 9RIQ, 46; 9EFZ, 29; 9DYT, 28; 9FB, 18; 9EM, 17; 9DVK, 15; 9MM, 9.

DAKOTA DIVISION

D. C. Wallace, Mgr.

SOUTH DAKOTA—There was no report from South Dakota this month because of the retiring A. D. M. who has gone away to school at Ames, Iowa, and the D. S. Mr. Leland Thompson, has also gone away to school. Sufficient notification was not given to re-establish the state organization in time for a complete set of reports. The new A. D. M. for the state is Mr. M. J. Junkins, 9CJS, and under his able guidance we expect great things from South Dakota.

NORTH DAKOTA—Hert Wick reports that many of the amateurs of North Dakota have become inveigled into the radio business, and so with the coming of fall, they became so active that reports were hard to get. He is working on the rejuvenation of the state, and helping the second district to become organized.

Traffic: 9AEJ, 7; 9CSI, 24; 9AMP, 42.

MINNESOTA—Things are picking up very well all through the state, and interest is becoming much keener in transmitting now that the quiet hours are removed on short waves, and dope is now available for getting down low.

Dist. No. 1: This district is on the up-hill climb, but received several setbacks when 9EGU blew his 50 watter, and 9DOE went off the air. 9GW will try to keep things humming in Duluth in 9DOE's absence. 9DXT is back from commercial operating on Lakes.

Dist. No. 2: With the SMRA convention gone but not forgotten, this district has girdled its belt for greater efforts, and much is expected from it in the way of traffic handled and efficient transmission this coming season. New Ulm is going strong on low waves, as is Sleepy Eye, with 9AWM back on the air with his 250 watter. 9UCH had bad luck in losing his mast in a storm, and 9MF blew another fiver. 9AEP, the low power wiz., worked all districts and WNP on a couple of amplifier tubes. 9DSW reports reception of UFT2 and others, but is leaving for the University this fall. 9BNF has finally installed a filter with fine results, and 9AXS is putting in Edison B batts. 9CPO's cup chewed the aerial rope forcing complete rebuilding of antenna support. 9COF is back on the air. 9BFU has school 9RM. 9GCG won the cup for the best all around SMRA station.

List. No. 3: Everyone is getting ready for a large turnout at the Dakota Division Convention in November, and from all indications it will be a hum-dinger, with Schnell and others of the QST gang expected. 9BMX is now C.M. of St. Paul. 9ZT lost his poles during the recent tornado when a tree knocked them over. Traffic: Dist. No. 1: 9CDV, 247; 9EGU, 50; 9CO, 43; 9AND, 25; 9EGF, 8; Dist. No. 2: 9COF, 5; 9AXS, 2; 9EGG, 3; 9MF, 12; 9BBF, 16; 9DDP, 16; 9AWM, 51; 9CPO, 10. Dist. No. 3: 9BMX, 31; 9CIP, 107; 9DYZ, 4; 9DFZ, 3; 9ZG, 3; 9DPX, 35; 9BOB, 14; 9BPY, 9; 9BQY, 8; 9HPN, 6; 9BIS, 22, 9ZT, 36; 9DAW, 3.

DELTA DIVISION
W. W. Rodgers, Mgr.

Kindly note that the address of the Division Headquarters is now 2080 Lee Place, Memphis, Tenn. Don't use any other address which you might have around your shack. Put this on your hook so you won't cause your reports to go astray.

With the First Delta Division Convention disposed of, and many of the visitors enjoying the use of the apparatus they won there, we are ready for the serious work of the season. Present reports are not very encouraging, but we hope to see better ones later.

MISSISSIPPI—5ALZ leads the state this month, though his total is a little bit below par. 5AKP is doing good work with a brand new station. 5AIR got back from the convention in time to handle a few messages on the short waves. 5QZ operated very little last month.

LOUISIANA—As is usually the case, no traffic was reported from this state. 5ZK has been running successful tests with NEK on three nights a week. 5ARI, 5NJ, 5MQ, 5KC, 5WY and 5ANC complete the list of active stations.

TENNESSEE—We are mighty glad to see 5EK heading the list this month. He will be on nightly for traffic this winter. 5KA runs second this month, says the convention took quite a bit of his time. He also will be on nightly for traffic this winter. 5NT is doing some good work on his 50 watter. 5CN and 5AHJ report little traffic, but have rebuilt for the winter. 5AIY reports a good bunch of messages.

Traffic: 5EK, 55; 5KA, 54; 5AIY, 22; 5NT, 21; 5CN, 5; 5AHJ, 4.

ARKANSAS—5WK is the only Arkansas station reporting any traffic. The D.M. was mighty glad to meet the Little Rock delegation at the Convention and hopes they enjoyed their stay in Memphis.

Traffic: 5WK, 26.

HUDSON DIVISION
E. M. Glaser, Mgr.

This is the first report of the Hudson Division. Since this report takes in only 15 days, and this short time was all that was had in organizing the Division, the report is naturally small. The organization in New York is entirely complete, but Jersey is unfortunately way behind. Only reports from the new Hudson Division Official Relay Stations are printed herewith, and no other reports will be accepted. The reports are handled as follows: The O.R.S. reports to his C.M., or D.S. if he has no C.M., on the 16th of the month. The C.M. reports to the D.S. (except in New York City) not later than the 19th, and the D.S. reports to the A.D.M. before the 23rd. Reports from O.R.S. must be made on Form J cards. To be issued an Official Relay appointment, the applicant must be an A.R.R.L. member and a GOOD operator. He must agree to the requirements stated on the application blank which is shown by his signature. He has to apply for an O.R.S. through his local traffic officer. If the applicant is satisfactory, the Division Manager sends him an O.R.S. certificate, which must be signed by him and returned to the D.M. for the latter's signature and serial number. The station may hold the appointment as long as the operator

is a member in good standing of the League and provided that he does not violate the conditions of the oath. All O.R.S. must be familiar with the rules and regulations of the Traffic Department of the A.R.R.L., a copy of which may be obtained from Headquarters by simply asking for it. All O.R.S. must use the method of numbering messages as described in June QST. Any official of the Operating Department is privileged to drop in at any O.R.S. and ask to see the messages handled for a month back. So keep the messages handled on file for at least a month, lest you get caught. In addition to stating the number of messages sent and received, state the number delivered. This includes delivery by mail, fone, or in person.

There are three A.D.M.s in the Division:—2CWR of New York City, 2GK of Eastern N. Y., and 2WR of Northern N. J. 2CYX has been appointed City Manager of Bronx, taking CWR's place. 2ACS has been appointed D.S., taking 2GK's place.

2BBX continues his fine work. He is going to enter Columbia, so he won't be as active as usual, but he says he is getting a second op who will help keep up the good work. The Y.L. op at 2CYX handled 40 out of 78 messages this month.

2CVU is doing good work on a single wire antenna and indoor counterpoise. 2AAI has been recommended as an O.R.S. All traffic correspondence from the Bronx is to go through 2CYX, the new CM.

2CHY has installed a pure D.C. set and will be on the air more often than heretofore. Brooklyn men please note that reports are to be sent to 2CHY as always, not to the D.M. 2WC is becoming one of the most active O.R.S., and is getting fine results on 80 meters. 2CPQ had the luck to get 1CPQ for his Boston home. 2ADC is moving and will be off the air a few weeks. 2PF promises to be on 80 meters before long, as does 2HO. 2ABN is having a hard time getting his set to park on 80. His antenna came down also. 2ARR is fixing things up. 2BBB acted as the New York end of the WNP

OCCUPATIONS No 47325

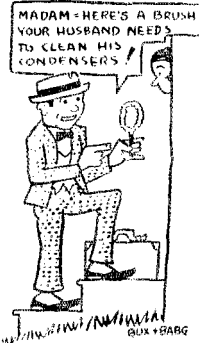

2DX, IRVING GROVES, IS A FULLER BRUSH SALESMAN WHEN NOT POUNDING BRASS.

relay to the North American Newspaper Alliance. One night 965 words of press were copied from WNP with the help of 1XW. This took the whole night because of poor weather conditions. 2BRB has also been reported the loudest station heard by IHT, with whom communication has been held steadily. IHT was 4000 miles away.

2AUY reports a breakdown of plate voltage and trouble with the landlord. Tough, OM. 2CHK has a new 4 coil Meissner using four 5 watters. 2GNK has a terrible kick with his two 250's and 500 cycles. 2AQL junked the spark (HOORAY) and is rebuilding for low wave work. 2KR and 2CKY have been recommended for O.R.S.

2CEV is experimenting with a 100 watt outfit. 2CEP is getting along OK.

Traffic:—2CVU-12, 2BBX-47, 2CYX-78, 2BRB-51 divd 12, 2CRY-29 divd 3, 2WC-20, 2CPQ-20, 2ADC-14, divd 4, 2ABN-14 divd 3, 2PF-3, 2ABR-14, 2BNL-28, 2AUY-7, 2CNK-6, 2CEP-22, 2CEV-8.

Eastern N. Y.—Real stations throughout the state are rapidly being made O.R.S., and considering that only 15 days have elapsed since the birth of the Division, this territory is getting into full swing very rapidly.

Fincher, 2CXB, of Dist. No. 1, reports that everyone is building an 80 meter set.

Decker, 2UA, came across with some real dope right off the bat. 2BQB is kicking off F.B. on 150 with a pair of fifties. He is on the job at all times. Yonkers is coming along OK. 2APY and 2ADD are on 80 meters. 2AAN will be there soon also. 2CIL has been recommended as an O.R.S. 2CFE is the only active station in New Rochelle. He is also on the low waves.

Du Bois, 2ANM, hasn't much to say because there are only two O.R.S. in Dist. No. 3. 2GDH is getting out fine and makes every effort to handle traffic and keep the ole ball rolling. FR, OM, 2ANM has had the surprise of his life by QSYing 79. He has already worked the coast and is very consistent.

Taber, 2AGQ, of Dist. No. 4, sent in a good report. 2AQR is rebuilding to take advantage of the low waves. 2CHZ continues his good work and is rounding into mid-winter form rapidly. 2CXG changed to coupled Hartley and is always QRV traffic. 2CYM has been recommended for an O.R.S. 2AGQ has been QRW with the apple crop, but managed to bear them all in traffic.

Graham, 2ACS, the new D.S. of Dist. No. 5, is getting things going up there. Schenectady is easily the most active city in the Division outside of New York. The Schenectady Amateur Radio Assn. is progressing rapidly under the leadership of 2BY. 2ACS got his new gutter pipe mast up and worked 7QC the first night. FR. 2BY is the star DX station with his power plant, and continually works the west coast. 2GK has a terrific punch on 80. He has worked all districts in a few hours several times, even before it was dark on the other coast. FR.

The combination of the short waves and reorganization of the Jersey part of the Division resulted in a large drop in traffic reports. 2BMR is the leading star station both in traffic and DX. He received two reports from Germany. 2EMB operates at 2MBR. 2CDR is back on the air and hopes to erect another tower soon. 2CXE has been rebuilt, and one of the changes is that it is remote controlled. 2CMK has been recommended as an O.R.S. and City Manager of Newark. Let's see some action, OM. 2CQZ took another 100 word press despatch from WNP just before she docked. 2WR will reopen on the short waves with a fifty and later change to a 250. 2AXF is on 80, and exchanged calls with a West Coast station. 2FC blew a few transformers, but will be heard again shortly, and this time with higher power. 2BGI expects to use 200 watts in a Coupled Colpitts.

Traffic: Eastern N. Y.—2BPB-6, 2CXB-1, 2BQB-36, 2ADD-33, 2AAN-3, 2APY-24, 2CFE-15, 2ANM-72, 2CDH-128, FB, OM, 2CHZ-31, 2AQR-12, 2AGQ-109, FB, 2AWF-5, 2ACS-86, 2BY-40, 2GK-86.

New Jersey—2BMR-101, FB, 2CXE-76, 2CQZ-23, 2AXF-16, 2CDR-7, 2FC-4, 2WR-4, 2BGI-2.

Let's have a little more co-operation, fellows, especially in Jersey, where there is a lot to be done. Things are going fine for a starter.

MIDWEST DIVISION

P. H. Quinby, Mgr.

NEBRASKA—There is a fine report from district No. 1 and from the way things look there will be a large number of traffic handlers in this district during the coming season. 9AWS and 9EGA have consolidated and their set seems to be reaching out. They have been reported in Australia. 9EB reports static heavy in his locality during the month. 9BNU is as regular as ever. The new station is coming

along fine at Grand Island and from all indications will be on by the first of October. 9CIM is off the air because of forced removal of guy wires on his pole. 9ATC has been doing some experimenting on the shorter waves and expects to be on in a short time. 9NL is a new O. R. S. in this district.

Dist. No. 2: Reports from this district point toward a very active season. O. R. S. application blanks can be obtained from the D. S. Mr. Herbert Spencer, 2511 "R" St., Lincoln.

9EAK warns us he is going to be on with a 250 watter. 9ADS is managing to QSO coasts regularly. 9BDU is on with 100 watts working DX. 9AFR is off the air now but plans to be on soon. 9EAK is the only new appointment in this district.

KANSAS—9CCV, the D. S. for Dist. No. 1, left hurriedly for Minnesota, and so no reports were received from the first district hams. 9AOG has been operating at KSZ, and has a 250 hooked up. He works both coasts nightly. 9CFI and 9AIM are using the big tubes (250). The messages are going through the state with lightning speed. Several of the boys are working on the 75 meter waves. The K. C. gang are real DXers in addition to message handlers. 9EFU has gone to Ark. to college. He and 5AFQ will be on this winter. 9CCS keeps the 50 burning. Anyone wishing O. R. S. certificates get in touch with the new D. S. 9CFL. 9EFU heard 2IAO and it has been confirmed. 9EFU was the boy who heard 9AB. 9DHW, 9AYP, 9AVG, 9CCZ, and 9RY are stations opening up for winter. It looks like 9BRD leads the state at this writing.

Traffic: Dist. No. 1: 9AWS, 55; 9EB, 16; 9BNU, 13; 9DJJ, 17; 9DXY, 23. Dist. No. 2: 9BRD 114; 9AFP, 12; 9BIO, 7; 9CEA, 23; 9CCS, 40.

IOWA—In general traffic has picked up considerably the last month and with the newly appointed O. R. S., we should roll up the msg. total. B. A. Beck, 9CZO, has been appointed D. S. of the Western half of Iowa (dist. No. 1) to succeed D. S. Decker. We hope all stations will give Mr. Beck their cooperation.

9CTD is QSO both coasts but will attend college again this year. 9AHH reports that he will be at school this winter. 9DXC is handling his job as C. M. 9CLG helped handle a good share of the traffic at the State Fair station. 9CLG copped the honors by handling 600 messages and 9DJJ of Ames, who was their main outlet, was second with a total of 192. 9BR8 is playing radio and football. 9DIP, 9AYE and 9CLG handled most of the traffic in Des Moines last month. New O. R. S. appointments in this state are: 9DMS, 9CLQ 9BR8, 9JF, 9ATN, 9AED, 9DJJ, 9DAL 9APM, 9BAC, 9BPF.



Traffic: 9DSL, 94; 9DJA, 42; 9CGY, 22; 9HK, 60; 9CS, 10; 9DMS, 24; 9CLG, 600; 9DIP, 89; 9DJJ, 192; 9AYE, 15; 9AED, 8; 9CTD, 73; 9BEW, 34; 9CZO, 77; 9DRT, 80.

MISSOURI—Traffic has not been what it should be for this time of year. All O. R. S's are complaining of heavy QRN as yet. Most every one of the gang are trying to get their transmitters operating on the short waves, but have failed to state their results. 9AAU, 9EKY, 9DVK and 9EKF are doing some traffic work as well as their usual experimenting.

Additional O. R. S.'s issued: 9ACX, 9BKO, 9GEE. 9SS reports B. C. L.'s commencing to kick on high harmonics from amateurs using 75 meters during B. C. L. hours, and notes that these seem all to be directed against stations using more than one oscillator tube in the transmitter. The R. I. says stations complained of would better QRT as before until their sets are operating better, otherwise, quiet hours will be clamped down again. Nothing seems to be done in the way of compelling better sets in the B. C. L. class—they can use anything and the amateur must do all the sidestepping. Somehow short waves begin to lose their appeal in the face of such statements.

Rumors are current around E. C. that O. M. Turner, former D. M., is to be a Deputy R. I. in this neck of the woods, but we have not seen him for a long time so cannot confirm the rumors.

Ham visits are the order of the day. 9BLG of St. Louis paid a visit to K. G. recently and saw practically every station in town.

Traffic: 9EKY, 25; 9EKF, 15; 9DWK, 14; 9BRU, 13; 9AAU, 10; 9BLG, 6; 9DXN, 5; 9BKK, 53; 9BKO, 12; 9ADR, 29; 9CDO, 20; 9CYK, 11; 9EAO, 10; 9DIX, 51; 9CKS, 11; 9RR, 13; 9IB, 1; 9ZD, 11; 9DAE, 8; 9RR, 1; 9ZB, 8.

NEW ENGLAND DIVISION

I. Vermilya, Mgr.

MAINE—The prospects for the coming season are very promising in this state. The Traffic Dept. has been reorganized and is working perfectly. The following D.S.'s have been appointed: 1PD, Dist. No. 1; 1BTT, Dist. No. 2 and 1AUC, Dist. No. 5.

Emergency storm routes are being worked out on the Maine Central R. R. and this will be extended to the Grand Trunk Traffic routes are also being worked out.

1CRU is still experimenting with Master Oscillator on 80 meters. 1BTT is on for traffic every morning from 2:30 to 7:00. 1PD is on 75-80 meters.

1CKP, ex-9AES, 1APM, 1ASR, 1KL and 1KX were among those at Wiscasset to welcome WNP. 1MO-1XW were located at Wiscasset for a couple of weeks and while there worked 1HT 300 miles off the coast of Brazil. 1HT was audible 2 feet from phones with 1 step audio. The antenna used at 1XW was about 30 feet high and 70 feet long with counterpoise the same dimensions.

NEW HAMPSHIRE—Mr. B. Stevens formerly A. D.M. for the state has resigned and Mr. C. R. Sawyer, 1GL, has been appointed in his place. Due to the appointing of a new A.D.M. the report is rather small this month, but next month we will announce new relay routes where messages will be delivered within 24 hours.

1AVL was heard by CB8. 1BZP, using four 5 watters, worked two-way in daylight with Porto Rico 4SA.

VERMONT—With the end of summer, the stations with ops home for the summer are closing down, and 1ARY and 1YD college stations are back. The gang are trying short waves more and more all the time. 1FN's antenna came down when the rope broke. The result will be a new antenna and loose coupled set. 1BDX with 50 on 150 meters, takes the prize this month for traffic and DX both. 1AJG and 1CPO have both been doing fine on 76 meters. 1ARY has hopes of improving this winter as the college has just put in a BC set to go with it. 1AJG finds that short waves solve the delivery problem.

RHODE ISLAND—1AD, our YL, and Acting D.S. sends us an excellent report as usual. She is installing a new aerial and counterpoise. 1CAB is back on the air after a long absence, both he and 1AEI are the latest O.R.S.'s, and good ones too. 1II is back from Europe and is packing up the set for college. He reports logging 14 American stations on one morning in Italy, making a total of 30 all together during the trip. 1ABP has put up a new counterpoise. Our new station, 1QV, is sure doing some fine work. He has raised his aerial and is stepping out fine. 1AAP and 1BVB are getting

ready for the low waves. 1BVB with the help of 1AJT of Norwich, Conn. (who is a wizard at building tuners) has constructed a tuner that tunes to 3 meters and by changing coils can go to 20,000 or higher. 1BQD is going good on a 100 watter.

CONNECTICUT—The past month has been one of getting down to 80 meters and at this writing 1MY, 1CKP, 1CPV, 1AVJ, 1IV, 1AJP, 1MO, 1FD and 1APC, all new O.R.S. men, can be found between 75 and 80 meters. The sigs. down there are certainly great. 1CTI and 1BIJ are new to our O.R.S. ranks and are both competent fellows. 1MO has returned from Maine where he had his station erected for special contract with WNP. Some fine work was done through this station and fast relay service was accomplished thru 1MY at Hartford and 2BRB at Brooklyn, N. Y.

EASTERN MASSACHUSETTS—Things seem to be opening up quite a bit. Although the traffic report is not very large more stations seem to be reporting and handling same. 1AAC is on 75-80 meters, exclusively now. 1AIR lost his aerial during a storm. 1KY our YL operator, is maintaining her own with the traffic hounds. 1BZQ's operating hours are 12:15 to 1:00 P.M., 6 to 7:30 P.M., and 11:30 to 1:00 A.M. He has not been able to maintain any schedule as he has been having very severe power line QRM. 1ALL is rad. 4.2 amps on 150 flat, with 100 watts, and is QSO everywhere 1LM collected all msg's. in sight but traffic light. As 1CJR is going to school this winter he won't be on much. 1SE (O.M.) reports that quite extensive rebuilding is taking place in and around Attleboro. 1AVP is another expounder of the short waves—on 76½ meters. 1ZW is still at a standstill this month. He hasn't had much time to operate as vacations and his wife's illness have taken most of his time. 1FP reports hearing WNP the last month. 1DY expects to get on pretty soon with the ole stone crusher.

WESTERN MASSACHUSETTS—Dist. No. 3: 1-ARF is shut down at present and will probably be away at school this fall. 1ARE is on somewhat and expects to be on regular this fall. 1BBO has returned to Harvard College, where he is Secretary of the Wireless Club.

Dist. No. 4: One new O.R.S. has been added to this district, 1ABF. This station is doing some fine relay and DX work. 1AIN has been enjoying a vacation but is now back and getting out fine. 1BLU has installed storage batteries for plate supply and is now working on a Master Oscillator with a coupled Hartley system. 1BSJ will be on this fall. 1PY is heard often and handles traffic regularly. 1CBH is on at times. He also operates at 1XAE. 1JQ is not in operation as yet. 1IL is now back and will be moving traffic. 1EO will be on soon. 1AWW is on with a new 100 watt set and was logged by Huddy in Florence, Italy, Aug. 20th on one tube. 1VU is a good relay station and handles traffic well. 1BVR is returning to college. 1CVS, the Eastern States Exposition station, was handled by 1AAB, under the auspices of the Junior Achievement. 1AAB is from New Britain, Conn. 1ON will be on the air again soon.

Dist. No. 5: The only active station in this section seems to be 1RIZ. 1CI is off, having returned to college. 1KC is seldom heard. 1ADU has reported that he is operating a 5 watt spark coil C.W. set.

Dist. No. 6: 1BOM is the only active station in this district.

Dist. No. 7: There has been two new O.R.S. appointments in this district during the month. 1DB and 1BQK. 1DB worked S. S. Arctic (VDM) Sept. 18th, taking 3 messages and a position report. 1AQM is back on the air. 1AAL one of the new O.R.S. is getting out fine and moving traffic. 1ASU has recently joined the ranks of the "Benedict." 1JV has not been operating during the past month. 1RV is moving traffic. 1ZF will have a 250 watter going soon. 1BQK is on 75-80 meters. 1DE ex-1BYN, will be away at school. 1AOU-1ZAC is on again. 1AKZ is handling traffic well through Gardner. 1BCU has the high total for messages in dist. No. 7, having handled 46 during the month. 1BAL is reported to have a fine operating room and a good antenna. 1VE is heard often. 1BBP is

a five wire and is president of the Massachusetts Radio Assn. The following stations have reported that they will be glad to make traffic schedules. Other districts and A.D.M.'s please take notice. 1ABP, 1BZ, 1AIN, 1ASU, 1DB, 1AAL, 1BBO, 1AQM and 1AWW. Traffic: 1ACO, 22; 1ALK, 1; 1APM, 6; 1AUC, 4; 1AUR, 15; 1BHR, 28; 1BTT, 42; 1FM, 15; 1KX, AXQ, 30; 1PD, 8; 1VF, 2; 1AER, 15; 1ATJ, 14; 1AVL, 15; 1B4F, 68; 1BTF, 15; 1BZP, 5; 1GL, 5; 1AVF, 21; 1AIR, 15; 1SE, 23; 1AHL, 6; 1NT, 3; 1ALL, 23; 1LM, 26; 1PP, 12; 1BZQ, 22; 1CJD, 44; 1AKI, 23; 1AFS, 13; 1KY, 22; 1GA, 16; 1RR, 41; 1AAC-ZD, 16; 1CTD, 14; 1CJR, 55; 1AQL, 9; 1ARE, 13; 1BBO, 31; 1ABF, 3; 1AWW, 50; 1BVR, 18; 1LL, 37; 1PY, 15; 1CVS, 4; 1BIZ, 67; 1AAL, 18; 1AJK, 18; 1AGT, 35; 1AKZ, 23; 1AOU-ZAC, 9; 1ASU, 29; 1BCU, 46; 1BP, 41; 1DB, 36; 1DE, 29; 1UM, 4; 1ZP, 5; 1RV, 33; 1ARF, 1VU, 30; 1IV, 11; 1CTI, 15; 1AJP, 15; 1PA, 4; 1BLJ, 5; 1AJT, 11; 1FD, 6; 1AYT, 5; 1AVJ, 8; 1CKP, 10; 1AWY, 4; 1AYR, 4; 1CPV, 29; 1MY, 132; 1QW, 15; 1GV, 25; 1BIE, 11; 1BCC, 27; 1AWV, 22; 1AEL, 28; 1AD, 58; 1QV, 31; 1AAP, 44; 1BVB, 46; 1BDX, 52; 1FN, 12; 1CQM, 16; 1AJG, 24; 1AEX, 1.

NORTHWESTERN DIVISION

Glenn E. West, Mgr.

Activity in the Northwestern Div. is now back to normal. The weather has cleared up now and nearly all of the old timers are back at it, with a goodly sprinkling of newcomers. The past month has been a record month for the amount of experimenting done. Almost every station in the division has invaded the lower waves with one kind of transmitter or another. Traffic totals are necessarily low due to this unusual amount of experimenting and rebuilding. The band between 75 and 80 meters is about the busiest strip of ether in the universe.

Washington—Conditions have been good for DX especially on the lower waves. TFD has repeatedly worked all districts on a single night. He is on 78 meters. 7GR is doing the same thing with one five watter. Traffic figures took a jump in the right direction this month, with 7QC at the top and 7GP a close second. 7GP has been using the 40-43 meter waves and reports very favorable results. Many of the gang are having trouble getting their transmitters down to the short waves. 7WS is now going under 3 calls, 7WS, 7ZZ and 7PM. The R. I. visited at Aberdeen a short time ago. 7NO is back at his key again. He couldn't stay away after he got that report card from Samoa. OM 7BJ has been experimenting with the low waves. 7DM is still kicking out fine. 7LX handled a few messages. 7QC handles traffic direct with 1st. and 8th. dist. stns.

Traffic: 7QC-123; 7GP-102; 7RY-85; 7GE-ZX-68; 7SF-60; 7NO-56; 7BM-40; 7GR-33; 7CA-30; 7NW-30; 7PZ-18; 7BJ-16; 7IX-16; 7DM-16; 7IH-14; 7WS-12; 7LH-10; 7FD-5; 7ZZ-5; 7AFB-4; 7SH-4; 7PM-4; 7KV-4. 7GX-8 Total 763.

IDAHO—Our old friend 7LN has gone East to college. All the gang join in a hearty "Thank You" for the faithful services he rendered as D.D.M. Mr. Kenneth S. Norquest, 7OB has been appointed as new A. D. M. His first report is as follows: 7AHS handled 29 and is in line for O. R. S. 7ACE of Huhl is on consistently and has a new O. R. S. certificate. 7CX has a dandy new 80 foot tower and is rebuilding his set for the winter. 7GW increased the power to 10 watts and blew his plate transformer.

7IO is always very GSA—7OT has been experimenting with short waves and says they are F. B. 7SI the only YL in this district has a fine flat top aerial swinging from two 50 foot sticks. She will be on the air soon so QRX men!

7LN is going to college in Kansas. He shipped his stuff and will be QSO Idaho next winter. 7IU has also gone to college and taken his set with him. 7PX and 7TB sold out. 7OR is dismantling and combining with 7RQ. They will have a regular HE station. After a whole year of silence 7YA is back with 100 watts and B-Battery supply. Five ops have reported for duty. 7RQ has a nifty 60-foot

lattice mast, which will support the best antenna in the Northwest. Everything will be "LOW LOSS" from the enameled aerial wire and glass insulators down to the receiving coils.

OREGON—New ORS certificates have been issued to 7AEK, 7AIP, and 7LR. The season has again come into full swing with many new stations and all the old ones "dressed up" in their new Winter "fixins". Nearly all the old standbys have fell-to and are on the air with the new short waves. The way some of the fellows are kicking out on 80 meter at practically every relay station. In Portland what the short waves will do for us later in the season. Another good sign is the evidence of a wave-meter at practically every relay station. In Portland 7AV and 7GV have been taking most of the Coast traffic Fb. Eastern traffic from Portland is moved thru 7AKK on 80 meters. 8LQ, 7AEK, 7AIP, and 7LW are also handling traffic. In Eugene most of the fellows are tuning their transmitters on 80 meters—7GQ, 7LR, 7SY, and 7IW. 7LR is back for the winter to pound brass at home after a strenuous (?) summer pounding brass in Alaska. In Medford power. 7FR-ACM works a schedule with 6ALS of Hawaii every Saturday night, so give him your Island messages.

Traffic:—7MF39; 7ACM-FR, 70; 7TQ, 7; 7IS, 4; 7GQ, 4; 7AV, 39; 7GV, 86; 7AKK, 67; 7AEK, 41; 7AIP, 9.

MONTANA—Not much traffic has been handled during the past month. Several of the old gang have left for college, while others have been rebuilding their sets to work on the shorter waves. 709 is now the most consistent station in the state. He is on about 170 meters now. 7ZL our ADM has been away most of the summer but reports hearing lots of DX on short waves. Both 7ADJ and 7AGF are attending college at Bozeman. 7NO is away on a tour of the state and will visit all ham stns. 7ACI is getting ready to move away. 7ZU has been down on 75 meters but reports no unusual results.

ALASKA—Most of the summer residents have left for the states and with them have gone a good number of operators. 7AEB is still working and is QSO the states regularly. He works 7NO on schedule and will be glad to have any traffic for Alaska.

PACIFIC DIVISION

M. E. McCreery, Mgr.

CALIFORNIA—Dist. No. 1; Traffic has taken a big slump this month due to vacations. QRN, remodeling of stations, etc. 6ALK will not be on this winter because of school. Traffic: 6CDV, 5.

Dist. No. 2; Traffic in and about Los Angeles is holding up exceedingly well. The actual amount of traffic handled is an increase over previous months. Many of the gang work well into the fifth and ninth districts and occasionally the eighth. 6ZP and 6AAO sent in excellent reports. Several of the old stations are coming back on the air after having been off for a few months. The high point stations in traffic handling were 6BRF, 6CGW, 6AFG, 6PL and 6IH. 6IH is a new O.R.S. and he rates with the leaders the first month. 6AFG is 18 miles from Los Angeles and does splendid work without QRM. 6MH is on the air again going strong with a 50 watter. 6PL and 6MG have gone to Victoria, B. C. on a short trip. 6AAO-6CHV has been trying to put up a 70 foot pole that will give his signals an additional wallop. 6BEG is on the air once more and works everything west of the Rockies. 6TS was trying to get down to 80 meters when his tube went soft. 6AHD is having trouble with his power supply. 6AGK had done good work with his since up to this month. 6AKQ expects to have a 50 watter soon. 6CAE's report slumped because of a Y.L. 6CGW is going to college in the fall, but 6MV will be at his station as chief operator. 6CNH is going away to school. 6QJ is moving to Pasadena. 6AJD is all set to use the new short waves. 6RN has been at ICUE all summer but expects to be back by fall.

It's rumored that 6ALF is going to take on a permanent O.W. soon. 9AER has been in Hollywood all this summer. 6BLS sold all his stuff as he intended to go away. He didn't and is now S.O.L. 6BBQ has been up the state on business. 6ZP says the QRN is bad over his way which accounts for the small amount of traffic handled there. 6BNY blew his tubes and is waiting for more. 6PL finally gave up the ladies for the set. 6BLW is on with 10 watts in a Meissner circuit. 6AJI has been laid up with the smallpox but he has been up and around of late. 6US is on temporarily. 6ZP is being rebuilt. 6ZH was in Los Angeles. 6CDY reports his antenna and pole a total wreck. 6PC is a speed cop. His one delight is to pinch B.C.L.'s. Traffic: 6BRP, 106; 6CGW, 97; 6AFG, 76; 6PL, 63; 6IH, 55; 6AAO, 44; 6MH, 32; 6AJI, 29; 6CMU, 25; 6CAE, 24; 6CDY, 22; 6BBO, 16; 6CNH, 14; 6APW, 10; 6AKQ, 10; 6CIA, 7; 6CHZ, 7; 6US, 5; 6NB, 3; 6BLW, 3; 6AJD, 3; 6CBB, 2; 6CGO, 103.

Dist. No. 3: Traffic has been somewhat slow in this district, but things are looking brighter now. 6CGD was off on a vacation. 6JJ has been on regularly and is establishing a schedule north and south. 6CDG will not be on regularly until October. 6ZBT and 6CMD are on regularly and moving traffic. Traffic: 6JJ, 32; 6CDG, 20.

Please note the change in the dates for the convention to be held in Modesto, Calif. The convention to be held on November 7th, 8th, and 9th, and three officers from Hartford will be present.

The following O.R.S. appointments have been made in districts No. 4, 5, and 6, inclusive. 6BW, 6RY, 6CCT, 6BUY, 6CLB, 6ZCA-ALX, and 6BON. S. Wymar, Route 4, Box 15, Turlock, Calif. has been appointed C. M. for Stanislaus and Mercer counties.

Dist. No. 4: 6LV is remodeling for 80 and 150 meters. 6CLV is now using 10 watts on 150 meters. 6ALW is using 10 watts but will have 20 soon. 6CIE just added another 5 watt and is changing his circuit to 4 coil Meissner. 6CEI is remodeling his set. 6CFT is using 50 watts. He just put in a coupled Hartley. 6CTE was reported in all districts except the first, during July and August. 6BCL has just put in a coupled Hartley and is QSO Hawaii. 6NX was one of the first stations on the coast to go down to 30 meters, and he has schedules with 9CIP in Minnesota every night at 7 P. M.

Dist. No. 5: Not much traffic handled this month on account of the two-way Trans-Pacific tests. Reports are also very slim. 6BBS had his call changed to 6BHP and is moving to Berkeley to attend U.S. 6HJ reports things going along fine this month. 6CKC is still busy printing cards. 6AUT is busy courting so has no time for radio. 6BFY and 6BPV are still taking the YL's out so they are off the air. 6CNT will be on again soon. 6CLS says not much doing on account of QRN. He raised his aerial and expects to do much better next month. 6RY is still doing F.B. 6BQL will be on again soon with that 4 coil Meissner. 6CMM is still doing fine. He is moving to Palo Alto next month to attend Stanford University. 6BAA fractured his right arm so will be off the air for a while. 6AWW is on the air again after being off for a long time. 6AOU is getting out F.B. on 150 meters, using a 50 watt. 6VF is doing fine business and handling his share of the traffic. 6CPW finally managed to get another drain-pipe mess up and it sure looks fine. 6CHL has finally completed his antenna system and with his 100 watt set has done remarkable work this month. He worked the Atlantic coast. 6AWT is ready for all the eastern traffic. He has worked the Atlantic coast several times this month. 6IP is still under construction and will be on soon. 6ZX just got his 50 perking and will have another op. on. 6AFZ. 6AEA blew a 50 watt and is looking for a 5'er. 6ALX's transmitter is out of commission, but he will be on soon. 6AMO blew a 50 and is doing better DX with a lone 50 watt. 6AVH is using 10 watts of self-rectified. 6ACF is teaching now in Northern California. 6BW is back in the game again after a long absence. 6RHW will be on with a 50 soon. 6RIP is putting the finishing touches on his 4 Coil Meissner. 6BMV has joined forces with 6CGL and will be on with a 50 watt soon. 6CCT

is trying to get a 50 watt going. 6FG lost his antenna but is putting up a 70 ft. mast. 6CGL has gone to sea. 6CLB is rebuilding his station using coupled Hartley. 6COG will be on soon with 10 watts and a new antenna. 6NH is getting out 10 on 10 watts. Old 6AMV and 6IK are coming back on this winter. 6BFU and 6ASN handle most of the traffic through Berkeley. 6CLZ says everyone says QRU. 6AJF complains of a Power leak that ties up his receiver completely a 9 tube super and it sure percs. 6CKC and 6AJF expect to be on 80 meters soon. EX 1CTP has an 80' lattice mast up now, but as his apparatus has not arrived from the East yet he is unable to sign a "6" call as yet. 6CEU is going back to Honolulu because he wants to break CB8's DX record.

Traffic: 6LV, 74; 6CJV, 18; 6ALW, 52; 6CIE, 4; 6CFT, 8; 6CTE, 28; 6BCL, 5; 6CHL, 20; 6RY, 10; 6AWT, 40; 6CMM, 63; 6HJ, 12; 6BQL, 3; 6BAA, 1; 6AWW, 5; 6AMS, 9; 6BFU, 29; 6CSL, 1; 6CSN, 1; 6CW, 5; 6CLS, 10; 6AMO, 66; 6AVH, 22; 6BHW, 9; 6BP, 2; 6BMV, 6; 6CCT, 36; 6CFG, 18; 6CLB, 17; 6CQG, 3; 6NH, 27; 6BFU, 70; 6CLZ, 2; 6BUY, 1; 6CDP, 2; 6CKC, 8; 6ASN, 34; 6CU, 4. Dists. No. 7 and No. 8: Organization in these two districts has been completed, but no traffic was handled on account of stations rebuilding and waiting for authority to work on 85 meters.

HAWAII—7FR takes the honors to be first coast station to work through Honolulu, Oahu direct. He was QSO with the best station 6ALS operated by 6BFD, 6ASR, 6TQ and Wilder. It is noticeable that stations working between 150 and 160 meters are received with better signal strength and less QRM than those working around 200 meters. To date, Hawaii has not been able to pick up signals from Australia or New Zealand. Local transmitting station have been reported as QSA by N.Z. Traffic: 6ALS, 1.

ARIZONA—Old 6ZZ now 6FP, has been prevailed upon to still hold Arizona down.

ROANOKE DIVISION

W. T. Gravelly, Mgr.

Well, the division is shot to pieces again trying to get down on the low waves, but those using them report success and good DX. While the thing is not old enough to tell much about it possibly better reports and better traffic handling can be done.

We regret to announce the death of Herman Vandenberg, 3BEX, caused by accident received while swimming. The whole gang wishes to express sympathy to the family.

Under the new regulations, only those stations holding membership in the A.R.R.L. and O.R.S. certificates will be represented in this report. Be governed accordingly, and if you want to be in the line-up, get the O.R.S.

3CKA reports 16 messages handled which is good daylight work on a lone five'er. 3CKK reports 16 also, and 3PI 9. 3BBT and 3TU have gone to college. 3BMN handled 18 messages. 3AUF is working on 80 meters now and building up a first-class lab. for the gang's use. 3ABS has his MG now and is on 75-80 meters. 3ATB has a 10 watt on 75-80 meters. 3RVL handled 7 and had to close up and go to school. 3BGS reports too much changing of waves for much traffic, and he is fixing up for 75-80 meters. 3FX closed up and is off to college. 3LX is in the same boat. 3BFE handled 14 and works on 80 meters with a 50 watt. He worked all districts one night and reports low waves F.B. 3CKL covers a good DX with lone 5 watt, has a good note and says ND on 75-80 as he don't want to lose the note in changing around. HI. He handled 30. We expect 3DT back on the air now with a flock of operators. 3BZ on 75-90 meters now and sent one CQ and got 13 answers and four bushels of cards. He handled 5 messages. D.S. Beck reports his gang as getting down and expects big report from him next month. 3ASE has 4 transmitters, a 10 watt Meissner, 20 watt Hartley, 100 watt Hartley and 1000 watt self-rectified, using two 500 watt bottles. SSP is on 75-80 meters, and

has a 73' copper mast for aerial. SDOI has handled some traffic 10 in all. 8AMD is on constantly and doing good work. He handled 34 msg. SDSA, a new station, is arranging short wave schedules and handled 15. 8BJG has a sore spot for those "birds" that will not QSR. 8ZW has gone to college and the station is closed. SATP handled one and 8CXM 17.

NORTH CAROLINA—No report has been received from the A.D.M. this month, so we are unable to make much of a report of the activities of the individual stations.

Dist. No. 2: 4MI is frequently heard on the air.
Dist. No. 3: 4TJ and 4JR are the live wires in this district.

Dist. No. 4: 4BX, 4RW, 4UN, 4RI, 4FT, 4EA, and 4SIJ are on more or less consistently and handling traffic.

There are only six O.R.S.'s in North Carolina at present, namely, 4BX, 4RW, 4JS, 4UN, 4TJ and 4JR. These stations hold the new certificate and are backing the A.R.R.L. to the best of their ability.

In the future only activities of those stations holding the new O.R.S. certificates will be reported, and anyone desiring one of these certificates may procure same by complying with the regulations and sending in an application properly made out. Blank applications may be had from the D. M. if the A.D.M. hasn't furnished you with them.

ROCKY MOUNTAIN DIVISION

N. R. Hoed, Mgr.

COLORADO—Stedman, 9CAA again leads with the most messages to his credit. 9AM rates second place with 60. 9EFY, a new O.R.S., has been on and put through 20 as a starter. 9BUN, 9BTO and 9EEA have all put through small bunches of traffic. The above are the only stations in the Denver district to report.

Dist. No. 1: 9BVO is the only station reporting from this district.

Dist. No. 2: Again, 100% report from this district! The news most notable in this district is that the D.S. stepped off and was married. 9CHT leads in the district with 34 to his credit. The station of the D.S. comes second with 21. 9EAE, 9DFH and 9CDE have all been on fairly regularly and have moved traffic. The entire state is rebuilding which accounts for the small amount of traffic. 9AMB has a new low-loss antenna up which is favorably looked upon by most of the hams in Denver. 9EEA is installing the same. 9EFY, the new O.R.S., is a new comer from Chicago. 9BXQ has installed his set in a desk but no report as to its working abilities. Traffic: 9AMB, 60; 9BUN, 3; 9CAA, 93; 9EFY, 20; 9BVO, 5; 9CDE, 18; 9CHT, 25; 9CLD, 34; 9DFH, 8; 9EAE, 21.

UTAH—Dist. No. 1: 6CJB is not yet in his new location so activities are curtailed. 6RM and 6ZT are moving their stations and have been off the air. 6BUH, with a new 50 watter, put through 6AJA handled 28. 6FM put through 14. 6ZT and 6CJB have applied for all the waves in the new regulations. The experimental license of 6ZT has been cancelled. 6XBE. The above stations are the only ones reporting in this district.

Dist. No. 2: Several of the stations from this district have been dismantled, due to their operators leaving for school at Salt Lake. However, we expect a good station at the Provo University which should be on the air soon.

Art Johnson, 247 East 7th South St., Salt Lake City, has been appointed A.D.M. for the state. Give him your support and let's make Utah fly high. Rulon Bidulph, Provo, has been appointed D.S. for Dist. No. 2.
Traffic: 6CJB, 10; 6FM, 14; 6AJA, 28; 6BUH, 42.

WYOMING—Dist. No. 1: 7AJT is now on low waves with a new set.

Dist. No. 2: 7HW at Laramie reports radio activities at the State Fair at Douglas has taken his time this month. Rebuilding the set after the display is now in progress and he will be on the air shortly.

7ZO has been rebuilt, but at this writing is not ready for traffic.

The Radio Inspector, O. R. Redfern, passed through the state early in September and gave all the stations the once-over and passed out the exams. to the applicants.

SOUTHEASTERN DIVISION

H. L. Reid, Mgr.

SOUTH CAROLINA—Winter is here again and with it better DX. 11I, while touring Italy, heard 4DX twice on detector alone. Getting cards from sixes is old stuff with 4PV since he put up a new antenna. 4RR-4VL is on 75 meters with 30 watts input. 4DX and 4SH are at college now.

Traffic: 4DX-4SY, 206; 4PV, 13; 4PR-4VL, 18.
ALABAMA—Active operation in Alabama seems to have apparently slowed up during the past month. This can be attributed chiefly to the arrival of the good news regarding the new low waves. Most every station is attempting to get down on the low waves.

A total of 138 messages was handled for the month. Dist. No. 1 leading with 99 messages and district No. 3 following second. 5AMH noses ahead this month by only one message.

Dist. No. 1: 5ACM handled 32 messages for the month. 5WB is showing some activity but is handling no traffic. 5AMH still leads the Birmingham stations by a good margin. 5VV has deserted his key for football. 5MI can be heard on the air regularly now. 5QP sold his 50 watter and has gone back to 10 watts for better work. 5KU and 5ARI are getting out in fine shape and promise to be consistent stations during the coming season. 5KQ is now working regularly on 78 meters.

Traffic: 5ADA, 5; 5AC, 1; 5ACM, 32; 5AJP, 28; 5AMH, 33; 5AR, 5; 5MI, 12; 5VV, 22.

Dist. No. 2: 5AR's transmitter was badly damaged by lightning recently. 5AOM has returned from camp and is expected to be on the air soon with 50 watts. 5QK was the only station in Mobile actively operating last month.

Dist. No. 3: 5AJP is working now and reports 28 messages for the month. 5WI suffered from the elements last month. A recent storm blew his 90' mast down. 5ADA has just opened up and promises to be a reliable station.

Dist. No. 4: Nothing has been heard from 5XA this month.

PORTO RICO—With the improvement in atmospheric conditions activity has increased among our amateurs. The use of lower wave bands has also aided the situation greatly. 4UR continues his good work and is able to connect with the mainland and almost nightly. 4KT is doing good work with the inland stations at Cayey and Catano. 4JE and 4BJ are handling most of the local traffic while 4OI is silent on account of damages to his station by the recent hurricane. 4BJ seems to have a monopoly of all Calle Cristo traffic. A new station will be installed at Mayaguez on the western side of the Island.
Traffic: 4JE, 21; 4KT, 12; 4BJ, 27.

WEST GULF DIVISION

F. M. Corlett, Mgr.

Only 57 stations reported handling traffic in this division this month with the small total of 739 messages.

OKLAHOMA—Oklahoma hams were slow and negligent about reporting for this month. 5APG leads the traffic with 34 messages handled. 5CE comes next with 20. 5ANF handled 5 and 5AHD, the fourth and last ham to report, handled 2.

Note: Reports are to be sent to C. E. Whartenby, 5ZM, at Enid, who is A. D. M. for this state, not later than the 18th of each month.

NORTHERN TEXAS—With the coming of the cooler weather this month, DX working has been greatly improved. Many stations are taking advantage

age of the new opportunities on the low waves. New O. R. S. appointments have been issued to 5DW, 5AHC, 5ALI, 5VU, 5FC, 5UN, 5XAJ, 5AKN, 5CV, 5FA, 5AJH, 5ALD, 5AMB, 5JF, 5SD, 5QW, 5PH, 5CT, 5AGH, 5ADH, 5AVD, 5TO.

Traffic: 5ANA, 6; 5NW, 20; 5AMB, 9; 5DW, 10; 5LI, 11; 5JH, 2; 5AJT, 12; 5VU, 23; 5ALI, 23; 5FC, 21; 5JF, 16; 5AMG, 7; 5UY, 8; 5PH, 30; 5UO, 75; 5AEP, 42; 5UN, 4; 5XAJ, 46; 5AJH, 64; 5AKD, 24; 5OQ, 20; 5PN, 4; 5AKN, 51; 5CT, 4; 5HY, 40; 5MZ, 47; 5AQC, 1; 5QL, 2; 5BD, 35; 5AGQ, 10; 5CV, 9.

SOUTHERN TEXAS—Activity is still slow in this section of the country. QRN and the rebuilding of stations is still in progress. There are several promising stations coming up and O. R. S. certificates are fast being issued to deserving stations.

E. A. Sahn, the A. D. M. and L. L. Wall, the D. S. met with the San Antonio Radio Club and explained the obtaining of O. R. S. certificates. The club is very much alive but will suffer heavily by losing some of their best stations due to owners going to college. Southwest Texas is showing signs of renewed activity as is also the El Paso section. Thus with several promising Austin stations we hope to have a good network of relay lines.

Those who have not yet received O. R. S. certificate and feel that you meet the requirements, please apply to your D. M. at once. Don't get im-

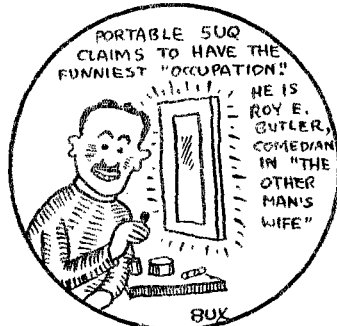

patient if you have to wait a bit—we are turning them out as fast as good sense will permit.

Traffic: 5XAQ, 1; 5XAV, 1.

CANADIAN SECTION

A. H. Keith Russell, Canadian General Manager

Another great month for Canadian Radio has just come to an end. At the first of the month the Department of Marine and Fisheries, Radiotelegraph Branch announced that all Canadian amateurs were empowered to use the short wave length bands similar to those in the United States. The regulations covering the use of these bands are not so stringent as in the States insofar as any licensed amateur is entitled to use these waves at will in addition to his other assignments and no restriction is put on the use of closely coupled transmitters although the Canadian General Manager and the rest of the traffic Department requests all amateurs in Canada to use coupled transmitters to avoid any chance of interference with the broadcast listener. All ready several amateurs in the division are operating on the short waves and reporting greatly extended range. The thanks of every Canadian amateur is due to Mr. Edwards and the Radiotelegraph Branch for this extension of wave lengths.

The steamer Arctic, with Bill Choat as operator, landed in Quebec on the 24th of September after a very successful voyage both from a radio and exploration standpoint. During the latter part of July and the first part of August little communication was had but around the end of August, while the Arctic was still well within the Arctic Circle, communication was again established and was maintained with more or less regularity until the Arctic's return to Quebec. The lessons of this trip will

no doubt impress themselves both on the Canadian amateur and the Radiotelegraph Branch of the Department of Marine and Fisheries and the Department of the Interior and we think it extremely likely that the Arctic will always carry a short wave amateur set in its future annual trips to the North. The amateur has proved his right to the use of the ether in the service he has rendered the Government in this matter and the Government has responded to his valuable service by issuing permission for future experiments in the lower waves.

Negotiations with a view to a convention in Winnipeg this fall have ended in a failure due to the refusal of Winnipeg amateurs to assist in the preparations for a convention in that City. The Canadian General Manager wrote to the active Winnipeg A.R.R.L. members asking them if they would assist. Only one reply was received and that reply was a refusal of assistance. However plans are still going forward for a meeting of the C. G. M. with the five division managers in the West this fall and full particulars will be given from our broadcasting stations and by mail so that those desirous of attending this meeting can be present. The C. G. M. would like all amateurs who can be in Winnipeg on or about the 1st of December to write me for details of the meetings.

In concluding this month's report the C. G. M. would like to impress upon all A. R. R. L. members in Canada the fact that

(Continued on page XV)

Calls Heard



IMPORTANT NOTICE

When preparing a list for QST, it is essential to observe the following rules:

1. List the calls neatly on a separate sheet of paper with a line of space between lines; do not embody them in a letter.

2. Arrange the calls as they will appear in QST: across the page numerically by districts, alphabetically in each district, Canadian and foreign calls listed separately, state whether spark or C.W., and give period of time covered by the list.

3. Forms close on the fifth of the month preceding the date of issue of QST. Make your lists cover the period from the first of the month to the first of the next if possible, but don't let your list come in late.

4. List only calls over 500 miles distant.

HEARD DURING SEPTEMBER

unless otherwise specified

G2SH, 34 Bishops Road, Highgate, London, Eng.

1aac, 1aal, 1ahm, 1ajg, 1ajp, 1all, 1apc, 1boa, 1bsd, 1are, 1bvt, 1bza, 1bzz, 1ccx, 1cll, 1cln, 1co, 1cpe, 1cpr, 1cpv, 1pm, 1sf, 1xae, 1xak, 1xw, 1yb, 2agb, 2bro, 2bu, 2cu, 2ek, 2pd, 3adp, 3bga, 3btu, 3bra, 3cbl, 3od, 3rs, 3vw, 4fs, 4rr, 4sa, 4ye, 4zd, 8avl, 8ccq, 8ccr, 8cyl, 8gz, 8mz, 8ab, 8pl, 8va, 8vz, ncf, Canadians; lar, 2ag, 3ba.

G5US, 5 Elm Grove, Burely-in-Wharfedale, Yorks, England.

1bgq, 1bbo, 1blb, 1bkr, 1cln, 1cpe, 1co, 1fd, 1ze, 1yb, 2ev, 2gk, 2xq, 3ajd, 3bg, 3bp, 3oq, 4nf, 4in, 8nb.

G5BV, Wimbledon Park, London, England.

1all, 1awm, 1bge, 1bwi, 1bsd, 1cmp, 1cmx, 1er, 1iv, 1rw, 1uh, 1xah, 1xak, 1xam, 1xaq, 1xar, 1xi, 1xw, 2uwl, 2agb, 2bj, 2bs, 2bse, 2bqh, 2btp, 2bum, 2by, 2fp, 2co, 2ru, 2wa, 3bdo, 3buc, 3ot, 3yo, 4ft, 4ny, 5up, 8aib, 8aoc, 8hn, 8hv, 8tt, 8vj, 8uf, 9aau, 9eky, 9uz, 9xw, Can. lar.

G6LJ, London, N. W. 6, England, Sept. 21 only, one tube.

1aal, 1abt, 1ajg, 1ajp, 1all, 1apu, 1axl, 1bfg, 1bjo, 1bkr, 1boa, 1gv, 1yb, 2aay, 2ajc, 2bju, 2brc, 2brd, 2by, 2byc, 2ca, 2cgl, 2crr, 2ctg, 2cxa, 2gk, 2gc, 2mu, 2vd, 3ajd, 3br, 3bof, 3bct, 3bva, 3cbl, 3cbb, 3ic, 3kd, 3oq, 3wb, 4tl, 5tr, 8bpu, 8ccq, 8clc, 8cnw, 8cyl, 8dme, 8dn, 8kr, 8pl, 9bqu, 9dqu, 9dwb, ntv, Canadians; lar, 1ie, 1cl, 3bp.

W. Hartley, 3 Cambridge Terrace, Harrogate, Yorks, England.

1asl, 1aid, 1amw, 1bkr, 1co, 1li, 1vj, 1ze, 2aay, 2oq, 3avk, 3bg, 3bk, 3oq, 4sa, ncf, iht, Can. 2bg.

F8EM and 8G0, 45 Boulevard de la Saussaye, Neuilly sur Seine, France.

1aak, 1aal, 1aid, 1aur, 1azl, 1bb, 1bs, 1bep, 1bgc, 1bk, 1bkr, 1igk, 1ii, 1mb, 1mto, 1vi, 1se, 1ze, 1zz, 2zay, 2agw, 2aww, 2bd, 2cu, 2gk, 2hf, 2ix, 2nw, 2nd, 2nud, 2pd, 2qv, 2 rv, 2wc, 2xbh, 2xma, 2xg, 2udp, 2agt, 2ari, 2chl, 2odn, 2ep, 2oa, 2su, 2nf, 2su, 2tj, 2tw 4ke, 4xet, 4zd, 4zy, 5ue, 7zm, 8avl, 8ei, 8cca, 8ef, 8gz, 8mz, 8pl, 8vt, 9df, 9br, Can. lar, r1wj (?) , iht.

F8FJ, Le Blancet, Can B. P., France.

1ajp, 1ajy, 1bdx, 1boa, 1cpe, 1kww, 1ky, 1oby, 1sf, 1xae, 1xw, 2apy, 2brb, 2byw, 2ck, 2cpa, 2erp, 2gk, 2vda, 4al, 4bz, 4fg, 4io, 4ku, 4lt, 4mi, 4su, 4ts, 4oa, 4zd, 5nn, 5lz, 6gg, 7gr, 8cyl, 8gz, 8mz, 8rt, 8pl, 8rs, 8brx, 9za, 9zd, wdz, wgz, wjz, koka, Argentine C68, iht, Finnish 2om, Swedish smzs, amzz, Danish 6cc.

Heard by Major R. Raven Hart, Los Andes, Chile.

1ccz, 1cwc, 1gv, 2cy, 4ft, 4gc, 4iz, 4ue, 4sa, 5na, 5ni, 5zt, 5amh, 6im, 6zas, 6zg, 6cgv, 6dhs, 9aau, 9bmu, 9cee, 9ef, 9eky 9zd, Can. 2go, Australian 3em.

F. C. Worthington, Byron Ave., Takapuna, Auckland, New Zealand.

5aju, 5ajj, 5amh 5do 6abk, 6adt, 6agk, 6alg, 6ano, 6any, 6apn, 6apw, 6ar, 6arb, 6ar, 6arf, 6avi, 6bcp, 6beo, 6bic, 6brf, 6bmm, 6buo, 6hwl, 6cbb, 6ccy, 6cee, 6cgs, 6cgv, 6cmi, 6cmu, 6efz, 6gr, 6gq, 6gs, 6ij, 6ht, 6jic, 6pl, 6qjb, 6rn, 6vlb, 6w, 6y, 7zu, 9amb, 9cca, 9cit, 9dm, 9eky, 9su, Can. 9bx.

Log of CGS "Arctic", VDM, on 1924 Cruise to the North.

July 22, 1924, in Pangnertung Fjord, 3000 ft. mountain surrounding ship, 5xaw.

23rd, cleared Pangnertung, 1cc.

24th, off Cape Mercy, Adx, clar, sak.

27th, n64° 20' w60° 0' whu working 2xbd.

30th, 8dec, 9dvr, 9fp, 9bva, 8bmb, 9cl, 9dfq, 8cci, 9drr, 9chk, 9nj, 9dpp, 9bpu, c4bk, 3oe, 9aau, 1cc.

Aug. 3, 1cmp, 8cci, 8ng, 1cab, 8gz, 8daa, 8ctm, 9dt, 8brf, 3bv, 9ct, 3bc, 8cch, 3cbb, 3co, 8bkh, 2ana, 9dlo, 8ccf, 8cwg, 8bic, 8btl, 8axn, 9vm, 8btt, 8dmx, 8dgo, 9aau, 9zt, 9efz, 8bic, 9bmk, 1ael, 9ds, 1bga, 8dep.

Aug. 5, 9efz, 2le, 3zo, 9beb, 1xw, 9edv, 9xb, 8iv.

Aug. 8, 2bqh, Ser, 3bqa, 1aw, 3dqe, 8cnv, 9dkk.

Aug. 10, clearing Craig Harbour, 1ow, 2co, 9dpx, 9bmk, 2btr, 1axa, 9and, 8dpx, 2btr, 9hw.

Aug. 13, (5 miles from Etah) 9ddf, whu, 2bmr, 9btk.

Aug. 16, (off Cobourg Island) c3rk.

Aug. 17, (off S. End Cobourg Island) 8doo, 1gv, 2by, 1bqe, 3brc, 9hf, 8vq, 8ry, c8aa, 1bie, c3rn, 9dbo, 3bay, 9hw, 9bva, 2bq, 9bzj 9ddp, 9dvj, 9ny, 1bie, 8tl, 8cwp, 8dgo, 8btl, c3bg, 6cgv, 8cwp, 8cmf, 9bna, 8tk, 8bg, c4dq, 8czz, 9aau, 8app, 8ry, 8fj, 8cwp, 9amb, 9bkg, 9cf, 7wa, 9cza 8pw, 7rg, 8am.

Aug. 18, (at Dundas Harbour) 9dqu, 1bie, 2bqb, 9ebh.

Aug. 19th, 8xab, wnp, c8co, (at North Devon).
 Aug. 20th, (Dundas Harbor) 3lg, 1cmx, 8wx, 9xw, 9dpx, 1xae, 9rb, 9dip, 9aks, wnp, 9caa, 9dei, 9aka.
 Aug. 21st, (Dundas Harbor) 2pd.
 Aug. 22nd, (Dundas Harbor) 1cmp, 1cmx, 9xw, wnp.
 Aug. 23rd, (Dundas Harbor) 9bnk, 8dpx, 9amb, 9ddp, 8cwr, 9aws, 7ahs, 9bzf, 9aed, 9egu, 9evj, 9egz, 9bia, 9cwp, 9cfi, 9cdv, 9aic, c4da, c4gt, 7co, 9hm, 9dwx, 9ahc, 8ajj, 9cze, 9cwc, 9cov, 8bvd, 8bta, 3gc, c8h, 8ab, 1hu, 2bh, 3cjn, c4cr.
 Aug. 24th, (8vg, 8bit, 1cmj, 1yk, 3cjn, c8gc, 9bmu, 8ab, 9bmu, 1gv).
 Aug. 25th (Dundas Harbor) c4cr.
 Aug. 26th, 2bq, 9edv, 9czi, c8co, 1cmx, 9cms, 9dct, 9ccl, 9bmk, 8sg, 8aww, c8vh, 9bmk, wnp, 6cgw, 7dm, 9amb, 8bc, 1rv, (c4fv).
 Aug. 27th, 2gm, 1rv, (9ddp), (c4fv), 7gr.
 Aug. 28th, (8edc), (c8vh), (c8co), 9aic (near Pond's inlet).
 Aug. 29th, (Pond's inlet) c4cr, (c4dq), (c4fv), (8cf), (7gr), 7av, 7ay, 7af, 6cgw, 9dcw, 9eiv, 9eky, 9xbg, 9dl, 7akk, 7lv, 7it, 5gg, 7ge, 9ec.
 Aug. 30th, (Albert Harbor) 8tt.
 Aug. 31st, (Albert Harbor) (wnp), 6cgw, 7ahs, 9cbz, 8cud, 9shb.
 Sept. 5th, (off Baffin Land), 2cpp, 3bta, 8alf, c8co, (c8gz), 9bdu, 2crp, 6cdg, 9caj, 8art, 7sa, 8xbe.
 Sept. 6, (15 miles from Clyde River) 4dx, 2crp, 8ad, (c8co), 9ecl, c8x9 amb, 3buy, 9cn, 9ehj, 9ctr, 9au, 4fo, 9dfg, 9ap, wnp.
 Sept. 7, (off Baffin Land) 8bln, 8abm, 2bq, 9ccm, 9ayx, 2ccc, c8gg, wnp, 8gr, 7nx.
 Sept. 9, (75 miles s. of Home Bay) 1rv, (wnp), 4tj.
 Sept. 11, (off Cape Mercy) 3oe, 4fg, 8ag, 4af, 2rv, 1ts, 8brc, 8cxm, 9aog, 2rk.
 Sept. 12, (east of Frobisher Bay) 9bsz, 9ry, 9ccc, 9ayx, 8aw, 4dx.
 Sept. 13, (30 miles off Hudson Straits) 4hf, 4tj, 4gt, 9cr, 6cgw, 9vm.
 Sept. 14, (150 miles S. Hudson) c1dd, 1axa.
 Sept. 15, (1-3 way down coast Labrador) 1mo, wnp, 3bco, (c8co), 1all.
 Sept. 17, (off Belle Isle) 1ajx, 1rv, zwz, 1afn, 3yv, (2guy), 1ccz, 1yb, (1db), (1my), 2chz, 8ku.
 Sept. 19, (passed Str. Belle Isle) c8bq, 2amm, (1db), 3bu, (clar), (c8wv), c8mf.
 Sept. 20, (abeam Natashkwan light) (c8afp), (c8vh), (clar), 1ah, (c8co).
 Sept. 21, (c8afp), (clar), (gznm), (8dfm), 2bck, 9dpx, 9eky.
 Sept. 23, (8cvt), (c8afp), (c8vh), (8mv).

Ex-7ZG, aboard S/S Lillian Luckenbach.

Aug. 29th: 650 miles south NYC. QRN very bad. 1ccz, 1bck, 1all, 2bdz, 8bva, 3cdk, 8mi, 8bit, 8do
 Aug. 30th: 975 miles south NYC. QRN bad. 1amv, 2aae, 2bv, 2blm, 2ccc, 2cv, 2vj, 2iw, 2xay, 3auv, 3bco, 3bta, 3eel, 3cjn, 3fs, 3lg, 4af, 4dx, (pr) 4sa, 5nj, 5zai, 8zaa, 8abm, 8bmd, 8bkh, 8cjd, 9au, 9abm, 9vrm.
 Aug. 31st: In Windward Passage south of Cuba. QRN bad. 1ahm, 1apl, 1gv, 4af, 4ai, 5kr, 9bww.
 Sept. 1st: 425 miles N.E. Colon, C.Z. QRN bad. 1rv, 3bgl, 4af, 4fg, 4my, 5gl, 5nj, 5zai, 6cgw, 9au, 9eky.
 Sept. 2nd: 35 miles N.E. Colon, C.Z. QRN bad. 1ccz, 2ccc, (pr) 4sa, 8fm, 6cgw, 8apw, 8rt.
 Sept. 3rd: 50 miles S. Balboa, C.Z. QRN fierce. 3bco, 4af, (pr) 4sa.
 Sept. 4th: 300 miles N.W. Balboa, C.Z. QRN bad. 1ccz, 8brc.
 Sept. 5th: 750 miles N.E. Balboa. QRN bad. 5ux, 8brc, 6cgw.
 Sept. 6th: 1100 miles N.W. Balboa. QRN not quite so bad. 1ahm, 1ts, 1ccz, 3auv, 3me, 3blu, 3cdk, 3rl, 4uf, (pr) 4sa, 5adz, 5air, 5adv, 5akn, 5ek, 5ez, 5fm, 5ft, 5ek, 5xi, 5kr, 5mi, 5nj, 5nn, 5qa, 5uk, 5fe, 6vd, 8hp, 8bmb, 8kr, 8btf, 8z, 9akd, 9aks, 9aog, 9del, 9ctr, 9eel.
 Sept. 7th: 1500 miles S.E. Los Angeles. Rain—QRN. 4lke, 5avv, 6alz, 5acm, 5air, 5akd, 5hq, 5qh, 5ph, 6enk, 6vd, 8do, 9aog, 9awm, 9bkk, 9bic, 9bdu, 9ccc, 9eel, 9eky.

Sept. 8th: 1150 miles south E. Los Angeles. QRN bad. 5aai, 5agh, 5amo, 5bd, 5bj, 5fm, 5fl, 5nj, 5oq, 6azo, 6ale, 6buy, 6cbn, 6cfe, 6ih, 6cjh, 6arj, 9bkk.
 Sept. 9th: In the Gulf of California. QRN as usual. 4br, 8acf, 5akd, 5bd, 5gk, 5gu, 5og, 5lm, 5vu, 5wo, 6aok, 6bqr, 6bwl, 6cgw, 9aog, 9bdu, 9bvw, 9eky.
 Sept. 10th: 600 miles S.E. Los Angeles. QRN quite bad. 2by, 2rk, 5afu, 5amw, 6ajj, 6arb, 6ajh, 6bql, 6bge, 6bwd, 6bwl, 6cgs, 6cnf, 6cgw, 6chx, 8vq, 9and, 9bmk, 9eky.
 Sept. 11th: 250 miles S. Los Angeles. Atmospherics better. Can 3wv, 4oa, 5acm, 6ce, 6cet, 6che, 6czp, 7acf, 7ok, 8dbm, 8dcw, 8dhs, 8ku, 9ccc, 9bpy.
 Sept. 12th: Arrived at San Pedro, Port of Los Angeles.

KFLI, Str. Ishpenning, Marine P.O., Detroit, Mich.

1er, 1fd, 1lg, 1ps, 1sf, 1te, 1yw, 1aal, 1aar, 1abl, 1aca, 1api, 1asa, 1awr, 1awg, 1aww, 1azl, 1bgn, 1bip, 1bsb, 1ccx, 1cpn, 2kx, 2pd, 2xg, 2axf, 2blm, 2bnz, 2brb, 2btw, 2cil, 2egl, 2cnk, 2cog, 2ctn, 2xbb, 3bp, 3bz, 3cj, 3dl, 3mb, 3vp, 3ahp, 3bay, 3bbv, 3bdo, 3bof, 3bta, 3buy, 3bva, 3chl, 3chg, 4fg, 4io, 4fg, 6do, 5aai, 5acf, 5ajh, 6gl, 6wt, 6aao, 6bgr, 7bi, 7fd, 7aci, 8bp, 8br, 8dn, 8lo, 8nb, 8pl, 8tr, 8vx, 8xs, 8zf, 8zg, 8ada, 8adk, 8atp, 8avi, 8avx, 8bce, 8bfh, 8bjv, 8bkh, 8bic, 8bkh, 8blr, 8bpl, 8bxh, 8bz, 8zf, 8cp, 8egl, 8crv, 8eyi, 8ezt, 8dhw, 8djt, 8dme, 8dnk, 8dqt, 9bl, 9ei, 9es, 9nq, 9nu, 9rc, 9zb, 9aad, 9au, 9ado, 9ahy, 9aim, 9apk, 9aps, 9auw, 9awm, 9awr, 9bbj, 9bkr, 9bkw, 9btx, 9btl, 9bmx, 9bnf, 9bqv, 9bul, 9bvz, 9bve, 9ebf, 9edo, 9efi, 9dix, 9dlj, 9dpx, 9duq, 9dup, 9dwk, 9dyn, 9dyv, 9egg, 9ekf, 9ejj, 9xnb, 9zt, Canadians: 3za, 3bp, 3fc, 3kq, 3ph, 4cr.

R. Wharton Barrington, S S Ala, KDOB

9-10-24, 1500 miles east New York. 2bdz, 2boo, 3cdk, 3tf, 8bit, 8brc, 8sf, 9aua.
 9-10-24, 1750 miles east of New York. 1ccz, 2kf, 3ats, 3wv.
 9-11-24, 2000 miles east New York. 2by, 2ce, 2xbf, 2xd, 3auv.
 9-12-24, 2250 miles east New York. 1abs, 1azr, 1nt, 2ccc, 2cci, 2chz, 2cvj, 2xd, 3zf.
 9-13-24, 2500 miles east New York. 2xd, British: 5nw, 5sl, 5wi.

G. E. Hoke, ex 9DJU, Map2mi, Durango, Mexico.

2cxy, 4pb, 4ft, 5ajt, 5apm, 5et, 5aag, 5anf, 5acf, 5rb, 5ih, 5oq, 5ip, 5ak, 5nj, 5yl, 5il, 5ac, 5hp, 5ue, 5aw, 5aou, 5vm, 5nt, 5aw, 5ii, 5amw, 5abg, 5aj, 5pn, 5bai, 5awm, 5ajj, 5acb, 5ba, 5vv, 5aoc, 5ajn, 6bfh, 6ajh, 6alg, 6pl, 6brf, 6cbb, 6ma, 6avj, 6ne, 6cz, 6jo, 6cdy, 6auk, 6asv, 6awe, 6pq, 6aof, 7yc, 8daa, 8dmx, 9aob, 9ne, 9day, 9eky, 9aim, 9bvo, 9cfl, 9dhw, 9au, 9cht, 9dc, 9cjc, 9adv, 9azm, 9bjk, 9aj, 9deq, 9ado, 9edn, 9cvm, 9eud.

1BVU, 393 Ashmont St., Dorchester, Mass.

4af, (4ai), 4eq, (4js), 4ku, 4mi, 4oa, (4sa), (4sb), (4tj), 4xe, 4zd, 5kq, 5ot, 5aai, 5ajh, 5ame, 5zas, 5kg, 6apw, 6cgo, 7bj, 7gr, 8dc, 8pl, (8wz), 8acy, 8azp, 8opa, 8bpl, 8bos, 8bkh, 8cjd, (8cmi), 9bm, 9em, 9eo, 9zb, 9zt, 9aad, 9ahf, 9agl, 9ahr, (9aps), 9auw, 9awm, 9axz, 9bbf, (9bhc), 9bkr, 9bna, (9bnf), 9bmu, (9bmx), 9bqv, 9bso, 9buk, 9bvz, (9bye), 9cbf, 9edv, 9efi, 9efi, 9cip, 9cjc, 9cjs, 9cju, 9cmw, 9cog, 9cos, 9ctr, 9cus, 9dbf, (9dga), 9dhw, (9djd), (9dkt), (9dpx), 9dqa, (9dqu), 9drx, 9dvp, 9dwk, 9dxn, 9dyn, 9eky, nck, nfv, lpz, poz, utf.

1AAC, 120, Framingham, Mass.

1ai, (4cl), (4eq), (4fs), (4io), 4js, 4ku, (4mi), (4oa), (4pi), (4qv), (4rr), (4sa), 4si, (4tj), 4xc, (4zd), 5aai, 5ads, 5ail, 5ajh, 5ame, 5be, 5cn, 5kq, 5mi, (5ot), 5wy, 6anb, 6aww, (6bfw), 6bqa, 6bra, 6cgo, 6civ, 6cmi, 6cg, 6lv, 6vc, (6mt), 6xbn, 7bi, 5mi, (5ot), 5wy, 6anb, 6apw, (6bw), 6bqa, 6bra, 6ggo, 6civ, 6cmi, 6cg, 6lv, 6vc, (6wt), 6xbn, 7bi.

(7fd), 7fr, 7gk, 7ij, (9aad), 9abf, (9auw), 9axx, (9abb), 9bet, 9bis, 9bko, (9bxx), 9bmx, (9bnu), (9bqy), (9brx), 9buk, (9bvz), 9bxq, 9can, (9cbf), (9ccx), (9cdv), 9ced, (9eju), (9efi), (9eci), (9evi), 9evs, (9ddp), 9dfa, (9did), 9dkh, (9dqa), (9dtk), 9dxn, (9dzn), 9egu, (9hw), (9ny), (9qw), (9zt).
 Can.: (4cr).
 Eng.: (2kf).
 Others: iht, (niv), (nkf).
 "5-warrier" hr. QRK?

2BIR, Nutley, N. J.
 (From Aug. 30 to Sept. 15).

(4ea), 4eg, 4fg, 4ft, 4ik, 4io, 4my, 4on, 4qf, (4qw), 4rl, 4ru, (4rz), 4sb, 4sh, (4tn), 4tw, 4uk, 4ur, 5aa, 5aek, (5aeg), 5agj, 5agw, 5ahj, 5air, 5ajn, 5al, 5amu, 5amw, 5anl, 5agy, 5ay, 5ek, 5fm, 5fs, 5fv, 5gl, (5ka), 5mg, 5mz, 5nj, 5ok, 5ql, 5tg, 5uk, 5uo, 5vo, 5aao, 5awt, 5chl, 5pl, 5aal, 5aaw, (5abb), 5ado, 5add, 5ahy, 5aif, 5ain, 5ayk, 5bbk, 5bcc, 5bcd, 5bdu, 5bgn, 5bbh, 5bie, (5bna), (5bqj), 5cee, 5edo, 5efi, 5egr, 5eje, 5ekh, 5cmf, 5cht, 5ctg, 5cvt, (5cwk), 5cwx, (5del), 5dgb, (5dhl), 5dkt, (5dlj), 5dmu, 5dnn, 5efz, 5eks, 5eky, 5bk, 5bv, (5ct), 5em, 5eo, 5fb, (5fi), (5hk), (5hl), 5hp, 5mf, (5my), (5ph), 5qr, 5rc, (5ve), 5vm, 5wb, 5zw.

3BVA, 40 So. Beaver St., York, Pa.

U. S.—5aaq, (5arm), (5ags), (5agv), 5aij, 5all, (5aiy), 5ajh, (5akd), 5amh, (5alz), (5apc), (5cck), (5cen), (5gi), (5gj), 5gp, (5ka), (5kaq), (5mz), 5nj, (5nt), 5oq, (5ox), 5 ph, (5qh), (5sh), (5to), (5wo), 5ek, (5zai), 5aao, 5alv, (5apw), 5arb, (5amb), 5awt, 5avj, 5bqr, (5bra), 5edu, 5edg, 5cek, 5eej, (5cgo), 5civ, (5cgs), (5cgv), 5chl, 5cm, 5fy, (5hp), (5lv), 5pl, 5ti, 5vc, 5akt, (5bj), 7fd, 7fr, 7gk, 7gr, 7mf, 7qc, 7sf, (9aal), (9aac), 9agl, (9agz), (9afu), 9aic, (9aks), (9amb), (9aog), (9azr), (9atn), (9awm), (9aws), (9axu), (9bdu), (9biq), 9bko, (9bkr), (9bm), (9bmk), (9 bmx), (9bmu), 9bwf, (9buk), (9bvn), 9caj, (cee), (9cej), (9cdv), (9cbf), (9ccw), (9cjl), (9cql), 9cip, (9co), (9cvi), (9ctf), (9cez), (9czw), (9dap), (9ded), 9dfa, (9dfz), (9djd), (9dle), (9dlj), (9dkh), (9dng), (9dms), (9dpc), (9dpz), (9dww), 9du, (9dxr), 9dxy, (9dzz), 9dxn, (9efy), (9ebh), (9ekf), 9eky, 9em, (9gp), (9hw), (9ny), (9oa), 9za, (9zd), (9ze), 9zf, 9zt.
 Canadian—(lar), (lel), (2cg), (3hq), 4cb, (4cr), 4dy, (5go).
 Special—iht, nkf, poz, vdm, wnp.

3AHS, Philadelphia, Pa.

4bx, 4dt, 4gw, 4hs, 4iz, 4jr, 4kk, 4ma, (4my), 4rp, 4sl, 4ti, 4tv, 4um, 5aav, 5da, 5ft, 5fv, 5nt, 5oh, 5uk, 5uk, 5vv, 5yd, 6cdn, 9aaf, 9aaj, 9aau, 9adk, 9ado, 9aen, 9ahe, 9aim, 9and, 9aob, 9ao, (9ayo), 9bbj, 9bcd, 9bhi, (9biq), 9bia, 9bil, 9bkj, 9bkk, 9bob, (9hof), 9bsz, (9bxg), 9bre, 9cbz, 9cdp, 9ced, 9cek, 9 cf, 9cgr, 9cic, 9ckm, 9co, 9cnb, 9cnc, 9ccg, 9czb, 9daa, 9day, 9dbh, 9del, 9deg, 9dhg, 9dhl, 9dhz, 9djin, 9dle, (9dlw), 9dnn, 9dnp, 9duj, 9dvw, 9dww, 9dyt, 9dzz, 9dzz, 9ee, (9eii), 9eiv, 9eky, 9elv, 9ep, 9ev, 9fm, 9if, 9jt, 9kp, (9pb), 9ar, 9su, 9uu, 9ws, (9wu).
 Canadian: lar, 1dd, 3co, (3he), 3ml, 3ph.
 Spark: zhs, 8str.

3AWA—2316 N. 7th St., Phila. Pa.

Heard on the mornings of Sept. 4 and 5
 4af, 4dx, 4eu, 4io, 4mb, 4pv, 4qf, 4rz, 5aw, 5bj, 5en, 5ek, 5fs, 5hp, 5in, 5jf, 5ju, 5ka, 5nj, 5ng, 5om, 5ox, 5up, 5vh, 5rv, 5wy, 5acm, 5agj, 5agv, 5aek, 5aeg, 5aii, 5air, 5aiv, 5ajn, 5aiv, 5alz, 5ams, 5anf, 5ape, 5apz, 5aok, 5aqv, 5arb, 5xzb, 6b—7, 6im, 6pl, 6ti, 6aao, 6alw, 6arb, 6awt, 6cdn, 6efe, 6chr, 6civ, 7ob, 7pj, 9bl, 9hm, 9ce, 9em, 9es, 9hk, 9hp, 9le, 9mf, 9nq, 9pb, 9ry, 9uc, 9vc, 9wu, 9yz, 9zb, 9zw, 9zy, 9aa, 9aaf, 9aao, 9aag, 9aau, 9aaw, 9add, 9ado, 9afk, 9agz, 9ahj, 9ahz, 9alf, 9ain, 9amb, 9amf, 9amp, 9and, 9aog, 9aon, 9aoo, 9aoc, 9aps, 9arf, 9arp, 9ash, 9atx, 9ato, 9and, 9axu, 9ayk, 9ayo, 9azg, 9bay, 9bz, 9chb, 9cd, 9dhl, 9dbu, 9dcl, 9bew, 9ben, 9bbh, 9biu, 9bjz, 9bkl, 9bkk, 9bkr, 9bmc, 9bmk, 9bna, 9hof, 9bse, 9btk, 9bum, 9buo, 9bva, 9bvn, 9bwa, 9bxg, 9byn, 9caj, 9cap, 9edo, 9edv, 9cee, 9cef, 9ceo, 9efi, 9egn, 9egr, 9ef, 9cic,

9ekh, 9elo, 9ela, 9cmf, 9epb, 9ero, 9eto, 9ezb, 9eal, 9ezn, 9ded, 9del, 9dex, 9dgh, 9dgc, 9dhl, 9dng, 9djd, 9din, 9dkk, 9dkw, 9dkv, 9dic, 9dmd, 9dms, 9etr, 9evi, 9evr, 9ewz, 9eym, 9czb, 9czl, 9czn, 9ded, 9del, 9dex, 9dgb, 9dhl, 9dgc, 9dhl, 9dzz, 9eak, 9ebh, 9ebq, 9eep, 9efo, 9eji, 9ejn, 9ekf, 9eky, 9ela, 9xhb, 9xbe.

Station 4MS—40L, 1311 No. 15th Ave, Pensacola, Fla.

(ew) 1arf, 1bcf, 1bgq, 1rv, 2cee, 2erp, 2cpa, 2by, 2ky, 2rk, 2ubf 777 (qra?), 3abw, 3agl, 3bbv, 3bco, 3bdj, 3buy, 3bva, 3ek, 3kl, 3hg, (4pk), (4my), 5aa, 5acm, 5adv, 5akn, 5air, 5aiy, 5al, 5amh, 5ek, 5cy, 5ek, (5ew), 5gl, 5if, 5kr, 5lh, 5mi, 5ni, 5nt, 5ox, 5ok, 5rh, 5ue, (5uk), 5ua, 5vv, 5yd, 5zat, 5zas, 5cgw, 5anb, 5apw, 5apn, 5ate, 5axf, 5amb, 5bcb, 5bso, 5sci, 5ced, 5cpl, 5cwu, 5dal, 5dea, 5dff, 5eo, 5es, 5fm, 5ry, 5va, 5aau, 5atn, 5bmk, 5cep, 5oje, 5dcw, 5ctr, 5eky, 5xbe, 9bk, 9gr, 9ar.
 (Spark) 4fg, (4ag), (4ty), (4so), (4sz).
 (Naval Aircraft Hi Hi) 75x, 75a, 75h.

4SA, R. Bartholomew, Garrochales, Porto Rico.

1aac, (1abf), 1aea, 1all, 1 anr, (1bdx), 1bge, 1bg, 1blx, 1bkr, (1bvl), (1ayt), 1bzp, 1ccz, 1db, 1de, 1lh, 1my, (1sf), 1te, (1xam), 1xap, 1xp, 1xw, 2adj, 2brb, 2by, (2cla), 2cu, 2gk, (2od), 2rk, 2zd, 3adb, 3adp, 3ary, 3bta, (3chg), 3mb, 3od, (4av), 4cy, (4fg), (4io), 4fs, 4ay, 4aa, 4ti, (4xe), 5asp, 5ame, 5cn, 5awt, 6cgv, (8bpa), (8brc), 8col, (8ef), 8gz, 8zg, int, poz, uft.

4RI-ATL, 13 Olimpo Avenue, Santurce, Porto Rico.

1ccz, 1fd, 1sf, 2aw, 2bgo, 2boo, 2bq, 2brb, 2bx, 2gk, 2pd, 2za, 2xx, 3hta, 3cjin, 3fg, 3ap, 3wo, 4g, 4 ku, 8bit, 8hdj, 8mx, 8cvi, 8gz, 8hn, 8xb, 8xs, 8zg, lpz, poz, fl.

5JF, 1607 Fannin St., Marshall, Texas.

(1abf), 1all, 1axa, 1fb, 1fd, 1gul, 1ii, (1mi), (1xw), 2ann, (2hrb), 2bsc, (2bv), (2cee), 2erp, 2rk, 2zd, 3abw, 3bco, 3bg, 3edg, (3edk), (3ech), (3chg), 3hg, 3io, 3vv, 4g, (4bx), 4eg, (4fg), 4gw, 4kk, (4mb), (4my), 4on, 4pd, (4pv), (4si), 4tn, 4vl, 5aao, 5aag, 5ahp, 5ajh, 5alg, 5ame, 5ani, 5ar, 5arb, 5avj, 5awt, (5bco), 5brt, 5bwl, 5cbr, 5cfl, 5cwh, 5cmi, 5cvi, (5 anh), 5enl, 5cge, 5erx, 5eto, 5gt, 5gi, 5ms, 5nx, 5pl, 5rn, 5tr, 5ti, 5vd, 5xad, 7fd, 7fr, 7sf, (7zn), 8alw, (8anb), 8ann, 8 anp, 8arp, 8apw, 8art, 8avx, (8axf), (8hgn), 8bhs, (8bit), 8mb, (8bnh), 8boe, 8hp, (8bai), 8brs, 8bt, 8bv, 8byn, 8cab, 8ced, (8cnl), (8doi), (8dsn), (8sf), 8tt, 8vq, Canadians—8ad, 3bi, 3co, 5go, Mexicans—ib, lx.

5AJH, Abilene, Texas.

1aac, (1alj-1sf), 1bbo, 1bcf, (1bkr), 1boq, 1bqk, 1cpv, 1fd, (1mv), 1rv, (1vj), 1xam, (1xas), (1xav), 1xw, 1xz, (2aay), (2brb), (2btw), (2byk), 2bx, (2cee), (2chz), 2cz, 2erb, (2exv), 2cyx, (2dx), 2gk, 2kf, 2ku, (2mu), 2pd, 2qs, 2wk, 2zd, (3adp), (3bfe), 3bdi, 3bdo, 3hof, (3hta), 3btu, 3bz, 3chz, 3chh, 3ekl, (3hg), (3hs), 3kq, (3rv), 3vw, (4af), (4ag), 4ai, 4dx, (4fg), 4fs, (4io), 4js, 4ku, 4mc, 4mi, (4oa), 4oy, (4pi), 4pv, 4sa, 4si, (4ti), 4xe, (4zd), 5aao, (5agk), 6aja, 6alf, 6alv, 6anb, (6apw), 6avh, (6awf), (6beh), (6bjx), (6bra), (6bsg), (6brs), (6bw), 6go, (6cgs), 6chl, (6cmq), (6cnk), 6erx, (6fy), (6gz), 6hk, 6ih, (6lv), (6ms), (6nx), 6oh, (6pq), (6rn), (6ry), 6in, (6vi), (6vd), 6wt, (6xbn), 6zo, 7ahs, (7av), 7bj, (7fd), 7gk, (7gr), (7gv), 7io, 7ia, 7ae, 7vn, (8abm), (8ada), (8ajn), 8anb, 8atp, 8avx, 8axf, (8bce), (8bkh), 8byn, 8cbm, (8cdj), (8cle), 8emy, 8enk, (8cvi), (8evt), (8dae), (8dbm), (8dhw), 8doo, (8gz), 8jq, 8pl, 8sf, 8xbe, (8zd), 8zz, Canadian: (3aa), (3ad), 8bq, 8fc, 3ni, (4cr), (4fv), 5go, Mexican: (ib), zm (qra?). Italian: iht hrd gas working ubm. (qra) at time Canary Islands. ndf nfv, nkf, whu.

6AB, Blythe, California.

1aae, 1aal, 2brb, 2by, 2cbg, 2cbk, 2cee, 2chg, 2cpc, 2erp, 2zd, 3auv, 3cjin, 4dv, 4cw, 4fa, 4fn, 4ft, 4sb, 4tv, 5abg, 5aef, 5acm, 5ay, 5ex, 5ahd, 5al, 5ajt, 5aju, 5ame, 5anl, 5am, 5apz, 5arb, 5bu, 5co, 5dm, 5ei, 5ek, 5fs, 5hp, 5kk, 5ka, 5il, 5nj, 5og, 5 ox, 5ahm, 5uk, 5vv, 5yd, 7acf, 7adm, 7aim, 7ajt, 7eo, 7gq, 7lq, 7mf, 7ndp, 7no, 7pj, 7af, 7xaf, 8ab, 8ae,

SA.I. 8ase, 8ldw, 8hyn, 8daa, 8dfo, 8sf, 8uf, 8up, 8vq, 8ach, 8adq, 8ahq, 8aif, 8aim, 8aio, 8akk, 8akn, 8aol, 8aps, 8ato, 8awp, 8bcd, 8bdu, 8be, 8bgi, 8bjk, 8bm, 8bmu, 8bna, 8bof, 8bra, 8bsp, 8btk, 8bvm, 8bxc, 8bzf, 8ccx, 8ccr, 8ccs, 8cfs, 8cgl, 8cjb, 8ckb, 8clz, 8coc, 8cro, 8ctg, 8ctr, 8cvi, 8dad, 8dbh, 8dhh, 8dhw, 8dlm, 8dng, 8dnp, 8dgg, 8eam, 8eji, 8eky, 8la, 8ln, 8rc, 8ry, 8qr, 8vc, 8xdb. Canadians: 8ad, 8bq, 8co, 8dq, 8fn, 8fv. Mexican: BX.

Horace L. Kemper, 410 So. Burlington Ave., Los Angeles, Calif.

1xae, 2hrb, 2pd, 2xd, 3bta, 4oa, 4pd, 5ado, 5adv, 5ajj, 5ah, 5ame, 5en, 5fg, 5lm, 5oq, 5ot, 5qx, 5xaz, 5zl, 6cki, 6cmq, 6cl, 6zam, 7adi, 7aek, 7agi, 7ahs, 7aim, 7aip, 7ais, 7aiy, 7akk, 7akt, 7alk, 7bj, 7fa, 7fd, 7fr, 7fs, 7gz, 7ak, 7ar, 7gv, 7gw, 7if, 7io, 7it, 7iu, 7ix, 7in, 7iq, 7is, 7iw, 7ry, 7sf, 7sl, 7ta, 7vn, 7wm, 7zn, 8cde, 8gz, 8vt, 8vy, 8xs, 9aim, 9amb, 9atn, 9awm, 9bm, 9bpt, 9caa, 9cbf, 9cdv, 9cfl, 9cfr, 9cil, 9cip, 9cls, 9cju, 9cks, 9cpu, 9dcp, 9ded, 9dkv, 9dpx, 9dqu, 9dxq.

GIL, Tujunga, Calif. (Det. only.)

5aat, 5aef, 5aen, 5adv, 5aec, 5aex, 5afu, 5afx, 5aih, 5ajh, 5akj, 5ak, 5akl, 5am, 5amw, 5ank, 5aw, 5az, 5bj, 5bo, 5ec, 5ee, 5et, 5ek, 5ew, 5fc, 5fm, 5fv, 5ge, 5gr, 5hp, 5hy, 5ig, 5il, 5lg, 5lh, 5lm, 5lp, 5nj, 5nw, 5oi, 5oa, 5ou, 5ov, 5pn, 5qa, 5qh, 5rg, 5sg, 5ue, 5uk, 5uo, 5ux, 5ox, 5vu, 5va, 5za, 5zae, 5zh: 467, "6's": 7acf, 7adf, 7afo, 7agi, 7aho, 7ahs, 7ah, 7ap, 7aix, 7ajq, 7ajt, 7akk, 7alk, 7ao, 7av, 7bd, 7bj, 7co, 7fh, 7fa, 7gh, 7go, 7gr, 7gu, 7gv, 7ho, 7hw, 7ih, 7ij, 7im, 7io, 7it, 7ix, 7ih, 7in, 7iw, 7ma, 7mf, 7mg, 7my, 7no, 7nx, 7ob, 7ok, 7ot, 7pz, 7qc, 7ra, 7ry, 7sf, 7sy, 7td, 7un, 7uv, 7vn, 7wm, 7zu, 8btl, 8bw, 8eel, 8emy, 8dgo, 8vy, 8zz, 9aau, 9abc, 9acd, 9ado, 9aen, 9aim, 9amp, 9aob, 9arj, 9ash, 9atn, 9avv, 9awm, 9ayq, 9bbf, 9bbu, 9bcb, 9bck, 9bf, 9bfn, 9bjl, 9bkk, 9bmk, 9bnk, 9baf, 9bjq, 9bri, 9bun, 9bvo, 9bw, 9bww, 9bxa, 9ccs, 9cey, 9cfu, 9cfr, 9cht, 9cjc, 9cju, 9cpu, 9err, 9dbh, 9ddl, 9ded, 9dxi, 9dhw, 9djm, 9dkv, 9dms, 9dm, 9drw, 9dte, 9dty, 9dun, 9dww, 9dxq, 9dy, 9eae, 9eap, 9ebj, 9ee, 9ec, 9ejn, 9eky, 9vc, 9zd, 9zy. Can.: 5ba, 5ct.

7GR, P. O. Station A, Vancouver, Wash.

(1bbo), 1bgq, 1bvl, (1cpv), 1er, (1sf), 2hrb, 2cee, 2egz, (2zki), 2ku, 2pd, 3abw, (3adp), (3bfe), 3bsb, (3hq), (3hs), 4er, 4eq, 4io, (4oa), (4tj), 4sa, 4rr, 5ajj, (5ajh), 5aku, 5ame, (5cn), 5ka, 5kq, 5ot, (5ph), 5wy, 8axf, (8bpa), 8ced, 8eel, (8cjd), (8con), (8gz), (8nb), (8pl), (8wx), 8vg, 9aad, 9abf, 9agl, (9aog), (9awm), (9bdu), 9bet, (9bib), 9big, 9bkc, 9bmk, 9bmu, (9bmx), (9hmu), (9bpy), (9bzy), 9brx, 9bso, (9bvzi), 9bye, (9ecs), 9cdv, 9cfl, (9cfr), 9cil, (9cip), (9cju), (9cls), 9cro, 9cvs, (9ddp), 9dqm, 9dvp, 9ej, 9zd. Canadians: 3ba, 4ab. New Zealand: 4aa, nfv.

Walter N. Pierson, 1487 Neil Ave., Columbus, O.

1abt, 1adt, 1agy, 1bog, 1bf, 1cw, 2aek, 2as, 2bhg, 2de, 2eg, 2ma, 3aky, 3bdo, 3blu, 3bu, 3cbx, 3cev, 3chr, 3cpv, 3ho, 3ig, 3ml, 3mo, 3nt, 3oo, 3qw, 3rf, 3ta, 3tf, 3uy, 3vw, 3zo, 4dt, 4eg, 4fm, 4ft, 4w, 4hr, 4jr, 5ad, 5adz, 5aex, 5azj, 5ajp, 5air, 5ay, 5amw, 5ayy, 5da, 5er, 5uv, 5ka, 5nj, 5vv, 5xab, 9aau, 9ado, 9amp, 9bex, 9bh, 9bp, 9bvm, 9cas, 9cf, 9cm, 9cjc, 9dor, 9dgv, 9dib, 9doo, 9dsa, 9dsv, 9dy, 9ef, 9efp, 9ekv, 9ex, 9jg, 9wo, 9ws.

Canadian: 3om. Jones: 8asu, 8bfc, 8bre, 8bss, 8cab, 8can, 8ets, 8cwo, 8dat, 8dma, 8dmz, 8dpc, 8dfe, 8bwn, 9dmt, 9ws, 9ahy, 9ak, 9amw.

All hrd on a one lung single circuit. Pse qsl om, I will.

9DMA, Caledonia, Minnesota.

1aad, 1abf, 1ajx, 1bbo, 1bbx, 1bfc, 1bcu, 1bgq, 1bpd, 1ccz, 1cki, 1cpa, 1cmx, 1ctl, 1kv, 1mo, 1oj, 1pp, 1rv, 1ts, 1xaa, 1xae, 2acn, 2aja, 2ay, 2azy, 2bdz, 2bgo, 2bmr, 2bnz, 2boi, 2boo, 2bse, 2bx, 2bw, 2cdn, 2cty, 2cvu, 2cyw, 2cyx, 2eg, 2gm, 2rk, 2wz, 2zbf, 3ad, 3af, 3aih, 3aoj, 3ats, 3auw, 3bcu, 3bj, 3bhl, 3blr, 3blu, 3bmn, 3bnu, 3bt, 3bta, 3btq, 3buy, 3bva, 3cev, 3cdk, 3cdu, 3cfe, 3gc, 3ch, 3sch, 3chg, 3cj, 3cjn, 3co, 3ctk, 3dq, 3he, 3hz, 3lg, 3ph, 3pi, 3tf, 3xp, 3zm, 3zo, 4es, 4eq, 4fn, 4gl, 4hr, 4kl, 4ll, 4lp, 4nr, 4oa, 4on, 4pk, 4qf, 4sk, 4si, 4tj, 4tn, 4ts, 4um, 5aa, 5abg, 5acm, 5afx, 5agl, 5air, 5ali, 5alz, 5anf, 5anh, 5ape, 5apm, 5aqw, 5aw, 5da, 5ek, 5fe, 5fm, 5fv, 5ka, 5mi, 5nc, 5nj, 5oq, 5ox, 5ph, 5rg, 5sg, 5sh, 5su, 5ua, 5ux, 5xab, 5zas, 5afq, 6aja, 6amf, 6awt, 6bao, 6gwg, 6chl, 6fm, 6pl, 7afe, 7akt, 7co, 7gr, 7mf, 7qc, 7un, 7uv, 8aa, 8add, 8aeb, 8aee, 8aey, 8afq, 8aif, 8akk, 8alk, 8anb, 8app, 8apx, 8apy, 8apw, 8aq, 8art, 8arw, 8ate, 8atz, 8bbw, 8bdw, 8bit, 8bjd, 8bit, 8bkk, 8bkm, 8bmb, 8bnh, 8bo, 8boc, 8bp, 8bpl, 8bre, 8bro, 8bsm, 8bvw, 8btz, 8buc, 8bzd, 8byn, 8bzf, 8bzu, 8eci, 8eck, 8ecp, 8ecr, 8ect, 8edq, 8cjp, 8ckm, 8cko, 8clo, 8cm, 8eng, 8eon, 8cuv, 8cwr, 8cww, 8daa, 8dab, 8dc, 8dm, 8dfb, 8dvm, 8dgo, 8dgp, 8dgt, 8dhs, 8dmx, 8dok, 8doo, 8dof, 8drl, 8eo, 8enn, 8fm, 8gz, 8hb, 8hv, 8ku, 8qb, 8sr, 8ry, 8sf, 8tt, 8uf, 8ut, 8vq, 8vt, 8wv, 8wo, 8wx, 8wz, 8xht, 8xj, 8z, 8z. Canadian: 3bg, 3 bp, 3bq, 3co, 3oh, 3wv. Naval: nkf on 100 m. Phone: 8ban, 8bpd, 8bre, 8dat, 8dmt, 8xat.

TRAFFIC DEPARTMENT

(Continued from page XI)

we should use the short waves which we have been granted as our experiment with these waves is going to be of intense value and it must not be forgotten that if we do not use these waves ourselves there are numerous forces at work which will be only too glad to acquire them.

MARITIME DIVISION

W. C. Borrett, Mgr.

In accordance with instructions from the traffic manager, the report of the radio activities of the Maritime Division, will in future, only contain the mention of Official Relay Stations, who carry out the purpose of the traffic department.

Radio activity has taken a decided jump onward during the last thirty days. The return to home waters of VDM and WNP gave two of our stations a splendid opportunity to show that the maritime gang are still there with the goods when needed.

1AR makes a new record, having handled 118 messages, including 23 from VDM. 1AR has been the most reliable station for VDM traffic of any U. S. A. or Canadian amateur. 1DD also came into prominence by working WNP on four occasions on his way home from Battle Harbour and handling 10 messages with WNP. 1DD's message total for the month being 24. 1BQ and 1EF report no traffic, having been on a visit to U. S. A. first and second district most of the month. They are now back on the air ready for Transatlantic work. (ROTAB's). 1AF of St. John, N. B. is on nearly every night from midnight until early morning. He has handled 15 messages this month. 1AF of Jacquet River, N. B. is rebuilding. 1AF is much needed for Trans-Canada traffic. 1BZ and 9AK of Charlottetown P. E. I. report building operations on their sets for the winter. 1AW is the leading station of Cape Breton and reports 3 messages and is stirring up interest among other amateurs of his district.

The European stations are now QSO to the Maritime Division and the activities of the ROTAB's should increase from now on. g2OD, g2NM, and f8AB being the first Europeans to renew contact after a

few months of silence, 125 and 140 meters continues to be the popular wave of Maritime stations. A few have ventured to 80.

ONTARIO DIVISION C. H. Langford, Mgr.

General quietness as to the spectacular work and new improvement seem to be the order of affairs generally in this division. The possibilities of the short waves are becoming well known, but we don't know enough about them. The 75 meter wave seems well populated now and considerable work is being carried out there. There are many of the Ontario gang who are keeping out of the low bands. Get in on it fellows so that smooth relays can be made really successful.

While individual stations could be listed, the general reports indicate that the real ham is doing intensive work in keeping up his station as modern as possible and digging down to the new wave bands. This applies to many of our stations across Ontario. For the information of some of the gang I can say that it is against rules to fill up the monthly report with only the ordinary run of affairs or changes in the individual station.

3NF is putting in 50 watts in a new station. 3VW, a converted BCL, is using 5 watts. 3MP of Cornwall is trying to get interest up in his town. 3VH of Toronto is the Official Broadcasting Station for that district. 3IA is the new C. M. of St. Thomas. Several new Sarnia stations are expected to open up shortly.

Traffic: 3OM, 6; 3IA, 2; 3LY, 5; 3QO, 6; 3OJ, 3; 3KQ, 10; 3FC, 15; 3VR, 12; 3XX, 19; 3AL, 60; 3WG, 3; 3BQ, 4; 3BC, 3; 3CO, 36.

QUEBEC DIVISION J. V. Argyle, Mgr.

The entire active membership held a convention at the home of the D. M. in Montreal on September 25th, at which attention was given mostly to League business. Re-unions followed business and it may be said that enthusiasm jumped 100 percent. The following active stations were appointed to assist in Emergency Railway Communication during the coming winter: 2BV, 2HV, 2FL, 2AZ, 2CI, 2FL, 2CN, 2BM, 2CT, 2AG, 2BI, 2BE, 2BG, 2BN, 2CG and 2AM. We especially welcome to our ranks an O. W. who is a real pounder, Mrs. Sturgess of 2CN. With the OM of 2CN we have our first 24 hours a day relay station. Official Relay Stations of this Division are 2BG, 2BE, 2CG, 2BN, and 2FL. All other divisions and O. R. S's please note. These stations will DELIVER the traffic—give them whatever you've got. Stations desirous of obtaining the O. R. S. certificate communicate with the D. M.

Note: From this time on no mention of your activities can be made unless you are an O. R. S.

2BE and 2CG will be found almost exclusively on 80 and 75 meters. 2BG is not so active but is on 80 meters. 2BN returned from Hamburg, Germany reports hearing 17 amateurs in one evening whilst in German waters. 2CG on vacation at River Beau-dette, P. Q., worked 300 miles in broad daylight every day for nearly two weeks using single wire aerial and counterpoise on 75 meters, with one U. V. 201A with spark coil. The night record was 9CIP. 2BE is hearing the Europeans again and the gang are all set to work 'em. We welcome Foster 2AG back to the air. Arrangements were completed for the preliminary work at the first Quebec Radio Show. This is going to be a big affair at the Windsor Hotel and this Division will have a complete station in operation on a short wave. Special mention is given to 2BE one of our most active O. R. S's who was able to put a message into Minnesota when the telegraph company was not able to handle it due to destruction of lines in the western cyclone.

WINNIPEG DIVISION J. E. Brickett, Mgr.

Holidays and fine weather have been the means of keeping some of our regular stations off the air this last month, and the change of wave length as now allowed has also given the gang a good deal of remodeling to do.

The following stations are now in possession of the new O.R.S. certificates: 4HH, 4CB, 4AO, 4ER, 4FN, 4AA, 4FV, 4BR, 4AJ, 4CO, 4CN, 4AW, 4EA, 4DY, 4GH and 4FC.

The Prince Albert gang is going strong, and there are some new stations under construction there. Regina is on the air strong now for the first time, being represented by three fine stations. Ex-65MX is operating at station 4FV just now, but will be on the air with his own power very soon. 4IX, 4IQ and 4DR are all raising their power for the winter traffic. 4ER, 4AO and 4BF are busy with their aerials, as we had some very strong gales up here this summer.

VANCOUVER DIVISION A. J. Ober, Mgr.

ALBERTA—4AX has his 50 watter going and is getting out in great shape. 4IO is a great clearing station, always QSO south and east. 4GT with his two 250's will be in his new station soon, located at 223—2nd Ave. N.E. and will have a second op. on the job. 4CW is working fast and furious on 100 meters and reports good DX. 4IC is on with a good D.C. note. 4AB is on the air again. 4DQ is on each night with a second op and handled traffic with V.D.M.

Traffic: 4IO, 6; 4GT, 11; 4AX, 6; 4DQ, 36.

EDMONTON—4HF is the only station on in this district and is QSO east and west most of the time. Traffic: 4HF, 26.

VANCOUVER ISLAND—VDM and WNP logged at 5 CT and he reports little traffic moving but has a D.C. QSB at last. (Hi. FB,—D.M.) 5HK was on 125 meters and it was hard to raise anybody so QSYed up again.

VANCOUVER—The D. S. hands in a card with a report of "Everybody getting fixed up for fall convention." 5GO says his L1L sis. will soon be 3rd Op. 5GF is a real op with a good station, always clears traffic. All active stations must make their reports to the D.M. not later than the 15th of each month until further notice.

Traffic: 5GF, 9.

Midwestern Convention

Last minute notice—arrived just in time to make this number of QST!

The Midwest Division Convention will be held at Omaha, Nebraska, on November 24, 25 and 26.

All particulars can be gotten from Midwest Division Manager P. H. Quinby, Route 6, Omaha, Nebraska.

We don't know anything about the program except that Hebert and Kruse of A.R.R.L. headquarters will speak. However, we do know the Midwestern crowd, and that's enuf to make us sure there will be a fine convention.