

# QST

DEVOTED ENTIRELY TO  
**AMATEUR RADIO**

*Published by*  
AMERICAN RADIO RELAY LEAGUE

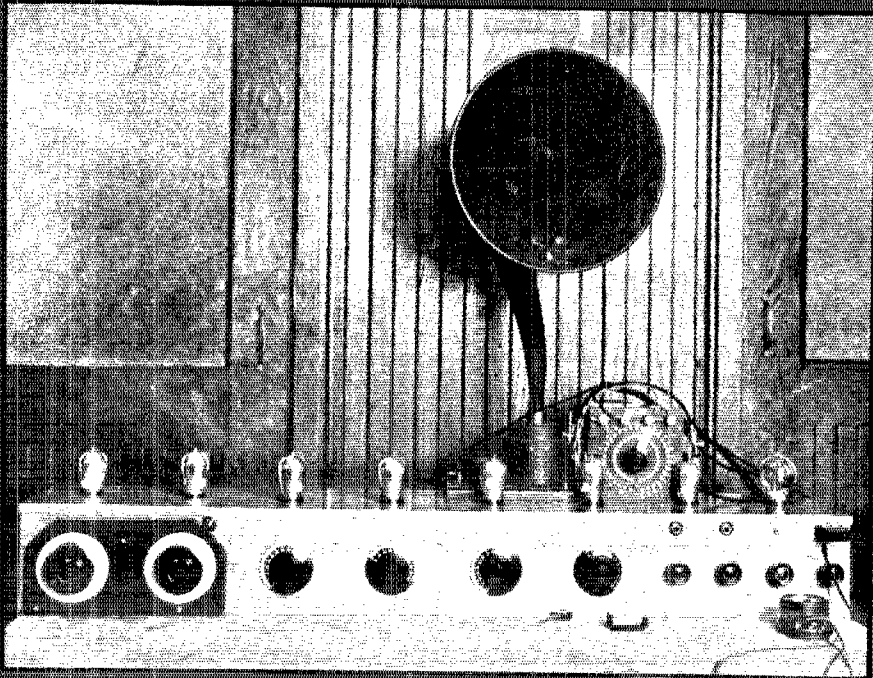

BEGINNING IN THIS ISSUE  
A SERIES OF CONSTRUCTIONAL ARTICLES ON THE  
**SUPERHETERODYNE**

JUNE 1924

20¢

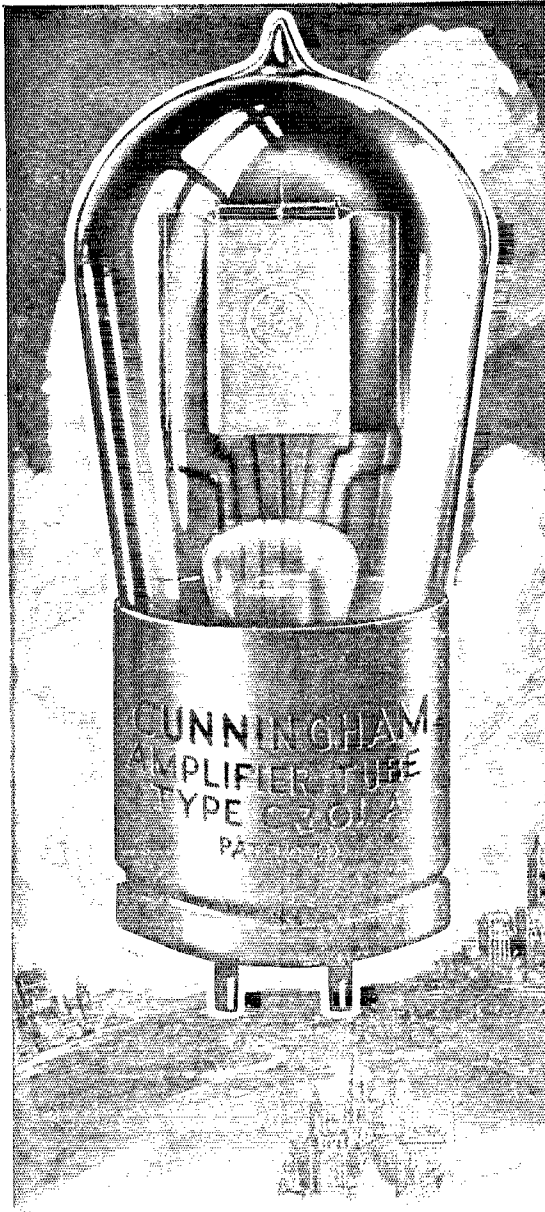

*Cunningham*  
**RADIO TUBES**

*The Standard Tube of the  
 World for*

**RADIO  
 RECEPTION**

The Radio Tube, through radio telephony and public broadcasting, has been largely instrumental in establishing the new and increased interest to humanity attuned to Radio. This tremendous progress in Radio has brought about the development of radio receiving sets resulting in clearer reception of voice and music throughout the broadcast world.

Cunningham Radio Tubes are the product of years of research and experimental work by the engineers of that great scientific organization, the Research Laboratory of the General Electric Company.

There is a Cunningham Radio Tube designed to meet the requirements of your particular set—ask your dealer.

**PATENT  
 NOTICE**

Cunningham tubes are covered by patents dated 3-18-08, 2-18-12, 12-20-13, 10-23-17, 10-23-17, and others issued and pending. Licensed only for amateur, experimental and entertainment use in radio communication.

Any other use will be an infringement.

Cunningham 10-page Data Book fully explaining care and operation of Radio Tubes now available by sending five in stamps to San Francisco office.

*E. J. Cunningham Inc.*

HOME OFFICE :  
 182 Second Street

Branch Office  
 Chicago

SAN FRANCISCO

Branch Office  
 New York

**PRICES ON  
 CUNNINGHAM  
 RADIO TUBES**

Now in Effect

- C-301A—5 Volts 1-4 Ampere filament \$5.00
- C-299—3 Volts .06 amp. Dry Battery Det. & Amp. \$5.00
- C-300—5 Volts Gas Content Detector \$5.00
- C-11—1.1 Volts .25 amp. Dry Battery Det. and Amp. Special Base \$5.00
- C-12—Similar to C-11 with standard base . . . \$5.00

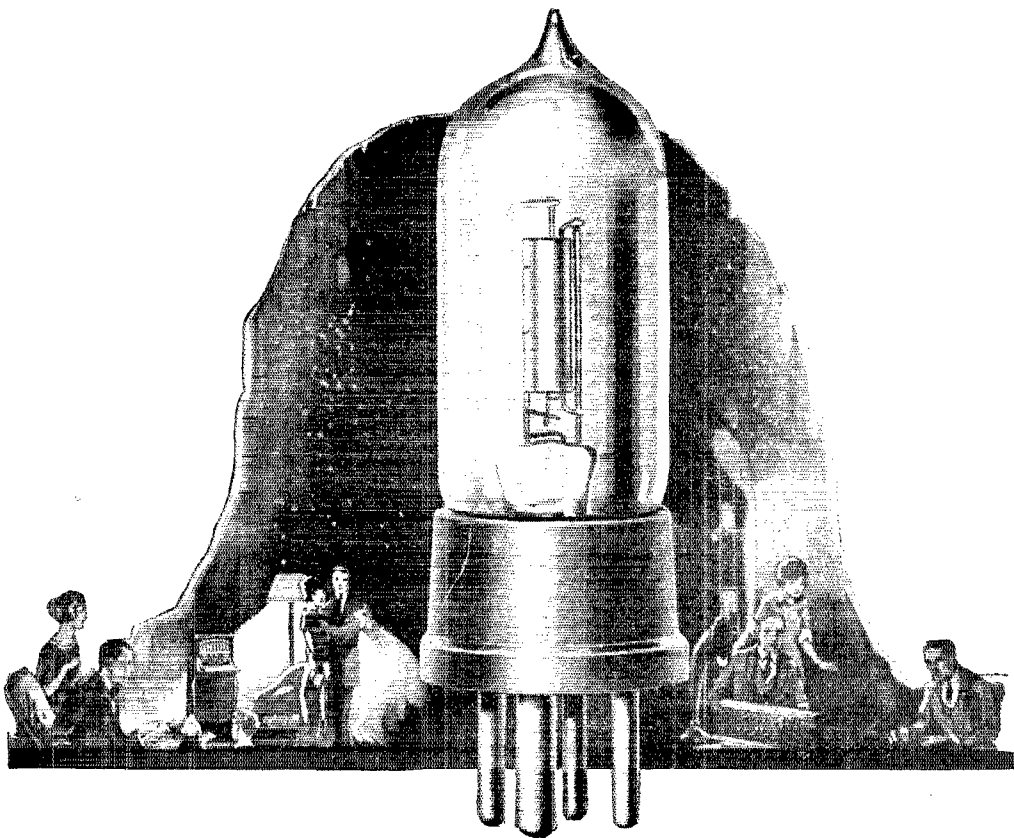

## IS IT GENUINE?



This symbol of  
quality is your  
protection

### RADIOTRONS

Radiotron WD-11 \$5.00  
 Radiotron WD-12 \$5.00  
 Radiotron UV-199 \$5.00  
 Radiotron UV-200 \$5.00  
 Radiotron UV-201-A \$5.00

Send for free booklet that describes all  
 Radiotrons giving their characteristics and  
 circuit diagrams.

### Radio Corporation of America

Sales Offices:

233 Broadway, New York

10 So. La Salle St., Chicago, Ill.

433 California St., San Francisco, Cal.

# RADIOTRON

Reg. U. S. Pat. Off.

**T**HAT is the question every radio dealer hears today. "Is it a genuine Radiotron?" Be sure to look for "RADIOTRON" and the RCA mark on the vacuum tube—to be certain of clear reception and long service. There is a Radiotron for every type of receiver. Ask for the one you want by its name.

And be sure you get it!

RADIO CORPORATION OF AMERICA  
 Dept 296 (Address office nearest  
 you.)  
 Please send me your free Radio-  
 tron Booklet.

Name \_\_\_\_\_

Street Address \_\_\_\_\_

City \_\_\_\_\_ R.F.D. \_\_\_\_\_

State \_\_\_\_\_

# ACME prize contest winners!

Here are the names of the winners of cash prizes in the ACME Prize Essay Contest on the subject: "How radio frequency helped me eliminate interference."\*

## First Prize \$250

MAJOR DOUGLAS H. NELLES  
537 Percy Street,  
Ottawa, Ontario

## Second Prize \$150

C. A. LIDDALL  
4842 N. 15th Street,  
Philadelphia, Pa.

## Third Prize \$100

EDWARD C. THOMPSON  
35 Ivy Street,  
Boston, Mass.

\*The idea of the contest was not necessarily to get the greatest distance or the greatest number of different stations logged, but the best actual information on how radio frequency helped to eliminate interference. Names of other prize winners on request.

Although this contest was open to all, whether they used Acme Transformers or not, it was a fact worthy of your attention that 70 per cent of those who mentioned the apparatus used, used Acme Transformers.

ACME APPARATUS COMPANY

Dept. 39

Cambridge, Mass.

*Send for valuable ACME books*

ACME APPARATUS COMPANY  
Dept. 39, Cambridge, Mass.

Gentlemen: Kindly send me your latest catalog of:

- Transmitting Apparatus
- Receiving Apparatus
- Booklet on Amplification without Distortion (Enclose 10¢)

Name.....

Address.....

City.....

*For best results use ACME Apparatus throughout*

A-2 Audio Transformers  
R-2, R-3 and R-4 Radio Transformers  
30 K.C. Transformers for long wave R.F. circuits  
C.W. Transformers  
Lowest Loss Variable Condensers  
Potrheo

# ACME ~ for amplification

# THE TRAFFIC DEPARTMENT, A.R.R.L.

## ATLANTIC DIVISION

**Manager**  
A.D.M. D. of C.  
A.D.M. Maryland  
A.D.M. No. N. J.  
A.D.M. So. N. J.  
A.D.M. East. N. Y.  
A.D.M. West. N. Y.  
A.D.M. East. Penna.  
A.D.M. West. Penna.  
A.D.M. Delaware

C. H. Stewart  
A. B. Goodall  
G. L. Deichmann, Jr.  
A. G. Wester, Jr.  
H. W. Densham  
E. M. Glaser  
S. Woodworth  
J. F. Rau  
P. E. Wiggins  
H. H. Layton

1824 Ingleside Ter.  
Chapel Gate Lane, Ten Hills,  
1075 Chancellor St.  
140 Washington St.  
845 E. 13th St.  
425 Brownell St.  
2085 E. Kingston St.  
714 Johnston St.  
805 Washington St.

St. David's, Pa.  
Washington  
Baltimore  
Hilton  
Collingswood  
Brooklyn  
Syracuse  
Philadelphia  
Wilkinsburg  
Wilmington

## CENTRAL DIVISION

**Manager**  
A.D.M. Michigan  
A.D.M. Ohio  
A.D.M. Illinois  
A.D.M. Wisconsin  
A.D.M. No. Indiana  
A.D.M. So. Indiana  
A.D.M. Kentucky

R. H. G. Mathews  
C. E. Darr  
C. E. Nichols  
N. C. Smith  
C. N. Crapo  
M. W. Hutchinson  
D. J. Angus  
J. C. Anderson

382 S. Mich. Ave.  
187 Hill Ave., Highland Pk.  
739 Weadock Ave.  
1035 N. Dearborn St.  
443 Newton Ave.  
1222 Washtenaw Ave.  
Rm. 66, Y. M. C. A.  
Clengarry Farm

Chicago, Ill.  
Detroit  
Lima  
Chicago  
Milwaukee  
Ann Arbor, Mich.  
Indianapolis  
Lexington

## DAKOTA DIVISION

**Manager**  
A.D.M. Minnesota  
A.D.M. So. Dakota  
A.D.M. No. Dakota

D. C. Wallace  
D. C. Wallace  
Orville Wheelon  
Bert Wick

54 Penn Ave. N.  
54 Penn Ave. N.  
809 E. Capital Ave.  
1025-3rd St.

Minneapolis  
Minneapolis  
Pierre  
Devils Lake

## DELTA DIVISION

**Manager**  
A.D.M. Louisiana  
A.D.M. Mississippi  
A.D.M. Tennessee  
A.D.M. Arkansas

W. W. Rodgers  
V. L. Rosso  
W. L. Keaton  
W. G. Hutcheson  
Dr. L. M. Hunter

1106 Union Ave.  
Box 415  
University Post Office  
207 1/2 Main St.

Memphis, Tenn.  
Plaquemine  
Mississippi  
Wind Rock  
Little Rock

## EAST GULF DIVISION

**Manager**  
A.D.M. So. Carolina  
A.D.M. Alabama  
A.D.M. Florida  
A.D.M. Georgia  
A.D.M. Porto Rico  
A.D.M. Cuba

H. L. Reid  
A. DuPre  
V. C. McIlvaine  
C. P. Clark  
T. M. Keith  
Luis Rexach  
R. H. Tormo

76 E. 12th St. Apt. 6  
290 Wofford Campus  
106 W. 3rd St.  
c/o Western Union Tel. Co.  
601 Highland Ave.  
Box 319  
Avenida de Italia No. 29

Atlanta, Ga.  
Spartanburg  
Sheffield  
Jacksonville  
Atlanta  
San Juan  
Havana

## MIDWEST DIVISION

**Manager**  
A.D.M. Iowa  
A.D.M. Missouri  
A.D.M. Kansas

P. H. Quinby  
D. E. Watts  
L. R. Laizure  
Clifford Peters

Box 184-A, Rt. 6  
116 Highland Ave.  
8020 Mercier St.

Omaha, Nebr.  
Ames  
Kansas City  
Tonganoxie

## NEW ENGLAND DIVISION

**Manager**  
A.D.M. Rhode Island  
A.D.M. New Hampshire  
A.D.M. Vermont  
A.D.M. Maine  
A.D.M. West. Mass.  
A.D.M. East. Mass.  
A.D.M. Connecticut

I. Vermilya  
D. B. Fancher  
B. H. Stevens  
W. W. Hall  
L. Hilton  
A. S. McLean  
B. H. Chase  
D. C. S. Comstock

86 Franklin St.  
118 Brook St.  
3915 Union St.  
20 Wood St.  
585 Armory St.  
39 Chester Ave.  
1622 Main St.

Mattapoisett, Mass.  
Westerly  
Manchester  
Burlington  
Lewiston  
Springfield  
Winthrop  
E. Hartford

## NORTHWESTERN DIVISION

**Manager**  
A.D.M. Montana  
A.D.M. Washington  
A.D.M. Idaho  
A.D.M. Oregon  
A.D.M. Alaska

Glenn E. West  
H. E. Cutting  
Everett Kick  
LaVerne Martin  
P. R. Hoppe  
Geo. Sturley

Box 517  
3802 Hoyt Ave.  
423-14th Ave. S.  
1633 Williamette St.  
206 E. 17th St.

Polytechnic, Mont.  
Bozeman  
Everett  
Nampa  
Eugene  
Vancouver, Wash.

## PACIFIC DIVISION

**Manager**  
A.D.M. Arizona  
A.D.M. Nevada  
A.D.M. So. Calif.  
A.D.M. Central Calif.  
A.D.M. No. Calif.  
A.D.M. Hawaii

M. E. McCreery.  
H. L. Gooding  
G. M. Lewis  
M. E. McCreery  
B. R. Coles  
E. C. Garrette  
K. A. Cantin

628 W. 49th St.  
Box 175  
211 West St.  
628 W. 49th St.  
16 Ellenwood Ave.  
1593 Piiki St.

Los Angeles  
Douglas  
Reno  
Los Angeles  
Los Gatos  
Coloso  
Honolulu, T. H.

## ROANOKE DIVISION

**Manager**  
A.D.M. West. Va.  
A.D.M. Virginia  
A.D.M. No. Carolina

W. T. Gravely  
J. L. Rock  
J. F. Wohlford  
T. M. Simpson

854 Main St.  
Main St.  
118 Cambridge Ave.  
Peoples Nat'l Bank Bldg.

Danville, Va.  
Farmington  
Roanoke  
Winston-Salem

## ROCKY MOUNTAIN DIVISION

**Manager**  
A.D.M. Utah  
A.D.M. Colorado  
A.D.M. Wyoming

N. R. Hood  
H. C. Wilson  
P. M. Segal  
P. N. Mitchell

1022 S. Ash St.  
c/o Deseret News  
604 Interstate Trust Bldg.  
Box 575

Casper, Wyo.  
Salt Lake City  
Denver  
Greybull

## WEST GULF DIVISION

**Manager**  
A.D.M. New Mexico  
A.D.M. Oklahoma  
A.D.M. So. Texas  
A.D.M. No. Texas

F. M. Corlett  
Louis Falconi  
C. E. Whartenby  
E. A. Sahn  
W. B. Forrest, Jr.

2515 Catherine St.  
Box 421  
211 News Bldg.  
Box 569  
502 Royal St.

Dallas, Texas  
Roswell  
Enid  
New Braunfels  
Waxahachie

## MARITIME DIVISION

**Manager**  
A.D.M. P. E. I.  
A.D.M. New Brunswick

W. C. Borrett  
W. Hyndman  
T. B. Lacey

14 Sinclair St.  
c/o N. B. Power Co.

Dartmouth, N. S.  
Charlottetown  
St. John

## ONTARIO DIVISION

**Manager**  
A.D.M. Central Ont.

C. H. Langford  
Wm. Choat

253 Cheapside St.  
241 Roberts St.

London, Ont.  
Toronto

## QUEBEC DIVISION

**Manager**

J. V. Argyle

493 Decarie Blvd.

Montreal

## WINNIPEG DIVISION

**Manager**  
A.D.M. Saskatchewan  
A.D.M. Manitoba

J. E. Brickett  
E. L. Maynard  
E. Nicholson

260 Athabaska St., E.  
Box 339  
397 Burnell St.

Moose Jaw, Sask.  
Morse  
Winnipeg

## VANCOUVER DIVISION

**Manager**

A. J. Ober

Cor. Main & Minerva Sts.

Vulcan, Alberta



# GREBE

## INDIVIDUAL SHIELDS

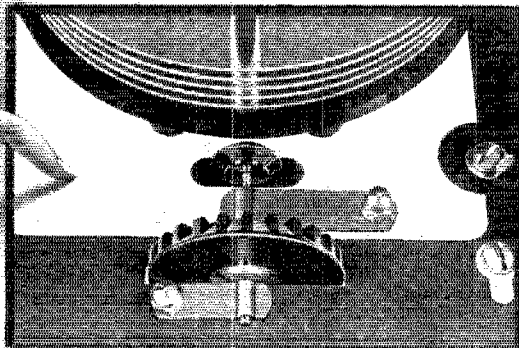

*"The Sage attends to the inner and not to the outer."  
— Lao Tzu*

*The wise buyer of a radio receiver is not misled, he looks inside the cabinet.*

*Doctor Mu*



Grebe Regenerative Receivers are licensed under Armstrong U.S. Pat. No. 1,113,149.

CLOSE inspection of many receivers reveals but one large shield to prevent body-capacity effects. As a result of research, each tuning control on a GREBE Receiver has its own aluminum shield of special size and shape.

This is just one of many details of craftsmanship which make for the high efficiency of GREBE Receivers.

*Ask your Dealer or write us.*

A. H. GREBE & CO., Inc.

Van Wyck Blvd.

Richmond Hill, N. Y.

Western Branch: 451 East 3rd Street, Los Angeles, Cal.



# The Official Organ of the A.R.R.L.

VOLUME VII

JUNE, 1924

No. 11

Editorials		7
WWV Schedules		8
Notice to Our Newsstand Readers		8
Building Superheterodynes That Work— Part I	<i>Edited by S. Kruse</i>	9
Canadian Amateur Radio Gains More Niches in the Hall of Fame		17
Rules Governing the A.R.R.L. Information Service		18
Election Results		19
Practical Master Oscillator Sets	<i>E. A. Laport</i>	20
Fifth Convention of the Third Radio District		25
How To Number Messages	<i>F. H. Schnell</i>	26
7DJ Works the "Bowdoin" With One Five-Watter		27
Experimenter's Section Report	<i>S. Kruse</i>	28
Obituary		30
Seventh District Convention		31
Checking Up Antenna Formulas	<i>Ralph R. Batcher</i>	32
A Good Break-In System	<i>Philip Laskowitz</i>	33
The Receiving Experimenter		35
Unscrambling Things		36
Concerning the McLaughlin Tuner		37
Two More Trophies		37
The Maritime Convention		38
An Eighty-Foot Latticed Mast		39
Amateur Radio Stations		40
International Amateur Radio		42
The Amateur Builder		44
With the Affiliated Clubs		48
"Strays"		49
Communications		52
Book Reviews		55

QST is published monthly by The American Radio Relay League, Inc., at Hartford, Conn. Kenneth B. Warner (Secretary, A.R.R.L.), Editor and Business Manager  
S. Kruse, Technical Editor; H. F. Mason, Department Editor  
F. C. Beekley, Assistant Editor

Edwin C. Adams, Advertising Manager.

Subscription price in United States, Possessions, and Canada, \$2.00 per year.  
Foreign, \$2.50. Single Copies, 20 cents.

Entered as second-class matter May 29, 1919, at the post office at Hartford, Connecticut, under the act of March 3, 1879. Acceptance for mailing at special rate of postage provided for in section 1103, Act of October 3, 1917, authorized September 8, 1922.

Copyrighted, 1923, by the American Radio Relay League, Inc.,  
Title registered at United States Patent Office.

THE AMERICAN RADIO RELAY LEAGUE, Inc.  
HARTFORD, CONN.

# THE AMERICAN RADIO RELAY LEAGUE

The American Radio Relay League, Inc., is a national non-commercial association of radio amateurs, bonded for the more effective relaying of friendly messages between their stations, for legislative protection, for orderly operating, and for the practical improvement of short-wave two-way radio telegraphic communication.

It is an incorporated association without capital stock, chartered under the laws of Connecticut. Its affairs are governed by a board of Directors, elected every two years by the general membership. The officers are elected or appointed by the Directors. The League is non-commercial and no one commercially engaged in the manufacture, sale or rental of radio apparatus is eligible to membership on its Board.

"Of, by and for the amateur," it numbers within its ranks practically every worth-while amateur in America and has a history of glorious achievement as the standard bearer in amateur affairs.

Inquiries regarding membership are solicited. Ownership of a transmitting station, while very desirable, is not a prerequisite to membership; a bona-fide interest in amateur radio is the only essential. Correspondence should be addressed to the Secretary.

## OFFICERS

*President*  
HIRAM PERCY MAXIM  
Hartford, Conn.

*Vice President*  
CHAS. H. STEWART  
St. David's, Pa.

*Traffic Manager*  
F. H. SCHNELL  
1045 Main St.  
Hartford, Conn.

*Canadian General Manager*  
A. H. K. RUSSELL  
243 Westmount Drive  
Toronto, Ont.

*Treasurer*  
A. A. HEBERT  
Hartford, Conn.

*Secretary*  
K. B. WARNER  
Hartford, Conn.

## DIRECTORS

H. M. ANTHONY  
Muncie, Ind.

H. A. BEALE, JR.  
Parkesburg, Pa.

A. H. BABCOCK  
Berkeley, Calif.

V. F. CAMP  
Brightwaters, L. I.

F. M. CORLETT  
Dallas, Tex.

C. E. DARR  
Detroit, Mich.

A. A. HEBERT  
East Hartford, Conn.

H. P. MAXIM  
Hartford, Conn.

A. H. K. RUSSELL  
Toronto, Ont.

F. H. SCHNELL  
West Hartford, Conn.

C. A. SERVICE, JR.  
Glastonbury, Conn.

C. H. STEWART  
St. David's, Pa.

K. B. WARNER  
West Hartford, Conn.

K. W. WEINGARTEN  
Tacoma, Wash.

M. B. WEST  
Lima, Ohio

G. L. BIDWELL  
Washington, D. C.

## ADVISORY TECHNICAL COMMITTEE

STUART BALLANTINE  
WM. C. BALLARD, JR.  
LEROY M. E. CLAUSING  
FRANK CONRAD  
LEO C. YOUNG  
MINTON CRONKHITE

J. H. DELLINGER  
C. L. FARRAND  
PAUL F. GODLEY  
F. C. BLAKE  
MELVILLE EASTHAM

L. A. HAZELTINE  
C. D. TUSKA  
R. H. G. MATHEWS  
GERALD M. BEST  
S. KRUSE  
D. G. McCAA

Address General Correspondence to Executive Headquarters, Hartford, Conn.



# EDITORIALS

## de AMERICAN RADIO RELAY LEAGUE



### Standard Time for Quiet Hours!

**W**ITH the advent of Daylight Saving Time in many parts of the country much confusion is discerned on the amateur air in the observation of Quiet Hours; some amateurs are following standard time, some daylight saving. To clear this up let us say as plainly as possible that standard time must be observed for the silent period, and that amateurs who are basing their QRX period on daylight saving time because their town has advanced the clock an hour for the summer are violating the regulations as certainly as if their act were intentional. Be careful about this, fellows, or trouble will result for you. The Bureau of Navigation has ruled that a nationally uniform plan must be followed, and that the quiet hours shall be observed in standard time whether or not our individual communities adopt D.S.T. during the summer.

### Expansion of Silent Period During Summer

**I**T is probable that we amateurs will be asked by the Bureau of Navigation to stand by an additional hour during the time that daylight saving time is in vogue. The quiet hours are designed to protect listeners-in from local amateur interference, and were set originally to embrace a period which the Bureau considered as representing adequate cooperation on the part of the amateurs. Daylight saving time, while no fault of ours, has brought about a condition where this adequate protection is no longer granted local listening for even tho all amateurs observe standard time in their quiet hours (which is correct) some listeners will be on one time and some another, and the same is true of the broadcasting stations to which they listen. Frequently there is no system whatever to the adoption of D.S.T. If it went solid by states it wouldn't be so bad, but often the rural districts keep on standard time while the cities adopt D.S.T., and sometimes adjacent towns are on opposite plans. In the resulting confusion the listener-in is not accorded the contemplated protection.

It is up to us to see that he gets it. The same reasoning that demanded that we have quiet hours in the first place makes it very desirable that we acquiesce whole-heartedly to the Bureau's proposal

to expand the silent period an hour. Many of the western states, and more particularly the northwestern, do not follow daylight saving time, but the Bureau feels that any plan put into execution should be uniform thruout the entire country, as it is probable that the 6's and 7's will be asked to give with the rest of the amateur world. Just what form the proposed expanded hours will take we do not know, but probably either 7 to 10:30 P.M. or 6:30 to 10 P.M., *standard time.*

All of us should understand clearly that this regulation, when and if it comes, will not represent a dangerous further abridgment of our privileges. It will not be permanent; it will be but for the duration of Daylight Saving Time this summer; and the regulation quiet hours of 8 to 10:30 P.M. will again apply with the abandonment of D.S.T. in the fall. With this in mind, and because the order will be really necessary to achieve the thing that we have a silent period for, we urge upon all amateurs a cheerful and whole-hearted compliance in the interests of cooperation.

### Mutual Aid

**W**E sometimes wonder if amateurs realize how much the radio trade—manufacturers and dealers alike—really means to them. Although it has faults—any trade of its youth and size has—yet it is continually improving in the quality of apparatus presented and the service rendered.

The "summer slump" is a thing of the past. Nevertheless there is bound to be a decided falling off in the radio business in warm weather as against that done in the fall and winter. Any business operates most efficiently for itself and its customers when it can maintain an even yearly sales average.

Here's where you men can do yourselves and the trade that serves you some real, practical good. Use the coming months when traffic is lightest and QRN worst to overhaul and refit your set. You can get good ideas from our reading pages. Put them into operation in your shacks this summer, and buy the apparatus necessary from *QST's* advertising section whenever you can, mentioning *QST* in the process.

The radio trade is honestly trying to help you get what you need. Here's your chance to return the compliment and help them get what they want, more summer sales.

## The Radio Tax Is Eliminated

**D**URING April an ill-advised suggestion on the part of the Senate Committee on Finance, considering the revenue measure, to place a 10% excise tax on all radio apparatus and parts, caused quite an alarm throughout every branch of radio in this country.

Whatever differences the various branches of radio activity may have amongst themselves were forgotten in this common danger, and everybody went to work to point out the injustice of the proposed levy. It had come without warning and the time for an organized effort against it was very short. The trade associations formed emergency committees, and most of the broadcasters put out appeals to their listeners, telling them what this tax would do to them and urging their cooperation in its elimination. The tax would have affected us amateurs as much as anybody, for it would have added 10% to the cost of all our equipment. A rush broadcast was put out by our Traffic Department and covered the country from coast to coast, calling upon members and clubs to protest to their Senators, and messages of opinion were solicited from hundreds of mayors of towns and cities and forwarded to Senators in Washington via amateur radio.

These efforts had their effect, for on May 2d the Senate threw out the proposed tax by a vote of 40 to 13, after a lively discussion which showed that the Senators had been flooded with protests since the levy was tentatively placed in the bill.

It is well. The tax would have been a most unfair one. Considering experimental radio only, it would have put a heavy discouragement on a work that should have every encouragement. It would have taxed an infant industry not yet stabilized, one which is struggling with many difficult problems. If radio were purely an amusement, the idea of an amusement tax or a luxury tax might have been more easily entertained, but radio is essentially an educational medium of unprobed potentialities, and it would have been most unfortunate to handicap and delay its endeavor to stabilize itself by so discouraging a thing as a heavy tax. This seems so obvious that one may be permitted to wonder how the ambition to tax it ever arose in the breasts of the Senate Finance Committee. And right there a most illuminating discovery is made!

The Senator from Connecticut who is a member of the Committee answers our protest by saying that "the Committee was informed that the manufacture of these parts was very largely controlled by one concern, consequently, the price charged was all the trade would bear and the profits were naturally large. Of course, you

realize that the Committee had to find sources of revenue that will pay expenses and this cannot be done without taxing somebody". Oho! so there is but one radio manufacturer in the country! This is further borne out by the *New York Times'* report of the discussion on the Senate floor, in which "Senator Smoot attacked radio manufacturers fiercely. 'The sets are made by the largest concern in the United States and it's a monopoly pure and simple. They are demanding every dollar that the trade will bear'". Yes, the Radio Corporation was mentioned as the concern in mind.

Based on the ridiculous misconception that all the radio sets and parts in the country were made by one manufacturer, who charged fabulous prices and hence could be taxed without hurting anybody, it is easy to see why the proposed levy was thrown out by the Senate as a whole to the tune of 40 to 13.

## WWV Schedules

Schedules of Frequencies in Kilocycles				
(Approximate wave length in meters in parentheses)				
Eastern Standard Time	June 5	June 20	July 7	
11:00 to 11:08 PM	300 (1000)	550 (545)	1363 (220)	
11:12 to 11:20 PM	315 (952)	650 (461)	1430 (210)	
11:24 to 11:32 PM	345 (869)	750 (400)	1500 (200)	
11:36 to 11:44 PM	375 (800)	833 (360)	1600 (187)	
11:48 to 11:56 PM	425 (705)	940 (316)	1700 (176)	
12:00 to 12:08 AM	500 (600)	1050 (285)	1800 (167)	
12:12 to 12:20 AM	600 (500)	1150 (261)	1900 (158)	
12:24 to 12:32 AM	667 (450)	1250 (240)	2000 (150)	

## Notice to Our Newsstand Readers

As announced in recent issues, The Traffic Department Report and the "Calls Heard" Department have been eliminated from the newsstand edition of *QST* because our non-member readers in general are not particularly interested in them. This results in a saving in expense which makes possible the publication of a larger and better *QST*.

These two departments are included in the edition supplied to members of the A.R. R.L. If you are interested in them, it is proof positive that you ought to be a member of the League. May we not direct you to the handy application blank appearing on page 88 of this issue?

# Building Superheterodynes That Work -- Part I

Edited by S. Kruse\*

This is the first of a series of articles describing superheterodyne receivers using the following types of amplifying transformers: Neutroformer, fixed air-core, fixed iron-core. The second and third articles will appear in following issues of QST.

**T**HE superheterodyne is the worst or the best of receivers, depending entirely upon the long wave amplifier in the circuit *and the short wave tuner in front of it.*

For these reasons it seems worthwhile to explain carefully the very things that the builders of most superheterodynes (and superheterodyne parts) overlook; namely, the tuner and the amplifying transformers.

## Why Radio Amplification?

In Figure 2A we have a tuner with an

as regularly as some of the more elaborate tuners because the set is not sensitive enough. But if C.W. is to be received one should not be in too big a hurry about giving up a good regenerative detector with audio amplification.

To increase the sensitivity of the set one can add three or four stages of audio amplification but they will be very noisy unless special circuit tricks are used and unfortunately these tricks make a large and expensive amplifier. It is better to amplify before getting to the detector; in

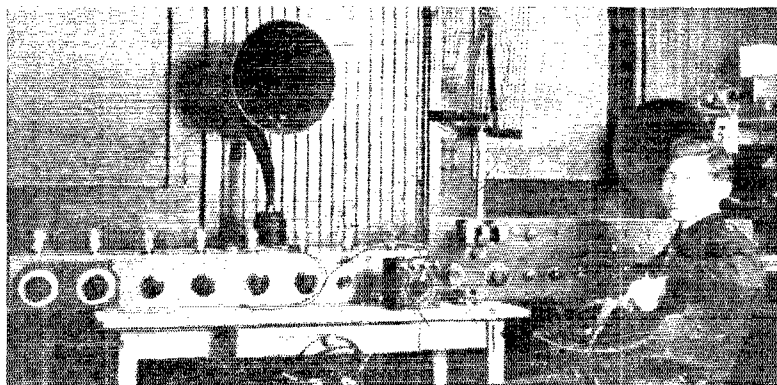

J. L. McLaughlin, the Builder of the Superheterodyne Described in this Article.  
European Broadcasting is Frequently Copied Using this Receiver  
and a 3-foot Loop Antenna.

audio detector and amplifier, the simplest of modern receiving sets. If the set is good and the operator is patient enough, *he will eventually hear just about anything that can be heard with the best set made.* However, he will not hear distant stations

other words, to use radio amplification.

\*Acknowledgment—The Editor wishes to acknowledge indebtedness to the following men for contribution of suggestions, diagrams, photographs and important portions of the text.

Stuart Ballantine, Radio Frequency Laboratories.  
Dr. Lewis M. Hull, Radio Frequency Laboratories.  
Melville Eastham, president General Radio Company.  
H. S. Shaw, Jr., IJK, treasurer General Radio Company.

Glenn West, 7ZU, Dept. of Physics, Montana Polytechnic Inst.

A. J. Haynes, pres., Haynes-Griffin Radio Service.  
O. A. Kimball, 9RY.

Harold Harvey, 3XAQ-3TE-3DN.

Captain H. J. Adams, radio instructor, Signal Corps, U.S. Army.

Dr. Elliott White, 1YB-1XAV, Dartmouth College.

There is another way of looking at this thing which gives an additional reason for the use of radio frequency amplification. Supposing for a moment that our audio and radio amplifiers are going to work equally well and that they have an amplification constant of eight, counting both the transformer and the tube. Now in Figure 1A if we supply 2 microvolts to the radio frequency amplifier we will get out of it 2 times 8 or 16 microvolts. When we supply these 16 microvolts to the detector we will get from it a response proportional to 16 times 16 or 256. It will be noticed that the effect is as if the detector squares the input voltage.

Now in figure 1B if we supply the *same* 2 microvolts to the detector, we will get out of it a response proportional to 2 times 2

or 4 microvolts. When this is supplied to the audio amplifier it will be multiplied by 8 as before and we will get the effect of 32 microvolts out. It will be noticed that this is very much less than was secured in the case of the radio amplifier.

In practice the effect is not quite as good as this because a stage of audio amplification gives considerably more amplification than a stage of radio if both are run well below the oscillating point.

### The Superheterodyne Idea

In Figure 2B a radio amplifier has been added to our detector-audio circuit of Fig.

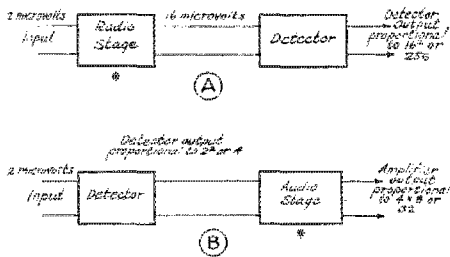

\* These stages assumed to have voltage amplification of 8 per stage, counting tube and transformer.

FIG. 1 WHY RADIO INSTEAD OF AUDIO

2A. It is supposed to be working below 600 meters, therefore it is a short wave amplifier. This increases the sensitivity of our set considerably as proven by the Superdyne, Neutrodyne, etc.; also by the various reflex sets. Spark and telephone reception are improved very greatly. Whether C.W. reception is improved depends on some things we will take up later.

Radio amplifiers are less effective and less stable as the wavelength goes down. Below 100 meters many of them will not work at all and most of them begin to go off very badly below 300 meters.

A long wave radio amplifier is very much more stable than a short wave one of the same type, also it amplifies somewhat more. Therefore it would be convenient to change our short wave signals into long wave signals before amplifying them. That is the Armstrong superheterodyne idea, shown in Figure 2C.

### The Frequency Changer

Of course there must be a wavelength-changer between the short-wave tuner and the long-wave amplifier, just as shown in Fig. 2C. This frequency changer consists of an audio detector and an audio oscillator whose wavelength is controlled by a variable condenser.

If the long wave amplifier is tuned to 50,000 cycles then the oscillator must always be set 50,000 cycles above or below the tune of the incoming signal. All stations can be heard on two or more settings of the oscillator. This is the main defect

of the superheterodyne. However, if interference is met on one of the settings the other one is often clear.

### The Tuner

The thing that most builders of superheterodynes cannot seem to understand is that the "super" is an amplifier. Ahead of it there *must be a good tuner* if decent selectivity is expected. More, much more, will be said about this.

### Is the Superheterodyne Better?

For radiophone reception one can say confidently that a good "super" will at least equal the range of other sets and be easy to control in addition. For spark or I.C.W. work the "super" does its best work, being supremely sensitive.

For C.W. reception the superheterodyne is by no means convincing; in fact, the simple oscillating detector and audio amplifier shows up very well against all competition.

### Choosing the Amplifier Wavelength

Having decided to build a superheterodyne receiver one must next pick the kind of amplifying transformer that is to be used and the wavelength at which it will work. The easiest way to clear this up is to talk about the different kinds of transformers one after another.

### Tuneable Transformers

When a condenser-tuned radio transformer is used, the intention is usually to get high amplification at one wavelength and to have it drop off sharply to either side. Another way of saying this is that we are trying to make a sharply tuned transformer. Accordingly such transformers are usually made air-core. The best known example of this type is the Hazeltine neutrodyne transformer commonly called a "neutrodyne". The resistance of such devices is low and the tubes tend to oscillate. This can best be controlled by some anti-regeneration method, such as those used in the "Neutrodyne", "Superdyne", "Rice circuit", etc.

At short wavelengths condenser-tuned air-core transformers are entirely satisfactory. At long wavelengths, such as 10,000 meters, they are entirely satisfactory for everything *excepting* for radiophone where they *cannot be used* on account of the sharp tuning which tends to cut off a portion of the side bands with the result that there is serious distortion. (See Fig. 3A.)

If such transformers are used in a superheterodyne they must accordingly *not* be used on wavelengths much above 1500 meters.

Air-core transformers are never very

1—See "Anti-Regenerative Amplification", by Dr. L. M. Hull, p. 12, QST for January, 1924; also "Radio Amplification", by Stuart Ballantine, p. 11, QST for March, 1924.

compact; accordingly they will pick up long wave interference and must be enclosed in shields.

The use of such transformers in a "super" will be explained in an article describing Mr. J. L. McLaughlin's neutrodyne-superheterodyne receiver.

**Fixed Air-core Transformers**

Fixed air-core transformers are tuned by the distributed capacity of the coils. Because they are fairly sharp their performance is best if the wavelength is not made too long. Since there is no way of adjusting the tuning after the set is finished these coils must be made to tune *exactly* alike before putting them into place. Methods for doing this will be given later.

Since this type of transformer can be made of small wire they can be made fairly small and it is not necessary to shield them unless one is near a high power long-wave station. However, on the Atlantic, Pacific or Gulf Coast the pick-up by these transformers is still enough to make trouble and each stage should be enclosed in a metal shield. Details will be given in a later article covering this type of long-wave amplifier.

**Iron-Core Transformers**

Iron is used in radio frequency transformers for two general reasons; to increase the coupling between the primary and secondary while still permitting ample insulation between the two windings, and to broaden the tuning so that the transformer will cover a wider wave band. It is hard to make general statements about such things but as a rule iron-core radio-frequency transformers tune more broadly and do not amplify to such a high peak at any place. If one is going to operate a superheterodyne at relatively very long wavelengths, where the greatest advantage from this type of receiver may be obtained, then the iron core transformer is naturally attractive because it is evident from what we have already said that a sharp radio-frequency transformer could not be used at these very long wavelengths. However, the thing is not as simple as it sounds. Supposing we go to 9000 meters, which is 33 kilocycles. If we are to amplify at this wavelength, the transformer must of course tune broadly enough to take in at least 10,000 cycles at either side with practically equal amplification; in other words it must have a flat top curve extending from 23 kilocycles to 43 kilocycles. Now if the transformer is not well designed the curve may very easily slant over into the audio range as indicated in Figure 3B, with the result that the transformer will be noisy. Iron-core transformers, however, have many other advantages which will be indicated in the third article of this series.

**Regeneration**

Regeneration is mentioned here for just

one reason, to say that any radio frequency amplifier has leanings toward regeneration. We do not recollect having seen a R.F. amplifier with a "regeneration encourager" but all of them have some sort of a "regeneration limiter," although it is not always adjustable and the designer does not always suspect that it is there. This tendency of the amplifier to oscillate is actually desirable in a single stage; one can control it in one way or another and thereby gain the usual advantage of a regenerative tube. When a number of stages are used, things look entirely different; unless each stage is "neutralized" the string will be exceedingly hard to control. It will be so hard to control that a large amount of "lossing" will be needed and the overall amplification will drop badly. The proper way to get around this is to neutralize each stage.

**Getting Started**

We have talked a great deal and done nothing but scare up new questions. Let us settle a few of them. It is evident that one can use condenser-tuned air-core transformers, fixed air-core transformers, or fixed iron-core transformers, in a superheterodyne. If we are using condenser tuned air-core transformers it is more or less an open question whether anything

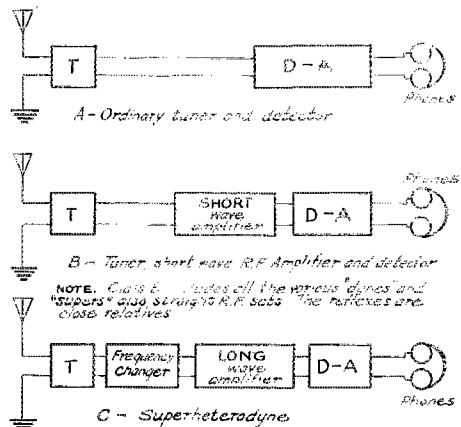

FIG. 2 THE SUPERHETERODYNE IDEA  
In all three diagrams T is a good tuner, D-A is a detector and audio amplifier.

has been gained in the way of sensitivity by going to the superheterodyne; we might as well stick to a straight Neutrodyne. However, one thing *has* been gained: we now have only two adjustments as against three in the normal Neutrodyne. The neutrotransformers can be left alone after they have once been tuned. However, some one of these days an enterprising Neutrodyne manufacturer will take care of that difficulty by producing a Neutrodyne with two controls.

In the meantime, however, we can produce an interesting tuner by building a neutrodyne-superheterodyne.

If air-core transformers *without* adjustable tuning were used we would not get satisfactory amplification over a wide band at the short waves, and it is obvious that these are suitable only for such a circuit as the superheterodyne where the peak can

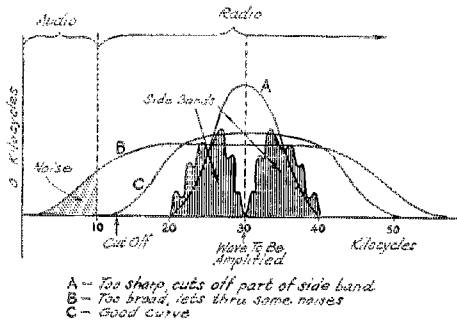

FIG. 3

be placed at the desired long wave and left there.

Iron-core transformers can be made broad or sharp and therefore are available either for superheterodynes or for the usual variety of broadly-tuned short-wave amplifiers. However, one can see immediately

## A NEUTRODYNE-SUPERHETERODYNE

**W**E are indebted to Mr. J. L. McLaughlin of Rochester, New York, for detailed information on his very excellent neutrodyne-superheterodyne.

To convert a normal neutrodyne into a superheterodyne-neutrodyne nothing is necessary except to substitute long wave transformers for the usual short wave transformers and then to put a frequency changer between the tuner and the first step of radio amplification. The neutrodyne part of the set consists of exactly the same things which are found in an ordinary neutrodyne, the only difference being that the transformers have more turns and tune to a longer wavelength. There is nothing peculiar about the short-wave tuner in front of the amplifier either, nor is there anything unusual about the detector and audio amplifier at the output end of the set, they are left just as they originally were.

The frequency changer, as is usual with superheterodynes, consists of a detector and an oscillator.

In point of fact Mr. McLaughlin did *not* convert an ordinary neutrodyne but built his device from the ground up for reasons which will be seen a bit later.

### The Tuner

No receiver can hope to be very selective

that the same number of stages will give far more amplification if the transformers are built to give a high peak at a long wave than if they are given a broad low peak at a short wave. These transformers therefore look more promising for the super than for the ordinary radio amplifier.

The final result is that all three types may be used in the super and the choice is mainly one of individual opinion. That is why the following series of articles present superheterodynes using different amplifiers.

### C.W. Reception

It must be remembered that the oscillator in the frequency changer of a superheterodyne does not make continuous waves audible. In order to hear them it is necessary to employ another oscillator after the long wave amplifier or else to make the second detector tube itself oscillate. It is also possible to make the long wave amplifier oscillate but this usually is not very satisfactory.

Neither is it usually very satisfactory to make the second detector oscillate because, at long waves, one cannot get an audible note in this fashion without tuning the detector very far off of the working wave.

The method by which it is possible to receive continuous waves without using an excessive number of tubes will be described in the second article of this series.

unless there is a good tuner ahead of it. This is true for a regenerative set and it is *far more true for a non-regenerative set*. It is surprising how hard people find it to believe this simple fact. We have seen a number of superheterodynes that were very carefully built all the rest of the way through but were handicapped by a tuner that could only be described as terrible.

Quoting from Mr. McLaughlin, "Most of the super-heterodynes brought out of late have to depend on the oscillator for selectivity; the tuner is generally broad. In this set one-half degree movement on *either* the oscillator or the tuner will completely eliminate local broadcasting stations". The settings of the radio amplifier tuning condenser are not critical unless the stages are improperly neutralized.

The tuner in Mr. McLaughlin's set is meant to cover both amateur and radio-telephone waves. This could be done without tapping the secondary but would make the tuning very crowded at the lower end of the condenser scale. For that reason the secondary is tapped at the thirtieth turn. Another tap at the sixteenth turn will make it easier to get down to the very short waves now used by some broadcasting and amateur stations. The construction of the tuner is sufficiently explained by the photographs

and by Figures 4a, 4b and 4c.

For simplicity in tuning, a fixed primary  $L_1$  is used. Since a very short antenna is ordinarily employed this is entirely satisfactory. A large antenna should never be used, partly because it is not needed and partly because the main effect will be to confuse the signals that are wanted with others that are not wanted, also with static and line noises.

For the sake of securing good selectivity the coupling is made moderately loose, a space of  $1\frac{1}{4}$  inches being allowed between the primary and secondary windings; see Fig. 4b. This spacing should not be reduced but it may be made larger with advantage, especially if a big antenna is used.

#### Building the Tuner

All of the usual rules of good tuner construction apply here. Before beginning the reader is advised to re-read our articles call "Low-loss Tuners" and "Short-Wave Tuner Design." The tube which carries the windings should be very thin, certainly not over  $\frac{1}{16}$  of an inch, and should be made of entirely dry waterproof material.

good quality with the contacts spaced three-quarters of an inch or more. A poor switch will spoil the entire tuner; perhaps it is best to play safe by using a clip.

#### The Condenser

Of course the variable condenser in the tuner should be a good one and as usual the movable plates and the shaft should be connected to the filament side of the circuit. The stationary plates of the tuner condenser are connected to the flexible cord and clip which we have just mentioned or are connected to the blade of the secondary switch, if one is used. At the risk of becoming tiresome we will repeat that *in a non-regenerative tuner it is of the utmost importance to use the very best condenser that you can purchase.*

#### The Frequency Changer

The frequency changer consists of a detector and an oscillator. The oscillator coils, Fig. 4a, are so proportioned that they will cover the entire amateur and broadcast band. If it is desired to go lower the coil  $L_1$  may be tapped to a two-point switch.

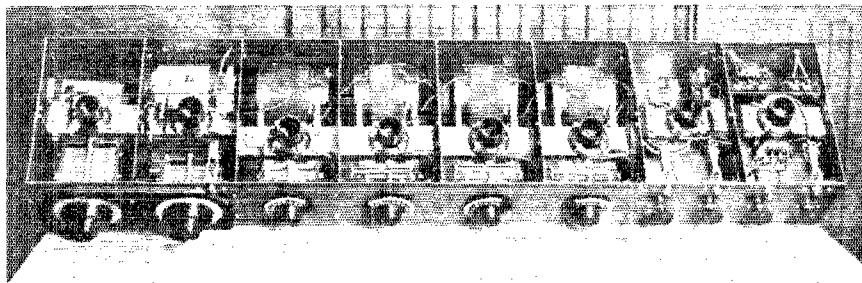

MR. McLAUGHLIN'S SUPERHETERODYNE

Note the individual metal cells which shield the tuner. The radio-frequency transformers are tuned but these adjustments are fixed, once the right values are found. The first tube is the oscillator, then comes the first detector, then four stages of tuned and neutrodyne long-wave radio-frequency amplification. At the right end of the tuner are the second detector and one step of audio amplification.

A light cardboard tube well dried and treated with a light coat of airplane dope or paraffin is as good as anything. For the way of doing this see "Short-Wave Tuner Design."

In mounting the tube keep it away from the panel and if possible keep the grid end of the coil entirely in the center of the box.

Since the secondary,  $L_2$ , is tapped it will be necessary to use a flexible cord and a clip or else to run taps to a switch. It is slightly better to keep this switch inside of the box so as to keep the grid circuit clear of the panel. If a switch is used it had better be mounted on hard rubber of

The tap should be taken from about the center of the coil.

#### The Amplifier

As we have said before, the amplifier is simply a long wave neutrodyne. The construction of the neutroformers (a radio-frequency transformer) can best be understood by following Figure 4c. The secondary coils,  $L_2$ , have 250 turns, therefore they are wound triple-banked to shorten them up enough so that they are usable inside of a receiver without having any part of them too close to the metal shield. Simply winding the coil in three layers will not be satisfactory; the performance of such a coil will be very poor indeed. Since some readers are not familiar with banked windings we will quote from Mr. M. B. Sleeper's

2—"Low-loss Tuners," by S. Kruse, page 8, QST for February 1924.

3—"Short Wave Tuner Design," by K. E. Hassel, page 37, QST for December 1923.

"Ideas for the Radio Experimenter's Laboratory"

"The problem of producing an efficient coil of high inductance in a small space is a difficult one for the man who makes his own apparatus.

"Figure 5 shows bank-wound coils. (Type A is supposed to represent the ordinary single-layer inductance.) Type B has two layers with the turns bank-wound in the order indicated by the numbers. The fourth

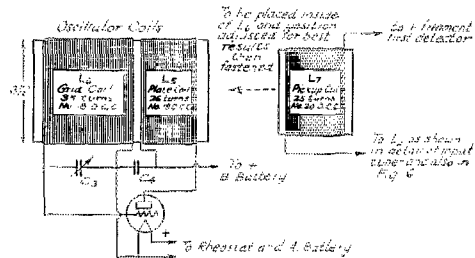

FIG. 4A THE OSCILLATOR

turn is bent opposite the start of the winding and between the second and third turns. The sixth turn is brought down to the tube and two more turns are wound. This may seem difficult at the beginning but is easy after a few trials. The whole secret of bank winding is in getting the right tension so that the turns will stay. Cardboard tubes are the most satisfactory cores as they are just rough enough to keep the bottom layer from slipping. Type C is more difficult to wind as the wires tend to slip off the top layer. They have their advantages, however, in saving space and increasing the inductance for given number of turns. A simple series of experiments was made in which 19 turns in a single layer give an inductance of 23,180 centimeters while the same number of turns (and almost exactly the same length of wire) wound as at C had an inductance of 36,040 centimeters. The coil was only 42% as long. Coils can be wound in this way with any kind of solid wire . . . . . if the proper method is followed. There are two secrets which are not generally recognized. The first is that the bends in the wire must be sharp; the second that too great tension must not be put on the wire and the crossovers. A three-bank coil is wound in the following manner:

"Four turns are wound closely and tightly on the tube. Then with a screwdriver or similar dull instrument the wire is held in place on the tube and bent sharply to the left (back toward the first turn of the coil.) With the thumb and first finger holding the wire and winding against the tube

the wire is swung forward. Next, without releasing the bend, the tube is turned half-way around. Now both wire and bend will keep their places. Two turns are layed over the first four. At the end of the second turn of the second layer another crossover is made in a manner similar to the first and one turn is wound in the third layer. Again the crossing is made sharply, for long crossovers cause the layers to break down."

The coil has now been started and the following turns are put on as indicated by Figure 5. Each one of the bends should be made next to the last one so that on the finished coil bends make a regular spiral around the coil as shown in Fig. 4c.

"Sometimes difficulty is experienced with a smooth tubing for the under wires are apt to slip out of place. This can be remedied by an application of spar-varnish. A rough finish can be obtained by striking the tube with the flat side of the brush until the varnish is sticky.

"This method of winding is difficult to learn but once the knack is mastered it is very simple and can be done rapidly."

The primary of the amplifying transformer is wound over the low-voltage (filament) end of the secondary in the fashion indicated by the figures and photographs.

Neutralizing Condensers

The neutralizing condensers (neutrodons) are arranged in the fashion customary with this type of amplifier. These condensers can be of the usual variety but it is recommended that they be made with glass tube insulation, not with a piece of varnished cambric tubing (spaghetti) as is sometimes done. Some makes of the fabric tubing become quite wet in rainy weather. In the photograph the neutralizing condensers may be seen just above each r.f. tuning condenser.

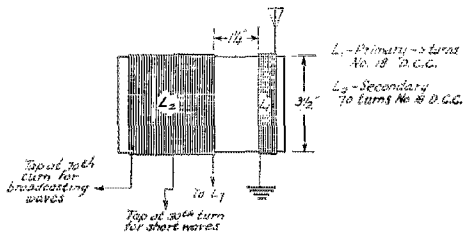

Tuner details, see Fig. 6 for connections of complete set. FIG. 4B

The neutralizing condenser for the first stage is in the second stage stall and the second stage one is in the third stage stall, etc. No neutralizing condenser is used in the last stage because a little regeneration at this point is helpful. Any tendency to oscillate can be controlled by slightly detuning the last stage.

4—"Ideas for the Radio Experimenter's Laboratory," by M. B. Steeper, 25¢, QST book department.



**Output Choke**

Each neutroformer has its secondary connected to the tube which is in the same stall with it. It will be noticed that there is no neutroformer in the detector stall (next to the right end of the set). The reason is that the last amplifier tube is coupled to the detector by means of a tuned choke. The construction of this choke is shown in Figure 4D and the way it is connected to the circuit is explained by the main diagram of Figure 6. This choke is tuned by means of a "Connecticut" variable condenser which

pletely until the cover of the set was closed down. This means that the neutrotons must be set forward a little at a time, closing the cover down each time to find out what the effect is.

**Adjusting the Amplifier**

When one has built a super-heterodyne of this type one is not ready to begin receiving. First the amplifier should be adjusted. This can be done by using the connections shown in Figure 7. The method is as follows. Connect the antenna and ground to the set. Now start the buzzer on the little driver and set all the tuning condenser's  $C_0$ , in the amplifier at some convenient value, such as the center of the scale. (Set them all alike.)

By moving the various condensers on the driver, adjust its wavelength until the best signal is heard from the phones on the set. Now let the buzzer run and go back to the set. By careful tuning

of all the different condenser's  $C_0$ , in the amplifier, and the condenser  $C_0$ , in the oscillatory, gradually increase the signal strength. While doing this you will probably have to move the driver back several times to a greater distance. If things are working right it will be possible to get a good signal with the driver 30 or 40 feet away.

By this time you will find that the amplifier has begun to oscillate. To get rid of this the neutrodyne capacities  $C_0$  must be increased *but this must be done one step*

is placed inside of the stall. The tune of this choke is set first and all of the other stages are adjusted to it.

**Shielding**

The shielding of this particular set is unusually complete, the entire box having been made of metal. In doing this it is best to use heavy sheet brass or copper; a thin metal of any kind is unsatisfactory. Sheet iron is not useful because it increases the losses and does not shield very effectively.

There are two reasons for this shielding: the set will not pick up long wave interference, and it is not necessary to take the elaborate care about setting the neutroformers at any particular angle. The users of superheterodynes usually do not realize that they are getting long wave station interference because the signals are ordinarily not readable and only result in very poor audio quality. Before leaving this subject it is worthwhile to look very carefully at Mr. McLaughlin's set and notice how every coil and condenser has been kept absolutely clear of the metal walls. The cover of the set should be provided with a metal lining (if it is not entirely of metal) and should have a flange that will come down inside of the metal lining of the box, touching it as much as possible and overlapping at least half an inch.

Mr. McLaughlin says that the performance of the tuner would, in his estimation, be considerably improved by making the stalls somewhat larger so as to remove the coils still further from the shields. The shielding, however, was absolutely necessary; in fact it was not found possible to neutralize the long wave amplifier com-

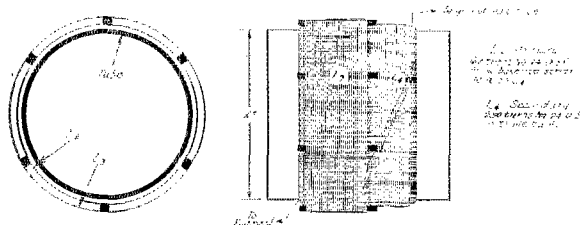

FIG. 4c R.F. TRANSFORMERS (Neutroformers) USED IN THE AMPLIFIER

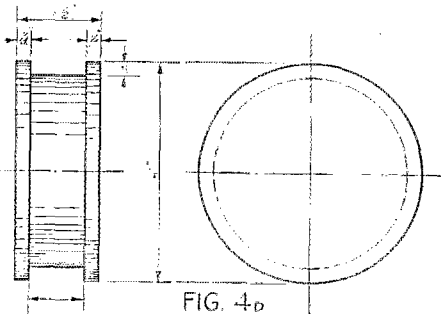

FIG. 4d SPOOL FOR TUNED CHOKE WINDING 200 TURNS NO. 24 D.S.C. "SCRAMBLE WOUND"

at a time and cannot be done for the whole amplifier at once. Begin by disconnecting the filament of the first amplifier tube. This may be done by putting a small piece of paper over one of the prongs of the tube so that it does not light when put into the socket. This must be done carefully so that all of the other prongs do make contact. It can also be done by discon-

necting the positive side of the filament battery from the socket. The break must be made *right at the socket* and the wire should not be bent up any further than

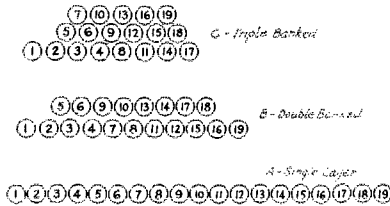

FIG 5 ARRANGEMENT OF TURNS IN BANKED WINDINGS

necessary, so as to change things as little as possible. Now adjust the first neutrodon until you can hear the buzzer, even when it

the way through the amplifier it is a good idea to go back and check the adjustments from the front again. If they have been properly made, the amplifier will not oscillate excepting perhaps at the ends of the tuning range.

The whole thing can be done on a good strong received signal if one is sure it will keep going.

**Tuning the Amplifier**

When receiving, all of the amplifier stages are supposed to be tuned to exactly the same wavelength. If any of them must be thrown off tune to prevent oscillation, the neutrocons should be readjusted.

It is not necessary to re-tune the amplifier at any time unless some particular station interferes. In that case all of the stages should be returned to a new point and the controls on all the  $C_s$  condensers again locked in place. There is little, if any, ad-

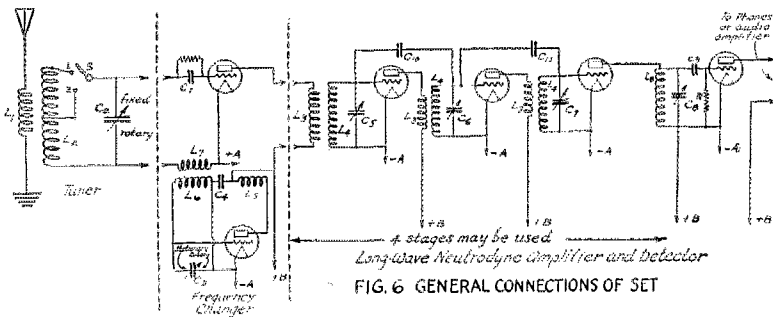

FIG. 6 GENERAL CONNECTIONS OF SET

**FIG. 6—DIAGRAM OF CONNECTIONS.**

To simplify the diagram only enough tubes are shown to give the system of connections.

- L1—Input tuner primary
- L2—Input tuner secondary
- L3—R.F. transformer primary
- L4—R.F. transformer secondary
- L5—Oscillator plate coil
- L6—Oscillator grid coil
- L7—Oscillator pickup coil
- L8—Tuned choke

See Figs. 4a-b-c-d for details.

- C1 and C2—.00025 microfarads; use a good fixed mica condenser.
  - C3—.0005 Cardwell variable condenser.
  - C4—.001 Cardwell variable condenser.
  - C5—.005 microfarad or larger; use good fixed mica condenser.
  - C6, C7, C8—.00025 Cardwell variable condenser.
  - C9—Connecticut variable mica condenser.
  - C10—.00025 Micadon fixed condenser.
- R—Grid leak.

Notes—Return all grids as indicated. Negative B battery return is to the positive A battery. It is best to connect a good 1-microfarad paper condenser from the positive B battery to the negative A battery. For sake of simplicity rheostats are omitted. For proper location see Mr. John C. Warner's article in Feb. QST. When the photograph was taken a special primary was being used on the first neutroformer. This fitted inside of the secondary but was afterward replaced by the same kind of primary shown for other stages.

is brought fairly close. If you cannot make it entirely quiet get the adjustment which gives the least noise. Now light the filament of the first tube again and turn off the next one by one of the schemes suggested. Then make the entire adjustment for the second neutrodon.

When this scheme has been carried all

vantage in leaving the  $C_s$  controls adjustable and it greatly complicates the operation of the set and introduces a chance for trouble.

**Adjusting the First Detector**

When the amplifier is known to be working well the phones should be connected from the positive B battery directly to the

plate of the first detector, all other tubes having been taken out or turned off. Now tune in some good strong spark or phone signal and adjust the grid leak and the plate voltage until this detector is operating well. If you can hear a fainter station, check the adjustment with that one.

#### Operating the Finished Receiver

Having made all of the adjustments that have been described the condenser  $C_2$  should now be rotated slowly with the secondary switch on the upper contact. At the same



FIG. 7

FIG. 7.—DRIVER to be used in adjusting the Neutrods if no strong signal is available. The condenser and coil can have any proportions that will tune to 400 meters or so. A convenient combination is a .0005 or .001 microfarad condenser with a coil of 50 turns of No. 18 D.C.C. on a  $3\frac{1}{2}$ " or 4" tube.

time the condenser  $C_3$  should be turned back and forth over its entire range. When the tuning of this condenser crosses that of the condenser  $C_2$ , stations will be heard if there are any on that particular wavelength. As has been mentioned before there will be two settings of the condenser  $C_3$  for each station, but only one for the tuning condenser  $C_2$ . Sometimes other settings of

the condenser  $C_3$  will be found where one of the harmonics of the oscillator heterodynes the incoming signal. This difficulty can usually be reduced by loosening the coupling between  $L_1$  and  $L_2$ . This will not cure the effect entirely, however, and it is more or less present in all superheterodynes. In general the coupling between  $L_1$  and  $L_2$  should be made as loose as possible. If it is too close various difficulties will occur, such as lack of selectivity, irregular tuning effects and a tendency for the oscillator to stop working without warning at some wavelengths. If the coupling is too loose the oscillator will have little or no effect.

#### Learning to Tune

The set should be used first without any audio amplifier and with the phones connected directly to the second detector. By running up and down the scale repeatedly with  $C_2$  one should learn the corresponding positions for  $C_3$ . This should be done until one is familiar with that range and then be repeated on the other contact.

Since there is not always a station going to tell when the oscillator and the tuner are in resonance it is necessary to watch for the slight noises which come through. These so-called "background noises" are a good indicator. They consist of faint static and other accidental things.

The second section of this article will deal with superheterodynes having fixed air-core transformers in the long wave amplifier. It will also deal with the use of the superheterodyne in receiving continuous waves.

## Canadian Amateur Radio Gains More Niches in the Hall of Fame

**A**NOTHER chapter was added to the already glorious history of service of the American Radio Relay League on April 17th when the broad Atlantic was spanned by two Canadian members of the League, in an emergency when the cables were out of order.

Dartmouth, Nova Scotia, a small town on the eastern side of Halifax Harbor, is the news center for European news for several large American newspapers, which there maintain an up-to-date receiving station which is on the job every day of the year receiving news direct from their foreign representatives by means of high-powered European radio stations. These stations transmit on schedule and the Dartmouth station, doing receiving only, is obliged to send cables when special news is required or when a repeat is made necessary by interruption or interference.

On the evening of April 17th an important news item was wanted repeated, and as usual the cable companies were called upon, but they were unable to deliver the message because two of the cables had been broken that afternoon and the third company was so overloaded with business that delivery that night was impossible. The superintendent of the Dartmouth receiving station was getting anxious after waiting nearly three hours without the repeat he had cabled for. He had but an hour and a half and his last schedule with the British high-power station would be over. Anxious but helpless, suddenly he thought of the A.R.R.L. and straightway got in touch with Major Wm. C. Borrett, of Canadian 1DD, and told him his troubles. As on many previous occasions, the League was not found wanting. Major Borrett, who is Manager of our Maritime Division, immediately got in touch with several Halifax

and Dartmouth amateurs and gave them instructions to listen in on short waves and if a European amateur was heard, to call him immediately and ask him to get in touch with the English high-power station and request him to repeat the required news item for the American press. The only local operators at their sets were 1EB, 1DJ, 1BQ and 1DD, but as every amateur station in Halifax and Dartmouth has worked trans-atlantic, a few were as good as a dozen.

Half an hour was used in listening but no signs of any European amateurs. 1BQ and 1DD then decided to send out the message as a QST, in the hope that some DX listener of England would pick it up, while the other two stations kept watch. The QST was kept up for fifteen minutes, and then another fifteen were spent listening in. They had about decided to send out a second QST when the telephone rang and the superintendent of the T/A receiving station was heard saying "Thanks, you have put it over all right. We are now getting our repeat." Oh, boy, what a grand and glorious feeling! Another niche in the Hall of Fame.

It did not take long to find out which station had been the successful one. 1AR, another member of the Maritime Division, having returned home, got down to the usual sport of listening for Europe and before long heard British 2SZ calling. He gave him a buzz and received the following message: "To Canadian 1BQ and Canadian 1DD. Both your QSTs copied by British 5BV and myself and forwarded as requested. G2SZ."

Thus ended another chapter in the history of A.R.R.L. service.

#### Canadians Handle Message from England To Vancouver in Record Time

**W**ORKING on their new short wave, a group of Canadian amateurs recently handled a message from Bristol, England, to Vancouver, B.C., a distance of over 6,000 miles, in slightly over an hour.

The test, as far as can be ascertained, was conceived by Mr. S. G. Vigers, c3WS, Port Arthur, Ont., who got in touch with 9BX of Morse, Sask., and 3BQ, of Kitchener, Ont., and asked them to make arrangements with western and eastern stations, respectively, to be on the air the night of the test; while a message was relayed to 1AR, Dartmouth, N.S., asking him to request an English station to give him a message for Vancouver. 1AR raised British 5KO, at Bristol, who eagerly consented to be on the job.

The test night saw everyone on deck waiting. The message was received by 1AR from British 5KO at about 2:10 A.M. Atlantic Time, and immediately relayed to 3BQ, who passed it on to the waiting 3WS

less than five minutes later. 3WS had difficulty, however, and it was half an hour before he succeeded in raising 9BX, who eventually OK'd for the message and forwarded it to 4DQ, of Vulcan, Alta. After much CQ-ing, 4DQ was able to give the message to the addressee, Mr. E. Chang, 5GO, Vancouver, B.C., at about 11 P.M. Pacific Time. Mr. Chang immediately started a reply message, which was handled thru the same stations as far as 3BQ. There it was delayed until 7 the following night, however, for it seems 1AR had felt the call of Morpheus and "hit the hay." As far as is known, tho, the reply went back to England that second night.

Bully good work!



#### Rules Governing the A.R.R.L. Information Service

- 1—Before writing, search your files of QST. You will probably find the answer there.
- 2—Do not ask for comparisons between advertised products.
- 3—Be reasonable in the number and kind of questions you ask.
- 4—Put questions in the following form:
  - A—A *standard business size* (not freak correspondence size) stamped, self-addressed envelope must be enclosed.
  - B—Write with typewriter or ink on one side of sheet only.
  - C—Make diagrams on separate sheet and fasten all sheets together.
  - D—Number each paragraph and put only one question in a paragraph.
  - E—Keep a copy of your letter and your diagrams.
  - F—Put your name and address on each sheet. *We can not spend time digging your address out of the callbook.*
  - G—Address all questions to Information Service, American Radio Relay League, 1045 Main Street, Hartford, Connecticut.

# ELECTION RESULTS



**D**URING the month of April an election was held under our new Constitution to elect new Directors, one each from the Divisions of the A.R. R.L. in the United states, and a Canadian General Manager. These territorial Directors, with a president and a vice-president to be chosen by them, constitute our new Board of Directors.

In accordance with the Constitution the Committee of Tellers met at League Headquarters on May 1st and carefully counted the vote, finding the Directors of the new Board to be as follows:

	DAKOTA—455	
Cyril M. Jansky, jr.	.....	217
	DELTA—256	
Benj. F. Painter	.....	89
W. W. Rodgers	.....	66
	EAST GULF—350	
Harold S. Brownell	.....	72
Harry F. Dobbs	.....	120
	MIDWEST—1085	
L. Boyd Laizure	.....	252
Porter T. Quinby	.....	215
	NEW ENGLAND—1690	
James L. Hubbard	.....	335
George H. Pinney	.....	385
	NORTHWESTERN—473	
Karl W. Weingarten	.....	177
	PACIFIC—984	
Allen H. Babcock	.....	111
	ROCKY MOUNTAIN—171	
Everett J. Seely	.....	29

- Canadian General Manager
- Atlantic Division Director
- Dakota Division Director
- Delta Division Director
- East Gulf Division Director
- Midwest Division Director
- Pacific Division Director
- Central Division Director
- New England Div. Director
- Northwestern Div. Director
- Roanoke Division Director
- Rocky Mountain Div. Director
- West Gulf Division Director

- A. H. Keith Russell, 99AL Term ends Jan. 1, 1926.
- Geo. L. Bidwell " "
- Cyril M. Jansky, Jr., 9XI " "
- Benj. F. Painter, 5MB " "
- Harry F. Dobbs, 4ZA " "
- L. Boyd Laizure, 9RR " "
- Allen H. Babcock, 6ZD " "
- Clyde E. Darr, 8ZZ Term ends Jan. 1, 1925.
- Geo. H. Pinney, 1CKP " "
- Karl W. Weingarten, 7BG " "
- W. Treadway Gravelly, 3BZ " "
- Paul M. Segal, 9EEA " "
- Frank M. Corlett, 5ZC " "

Of these, Messrs. Russell, Bidwell, Babcock, Darr, Weingarten, and Corlett are members of the retiring Board and so have been re-elected. The new members of the Board are, without exception, men who have made their mark in amateur radio, and are as fine and representative a selection, we believe, as any of us could wish for.

In some of the Divisions there was but a single candidate; in others there were several; and in some of them, particularly the Central, there was a lively contest. A total of 14,028 ballots was mailed, from which 5,850 votes were polled, or a 41.7% vote. The detailed result by territories was as follows, the figure after the name of the division indicating the number of ballots mailed to members therein:

	CANADA—682	
A. H. Keith Russell	.....	270
	ATLANTIC—3994	
George L. Bidwell	.....	1850
	CENTRAL—2913	
Albert H. Cain	.....	170
Clarence N. Crapo	.....	282
Clyde E. Darr	.....	851
Loren G. Windom	.....	69

Paul M. Segal	.....	67
	ROANOKE—519	
W. Treadway Gravelly	.....	130
	WEST GULF—656	
Frank M. Corlett	.....	293

The new Board goes into office at noon on July 1st, and will have its first meeting some time that month, at which League officers will be elected and appointed.  
—K.B.W.



# Practical Master Oscillator Sets

By E. A. Laport, ex-1CBO

Amateurs are accustomed to think of a master-oscillator power-amplifier transmitter as using a mysterious new circuit. The following article shows that this is not correct.—Technical Editor.

**C**ONSTANT-FREQUENCY transmission represents one of the latest advancements of the day. It is with this in mind that these notes, obtained from first-hand engineering experience, are submitted to the gang by one of the gang.

The "What" of the Master Oscillator is simple enough. The master oscillator (or "M.O.") is simply a small tube transmitter that uses any one of the common cir-

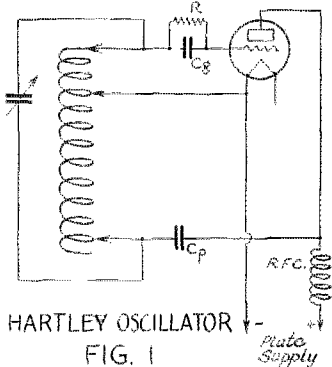

cuits. The only difference is that the output of this little set is not fed to the antenna directly. Instead it is first put thru a stage of radio-frequency amplification called the power amplifier or "P.A."

### Advantages of Master Oscillator

The "Why" of the master oscillator can be summarized as follows:

1. Eliminates swinging signals because the master oscillator keeps the wave steady.
2. Makes possible greater plate-circuit efficiencies because the tubes connected to the antenna have their grid losses supplied by the master oscillator. They are accordingly able to use all of the power supplied to their plate circuit.
3. Provides precision wavelength control not approached in any other type of transmitter.

### Experiments

The initial experiment should be carried out with the apparatus set up on a board to allow access to, and observation of, all parts of the circuit. When the final working combination has been found, the set may be made up on a panel if that is thought desirable.

### The Master Oscillator

The master oscillator is the circuit and the tube that generate the sustained wave and set the frequency at which the entire set will work. The Colpitts or Hartley circuit may be used; there is little choice. The "reversed feedback" circuit is nothing but a variety of Hartley so need not be considered singly. It may be stated, however, that the Colpitts circuit is a particularly good master oscillator.

Figure 1 shows a Hartley oscillator. In this circuit the tuning inductance is a continuous coil provided with clips which allow the change of both plate and grid inductance to obtain plate and grid high-frequency excitation to satisfy the conditions for effective generation. A condenser  $C_g$ , preferably variable, is connected to the grid and plate clips on the inductance, with which it forms the oscillation circuit which sets the wavelength. (To make the wave as steady as possible it is desirable to use a rather large capacity and few helix turns. The circuit is then not so much affected by variations in plate voltage.—Tech. Ed.) The oscillator wavelength is readily controlled by variation of the condenser capa-

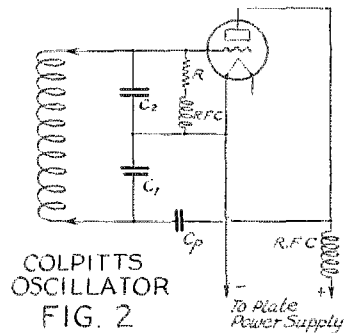

city  $C_g$ . The grid- and plate-blocking condensers  $C_g$  and  $C_p$ , both essential, should be of mica with low power-factor. The capacity of these condensers must be large enough to give very low reactance at the working wave lengths. For waves below 200 meters .002  $\mu\text{f.}$  is sufficient. Larger values can be used but without any material gain. The grid leak R should be high enough to hold the plate heat to a very dull safe heat when the key is down and the oscillator is working its hardest. The

oscillator plate should be practically cold when not exciting the power amplifier.

**The R. F. Choke**

The radio-frequency choke in the plate lead should be a *single-layer* coil of inductance great enough to completely isolate the radio-frequency circuits from the power supply. The circuit will not oscillate without this choke. A single-layer coil composed of around 200 turns of No. 30 insulated wire on a 2" tube, will fill the requirements, and will answer for any part of a circuit whose wave does not exceed 200 meters. *Concentrated inductance coils should not be used because their distributed capacity is usually high enough to by-pass an appreciable amount of R.F. and render the choke more or less ineffective, causing instability of the oscillator.* (The same thing applies to ordinary direct-

with clips for variation or it may be a variometer of inductance up to 100 microhenries max., wound with heavy solid wire. The R.F. chokes, blocking condensers and grid leak suggestions are the same as explained in connection with the Hartley circuit.

**The Amplifier**

When the master oscillator is working properly over the entire wavelength range, the next consideration is the amplification of the M.O. output. It is obvious that the radio frequency amplifier (which we call the power amplifier) must be an efficient circuit free from bad wiring, poor insulation and high resistance.

The power amplifiers (P.A.) may be one tube or several tubes in parallel. These tubes may have the same power rating as the M.O. or may be of larger size. Do not make the mistake of having the power am-

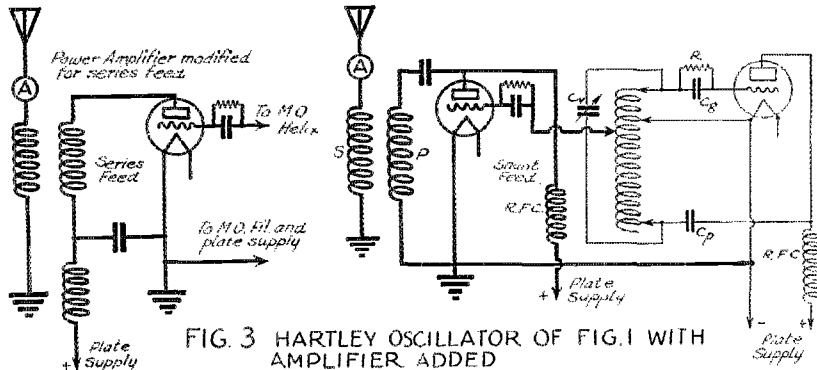

FIG. 3 HARTLEY OSCILLATOR OF FIG. 1 WITH AMPLIFIER ADDED

coupled transmitters. During the past winter we have had to advise at least 50 stations to put in good single-layer chokes before they got proper operation. Even that is not enough unless they are kept away from the helix.—Tech. Ed.)

Fig. 2 shows a Colpitts oscillator and makes use of the potential built up across capacities for its plate and grid H.F. excitations. In a direct-coupled set the antenna would replace  $C_1$ . Both  $C_1$  and  $C_2$  are fixed mica condensers and should have a current capacity of around 2 amps. at 200 meters. They should be capable of standing around two or three times the potential applied to the plate, although the voltage they are required to stand is determined by the wavelength and the circulating current, the latter dependent on the LC ratio. Radiotron tubes generally require about *one-half* as much A.C. grid voltage as A.C. plate voltage, so that the grid condenser should have twice the capacity of the plate condenser, and it is suggested that  $C_1$  be .0001 and  $C_2$  be .0002  $\mu$ d., and the inductance be varied for tuning. The tuning coil should be a single layer

plifier too large for the master oscillator. The following will give an idea of good working arrangements.\*

Master Oscillator		Power Amplifier	
1	UV-201	1	UV-202
1	UV-202	2-4	UV-202
1	UV-202 with high plate voltage	1-2	UV-203
1	UV-203	2-4	UV-203
1	UV-203	1	UV-204

Figure 3 shows one method of coupling

\*For the benefit of our foreign readers the normal ratings of the tubes mentioned will be given.

Type	Normal output	Normal plate volts	Normal Milliamperes
UV-201 or C-301	Audio amplifier for receiving	40-90	1
UV-202 or C-302	5 watts	350	40
UV-203 or UV-204	50 watts	1000	150
UV-203 or C-304	250 watts	2000	250

The watt-output ratings are very liberal and can be greatly exceed in normal operation. They are even more greatly exceeded when abnormal plate voltages are used.

a Hartley M.O. to the power amplifier. All filaments are at ground potential so the connection from the M.O. to the P.A. filaments is common. The exciting voltage for the P.A. is obtained by taking the inductive reactance drop across all or a part of the M.O. plate coil. This adjustment is not critical.

Figure 4 shows the way to couple a Colpitts M.O. to the P.A. The P.A. excitation is obtained by taking the capacity reactance drop across the M.O. plate condenser, which is impressed directly across the P.A. input thru a blocking grid condenser of low reactance. The P.A. grid bias is obtained by using a grid leak. The grid bias for any tube using a grid leak is always calculated by Ohm's Law when the resistance and grid-leak current is known. This value will be in negative volts.

**Adjusting the Oscillator**

Both these circuits should oscillate at high efficiency and with stability. Instability should be approached first by increasing the inductance of the plate choke and secondly by varying the grid condenser capacity (C<sub>g</sub>). The grid leak should be around 10,000 ohms for a starter, and if more output from the M.O. is desired, the leak resistance can be lowered. If the tube oscillates smoothly but heats up excessively when exciting the power-amplifier the leak resistance should be increased.

**Feeding the Antenna**

The rest of the circuit is a straight radio amplifying circuit. Figure 3 shows the

is gained by using large wire. The same thing can be said of the grid circuit. These things are not true if a condenser is used across such a coil or if the antenna current runs through. In that case large wire should be used.—Tech. Ed.) It should be tapped and so adjusted that when the antenna is detuned (or the antenna switch opened) the plate current of the amplifier tubes will drop sharply.

The best way to start the design of this output transformer is to wind the primary first and connect it in the amplifier plate circuit without using the antenna at all. Now bring the P.A. and M.O. into normal operation with full voltage and hunt for that position of the plate clip in the output transformer primary where the plate current and plate heat are very low over a range of wavelengths. The plate current shouldn't greatly exceed 1/10 of the full operating value under these circumstances. When the primary has been so adjusted that it will handle the tubes safely the secondary can be wound.

Due to the heavy currents in the antenna the secondary should be wound with heavy wire. This secondary coil must fit closely into the primary. The reactance of the secondary to the reactance of the primary must be in the same ratio as the antenna reactance to the tube impedance. It will therefore be necessary to try different secondary windings but ordinarily this winding will not exceed 10 turns. When the secondary winding is right, some final adjustments may be needed in the primary. This will take a little time but if the M.O.

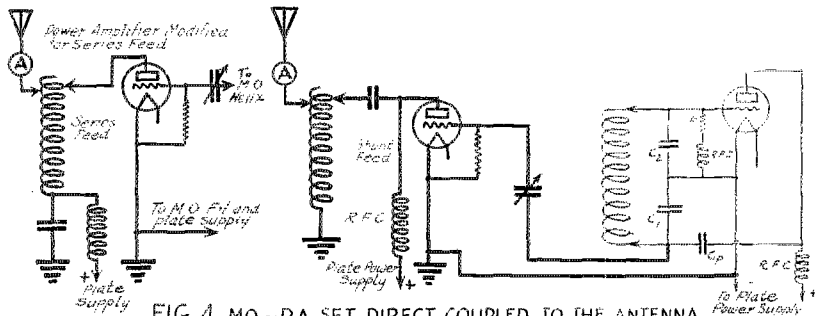

FIG 4 M.O.—P.A. SET DIRECT COUPLED TO THE ANTENNA (M.O. used is same as Fig 2.)

plate of the amplifier coupled to the antenna inductively. The output transformer is usually wound on thin tubes of the best insulation and the primary should be about 3½ in. in diameter. A primary wound with No. 26 or 28 wire is suggested, and 40 turns will serve as a starting suggestion. (The radio frequency plate current is always of the same size as the direct current in the plate circuit. Therefore the plate winding may be made of small wire and nothing

is operating well the success of the whole set will lie in the design of the output transformer and by continually improving it the antenna current will continually increase. For powers up to about 200 watts the coupling can remain fixed for different wavelengths but variable couplings should be provided for greater powers. Be sure to design this transformer for the exact combination of tubes you intend to use because the addition of another tube will change the

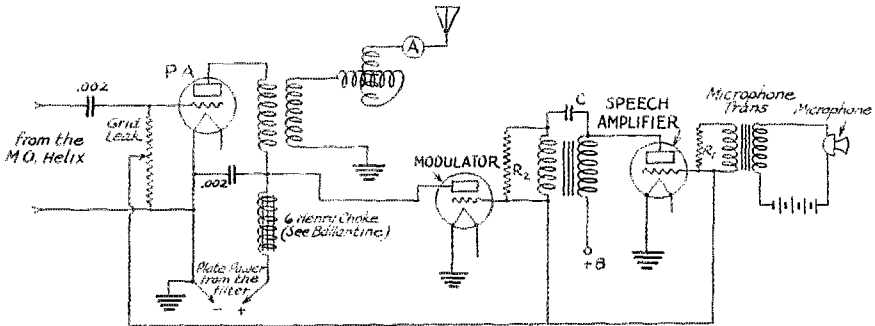

plate circuit impedance and the ratio of the transformer, upsetting the entire design. The wide variety of antennas makes it impossible to give definite data on the output transformer. A very small difference in resistance, inductance or capacity of an antenna will change the specifications of the output transformer. The correct number of turns for the primary and secondary can be found by experiment with very little trouble.

**Direct Coupling to the Antenna**

In Figure 4 is shown a way of coupling

tions for keying are to let the M.O. ride without interruption when the P.A. is being keyed (the M.O. should never be keyed) and to key in such a way that the P.A. will be entirely inoperative and protected when the key is open. The best locations for the key are in series with the P.A. grid-leak, and in the low potential lead of the plate supply. When the key is inserted in series with the grid leak, the P.A. is completely blocked and rendered inoperative when the key is opened. It is well to shunt the key with a capacity of around .002  $\mu$ d. When this keying is completely performed, and



**FIG. 5 COMPLETE MODULATION CIRCUIT** (Show here for the series-feed P.A. of Fig 3 but can be used with many other circuits) The right sizes for  $R_1$ ,  $R_2$  and  $C$  must be found by trial.

the P.A. to the antenna with a helix used as an auto-transformer. (when working with a grounded antenna). This method of coupling may be simpler to adjust than the inductive coupling although the two methods should compare favorably when properly designed. The setting of the plate clip is found as in the case of the inductive coupling; the antenna clip is located for best output, the antenna tuning being outside of this helix.

**Antenna Tuning**

It will be noted that the antenna receives its energy from a coupling coil which is either the secondary of an output transformer or else a few turns of the auto-transformer (helix). The antenna tuning must be taken care of separately. In a circuit of this kind the antenna tuning is extremely critical and the tuning device must be closely variable. When working at long waves the most convenient form for the antenna tuning coil is a variometer although a single-layer helix which permits contact with all parts of each turn will do. (When working at short waves the antenna variometer hardly fills the requirements. Antenna series condensers must be used anyway and it is simplest to make them variable and use them for the antenna tuning.—Tech. Ed.)

**Keying**

There are several ways to key these circuits for telegraphy. The main considera-

there is no leakage, the plate current will fall to zero and the tubes are fully protected. With low powers the keying troubles are few, but with the larger tubes the subject of proper keying is sometimes complicated.

When the key is located in the negative lead of the high voltage, heavy sparking at the key contacts results unless shunted by a large condenser. A paper condenser of .25  $\mu$ d. or larger will be suitable. In addition to this, it is often necessary to use a resistance in shunt with both key and condenser. This should be roughly around 10,000 ohms, but is not critical. When this resistance is about correct there will be very slight sparking at contacts. In both these arrangements the M.O. rides continually, and the signal as heard at the receiver is smooth and clear in its interruptions, and is free from the clicky notes which are often heard. Clicky interruptions are ordinarily caused by transients set up in the circuits when the key is closed. Good keying arrangements will eliminate clicks, which greatly impair many an otherwise pure note.

**Modulation**

If it is desired to modulate this type of transmitter a constant-current reactance can be inserted in the P.A. plate lead between the R.F. choke and the power supply, and another set of modulator tubes,

identical to the P.A., connected on so that the modulator plates are fed from the plate supply and the constant-current reactor is in the modulator supply circuit. The P.A. should be modulated and not the M.O. Tests have shown that by this system of plate constant-current modulation, properly adjusted as to bias and balance of modulator and P.A. output powers, perfect modulation of the radiated wave was possible. This was proved by the fact that with a 250-

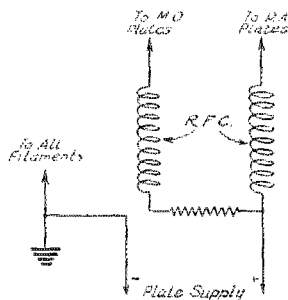

FIG. 6

watt tube, continuous variation of plate e.m.f. from zero to 4000 volts produced a straight line characteristic when plotted against antenna current. Fig. 5 shows a complete modulation circuit.

#### Wrong Adjustments

When a power amplifier set operates at low output and low efficiency, the main causes are usually high radio-frequency leakages and the improper design of the output transformer. If the efficiency is high but the output low the difficulty is probably in a high resistance antenna or in very loose coupling between the plate of the amplifier and the antenna. This condition may also be caused by too high resistance in the grid leak. Perhaps the commonest wrong condition is that of high output and low efficiency. This gets the power into the air but wrecks many tubes. It may be due to proper transformer ratio but too few turns in both the plate and antenna inductance. The condition may be caused by too low a grid leak resistance and at the higher powers by too great coupling between the plate and the antenna.

Every part of a circuit developing heat represents a power waste. A small amount of power loss can be allowed but appreciable heating should be remedied if one is to have an efficient transmitter. The real joy of operating a master oscillator lies in its possibilities as a reliable transmitter operating at high efficiency. An efficiency of 60% between output and input of the P.A. is good but 75% is quite common. When the P.A. operates at high output it does not require a high grid

potential for excitation, as when operating at low output. For instance a UV-203A requires a high frequency grid voltage of 320 when it is putting out 30 watts, but only 200 volts when putting out 120 watts

#### A Plate Voltage "Stunt"

When the same kind of tubes is used in both the M.O. and the P.A. the same plate voltage supply may be used on both. When operating with small tubes in the M.O. the plate voltage must be cut down for them. This can be done by inserting a series resistance in the M.O. plate lead as shown in Fig. 6. The resistance required can be readily calculated from Ohm's Law when the plate current is known.

#### Conclusion

The writer has developed transmitters of this type for all waves up to 3000 meters, and all powers up to 600 watts, and can testify to the merits of the foregoing. One set in particular employed a UV-202 M.O. and a UV-203A for P.A. on waves from 120 to 180 meters, and later up to 240 meters, and obtained outputs of 120 watts after about three hours work. Due to lack of time, numerous other improvements were neglected, it being but an experiment. It used the Colpitts oscillator. With more attention this same transmitter could easily have been increased to 150 watts output, and the efficiency increased from 55% to probably 65 or 70%. But the only time available for the work was one afternoon so the results are very creditable. Sufficient to say that once this circuit is given a fair tryout and its merits observed, it will be generally adopted.

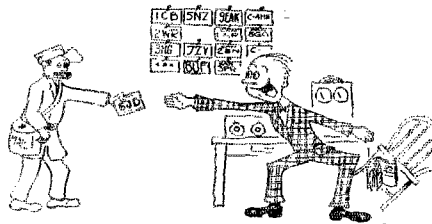

THE MISSING LINK.

Be sure not to miss the second article of our super-heterodyne series. This article will appear in the July issue and will describe in detail the construction of several super-heterodynes using fixed transformers.

## Fifth Convention of the Third District

**W**E meant to count the stories but we never got around to it. That's why we have not the least idea how far it is from Chestnut Street to the sunny balcony of the Hotel Adelphia's roof garden. But we do know that on a perfect Pennsylvania spring day it is a most splendid place for a congenial group of radio folk to loaf and talk and watch little white clouds drift by while their shadows play frantic leapfrog over Philadelphia's office buildings.

We happened to find that out because the Adelphia roof was owned by the Third District Convention for three days. Now we are willing to admit that on the map the Third Radio District does look as if a kindergarten child had whittled it out with a pair of very dull scissors—but we claim that it manages to stage some of the most beautifully friendly and kindly conventions that happen on the Atlantic coast. These conventions are passed around from city to city (other districts please note) and the competition certainly makes them hum. This year the convention was back in Philadelphia where it started five years ago.

Therefore Thomas Appleby and his "Dirty Dozen" invented several thousand jobs and did all of them. Only those who have been on convention committees can understand what work there must have been behind the beautifully smooth convention of April 24th, 25th and 26th.

Everything happened on schedule, *everything*. The speeches were on the dot, they were good, and they were brief. The speakers ranged all the way up to President H. P. Maxim and the Only John Reinartz. There was an honest-to-goodness amateur radio station, 3DRC (Third District Radio Convention) that handled traffic over nice long distances whenever the hotel manager could be persuaded to go away and stay away. Also portable

station 3XAS was there with a 50-meter transmitter that rode around in a Ford and worked back to NKF at Washington. Bradley Martin calibrated wave meters, Captain Adams bought cough drops so he could explain the superheterodyne some more, Supervisor Cadmus gave license

examinations. Then there were tours and exhibits and demonstrations of radio control and a raffle with some excellent prizes.

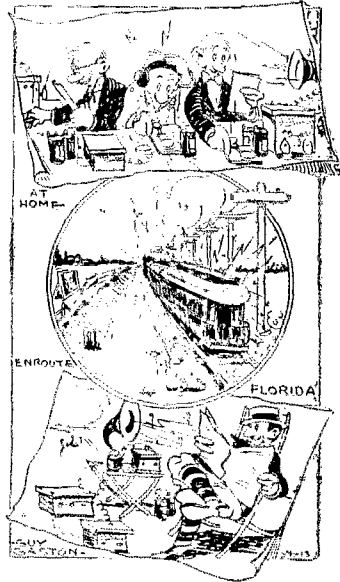

The "Baltimore News" envies District President Horace Beale's 3ZO-3XW-WQAA station at Parkersburg, Pa., and seems still more worked up about Portable 3OI at Sarasota, Fla. Just the same we noticed that Beale got back in time for the wind-up. (Courtesy Baltimore News and 3BCK)

The R.O.W.H. initiation was preceded by a playlet "In a Radio Store" and by still another playlet with the Apple sisters—Cora and Seeda.

Altogether it sounds like a pretty full program, doesn't it?



Philadelphia Wouff-Hong Initiation Officials and Characters.  
(Photo by SAR)

Now here is the remarkable part—there was time left to loaf. This does not seem reasonable, we don't pretend to understand it, but somehow Appleby and the D.D. managed to gain the time for it, and we said at the start that the Adelphia roof is an excellent place to loaf.

Those who did not feel like loafing went exploring and got into arguments with the Philadelphia traffic police—for how does a stranger know what to do when he sees “Traffic Control” painted on the pavement? From these scouting parties we learn that the Delaware suspension bridge is coming along finely, that the Victor phonograph plant does not receive on Saturdays, also that the Baldwin Locomotive works is building 75 behemoths for the Santa Fe, and that 40 can have an excellently noisy supper at Leonecavallo’s for \$1 a head.

At about this point we begin to get a bit confused but we do remember the banquet. It was the real thing; plenty of good food, enthusiasm, laughter and noise, but all hands willing to “pipe down” and give the speakers a chance. These speakers

had been equipped with time switches—they glowed brightly for a brief time and then went off. This was good—so were the speeches.

There really was only one thing wrong about the banquet, District President Horace A. Beale, Jr. and Stuart Ballantine were both kept away by ill health and could be present “in spirit only” as Ballantine’s telegram said.

Yes, it was a good convention. The best proof of that is that this year’s manager, Thomas Appleby 3XV, is now Third District President. The vice-president is Chas. J. Goodfellow and the secretary Charles Riskey. To them, and to Atlantic City, we look for the 6th Convention of the Third Radio District.

—W. Bradley Martin + S.K.

## How To Number Messages

--- Announcement of New A.R.R.L. Practice in Relaying ---

By F. H. Schnell, Traffic Manager

**E**VER since we started handling messages we have used a system of numbering that has been followed by some commercial companies. Perhaps that system of numbering is practicable where there is but a limited number of stations, but in amateur radio there are far too many stations handling messages to use a system which calls for a new series each day with each station with which communication is carried on.

As it is today, we start a new series of numbers beginning at midnight. Some of our stations communicate with over a dozen different stations each night. If messages are sent to these various stations, there may be a dozen messages bearing Nr. 1. If it becomes necessary to trace one of them, it is a task almost beyond hope. Therefore the A.R.R.L. is discontinuing this practice for one that seems to have certain features necessary in amateur traffic handling. While it may seem cumbersome at first, a few days of using it will give you a better understanding of the principles and the reasons therefor. Messages will be easy to trace over their entire routing—provided, of course, that logs are kept. A station without a log is like a ship without a rudder—can’t tell where anything is going or why! Keep an accurate log—always!

The new A.R.R.L. system of numbering messages: Beginning at midnight on the first day of each year, a new series of numbers shall be started at each station. This series is to cover the entire year. (For

the year 1924, the new system shall become effective at midnight June 30-July 1.)

Only at stations at which messages are filed or originated shall numbers be assigned. The original number assigned to each message shall be used throughout by the intermediate stations relaying the message. No new number shall be assigned by any other station. The original number should reach the addressee just as it left the station of origin.

Here’s an example: Suppose a message originates at or is filed at 1AW on July 5, addressed to 7BJ. This may be the first message filed at 1AW on July 5, but it is assigned the next serial number of 1AW, which, we will say, happens to be Nr. 43. Because the message was filed at 1AW, 1AW assigns the number, and this number should be the number of the message when it reaches 7BJ.

We now have a message bearing the number 43, addressed to 7BJ, and which is filed at 1AW on July 5. Now let’s see how this would look if we transmitted it according to the old system. Here is the way it would start: *Mr msg nr 43 fm Hartford Conn to 7BJ*—and as this message passed through the several relay stations it would be assigned a new number at each station and when it arrived at 7BJ it might be number 5 or 555. It has nothing to indicate when the message left Hartford—nothing by which it could be traced without a great deal of difficulty.

The new system means a very slight

change in the preamble of the message, and here is how it would be started from 1AW: *Hr. msg fm HARTFORD CONN 1AW NR 43 JULY 5 to 7BJ.* Get that preamble set in your mind and after you use it a few times it will be as easy as rolling off a log. Keep in mind the city in which a message originates, the call of the first station handling the message, the number and the date. This same preamble is to be used by each station relaying the message. No matter how many relays there are, the message is to be transmitted starting with "hr msg fm HARTFORD CONN 1AW NR 43 JULY 5", and should arrive at 7BJ exactly as it was started.

It will be an easy matter to trace a mes-

sage of this kind by putting out a general call for information on 1AW's message Nr. 43. Everybody handling it will be able to identify it without the slightest difficulty. It must be remembered that there may be hundreds of stations starting a message bearing the Nr. 43 and in this connection it is important that *the call of the station* always be transmitted as it becomes a necessary part of the preamble for identification.

Don't forget—we start the new system at midnight of June 30-July 1 and the 1924 series of numbers is to continue up to midnight of Dec. 31-Jan. 1, 1925. Remember, only stations starting messages shall assign numbers to the messages.

## 7DJ Works the "Bowdoin" With One Five-Watter

**A**FTER weeks in which nothing but a few weak signals had been heard from WNP, the "Bowdoin" of the McMillan Arctic Expedition, during which time a hundred of our best stations had been asked by the Traffic Manager to make a concentrated endeavor to

broadcast "All well 30 below daylight all the time", and then calling CQ. He answered the call and Mix came back immediately. Quiet hours were coming on, however, and 7DJ told Mix he couldn't transmit, but Mix told him to copy, which he did. From the messages received it is



Everett Sutton, At His Station, 7DJ, First to Work WNP in Months.

establish communication. Everett Sutton, 7DJ of Port Angeles, Wash., on April 13th worked Mix for an hour in good two-way communication and took a string of messages from him. Attaboy, 7DJ! We hope the Northwestern Division is as proud of you as the rest of the A.R.R.L. is!

Sutton first picked up WNP sending a

apparent that the "Bowdoin" is in steady daylight and had been unable to raise anybody for over a month; that all the crew were well and had been having a great time all winter. Mix said he didn't expect to be able to work to the outside again, and sent word to his family not to worry if they didn't hear from him again until fall.

Sutton is but fifteen years old. Altho he has been in radio for several years, he has operated C.W. only since last Christmas. Ether-burners please note that his set has but one "5-watter", in a 1DH circuit, and works on a 2-wire aerial 50 ft. high, using the clothesline in the backyard for a counterpoise; his receiver is a single-circuit regenerator with one-step audio. This lad and this station have done what a hundred of our best have failed to do, and we think it the most outstanding incident in the WNP communication this year.

The following additional reports of reception of signals from WNP have been received at Headquarters up to May 7th: March: 8th, 9DKR; 9th, 8LU; 15th, 7LR and F. H. Stueve, Cincinnati; 20th, 2ZB; 28th, 6CMP; 29th, QSA, by 7VM aboard WPQ, off Kodiak; 30th, 9CXP, 6BUH, and Canadian 4ER. April: 2d, Canadian 3DF; 3d, 9AQC; 4th, 5JB and ex-9AZS; 5th, 8CWR; 7th, 2BRB, 8RY; 9th, 8CYI and H. C. Barney, Providence, R. I.; 13th, 7CO; 16th, 6CKC; 18th, 2CTJ; 20th, 9BWQ; 30th, 8CEI.

U. J. Herrmann, manager of the Chicago Radio Show to be held this fall, realizing the difficulty which henceforth will be experienced in communication with WNP, has offered \$100 in gold to the first amateur to receive a "confirmed message" from MacMillan subsequent to April 24th. E. F. McDonald, jr., president of the Zenith Radio Corp., has offered another \$160 Zenith receiving set to the second amateur to receive and deliver to him a "confirmed message" from MacMillan (MacMillan has sent frequent messages to McDonald). Here's some additional incentive, fellows.

Careful observations should be made when signals believed to be from WNP are heard, so as not to confuse them with signals of dozens of stations calling and broadcasting to WNP throughout the entire week.

We must continue our nightly vigil for Mix and endeavor to connect up long enough to get over to him the idea of using shorter waves, probably around 100 meters, for transmission and reception.

—K.B.W.

## Experimenter's Section Report

By S. Kruse, Technical Editor

**S**O many inquiries have come in that I will again state the nature and the purposes of the Experimenter's Section. This can be done most easily under headings as follows.

### What the Section Is

There is no formality about the Experimenter's Section; we believe that radio experimenters do not care for complicated organization and therefore we will organize just as little as possible. This at once removes the need for monthly reports and extensive correspondence.

Membership in the Section is open to anyone interested in radio experimentation in company with others.

### Joining the Section

The business of joining the section is extremely simple—just address a request to *Experimenter's Section, A.R.R.L., 1045 Main Street, Hartford, Conn.* What little detail there is will be explained at once.

### The Services of the Section

The Experimenter's Section offers the following services:

A List of men who are interested in your problem.

A list of problems that are in need of work at present.

Outlines suggesting the best way of attacking your problem.

All of these are kept up to date and are available on request to those who have enrolled their names in the Section.

### Problems

A list of the problems chosen by various members of the Experimenter's Section is given below. Active work on most of these problems has begun.

#### Radiating Systems

1. Practical information on receiving with resonance wave coils.
2. Best operating wave length for transmitting antenna.
3. Counterpoises. Best height, size, spacing of wires, insulation.
4. Tests of antenna insulators, electrical and mechanical.
5. Development of a good lightning switch.
6. Imperfect dielectric in field of antenna and counterpoise.
7. Ground vs. counterpoise for C.W. transmission.
8. Beverage antennas.
9. Underground antennas.

#### Receiving Sets

1. The super-heterodyne for work below 200 meters, especially C.W.
2. Improvement of the standard tickler-regenerative set.
3. Tests of receiving inductances of various forms, size of wire, method of winding, spacing of wire, kind of insulation.
4. Effect of "dope" on receiving coils.
5. Comparison of head phones.
6. Comparison of B batteries.
7. A good radio frequency amplifier for 200 meter work.
8. Comparison of available receiving tubes as far as their actual value as a detector or amplifier is concerned.
9. Audio amplifiers. How to make them absolutely quiet, for one thing. How to secure "maximum distortion" with peak at 1000 cycles.
12. Reception of C.W. sets on double and half their wavelength.
13. Tests of plugs and jacks.
14. Effect of L/C ratio.
15. Tests of grid leaks and condensers.

## 16. Portable receivers.

**Transmitting Sets**

1. How can we do away with key clicks and voltage surges that blow tubes and interfere with broadcasting reception?
2. Comparison of keying methods. What is best location of key?
3. Cause and remedy for unsteady wave.
4. Develop a good method of keying when a 1000 or 2000 volt motor-generator set is used.
5. Transmitting inductances. Best form, best conductor, dead ends, insulation, etc. Compare helix with pancake, solid with litz, etc.
6. Development of a good wavechanger.
7. Comparison of plate supply: 60 cycles, full-wave self-rectification, D.C., ICW 500 cycles. Compare range with fixed input to set.
8. Efficiency of various methods of obtaining D.C. plate supply from A.C. Line. M.G. sets and various rectifiers.
9. Protection of motor-generator sets from high voltage surges and from radio-frequency currents.
10. Does it pay to use a good grid condenser and leak?
11. Comparison of various makes, American, foreign, G.E., W.E., and other transmitting tubes. Operating data on them.
12. Harmonics from tube transmitters.
13. Pyzzer signal. (See QST October 1923, p. 15)
14. Mercury arc rectifier for plate supply.
15. Work on waves below 150 meters. (X license absolutely necessary).
16. Loop transmitters.
17. Portable transmitters.
18. Amateur arcs.

**General**

1. Wired Wireless.
2. Tests of insulation at radio frequencies.
3. Effect of weather, barometer and moon on radio conditions.
4. Static elimination.
5. Distant control.
6. Break-in systems.

This list is not complete by any means. Let's have your suggested additions.

**Particular Problems**

The following particular problems seem to deserve brief discussion.

**Antenna Formulas**

See the article by Mr. Ralph Batcher on page 32 of this issue.

**Keying Click**

The biggest single difficulty in radio today is local interference caused by keying clicks or thumps. Some stations that do not interfere at all when they hold the key down make horrible pests of themselves whenever they key. A satisfactory scheme for stopping this is not at hand right now and some work is very badly needed. One can see off-hand that any successful method will have to slow down the starting and stopping of the antenna current. This may mean loose-coupled circuits in all amateur stations but something *must be done*. A simple way of slowing down the surge is to key by means of a vacuum tube but this calls for rather expensive equipment and therefore does not take care of the chap who can only afford a single "5-watt" tube. In general sets that use alternating plate supply are free from this difficulty as the key is in the transformer primary and the shock is taken up by the transformer. However, we are trying to get away from A.C. plate because of its slight broadness.

**Distortion Amplifiers**

Makers of rectifiers and generators should be especially interested in this problem. We would like to hear from them.

Most audio amplifiers today are attempting to get away from distortion. For telegraphy this is exactly the wrong thing to do. It is very desirable that we do some work to develop audio transformers that give very bad distortion so as to amplify strongly at 1000 cycles and very badly at higher or lower notes. This will greatly reduce static noises and line escapes. The old 9-to-1 Radio Corporation transformer was designed to accomplish this and was very excellent for the purpose. We wish to hear from men who have the equipment to work on this problem, either in building the transformers or else in testing them afterward.

**Audio Tests**

A method of testing headsets (or loud speaker units) and at the same time spending a few hours in a most interesting fashion is given on page 454 and 455 of *Popular Radio* (New York) for May, 1924. The author, Prof. J. T. MacGregor-Morris, uses the method of scattering fine sand grains on the receiver diaphragm which has been exposed by cutting away the receiver cap. When the diaphragm vibrates in a regular fashion the sand dances into patterns that show how the diaphragm is moving. Such patterns are known as "Lissajou's figures" or "Chaldni's figures", after their discoverers.

If one does not wish to cut a receiver cap the experiment can be made without a cap but the figures will be different and will not tell anything about the receiver. The reason for this is that the cap ordinarily clamps the edges of the diaphragm and makes it operate in a different fashion than it does when the cap is off.

By all means read the articles and make the experiment.

We wish to hear of someone who is equipped to test loud speakers.

**Audio Transformer Tests**

Anyone able to test audio frequency transformers please let us know. These tests are not worth much when made in the usual fashion and a method that seems to be better will be indicated on request.

**Experimenter's Handbook**

We have had a number of inquiries as to a suitable laboratory manual to be used in experimental radio work. We wish again to call attention to "Experimental Radio" by Prof. R. R. Ramsey of Indiana University. The book has just been revised and enlarged. New experiments have been added and the suggestions as to construction of apparatus very much increased. The book now covers 85 experiments and 105 pages.

The experimenter who has handy "Experimental Radio" and Ballantine's "Radio Telephony for Amateurs" is not likely to get into real difficulty with any ordinary problem.

"Experimental Radio" at \$1.60 and "Radio Telephony for Amateurs" at \$2.00 may be purchased from our book department, as can also M. B. Sleeper's 25-cent book "Ideas for the Radio Experimenter's Laboratory."

#### Power Line Interference

Our item on page 38 of the May issue brought immediate response.

Mr. W.R.G. Baker of the Radio Engineering Department, General Electric Co., states that "G.E." will be glad to try out any suggested devices for locating the cause of radio interferences and will be glad to report on the results. Much work of this sort has already been done by them. In the "Communications" section of this issue there also appears a letter from the Superintendent of Electrical Transmission for the New Haven Railroad. This letter should not be overlooked by any amateur living near the electrified zone of the N.Y. N.H.&H. Mr. E. H. Steele, Electrical Engineer of a Massachusetts generating and distributing organization, has stated that he will be very glad to receive the cooperation of any amateur in his region in locating power leaks or suggesting methods that the company might try. From several points we have received letters indicating that Cottrell Electrical Precipitators (used in depositing soot and smelter dusts) are at times causing very severe interference over large areas.

At the present time it seems that we are long on experimental fields and short on helpers and methods. Correspondence from any one in the regions mentioned is invited. Letters to any of the men and firms above will be forwarded if addressed to the attention of the Technical Editor.

Suggestions and assistance are invited.

#### Correspondence

It has become absolutely necessary to insist that all correspondence be addressed exactly as requested above, also that a self-



addressed and stamped business envelope be supplied with each letter. This is done to secure correct addresses and to save postage.

## Obituary

IT is with deep regret that we chronicle the passing of four well-known amateurs during recent months.

Amateur radio lost a real enthusiast and staunch friend in the passing on March 14th of Mrs. May O. Houston, formerly 6BAZ and later 6MI of San Diego, California. She was an active member of the old Sunset Radio Club and the call 6BAZ was well known in the southwest in the spark days.

Ray T. Shaw, 17, 3AFB of Wilmington, Delaware, died April 13th. He was an ardent radio amateur and District Superintendent for the first Delaware District, A.R.R.L. His exceptionally good work in radio organization and in the past transatlantic tests is too well known for comment. His station was one of the best in Delaware and its signals will be missed from the air by his many friends.

Dr. Phillipe Lesage, 25, c2AF, departed this life at the Notre Dame Hospital, Montreal, on March 18th, following an unsuccessful operation for appendicitis. Dr. Lesage started his radio career in 1914 when he entered the merchant marine as a radio operator. Later he was on the air with a spark set and all old timers remember hearing his call. The amateurs of the Second Canadian District sent a wreath to the bereaved family as a token of the esteem in which he was held by his A.R.R.L. brethren, and a large number of amateurs attended the funeral.

J. Edward Page, 19, of Baldwinsville, New York, passed away early on the morning of April 11th at the Syracuse Memorial Hospital, following an operation on a hip that was fractured about a year ago in an accident and which did not knit correctly. Infection, which developed, could not be checked. "Ed" Page was very well known in the amateur fraternity as he was for two years operator at 8AQO, the station of Mr. Clive Meredith at Cazenovia, New York. His passing is mourned by his many friends.



# Seventh District Convention

Reported by "The Gang"

**A**LL of the 7CQ-ers who missed the convention at Seattle on April 11th-12th, held under the auspices of the Executive Council of the Amateurs of the Seventh Radio District, missed the joys and delights of two days of Amateur Paradise. Every state in our district was represented except Wyoming. Every Ford that could sneeze and give the password, "Enough Gas", carried a full cargo of hams to Seattle. Our Division Manager, Glen E. West, 7ZU, was on hand early, having come over 700 miles from Billings, Montana. Thursday night the lobby of the Y.M.C.A. where the convention was held, became a hotbed of static, QRM, and QTC.

The annual meeting of the Executive Council opened at 10:30 the following morning. The President, Mr. Maybee, 7GE, was still out piloting his flivver around snowed-under mountain passes and bad roads, so was not on hand to take the chair. The Vice-President, Mr. P. R. Hoppe, 7IW, called the meeting to order. Officers for the coming year were elected as follows: President, Mr. George Sturley, 7BJ; Vice-President, Mr. Robert Waskey, 7UU; Secretary-Treasurer, Mr. R. D. Hoffman, 7ADP.

A letter from Mr. Warner of the A.R.R.L. and many other communications from amateurs who were not able to attend, all wishing the convention success, were read. The rest of the day was spent in visiting the University of Washington Electrical Engineering open-house. Cars kindly furnished by the Seattle Chamber of Commerce carried the gang out and some very interesting machinery and displays held us in groups all about the building. Many amateur stations were also visited—in fact all stations around town suffered terribly, chiefly from overloading the standing-room

next year's convention. Cries of "FB" greeted the offer of Mr. Kenneth Stone, 7FH, who stated that the all-famed publication, "The Dial", would gladly cooperate with the council and do what it could towards being a Seventh District amateur paper. Lively discussion on subjects affecting the amateur continued until someone said "Let's eat".

The business meeting was finished in the afternoon session, after which Mr. West, 7ZU, favored the bunch with an excellent talk on super-heterodyne sets. Adjourning at 3:30, the rest of the afternoon was used up in hamfesting, rag chewing, and visiting stations.

Then came the banquet. Mr. Rountree, 7AFE and toastmaster, had a worse time pounding for order than KPH fighting Jap QRM. The eats disappeared like QTC rush. Mr. O. R. Redfern, Supervisor of Radio of the Seventh District, was the first speaker. Other speakers were Mr. L. C. Maybee, Past President of the Executive Council; Mr. George Sturley, 7BJ, newly elected President of the Council; Mr. J. D. Ross, Superintendent of Lighting, City of Seattle; and Mr. K. W. Weingarten, Northwestern Director for the A.R.R.L.

After the festivities there was an intermission of an hour or so before the hall was ready for the Wouff-Hong initiation. 7IB was the candidate chosen to go through the mill. Much credit is due the Seattle gang for the success with which they put on the Wouff-Hong initiation.

This marked the close of the convention. If its success is measured by everyone having a good time and wishing all days in the year were like those two, then this year's convention was a huge success.

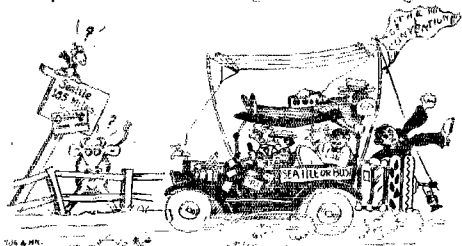

capacity of shacks. 7ADP says the floor and wall are out of plumb and the door won't shut—his shack will never be the same!

Saturday morning the Council meeting resumed at 10:30. After much QRM Spokane was chosen as the place for the

# Checking Up Antenna Formulas

By Ralph R. Batcher\*

**F**OR a number of years the writer has endeavored to collect the necessary data for checking several formulas for the determination of aerial capacity and inductance. A practical check of these formulas involves a vast amount of work in the erection and measurement of various types of aeri-als, and the thought has occurred that very good data probably can be found in the files of many A.R.R.L. members.

Since many other radio experimenters might be tempted to measure the constants of their aeri-als if any easy method were to be presented, the following plan is disclosed. The apparatus required is a standard wavemeter and a variable condenser with a capacity calibration. The condenser belonging to the wavemeter will do if it is calibrated. Also a source of high frequency energy such as an oscillator, or a transmitter set if its wavelength can be readily varied. A resonance indicator such as an antenna ammeter of some kind is necessary as well.

The method outlined below may or may not be new, but the author has never seen it disclosed before. Insert a small inductance in the aerial and ground lead, together with the ammeter, and adjust the oscillator until resonance occurs, using as loose a coupling as possible. See Fig. 1. Then measure the wavelength of the oscillator, calling the value  $\lambda_x$ . Disconnect the antenna from the circuit and connect the standard condenser across the induct-

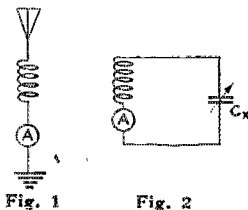

ance and the meter and adjust it until resonance occurs with the oscillator, set as before. See Fig. 2.

Designate this value of capacity  $C_x$ .

Repeat all of the above measurements with a larger inductance in series with the aerial, say one with two or three times the number of turns, as shown in Figs. C and D. Designate the values of wavelength and capacity so found by  $\lambda_y$  and  $C_y$ .

After the values of  $C_x$ ,  $C_y$ ,  $\lambda_x$  and  $\lambda_y$

have been determined, the antenna capacity  $C_a$  and the antenna inductance  $L_a$  may be determined from the following formulas:

$$C_a = \frac{C_y(A^2 - 1)}{A^2 - B} \text{ in mfd.s. if } C_y \text{ is in mfd.s.}$$

$$L_a = \frac{\lambda_x^2(C_x - C_a)}{3552 \cdot C_x C_a} \text{ in centimeters, if capacities}$$

are in microfarads. Here A equals the

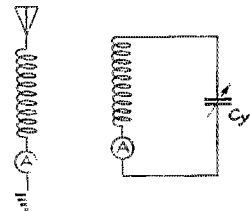

Fig. 3

Fig. 4

ratio  $\lambda_y / \lambda_x$ ; and B equals the ratio  $C_y / C_x$ . I have derived these formulas from fundamental equations, but an analysis of their derivation need not be given here. They are not difficult to use and the mathematical work should not take long.

If sufficient experimenters will send in the results of their measurements, together with the following data, it is believed that fairly reliable working rules can be devised that will enable anyone to predetermine the constants of the aerial he intends to build. Give the following information as accurately as possible on a postcard. Length, height (at each end), number of wires, spacing, type and length of lead-in, where located, aerial surroundings (rough sketch of buildings, masts, trees, etc., with estimated distances from antenna), type of wavemeter and standard condenser used, Values of  $C_a$  and  $L_a$ .

If a calibrated variable condenser is not available the value of B can be determined roughly by the reciprocal of the ratio of the scale readings, if the condenser has a straight capacity curve.



\*Radio Engineer A. H. Grebe & Co., Inc.

# A Good Break-In System

By Philip Laskowitz, 9DHI

**B**REAK-IN systems, it seems, have been the "dark horses" of amateur radio; as a rule they have not been very popular with the owners of amateur stations. The probable reason is that most systems that have been introduced used a separate receiving antenna.

The most important advantages of a break-in system are that it *cuts down needless interference* and raises the operating efficiency of your station.

## Two-Antenna Systems

In such a system the receiving antenna should run at right angles to the transmitting antenna. This takes up more space than the average city amateur has at his disposal. Then there is the patience that one must have to get such a system to work at its best. To prevent the transmitter from "knocking" the receiving set, one must give a great deal of time to making traps, and to getting his antennas placed right. Where the transmitting is done on a wave considerably different from the wave on which the operator is receiving, "knocking" the receiver does not have to be worried about, but where all work is done on one wave (broadly speaking) as in the case of amateur stations, it is an important thing to think about.

## True Break-In Systems

In a station using a true break-in the receiving set is connected with the antenna



A Break-in System

when the key is up, and when the key is depressed the antenna is disconnected from the receiver and connected with the transmitter. These operations are done automatically, and therefore the operator can break the sending operator at any time

in case of interference or for a repeat. With so many stations on the air, speed in handling traffic is a very important item. *With a good break-in traffic can be moved from twenty-five to fifty percent faster than with the usual antenna change-*

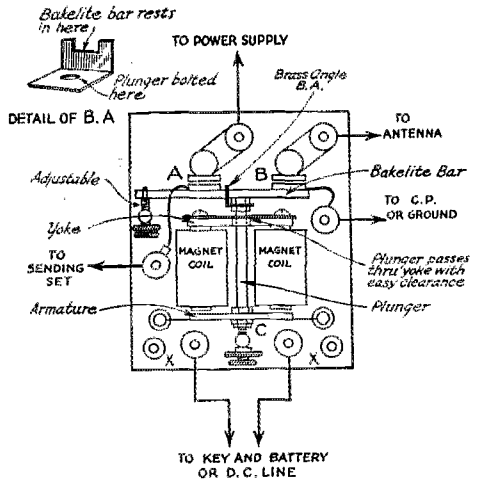

FIG. 1 THE LEACH BREAKIN RELAY

over switch. There is no need to spend precious minutes repeating a whole message in order that the other operator can get a small part of it. If the receiving operator missed a word or two he only needs to break the sending station and ask for the missing part.

## A Break-In That Works

The break-in about to be described does away with the disadvantages of other methods used, but still retains all the advantages. It is not only a break-in but a relay also, whereby a small key or "bug" can be used on large sets. The big thing that is conspicuous is the absence of the receiving antenna; this device uses the same antenna for sending and receiving.

This instrument can be constructed by anyone who calls himself a "ham," with the tools that every amateur possesses, and from unused "junk" that is usually lying in the attic. In the rough the materials needed are a pair of electromagnets wound for any convenient D.C. voltage; two pairs of heavy silver contacts, one of which is used in the antenna circuit, the other pair in the main keying circuit

of the transmitter. In addition to these two pairs, an auxiliary pair of contacts can be added; these need not be so heavy as they only break the B battery circuit of the detector tube in the receiver.

In assembling this device, the magnets should be mounted with the pole faces

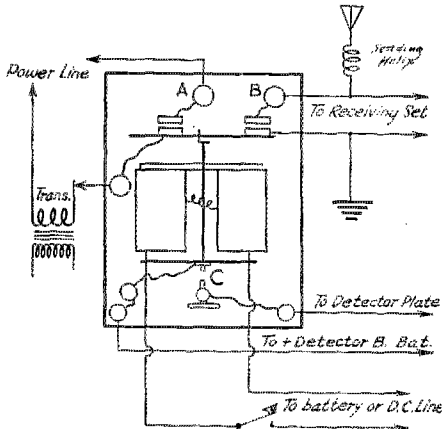

OPERATION—When key is closed, C opens first and disconnects detector B battery, then B short-circuits the tuner and finally A connects transformer to the line  
 FIG. 2 CONNECTIONS OF LEACH BREAKIN FOR SPARK WORK.

pointing downward; the armature is mounted in front of the poles so that when it is actuated it is drawn up. To the center of this armature a plunger is made fast. This rod is fixed to the side of the armature that is toward the magnets and goes up between the magnets where it is connected to a bakelite strip. It is not fastened firmly to the strip, but is fastened by two lock nuts to the base of a right angle made of sheet brass. The vertical part of the angle is cut out so as to make it U shaped. The bakelite strip rests in this U and thereby forms a flexible coupling with the plunger, the importance of which will be seen later. The bakelite strip carries the contacts, having one movable contact on each end, so that when the current is applied to the magnets the plunger will push the strip up and make contact with the stationary contacts. The method of attaching the bakelite to the plunger, and of mounting the contacts, is shown in the diagram, and so nothing more need be said about it here.

**Adjustment**

The secret of perfect operation is in having the pair of contacts in the open circuit of the transmitter make before the pair in the key circuit; this is done a split-fraction of a second before the key circuit is closed. The idea is to have the antenna circuit absolutely closed before the

set is made to oscillate. The instrument is made to perform this feat by having the U shaped seat a little off the center of the bakelite strip, and by having it flexibly coupled to the bakelite. It should be a trifle nearer the end that carries the antenna contact. Since the distance from that end to the U is shorter than on the opposite end, it will be pushed up and will "make" before the other set of contacts will. For smooth operation small adjustable springs have been added as will be seen from the drawing.

Just before sending this in I find that by hooking the relay up as I have shown in Fig. 3 it will work a little better for receiving C.W., than the other way where the primary of the tuner is shorted. The idea is then, that the receiver will never fail to oscillate. In case this method is used, the auxiliary contacts are not used for the B Battery circuit as in Fig. 3 and of course, the primary of the receiving set is not hooked up as in the original.

This relay was originated on the Pacific coast by an ex-commercial operator who is now making them for the market.\* They have been used by commercial and ship operators on the Pacific coast for quite a long time, but have not been introduced to amateurs yet. This device is used extensively on marine sets of both spark and C.W. types, and there is no reason why it cannot be used by amateurs on the same kind of apparatus.

It certainly is a pleasure to listen to two stations equipped with this system

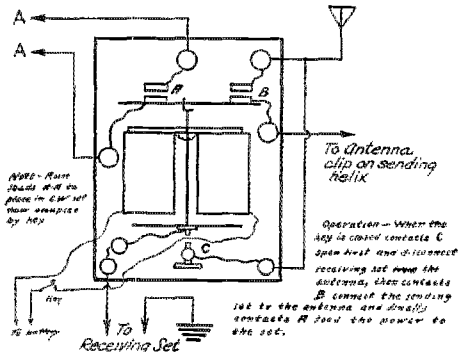

FIG. 3 CONNECTIONS FOR C.W. AS WORKED OUT BY 9DHI

working each other; the work is carried on just as it is on a land line. The interference near San Francisco is very great, probably one of the worst places in the world, but by using these break-ins it has been cut down considerably.

Let's see more hams use it. Cut down on the jamming and come up on traffic efficiency!!

\*V. A. Leach, 591 Mission Street, San Francisco, California.

# The Receiving Experimenter



CONDUCTED BY S. KRUSE, TECH. ED.

## Setting a Mast on the Edge of the Roof

Often one would like to put an antenna mast at the edge of a house roof so as to make the antenna somewhat longer. Generally one has to give up the idea on account of lack of room. Last summer we saw a 40-foot iron pipe mast at 726 Massachusetts Street, Lawrence, Kansas,

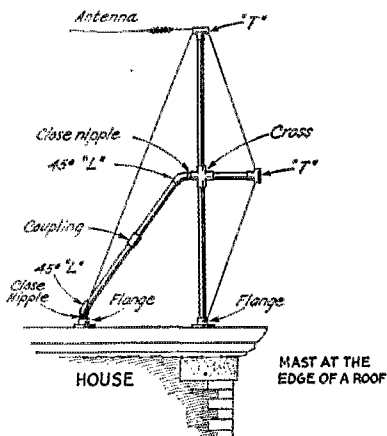

The side guys are not shown as they would run directly to and from the reader.

which seemed to be entirely workmanlike and which could be used on either a flat or a sloping roof. See sketch.

## Spoiling Good Coils

When a good coil has been built, one should give it a chance to remain good. There is no sense in constructing a good coil and then putting it within an inch of other things in the set. In fact an inch is the absolute lower limit and two inches is very decidedly better. It is especially inexcusable to put the grid end of a secondary coil or variometer near anything. Just what the object is does not matter so much; an insulating panel and a metal shield are about equally bad. Of course this does not make for compactness but the idea of compactness is being rather overdone in radio receivers these days.

## Ventilating Condensers

L. W. Hatry of 5XV calls attention to the fact that a poor condenser can be made into a good one by chopping out enough of the poor insulating material. A condenser that has moulded end plates of poor material or else has end plates

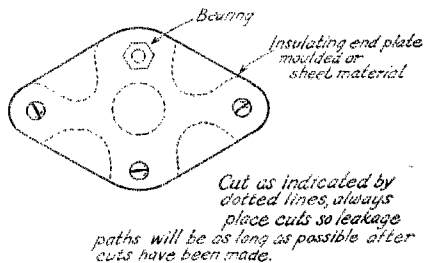

"VENTILATING" A CONDENSER—IDEA BY 5XV

of ordinary fibre can be materially improved by cutting as shown in the figure. Even at that the fibre is so poor that the condenser should not have been bought in the first place.

Although poor moulded material is especially spoken of the same scheme will improve any condenser that uses insulating end plates.

## Wooden Panels

For the experimenter wooden panels are a mighty handy thing because they are cheap and there is no hesitation about drilling a fresh set of holes in them. The performance of the panel will be exactly as good as that of the expensive materials as long as all the things on the panel are kept at low voltage. This simply means that the variable condensers should be mounted with the filament end connected to the panel. However, the losses in a wooden panel used exactly as one would use any other material are not serious if it is entirely dry. A good dry piece of wood which has been soaked in hot paraffin makes a very respectable panel indeed.

## Cardboard Panels

From the standpoint of efficiency there is nothing very much better than a "Beaverboard" panel that has been cooked in paraffin. However, the cooking must be done carefully so that the paraffin will not be scorched. This generally means that something must be put in the bottom of the pan to prevent the panel from touching.

Almost as good results can be gotten by brushing or pouring on paraffin that is melted and hot enough to smoke. The paraffin treatment is far better than one with varnish because one is never sure that varnish does not contain water.

A panel of this kind is not beautiful but it is very cheap and as good as anything that can be purchased at any price.

# UNSCRAMBLING THINGS



**T**HIS an attempt to explain several things that seem to have gotten pretty badly mixed up in amateur radio—and otherwise.

### What Does "Aperiodic" Mean?

We are constantly getting letters from fellows who insist that the Reinartz tuner and others of its general type are using an "aperiodic" antenna. Now aperiodic means "having no period". This is true only if the circuit has such a very high resistance that—

$$r^2 \text{ is greater than } \frac{4 L}{C}$$

However, you don't need to be interested in the formula to understand that an ordinary antenna does not suddenly become

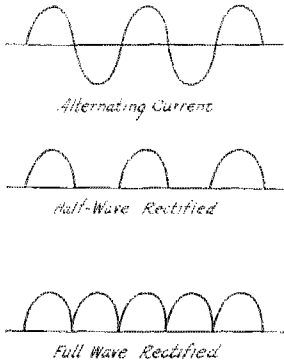

FIG. 1 RECTIFIERS DO NOT DELIVER CONTINUOUS CURRENT

"aperiodic" when we stop adjusting the number of primary turns. What we are really trying to say is that the primary circuit is "fixed tune." If this "fixed tune"

is far enough outside the working range of the tuner, the antenna will act almost exactly like a true aperiodic one.

### "Current or Voltage"

A good many letters blow in here asking whether we want current or voltage in this or that circuit. This shows a failure to understand the fact that no current will ever flow unless there is a voltage to make it flow. The two things simply do not happen independently.

### Does a Rectifier deliver Direct Current?

A rectifier does *not* deliver continuous current. According to Webster's dictionary it *does* make "an alternating current unidirectional, varying periodically between zero and a maximum". In other words, it turns out "bumps" of current with gaps between them. Still another way of saying this is that the current is "pulsating". See Fig. 1. This sort of current is good enough for charging storage batteries but not for operating receiving tubes, either filaments or plates. It can be smoothed out with a filter until we do really have continuous current but the filter is not

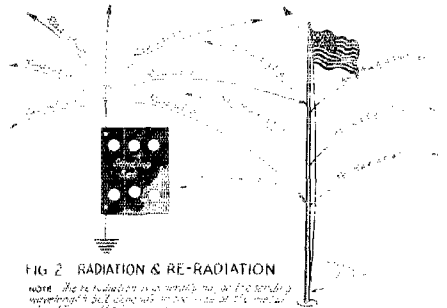

FIG. 2 RADIATION & RE-RADIATION  
 note: Re-radiation is a result of the transfer of energy to a secondary circuit of the receiving antenna.

simple or cheap so that most of us prefer to keep on using "A" and "B" batteries.

### "Re-Radiation"

From the way the world is put together one can easily see that "re-radiation" means "energy that is sent out for the second time." Of course it has to be received before it can be sent out again. Almost any large metal object near a transmitting station will absorb energy and will re-radiate a little of it. See Fig. 2. A receiving antenna that is very close to a transmitter will do the same thing but this has very little to do with the receiving set itself. If the tuner is taken away and the antenna grounded the performance may continue. However, re-radiation is usually a weak thing that does nobody any harm. When it does happen you will always find the original tone of the sending station very faithfully reproduced.

Lately a lot of radio papers have taken to using re-radiation to mean "transmis-

sion by an oscillating receiver". This is nonsense; the receiving antenna in such a case does not re-radiate but simply radiates. It has become a small transmitting station and no one ever thinks of referring to a sending station as re-radiating.

### Concerning the McLaughlin Tuner

**M**R. J. L. McLAUGHLIN'S excellent tuner was treated rather badly in our May number; we accidentally short-circuited the phones, and even a good tuner will not work well that way. The

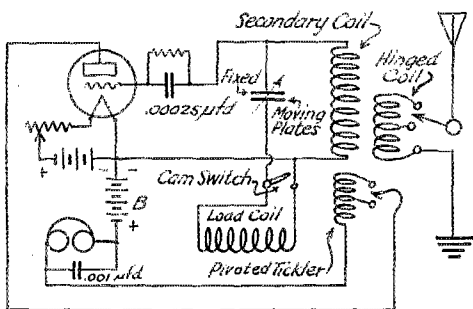

CIRCUIT SHOWN IN MAY QST

correct diagram is shown here and an improved diagram is added.

The improved diagram will give louder signals but the tickler seems to have just

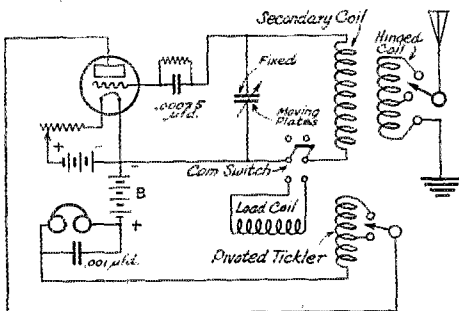

IMPROVED CIRCUIT

a shade more effect on the tuning. The difference is small and we may be mistaken. Certainly the improved circuit does give stronger signals and we think it will bring in the weak ones better.

### Two More Trophies

**O**UR readers will remember that throughout 1923 QST had an offer posted of a brown derby to the first American ham to work two-way across the Atlantic and that, much to our surprise, the deed was done by our own Traffic Manager in November. We have not believed that he should be barred from receiving the trophy just because he is a member of the A.R.R.L. Headquarters Staff, and so the hat has been prepared for him and was presented by the Editor at the Third District Convention in Philadelphia recently, in the presence of innumerable eye-witnesses.

We firmly believe this to be the only brown derby in New England. We had a



Traffic Manager Schnell, Wearing QST's Brown Derby.

hard time buying it; all the clerks thought we were spoofing them; finally we found one for a shade of its original price, in a bargain basement. Then it was "done in oil" by Hick, QST's "interior decorator," until it is a thing of beauty, no kidding. In the front, crossed French and U.S.A. flags are surmounted by the A.R.R.L. device, and around the stern the following inscription appears: "Awarded to Fred H. Schnell, 1MO, first North American amateur to work across the Atlantic Ocean in two-way radio communication, November 26, 1923, with 8AB, Nice, France."

Thus does truth outdo fiction: a hand-painted brown derby!

As previously reported in our columns,

the Editor had another wager with Mr. W.

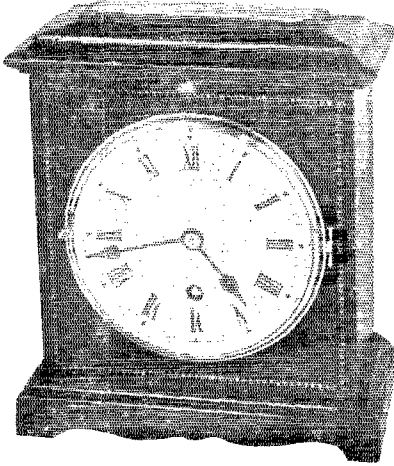

The Burnham Clock Won By The Editor Witt Burnham, of London, g2FQ, on the

outcome of the Fourth Transatlantic Tests, Mr. Burnham betting that we would not succeed in hearing as many as twelve different European amateurs. It is now history that we copied some three dozen different stations. As a result the Editor has received the very handsome Hamilton clock illustrated in our photograph. It is a beauty in every respect, and we are justly proud of it. A plate on the top of the clock bears this inscription: "Kenneth B. Warner, from W. Witt Burnham, to settle a bet on the success of the Anglo-American Amateur Transmissions, December 1923. F.B., O.M." Tnx vy, OM.

Mr. Burnham suggests that we might equip the clock with rings so as to wear it on a cord around our neck, as a breast-plate, and then, wearing the hat and cane won in previous bets, and brandishing the Wouff Hong aloft, we might proceed to Los Angeles and get a job in the "fillums." Yes, or in some nice bug-house between here and there!

—K.B.W.

## The Maritime Convention

**A**PRIL 5th and 6th saw the first real Maritime Convention in progress at Halifax. This meeting was the first where amateurs in this Division have really gotten together and become acquainted, and was a great success. The convention started with a general meeting at the Nova Scotia Technical College

ward Island. The work of the Division during the year was reviewed by the D.M. and general discussion followed.

That evening there was a banquet and musical program at the Queen Hotel to which everybody present did full justice. Alderman L. A. Gastonguay represented the city and gave the visitors a warm welcome.

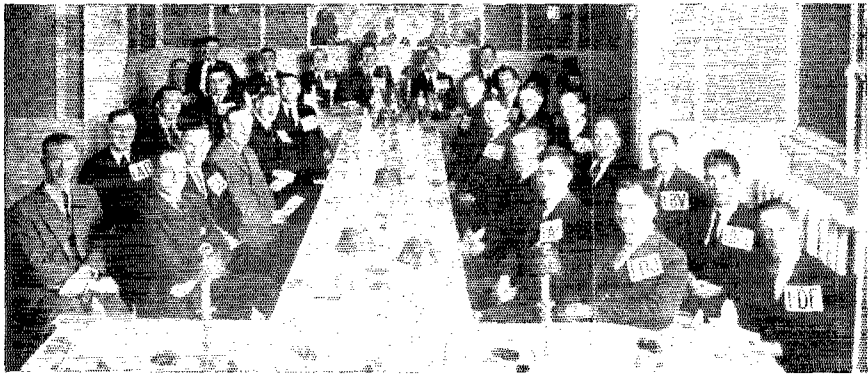

Annual Convention of the Maritime Division, A.R.R.L. held at Halifax, N. S., April 16, 1924.

in the afternoon of the 5th. The Division Manager, Mr. W. C. Borrett of Dartmouth, N.S., presided, and gave a hearty welcome to the delegates from the provinces of New Brunswick, Nova Scotia, and Prince Ed-

He also presented the "Murphy Amateur Radio Cup", donated by Mayor Murphy of Halifax, to be awarded for the best feat of the year in amateur radio in the Maritimes. The cup was awarded to Arthur



Greig, 1BQ, for his success in working European amateur stations. Mr. Greig then gave a short talk, telling of some of his experiences in working transatlantic. Certificates and prizes were also given for various competitions arranged by the Division Manager during the winter.

The most amusing and popular stunt of the evening was the initiation of 1BQ, 1DQ, 9BL, 1DD, and 1AR, into the "Royal Order of the Transatlantic Brass Pounders". The Old Man himself appeared on the scene and conducted the initiation, much to the delight of those present.

The "Antenna Sextette", composed of

members of the Halifax gang, provided excellent musical entertainment for the evening and their efforts were certainly appreciated. Telegrams were received from A. H. K. Russell, Canadian General Manager of the League, and from the Glace Bay Radio Society, wishing the convention success.

After the banquet some of the visitors went to some of the local stations and were successful in working both California and European amateurs. Sunday was spent as a general visiting day around the local stations. Parting words were said late Sunday afternoon, and a good time was had by all.

## An Eighty-Foot Latticed Mast

By Gordon Hammond, 3CEL

NOT long after erecting my 80 foot mast I had a station card made showing a photograph of the mast and saying that it cost \$5.00. Now that \$5.00 seems to get the best of the gang and for every card that I send out I have to send another telling how I did it at that cost.

The mast at 3CEL is constructed like the one described in September *QST* by 1GL. However, at 3CEL we used one inch by two inch by sixteen foot lumber for uprights, and common ordinary *plaster laths* for cross pieces. Four bricks were used for the foundation and some lengths of one inch pipe were driven in the ground for guy posts. The whole thing was given one coating of tar. I had everything but the lumber, tar and nails. Nine bundles of laths at 30¢ per bundle and \$1.30 for the upright strips account for \$4.00. The other dollar will more than cover the price of the tar and nails. The one-inch pipe could be bought at a junk shop so that this, with the guy wire, would certainly not put the price above \$10.00 for an 80-foot mast.

3CFV and 3CHQ both have 75-foot masts but I will not explain why the cost of those two was away below mine.

### Construction

A level place as long as the mast is required for putting it together. Begin by stretching two chalk lines along the ground, spacing them two feet at one end and four inches at the other end. These lines are to serve as a guide for building the tower. Begin by assembling the corner pieces, splicing on as shown in the drawing until you have the necessary length. The finished corner pieces must be exactly the same length. Now lay out two of the corner pieces and mark them every two feet

for the cross braces. Always saw four of the cross pieces at one time so as to keep the finished sides of the tower alike, but do not mix these pieces before using them.

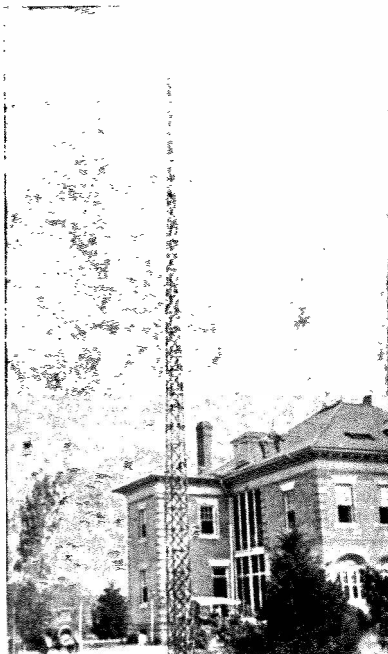

When one side of the tower is finished, turn it over and use it as a pattern for the next side. When the two sides are complete, stand them on edge and nail on the cross-bracing for the third side. Now turn the whole thing over and put on

(Continued on page 55)

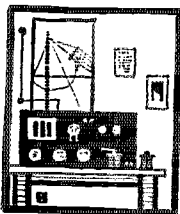

# Amateur Radio Stations

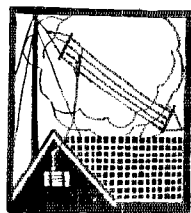

## 4KU, Atlanta, Georgia

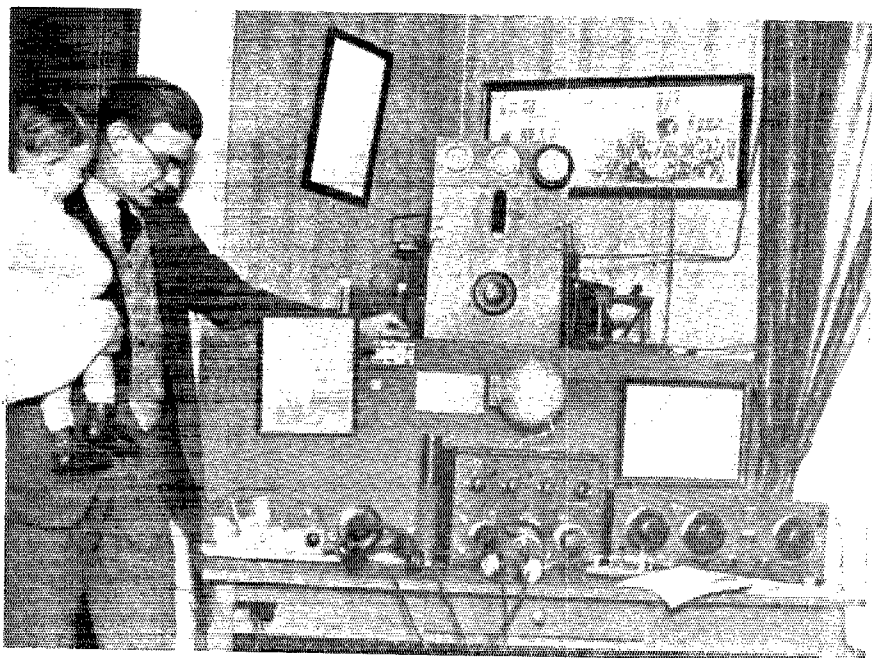

This station is owned and operated by H. L. Reid, East Gulf Division Manager for the A.R.R.L. Traffic Department, at 76 East 12th Street, Atlanta, Ga.

From left to right the first thing on the table in the way of radio apparatus is one of those low loss tuners, built up in a hurry as most of them seem to have been, but which works fine. The next receiver in the photo is a Reinartz set, built from directions in the June, 1922, *QST*. This is the receiver that did all of the work at 4KU until lately and for some unknown reason it possesses a wicked ability for bringing in the signals. The detector and two audio amplifier tubes are enclosed in the same cabinet with the tuner. On the extreme right is a Grebe CR-13.

The transmitter can be seen on the shelf above the receiving table. At present it uses one 250-watter in the reversed feedback circuit with series feed. Using

1500 volts on the plate and with 100 milliamperes the antenna current is 4.6 amperes at 200 meters. Two 50-watt tubes were used until recently. That was the tube equipment used last fall when the set did such good work at its old location. Plate current is furnished by a 1500-volt 400-watt Emerson motor-generator set. The antenna is a fifteen inch cage 65 feet long and about 50 feet high. A counterpoise is used for both receiving and transmitting.

A constant watch was kept at 4KU during the winter months by four operators. By next winter old 4KU expects to be back in a good location and ready to carry on again.

It might be well to introduce to you the persons in the picture who are none other than OM 4KU himself, and young 4KU, Everett Lamar.

## 6CGW, Long Beach, Calif

Many amateurs would like to have a list of DX records to their credit that would compare with the work done by 6CGW. The transmitter shown in the photograph, using one 50-watt tube most of the time, has been reported heard in the following places: all of the United States, Australia, England, Samoa, Holland, New Zealand, Porto Rico, Alaska, Panama, Tonga Islands, Hawaii, Mexico, Canada, Cuba, and

improvement and careful attention to details has brought the station up to its present standard.

6CGW has a good antenna. Two 80-foot guyed wooden masts placed 70 feet apart support a 40-foot 6-wire cage three feet in diameter. The down-lead is brought from the center of this top, "T" fashion, and consists of a six-inch cage, having 6 wires. The counterpoise, suspended directly beneath the antenna, is a 6-wire "T" flat top 60 feet long with 15-foot wooden spreaders and a cage leadin. The whole radiation system is insulated with strings of Ohio Brass Co.'s insulators.

The transmitter uses one 50-watt tube in the Hartley circuit. A 48-jar electrolytic rectifier and a partial filter consisting of 8 microfarads across the line and two 4½-henry choke-coils in series are used. Plate current is supplied the rectifier at 2,000 volts. This apparatus puts 6 amperes into the antenna system on 200 meters and about 4 amperes on 150 meters. The latter wave is used mostly now. Absorption-loop modulation is used for phone work occasionally.

Mr. Reidman says the 250-watt tube on the table does not work as well as a

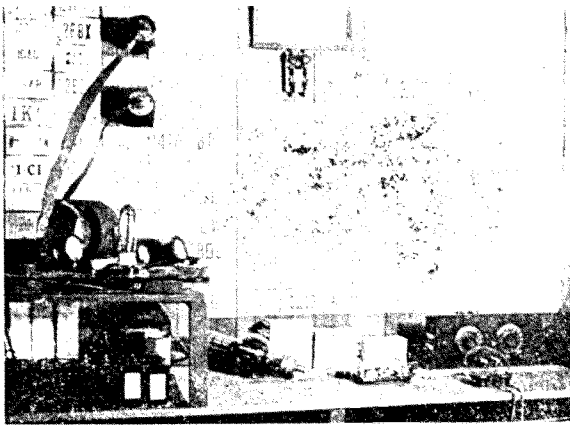

by ships off the coast of Spain, off Cape Horn, and off the coast of Peru. 6CGW has repeatedly worked stations in all districts of the U.S., besides Cuban 2BY, Hawaiian 6CEU and many Canadian amateurs. The best DX to date on phone was with 8CA and 8BRL.

To us there are three good reasons why 6CGW gets out the way he does. First, he has a good antenna system, and second, the tube is greatly overloaded. The third reason, which is perhaps the most important, is that the station was built to work. It is not a bunch of apparatus hastily thrown together and expected to do wonders, but is the result of many years of experience on the part of the owner.

This station came on the air with C.W. in November, 1922, after abandoning the old spark set, and has been in commission ever since. The call was changed to 6CGW the first part of last year and since that time has become known every amateur in the country.

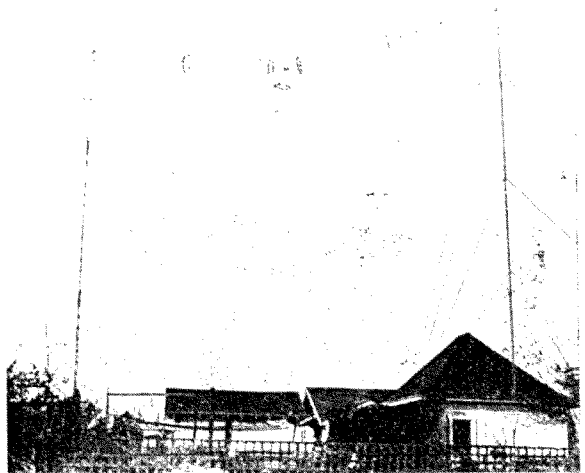

WHO WOULDN'T BE HEARD IN AUSTRALIA with an antenna like this? It is forty feet long and eighty feet high.

to almost Constant 50-watt tube, so he uses the 250-watt (Concluded on page 56)



# INTERNATIONAL Amateur Radio

## PCII, Leiden, Holland

Though PCII has not been in operation for some time it was one of the pioneer transatlantic stations that used to be heard steadily by American and Canadian amateurs. PCII had four operators, all of whom could handle traffic in a way that had some of our American traffic stations backed off the map. During the time it was in operation PCII worked over 25

to 2.8 amperes. Plate current is furnished through an electrolytic rectifier made of 64 half-pint "jampots" with an ammonium phosphate solution. The supply to the transformer is 125 v. 50 cycles A.C. The circuit used was the three-coil Meissner, with series feed and a variable condenser across the grid coil. A four-wire cage 49 feet above the counterpoise and 72 feet long constituted the antenna, while the

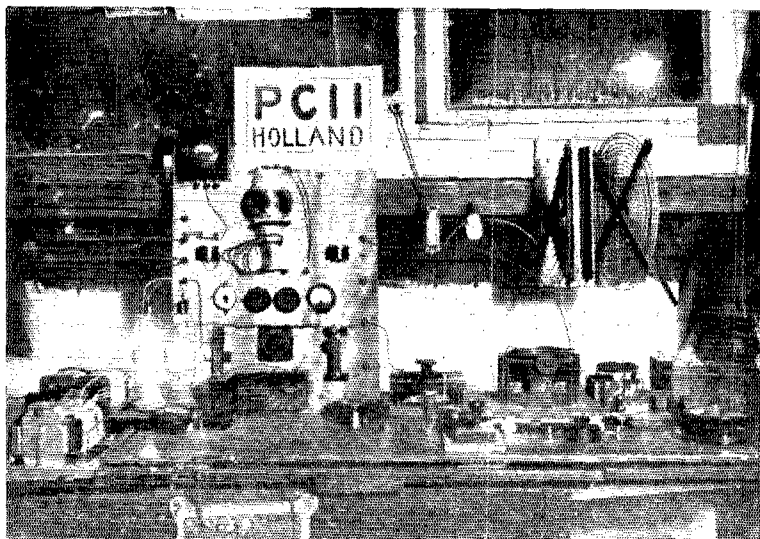

The Transmitter at PCII, Leiden, Holland, which has been heard many times by amateurs in the U. S. and Canada.

different stations on this side of the ocean. As far as we know SAOL at Farewell, Michigan, was the most distant. This represents a distance covered of practically 4,000 miles.

Most of the work was done with the transmitter as it is shown in the accompanying photograph. The receiving apparatus is on another table to the right. The transmitting tubes used were two 75-watt RS-17 tubes working in parallel with a Mullard 150-watt tube. The total plate input averaged around 300 watts. Antenna current on 110 meters was from 2.7

counterpoise was a five-wire fan of about the same length.

We have heard little as to why PCII is not on the air at present. It is believed, however, that the Dutch authorities have forbidden the operation of the station and possibly have confiscated the apparatus. Whatever the consequences, PCII deserves credit for being one of the first and best stations to work across the Atlantic on short waves

## Pan-American Tests Look Promising

Amateurs need not fear that they were burning watts in vain when they took par

in the Pan-American tests, just ended. Reports to date show that the South American amateurs are making rapid progress in their ability to do good receiving on short waves. The short wave transmission from WGY and KDKA, especially the former, are being heard by a large number of South American amateurs, and once these stations are heard it is a simple matter to log the signals from amateur and experimental stations.

Notable among the results obtained are those of Major R. Ravenhart, O.B.E., Supt. Telegrafos, F. C. Transandino, Los Andes, Chile, South America. At the time of last writing Major Hart was trying his best to copy a complete message from a North American station, even though static made reception hopeless on several nights each week. 9XAX (9ZT), 1XAM and KDEF (P.O. Dept., Omaha, Neb.), both in the vicinity of 100 meters, were being received quite well. Other stations that had been heard were 1XW, 3MB (or 3AB), 2BE, 4XC, 9CF, 9XU, WGY, KDKA.

Amateur transmission in Chile is allowed under extremely severe restrictions as to wavelength, power, decrement, and length of antennas, but no one takes the least notice of these restrictions and nothing is said about it. No official call letters exist but the Radio Club there has issued some unofficially.

#### European Notes

European amateurs are gradually reaching out and being heard and worked by American stations in the greater part of the U. S. British 2NM has been heard by 6ZAR of Los Gatos, Calif. French 8BF has been heard by 7LH in Junction City, Oregon, and British 2KF has been heard at 7ZU, Polytechnic, Montana. All U. S. districts have been worked from the other side of the Atlantic with the exception of the 5th, 6th and 7th. Who will be the first European amateur to work all U. S. districts?

Recently 1CMP worked French 8AB and later received a card from Mr. Deloy saying that 1CMP was copied on 90 meters during the communication. 1CMP's regular wave was 180 meters, so it was his half-wave harmonic that was being copied in France. Some harmonic!

Short wave stations continue to spring up overnight throughout Europe. The latest additions are 8SSU, at Bonn, Rhineland, 1KK at Berlin, 37X in Holland, and P2 at Brussels, Belgium. All of these stations have been heard or worked by English amateurs. Two-way has also been done with XY at Geneva, Switzerland.

#### New Zealander Takes Honors for Short Wave Reception

Mr. Frank Bell, 4AA of New Zealand, has recently gone through his logs for the

past year and some remarkable statistics on the reception of American and Canadian amateurs in New Zealand are the result.

The total number of different American and Canadian amateurs heard by Mr. Bell from February, 1923, to March, 1924, was well over 500!

Of these, 300 stations were heard on only one night; 105 were heard on two different

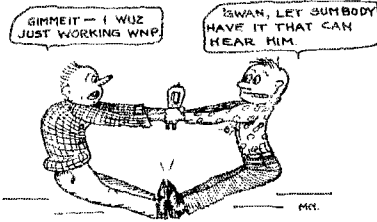

GQJ AND 6AHD SHARE ONE 5-WATTER BETWEEN THEM.

nights, 44 were heard on three different nights, and 65 on four or more different nights. A list of the calls heard on four or more nights, with the number of nights each was heard is as follows:

1FD-4, 4FT-7, 4MY-4, 5AIU-6, 5HT-14, 5LR-5, 5VM-5, 5ZAV-7, 6ARB-15, 6ALK-8, 6AWT-13, 6AAK-5, 6AHP-4, 6AOI-5, 6AOS-10, 6AUY-4, 6AVV-6, 6AAO-7, 6BVG-14, 6BIC-7, 6BJQ-4, 6BBC-11, 6BEO-12, 6BVS-6, 6BPZ-4, 6BUO-4, 6BQL-4, 6BRF-5, 6CKR-7, 6CMR-8, 6CFZ-6, 6CEU-5, 6CHL-8, 6CGW-22, 6CKP-6, 6CMU-4, 6CBB-9, 6CNG-5, 6CFY-4, 6JD-4, 6KA-9, 6LV-4, 6PL-19, 6RM-7, 7AEL-5, 7BJ-4, 7CO-6, 7HG-4, 7PF-5, 7QJ-6, 7SC-5, 8BDA-7, 8VY-7, 9AIM-5, 9BZI-4, 9BLY-5, 9CLQ-4, 9DKY-4, 9EKY-17, 9MC-25, 9VM-11, 9ZT-15. Canadian 5CN-7, 5GO-7.

"You will notice that 9MC, 6CGW, 6PL, 9EKY, 9ZT, and 6ARB head the list in the order mentioned. There are others, like 6KA and 6JD, who are just as loud if not louder, but they do not seem to be on the air so often.

"9MC is easily the leader, as he has been knocking 'em dead here for months. Have heard him with no antenna, on a loop using R.F., and on an apology for an antenna 20 feet long using a single valve. He is often stronger than some of our low power stations.

"Among those who have actually verified my reception of their signals, or whose signals have been heard under such conditions as to make any error well nigh impossible, quite a number were using 5-watt tubes," says Mr. Bell. "For instance, 1ALJ, 3ME, 5AIU, and 5AHD were each using four 5-watt tubes with antenna currents around 2 amperes. 5UW got across on three 5-watt tubes by using 275 volts from batteries for plate supply with an antenna

(Concluded on page 56)

# THE AMATEUR BUILDER

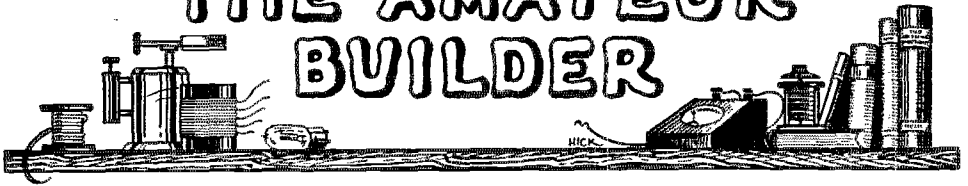

## SMALL TRANSFORMERS FOR THE AMATEUR—II

### Simple Fundamentals and Design

By H. F. Mason, Department Editor

**H**OW to design a transformer for your own particular needs was told in the first section of this article in the May QST. Upon completion of the design the builder can refer to the present article for practical information on the actual construction.

#### Cutting and Assembling the Core

The amateur usually has little choice in selecting the material for the core of his transformer. Fortunately, any kind of transformer iron or silicon steel will serve the purpose. The amateur can nearly always obtain the remains of an old power transformer from the shops of his local electric light company or junkyard, the core of which may be cut down and used; or, he may obtain the core material from one of several companies who advertise in QST, cut to his specifications beforehand. The material should be about No. 28 gauge. It is not worth while to use ordinary stove-pipe iron because it is harder to handle and cut and will not lay flat, besides requiring a much larger core for the size of transformer being built. Neither is it worthwhile for the amateur builder to try to cut

good joints in the core cannot be made unless the pieces of iron are carefully cut.

The first step of course is to find out how large to cut the pieces that form the core. This depends upon the way the core is put together and on the size of the core. A good method of assembling a core for a transformer is shown in Fig. 1. The core is built up of separate pieces forming the four sides. Pieces of core iron or laminations cut in two different sizes are required, A and B. Three sides of the core are built up at one time, the windings put on, and then the fourth leg of the core put in place, one piece at a time. Knowing the size of the window in the core, and the cross-sectional dimensions, it will be easy to figure just how large pieces A and B should be. If the cross-section through the core is square you will need enough pieces of each kind to make a stack, tightly compressed, twice as high as the finished core.

The core laminations should be insulated from each other to minimize the eddy current losses. Iron rust or scale already on the pieces of core material will serve for insulating the laminations in most cases. If, however, you wish to better the insulation between the laminations, coat one side of each piece with thin shellac, allowing it to dry thoroughly before assembling the core.

In building the core for a choke coil there should be an air gap somewhere in the magnetic circuit. The core therefore should be put together as shown in Fig. 2, with the winding on the long leg of the core. A variation of this method is shown in Fig. 3 where the four parts of the core are not interleaved with one another. This latter construction is OK for choke coils as an air gap is necessary anyway, but unless the pieces are very accurately cut and fitted together such construction for transformers should not be attempted by the amateur.

The air gap or gaps can always be adjusted to the required length after the choke coil is finished and should then be filled with cardboard or pieces of wood to prevent any possibility of the magnetic attraction slowly closing the air gap. The total air gap, if

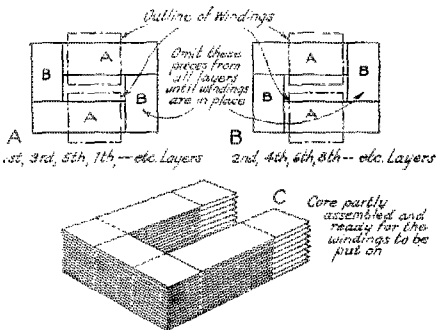

FIG. 1 HOW TO PUT A TRANSFORMER CORE TOGETHER.

the core himself unless he has access to the squaring shears in a good tinshop. It always pays to have all of the core laminations cut to exactly the same size as appearance counts in the final results. In addition,

there is more than one, of course will be the sum of the length of the separate air gaps. The location of the gap makes no difference; its total length is what counts.

The design data for choke coils of various inductances and carrying capacities are given on page 22 of the August, 1923, *QST*, to which the builder is referred for that information.

A cigar box with two of the adjacent sides knocked out and the cover removed will be convenient for a guide in building up the core. Build it up layer by layer, making alternate layers dissimilar, as shown in Fig. 1 or Fig. 2 as the case may be. When three of the legs are completed, tie the whole together with string temporarily, clamp it in a vise, and then tape the legs on which the windings are to fit with a single layer of friction tape. The tape should be laid on as tightly as possible so as to hold the core securely together. Remove the string as the taping is being done.

It is essential that the joints in the core be well-made, and that the core be square and even. The joints may be hammered up tight with a rawhide hammer. A joint that is not hammered up tight, Fig. 4A, is not good for a transformer because the many small air gaps between the laminations reduce the effective area of the core at that point. If the laminations are all cut to exactly the same length and hammered up tightly the joints in the core will appear as in Fig. 4B.

### Winding the Coils

The size of wire and number of turns for the coils of the transformer were obtained by computing them from the data in last month's article. Before starting the actual winding a few things should be said about transformer windings in general, from the standpoint of the amateur builder.

Transformer windings always should be carefully wound in layers because the wire takes up much less space when so wound, and the winding is much easier to insulate well. Windings of enameled wire should have a layer of paper between each layer of wire, especially where the wire is smaller than about No. 20. The layers of paper will better the insulation and also help to keep the layers even. In windings of large wire the layer of paper may be dispensed with because there will be fewer turns of wire per layer and the voltage between the ends of the layers will not be so high. If desired the paper may be cut between every two layers. Heavy wrapping paper usually will do, though special insulating papers are better. The paper should be cut in strips the required width before starting to wind the coil. For small coils of enameled wire, thin paraffined paper may be used between each layer.

It is customary to paint or impregnate the coils with a good insulating varnish or wax to keep the moisture out and to make them more rigid. In the average winding

of double-cotton-covered wire a coat of shellac, put on as each layer is wound, is sufficient from the amateur's standpoint. Transformer manufacturers usually impregnate the whole coil by a vacuum process which removes the air and moisture from the coil and then forces insulating

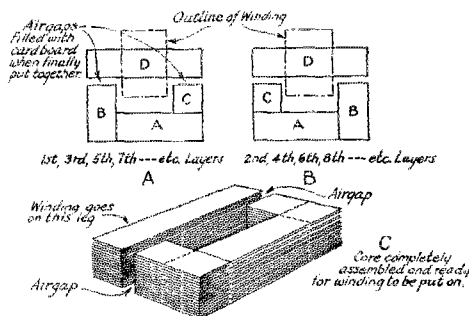

FIG. 2 HOW TO PUT A CHOKO COIL CORE TOGETHER.

compound, under pressure, into every part. Small coils of enameled wire may be moisture-proofed by dipping or impregnating them in a mixture of melted beeswax and rosin.

The best way to moisture-proof a large enameled wire coil is to paint the outside of it with a heavy insulating paint. Do not, under any condition, shellac the layers of enameled wire as they are wound, because the enameled wire will not absorb the moisture in the insulating varnish or shellac and hence the varnish will not dry. In addition, shellac dissolves the enamel on the wire and may thus impair the insulation of the coil.

The first step in building the coil is to make a wooden form on which to wind it. This should be a block of wood as large or just slightly larger than the leg of the core on which the winding is to be put, and a few inches longer than the winding. Care should be taken to make this block of wood the right size and smooth. It can be made of several pieces nailed or glued together if one piece the correct size cannot be made.

A means for rotating the form as the wire is wound on is now necessary. Any ingenious amateur can contrive some means of rotating the form. One way is to fasten it with wood screws to a large disc of wood which is bolted or lashed to the flywheel on your mother's sewing machine. Another very satisfactory way is to fasten the form to the spindle carrying the grinding wheel on a geared hand grinder. Probably the simplest way for many is to drill a hole in one end of the form, drive in a spike with the head cut off, and fasten it into the chuck of an ordinary geared hand drill. This hand drill is in turn fastened in a vise. A lathe can also be used. If much winding is to be done it may pay the amateur builder

to get an old foot-power sewing machine, take the top part off and substitute a grinding head, belt-driven from the foot power arrangement.

A revolution counter, which can be obtained for about \$2.00, is also a great help and nearly a necessity. The winding form should be firmly fastened to the winding rig and the counter put on the other end as shown in Figure 5. If the winding is done in a lathe, a wooden plug can be put in



FIG. 3  
ANOTHER METHOD OF BUILDING A CORE FOR A CHOKE COIL

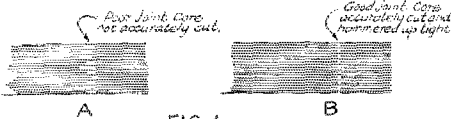

FIG. 4  
GOOD AND POOR JOINTS IN THE CORE

the left-hand end of the live spindle with the counter fastened thereto.

The next step is to wind a layer of heavy string on the form, fastening the ends to tacks. This string is to be removed when the winding is finished, thereby leaving room for slipping the winding off of the form. At the same time it makes the winding a little larger than the core and allows room for slipping it on the core. If the winding is to be taped, two layers of string should be put on the wood core as the tape will take up some room.

You will need a solid backing for the first few layers of wire, to serve also as insulation between the core and winding. In amplifying transformers and such, a few layers of heavy paper is sufficient. On C.W. transformers two or three layers of heavy fish paper or thin fibre should be fitted closely to the winding form over the string and glued down. This will suffice for the primary or filament winding but for the secondary winding put on several layers of Empire cloth in addition. The corners of this insulating tube should be made square and the material for it should be cut the exact length the finished winding is to be.

You are now ready to start winding. This is the easiest part if you know how to go about it, but trouble may be expected at first. Holding the loose end of the wire while getting started is the first problem. This can best be overcome by having on hand several pieces of ordinary cotton sewing tape about  $\frac{3}{8}$  of an inch wide, putting a piece of it about 2 inches long around the first turn on each of the four sides of the coil. As shown in Figure 5, the following turns then will hold the first one in place.

Enough of the wire should be coiled around a lead pencil and left hanging loose to provide a lead to the inside end of the coil. When these tapes have been pulled tight and the first few turns put on, the winding form can be revolved more rapidly and the winding done quite quickly. If the coil is wound with wire of about No. 30 gauge or smaller, the lead and the first half layer or so should be made of a larger wire. The fine wire may then be soldered on near the middle of the layer and a bit of paper or Empire cloth folded over the joint. Keep an eternal lookout for short-circuited turns and layers. If even one turn is short-circuited in the entire winding, a transformer will be created with the one turn as its secondary winding. This one turn will immediately burn up, rendering the whole transformer or choke coil useless.

In winding the coil feed the wire with a cloth over your hand about two or three feet away from the winding and rotate the form. By holding the wire far away from the form it is much easier to let the wire guide itself and wind on in even layers. Keep the wire just as tight as possible without breaking it. The wire, no matter how small, should always be wound in even layers with no spaces between the turns and with no turns on top of each other.

When about  $\frac{3}{4}$  inch from the end of first layer, lay on four more pieces of sewing tape about two inches long. These are to

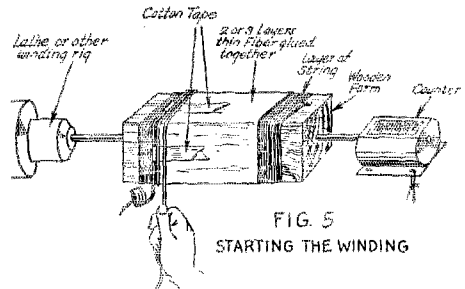

be bent back under the second layer and will hold the end turns of the first layer in place. The same thing may be done at the end of the second layer, and so on, if no paper is put between the layers. With fine wire coils having paper between the layers, tape at the end of the layers usually is not necessary. In this type of winding it is well always to end the layers about  $\frac{1}{8}$  of an inch from the edge of the paper. Where no paper is used, run the layers as near to the end of the form as possible, keeping the wire very tight.

If taps are to be taken out on the coil, arrange the number of turns per layer so the tap comes at the end of a layer. The tapping may be done as shown in Fig. 6. Beware of shorted turns!

Figure 7 shows how to finish off the end



of the winding. It is done by putting on a piece of tape about half way on the last layer, making it into a loop when about five turns from the end of the winding, and poking the end through the loop. With coils of fine wire, the last half layer should be of heavier wire so as to provide a stronger lead. Unless the winding is now to be taped, a piece of heavy paper should be put

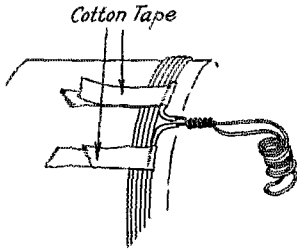

FIG. 6 BRINGING OUT A TAP

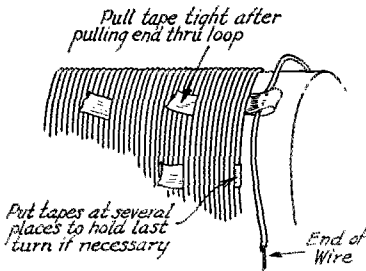

FIG. 7 FINISHING OFF THE WINDING

over it, for appearance's sake and to prevent anything from cutting the wire.

**Taping the Windings**

The windings may be taped if desired. High voltage coils should be taped with Empire cloth tape. Other coils can be taped with ordinary friction tape or with untreated cotton tape about one-half inch wide, depending on the size of the coil. Lay the tape on smoothly so that each turn advances one-half the width of the preceding. The tape should be pulled tight, but not so tight as to distort the winding. Be careful also about letting the tape bunch up at the inside corners.

The leads should have pieces of sleeving slipped over them when the taping is being done. These pieces of sleeving are held in place by the tape. Varnished cambric tubing (spaghetti) may be used for this purpose on the high voltage coils, while pieces of an ordinary flat tubular shoe lace will make good sleeving with which to cover the primary and low voltage leads.

After the coils are taped they can be impregnated or given a coat of insulating paint or varnish.

Having partially assembled the core, and with the finished windings at hand, you are now ready to put the transformer together. Slip the windings on the core so the leads do not touch the core. If the windings fit loosely they can be held in place by small wooden wedges driven in lightly from each end. The other leg of the core is now put in place by slipping in the laminations, one at a time, and driving them up tight with a rawhide hammer.

**Mounting the Transformer**

The transformer is not really complete until it is mounted in some fashion with a terminal board arranged so that windings can easily be connected to the external circuits. It would be well to test the transformer before connecting it up permanently, however. Connect the primary winding to the line and leave it on for several hours. If at the end of this time the primary winding is only slightly warm you are certain that it is OK. If you can put some kind of a proper load on the secondary at this time, so much the better. The main defect is liable to be shorted turns and these will immediately show up in the form of heat, fireworks or both.

Several ways of mounting the transformer are shown in Figure 7. Other arrangements will be evident to the amateur builder. Pieces of 1/2 by 1-inch angle-iron, or larger, or pieces of strap iron, make a good mounting. The mounting should be arranged so that the core is clamped tightly by several bolts at the corners.

The terminal board should be placed so there is plenty of room beneath it for the leads to come up from the windings. At the same time the terminals from the different windings should be separated a maximum amount so that there will be no danger

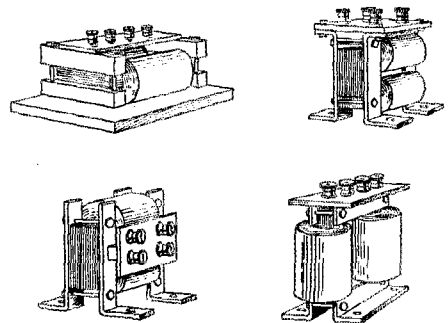

FIG. 8  
WAYS OF MOUNTING TRANSFORMERS

of their becoming crossed. The terminal board can best be a piece of bakelite or similar material and the terminals themselves, for ordinary currents, can be ordinary. (Concluded on page 56)



### Denver Amateurs Create Good Will

The past few months have been red-letter ones for the amateurs in the biggest city of the Rocky Mountain Division. Two outstanding things occurred which did a great deal to strengthen the position of the amateur in that territory. "Formerly the radio listeners did not have the least idea of the purpose of the A.R.R.L.," says Mr. Howard Williams, 9BXQ; "now they all

united in agreeing that this was worth coming ten miles to hear if there had been nothing else on the program.

The other outstanding event of the radio season was the radio exposition held in Denver in the latter part of March. The Associated Radio Operators of Denver obtained a booth in a splendid location and installed a complete amateur station there. Messages accepted the first day totaled 446. By the end of the week the total ran between twelve and thirteen hundred. This booth attracted more attention than many of the more elaborate ones, and much credit is due the Denver crowd for the fine way in which their part of the exposition was handled.



The A.R.R.L. Booth at the Denver Radio Exposition

seem to at least know who we are, and we are referred to by many as an authority and we seem to have the good will of most everyone."

On the 22nd of March the Associated Radio Operators of Denver rented the auditorium of the Y.M.C.A. and put on a blowout for the listeners. The meeting was a complete success. Captain W. L. Winner, an ex-army man, well known and well liked by hams and BCL's alike, and a man that really knows radio, gave an excellent talk on receiving sets. Mr. Paul M. Segal, president of the Denver Club, told of the A.R.R.L. and its work, putting the talk across in fine style. The first of two entertainment numbers for the evening was a double mixed quartet gotten together by the club and which got away with much applause. The second event was a debate staged by one of our ex-congressmen against a prominent minister in Denver on "Resolved, that Maggie is a better wife than Jiggs is a husband." This was a perfect scream from start to finish and everyone

### Amateur Exhibit at Radio Show

At the Radio Show held in Washington, D. C., March 19th to 26th inclusive, an excellent amateur exhibit was shown by the Washington Radio Club. The exhibit brought members for the club and friends for the amateur game.

Station 3LR was brought down to the show and set up as shown in the picture. On the table opposite was a display of amateur calibration apparatus together with pictures of various amateur banquets and conventions. The center table carried an assortment of receivers, and an old-time spark transmitter labeled "This Type of Transmitter Was Generally Used By Amateurs Five Years Ago But Is Now Obsolete."

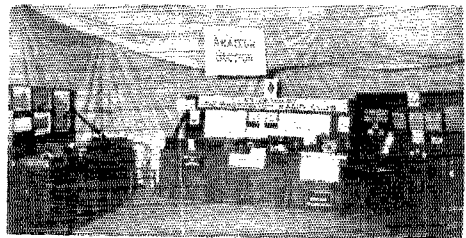

(Photo courtesy 3AB and 3CDQ)

Having Been Replaced By the More Efficient Tube Transmitter". Next to that was the transmitter from 3ASO and the historical little tube set that was used at 3JJ in 1919-20 when all broadcasting was done by amateurs. This particular set was the

(Concluded on page 56)

# Strays



## QRD Happiness

Frank M. Corlett, pioneer manager of our West Gulf Division and A.R.R.L. director since the creation of the Board, stepped off from "single blessedness" and was married on April 9th to Miss Ellen Ivon Cameron, of Beaumont, Texas. Congratulations of the gang, OM—FB!

The management of the New England Division Convention recently held in Springfield wishes to express its great thanks to the Acme Apparatus Co., General Radio Co., Wetmore-Savage Co., and Chelsea Radio Co., for their generosity in donating apparatus for prizes awarded in the contests; their cooperation was greatly appreciated by the fellows and helped to make the convention a success.

The American Radio Relay League has no connection with the so-called "Loyal Order of Fle". The activities of this organization are of such a nature that the League cannot endorse them.

The American Transformer Co., Newark, N. J., has just purchased the property 75 by 100 feet adjoining their present factory; thus expanding their facilities for the manufacture of the well known AmerTran line of audio frequency transformers.

As a result of charges brought by the Dubilier Condenser and Radio Corporation, Harold Hymans, doing business under the name of the Micadine Company, pleaded guilty to having imitated the Dubilier Micadon fixed condenser, widely used in radio. A sentence of thirty days in jail or \$100 fine was imposed by the court.

Eight free balloons which took off from Kelly Field near San Antonio, Texas, on April 23rd for the national balloon elimination race had their progress followed closely by radio amateurs who reported the movements of the balloons to the "Balloon Race Executive." Arrangements were made by Mr. L. D. Wall, Dist. Supt. for the San Antonio District of the A.R.R.L., to have three or four local amateurs keep a twenty-four hour watch during the race for the purpose of handling incoming messages and

promptly forwarding them to officials in charge of the race.

Eight hundred station and operator photos must be in the hands of James A. Wilson, 8CPY-8DKC, at his new QRA at 911 Lay Blvd., Kalamazoo, Mich., by July 1st, or the book of *Amateur Stations in Pictures* he proposed to publish can not be published. Clean sharp pictures are the only ones that can be used. Don't fail to send stamps if you wish them returned. This business is worth your support, fellows—see article in February *QST*.

1TS, at Bristol, Conn., has received dozens of cards that are really meant for Mexican 1B, Mr. M. L. Perusquia, P. O. Box 540, Mexico City, Mexico. Many of these cards even suggest that 1TS improve his list because he sends his call as if it were 1B! What is the trouble, fellows? Can't you read the code?

At the top of page 31 of our March issue it was incorrectly stated that Mr. S. G. Paterson, c4DY, was the editor of the Canadian amateur magazine, the "Radio Bug," when that publication first started. Mr. Paterson wishes to state that though he did act as secretary, pro-tem, for the C.R.R.L. after a meeting of amateurs in Winnipeg last fall, he was at no time the editor of or connected with the "Radio Bug." Sorry, OM; our mistake.

Many American amateurs have wondered "how come" that so many Canadians are operating around 125 meters. Mr. A. H. K. Russell, Canadian Manager of the A.R.R.L., explains this by giving the wave lengths and wave bands allotted to various types of amateur transmission under the latest regulations of the Department of Marine and Fisheries at Ottawa. They are as follows: Pure C.W. stations are allotted the band from 125 to 150 meters, 175 meters, and the band from 200 to 225 meters. Spark stations are allotted the wave of 175 meters only. Phone and I.C.W. stations are limited to waves of 150, 175, and 200 meters only. The above will greatly clear the veil of mystery that seems to exist regarding what wave lengths our Canadian brothers are permitted to use.

Ludwig Hommel Co., of Pittsburgh, have just issued an attractive catalog and price list which will be of interest to all radio users.

Some of the fellows are missing or misreading the intermediate signal, for New Zealand 4AA has received several reports on his signals that really should have gone to Canadian 4AA. Watch this, OM.

As a result of accidentally coming in contact with 1,000 volts from his kenotron rectifier, Wilbur Jerome, 8ACY, of Bedford, Ohio, lost the tips of two fingers and it is thought others may have to be amputated because of burns. He suffered greatly from the shock and is still in bed, though he expects to be up and around soon.

This should serve as a warning to all other amateurs to be everlastingly careful when working with radio transmitting apparatus. It is just the "didn't-know-it-was-loaded" story over again. Electricians always wear rubber gloves when working around circuits that are "hot". They appreciate the value of "Safety First". Radio amateurs should do likewise.

It is requested that the secretary of every radio club in the Third Radio District communicate his address and the name of the club to Thomas Appleby, President, Executive Radio Council, Third Radio District, 5847 Ellsworth St., Philadelphia, in order that they may be kept informed on all matters pertaining to the Third District.

The French Government is conducting short-wave tests with the A.R.R.L. thru the Eiffel Tower station, FL. FL can be heard every night now on 115 meters, and tests are projected thruout May and June on that wave and on 50 and 25 meters. Schedule has not yet been received but interested amateurs should file their names with the Traffic Manager for rush advice upon receipt; also watch the A.R.R.L. broadcasts for further information.

Mr. Boyd Phelps, "BeeP", formerly Assistant Editor of QST and lately with the C. D. Tuska Co., as research and development engineer, has left that concern and is now with the Grimes Radio Engineering Co., of Staten Island, New York. Incidentally his new radio call is 2EB, 1HX is nm.

Speaking of "miles-per-dollar" records, 7EL at Stevensville, Montana, recently worked two-way with 9DWA of Otterholm, Indiana. Score for 7EL, 77 miles per dollar cost of transmitter. One 5-watt (so-called, of course) tube used.

3AEX suggests that the glass rod insulators described by Mr. Atkinson on page 39 of the April issue can be annealed very

easily by allowing them to cool in hot sand.

A monthly supplement is now being issued by the Citizens Radio Service Bureau, Inc., of 508 South Dearborn St., Chicago, which gives all changes in address, cancellations, and new calls issued. This covers the entire nine American districts, all Canadian districts, and broadcasting stations. The charge is only 25 cents per month, payable six months in advance at the time you purchase your Citizen's Radio Call Book. This monthly service is only sold to users of the Citizens Call book. This is what we amateurs have been wanting for years. Let us give it our hearty support now that we have it.

Definite schedules expire June seventh but continue to listen for A.R.R.L. daylight tests from NKF on 52 65 and 75 meters, also NKF1 in the evening on 75 meters.

The license of 7IV, K. B. Aldrich, 3315 N. 29th St., Tacoma, Washington, has been suspended for a period of thirty days for working his transmitter during the quiet period.

## NEW APPARATUS

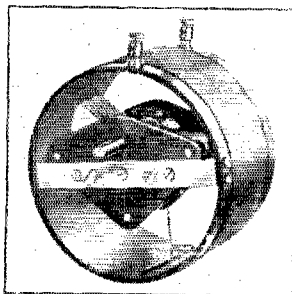

The Horne Electric and Mfg. Co., of Jersey City, N. J., makes an instrument that finds many uses in a receiving set and in the experimental laboratory. This instrument, the Horne Verni-Tuner, is essentially one or more single layer coils wound on a tube with a variable condenser mounted inside of it. The instrument is made in several styles with the coils arranged and plainly marked for use in various well known circuits. In addition, the Horne Verni-Tuner can be used as a wave trap, wave meter, or antenna coupler. It is a handy addition to any station.

The Magnavox Company has distributed to the trade new models of their R-3 and R-2 radio reproducers. By means of a new control rheostat the battery current through

the Magnavox can be varied between .1 and .6 amperes, when supplied with six volts. This improvement contributes to a saving in current consumption as well as making possible better reproduction. Careful attention has been given the matter of improved appearance.

The New Crosley Model 51 receiver using a regenerative detector and one stage of audio amplification is the best value in a receiving set for \$18.50 that we have seen for some time. This little set is built in a handsome mahogany cabinet and, for those who desire a good but inexpensive broadcast receiver, it is an excellent buy.

The Allen-Bradley Co., Milwaukee, Wis., has added another item, known as the Bradleyohm, to their line of radio products. The Bradleyohm is an adjustable resistor similar in general appearance and operation to the other Allen-Bradley graphite disc rheostats such as the Bradleystat and the Bradleyleak. The resistance of the Bradleyohm can be varied over a wide range by turning the adjusting knob. It is made in three types. Type 10 covers the resistance range from 10,000 to 100,000 ohms; type 25 from 25,000 to 250,000 ohms;

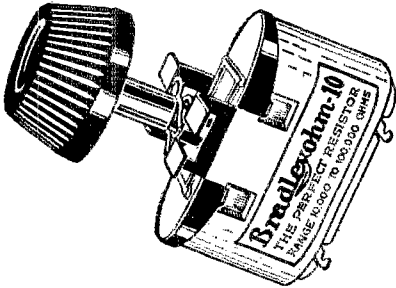

and type 50 from 50,000 to 500,000 ohms. These resistors may be used across the secondaries of audio transformers for reducing distortion, as coupling resistances in amplifiers, filter resistances in receiving circuits, and for many other purposes.

Both amateur and broadcast wave lengths can be covered very well by a vario-coupler of the type illustrated herewith, manufactured by the General Radio Co. of Cambridge, Mass. Some of the desirable features of this coupler are lower losses due to the use of less insulating material, and small distributed capacity resulting from the use of small gauge double-silk-covered wire. The coupler has a single tap in the center of the stator winding to permit its use on both amateur and broadcast waves. Its construction easily permits winding a few turns of wire over the stator winding for antenna coupling. There is practically no end to the

number of circuit arrangements in which this coupler can be used.

The compactness of this vario-coupler is a distinct advantage, and a pleasant contrast to the older and larger couplers. The smaller the instrument, the smaller will be the tendency for the builder to crowd the parts behind the panel in his set and cause

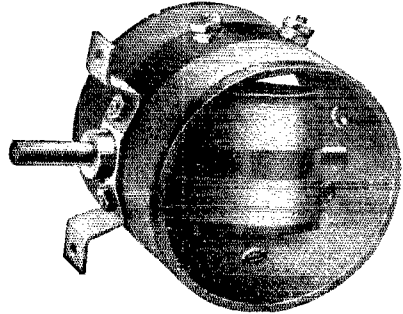

reaction between the various pieces of apparatus. Then, too, from the viewpoint of portability, the smaller vario-coupler is particularly desirable. This makes the coupler ideal for portable sets which are so much in favor at this time of year. Considering its many advantages, the small size, and neat appearance of this latest General Radio product, it is a very creditable improvement in coupler design.

The Daven Radio Co. of 9-11-13 Campbell St., Newark, N. J., has put on the market a moulded bakelite mounting for cartridge type grid-leaks and postage-stamp-type variable condensers that will come in handy in any station. The cut shows the mounting, which is made in three styles. Type 50 is intended to hold a resistor grid leak. Type 51 is intended for a resistor and grid condenser of the mica "postage stamp" type. Type 52 is intended to hold a fixed mica condenser only. The latter type is especially useful in experimental circuits where it is convenient to clip into the circuit small condensers of various sizes without having to untwist wires, etc.

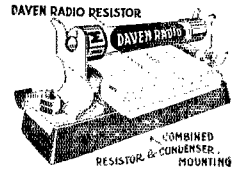

It is now possible to obtain Myers radio vacuum tubes in practically every big city in the U.S. If, however, there should be any difficulty in obtaining Myers tubes in your town, users can secure them from the manufacturers, E. B. Myers Co., Ltd., 240 Craig St., West, Montreal, Canada, who have made special arrangements to deal with orders from the United States.

# Radio Communications by the Amateurs

The Publishers of QST assume no responsibility  
for statements made herein by correspondents



## A Word to the Experimenter

Boonton, N. J.

Editor, QST:

Inquiries have been made as to the construction of coil L in Fig. 4D of my article in QST for January, 1924.

The only requirement on coil "L" is that its inductance should be so large that its distributed capacity predominates at the required wavelengths, and it behaves as a fairly constant capacity reactance. The condition of balance is as follows:

$$C_1 C_c = C_2 C_m$$

$C_1$  cannot be too large, for this would make  $C_2$  large and limit the signal amplitude. I have not worked with this circuit enough to specify definitely the best form of winding to use, but I have used in one particular assembly a 1000-turn honeycomb coil at L which was quite successful. The inductance of this coil is 95 millihenries and its distributed capacity about 20 micro-microfarads. I would suppose that if you used an ordinary multi-layer coil wound on a 3" tube, yielding a higher ratio of distributed capacity to inductance, you could get along with considerably smaller inductance. I would try at first about 500 turns of #22 D.C.C. wire wound on a 3" tube in three layers.

—Radio Frequency Laboratories,  
by Lewis M. Hull.

## What Ails Us?

40 Fourth Street,  
Ridgefield Park, N. J.

Editor, QST:

We are going to touch on a topic that has been done to death several times in the past but which always will offer one an excuse to write to the editor. Coming at a time when amateur radio is patting itself on the back and congratulating itself on its wonderful trans-this and trans-that successes, we feel that we will not be listened to as we should. Nevertheless, the fact still remains that there is something wrong with the game.

People, and there are many of them, have been whispering, nay, even shouting to us that the amateur is doomed. We are continually shown that we are "persona non grata". It behooves us to take stock of our power, our troubles, and to find out the why, what and wherefore of the whole situation. This is not a sudden call

to arms over any one particular ailment but is, on the other hand, an honest to goodness appeal to our amateur brethren to get a move on, to wake up and to act as though they were so.

The problems of the amateur today are legion. The BCL's next door, the power company's hints that we put in a special power line, the guy with the CQ mania, the radio club that isn't, the fone hound on the air at one A.M. and a countless multitude of kindred situations are constantly before us. We fight each other on the air; some of us don't even bother to do that, we test and CQ to our heart's content. We are continually squawking, screeching, gargling, yes gargling, while the guy with the traffic sits and fumes and sends us all to the land of the coal heavers. We don't know what a trunk line is anymore, and as for message delivery—Ye Gawds! The patient certainly has many ailments, more of them than a dog has fleas, but there is a remedy for it all.

We must put our shoulders to the wheel, we must cooperate with each other. We must keep our local clubs going, we must back up our local Executive Councils, we must see that everybody knows about it whenever a question of vital importance to amateur radio is brought up. Above all we must stick together in all matters.

The average amateur is a great man on the air, but when it comes to helping out the local club, signing a petition, or doing anything toward helping the rest of the gang push across a big affair, "Let George do it" is the slogan of fifty per cent of our amateurs. We are content to let the A.R.R.L. do our fighting for us; we don't even help the League do that. Last year or the year before we were given a chance to test our influence with Congress. Did we send in petitions, write to our Congressmen or write to local newspapers expressing our opinions? Emphatically NO. We let the A.R.R.L. send representatives to Washington to fight for us; they did a mighty good job; but did we help them?

The day is coming when broadcasting stations will ask for the right to transmit below 200 meters. Already the BCL editions of the Saturday papers insinuate and prepare their readers' minds to the fact that music will come in four times as loud on a hundred meters as it will on

four hundred. We amateurs will find this factor becoming a menace of greater magnitude each day. However this is only a part of our troubles.

On the air we waste our time and that of others by CQ-ing, testing, gargling on our A.C.C.W. fones, and making the air a safe place to stay out of for the rest of the gang. After CQ-ing we go off the air leaving a dozen stations calling us and wasting their time. You laugh but the writer has actually heard several such occurrences. Then there is that pest who goes "dah dit diddidit dah", never signs, and finally apologetically pounds out "nm nw". And, gosh dern him, there is the fellow who works DX, gets several messages, promises to pass them on, and then promptly forgets about them. Why in the name of mud do we act this way? Hasn't the average amateur a sense of responsibility? Why be a crab on the air and a real good fellow when off the air? Why do we try to get everything for nothing and give nothing? We are all glad to win a prize for trans-this-and-that reception or transmission but do we give a hang whether the other fellow gets the same chance? No sir! If we feel that we haven't a chance to win we go right ahead and break the rules and account for our actions by saying that we never believed in such bunk anyway. If we have a chance we go up in the air because the other fellow did what we would have done if we had felt that we didn't have a chance. Why not study the Golden Rule and apply it to this great game of ours, fellows? It's a great game when we make it so. Why not make it so all of the time?

There is one remedy to the situation. Through our radio clubs we should be able to reach these fellows whom we would like to convert to our way of thinking. Through our clubs we should be able to find out what interests the other fellow, we should get to know him personally. In New Jersey the N.N.J.R.A. has started a movement in this direction. All the clubs that we can get hold of are getting together and holding a joint meeting five times a year. Every ham gets to know the other fellow and knowing him thinks twice the next time he feels like CQing or warbling away on fone at one A.M. It isn't a question of force, rather it is one of psychology. A man will act decent if he thinks that there is someone he knows listening to him. If you know the whole gang and the whole gang knows you, you will hesitate before you make a fool or pest of yourself on the air. **THINK IT OVER AND REFORM—WE NEED IT.**

—John J. Escobar, 2CRO.

## More News From New Zealand

148 Colombo St.,  
Christchurch, N.Z.

Editor, QST:

Now that New Zealand is a familiar name to most U.S. hams, a little information regarding the work and organizations of the Radio Society of Christchurch, as well as additional news of amateur activities of this Dominion, may be of interest.

This Society was formed three years ago, and has grown in membership and influence until it is now the most well known and influential body of radio amateurs here, and is looked upon as the headquarters of amateur activity in New Zealand.

The aim of the Society is to popularize radio as much as possible, and to further this end, with the generous assistance of the local dealers, a broadcasting station was put into operation and constantly run three nights a week for six months. This made radio known to thousands, and the members felt adequately repaid for their time and trouble expended. This helped the membership, and it was significant that the more that joined up thru the station the more attended the code classes. The operators and announcers who operated the station were all "well gone" hams, and would not listen to a broadcast for 2 minutes on end, though they were quite ready to provide pleasure for the BCL's.

Before we started there were two dealers in this city, now there are eighteen. This shows the growth of the army of listeners-in.

The Society holds weekly meetings, annual radio camps, and periodical "Ham-fests." The radio camps are devoted to experimental work on fairly short waves mostly (from 20 meters to 60 meters), though other experimental work is done. Plenty of power is available, as we harness a stream, or take a petrol engine out to drive a generator, which charges our bank of storage cells. Every member of the Society arranges to spend at least a week at the camp. Aerials of all descriptions have been tried out, and the cage gets it for transmitting.

We don't use much power on an average—a 5-watter gets you anywhere in N.Z. 3AF here works Aussie (Australians) *anytime* on one with normal input. 4AA, of whom only the dead have not heard, is always on the air. Last nite he was listening for 2CDM with eleven valves perking. 2AQ is our best amateur fone here and he *is* good, both in strength and modulation. 1AA is a big noise. 2AE also shakes the nails out. 2XA certainly knows how to swing a chopper around, while 2AC is loud enough to be heard in Siberia. 2AE operates his station well. 4AK has a lopsided note, but one gets used to it. 3AM gets discouraged but knows how to get the *best out of his set*, something we all can't do. 3AF is some "op" and has a good station and doesn't

CQ much. 4AD thrives on this last, however. On the whole, the fists of the N.Z. and Aussie stns. are very good and clean. Some of the Yanks we hear pse copy.

I notice you people are at last getting wise to the short waves. The N.Z. gang have always kept down. Out there we work as a rule from 135 to 175 meters, and only occasionally does a bird come twittering in above that. The Aussies work on the long waves (from 200 to 250). Some are quite strong here. It is sometimes hard to tell whether a station is N.Z., Yanky or Aussie, as the signal strength is often no help. Transmitting the right intermediate signal is the only answer. The best time to hear us is about three o'clock in the morning over there. Things are in full blast here then.

One thing I like the hams over there for, however; they QSL. This is more appreciated than we can tell. Every U.S. mail is eagerly looked forward to for QST and QSL's of calls heard.

QST is more than a magazine here—it's a link between the U.S. hams and ourselves. No dead millionaire uncle's will was ever read with as much gusto as QST is devoured by the N.Z. gang. Read in bed at night, propped against the sugar basin at breakfast, open at every opportunity. The last QST containing the article on the low loss tuner was F.B. Personally I had one made 48 hrs after I received the magazine. Upon trying it out it worked 25 times better than I expected. I rushed it around to 3AF, and we logged more Yanks and Aussie's that nite than we had done in a week. After a heated discussion I managed to get it home again. If he had been a little bigger I wouldn't have.

Next time I visited him he had one going and we logged 4 Aussies and 15 Yanks in 2½ hours. Now the dogs are making 'em.

Well, sir, I will not occupy more of your valuable time, and assuring you of our appreciation of your magazine and the cooperation of the Society in any work of amateur interest, will QRT. 73's.

Francis Vincent, z3AB, Hon. Sec.,  
Radio Society of Christchurch.

### A Correction

140 Parkwood Blvd.,  
Schenectady, New York.

Editor, QST:

In my article "Capacity and Inductance Measurements for the Amateur", printed on page 32 of the May, 1924, QST, a serious error has been made. At the head of the second column on page 33 the article reads, "If the inductance of the wavemeter coil is known, the value of K may be calculated from  $\lambda = 59.6 \sqrt{LC}$ ." The value of the inductance does *not* need to be known. K is the numerical value of the product of the inductance and capacity at the wave-

length the measurements were made. In other words suppose we first set the wavemeter at 250 meters. To find K, substitute,

$$250 = 59.6 \sqrt{\frac{LC}{250^2}}$$

$$LC \text{ (or K)} = \frac{250^2}{59.6}$$

$$LC \text{ (or K)} = 1045$$

Thus it is *not* necessary to know the value of the inductance of the wavemeter coil (which is seldom known accurately) but only the wave length at which the measurement is made.

The remainder of the article is O.K.

—Frank Reid Stansel.

### The Good Old Spark Days

4547 Greenview Ave.,  
Chicago, Illinois.

Editor, QST:

"Good Old Spark Days," is what T.O.M. calls them and they sure were. Radio used to be a science. Now it is a hobby and in everyday conversation it rates about as high as golf or the weather.

A few remarks are in order which will probably be of interest, especially to the old-timers. Remember when you use to go to the *one* radio store to get your stuff from those eternally high-handed clerks? Remember how you handled so reverently your gas-filled two-filament audiotron; your five hundred feet of aerial wire; your big loose coupler with about four hundred taps; and the eternal Murdock 'phones?

Remember when you used to show your set to astonished neighbors, and told them fairy tales about it, and they stood there pop-eyed and called you a genius? They asked you some pretty dumb questions too. Even the two-year olds know better now.

Remember the trouble you had putting up your aerial? My landlady in particular was an old maid of dubious disposition. Calamity was written all over her skinny face. "No, you can't put up those electric wires!" she cackled. (In minds of the ignorant, electricity and wires were synonymous with death). She said it stood to reason that anything with wires attached was dangerous. (I'll bet she's got a "radio" herself now). Finally the aerial went up, and my immediate neighbors said their prayers more regularly. A few weeks later when two power lines burned down about a block away, suspicious eyes accused me every time I left the flat.

Soon after that I got my transmitter. My Thor was a "HE" transformer. Well, one night my rotary slipped loose from two tacks. The transmitting heterogeny was in a big cardboard box. Needless to say, when the room was dark, the box open, and the spark flashing an unearthly color over my face, the neighbors congregated. One night the vital tack that held the rotary failed. Ten thousand wild volts tried to crowd where only one hundred and ten were wont



to roam. As I saw the lights in the nearby buildings also go out, I remembered an engagement. While I was going down the back stairs I saw cursing papas holding candles.

The next day the Edison company sent over a wheelbarrow full of fuses and the landlady told me the fireworks scared one family so bad that they packed up and broke their lease; and that my presence in the flat was no longer desired,—nor would it be tolerated. So my family found new quarters where I could bore holes in the floors, put up wires and pursue my unearthly researches without being molested.

T.O.M. is right. They sure were the "good old spark days."

—Ray Hutchins, ex-9AGL.

## BOOK REVIEWS

### Books Sold by QST Book Department

Numerous inquiries seem to call for a reprinting of the lists of books sold by our Book Department. They are as follows:

- Ballantine: "Radio Telephony for Amateurs", \$2.00.
- Ramsey: "Experimental Radio", \$1.60.
- Morecroft: "Principles of Radio Communication", \$7.50.
- Lauer & Brown: "Radio Engineering Principles", \$3.50.
- Phelps: "Constructional Data on the Superdyne Receiver", \$0.50.
- Sleeper: "Ideas for the Radio Experimenter", \$0.25.
- "Henley's 222 Radio Circuit Designs", \$1.00.
- Nelson: "Radio Questions and Answers", \$1.00.
- Ballard: "Elements of Radio Telephony", \$1.50.
- Jansky: "Principles of Radio Telegraphy", \$2.50.
- Lescarboura: "Radio for Everybody", \$1.60.
- Gernsback: "Radio For All", \$2.00.

"Radio Instruments and Measurements" (Circular 74 of the Bureau of Standards). Bureau of Standards, Dept. of Commerce. Sold only by the Supt. of Documents, Washington, D. C. Price 60 cents cash or money order.

Who in radio has not heard of the famous Circular No. 74? Certainly no one that takes radio very seriously.

It is certainly good news that "C74" has again been made available and still better that it has appeared in a revised second edition.

Those who have used the first edition will need no introduction to the circular, which is no circular at all but an excellently made book of 340 pages. To others we strongly recommend a sixty-cent purchase that will give a truly monumental amount of information which cannot be found anywhere else in such convenient form.

Part I deals with the theoretical basis of radio measurements. Part II with the instruments and 3 methods. and Part III with formulas for the calculation of capacity, inductance and resistance. To this has been added an appendix giving the symbols used in the circular, the valuable list of references, and an article describing the radio work of the Bureau of Standards.

"What Sodian Means to Radio"; Connecticut Telephone & Electric Co., Meriden, Conn. Sent on request.

We wish that the title of this booklet were "How to use the Sodian Tube," for that is what it ex-

plains very beautifully indeed. The Sodian tube does not operate in just the same way as other tubes and often it is accused of being "no good". In such cases the cure is to read this booklet and to follow the very clear instructions given.

### AN EIGHTY-FOOT LATTICED MAST

(Continued from page 39)

the cross-bracing for the fourth side. After this put a diagonal brace through the tower both ways every four feet.

Before starting to put the mast together, lay out the strips and the laths and give them a coating of hot tar.

When fastening the guy wires on the mast run them entirely around it before making the tie. To raise the finished mast use a twenty-five foot gin pole or run the guy wires over a house and raise it by pulling on these guys. Fasten the base down to keep it from lifting while you are raising the mast. A good way to tie down the base of the tower is shown in the drawing.

#### Material

The material used in building the mast is, nine bundles of laths, eight pieces of

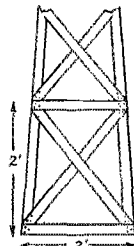

SIDE OF TOWER  
FIG. 1



THE WAY THE UPRIGHTS ARE  
NAILED TOGETHER

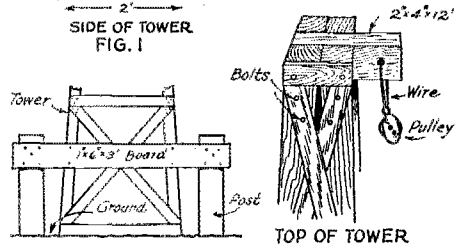

TO TIE TOWER DOWN

TOP OF TOWER

FIG. 2

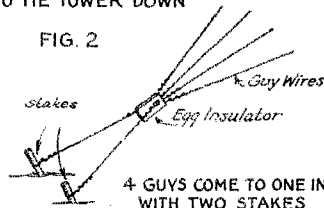

4 GUYS COME TO ONE INSULATOR  
WITH TWO STAKES

1" iron pipe four feet long, 22 pieces of clear pine 16 feet by 1" by 2" and the necessary guy wire and egg insulators.

#### Strength

The masts at 3CEL, 3CFV and 3CHQ

have all been up for some months and have been through storms that wrecked other masts in the neighborhood. They are all in good condition and have been so satisfactory that another one is just being put up at 3CEL.

The other day as I was passing 3CHQ I saw the owner climbing his 70-foot mast. He weighs about 165 pounds and I watched him until he got to the top. He was working on something up there as I drove on. This shows what the masts will stand; however, I do not advise climbing them.

(It is well to note that 3CEL is fortunate in living where lumber is cheap. We just tried this in Connecticut—bought the lumber this afternoon—and it cost \$15.70. Even so, it is still cheap.)

## AMATEUR RADIO STATIONS

*(Concluded from page 41)*

only when out of the others. As for plate current, Mr. Reidman did not say what it was, but we imagine that in order to put 6 amperes into that antenna the plate current is just about all a good tube will stand, probably around 250 or 300 milliamperes.

There is nothing unusual about the receiver, seen in the right hand part of the photo. It is the more or less conventional low-loss type with one stage of audio amplification.

Oh yes, the station is located at 243 Euclid Ave., Long Beach, Calif., and the owner and chief operator is Mr. K. L. Reidman. Will be glad to QSR anytime if possible, he says. Operating hours are from 6 to 7 P.M. on week days, and all night on Friday and Saturday nights.

## INTERNATIONAL AMATEUR RADIO

*(Concluded from page 43)*

current of  $\frac{3}{4}$  ampere. 7AEL used two 5-watt tubes and plate input of 70 watts. 6AHD and 6QJ were heard when using a plate input of 44 watts and one 5-watt tube; while 6CGL used one 5-watt tube and a plate input of 36 watts. Some 'millesper-watt' records are represented here!

"The writer has listened once or twice in the vicinity of 100 meters and a few Yanks were heard QRK on detector only. This short-wave stuff is sure the dope, all right. If ever we in Australasia are to land signals in the U.S.A., I am convinced that the short waves will do the trick.

"I am beginning to rather dread arrival of the U.S. Mail. The last one brought me

15 cards wanting QSL's on their sigs. I have had cards from a dozen or so verifying my reception of their signals, but the majority do not seem to bother to tell me what time they were transmitting so I can check with my log. All they want is the coveted card to tack on the wall of their shack.

"In connection with verifying reception please note that an odd habit we have, is to use entirely our own type of postage stamps on our letters. Thus, to those generous but misguided hams who enclose large contributions of 1 cent stamps for return postage I am forced to cry 'Hold! Enuf!' for said stamps are not even any good to supply the 'postage due' on the equally numerous cards that arrive with only a single one cent stamp, instead of two, as demanded and decreed by Congress, His Majesty's government, and others."

## THE AMATEUR BUILDER

*(Concluded from page 47)*

ary 8-32 screws with nuts on the top. It simplifies the making of the connections a good deal if lugs are used in fastening the coil leads to the underside of the terminal board. The terminals should be marked in some fashion, either by white ink or labels glued on, or by metal stamps, for even the builder of the transformer may forget after a time which terminal is which.

## AFFILIATED CLUBS

*(Concluded from page 48)*

first broadcasting station in Washington.

By the way, take a look at the clock on 3LR's receiving set. Notice the black paper covering up the time from 8:00 to 10:30?

The gang that put on the exhibit included Wadsworth of the famous 3JJ, Basim 3CKG, Brown 3HQ, Kriz, MacDonegal of 3IW, Perine and Flather of 3LR, and Goodall, of 3AB.

## CRESCENT LAVITE RESISTANCES

Absolutely non-inductive.

12,000 }  
48,000 } Ohms.  
50,000 }  
100,000 }

LIST  
\$1.50  
EACH



Special resistances to order. Used in all circuits.  
Dealers write for discount.

CRESCENT RADIO SUPPLY CO.

1-3-5 Liberty St.,

Jamacia, N. Y.

# This Radio Battery Has "Over Twice the Life"

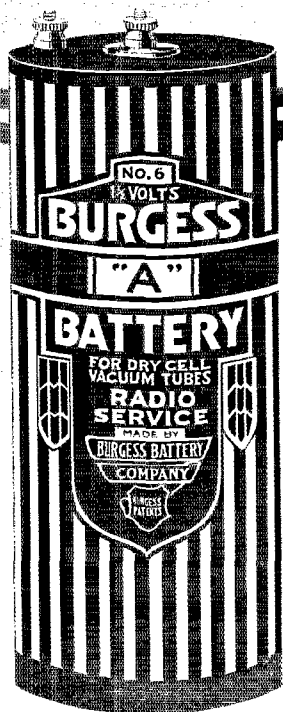

**T**HE Burgess Radio 'A' is exclusively a radio Battery, designed especially for service on the 'A' or filament circuit of dry cell vacuum tubes.

In Radio service it has over twice the life of the ordinary No. 6 ignition battery . . . costs approximately the same . . . has a rapid recovery to high voltage after short periods of rest . . . practically no voltage is lost when not in use.

Replace your worn out 'A' battery with a Burgess. Compare the service in your own set under any and all conditions. Then let your experience guide you in your future purchase of Radio 'A,' 'B' and 'C' Batteries; there's a Burgess Battery for every Radio purpose.

**"ASK ANY RADIO ENGINEER"**

## BURGESS RADIO BATTERIES

### BURGESS BATTERY COMPANY

Engineers - DRY BATTERIES - Manufacturers  
FLASHLIGHT - RADIO - IGNITION - TELEPHONE  
General Sales Office: Harris Trust Bldg., Chicago  
Laboratories and Works: Madison, Wisconsin

*Branches:*

New York Boston Kansas City Minneapolis  
Washington Pittsburgh St. Louis New Orleans

*In Canada:*

Plants: Niagara Falls and Winnipeg  
Branches: Toronto - Montreal - St. John.



# CROSLLEY

## Better-Cost Less Radio Products

65<sup>00</sup>

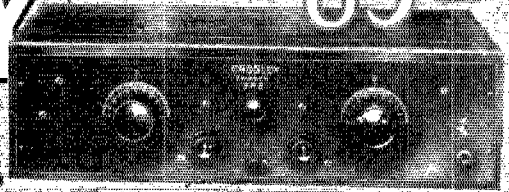

CROSLLEY TRIRDYN 3R3



75<sup>00</sup>

CROSLLEY TRIRDYN 3R3 SPECIAL

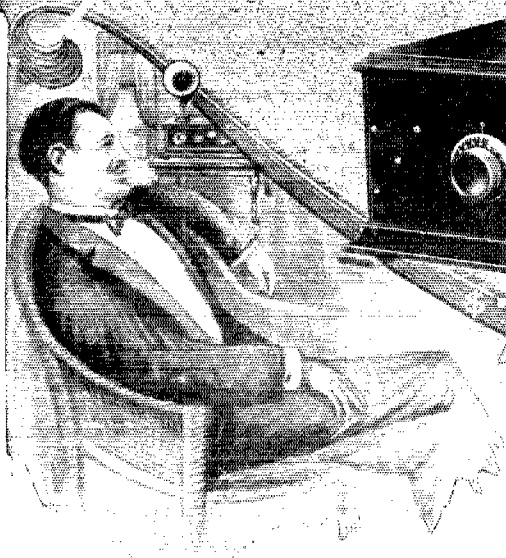

## WORLD LEADERS

**I**N every field of endeavor there is always a champion—a man, a product or a thing that takes the leadership, not by accident, but because of actual merit. In the new industry of radio, a leader has already arisen—Crosley Radio Receivers.

There is nothing miraculous about the tremendous popularity of Crosley Instruments. They have taken their place at the top through proven performance, continually giving perfect satisfaction where, perhaps, radio disappointment had been purchased elsewhere at a much higher price.

In new inventions, new simplified devices and new ways and means of giving greater radio value at a lower price, Crosley has constantly lead. As a result, the purchaser of a Crosley Radio Receiver knows that he is getting the last word in radio perfection.

This is evidenced by the fact that Crosley is building more radio receivers than any other manufacturer in the world.

Above are illustrated two good reasons for Crosley supremacy—the Crosley Trirdyn 3R3 and Crosley Trirdyn 3R3 Special.

These instruments are the latest radio engineering triumphs—three tube sets giving five tube efficiency.

They contain the following attractive features: Tuned Radio Frequency Amplification, Regenerative Detector Reflexed back on the first tube, and an additional stage of Audio Frequency Amplification.

They are non-radiating, thus entirely eliminating neighborhood interference. For ease of picking up new and distant stations, perfect calibration and extreme selectivity, the Trirdyn is unexcelled.

The only difference between the two models is in the size and style of the Cabinets. The Trirdyn 3R3 Special is completely self containing, having places for the necessary dry batteries, headphones and other accessories.

Over 200 experts have thoroughly tested the Crosley Trirdyn. Their opinions are one and the same. "There is no receiver to compare with it at any price."

*All Crosley Regenerative Sets are Licensed under Armstrong Patent No. 1,115,149*

Before you buy see the Crosley line

For sale by good Dealers Everywhere

## THE CROSLLEY RADIO CORPORATION

Powel Crosley, Jr., President

Formerly The Precision Equipment Company and Crosley Manufacturing Company

618 ALFRED STREET

CINCINNATI, OHIO

Crosley owns and operates Broadcasting Station WLW

# The 24 day wonder

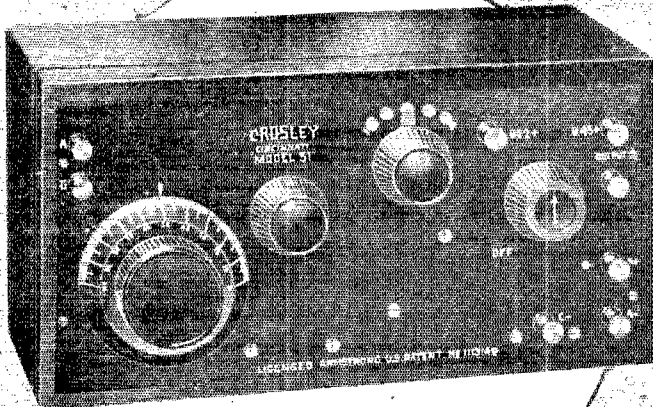

CROSLEY MODEL 51

\$18.50

**CROSLEY**  
Better - Cost Less  
Radio Products

## A Wonder in Sales and A Wonder in Performance

Never has any Radio Receiving Set made such a record in the appreciation accorded it by the public.

Thousands of homes have been made happy by this little Crosley Model 51. In twenty four days from its first appearance it was selling at the rate of 1,000 per day and hundreds of letters expressing appreciation of its excellent performance assured us that it was a favorite.

One of its two tubes is the noted Armstrong regenerative detector with the hook-up made popular in the Crosley Type V. Added to this is one tube of Audio Frequency Amplification giving loud speaker volume on local stations at all times and on distant stations under fair receiving conditions. Otherwise head phones should be used for distant reception.

This Crosley two tube marvel has been a surprise to the Radio World and has proven the biggest seller on the market today.

*All Crosley Regenerative Sets are licensed under Armstrong Patent No. 1,113,149*

Before you buy see the Crosley line

There is a Crosley priced for every home.

- CROSLEY MODEL V—our noted one tube receiver famous for distant reception ..... \$16.00
- CROSLEY MODEL VI—two tube receiver incorporating radio frequency amplification..... 24.00
- CROSLEY TYPE 3-B—a three tube regenerative set noted for excellent performance ..... 32.00
- CROSLEY MODEL X-J—a four tube receiver with radio and audio frequency amplification ..... 55.00
- CROSLEY MODEL X-L—a console, with loud speaker, built like a piece of furniture..... 120.00

Between these are priced the Super VI, the Super X-J, the 3-C Consolette and others.

For sale by good Dealers Everywhere

## THE CROSLEY RADIO CORPORATION

Powel Crosley, Jr., President

Formerly The Precision Equipment Company and Crosley Manufacturing Company  
618 ALFRED STREET CINCINNATI, OHIO

Crosley owns and operates Broadcasting Station WLW

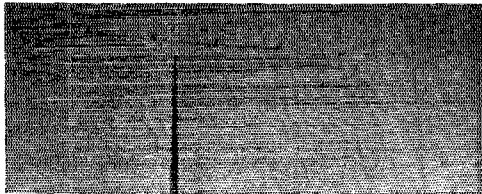

When you buy a Whittlesey Self-Supporting Standard Steel Mast you buy a Mast-Head Pulley, Raising Cable and Winding-Up Reel as well. This is the Whittlesey System of Aerial Support. No necessity for climbing up, "use the elevator." No ladders, platforms, guy ropes or other unsightly unnecessary surfaces exposed to the winds. These masts are solid, stiff and rigid, designed for 1500 pounds strain at the tip. Correct engineering enters every detail. These masts are beautiful, distinctively characteristic and dignifying. They stand as sentinels signaling the best in radio, 50 to 150 feet shipped in 25- ft. sections, bolted and raised in one piece. Drawings furnished. This 75-ft. Standard \$300. f.o.b. Cleveland. Broadcasters 3000 pounds and heavier. Write for information and describe your aerial.

THE WHITTLESEY ENGINEERING CO.  
Cleveland, Ohio.

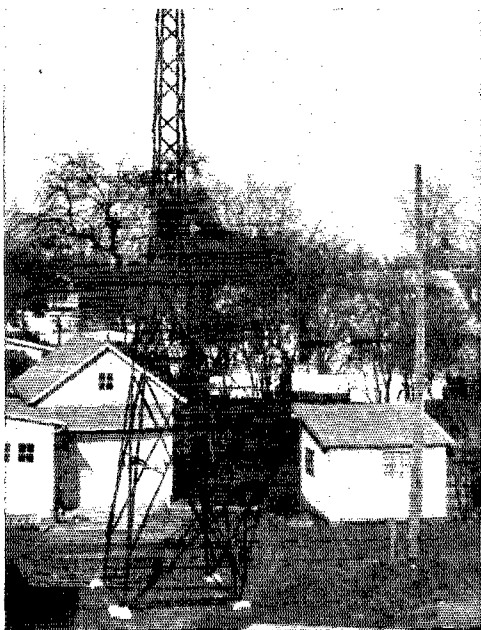

YOUR OWN Name, Address and Station Printed



**FREE on CALL CARDS & RADIOGRAMS**  
ARRL Emblem added if requested  
Cards: Red call, black printing.  
High quality, latest design, 100-\$1.75;  
200-\$2.75; 300-\$3.50. POSTPAID.  
Radiograms: Bond paper, 100-\$1.35;  
200-\$1.85; 300-\$2.35. POSTPAID.  
**MONEY REFUNDED if Not Delighted**

Write for **INDIVIDUAL** Radio Stationery and log samples and prices.  
Send order with check or money order **Today—NOW.**  
**RADIO PRINTERS, 16 Main St., Mendota, Illinois**

**All The Rage  
ORDER TODAY**

## The National Perfect Vernier Condenser

TYPE DX

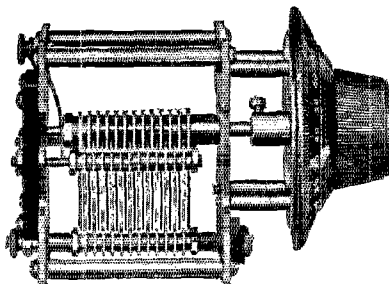

A Vernier Condenser, that operates with no back lash and with a touch of "velvet smoothness".

Its mechanical and electrical characteristics have justified its commendation by a number of the country's prominent radio engineers.

Excellent results have been obtained when used in combination with Reflex, Radio Frequency, Neurodyne and Super-Heterodyne circuits.

Sizes:	.001	.0005	.00035	.00025
Prices	7.00	6.00	5.75	5.50

Write for Bulletin 2104 A  
Made By

**NATIONAL COMPANY, INC.**

Estab. 1914

Engineers & Manufacturers  
Cambridge 39, Mass.

for efficient  
rectification—

the STAHL  
"SYNC"

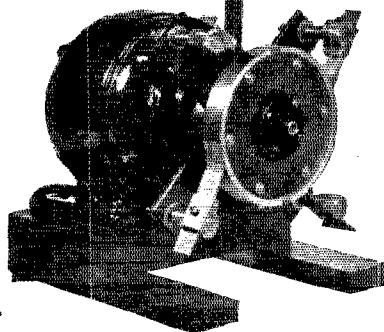

A noiseless Synchronous Rectifier which will safely carry 5000 volts at .5 amp.

Manufactured for 110 or 220 volt, 60 cycle current only.

Price \$60.00 F.O.B. Chicago

Write for information

**STAHL RECTIFIER CO.**

1457 W. Congress St.,

Chicago, Ill.

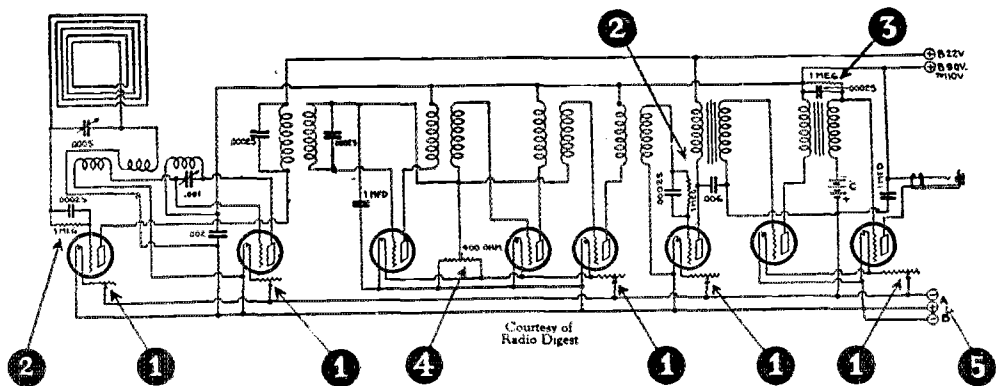

# For the Super-heterodyne



## Bradleystat

**PERFECT FILAMENT CONTROL**  
For all tubes. Provides a stepless, noiseless range of control that simplifies tuning and oscillator control. Holds the record for long range tuning.



## Bradleyleak

**THE PERFECT GRID LEAK**  
Provides a stepless range of grid leak control from  $\frac{1}{4}$  to 10 megohms. Furnished with or without grid condenser rated at 0 00025 m.f.



## Bradleyohm

**THE PERFECT RESISTOR**  
Made in three ranges:—10,000 to 100,000 ohms; 25,000 to 250,000 ohms; 50,000 to 500,000 ohms. Ideal for use as fixed or adjustable resistors.



## Bradleyometer

**THE PERFECT POTENTIOMETER**  
Made in 200-ohm and 400-ohm ratings for all circuits. Gives a smooth, stepless range of potential control, so essential for super-heterodyne circuits.



## Bradleyswitch

**PERFECT BATTERY SWITCH**  
A compact, enclosed battery switch which requires only one hole in panel to mount it. Nickel-plated and well built. Should be installed in every set to protect tubes against accidental burning. Saves time, tubes, and batteries.

**T**HIS remarkable radio receiver, when properly constructed, is a marvelous hook-up for selective tuning and long range.

It is gaining in popularity, everywhere, and is destined, no doubt, to become one of the leading types of receivers among discriminating radio enthusiasts.

The surest way to build a successful super-heterodyne receiver is to use only the finest parts. Among the important items are the adjustable grid leaks, potentiometers, special resistors, filament rheostats, and battery switches. In fact, there are no parts more important than the grid leaks and condensers.

For these parts, standardize on Allen-Bradley radio products listed on this page. They represent the experience of rheostat designers with more than twenty years of training in this important field. Attempts have been made, from time to time, to imitate Allen-Bradley radio products, but without avail. They stand supreme in their field, and with a record of successful performance that places them in the front rank of high-grade radio products.

### Mail this Coupon for Radio Bulletins

If you will drop this coupon in the mail, with your name and address, we will send you a complete set of folders describing Allen-Bradley radio products in detail. Be sure to get this information before you lay out your super-heterodyne receiver.

**Allen-Bradley Co.**  
Electric Controlling Apparatus

277  
Greenfield  
Ave.



Milwaukee,  
Wis.

**Allen-Bradley Co.**  
277 Greenfield Av.  
Milwaukee, Wis.

Please send me, by return mail, a complete set of your radio folders on Allen-Bradley radio products. RUSH.

Manufacturers of graphite disc rheostats for over 20 years

Name .....

Address .....

**For best results—  
Weston Radio Instruments.  
The choice of A.R.R.L. men Everywhere**

**WHETHER** in transmitting or receiving—correct voltage or amperage information is of utmost importance to efficient and economical operation.

Control of the filament current or filament voltage makes it possible to prevent premature burnouts. Facilitates exact tuning. Duplicates results instantly. The Weston Filament Voltmeter and Filament Ammeter have been designed expressly

to meet these requirements. Accurate determination of the plate voltage is also desirable. The Weston Plate Voltmeter is a necessity on every transmitting set and a convenience on all receiving sets.

Effective transmission depends upon the proper antenna current flow. The Weston Thermo-Ammeter is recognized as the most highly developed, scientific and dependable instrument for this purpose.

Booklet J describes and illustrates Weston Instruments. Sent free on request. If your dealer cannot supply you with Weston instruments, we will gladly see that your needs are promptly supplied.

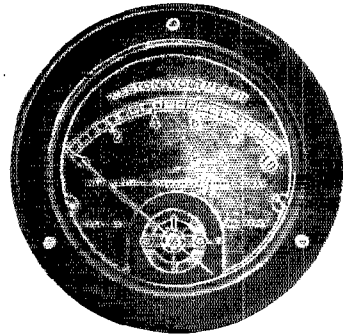

Filament Voltmeter

**Weston Stands Alone**

The Weston Electrical Instrument Company has pioneered in the development and manufacture of electrical indicating instruments for 35 years in every branch of the electrical industry. The name Weston on an instrument means that there is none better.

**WESTON ELECTRICAL INSTRUMENT CO., 158 Weston Ave., Newark, N. J.**

*Electrical  
Indicating  
Instrument  
Authorities  
Since 1888*

# WESTON

**STANDARD - The World Over**

**HIGH QUALITY CONDENSERS  
—SIXTON—**

**READY SEPT. FIRST  
NEW MODEL  
Exceptional Low Losses**

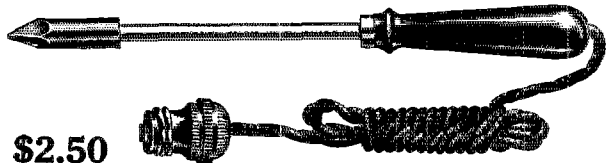
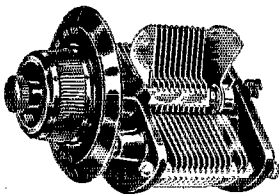

**\$2.50**

**A QUALITY SOLDERING IRON AT A POPULAR PRICE**

Renewable Tip  
Six Foot Cord

Renewable Heat Unit  
Two Part Plug



**HIGH QUALITY**

**INSTRUMENTS**

**HARTFORD INSTRUMENT CO., 308 PEARL ST., HARTFORD, CONN.**

**SOLDER LUGS—BUS BARS  
STAMPINGS**

Solder lugs of pure copper, tinned to give better soldering results.

**\$2.25 per M., P. P. Prepaid**  
Discounts to Jobbers and Dealers

**Toaz Engineering & Sales Co.**  
11703 Robertson Avenue,  
Cleveland, Ohio



De Luxe Contact

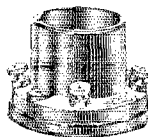

Na-ald De Luxe  
No. 400

**NA-ALD**

**De Luxe Socket**

The laminated phosphor bronze contacts of the Na-ald De Luxe Sockets press firmly on both the ends and sides of tube prongs, keeping the surface clean and insuring clear reception. Moulded of genuine Bakelite this socket expresses the very highest quality in appearance and workmanship.

**ALDEN MANUFACTURING CO.**  
Largest Makers of Radio Sockets and Dials in the world.

Springfield, Mass.  
Dept. M 52 Willow St.



# ANNOUNCING



*"Products of Proven Merit"*



## the NEW

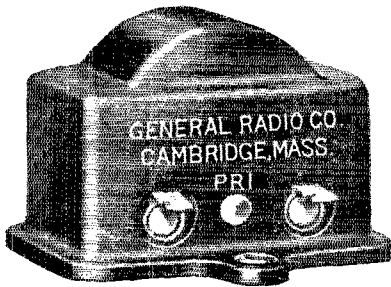

## Medium Frequency Transformer

Manufactured by the

**General Radio Company**

Massachusetts Ave. and Windsor St.

**CAMBRIDGE**

**MASS.**

### Type 271

### M.F. Transformer

The amplification of wave-lengths of the order of 10,000 meters (30 k.c.) requires a transformer of design materially different from that required for short wave radio or audio frequency amplification.

The Type 271 M.F. Transformer has been designed to meet the specific requirements of a medium frequency transformer for use in long wave reception and in the superheterodyne circuit.

The core and coil windings are completely enclosed in a metal shell. The transformer is shielded both electrostatically and electromagnetically making it possible to use several of these transformers in cascade with a separation as small as one inch between transformers. The shielding also permits associated tubes to be operated to full capacity.

The Type 271 M.F. Transformer is a very compact, rugged, and efficient instrument.

**Price \$5.00**

# GENERAL RADIO Co.

# RADIO FREQUENCY AMPLIFICATION

Read Mr. Kruse's report in "QST"  
for February on the construction of

## BALLANTINE VARIOTRANSFORMER

"Outstanding is the flat-top curve giving same high amplification over the entire broadcast range." The underlying cause of Mr. Kruse's italics is in the continuously variable windings of this instrument. Here's a tuned r.f. unit complete in a space 3 1/2" x 2" dia. back of the panel. Complete shielding and pig-tail connections.

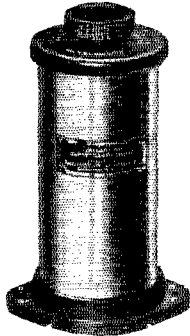

For the Amateur Who Entertains  
Reproduction equal to the victrola is quite possible with a BALLANTINE. Let your friends really enjoy programs from a distance.

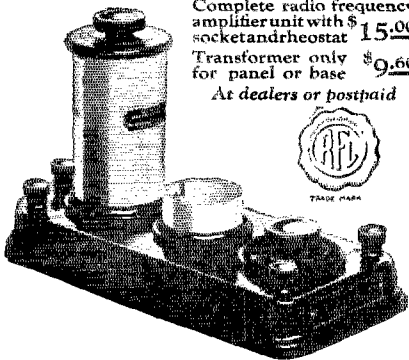

Complete radio frequency  
amplifier unit with \$ 15.00  
socket and rheostat  
Transformer only \$ 9.60  
for panel or base  
At dealers or postpaid



Revised edition of "Radio Frequency Amplification with the Ballantine Variotransformer" contains advance practices of interest to the amateur. Mailed on request.

**BOONTON ROEBER MFG. CO.**  
Pioneers in Bakelite Moulding  
124 Fanny Road, Boonton, N. J.



*"Built First to Last"*

**If it's Really Portable  
it's Coto Compact**

The most fascinating of all radio set building is preparing that portable set for your summer radio. Imagine a two tube D-X receiver on panel 5 x 10 inches using this moulded Variocoupler and other Coto Compact guaranteed parts.



\$5.50

*If your dealer does not carry Coto mail us his name and list of parts needed*

**COTO-COIL CO.** 87 Willard Ave.  
Providence, R. I.

Los Angeles, 329 Union League Bldg.  
Minneapolis, Geo. F. Darling,  
705 Plymouth Bldg.  
Atlanta, C. P. Atkinson,  
Atlanta Trust Co. Bldg.  
Canada, Perkins, Electric Co., Ltd.,  
Montreal, Toronto, Winnipeg



## Up to the Progress of Radio

Material and workmanship equal to the most exacting requirements of the latest circuits.

**For** Superheterodyne, Superdyne, Inverse Duplex, Four Circuit Tuner

**Use** Vernier Cap. .00057 Mfd. (24 Plate) or Plain Cap. .00055 Mfd. (23 Plate)

Condensers of recommended capacity for all known circuits are also carried in stock by leading radio retailers.

### End Plates of CELORON

*Be Sure of Quality—*

**BUY U. S. TOOL CONDENSERS  
100% GUARANTEED**

*Write for Booklet*

**U. S. TOOL CO., Inc.**  
112 Mechanic St., Newark, N. J.

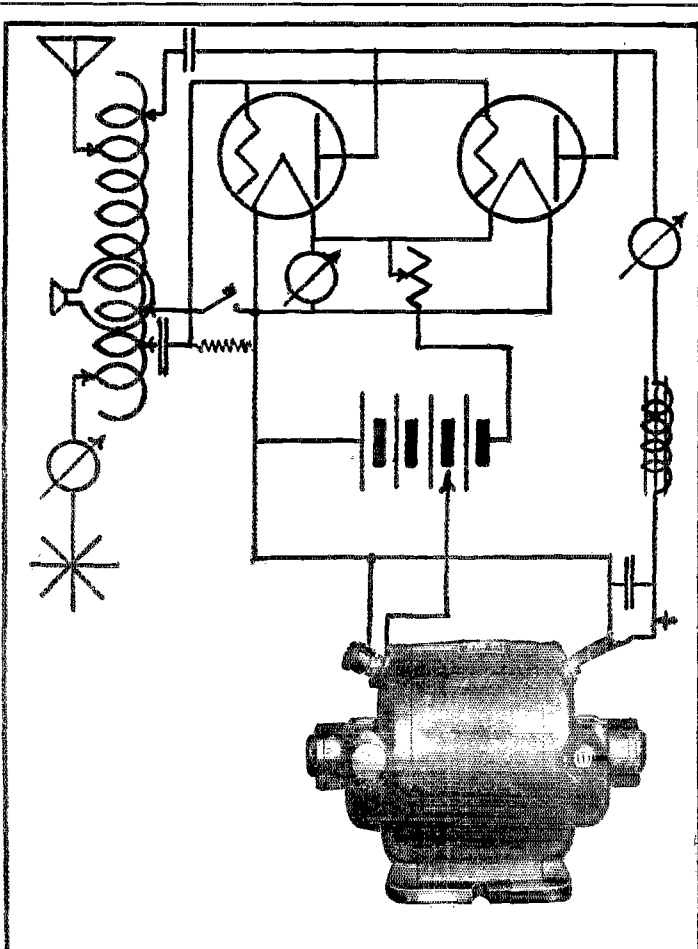

ITEM 45

## A FEW GOOD COMBINATIONS

Item	Description			Recommended for	
2	350	V	40 Watt	2-5	watt with separate Fil. supply.
7	500	V	100 Watt	4-5	watt with separate Fil. supply.
8	500	V	150 Watt	5-5	watt 2 mod. 1 mast. osc.-2 osc. sep. Fil. supply.
13	1000	V	300 Watt	dbl. comm.	2-50 watt with separate Fil. supply.
15	1000	V	500 Watt	dbl. comm.	3-50 watt or 2-50 watt and 4-5 watt as speech amplifier and mast. osc. sep. Fil. supply.
16	1000	V	650 Watt	dbl. comm.	4-50 watt with separate Fil. supply.
20	1500	V	600 Watt	dbl. comm.	2 to 3-50 watt with separate Fil. supply.
24	2000	V	500 Watt	dbl. comm.	1-250 watt with separate Fil. supply.
26	2000	V	1000 Watt	dbl. comm.	2-250 watt with separate Fil. supply.
31	500	V	100 Watt	-10 V	60 watt Same as item 7 but with Fil. supply.
35	1000	V	300 Watt	-12 V	150 watt Same as item 13 but with Fil. supply.
41	2000	V	500 Watt	-14 V	200 watt Same as item 24 but with Fil. supply.

Many other sets for various combinations of tubes.

Special sets made to order.

Trade "ESCO" Mark

## ELECTRIC SPECIALTY CO.

225 South St., Stamford, Conn., U.S.A.

Pioneers in Developing and Perfecting High Voltage Wireless Apparatus

### Motors Dynamotors Generators Motor-Generators

Used by more than 150 Universities—Colleges—Research Labs., etc. Many Federal—State—County and Municipal Depts.

Write for Bulletins 237B and 242A listing over 200 combinations

Send us your problems—we'll help you solve them.

# Pioneers

## JEFFERSON TRANSFORMERS

The trail blazers through their untiring efforts are always the pioneers of industry.

The present day perfection of Radio Transformers is due in no small measure to the faithful and persistent efforts of Jefferson Engineers who designed and experimented with Audio Amplifiers long before Radio reached its present day popularity.

### Transformer Specialists

These extra years of experience are reflected in the quality and performance of Jefferson Transformers.

The name Jefferson is associated by both professional and amateur Radioists as regards Radio, Intermediate and Audio frequency Amplification with extremely high quality.

The installation of Jefferson transformers in your set will assure you of a quality of Reception that is unparalleled. There's a Jefferson Transformer for every circuit.

Send for our latest Bulletin "Putting Quality into Radio."

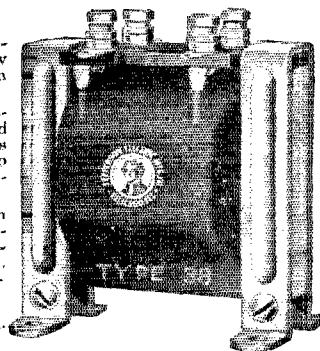

JEFFERSON ELECTRIC MFG. CO.

425 So. Green Street,

Chicago



*The voice from a thousand miles away!*

There's an immense field of radio enjoyment in summer, (the best political orators in America are on programs)—but you must have extremely sensitive reception apparatus to get good results.

## Stromberg-Carlson

HEAD SETS and LOUD SPEAKERS

have powerful magnets, the sensitivity of which gives them wide range, bringing in the fainter signals with volume and clearness.

They also have layer wound and layer insulated coils—an exclusive Stromberg-Carlson type of construction—which will stand up under the high plate voltages now used.

Ask your dealer

Stromberg-Carlson Telephone Mfg. Co.,  
Rochester, N. Y.

### Powerful Magnets



Layer Wound and Layer Insulated

## Have you tried it?

### Chelten Midget Vernier

You've often wished for a closer capacity adjustment of your variable condenser. Here it is—the Chelten Midget Vernier. The 13 tiny plates and air spaces give sharp tuning. Costs but \$1.50.



A Precision Instrument

**CHELTEN ELECTRIC CO.**

4861 Stenton Avenue

Philadelphia

## EISEMANN RADIO EQUIPMENT

comprises

Headsets, Variometers, Variocouplers, Condensers, Potentiometers, Detector, Resistance-Adapter, Radio and Audio Amplifier Units, A.F. Amplifying Transformer, and ready drilled metal panels. Also, the new RF-2 Broadcast Receiver.

Write for Prices and Descriptive Literature



EISEMANN MAGNETO CORPORATION

165 Broadway, New York  
Detroit Chicago San Francisco

# MICARTA

REG. U. S. PAT. OFF.

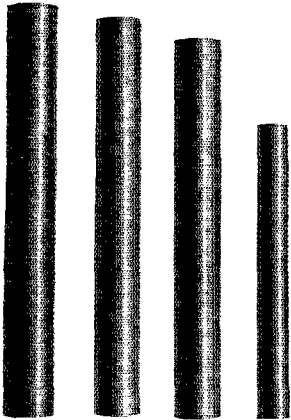

## Ideal Material *for* Radio Construction

Micarta tubes, plates and other forms are appreciated by both amateur and professional builders of radio sets. Both know that Micarta affords that splendid insulation so vital to perfect receptivity. They know Micarta is not a substitute, but a better material.

Micarta is easily machined, drilled and punched. It takes a high polish. It does not expand or shrink due to contact with oil or moisture.

Get Booklet F 4566 entitled "A Material of Endless Possibilities."

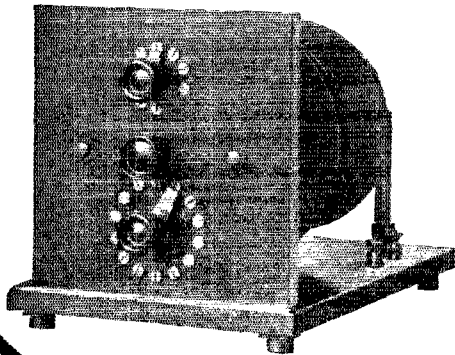

Westinghouse Electric & Manufacturing Company  
East Pittsburgh Pennsylvania  
Sales Offices in All Principal Cities of the  
United States and Foreign Countries



# Westinghouse

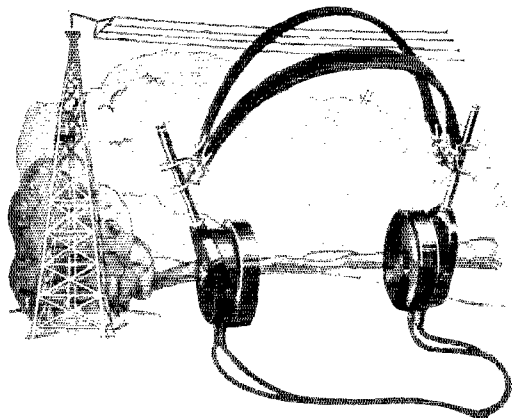

## Good phones are essential to good DX reception

TO BE a real link in the chain of relaying—you must use dependable headphones. Thousands of amateurs use Murdocks—because of their unsurpassed sensitiveness, clarity and volume reproduction.

### Built, not assembled

MURDOCKS are made of superior moulded insulation. The parts are moulded together—and can't get out of adjustment. They are equipped with powerful magnets and sensitive diaphragms, which are essential to good DX reception. The new improved flat headband enables you to wear Murdocks for hours without discomfort.

Get a pair of Murdocks and test them out on your DX work. They are fully guaranteed.

WM. J. MURDOCK COMPANY  
343 Washington Avenue, Chelsea, Mass.  
Sales Offices: Chicago and San Francisco

# MURDOCK RADIO PHONES

Standard since 1904

WM. J. MURDOCK CO.,  
343 Washington Ave., Chelsea, Mass.

Gentlemen: Please send me, without obligation, your free booklet—"The Ears of Radio."—which contains important data on headphones.

Name .....

Address .....

# DUPLEX

## Series "FR" Condenser

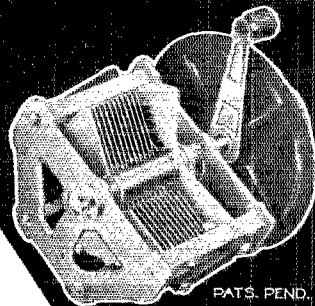

PATS. PEND.

Designed to ground rotor to frame.

Mechanically and electrically perfect.

We have reduced the electrical losses to an immeasurable minimum.

Some profitable jobber territory still open.

Write for Bulletin "Facts for Fans" on Condensers

The Duplex Engine Governor Co., Inc.  
50 Flatbush Ave. Extension  
Brooklyn, N. Y.

TRADE MARK  
NONE OTHER

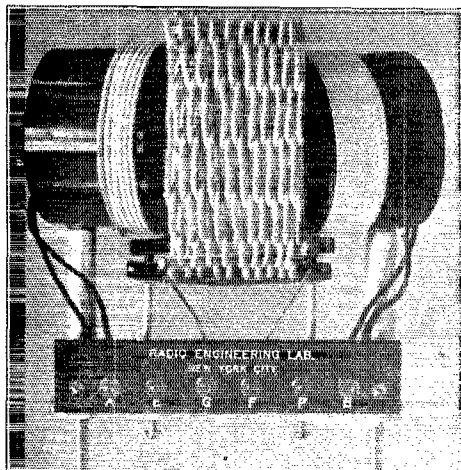

## LOW LOSS TUNER

MOST EFFICIENT TUNER AVAILABLE  
GOOD D.X. RECEPTION  
EXTREMELY SHARP TUNING  
TWO TYPES

AMATEUR—30 to 275 METERS  
BROADCAST—250 to 550 METERS

Write for Circuit Diagram Price \$10 each  
Radio Engineering Laboratories  
26 THAMES STREET NEW YORK CITY

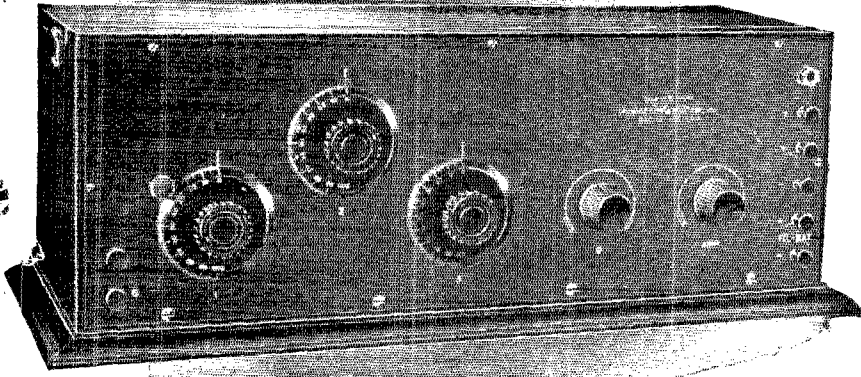

## A SPECIAL LOW WAVE RECEIVING SET

*Wave Lengths from 90 to 380 Meters*

Will your receiving set pick up those transatlantic short wave signals? Most of the transocean amateur work has been done on waves between 108 and 118 meters. If your set won't pick them up you should have a WC-5-SW. It is the most practical set for low wave specialists. The WC-5-SW eliminates the trouble which transmitting amateurs are having with ordinary receiving sets. Enthusiastic operators everywhere write us praising its efficiency in low wave reception. It will pay you to investigate the WC-5-SW.

# WC-5-SW

**Built Especially for Transmitting Amateurs**

The WC-5-SW is a 4-tube set. One stage of tuned Radio-Frequency amplification is employed ahead of the detector to make it supersensitive. Two stages of audio-frequency are used to bring up the signal strength. Uses any type of tubes. Gives perfect control of audibility. Detector rectifies only. Uses antenna compensating condenser. Only two control adjustments. Pure negative biasing on all tubes, thus marked saving on "B" Battery

current. Tuned Radio-Frequency sharpest known and most selective principle ever adopted. Plate potential non-critical. Mono-block tube socket. No grid plate leads on audio amplifiers. Audio amplification absolutely necessary when using low efficiency receiving antenna, i.e., underground or indoor. Mahogany cabinet, piano rub finish. Rabbited-in panel. Split lid cover. The Price is only \$35.00 for this special low wave set.

*Write for complete description and illustrated folder on this practical set for low wave specialists. All transmitting amateurs will be interested in this literature.*

## OTT RADIO, Inc.

224 Main Street

La Crosse, Wis.

OTT

# Federal Announces

its latest achievement in the field of radio—

The "No. 102 Special" Federal Receiving Set will be demonstrated to radio enthusiasts beginning May first.

*If you do not know the name of the Federal Dealer in your locality, write immediately to --*

**FEDERAL TELEPHONE AND TELEGRAPH CO.**

BUFFALO, N. Y.

Boston      New York      Philadelphia      Chicago      Pittsburgh  
 San Francisco      Bridgeburg, Canada      London, England

Look for this sign



## Federal

Radio Equipment

*The New  
and Perfect  
Variable Grid Leak*

# 65¢



Can be installed in any set in a second! Does not change calibration with age or use! Officially adopted for Ultra-dyne, Polydyne, etc. circuits.

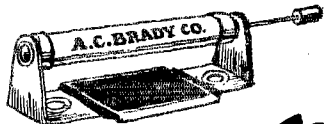

COMPLETE WITH MICA CONDENSER AND PERFECT LEAK MOUNTING \$ **1<sup>00</sup>**

**A.C. BRADY CO.**  
*Improved Radio Apparatus*  
 108-SEVENTH AVE. NEW YORK CITY

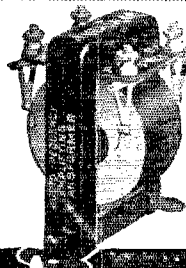

*Improve your  
set with an  
AmerTran*  
 and enjoy radio  
this summer as  
never before.

# AMERTRAN

TRADE MARK REG. U.S. PAT. OFF.

TYPE AF-7 is now offered as a companion transformer to AF-6 (Turn ratio 5), for second or third stage amplification. In this use AF-7 decreases the tendency to overload the last amplifying tube on loud signals.

Henceforth, then, it is possible to obtain a low ratio AmerTran which insures perfect tone quality and full amplification of low notes when used with AmerTran AF-6 in the first stage.

Price, either type, \$7., at your Dealer's

**American Transformer Co.**

*Designers and builders of radio transformers for over 23 years.*

176 Emmet Street, Newark, N. J.



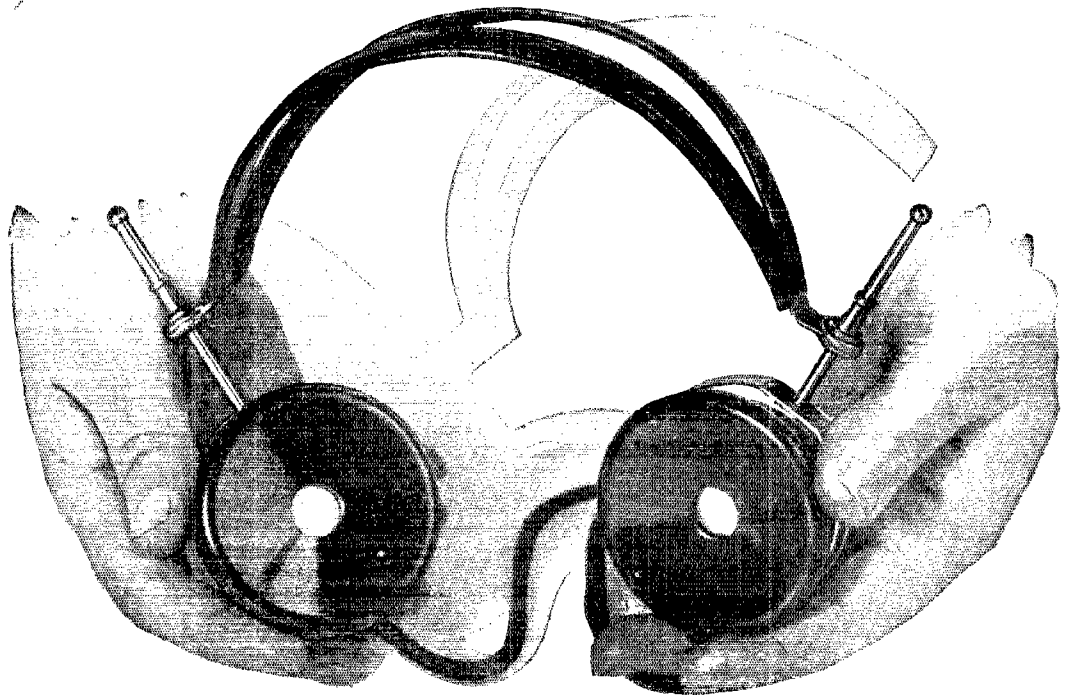

# The Phones with the New Idea

**N** & K Head Sets mark a new era in radio reproduction—an era of *clearness* and *naturalness*. Designed especially for the reception of *musical tones*, they record the entire range of the human voice and of musical instruments with extreme clearness and freedom from distortion. This is due to mechanical design different from that of any head set produced in America. The *extremely careful quality of workmanship* used is almost impossible to obtain in this country.

## Sold on a comparison basis

If, when you use N & K Phones on your own radio set, you do not find that they reproduce all the tones more clearly and naturally than any set you ever used before, and if they do not fit more comfortably, the store where you bought them will refund your money, promptly and cheerfully. We protect dealers and replace any returned phones.

N & K Head Set, Model D, 4000 ohms, has extra large diaphragms and ear caps, insuring better reproduction, better comfort and the exclusion of outside sounds. Sanitary, leather-covered head bands. Six feet of stout cord. Retail price \$8.50. Write for "The Phones the Fans Are Talking About," interesting new descriptive folder.

**TH. GOLDSCHMIDT CORPORATION**

Dept. Q6 15 William St., NEW YORK

Exclusive Distributors for U. S., Canada and Mexico

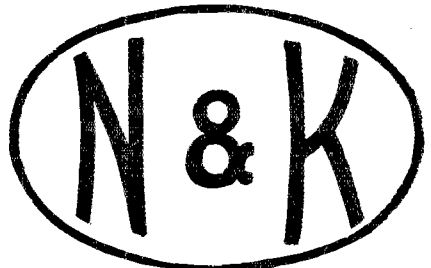

Imported

# PHONES

DEALERS: N & K Phones provide the high spot in the radio stocks of dealers all over America. Backed by advertising and strong sales co-operation, they are proving attractive profit-makers. Packed in cartons of ten, with display material.



*"The only loud speaker  
that can hold my receiving  
set is the*

# THOROPHONE

TRADE MARK REG. U.S. PAT. OFFICE  
—says WM. G. SMITH

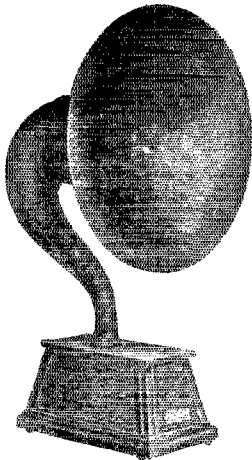

High  
Power  
Model  
S-5  
\$45.00

**P**OWER that makes other loud speakers jump off the table merely makes the Thorophone produce greater volume. The Thorophone will take all you can give it and still reproduce voice and music so naturally that you'd think speaker or musician were right in the room.

Until you have heard the Thorophone you have not learned how wonderful radio is. Whatever your receiving set, the Thorophone will make it sound better. It reproduces perfectly. The controlled mica diaphragm; the scientifically designed Thorite horn; the additional power from the 6-volt storage battery—these things make the Thorophone the ultimate loud speaker.

For endless satisfaction, buy the Thorophone.

*Write for booklet*

**WINKLER-REICHMANN CO.**  
4801 S. Morgan St., Chicago, Ill

Tested and Listed as Standard by Underwriter's Laboratories

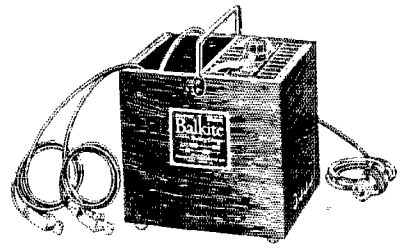

FANSTEEL  
**Balkite**  
PATENTS APPLIED FOR *Battery Charger*

**NOISELESS and INDESTRUCTIBLE**

A new battery charger for Radio "A" (6 volt) batteries. Entirely noiseless. Has no moving parts, requires no attention or adjustment, and cannot get out of order. No bulbs to break. Simple and unfading in action. Can be used while the radio set is in operation. A positive economical charger for home use. Can also be used to charge "B" and automobile batteries. If your dealer can't supply you, sent direct on receipt of price. Money back guarantee.

**Price \$19.50** ( \$20 West of Rockies )

Dept. Q6 Fansteel Products Co., Inc.  
North Chicago, Illinois

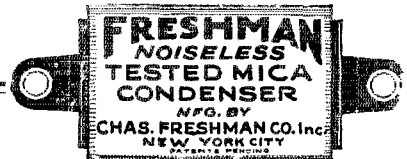

**ACCURATELY  
RATED CONDENSERS  
for CRITICAL CIRCUITS**

Through the accuracy and dependability of Freshman Noiseless Tested Mica Condensers, hookups and circuits have been perfected which have completely revolutionized the art of radio reception. The Freshman is so designed that constant equal pressure is exerted on the condenser plates over the entire area. They are the only condensers that do this and therefore the only ones that avoid noises, due to variable pressure on the plates.

All capacities — from 35c up.

Your dealer has all sizes of Freshman Condensers in stock. Ask for prices.



*"Get Freshman! — the Long Distance Smile"*

Write for circular M-3, giving complete information and prices on our entire line.

**Chas. Freshman Co. Inc.**  
*Radio Condenser Products*

106 Seventh Avenue, New York

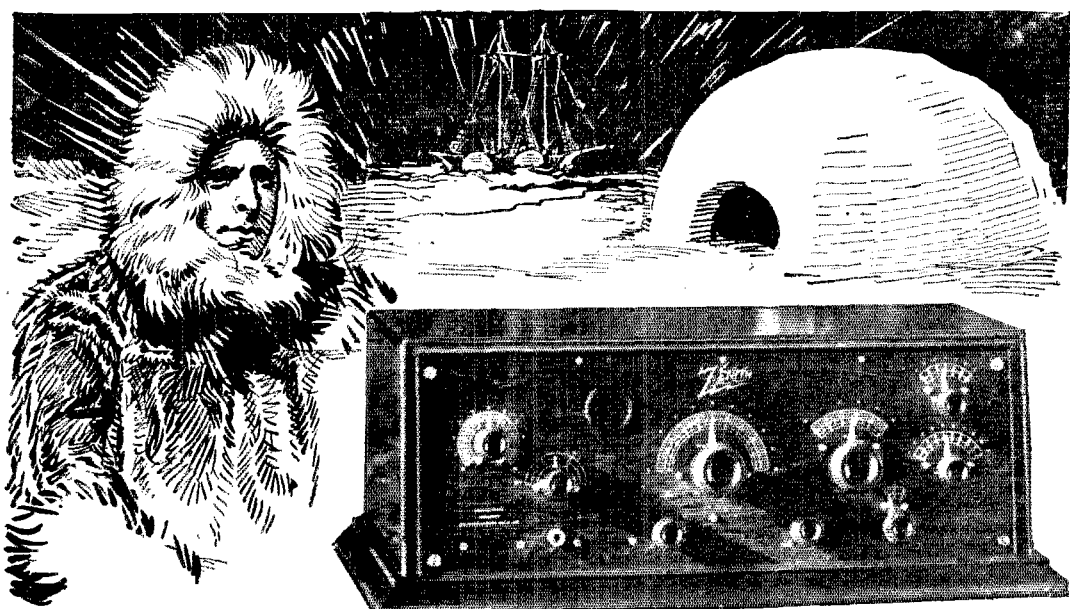

Licensed under Armstrong U. S. Patent No. 1,113,119

# MacMillan Listens to Honolulu and New Zealand "Tunes In" California

From a little ice-bound schooner—eleven degrees from the North Pole—comes this message:

"Am very thankful that Arctic Exploring Ship Bowdoin is equipped with complete Zenith radio apparatus. Here at top of world, in darkness of great Arctic night, we have already listened to stations practically all over the United States, from Europe, and even from far away Honolulu. Zenith has united the ends of the earth.—MacMillan."

Again, from far-off New Zealand comes a report of radio reception even more startling:

"It may interest you to know that the writer last evening landed KGO, Oakland, California, between 6:45 and 7:30 P. M. Heard his call four or five times distinctly, and jazz music. As San Francisco is **6,300 miles from New Plymouth**, and only one tube was used, we think this is a very fair performance."

—(signed) H. Charles Collier.

The sets used by Captain MacMillan and Mr. Collier are earlier models—since improved by the addition of **a third stage of audio frequency**. These new models represent an achievement not duplicated in any other set on the market. Write today for full particulars and name of nearest dealer.

**Zenith Radio Corporation**  
McCORMICK BUILDING, CHICAGO, ILLINOIS



—using—

**Model 3R** The new Zenith 3R "Long-Distance" Receiver-Amplifier combines a specially designed distortionless three-stage amplifier with the new and different Zenith three-circuit regenerative tuner.

Fine vernier adjustments—in connection with the unique Zenith aperiodic or non-resonant "selector" primary circuit—make possible extreme selectivity.

**2,000 to 3,000 Miles With Any Loud-Speaker**

With the new Zenith 3R satisfactory reception over distances of 2,000 to 3,000 miles, and over, is often accomplished in full volume, using **any ordinary loud-speaker**. The Model 3R is compact, graceful in line, and built in a highly finished mahogany cabinet **\$160**

**Model 4R** The new Zenith 4R "Long-Distance" Receiver-Amplifier comprises a complete three-circuit regenerative receiver of the feed-back type. It employs the new Zenith regenerative circuit in combination with an **audion detector** and **three-stage** audio-frequency amplifier, all in one cabinet.

The Zenith 4R may be connected directly to any loud-speaker **without** the use of other amplification for full phonograph volume, and reception may be satisfactorily accomplished over distances of more than 2,000 miles **\$85**

ZENITH RADIO CORPORATION,  
Dept. 1-R 323 South Michigan Avenue, Chicago, Illinois

Gentlemen:  
Please send me illustrated literature on Zenith Radio.

Name .....

Address .....

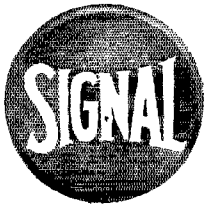

# A RADIO TABLE BUILT BY RADIO ENGINEER

The Signal Radio Table is not a make shift, but a practical table designed by practical radio men, for radio set owners.

The top has ample space being 20" wide x 36" long.

The cabinet beneath has plenty of room for A & B Batteries, tools, extra equipment. A place for everything. The compartment is 12" high, with doors opening entire length. Made in Mahogany finish and Solid Oak.



"Signal"  
Radio Table  
Top  
20 x 36 in.  
Height 30 in.

Write for illustrated folder

## SIGNAL Electric Mfg. Co

Atlanta Cleveland New York St. Louis  
Boston Minneapolis Pittsburgh Toronto  
San Francisco Montreal Chicago

(You'll find our branch offices in the Telephone Directory)

Factory and General Offices:  
1915 BROADWAY, MENOMINEE, MICH.

## ARE YOU A 1923 MAN? IF YOU ARE—GET OUT OF THE RUT

Radio has improved with leaps and bounds since last year—to be a 1923 man is to be satisfied with last year's results—Broadcasting and CW will accomplish wonderful results this year and for you to share in these coming successes—both receiving and transmitting—you need a good set, made from the latest and most improved parts.

### ROSE RADIO HAS IT !!

(and I don't mean maybe)

## ROSE RADIO AND ELECTRICAL SUPPLIES

129 CAMP STREET,

NEW ORLEANS, LA.

## FROST-RADIO

Ask Your Neighbor



No. 140 Best value in a Two-Fone Plug ever offered. Holds fone cord tips under set-screw. Used with two pairs head fones or one pair and loud speaker. At your dealer's.

**2 FONE** Plug 60c

HERBERT H. FROST, Inc.

New York

CHICAGO

Kansas City, Mo.

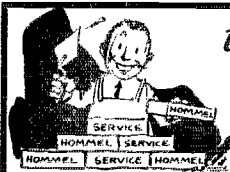

Use **HOMMEL SERVICE**  
to build your radio business

By aligning yourself with the Hommel Organization you have access to ample stocks of the leading lines of radio equipment at all times, and can serve your customers promptly without the necessity of tying up your own working capital.

Write for Hommel's illustrated Encyclopedia #246.  
**LUDWIG HOMMEL & CO.**

Wholesale Jobbers Exclusively

Pittsburgh,

929 Penn Avenue,

Penna.

# Announcing:

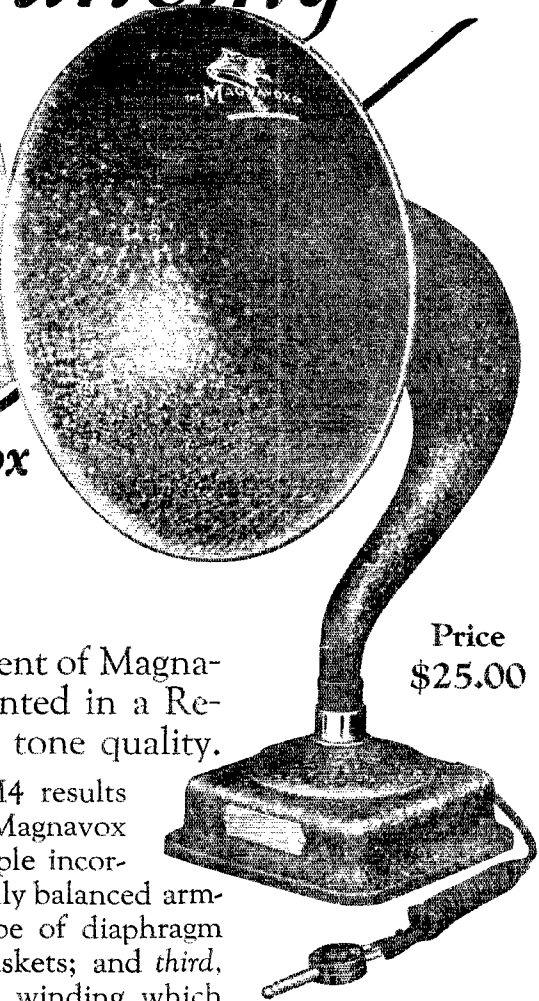
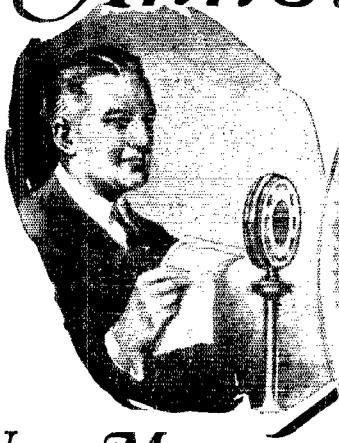

## A New Magnavox M4 requiring no battery

Price  
\$25.00

THE supreme achievement of Magnavox engineers represented in a Reproducer of truly *exquisite* tone quality.

The superb tone quality of M4 results from the perfection of the Magnavox semi-dynamic operating principle incorporating; *first*, a new magnetically balanced armature; *second*, an improved type of diaphragm supported by hollow rubber gaskets; and *third*, an extremely high resistance winding which makes M4 unusually sensitive.

*Magnavox M4 and other Magnavox Radio Products can be had of good dealers everywhere*

THE MAGNAVOX CO., OAKLAND, CALIF.

New York Office: 350 West 31st Street

Canadian Distributors: Perkins Electric Limited, Toronto, Montreal, Winnipeg

# MAGNAVOX

*The Reproducer Supreme*

Beautifully finished in dark enamel with gold high lighting.

Equipped with flexible cord and West-on plug ready to connect as simply as a head set.

# Save 25 to 50%

on your

## Radio Panels

By Insisting Upon Getting Panels  
Bearing This Name and Trade-mark:



TRADE

MARK

Electrasote, the new panel material introduced by THE PANTASOTE COMPANY, INC., has highly desirable radio-electric properties—greater volume and surface resistivity than any other panel, therefore less surface-leakage and power-loss in the set.

Electrasote Radio Panels are a distinctly *quality* product, beautifully finished; each panel in an individual envelope.

Remember—a good panel deserves proper handling. To get the best results use a new, *sharp* drill with *slight* pressure.

All Standard Sizes at good Radio Dealers

JOBBERs AND DEALERS:

Write for our interesting proposition.

M. M. FLERON & SON, INC.

Exclusive Sales Agents for Electrasote Radio Panels

Trenton, New Jersey

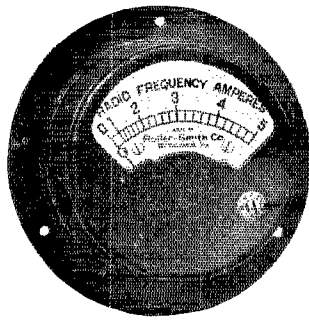

A  
SURPRISE  
FOR  
YOU

Look on Page 5 of new Bulletin AG-10 and you will find a *new instrument* that will be of interest to every owner of a radio set—transmitting or receiving.

By the way, there are a lot of other interesting things in this little radio instrument manual.

A copy is given for the asking. Send for new Bulletin AG-10.

**ROLLER-SMITH COMPANY**  
**16 PARK PLACE, NEW YORK**

Offices in principal cities in U.S. and Canada

## SUMMER READING!

Now is the time to get your sets and stations in A-1 shape for cold weather DX.

As references, a storehouse of good, practical ideas, a buying guide to the apparatus you need—the QST's listed below are invaluable.

And we'll send you, postpaid, the following TWENTY-SIX QST's for only \$3.00.

May, June, July, August 1917

June 1919 and 1921

April to December (except August) inclusive 1922

January to December inclusive 1923

Mail your order NOW to

**QST**

1045 Main St., Hartford, Conn.

KELLOGG RADIO

D.C.		OFFICIAL SCORE BOARD			
9	CHICAGO	0	0	2	1
1	ST. LOUIS	0	1	0	0
9	NEW YORK	0	0	0	0
1	BROOKLYN	0	2	1	1
1	CINCINNATI	0	0	0	0
8	PHILADELPHIA	1	0	0	1
8	BOSTON	0	4	0	0
9	PITTSBURG	0	0	0	0

# BASEBALL SCORES BY RADIO

## SAY THE RADIO BUGS

**B**ASEBALL fans the country over will be counting on Radio this year more than ever before. Most Radio fans are baseball fans. Every one of them should see that his new set of Kellogg radio parts is ready in time for the baseball scores.

Get the sport records and scores quickest by Radio—build your set of Kellogg radio parts for dependability and economy.

There is a certainty of satisfaction with Kellogg as shown by records of this equipment in use. Kellogg transformers rank among the best. To hear them in operation is to want them. Kellogg tube sockets give the utmost of service, while Kellogg switch arms and knobs are in a class by themselves for quick assembly, low resistance and satisfying operation.

Kellogg variable and fixed condensers, variometers and variocouplers are all designed and built to give the satisfaction which the word Kellogg expresses in the electrical apparatus field. Kellogg rheostats have but one movable part. They come in six and twenty-five ohm resistances, easily interchangeable. They are simple, yet vary in control on the half turn of the resistance element. Kellogg DX head sets are known wherever radio is in the air. They are built mechanically and electrically for long service, sensitiveness, extreme lightness in wearing, and handling does not affect their tuning. They have Kellogg solid bakelite shells and are furnished with the Kellogg famous receiver cords of which many hundreds of thousands are in use today in the telephone field. Kellogg radio parts are especially suitable in portable sets because of their strength and high class manufacture. They will stand rough handling as will no other radio equipment and yet have the range and afford the selectivity, in the limits of the circuits used, surpassed by none.

If you don't want to bother to pick out the parts for your favorite hook-up buy one of our Radio Kits which include all the necessary and suitable parts including two stages of audio amplification; you can select the tuning units, as you desire.

This summer as never before radio will be heard in every summer resort and camp. See that your set is made of Kellogg radio parts. Specify Kellogg Radio—

*Use—Is the Test*

# KELLOGG SWITCHBOARD & SUPPLY COMPANY

1066 West Adams St., CHICAGO, ILL.

# FOR PERFECT MUSICAL REPRODUCTION

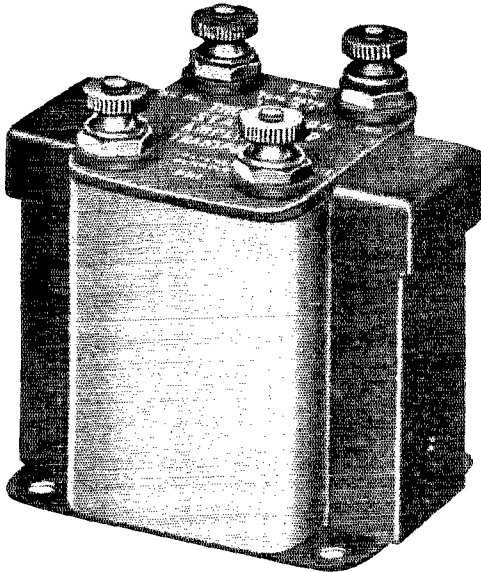

## "Super Transformer"

\* \* \*

Makes a musical instrument of any receiving set.

\* \* \*

Used in three stages by Kennedy & Zenith.

\* \* \*

Ideal for reflex purposes.

\* \* \*

Treat your set to "Super Transformers"

\* \* \*

Even Amplification Over the Entire Musical Range

CHICAGO

# THORDARSON

ELECTRIC MFG. CO.

ILLINOIS

### AN EXPERT SAYS: RESISTANCE COUPLED AMPLIFICATION!



G. Y. Allen, of the Westinghouse Electric and Manufacturing Co., writes in the *May Radio Broadcast*.

"True, great improvements have been made, but the fact remains that fundamentally the transformer cannot ever give distortionless amplification. For those who demand quality the resistance coupled amplifier is unquestionably the most desirable."



"Cost" is no longer a draw-back! Daven specialized resistance coupled amplifier parts have cut the price to less than \$3.00 per stage!



Special inexpensive resistors from 5,000 ohms up. Our RESISTO-COUPLER, to hold resistor, leak and condenser .....\$1.50



Ask your dealer—or let us help you out.

**DAVEN RADIO COMPANY**

"Resistor Specialists"

11-13 Campbell Street, Newark, N. J.

### "Kills Reflex Troubles"

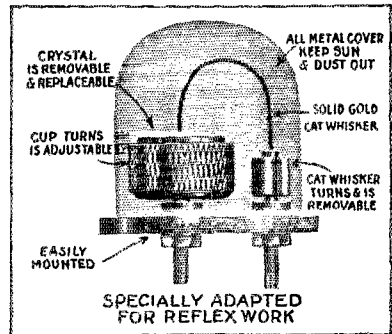

### "LINCOLN" DETECTOR

Creating tremendous sensation. Enclosed, fixed, adjustable. New. Brings in distant stations loud and clear. You need it. Price only \$3.00. Absolutely guaranteed for one year. Jobbers, Dealers: Wire or write. Mention this ad.

**LINCOLN MFG. CO.**

Los Angeles, Cal.

## RED-HEAD PHONES

Used and Praised the World Over

3000 Ohm \$6.50. 2000 Ohm \$5.00.

Complete with Cord and Headband

At your dealer's, or sent direct

**The Newman-Stern Co.,** Newman-Stern Bldg., CLEVELAND



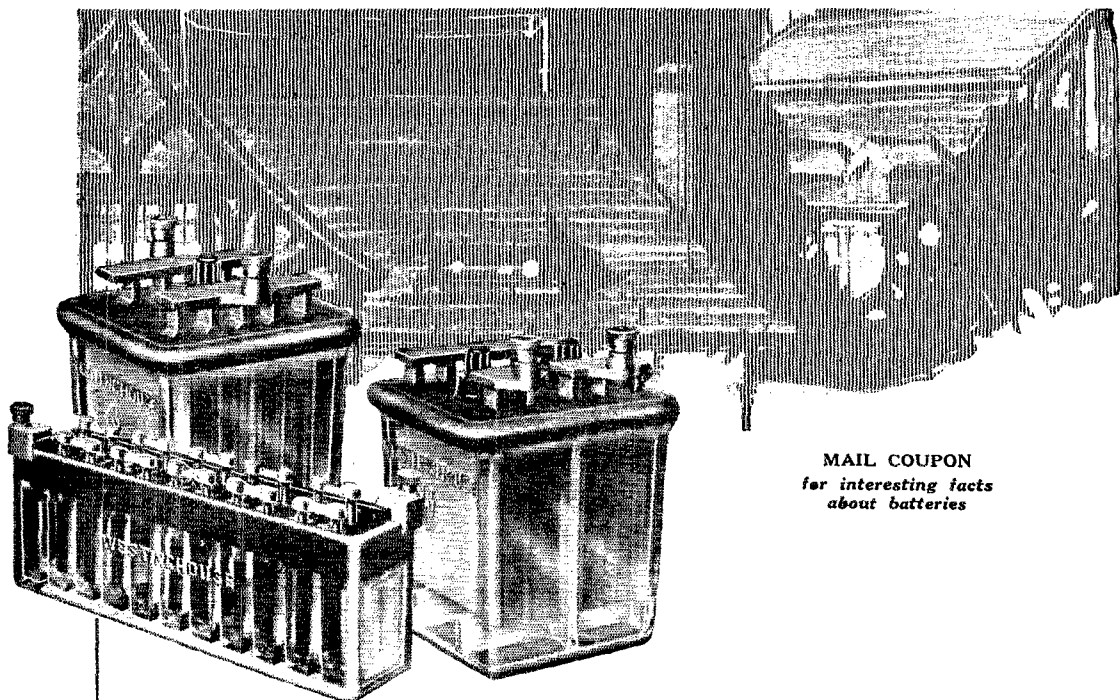

MAIL COUPON  
for interesting facts  
about batteries

**F**ULL voltage battery current all the time! That's what you want. Westinghouse Radio Storage Batteries will give it to you. No more operating with run-down batteries! No more sudden drops in battery voltage! No more throwing away worn-out batteries! Westinghouse Batteries last. They hold their charge. They can be easily recharged. There's a size and type for every radio need. Built by Westinghouse, you *know* it's **RIGHT!**

Westinghouse **CRYSTAL CASE** Batteries have one-piece clear glass cases, with solid glass cell partitions and high plate rests (deep sediment spaces). Perfectly insulated against current leakage. "A" Batteries. 2 volts, for low-voltage tubes, such as WD-11 and WD-12. 4 volts, for tubes like UV-199. 6 volts, for tubes UV-201A or C-301A. Also rubber-case types. "B" Batteries. 22 volts. Regular and quadruple-capacity types. "C" Batteries in 6-volt units.

WESTINGHOUSE UNION BATTERY CO., Swissvale, Pa.

# WESTINGHOUSE

## RADIO

## "A," "B" and "C" BATTERIES

Westinghouse Union Battery Co.  
Swissvale, Pa.

Send me Westinghouse Radio Battery  
Folder A-3-D.



PATTERN NO. 95

## RADIO TEST SET

- ¶ This radio test set has been designed to meet the demands coming to use from serious experimenters, manufacturers and dealers in radio equipment and supplies, for a complete radio testing outfit.
- ¶ While the various ranges of readings permit making practically every test necessary in connection with radio receiving sets, it has been particularly designed for the taking of characteristic curves on vacuum tubes, the only extra equipment required being the batteries.
- ¶ The several instruments, any of which may be used independently, include a 0-1.2 filament ammeter, a 0-6 filament voltmeter, a 0-120 plate voltmeter, a 0-10 plate milliammeter, and a 10-0-10 grid voltmeter.

Complete With Instructions

Price, \$75.00

Send for Circular

ORDER FROM DEALER

JEWELL ELECTRICAL  
INSTRUMENT CO.  
1650 WALNUT ST.  
CHICAGO

## A Buffalo Radio Fan Gets London with the help of a **KIC-O**

Mr. E. C. Lewis on March 18th heard Mr. Marconi's voice on a Model 10 Atwater Kent Set. He said it would have been impossible without a KIC-O Battery. Improve your set with a KIC-O. Our guarantee protects you.

### GUARANTEE

Your money back on any KIC-O Battery if not satisfied within 30 days' trial.

Write for full information on "A" and "B" Batteries.

Volts	Price Plain	With Panels
22	\$5.50	\$...
32	7.25	11.75
48	9.50	14.00
68	12.50	17.00
100	17.50	22.50
145	23.50	28.50

**KIMLEY ELECTRIC CO., Inc.**  
2666 Main St., Buffalo, N. Y.

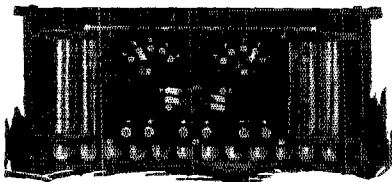

100 Volt Type

## NA-ALD

When phonographs were first made they were square boxes without ornamentation. Likewise the first dials, turned out in a laboratory,—had hard straight lines for shape. Beauty is a later development. Na-ald dials have soft, graceful lines which makes them very pleasing to the eye. They lead in both beauty and quality. They have the right grip for delicate, exact tuning.

ALDEN MANUFACTURING CO.  
Largest makers of Radio Sockets and Dials in the world  
Springfield, Mass.

Dept. M 52 Willow St.

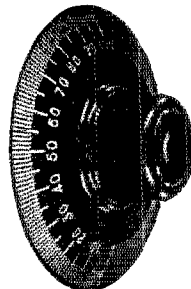

3 inch  
No. 3003-4  
35c, 3 for \$1.00

## Marle Transformers

The Heart of a Good Receiver

Marle Engineering Co.

Orange

New Jersey



QUALITY RADIO EQUIPMENT  
CHELSEA RADIO CO., Chelsea, Mass.

# BAKELITE

TRADE MARK REG. U. S. PAT. OFF.

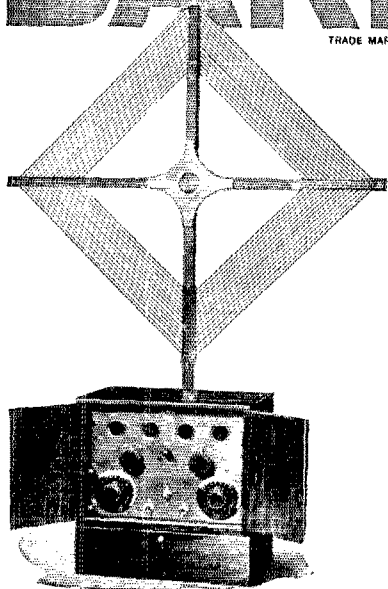

## DeForest and Bakelite

Bakelite is standard insulation on all DeForest Radiophones—from panels to transformer covers. The effective protection afforded by Bakelite is a strong factor in the success of these well known radio sets.

Good insulation must have mechanical strength and rigidity, chemical inertness, heat and water as well as electrical resistance and, last but not least, durability. Bakelite possesses all these characteristics in a very high degree.

The fact that practically every radio manufacturer uses Bakelite is an excellent endorsement of its value for radio insulation.

### Send for our Radio Map

Enclose 10c and let us send you the Bakelite Radio Map. It lists the call letters, wave length and location of every broadcasting station in the world. Address Map Department.



*Write for a copy of  
our Radio Booklet C*

### BAKELITE CORPORATION

247 Park Avenue, New York, N. Y.  
Chicago Office: 636 West 22d Street

---

THE MATERIAL OF A THOUSAND USES

---

TOWER'S

**TOWER'S Scientific**  
 WEIGHS ONLY 80Z  
 Perfect Tone Mates  
**\$2.95**  
 Plus a few cents postage



**OUR \$200,000.00 COMPANY STANDS SQUARELY BACK OF EVERY HEADSET**

**WORLD'S GREATEST HEADSET VALUE**

Formerly \$6.00, now \$2.95, with Notable Improvements  
 Longer Cord (full 5 feet), Stronger Magnets, Higher Resistance, Increase of Sensitivity, Perfect Tone Mates  
 EVERY SET TESTED BY LICENSED RADIO OPERATORS

*Send no money - Order on a Post-Card*

THE TOWER MFG. CO. : 98G BROOKLINE AVENUE, BOSTON, MASS.

Scientific



Inspect this wonderful kit at your dealer's today. If he hasn't it in stock, send money order or write for further information.

List price \$20

**"37 Stations Heard In One Night"**

FANS everywhere are smashing distance records with sets built with the Shamrock Kit. Mr. H. A. Weddell, Kenmore Ave., Chicago, tuned in 37 distant stations on February 28th, 1924. Some of those heard were: WSB, Atlanta; OKCK, Regina, Can.; WOR, Newark; KHJ, Los Angeles; KGW, Portland; WKAQ, San Juan, P.R.

SHAMROCK MANUFACTURING CO. Newark, N. J.  
 Dept. 82, Market St.,

**WE REPAIR RADIO TUBES**

WD-11 .....	\$2.50	DV-2 .....	\$2.50
WD-12 .....	2.50	DV-6A .....	2.50
UV-200 .....	2.50	UV-199 .....	2.50
C-300 .....	2.50	C-299 .....	2.50
DV-6 .....	2.50	UV-201A .....	2.50
DV-1 .....	2.50	C-301A .....	2.50

Mail orders solicited and promptly attended to.

**H. & H. RADIO CO.**  
 P. O. Box 22-W  
 Clinton-Hill Station Newark, N. J.

**"WARRANTED" Audio Transformer**  
 MTD. \$2.00, UNMTD. \$1.45  
 10 Days Money Back Guarantee  
 Dealers Write

**C. C. ENDLY**  
 22 Sturges Ave.  
 MANSFIELD, O.

**SPARK TRANSMITTERS**  
 75 Watt, Portable.  
 Made for U. S. Army Aeroplanes  
 Government Cost \$45.00 each  
 Our Price \$5.00 Each

**AMERICAN SALES AGENCY**  
 38 Park Row New York City  
 Tel. Cortland 5181



# "RADIO CALL PINS"

Are Worn From  
COAST TO COAST

Solid Gold  
Call  
letters  
raised  
on 20 yr.  
gold plate  
back



Wearers  
write  
back:  
"Vy-vy  
FB"  
"Neat  
stuff"  
"FB art"  
"Vy mch  
psed"  
"Sure  
nifty"  
"I wear it  
right un-  
der my  
ARRL  
pin"

(Twice actual size)

Put Your Call in Solid Gold  
On A 50 watt "Bottle"  
And Wear It With  
Your ARRL Emblem

Call—in  
polished  
gold  
Back-  
ground—  
dull gold

Wearers  
write  
back:  
"Mighty  
classy"  
"Admire  
it vy mch"  
"Perfectly  
darling"  
(YL) "A  
vy fine  
job"

All un-  
solicited  
letters

Pins FB  
or money  
back

\$2.00  
M.O. or R. C. BALLARD, 9FZ  
Check

1202e W. OREGON St.

URBANA, ILL.

## SILVER KEY CONTACTS

Dia.	Thickness	Lth. of shank	Thread	Per Pair
1/4"	3/16"	1/8"	8-32	\$1.50
3/8"	1/4"	3/16"	10-32	1.75
1/2"	5/16"	1/4"	10-32	2.00
5/8"	3/8"	5/16"	10-32	2.50

We specialize in BREAKIN RELAYS, STRAIGHT RELAYS, ARC RELAYS and automatic switches.

Write for circular.

LEACH RELAY COMPANY

591 Mission Street

San Francisco, California

## HEATH Radiant Condensers

A definite guarantee of lasting accuracy—PERMANENTLY FLAT Plates. The Heath process of stamping to absolute flatness and their tempering to steel hardness protects you from warping, buckling plates. The difference is worth the effort of insisting on Heath Condensers.

Micrometer Geared Vernier

Reducing gear gives hair-line adjustment. Separate tension adjustment.

Write for Literature

Jobbers and Dealers: Write Immediately for Proposition

HEATH RADIO & ELEC. MFG. CO.

207 First Street

Newark, N. J.

Canadian Distributor: Marconi Wire-  
less Telegraph Co., Montreal, Canada.



ALWAYS MENTION QST WHEN WRITING TO ADVERTISERS

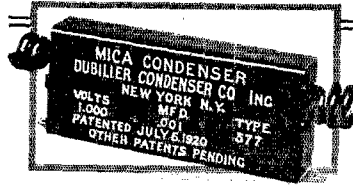

Type 580 is designed for low power continuous-wave telephone and telegraph transmission. It is used also as a tuning or coupling condenser, as a series or tuning condenser in the antenna circuit, or as a grid condenser.

Type 577 designed for use in radio and audio frequency circuits; for receiving equipment (especially super-heterodyne); self-rectifying circuits; d.c. and other tube transmitters up to 100 watts. An excellent grid, plate by-pass and antenna series condenser.



# Dubilier Condensers

## for efficient Amateur Transmission

Dubilier Condensers Types 577 and 580 are preferred where low losses and accurate capacity condensers are required.

The Dubilier patented method of manufacture embodied in these condensers assures permanent capacity under all service conditions. They are suitable for use as laboratory standards in precision circuits and for low power C.W. transmitters.

Type 577		Type 580	
Capacity in mfd.	Voltage	Capacity in mfd.	Voltage
.00025	1000	.001	5000
.0005	1000	.002	5000
.001	1000	.005	2500
.002	1000	.01	2500
.005	1000	.02	2500
.0075	1000	.0003	These 3 capacities combined in one condenser
.01	1000	.0004	
		.0005	

Other transmitting condensers are made to your specifications for broadcasting purposes.

Complete information will be supplied on request.

Dubilier Condenser & Radio Corp.

42-50 West Fourth Street, New York

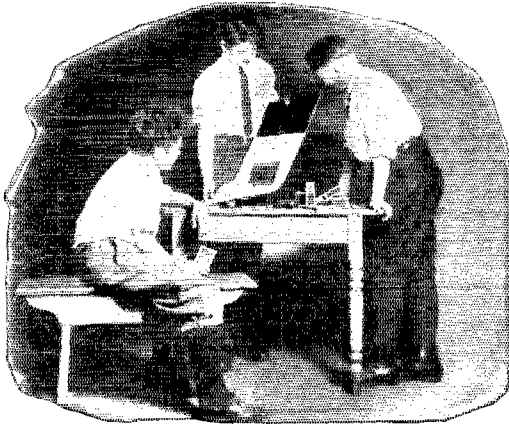

## Performance plus Beauty

Choose your panel for its insulating value as well as for its appearance.

### MAHOGANITE Radion Panels

give you both the supreme insulation and the beauty of polished mahogany. For Mahogany is not a surface finish but an insulating material which extends from one side of the panel to the other.

#### 21 Stock Sizes Mahogany and black

6 x 7	7 x 14	8 x 26
6 x 10½	7 x 18	9 x 14
6 x 14	7 x 21	10 x 12
6 x 21	7 x 24	12 x 14
7 x 9	7 x 26	12 x 21
7 x 10	7 x 30	14 x 18
7 x 12	7 x 48	20 x 24

# RADION

The Supreme Insulation

## PANELS



Look for this stamp on every genuine RADION Panel. Beware of substitutes and imitations.

At the best radio shops or write to  
**AMERICAN HARD RUBBER CO.**  
11 MERCER STREET NEW YORK

## BRISTOL

TRADE MARK

### AUDIOPHONE

REG. U. S. PAT. OFFICE

### LOUD SPEAKER

This is known everywhere as the Loud Speaker with the quality tone. Not only is the tone natural and without mechanical distortion, but is sufficiently big in volume to be easily heard in a large room or all through the house. Comes to you ready to use—no auxiliary batteries are required.

Made in three models:

Audiophone Senior  
Price \$30.00

Audiophone Junior  
Price 22.50

Baby Audiophone  
Price 12.50

Bulletin AX-3014 describes these Loud Speakers.

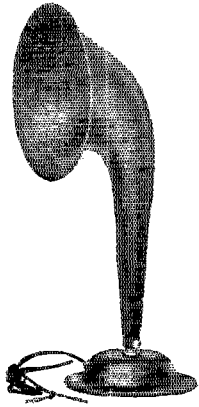

This is the Baby Audiophone equipped with the Fiber Horn which is now standard and supersedes the metal flare previously used. Price \$12.50

**THE BRISTOL COMPANY**  
WATERBURY, CONN.

## RADIO TUBE EXCHANGE

We Repair All Standard Makes of Tubes, Including

W.D. 11 or 12  
U.V. 199 or C299  
U.V. 201A or C301A  
C. 11 or 12  
D.V. 1 or D.V. 2  
U.V. 200 or 201  
C. 300 or 301

**\$2.50**



All tubes guaranteed to do the work.

**RADIO TUBE EXCHANGE, 200 Broadway, New York**  
All Mail Orders Given Prompt Attention  
Orders Sent Parcel Post C. O. D.

## VOLT-X

RADIO PRODUCTS  
For Clearer Tone!

Tone Filter (every set should have one) .....\$2.50  
Ball-Bearing Variable Grid Leak—Ranges ½ to 15 meg-ohms, 30,000 to 150,000 ohms and 10,000 to 30,000 ohms. Once Set—"stays put." Operation smooth—resistance unit cannot wear or tear and is protected from atmospheric conditions.....\$1.00

Sold—Through Jobbers—By  
**BURTON-ROGERS CO.** Boston, Mass.  
Write for Free Descriptive Matter

## RADIO BOOK

514 PAGES—Greatest book on Radio ever written. New—authoritative—complete. Packed with sound, practical information useful to every radio fan. Send \$1 to-day. Money back if not satisfied.  
International Correspondence Schools  
Box 6134-B, Scranton, Penna.

**1 C.S. RADIO HANDBOOK \$1**

## Around the World!



A New Zealand amateur got Alabama (10,000 miles) on one Myers Tube—heard the signals and message perfectly. Certified by Radio News.

This remarkable performance indicates that there is no limit to long-distance reception with Myers Tubes because their design is right.

# MYERS TUBES

Practically Unbreakable

(1/2 size) add to the efficiency of any set by cutting out noise, tube hiss and interference.

**\$5** Two types: Dry Battery and Universal (for storage battery). Write for free circuit diagrams.

Insist on the New Improved Myers Tubes—at reliable dealers—otherwise send purchase price and be supplied postpaid.

EACH complete with clips ready to mount on your set; no sockets or other equipment necessary.

**F. B. Myers Co. Ltd.**  
*Radio Vacuum Tubes*

240 Craig St., W.  
Montreal, Canada

## AMATEUR LICENSE

Why not go up for an amateur license? Demonstrate your ability as a first class experimenter. Stand head and shoulders over the crowd by qualifying for an amateur license.

Our short course teaches you to read the code, draw diagrams and understand the theory and practice of Radio.

Special course for amateurs.  
Send for further information.

**Y.M.C.A. RADIO SCHOOL**

152 E. 86th St. New York City  
Tel. Lenox 6051

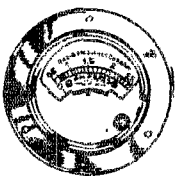

### HOT WIRE AMMETERS

0-2.5 Amps. Flush Panel Model.

Manufactured by

**ROLLER-SMITH CO.**

Extra Special Price \$2.75 each

American Sales Agency

38 Park Row New York City

Use — Price 75¢



**Variable Grid Leak**

At dealers, or postpaid  
Durham & Co., 1936 Market St., Phila.

Which is the BEST Hook-up?  
Which is the BEST receiving set?  
Which is the BEST headphone?  
Which is the BEST rheostat?  
Which is the BEST variometer or coupler?  
Which is the BEST grid leak?  
Etc., Etc., Etc.,

## Which is the BEST Condenser?

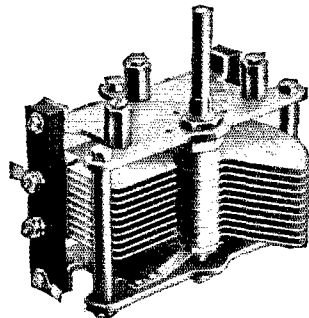

**W**HILE the claims of the various manufacturers for the superiority of their products are interesting, it should be kept in mind that with ONE exception there is no consensus of authoritative opinion which single item really IS the best,—the acknowledged standard for comparison.

It is a significant fact that of all the various kinds of radio apparatus on the market to-day the **CARDWELL CONDENSER** is the **ONLY** unit which is recognized by engineers and technical Editors of National prominence as the **ONE** best.

**The Allen D. Cardwell Manufacturing Corporation**

81 Prospect St. Brooklyn, New York

Build "the Rolls-Royce of  
Radio"—a

**Super-Heterodyne!**

All-American is ready for you! Ready with a thoroughly tried and proved transformer—at only \$6—that makes the utmost of the high efficiency of long wave radio frequency amplification.

Ask to see the new All-American Type R-110, a little gem of beauty in its handsome, round, nickel-plated shield. Easy to assemble. Works to perfection in all Super-Het, Ultradyn, straight radio frequency and reflex circuits. For wave lengths 4,000 to 20,000 meters.

**SPECIAL OFFER!** Book of tested hook-ups and diagram-circular on Power Amplification mailed for 4c.

**RAULAND MFG. CO.**

2642 Coyne St., Chicago

A type for every circuit



**ALL-AMERICAN**

*Largest Selling Amplifying Transformers in the World*

***A.R.R.L Members -- What about your friends ?***

You must have a friend or two who ought to be members of our A.R.R.L., but aren't. Will you give us their names, so that we may write to them and tell them about the League and bring them in with the rest of us? The A.R.R.L. needs every eligible radio enthusiast within its ranks, and you will be doing your part to help bring this about by recommending some friends to us. Many thanks.

.....1924

American Radio Relay League,  
Hartford, Conn.

I wish to propose

Mr..... of.....

Mr..... of.....  
Street & No. Place State

for membership in the A.R.R.L. I believe they would make good members. Please tell them the story.

.....  
.....



# CELORON

STANDARD RADIO PANEL

Dielectric — easily worked — uniform quality  
No. 3  Size 7x12 1/2 in.

Manufactured by  
**DIAMOND STATE FIBRE COMPANY**  
Bridgeport, Pa., U.S.A.  
Branches in Principal Cities

## The right front door

Expensive radio parts should have the best panel money can buy. A Celoron Radio Panel gives insulation these radio parts need. Celoron, a bakelite material, is approved as an insulating material by the U. S. Navy and Signal Corps and is used by leading radio manufacturers.

Celoron panels come cut in nine sizes, in black, mahogany or oak. Other sizes cut to order. Ask your dealer.

**DIAMOND STATE FIBRE COMPANY**  
Bridgeport, Pennsylvania  
Branches in Principal Cities  
Toronto, Canada      London, England

## GHEGAN RADIO RELAY

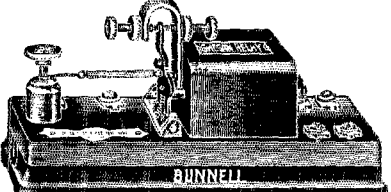

Taps permit tubes of various impedance to be used. With Bunnell Register this Relay will copy telegraphic signals at a speed of 60 to 90 words per minute. With Siphon Recorder speeds up to 200 words per minute have been obtained. Normal operating current is 1/2 to 2 Milli-Amperes. Send stamp for catalogue No. 45 Q., Ghegan Radio Relay.....\$40.00  
Special Price to Dealers.  
**J. H. BUNNELL & CO., 32 Park Place, New York**

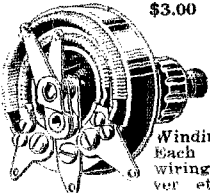

\$3.00

### SOMETHING ENTIRELY NEW PREMIER "DUOSTAT"

Two Rheostats in One  
(Trade Mark)

Windings independent of one another. Each operates one tube. Simplifies wiring. Bakelite moulded base. Silver etched dial. Winding "NICHROME" wire. Made for all types of tubes. No. 12 two windings, each 7 ohms; No. 13 two windings, each 25 ohms; No. 14 two windings, each 40 ohms.  
Price all types—\$3.00

Our Free bulletin #92 gives complete list of Premier Radio parts priced right. Ask your dealer.

**Premier Electric Company**

3811 Ravenswood Ave., Chicago

## SELECTIVE TUNING

An efficient condenser with a properly designed inductance insures selectivity—and that means

### THE LOW LOSS

GENERAL  
INSTRUMENT CORPORATION  
GROUNDED ROTOR CONDENSER

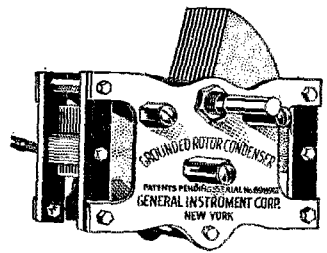

## Greater Distance and Volume

Than is Possible with the Average Variable Condenser

*CHARLES SREBROFF, operator and owner of station 2BHY writes, "You can use my name in your advertisements so that other amateurs may profit by my experience with your Low Loss Grounded Rotor Condenser. There is no other condenser to equal yours and I can honestly say that my station is entirely free from any condenser losses since using your GROUNDED ROTOR CONDENSER. Amateurs can call me any night between 11 p. m. and 1 a. m. on 180 meters—three operators always on watch."*

		Minimum	Maximum	
Type 46X..	11 Plate	5 mmfd	.00025 mfd	\$4.50
Type 46A..	13 Plate	6 m mfd	.0003 mfd	4.50
Type 46D..	21 Plate	9 mmfd	.0005 mfd	5.00
Type 46F..	43 Plate	15 mmfd	.001 mfd	5.50

AT YOUR DEALER

Otherwise Send Purchase Price Direct to Us  
And You Will Be Supplied

**GENERAL INSTRUMENT CORPORATION**

423 Broome Street, New York City



Quantity warrants the 90% discard. Only 10% marketed but it pays us. Your dealer will get you one.  
**B-Metal Refining Co.**  
525 Woodward Ave.  
Detroit, Mich. 6th flr.

## AUDIOTRONS GENUINE OLD STYLE DOUBLE FILAMENT

Special **\$4.50** Postpaid  
**EMPIRE RADIO CORP.**

271 W. 125 St.

N. Y. C.

## To Our Readers Who Are Not A.R.R.L. Members

Wouldn't you like to become a member of the American Radio Relay League? We need you in this big organization of radio amateurs, the only national amateur association that does things. From your reading of *QST* you have gained a knowledge of the nature of the League and what it does, and you have read its purposes as set forth on page 6 of every issue. We would like to have you become a full-fledged member and add your strength to ours in the things we are undertaking for Amateur Radio, and incidentally you will have the membership edition of *QST* delivered at your door each month. A convenient application form is printed below—clip it out and mail it today.

.....1924

American Radio Relay League,  
Hartford, Conn.

Being genuinely interested in Amateur Radio, I hereby apply for membership in the American Radio Relay League, and enclose \$2 in payment for one year's dues. This entitles me to receive *QST* for the same period. Please begin my subscription with the.....issue. Mail my Certificate of Membership and send *QST* to the following name and address.

.....  
.....  
.....

Station call, if any.....

Grade Operator's license, if any.....

Radio Clubs of which a member.....

Do you know a friend who is also interested in Amateur Radio, whose name you might give us so we may write to him about the League?.....

.....Thanks.

### NEW A. R. R. L. APPARATUS !!!

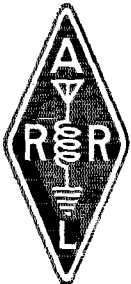

Large emblems have become so popular with the membership that we have added another piece of apparatus, a large ARRL shield of re-inforced papier mache, black and gold, 18 x 9 inches with brass ring to hang on the wall of your shack.

Just the thing for ARRL Convention decorations, ham booths at radio shows and your radio room. Sent postpaid for 1.25. Be sure to specify "ARRLShield" in ordering.

The League pins are still \$1.

# HAM-ADS

Six cents per word per insertion in advance. Name and address must be counted. Each initial counts as one word. Copy must be received by the 1st of month for succeeding month's issue. NOTE NEW CLOSING DATE.

BUILT TO SERVE YOU, NOT MERELY TO SELL—A LIFETIME B OF LIVE-PEPPY EDISON ELEMENTS, 54 VOLT BATTERY, 42 CELLS \$8.75; 100 VOLTS, 78 CELLS \$16.00; 130 VOLTS, 102 CELLS \$20.00; 150 VOLTS, 117 CELLS \$23.50. EACH IN WAX FINISHED FUMED OAK COVERED CABINET, RIBBED RUBBER MAT, LARGEST EDISON ELEMENTS WIRED WITH PURE SOLID NICKEL (NOT PLATED IRON), NON-FLOATING PERFORATED HARD RUBBER SEPARATORS, BANDS, GENUINE EDISON ELECTROTYPE (THAT'S NO LYE), WHITE SEALING OIL, WILLARD COLLOID, A REAL RECTIFIER \$2, JUMBO SIZE \$3, TUNGAR H VOLTAGE CHARGERS, ANNEALED GLASS TEST TUBES INDIVIDUALLY WRAPPED,  $\frac{3}{4}$ " x 6" 3c, 1" x 6" 4c,  $1\frac{1}{2}$ " x 7" HEAVY FLAT BOTTOMED 7c, 99% PURE SOFT DRAWN SOLID (NOT PLATED OR ALLOY) No. 20 NICKEL WIRE FOR CONNECTORS  $1\frac{1}{2}$ c FOOT PREPAID, PERFORATED HARD RUBBER SEPARATORS  $\frac{1}{2}$ c. GENUINE EDISON ELECTROLYTE (THAT'S NO LYE) FOR 100 VOLTS \$1.50. PURE POTASH 80c LB. TYPE A EDISON ELEMENTS 6c PAIR, 7c DRILLED, WIRED WITH PURE SOLID NICKEL 10c PAIR. TYPE G DRILLED ELEMENTS 4c PAIR, 2 POSITIVES 1 NEGATIVE 5c, 3 POSITIVES 2 NEGATIVES DRILLED AND CUT IN HIGH CAPACITY UNIT READY TO WIRE 10c. HI-CAPACITY CELL PARTS 17c. SAME READY TO WIRE 19c, WIRED 24c, INCLUDING SOLUTION. GREAT FOR TRANSMITTERS, POWER AMPLIFIERS, SUPERS, SUPER-CELL, 6 A ELEMENTS IN  $1\frac{1}{2}$ " x 7" HEAVY FLAT BOTTOM CONTAINER, EVERYTHING READY TO WIRE 30c, INCLUDING SOLUTION. 3000 MILLIAMP HOUR CAPACITY, EVERYTHING FOR THAT EDISON B, FRANK MURPHY, RADIO 8ML, 4837 ROCKWOOD ROAD, CLEVELAND, OHIO.

WILL TRADE—Edison Rectifier for set of Honeycomb coils. Rectifier with Ammeter and control board. Good shape, rated at 10V 16 amp. P. T. Perdue, Salem, Va.

CHEAP—complete one hundred watt set Radio Corporation parts, also large Boston Key and latest model Corona. Parts for four tube Neutrodyne. B. L. Hinant, 4 NT Care Southern California Edison Company, Compton, Calif.

SELL—One General Radio 0-1 hot-wire ammeter, brand new, \$6. Other stuff. U. B. Carter, 1001 Woodrow St., Columbia, S. C.

FOR SALE—RC magnetic modulator UT1643 \$8.00 GE 0-200 milli ampere \$4.00, 20 burnt out tubes, UV200, UV201 and A's, UV202, UV216 50c each. Several Victrola attachments complete with midget horn 75c each. John B. Gray, Jr., Wilson, N. C.

ZENITH MODEL—1R Receiver 2M Amplifier for sale, complete with tubes and B batteries. Guaranteed. First \$100. takes it. Dawes, Box 663, Bozeman, Montana.

NEW SELECTIVE 3 circuit tuner, det., two step. Build like Grebe CR3, Rord. With tubes, \$80.00. Send for Photo, Description. John Shakespeare, Kalamazoo, Michigan.

WANTED—Tubes for private collection. All foreign, odd, special or obsolete tubes wanted. Send all description or information to D'Agostino Radio Laboratories, 228 Walnut Street, Morgantown, West Virginia.

SELL—Two No. 4000 "S" Tubes new type \$15. Also new Acme 300 watt C.W. Transformer \$18. Wm. H. Hebal, Stevens Point, Wis.

FOR SALE—Kennedy Type 281 with 521 amplifier; also one pair Baldwin phones both used ninety days. Best of care, First eighty dollars gets it. Dick Bryan, Box 448, Tyler, Texas.

HOWDY GANG—THO'T WE'D WRITE YOU THIS LITTLE LETTER AND TELL YOU WHY YOU NEED OUR HAM PRICE LIST. ITS BRIM FULL OF GOOD PARTS FOR THE CW SET, AND CONTAINS ITEMS THAT YOU CANNOT FIND ANY-WHERE ELSE. WE GET ORDERS FOR CHEMICALLY PURE ALUMINUM, 90¢ PER SQUARE FOOT, FROM ALL OVER THE U.S. AND SHEET LEAD, AT 30¢ PER LB. or  $2\frac{1}{2}$  LBS. TO THE SQUARE FOOT SELLS EQUALLY AS WELL. THIS HAM PRICE LIST LISTS THE ESSENTIAL SIZES OF LARGE MAGNET WIRE, THAT YOU WILL NEED IN BUILDING THAT LOW LOSS TUNER, OR TRANSFORMER, TELLS YOU WHAT WE CARRY IN THE JEWELL METER LINE, GIVES THE DOPE ON FOUR SIZES OF ACME TRANSFORMERS THAT WE HAVE IN STOCK AT ALL TIMES, AS WELL AS THE ACME DOUBLE COIL CHOKES THAT SELL FOR \$8.00. LET US HAVE UR QRA, IN ORDER THAT OUR MAILING LIST WILL BE COMPLETE, AND IN RETURN WE'LL KEEP YOU POSTED ON OUR STOCK AT REGULAR INTERVALS. IN ORDERING FROM US, YOU HAVE THE ASSURANCE THAT WE UNDERSTAND YOUR LANGUAGE, AS WE KNOW OUR STUFF, AND THAT YOU WILL GET SERVICE SECOND TO NONE. BY THE WAY, WHEN ORDERING LEAD, HAVE A HEART AND SLIP US A LITTLE EXTRA JACK TO PAY THE POSTAGE. WE'RE THE ONLY HAM STORE IN THE FIFTH DISTRICT. FT. WORTH RADIO SUPPLY CO., 104 EAST 10TH ST., FT. WORTH, TEXAS.

GREBE CR8, Three circuit tuner, latest model, in original carton. Never used. Must sell, \$50.00. Martin J. Roach, 3006 N. 2nd St., Phila, Pa.

TELEFUNKEN POWER TUBES TYPE RSSc II Price \$16.00; 7 HG using two of these tubes worked Japan (QST, February 1924) 50% discount on the following R.C.A. Faradon condensers and apparatus. U.C. 1803 .000025 list \$5.00, U.C. 1806 .002 list \$7.00; U.C. 1015 .0003-.0005 list \$5.40, U.C. 1831 .0012 variable list \$9.00, U.C. 1820 .0005 variable list \$7.00, U.C. 1819 .005 variable list \$3.75, R.C.A. Rheostats list \$3.00, R.C.A. Hot Wire Ammeters 0-2 $\frac{1}{2}$ , 0-5 list \$6.00, R.C.A. UP 1016 power transformer (750 watt) list \$38.50. Grebe C.R. 9 list \$130, special \$50. ALL APPARATUS NEW AND IN ORIGINAL CARTON. Sent C.O.D. or money order prepaid. Inquiries invited. Arthur Beyer, 106 Morningside Drive, N.Y.C.

2 PLATE reactor UP 415 New, \$3.50 each; 1 filament transformer UP 1658 New, \$6.50 each; 2 transmitting condensers UC 1015 \$2.50 each; 2 Faradon Variable transmitting condensers UC 1831 \$4.50 each; 2 porcelain sockets UT541 new, \$2.00 each; 2 Kenotrons UV216 \$5.00 pair; 1 Acme double  $1\frac{1}{2}$  henry choke. \$3.00; Ray Schweinsberg, Boonville, N. Y.

WANTED—220 Volt A.C., 500-Cycle Single Phase Voltmeter. Also Frequency Meter. Box F, QST.

GREBE CR-13 never used, absolutely guaranteed must sell immediately for \$68.00; send money order or C.O.D.—W. Egerton, 438 Main Ave., San Antonio, Tex.

9DLT totally destroyed by fire. Want all parts for 100 watter or 250 watter. Price them low, OM. Want motor-generator 1000V or 1500V. 9DLT.

RAMSEY'S RADIO REVISED. Price \$2.00 postpaid. For review of first edition see April QST page 50. Eighty four experiments, mimeographed. Note enlarged book brought to date. University Book Store, Bloomington, Indiana.

10-WATT, CW, ICW, Fone bread-board style Colpitts circuit, best parts including Acme filament transformer and 350-V generator running off 110 AC through special transformer and Tungar bulb or rectifier jars shipped complete less tubes and meters for \$40. A real bargain—2WC, 101 Lenox Road, Brooklyn, N. Y.

FOR SALE—Imitation "Paragon" regenerative receiver 140 to 650 meters, with 2 stage amplifier, built in 2 separate units. Looks like commercial product. As for results—have heard amateurs every district and over 75 broadcasters, including California. Price \$75. (plus express) and worth it. Photos on request. Ewald I Winquist, 229 Garfield Ave., Jersey City, N. J.

SELL—Deforest Reflex, forty-five dollars; three thousand volt plate transformer, twenty-five dollars, ten thousand volt, .01 Dubilier, eleven dollars, UV203s for twenty-three dollars, twelve thousand volt, .0002 condensers, five-fifty, alternators, WE fifties, sink rectifiers. Morris Decker, Baldwinville, N. Y.

**SELL**—Esco dynamotor five hundred volt one hundred watt to run from 110 volt DC A-1 condition; first reasonable offer accepted. Write R. A. Ohle, Hadley, Pa.

**TRADE ANYTHING**—What have you, What do you want. Dept. X, General Merchandise Brokerage, Box 641, Atlantic City, N. J.

**SACRIFICE**—SUB'S 20 watt CW and fone transmitting set complete, used only six weeks. Worked all U.S. 3 Can. Districts and heard in London in above time. Cost \$130. goes for \$80 cash. Can easily be adapted to 100 watt set. Two 50 watt tube sockets go with it. Also Reinartz DX receiver Cardwell condensers 80 to 235 meters Two Tube \$15. R. Disheroon, 893 Park Ave., Hot Springs, Ark.

**IVORY RADIO PANEL**—White "Ivorlyte", makes most beautiful set. Guaranteed satisfactory. Any size 1/8" thick. 3c per square inch. Order or sample sent. E. P. Haltom, 614 Main, Dept. T., Fort Worth, Texas.

**SELL**—Honeycomb regenerative set with detector and two stage amplifier. Write Maxwell Murphy, Eastport, Maine.

**AMRAD Type C 50000 V Spark Coil \$28.50 list Amrad Quenched Gaps G2 1/2 KW and G3 1/4 KW or Spark Coil—Stand long CO without Heating. Make Offer, Separate or Lot. J. T. Butler, 155 Court Street, New Haven, Conn.**

**GREBE**—CR-13 never used, absolutely guaranteed, must sell immediately for \$68.00, send money order or C.O.D. W. Egerton, 438 Main Ave., San Antonio, Texas.

**RADIO MOTOR GENERATOR Bargains.** ESCO Motor 220 Volt Direct Current, Generator 500 Volt 200 Watts \$35. Moto General Electric, 220 Volt Direct current, Generator 1000 volt 500 watts \$75.00. Esco double Armature 1000 Volt Generator no Motor. \$60.00. Also others. 500 Volt 200 Watt Generator for belt drive \$25.00 with field rheostat. Queen City Electric Company, 1734 West Grand Avenue, Chicago, Ill.

**RCA Transformers, filters, sockets, meters etc. at 1/2 price.** Send for list. All new. J. Lindauer, 8 Park St., Jersey City, N. J.

**FOR SALE OR TRADE, DE FOREST D7A Receiver with loop—Crosley XV receiver—Hall Relay and Recorder, new type; 2 Kellogg 43 plate condensers; 2 Tuska variometers; Superdyne Receiver; 2 oxy-acetylene Welding outfits. Want 100 Watt Apparatus or what have you got. E. N. Ebeling, Atwood, Kansas.**

**SELL**—R.C.A. Chopper with motor \$9; 50 watt sockets \$1.50; Honeycombs; Reinartz tuner, detector, 1 step, \$25; Va'ley ABC Charger like new, \$12; 1/2 H.P. 110 V D.C. Motor, \$12. 9CVO.

**DRY BATTERIES RECHARGED** for about 5c. Guaranteed easy method 25c (Stamps not accepted). Gruenewalders Laboratories, 719 Catalpa, Webster Groves, Missouri.

**TRANSMITTING storage battery for sale, all or in part.** 800 cell, 1600 volt, 25 ampere hour capacity. Brand new. Never been used. Transparent Pyralene cells, hard rubber separators. 8 cells per unit \$5.75 each. Single cells 80c prepaid. 6 volt 60 ampere storage batteries, brand new, transparent Pyralene cells @ \$50.00, J. Zied, 530 Callowhill St., Phila., Pa.

**MAKE your own transformer, use Magto for the core, its powdered, fill a tube and the transformer is made, highly magnetic, has many other uses, all of which are not known. Throw away your sheet iron and wire, and use powdered Magto. One dollar will bring you five pounds, postpaid. American Chemical Co., 72 First Street, East Youngstown, Ohio.**

**FOR SALE**—Advance sink rectifier slightly used. Write W. Baker, 235 7th Ave., San Mateo, Calif.

**SUBSCRIBE Popular Mechanics \$2.50 year.** Raymond Bernhart, Piqua, Ohio.

**FOR SALE**—Panel mounted CW and fone transmitter includes tubes, meters, transformers, rectifier, filter complete (\$80) sixty dollars. This transmitter located on the Pacific Coast; heard in all districts. Floyd F. Henriot, Winlock, Wash.

**TRANSMITTING AMATEURS Attention**—Don't leave those costly tubes and meters lying around to be

broken. Mount your transmitter on panel. Looks better, works better. QST says so. It's easy to cut those peep and meter holes with my panel tool. Cuts smooth hole one to five inches in diameter; only \$2.50 postpaid or C.O.D. Homer H. Malcomb, Whitewater, Wisc, 9EKH.

**WANTED**—CW and phone transmitter. Must be in good condition. W. M. Hansen, Niles, Mich.

**SELL**—New Acme 200 power transformer. \$15.00. 9CIU.

**FOR SALE**—Neutrodyne Fada one sixty Factory Guarantee. First check \$90, Gets it. A. A. Schamber, Meridian, Miss. 5WH.

**CALLS HEARD POSTAL CARDS (for DX reports).** Send \$1.00 with your name, address and call letters for 100 (\$1.75 for 250) DX report postal cards printed in two colors. Call letters red, green, yellow, or blue. Complete form for description of your station, etc. State if member of A.R.R.L. Cards also printed to order; prices upon application. Twenty-four hour service. Samples on request. Printed by 9AVO—member A.R.R.L. Radio Print Shop, Box 582, Kokomo, Ind.

**LOW LOSS**—Schnell type coils, \$3.00 per set; other types to your specifications; 9.8 to 1 gear for coils, \$1.75; General Radio Material: condenser, .00225 plain \$2.90, geared \$4.60; sockets, \$.95; Amplifying transformers \$4.50; UV201A'S, \$4.50. Let us know your needs. Watch for more low loss. Postpaid east of Mississippi. Frosell Radio Laboratory, South Williamsport, Penna.

**NAVY TYPE (CW W938A) transmitter receiver; switchboard, power amplifier, remote control, box, spare part box and parts, loud speaker, 3VT2, 5VT1, 2 microphones, key phones, 2 generators, all above Western Electric goods, new, used two weeks. \$275.00 Write, Ernest Roy, FINDERNE, N. J.**

1/2 K.W. Spark, complete and ready to operate, with Rotary spark gap, and ammeter, \$20. Frank D. Sutton, Sparta, Tenn.

**FOR SALE**—GREBE Demonstrator CR-8 with Rork amplifier complete \$75. Baumgartel Radio Co., 537 Coit Ave., Grand Rapids, Mich.

**FOR SALE**—Fada No. 160 Neutrodyne Receiver \$98.00 Thompson Neutrodyne Receiver, \$98.00 Grebe CR 8 Set with Rork Amplifier, \$75.00; R-3 Magnavox, \$24.00 Air Magnavox, \$35.00; Old type Michigan 3 tube set, reg. price \$125.00 now \$30.00. M-1 Magnavox \$22.00. FF DC Charger, \$11.00. We guarantee each item to be electrically and mechanically perfect but slightly shopworn. Commonwealth Appliance Company, 382 Robert St., St. Paul, Minn.

**MASTER RADIO CODE IN 15 MINUTES.** Ten word speed 3 hours. Our Students made these world records. Failures all methods thank us for License. Hesitation kills speed. Our method kills hesitation. Instructions that instruct only \$2.00. Qualifying records 100 students free. Dodge Radio Shortcut, Dept. SC, Mamaroneck, N. Y.

**CHARGE YOUR OLD DRY CELL B BATTERIES**—No charger needed; absolutely no expense, enclose 50c for information and receive a large radio map free. Lee West, 112 Medford St., Arlington, Mass.

**A BARGAIN**—Special Built Honey Comb Coil receiver with long and short wave coils, det and 2 step amplifier. All answered. Carl Cardin, Cushing, Okla.

**30 HENRY CHOKES**—current rating 750 milliamperes, \$10. Wavemeter, range 40.5 to 115 meters, \$18. 3PZ-3XO.

**ANY LICENSED HAM CAN** after memorizing Code our way (15 minutes) quickly increase speed. Many anchored at about 12 per now do 25 per. Reports corroborating this statement free but please give call. Dodge Radio Shortcut, Dept. SC, Mamaroneck, N. Y.

**WANTED**—Motor-Generator Set 1000 or 1500 V.D.C. 400 watts or over. Motor 60 110 V. Specify make, condition and price in first letter. 5VI, 327 St., Charles St., New Orleans, La.

**SELL GREBE AND STAHL SINK!!!** Why? Need money. Both perfect condition. Sink passes THOUSAND WATTS easily, hasn't "slipped pole" yet, perfect. Nuff sed. Highest offer takes both. 9CP.

MANY BEGINNERS ANCHORED AT about 5 per now thank us for License. Qualifying records 100 Licensed Students free. Dodge Radio Shortkut, Dept. SC., Mamaroneck, N. Y.

INDIVIDUAL PRINTED TO ORDER Q-S-L CARDS. 500 CALL CARDS—BLACK PRINTING—LARGE RED CALL LETTERS, \$4.00. SAMPLE CARDS FROM EVERY DISTRICT 10c. A.R.R.L. CUT USED IF WANTED BY MEMBER. TWO COLOR B-C-L CARDS AT THIS PRICE ALSO. CASH WITH ORDER. A.R.R.L. MEMBER, CURTIS, 1109J. 8TH AVE., FORT WORTH, TEXAS.

FOR SALE—One Acme CW Inductance \$5.00. 1/4 K.W. Acme Power Transformer with Marconi Rotary \$15.00. 9AZN.

EDGEWISE WOUND COPPER RIBBON—1/8" wide outside diameter; 5 inches 12 cents; 6 inches, 15 cents; 7 1/2 inches, 17 cents per turn. Genuine new Remler Gblin and Deforest coils mounted on bakelite plugs 100-150-200-300-400-500-750-1000 turns half list price. Pure sheet aluminum 1/8 inch 80 cents; 1/2 inch \$1.60 sq. ft., postage extra 1/4" 2 lb., 1/4" 3 lbs. No C.O.D. on aluminum. Genuine silicon transformer steel, cut to order, 25 cents pound, 10 pounds and over, 4 cubic inches weigh 1 pound, postage extra, Bakelite panels up to 5" wide any length, 1/8" thick, 1 cent square inch, 100 inches and over, postage 2 lbs. to 100 inches extra. Geo. Schulz, Calumet, Mich.

SPECIAL for neotrodynes and super-hetrodynes. 2000 milli amp capacity, 48 volt Edison element storage B batteries \$9.00. 100 volt, 1000 milliamp storage B, complete, \$12.25. Type A elements 5c. Type G 3c. No. 20 Grade A pure nickel wire 1c per ft. Rubber tubing 3c per ft. Separators 1/2c. 3/4x8" container 3c. 40 cell knocked down rack, \$1.25. 78 cell rack \$1.95. Rubber stoppers for 3/4" tubes 3c. J. Zied, 530 Callowhill St., Phila, Pa.

MOTOR GENERATOR WANTED—350 or 500 volt. Give full description and price. Robt. G. Starrett, Sheldon, Iowa.

FOR SALE—Fifty watt Radiotron, absolutely new \$24. Clapp-Eastham 0-10 H.W.A. \$5.25 Radio Corp. 0-15 ampere rheostat \$7.50. SATX.

WILL SELL my Grebe CR-8, guaranteed good as new, for \$60.00. G. Atchison, 3712 Roosevelt Ave., San Antonio, Texas.

DON'T BUY MUD for that short wave set. Radio Corp Porcelain Sockets, seventy-five cents; Freeman Porcelain Sockets, forty cents. Superior Coil Company, Harwichport, Mass.

PURE SHEET ALUMINUM AND LEAD 1/8" 75c SQUARE FOOT, 9DVK.

EXCHANGE Radak Receiver for Transmitting Equipment. What have you? Rexford De Tompkins, Ottawa, Illinois.

GREBE CR8, 3 tubes, Baldies, complete parts for 2 step, Burgess 45 volt battery, worth \$125.00. Will take best offer. Irvin Ellman, 1012 E5 St., St. Paul, Minn.

300 WATT Acme Transformer \$17, also parts for 100 volt Edison B battery, Cheap. 2BQC.

MORE BARGAINS—3 UV-204's at \$70, new; two ampere Tungar charger with bulb, \$10; 2 50 watt rheostats at \$4.50; 2 pair mountings for UV 204, at \$1.25; 1 UV-712 9-1 RCA transformer, \$3; RCA hotwire 0-2.5 ammeter, \$2.50; 1/4 KW quenched gap, \$1. Derrick, 58 North Sixth, Newark, N. J.

\$10,000 WORTH of Radio Transmitting and Receiving Sets, Marconi Generators, Condensers and Parts of Transmitting and Receiving Sets. Head Sets with Helmet, having Receiving and Transmitting Attachments, \$5 each. Postage free. All merchandise bought from the U. S. Government Aircraft Department. We will sell at reduced price. Special attention given to radio and transmitting experts. Mail orders answered. Weil's Curiosity Shop, 20 S. 2nd St., Philadelphia, Pa.

COMPLETE RECEIVER—Grebe CR5, Rork, R3 Magnavox, Brandes Fones, Marko 80 Hr. Battery, Hom Charger, Tubes, \$165.00, All A1 condition. Arthur Williams, Jr., Holliston, Mass.

100 METER coil and complete data for Reinartz Circuit. Postpaid \$1.50. Superior Coil Co., Harwichport, Mass.

TEN WATT SET parts, all Radio Corp. make, 0-500 DC voltmeter, \$7.50; 0-2.5 thermoammeter, \$5; 0-250 milliammeter, \$5; ten 1/2 mfd. 750 volt filter condensers, 75c each; 325 watt transformer, \$11.25; 25 henry choke, \$6; filament bypass condenser, double unit \$1; two rheostats, \$1.25 each; Arscis, 10 Beecher, Newark, N. J.

AMATEURS—Expert Tube Repairs by 3BOV at HAM Prices only such as U.V. 200, 201, 201A, 199, WD11, \$2.50; 202, \$3. etc. All Guaranteed with 24 hours sure Service. S. Strobel, 3923 N. 6 St., Phila, Pa.

50 to 75% DISCOUNT on all RCA transmitting parts. Frinstance: 750 watt transformers list \$38.50, \$20.00; chopper wheels, list \$7.25, \$3.00; antenna ammeters, list \$6.25, \$2.50; everything guaranteed. Get complete list. William Golden, 2AEN, 680 West End Ave., New York.

WILL TRADE Royal Typewriter for Transmitter. Ben C., 1904 E. 79, Cleveland, O.

SELL—Thordarson T-1 transformer, \$12, Racine fan motor, \$4, Hawkins Guides, \$5. Paul Potter, Riceville, Iowa.

LITZ WIRE green silk two cents per foot. Postpaid. Superior Coil Co., Harwichport, Mass.

BEST PRICES you ever saw. Astounding discounts on nearly all RCA goods. PR535 Rheostats \$1.35; PT537 Rheostats \$6.50; UP1368 Power Transformers \$14.50; UP1653 160 mill. Filter Reactors \$7.25; UP1627 300 Mill. Filter Reactors \$10.45; PX1638 Choppers with brush \$3.60; Magnetic Modulators, all sizes half price; Kenotrons half price; UM530 2 1/2 amp HW Meters \$3.50; UM533 5 amp. Meters \$3.65; RCA milliammeters, Plate Voltmeters, Thermo-ammeters, about 40% off. Write for complete list. Shipments COD, no deposit required. We trust any Ham. Quantities limited, order early. E. F. Johnson, 9ALD, Waseca, Minn.

FOR SALE—two 1500 Volt, 500 Watt Motor Generator Sets, Motor end 110 Volt Direct Current. Price each \$75.00, complete with field rheostat and starting box. Queen City Electric Company, 1734 W. Grand Avenue, Chicago, Illinois.

HAMS—Get our samples and prices on printed Call Cards in One, Two, and Three Colors. Also Radiograms, Letterheads and Envelopes. Hinds & Edgerton, 19 S. Wells St., Chicago, Ill.

FOR SALE—All standard radio apparatus at 10% off list. SDKL.

R & M motor-generator set 500 V, 200 watt \$55. Other apparatus for 20 watt CW and phone. For particulars, address, J. England, 321 Trowbridge Ave., Detroit, Mich.

SELL—JEWELL Wavemeter \$10, list \$20; Sleeper variometer \$4.00, list \$7.00; Acme R-3 \$2.00, Coto Coil Radio transformers \$2.00. Everything new. Back issues, QST and Modulator. McAllister, 209 Hoyt St., Brooklyn, N. Y.

SELL—Fifty watt transmitter, Western Electric tube, complete or parts. Carlton Fidler, Box 303. Fort Lauderdale, Florida.

ATTENTION RADIO AMATEURS—We can supply the following: R.C.A. Transmitting apparatus, R.C.A. receiving apparatus, Paragon and Zenith receivers, Murad Supreme receivers, Atlas Loud Speakers. Write for Bulletin and Price List. The Amateur Radio Supply Shop, 525 Park Ave., Kent, Ohio.

MAGNAVOX R3—Latest nationally advertised reproducers; electrical modulator. List \$35. Introductory \$25. The factory sealed carton is your guarantee. Radio Central, Dept. Q, Abilene, Kansas.

FOR SALE OR TRADE—Dubilier Condenser, .01MFD., 25,000 volt. 9AZH.

FOR SALE—2 Crosley Sheltran transformers 9 to 1 ratio. \$2.00 each, also 5 x 7 plate camera if interested. Write Fay Allarding, Lake Odessa, Mich.

FOR SALE—Grebe 13. New. \$65.00. A. H. Hardwick, E. Highland Avenue, Orange, N. J. 2PD.

150-250 METER Spiderweb coil, No. 18 wire for Reinartz Circuit. Postpaid \$1.50. Superior Coil Co., Harwichport, Mass.

ACME 375V Transformers \$8.00. R. Fuller, Ypsilanti, Mich.

WAVEMETER—General Radio, Type 174, new as per used \$60.00. Western Electric 2A current supply or 7A amplifier, never used, \$55.00. Two Westinghouse generators 27-350 V. in cradle \$15.00. Fifteen dual omnigraph, used two months \$22.00. Model C Experimenter's Information Service Super Heterodyne \$175.00. Western Electric 10D Loud Speaker \$35.00. W. E. Thompson, 506 Fort Washington Ave., New York City.

I HAVE NO need for two sets, will sell, absolutely new, Paragon RA-10 and detector 2 stage, for \$105.00. Clifford Tatom, 301 Marshall St., San Antonio, Texas.

FOR SALE—Sherman 100 watt, 500 volt motor generator speed 3500, 56 bars. Guaranteed factory cond. \$58, cost \$75. Acme det. 2 step, never used \$30. 3 tube, 3 ckt. receiver, best parts thruout, guaranteed, an excellent receiver \$50.00. We swap sets for 50 watt parts. What have us? 9DRS.

RADIO GENERATORS—500 volt 100 watt \$28.50 Battery Charging Generators \$8.50, High Speed Motors Motor Generator Sets, all sizes. Motor Specialties Co., Crafton, Penna.

KNOCKED DOWN—50-150 Meter receivers, detector and one stage. Panel drilled ready to assemble and wire. Best of parts. Price \$20. Superior Coil Company, Harwichport, Mass.

HAVE THE BEST aerial in your part of the state. Don't be fooled with something "Just as Good." Ohio Brass Co. Porcelain Antenna Insulators absolutely the best. QST says so. 5" 75c, 10" (glazed all over). \$1.50. Postage allowed to 3rd zone. Flux distributing shields added \$1.00. A bright shimmering aerial sure does make em pound in. Don't use your aerial for a grid leak? Keep it clean. No. 12 solid copper enameled aerial wire stays new. Easy to put up, doesn't wrap around your neck, nor become brittle. 1c a foot, postage allowed to 3rd zone. Radio 8ML, 4837 Rockwood road, Cleveland, Ohio.

RADIO CORP TRANSMITTING PARTS—all brand new and guaranteed. 0-1500 DC voltmeter, \$10; 0-5 thermoammeter, \$6; 0-500 milliammeter, \$6; 1/4 mfd. 1750 volt filter condensers, \$1; .002 mfd. 6000 volt mica condenser, \$1.50; 325 watt transformer, \$11.25; 750 watt transformer, \$15; chopper wheel, \$1.50; 40 henry choke, 300 MA, \$8; mercury variable condenser, \$1.25. 2 AHO 53 North Sixth, Newark, N. J.

IF YOUR Neutrodyne won't "Neut" O.K., send 10c for details of Kladag Coast To Coast circuit, bill of materials, etc. to change over your Neut into a set that will bring them all in from Mexico City to Tunucu, Cuba, on a loud speaker. Or send \$5.00 for all extra parts, blue print, etc. you need to do this. Stamps accepted. Radio list for stamp. Super Heterodyne specifications, 10c. Kladag Radio Laboratories, Kent, Ohio.

MAKE \$120 WEEKLY IN SPARE TIME. Sell what the public wants—long distance radio receiving sets. Two sales weekly pays \$120 profit. No big investment, no canvassing. Sharpe of Colorado made \$955 in one month. Representatives wanted at once. This plan is sweeping the country—write today before your county is gone. OZARKA, 853 Washington Blvd., Chicago.

\$12. EACH takes Ohio or Wagner synchronous 110 volt sixty cycle eighteen hundred R.P.M. motors built in 1/2 H.P. frames. Can be used as power motors. Highest quality 1 1/2" x 6" test tubes \$3.00 gross. Perforated hard rubber separators 1 1/4 c. No. 20 99% pure nickel wire \$1.50 per hundred feet. Kimley Electric Company, Inc., 2685 Main St., Buffalo, N. Y.

IF YOUR B is on its last legs don't buy another dry cell—They go dry sure nuff these hot days, and a lead B needs a nurse when you're away. An 8ML Edison B for summer Radio. Use it or abuse it, it's all the same.

FOREIGN amateurs, KDKA and WGY pound in on low waves. Blueprint and complete data for One Dollar. Low loss condensers, eleven plate, three dollars, twenty-three plate three fifty. Send stamp for complete list. Superior Coil Company, Harwichport, Mass.

TELEGRAPHY—Morse and Wireless—taught at home in half usual time and at trifling cost. Omnigraph Automatic Transmitter will send, on Sounder or Buzzer, unlimited messages, any speed, just as expert operator would. Adopted by U. S. Govt. and used by leading Universities, Colleges, Technical and Telegraph Schools throughout U.S. Catalog free. Omnigraph Mfg. Co., 16M Hudson St., New York.

LOCAL RADIO representatives wanted for special work at convenient hours. Full information. Maitland Roach, 2905 Columbia Ave., Philadelphia.

\$1100 IN RADIO EQUIPMENT, some used in one or two experiments, rest new—most anything a transmitting amateur requires at 10% to 50% off. Sets, tubes, wire, parts, new hardware, vioprolex. Will quote. Grahak Laboratory, 2029 West 52 Cleveland.

GREBE CR9 Receiver for sale cheap excellent condition not a scratch on it. Have received California and Cuba. \$75 cost \$130. Orton Barnes, Binghamton, N. Y.

FOR SALE—Grebe 13, cost \$95.00 sell for \$68; haven't time to use. Used two weeks. L. M. Ripple, 1601 2nd St., N.E., Canton, O. Radio 8JU.

PURE SHEET ALUMINUM AND LEAD 1/4" 75c SQUARE FOOT, 9DVK.

NEW R.C.A. Stuff cheap! 750 watt transformer, \$22.50; 4,000 volt variable mercury antenna condensers \$4.00; Grebe CR2 \$22.50. 2WZ.

FOR SALE—Special cabinet, honeycomb, detector and two stage amplifier receiver. Fine performance. Fine appearance. NOT home-made, \$85. Also Paragon RD-5 new, \$45. Prescott Smith, Phi Kappa Psi House, Amherst, Mass.

PURE DC FOR THE PLATES—New 1500 volt 500 watt General Electric dynamotors operating from 24 volts. \$45. Holtzer-Cabot 500 volt .07 ampere for 12 volts. \$22. General Electric 350 volt .143 ampere for 12 volts with filters \$18. Either of above for belt drive \$3. additional. When driven will also develop current for filaments, etc. General Electric fone, cw, icw transmitters originally costing \$350. new—complete with two tubes, dynamotor, spares, etc. \$75. Portable. Operates from 12 volts. 500 cycle generators with and without motors. 10000 watters \$150. W.E. 50 watters \$25.00. Henry Kienle, 501 East 84 Street, New York.

ORS A.R.R.L. is certificate proficiency. List our students holding this appointment also records rapid progress, quick success free. Dodge Radio Shortkut, Dept. S.C. Mamaroneck, N. Y.

FOR SALE—Parts for 100 watter. Other CW and spark parts. Write for Bargain List. 9ABV.

PURE SHEET ALUMINUM AND LEAD 1/4" 75c SQUARE FOOT, 9DVK.

MUST SELL OUT at once complete stock, or in parts, of receiving equipment at less than wholesale. A few bargains: Regenodyne Dial Coil \$3.75; 30 ohm rheostats \$0.45; switch levers \$0.15; Porcelain sockets \$0.20; 41 Jefferson Transformers \$2.85; Kellogg Couplers \$7.25; Autoplex Variometers \$1.50. Write for list. Radio Shop, Belmond, Iowa.

BETTER PRINTING at a more consistent price. Quality Press, Canton, Ohio.

SELL—2 Grebe Rorn, \$25.00; CR-3, \$30.00; Rord, \$40.00; Amrad Short wave, \$25.00; 1-Step set, \$20.00; 75 watt Acme transformer, \$11.00; Thoroophone, \$25.00; Michigan Variocouplers, \$2.50; Model C superheterodyne \$200.00 with storage B, loud speaker etc. Write for list. 9DVK.

PURE SHEET ALUMINUM AND LEAD 1/4" 75c SQUARE FOOT, 9DVK.

DUBILIER MICA Condensers, Limited Quantity, Type C.A.3. .004, 8500 volts. Excellent for C. W. and spark. Price \$3.50 prepaid. F. A. Alexander, 62 West 14th St., New York, N. Y.

FOR SALE—Ten watt C. W. Transmitter Parts. Never been used. Victor E. Furman, Lebanon, Ohio.

FOR SALE—100 watt CW & Fone complete, Excellent transmitter, \$275.00 with microphone and key. Portable 15 watt cw & fone in cabinet \$15.00. Complete 1/2 KW spark transmitter apparatus \$50.00. Portable 10 watt cw & fone in cabinet \$15.00, wonderful record. Detector unit in cabinet \$7.00. 3 circuit regenerative tuner \$20.00. Single circuit tuner in cabinet \$18.00. Other extra receiving and transmitting apparatus obtains. (9cly) F. G. Packwood, Chaffee, Mo.

GREBE SETS at a Sacrifice—brand new stock—Never been used: 1 CR-5, 1 CR-8, 1 Rord, 1 Rork also 1 OT-3 DeForest Midget Radiophone, never been used, \$49.00, M. M. Fleron & Son, Inc., 113 No. Broad St., Trenton, N. J.

158 GENUINE Foreign Stamps. Mexico War Issues. Venezuela, Salvador and India Service Guatemala, China, etc., only 10c. Finest approval sheets 50 to 60%. Agents Wanted. Big 72-p. Lists Free. We buy stamps. Established 20 years. Hussman Stamp Co., Dept. 151, St. Louis, Mo.

REAL ANTENNA INSULATORS—10 inch porcelain, 90 cents each, Lorain Radio Supply Co., Lorain, Ohio.

TRANSMITTING—Grid leaks, 5W. RCA \$1.10. RCA Filter Reactors UP1626, 5W. size, regular 1250, special price, \$6.00. Philadelphia Wireless Sales Corp., 133 N. Eleventh St., Phila., Pa.

ATTENTION AMATEURS—FOR SALE: Western Electric tubes \$28; 203A tubes \$25; 250 watt western electric \$110; R.C.A. Radiation meters (hotwire 0-2.5-0-5) \$2.90; thermocouple TYP-0-2.5 0-5 \$7.50; 0-1500 volt-meters (with external resistance) \$15; 0-500 volt-meters with external resistance \$10.00; 0-250 and 0-500 millimeters \$7.50; large assortment of filter condensers in stock; Faradon antennae series condenser \$2.50; Crocker-Wheeler 1/2 kilowatt 500 cycle generator and exciter; Westinghouse 30-350 DC volts Dynamos \$15.00 each; \$25.00 for set of two; with gas engine drive. Best offer gets it. Large 7/8" bakelite sheets 36 x 36" good for transmitter panels at very low prices. New Federal modulation transformers \$4.25; R.C.A. Plate and filament transformers; 750 watts \$25.00; 325 watts \$17.00; 1000 volt 250 watt New Westinghouse A.C. motor generators \$110.00. See us for your transmitter wants. Our stock too big to enumerate. Troy Radio Company, 1258 St. John's Place, Brooklyn N. Y. Tel. Decatur 6139J.

A REAL BUY—Single circuit set special design with very selective properties, two stage amplifier for \$35; UV201 and UV200's for \$2.75; Various receiving parts, all in A-1 condition; all letters answered. H. T. Opsahl, Barnesville, Minn.

SUPER-Heterodyne—Build your own—The best circuit. Four Air Core transformers (no iron), baseboard and panel layouts, and circuit, price \$25.00. Also complete parts, including drilled and engraved panel, solder—everything except cabinet \$85.00. 2LO on a loop. Agents wanted. Philadelphia School of Wireless Tel. 133 N. Eleventh St., Philadelphia, Est. 1911.

FOR SALE—250 watt G. E. Tube never been used; tested out at WGI, \$65.00; Leslie Williams, 40 North St., Salem, Mass.

FOR SALE—Slightly used two—43 plates 2—23 plates, 1—3 plate Sexton condensers at \$2.00; 1 Crosley "D" condenser; 1 Crosley Va-rind at \$2.00; 2 UV 201 at \$2.50; 1 WDT 2 1 WD 11 at \$2.00; 1 Federal No. 400W Pleiophone \$5.00; 1 Weston 0-100 M.A. \$5.00; 1 UC 488 1 Mfd. cond. \$1.00. 1 Weston model 439 0-8 0-150 voltmeter new \$7.50; 1 Western Electric 10-D Loudspeaker used one week \$40.00; 1 home charger excellent shape \$6.00; everything in great shape, first money order gets them. Alfred S. Werhan, 872 Kenyon St., Akron, O.

FOR SALE—GREBE CR-13 Cost \$95. brand new with tubes \$55.00; reason need money. H. Jacobson, 1928 Sherman, Evanston, Ill. 9EDZ.

FOR SALE—One ten watt CW transmitter complete with power transformer and everything except tubes, 50c; one Reinartz tuner and two stage complete with tubes and battery less "A" battery. Both working excellent. Rec. set. \$75.00. 9EEI, Frank Schnepfer, Cresco, Ia.

## Q R A SECTION

50c straight, with copy in following form only: CALL — NAME — ADDRESS. Any other form takes regular HAM-AD rate.

1AIXT—Reassigned to Philip Michel, West Suffield, Conn.

1AXU—Leonard B. Randall, Benneck St., Orono, Me.

1BX—Richard B. Hodskins, 24 Converse St., Longmeadow, Mass.

1XAS-1ZI—Harris Fahnestock, Jr., Lenox, Mass.

2AGM—C. C. Fingar, Jr., 353 Union St., Hudson, N. Y.

2DV—Frederic R. Colie, Woodcrest Ave., Millburn, N. J.

2FO—J. V. Settle, 32 Dodd St., E. Orange, N. J.

Canadian 3GG—M. J. Caveney, Lat. 48, Long. 81 near TIMMINS, Northern Ontario, Canada.

Canadian 3GV—Alan G. Simmons, Ottawa, Canada.

3XAR-3IW—124 Villa Road, Clarendon, Va.

4PT—A. J. Barclay, Box 1662, Tampa, Florida.

4TT—E. V. Erickson, 620 W. Adam St., Lakeland, Fla.

4XE—Cooper and Lee, Ortega Fla.

5AIL—Thos. H. Holmes, 573 College St., Beaumont, Tex.

5ACJ—W. E. Lott, Jr., Mineola, Texas.

5WI—L. B. Hallman, Jr., 508 S. Oats St., Dothan, Ala.

6AWZ—A. Roy McGregor, 749 Farrington, Burlingame, Calif.

6CPJ—Frederic W. Procter, 1103 Armada Drive, Pasadena, Cal.

6DO—Norman A. Woodford, 440 Tenth Street, Richmond, Calif.

6HQ—Robert Johnson, 5th and Central Ave., Ontario, Calif.

6XBQ—L. Picker, San Ysidro, Calif.

6ZCD-6ACM—W. A. & L. W. Newman, 2130 Emerson St., Palo Alto, Calif.

7JH—Box 5, Pendleton, Oregon.

ALASKAN 7LL—Albert Johnson, Northwestern Fisheries Co., Kenai, Alaska.

8CKM—Chas. Ross Acklin, 1233 Kenneth Ave., New Kensington, Pa.

8DIV—Lyle B. Dusenbury, 216 Liberty St., Pontiac, Mich.

8DNN—Slidell B. Wolfe, Beverly Hill, Kingwood, W. Va.

8ZQ es 8CVD—Warren F. Copp, 92 E. Dayton St., West Alexandria, Ohio.

9EGS—C. C. Patten, 605 Howard Ave., Carthage, Mo.

9AQB—Herbert A. Turner, Box 512, Carthage, Missouri.

9BQK—Malcolm McGregor, 815 Clark St., Warsaw, Ill.

9CSE—J. L. Teats, P. O. Box 106, Elk City, Kas.

9E-G-S—C. C. Patten, 605 Howard Avenue, Carthage, Missouri.

"THE AIR IS FULL OF THINGS YOU SHOULDN'T MISS"



## More Power for Summer Radio

WHEN you take radio away with you—take Eveready Radio "A" and "B" Batteries, the batteries whose great power lasts longer. Remember, summer's the time when radio signals are weaker.

Batteries do get used up in time. The ones you've been using, though partly exhausted, may be satisfactory for the strong winter signals, but are probably inadequate for the weaker summer signals.

For a "B" Battery use the familiar standard 22½-volt Eveready "B" Battery No. 766. It has variable taps for "soft" detector tubes. Put two, three or four in series to provide sufficient power for amplifying tubes.

To light the filaments of your dry cell vacuum tubes for the longest time, use Eveready Dry Cell Radio "A" Battery No. 7111. The Eveready "A" will astonish you by its long-sustained vigor. It is advisable to use two Eveready "A's"

connected in multiple for each WD-11 or WD-13 tube—this gives the "economical eighth" ampere drain per cell which insures maximum economy and longer life. For sets employing one to three UV-199 tubes use three Eveready Dry Cell Radio "A" Batteries No. 7111 connected in series.

The greatest electro-chemical laboratory known created these famous dry cell batteries on which radio largely depends. The experience of thirty years in battery making stands back of them.

Buy Eveready Radio "A," "B" and "C" Batteries—lively, peppy, long-lived producers of power.

For your light-weight sets to take camping or on hikes, Eveready has suitable small batteries.

Manufactured and guaranteed by  
NATIONAL CARBON COMPANY, Inc., New York, San Francisco  
Headquarters for Radio Battery Information  
Canadian National Carbon Co., Limited, Toronto, Ontario

Informative and money-saving booklets on radio batteries sent free on request. If you have any questions regarding radio batteries, write to G. C. Furness, Manager, Radio Division, National Carbon Company, Inc., 124 Thompson Avenue, Long Island City, N. Y.

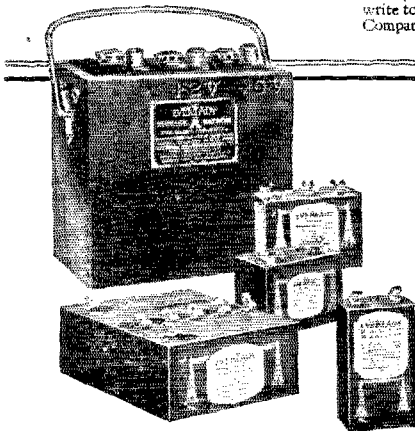

# EVEREADY Radio Batteries

*- they last longer*



—FOR YOUR CONVENIENCE—

# QST'S INDEX OF ADVERTISERS IN THIS ISSUE

Acme Apparatus Co., The.....	2	Jefferson Elec. Mfg. Co.....	66
Alden Mfg. Co., The.....	62, 80	Jewell Elec. Instrument Co.....	80
Allen-Bradley Co., The.....	61, 96		
American Hard Rubber Co.....	84	Kellogg Switchboard & Supply Co.....	77
American Radio & Research Corp.....	4th Cover	Kimley Electric Co.....	30
American Sales Agency.....	52-85		
American Transformer Co., The.....	70	Leach Relay Co.....	56
A.R.R.L. Application Blank.....	36, 88	Lincoln Mfg. Co.....	73
A.R.R.L. Shield.....	88		
		Magnavox Co., Inc.....	75
Bakelite Corporation.....	81	Marie Engineering Co.....	30
Ballard, R. C.....	56	Murdock, William J.....	63
B-Metal Refining Co.....	87	Myers Co., Ltd., E. B.....	35
Boonton Rubber Mfg. Co.....	64		
Brady Co., A. C.....	70	National Co., The.....	60
Bristol Co., The.....	84	National Carbon Co., Inc.....	94
Bunnell & Co., J. H.....	27	Newman-Stern Co., The.....	73
Burgess Battery Co.....	57		
Burton-Rogers Co. ....	84	Ott Radio, Inc.....	69
		Premier Elec. Co.....	87
Cardwell Corp., The Allen D.....	35	QST Back Copies.....	76
Chelsea Radio Co.....	80	Radio Corp. of America.....	1
Chelten Elec. Co.....	66	Radio Engineering Lab.....	68
Connecticut Tel. & Elec. Co.....	3rd Cover	Radio Printers.....	60
Coto-Coil Company.....	64	Radio Tube Exchange.....	84
Crescent Radio Supply Co.....	56	Rauland Mfg. Co.....	86
Crosley Mfg. Co.....	58, 59	Roller-Smith Co.....	76
Cunningham, E. T., Inc.....	2nd Cover	Rose Radio & Elec. Supplies.....	74
Daven Radio Co.....	78	Shamrock Mfg. Co.....	32
Diamond State Fibre Co.....	87	Signal Elec. Mfg. Co.....	74
Duplex Engine Governor Co., Inc., The.....	68	Stahl Rectifier Co.....	60
Durham & Co.....	85	Stromberg-Carlson Telephone Mfg. Co.....	66
Eby Co., H. H.....	56	Thordarson Elec. Mfg. Co.....	73
Eisemann Magneto Corp.....	66	Toaz Engineering & Sales Co.....	62
Electric Specialty Co.....	55	Tower Mfg. Co.....	32
Empire Radio Corp.....	37		
Endly, C. C.....	32	U. S. Tool Co. ....	64
		Westinghouse Elec. & Mfg. Co.....	67
Fansteel Products Co., Inc.....	72	Westinghouse Union Battery Co.....	79
Federal Tel. & Tel. Co.....	70	Weston Electrical Instrument Co.....	62
Fleron & Son, Inc., M. M.....	76	Whittlesey Engineering Corp.....	60
Freshman Co., Inc., Charles.....	72	Winkler-Reichmann Co.....	72
Frost, Herbert H.....	74		
		Y.M.C.A. Radio School.....	85
General Instrument Corp.....	87	Zenith Radio Corp.....	73
General Radio Co.....	63		
Goldschmidt Corp., Th.....	71		
Grebe & Co., A. H.....	4		
HAM ADS.....	89-93		
H & H Radio Co.....	52		
Hartford Instrument Co., The.....	62		
Heath Radio & Elec. Mfg. Co.....	56		
Hommel Co., Ludwig.....	74		
International Correspondence Schools.....	84		

ALWAYS MENTION Q S T WHEN WRITING TO ADVERTISERS

# Adjustable Resistors

## for Radio Circuits



### —Ranges—

Bradleyohm-10 10,000 to 100,000 ohms

Bradleyohm-25 25,000 to 250,000 ohms

Bradleyohm-50 50,000 to 500,000 ohms

Retail Price—\$2.00

Radio experimenters are all greatly interested in the recent announcement of the new Bradleyohm. This is an adjustable resistor made especially for radio circuits and is one of the regular Allen-Bradley products. Like the Bradleystat and Bradleyleak, it is adjustable over a wide range without steps or jumps. The range of control obtainable is indicated in the table for the three types of Bradleyohms now on the market.

The Bradleyohm is ideal for shunting audio-frequency transformers and for numerous other applications requiring a high resistance for coupling or other purposes.

Write for latest circular on this wonderful addition to the famous Allen-Bradley line of radio products.

**Allen-Bradley Co.**

Electric Controlling Apparatus

277 Greenfield Ave.

Milwaukee, Wis.

Manufacturers of the Bradleystat & Bradleyleak.

*Use the*  
**Bradleyohm**  
**THE PERFECT RESISTOR**

# LOW LOSS

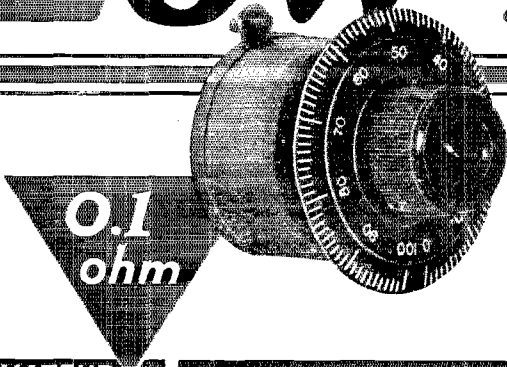

0.1  
ohm

AMATEUR  
150 RANGE 220

226

BROADCAST RANGE

546

## The Test That Tells the Truth

The test which established the resistance of the

### CONNECTICUT

#### Triple Range Variable Condenser

as 0.1 ohm at a capacity of 330 micro-microfarads on a 215 meter wave length shows this to be one of the most efficient instruments of its kind yet developed.

This was a real test—and it tells a real story.

Had it been made in the usual way—by measuring the resistance of the condenser at a certain capacity at 1,000 cycles, audio frequency—it would not give you any more than a general idea of its efficiency—

But because the test was made at a wave length well within the range of amateur and broadcast work—

Because the resistance was measured at radio—not audio-frequency—and

Because the result obtained was secured under the same identical conditions you encounter in every day receiving—

It not only gives you an accurate indication of the losses in this instrument but it gives you a true idea of the extent to which it will increase the selectivity and the signal strength of your set.

#### Triple Range—Three Condensers in One

This is the condenser which enables you—by a few simple changes in the wiring connections, to cover the full field of usefulness with a single instrument.

It is three condensers in one.

The chart tells the story—

The range indicated by Curve B—from .000075 to .000275 mfd.—approximately that of an eleven plate condenser, is secured by wiring into the circuit from posts G and B.

The range indicated by Curve A—from .0001 to .0006 mfd.—approximately that of a twenty-three plate condenser, is secured by wiring into the circuit from posts G and A.

The range indicated by Curve AB—from .00015 to .00085 —approximately that of a forty-three plate condenser is secured by bussing A and B and wiring into the circuit from G and B.

**FEATURES: Vernier Scale—Complete Shielding—Compact Size  
And all the convenience that goes with One-hole Mounting**

**PRICE \$4.50**

Complete with dial, index stud, spacing washers and buss bar.

Send for Bulletin A-104 describing this unique instrument, with information and diagrams illustrating its special applications.

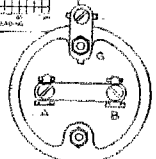
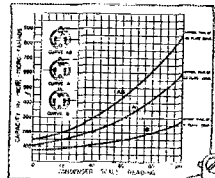

**CONNECTICUT**  
MERIDEN

**TELEPHONE  
& ELECTRIC**  
RADIO DIVISION

**COMPANY**  
CONNECTICUT



# AMRAD

## The Famous Inductrole

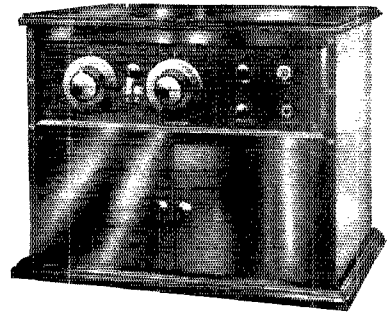

Price Only \$100.

### *Use of Amrad Basketball Variometers Assures Real Selectivity*

All of the latest AMRAD Sets including the "Inductrole" are tuned with Basketball Variometers. This partly explains the remarkable performance records reported by AMRAD owners.

Leading amateurs and radio engineers are familiar with the unequalled efficiency of Basketball Variometers—exclusively AMRAD. They permit utilization of the basic scientific principle of AMRAD Inductance Tuning.

Inspection of the Basketball Variometer construction reveals why distributed capacity and dielectric losses are so low; and why

the superior inductance principle may now be used. Inductance Tuning assures many benefits, but the greatest of all is that of selectivity—the feature of the properly built Basketball Set.

AMRAD Basketballs sell at low prices—Variometer only \$3.75; Vario-Coupler \$3.85. This is due to the development of special automatic machinery for their economical production.

Bulletin V describes these efficient Basketballs. Write for this Bulletin Today.

### *How Amateurs Can Help Their Friends and Radio*

It is not an easy thing for a layman to build a good radio set. Amateurs can render radio a real service by recommending to their friends (who are not experts) the purchase of complete Sets which incorporate features of known efficiency appreciated only by the technical man.

Folder 350-3 describes the famous "Inductrole" which uses specially developed AMRAD Parts including Basketball Variometers. This Set has the basic fundamentals for radio enjoyment and is endorsed by the foremost engineers. Send for Folder 350-3 and see why!

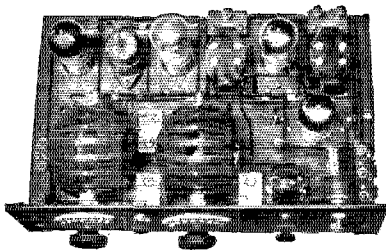

Interior of "Inductrole" illustrating Basketball Variometers. Tuning by Inductance—not Capacity.

## AMERICAN RADIO AND RESEARCH CORPORATION

205 College Ave., Medford Hillside, Mass.

AMRAD Dealers in Principal Cities and Towns

# A New Radio Signaling System

By Paul B. Findlay\*

TEN years ago when Lewis M. Clement stood watch in the radio room of S. S. Manchuria, he vowed that some day he would develop a system by which radio operators could rest their weary ears and let a bell call them when another station wanted them. Recent developments in radio in

of five cycles per second will double the current required to operate it. *This ensures that static, telegraph signals, voice currents, etc., will have relatively little effect on it.* The way it operates the next relay is a further protection against false signals. The vibrating relay may close its contacts for only 1/5000 of a second at each stroke and all the electrical energy to pull up and hold another relay must be passed while the contacts are closed. Into a relay of workable size energy flows too slowly for enough of it to be stored in the form of magnetism during such a short time. But electrical energy flows rapidly into a condenser, and so the circuit is arranged to charge a 1  $\mu$ f. condenser during the 1/5000 second interval. During the time that the vibrating relay contacts are open, the condenser discharges slowly through the second relay, and this current is still flowing when the contacts close again to recharge the condenser. Thus a continuous pulsating current flows through the second relay, and operates it to close its contacts. These contacts will in turn operate any electrical device, such as a bell, a signal lamp, or a selector switch.

The use of the standard train-dispatching equipment enables the system to be used to call any one of a number of stations from a central point. For

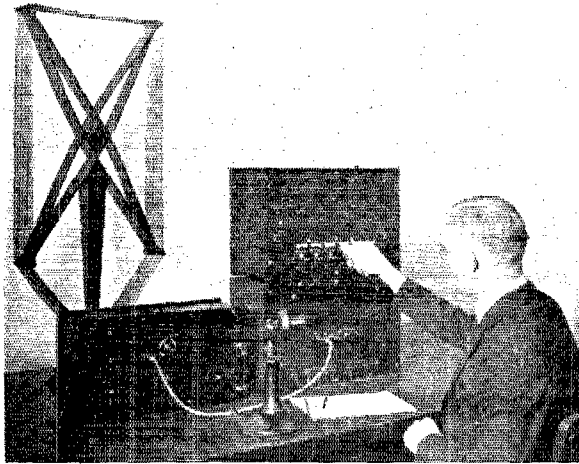

Fig. 1. Sending a call by radio. Milton L. Almquist shows how a central station can "ring" any or all of a group of receivers, all tuned to the same wave length.

which he took part as an engineer of the Western Electric Company have brought his dream to reality, and now such a calling system is available. It will find use in those new applications of the radio telephone in which a continuous watch may not be necessary for the public safety, as for instance in ship-to-shore telephony.

The new system is an ingenious adaptation of well known wire telephone apparatus to radio. Briefly, it consists in putting a 135-cycle alternating current into the radio system, transmitting it as other frequencies in the voice range are transmitted, and at the receiving end using it to operate a sensitive relay.<sup>1</sup>

To supply the alternating current, a buzzer operated by direct current is used, and its output is passed through a filter network which suppresses harmonics of the 135-cycle fundamental. Accurate mechanical tuning is essential for both the vibrator at the sending end and the sensitive relay at the receiving end. So closely can the relay be tuned that a difference

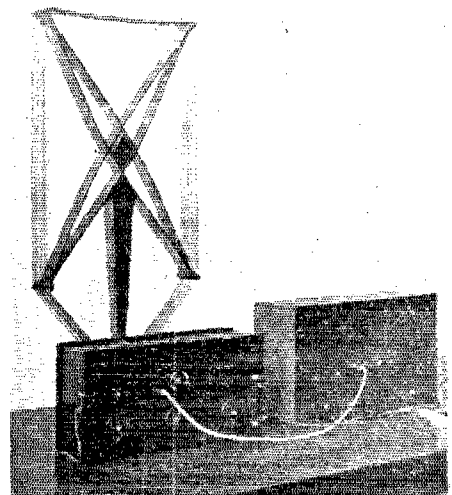

Fig. 2. Outlying station without selective ringing equipment.

\*Technical Publicity Section, Western Electric Co. —The 135-cycle modulation can be fed into the transmitter thru the usual modulation transformer and modulating tube. At the receiving end it is detected and amplified in the same fashion as any other modulation. It then goes to the tuned vibrating relay.

instance, the control operator, by turning a key marked with the name of a particular

station, can send out electrical impulses which will operate selector switches at the receiving stations. Each of these switches is arranged like the combination on a safe, to close its contacts and ring its bell only when a certain combination of impulses is sent out. This apparatus allows as many as 78 stations on one wave length to be signalled separately.

The same apparatus can also be arranged so that at each one of the 78 stations, four supplementary stations can be signalled individually. For example if a marine radio telephone system is involved,

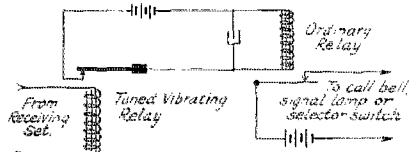

FIG-3 HOW A WEAK ALTERNATING CURRENT MAY BE USED TO OPERATE A CALLING DEVICE

the pilot house, the captain's quarters, the purser, and the engine room on each of 78 boats could be signalled separately. In addition, it is possible to signal all the pilot houses, etc., at the same time, with a further slight modification in apparatus. It is possible to extend the system to signal all or any one out of more than 200 stations.

While this signaling system will be of decided importance in many applications of radio telephony and telegraphy, curiously enough it is not based on any startling new discoveries, but rather represents the adaptation of certain apparatus that is well known in wire telephony. The 135-cycle input is

fed into the audio-frequency input amplifier at a point appropriate to its energy level. In small transmitters it may be applied directly to the modulator tubes. At the receiving end the output of the detector tube of the regular radio receiver is connected through a special 1-stage amplifier to the vibrating relay. Five vacuum tubes must be kept lighted continuously while the station is to be ready for incoming calls, but the current consumption is so small that it is a negligible part of operating costs. Considering the value of an attendant's time, the use of tubes and power in this way makes possible a substantial saving.

As to the effect of interference, tests show that the electrical and mechanical tuning of the receiving circuits and apparatus is so effective that radio telegraph signals similar to those from an I.C.W. or spark transmitter would render speech unintelligible long before they would make the signaling system fail.

That this system gives no privacy to the conversations is evident. Any station, or for that matter any receiving set within the transmitting range, can overhear what is going on. For some purposes, where all stations are more or less concerned in what is being done by others, this is a decided advantage. The system in its operating features is the radio replica of the train dispatcher's circuit where any station can be rung without disturbing others, and where any station can talk to any other as well as to the dispatcher.

Collaborating with Mr. Clement on the new system were Messrs. C. S. Demarest and M. L. Almquist of the American Telephone and Telegraph Company.

## More Traffic Facts

By F. H. Schnell, Traffic Manager

**L**AST month we called it "Some Traffic Facts" and this month we merely continue what was started and enlighten you with "More Traffic Facts." It is quite interesting to follow messages with tracers and note the flimsy excuses that come back on some of them. There is no possible excuse for holding any message longer than 48 hours. Some of the excuses are mentioned with the messages. Anybody who doesn't understand that a message is to be mailed when it has been held 48 hours for some reason or another is either dead or doesn't read QST. Yet it is being done by some of the stations that were regarded as among our best, but they will pass out of the picture unless they shake it up a bit.

Others fail to give accurate information concerning messages. There doesn't seem to be an excuse for this either. We didn't think the amateur existed who didn't keep a real log, but we have learned to the contrary in a few cases. (Log sheets can be secured from A.R.R.L. Headquarters at a very nominal price. They are complete and ready for you to fill in the date, time, and call, if you can spare that much time toward an accurate log.) We know now why it has been utterly impossible to secure information on DX records and Transatlantic and Pacific work. No logs!

All the following messages were started from LXW-IMO and in every case complete address was transmitted, with a date, on each message. No

abbreviations were used in the texts. For recording purposes, the addresses have been cut down. Complete records are on file at A.R.R.L. Headquarters for those who have questions to ask.

Nr. 13. The Bee, San Francisco. 1XW to 6XBC 2/22 3:29 A.M., to 6XE 3/8. No further record. This is awful! No time is given by 6XBC as to when the message was relayed to 6XE, and 6XE ignored the tracer.

Nr. 14. J. V. Wise, Walnut Grove, Calif. 1XW to 6XBC 2/22 3:40 A.M. to 6XE 3/8. Same status as Nr. 13—still awful!

Nr. 15. A. H. Babcock, San Francisco. 1XW to 6XBC 2/22 3:52 A.M., to 6XE 3/8. Same as Nr. 13 and 14. 6XBC complains that he was unable to raise anybody south, but he seems to forget that Uncle Sam can raise 'em after 48 hours.

Nr. 30. K. E. Goodacre, St. Petersburg, Fla. 1XW to 4EB 2/29 12:03 A.M., to 4RW 3/17?, to 4FZ 3/4 6:20 P.M., to 4EZ 3/5 5:10 P.M., to 4ER 3/6 about 7:00 P.M. Message was not delivered. 4BW reports receiving it from 4EB 3/2 11:40 A.M. One or the other or both would do well to get a calendar and clock and keep count of days and time on their logs. 4BW is guilty of delay and 4ER has not replied to the tracer. More rotten relaying!

Nr. 32. W. W. Rodgers, Memphis, Tenn. 1XW to 3PZ 2/21 11:32 P.M., to 3BMN 2/24 5:09 P.M., to 4JR 3/1 6:40 P.M., to 5KA 3/1 7:40 P.M., and

delivered 3/3 11:30 A.M. according to report from Rodgers. The first delay goes to 3PZ, worse delay to 3BMN, and the last to 5KA who reports the message delivered 3/1 8:00 P.M. Hartford to Memphis in 11 days. Ye Gawds! You might look good on the air, but what do you think of yourselves on paper? That's something else again, but wait, there are others just as bad as you—read on.

Nr. 33. Radio 5FV. 1XW to 3PZ 2/21 11:27 P.M., to 3BMN 2/24 4:59 P.M., to 4OH 2/28 11:20 P.M., and there it stuck because 4OH says he is remodeling his station and can find no trace of the message. What could be worse—no log! 3PZ gets the leather medal for the first delay and 3BMN gets what is left. 3BMN reports the message received at 4:38 P.M. instead of 4:59 P.M. An error of 11 minutes in somebody's clock is bad business. Whose clock is it? Some nice routing on this message, too—Hartford to Nashville by way of Florida—fine!

Nr. 34. Radio 5AC. 1XW to 3PZ 2/21 11:35 P.M., to 3BMN 2/24 5:04 P.M., to 4JR 3/1 6:12 P.M., to 4MI 3/2 1:16 P.M., to 5AAG about three days later in the afternoon (very accurate log 4MI keeps), mailed 3 days later, but it couldn't possibly get to 5AC because the address as reported back by 5AAG is badly garbled. No special comment on this one for anybody—look it over and if you can think in decent language go ahead and use it. All we can say is "very rotten." We must mention that the error in somebody's clock, either 3PZ or 3BMN, is only 4 minutes in this case—some clock.

Nr. 35. Radio 8ZZ. 1XW to 3PZ 2/21 11:40 P.M., to 8XBH 2/25 7:24 P.M., to 8COI 2/28 6:00 P.M., who says he never received the message nor did he work 8XBH. However, the message reached 8ZZ thru 8WA, who phoned it 2/23 at 8:00 P.M. Poor old 3PZ. Relaying for him seems to be just one darn delay after another—hope he perks up with his new call. 8XO. And 8XBH gives as his excuse the fact that sleet and ice slid off the roof and damaged the antenna, which wasn't repaired until 2/28, but blessed if we can tie this in with any delay on the part of Uncle Sam and his mail routes. How the message got to 8WA, we don't know.

Nr. 36. This one has to be quoted in order to give you an idea of how a message looks after going through a coffee mill and then getting ironed out by a steam roller with a lopsided wheel. Here is the way it looked when it left Hartford:

Hartford Conn 1XW  
R H G Mathews  
Chicago Radio Laboratory  
232 South Michigan Ave  
Chicago Ill

February 22

Your letter regarding mailing tubes for official relay station certificates has been answered stop you are to ascertain the price in Chicago and advise me that figure before buying.

F H Schnell

And it looked like this from the copy Mathews sent back which he received by mail from 9CAH:

Hartford Conn 1XW  
Mathews 9ZN

c ur ltr regarding mailing O R S certificates has been ans ur to ascertain price es advise member  
F H Schnell

Could anything be so badly garbled? We didn't think so, but there it is. Left 1XW to 8XBH 2/22 5:47 P.M., to 8ADA 2/25 10:30 P.M., to 9ER 2/25 11:55 P.M. 9ER replied to the tracer by a radiogram and it was as badly garbled as the above message. The best routing, according to the message, reads "Ur msg taken as ur 1 fm 8ADA QSR'd by 9ALZ then to 9BAY to 9AWV then 9AWV got 7SM"—which doesn't mean a thing. 8XBH must have been bothered with sliding sleet and ice—notice how his dates check with Nr. 35. Must have a lot of sliding sleet ar't. Unless 8ADA garbled that message he has a clean bill of health. Write your own wheeze for the others. MIM!

Nr. 37. Radio 8VQ. 1XW to 3PZ 3/17 7:50 P.M., to 3BVA 3/22 12:23 A.M., to 8XE 3/22 about 3:00 P.M. 8XE reports delivery at 3:15 P.M. same day, but something is rotten here because the message was for 8VQ, who received it by mail from 8DHW 4/9 9:00 A.M. Make up your own routing—anything will be as good as we have.

Nr. 38. Radio 6ZAU. 1XW to 6XBC 3/18 10:50 P.M., to 6BZ 3/24, and that is all we have. Hot stuff and fine logs! 6ZAU reports that the message was copied solid from 1XW by 6ZAR who delivered it personally two days later, but no other sign of the message has come to light.

Nr. 39. H. E. Cutting, Bozeman, Mont. 1XW to 9XAX 3/19 12:01 A.M. EST, to 9DKB 3/18 11:54 P.M. CST, mailed 3/21.

Nr. 40. Radio 6XAD. 1XW to 6XBC 3/18 10:55 P.M., mailed 3/19. That's the thing to do, OM; mail 'em after 48 hours.

Nr. 41. Radio 9EEA. 1XW to 8PL 3/18 11:45 P.M., to 9XAX 3/19 7:00 P.C. CST, to 7CO 3/21 12:33 A.M., to 9AFP 3/21 12:15 A.M. MST, and delivered next day. Good work, all of you!

Nr. 42. N. H. Jensen, Sioux Falls, S. D. 1XW to 8PL 3/18 11:48 P.M., to 9XAX 3/19 7:16 P.M. CST, and mailed by 9XAX same day.

Nr. 43. Radio 9AAL. 1XW to 8PL 3/18 11:52 P.M., to 9XAX 3/19 7:18 P.M. CST, to 9DWA 3/22 7:00 A.M., to 9AWQ 3/22 7:30 A.M., and from there we lose track of it until 9ELA delivered it 3/22 6:30 P.M. 9ELA got it from 9ASX. Good relaying, but time lost even though nobody held it longer than 48 hours. It wasn't garbled either.

Nr. 44. Radio 7ZU. 1XW to 9XAX 3/19 12:12 A.M. EST, to 9DKB 3/19 12:01 A.M. CST, and mailed 3/21.

Nr. 45. Radio Canadian 9BP. 1XW to 9XAX 3/19 12:09 A.M. EST, to 9DKB 3/19 12:03 A.M. CST, and mailed 3/21.

Nr. 46. Radio 7ZO. 1XW to 9XAX 3/19 12:06 A.M. EST, to 9DKB 3/18 11:57 P.M. CST, and mailed 3/21.

Nr. 47. W. B. Schulte, Madison, Wis. 1XW to 9XAX 3/19 12:17 A.M., and mailed same day.

Nr. 48. Prof. Jansky, Minneapolis, Minn. 1XW to 9XAX 3/19 12:24 A.M., and mailed same day.

Nr. 49. Radio 3BZ. 1XW to 3ARZ 3/25 11:19 P.M., to 3BEI 3/26 5:00 P.M., mailed from there also relayed to 9EP (we don't know why this routing on a message to Danville, Va.) 3/27 4:40 P.M., to 4BQ 3/28 5:20 P.M., and there she stops.

Nr. 50. Radio 4KU. 1XW to 3ARZ 2/25 11:23 P.M., to 4AF 3/27 6:55 P.M., but no further record. Who lost it?

Nr. 51. Radio 6XBE. 1XW to 8PL 3/25 11:49 P.M., to 9XBD 3/26 6:35 P.M. CST, to 9XAX 3/26 6:50 P.M., and mailed. Received 3/30.

Nr. 52. R. H. G. Mathews, Chicago, Ill. 1XW to 8PL 3/25 11:55 P.M., to 9XBD 3/26 6:25 P.M. CST, delivered in person 3/26.

Nr. 53. Radio 7ZU. 1XW to 8PL 3/25 11:57 P.M., to 9XBD 3/26 6:30 P.M. CST, to 9XAX 3/26 6:55 P.M., and mailed.

Nr. 54. 1XW to 3BG 3/28 7:46 P.M., to 8XBP 3/30 1:35 A.M., to 6XBC 3/31 1:37 A.M. EST, and mailed 4/3. 6XBC reports receiving it 4/1. Either 7XBP or 6XBC is wrong on the date. Settle it yourselves.

Nr. 55. A. E. Banks, San Diego, Calif. 1XW to 3ARZ 3/26 5:55 P.M., to 8ALO 3/27 10:44 P.M., to 8DHW 3/29 about 3:00 P.M., to 8CEI 3/30 about midnight, who reports that he has no record of working 8DHW as mentioned. It looks pretty bad when a fellow doesn't know with whom he was working. Keep a log and you won't have to make wild guesses at these things.

Nr. 59. K. P. Frederick, Los Angeles, Calif. 1XW to 3BG 3/28 7:41 P.M., to 5DW 3/30 1:07 A.M., to 6ZCD, but 5DW must have got his called twisted. There is no 6ZCD. Well, anyhow the message was received by Frederick, according to his report 3/29 at 9:00 A.M., or about 15 hours before it left 5DW, which is going some. Let's have some more deliveries like this. Hi!

Nr. 61. Radio 5RZ. 1XW to 2CVU 3/28 7:34 P.M., to 4RR 3/29 about 3 to 4 A.M. (another accurate log), and mailed. Rodgers mentions the fact that copy was perfect. It ought to be; only two stations handled it and it didn't have time to get chewed to bits.

We are learning a great deal about what happens to some of our messages and we are beginning to know what sort of service some stations are passing out on delivery. A great many stations sound fine on the air, they get good DX and a flock of cards, but on paper some of them look worse than a fellow who has been in the game less than three hours. We could go back and point them out for you, but surely you can do that for yourself.

There is more to come, OM; just watch your step. Keep a log, transmit the date on all messages, don't garble them, don't hold them longer than 48 hours, reply to the tracers and be sure your dope is correct, and you won't get caught in "Traffic Facts," because this is being c-o-n-t-i-n-u-e-d in next QST.

# The Traffic Department

F. H. Schnell, Traffic Manager  
1045 Main St., Hartford, Conn.

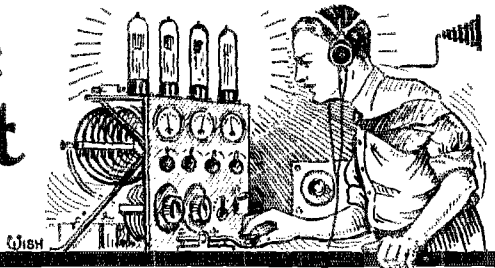

When ADM Hilton, of Maine started the Pine Tree State A.R.R.L. News, he launched an idea that has brought out two more divisional papers and we want to see more of them. The Delta Division boasts the "Delta Ugerumf" and Wisconsin blossoms forth with "Badger A.R.R.L. News." The "Delta Ugerumf" is a division paper because of the small number of men operating and Rodgers is the editor, publishers, circulation manager, office boy, janitor and everything else that goes with a big monthly magazine. ADM Crapo is the founder of "Badger A.R. R.L. News" and undoubtedly will be kept busy supplying the demand for copies.

The most surprising thing about all of these papers is that money cannot buy them—you have to send in your report to get a copy and we'll say that's some real idea—no wonder these places break out with so many active stations. Keep it up fellows, more state papers will be developed and right now these things look to be the finest means of getting reports from all stations every month and that is what we want.

The new manager of the Pacific Division is Mr. M. E. McCreery (6LJ) 628 W. 49th St., Los Angeles, Calif., and he succeeds J. V. Wise, who resigned because of too many other duties.

The Dakota Division loses the best manager it ever had when N. H. Jensen resigned—also because of personal business pressure. "Nick" stands ace-high with the Dakota boys and Headquarters proudly seconds the motion. The new DM will be announced next month.

Official A.R.R.L. Broadcasting Stations broadcasting the latest news from Headquarters every Saturday and Sunday night at 10:30 P.M. are 1ARY, 1GV, 1CK, 1GL, 1CKP, 1BEP, (1FD—190 meters Saturday and Sunday at 6:00 P.M., EST) 1BDI, 2BRB, 2CFE, 2CRQ, 2GK, 2AWL, 3OE, 3HH, 3ZS, 3AIS, 3BMN, 4JE, 4EL, 4JZ, 4HS, 5AMF, 5ALV, 5KR, 5XB, 5UO, 5XAB, 5AOM, 5XA, 5MB, 5ZM, 5AJP, 5ZAV, 5XRF, 5ADB, 5VX, 5YE, 5ZAS, 6ZH, 6ABX, 6KA, 6ALS, 6BBH, 6ZAM, 7CO, 7ZU, 7JF, 7ZO, 7AGF, 7WM, 7BJ, 7TO, 8DAA, 8ATP, 8ZW, 8VG, 8ZZ, 8KG, 8BVR, 8PL, 8ZH, 8BHF, 9DBF, 9DXY, 9ZY, 9EBT, 9AUU, 9DJB, 9AJM, 9DKY, 9EGU, 9EKY, 9AAP, 9BGT, 9BZI, 9OX, 9APS, 9ZG, 9DSW, 9AMB, 9AEC, 9AZA, 9AAW, 9BAV, 9MC, 9AHQ.

Information on tests, special relays, conventions, etc. is sent out each week and there is no spot in the United States or Canada which cannot copy at least two of

the above stations under most any condition—if you fail to keep yourself posted on what is going on it is because you don't care to spend a few minutes at 10:30 to listen for the broadcasts. Don't be so anxious to pound that key—use your ears more. That's the way to get information, by listening and not pounding the key.

## ATLANTIC DIVISION C. H. Stewart, Mgr.

EASTERN NEW YORK—Messages have fallen off very considerably but the quality has greatly improved. New York City still keeps up the totals, though Brooklyn and the Bronx have excellent reports. 2CRQ gets the honors this month. F. W. Hanna, 2HW, has lost his job as D.S. N.Y. Dist. No. 3, for failure to report. If R. W. E. Decker, 2UA, Theodore Van Loan, 8CKN, A. A. Johnson, 2CNI, Steven Vanderveer, 2CNP, and Elmer Wirsing, 2AWF, fail to report as they have done this month, there will be some more removals. If there is nil to report DROP A CARD AND STATE THAT SIMPLE FACT SO THAT WE KNOW YOU ARE STILL ALIVE.

Traffic: Brooklyn: 2ATZ, 180; 2BO, 123; 2BRB, 81; 2CHY, 79; 2CRB, 78; 2KU, 54; 2ADC, 42; 2CJR, 42; 2ABN, 40; 2ABR, 34; 2CMA, 32; 2DL, 17; 2WC, 18; 2IE, 8; Bronx: 2CRB, 431; 2CYX, 102; 2CJJ, 18; 2SM, 13; 2BBX, 30; 2CWR, 9; 2FZ, 12; 2ABM, 20; Manhattan: 2BNL, 44; 2KE, 31; 2XNA, 31; 2CHK, 28; 2CSL, 24; 2CZR, 37; 2CTE, 12; 2CPK, 48; Richmond: 2CFE, 12; 2CAJ, 8; 2CKT, 6; 2CHJ, 12; 2ACZ, 28; 2AGC, 4; 2ND, 3; 2CEV, 71; Queens: 2BSL, 8; 2AVE, 2; 2BCK, 2; 2BSC, 50; 2CXB, 31; 2BQW, 28; 2AVJ, 30; 2AOT, 3; 2BQH, 40; 2BXP, 11; 2CGH, 71; 2CGJ, 10; 2ACS, 84; 2AIO, 21; 2GK, 45; 2CFE, 12. Youkers: 2ADD, 1; 2CUZ, 30; 2APY, 22; 2AAC, 4; 2ANM, 22.

WESTERN NEW YORK—The new A.D.M. for Western New York is C. S. Taylor, 8PB, Buffalo. He promises to hit the ball year 'round. 8AXN plans to operate through the summer months. 8ND is reaching across the pond once in a while. 8WU has installed a 500 cycle transmitter. 8UE is increasing his power somethin' awful! 8ABX has been over-hauled. Ithaca has some good stations in 8XU, 8ZU, 8NI, 8BIA, 8ABG, 8ALM, 8ADM, 8ACM, but they better bolster up a bit. Jamestown active stations are 8ROE, 8DIS, and 8BQC. 8DAJ is the only station working at Niagara Falls, but 8ARL will be poking holes in the air very soon. Rochester is brimming over with activity. The outstanding stations making good DX records and moving traffic are 8ATR, 8BLP, 8BZA, 8NB, 8CYI and 8AMR. Traffic: 8PJ, 100; 8ND, 277; 8BSE, 101; 8AQM, 7; 8ABX, 28; 8DAA, 25; 8DFR, 5; 8AVD, 15; 8ATR, 111; 8BLP, 53; 8BZA, 3; 8NB, 63; 8CYI, 86; 8AMR, 208.

NORTHERN NEW JERSEY—2CQO is rebuilding and increasing power. 2CRW has the distinction of having a shack next to a Brewery which accounts for his kick. 2ACO will jam the ether with 100 watts shortly. 2CQZ is on the air again with lots of pep. 2AXF has resumed with a chemical rect. and has worked the west coast several times. 2CXD is using "S" tubes. 2ARY is a new comer. 2WR is QSO west coast traffic direct. 2ANA can be heard nightly. 2JH is still on spark but reports no traffic. The R.L. got after 2AGB re 100 meters transmission so now he's back on 175 again. 2BXD is the only Newark station going and he is handling traffic in good shape.

Traffic: 8APB, 16; 8REL, 32; 8BWJ, 42; 2CGK, 1; 2WR, 31; 2ANA, 30; 2AXF, 30; 2CQZ, 39; 2BEO,



86; 2BXD, 45; 2CBP, 34; 2CRW, 38; 2CYW, 32; 2CYQ, 23; 2BGO, 20; 2CTS, 12; 2ACO, 12; 2CXD, 5; 2AEY, 17; 2CJX, 191; 3CS, 8; 3FP, 27; 2CJX, 67; 2ATE, 31; 2ADU, 10; 2DAB, 3; 2CUB, 54; 2BE, 35; 2AJF, 4; 2FC, 15; 2BUY, 32; 2CXY, 28; 3BLZ, 16; 3XAN, 5.

**DISTRICT OF COLUMBIA**—3HS is the most active station in Washington and is to be commended upon keeping an opening with the outside world. 3TY is having trouble getting a 50 watt tube that will hold up for any length of time, but is doing its best. 3BPP, using a single 5-watter, is being heard over the most of the country, and has recently worked two sixth district stations. The antenna at 3BWT has been down for the better part of the month. The station is on the job, though. For important work, with a temporary antenna, 3PZ has been assigned 3XO and is heard on 100 meters. 3AB has been out again due to loss of antenna, but will be on the job as much as possible with a single wire until the aerial can be put up. 3JJ is still to be heard from.

Traffic: 3HS, 80; 3BPP, 15; 3CEJ, 8; 3TY, 4; 3BWT, 34; 3PZ, 25.

**MARYLAND**—As yet no falling off in DX activity has been noticed in Baltimore. Quite a bit of traffic is being handled nightly. 3LG leads by a wide margin in number of messages handled. 3FW is a new station operated by L. C. Herndon, acting supervisor of radio in Baltimore, Md. 3AOJ is another new one. 3BML is doing good DX with a 15 watter. 3WF has lost a couple of fifties and is using 10 watts temporarily. 3SS is back again. 3TF is reaching out FB with a coupled Hartley circuit. 3TE is operating on low waves with a special 3XAO. 3AJD, 3MP, 3PH, 3DQ, 3BMO, 3ZD, 3CJC, 3AEK, 3CDU, 3CJW, 3CHB, 3FK, 3BU, 3GL, and 3LL are all active, and reach out well. 3EM has opened up with the call 3DW at Mt. Ranier.

Traffic: 3LG, 217; 3APT, 21; 3BU, 10; 3TF, 15; 3EG, 18.

**DELAWARE**—I am sorry to report the loss of D.S. R. T. Shaw (3AUF) who was called by death on Sunday Apr. 13th. Shaw will be terribly missed as he did very good work during last year's Trans-Atlantic Tests. He had the best transmitter in this state. 3BSS is on the air but one night a week, Saturday night. Very little traffic was handled last month as all hands are constructing short wave receivers.

Traffic: 3AIS, 6; 3WJ, 1.

**EASTERN PENNSYLVANIA**—The report is rather slim this month with only a few districts coming across. District No. 1 continues to handle their share of traffic and are consistent reporters. 3CHG has buried a hundred dollars worth of 5 watt tubes, all blown within the last six months. Can't keep a good man down so he will be on in the fall with a 250 watter. 3HVA popped two 50 watt tubes but a "fliver" replaced them and brought down 190 mssg. 3CCU piles up a good total and was heard in Hilo, Hawaii. Harrisburg stations are active and on the job.

The A.D.M. would like to know how much traffic is passing through Philadelphia. If you don't know who your C.M. is please write or phone me FKD 2248-W and I will be glad to receive your reports and advise to whom you should report. Let's have your reports, fellows, and put Philadelphia on the map.

Traffic: 3ZM, 17; 3ARN, 20; 3AKR, 2; 3HH, 237; 3BNU, 46; 3HAQ, 12; 3CJN, 99; 3MQ, 7; 3TP, 32; 3AVL, 24; 3AUV, 38; 3ZO, 213; 3BVA, 190; 3CCU, 103; 3BRF, 51; 3CCX, 16; 3BBV, 8.

**WESTERN PENNSYLVANIA**—Dist. No. 8: Activity in this district has fallen off to a great extent. 3AOX reports a small amount of traffic. 3AKI has been closed down during the past month.

Dist. No. 9: 3BW reports working 9CAA in Denver using a 5-watter after sun-up. 3QD reports little activity along the western front. 3CTP has also worked 6 west coast hams. 3CEO is on regular schedule with 4R.

Pittsburgh: C.M. C. C. Young, 3CTF, has undertaken a big job in organizing his section. A hamfest was held at his home only a few days ago at which 25 amateur operators attended. Both the D.S. and the A.D.M. attended this hamfest and were very much impressed with the enthusiasm shown by the hams. A district hamfest was held at the C.M.'s station, 3AGO, on April the 4th for the purpose of organizing this district. The A.D.M. gave a talk on the purpose of organization and outlined a plan calling for the stations to operate on schedule in the future so that an emergency communication might be submitted to the railroads. All amateurs present agreed to establish schedules with other amateurs between 6 P.M. and 8:30 P.M. for the purpose of handling all kinds of traffic, both local and DX. 3AGO, in conjunction with 4JM-4MI, has inaugurated a "sure fire" daily, early evening schedule with hopes of a Daylight Trunk Line from the lakes to the

Gulf as a goal. 3AGO has not been able to establish permanent northern connections yet, but hopes to with the help of 8DKI 8AQ and 8AYT. South of 4JM, things are progressing fine. 3CEJ is on the air constantly. 3CVX is working on some early evening routes. If we can get another north-south route and a couple of east-west ones going strong, we certainly will make things hum. 3DHW is another working out better facilities for distributing mssg. 3BED has a new generator going. A new cage antenna is under construction. 3BHJ is going to be on three evenings each week. 3PX is working on a "sure fire" short jump, relay route for day or night traffic. This route is to take in Virginia, Ohio and Kentucky. 3AYW has a new Lowloss Tuner. 3SF put in a 50-watter. 3CES is a new station. 3VE finally has his own set going since the A.D.M. moved. 3VE is now on a one wire aerial 45 x 45 feet. On the first night in operation this 45 x 45 feet. On the first night in operation this with a PLATE INPUT of only 84 watts was heard "vy QSA" by 7AGI. 3ADS is rebuilding. 3BYI is getting out very well with his set but is handling very little traffic. 3BRK has started out with his first msg. report.

Dist. No. 11: 8DKI and 8CON are the only ones doing any work at all. The fact that 95 mssg were handled by these two stations shows that some traffic is headed that way.

Traffic: 3AOX, 14; 3QD, 47; 3CTP, 36; 3AGO, 38; 3CEL, 68; 3CEJ, 51; 3CVX, 28; 3CFM, 14; 3DHW, 18; 3BED, 18; 3BHJ, 4; 3PX, 4; 3CC, 22; 3DAH, 4; 3DIZ, 1; 3CCK, 44; 3BRB, 10; 3ADS, 19; 3BYI, 52; 8DKI, 52 8CON, 48.

### CENTRAL DIVISION R. H. G. Mathews, Mgr.

**MICHIGAN**—Dist. No. 1: 8CBO has been in a hospital for some time, but will be on the air soon. 8XBF and 8XBQ, Detroit, are 9SO California on 109 meter wave. 8CWK and 8MR of Detroit worked 9YA Omaha, Nebr. in daylight.

Dist. No. 2: 3CFQ takes first honors in this district this month with the new Battle Creek High School station. 3YN, a close second. (Glad to see a school up amongst 'em, fellows—D.M.) "CFQ" says "no rubber stamps." Lansing will have the 1925 Michigan State A.R.R.L. Convention, Feb. 13 and 14.

Dist. No. 3: 8DKF, 3DCY and 8CPD ran a close race for highest totals.

Dist. No. 4: Mr. Milton W. Walker, 9AEN, 350 Florence St. Houghton, Mich. has been appointed D.S.

(Upper Peninsula of Michigan.)  
9CE and 9DRR report this month with the best totals for District No. 4 we have had for some time. Traffic: 3CFQ, 280; 3YN, 221; 3DCW, 190; 3DKF, 146; 3DCY, 130; 3CRW, 120; 3CST, 114; 9CE, 104; 3BNC-3DAG, 82; 3BWR, 77; 3DDT, 75; 3BGG, 71; 3DRR, 69; 3NX, 58; 3ARV, 52; 3CAP, 48; 3CZZ, 45; 3CWK, 44; 3AHJ, 42; 3CQG, 38; 3CPY, 33; 3DIL, 33; 3CFM, 26; 3CGG, 26; 3ZF, 20; 3ZZ, 20; 3FC, 20; 3WA, 17; 3JJ, 10; 3ZH, 9; 3AQA, 9; 3BWY-3ZK, 6; 3AMS, 4; 3DBO, 3; 3BKC, 3; 3BDY, 2; 3BXA, 2.

**SOUTHERN INDIANA**—9CSG is rebuilding and re-modeling. 9CYO has just started up with a 10-watter. 9DUC is getting onto the game of handling messages. 9ES is reaching out very well touching messages. 9ES is reaching out and seventh. 9TF is now all districts but the sixth and seventh. 9TF is now a salesman on the road so can't razz the brass. 9EDC has left town. 9AG is on regularly with and will be on with tubes. 9PR is on regularly with his spark coil. 9CGF has gone to North Dakota. 9BPJ is off temporarily. 9BDB is handling the bulk of the traffic at Richmond. 9CSR is handling some traffic. 9TA and 9TG at Franklin are doing very well with C.W. 9EUI is QSO Atlanta. Traffic: 9BCC, 203; 9BDB, 138; 9PB, 78; 9ES, 52; 9BVZ, 42; 9AWG, 33; 9EJL, 32; 9DIS, 25; 9UR, 21; 9EUI, 17; 9BJR, 10; 9AQJ, 8; 9CYQ, 7.

**NORTHERN INDIANA**—Northern Indiana has perked up and is going as the reports for this month are the best ever received. The fellows are all afraid that if they don't do something they will not get official certificates and so have come through with some dope.

The A.D.M. especially wishes to commend Tudor for his work in getting the stations to report and Miller for sticking to the job with only a few stations, and yet in keeping the message totals up at a time when messages are hard to get. It is sincerely hoped that the spirit will keep up and the stations stay on the air.

Dist. No. 1: Most of the fellows are going strong for rebuilding their sets and for putting in higher power. All would be fine if they only put it to

good use afterwards. 9AFY topped the list in messages handled. 9CUI is using a new M.G. coupled to a 50-watter. 9DWW is using a 5-watter and trying short waves. 9DBJ is using a 50-watter and "S" tubes. 9DLN is using a 5-watter coupled, and says it is hard to work through the gang. 9AMJ is in Hawaii. 9ABL is using a 50-watter. 9DJZ is using a 5-watter. 9BUJ is going FB. 9CBA is out of commission. 9CGX is using a 5-w. spark set, and a 200-watter. C.W. 9CUS will be on the air after June first. 9BYI will be on regularly. 9DIO is still using spark coil. WOW! 9UB is using a storage battery for his transmitter and is going strong on 100-watter. FBI 9DIC is using a spark coil to supply energy for a 5 watt tube. 9APD is doing good work on a 5 watter. 9CTB is using a 5-watter, and putting a thousand volts on the plate. He is working everything. 9DCB is again on the air with a 50-watter. 9DMI is a 10-watter. 9BYN will be on in the summer. 9CLN is all fixed and is on with a 100-watter. 9AZX has raised three Britishers.

Dist. No. 2: 9DWA is a new station. 9DYT works through to the west coast. Give your California stuff to 9DYT. 9BON is still on the job. 9DHJ always QSR's his traffic. 9CP is not on much except in the early morning.

The C.M. of South Bend has stirred up the gang and some activity has been the result. 9CNO and 9DLZ are the new ones. 9EFL does good work but is not on regularly. 9AKD is doing good daylight work. 9BBI is using RAC on the plate. 9CTE is experimenting with a mercury arc rectifier—the first one blew sky high. 9CYW is using a 100-watter and has been heard in England.

The A.D.M. has been directing the district activities by radio which is quite the stuff and keeps him well posted on the active stations.

Traffic: 9DWA, 142; 9AFY, 110; 9EFZ, 92; 9BUJ, 62; 9DYT, 50; 9DWW, 45; 9MM, 44; 9CUI, 42; 9CUS, 35; 9BON, 26; 9CYW, 20; 9DJZ, 18; 9AZX, 17; 9APD, 11; 9DBJ, 10; 9DLN, 7; 9QR, 6; 9AMJ, 5; 9CNY, 4; 9DHJ, 25.

KENTUCKY—Dist. No. 1: 9ARU will have an O.W. on his hands soon. (Let's hope she becomes 2nd opr. at 9ARU—D.S.) (I know 'em better—she'll be first operator or none—D.M.) (You tell 'em Matty, you know—T.M.) 9ELL has been appointed C.M. of Louisville. 9WU-9OX has been overhauled.

Dist. No. 2: The D.S. is J. W. Coleman, Jr. 211 N. Broadway, Lexington, Ky.

Traffic: 9DTT, 41; 9EP, 41; 9ARU, 37; 9WU, 35; 9BAZ, 22; 9EI, 16; 9DYC, 14.

ILLINOIS—Dist. No. 1: 9DAY is working 'em all FB. 9CPK is a satisfied user of a loose coupled

a coupled transmitter. 9DIJ is using A.C. on 180 meters. 9CTV is closed down.

Dist. No. 2: DX is a very common thing with 9CA on 150 meters, and he works both coasts nearly every night. 9ABE is on the air again. 9AIC is doing good work as usual. 9DXL sounds FB on the C.K. but smears the air up with a mob of key clicks. 9BJT is putting up a new aerial and will be on the air soon with the 250-watter. 9DLO is using fone nearly all the time but does excellent work. The fourth opr. has blossomed out at 9CXH and a new mast is up. We can expect some good work from now on. 9CTF is ahead in message traffic for this district, he is using a loose coupled transmitter. 9BRX is getting 5 amps on one 50-watter. (Another one of those birds that thinks the ammeter reads in miles.) 9BDF has moved to Chicago and has taken the old spark with him, and threatens to open up with it. Perhaps he hasn't heard that a few of the stations work DX on 100 meters on C.W. Also that the Chicago Radio Traffic Assn. and the Radio Inspector are "death" on sparks. 9CGV is doing fine work. 9ARM has been appointed O.R.S.

Dist. No. 3: 9CMN has a new pole and aerial. 9AWQ finally worked a 6. 9BHH is using inductively coupled C.W. Results, FB. 9AHJ lost his mast in the big March blow. 9MC has not been on much. 9EFQ is on the air again with a 100-watter. 9CMC deserves honorable mention as this is his 14th straight message report. 9CXT reports traffic moving in good shape but school QRM vs. 9CLZ works sixes and sevens most every night. 9ATT is doping out a new aerial. 9CRX is putting in more power and "S" tubes. 9TW is remodeling. 9BYX has failed to get his tubes out of soak as yet.

Dist. No. 4: 9DCR is now licensed for 150 meters. 9OP is remodeling. 9DWS is doing much experimental work. 9CZL is high man this month. 9BCB is on regularly and handles considerable traffic. 9DQU is using coupled ckt now and reports it FB.

Dist. No. 6: 9DVG is back on and is having pretty good luck. 9AQD is getting out very well. 9DNP is working dandy with a 10-watter. 9DQR started up again. 9CHU and 9ANP are also getting ready. 9CDY is on once in a while. 9KD has taken over the mast at 9BQW, the latter being off until fall. 9ARB put up a neat DX record with his five. 9AKB is about to be given solitary confinement in a padded cell all because he changed from twenty to a hundred and then back to fifty again. It is the prize ornery set. The only dang thing hasn't been gone over is the pulley on the north tower. 9CSE and 9XBF have been experimenting on 50 meters. 9DVM blew a fifty and had to give the generator back to WABA so he is QRT. 9DPL has been doing consistent DX and handling traffic. 9GT and 9DFV have been handling school exchanges. Anyone interested communicate with 9DFV or GT. A schedule is used, generally with 9DIL, 9ASA, 9DFV and 9GT, each sending their traffic in turn on Tuesday, 7 A.M.

Dist. No. 7: Traffic is still slow in Chicago. 9BE heads the list. 9XBA-CD is still getting out in fine shape, using only one 5. (7) watter. He has been reported in every U.S. district, worked in fact 4 Canadian districts. All on low wave—110. 9DKK has just started up with a 400 watt MG behind his tube and worked every district. 9CFT and 9AIO are getting out in fine shape. 9ARF has put in a 200 watter and is just about getting it going. 9ALL wasn't on much account tube trouble. 9XBD-AAW is getting out in fine style on 111 meters, with 250 watt jug. 9DWX has remodelled his whole station. 9AOY is still knocking 'em out on tube and spark. 9LZ is working the 6th and 7th regularly with four 50-watters. 9HL is back from Dartmouth. He was one of the ops at 1YB. 9PO, 9CLX, 9BGA, ex 9BNA are on and handling traffic in fine shape. 9CYD is trying to sell his transmitter. 9CVS will be on soon with 250 watt jug. 9DHQ is still having trouble from plate supply. 9BP now has 9XBF for 100 meters. 9EDG will be on regularly between 2 and 6 A.M. 9EI and 9EDZ will not be on for a while. 9BRE is being operated by A. Maxwell and A. L. Charles of 9CCK.

HIGH SCHOOL: exchange of school news by radio has been carried out on schedule between suburban high schools with the following line-up.

Station	Location	Representing	Counties
9GT	Highland Park	Deerfield-Sheldis	H.S. Lake
9DFV	Elmhurst	York Township	H.S. Du Page
9ASA	Glencoe	New Trier	H.S. Cook
9EEG	Evanston	Evanston	H.S. Cook
9COW	Maywood	Proviso Township	H.S. Cook
9DIL	Oak Park	Oak Park	H.S. Cook

Any schools interested should get in touch with 9GT or 9DFV.



The Dayton, Ohio, gang have a YL of whom they are justly proud. Meet Miss Beatrice Bourne, 859 Washington St., Dayton, (telephone number unknown!) who is the owner and chief op. of 8BI.

transmitter, rated as a 20 watt set. 9BZQ shut down for an overhauling. 9AFQ is on the air again. 9BIZ is on the job again regularly. 9CGU is practically closed down. The absence of this station cuts a big hole in the traffic report. 9LF is off the air. 9DYY is working regularly. 9EIB is trying

North Shore Radio Club has a loop receiver for running down QRM. It is in charge of 9DHQ and 9EDG. One illegal station has been located according to 9DHQ. 9EHD is still clinging to spark and is the worst QRM—sharing honors with 9RC. 9EEG will not be on until next fall. 9CCK got married. Traffic: 9CTF, 402; 9BRX, 339; 9CZL, 267; 9ABE, 202; 9CFK, 175; 9DAY, 171; 9CMM, 183; 9DBP, 123; 9AQD, 111; 9AWQ, 108; 9BHL, 92; 9AHJ, 90; 9DBF, 85; 9MC, 78; 9EFQ, 75; 9LZ, 74; 9CMT, 72; 9DXL, 71; 9BB, 69; 9AUE, 65; 9DVVV, 58; 9BZQ, 56; 9BWO, 56; 9IE, 54; 9DYY, 53; 9RRR, 53; 9BNA, 52; 9DNP, 52; 9DAP, 44; 9BHD, 44; 9AOY, 42; 9AAW, 41; 9AFQ, 38; 9BIZ, 37; 9AZJ, 35; 9XBA, 34; 9CXT, 33; 9EHQ, 32; 9CXH, 31; 9BCB, 31; 9CLZ, 31; 9ATT, 30; 9CRX, 30; 9DKK, 30; 9ARK, 30; 9CLX, 30; 9ARM, 30; 9TW, 29; 9BBC, 29; 9DQU, 27; 9CYD, 25; 9ADG, 24; 9DWX, 23; 9CSW, 23; 9ALW, 20; 9CCV, 20; 9CHF, 19; 9DCR, 17; 9BJ, 16; 9EBH, 16; 9BGA, 16; 9OU, 14; 9ABB, 14; 9EEG, 13; 9VK, 12; 9DPL, 12; 9DWS, 12; 9BGC, 12; 9DKH, 10; 9AIO, 10; 9AMZ, 9; 9DHQ, 9; 9BWQ, 7; 9CVS, 6; 9BAW, 6; 9AP, 6; 9EYI, 6; 9BHX, 4; 9ALL, 4; 9DZH, 4; 9DQN, 4; 9EJX, 4; 9BYX, 4; 9AER, 3; 9EAS, 3; 9BXD, 3; 9CAN, 1; 9DHz, 46; 9NQ, 13; 9EDH, 5.

WISCONSIN—Dist. No. 1: 9CCD leads district No. 1 in message handling, with 9DTK second high. Good reports were also turned in by 9ELV, 9CII, 9AAP, 9ATO and others.

Dist. No. 2: The best work is reported by the Madison gang who are rapidly forging to the front. Racine is going strong and has the star station for the month, 9BIB. 9AZA reports much activity in Whitewater.

Dist. No. 3: 9CMK is a new station at Fond-du-lac. 9DCT is doing good work on 155 meters. 9DRO is on regularly and works them all. W. W. Wick is the new C.M. of Sheboygan.

Dist. No. 4: Traffic has taken a drop due to increase of static and partly to the passing of 9BLE's five watters. He kept them hot while they lasted but they died of over-work. He is now using the old rock crusher to the disgust of the Sparta BCs. 9ALI is first on the traffic list. 9CFX either has a wonderful layout or is blessed with a glorious location. He recently worked three California stations in one night, on 15 watts and can do it most every night. He is to be congratulated for the good DX.

Dist. No. 5: 9DPR has installed a fifty. 9ELI is remodeling. 9UTH is temporarily using a single wire antenna. 9UGY has grown weary of replacing five watters and is installing a squad of fifties. 9GD is being reconstructed. The Superior gang is getting organized under the leadership of W. C. Bridges. 9BTH. Traffic: 9BIB, 353; 9CCD, 300; 9EAR, 195; 9DTK, 162; 9CCF, 105; 9EVL, 102; 9CUI, 91; 9CIU, 81; 9ALL, 83; 9ADP, 82; 9EGW, 74; 9BMT, 72; 9BVA, 71; 9AAP, 60; 9CYG, 51; 9AZA, 50; 9BLE, 50; 9ATO, 47; 9BYE, 43; 9ELD, 37; 9DPR, 36; 9AGT, 35; 9CII, 33; 9OT, 31; 9DBM, 30; 9BYJ, 30; 9DHG, 27; 9ALA, 26; 9BSO, 26; 9AZN, 25; 9BQG, 25; 9CHE, 25; 9AEU, 23; 9BBY, 22; 9DST, 22; 9CFX, 22; 9AKY, 20; 9DCT, 20; 9CVI, 20; 9ELI, 18; 9CPT, 18; 9DP, 17; 9EGH, 15; 9ATW, 13; 9GD, 12; 9AFZ, 11; 9BKR, 10; 9AOX, 10; 9BMY, 6; 9DZV, 6; 9EIL, 5; 9COI, 4; 9BTH, 4.

OHIO—Dist. No. 1: The new D.S. is F. W. Allen, Defiance, Ohio. 9CCI is doing consistent work. 9FU still on the air with his 250-watt after blowing a fifty he had borrowed from 8ZY.

Dist. No. 2: 9AAJ takes the honor this month for district No. 2. 9GX-9YAE-8ZE is doing good work on his 100 meter harmonic. 9RY says most of his messages are 20 to 30 words long.

Dist. No. 3: Our D.S. is resigning and a new one will be appointed in the new future, hence no report from Dist. No. 3. Sorry to lose Mr. Marsal as he has taken a keen interest in amateur welfare.

Dist. No. 4: 9EB's tower blew down. 9APR worked several stations in the 7th district with amplifier tube. 9CHB operates mostly on Sunday. 9CWR has another fifty watt and is going strong. 9BGW moved to Pennsylvania. 9CNL burnt out his last 5-watt. The wind blew 9CNR's tower down.

Dist. No. 5: 9BYN says traffic is hard to get on account of too many DX hounds, too busy to QSR and he intends to be on all summer working the west coast regularly, especially 6AHP. 9PI works all districts and has many reports from England. 9ZNM has tried to connect but is unable to hear him.

Dist. No. 6: Honors for Dist. No. 6 go to 9AK. 9BVX is putting up a real station. 9CRC and 9EF have not been on the air much last month. Traffic: 9BYN, 213; 9AK, 253; 9CWR, 208; 9ZAB, 203; 9CVH, 193; 9CHY, 172; 9CNL, 122; 9AAJ, 121; 9DBM, 100; 9PL, 99; 9ZC, 91; 9BBH, 78; 9GX-9YAE-8YAE, 76; 9CCI, 69; 9TI, 68; 9FU, 65;

8BIU, 51; 9GD, 46; 9AGP, 40; 9CAB, 40; 9CHB, 36; 9DAW, 32; 9ABD, 30; 9DFF, 25; 9CTA, 21; 9APR, 20; 9UQ, 17; 9BIE, 17; 9CMU, 15; 9BWC, 12; 9BCE, 10; 9CRC, 7; 9AHY, 3; 9BGH, 2; 9CSK, 1; 9AVN, 52; 9TJ, 40; 9DLS, 60; 9RW, 59; 9RY, 56; 9BN, 52; 9ALW, 52;

## DAKOTA DIVISION

N. H. Jensen, Mgr.

MINNESOTA—Dist. No. 1: Traffic during the month moved through the central and western part of the district. 9DOE captured the honors for greatest amount of traffic handled. A campaign has been

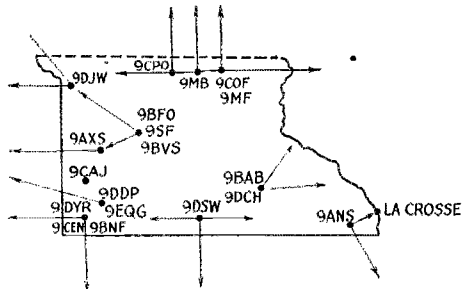

## MINNESOTA DISTRICT NO. 2

carried on by the D.S. to get new stations to handle messages. Excellent support has been given by newspapers throughout the district in this work. 9DOE is the new C.M. of Duluth.

Dist. No. 2: The new D.S. N. A. Canfield, of Luverne, is doing fine work in getting the district organized. 9ANJ is just out of the hospital at Rochester after having been laid up for three weeks. 9CPO is boasting a new brass pounder—a 10 pound baby boy. (FB—D.S.)

Stations shown in the map are ready to handle summer daylight traffic. Operating hours: 9CPO 6:30 a.m. to noon; 9BAB every day 7:00 p.m.; 9COC 5:00 to 6:30 p.m. (keeping regular schedules north and south) 9DCH 6:30 to 7:00 p.m. and Sunday afternoons. Stations that will be on at various hours are: 9MF, 9MR, 9ANJ, 9DDP, 9EGG, 9COC, 9AXS, 9DJW, 9SF, 9BFO, 9BVS, 9BNF, and 9DYR.

Traffic: 9DOE, 358; 9EGU, 262; 9BMR, 156; 9CDV, 142; 9RAV, 127; 9CO, 74; 9ABI, 72; 9AND, 54; 9EAU, 47; 9EEP, 42; 9CGB, 37; 9EGF, 22; 9DXT, 14; 9COF, 18; 9AXS, 36; 9DJW, 7; 9DDP, 50; 9DYR, 20; 9MB, 3; 9MF, 39; 9SF, 23; 9BFO, 4; 9DCH, 15; 9CPO, 10; 9ERC, 20; 9BTL, 41; 9BTT, 40; 9BLY, 30; 9DGV, 5; 9CTO, 5; 9DQH, 161; 9DAW, 29; 9CSJ, 64; 9CRW, 12; 9CV, 169; 9CZQ, 17; 9ABK, 68; 9DGE, 65; 9DCJ, 40; 9AQV, 35; 9CVJ, 3; 9AWV, 110; 9CXF, 75; 9CVV, 21; 9BPY, 18; 9HM, 14; 9AGB, 33; 9GZ, 57; 9BMY, 45; 9DZF, 15; 9BPN, 9; 9BDQ, 20; 9ASW, 5; 9ZG, 21; 9ZT-9XAX, 165; 9DEV, 48.

NORTH DAKOTA—The R.L. has been thru the state and given examinations. 9DKB is located at Fargo again and is making a desperate attempt to get in touch with WNP. The spring slump is making its appearance but not seriously as the message report for the month shows. Several stations failed to report which is another indication that interest is decreasing with the coming of warmer weather. Honors go to 9AMP for the largest message total with 9AEJ second. Traffic: 9AEJ, 55; 9AMP, 51; 9DKB, 30; 9DNX, 24; 9EBT, 47; 9UH, 9; 9CST, 26; 9DM, 22. Traffic—South Dakota: 9AYD, 20.

## DELTA DIVISION

W. W. Rodgers, Mgr.

MISSISSIPPI—9AKP reports steady QRN. 9QZ had a very nice total. 9AGV turned in a good total with no rubber stamps among them. 9ALZ is starting up. 9KR fell off in traffic due to the sickness of one of the ops.

ARKANSAS—Mr. Daly, 5DQ, formerly D.S. of Arkansas Dist. No. 1, has resigned and his 9RA is Memphis. A new D.S. will be announced later. 9HI is rebuilding. 9EA operated but one night this month. 9AB is working all districts.

TENNESSEE—9KA blew his transformer five times this month. 9EK is going strong. 9MO uses "TWO

hundred" and moves jobs of traffic. 5AAZ is operating. 5ALV works both coasts on a 10-watter. 5NT is with us once more. Old 5DA has hit the air after a silent period of several months. 5AIE and 5AIK have consolidated. 5CN is a new station at Bemis. 5CN is ex-4KM.

LOUISIANA—5EB and 5WG are keeping things running as usual. 5KC is high man for the division. 5KC has arranged schedules to beat old man QRN and will be able to carry on thru the hot season. 5ML, 5VA, 5LH, 5UK, 5ZK and 5GI complete the list of active stations.

Traffic: 5AAZ, 1; 5AGV, 22; 5AGS, 23; 5AIK, 9; 5AIR, 39; 5AKP, 31; 5ALV, 65; 5ANT, 42; 5CN, 60; 5DA, 26; 5DQ, 51; 5EA, 8; 5EB, 5; 5EK, 39; 5JR, 23; 5KA, 31; 5KR, 71; 5KC, 103; 5MO, 62; 5NT, 60; 5QZ, 39; 5WG, 12; 5AFV, 25.

### EAST GULF DIVISION H. L. Reid, Mgr.

SOUTH CAROLINA—Dist. No. 1: 40X has been appointed D.S. Charleston has a new station in 4SS. The active stations appear in the traffic figures.

GEORGIA—There were fourteen stations in Georgia which reported handling traffic. 4XR continues to do fine work and is letting Europe know that Savannah is on the map. 4GL has given up his home in Savannah and has moved to LaGrange, Ill. on account of his health. He was escorted to the station by all the Savannah gang and was given a real send off. 4GL has done consistent good work and has made friends with all the hams in the south-east, and we hate to lose him. We all hope he will get on the air at his new home and with him all the success and good luck there is. (Headquarters wishes "Chain Lightning Hill—4GL" a world of luck—T.M.)

All the stations in Macon have been on the air. 4BW has a daylight schedule with a station in Mississippi, and is pushing the traffic over to Texas. The DM in Macon, 4FZ is one station of the trunk line between the Great Lakes and Florida. 4FZ, 4JM, 8AGO and others make up this trunk line, and are QSR towards the north. 4PL is shooting the msgs over into Florida and is giving dependable service south. In Atlanta 4IO, 4XC and 4HZ have been very active. 4XC has a number of foreign stations to his credit. 4IO and 4HS have gone west with C.W. until new fittings arrive.

Considering the static, the QRM from the YLs, and the burial of fifty watt tubes, the gang in Georgia seem to be sticking to business pretty well during the warm weather.

FLORIDA—Florida continues to be a traffic state, and traffic is flowing into and out of Florida with the same regularity as in mid-winter. We have a net-work of good stations which will insure dependable relay routes during the summer months.

Dist. No. 1: Jacksonville remains the most important relay point for the state, being in daily contact with St. Augustine, Orlando, Tampa and Miami. 4IU and 4EZ keep schedules with these points and handle the bulk of South Florida traffic, while 4ER specializes in bringing it in from the north. 4ER keeps a schedule with Denver, and 4UZ has a schedule with Philadelphia. 4ER and 4EZ are now working Cuban 2BY, making six Jax Stations QSO Cuba. 4FS copied a rush msg from Gainesville, delivered it by phone, and QSRd the answer back to 4OH, all in three minutes. 4IU copied a msg from Cuban 2BY, QSRd to Miami, copied the answer from 4CH, and QSRd back to Cuba, all in 50 minutes. This was not done through schedule, and shows the dependability of the Florida traffic routes. 4SB still keeps schedule with 4JE and is probably the most important contact with Porto Rico. 4PI is now reaching out better, his loose coupled transmitter does the trick. 4OH is keeping west Florida opened up in fine shape. 4TC is a new station in Daytona, and opens up a section of the state which has heretofore been closed to relay traffic.

Dist. No. 2: 4IZ is back on the job and works Jax and St. Augustine on schedule. 4RO has moved to Miami but the set is still operated by 4II. 4JZ makes St. Petersburg an important relay point. 4PB is back on the air. 4BL remains one of our foremost message pushers. 4LR has gone back to 8AQP. Sorry to lose you, OM. 3OI has returned to 3ZO.

Dist. No. 3: 4DL is wide open for traffic.

Dist. No. 4: 4CH is on regularly and keeps Miami open for traffic. 4ES started up and is operated by 4DP. 4QY of Ft. Myers is making a reputation for DX and has become an important relay point between north and south Florida.

Traffic: 4ER, 183; 3OI, 184; 4EZ, 102; 4IZ, 76; 4PL, 45; 4OH, 43; 4IU, 36; 4SB, 35; 4FS, 32; 4PK, 28; 4QY, 26; 4JZ, 12; 4IL, 12; 4TX, 8; 4LR, 6; 4DP, 2; 4ZA, 10; 4BG, 28; 4IO, 50; 4EQ, 89; 4EH,

13; 4RZ, 135; 4HS, 12; 4PI, 16; 4EZ, 114; 4RW, 17; 4JD, 12; 4DY, 8; 4XR, 20; 4ZD, 15; 4OV, 8; 4SH, 99; 4RR, 21; 4BL, 34; 4CH, 15; 4IO, 17; 4HS, 7.

### MIDWEST DIVISION P. H. Quinby, Mgr.

NEBRASKA—9AEC leads the state for traffic this month, followed closely by 9DXY, 9EAK and 9AWS. Few stations are active in Northern Nebraska and those reporting all agree on the QRN. 9BNU is the most consistent station in the district. The new C.M. for Omaha is R. E. Yawerka, 3071 So. 32nd St. The most consistent stations are 9CIM, 9CMK, 9AWS, 9HG and 9CGS. 9GGA was on the first part of the month, and 9CUP has hit town again and is opening up the old clicker. A new station opened up with call 9BFG using a 100-watter. 9CJT is on the air regularly with a 50-watter. 9EFA has completed a new transmitter. 9CMK is exploring low waves. 9AWS tried out the circuit used at 9DXY and put 4 healthy ams in the air with 3.5-watters(?). I BCF Tuner Review was staged at the last meeting of the Citizens Radio Club to the mutual benefit of all present. 9CMK, 9DXY, 9AWS, 9EFA, 9BFG, 9CIM and others have completed theirs.

Dist. No. 2: Traffic was helped along by the messages originating with the Denver Post Radio Show. Over 150 of these msgs went through Nebraska. This district leads the state in traffic, although the actual number of stations is less. They are all reporting regularly. 9AFR's halvard was cut by a delegation of BCLs, but thanks to his well trained pulley, the rope jumped the track and the antenna stayed up.

Traffic: 9EAK, 59; 9DJP, 37; 9AKS, 50; 9AFR, 35; 9ELW, 8; 9AEC, 101; 9BXT, 19; 9ATE, 44; 9AML, 3; 9ANY, 10; 9EFA, 11; 9CIM, 27; 9AWS, 58; 9CGS, 4; 9CMK, 20; 9DXY, 98; 9CJT, 25; 9AQO, 3; 9BNU, 88; 9DNC, 3.

MISSOURI—Dist. No. 1: 9RLG lost an aerial in the storm but handled traffic anyway. 9NU is handling traffic on lone. 9EKY, 9CVO, and 9EKF are getting out in great shape on 250 watters. 9EKF has been sick. 9CRM is trying to make a 5-watter talk back to the old crusher, and seems to be getting away with it. A tree fell on the antenna at 9CYK with disastrous results, so he took a little trip up to 9DXY's and put in a boiled owl session there. 9BQS has shut down. 9AJD is on the air but reports no traffic. 9ADC rings up a big total on a 50-watter in spite of heavy outside work. 9DZO lost a 202 and a 203 exploring the low waves. 9DAK just recovering from an illness is trying C.W. 9ST knocks the ball over the fence with a total of 326. Who said the gang wouldn't take traffic from the Denver Post Radio Show???? The new A.D.M. expresses his hearty appreciation of the cooperation that the gang is giving him.

Traffic: 9BLG, 30; 9EKY, 57; 9ELY, 3; 9CVO, 53; 9EKF, 31; 9AAL, 22; 9BXW, 15; 9DRX, 25; 9RHL, 20; 9DMJ, 20; 9PW, 17; 9AWP, 14; 9ACI, 131; 9NU, 26; 9AAU, 117; 9DCW, 31; 9UXN, 15; 9CKS, 125; 9CZO, 21; 9ADC, 167; 9CRM, 29; 9ADR, 3; 9ACX, 36; 9AHZ, 98; 9AVN, 10; 9AYL, 3; 9BDZ, 11; 9BKO, 2; 9BST, 26; 9CDO, 5; 9CXO, 34; 9IB, 12; 9JBE, 3; 9ELZ, 15; 9RR, 34; 9SS, 11; 9ST, 325; 9BQZ, 6; 9DKX, 6; 9DEJ, 9; 9DOJ, 10.

IOWA—A.D.M. Wats reports traffic at low ebb this month. The gang staged a ham convention at Ames on the 18th and 19th, with 180 and 200 hams in attendance. 9ZT was present and gave some interesting talks on low wave transmission.

D.S. Bailey, 9CS says that gang is very slow in getting their reports in. 9BSL, 9CHN, and 9ECX are still going strong. 9BCD is back in Clinton and is installing a 50. 9RHG leads the gang with 275 msgs. this month. 9AYE and 9DAI are doing good work on the little tubes. 9CLQ is working 'em on a 50-watter and sync rect. Jack H. Duncan, 9BRS, 1357 East 13th St. has been appointed C.M. for Des Moines.

Traffic: 9AYE, 10; 9CLQ, 100; 9RHG, 275; 9BCX, 112; 9FK, 42; 9CHN, 73; 9DSL, 28; 9CS, 14.

KANSAS—Dist. No. 1: QRN was worse this month than a good many hot summer months. 9CFI tried sink rectifier and passed it along in favor of the old chemical. 9BVV handled a great number of messages. 9BVN handled 315 messages and handled all the traffic east from the radio show in Denver F.B. 9CCV has been too busy for active work. 9DHB lost one 5-watter and three masts 9BXC and 9DLM are on the job all the time. 9CCV was heard in New Zealand on three 5 watt tubes.

Dist. No. 2: 9KG, a new station is going in Yates Center. 9EJC, 9AYP and 9CCZ are off until

fall. 9EFU sports a new 50-watter. 9EFU heard French 8AB. (F.B., OM.) 9DES is steady with his reports. 9EFA was off. 9ABV is at it again strong. 9CCS is remodeling. 9AVG is still doing great DX on a 10-watter. 9AIM is there as usual. 9BRD worked 4 states and handled messages in daylight, using a tender 201A. (FB) 9BIO worked 1250 miles on a 5-watter and handled a good number of messages. Old 9AEG in El Dorado is coming to life. Traffic: 9CEA, 53; 9HN, 36; 9IW, 49; 9IWI, 15; 9CRO, 70; 9AJV, 15; 9DMX, 9; 9EHT, 24; 9BVN, 315.

### NEW ENGLAND DIVISION I. Vermilya, Mgr.

MAINE—IADI sends in his first report. IALK has a 15 watter. IASR is using "S" tubes. IAUC is using a Hartley like IXAM. IAUR worked British 2OD and shoved a message across. IBDB is changing to Hartley and "S" tubes. IBDI was off 12 days to go to the convention. Foreign schedules kept QSO same as usual. 29-RY added. Worked 2SZ-NM-OD about five nights a week. 287 words px to 2ZNM ex 2 otr msqs of 80 and 20 wds the 15th. Wkd many 6s and 7BJ. IBQL is dismantling his set. ICIB is on with a 50 coupled Hartley. ICTP has his 50. Tfc race wid IAUR next month. Everybody welcome. IEF DX 9BUK. Good work, OM. IGA wkd Missouri and Minnesota OK. IKX is waiting for some new "S" tubes but going just the same. IPD ex-IAWQ is on with us again. IYF has changed to 10 watts CRAC and is much better.

NEW HAMPSHIRE—IATZ is turning to C.W. Not so with IBTE. IYB is slipping a little. They complain about non-delivery of messages. IBNK is on again. IATJ had to build an addition on his shack to get his new O.R.S. appointment in. IMC is building a new 100 watt set.

VERMONT—ICPO is back from the south. ICQM's tubes went west. ILA and ICKD are getting out FR. IBDX is having better luck with his set. IAOZ is getting out with a receiver-transmitter. IARY is working on a rectifier—they need one.

EASTERN MASSACHUSETTS—Dist. No. 1: IDY will blossom forth with a 50 in the fall. ILM hasn't been able to be on quite as much as usual. IAOO came through with a good report. IBBK has opened up in Newburyport. IPP is doing very fine work on his flivver coil C.W. ICJR is out for baseball so doesn't get on much. IAAC-ZO is doing his usual DX. ISN says QRN is killing his DX. ISK is the star traffic station this month. IAP-XJ is carrying on pretty regular communication with England.

Dist. No. 2: The star station in this district is IAJA. Foreign stations worked are British 2KW, 2KF, 2OD, 5LF, 2SZ, 3NM, 2SH, and 2WJ. Dutch PCIL, PCTT and PA9. French 8CS. IBBM has made a short wave tuner, and has copied a dozen foreigners. IADM is getting out pretty well. IAIR got going again, and is reaching out in fine shape. IAQY's traffic dropped. IALL has received a couple more reports of his signals from England. ISE came through with his fine report. INY is on with a 15 watter and is QSO nines consistently. IAHL has rebuilt. Two new stations in Mansfield are: IADM and IBQQ.

WESTERN MASSACHUSETTS—Dist. No. 3: IAKF will be on consistently with 50 watts after the middle of June. IVC is back on the air and IARE is on more or less.

Dist. No. 4: IEO has been on the sick list. IVU is back with four fivers. IAWW is shutting down for its annual repairs. ICBH has two fifties.

Dist. No. 5: Both ICI and IAKL are active stations but neither reports. IKC reports a scarcity of messages.

Dist. No. 6: IBOM has sent two fifties west and is now on a five again. IBSZ keeps a bottle of smelling salts handy as its about time his 250 watter died.

Dist. No. 7: Bates says that reports for Worcester have been very unsatisfactory—not from lack of cooperation, but from slack reporting of activities. C.M. Carr has been very ill.

RHODE ISLAND—Dist. No. 2: IAAP is slamming out in all directions and doing excellent work. IANX is going good on one 50 watter. IBBV has shifted to the IQP circuit and has received cards from England, California, and Porto Rico. Not so bad for four fives. (Shhhhhh) 1200 volts on the plates tho. Hi.

Dist. No. 3: IBQD is the only one that is holding up this section at present. IBHK gets on week-ends but doesn't have time to do much.

CONNECTICUT—Reports are coming slow and traffic is scarce, due, no doubt to the usual Spring Fever. IBIL, IAWY, IND, and IBHH reported no traffic handled. Many thanks, OM. I would like to insert a warning that if the new O.R.S.s do not send

in their reports each month, whether they handle traffic or not, some of the new certificates will be called in for cancellation. IADP sent a msg to his brother in Italy recently, and got a reply. Hws that? IIV is working English and Dutch stations when conditions are favorable. IAVW and IIV and IBM are logging a bunch of foreign stations. IAXN blew a 50-watter but has another to take its place. IZT-IPA says the 5-watters sure do perk at his station. IZL was reported by 6AKW, using 5 watts. (FB, OM.)

Traffic: IAVJ, 48; ICKP, 14; IAH, 54; IAWY, 56; IAYR, 45; IAYT, 71; IUO, 142; IFD, 30; IAJT, 16; ICDE, 98; IMO, 67; IMY, 142; IBGC, 40; IAXN, 51; IAJP, 25; IZT, 23; IIV, 21; IBM, 5; IZL, 25; IACO, 57; IADI, 26; IALK, 29; IAPT, 2; IASR, 45; IAUC, 20; IAUF, 6; IAUR, 7; IAXU, 6; IBDB, 20; IBDH, 3; IBDL, 102; IBJS, 11; IBNL, 28; IBQT, 47; IBTT, 38; IBUB, 118; ICDO, 15; ICIB, 40; ICNP, 3; ICQN, 6; ICTP, 15; IEF, 55; IFR, 34; IGA, 85; IKX, 35; IPD, 10; IYF, 51; IBHR, 62; IBID, 46; IIB, 3; IIT, 37; IKL, 2; IYB, 145; IAEK, 224; IBNK, 68; IBJF, 93; IATJ, 59; IAVL, 145; IARY, 33; IAG, 21; IAFN, 16; IYD, 71; IARF, 91; IASU, 82; IBSZ, 69; IABF, 61; IAWW, 57; IIL, 52; IAOU, 46; IAKZ, 40; IDB, 37; IARF, 36; IDE, 30; IBBP, 26; IVT, 26; IKC, 25; IAAI, 21; IBOM, 19; IPY, 17; IAPA, 15; IGY, 11; ICBH, 10; IBTU, 9; IAJK, 9; IBO, 7; IJQ, 3; ICIT, 38; IYK, 10; IAQY, 17; IATR, 85; IJK, 8; IAOO, 68; IBTF, 40; IAZT, 83; IGSS, 50; ISK, 163; IBRM, 37; ISN, 14; IAAC-ZO, 107; ICJR, 70; IAOM, 10; IPP, 56; IAF-XJ, 92; IBDU, 3; IAHL, 15; INT, 55; ISE, 18; IBM, 18; IAJA, 104; IRR, 20; IANX, 75; IAAP, 64; IBVB, 190; IBQD, 132.

### NORTHWESTERN DIVISION Glenn E. West, Mgr.

WASHINGTON—Traffic continues to fall off. Mostly on account of tube trouble or just plain Spring Fever.

Dist. No. 1: 7RC was off for two weeks on account of a blown tube but is on again.

Dist. No. 2: 7FD is away so we have 7ADP acting C.M. 7MA, a new station, shows great possibilities of being a good relay station. 7IH takes the cake for relaying most msgs in the city. 7ADQ, 7FD, 7AEL, 7OY, 7CA and 7ADP all helped to make a better total. 7AIB received a message from WNP under a broadcast. 7ABB is back again.

Dist. No. 3: 7WS was the only one that reported handling any traffic. 7FS, a new station, handles a buc with a wicked speed. 7AIF will be shipping out to sea anytime. 7DC seems not to have enough ambition to start up his transmitter again.

Dist. No. 4: 7NO heads the list as far as messages are concerned. 7SH with a 10 watter gets cards from all districts. 7DI is in mourning over his lone departed 5 watter. 7AGZ using a 10-watter was QSO Georgia. 7KV is not doing much. 7HC, 7ADF, and 7LH are down on the lower waves and doing fine work. 7LH tried the real low ones (115) but the R.L. convinced him that 150 was low enough. 7QX was doing fine work until his fiver joined the ranks of the Dead Ones. 7SF has been having hard luck with his 250 watter. 7AHA was on every night until his fiver failed him.

Dist. No. 6: 7AX holds high traffic honors also works 9's and 5's. 7VN holds his own with a 10-watter and does fine DX. 7GR has worked a 2 in Montreal. 7IY worked 2BRR completing all districts. 7AJY worked a New York 8. 7BJ says that the three bother him a lot when he CQs.

Dist. No. 9: 7RY put over a nice total. Also 7QC. 7GE-ZX being QRW is not on much but pounds brass during spare moments.

Dist. No. 10: 7AF is back again with a great wallop. In his back yard stands an 80 footer which surely accounts for it. 7WA is handling messages occasionally. 7GI gave a few msqs, a lift. 7EB and 7SZ have been keeping quiet.

OREGON—The handling of amateur messages has increased somewhat, altho the DX craze is still in our midst. All the gang are especially camping around 220 meters trying to get in touch with WNP. Static seemed to start early, but east coast stations still pound in as well as ever.

Dist. No. 1: 7IW and 7GQ are working all districts, much to the downfall of their school work. 7SY and 7JU are both doing good work. 7AHZ promises to be on more as soon as he moves to a better location. 7SC is now on again with two fivers using "S" tube rectifiers. 7QT, 7QU, and 7OH are moving all the traffic they can get hold of. They handle lots of biz for the college. 7FA is off the air.

Dist. No. 3: 7KS reports QRM from NPE early in the morning. 7AID is using a combination of a

5 watt and a receiving tube and gets out in good shape. 7AKH reports his hook clear and ready for more.

Dist. No. 4: 7AKK and 7UT are the stations at present. 7TO is again on the job with a 50. 7TT, 7RD, 7AEK, 7AV, 7AIP and 7CW can be heard any time. 7QJ reports too much QRM from married life at present.

Dist. No. 7: 7QD, 7EM and 7TQ are doing most of the work. 7TQ has his new 70 footers up and is getting lots of kick using series condensers.

Dist. No. 8: 7ABY is doing all of the northern work of late.

IDAHO—Dist. No. 2: 7ACF has put Buhl on the map for the first time. 7OB is at it in the same old fashion with his "knock-out" transmitter. 7IO has good luck working 4's and 8's as well as the closer ones. 7OB talks like he is going to shut down until next winter. 7GW is becoming a regular owl. 7GX is erecting a new 80 foot tower. 7IU is working east with ease. 7OT seems to be silent now. 7FT is now operating a commercial station in Alaska. 7LN longs to twirl the knobs but his school work, plays, etc. just won't let him.

MONTANA—The usual spring slump has not affected this state. On the contrary more stations have been heard and message totals compare favorably with the more favorable winter months. A peculiar phenomenon has been discovered. For years many of the best stations in Montana have not been working each other. This is partly explained by the fact that some of the stations are using the short waves but probably it is due to the fact that during the early evening twilight hours the ether has peculiar properties which it quickly loses as soon as darkness settles down.

7CO again takes first honors for the state as well as for the whole district, for consistent work and number of messages handled. The most active stations in Montana, in order of consistency are: 7CO, 7ACI, 7ZU, 7AGF, 7AJD, 7IT, 7WP, and 7EL.

Dist. No. 1: 7WP reports some loss of interest due to spring fever and increased QRM. 7KZ is going in good style. 7AGF is on the air a few minutes each night.

Dist. No. 2: 7ACI is the most consistent station in the district. 7IT and 7EL have been pounding along as usual. 7NT is often heard using an X on the starter waves.

Dist. No. 3: Same as usual—DEAD from the bottom up. Our only hope is 7KL.

Dist. No. 4: 7CO is on as regular as a clock and handles messages like a veteran. 7AJD lost a 5-watter during the month. 7ZU's second op. kept the ether hot and a good number of msgs were handled.

Traffic: 7ABB, 123; 7AJY, 53; 7GE-ZX, 31; 7AF, 26; 7GI, 20; 7QX, 12; 7ZU, 87; 7AHZ, 10; 7AEK, 22; 7AKK, 50; 7SY, 94; 7GX, 10; 7IH, 114; 7SH, 45; 7RC, 30; 7WS, 25; 7AGZ, 20; 7ADP, 10; 7AJD, 63; 7TT, 5; 7UT, 33; 7AKH, 58; 7OB, 28; 7RY, 88; 7MA, 43; 7QC, 28; 7AIB, 24; 7KV, 20; 7FD, 7; 7AGF, 10; 7AIP, 18; 7CW, 33; 7AV, 50; 7CO, 250; 7NO, 79; 7AEL, 40; 7OY, 27; 7LH, 24; 7ADQ, 18; 7CA, 3; 7KZ, 46; 7KS, 18; 7GQ, 38; 7ALD, 64; 7IO, 4; 7ACF, 32; 7GW, 14; 7AJ-LC, 18; 7AX, 125; 7GR, 65; 7BJ, 35; 7WA, 27; 7DI, 27; 7DI, 22; 7ADF, 18; 7BM, 2; 7WP, 22; 7JU, 26; 7RD, 39; 7TW, 67; 7LN, 12.

### PACIFIC DIVISION M. E. McCreery, MGR.

CALIFORNIA—Dist. No. 1: 6AVR-6ZBF works all districts using a 50-watter on 189 meters. 6ALK put in a series condenser and works each coast regularly. 6AHP, 6ARY, and 6BFG have consolidated and installed a 250 watter, with which they work every district. 6AWX roars in on C.W. and phone. 6ANQ goes to College so don't get much chance to be on except Saturdays. 6XN-6ZB has been doing considerable experimenting on the low waves. 6AWQ at the San Diego High School has had it's license suspended for being on the air after 8 P.M. 6EBE and 6BJU both old spark hounds are on now with C.W. 6AQJ works the fellows around town on a receiving set.

Dist. No. 1-A: Catalina Island: There has been an entire change of wave-length at 6XAD-6ZW. The 500 watt Western Electric is on 178 meters. The 250 watt G.E. is on 216 meters. The 100 watt W.E. is on 192 meters.

Dist. No. 2: DX weather seems to be at its best at the present and many stations are working every district without any trouble. 6BEG lost another stick. 6LJ suffered hard luck by having most of his heap burnt up. He finally got back on the air again and is doing fine when operating. 6AAO-

6CHV is using 100 watts and improved his radius a lot. 6BVG is working on low waves. 6KA-6XBC also has been down on 100 or below and is doing likewise. 6ALG-6ZBB lost another one of his sticks and was forced to QRT for a while. 6NB has been working everything. 6BRO is still using AC on his plate and sure raises Cain around the city. 6MH was forced to quit by putting 110 volts on his filaments by mistake. 6PL seems to be trying to get his wave up as high as the navy area and almost has succeeded. 6CNI don't know how to use anything else than a buzzer and does good local work with it. 6BRA raised his antenna and has about twice the wallop. 6EA and 6EB promise to have a real wallop when they get going right. 6CMR finally came on after suffering from the loss of his tower. 6CMU has a 50-watter and surpasses his old wallop. 6BRF is going to raise a new stick. 6PL-6MG have been scarcely heard on the air. 6AQD hasn't been heard for a long time. 6CGS is a new station in Hollywood doing good DX. 6ALF and 6ALH have been making plenty of noise. 6BVZ claims that his DX is 48 states. 7ABB's brother was in the city and visited a few of the gang. 6AFG is going to move to the country. 6BWD is handling a bunch of traffic. 6PQ is losing his welcome with the bunch around L.A. because of using an untuned (Very much so). (Plenty broad). 6BWE does plenty of good DX. 6OG, a new station, promises to have 250 watts going pretty quick. 6KE claims the same. 6BIC has been reaching in all directions. The bunch seem in earnest as to all the tests that are being run and can't wait until the next one starts. 6CIX is beginning to handle traffic and has worked 3MO and 4LL—Mex. BX. 6BB gets out great as usual working the east coast regularly. 6BUR has not been on much but all districts but the third have been worked. 6CGW is getting out F.B. and has installed remote control so that he can operate from his bed. 6HMB has one stick up and hopes to pound brass soon. 6NE was reported in New Zealand the first week he was on. 6WT was on the air three days with a detector tube, 600 on plate, 1.6 amps. 6AUR finally got his cage antenna up. 6CMX had a hard time with a Y.L. and finally gave up radio. 6JA is going to put up some new 65 foot sticks. 6BOS got acquainted with a Y.L.—enuff said! 6BQT is on now and then with his spark. 6AKQ ex-9ARB had a streak of bad luck. While he was away someone stole his receiving tubes and power tubes. 6IF is married, but is on the job with C.W. 6CNH moves so much that the radio inspector can't keep his QRA correct.

Dist. No. 3: 6CDG is our star station this month. 6BLZ has gotten several 8's and succeeded in hooking up with some nines. 6MP has been raising quite a noise with a H' 5 till just lately. 6QB has his fifty working east now. 6DT is on the air. 6AVV is to be complimented on his building up district No. 3 and increasing activities to the extent of making a district out of that which we all considered a wide place in the road as far as radio activity was concerned—A.D.M.

Dist. No. 4: The landslide to short waves has caught 6LV. He reports working all but 4th district the first night on 150. 6CJV has worked all districts but one on so called "five watts." 6AO is on again using 3 phase 300 cycle juice with a chemical rect. and no filter but it sounds like B batts. 6NX says the guys didn't come through well at all this month. 6XE has been working on 110 meters all month and has worked across country many times. 6CJX is handling a little traffic now and then as are 6NX and 6APS. 6ZAU-6ATC is off the air due to building a new antenna system and tower. 6ZAR-6TV blew his 5fies but put in ten watts (?) and a coupled Hartley ckt and proceeded to work all districts. One February 29 6ZAR-6TV heard a very QZV A.C.C.W. sig on about 110 meters that signed 6ZNM. Marcus. 6ZNM has confirmed this reception, which was done on a Low Loss Tuner using one stage of A.F. 6ZAH-6TU has changed to coupled Hartley and all districts report him much better than ever before. 6IN-6ZAT is on again. 6BZ is running with R.A.C. on about 195. 6AME still hangs on as our star low power station. This month he was on eight nights but was heard in all but 4th district on 24 watts input B batts for supply. He is using a big antenna and working about 20 meters below the fundamental on 155. As usual 6ZBU-RIH worked all districts. 6CIB, 6AMG, 6CJD, 6MP, sent message reports. 6CJJ lost his poles in a wind storm. 6AMG lost 6CEI complains that msgs are hard to get. 6TV a pole and a fiver. 6FY is off the air for a while. worked 6BFF in Oakland who was using a fiver with four volts on the plate.

Dist. No. 5: 6CFZ is breaking up the ether in San Francisco with a 250 watt bottle. 6CHL is

still being kept away from his radio set by the mysterious person. 6AWT is not on the air at all lately. 6CEC thinks summer wx. is the best for DX, he expects to come on with a 100-watt. 6CPT has been laying off for a while. 6RW believes in business before pleasure so has not been on much. Old dame rumor has it that 6CLV will shelter a 100 watt set. 6CKF must have robbed a bank as he now has a 1000 watt 1000 volt M.G. and he will be on with 150 watts. 6CMM has been fooling around with Low Loss Tuner. 6BUF will be on with 20 watts soon. 6AUI will discontinue his 100 watts and QRP on 5 watts. 6HQL reports DX FB on his 50-watt. 6GW is doing FB on 10 watts. Traffic: 6HQL. 54; 6CMM. 22; 6CLV. 93; 6CKF. 21; 6APH. 10; 6AUI. 50; 6CEC. 8; 6CET. 15; 6AWT. 27; 6CHL. 33; 6RW. 11; 6BFY. 18; 6TU. 21; 6ZAR. 10; 6TV. 14; 6ZAH. 10; 6CEI. 8; 6ZBU-BIH. 246; 6CIB. 21; 6AMG. 10; 6CJD. 5; 6MP. 30; 6AME. 26; 6CJV. 46; 6LV. 202; 6NX. 17; 6CJ.K. 7; 6AQD. 69; 6BRF. 85; 6ALF. 5; 6CBB. 25; 6BWD. 17; 6PL. 208; 6MG. 17; 6ALG-6ZBB. 34; 6NB. 200; 6CMU. 121; 6CGS. 10; 6BRA. 12; 6BVZ. 2; 6BRO. 4; 6AAO-6CHEV. 157; 6CNL. 110; 6AJQ. 5; 6RF. 12; 6AGA. 5; 6BNG. 40; 6AUR. 10; 6BQS. 1; 6CGW. 45; 6CNH. 6; 6JA. 42; 6WT. 6; 6NE. 14; 6BUR. 106; 6BRW. 73; 6CTX. 9; 6LJ. 14; 6AVR. 209; 6ALK. 135; 6ZH. 70; 6AHP. 67; 6AWX. 12; 6ANQ. 8; 6BNY. 9.

### ROANOKE DIVISION W. T. Gravelly, Mgr.

WEST VIRGINIA—Traffic was very short, many of the stations in Wheeling being put out of commission by recent storms. 8AUE worked 30 states in the past month and gathered but 29 messages. 8AMD worked 43 states in less than 15 days and only got 9 messages out of the bunch. The active stations appear in the traffic list.

NORTH CAROLINA—Not a single report from this Old North State.

VIRGINIA—D.S. Carr has the axe hanging over some of these birds that have stations and don't use them, or use them and fail to make a report. 3SG is out of commission. 3MT is re-building. The average delivery of traffic at 3BMN's station is 10 hours. 3W is also 3XAR. 3DT, at VPI Blacksburg, is one that has recently been developed by some of the students at this Institute. 3BZ has recovered from his recent disaster after the storm laid him flat and is setting out all over the lot. A storm does good sometimes. HI!

(If you fellows in Virginia want the new O.R.S. certificates, you had better get busy and make applications for them—T.M.)  
Traffic: 3CKL. 40; 3CXM. 44; 3ATC. 40; 3AUE. 29; 3IW. 24; 3DT. 23; 3WZ. 17; 3LX. 16; 3BMN. 12; 3SP. 12; 3BPU. 11; 3BBM. 10; 3AMD. 9; 3DES. 9; 3CA. 8; 3ATB. 5; 3AOT. 3; 3AIF. 2; 3BZ. 12.

### ROCKY MOUNTAIN DIVISION N. R. Hood, Mgr.

9CAA 733 Msgs

C. W. Denver

COLORADO—8RN which was set up for the Denver radio show put thru 1450 messages during the three days duration of the show. 9CAA is one of our steady stations so he sets in the box seat. QRN is already making itself known but this month shows the greatest traffic total this season. 9AMB has not trenched his stride yet. 9EEA has been on and moved traffic. New relay certificates have been issued to 9AMB, 9APF and 9QL.

All the stations in district No. 2 reported. 9CHT, 9CLD, 9CDE and 9DFH have moved traffic. Some

very strong winds have removed several antenna systems.

Traffic: 9AMB, 95; 9BUN, 150; 9BXQ, 160; 9CAA, 733; 9EFA, 72; 9QL, 50; 9APF, 190; 9CJY, 452; 9BN, 1450; 9ABC, 41; 9BIC, 11; 9DTE, 214; 9DFH, 15; 9CHT, 50; 9CLD, 33; 9CDE, 29; 9EAE, 166.

WYOMING—7NR leads in Wyoming. 7HW has been on regularly. 7ZO and 7ZV have been off the air.

Traffic: 7NR, 65; 7ZD, 10; 7HW, 15.

No report had been received from Utah April 26.

### WEST GULF DIVISION F. M. Corlett, Mgr.

New O.R.S. certificates were issued to the following: 5LR, 5XAQ and BX down in old Mexico.

5ZAE, L. D. Wall, has been appointed D.S. for District No. 8 in Southern Texas.

5ZAV-TNG, L. Moffett, Jr. has been appointed C.M. for Oklahoma City and the County of Oklahoma.

5CV, J. S. Braun, has been appointed C. M. for Waco and McLennan County.

The new O.R.S. certificates are being "dished out" as fast as the necessary data can be obtained from the field, i.e., from the C.M.s and D.S.s, the certificates properly signed and made out. The work is necessarily slow. Division Headquarters is taking its time in issuing these valuable certificates of honor to the reliable relay stations. A number of applications are on file—just keep cool fellows, you will get yours or you will get a good and sufficient reason why you do not qualify.

Our message traffic dropped off some more this month as did the total number of stations reporting. QRN had something to do with it.

5LR shipped back into first place again with a total of 440 real messages.

NORTHERN TEXAS—5DW and 5LI are taking care of the bulk of the relaying at Greenville. At Denton 5AHC is out of commission, but 5AMB is holding the fort. Dallas is represented by 5AJJ, 5LR, 5HY, with 5ANO helping out at 5LR. 5AJJ and 5LR are QSO Mexico City and Havana every Tuesday night. At Ft. Worth 5MZ is the only station reporting. 5BD represents Arlington.

Dist. No. 2 handles most of the traffic, 12 stations reporting—10 of them reporting a good batch of messages. Traffic is moving throughout the district. Traffic: 5LR, 440; 5AJJ, 248; 5SD, 109; 5AJT, 102; 5CV, 30; 5AMM, 64; 5ABW, 44; 5AGH, 34; 5ADH, 68; 5PH, 97; 5AET, 1; 5CT, 16; 5HY, 30; 5BD, 87; 5LL, 21; 5AMB, 24; 5MZ, 92; 5DW, 35; 5QW, 30.

SOUTHERN TEXAS—Dist. No. 6 seems to be represented by 5OC and 5PK of Port Arthur on the air most every night, and traffic is moving OK.

Dist. No. 7: 5ZU has sent his entire set, transmitter and power plant to ex-5EN, who is now in Bogota, Columbia, S.A. and will install and operate an amateur station there. 5AIR is the only other Austin station reporting.

Dist. No. 8: San Antonio is well represented by 5UX; (new QRA R. W. Carr, 1020 W. Woodlawn Ave.) 5MN, 5WP, 5AKZ, 5EZ and 5ZAE. 5PS is doing the trick out San Angelo way.

Traffic: 5EZ, 29; 5AKZ, 95; 5ZAE-5GB, 10; 5OC, 10; 5PK, 44; 5UX, 22; 5AKZ, 105; 5ALR, 41; 5ANF, 11; 5PS, 14; 5MN, 6.

OKLAHOMA—Dist. No. 1: 5ANF, is holding the district down all by his lonesome.

Dist. No. 2: Traffic moving fairly well over this district and 5GA, 5XBP, 5AJQ, 5ED are responsible, while over Sapulpa way 5AAW is on the job.

Dist. No. 4: 5AGZ at Ringling and 5AHD and 5VM of Norman are passing them along for this district.

Traffic: 5AJQ, 15; 5AGZ, 41; 5GA, 11; 5AHD, 35; 5VM, 12; 5AAW, 16; 5ED, 7; 5XBF, 5. New Mexico: 5LG-5SC, 16; BX, 25.

## CANADIAN SECTION

April has not been very good for radio from a weather point of view but a couple of outstanding events have taken place.

Firstly, the second division managers' tests were unsuccessful except in the eastern portion of the country owing to very high static which covered the whole country and which in the eastern portion of the country took the form of an electric storm. This failure however was counteracted by

the success of an impromptu test of the week end of April the 5th-7th. These tests were conceived by 3WS at Port Arthur who told the gang to get on the air on Saturday night the 5th and try and work a message across direct from England to the West Coast of Canada and back in one evening.

The message was duly started by British 5KO in Bristol who sent the message to Canadian 1AR at Halifax. 1AR promptly

shoved it on after a delay of about ten minutes during the time that 3BQ and 3WS were hooking up and gave it to 3BQ in Kitchener. 3BQ handed it to 3WS in Port Arthur who after a delay of half an hour gave it to 9BX in Morse, Saskatchewan. 9BX shot it along to 4DQ in Vulcan, Alberta who had trouble for some time in getting rid of it, finally handing it to 5CT who started the return trip. It was too late in the morning however to work it back to the east coast and the return message was not shot into England until the 7th. However the success of getting it across from England to the West coast of Canada during one night was pretty fair glory for those concerned. The amusing part of this is that in every case stations in the large cities were not used as neither Montreal, Toronto nor Winnipeg were in on the relays although stations in all these cities were on the air.

The short wave business has been growing rapidly so that at least 75% of those Canadians heard on the air at the present time are down around 150 meters or so. This is first rate work.

Another excellent thing from the Canadian point of view is the recent decision of the Department to allow operation of transmitters in Canada on any wave between 125 and 150 meters and between 200 and 225 meters instead of the former arrangement of set wave lengths. Incidentally this change can be credited to the courtesy of the Superintendent, Mr. Edwards, and was made at the request of the A.R.R.L. through their Canadian General Manager. In respect to wave length allowance the Canadian amateur now has it over his United States cousin like a tent for which we have to thank the progressive nature of the radio branch of the Department of Marine and Fisheries and the flexibility of the Canadian Radio Telegraph branch which enables the Department to change allowance of wave lengths at a minute's notice to comply with the development of the art.

#### MARITIME DIVISION W. C. Borrett, Mgr.

1EI reports things in New Brunswick are getting better. 1AF is unobdying the honor of northern New Brunswick. All N.B. stations are requested to report to the A.D.M., T. B. Lacey, c/o N. B. Power Co., St. John, by the 30th of each month.

In Prince Edward Island the total amount of stations working is still the same as last month. The A.D.M., Walter Hyndman, of 1BZ, made a great hit with the Halifax gang at the convention and his station is again on the air. Major Keith Rogers, 9AK, has been on the air on short waves for the last month and is handling traffic in fine shape.

Cape Breton Island is coming along fast. 1AW should be on by the time this is in print.

Halifax, the center of activity, has performed the miraculous. The Garrison City has had ten stations in operation for some time and each one has worked stations are 1AR, 1BQ, 1EB, 1DT, 1DJ, 1DF, 1BV, 1DD, stations are 1AR, 1BQ, 1BR, 1DT, 1DF, 1BV, 1DD, 1DQ, and 1EF. All have done it on less than one hundred watts input.

1DJ holds the honored position of being the first Maritime station to call and work Europe with one UV-202 with a 32-watt input, when he worked 220D. 1DT has worked all U.S. districts, excepting the 6 and 7, England and France in 15 days. 1EB worked 3 European stations with one 202 with an input of 40 watts. 1BQ, the winner of Mayor Murphy amateur radio cup for 1923, is QSO Europe every night. He has worked every U.S.A. district, transmitter. A Y.L. got poor 4GR.

1, 2, 3, and 4 Canadian, also England, France and Holland. 1DQ is suffering from loss of tubes at present.

The mighty 1AR is back with a vengeance. 1EF has been appointed C.M. for Halifax in place of 1BV who is now a traveling man.

Newfoundland has three of four members of the A.R.R.L. now and the Maritime gang are all anxious to gain the honor of being the first to work them. 8AW has had correspondence with several of the gang and should be on soon.

Traffic: 1ET, 10; 1AF, 18; 1DN, 1; 1RZ, 1; 9AK, 10; 1DJ, 5; 1DT, 2; 1EB, 7; 1BQ, 18; 1AR, 53; 1EF, 75; 1DD, 32.

#### ONTARIO DIVISION C. H. Langford, Mgr.

Fellows, it certainly is hard to keep back some good news. The only way I can tell you without saying anything that I shouldn't, is to keep your ears glued on the short wave-lengths and watch the activities of a well-known Central Ontario man. You will be surprised and then anxious to get in on the work when the lid is off. For the time being, get that transmitter in the best condition --and watch.

EASTERN ONTARIO--The active man of the month is 3AEP. Kingston is well represented by 3NF, 3AEZ, 3AEL, and 3HE. The new D.S. of Central Ontario is W. V. Sloan of 9BJ. Central Ontario wins the honors in a real traffic report. It totals 600 messages. Most of this has been cleared by daylight schedules. 3MS and 3AEC have been reaching out to both coasts without any difficulty. 3KP is heard on the air every week-end when he is home. 3DE is closed down permanently. 3VH has a brand new message hook and is shouting for traffic. 3QO is doing good work. 3AD is working C-one and U-fives with ease. 3SB is getting started with his fiveer. 3BQ is working C-fours and U-sixes and sevens and doing good all-around business.

WESTERN ONTARIO--London is represented by 3TB and 3XN. Ingersoll is somewhat backward at the present time though 3DF and 3ADF are building transmitters. 3YV is the only active station at Sarnia. 3KO of Chatham is having success with his 125 meter experimental work. 3GN-9AK is doing good work and is a booster for the short wave stuff.

NORTHERN ONTARIO--3BQ is QRM at 22NM. Don't forget to hang around the short wave band and give yourself a surprise.  
Traffic: 3ACV, 10; 9AL, 57; 3YV, 41; 3KO, 38; 3LB, 1; 3BQ, 29; 3BQ, 56; 3ADU, 31; 3YH, 12; 3DS, 61; 3HT, 108; 3EY, 40; 3QO, 18; 3XZ, 138; 3OH, 40; 3MS, 34; 3AEC, 20; 3ACO, 50; 3VH, 20; 3WG, 47; 9AL, 61; 9BJ, 72; 3BQ, 18.

#### VANCOUVER DIVISION A. J. Ober, Mgr.

The only way to be QSO anybody is to drop to 125 meters. 4HH and 4DQ are QSO daylight and through the worst kind of xray QRM. The Can-Transoceanic Tests were FB in this division. The west coast knew nothing about it, and a little time was lost in raising a station, but the old reliable 5CT was on the job and linked the coast.

ALBERTA--A good traffic report this month. 4IO is working into 88, 58 and has been reported on the east coast. 4AX is on regularly now. 4CW is still the N.H. of this district and thinks nothing of working the east coast. 4IC has a real QSB. 4AB is on the air regularly and consistently working over 800 miles. 4DQ is QSO Chicago and the 5th district.

VANVOUVER ISLAND--5CT is on the air regularly, and found 5CH of Prince Rupert. This makes us QSO P.R. once more. Where, oh where has 9BP gone? Must be daylight QRM same as WNP..

EDMONTON--4CL is closed for a few months. He has left to take out first-class license and expects to sail the seas. 4AH is the new D.S. now.

#### WINNIPEG DIVISION J. E. Brickett, Mgr.

MOOSE JAW--Five stations are handling traffic here. 4HH is on the air again on 150 meters and working all districts. 4ER is pushing a wicked key. He worked 400 miles with neither C.P. or ground, simply a condenser shunting the helix. 4IW is still the "Jinx" of the B.C.L.s with A.C.C.W. and is hurrying along with a rectifier. 4EO has a new 5-watt with 1100 volts on it.

PRINCE ALBERT CITY--4FC is rebuilding. 4AV has his spark and a C.W. going. 4AM is hitting it with a 10-watt. 4HS is still working on his transmitter. A YL got poor 4GR.

(Concluded on page 9V1)



# Calls Heard



When Preparing a List for QST, it is Essential to Observe the Following Rules:

1. List the calls neatly on a separate sheet of paper with a line of space between lines; do not embody them in a letter.
2. Arrange the calls as they will appear in QST: across the page, numerically by districts, alphabetically in each district, Canadian and foreign calls listed separately, state whether spark or C.W., and give period of time covered by the list.
3. Forms close on the fifth of the month preceding the date of issue of QST. Make your lists cover the period from the first of one month to the first of the next if possible, but don't let your list come in late.
4. List only calls over 500 miles distant.

## HEARD DURING APRIL

unless otherwise specified

T. W. Higgs, 5KO.

45 Howard Road, Westbury, Park, Bristol, Eng.  
(March 18th to Apr. 18th)

1aac, 1aja, 1ajp, 1alw, 1apu, 1apy, 1aul, 1awe, 1blb, 1bsd, 1bvl, 1cene, 1my, 1se, 1sw, 1vc, 1xae, 1xah, 1xam, 1xap, 1xau, 1(xar), 1xas, 1xj, 1xw, 1ze, 2eei, 2ela, 2elu, 2epd, 2di, 2zk-2xab, 2yac, 3bl, 3bpp, 3udn, 3rkh, (3pz), 3xar, 4xc, 4xe, 4xr, 5mi, 8dfl, 8gz, 8xbh, 9xax-9zt, 9acu.  
Can.: (1ar), (1bq), 1dd, 1dt, 1ef, 1fe, 2be, 2bg, 2bn, 2cg, 2hg, 3bp, 3ko, 9al, (9bl).

Roy W. Galpin, 5NF.

Bank House, Herne Bay, Kent, England  
(Heard during March)

1abx, 1aki, 1amb, 1aur, 1awl, 1axa, 1bie, 1bom, 1cak, 1cl, 1emp, 1eo, 1kv, 1ic, 1xab, 1xad, 1xak, 1xar, 1xw, 1xy, 2awp, 2bbx, 2bux, 2buy, 2bvm, 2epd, 2gk, 2hh, 2xab, 3ein, 3hv, 3lg, 3af, 4ait, 4eu(?) 7, 4io, 4lg, 8bat, 8dda, 8fm, 9am, 9bhx, 9brk, 9dhk.

Frederick L. Hogg, 2SH

37 Bishop's Rd., Highgate, London, N.C., England  
Mar. 20th to Apr. 22nd. Mostly in 100 meter band: (1aac), 1ael, 1aja, (1alw), 1asr, (1aur), 1blb, 1boa, (1bvl), 1emf, 1dj, 1dt, 1vc, 1vf, 1xah, 1xam, 1xj, 1xw, 1xz, 2aa, 2adx, (2awf), 2bse, 2iu, 2xar, 2xc, 2xna, 3bj, 3blu, 3eko, (3fi), 3mb, 3me, 3pz, 3xar, 4xc, 8aol, 8dda, 8dkj, 8ef, 9xw.  
Can.: (1ar), (1bq), 1dd, 1eb, 1ef, 2be, 2bg, 2cg, 3bg, 3ds, 9bl.

R. L. Royle, 2WJ.

"Southwold" Alderman's Hill, Palmers Green  
London, N. 1, 3, England  
(Mar. 19th to Apr. 19th)

(1aac), (1aja), 1aur, 1blb, 1bsd, 1ef, (1xj), (1xah), 1xam, 1xu, 2az, 2brb, 3bg, 3bi, 3bv, 3pz, 3yo, 3bla, 4ba, 4oa, 4xc, 4xe, 4xn, 8pl, 8yv, 8ebh, 9ef.  
Canadian: 1al, (1ar), (1ba), 1bg, (1dd), 1dj, 1dt, (1eb), 1ef, 2bn, 2cg, 9al, 9bl.

Roger Dupont, 8BM

La Briquette, Valenciennes, France

Feb. 17th to 23rd—1bcf, 1bdi, 1bsd, 1cmg, 1cmp, 1iv, 1xah, 1xam, 1xj, 1xw, 3mb, 3ot, 8abm. Can.: 1bq.

March 11th to 21st—(1xah). Can.: (1ar), 1dq, April 2nd to 18th—1alw, 1xah, 1xam, 1xj, 1xw, (2awf), 3bj, 3mb, 3ms. Can.: (1bq), 1go.

QST FOR JUNE, 1924

P. Penning.  
177c Zandvoortschelaan, Zandvoort, Holland  
1aja, 1alk, 1bgc, 1cwl, 2ar, 2avf, 2bxd, 2ctz, 2jd, 2mu, 3il.  
Can.: 1bq, 1el, 2bn, 9bl.  
Receiver, single valve.

Santangeli Mario, IER1.

via S. Eufemia 19, Milano (5) Italy  
(February and March)

American: 1dj, 1xah, 1xam, 1xar, 1xav, 1xj, 2ad, 2bg, 2bn, 2wj, 3pz, 8yv.  
Danish: 7ZM.  
Dutch: peil, pag, ptt, pe2, ozn, ony, okx, oys, ous, oph, obq.

Belgian: p2, 2na.  
Luxembourg: oaa, 1jw.  
English: 2cw, 2df, 2fg, 2fn, 2kw, 2kf, 2mn, 2lz, 2od, 2pc, 2zv, 2uv, 2vn, 2xq, 2xy, 2xaa, 2wj, 2yq, 2zt, 5as, 5aw, 5bv, 5dn, 5ko, 5iu, 5nn, 5nm, 5mo, 5sl, 5us, 6al, 6nf, 6ry, 6jx, 4zz(?).

J. H. Worthington.

Byron Ave., Takapuna, Auckland, N. Z.  
(Feb. 3rd to April 6th)

2rk, 5kg, 5lg, 5mn, 5xd, 5ado, 5cke, 6lq, 6lu, 6lv, 6of, 6pu, 6uk, 6ajf, 6ajh, 6alo, 6aly, 6apc, 6atn, 6cax, 6cdc, 6ecl, 6egw, 7fd, 8ct, 9yy, 9zt, 9acj, 9amd, 9blj, 9bof, 9cly, 9cvo, 9eky, Can. 5go, 9bp.

R. W. Bates, New Plymouth, New Zealand

(Heard on one tube in Feb.)

5gd, 5gm, 5tj, 6bk, 6dd, 6fy, 6ip, 6pe, 6rn, 6ue, 6acm, 6ahp, 6ahw, 6asf, 6bbg, 6bik, 6bjj, 6egw, 6ekr, 6cng, 6zba, 7ad, 7em, 7sf, 7ta, 7ve, 9bry.

Ralph Slade, 4AG.

15 Harbour Terrace, Dunedin, New Zealand  
(Dec. 23rd to Apr. 8th)

4bz, 5ny, 5aom, 5zav, 6ka, 6zh, 6aao, 6agk, 6acw, 6agk, 6asr, 6bij, 6bjj, 6bmr, 6buo, 6bur, 6cbb, 6cdb, 6ceu, 6cgw, 6ckr, 6emr, 6emu, 6xad, 7ach, 7aim, 8tx, 8bep, 9mc, 9yy, 9atn, 9azy, 9bez, 9bt, 9bzv, 9ccv, 9epo, 9dlj, 9dxk, 9dzv, 9ees, 9eht, 9ekf, 9xaw.

H. W. Lavallin-Puxley

Ealing, New Zealand

Mar. 23rd and Apr. 6th: 1cl, 1er, 1kc, 1aur, 1zkl, 1ber, 1bie, 1epo, 2bh, 2vr, 3mo, 3qv, 5qv, 5arc, 5zav, 6gt, 6zt, 6abk, 6bbe, 6ckr, 6zcd, 7em, 9ee, 9em, 9hm, 9mc, 9re, 9ry, 9ss, 9aep, 9ahz, 9auc, 9bdq, 9bgr, 9bhy, 9bc, 9dbf, 9doe.

L. S. Spackman, 1AC

50 Wanganui Ave., Herne Bay, Auckland, N. Z.  
All on one tube in Cockaday circuit: 1cs, 1hw, 1pc, 1ajp, 1aul, 2ac, 2an, 2rk, 2zg, 3co, 4ft, 4st, 5to, 5za, 6aa, 6ak, 6ba, 6ck, 6cu, 6fy, 6fz, 6ka, 6pl, 6pn, 6wl, 6yn, 6za, 6zc, 6zw, 6aao, 6abk, 6aea, 6ahp, 6ak, 6amu, 6any, 6apc, 6ard, 6asr, 6aun, 6auu, 6av, 6bic, 6buy, 6bte, 6ebb, 6ebi, 6egr, 6cgv, 6ckp, 6ckr, 6ela, 6emu, 6cmw, 6ve, 6xad, 6xan, 6zas, 7au, 7cd, 7sc, 9ac, 9cp, 9rk, 9zt, 9bkl, 9blq, 9bri, 9dic.  
Can.: 9pw, 9bp.  
English: 5au.  
Special: 2CDM, QSA at 2,000 miles.

(Another list sent in by Mr. Spackman follows)

1ajp, 1bom, 1hw, 1pc, 2ai, 2bu, 2ek, 2kc, 2qz, 2rd, 2rk, 3akg, 4ak, 4cb, 4co, 4ft, 5alo, 5ch, 5ei, 5oh, 5qj, 5xd, 5za (Tone & CW), 6ak, 6ao, 6aa, 6abk, 6aex, 6ack, 6ahp, 6aja, 6ajv, 6akn, 6alk, 6ar, 6arc, 6ark, 6aro, 6avv, 6avy, 6awv, 6awc, 6bb, 6bic, 6bin, 6blu, 6buy, 6bvv, 6bzv, 6cau, 6cbb, 6ebi, 6efy, 6ega, 6cgs, 6ckw, 6ckr, 6cll, 6emu, 6enk, 6cnw, 6eyf, 6ef, 6en, 6fz, 6ka, 6ne, 6rn, 6su, 6xad, 6zal, 6xan, 6xl, 6yn, 6yo, 6zc, 6zw, 6za, 7ael, 7amu, 7au, 7cm, 7co, 7em, 8amm, 8aau, 8ak, 8anf, 8apt, 9awm, 9bf, 9bqv, 9brv, 9bvm, 9ccz, 9cht, 9cly, 9cp, 9cv, 9dfc, 9dws, 9mc, 9pw, 9rk, 9zt, kfi, kgo, khj, kpo, wjaz.  
Canadian: 9pw, 9zf.  
Special: 2cdm.  
Ami stns rept bi me cn hv end if they wl QSL wl QRA es power etc.

**Roy Bucy. 7VM. aboard WPQ**

**Fishing off Kodiak, Alaska**

lapu, 4su, 4xc, 5ek, 5lg, 5tj, 5xa, 5aiu, 5air, 5amu, 6cu, 6dd, 6fp, 6fw, 6gt, 6kj, 6ll, 6mb, 6ne, 6op, 6py, 6eb, 6rn, 6ue, 6ux, 6wp, 6aak, 6aan, 6aao, 6aac, 6abd, 6acm, 6acv, 6adt, 6afk, 6aft, 6age, 6ahp, 6ahz, 6aiv, 6akw, 6alg, 6amb, 6ana, 6any, 6aol, 6ape, 6ara, 6arf, 6atr, 6ata, 6au, 6avh, 6avj, 6avr, 6avv, 6bcl, 6bcr, 6bih, 6blv, 6but, 6buy, 6bou, 6bqb, 6bvr, 6bwp, 6cbb, 6bdf, 6cud, 6ecu, 6ecy, 6ede, 6edg, 6ecu, 6egl, 6chl, 6chv, 6civ, 6ckc, 6ckr, 6cmc, 6cm, 6czh, 6zfb, 6zbu, 6zcd, 7ax, 7co, 7dj, 7dm, 7dz, 7ee, 7ej, 7fn, 7ff, 7fs, 7go, 7gv, 7ih, 7ip, 7kz, 7lq, 7lw, 7no, 7om, 7qd, 7re, 7rd, 7sh, 7tj, 7to, 7tq, 7vn, 7zu, 7abb, 7ada, 7adg, 7adr, 7aek, 7ael, 7aek, 7aft, 7agl, 7ahn, 7ahs, 7aib, 7ajd, 7ajy, 7akh, 7ali, 7all, 7hu, 7or, 7sv, 7ate, 7axk, 7bxx, 7bxc, 7ab, 7mc, 7su, 7vm, 7zg, 7aim, 7ajv, 7amc, 7amg, 7aml, 7amq, 7aac, 7ash, 7asj, 7bct, 7bbz, 7bjo, 7bly, 7off, 7paz, 7qbj, 7qbt, 7qca, 7qam, 7qcf, 7qcb, 7qec, 7qga, 7cw, 7eyn, 7ede, 7dge, 7dri, 7dvw, 7dro, 7doe, 7dte, 7dvw, 7eak, 7ebt, 7eli, 7exb.

**Canadian 3PZ.**

**104 Bernard Avenue, Toronto, Ont.**

4af, 4er, 4io, 4ll, (4sl), 4sx, (4sat), 4sz, (4abn), 4ack, 4agl, (4agv), 4aiy, 4alb, 4alr, 4mi, 4oo, 4ph, (4fj), 4xar, 4xat, 4xbh, 4abk, (4ahp), 4alk, (4ame), 4apw, 4arb, (4arf), 4avr, 4bcl, 4bek, (4hex), 4bll, 4bnt, (4bui), (4buo), 4cbw, 4cee, 4cej, 4ces, 4clb, 4ea, 4fo, 4lv, 4pb, 4tu, 4zr, 7afn, 7abb, 7bi, 7gu, 7ip, 7ly.

Canadian: (1ef), (1eb), 1ur, (1af), (4fz), (4hh), 4dq, 4cb.  
French: 8bf.

**Canadian 4DY, Portage LaPrairie, Man.**

1aac, 1agk, 1aiw, 1awv, 1ek, 1epi, 1lc, 1vc, 1xah, 1xu, 2abn, 2ack, 2blmu, 2brb, 2bsc, 2bxo, 2cec, 2hgg, 3bpb, 3buy, 3bva, 3ccu, 3ckj, 3gc, 3hh, 3jx, 3me, 3pz, 3xaq, 3xar, 3co, 4af, 4cq, 4io, 4xc, 5aar, 5alt, 5alj, 5ajt, 5alo, 5amh, 5en, 5eh, 5ov, 5ph, 5po, 5rh, 5xa, 5xnc, 5vd, 5zb, 6abk, 6agk, 6ahp, 6alc, 6ame, 6any, 6bui, 6buo, 6brf, 6bc, 6egw, 6hp, 6tn, 6xhc, 6zbi, 7abb, 7ajd, 7dj, 7fs, 7kz, 7lu, 7oc, 7wm, 7xaf, 7xba, 7ya, 7zj.

Canadian: 1ar, 1bq, 2az, 2bn, 2cg, 3aac, 3bg, 3bq, 3co, 3hl, 3ko, 3ml, 3ni, 3tf, 3vh, 3ws, 3xx, 4eo, 4er, 4ow, 4hh, 9bl, 9cf.

**Canadian 5AY.**

**River Jordan, B.C., 25 Miles West of Race Rocks**  
5aaq, 5aiu, 5ajb, 5aji, 5akd, 5amu, 5na, 5zav, 6ahp, 6aid, 6aja, 6avv, 6buh, 6ccb, 6cll, 6fm, 6gr, 6hi, 6ij, 6no, 6pu, 7aep, 7agf, 7dd, 7mn, 7nv, 7ob, 7td, 7zv, 9abo, 9ahv, 9af, 9df, 9ben, 9bjk, 9caa, 9ce, 9cjt, 9civ, 9cwi, 9dri, 9dvn, 9eak, 9eam, 9fv.  
Canadian: 4ab, 4cl, 4eo, 4eo, 4er, 4io, 5ch.

**I.AWE, N. H. Miller, 25 Phillips St., Providence, R. I.**

(4fz), 5aad, 5uaz, 5agw, 5air, 5aiu, 5aiy, 5alj, 5alo, 5bx, 5cn, (5de), 5ll, 5nv, 5ph, (5qd), 5rg, 5rv, 5sz, 5ws, 5xa, 5zav, (6ahp), 6ajd, 6ajf, (Phone), 6apw, 6arb, 6avr, 6bcl, 6bri, 6bui, 6buo, 6egw, 6civ, 6cmr, (6ea), 6eb, 6fp, 6lv, 6rn, 6zab, 6zp, (7abb), 7ahv, 7akk, 7co, 7fs, 7gu, 7vc, (9aci), (9alc), (9apf), (9ayx), (9bcl), (9bmu), (9bva), (9caw), (9cdv), (9cim), (9cmk), (9cwf), (9dcj), (9dct), (9ehq), (9ec), other 9's too numerous.

**IBIS, J. A. Baker,**

**120 Myrtle St., Claremont, N. H.**

4er, 4io, 4ll, 4mb, 5aar, 5aaw, 5aek, 5agv, 5bz, 5dd, 5mi, 5nw, 5vv, 5wi, 5ajf, 5bic, 6bpm, 6fp, 7co, 7if, 7qu, (8bed), (8daw), (8dy), 9aaq, 9ahz, 9amb, (9ayj), 9bjk, 9bmx, 9bnu, 9hov, 9bvw, 9bsj, (9bt), 9caa, 9che, 9eka, 9cmk, 9cjp, 9civ, 9cvi, 9dft, 9dri, 9dvn, 9eak, 9eam, 9ekf, 9hg, 9pw.  
Cuba: 2ww.

**ICTP, Auburn, Maine**

(3apv), (3arb), 4az, 4eb, 4er, 4fg, 4hr, 4it, 4mb, 4mv, 4oa, 4og, 4oh, 4pv, 4sh, 4st, (4su), 5aaq, 5abn, 5aik, 5akn, (5cn), 5ek, 5lr, 5uk, 5wl, 5xbh, (6gt), (8aee), (8apt), (8ayj), (8cke), (8jv), (8rn), (8wz), 9aad, 9abt, 9aci, 9ada, 9aeu, 9agb, 9ahe, 9ahv, 9ahv, 9alc, 9amt, 9aue, 9avb, 9awg, 9awu, (9ayx), 9bhc, 9beb, 9bex, 9bhd, 9hgc, 9hia, (9hkr), 9hna, 9hof, 9hsp, 9hdt, 9huk, 9hvf, 9hwg, 9huw, 9hzt, 9ccl, (9cfl), 9che, 9civ, 9ciu, 9cof, 9cow, 9ctb, 9cvi, 9cvs, 9cvt, 9cvg, 9dal, 9day, 9dji, 9dbm, 9dcr, 9dca, 9dhr, 9dml, 9dnp, 9doe, 9dro, 9dru, 9efa, 9eh, 9eia, 9eky, 9elh, (9eli), 9emb, 9ei, 9il, 9kd, (9ot).  
Can: (3ach), (3fc), (3ly), (3wg).  
Cuban: 2by (pse QSL w/ QRA).

**2WR, Hilton, N. J.**

4ag, 4ai, 4eq, (4er), 4fg, 4fz, (4io), (4lr), 4mb, 4rr, 4sh, 4sx, (5ap), 5eh, 5kc, (5kq), 5ml, 5nw, 5qy, 5sd, (5ut), 5vc, (5aac), 5aaq, 5aaz, 5abw, 5afn, (5agv), 5aiy, (5ajg), (5ajt), (5alo), (5aom), 5xbh, (6gt), (6zp), 6avr, 6cgv, (6cix), 6zcd, 7em, (7iw), 7mi, (7ahv), (9dr), (9eq), 9hg, (9hm), 9le, 9pw, 9vu, (9aad), (9abc), (9aci), 9aem, 9aep, (9aes), (9agb), (9agi), 9agz, 9alc, (9anf), (9aad), 9aue, (9awv), (9ayx), 9bal, 9bcb, (9bqd), (9bel), 9bmu, (9bnu), 9bqa, 9bvz, (9bxv), 9bzx, (9cdv), (9cgh), 9cme, (9cpa), 9crr, 9cvi, 9czm, 9dap, (9dcw), (9dmc), 9dpp, 9dro, (9drr), 9dws, 9dkk, (9dxi), 9eht.

Canadian: 4eb.  
Mex: 6x.  
Cuban: (2ww).

**2AEY, Elizabeth, N. J.**

4af, (4ll), 4mb, 4my, 4oq, 4rr, (4rz), 4sh, 4su, 5aiu, 5amb, 5hc, 5mo, 5rg, 5wi, 6xad, 6fp, 7co, 8aal, 8abx, 8ada, 8aep, (8amr), 8az, 8axf, (8bci), (8bfe), (8bjs), 8bwc, (8cpl), 8cnw, (8daj), (8dbm), 8dft, 8dga, 8dgs, (8dgp), 8dmc, 8dnf, (8bk), (8oi), 9abt, 9aci, 9azp, 9bbg, 9bep, 9bfi, 9bhd, 9bis, 9bly, 9bne, 9bya, (9cmc), 9ctb, 9cte, (9cwy), 9day, 9dbm, 9dvw, 9dvn, (9dma), 9dvy, (9ecb), 9edo, 9efo, 9eji, (9ba), 9ar.  
Can.: (3fc), 4eo.

**2BRB, Brooklyn, N. Y.**

(4af), 4cg, 4ch, 4ea, 4eb, 4ed, 4er, 4ez, 4fg, 4pk, 4fz, 4gx, (4hr), 4io, 4mb, 4bv, 4rr, 4sh, 4sl, 4xc, 4ez, (5in), (5kq), 5li, 5mi, 5ph, 5ql, 5xz, 5wt, 5xa, 5zd, 5xv, (5aaq), 5aat, 5aji, 5amw, (5aom), 5xar, (5xau), 9ea, (9ab), 9ec, (9liv), 9tu, 9xe, 9zp, 6abk, (6ahp), (6ajd), (6ame), 6auc, (6apw), 6arb, 6aru, (6avr), 6bhw, (6bcl), (6bic), 6bnt, (6bul), (6bui), (6buy), 6cay, (6cee), (6cef), (6cix), 6cmr, 6xjb, 6zcd, 7bi, (7em), 7ev, 7fs, 7gu, 7gr, 7iw, 7ks, 7li, (7ly), 7vo, 7ot, 7abb, 7ad, 7afn, 7aft, (7akk), 9bc, (9em), (9hm), 9kd, 9le, 9ny, (9ta), 9tq, 9xl, 9zt, 9aar, 9abf, 9acs, 9acc, (9aee), (9agl), (9agz), 9ahz, 9ale, 9amv, 9apf, 9ato, (9auc), 9aws, 9ayk, (9bib), 9bjf, 9bmx, 9bop, 9hov, 9bvw, 9bvw, 9bvt, 9bvn, (9caj), 9eac, (9eca), 9eex, 9eri, 9esj, 9evf, 9evi, 9exp, 9cwy, (9dcj), 9dct, 9dvw, 9dva, 9dvg, 9dvi, (9dkk), 9din, 9dro, 9dxc, (9dxy), 9dyz, 9eeb, 9elt, 9eib, (9eji), (9eid), 9eji, 9xax.  
Canadian: 1ar, 1dd, (1dj), 2az, (2bn), 2cg, 4er, (4dq), (4fz), 4hh, 4sh, 5cn, 5hh, 9ar, 9bc, 9bl, 9bw.

English: (2nm), 2od, 2az, 5nn.  
Q-2ww, wnp, M-hx.

**3BYA, 40 S. Beaver St., York, Pa.**

5aa, 5aac, 5aag, (5aas), (5aat), 5aaw, 5aaz, (5abn), 5abd, 5aek, 5agh, (5agi), (5agv), 5air, (5aic), 5aiu, 5aiy, 5ajb, 5ajh, 5aji, 5aim, 5ajt, 5ak, 5akn, 5alo, 5alv, 5amb, 5amo, 5anf, (5aom), 5ap, 5he, (5bx), 5ce, 5cn, 5co, (5da), 5dm, (5dq), 5dw, 5ek, 5ex, 5ez, 5gf, (5gi), (5hj), 5ik, 5ja, 5jf, 5jl, 5ka, (5kc), 5kg, 5lj, (5lr), 5mi, 5ml, 5nk, (5nn), 5nt, (5nw), (5om), (5ov), (5ph), 5vi, 5vml, 5vz, 5ah, (5ql), 5rb, 5rc, 5rg, 5ua, 5uk, 5vc, 5vv, 5wv, 5xk, (5xat), 5xaw, (5xau), (5xar), 5xbh, 5xd, 5zav, 5zka, 6aao, 6aan, 6abk, 6adt, 6afc, 6agk, (6ahp), 6aja, (6ajd), 6akw, 6akz, 6alk, 6ame, 6aol, 6apw, (6arb), 6arf, (6aru), 6aau, 6avr, 6avv, 6awg, 6bau, 6bb, 6bbh, 6bbw, 6bez, 6bic, 6bkk, 6blw, 6bmb, 6bpm, (6bql), 6brf, (6bui), 6bur, (6buo), (6buy), 6cc, 6ccy, 6cdg, 6cdi, 6cee, 6cef, 6cej, 6ecu, 6egw, 6cie, 6civ, 6ckr, 6cmu, (6ea), 6eb, 6fh, 6fp, 6gt, 6hp, 6ka, 6ic, 6lv, 5vn, 5no, 6pl, 6tu, (6td), 6xad, 6xau, 6xhc, 6xe, 6xn, (6zar), 6zcd, 6zcd, 6zh, 6zv, 7abb, 7abh, 7adf, 7add, (7adl), 7af, 7afn, 7ahv, 7aid, 7akk, (7bi), 7co, 7em, 7ey, 7fd, 7fa, 7fr, 7iv, (7tq), 7er, 7oc, 7ip, 7it, (7ic), 7ki, 7lp, 7ln, 7ly, 7mx, 7ob, 7ol, 7ry, 7of, 7oc, 7io, 7lu, 7pw, 7xba, 7ya, 7zu, 7zv, 9aal, (9aau), 9abc, (9abf), (9acc), 9ada, (9aec), 9aed, (9aem), 9aep, 9afy, (9agl), 9agz, 9ahs, 9aij, (9ajv), (9aks), (9amb), (9aju), (9amx), 9amf, 9and, 9ap, 9apf, (9aac), 9and, 9aag, (9aac), 9avv, 9aru, 9arr, 9atm, 9atn, 9aus, 9awg, 9axt, (9ayj), (9ayx), 9azg, 9azp, 9azx, 9ba, (9bab), 9bay, 9bbb, (9bbr), (9bbs), 9bce, (9bec), (9bdi), 9bed, 9bel, (9bez), 9bfp, 9bfz, 9bgh, 9bkk, (9bhv), 9bhx, 9bis, 9biz, (9bjk), 9bko, 9bky, 9bmo, 9bmv, (9bmu), 9bmx, (9bna), 9boc, 9bop, (9hoz), (9hvw), (9hvv), 9hvx, (9hvb), (9bre), 9brk, 9brx, (9bsi), 9btr, (9bt), 9buh, 9bun, (9bvn), 9bvz, (9bvc), 9bwo, 9bwg, 9bxm, 9bxz, (9bxw), (9bvc), 9ca, (9ca), (9caj), (9ced), 9cew, (9cwb), (9cea), (9cfl), (9cfl), (9cfa), 9cra, 9cu, 9cho, 9cit, (9cim), 9cin, 9civ, 9cip, (9cic), (9cim), 9cjt, (9civ), 9eka, 9ekj, (9eko), 9clq, (9eme), (9emk), (9eno), (9cov), 9epu, 9epz, (9esj), 9ete, (9oto), (9evo), 9evn, 9evs, (9cwf), 9exo, (9exp), 9ey, (9eyb), 9eyd,

(9cyq), 9cyy, 9czz, 9czu, (9dap), 9day, 9db, (9dcj), (9dct), 9dcw, (9ddp), 9dds, 9dfh, (9dfq), 9dga, (9dhh), 9dip, 9djz, (9dkb), 9dlb, (9dlf), (9dlm), 9dlw, (9dly), (9dnp), (9dr), 9dro, 9dte, (9dub), 9dwa, (9dwb), 9dwn, 9dxn, 9dxu, (9dxy), 9dyr, 9dyt, (9dyz), 9dzg, 9dzz, 9eac, (9eak), 9edo, 9eea, 9eg, (9egw), (9ehq), 9ehn, 9eht, (9ei), 9eib, 9ekf, 9eky, (9elb), 9eld, 9elj, 9elw, (9elw), (9elz), 9em, 9eq, (9er), 9gs, (9gz), 9hg, (9hm), (9kd), 9ks, (9lb), 9le, (9lz), 9ln, 9mc, 9mf, 9my, 9nc, 9nu, 9rc, 9ny, 9ry, 9rt, 9ss, (9tm), 9ta, 9vc, 9wm, (9xax), (9xbd), (9xbe), 9xi, (9yau), 9yx, 9zt.

Spk.: 4bl, 4fg.  
Canadians: 1af, 1ar, (1bq), 1bv, (1dd), (1dq), (1dt), 1eh, (1ef), 1ei, 2az, (2be), (2bn), (2cg), 2ei, 2fu, 2hg, (3bq), (3he), (3ly), (3vh), (3wg), (3xx), 4bk, (4ch), (4cr), (4dq), 4eo, (4fz), 4th, 4io, 5cn, 5gf, 9ak, 9al, (9bl), 9bx.  
English: 2kf, 2sz, 2yt, 2nm. French: 5ab. Dutch: 6cii. Cuban: 2ww. Porto Rican: (4je). Mexican: bx, 1b. Hawaiian: 6ceu.  
1bzf tuner used—5 watt tube in transmitter.

**3CCU, Emigsville, Pa.**

5ac, 5aac, 5abn, 5ady, 5aeg, 5ah, 5ago, 5aht, (5aie), 5ail, 5air, (5aiu), 5ajb, 5akn, 5alv, (5aom), 5aov, (5be), 5cn, 5dw, 5ek, 5ft, 5gm, (5gi), (5io), (5jb), 5j, (5ka), 5lr, 5mn, (5nw), (5ph), 5oh, 5ol, 5rg, 5rh, 5ri, 5sg, 5uk, 5ux, 5vm, 5vv, 5wi, (5xa), 5xbh, (5zav), 5zb, 5aao, 5abt, 5adt, 5age, 5akg, 5ame, 5arw, 5arb, 5avr, 5bcl, 5bur, 5ebu, 5ecl, 5eef, 5egs, 5egw, 5eix, 5emu, 5enc, 5eor, 5gt, 5ki, 5lv, 5pl, 5rm, 5tu, 5xn, 5xad, 5xhc, 5zed, 5ap, 7adz, 7akk, 7bj, 7co, (7dz), 7em, 7fo, 7ge, 7gq, 7gw, 7ih, 7iw, 7ly, 7lh, 7mp, 7no, 7zu, 8aau, 8abl, 8av, (8acs), 8acx, 8ada, (8adg), (8aec), 8aed, 8aem, 8aep, (8agb), 8agf, 8ago, (8agz), (8aic), (8aim), 8aiu, 8ajj, 8ake, 8amz, (8apu), (8aqd), 8arr, 8arp, (8arr), (8ash), (8asi), 8asw, 8ato, 8atr, 8auc, 8aut, 8avj, 8ayk, (8ayv), 8aza, 8azj, 8azr, 8bbg, 8beb, (8bh), (8bh), (8bid), 8big, 8bjk, 8bkf, (8dkr), (8blg), (8bl), 8bnu, 8bof, 8bpv, (8bre), 8bsk, 8bsp, 8bun, (8bva), 8bvz, (8bw), 8bz, 8caa, (8eaa), 8ecg, 8eci, 8ecw, (9ed), 9ede, 9edv, 9ee, (9efk), (9egh), 9eho, (9ejh), 9eka, (9ekb), 9ekh, 9eko, (9elz), (9em), (9cmc), 9cmd, (9eme), (9emn), 9eo, 9eow, 9eas, (9etg), 9etr, (9eme), 9evo, 9evs, 9evv, (9exi), 9exp, 9eyb, 9exp, (9dhr), 9dja, 9dkk, (9dli), 9dlm, 9dma, 9dml, 9dmw, (9dnl), (9dnp), (9dp), 9dr, 9dsv, (9dub), 9dvh, 9dwa, 9dwn, (9dww), 9dxc, (9dxi), 9dxi, 9dxu, 9dyv, 9dyn, 9dyr, 9dzn, 9dzy, 9eak, 9eb, (9ebh), 9ech, 9edo, (9eev), 9efu, (9eg), 9ehn, 9ehv, 9ei, (9eji), 9eij, 9eky, 9elj, 9eld, 9eli, 9eoa, (9ep), 9er, 9es, 9hy, (9hm), 9ib, (9ie), (9iz), 9mc, (9ml), 9rc, (9tm), (9xm), 9xn, 9xbd, 9zg.  
Canadian: 2da, 2dn, 3bp, (3oh), 3nr, 3wc, 3ws, 3yv, 3zt.

**4RR, Wofford Campus, Spartanburg, S. C.**

6adt, 6avj, 6js, 6lv, 6rn, 6ue, 6zb, 6zh, 6zt, 7aby, 7co, 7zu.  
Canadians: 1ef, 1di, 1dt, 2bn, 2do, 3aa, 3aec, 3aen, 3bq, 3oh, 3ta, 3yv, 4bk, 4cr, 4er, 4hh.  
Cuban: 2by.

**4EQ-4EH, Atlanta, Ga.**

(1ach), 1aig, (1axn), 1bcq, 1kx, 1yb, 1xah, 1xam, 1xw, 1xm, 2aa, (2acp), 2ana, 2exy, 2cyw, 3ava, 3bva, 3bu, 3ic, 3lr, 3jar, 3bz, 3me, 3yo, 3yv, 4dp, 4ft, 4je, (4jr), (4og), 4oi, (4rf), (4ro), (4so), (5abw), (5ajm), 5alk, 5amh, (5cn), 5ec, 5hw, 5jl, 5kr, 5xo, 5za, 5zav, 5zf, 6ahp, 6ak, 6ajh, 6akw, 6alg, 6arg, 6ata, 6aw, 6awt, 6beq, 6bik, 6brf, 6bv, 6bz, 6cbb, 6cfl, 6cgp, 6cwg, 6cl, 6en, 6fp, 6gl, 6mg, 6mu, 6ng, 6pl, 6vw, 6zbu, 6zh, 7aek, 7am, 7co, 7em, 7ou, 7at, 7wm, 7zu, 8ago, (8ah), 8aih, 8ajj, 8anb, 8ate, 8bth, (8bmb), (8bwg), 8brm, (8cni), 8cuj, (8cva), (8cvg), 8ewr, (8ez), (8dae), (8dcz), (8ded), (8dia), (8did), (8eb), (8ga), (8iy), (8jy), (8ars), (8aru), (8acr), (9baz), (9bbr), (9bgw), (9bhw), (9boo), (9boz), (9bsi), (9bvf), (9cng), (9cjc), (9cug), (9eou), (9dhr), (9dhf), (9dhw), (9dr), (9dsw), (9ei), (9eq), (9es), (9ib), 9mc, (9ojt), (9qr), (9vc).  
Canadians: (3yv), (3oi), 1dd, 2cg, (8ko), 2bn, 2bg.  
Mexican: bx, bl.  
French: 8ab, 8bf.  
English: 2kf.

**5AGV, 1725-24 Ave., Meridian, Miss.**

(1aac), 1abf, 1ajp, (1are), (1arf), 1aur, 1awe, 1bcr, 1bb, 1bd, 1bua, 1cak, 1emp, 1em, (1epi), 1fm, 1ke, 1xah, 1xam, 1xar, 1xas, 2aay, 2abn, 2cov, (2axf), 2ayr, 2brh, 2bse, (2cdp), 2erb,

2cwo, 2cx, (2exb), 2exl, 2cyw, 2ia, 2jd, 2ku, 2mu, (2wr), 6adt, 6ack, 6ajh, 6alk, 6ao, 6apw, 6arb, (6avr), 6awg, 6bbw, 6biq, 6bui, 6cfl, 6cwg, 6ea, 6lv, 6mg, 6pl, 6zh, 6zp, 7abb, 7akk, (7bj), 7co, 7em, 7gq, 7zu, kdef.  
Can.: 1ar, 1bq, 2az, 2be, 2bn, 2dn, (2hg), 3ef, 3co, 3kq, 3ly, 3ws, 3yh, 3yv, (3zt).  
Cuban: 2bv.  
Mex.: bx.

**5AFF, Martin Walters, Chattanooga, Tenn.**

2ejr, 3bz, 3ro, (3re), 3rk, 4cp, 4cs, 4ik, 4it, 4jm, 4jr, 4ma, 4na, 5ek, 5ht, 5lr, 5mi, 5mo, 5qh, 5ql, 5vd, 5aua, 5av, 5aji, 5akn, 5ami, 5mg, 5awg, 5edg, 5eel, 5ecl, 5er, 5ur, 5vt, 5we, 5vn, 5zz, 5anb, 5ate, 5bbf, 5bel, 5bhk, 5hk, 5mc, 5aau, 5arp, 5bmi, 5bsi, 5ede, 5dam, 5eam, 5eky.  
Can.: 4cb, 4fv.

**6EA, Los Angeles, Calif.**

1fd, 1fs, (1abf), (1are), (1awe), 1bsd, (2cla), (2cwo), (3bva), (5xag), 4bz, (4io), (4xc), 5er, 5xy, (5zk), (5abs), 5acm, 5am, (5bda), 5bim, (5bxx), 5ctp. Other districts too numerous to mention. The above DX was wkd on a 5 watt tube and hrd on a home-made low-loss tuner.

**6FI, (ex 2AAF), San Diego, Cal.**

1ajx, 1are, 1aur, 1epi, 1fs, 1k, 2ay, 2aet, 2atz, 2add, 2bgo, 2ecz, 2je, 2hh, 3cv, 4ed, 4id, 4mb, 4pk, 5aau, 5aaw, 5add, 5air, 5aiu, 5aji, 5ap, 5az, 5e, 5ef, 5dg, 5ef, 5gm, 5hs, 5jb, 5mv, 5na, 5nw, 5ph, 5ul, 5rg, 5sd, 5vm, 5xau, 5zav, 7aef, 7aek, 7afo, 7aiu, 7aju, 7ahs, 7aim, 7aid, 7aun, 7bj, 7co, 7di, 7dr, 7fa, 7fd, 7fg, 7fs, 7gb, 7gr, 7gs, 7ih, 7iq, 7il, 7lk, 7ly, 7nn, 7no, 7ot, 7pf, 7pj, 7qc, 7qd, 7qw, 7sh, 7we, 8aap, 8aim, 8aai, 8apt, 8bcp, 8bk, 8eel, 8coi, 8ed, 8epw, 8erw, 8bmn, 8dvy, 8dgp, 8die, 8kc, 8kr, 8pl, 8vn, 8wy, 8xhc, 8yn, 8aci, 8acv, 8aem, 8aep, 8af, 8agb, 8agy, 8ahz, 8aju, 8ami, 8apv, 8ape, 8ato, 8bbs, 8bef, 8bcx, 8bfp, 8br, 8big, 8bly, 8bnu, 8bob, 8bov, 8bpv, 8bq, 8bre, 8bt, 8bvn, 8c, 8cm, 8ecw, 8edv, 8eeh, 8efg, 8efx, 8eht, 8eje, 8eju, 8emh, 8eo, 8ev, 8exo, 8da, 8df, 8dcp, 8ddp, 8dfg, 8dgd, 8dgp, 8dgv, 8dhf, 8djb, 8dkk, 8dkq, 8dny, 8dp, 8dxi, 8dxr, 8dyi, 8eak, 8ede, 8efh, 8ejz, 8eq, 8hm, 8hn, 8hw, 8mc, 8ry, 8ux.  
Canadians: 4ab, 4cb, 5ah, 5bq, 5ga, 9bx.  
Mexican: bx.

**6AME, Route A, Box 11B, Modesto, Calif.**

1agh, 1akl, 1avf, 1ber, 1ci, 2atz, 2brb, 2bv, 2cee, 2hh, 2uu, 2wr, 2xna, 3ec, 3gc, 3je, 3me, 4xc, 5aau, 5agn, 5alm, 5amo, 5gf, (5mi), 5nt, (5nw), 5ny, (5ph), 5qh, (5ay), 5rg, 5ts, (5bav), 8apt, 8bnh, 8bpa, 8bwb, 8eel, 8etp, (8ercv), 8ery, (8cxm), (8dce), (8dp), 8hn, 8iq, 8kc, 8xbl, 8zk, 9aci, (9axc), (9azc), 9afr, (9agi), 9aju, 9amx, 9ant, 9apt, (9avt), (9ayz), 9azj, 9bjk, 9bly, (9bmx), 9bop, 9bpv, 9bl, (9bvn), (9bwc), 9bxu, 9bye, 9bze, 9caa, 9cew, 9cd, 9cfx, (9cvc), 9cjr, (9clz), 9eme, 9co, 9evn, (9ewf), (9czw), 9dci, 9dce, 9dms, 9doe, 9dpp, 9dun, (9dxc), 9dxy, 9eak, 9egw, 9eht, 9eld, (9hm).  
Can.: (3pz), 4dq, 4hh, 5en, 5eq, 5ct.  
Mex.: bx, na-7).

**6CGK, San Pedro, Calif.**

1ul, 1bnk, 1bqt, 1xak, 1xam, 2bn, 2wr, 2bgo, 3na, 3rs, 3wr, 3xw, 4bc, 4er, 4ev, 4pk, 4su, 4xc, 5ad, 5be, 5et, 5ef, 5eh, 5es, 5ga, 5jm, 5jw, 5lr, 5mb, 5mm, 5na, 5og, 5oq, 5ph, 5rg, 5rh, 5vm, 5aaq, 5aaf, 5ado, 5aes, 5afh, 5aiu, 5aja, 5aji, 5ajt, 5akb, 5all, 5alm, 5amo, 5awb, 5bz, 5zh, 5zv, 7co, 7dr, 7em, 7fr, 7fg, (7gq), 7hw, 7jr, 7iw, 7ke, 7ks, 7lh, 7lv, 7ly, 7mi, 7ob, 7qc, 7rs, 7ry, 7td, 7to, 7zu, 7zw, 7aci, 7adm, 7al, 7afe, 7ajv, (7akk), 7auf, 7di, 7er, 7es, 7fs, 7gl, 7acf, 7ah, 7ecl, 7dat, 7ef, 7dp, 7ec, 7gv, 7zt, 9aec, 9agf, 9aim, 9amb, 9apf, 9bu, 9bpv, 9bhd, 9bjk, 9bkl, 9bun, 9bpv, 9bvs, 9bto, 9bxg, 9caa, 9eak, 9ebt, 9cht, 9cia, 9eju, 9enb, 9ete, 9cwj, 9daw, 9dbx, 9dew, 9dro, 9dsw, 9dte, 9dwn, 9dyi, 9dxi, 9dxy, 9ebt, 9eca, 9elb.  
Fone: 9aj.  
Canadian: 4aa, 4dq, 9al.

**7AFU, Pullman, Wash.**

1bq, 1bsd, 1ka, 2awf, 2bn, 2cee, 2hh, 2jd, 2ku, 2xaq, 2zb, 3ws, 4bz, 4io, 4xc, 5aaw, 5dq, 5eh, 5h, 5lr, 5ly, 5mi, 5ok, 5ph, 5qd, 5ql, 5qw, 5rh, 5sk, 5xbh, 5xd, 8abm, 8abs, 8aol, 8bel, 8bod, 8ecz, 8egz, 8ekm, 8etp, 8dhi, 8dlf, 8fg, 8wa, 8xbf, 8xcp, 8xbq, 8ay, 8aau, 8abc, 8abf, 8aci, 8acc, 8aee, 8afg, 8afz, 8agb, 8age, 8azl, 8abz, 9ajv, 9alc, 9amb, 9amu, 9api, 9aqc, 9aad, 9awo, 9ayj, 9baf, 9bcj, 9br, 9bdj, 9bfp, 9bgs, 9bgx, 9bis, 9bjp, 9bl, 9bmx, 9bni, 9hof, 9bop, 9bpv, 9brk, 9btl, 9bwc, 9bvz, 9bxq, 9cve, 9bz, 9bzt, 9ck, 9caj, 9eak, 9enc, 9ehc, 9cim, 9cju, 9cjl, 9eka, 9emi, 9emk, 9emn, 9cnb, 9cnk, 9cpd, 9csj, 9cte,

9cto, 9evv, 9eyb, 9cyg, 9dj, 9dr, 9dbf, 9dcj, 9deq, 9dfh, 9dfz, 9dgh, 9dig, 9dkb, 9dka, 9dmv, 9dnf, 9dnx, 9dqn, 9dte, 9dtt, 9dum, 9dvw, 9dxy, 9dyu, 9dyz, 9eg, 9eam, 9ebt, 9eaa, 9ehh, 9ekf, 9eky, 9eld, 9elt, 9hm, 9hn, 9kjt, 9le, 9ql, 9rc, 9su, 9tm, 9xba, 9xbd, 9xbf.  
Canadian: 2kg, 3acc, 3ba, 3gg, 3ab, 4aj, 4bk, 4cr, 4ct, 4ew, 4dg, 4fz, 4ho, 4io.

**7AKK, Portland, Ore.**

(11a), 2axf, (2brb), 2ela, (8qv), (4xc), 5aiu, (5dc), (5nw), (5ph), (7ahb), (8apt), 8eci, (8cxm), 8cwr, (9acc), (9agi), 9ajf, 9aup, (9azp), 9bxc, 9bis, (9bly), (9ccau), (9ca), (9clq), 9dxx, (9eht), (9ekf), (9hm).  
Can.: 3pz, (4cm), (4fz).

**7AJT, Basin, Wyoming**

1avf, 1axn, 1zah, 1xc, 2e1x, 2eqz, 2el, 2sq, 2vh, 2xna, 3aa, 3adb, 3blu, 3ejn, 3dq, 3xir, 5aaa, 5ad, 5ae, 5ald, 5amu, 5ek, 5lp, 5lr, 5ql, 5rg, 5rm, 5sk, 5sp, 5zh, 5abx, 5acm, 5ah, 5amr, 5apt, 5arc, 5atc, 5axf, 5bn, 5bny, 5bxa, 5bum, 5bxx, 5dil, 5chw, 5eko, 5caw, 5ekp, 5erw, 5eyi, 5gdx, 5dhs, 5dl, 5djd, 5fc, 5fm, 5hn, 5ig, 5ij, 5pl, 5ry, 5st, 5ur, 5vt, 5xbc, 5xbh, 5xpd, 5yr, 5zz, 117 nines hrd.  
Can.: 3ws, 4aa, 4bk, 4cb, 4cr, 4dq, 4eo, 4er, 4fm, 4io, 5ah, 5ef, 5cf.  
Fone: 5akf, (6fm), (7co), (9aj).  
ICW: 2sq, (6fm), 8apt, 8cfs, 8dmx, 9acc, 9heu, 9evv, 9dlm, 9rc, 9xba.  
Spk.: 9auu (9pk7), 9btx, 9es or 9csnt, 9rr.  
Daitte: 5air, 5aiu, 5amw, 5lg, 5na, 5ql, 5sm, 7kc, 9aby, 9ac, 9ad, 9avv, 9aws, 9ba, 9bc, 9beu, 9bfp, 9bhd, 9btm, 9btx, 9bx, 9caa, 9ccs, 9cen, 9cju, 9ckj, 9ctg, 9ddf, 9dmv, 9dr, 9dwn, 9dyu, (9dxx), (9eht), 9een, 9ejn, 9iw, 9eky, 9elw.

**8DHQ, Cheaning, Mich.**

6es, 6mg, 6agk, 6aze, 6aao, (6agp), 6acu, 6akj, 6apw, 6br, 6buh, 6bra, 6ghm, 6bbe, 6blw, 6bmu, 6ano, 6ebb, 6ege, 6egw, 6ebw, 6emu, 6egk, 6cpj, 6oep, 6crn, 6dm, 6hs, 6if, 6dd, 6bri, 6gr, 6qg, 6tr, 6lu, 6rn, 6jj, 6fp, 6gb, 6zh, 6xad, 6zed, 6xr, 7aiu, 7ajg, 7ald, 7aur, (7aiv), 7el, 7em, 7fs, 7eo, 7gu, 7la, 7kz, 7gr, 7ly, 7st, 7zu.  
7kz, 7gr, 7ly, 7st, 7zu.  
Eng.: 2zs.  
Mexican (bx).

**8DCF, Ashtabula, Ohio**

1abf, 1aen, 1azx, 1aou, 1atj, 1awe, 1awy, 1ayt, 1bdx, 1boq, 1bqk, 1cdo, 1cib, 1ctp, 1fh, 1fn, 1it, 1iv, 1is, 1ke, 1lc, 1ml, 1pl, 1rr, 1uo, 1vk, 1xam, 1zas, 1zs, 2aay, 2ad, 2agb, 2ann, 2as, 2axf, 2ayl, 2bbw, 2beo, 2bgo, 2bm, 2bq, 2bq, 2bzj, 2bzj, 2cwp, 2epa, 2epd, 2epo, 2eqi, 2eqz, 2ezd, 2exl, 2cxw, 2cxy, 2eh, 2pf, 2rc, 2ec, 2wr, 2ad, 2ak, 2ak, 2ak, 2apv, 2ari, 2av, 2bdr, 2bgg, 2bhl, 2blc, 2blu, 2bnp, 2btr, 2bny, 2bvl, 2cc, 2ccj, 2ccx, 2cdk, 2cep, 2ceg, 2cgn, 2cgs, 2cbh, 2cjin, 2ckl, 2ct, 2eh, 2hh, 2hs, 2jx, 2lg, 2ly, 2me, 2oo, 2sl, 2tr, 2uc, 2uu, 2uz, 2zar, 2zd, 2ep, 2eb, 2ir, 2my, 2xc, 2ye, 2xr, 2aw, 2auu, 2aiu, 2bz, 2en, 2ek, 2gr, 2gw, 2hb, 2ad, 2agk, 2apw, 2br, 2gm, 2bnp, 2bra, 2cgr, 2eb, 2pl, 2eo, 2fo, 2gc, 2wp, 2agb, 2ak, 2aem, 2ay, 2aim, 2aar, 2ard, 2awp, 2azp, 2bcb, 2bhi, 2bkr, 2bpf, 2buc, 2bvx, 2bww, 2ccj, 2ccw, 2edo, 2ekf, 2eg, 2egr, 2ekj, 2cyl, 2eka, 2eme, 2emd, 2es, 2etu, 2eyw, 2dfl, 2der, 2det, 2doe, 2dqa, 2dqt, 2dte, 2tg, 2ud, 2xaj.  
Can.: 2fo, 3aa, 3ac, 3bq, 3rg, 3vh, 3yh, 3yv.  
Eng.: 2nm.  
French: 3ab, 3bf.

**8OAD, Cleveland, Ohio**

5aaa, 5agn, 5aic, 5aiu, 5aly, 5alb, 5ajg, 5ajt, 5akn, 5ak, 5alo, 5air, 5anu, 5es, 5dm, 5el, 5he, 5ky, 5lr, 5nw, 5om, 5pk, 5qd, 5aj, 5gw, 5rg, 5zd, 5za, 5zav, 5aao, 5agk, 5ahp, 5av, 5bl, 5bic, 5dc, 5egs, 5xt, 5lv, 5rn, 5uk, 5uw, 5zb, 5zed, 5zh, 7eo, 7zu, 9abc, 9aj, 9amb, 9amp, 9azg, 9bbl, 9bro, 9bun, 9caa, 9cyl, 9epu, 9eqg, 9ewj, 9dfh, 9dte.  
Mexico: bx.  
Porto Rico: 4je, 4oi.

**9ASW, St. Paul, Minn.**

1abf, 1ahr, 1are), (1avf), 1ayt, 1bbp, 1ber, (1bel), 1bge, 1bgo, 1bie, (1brl), 1cit, 1cmx, 1ga, 1gv, 1sk, 2ay, 2afp, 2al, 2ate, 2axf, (2bbn), (2be), 2bgo, 2bxd, 2ebg, 2edp, 2ece, 2egg, 2ela, 2rk, 2aq, 2wr, 2zn, 2xq, (3abw), 3amr, 3apv, 3acr, 3bel, 3ecu, 3ecl, (3cjin), 3ez, 3dt, 3hh, 3lr, 3ly, (3qt), (3qv), 3wx, 3xag, 4af, 4ag, 4ba, 4eb, 4in, 4oh, 4xc, 5aar, 5aas, 5adb, (5aiu), 5aiy, 5aji, 5amo, (5cn), (5eh), 5ek, 5fy, 5jb, (5ka), 5lr, 5su, 5pn, 5od, 5sg, 5sz, 5zaw, 6aao, 6ark, 6aoc, 6arb, 6bql, 6bul, 6buo, 6cdg, 6cef, 6eej, 6eka, 6emr, (6emul), 6enf, 6fy, 6go, 6ih, 6jj, 6rn, 6zed, 7afe, 7afz, 7ajy, 7akk, (7co), 7dr, 7ej, 7em, 7ew, 7fe, 7fs, 7gr, 7gw, 7if,

7iw, 7lk, (7no), 7nr, 8aaj, 8aem), (8alm), (8alx), 8apt, 8awj, 8avj, 8bec, (8bgy), 8bk, (8bas), 8bwh, 8cel, 8chb, 8etz, (8cwr), (8dae), (8dgp), 8ig, 8ob, (8ry), 8sr, 8tj, uk, 8vn, (8xbe), 8xc, (8yae), wnp, 8ry, (8eeo).  
Can.: 3co, 3pz, 4ba, 4cb, 4ch, 4dq, 4eo, 4fv, (4fz), (4ws).

**9CXP, Minneapolis, Minn.**

1aac, 1abf, (1ah), 1aja, 1are, 1aur, 1avw, 1axn, (1ber), 1bdx, 1bgo, 1bgt, 1bhm, 1bic, 1blb, 1bsd, 1btt, 1bvl, (1egq), 1cib, 1cit, 1ck, 1cmx, 1cp, 1ct, 1fd, (1il), 1ka, 1lc, 1ml, 1pl, 1sf, 1vc, 1xah, 1xu, (2aay), 2ab, (2abn), 2az, 2bbx, 2bqw, 2brb, 2bwy, (2cdp), 2evj, 2cx, (2cxb), 2hv, 2mu, 2pd, 2pf, 2abw, 2adt, 2afv, 2auv, 2bx, 2bj, 2bm, 2bn, 2bof, (2bpi), 2bva, 2bvh, 2cc, 2ccj, 2ccb, 2cjin, 2fc, 2hw, 2kb, 2lg, (2me), 2mo, 2oc, 2gt, 2tp, 2ry, (2rvv), (2wb), (2zar), 2xag, 2yv, (4af), 4ej, 4er, 4fs, 4ft, 4io, (4kl), 4oa, 4su, 4ax, 4if, 4kb, 4xc, 4xx, 4xm, 6aam, 6amm, 6amm, 6apw, 6arb, 6aru, 6avr, 6az, 6bel, 6bzz, 6bra, (6bui), 6ove, (6ocd), 6cdg, 6cee, 6eg, 6cgr, 6ea, 6lj, 6rn, 6rs, 6tu, 6xe, 6xn (7abb), 7ain, 7afs, 7amr, 7ax, 7gr, (7gp), (7to), (7zv), kdef.  
Can.: 1bq, 2az, 2bn, 2cg, 2ms, 3ml, 3ms, 3uz, 3ad, 3tf, 3vh, 3yv, 4ch, 4cr, 4dq, (4dy), (4fz), 4hh, 4io, 9ak, 9ar, 9bx.

**9DFV, 410 Addison Ave., Elmhurst, Ill.**

1abk, 1abl, 1abt, 1ach, 1ahi, 1aja, 1ajg, 1akl, 1alr, 1aur, 1avf, 1awe, 1axn, 1bdx, 1bhn, 1blb, 1bnk, 1bsd, 1cdo, 1cme, 1df, 1ef, 1fs, 1ga, 1ii, 1ml, 1uo, 2acs, 2al, 2amu, 2ap, 2aoo, 2ave, 2awf, 2axf, 2az, 2baw, 2bav, 2edp, 2ece, 2ela, 2cqi, 2csr, 2cty, 2fc, 2fo, 2ku, 2ab, 2akr, 2arp, 2arv, 2av, 2bvg, 2bml, 2bms, 2bva, 2cch, 2ccx, 2cej, 2cx, 2fc, 2hh, 2mo, 2qt, 2zs, 4af, 4er, 4eq, 4fz, 4jr, 4lr, 4gy, 4rr, 4yu, 5aal, 5abn, 5agv, 5ahd, 5akd, 5aim, 5alo, 5fu, 5nk, 6age, 6aod, 6blq, 6bqb, 6bri, 6bur, 6ego, 6chv, 6aj, 6zar, 7akz, 7ahv, 7ait, 7ej, 7ia, 7iv, 7jn, 7ou, 7tt, 7wp, 9abc, 9bkl, 9dfh, 9dun, kdef.  
Can.: 2fo, 3mw, 4af.  
Spark: 3hj, 4fg.  
Mex.: bw.

**9DYT, Ladoga, Ind. (One Tube)**

6aaq, 6abe, 6adt, 6afa, 6age, 6agk, 6ahp, 6aja, 6ak, 6ame, 6ape, 6apw, 6arb, 6arf, 6aru, 6awt, 6bel, 6bh, 6bin, 6bils, 6blw, 6bnc, 6bnt, 6bpm, 6bqb, 6buc, 6bcl, 6bt, 6bu, 6bu, 6bum, 6buo, 6bu, 6bny, 6bwd, 6ebw, 6ecd, 6edg, 6eee, 6eef, 6eeg, 6egw, 6che, 6cyl, 6emr, 6en, 6emm, 6epw, 6ea, 6eb, 6gt, 6ik, 6lv, 6od, 6pl, 6rn, 6su, 6tv, 6ad, 6zah, 6zar, 6zed, 6zh, 6zp, 7abb, 7acm, 7adz, 7ain, 7ahv, 7aif, 7akk, 7alk, 7ax, 7br), 7br, 7eo, 7ds, 7em, 7ey, 7fr, 7fs, 7gb, 7ag, 7ar, 7ij, 7ip, 7it, 7iw, 7ks, 7ly, 7mp, 7qt, 7ry, 7sc, 7so, 7wm, 7wp, 7zu.  
Fone: 1xu, 4er, 9ahz.  
Can.: 2dn, (3acc), 3co, (3kq), (3nr), 3oh, 4cb, 4en, 4er, 4fz, 4hh, 5go, 9al, 9bc, 9bl.  
Hawaiian: 6hdt, 6ceu.  
Mex.: bx.  
Foreign: G2od, G2sh, F8ab, F8bf, peii.

**R. L. Willis, 716 Oak Park Ave., Des Moines, Iowa**  
1md, 5aht, 5aht, 5aif, 5ail, 5aiu, 5aj, 5akf, 5akn, 5ec, 5eh, 5en, 5ep, 5ek, 5es, 5go, 5jm, 5kv, 5lo, 5na, 5ub, 5ai, 5ot, 5sq, 5td, 5vt, 5zh, 5zd, 5zl, 5zn, 7co, 7fs, 8add, 8ao, 8agb, 8agz, 8ah, 8aid, 8aly, 8aq, 8art, 8atc, 8bbh, 8bel, 8bd, 8bg, 8bsq, 8cap, 8edi, 8ekf, 8egj, 8egl, 8eh, 8emq, 8em, 8epk, 8en, 8esh, 8cig, 8cu, 8cyl, 8daa, 8dbs, 8dcf, 8ddl, 8ddm, 8ddq, 8dkg, 8dhe, 8dh, 8dhm, 8dho, 8djin, 8do, 8fa, 8ga, 8hi, 8ik, 8il, 8is, 8it, 8kg, 8oc, 8ol, 8om, 8ol, 8rp, 8rr, 8tm, 8tt, 8u, 8v, 8zc, 8zs, 8zd, 9aau, 9bhu, 9bic, 9bil, 9bpf, 9ebr, 9eza, 9ewj, 9ey, 9dhi, 9did, 9dte, 9dtt, 9eac, 9egb, 9ek, 9baz, 9bec, 9cen, 9cib, 9ei, 9ei.

**TRAFFIC DEPARTMENT**

(Concluded from page XII)

**SASKATCHEWAN**—4AI just opened up. 4CE works 4AF every night and moves lots of traffic. 4GH has rebuilt his station. 4EZ (remember he QUIT last fall!) has a U.S. Navy Spark. 4AA gets out FB, 4IQ, 4X, and 4DR. ex-fone friends are now pounding the brass. 4CB and 9BX in trouble as usual. can't get high aerial on 105' mast to act the way the book reads. 4JI will soon be on the air.

**WINNIPEG CITY**—4AW gets on the air once in a while. 4BK has installed rectifier. 4CO seems to reach anywhere he wants these days. 4AG was in town for a while and he and 4FA operated from 11 P.M. to daylight on 4EA's tower. They worked 6 districts and handled 85 messages and heard a station in Hawaii. 4CH has worked the coast (a long dreamed of feat) and claims the series condensers are the fruit. 4AD is making a lot of noise for a little feller. 4CR is using a 10-watter.