

QST

Published
by the
**AMERICAN
RADIO
RELAY LEAGUE**

Devoted entirely to
**AMATEUR
RADIO**

"10 Words per"

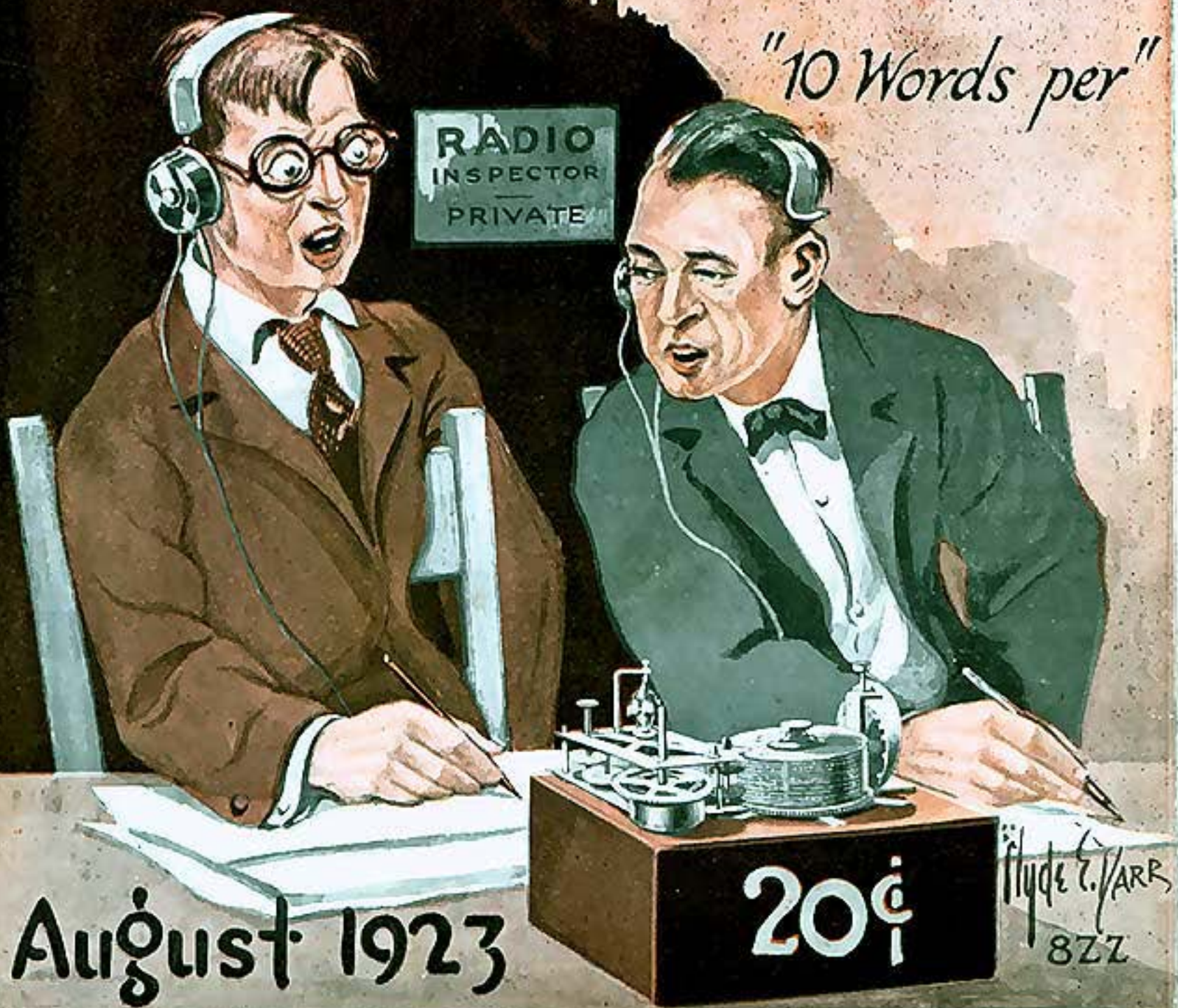

August 1923

SECOND NATIONAL A.R.R.L. CONVENTION
(See Page 64)



The Ideal Tube For the Call of the Open

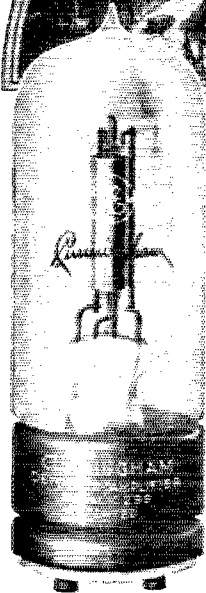

*A Specially
Designed Tube
For Every
Radio Use*

ARE you spending your vacation in the North Woods—at the seashore—in one of our many great national parks, or are you motoring across country? In any event the new Cunningham dry battery detector and amplifier, type C-299, makes it possible for you to take a radio receiver, which will be light in weight, compact in design, and highly efficient in operation. It is the special filament in this tube, having a current so low that it may receive its supply from standard No. 6 dry batteries or even from ordinary flashlight batteries, that makes possible this new and interesting application of radio.

The receiving set you now have can be readily adjusted to use this new tube and be a source of use and pleasure on your vacation trip. In any event your dealer can give you useful suggestions for the purchase or construction of a highly efficient and practical portable set.

Patent Notice: *Cunningham tubes are covered by patents dated 11-7-46, 1-15-47, 3-18-48, and others issued and pending. Licensed for amateur, experimental and entertainment use in radio communication. Any other use will be an infringement.*

E. J. Cunningham Inc.

Home Office:
228 First Street
San Francisco, Calif.

Eastern Representative:
154 West Lake St.
Chicago, Illinois

SEPARATE FILAMENT TRANSFORMERS

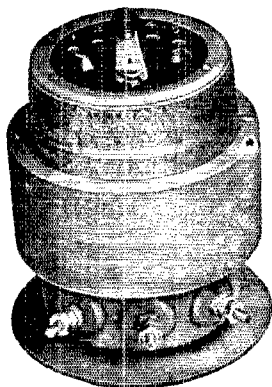

and all parts necessary for power supply, Phone, I. C. W. and C.W. circuits are shown in this new RCA booklet.

Amateur Transmitter Parts

- Grid Leaks
- Meters
- Condensers
- Filter Reactors
- Power Transformers
- Choke Coils
- Inductances
- Motor Generators
- Kenotrons and
- All Parts for the Amateur Transmitter

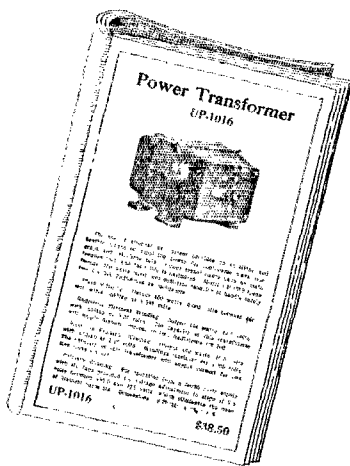

This symbol of quality is your protection.

Radio Corporation of America

WORLD WIDE WIRELESS

Sales Department
233 Broadway
New York, N. Y.

District Sales Offices
10 South La Salle Street, Chicago, Ill.
433 California Street, San Francisco, Cal.

Every licensed transmitting station needs this booklet.

**FILL IN AND MAIL
THE COUPON
FOR YOUR COPY!**



RADIO CORPORATION OF AMERICA,
SUITE 3000, 233 BROADWAY, NEW YORK.

GENTLEMEN: Please send me, without charge, your new booklet "Amateur Transmitter Parts."

Name

Street

City..... State.....

Are You Fixed for Fall?

The active radio season will soon be upon us. As a live amateur, your set and station will, or should be, completely equipped and "rarin' for DX."

How are you fixed as a League man? Got all the "A.R.R.L. Apparatus" you need? For your guidance and convenience, here is a list of what you should have.



The A.R.R.L. EMBLEM. The outward badge of the true amateur. Now, as never before, should every A.R.R.L. man wear the black and gold diamond that tells the world who and what he is—and gives him a definite and honorable place in the eyes of all intelligent observers. **The A.R.R.L. Emblem, in extra heavy rolled gold and black enamel, may be had by League Members, in either lapel button or brooch pin mounting, postpaid for \$1.00.**

CUTS OF THE LEAGUE EMBLEM, to print as illustrated above. Used on your Stationery and report postals, etc., your standing as a real amateur, an A.R.R.L. man, will be carried wherever the mail penetrates. **League Members can buy a cut of the "A.R.R.L. Diamond" at \$1.00, postpaid.**

OFFICIAL A.R.R.L. MESSAGE BLANKS. As necessary as his key to every transmitting "ham." **Pads of 100, 35c, or 3 pads for a dollar, postpaid.**

LEAGUE LETTERHEADS. When your tube's blown and you write instead of radio—do it on an A.R.R.L. Letterhead. It will add prestige and dignity to your correspondence. **To members at the following prices: 1000 sheets—\$6.00; 500—\$3.25; 250—\$1.70; 100—\$0.75.**

BACK COPIES OF QST. You can't afford to have your files incomplete. Here is a very special offer—a bargain! QST for May to August, 1917, inclusive; June 1919; April to June 1920, inclusive; March to September, 1921, inclusive; April to December, 1922; January to June, 1923, inclusive. **And all for only \$3.00, postpaid.**

A BINDER FOR YOUR QST'S. Are your precious copies stacked up loose somewhere, liable to loss or "borrowing" by some other ham? Gather them together in our special binder! Dark red, gold QST on back and front. **Complete, with two clips, postpaid, \$1.50.**

MESSAGE DELIVERY CARDS. Ready to be filled out and mailed. On U. S. Stamped Postals, 2c each; 1c apiece without stamp (for Canadians etc.) Postpaid anywhere. Stock up now!

A.R.R.L. LOG SHEETS. A necessity in every shack. Designed by hams for hams. 8½ x 11" bond paper, punched for standard 3-ring loose leaf binder. 125 sheets postpaid, \$1.00; 500 for \$3.50.

Please address all correspondence to QST or THE AMERICAN RADIO RELAY LEAGUE at

1045 Main Street, Hartford, Conn.

DIRECTORY OF THE PERSONNEL OF THE OPERATING DEPARTMENT, A.R.R.L.

ATLANTIC DIVISION

| | | |
|-----------------------|---------------------|----------------------------|
| Manager | C. H. Stewart | St. David's, Pa. |
| A.D.M. Dist. of Colo. | H. J. Wadsworth | Washington |
| A.D.M. Maryland | G. L. Deichman, Jr. | 70 V St., N. W. |
| A.D.M. So. N. J. | R. S. Johnson | Park Hgts. & Bancroft Ave. |
| A.D.M. No. N. J. | H. W. Densham | Red Bank |
| A.D.M. East. N. Y. | Dr. E. A. Cyriax | Collingswood |
| A.D.M. West. N. Y. | S. Woodworth | 219 E. 71st St. |
| A.D.M. West. Penna. | James F. Rau | 425 Brownell St. |
| A.D.M. East. Penna. | P. E. Wiggin | 2085 E. Kingston St. |
| | | 5106 Liberty Ave. |
| | | Pittsburgh, Penna. |

CENTRAL DIVISION

| | | | |
|--------------------|------------------|------------------------|---------------|
| Manager | R. H. G. Mathews | 332 S. Michigan Ave. | Chicago, Ill. |
| A.D.M. Michigan | C. E. Darr | 137 Hill Ave. | Detroit |
| A.D.M. Ohio | Mrs. C. Candler | 106 S. Ash St. | St. Mary's |
| A.D.M. Illinois | N. C. Smith | 51 E. Seminary St. | Hooperton |
| A.D.M. Wisconsin | B. A. Ott | c/o Segelke & Kohlhaus | La Crosse |
| A.D.M. So. Indiana | M. W. Hutchinson | | Middlebury |
| A.D.M. Indiana | J. E. Hall | c/o Seymour Elec. Co. | Seymour |
| A.D.M. Kentucky | J. A. Kolb | 1101 E. Broadway | Louisville |

DAKOTA DIVISION

| | | | |
|-------------------|-----------------|-----------------------|--------------------|
| Manager | N. H. Jensen | Box 894 | Sioux Falls, S. D. |
| A.D.M. Minnesota | Don C. Wallace | 54 N. Penn. Ave. | Minneapolis |
| A.D.M. So. Dakota | Orville Wheelon | 800 East Capitol Ave. | Pierre, S. D. |
| A.D.M. No. Dakota | Bert Wick | 835 Broadway | Fargo |

DELTA DIVISION

| | | | |
|--------------------|--|-----------------|-------------------|
| Manager | W. W. Rodgers | 1106 Union Ave. | Memphis, Tenn. |
| A.D.M. Louisiana | F. L. Pullen | | Houma |
| A.D.M. Mississippi | University of Mississippi (W. L. Kennon) | | University, Miss. |
| A.D.M. Tennessee | W. C. Hutcheson | | Wind Rock |

EAST GULF DIVISION

| | | | |
|---------------------|-----------------|----------------------------|---------------|
| Manager | B. W. Cochran | Box 113 | Palmetto, Ga. |
| A.D.M. So. Carolina | W. C. Etheredge | 36 E. Georgia St. | Woodruff |
| A.D.M. Alabama | V. C. Mellvaine | Box 12 | Auburn |
| A.D.M. Georgia | W. B. Pope | 197 Dearing St. | Atlanta |
| A.D.M. Florida | C. F. Clark | c/o Western Union Tel. Co. | Jacksonville |

MIDWEST DIVISION

| | | | |
|-----------------|-----------------|------------------------------|----------------------------|
| Manager | G. S. Turner | S W. Bell Tel. Co., Rm., 611 | Tel. Bldg., Kan. City, Mo. |
| A.D.M. Missouri | Dr. C. L. Klenk | 420 Metropolitan Bldg. | St. Louis |
| A.D.M. Nebraska | J. G. O'Rourke | 6406 Maple St. | Omaha |
| A.D.M. Iowa | D. E. Watts | 502 N. 4th St. | Clear Lake, Ia. |
| A.D.M. Kansas | C. Himoe | 739 Ohio St. | Lawrence |

NEW ENGLAND DIVISION

| | | | |
|----------------------|----------------|--------------------|--------------------|
| Manager | I. Vermilya | 23 N. Water St. | New Bedford, Mass. |
| A.D.M. Connecticut | J. L. Reinartz | 271 Hartford Rd. | So. Manchester |
| A.D.M. Rhode Island | D. B. Faucher | 86 Franklin St. | Westerly |
| A.D.M. Vermont | R. P. Slayton | | Burlington |
| A.D.M. Maine | F. H. Pierce | Jordan High School | Lewiston |
| A.D.M. New Hampshire | H. R. McLane | | Laconia |
| A.D.M. West. Mass. | A. S. McLean | 288 Main St. | Springfield |
| A.D.M. East. Mass. | P. F. Robinson | 149 Hollis Ave. | Braintree |

NORTHWESTERN DIVISION

| | | | |
|-------------------|------------------|---------------------|--------------|
| Manager | B. R. Bliss, Jr. | 417 Bannock St. | Boise, Idaho |
| A.D.M. Montana | H. E. Cutting | Box 517 | Bozeman |
| A.D.M. Washington | K. W. Weingarten | 3219 North 24th St. | Tacoma |
| A.D.M. Idaho | La Verne Martin | 423-14th Ave. | South Nampa |
| A.D.M. Oregon | P. R. Hoppe | 1633 Willamotte St. | Eugene |

PACIFIC DIVISION

| | | | |
|-------------------|----------------|----------------|----------------------|
| Manager | J. Y. Wise | Bisbee Highway | Walnut Grove, Calif. |
| A.D.M. Arizona | H. L. Gooding | Box 175 | Douglas |
| A.D.M. Nevada | G. M. Lewis | 812 N. Va. St. | Reno, Nevada |
| A.D.M. California | E. C. Garrette | | Colusa |

ROANOKE DIVISION

| | | | |
|---------------------|----------------|--------------------|---------------|
| Manager | W. T. Gravely | 354 Main St. | Danville, Va. |
| A.D.M. West. Va. | A. G. Heck | 410 Fairview | Mannington |
| A.D.M. Virginia | J. F. Wohlford | 118 Cambridge Ave. | Roanoke |
| A.D.M. No. Carolina | T. M. Simpson | Peoples Nat. Bank | Winston |
| A.D.M. Porto Rico | Luis Rexach | Box 319 | San Juan |

ROCKY MOUNTAIN DIVISION

| | | | |
|-----------------|----------------|-----------------|--------------|
| Manager | N. R. Hood | 1022 S. Ash St. | Casper, Wyo. |
| A.D.M. Utah | J. L. Bock | | Farmington |
| A.D.M. Colorado | J. L. Turre | 706-18th St. | Denver |
| A.D.M. Wyoming | P. N. Mitchell | | Greybull |

WEST GULF DIVISION

| | | | |
|-------------------|-------------------|--------------------|---------------|
| Manager | F. M. Corlett | 2515 Catharine St. | Dallas, Texas |
| A.D.M. New Mexico | Louis Falconi | Box 421 | Roswell |
| A.D.M. Oklahoma | M. L. Prescott | 426 Bufala St. | Norman |
| A.D.M. No. Texas | R. L. Clinkscales | 3913 Hamilton St. | Dallas |
| A.D.M. So. Texas | A. P. Daniel | 2504 Bagby St. | Houston |

HAWAIIAN DIVISION

| | | | |
|----------------|--------------|-----------------|-----------------|
| Acting Manager | K. A. Cantin | 1593 Piikoi St. | Honolulu, T. H. |
|----------------|--------------|-----------------|-----------------|

MARITIME DIVISION

| | | | |
|---------|--------------|---------------------|-----------------------|
| Manager | K. S. Rogers | 19 Upper Prince St. | Charlottetown, P.E.I. |
|---------|--------------|---------------------|-----------------------|

ONTARIO DIVISION

| | | | |
|---------|------------------|------------------|---------------|
| Manager | A. H. K. Russell | 11 Pinewood Ave. | Toronto, Ont. |
|---------|------------------|------------------|---------------|

QUEBEC DIVISION

| | | | |
|---------|---------------|---------------------|-------------------|
| Manager | A. J. Lorimer | Buzzell-Lorimer Co. | Cowansville, Que. |
|---------|---------------|---------------------|-------------------|

VANCOUVER DIVISION

| | | | |
|---------|-------------|-----------------|------------------|
| Manager | J. T. North | 2017-15 Ave. W. | Vancouver, B. C. |
|---------|-------------|-----------------|------------------|

WINNIPEG DIVISION

| | | | |
|---------------------|----------------|-----------------|-----------------|
| Manager | P. Socolofsky | | Loreburn, Sask. |
| A.D.M. Saskatchewan | J. E. Maynard | Box 339 | Morse |
| A.D.M. Manitoba | Vincent Thomas | 33 Roseworn St. | St. Vital |

"Dimensions are limitless, time is endless." Chuang Tzu

The wise man conquers the barriers of time and space with the New

GREBE

Broadcast Receiver

Doctor Mfg.



Receive all broadcasting without outdoor antenna, loop, or storage battery.

This Receiver employs Regeneration and Tuned Radio Frequency Amplification with only two simple tuning adjustments.

Write for "Seven Points of Satisfaction"

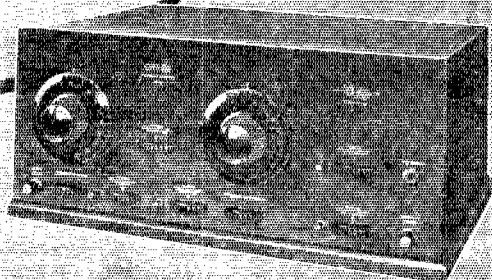

A. H. GREBE & COMPANY, Inc.
Richmond Hill, N.Y.
Western Branch: 481 East 2nd St., Los Angeles, Cal.

Licensed under Arrangement
U. S. Pat. No. 2,113,149

Type GR12

QST

The Official Organ of the A.R.R.L.

VOLUME VII

AUGUST, 1923

No. 1

| | |
|---|-----------------------------|
| The Passing of the Pacific | 7 |
| The New Amateur Regulations | 13 |
| Daylight Transcons! | 14 |
| The Departure of "WNP" | 16 |
| A Chance to Have Your Tube Troubles Unsnarled | 17 |
| Electric Filters—Part II | <i>F. S. Dellenbaugh</i> 18 |
| The League's Radio Information Service | 26 |
| Shooting Facts to the Public | <i>J. K. Bolles</i> 27 |
| Final Report on the Fading Tests | 29 |
| Our Index | 34 |
| Hard Rubber in Radio Instruments | 35 |
| Resonance Wave Coils | 36 |
| Editorials | 37 |
| The Operating Department | 42 |
| International Amateur News | 50 |
| Who's Who in Amateur Radio | 52 |
| Strays | 53 |
| Calls Heard | 56 |
| The Junior Operator | 59 |
| Radio Communications by the Amateurs | 63 |
| The Second National A.R.R.L. Convention | 64 |
| Classified Advertisements | 108 |
| QST's Directory of Advertisers | 111 |

QST is published monthly by The American Radio Relay League, Inc., at Hartford, Conn. Kenneth B. Warner (Secretary, A.R.R.L.), Editor and Business Manager. S. Kruse, Technical Editor; H. F. Mason, Department Editor. W. B. Cowles, Assistant Editor.

Edwin C. Adams, Advertising Manager.

Subscription price in United States, Possessions, and Canada, \$2.00 per year.

Foreign, \$2.50. Single Copies, 20 cents.

Entered as second-class matter May 29, 1919, at the post office at Hartford, Connecticut, under the Act of March 3, 1879. Acceptance for mailing at special rate of postage provided for in section 1103, Act of October 3, 1917, authorized September 8, 1922.

Copyright, 1923, by the American Radio Relay League, Inc.
Title registered at United States Patent Office.

THE AMERICAN RADIO RELAY LEAGUE, Inc.
HARTFORD, CONN.

THE AMERICAN RADIO RELAY LEAGUE

The American Radio Relay League, Inc., is a national non-commercial association of radio amateurs, bonded for the more effective relaying of friendly messages between their stations, for legislative protection, for orderly operating, and for the practical improvement of short-wave two-way radiotelegraphic communication.

It is an incorporated association without capital stock, chartered under the laws of Connecticut. Its affairs are governed by a board of seventeen Directors, elected every two years by the general membership. The officers, in turn, are elected by the Directors from their number. The League is non-commercial and no one commercially engaged in the manufacture, sale or rental of radio apparatus is eligible to membership on its Board.

"Of, by and for the amateur," it numbers within its ranks practically every worth-while amateur in America and has a history of glorious achievement as the standard bearer in amateur affairs.

Inquiries regarding membership are solicited. Ownership of a transmitting station, while very desirable, is not a prerequisite to membership, a bona-fide interest in amateur radio is the only essential. Correspondence should be addressed to the Secretary.

OFFICERS

President
HIRAM PERCY MAXIM
Hartford, Conn.

Vice President
CHAS. H. STEWART
St. David's, Pa.

Traffic Manager
F. H. SCHNELL
1045 Main St.
Hartford, Conn.

Canadian General Manager
W. C. C. DUNCAN
196 Ellsworth Ave.
Toronto, Ontario

Treasurer
A. A. HEBERT
Nutley, N. J.

Secretary
K. B. WARNER
Hartford, Conn.

DIRECTORS

H. M. ANTHONY
Muncie, Ind.

H. A. BEALE, JR.
Parkesburg, Pa.

A. H. BABCOCK
Berkeley, Calif.

V. F. CAMP
Brightwaters, L. I.

F. M. CORLETT
Dallas, Tex.

C. E. DARR
Detroit, Mich.

W. C. C. DUNCAN
Toronto, Ontario

A. A. HEBERT
Nutley, N. J.

S. KRUSE
Hartford, Conn.

H. P. MAXIM
Hartford, Conn.

F. H. SCHNELL
Hartford, Conn.

C. A. SERVICE, JR.
Hartford, Conn.

C. H. STEWART
St. David's, Pa.

K. B. WARNER
Hartford, Conn.

M. B. WEST
Chicago, Ill.

ADVISORY TECHNICAL COMMITTEE

C. S. BALLANTINE
WM. C. BALLARD, Jr.
LEROY M. E. CLAUSING
FRANK CONRAD
LEO C. YOUNG

MINTON CRONKHITE
J. H. DELLINGER
C. L. FARRAND
PAUL F. GODLEY
F. C. BLAKE
MELVILLE EASTHAM

L. A. HAZELTINE
C. D. TUSKA
H. H. G. MATHEWS
GERALD M. WEST
S. KRUSE
D. G. McCAA

Address General Correspondence to Executive Headquarters, Hartford, Conn.



A Magazine Devoted Exclusively to the Radio Amateur

The Passing of the Pacific

Kangaroo Outclassed as American Amateur Radio Signals Leap to Antipodes

HATS off to the 6th District!! Here's a long cheer for California and another for the Long Beach Radio Club and the *Radio Journal*. And here's a Tiger for the brilliant Transpacific Tests!

The telegram from the *Radio Journal* tells the story:

"Scores of American amateurs from almost every district read in Australia and New Zealand during Transpacific tests ending May 30th. First reception in some cases 50 feet from

land speaker on one tube. World's records smashed under bad weather conditions in Australia. 6JD—first across with 17-word message from *Radio Journal* to Wireless Institute. Unofficial report. Australia: 3AKC, 3IRD, 5AEC, 5NO, 6CGW, 6JD, 6BVG, 6BV, 6AVN, 6BUN, 6HD, 6CGM, 6BUM, 7PD, 7LA, 7TD, 9GK, 9HRL, 9UR, 9XK, 9URE, 9ARL, 9AUL, 9ZR, 9ARC. New Zealand unofficial: 1AJP, 3CL, 3YO (on land speaker), 4HW, 5ZE, 5PX, 6ZG, 6ZE, 6AJF, 6ARB, 6ALK, 6ZZU, 6APW, 6BNT, 6GD, 6AVN, 6AWT, 6BG, 6FH, 6GF, 6BV, 6BM, 6IF, 6AWX, 6BET, 6AWQ, 6BWP, 6CGW, 6BVG, 6BED, 6JD, 7BX, 7PF, 7BJ, 7AW, 7ZF, 8QK, 8AIO, 9UR, 9UM, 9MC, 9AYU, 9DGW, 9ZT, 9AUL, 9UU, 9CUD, 9APW. Arranging for tests in October, possibly two-way Australia, New Zealand, and maybe India. Wireless Institute compiling complete report from all over continent (of Australia, etc.) President Harding to be asked to send special message to Governor General of Australia. (Signed) Frederick, *Radio Journal*, Los Angeles."

How the Tests Were Planned

We quote from the *Radio Journal* as follows: "The committee for the American Amateurs is naturally headed by the amateur who conceived and worked the idea up to the final details, R. J. Portis, President of the Long Beach (Calif.) Radio Club, the Long Beach Club as a whole being sponsors for the tests. Other members of the committee were Lester Picker, 6ZH, San Diego; Hyman Fink, 6BRC, Los Angeles; C. DuVall, 6BRS, Venice, Calif.; F. W. Reed, Pasadena; C. E. Taylor, 6AIB,

Long Beach, Calif.; Jack Betterley, 6AQW, San Bernardino, Calif.; T. E. Nikirk, 6KA, Los Angeles; C. Thompson, 6UQ, San Francisco; Louis Falconi, 5ZA, Roswell, New Mexico; Harold DuVall, 6EN, Los Angeles; and the *Radio Journal*, Los Angeles.

"R. J. Portis.... conceived the idea last fall, and the first letter in reply to his query to Australia was written by H. Kingsley Love of Mel-

bourne, Australia, August 8, 1922. Mr. Love heads the Victoria section of the Wireless Institute of Australia.... At this time the idea was simply for a few Pacific Coast amateurs to attempt to send to a few Australian stations. Then the Melbourne Argus, one of the largest newspapers there, took it up; the Wireless Weekly followed suit and soon every section of the Wireless Institute of Australia was interested."

The tests took place during the month of May. Enthusiasm in Australia and New Zealand was intense, many special sets were built for the tests, the government took part in the work of reception and in checking the calls heard.

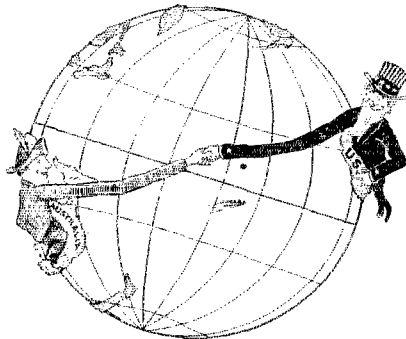

The American end had been well organized by the committee with the aid of the facilities and co-operation of the *Radio Journal*. Stations entering were assigned schedules and code combinations unless they chose to take their chances in the "free for all" periods. Some of the codes were two-letter combinations but a few had as many as 5 letters. These codes in duplicate were on file in the office of J. Malone, Esq., Controller of Wireless in the Prime Minister's Office at Melbourne. Many stations all through the Western States had been rebuilt, new equipment installed, and everything put in finest condition.

Both ends were waiting eagerly when May 1st arrived, and at 10:00 P.M. Pacific Standard Time the ether was torn wide open by scores of brand new "ether busters," each eager to be first across. Unfortunately an error had been made—10:00 P.M. P.S.T. is FOUR P.M. in Australia and 7,000 miles in daylight is asking quite a bit for even an American amateur station. On the 15th the schedules were changed, running tests from 1 to 4 A.M. which becomes 7 to 10 P.M. in Australia.

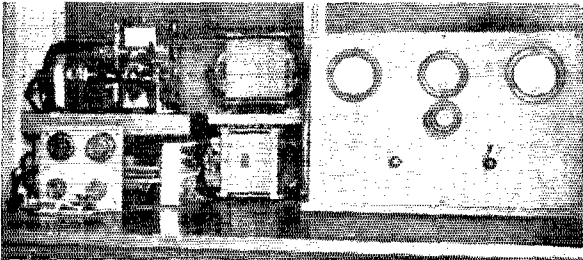

6JD—Rectifiers, Transformers, Filter, and Sending Panel

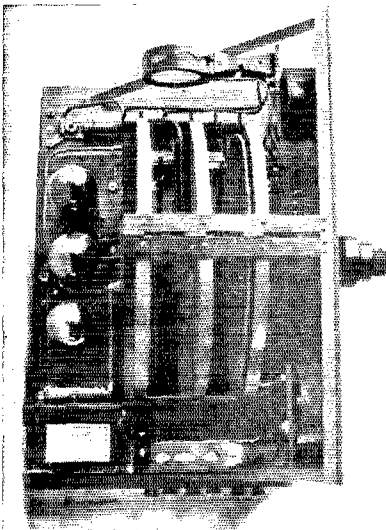

Top view of the set at 6JD showing coils of Meissner circuit. Note the three knobs for operating grid, plate, and antenna clips. One 250-watt tube used on this set during Tests.

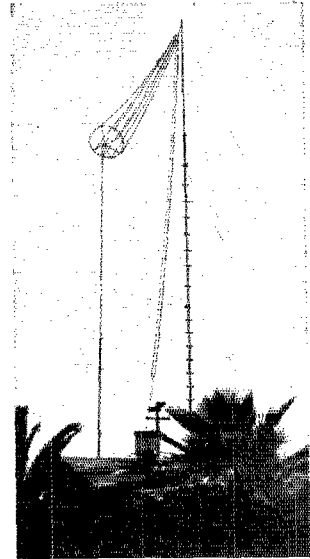

MESSAGES FOR AUSTRALIA ACCEPTED HERE

Antenna at 6JD, Los Angeles

11 amperes—7000 miles

6JD Shoots Message 7000 Miles

6JD was first across, not with a "call heard" but with a 17 word message which was copied solid. Nor was that all; before the tests were over 6JD had put three messages into New Zealand and even with the present incomplete report we know that other messages were copied from 6BJQ, 6XBC, 9ZT, 9AUL, and 3YO. This took good sending stations, but it also takes a receiving operator to establish records and the operators were there. Eager hams all over Australia and New Zealand were engaged in the new sport of "Yank Logging" and they showed ability and persistence that will soon make the best of us extend ourselves to beat them. When that outfit gets its new sending sets going more records will go to smash.

The Record-Smashing New Zealander and Australian

Truly American Amateur Radio must look to its laurels. These men do receiving that challenges our best and have begun to hang up sending records. New Stations are being rushed to completion and will be on the air before many weeks are past. It will not be another year before we are

QSO Australia and New Zealand. These things make the Transatlantics seem mighty small, and they make it seem very curious that Europe is unable to get into touch with us at a time when two-way communication across the broad Pacific is just around the corner.

9ARC, 9AYO, 9APW, 9AAU, 9AWN, 9AJP, 9AWM, 9AYU, 9BED, 9BX, 9BSG, 9CVO, 9CMK, 9CXP, 9CIP, 9CNS, 9CUD, 9DPX, 9DGW, 9DPD, 9DSG, 9DGE, 9DGW, 9GK, 9HRL, 9KP (voice), 9LG, 9MC, 9UR, 9UM, 9URE, 9UU, 9VM, 9XAC, 9XK, 9YAJ, 9ZT, 9ZR. Canadian 4BV. (Others



THE MIGHTY 9AUL. Copied in both Australia and New Zealand

List of American Amateur Stations That Have Been Heard in New Zealand and Australia, during or Before the Tests

(A large part of this list is taken from that very live paper, "New Zealand Wireless & Broadcasting News," which was introduced to us by Mr. F. D. Bell of Waihamo, Otago, New Zealand.)

- 1AJP, 1EL, 2FP, 3ARO, 3CL, 3ID, 3YO, 4HW, 4MY, 5AEC, 5AK, 5AX, 5DI, 5FT, 5GJ, 5ZAS, 5NO, 5PB, 5PX, 5SF, 5XAJ, 5XAT, 5XT, 5ZAV, 5ZB, 5ZLT, 6APW, 6ALK, 6ARB, 6AJF, 6AWQ, 6AVN, 6AHU, 6ALV, 6AWT, 6AWX, 6AVD, 6ANH, 6AWP, 6ABX, 6ARB, 6APB, 6AHO, 6ABX, 6AAK, 6ARB, 6ANH, 6AVR, 6AWQ, 6BM, 6BV, 6BET, 6BWP, 6BED, 6BCR, 6BQC, 6BUN, 6BUM, 6BUY, 6BIC, 6BBC, 6BJQ, 6BNT, 6BUG, 6BG, 6BVG, 6BO, 6CN, 6CBI, 6CGW, 6CU, 6CGM, 6EA, 6EN, 6ESH, 6FH, 6GD, 6GF, 6GR, 6GG, 6HD, 6IF, 6JD, 6JN, 6KA, 6KU, 6PD, 6PL, 6RM, 6TI, 6VM, 6XAD, 6XBC, 6XP, 6ZG, 6ZR, 6ZZ, 6ZND, 6ZMI, 6ZW, 6ZH, 6ZZU, 7AW, 7BJ, 7BX, 7GS, 7LR, 7LA, 7PF, 7PD, 7SC, 7SF, 7TD, 7ZF, 7ZU, 8AIO, 8BXX, 8CEI, 8QK, 8ZW, 8ZY, 9ANS, 9ARL, 9AUL,

probably Canadian also, as recorders are not familiar with intervals *de*, *v*, *fm*, and *aa*.)

The Star of the Transpacifc—6JD

Once in a while an amateur station makes good records by good luck but 6JD is not

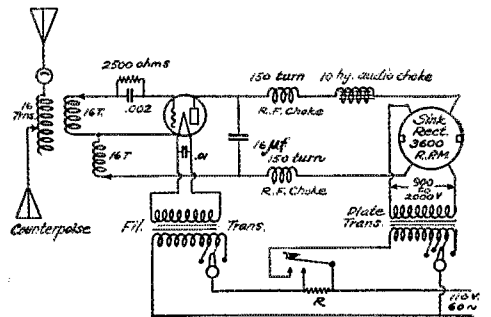

R. Resistance to compensate for line drop due to plate load.

The Hookup at 6JD

one of these. Bitz has a station that is good all the way through and that deserves the splendid record it has made. Heard

in half a dozen European countries, most of Canada and a considerable part of South America, 6JD was the logical candidate for the honor of putting the first message into New Zealand.

The two wooden masts are 80 ft. high and 50 ft. apart. Between them hangs a cage L antenna starting from a 7 ft. hoop

(Western Electric) substituted temporarily. With 2000 volts on the plate this gave an antenna current of 11 amperes and messages began lighting 8000 miles away. The "sink" rectifier, shown in one of the pictures, has a $4\frac{1}{2}$ " disc running at 3600 R.P.M., plate power being supplied by the transformer shown and the output being

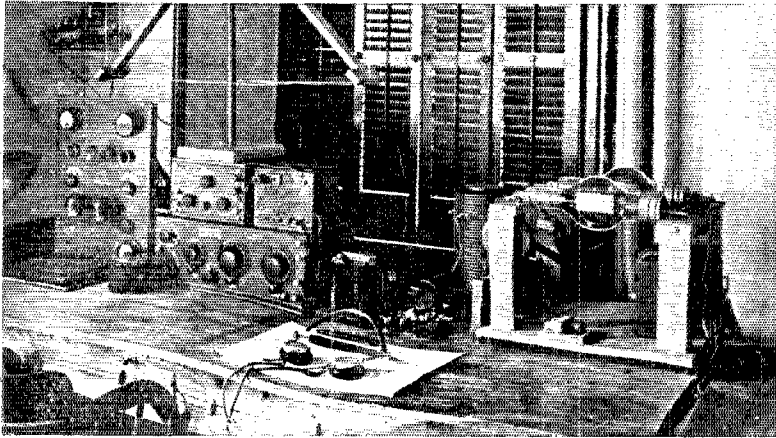

3YO, Easton, Pennsylvania

at the far end and tapering a 6" cage lead which runs 80 ft. to the set. The counterpoise is made of ten $\frac{3}{8}$ " copper strips hung fan-fashion under the antenna.

The sending set is unusual; it uses a Meissner circuit and the plate supply is from a synchronous rectifier. The sending set as shown has three sockets, one for a

filtered by the 10-henry choke and 6-microfarad condenser. Special attention is called to the Meissner circuit of the sending set. In this circuit only the antenna system is tuned. The sliders on all three coils can be moved while the set is running by turning the three concentric knobs on the front of the panel. Note also the stunt for

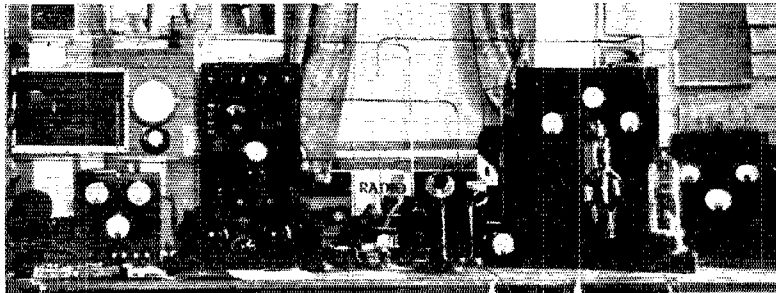

6XAD-6ZW, AVALON, CATALINA ID., CALIF. "6XAD as usual got across." The 100-set at the extreme left was heard on reduced power, both in the regular tests and in privately arranged check-tests. The big bottles were not used at all.

5-watt and two for 50-watters. When using low power the 50's are lifted out and the plate voltage reduced, giving an antenna current of 2.5 amperes. When more power is needed the 5 comes out and the 50's go in. At 1750 volts the antenna current is then 7 amperes. And finally, during the T.P. tests, all of these tubes were removed and a 250-watt tube (probably

preventing flickering of the line voltage when the key is worked.

6AWT, San Francisco

Conical cage antennas seem to be the style in California. Mr. Molinari's begins with a 30-inch cage at the 80-ft. mast, runs 35 ft. to another hoop at the top of a 55-ft. mast, then drops 50 ft. to the set,

tapering all the way till it is only 2" across at the lead-in. The counterpoise consists of 50 wires and covers 1000 square feet, being hung 10 ft. off the ground by means of glazed porcelain insulators.

The sending set uses a single C-304 tube connected in a straight Hartley circuit and supplied with electrolytically rectified current at 2500 volts. The rectifier consists of 120 jars with concentrated borax solution and plates 2" x 4". This set uses a real filter condenser—32 one-microfarad units connected in series-parallel to make

9AUL and 9ZT, Minneapolis

If there was any doubt as to the reasons for the fame of Minneapolis it has been pretty well cleared up by Smeby and Wallace, owners of the twin ether-busters 9AUL and 9ZT. Few cities have a pair of stations that can class with them.

9AUL uses an Electro-se-insulated 6-wire cage running in L form, the top being 45 feet long and 60 feet high. The top is 8 inches in diameter; the lead somewhat smaller. The counterpoise is of six wires 45 feet long, suspended 10 feet high so as

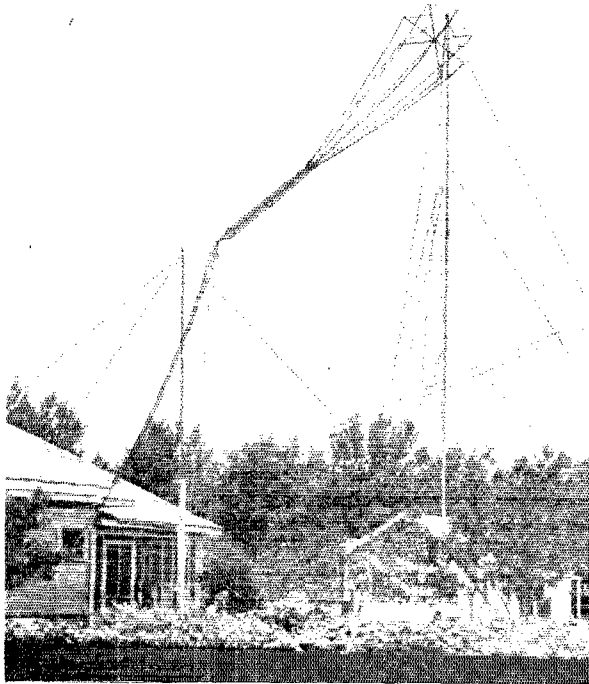

From the "OK City" to New Zealand
SAEC, Oklahoma City

an "8 mike" condenser that will stand the plate voltage. The voltage is supplied by a pair of Acme 500-watt transformers and the filament is heated by an Acme 300-watt filament transformer. To avoid the pest of flickering filament voltage the plate supply is driven off one side of the 3-wire 110-220 line and the filament system off the other side.

The antenna current is 16 amperes! It is no real wonder that GAWT had been heard all over the U.S., Canada, Mexico, and Hawaii before it began to hang up some real records and reached China, Alaska, and now finally the Canal Zone, New Zealand, and Australia.

to cover a strip 20 feet wide. The system is of copper wire and is varnished to prevent corrosion.

The output of the plate transformer (by the way, it's a re-wound Acme spark transformer) is rectified by a 144-jar chemical rectifier and fed thru the two radio chokes to the plate terminals of the two UV-204 tubes on the wall. The circuit is the regular shunt-feed Hartley circuit; the only one that the tubes seem to agree with very well altho other circuits seemed to be OK for smaller bottles. When the plate voltage is 2200 the plate current is 450 miliamperes and 15 perfectly healthy amperes go whizzing out thru the antenna ammeter. The

station has been used but 70 nights and in that time on full power it has been heard in Australia, Jamaica, England, France, and Alaska; also on half power in New Zealand, the West Indies, Panama, Mexico, Hawaii, all the States, most of Canada, 3400 miles S.W. of Panama, and 1600 miles west of Frisco. When working 8's or 9's (which means within 1000 miles) power is reduced still further and an antenna current of 3 amperes used.

9ZT was begun before the Wallace home. The lot was filled with an enormous grounding system which has been useful for just one thing, to show that an earth connection is "debutique" at 9ZT. But that didn't discourage an operator who had been through

at 9,000 miles. The antenna current that does this ranges from 6 amperes at 100 meters, to 10 amperes at 200 and 375 meters.

7BJ, Vancouver, Washington, U.S.A.

7BJ is the "Little Giant" of these tests. When a set with three C-202 "5-watt" tubes can casually flip signals across 8000 miles of space it's worth while to find out how the thing was done. There isn't room for all of the story here so I'm going to give the Department Editor a good chance to tell the whole of it later in station descriptions. He's the right man to do it too, 'cause he's ex-7BK, personal sine "MN" who knows 7BJ and most of the other stations in the

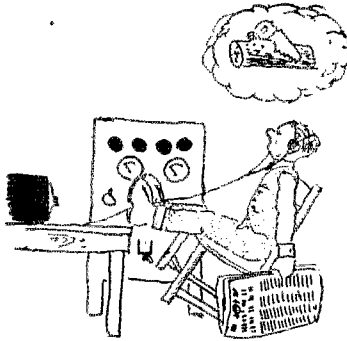

Nothing but Mars
AUSTRALIA

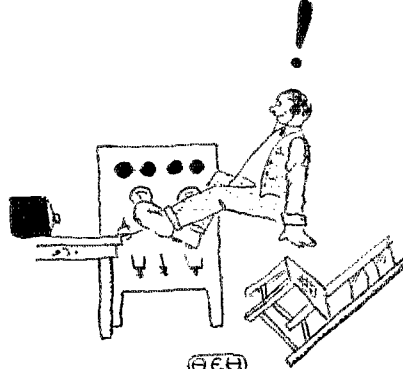

WHEEL! THERE'S 6JD
LISTENS IN

the mill in both the Navy and the old Marconi Company; Wallace put up a tremendous circular counterpoise, 200 ft. across, 8 ft. above the ground, and began to work most of the Western Hemisphere.

The antenna is the old reliable flat-top inverted L on 12 foot spreaders. The masts are 85 and 65 ft. high, respectively, and the top 50 ft. long.

The set still clings to the idea of starting at the ground; accordingly, the plate and filament transformer and the 120-jar electrolytic rectifier are in the basement, together with a filter system made of fourteen UV-1490 condensers and a "man-size" iron-core choke. The high tension D.C. then comes up to the one of the prettiest operating rooms on record. The sending set needs no comment except that it uses the Hartley circuit, the favorite for the 250-watt tube.

The receiving set is equipped with two wave traps, one coupled to the antenna lead and the other directly in series. These are necessary because there are 200 sending sets in the city and 9ZT must—and does—copy right thru the gang at all times.

It is rather easy to list the places where 9ZT has not been heard but we draw the line at listing "points reached" for a station that can drop messages into Australia

Northwestern from personal experience as D.M. of that division.

5AEC, Oklahoma City, Okla.

Years ago Oklahoma City boosters went around wearing buttons the size of a saucer. The buttons were red and white and they yelled at you "I'm from the OK City—ask me!". Well it's still the OK city if it can turn out stations like 5HK and 5AEC.

The antenna is a conical cage 8 feet across at the top of the 70-foot pole, tapering to a 3" lead-in which drops off the 71-foot pole, 94 feet from the first, to a station at the ground level. Of course there is a man-sized counterpoise of 16 wires arranged in fan form 6 feet off the ground.

The set is the big surprise—it uses only four 5-watters, uses the old 1DH circuit, and a plate voltage of 700 from a synchronous rectifier. It sounds exactly like a thousand other sets that never get outside the state—until you look at the antenna ammeter. In spite of that sky-scraper antenna and the low plate voltage the antenna current is 4.3 amperes. The adjustments of this set are right.

Everything in the place is home made—everything; helix, rectifier, condensers, maybe even the antenna ammeter. The

helix is only three inches in diameter and the grid coil only ONE inch. This grid coil is wound of 25 turns of No. 16 wire and is shunted by a .001 microfarad variable condenser.

Not exactly a "watt-burner," is it? But as we said before, there is a real antenna and the adjustments are right. 5AEC has not only been heard in Australia but in Hawaii, Porto Rico, Mexico, Panama, Alaska, most of Canada, and of course all over the United States. A fine example of a small set intelligently operated and doing everything the tubes are capable of. Take a look at 5AEC, some of you fellows with 50-watt tubes.

3YO, Easton, Pa.

3YO is almost on the Atlantic coast, a terrific handicap when shooting at Australia, yet this is the station that was copied "all over the place" on several occasions. And it was done with a loud speaker at that. To be sure the receiving set used 5 tubes but the result was a signal that ran the operator out of the room, which isn't bad

at 9,000 miles, even for a good husky amateur station.

The antenna, for a change, is of the T type, 75 feet long, apparently quite high because the lead-in is 90 feet long. As usual there is a big healthy counterpoise 10 feet off the ground. The set uses two 250-watt UV-204 tubes in the Hartley circuit, the universal favorite for these big fellows. 3YO does not yet use a rectifier and filter but the situation is saved by the fact that the tubes are at least used "on both sides of the cycle".

Because the set is worked *below* the antenna fundamental the antenna current of 6 amps. is not what one would expect off hand, but any doubt as to the punch of 3YO can be nicely done away with by looking at "Calls Heard" for the last year and then turning to the "Brass Pounder's League" of which 3YO is a charter member. Mr. Parkes didn't seem to think it worth while to tell us where the station has been heard but it doesn't matter—except perhaps to a few folks in Central Asia who don't own 200 meter tuners.

S.K.

The New Amateur Regulations

How They Happened and What They Mean to Us Amateurs

ON June 28th new amateur regulations were signed by the Department of Commerce and issued in the form of General Letter No. 252 addressed to Supervisors of Radio and others concerned, thereby ending several months of watchful waiting on the part of the whole amateur fraternity. This article is more or less a continuation of the recent history of amateur regulation as outlined in our leading editorial for July, and the reader not familiar with the subject should consult that article for an understanding of what has gone before.

Let us first present the new regulations and then discuss them more in detail:

"General and Restricted Amateur Radio Station Licenses will be issued permitting the use of any type of transmitter (C.W., spark, A.C.C.W., I.C.W., unfiltered C.W., and phone) with the restriction that when using pure C.W. they are authorized to use wave lengths from 150 to 200 meters and when using spark, A.C.C.W., I.C.W., unfiltered C.W. and phone the wave lengths from 176 to 200 meters only can be used. The types of transmitters must be specified in the application and the license.

"Special Amateur Radio Station Licenses will be issued permitting the use of pure

continuous wave transmitters only, authorizing the use of wave lengths from 150 to 220 meters.

"For the purpose of application to amateur stations, pure C.W. is defined as follows: A system of telegraphing by continuous oscillations in which the power supply is substantially direct current as obtained from (1) a generator, (2) a battery, or (3) a rectifier with an adequate filter. (A filter is not deemed adequate if the supply modulation exceeds five percent.)

"General, Restricted and Special Amateur Stations are not permitted to use a transformer input exceeding one kilowatt, or equivalent of this power based upon watt input to plates if tubes are used. (Where input rating of tube is not specified by manufacturer, this rating will be considered as double the manufacturer's output rating.)

"On licenses issued for amateur stations you will include the following: 'This station is not licensed to transmit between the hours of 8:00 and 10:30 P.M., local standard time, nor Sunday mornings during local church services.'

"Special Amateur Stations must be operated by persons holding an extra first grade amateur operator's license, or a commercial first class operator's license, or a com-

mercial extra first class operator's license. Applicants must also meet the requirements of Regulation 63.

"A new class of amateur operator's license is hereby established, to be known as 'Amateur Extra First Grade.' Licenses of this grade will be issued to persons passing the required special examination with a percentage of at least seventy-five and code speed in sending and receiving at least twenty words a minute, five characters to the word; who have had at least two years' experience as a licensed radio operator; and who have not been penalized for violation of the radio laws subsequent to the date of these regulations."

Putting Them Into Force

Upon receipt of these new regulations the Supervisors are writing all general and restricted amateurs, enclosing a copy of the new rules, and requesting the return of the station license for amendment. This amendment takes the form of an endorsement extending the wave length range and specifying the quiet hours. The license is not cancelled and re-issued; it is amended but otherwise the same, with the same expiration date, and is then returned to the amateur.

The licenses of special stations are being cancelled and recalled, and new licenses will be issued under the new regulations.

The Wave Lengths

We got the wave lengths pretty much as we asked. The day of a definite specified wave length on an amateur license is gone—we have a band now, and under our new licenses it will be legal to change our operating wave as we desire, so long as we keep between the upper limit of 200 meters (220 for specials) and the lower limit of 150 meters for pure C.W. and 176 meters for other kinds of sending sets (modulated). This is a big accomplishment and opens the way for interesting developments in rapid wave-changing.

Last month we expressed the hope that we might get "blanket" licenses which covered any authorized amateur transmission. That proved to be wanting too much; the Department regards it as essential that the

applications and licenses specify the apparatus in use, and it is much to our interests to have it so, for often complaints, etc., are answered merely by consulting the file and noting the apparatus at certain stations. But even tho applications must specify the apparatus, there is no objection to an amateur possessing more than one transmitter or more than one type of emission, and the station license will specify the wave length limits of each type.

Special licenses are to be issued separately. If an amateur owning a modulated transmitter also has a pure C.W. set and qualifies as an extra-grade operator, he may get a special license for the C.W. set in addition to the general amateur station license. The special calls will continue to be "Z" calls, but the method

of assigning them will be changed so as to create a great many more calls beginning with Z without running into four letters.

It must be understood that the restrictions on the type of transmitter eligible for use under a special license must be strictly complied with. Nothing but substantially pure "D.C. C.W." has any place here. No station without a good filter can hope to qualify, even if the supply is from a generator.

In general the new wave length specifications make not the slightest difference

in the operation of the average station. Their chief effect is to say that nothing but pure C.W. shall go lower than 176 meters. Thus our shorter waves, which today we call our most valuable ones, are protected from the interference of modulated transmitters.

Our A.R.R.L. has had no success in its endeavor to convince the Department of the desirability of throwing open the waves below 150 meters for non-exclusive amateur use. We have again been assured, however, that experimental licenses to use these waves will be freely granted by the Department to all amateurs seriously interested in their use and development.

Power

The power input remains a kilowatt, whether spark or tube is used. The intent

Daylight Transcons!!!

The A.R.R.L. brass pounding amateurs have challenged daylight and Father Time to a return engagement at relaying messages across the country between sunrise and sunset. The challenge has been accepted and the date is **Sunday, September 23rd**. Messages will start with the rise of the sun and must reach their destination before the sun sets. There will be enough messages to give every transmitting amateur a chance to put in some good ticks. Let's take this opportunity to establish good training quarters, get our stations in the pink of condition, have our logs all set, and be prepared to go at the sound of the gong. Further details in next QST.

F. H. S.

of this paragraph is also to make it contrary to regulations to use a tube or tubes the total *rated* input of which exceeds one kilowatt; and, in the case of our American tubes rated on output, this means that the combined *rated output* of our tubes should not exceed 500 watts. What we actually get out of them by efficiencies greater than 50% or by crowding them is immaterial to the Department as long as we do not exceed 1000 watts input.

The newer special station licenses recently issued have contained a power limitation of "500 watts in the antenna." This will be changed as the licenses are re-issued to read "an input to the oscillator of 1000 watts."

"Amateur Extra First Grade"

A new series of questions for the examination of applicants for the Amateur Extra First Grade Operator's License has been prepared and forwarded to the Supervisors, as has a supply of the new license form. The latter is similar to the Commercial Extra First Class license in form, printed on pink paper. The arrangements for this class of license, as a prerequisite to the acquisition of a special station license for a pure C.W. sender, are altogether in accord with A.R.R.L. recommendations. It should be noted that the possession of a commercial first class operator's license or higher is likewise satisfactory evidence of the required proficiency.

Quiet Hours

Now we come to the part that to some of us will not be as pleasant—quiet hours prescribed by endorsement on our licenses. We made our case as plainly and as reasonably as we could, to the Department of Commerce, but it was their judgment that the quiet hours were a necessary thing—and necessary even in our own protection. Our voluntary quiet hours have helped by greatly reducing interference, but all of us know that there were many amateurs who did not respect them and in considerable measure we have failed to accomplish our announced object of demonstrating fairness to the broadcast-listener by preserving quiet for him during the evening hours. The Bureau accordingly felt that it was necessary to make the quiet hours a matter of regulation, to be enforced on all stations operating below 220 meters. And really we do not know why any of us should feel badly about the matter, for it has many advantages for us. Those of us who have been observing the quiet hours voluntarily should not find it particularly distasteful to continue doing so under regu-

lation, and those who won't do it voluntarily can stand a little regulation. We are thankful for a uniform policy, applying to all amateur, technical and training-school stations alike. We are glad that the distasteful creation of classes is avoided by the abandonment of the original plan to prescribe quiet hours only on the licenses of new amateurs. We have felt that it would be great to see co-operation required of those in our midst who have kept hammering away during the hours of the "Voluntary Lid," and it must be said of those fellows today that they are the ones who have made it necessary for quiet to be made a matter of regulation.

The general position of the amateur is strengthened in critical localities, too, by this regulation. It amounts to a definition of what shall constitute amateur co-operation with the broadcast listener, made by the Department of Commerce. We know that it will be incumbent upon us to preserve quiet during those hours; similarly we know that when that period is passed our duty is done and we may open up freely. And the Department and every Supervisor will be right behind us, too, for has not the government decided what shall be a fair distribution of the hours?

The extension of the operating period to 8:00 P.M. standard time is a welcome feature, particularly to the thousands of younger fellows who can not stay up to all hours. That makes it possible to get off lots of traffic before the QRX period.

In appreciation of the successful operating of the Revised Pacific Plan, the Department is advising the Supervisors of the 6th and 7th Districts that the quiet hours provided under that plan, 7:30 to 10 P.M., may be observed in those districts instead of 8:00 to 10:30 P.M., until the expiration of that agreement in October. After that time the Department will expect the Coast to fit in with the rest of the country by building its plans around the new regulation.

The western amateurs should feel complimented that the Pacific Plan was the only co-operative scheme so recognized by the Department of Commerce.

It's a big relief to have something definite, to have the elimination of uncertainties and personal interpretations, and to have a plan which is uniform in its application to all of us. Let us all pull together to adapt ourselves to the new regulations as quickly and as efficiently as possible. There are some suggestions in the editorial column this month.

K.B.W.

The Departure of "WNP"

THERE was an impressive scene enacted in the beautiful little village of Wiscasset, Maine, on the afternoon of June 23d when the "Bowdoin," the tight little schooner of the MacMillan Arctic Expedition, threw off her moorings and sailed down the Sheepscot on the start of her fourteen-months trip to Ellesmere Land. Several thousand people had gathered to see her off and for days the little town had buzzed with excitement. The night before the sailing impressive testimonials had been offered Dr. MacMillan and his men at an open meeting on the village green and on the afternoon of sailing many notables were present to pay their respects and wish the little party godspeed and a safe return. Among the speakers was Hiram Percy Maxim, president of the A.R.R.L., for our League is playing an important part in this expedition, as was told in detail in last month's *QST*. At five o'clock Capt. MacMillan assembled his men and went aboard and amid the screeching of whistles and the waving of handkerchiefs, the "Bowdoin" shoved off.

She did not go far that night, only down to Boothbay Harbor, for things had to be made ship-shape and the compass adjusted before heading for the open sea. But on the following Monday she was off and on Friday reached Sydney, Nova Scotia, where she refueled and passed the Canadian customs. That is the latest at this writing.

While at her dock in Maine the radio set gave a good account of itself and already WNP is a familiar call in the amateur world. Stations as far away as Arkansas were worked, which is excellent considering the weather and the fact that her location was none too favorable. A few nights before sailing a 500-word news story was given to 2OM thru terrific static. A temporary receiving station erected on the dock at Wiscasset by the Traffic Mana-

ger and the Editor got the first messages from WNP after sailing—thanks and good-byes to the people of Wiscasset—but the first real communication was to 1CKP, who that night got a message thanking Mr. Pinney of that station for a gift of silverware to the crew. To Vermilya of 1ZE, first amateur in the U.S.A., goes the honor of receiving the first N.A.N.A. news despatch, which appeared in the June 27th edition of the newspapers having that service. Then the operator, who is Don Mix, lately of 1TS, Bristol, Conn., announced that he would be off the air until reaching Sydney, because the ship was under sail instead of power and the transmitter cannot be used while sailing. A brush with

VCO, the Dominion Government station at Sydney, prevented the use of the set in that port as contemplated, and it was not until she had cleared Sydney that the "Bowdoin" was again heard from.

Interesting international amateur possibilities are opened up by this expedition, on which our A. R. R. L. is so fortunate as to have an operator. The objective of the party, in

79° N. latitude and 79° W. longitude, is a point sufficiently far away to give amateurs all over the country a practically even chance of working WNP. Not only that, but the distance from WNP to England and France is no greater than to an average point in the United States, and that means that European amateurs are going to have the same chance at him that we of the U. S. and Canada will have. Yet more important is the fact that WNP's distance to either continent is less than that from here to Europe and, who knows, perhaps we'll have an international relay this fall with WNP as the intermediate relay!

All hands who have not seen and studied the story of this expedition in July *QST*

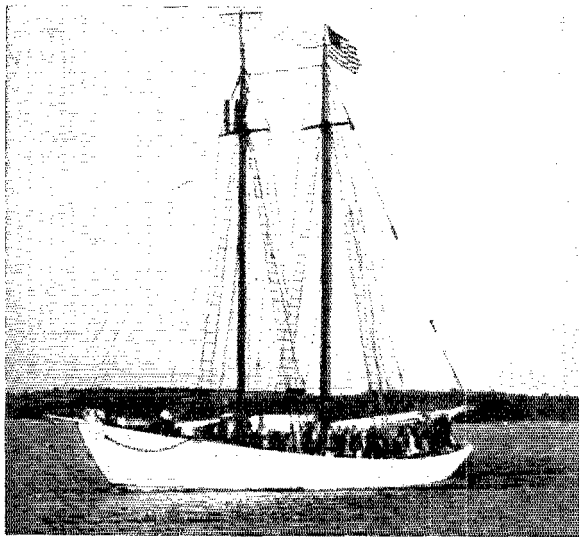

are advised to get a copy and read up.* Our A.R.R.L. is being depended upon to keep the MacMillan party QSO civilization, and to copy each week a coded 500-word news-story for the North American Newspaper Alliance and deliver it to the nearest member thereof. Full particulars were given in that article. WNP will be on the air for amateur two-way communication

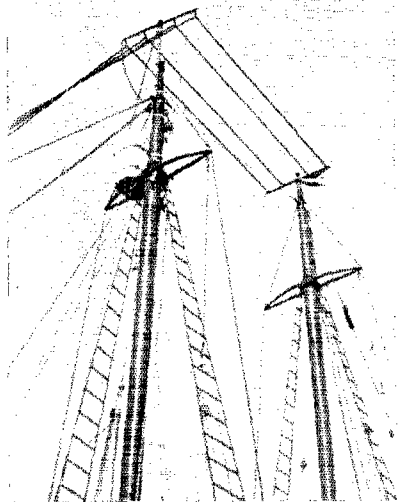

THE BOWDOIN'S AERIAL ISN'T VERY BIG. The little four-wire flat-top is but 23 ft. long, but it's about 70 ft. above the water. From the spreader on the foremost the antenna slants down towards the bowsprit, coming to a 3-ft. spreader from which the lead-in drops directly to the operating table in the peak of the forecabin.

*Can be obtained from the QST Circulation Dept. at the regular price.

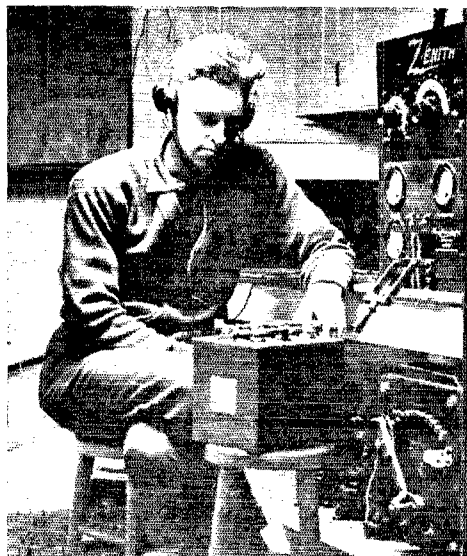

MIX AND "WNP." Heaven only knows what he was hearing on this storage batt. but that's the way the movie folks wanted him to pose, and it's the only inside photo we could secure. Starting box in the right foreground, motor-generator under the table.

each night from midnight to 2:00 A.M. Central Standard Time, and again from 4:00 A.M. to 6:00 A.M. C.S.T. Regular wave length, 220 meters; other waves, 185 and 300 meters; 500-cycle I.C.W.; 6 amperes in the aerial. All amateurs hearing WNP are requested to send a complete report to A.R.R.L. Headquarters. Monthly reports of communication will be published in QST.
K.B.W.

A Chance to Have Your Tube Troubles Unsnarled

MR. J. C. WARNER of the Research Laboratory of the General Electric Company has indicated his willingness to write for QST an article on the new receiving tubes, but has suggested that the nature of the article be left entirely to the members of the American Radio Relay League, in order that the article may cover the points which are of the greatest interest to the amateurs.

Our members are asked to send to the Technical Editor questions relating to receiving tubes, the best conditions for operation, the uses for which each tube is suited, in fact anything that relates to the tube itself. These questions will be

forwarded to the General Electric Company and will be used as a basis for the article. The G. E. Co. cannot answer these questions individually but will attempt to give in the article all information asked for.

In order to secure early publication it is important that all questions be sent in to arrive at Hartford not later than August 23d, allowing 6 days for letters from the West Coast.

Questions should in no case be sent to the General Electric Company, but only to the Technical Editor of QST.

The Rules

No attention will be paid to questions that are not in accordance with these rules:

1—The letter must be addressed—“Technical Editor QST, American Radio Relay League, Hartford, Connecticut. Tube Questions.”

2—Letters must arrive at the A.R.R.L. office before August 23d; allow 6 days from the West Coast.

3—When referring to a circuit give the diagram and indicate the sizes of con-

densers, also the sizes and turns of coils. It is not possible to guess what you mean by a “Smith circuit” or a “standard regenerative circuit.” This should not be taken to mean that questions as to circuits and sets are to be submitted, but only questions relating to performance of tubes in certain circuits, and that in asking such questions the circuit should be given.

Electric Filters --- Part II †

By F. S. Dettenbaugh*

In the July issue of QST Professor Dellenbaugh explained what filters are and how they work. In this installment we are told how to design filter circuits and filter chokes. The author has simplified this so that nothing but ordinary arithmetic is needed. If any part of the process is not perfectly clear the editors of QST will be glad to help out, providing detailed information is given as to the conditions under which the filter must work.—Technical Editor.

Review

Before beginning on the design of filters it is well to recall what has been said about them in the first part of this article. Electric Filters are special arrangements of inductances and capacities which *pass* some frequencies of electrical current and stop (*cut off*) other frequencies. There are several types of filters. The first type, which is the most commonly used, is called a Low Pass filter because it passes low frequency alternating current (and direct current) but cuts off high frequency alternating currents. Such a filter can be used to separate two frequencies of alternating current or to remove alternating currents from the output of a rectifier so as to leave direct current only. The second type is the High Pass filter which will pass high frequency currents but cut off everything below a certain point. The third type is called a Band Pass filter because it will pass a band of frequencies but cut off everything *both above and below* that band. Finally there is the Band Elimination filter that will cut out a narrow band but let everything else through.

The point at which a high-pass or low-pass filter begins to cut off is known as the *cut-off point* and the design consists of calculating the inductances and condensers needed to locate this cut-off at the desired frequency. The frequency at which cut-off begins or the “cut-off frequency” is usually referred to as f_c . In the case of band-pass and band-elimination filters we are interested in the *two* frequencies, at one of which filtering begins and at the other of which it stops. These are usually called

f_1 and f_2 . Finally, in almost all filters there is a frequency at which we get “maximum attenuation”; in other words, the best filtering effect. This frequency is called the frequency of maximum attenuation and is indicated by a small f followed by the “infinity” symbol (like a figure 8 lying on its side.)

The design of a filter consists of determining the capacities and inductances that must be used to locate the cut-off and the maximum attenuation where they are wanted, and in deciding how many sections the filter must have to make the cut-offs sharp enough.

Filter Design

While the complete calculation of filter circuits requires a certain amount of mathematics, the results can be tabulated so that the main features of design are easily determined. This has been done in the Design Chart shown in this article.

Use of the Design Chart

In the first two columns of the chart are given diagrams of T and “ π ” section filters. At first sight these seem to be the same but a closer look will show that the diagrams each indicate two sections and as a result the T diagrams have two shunt parts and three similar series parts while the “ π ” filters have only two series parts but three shunt parts. It will be remembered that the first part of the article stated that for most ordinary uses the T sections are better.

The figures under the heading “Characteristics” are not to scale, and are merely intended to show the *type* of results to be expected. Those under “Attenuation” show the fashion in which the current is reduced or attenuated before reaching the load, the black part being the part that is cut out by the filter. The frequency increases from zero at the left to infinity at the right while the attenuation is zero at

†Some of the filter calculations in the second part of this article are from the course in electrical transmission given in the past two years at Cruft Laboratory, Harvard University, by members of the engineering department of the Western Electric Company.

*Department of Electrical Engineering, Massachusetts Institute of Technology.

| NO. | TYPE | TWO SECTION CIRCUIT, T & π | | CHARACTERISTICS | | CONSTANTS FROM CUT OFF | | | | EQUIVALENT |
|------|------------|---|---|------------------------------------|---------------------------|--|--|--|--|--|
| | | T SECTIONS | π SECTIONS | ATTENUATION | TRANSMISSION | L_1 | L_2 | C_1 | C_2 | SYMBOLS |
| 1-3 | LOW PASS | | | | | $\frac{2Z_0}{\omega_0} = L_0$ | — | — | $\frac{1}{\omega_0 Z_0} = C_0$ | $b = \frac{2\sqrt{1-\alpha^2}}{\alpha}$ $d = \frac{1}{2\alpha\sqrt{1-\alpha^2}}$ |
| | | | | | | bL_0 | dL_0 | — | bc_0 | $\omega = 2\pi f$ $\omega_0 = 2\pi f_0$ $\beta = \omega/\omega_0$ |
| | | | | | | bL_0 | — | dC_0 | bc_0 | $\beta = 4\pi f/f_0$ $p = f_0/f_m$ $q = f_0/f_c$ |
| | | THE ATTENUATION APPROX: $\frac{2\beta C_0}{C_0}$ | PER SECTION OF ABOVE FILTERS IS WHERE $Q = \frac{\omega_0}{\Delta\omega}$ | | | | | | | $Z = \text{Load Resistance}$ |
| 4-6 | HIGH PASS | | | | | — | $\frac{2Z_0}{2\omega_0} = L_0'$ | $\frac{1}{2\omega_0 Z_0} = C_0'$ | — | $\alpha = \frac{f}{f_m}$ $\beta = \frac{f}{f_c}$ $\Delta = f_c - f_0$ $\nabla = f_0 + f_c$ |
| | | | | | | — | $\frac{L_0}{b}$ | $\frac{C_0}{b}$ | $\frac{C_0}{d}$ | $\Delta = f_c' - f_0'$ $\nabla = f_0' + f_c'$ |
| | | | | | | $\frac{L_0}{d}$ | $\frac{L_0}{b}$ | $\frac{C_0}{b}$ | — | $m_1 = \sqrt{1 - \frac{(b/f_0)^2 - 1}{(b/f_c)^2 - 1}}$ $m_2 = \sqrt{1 - \frac{(b/f_0)^2 - 1}{(b/f_c)^2 - 1}}$ |
| | | THE ATTENUATION PER SECTION OF ABOVE FILTERS IS APPROX: $\frac{2\beta C_0'}{C_0'}$ | WHERE $Q = \frac{\omega_0}{\Delta\omega}$ & β FAR FROM f_0 | | | | | | | |
| 7-15 | BAND PASS | | | | | $\frac{\Delta Z_0 m_1}{\pi f_0^2 (1-m_1^2) \Delta}$ | $\frac{\Delta Z_0'}{4\pi f_0^2 m_1}$ | $\frac{1-m_1^2}{4\pi f_0 m_1 Z_0}$ | $\frac{m_1}{\pi \Delta Z_0'}$ | |
| | | SAME | SAME | | | $\frac{\Delta Z_0' 4m_2}{\pi (1-m_2^2)}$ | $\frac{\Delta Z_0'}{\pi m_2}$ | $\frac{\nabla + f_0(1-m_2^2)}{4\pi f_0 m_2 Z_0}$ | $\frac{f_0 m_2}{\pi f_0 \Delta Z_0'}$ | |
| | | | | | | $\frac{m_1 Z_0}{\pi \Delta}$ | $\frac{(1-m_1^2) Z_0}{4\pi m_1 \Delta}$ | $\frac{\Delta}{4\pi m_1^2 Z_0}$ | $\frac{m_1 \Delta}{\pi f_0^2 (1-m_1^2) Z_0}$ | |
| | | SAME | SAME | | | $\frac{f_0 m_2 Z_0}{\pi f_0 \Delta}$ | $\frac{(f_0^2 - f_0 m_2^2) Z_0}{\pi \Delta m_2}$ | $\frac{\Delta}{\pi m_2 Z_0}$ | $\frac{4m_2 \Delta}{\pi (1-m_2^2) Z_0}$ | |
| | | | | | | $\frac{Z_0}{\pi f_0} = \frac{Z_0'}{\pi \Delta}$ | $\frac{\Delta Z_0' \Delta Z_0'}{\pi f_0^2 \Delta \beta}$ | — | $\frac{f_0}{\pi \Delta Z_0' \pi \Delta Z_0}$ | |
| | | | | | | $\frac{Z_0}{\pi \Delta} = \frac{f_0 Z_0'}{\pi \Delta}$ | — | $\frac{\Delta - \Delta Z_0}{2\beta f_0 \pi f_0 Z_0}$ | $\frac{1}{\pi \nabla Z_0 \pi f_0 Z_0}$ | |
| | | | | | | $\frac{Z_0}{\pi \Delta}$ | $\frac{\Delta Z_0}{\pi}$ | $\frac{\Delta}{\pi Z_0}$ | $\frac{1}{\pi \Delta Z_0}$ | |
| 16 | BAND ELIM. | | | | | — | $\frac{\Delta Z_0 - \Delta Z_0'}{\pi f_0}$ | $\frac{1}{4\pi f_0 \pi f_0 Z_0}$ | $\frac{f_0}{\pi \Delta Z_0 \pi \Delta Z_0}$ | |
| | | | | | | $\frac{\Delta Z_0}{\pi \Delta}$ | $\frac{\nabla Z_0}{\pi}$ | $\frac{Z_0}{\pi Z_0}$ | $\frac{\Delta - \Delta Z_0}{\pi f_0 Z_0}$ | |
| | | IN FILTERS #11,12,14 & 16 ATTEN PER SECTION AT $f_m = 2f_0/\sqrt{p}$ WHEN $\beta/\omega = 0.4$ TO 0.6 | | IN #13 ATTEN AT $f_m = 2/Q(p-1/2)$ | | $Q = \frac{\omega_0}{\Delta\omega}$ | | | | |
| | | | | $4\Delta Z_0$ | $\frac{Z_0}{4\pi \Delta}$ | $\frac{1}{4\pi \Delta Z_0}$ | $\frac{4\Delta}{\pi Z_0}$ | | | |

Filter Design Chart

the bottom and infinite at the top. The curves under "Transmission" are merely reciprocals of the others and indicate the manner in which current is passed, the black part being the part that goes thru to the load. The top of the curves repre-

sents 100% transmission while the bottom represents no transmission at all. It will be noticed that some types of filters have very sharp cut-offs but that beyond the point of maximum attenuation the current passed increases. Others cut-off more

gradually but continue to become poorer and poorer transmitters (in other words, better and better filters.—Ed.) as the frequency gets farther and farther from the cut-off value. This is a very useful difference. The first type is excellent for eliminating a single frequency but the latter is better for eliminating a whole series of frequencies.*

In building a new filter the formulas under the heading "Constants from Cut-Off" are used, as they give the values of inductance and capacity needed to give any desired combination of cut-off frequencies and frequencies of maximum attenuation. In using them the resistance of the load should be substituted for Z_0 and Z_c . The formulas are simplified by the use of symbols equivalent to expressions that occur in several of the formulas. The meaning of these symbols is given in the next column, headed "Equivalent Symbols." When using a formula that contains b , x , ω , m , and the like, take from the column "Equivalent Symbols" the combination corresponding to the letter appearing in the formula and substitute the combination into the formula.

Definitions of Symbols Used Frequently

Z_0 & Z_c = "Characteristic Impedance." Use load resistance when calculating a filter from the formula.

$\omega_0, \omega_1, \omega_2$, etc. = $2\pi f$, using the cut-off frequency, the first band-limiting frequency, etc., as the subscripts following ω may indicate.

f_c = the cut-off frequency at which a low-pass or high-pass filter starts to operate.

f_m = the frequency at the center of the band (for a band-pass or band elimination filter.)

f_1 = the frequency at one edge of the band passed by a band-pass filter, or at one edge of the band cut out by a band-elimination filter.

f_2 = the frequency at the other edge of the band for the above cases.

f_{int} = the frequency of "maximum attenuation" at which the filter does its best work, usually adjusted to fall on the frequency that must be gotten rid of. (This is usually written with the f followed by the 'infinity' symbol which looks like an 8 lying on its side but the symbol cannot be used here for lack of proper type. It appears in the design chart, however.)

L_0 and C_0 are the inductance and capacity calculated from the L and C formulas given for the first low-pass filter. They are used repeatedly in later formulas, after being multiplied by some one of the "Equivalent Symbols" such as a and b .

Example of Filter Design

Let us design a filter that is to work with a load of 894 ohms and is to have a cut-off

frequency of 1414 cycles. If we decide to use the first formula this will mean that the series choke coil in the middle section of the filter will be—

$$L_1 = \frac{2Z_0}{\omega_c} = \frac{2(894)}{2\pi(1414)} = \frac{1788}{8940} = 0.2 \text{ henrys}$$

The diagram in the design chart shows that the choke coils at the end of the filter would be $\frac{1}{2}$ of this or 0.1 henry each. The condenser for the filter is found from the formula in the table (under C_2) to be—

$$C = \frac{2}{\omega_c Z_c} = \frac{2}{2\pi(1414)(894)} = \frac{.25}{1,000,000} \text{ farads}$$

or 0.25 microfarads.

The finished filter is shown in Fig. 16. This is the same filter that was shown in Part 1 of the article where curves are given showing that that filter does what is expected of it.

Now let us suppose that we wish to pass all frequencies below 1414 cycles as before but that we especially desire to eliminate 1485 cycles as completely as possible. This cannot be done with the filter of No. 1 (of the Design Chart) unless a very large number of sections is used, so a filter of the sort shown in No. 2 or No. 3 is better. Either one has a very high attenuation near the cut-off but there is some choice between them depending on the power supply. No. 2 obtains its point of greatest attenuation by means of a series-resonant circuit across the line and this will become almost a short-circuit on the power supply at the resonant frequency, which is not wise, at least not with constant voltage supply which is the common condition. No. 3 depends on parallel resonant circuits in series with the line to obtain maximum attenuation and therefore will draw less power from the source, and for constant voltage this type is better. Turning to the design formulas we get the results below:

$$a = \frac{f_{int}}{f_c} = \frac{1485}{1414} = 1.05$$

$$b = \frac{\sqrt{a^2 - 1}}{a} = \frac{.305}{1} = .305$$

$$d = \frac{1}{4a\sqrt{a^2 - 1}} = \frac{1}{4(1.05)(.305)} = .744$$

- $L_1 = b L_0 = .305 (.2) = 0.061 \text{ henrys}$
- $C_1 = d C_0 = .744 (.25) = 0.186 \text{ microfarads}$
- $C_2 = b C_0 = .305 (.25) = 0.076 \text{ microfarads}$

A single T section of this filter would have two series parts, each consisting of $\frac{1}{2} L_1$ or a .03 henry choke, shunted by $2C_1$ or .372 microfarads. These series parts would be connected on each side of a shunt branch of C_2 or .076 microfarads. The total

*See the section on "Amateur Filter Problems."

capacity required for this filter is a little larger than before but the inductance is less. The values are correct for the load given only. If the load is changed much it will be necessary to change both L and

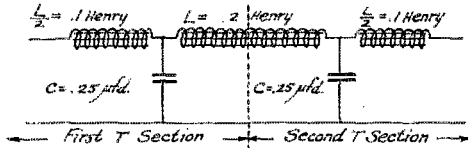

FIG. 16 LOW PASS FILTER WITH TWO T SECTIONS DESIGNED FROM THE CHART TO CUT OFF AT 1414 ~

C.* This particular filter is not as good as the first one for higher frequencies, and at 2100 cycles reduces the current only one-half, while the No. 1 filter at 2100 cycles reduces the current to 9/100 and gets still better at higher frequencies. Another section will reduce in about the same proportion, or at 2100 cycles to about 8/1000. A combination of these two types will reduce everything above 1414 cycles and also take out very thoroly the especially bothersome frequency at 1485 cycles.

The 1485-cycle frequency could be taken care of by a single section of the No. 3 filter, as a very great impedance is secured at the resonant frequency.

In this same way filters of any general characteristics can be built up. In most cases there is a choice of two filters, one having very low impedance at the frequency of maximum attenuation and the other having very high impedance at that frequency. Usually this can be estimated by inspecting the circuit and remembering the actions of parallel and series resonant circuits as previously explained. The choice depends on the nature of the load (demanding constant current or constant voltage) and the nature of the power supply (constant voltage or constant current). In the band filters No. 9 and No. 10 or No. 11 and No. 12, the maximum attenuation can be made to appear at either side of the band, depending on the relation of the shunt and series impedances. In general the ratio of the frequency of maximum attenuation to the cut-off frequency should be about 1.1. It is a good plan to terminate a long filter in a section of type No. 3, No. 6 or No. 7, to reduce distortion.

It is possible to design filters that operate with almost any desired degree of perfection. The extent to which the filter system is lengthened depends on the goodness of the filtering that must be obtained, the time and money that may be expended, and the filter-losses that can be tolerated.

Combining Sections

Some explanation as to combining filter

*Not very important for rectified alternating current.

sections may be worth while. As was mentioned in the first part of this article a single T section looks like Fig. 17a. Naturally two sections in series look like Fig. 17b but the mistake must not be made of attempting to use in the center portion of the filter a choke coil that is only as large as one of the end ones. This center choke is the result of combining the chokes of two sections and it must either consist of two chokes of which each has the value $L_1/2$ or if a single choke is used it must have the value L_1 as shown in Fig. 17c. This is a general rule that applies to all T section filters—the end choke is always $\frac{1}{2}$ as large as the others. A three-section T filter will look like Fig. 17d.

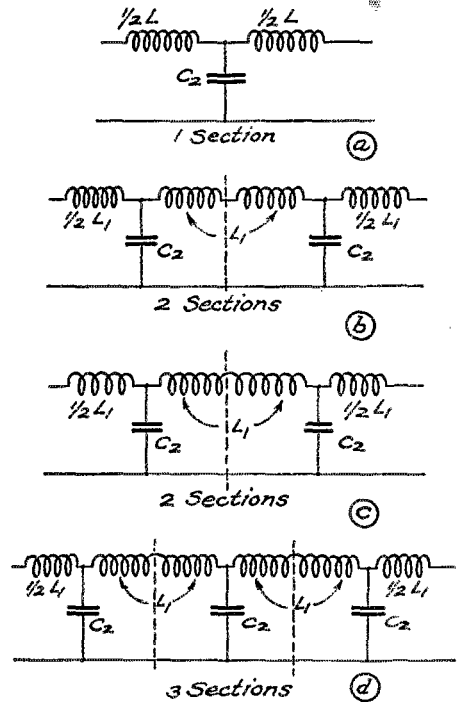

FIG. 17 HOW TO COMBINE T SECTIONS

The same sort of reasoning applies to "π" section filters except that here it is the condensers which change in size.

A composite filter is one that uses both T and "π" sections. Such a filter is shown in Fig. 18 and it can be seen that the precautions noted above have been observed.

Iron Core Chokes

The choke coil designs given in this article are based on calculations that cannot be repeated here on account of lack of space. The design of both the windings and the core is quite conservative and overloads can be carried.

DESIGN DATA FOR INDUCTANCE COILS WITH IRON CORES. *Weight of Steel Taken as 480 $\frac{lbs}{cu. ft.} = 0.28$ pounds per cubic inch*

| CORE SIZE Cross Section | INDUCTANCE HENRYS | EQUIV. GAP (G) | *ACTUAL GAP Decimals | GAP Nearest Fraction | NO TURNS (N) | FLUX DENS. (B) | WINDING FORM | | MEAN TURN inches | FEET OF WIRE | RESISTANCE (D.C.) | WEIGHT OF COPPER | CORE DIMENSIONS | | POUNDS STEEL |
|----------------------------|----------------------|-------------------|-------------------------|-------------------------|-----------------|-------------------|--------------|-------|---------------------|--------------|----------------------|------------------|-----------------|-------------|-----------------|
| | | | | | | | b | c | | | | | Long Piece | Short Piece | |
| 1/2 x 1/2 | 0.5 | .040" | .017" | 1/64" | 1600 | 6500 | 0.42" | 0.28" | 3.0 | 4.00 | 82.5 | 1.002 | 1/2 x 1.6 | 1/2 x .50 | 0.30 |
| | 1.0 | .041 | .019 | 1/64" | 2300 | 9000 | 0.50 | 0.33 | 3.2 | 6.15 | 127.0 | 1.5 " | 1/2 x 1.7 | 1/2 x .55 | 0.31 |
| | 5.0 | .043 | .023 | 1/32" | 5200 | 20000 | 0.75 | 0.50 | 3.8 | 1670 | 345.0 | 4.0 " | 1/2 x 1.92 | 1/2 x .75 | 0.37 |
| | 10.0 | .046 | .030 | 1/32" | 7600 | 27000 | 0.90 | 0.60 | 4.2 | 2640 | 545.0 | 6.5 " | 1/2 x 2.1 | 1/2 x .85 | 0.41 |
| | 15.0 | .048 | .035 | 1/32" | 9500 | 32000 | 1.00 | 0.68 | 4.5 | 3510 | 725.0 | 8.5 " | 1/2 x 2.2 | 1/2 x .85 | 0.43 |
| 3/4 x 3/4 | 5.0 | .043" | .023 | 1/32" | 3500 | 13000 | 0.62" | 0.42" | 4.3 | 1310 | 271 | 3.25oz | 3/4 x 2.4 | 3/4 x .75 | 1.0 |
| | 10.0 | .046 | .030 | 1/32" | 5000 | 18000 | 0.73 | 0.49 | 4.75 | 2000 | 411 | 5.0 " | 3/4 x 2.5 | 3/4 x .75 | 1.0 |
| | 15.0 | .048 | .035 | 1/32" | 6300 | 21000 | 0.82 | 0.55 | 5.0 | 2630 | 544 | 6.5 " | 3/4 x 2.6 | 3/4 x .75 | 1.05 |
| | 20.0 | .052 | .044 | 3/64" | 7600 | 24000 | 0.91 | 0.60 | 5.2 | 3280 | 678 | 8.0 " | 3/4 x 2.7 | 3/4 x .85 | 1.1 |
| | 50.0 | .070 | .100 | 7/64" | 14000 | 33000 | 1.25 | 0.83 | 6.0 | 7000 | 1445 | 18.1 " | 3/4 x 3.0 | 3/4 x 1.0 | 1.25 |
| 1 x 1 | 10.0 | .046" | .030 | 1/32" | 3800 | 14000 | 0.64" | 0.43" | 5.8 | 1760 | 364 | 4.55oz | 1 x 3.0 | 1 x .75 | 2.1 |
| | 15.0 | .048 | .035 | 1/32" | 4800 | 16000 | 0.69 | 0.49 | 5.8 | 2310 | 478 | 5.5 " | 1 x 3.0 | 1 x .75 | 2.1 |
| | 20.0 | .052 | .044 | 3/64" | 5700 | 18000 | 0.78 | 0.52 | 5.9 | 2800 | 580 | 6.75 " | 1 x 3.1 | 1 x .75 | 2.2 |
| | 50.0 | .070 | .100 | 7/64" | 11000 | 25000 | 1.10 | 0.75 | 6.7 | 6130 | 1270 | 15.0 " | 1 x 3.5 | 1 x 1.0 | 2.5 |
| | 100.0 | .100 | .250 | 1/4" | 18000 | 29000 | 1.40 | 0.93 | 7.4 | 11000 | 2280 | 18.10 " | 1 x 3.8 | 1 x 1.1 | 2.75 |
| 2 x 2 | 100.0 | .100" | .250 | 1/4" | 8900 | 14000 | 0.97" | 0.65" | 10.4 | 7700 | 1590 | 18.3oz | 2 x 5.5 | 2 x 1.0 | 14.5 |
| 1/2 x 1/2 | 0.5 | .040" | .017 | 1/64" | 1600 | 13000 | 0.55" | 0.38" | 3.4 | 4.50 | 46 | 2.202 | 1/2 x 1.6 | 1/2 x .63 | 0.31 |
| | 1.0 | .041 | .019 | 1/64" | 2300 | 18000 | 0.66 | 0.45 | 3.6 | 700 | 72 | 3.5 " | 1/2 x 1.75 | 1/2 x .70 | 0.35 |
| | 5.0 | .043 | .023 | 1/32" | 5200 | 39000 | 1.00 | 0.68 | 4.5 | 1950 | 200 | 9.5 " | 1/2 x 2.10 | 1/2 x .95 | 0.43 |
| | 1.0 | .041" | .019 | 1/64" | 1500 | 12000 | 0.53" | 0.37" | 4.3 | 540 | 56 | 2.702 | 3/4 x 2.10 | 3/4 x .63 | 0.87 |
| | 5.0 | .043 | .023 | 1/32" | 3500 | 26000 | 0.83 | 0.56 | 5.0 | 1470 | 151 | 7.2 " | 3/4 x 2.5 | 3/4 x .80 | 1.05 |
| 10.0 | .046 | .030 | 1/32" | 5000 | 35000 | 1.00 | 0.67 | 5.4 | 2250 | 230 | 11.0 " | 3/4 x 2.6 | 3/4 x .95 | 1.12 | |
| 1 x 1 | 5.0 | .043" | .023 | 1/32" | 2600 | 20000 | 0.71" | 0.49" | 5.8 | 1250 | 130 | 6.102 | 1 x 2.8 | 1 x .75 | 2.0 |
| | 10.0 | .046 | .030 | 1/32" | 3800 | 27000 | 0.86 | 0.58 | 6.1 | 1940 | 200 | 9.5 " | 1 x 3.0 | 1 x .85 | 2.2 |
| | 15.0 | .048 | .035 | 1/32" | 4800 | 32000 | 0.96 | 0.65 | 6.4 | 2550 | 260 | 12.5 " | 1 x 3.1 | 1 x .90 | 2.25 |
| | 10.0 | .046" | .030 | 1/32" | 1900 | 13000 | 0.60" | 0.42" | 5.5 | 1500 | 160 | 7.502 | 2 x 4.66 | 2 x 0.60 | 11.5 |
| | 15.0 | .048 | .035 | 1/32" | 2400 | 16000 | 0.68 | 0.46 | 5.7 | 1900 | 200 | 9.5 " | 2 x 4.75 | 2 x 0.66 | 12.3 |
| 20.0 | .052 | .044 | 3/64" | 2900 | 18000 | 0.75 | 0.51 | 5.8 | 2400 | 250 | 11.5 " | 2 x 4.85 | 2 x 0.75 | 12.5 | |
| 50.0 | .070 | .100 | 7/64" | 5900 | 24000 | 1.00 | 0.70 | 10.5 | 4600 | 480 | 18.65 " | 2 x 5.50 | 2 x 0.95 | 14.0 | |
| 100.0 | .100 | .250 | 1/4" | 8900 | 28000 | 1.33 | 0.90 | 11.2 | 8300 | 860 | 28.0 " | 2 x 5.90 | 2 x 1.15 | 16.0 | |
| 1/2 x 1/2 | 0.5 | .040" | .017 | 1/64" | 1600 | 32000 | 0.90" | 0.60" | 4.2 | 550 | 22.5 | 7.02 | 1/2 x 2 | 1/2 x .85 | 0.40 |
| | 1.0 | .082 | .120 | 1/8" | 3200 | 32000 | 1.30 | 0.85 | 5.1 | 1350 | 55 | 18.1 " | 1/2 x 2.5 | 1/2 x 1.10 | 0.50 |
| | 0.5 | .040" | .017 | 1/64" | 1000 | 21000 | 0.72" | 0.46" | 4.7 | 390 | 16 | 5.02 | 3/4 x 2.3 | 3/4 x .71 | 0.96 |
| | 1.0 | .041 | .019 | 1/64" | 1500 | 30000 | 0.90 | 0.58 | 5.1 | 640 | 26 | 8 " | 3/4 x 2.5 | 3/4 x .83 | 1.05 |
| | 1.0 | .041" | .019 | 1/64" | 1100 | 22000 | 0.75" | 0.50" | 5.8 | 530 | 22 | 6.552 | 1 x 2.9 | 1 x .75 | 2.10 |
| 5.0 | .086 | .170 | 1/64" | 3700 | 35000 | 1.40 | 0.92 | 7.3 | 2260 | 92 | 18.12 " | 1 x 3.6 | 1 x 1.20 | 2.7 | |
| 2 x 2 | 5.0 | .043" | .023 | 1/32" | 1300 | 23000 | 0.82" | 0.53" | 9.7 | 1050 | 43 | 13oz | 2 x 4.9 | 2 x 0.80 | 12.1 |
| | 10.0 | .050 | .040 | 1/64" | 2000 | 32000 | 1.05 | 0.68 | 10.5 | 1750 | 71 | 18.6 " | 2 x 5.2 | 2 x 1.0 | 13.8 |
| | 15.0 | .096 | .200 | 1/64" | 3300 | 28000 | 1.35 | 0.86 | 11.1 | 3060 | 125 | 21.6 " | 2 x 5.5 | 2 x 1.1 | 14.7 |
| | 20.0 | .104 | .280 | 3/32" | 4000 | 32000 | 1.43 | 0.95 | 11.5 | 3820 | 156 | 21.15 " | 2 x 5.6 | 2 x 1.2 | 15.2 |
| | 10.0 | .046" | .030 | 1/32" | 1300 | 22000 | 0.81" | 0.53" | 14.0 | 1510 | 62 | 18.3oz | 3 x 6.9 | 3 x 0.8 | 39 |
| 15.0 | .048 | .035 | 1/32" | 1600 | 26000 | 0.90 | 0.60 | 14.2 | 1900 | 77 | 11.7 " | 3 x 7.0 | 3 x 0.85 | 40 | |
| 20.0 | .052 | .044 | 3/64" | 1900 | 30000 | 1.00 | 0.65 | 14.4 | 2300 | 93 | 11.12 " | 3 x 7.1 | 3 x 0.9 | 41 | |
| 50.0 | .140 | .330 | 1/2" | 5000 | 28000 | 1.60" | 1.10 | 15.9 | 6600 | 270 | 51.2 " | 3 x 7.8 | 3 x 1.35 | 46 | |
| 100.0 | .200 | .600 | 19/32" | 8400 | 34000 | 2.10 | 1.40 | 17.0 | 12000 | 485 | 91.3 " | 3 x 8.3 | 3 x 1.65 | 50 | |
| 1/2 x 1/2 | 0.5 | .016" | .35 | 1/32" | 3200 | 32000 | 1.80" | 1.20" | 6.4 | 1700 | 35 | 218oz | 1/2 x 3 | 1/2 x 1.45 | 0.62 |
| | 0.5 | .08" | .170 | 1/64" | 1480 | 30000 | 1.25" | .83" | 6.0 | 735 | 15 | 18.2oz | 3/4 x 2.9 | 3/4 x 1.1 | 1.26 |
| | 1.0 | .016 | .35 | 1/32" | 3000 | 30000 | 1.75 | 1.20 | 7.2 | 1800 | 37 | 21.13 " | 3/4 x 3.5 | 3/4 x 1.5 | 1.6 |
| | 0.5 | .04" | .02 | 1/64" | 800 | 32000 | 0.90" | 0.60" | 6.2 | 410 | 8.5 | 10.8oz | 1 x 3.0 | 1 x 0.85 | 2.2 |
| | 1.0 | .082 | .17 | 1/64" | 1600 | 31000 | 1.30 | 0.85 | 7.1 | 945 | 19 | 11.8 " | 1 x 3.5 | 1 x 1.0 | 2.5 |
| 5.0 | .0387 | .75 | 3/4" | 7800 | 32000 | 2.90 | 1.90 | 11.0 | 7000 | 143 | 10.14 " | 1 x 3.2 | 1 x 2.2 | 4.2 | |
| 1 x 1 | 1.0 | .04" | .019 | 1/64" | 560 | 22000 | 0.75" | 0.50" | 9.8 | 460 | 9.4 | 10.8oz | 2 x 4.9 | 2 x 0.75 | 12.7 |
| | 5.0 | .086 | .17 | 1/64" | 1800 | 32000 | 1.35 | 0.90 | 11.3 | 1700 | 35 | 21.10 " | 2 x 5.5 | 2 x 1.15 | 15.0 |
| | 10.0 | .184 | .40 | 13/32" | 3800 | 33000 | 2.00 | 1.30 | 12.8 | 4100 | 83 | 61.6 " | 2 x 6.2 | 2 x 1.5 | 17.3 |
| | 5.0 | .043" | .023 | 1/32" | 860 | 30000 | 1.00" | 0.60" | 14.2 | 1000 | 21 | 18.1oz | 3 x 7.1 | 3 x 0.85 | 40.0 |
| | 10.0 | .092 | .20 | 13/64" | 1840 | 31500 | 1.40 | 0.92 | 15.3 | 2350 | 48 | 31.10 " | 3 x 7.5 | 3 x 1.15 | 43.5 |
| 15.0 | .130 | .30 | 19/64" | 2620 | 32000 | 1.65 | 1.10 | 16.0 | 3500 | 71 | 51.7 " | 3 x 7.8 | 3 x 1.4 | 46.0 | |
| 20.0 | .175 | .38 | 3/8" | 3500 | 32000 | 1.90 | 1.25 | 16.6 | 4850 | 99 | 71.8 " | 3 x 8.1 | 3 x 1.5 | 48.0 | |
| 50.0 | .432 | 80 | 13/16" | 8700 | 32000 | 3.00 | 2.00 | 19.2 | 14000 | 282 | 211.8 " | 3 x 9.3 | 3 x 2.5 | 58.0 | |
| 100.0 | .900 | 1.50 | 1/2" | 16700 | 31500 | 4.10 | 2.80 | 22.0 | 31000 | 620 | 471.5 " | 3 x 10.5 | 3 x 3.1 | 68.0 | |

* The Actual Gap can only be an approximation owing to the many factors which may effect fringing of flux, permeability of core etc. It must be adjusted by trial until the proper value of inductance is obtained or better yet, until the set up operates at the best point.
 † The values of (B), the flux density, are those obtained with all D.C. and A.C. or the effective B if all A.C. The maximum value in the latter case will be 1.41 x B as given. In the case of rectified A.C. applied to cord with no previous smoothing the maximum B may be 1.57 times the values given.

In all of the chokes the arrangement of the core and the winding is assumed to be that shown in Fig. 19. The dimensions *b* and *c* refer to the measurements of the coil and are to be used in connection with the design tables.

Notes on Iron Core Chokes

Air Gap—A large air gap will reduce the inductance and require a very large choke, making wasteful use of the material. A

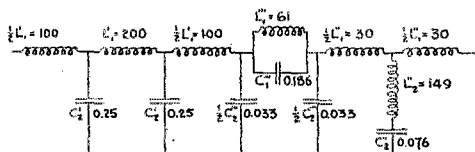

FIG. 18.

COMPOSITE LOW PASS FOUR SECTION FILTER.
CUT OFF AT 1414 ~. MAX. ATTENUATION 1485 ~.
FIRST TWO SECTIONS TYPE #1, T, L, & C.
THIRD SECTION TYPE #3, T, L, C, & C.
FOURTH SECTION TYPE #2, T, L, C, & C.
CONSTANTS GIVEN IN MILLIHENRYS & MICROFARADS.

small air gap increases the harmonics and defeats the purpose of the filter. A good value is one that which uses up about 90% of the ampere turns of the coil, the rest being used up in magnetizing the core. As the permeability of sheet steel is 1000 to 5000, a core 10 inches long will require an air gap only about .05 inches long to meet the requirement of using up 90% of the ampere turns. The exact value must be found by trial. (Some methods of doing this are given in the "Notes on the Brute Force Filter.")

Cores—The most convenient material is of course electrical (silicon) sheet steel, .014" or thinner being satisfactory. The thinner steels give lower losses. Fine iron wire is excellent. In all cases painting each piece of the core with shellac or japan is advisable to reduce losses. The corners should be made with *butt joints instead of the usual interleaved corners*. An air gap is needed in any case and the losses are lower with butt joints. After the adjustment of the air gap the core should be clamped firmly since the magnetic pull is considerable and if the yoke is loose the air gap will change the value of inductance, beside being noisy. (In the Acme chokes small pads of cloth are placed in the air gaps.)

Wire and Winding—Wire with the thinnest insulation should be used to make an economical design. As a comparison, a coil of No. 28 enameled wire 1 3/4" long and 2" outside diameter with a core 1/2" square gave the same inductance as a coil wound with No. 25 cotton-covered wire 2 3/4" long and 4" in diameter with a core 1" square.

Heavy flexible leads should be soldered to the ends of the coil and firmly taped down to prevent breaking off. For minimum amount of winding the core should be covered with a layer of tape and the winding run directly on that. For voltages above 500 extra insulation must be used but this should be no thicker than is absolutely necessary. Accordingly, the very best insulating material should be used under the winding. Before the winding is begun strips of cotton tape are laid along the coil and the fiber end flanges, and temporarily secured in place. For coils up to 2" in diameter 1/8" flanges will do and above that 1/4" should be used. After the coil is wound the cotton tapes are brought up and tied tightly over the coil to keep it from spreading.

The dimensions given here are for all of the winding on one side of the core. The winding may be split into two coils, one on each long core piece, which takes less wire per turn but does not use the copper so effectively (due to the leakage between coils) and hence requires more turns. If the winding is not any deeper than the thickness of the core it is probably not worth while to split the coils. If the winding is very deep the coil should be split and about 10% extra turns used on each of the two resulting coils.

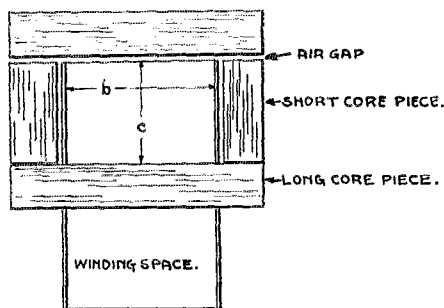

ARRANGEMENT OF INDUCTANCE COILS.

FIG. 19

The wire sizes given in the tables are conservative. 10% larger currents can be carried continuously and 25% greater for a short time. If the coils are heavily taped over the outside they will not cool well.

Amateur Filter Problems

Occasionally an amateur radio station has use for a band filter or for a high-pass filter, but the low-pass filter fills most needs. The commonest problem of all is that of removing a commutator ripple from the direct current supplied by a generator or that of removing the alternating currents from the output of a rectifier operating on commercial 25 or 60-cycle line supply.

Smoothing out a rectified wave may be considered from two angles. First we can say that the gaps in the pulsating output of the rectifier must be filled in by stored energy from the filter. From this viewpoint the exact arrangement of the apparatus is not important and it is desirable to connect large lumps of inductance in series with the line to store energy in magnetic

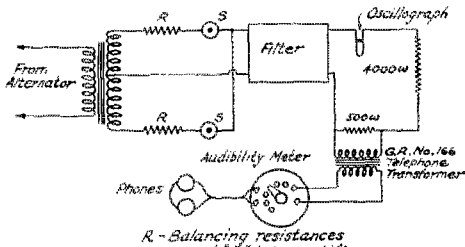

FIG. 20 FILTER TEST CIRCUIT

form and also large condensers in parallel to store more energy in electro-static form. The action is then like that of a flywheel. Secondly we can say that the rectifier output is D.C. plus a lot of frequencies of alternating current and by means of filter circuits carefully designed we can take out each of these frequencies and leave the D.C.

These two methods might be called the "brute force method" and the "intelligence method."

Comparison of "Brute Force" and "Intelligence"

A test circuit was set up as shown in Fig. 20 so that it was possible to put various filters between the rectifier and the load. As quick comparative tests were wanted an audibility method was used, part of the load current being tapped off to the headset. The entire load current was sent thru the oscillograph, which proved to be a very delicate detector for those frequencies that could not be heard easily but which would still have a serious effect in broadening the wave of a sending set or blurring the speech quality if the supply were used on the plates of audio amplifier tubes. These two devices were both very sensitive and detected weak alternating currents that would not make any trouble at all in either a sending or a receiving set. The tests were much more delicate than those used by Mr. Goldberg in his article in the April QST, as it is possible to notice a trembling of the oscillograph when the current is only a percent or so of the strength needed to give a curve that can be photographed. It is accordingly to be understood that when good filtering is mentioned here it is very good indeed.

Tested in this fashion the three filters of Fig. 21 gave about the same result, a barely

noticeable trembling of the oscillograph and an audibility in the headset of less than 10.

Conclusions As to Filters for Rectifiers
(Based on a series of tests not reproduced because of lack of space.)

1. The "brute force" method of filtering appears to give better results than a string of filter sections having higher cut-offs.
2. Fitting the filter to the load does not appear to be highly important.
3. A series choke alone is of little value.
4. Parallel capacity alone helps a great deal if large enough (60 to 80 microfarads).
5. Parallel resonant circuits are effective in eliminating one frequency. Several such circuits in series will be useful to take out several frequencies. In each case the constants of the parallel circuit will be given by

$$f = \frac{1}{2\pi\sqrt{LC}}$$

where L and C are in henries and farads.

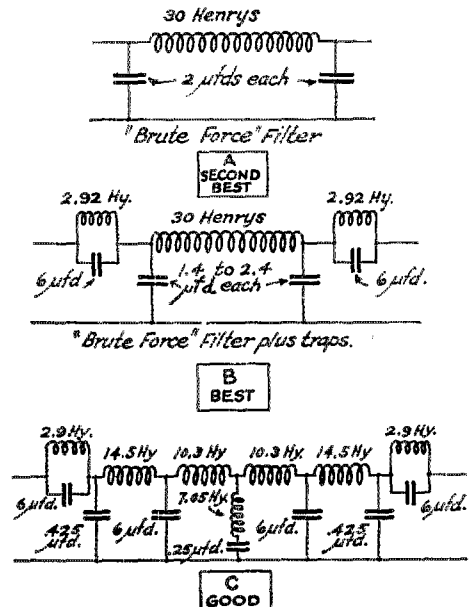

FIG. 21 THREE GOOD FILTERS FOR RECTIFIED 60~ A.C.

6. The best combination is a section with large inductance and capacity, ("brute force type") with resonant circuits in series at the ends as in Fig. 21b.
7. The simplest circuit that can be made thoroly effective in filtering rectified A.C. is a large series choke with large shunt condensers across the circuit at either end—in other words, the "Brute Force" type.

Testing Filters—Adjusting the Air Gap of the Chokes

In the "Brute Force" type of filter the choke does not have to be adjusted to any particular value of inductance; in fact we do not care what the inductance is, as long as it is more than about 30 henries.

The simplest way of adjusting the air-gap is to connect the filter to the load with which it is to work (tests with a different load mean very little) and then change the air gap till the best filter action is gotten. One of the circuits shown in

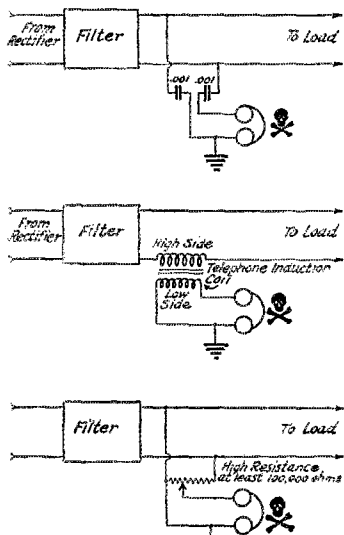

FIG. 23 TESTS OF FILTER ACTION

Fig. 23 may be used for this adjusting but DO NOT LEAVE OFF THE GROUND CONNECTION OR TOUCH ANY PART OF THE SET WHILE THE CURRENT IS ON. UNDER NO CIRCUMSTANCES WEAR THE HEADSET AS THERE IS AN EXCELLENT CHANCE OF BEING KILLED OR SEVERELY BURNED.

After a test has shown how the output of the filter sounds, turn off the power, unclamp the core of the choke and set the air-gap to a different value. Then clamp the core tight and try again. When things are properly adjusted the sound in the phones should be very weak. If nothing is heard at the start of the test the setting may accidentally be correct but the chances are that the apparatus connecting the headset to the line is wrong.

Finally—don't forget to ground one side of the phones and then keep the headset on the table; a well-filtered plate supply is of no use to a dead operator.

Notes on the "Brute Force" Filter
By the Technical Editor

The conclusions just given are to be

understood as applying to rectified alternating currents or other conditions where there are several frequencies of alternating current to be removed, leaving direct current. They do not necessarily fit other cases.

Even when rectified alternating current is to be used the "brute force" filter may be used in several ways. In Professor Dellenbaugh's tests it developed that with a 30-henry choke the capacities across the ends could be reduced to 2 microfarads each without damaging the filtering much. Ballantine recommends that not less than 2 microfarads be used but favors a 50-henry choke, for which designs are given on page 179 of his "Radiotelephony for Amateurs."

Radiotelephony

Ballantine calls attention to the fact that this type of filter is not useful when the oscillator is to be used for radiotelephony with Heising modulation, as the 2-microfarad condensers across the line by-passes the modulation and prevents the modulator from acting. He recommends that the 2-microfarad condensers be removed and a .02 microfarad condenser connected around the choke (not across the line). The filtering will not be as good, however.

Synchronous Rectifiers

When filters are connected to synchronous rectifiers the usual result is a violent display of fireworks—whereupon the owner,

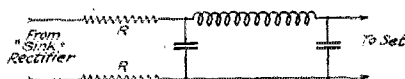

FIG. 22

GZB CIRCUIT PERMITTING USE OF FILTER WITH SYNCHRONOUS RECTIFIER RESISTANCE "R" ABOUT 5000 OHMS EACH FOR 1 TUBE, 2,500 FOR TWO, ETC

gets along without the filter, meanwhile raising an awful rumpus with his 60-cycle growl and the mush due to the sparks at the brushes. Dr. Banks of 6ZB has discovered that this can be stopped by use of the circuit shown in Fig. 22, which is reproduced from "Radio" for July, 1923.

Design of Iron-core Choke Coils

The dimensions for choke coils which are given in the tables on page 22 will fit most amateur needs. When a choke with less inductance is needed, turns may be removed from the winding, remembering that the inductance varies as the square of the number of turns so that taking off half of the turns will reduce the inductance to one fourth of the value it had before. The reverse change of adding more turns must not be attempted as the core will become saturated. The dimensions *b* and *c* may be understood by referring to Fig. 19.

The League's Radio Information Service

EVERY little while someone rises up and asks "Why doesn't QST have a 'Questions & Answers' service like that of other magazines?"

Here's the answer to that question.

Why We Need An Information Service

QST's purpose in life is to serve the American Radio Relay League, to give its members whatever they need in the way of radio information. The average amateur is everlastingly trying things and managing to dig up a lot of curious information, and, along with it, a lot more curious problems. When he runs into a snag he wants help and he wants it *right then*, not next month when QST comes along. So a "Questions & Answers Department" is not FAST enough. That isn't all; how could we possibly publish answers to all the questions that pile in here? It would take something like one QST every five days to contain them.

What the Information Service Is

Therefore, the A.R.R.L. information service answers questions *directly by letter*. At present this takes up most of the time of four people and at intervals we call in various manufacturers and laboratory men for advice. Once in a great while it is necessary to call on the expert advice of the Advisory Technical Committee whose names you will find listed in QST on page 6. This committee is reserved for serious problems concerning the whole League.

All of this takes time and costs money but it is for the League.

Where Our Questions Come From

As we said before, the average amateur does not want to wait long for his information. He would rather "try it and see if anything blows up" than to wait and get advice. Probably that's why most of our questions come from the fellows near us—New England and the Great Lakes. However, that doesn't account for that letter-writing Texas gang, nor yet for Georgia or California. Guess that's a bum theory. Just the same we want to make a special appeal to the entire gang in the South and West. If you have a problem that *can* wait 'til we get a letter to you, let us try to help. And if you dig up something new, we'll be mighty glad to hear about it.

Who Asks the Questions

As before mentioned, the service is mainly for the members of the A.R.R.L. and quite naturally most of our questions are from experimenters or brass-

pounders; in other words they are from amateurs. Occasionally there drifts in a query from someone who wants to know how to make parlor ornaments but he is the exception.

How to Help the Service

We said before that the H'q. Office tries to act as a clearing house for amateur information. So one of the best things any member of the League can do for his fellow members is to rush to us any new information that turns up. If your neighbor works out a freak circuit, *tell the H'q. Office about it*; if someone at a nearby school, electrical generating plant, mine,



or industrial plant, is carrying out some radio experiments, *tell the H'q. Office about it*; if someone near you has a station, a tuner, or anything at all in the radio line, that is very good or very new, *tell the H'q. Office about it*. Get all the pictures and diagrams possible; if you can't, let us know what is going on and we will try. But for the good of the League, **LET HEADQUARTERS KNOW!**

Some Things That We Need Information On Right Now

Experience with radio frequency transformers, both tuned and untuned.

Experience with loose-coupled (capacitive or inductive) tube sending sets.

"Wired wireless" or "line radio" work at amateur wave lengths.

Experiences with "Beverage Wires" or Wave Antennas.

Loop transmission.

Ways of filtering synchronous rectifiers.

Counterpoises (urgent, as very little good information on hand).

Antenna insulators (experiences and samples).

Short-wave arcs and other oscillators besides tubes.

Experiences with 5 and 50-watt tube sets—lots of detail and *all* the troubles and the cures for them.

Experiences with different antenna wires (send samples).

Transmission as affected by the moon and the barometer.

Lots of information as to "dead spots" you know of.

Comparisons of different kinds of tubes, especially the UV-199, C-299, C-301-A, UV-201-A, C-301, UV-201, and the UV-200 and C-300 as compared to each other and to other makes of tubes; for (1) radio amplification at amateur and broadcast waves, (2) as detectors, (3) as audio amplifiers. Give the circuit, the wave length at which you worked, and the voltages used; and again—lots of detail.

If it doesn't get into QST, it will be helping the gang just the same.

What We Do With the Information

Everything that comes in is filed under various subjects. The next time that subject makes trouble we can refer to it at the file and usually get the proper answer.

How to Ask Questions

It may sound funny but it is still a fact that over half of our questions can be answered by looking thru the copies of *QST* for five or six months back. This means that the question-asker could save time by looking it up himself. That's where the new index of *QST* will come in handily. It is issued as a supplement to this issue of *QST*.

Then again a vast number of letters come in that ask questions about the workings of a station without giving a wiring diagram. Nothing doing, O.M.'s—not a thing doing! Give us the diagram the

first time over and we will not have to write back and ask for it.

Observance of the following rules will help us both:

- 1—Before asking a question take a look thru your file of *QST*'s; the answer is probably there in plain print.
- 2—If the question needs asking, supply a *diagram* of the circuit you are asking about and give the *dimensions* of helices, the *capacities* of condensers, and *anything else* that a stranger needs to know in order to understand just what is going on.
- 3—All radiomen write a terrible "paw". Moral, use a *typewriter*, and *double space your letter*.

Some Questions We Can't Answer

We can't tell anyone which sending circuit is *best* unless he tells us something about his location, antenna, wave length and tube equipment. Neither can we tell anyone what receiving equipment is *best* unless he tells us these things and in addition tells us what he wants to hear. Neither do we try to tell anyone which tube is *best* unless he tells us what apparatus is to be used with it, and what the set is expected to do. And finally we can't give anyone a design for a filter or a transformer unless we know exactly what the voltages and frequencies and the current are going to be. We do our darndest but we are *poor mind-readers*.

And that makes rule four which is—

- 4—When you ask a question, *ask all of it*. There you have the story; we will do our best to answer such of your problems as we can, but for the other fellow's sake be reasonable and don't snow us under. In return, if you find anything interesting let us know.

The Technical Editor
The Department Editor

Shooting Facts to the Public

Function of A.R.R.L. Publicity Department is to Put Over the Truth About the Ham
By J. K. Bolles, Publicity Manager

AMATEUR radio has not and does not intend to offer any apology for its existence; its value has been tried and proven. There is no one now in radio circles who does not know that without the amateur, radio would not be where it is today. Therefore when it was decided to organize within the A.R.R.L. a new department for the dissemination of news, the Publicity Department, it was not with the idea of placing a halo around the head of the amateur, of holding him up as the

one and only champion of radio progress—rather simply to give the facts.

Away back in the old days, when the gang was only a little handful of experimenters, when no one except the real ham knew there was such a thing as the A.R.R.L., the so-called amateur was content to putter around in his little attic room. With his roughly assembled collections of stray parts and plenty of air with no strings tied to it, he was happy to take things as they were, without qualifications. Conditions were then ideal and he enjoy-

ed seeking knowledge of a new art and he gloried in the game and the fellowships in the air as he found them.

With the advent of broadcasting, accompanied by the natural confusion as to how much and by whom the air should be used, the old ham spirit was for the time stunned. The game warden idea was injected into what was the most glorious of hobbies; sportsmanship was dealt a severe blow under the belt. The amateur felt in much the same position as one of the Forty-Niners might on a game preserve with a .22-caliber rifle. To the old knights of the key the situation was heart-breaking.

But did they stall, fume around, shout that the game was up; did they quit? Everyone knows now that they did not. They adjusted themselves quickly to new

Hams Now Radio Editors

Many amateurs and clubs are supplying material for weekly columns which have become a regular feature of local newspapers. Among these is a page in a St. Paul newspaper by C. J. Otterholm, DPM of the Dakota Division; columns in the "Fairmont Times" (Va.) by Edward C. Jones, Jr., CC; in the "New Haven Register" (Conn.) by Warren Atwood, DPM of the New England Division; in the "Milwaukee Journal" by L. S. Hillegas-Baird, DPM of the Central Division; in the "Radio Globe" (N. Y.) by ZPI; in "Atlanta Journal" by the Atlanta Radio Club; "The Cleveland Times and Commercial" by R. P. Worden formerly ADPM of Ohio; in "The St. Catherines Standard" (Ontario, Canada) by the Niagara District Radio Association and many others.

conditions, offered their co-operation, held out a helping hand to the listeners, welcomed those who came into the game with shiny new ready-made tackle. Misunderstandings were bound to arise and they did; the amateur was comparatively unknown to the general public. Under the old regime this did not matter, the ham was never comfortable in the lime light; but with the changes came an urgent need for publicity.

In the last six months the A.R.R.L. has established friendly relations with scores of radio editors thruout the country, mailed news bulletins at regular intervals to approximately 500 newspapers. These bulletins have told the how and why of amateur radio and they have covered the latest A.R.R.L. news. A publicity organization has been built up and too much cannot be said of the fellows who have given up precious time at their key to do their share for the welfare of all hams and the betterment of the whole game.

Our plan of organization is somewhat similar to that of the Operating Department and to date the Publicity Department

is functioning in twelve A.R.R.L. Divisions. In each of these there is a Division Publicity Division Manager, many of whom have appointed Assistant Publicity Managers in their respective states and Correspondents in larger cities. Bulletins are sent to all members of the department and similarly local stories of general interest are handed up the line for insertion in these bulletins. It is worthy of note that the DPM's, particularly L. S. Hillegas-Baird of the Central Division and Boyd Laizure of the Midwest Division, have not only distributed news thruout their territory, but they have also taken an active part in the smoothing over many interference difficulties. They did not do this by cheap advertising methods, nor did they over-emphasize in any manner the status of the amateur. In these as in most similar cases the only requirement was a clear statement of facts.

We are sorry that we have not the space to include here the names of all the loyal workers in this department. However, the DPM's by divisions are as follows: Dakota Division, C. J. Otterholm, Commonwealth Electric Co., St. Paul, Minn.; Northwestern Division, Royal V. Howard 540 West 13th St., Eugene, Ore.; New England Division, William Halligan, Boston Telegram, Boston, Mass.; Roanoke Division, Allen S. Clarke, 893 Pine St., Danville, Va.; Central Division, L. S. Hillegas-Baird, 229 Ninth St., Milwaukee, Wis.; Midwest Division, Boyd Laizure, Kansas City, Mo.; Pacific Division, R. P. MacKenzie, 1016 4th Ave., Los Angeles, Cal.; Rocky Mountain Division, Howard Williams, 3207 West Lake Place, Denver, Colo.; Quebec Division, F. A. Baily, 364 Kensington Ave., Montreal, P. Q.; Hawaiian Division, T. P. Traugott, Honolulu Star Bulletin, Honolulu, T.H.; West Gulf Division, Bernard Shields, 414 Mercantile Bank Bldg., Dallas, Texas.

Just now the primary function of the Publicity Department is to tell the public what the A.R.R.L. is, what it stands for, what it is doing in order to bring

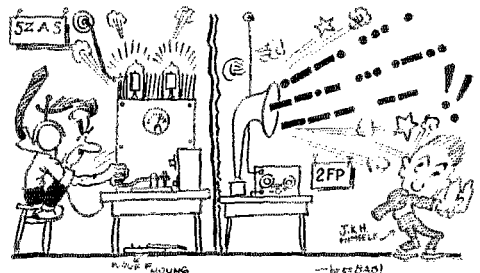

Know anybody else who never acknowledges report cards?

about what everyone in radio is looking forward to, a kind of millenium, when interference and kindred matters are minimized and the ether will have been so regulated as to make room for all. The Publicity Department is young yet and there is an urgent need for more workers. You fellows, especially the old timers, the pioneer key pounders, can help the game

by co-operating with the A.R.R.L. men whose names are mentioned above.

We have but one story to tell, the one point to get over, and succeeding in that we believe that the Publicity Department will be progressing and it will be accomplishing its main objective. It is the ham's privilege to condense and it is following that principle when we use but five words as our motto; THE TRUTH ABOUT THE HAM.

Final Report on the Fading Tests*

The fading tests were one of the large jobs that the American Amateur has tackled. They were run co-operatively by the Bureau of Standards and the American Radio Relay League, with the aid of the Naval radio station NSF at Anacostia, D. C. Seventeen sending stations and 243 recording stations participated in making 5684 observations of transmission conditions.

The object of the tests was to determine the nature and causes of "fading." In this the tests were not entirely successful but as compensation there was obtained a large amount of information regarding short-wave transmission—information that in these days of short-wave sending stations will interest both amateur and professional radio men.

I—Introductory

Definition of Fading

As a typical example of fading, suppose that the radio laboratory of Washington, D.C., were listening to a station in Massachusetts. This station may call and be received with satisfactory intensity, may begin the preamble of his message and then, as the message is begun, the signals may rapidly increase in intensity until they can be heard throughout an ordinary room. Then they may become rapidly weaker until they are barely audible or become entirely inaudible. This sort of thing is known as fading. It makes communication very difficult and calls for many repetitions.

Occurrence of Fading

Even very casual observation shows that fading is much more pronounced on the shorter wave lengths. It is not particularly objectionable above 400 meters and does not ordinarily take place within the daylight range of the transmitting station. It is primarily a phenomenon noted at long distances and hence is most prevalent during night time when transmission ranges are greatest. Curiously enough, recent observations have shown that fading becomes less again below 150 meters.

Why The Tests Were Made

Just before the beginning of these tests the general interest in short-wave commercial radio transmission had begun to develop. There was a distinct demand for in-

formation as to the cause of fading, the hope being that perhaps a cure could be found if the cause was known. These tests have advanced our ideas of the cause of fading (†) and have brought forth interesting facts about short-wave transmission in the region lying between 200 and 375 meters. It is only to be regretted that most of the work was done with spark transmitters. This could not be helped as tubes of ratings above 5 watts were then not generally available.

II—Organization of the Tests

The Radio Section of the Bureau of Standards proposed a system of short-wave fading tests to the American Radio Relay League. The plans were made in a conference on April 1, 1920, at which there were present the following: For the Bureau

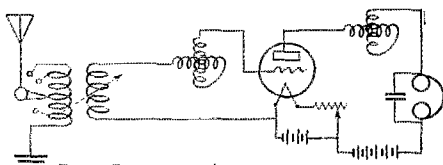

FIG. 1 RECEIVING CIRCUIT USED BY RECORDERS

of Standards, Dr. J. H. Dellinger, Mr. L. E. Whittemore, and Mr. S. Kruse; for the A.R.R.L., President H. P. Maxim and Mr. K. B. Warner; for the Naval Radio Laboratory, Commander A. Hoyt Taylor, U.S.N. R.F.; and for the Department of Terrestrial Magnetism, Carnegie Institution of Washington, Dr. S. J. Mauchley and Mr. A. Sterling.

The plan was made to have a large number of receiving operators make simultaneous records of the intensity of the signals received from picked amateur stations

†—See section VIII "Theories of Fading."

*First publication of the final analysis of the Bureau of Standards—A.R.R.L. Fading Tests. Abstracted from the (unpublished) Scientific Paper of the Bureau of Standards called "A Study of Radio Signal Fading," by Dr. J. H. Dellinger, Chief of Radio Section; L. E. Whittemore, Alternate Chief of Radio Section; and S. Kruse, former Associate Engineer, Bureau of Standards. Abstract by permission of the Director, Bureau of Standards.

"P" tubes with continuous current supply from generator. These tubes acted as power amplifiers, the master oscillator being a Western Electric type "E" tube, modulated by another similar tube upon whose grid was impressed 1000 cycle A.C. from a microphone buzzer. The antenna was multiple tuned, 85 feet high, 235 feet long; the total current in the three down leads was 9 amperes. Wave lengths, 200, 250, and 375 meters.

WVW—*Washington, D. C.*—Bureau of Standards Radio Laboratory. In Charge Dr. J. H. Dellinger; Operator, S. Kruse. Two General Electric type "P" tubes with continuous current supply from a generator. Modulation by a motor-driven chopper in series with grid-leak resistance. Antenna height, 80 feet; current, 5 amperes. Wave length, 200 meters.

3XF—*Washington, D. C.*—Mr. Francis M. Baer. One kilowatt, sixty cycle spark with a non-synchronous discharger worked at 480 sparks per second. Antenna height, 70 feet; current, 4.5 amperes. Wave lengths, 250 and 375 meters.

3ZW—*Washington, D. C.*—Mr. W. A. Parks. One kilowatt, sixty cycle spark with a non-synchronous discharger. (This station substituted for NSF on one schedule).

8XK—*Pittsburgh, Pa.*—Mr. F. Conrad. Two General Electric type "U" tubes with an A.C. plate supply of 3000 volts at 700 cycles. Antenna height, 50 feet; current, 5.5 amperes. Wave length, 250 meters.

8ZW—*Wheeling, W. Va.*—Mr. John C. Stroebel, Jr. One kilowatt, sixty cycle spark with a non-synchronous discharger, operated at 360 sparks per second. Antenna height 55 feet; current, 8 amperes. Wave length, 250 meters.

8ER-8ZL—*St. Marys, Ohio*—Mr. and Mrs. Charles Candler. One kilowatt, sixty cycle spark with a non-synchronous discharger worked at 300 sparks per second. Antenna height, 57 feet; current, 5 amperes. Wave length, 250 meters.

9ZJ—*Indianapolis, Ind.*—Mr. F. F. Hamilton. One kilowatt, 300 cycle spark with a non-synchronous discharger working at 210 sparks per second. Antenna height, 60 feet; current, 7.5 amperes. Wave lengths, 200 and 375 meters.

9LQ—*Indianapolis, Ind.*—Mr. C. W. Dean. One kilowatt, sixty cycle spark with a non-synchronous discharger worked at 120 sparks per second. Antenna height, 55 feet; current, 5 amperes. Wave length, 250 meters.

9ZN—*Chicago, Ill.*—Chicago Radio Laboratory. Operators, Messrs. R. H. G. Mathews, K. Hassell, Buck, Fitzsimmons. Two kilowatt, sixty cycle spark with a synchronous discharger operated at 120 sparks per second. Antenna height, 80 feet; current, 6 amperes. Wave length, 375 meters. Two kilowatt, 500-cycle spark

with a quenched gap, operated at 1000 sparks per second. Antenna height, 80 feet; current, 13 amperes. Wave length, 375 meters. During the April tests, the 500-cycle set was used with a temporary antenna, height 80 feet; current, 12 amperes. Wave length, 375 meters.

9AU—*Chicago, Ill.*—Mr. C. H. Zeller. One kilowatt, sixty cycle spark with a non-synchronous discharger. Antenna current, 3.75 amperes. Wave length, 250 meters.

9LC—*St. Louis, Mo.*—Mr. W. E. Woods. One-half kilowatt, sixty cycle spark, with a non-synchronous discharger. Antenna height, 55 feet; current, 4.5 amperes. Wave length, 250 meters.

Schedules of the Transmitting Stations (spark stations except as otherwise noted).

| Station Sending | Location | Wave Length | Starts at (Eastern Std. Time) P.M. |
|---------------------|--------------------|-------------|------------------------------------|
| July Test | | | |
| 1AW | Hartford, Conn. | 250 | 10:10 |
| 2JU | Woodhaven, L. I. | 250 | 10:20 |
| NSF | Anacostia, D. C. | 250 | 10:30 |
| 8XK | Pittsburgh, Pa. | 250 | 10:40 |
| 9ZN | Chicago, Ill. | 250 | 10:50 |
| 9LC | St. Louis, Mo. | 250 | 11:00 |
| October Test | | | |
| 1AW | Hartford, Conn. | 250 | 10:10 |
| NSF | Anacostia, D. C. | 250 | 10:20 |
| 8ZW | Wheeling, W. Va. | 250 | 10:30 |
| 8ER-8ZL | St. Marys, Ohio | 250 | 10:40 |
| 9ZN | Chicago, Ill. | 250 | 10:50 |
| January Test | | | |
| Group A | | | |
| NSF | Relay NAA time | 250 | 10:00 |
| 1AW | Hartford, Conn. | 250 | 10:10 |
| NSF | Anacostia, D. C. | 250 (ICW) | 10:20 |
| 2JU | Woodhaven, L. I. | 250 | 10:30 |
| NSF | Anacostia, D. C. | 250 (ICW) | 10:40 |
| 9LQ | Indianapolis, Ind. | 250 | 10:50 |
| 9AU | Chicago, Ill. | 250 | 11:00 |
| Group B | | | |
| NSF | Relay NAA time | 250 | 10:00 |
| 1BBL | Farmington, Conn. | 300 | 10:10 |
| 8XF | Washington, D. C. | 375 | 10:20 |
| 2RK | Brooklyn, N. Y. | 375 | 10:30 |
| 3XF | Washington, D. C. | 250 | 10:40 |
| 9ZJ | Indianapolis, Ind. | 375 | 10:50 |
| 9ZN | Chicago, Ill. | 375 | 11:00 |
| April Test | | | |
| Group A | | | |
| NSF | Relay NAA time | 250 | 10:00 |
| 1AW | Hartford, Conn. | 200 | 10:10 |
| NSF | Anacostia, D. C. | 200 (ICW) | 10:20 |
| 9ZN | Chicago, Ill. | 375 | 10:30 |
| 9ZJ | Indianapolis, Ind. | 200 | 10:40 |
| Group B | | | |
| NSF | Relay NAA time | 250 | 10:00 |
| 1AW | Hartford, Conn. | 200 | 10:10 |
| WVW | Washington, D. C. | 200 (ICW) | 10:20 |
| 9ZN | Chicago, Ill. | 375 | 10:30 |
| 9LQ | Indianapolis, Ind. | 200 | 10:40 |

In the July and October tests, the object was to note characteristics of fading from various points, all transmission being done on the same wave length.

In the January tests arrangements were such that two stations near each other sent at the same time on slightly different wave lengths, the recording being done by two groups of recorders.

In the April tests the same thing was done, but the stations transmitted simultaneously, on the *same wave* using different spark notes.

Accuracy

Fig. 3 shows a test of the method under operating conditions; the two curves being those drawn independently by Messrs. H.

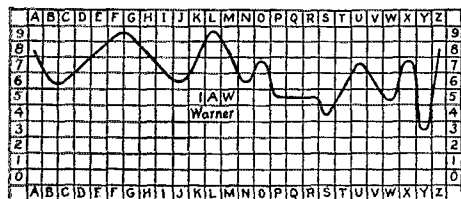

Transmission by 2JU - July 1, 1920

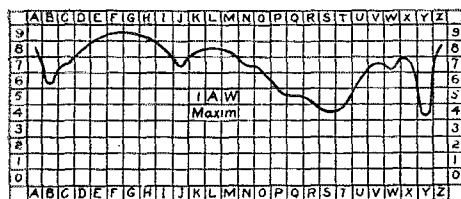

Fig. 3

P. Maxim and K. B. Warner at Hartford, Conn., while listening to the signals of 2JU in New York City. Two headsets connected to the *same* tuner were used. A similar test made in the laboratory gave the results shown in Fig. 4.

Observers

The best operators were not the best recorders as they paid too much attention to *copying* the signals and not enuf to noticing the variations. The result was a curve which was flat and lacking in detail. The best observers were men who had done laboratory observation work.

Average Distance Of Transmission

The average distance of transmission was approximately 400 miles, the input in no case exceeding one kilowatt.

Special Tests

Practically no signals were copied in the noonday test of October 24th; this test is classed as a failure. With the present tube sending sets the story would have been different. The sunset tests of October 17th showed nothing except that signals get stronger as night comes on. Tests transmitted by 8XK on October 26th and 28th demonstrated that some very peculiar and erratic fading could be charged to variations in the oscillator at the transmitting

station. These erratic variations disappeared when a very stable master-oscillator was allowed to drive the transmitting tubes as amplifiers instead of allowing the large tubes to self-oscillate.

Time Signals

Most of the receiving operators did not have tuners going up to the 2650 meter wave of the time signals sent from Arlington (NAA). Accordingly the Naval Air Station, NSF, at Anacostia, D. C., received the time signals on a ground wire, amplified them, and used them to modulate a high power radio phone set re-transmitting the signals on 250 meters; on which wave all recording stations were able to copy them.

Synchronization

During the last test in which stations sent in pairs the signals of 1AW at Hartford Conn. and 1BBL at Farmington, Conn., were synchronized by ear, 1AW sending steadily and 1BBL following as closely as possible. Station 9AU at Chicago followed 9ZN. 2JU at Woodhaven, L. I., also followed 2RK at Brooklyn, N. Y., by this method while 9LQ and 9ZJ of Indianapolis were synchronized through a wire line and 3XF and NSF, Washington, D. C., through a system of remote radio control.

IV—Problems

The great number of factors which influenced the fading, greatly complicate and confuse the data. Of the factors in the following lists some were noted by the observers on the recording forms; others were obtained from the weather maps of the Department of Agriculture, from the Carnegie Institution, Department of Terrestrial Magnetism, and other sources.

- (1) Weather conditions at observer: Clear, Cloudy, Rain, Snow, Sleet, Fog, Lightning.
- (2) General reception date of test.
- (3) Strays or "static" characteristics on date of test.
- (4) Atmospheric conductivity.
- (5) Atmospheric potential gradient.
- (6) Presence of aurora.
- (7) Barometric pressure.
- (8) Temperature.
- (9) Barometric gradient.
- (10) Temperature gradient.

V—The July Analysis

The first method of analysis consisted of laying the cards out on a table and making direct comparison between them. Several things of interest were found in this manner although their importance is doubtful.

Similar Curves

Similar curves such as those shown in Figure 5 were repeatedly obtained. In general this effect seems to occur very haphazardly as regards geographical distribution of the stations concerned and few

Table 1
 Summary of Fading Test Results, October, 1920,
 as to Weather Conditions as Obtained from Analysis of Maps.
 (Figures indicate number of similar reports received.)

| Fading | Signal Intensity | | | Strays (Static) | | | | | |
|--------|------------------|------|--------|-----------------|------|------|----|----|--|
| | Severe | Mod. | Slight | Strong | Med. | Weak | | | |
| 29 | 33 | 25 | 16 | 60 | 11 | 17 | 22 | 49 | Transmission from region of low to region of high barometric pressure. |
| 27 | 45 | 51 | 33 | 71 | 21 | 30 | 39 | 52 | Transmission from region of high to region of low barometric pressure. |
| 37 | 64 | 33 | 29 | 87 | 16 | 36 | 44 | 54 | Transmission between regions of approximately equal barometric pressure. |
| 50 | 54 | 46 | 36 | 92 | 26 | 41 | 40 | 75 | Barometer rising at sending station. |
| 40 | 48 | 42 | 31 | 72 | 30 | 27 | 34 | 72 | Barometer rising at receiving station. |
| 43 | 50 | 41 | 39 | 78 | 51 | 30 | 35 | 66 | Barometer rising in region between sending and receiving stations. |
| 20 | 21 | 8 | 9 | 55 | 5 | 6 | 10 | 33 | Barometer falling at sending station. |
| 22 | 27 | 14 | 11 | 43 | 7 | 12 | 12 | 33 | Barometer falling at receiving station. |
| 21 | 23 | 9 | 9 | 38 | 5 | 8 | 10 | 34 | Barometer falling in region between sending and receiving stations. |
| 6 | 5 | 3 | 4 | 7 | 1 | 3 | 1 | 3 | Rain at sending station. |
| 9 | 18 | 17 | 7 | 31 | 4 | 6 | 13 | 24 | Rain at receiving station. |
| 5 | 10 | 13 | 5 | 19 | 2 | 4 | 4 | 21 | Rain in region between sending and receiving stations. |
| 22 | 23 | 17 | 11 | 33 | 12 | 20 | 20 | 23 | Clear weather immediately preceded by cloudiness at the sending station. |
| 12 | 18 | 19 | 8 | 33 | 8 | 11 | 22 | 17 | Clear weather immediately preceded by cloudiness at the receiving station. |
| 6 | 10 | 9 | 4 | 16 | 7 | 6 | 13 | 8 | Clear weather immediately preceded by cloudiness in region between sending and receiving stations. |
| 24 | 34 | 24 | 24 | 46 | 12 | 17 | 26 | 43 | Transmission from region of lower to region of higher temperature. |
| 12 | 31 | 16 | 8 | 43 | 11 | 12 | 18 | 31 | Transmission from region of higher to region of lower temperature. |
| 57 | 76 | 69 | 46 | 131 | 26 | 55 | 62 | 84 | Transmission between regions of approximately equal temperatures. |

conclusions can be drawn. Of the 5684 observations there were found 380 pairs of similar curves including in this category the "traveling curves" which appear successively at different points. This is only 6.7 per cent of the total. It is interesting to observe the difference of direction from the transmitter of any two receiving stations when they submitted similar curves.

Summary of Similar Pairs

| | |
|--|-------|
| Total similar pairs..... | 380 |
| Percent of total observations..... | 6.72 |
| Number of similar pairs in same general direction from transmitter (within 45° angle)..... | 258 |
| Percent of similar pairs..... | 68.02 |
| Number of pairs in opposite direction from transmitter (within 45° of 180° angles)..... | 34 |
| Percent of similar pairs..... | 9.0 |
| Number of pairs at intermediate angles from transmitter..... | 88 |
| Percent of similar pairs..... | 23.02 |

The results of the October test were transferred to blank weather maps, such as those used by the department of Agriculture, for analysis. By glancing at such

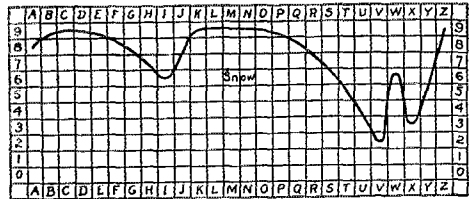

Laboratory Test of Recording Method.

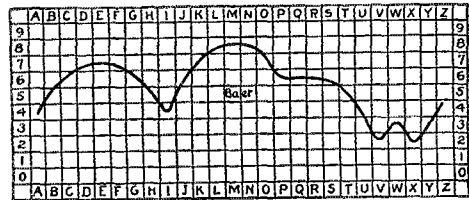

Fig. 4.

a prepared map one could determine the regions of best reception, most severe fading, and worst static. By having at hand a weather map for the day these factors could be compared with the climatic conditions.

Conclusions for October Map Analysis

When the barometer was falling at the sending or receiving station or between them, severe fading predominated over light fading (20, 22, and 21 as compared to 8, 14, and 9). When the barometer was rising there was little difference in the number of cases of severe and light fading.

Clouds had very little effect.

Transmission is slightly better along lines of equal barometric pressure than up or down the barometric gradient.

Signals are louder when clouds are present or when it is rainy at one end or in between.

The proportion of weak to strong signals is greater when transmission is from a region of higher to a region of lower temperature. In other words signals carry better from a cold to a warm region than in the reverse direction.

Strays are less severe when the barometer is falling at some point along the line of transmission.

When clouds are present it is usual to receive reports of weak static.

a representation of facts as just a representation of the tendency of observers to put their curves about the middle of the sheet.

There is noticeably more severe fading from the regions within 250 miles of the

Transmission by 2JU - July 1, 1920.

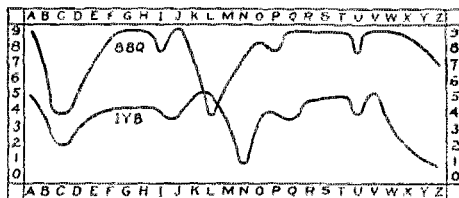

Fig. 5

sending station than from the region beyond that. 35% of the cases of fading within 250 miles are very bad while only 14% of the fading beyond that distance is very bad. This supports the old amateur transmissional proverb that "the station was too close."

Table 4

Range of Stations, Oct. 1920

| Station | Average Radius | Per cent of Maximum Radius |
|---------|----------------|----------------------------|
| | Miles | |
| 1AW | 730 | 60 |
| NSF | 940 | 75 |
| 8ZW | 960 | 87 |
| 8ER | 790 | 88 |
| 9ZN | 900 | 90 |

(To be Concluded)

The second installment of this paper will appear in QST for September. It will give the final results obtained by a machine-examination of 5,684 cards obtained in the October, January and April tests.

Table 2

Results, October, 1920, as to distance (In Number of Cases of Transmission)

| | Fading | | | Signal Intensity | | | Strays | | |
|------------------|--------|------|--------|------------------|------|------|--------|------|------|
| | Severe | Mod. | Slight | Strong | Mod. | Weak | Strong | Mod. | Weak |
| | | | | | | | | | |
| Within 250 miles | 66 | 67 | 54 | 50 | 139 | 75 | 31 | 70 | 95 |
| Beyond 250 miles | 17 | 61 | 42 | 29 | 89 | 57 | 33 | 38 | 73 |

Table 3

Results, October, 1920, as to distance (In Per Cent of Cases of Transmission)

| | Fading | | | Signal Intensity | | | Strays | | |
|------------------|--------|------|--------|------------------|------|------|--------|------|------|
| | Severe | Mod. | Slight | Strong | Mod. | Weak | Strong | Mod. | Weak |
| | | | | | | | | | |
| Within 250 miles | 35 | 36 | 29 | 19 | 58 | 28 | 24 | 32 | 44 |
| Beyond 250 miles | 14 | 51 | 35 | 17 | 51 | 32 | 23 | 28 | 51 |

From Tables 2 and 3 it can be seen that the proportions of loud, medium, and weak signals reported from the two zones are about equal. This is probably not so much

Our Index

THIS issue marks the beginning of Volume VII of QST. We have prepared an Index to Volume VI and it is now ready for distribution. A copy has been sent without charge to every A.R.R.L. member. Non-members may secure a copy by writing to QST, 1045 Main St., Hartford, Conn., and enclosing 4c in stamps to cover postage.

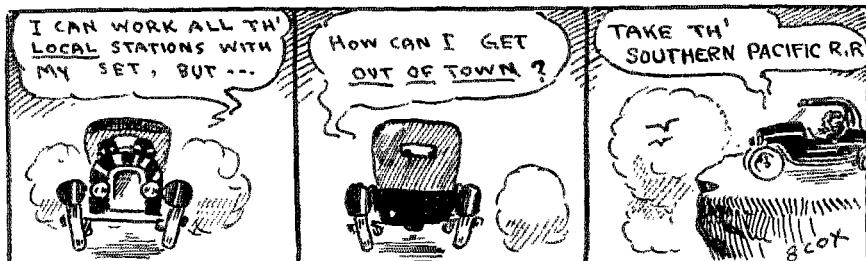

Hard Rubber in Radio Instruments*

While not the equal of the familiar phenolic resin insulating materials in mechanical strength, resistance of high temperature, or low-frequency puncture strength, it is possible for hard rubber, one of the oldest insulating materials, to claim a prominent place in the radio art because of its other properties. Especially will the transmitting amateur find it worth while to consider rubber for his sending set where relatively high radio frequency voltages are encountered.—Tech. Ed.

THE superior insulating qualities of specially compounded hard rubber for radio instruments was undisputed for years in the development of wireless communication. It still remains unsurpassed as an insulating material by any of the moulded plastic compositions, the use of which in molded parts became enormous during the rise of radio in popular interest. The principal reason for this seems to be the facility with which the phenolic resin compounds can be molded into highly finished pieces with or without metal inserts.

Radio engineers have determined that there are 4 most important characteristics to be considered in panel, or other radio insulating material. These are phase difference, dielectric constant, resistivity (both volume and surface), and the tendency to absorb moisture.

Phase difference is the property which expresses the heating of the material (when subjected to alternating fields) and at radio frequencies largely determines the . . . voltages the material will stand without injury It introduces resistance into the circuit and diminishes the selectivity. The phase difference should be the lowest possible.

Dielectric constant determines the amount of alternating current that will flow when an alternating voltage is impressed

Surface and volume resistivity determine the resistance to the passage of an electric current across the surface and thru the material respectively. The higher the resistivity, the better the insulation.

Absorption of moisture has an important effect on insulating materials, especially on the phase difference and resistivity. Insulating material should therefore absorb no moisture and have a high surface finish to produce the best results thru all seasons and in climates where humidity is a serious factor.

Comparison of Materials

Generally insulation used in radio appar-

atus can be divided into three broad classifications—Hard rubber compounds, Phenolic compounds and Laminated phenol-fibre compounds. Hard rubber is a compound of rubber with sulphur and other suitable materials mixed in certain proportions, depending on the use to which it is applied, and vulcanized over a pre-determined number of hours. The last two materials are somewhat similar and may be considered together.

The following comparative tests are from the results secured in the laboratories of the United States Bureau of Standards, the New York Testing Laboratories, and the laboratories of the American Hard Rubber Co., when comparing a special hard rubber known as "Radion" with phenolic insulators.

| | Radion | Phenolic and laminated phenol-fibre materials. |
|---|-----------------------|--|
| Phase angle | 0.5 to 0.6 | 2.0 to 3.7 |
| Dielectric Constant | 3.9 | 5.8 to 7.4 |
| Resistivity (megohms per c.m.) ³ | 1.0 x 10 ⁸ | 1.4 x 10 ⁴ to 2.2 x 10 ⁴ |
| Absorption of moisture in air | .005% to .02% | .28% to .49% |
| Absorption of moisture in water | .08% to .11% | 1.42% to 7.81% |

The results show phase difference of 1/4, dielectric constant of 1/2, and absorption of moisture of 1/14 of the same characteristics for phenolic and laminated phenolic materials.

Price of Rubber

It is interesting to note that hard rubber sheet in the form of panels is practically only half the price of panels made of the various phenolic resin compositions, either pure or composite.

Workability of Hard Rubber

The workable qualities of hard rubber give it distinctive advantage. It can be machined, drilled, cut, threaded, engraved, stamped, sanded, and polished with ordinary tools without danger of chipping. In large-scale factories hard rubber is cut with power circular saws of special design. In panel making, satisfactory results are obtained by cutting with an ordinary hack saw having 24 teeth to the inch. For drilling holes use a *straight fluted* (not twist) drill, feeding slowly without great pressure, otherwise the stock may heat excessively and the drill run out of true.

Hard rubber can be molded in steel molds

*Excerpted from an article in The India Rubber World. The original article was based on information supplied by The American Hard Rubber Co., The United States Rubber Co., The American Telegraph & Telephone Co., and the Tribune Institute. The figures for the phenolic materials have been added from information supplied by The American Hard Rubber Co.

under hydraulic pressure or in soft metal molds made from a steel matrix.

Simple Tests for Hard Rubber

Hard rubber is made in many grades and the quality can be easily judged by the

toughness of the shaving and by the facility with which it cuts and machines. The easier it machines the better the quality and the more readily it will take a high polish.

Resonance Wave Coils

Their Application to the Elimination of Static and Interference

From an interview with Dr. Louis Cohen

The work of the Signal Corps on resonance wave coils was begun three years ago by General George O. Squier, Chief Signal Officer of the Army, and has been carried forward steadily except as interrupted by the Paris International Radio Conference. The developments herein described are the work of Dr. Louis Cohen, Consulting Engineer for the Signal Corps, U. S. Army, and Major J. O. Mauborgne, Signal Corps, U. S. A.

WHAT is the Resonance Wave Coil? Suppose that we wind a single layer of fine insulated wire on a long pasteboard tube as shown in Fig. 1. Now let us connect one end of this coil to a radio receiving antenna, leaving the other end of the coil free. Now when a radio wave strikes this receiving antenna high frequency currents will flow up and down the antenna. As a result there will be a radio-frequency voltage at the left end of the resonance wave coil and radio-frequency currents will surge in and out of the coil. If it happens that the coil has a natural wave equal to that of the received signal (i.e., if the coil is exactly in tune with the incoming wave) we will have a high voltage at the free end of the coil. The voltage along the coil would be as shown in Fig. 1a. Usually, however, the coil is not in tune. Supposing that a shorter wave arrived at the antenna. We would naturally expect some

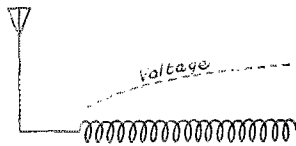

FIG. 1a

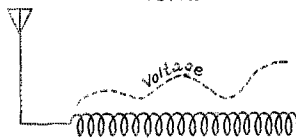
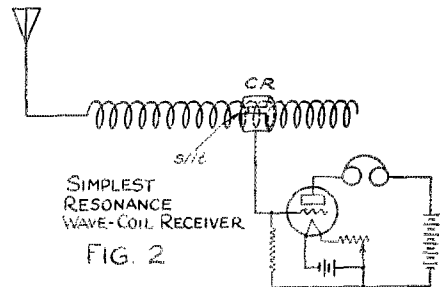

FIG. 1b

such voltage distribution as shown in Fig. 1b. The general result is that there will be voltage peaks along the resonance wave coil, the exact position of the peaks depending on the length of the wave that caused them. Between these peaks the voltage will be lower, altho not zero.

The Resonance Coil as a Receiving Device

So far all this has been interesting but not especially useful. However, it will be remembered that the audion is a "voltage operated device;" in other words, it gives results that depend largely on the voltage that the incoming signal places on the grid of the tube. It seems reasonable then that an audion should work excellently if we could apply to its grid the rather high radio



SIMPLEST
RESONANCE
WAVE-COIL RECEIVER

FIG. 2

voltages that appear along the resonance wave coil. The simplest way of doing this is shown in Fig. 2. CR is a "collector ring" of metal, forming a capacity connection to the coil, but otherwise insulated from it. This ring "picks off" the radio voltage at the particular point where it is located and transfers it to the grid of the tube. By moving the ring it is possible to pick off various signals, remembering that the peaks of different stations do not appear at the same points.

This is the simplest resonance wave coil receiver but it can be improved upon in several ways. It is interesting that in this, as well as in other receivers of this type, the antenna is merely a collector and does not tune in the ordinary fashion.

It is possible to use two collector rings at different points on the same resonance coil, and receive two different signals, of

(Continued on page 39)

EDITORIALS

de AMERICAN RADIO RELAY LEAGUE



Some Jobs To Do

In bygone days it has been contrary to regulations for us amateurs to diverge from the wavelength (or perhaps there were two of them) specified in our station license. But now, under the new regulations, we are given the opportunity to roam at will thruout our band, and that opens up many pretty possibilities for us in the direction of improving our methods and our results.

First off, of course, it is apparent that we can scatter around and permanently reduce the "instantaneous maximum" of interference with each other by eliminating the congestion that was always with us when everybody tried to make 200 meters his operating wave. We have so many cycles in our band that if we distribute ourselves even approximately evenly we should have almost no QRM. And now it will be legal for us to QSY to whatever wave the fellow we are working with specifies to get around his QRM conditions, and that will make communication easier too.

These things make it apparent that we need a method for rapidly and accurately shifting the wave length of a tube transmitter to any point within its authorized band. This is something we have never developed because it hasn't been permitted us before, but we ought to get busy right away and work it out. If anyone doubts the value of the idea he has only to reflect upon past difficulties of raising a station which was listening on a wave differing but a few meters from his own. The other night for example, we were trying to get hold of WNP. Our wave was 200 flat. WNP was working an amateur whose wave happened to be 215 meters. He had QRX'd temporarily, and we knew he was on that wave. We called him in the hope that he was finishing around, but no amount of calling would raise him. Oh to have had a rapid and accurate wave-changer, so that we could have advanced our wave to the exact wave length on which we knew he was listening! A short call, a "QSU?", and we'd have been QSO in a few minutes. How often you hear a station you want working with another chap whose wave differs from yours; if you could but shift to the second chap's wave and call the man you want, he'd be bound to hear you.

When we come to think about it, how funny it is to call blindly and hope our correspondent will be kind enough to turn his knobs to *our* wave; how much more to the point to call on the wave we know he's listening on!

To do these things probably the best method would be to couple a wave-meter to the tuner and measure the received signal by siphoning it out, and then provide means for adjusting the transmitter to that same wave on the same meter. At once we see that any step-by-step adjustment is hopeless. Probably the stations having 176 to 200 meters for their band will have no particular difficulty in arranging for quick shifting, preserving good efficiency thruout, but it becomes an engineering problem when the band from 150 to 200 or 220 is tackled. We don't believe there is a circuit whereby it can be done efficiently with even two controls; the couplings have to be changed and it is likely to become a half-hour job. The Meissner circuit of GJD with sliding clips on three pancakes, described in this issue, offers much promise in this direction. It is a problem worthy of the effort, and *QST* is anxious to hear from League members who have devised successful arrangements to solve it.

Another big job we must undertake and whip is the creation of a transmitter which is silent on the waves it isn't supposed to be using, even when listened to next door. The Department of Commerce intimate to us that when we can show that we have such transmitters they will be inclined to lift the quiet-hours restriction on all such stations. The problem is this: operating on 200 meters or less, we must be inaudible on a poor tuner right next door, on which an unskilled listener is trying to receive broadcasts on 222 meters. Pure C.W. of course is the only possible method. It must be really pure, too, or the nearby non-oscillating receiver will hear all the audible modulation. That means battery-power or a perfect filtering system. We have some very valuable information on amateur filters in this issue. Then comes the key-click QRM, which often puts Morse clicks all over adjacent tuners to the utter disruption of all reception. In our last issue we gave some successful methods of overcoming this evil.

When all these things are solved a "bug-proof" amateur transmitter will be the result; we shall be much happier, our work will be much more pleasant and more enjoyable. We think they are worth any amount of hard work. It shall be *QST's* endeavor to present as much helpful information along these lines as we can find, and you fellows will be helping all of Amateur Radio if you'll let us know of your successful experiments on these problems.

Summer—When Life Is Joyous

THERE'S only about one good thing that can be said for winter—amateur radio certainly is fun then. The cold clear winter nights may be perfectly beastly in every other respect, but they let the old sigs get thru in great shape and we hams get our fill. That makes us like winter.

But being perfectly human we join the rest of the world in waiting for summer to come. Now good old summer is here and life is worth while. With out-of-doors so perfect, we are filled with a lunatic desire to run out into a large open place and sing and yell and dance in wild approval of Old Mother Nature's scenery and the happy activity of all her children. But by the time mid-summer rolls around we're liable to find ourselves slumping off as radio amateurs, because the shack is stuffy and the outdoor reaches glorious, there is wheat to be harvested, and contractors are willing to pay nice wages for a lad with reasonably good intentions and passable biceps who will grab hold of a hod of bricks in firm and earnest fashion and help make his part of the country a nice place to live in. And the glories of nature—that blue gem of a northern lake set in forest green, the long wind-driven waves racing across that yellow wheat field, that gulf-coast sunset behind the royal palms—are very apt to make us feel that the things we have done are pretty cheap and poor at that!

How much better we could do our own amateur work! How far from perfect we are, when we contrast our handicraft with the beautiful work of the God-of-out-of-doors! Oh, we know it, fellows, we all know it. Yet radio means so much to us chaps—it's the very life-blood of us amateurs. Let us then get a new grip on ourselves, and resolve to make our amateur work more worth while. Let us, in emulation of the perfection we see all about us in this good old summer time, fix up our miserable junk piles so that they are more what a radio amateur's station should be.

And then when we have got the inspiration of the out-of-doors, and blow the cobwebs out of our dusty minds with the pure fresh air of this beautiful season, let us

give a little thought to the work of our A.R.R.L. There's one little thought we'd like to put over to you this month, fellows: we must not fall down on our relay work. The traffic report shows by its slump just how confining a winter we had. We must guard against the dissolution of our precious traffic machine, the beautifully-working organization which we built up to such a fine stage of performance by such hard work. We must stay on the job enough to keep in touch with each other, we must hold the routes intact, and we must be sure to make monthly reports to our traffic officers the same as if it were still January. The little investment in effort it takes to do that thruout the summer is so well worth while—we'll be happy for having done it when fall rolls around and the old Department is all set for glorious accomplishments without the necessity of housecleaning.

Stick with the game, fellows.

"New" Circuits

EVERY few moments a newcomer scurries breathlessly up the steps of the radio-publicity rostrum and screams to all who pass an urgent appeal to discard all known receiving apparatus in favor of the wonderful new Whozit circuit that has only a moment ago been hatched by the rising Marconi of Bingville. The shouter does not shout long—the next man is half way up the steps at that very moment—but his words are snatched at, are printed in the saffron radio journals and in the radio funny-sheets that come with the newspapers. And when printed they appear with a broad border of advertisements by those that have for sale curious new apparatus without which the revolutionary circuit positively will not revolve.

All this leaves us perfectly cold; we do not even get out the notebook; we know that within a week the same sheets will be using the same sort of type to make a similar noise about still another circuit quite as worthless as the first.

Miracles do not happen on schedule, Marconi is not born every Saturday, and the radio art is not revolutionized by Armstrong once a week; in all the years of radio development there have been perhaps a dozen basic changes in receiving tuner circuits. It cannot be otherwise than that the major portion of the new circuits are pure hokum, the most miraculous thing about them being that there can be found a paper so patient that it consents to go out bearing on its surface such arrant nonsense. A tributary miracle is that there exist radio editors who allow the stuff to get as far as the linotypes.

Our new circuit sharks are depending on our ignorance or else are themselves in

the primer class of radio. Would it not be fine if some of these three-weeks self-made authorities could be induced to wander back down the corridor of radio history where sit the dim shapes of many serious radiomen, each one before a desk piled deep with sheets of paper bearing every conceivable circuit? How would our suddenly-created expert feel to see these folk impatiently brushing to the floor many of his wonderful circuits, consigning them to the family furnace for their first active duty?

Perhaps it would then dawn on the new man that his circuit had better be compared with some others before too much crowing was done. That would in truth be good luck for we would soon be saved the perusal of 90% of the "new" circuits which tests would show to have no virtues.

If that result can be attained it may be possible later to impress on the new authorities the fact that a tuner is supposed to do more than to bring in signals—it is also supposed to *tune*, to discriminate between signals not of the same wavelength. We pray for the day when the ability to tune will be demanded by all users of radio apparatus, for on that day there will start a mighty exodus of freak-receiving sets, and their leader on the march toward the caves of obscurity and evil memory will be that invention of the devil known as the "single-circuit tuner."

And now to start things toward that millenium we respectfully suggest to all who write, print, or lecture on radio that hereafter they insist that any circuit submitted will not be made public until it has been compared with the standard American receiver—the reliable old *inductively* coupled tuner with regenerative detector plus one step of audio amplification. If the new circuit can take the *same* two tubes and show results that are superior as to selectivity, intensity or distance of origin, then it is time to go ahead and investigate the ease of manipulation of the new set. But unless the new set can prove its selectivity and sensitivity it should be thrown out of court. The Editors of *QST* propose herewith to adopt that policy toward all future receiving circuits submitted to *QST* and will insist that the evidence be quite specific, especially in the amateur range of wavelength.

RESONANCE WAVE COILS

(Continued from page 36)

different wave length, at the same time. This of course calls for two operators, each one with his own audion having its grid connected to one of the collector rings.

If C.W. is received it is desirable to make the receiving tube oscillate and even for spark or radiophone reception re-

generation is desirable. Sharp tuning and regeneration are accomplished by the circuit of Fig. 3. There is a collector ring as before, L_1 and C_1 are a tuned secondary circuit of the usual type (for instance, a honeycomb coil and variable condenser), L_2 is the regular tickler, and C_2 is the phone-shunt condenser. This circuit is, of course, quite the usual thing in receiving circuits *except* that the radio voltage is not supplied to the grid by coupling the secondary to a primary but by connecting

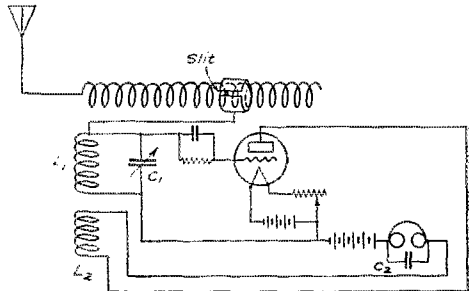

FIG. 3 REGENERATIVE RESONANCE WAVE-COIL RECEIVER

the grid direct to the collector ring. Both L_1 and L_2 should be kept several feet away from the resonance coil.

The Resonance Coil as a Static Reducer

In Fig. 4a there has been added a sort of exaggerated collector ring at the end of the resonance coil which is nearest the

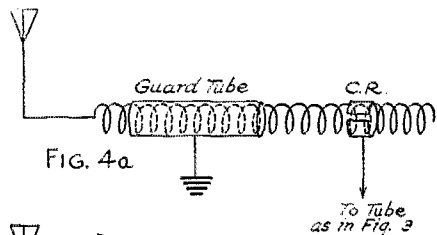

FIG. 4a

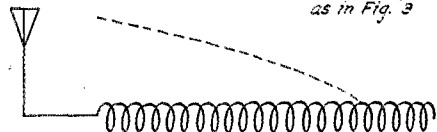

FIG. 4b VOLTAGE CAUSED BY A STATIC "SPLASH"

antenna. This "guard tube" may or may not be slit, and should have a length equal to $\frac{1}{3}$ to $\frac{1}{2}$ that of the resonance coil. If we ground this tube directly as shown in Fig. 4a it seems reasonable that it will pick off *all* of the radio voltages that get into the coil and as a result none of them will reach the far end of the coil where the collector ring is located. That is ex-

actly what happens, the tube cuts out all the signals; but it does something else as well. So far we have been thinking about the effects produced by radio-frequency alternating currents in the system. Let us now consider the effect of an impulse caused by a "splash of static." It is fairly safe to say that static impulses are either of very low frequency (200 or 300 cycles) or else are entirely without frequency, being simple uni-directional impulses. If such an impulse strikes the antenna the effect will be to put a high voltage on the left end of the resonance wave coil—to put it on very abruptly at that. See Fig. 4b. Then this voltage will start to travel along the coil, to "soak into the coil." If that is allowed to go on the result will be to make the coil oscillate at its own wave length.

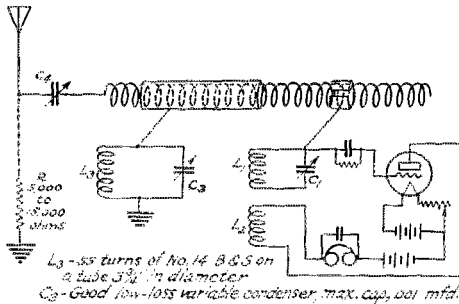

FIG. 5 COMPLETE RECEIVING CIRCUIT WITH STATIC GUARD TUBE

However, if we are using the guard tube just described the major portion of the static-impulse-voltage is drained off and does not set the coil into oscillation.

The removal of the static impulses is very fine but unhappily we have removed all of our signals in addition. Fortunately it is possible to ground the guard tube in such a fashion that the connection will act as a "solid" ground on all waves except one. This is done by means of a so-called "rejector circuit." If this rejector circuit is added we have our first complete receiving circuit, which is shown in Fig. 5. L_2 and C_2 constitute the rejector circuit. When this circuit is tuned to 300 meters all wave lengths except 300 meters go to ground freely but the circuit rejects 300 meter signals which go on thru the resonance coil to the collector ring. This rejector circuit accordingly does two things—it lets the static impulse go to ground and it also lets interfering signals go to ground. To be a good rejector circuit it must have very low resistance. This calls for heavy wire in the coil and a first-class variable condenser with low losses. See the constructional notes for details. In any case do not use a variable condenser insulated with "moulded mud." C_1 serves to change the coupling between the antenna and the

resonance coil. It need not be used but is convenient. Sometimes it is an advantage to make the antenna aperiodic by grounding it thru a high resistance R.

It is possible to use the resonance wave coil with an ordinary single-circuit or inductively coupled tuner by using the connections shown in Fig. 6. The use of an inductively coupled tuner may result in excessive sharpness of tuning.

It is also possible to use the resonance wave coil with a tuned antenna system as shown in Fig. 7. Here again extreme selectivity is obtained but an extra adjustment must be made. The switch S is provided so that the resonance coil may be connected above the tuned primary circuit when receiving weak signals or below (at the ground connection) when receiving strong signals thru interference.

Sometimes more complete elimination of static and interference can be gotten without additional critical adjustments by splitting the guard tube into two parts as shown in Fig. 8, and adding a second resonance wave coil on which the collector ring operates. The second resonance coil is wound exactly like the first. In this circuit also the receiving tuner may be of almost any sort.

Performance of Resonance Wave Coils as Static Reducers

The work at the laboratory of the Signal Corps has been done on long waves. Some very favorable results were obtained. On one occasion it was possible to hear the naval high power station NPL at San Diego, Cal., without any sign of static altho an ordinary receiver was entirely useless because the static was so strong as to bury the signal completely.

Constructional Notes

Winding the Coils

The size of wire and manner of winding it is not very important. Some of the early long-wave coils were wound in single layers, others in blanks and still others in sections

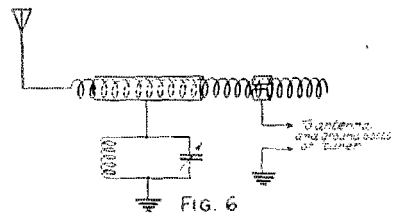

FIG. 6

an inch long, each section being banked. All gave about the same results. For 200 meters there is suggested a coil wound double-banked on a four inch cardboard tube ten inches long. Number 30 B. & S. gage single cotton covered is convenient but the size and covering are not critical. For broadcast work from 200-600 meters,

try a single layer of No. 30 B. & S. gage 18 inches long on a tube 3 or 4 inches in diameter.

The Rejector

The rejector circuit may consist of a good variable condenser of about .001 microfarads capacity shunted across a coil having 55 turns of double cotton covered wire, No. 14 B. & S. gage, wound on a tube 3 3/4 inches in diameter. This will give an inductance of 0.1 millihenry. The condenser had best be insulated with hard rubber.

The Sliding Tubes

The collector ring and the guard tube may be made of brass and should fit very closely. A convenient arrangement is to cover the winding with a layer of thin paper and then use tubes that will just slide smoothly over the paper. The guard tube need not be split but the collector ring must be.

Regeneration

Regeneration may be accomplished by the use of a tickler in the usual fashion or by the use of a plate-circuit variometer. Either scheme calls for a tuned secondary

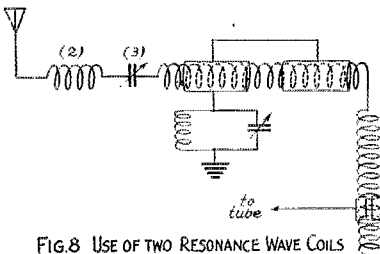

FIG. 8 USE OF TWO RESONANCE WAVE COILS

circuit connected to the grid as shown in some of the diagrams. It is possible also to regenerate by means of the resonance coil itself without extra windings. A little thought will show the way of doing this.

Tuning the Set

If the antenna shows a tendency to tune, it had better be made aperiodic by use of the resistance to ground as shown in Fig. 5. This of course does not apply to the case of Fig. 7.

It is possible also to use these circuit arrangements with a loop. (Note—One end of resonance coil is connected to one side of loop tuning condenser.—Ed.) Because

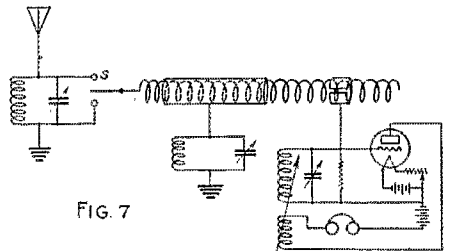
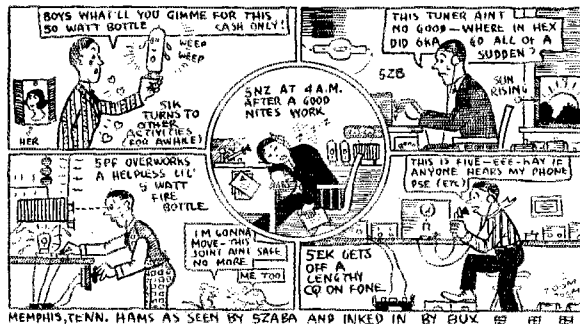

FIG. 7

the resonance coil as well as the receiving set can act as a collector it must be screened if very violent static is to be eliminated. To be of any use screening of this (or any other) receiving device must be quite complete, otherwise it will be useless. Complete screening means that the entire set must be enclosed in an airtight copper case of fair thickness (18 gauge) and there must not be any batteries or battery wiring outside this case. Even the phone cord should be run thru a piece of copper Belden braid which is grounded to the copper shield.

Reports on Results

We are very anxious to hear of the results obtained with the circuits shown here or with other combinations which they suggest. Address communications to A.R.R.L. Headquarters. We would especially like to hear from the Gulf States where there is real static.



The Operating Department

F. H. SCHNELL, Traffic Manager
1045 Main St., Hartford, Conn.

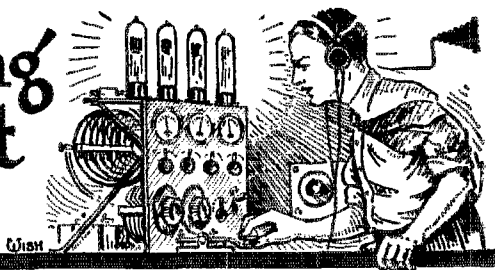

Appreciating this opportunity when most of our good transmitters are inactive, it is well to be reminded there is a question for you to answer before you start your regular daily traffic handling again.

We all have rather poor memories and since that will do for an excuse, let's just say that time and time again articles have appeared in QST begging you to get down to 200 meters. With the new regulations (quoted elsewhere in this issue) we have a slightly different tune. It used to be "down to 200 meters." We now add two words and say get "down to 200 meters or below." It

where you are; and, before you finish, put your transmitter on the wave length specified and leave it there.

We can't sing nor write music, but if we could compose it to the above you would readily understand that is written in the best of spirit. It's true, ar't, isn't it, OM?

Mani tnx to you all for putting a stop to the rubber stamp messages. It was FB the way they dropped off last month. A great many stations have remarked about it. Gradually they will disappear and everybody will be happy again.

It takes a lot of nerve to sit at a radio set

Message Traffic Report by Divisions

J U N E

| Division | C.W. | | SPARK | | TOTAL | |
|----------------|------------|--------------|-----------|-------------|------------|--------------|
| | Stns. | Msgs. | Stns. | Msgs. | Stns. | Msgs. |
| Atlantic | 75 | 5155 | 10 | 410 | 85 | 5565 |
| Central | 104 | 9443 | 16 | 1101 | 120 | 10544 |
| Dakota | 35 | 2401 | 3 | 140 | 38 | 2541 |
| Delta | 12 | 359 | — | — | 12 | 359 |
| East Gulf | 30 | 705 | 3 | 49 | 33 | 754 |
| Hawaiian | 5 | 38 | — | — | 5 | 38 |
| Midwest | 37 | 2311 | 3 | 157 | 40 | 2468 |
| New England | 54 | 3822 | 1 | 10 | 55 | 3832 |
| Northwestern | 21 | 924 | — | — | 21 | 924 |
| Pacific | 11 | 384 | 2 | 155 | 13 | 539 |
| Roanoke | 19 | 1896 | — | — | 19 | 1896 |
| Rocky Mountain | 9 | 465 | — | — | 9 | 465 |
| West Gulf | 45 | 4517 | 6 | 206 | 51 | 4723 |
| Total | 457 | 32420 | 44 | 2228 | 501 | 34648 |

C.W. Messages 32,430—94%
Spark Messages 2,228—6%

Total 34,648

depends on what your license calls for on wave length. Well, whatever it is—here's the question—does your transmitter comply with the law particularly as regards wave length? You can say "yes," or you can say "no." There is no other answer. Either it does or it doesn't. If it does,

and handle traffic when the static is so strong it almost recharges the batteries, yet 5TM did just this thing.

* R. L. Lay 5TM *
* Yaokum, Texas *
* West Gulf Division *
* 1986 messages *

Wanted—Suggestions on how to get messages delivered. So much has been said about our message delivery, or our non-delivery, that we would like to have some good practical suggestions on how to do it.—F.H.S.

you are complying with the law, if it doesn't, you are violating the law? If you are violating the law and don't know it you had better learn of it. If you learn of it, you had better correct it before you use your transmitter. Get a good accurate wavemeter; measure your wave in order to see

Our brass pounders faded away to a thin shadow of their former selves. Well, it's nothing to get alarmed over; look at the percentage of messages handled by a few reporting spark stations. It won't be long before the spark will be among those conspicuous by their absence.

BRASS POUNDERS' LEAGUE

| Call | Msgs. | Call | Msgs. |
|------|-------|-------|-------|
| 5TM | 1986 | 8BCY | 427 |
| 8AVD | 825 | *8AIB | 424 |
| 9DQU | 553 | 5AIF | 422 |
| 9CZL | 520 | 9DUQ | 406 |
| 8AJG | 517 | 8CWP | 401 |

*Spark

TRAFFIC REPORTS FROM A.R.R.L. OFFICIAL RELAY STATIONS

HAWAIIAN DIVISION—C.W.: 6AND, 2; 6ASR, 13; 6CCR, 2; 6CEU, 15; 6TQ, 6.

DELTA DIVISION—C.W.: 5EK, 10; 5NV, 15; 5ZBA, 9; 5ZB, 1; 5PV, 27; (5BW, 30—C.W. and spark) 5AHJ, 6; 5FV, 40; 5YE, 16; 5KC, 183; 5NZ, 15.

DAKOTA DIVISION—C.W.: Minnesota: 9DUQ, 406; 9BAF, 63; 9BAV, 10; 9EA, 4; 9QF, 81; 9CBW, 41; 9MF, 37; 9EGG, 35; 9DMA, 1; 9COF, 114; 9ZT, 286; 9IG, 150; 9APW, 136; 9CIP, 135; 9APE, 44; 9AUA, 39; 9DPX, 35; 9CTO, 31; 9DFW, 22; 9DGV, 15; 9BTL, 14; 9BIS, 9; 9DGE, 5; 9DGV, 5; 9AUL, 2; 9CVV, 4. North Dakota: 9AHC, 50; 9DLE, 29. South Dakota: 9CKT, 10; 9YAK, 71; 9DWN, 148; 9BRI, 110; 9CGA, 91; 9AYI, 90; 9AVZ, 19. SPARK: Minnesota: 9EGF, 20. South Dakota: 9BDH, 97; 9BOF, 23.

PACIFIC DIVISION—C.W.: 6ASN, 28; 6BFL, 40; 6HP, 56; 6ALK, 98; 6AVR, 34; 6EC, 36; 6BRU, 2; 6ABK, 47; 6NX, 15; 6CC, 28; 6TC, 4. SPARK: 6AOA, 60; 6AQU, 95.

ROCKY MOUNTAIN DIVISION—C.W.: Wyoming: 7DHL, 55; 7ZV, 13. Colorado: 9BUN, 56; 9BVO, 41; 9CFY, 34; 9BXA, 22; 9DTE, 94; 9EEA, 3; 9CAA, 147.

MIDWEST DIVISION—C.W.: Nebraska: 9YU, 126; 9AVC, 125; 9BXT, 31; 9BWE, 19; 9BDU, 51; 9DKY, 52; 9ASO, 154; 9AQK, 135; 9ATC, 96. Iowa: 9CWF, 107; 9BPV, 47; 9AED, 32; 9DXU, 15; 9AOU, 10; 9DJA, 18; 9ARZ, 51. Missouri: 9DXN, 100; 9EKF, 85; 9BLG, 84; 9AAU, 67; 9EFB, 55; 9DLT, 55; 9BHL, 32; 9ALX, 20; 9CEE, 18; 9AAL, 10; 9ACO, 2; 9BNP, 1; 9WJ, 1; 9DWK, 10; 9CAO, 173; 9BKO, 152; 9AYL, 97; 9ACK, 62; 9SS, 30; 9ST, 2; 9DJB, 20. SPARK: Nebraska: 9DNC, 63. Iowa: 9BXT, 36; 9CS, 58.

WEST GULF DIVISION—C.W.: Northern Texas: 5QI, 51; 5ACQ, 18; 5AIF, 122; 5MN, 140; 5NY, 12; 5AMP, 7; 5IX, 74; 5HY, 110; 5UP, 20; 5FX, 128; 5AFH, 35; 5UY, 31; 5AHC, 20; 5ALI, 8; 5FA, 66; 5FC, 21; 5LL, 56; 5XAJ, 82. Oklahoma: 5ZAT, 16; 5KE, 100; 5ZAV, 32; 5ZM, 43; 5KW, 29; 5XBF, 35; 5GA, 86; 5VM, 12. New Mexico: 5LG, 4. Mexico: "BX", 89. Southern Texas: 5NN, 53; 5XV, 7; 5ZX, 6; 5AMA, 40; 5VY, 54; 5YK, 92; 5VO, 27; 5ZAE, 23; 5ALR, 93; 5TM, 1986; 5RN, 56; 5JP, 10; 5SS, 107; 5MT, 163; 5GE, 53. SPARK: Northern Texas: 5AL, 6; 5ACQ, 8; 5AIC, 100; 5CT, 55; 5JH, 20; 5AJT, 17.

EAST GULF DIVISION—C.W.: 5AME, 10; 5UP, 25; 5AGJ, 48; 5CP, 37; 5VV, 1; 4FS, 18; 4HZ, 5; 4AG, 8; 4DB, 60; 4AY, 8; 4EL, 46; 4DT, 34; 4EB, 161; 4KU, 35; 4MB, 32; 4EQ, 26; 4MY, 25; 4HW, 20; 4HS, 18; 4AZ, 15; 4NA, 12; 4CG, 12; 4DO, 10; 4FJ, 8; 4BL, 7; 4ME, 6; 4DN, 5; 4GM, 6; 4CY, 5; 4OD, 3. SPARK: 5XA, 9; 4HS, 25; 4IO, 15.

ROANOKE DIVISION—C.W.: 3AJG, 517, 3CEL, 202; 3BMN, 197; 3APE, 173; 3IW, 71; 3TJ, 65; 3SG, 46; 3ABS, 38; 3CA, 38; 3BW, 22; 3ASP, 15; 3AEV, 3; 3HVL, 19; 3NF, 172; 4EA, 14; 4FT, 167; 4BX, 70; 8ATP, 26; 8CQH, 41.

NEW ENGLAND DIVISION—C.W.: 1BQD, 102; 1AML, 51; 1GV, 2; 1CAB, 30; 1AWE, 13; 1BES, 21; 1AWV, 5; 1ABC, 4; 1OW, 12; 1BVB, 207; 1SK, 105; 1SN, 122; 1CNI, 60; 1AIR, 29; 1AQM, 137; 1CIT, 90; 1YK, 26; 1BET, 44; 1BFQ, 7; 1BLX, 30; 1BQK, 8; 1AOU, 10; 1ADN, 106; 1CJW, 27; 1CPD, 52; 1AQM, 137; 1JV, 167; 1BKQ, 201; 1CPN, 306; 1DB, 31; 1ASU, 48; 1RR, 89; 1CPI, 348; 1BDU, 28; 1CMP, 60; 1BNT, 150; 1ACO,

48; 1CDO, 247; 1BJS, 51; 1KX, 28; 1CKQ, 14; 1BNL, 21; 1ACO, 48; 1BRQ, 78; 1CRU, 3; 1ARY, 23; 1CPO, 32; 1CMK, 82; 1AWW, 74; 1IL, 64; 1CTT, 52; 1ARF, 45; 1BSJ, 16; 1FD, 25. SPARK: 1ARY, 10.

NORTHWESTERN DIVISION—C.W.: 7LR, 214; 7AGF, 118; 7HM, 63; 7ZF, 46; 7AF, 60; 7WA, 40; 7IW, 56; 7ABY, 47; 7KR, 2; 7ADJ, 4; 7FH, 24; 7JE, 15; 7AGF, 118; 7HM, 63; 7ZF, 46; 7AF, 60; 7WA, 40; 7CZ, 44; 7TG, 15; 7ADJ, 5; 7AHQ, 12; 7ZU, 26; 7ZL, 36; 7ZN, 51; 7IO, 32; 7LN, 13.

ATLANTIC DIVISION—C.W.: Northern New Jersey: 2AGB, 285; 2CXE, 132; 2CUI, 45; 2AJF, 10; 2BGL, 12; 2FC, 23; 2BUY, 74; 2CGK, 24; 2BSO, 6; 3FP, 22; 2BWW, 23; 2CTC, 25; 2CDR, 45; 2ALY, 53. Southern New Jersey: 3BEL, 76; 3ACQ, 54; 3AHV, 26. Western New York: 3BOA, 186; 3ATR, 19; 3CUI, 39; 3CSE, 11; 3BCP, 16; 3ASK, 15; 3HJ, 10; 3BUM, 34; 3COI, 20; 3AWP, 20; 3CQL, 10; 3BBW, 8; 3BSF, 350; 3AFL, 70; 3CTK, 10; 3AMM, 38; 3AVD, 825. Pennsylvania: 3RD, 83; 3FS, 19; 3HX, 3; 3VW, 19; 3OE, 94; 3IH, 70; 3CCX, 20; 3RRV, 20; 3API, 18; 3HH, 93; 3ZM, 9; 3ADX, 3; 3AKR, 12; 3AWF, 38; 3BOB, 33; 3BLU, 48; 3BIP, 41; 3ADP, 10; 3ADQ, 13; 3BNU, 375; 3BAQ, 34; 3CTZ, 49; 3ATA, 2; 3RH,

The following have been appointed Official A.R.R.L. Broadcasting Stations. Each Saturday and Sunday at 10:30 P.M. standard time these stations broadcast an official message from A.R.R.L. Headquarters, giving the very latest information on hand.

| | | | | |
|------|------|------|------|------|
| 1CK | 3APR | 5ZM | 7DH | 9CFY |
| 1BDI | 4HS | 6BIP | 7ZU | 9DGV |
| 1LX | 4EL | 6KM | 8AWP | 9APS |
| 1BSZ | 4EA | 6APL | 8ZW | 9AIG |
| 1CKP | 4NT | 6ZAM | 8ATP | 9MC |
| 1FD | 4EB | 6ABX | 8ZAF | 9CA |
| 1GL | 4HZ | 6AJR | 8AND | 9US |
| 1GV | 4BC | 6BBH | 8CED | 9II |
| 1CPO | 4HX | 6ZH | 8ZZ | 9UR |
| 1BAC | 5XA | 6BKE | 9AVZ | 9EEA |
| 1BKQ | 5RK | 7JF | 9ARZ | 9BZI |
| 1AIQ | 5ADB | 7ZN | 9BBF | 9BGT |
| 2BRB | 5MB | 7SC | 9OX | 9ADG |
| 2AWL | 5ZAV | 7ZO | 9ZY | 9AAU |
| 2OM | 5XB | 7TO | 9BAV | 9DJE |
| 3BMN | 5YE | 7AGF | 9AZA | 9DXY |
| 3ASP | 5ZAK | 7ZV | 9ADZ | 9CWC |

Note:—Broadcasting at 12:01 A.M. discontinued.

4; 3ZO, 305; 3AUV, 65; 3CCU, 229. Maryland: 3APT, 12; 3TE, 9; 3HG, 46; 3HS, 250; 3AB, 147; 3SU, 122; 3BWT, 36; 3PZ, 25; 3KM, 20; 3BSB, 18; 3JJ, 112; 3IL, 7. Delaware: 3BBS, 5; 3AIS, 12. SPARK: Northern New Jersey: 2BQZ, 42; 2BZU, 32; 2OM, 74. Southern New Jersey: 3BEL, 28. Western New York: 8TC, 76; 8AEO, 85; 8CHY, 5; 8AAW, 50; 8BJY, 12; 8QN, 6.

CENTRAL DIVISION—C.W.: Wisconsin: 9ARC, 31; 9CZY, 77; 9BVA, 50; 9DCT, 9; 9BCH, 21; 9CJI, 92; 9DLY, 20; 9DHG, 21. Ohio: 8CWP, 401; 8ABL, 380; 8BEK, 322; 8BYN, 287; 8ANB, 209; 8YAE, 171; 8ADA, 169; 8IJ, 167; 8DAE, 130; 8BBH, 105; 8ES, 102; 8FU, 85; 8BXX, 76; 8CMI, 64; 8CVH, 63; 8AL, 60; 8ABE, 51; 8TJ, 46; 8WY, 41; 8CRC, 41; 8CKV, 34; 8AKP, 30; 8CIE, 30; 8GZ, 28; 8CYZ, 26; 8AWN, 25; 8BHY, 18; 8RY, 15; 8AER, 10; 8AHY, 7; 8AZF, 6. Southern Indiana: 9UR, 47; 9AMO, 32; 9EAD, 31. Michigan: 8BCY, 427; 8BGT, 220; 8DKC, 92; 8HDR, 81; 8DI, 66; 8UBO, 60; 8CGJ, 59; 8BGJ, 56; 8CZZ, 55; 8ZZ, 52; 8ATX, 51; 8BBJ, 51; 8YN, 50; 8CJL, 46; 8ZF, 45; 8BXA, 36; 8AND, 31; 8CDD, 31; 8CBO, 20; 8KI, 19; 8CAP, 15; 8BZD, 11. Chicago: 9BNA, 59; 9EBK, 53; 9US, 52; 9SE, 27; 9BFX, 23; 9ASA, 19; 9AOY, 10.

Illinois: 9DQU, 553; 9CZL, 520; 9CPA, 248; 9BYX, 210; 9CBU, 187; 9CDR, 124; 9BWA, 109;

9COX, 39; 9BHX, 75; 9BZQ, 67; 9MC, 56; 9AWQ, 48; 9CLZ, 45; 9OXT, 44; 9CMC, 38; 9DJG, 32; 9CTK, 31; 9BIL, 25; 9DZG, 23; 9BIT, 14; 9CMN, 12; 9DBW, 10; 9AQA, 8. Northern Indiana: 9DVK, 350; 9EHI, 218; 9BCB, 180; 9DFB, 127; 9CP, 50; 9EJU, 15; 9EG, 12; 9BBQ, 10. Kentucky: 9APS, 167; 9DRI, 111; 9AWF, 106; 9ROO, 44; 9AMH, 30; 9BRY, 25; 9EP, 14. SPARK: Wisconsin: 9BQG, 32; 9DHG, 48. Ohio: SAIB, 424; 8CNL, 175; 8TJ, 55; 8BCO, 30; 8CMI, 4. Chicago: 9DWX, 38; 9AOY, 21; 9DMY, 18; 8CFP, 12; 9AES, 10; 9EDH, 6; 9DFV, 5. Illinois: 9DHZ, 140. Northern Indiana: 9BON, 72; 9CP, 10.

ATLANTIC DIVISION

C. H. Stewart, Mgr.

The general census of June traffic reports show a gradual decrease of messages handled and station operation. It is very essential, that even though message traffic falls off to nearly zero, that you should still report on the activities of stations in your district, and let us know what's doing. Nearly every traffic officer complained of late and absent traffic reports this month.

Every fellow knows that we have been getting wonderful cooperation throughout the Atlantic Division and did much to keep the time to fall vision up in front—now is not the time to fall down. We should all keep plugging and be all set for some "record" relay work in the fall.

Under the able direction of SAWP, Western New York has been pushing ahead. New life seems to have been added and many new stations have been given appointments. Vacancies existing for officials to act as district superintendents and city managers are being filled as fast as able men can be found. Every man on the personnel of Western New York seems alive and anxious to do something. For that reason it leads this month in handling traffic.

SAVD is the leading station this month for messages handled. SAVD, Waverly, N. Y., handled 825 messages; owned by Theron Tappan, who is our superintendent for New York district 11. 8NB is about ready to open up for traffic again, having been out of commission due to blown tubes. 8ASL is still bemoaning the fate of his district, (Dist. No. 16) which dropped in three months from 1400 to 0 messages. 8AMM says the whole works is shot with all good relay stations closed or out of order.

Some activity around Newark this month. Much interest is being shown by fellows around this section listening to station WAAM of the I. R. Nelson Co., Newark, N. J., on Tuesday nights. 2KK is manager of this station and is assisted by 2CMS. Both of these men are well known in the second district, and have organized what is known as "Amateur Night" from station WAAM. Tuesday night has been set aside for amateurs to sneak from this station. So far, a great many well known amateurs have given talks on subjects of general interest to other amateurs and A.R.R.L. men.

3CS buried his spark with appropriate ceremonies due to its unpopularity around Trenton. 2AWL says things are pretty slow and takes a lot of effort just to keep the gang together. 2AJF, who now and then likes to work a good spark set, says traffic is dying away as rapidly as it jumped. Official relay station appointments are still being put through. (Stick together fellows and we will open up all set and fully organized for fall and winter relay work.)

MARYLAND: 3TE is spending four months in France, and may have interesting news regarding the reception of American stations during the summer. 3HG has dismantled his set and moved but will undoubtedly be on in the fall. 3GZ has left for Schenectady.

DISTRICT OF COLUMBIA: Stations have been very active this month and seem to continue to be so. 3HS is moving to St. Paul and will open up there. 3AB is very active and is one of the best regulars. 3ZW's "radio central" will be on the air again, and it promises to be a "HE" set. 3JJ is the star schedule station, maintaining reg-

ular schedules north and south. 3DM, 3SU, and others have been hard hit by the heat, but are on the job at intervals.

DELAWARE: 3BBS is still under doctor's care but will be on in a few days. 3AFB will be on now that school has closed. We are losing 3BLV who is joining the ranks of the Navy. 3BSS and 3AIS will be on all summer, regardless of the QRN.

PENNSYLVANIA: Dist. No. 1. The Lansdowne Radio Assn. gave an exhibition of A.R.R.L. traffic to the local BCL's who showed keen interest to our game. 3BLU and 3BTL will be off the air for awhile. 3AWF, 3HH, 3ZM, 3ADX, 3BOB, and 3AKR consistently report for this district. Chester stations reporting are 3BIP, 3ADP, and 3ADQ.

Dist. No. 2. 3YO is closed until September.

Dist. No. 3. 3ATA and 3RH are the only stations that moved traffic.

Dist. No. 4. 3ZO claims their decrease in traffic is due to the change of wave length from 200 to 175. (What say, T.M.) Probably true because the gang does not listen down to even 200 meters. But wait!! It won't be long before the gang is down where we belong. At present, most of us are above 200 meters—(T.M.)

3AUV is still going strong. 3BJ has a good set but his "Hudson Super" works better in the summer. 3AUW sure has been bitten by the "love bug"—make her an op. OM.

Dist. No. 5. All the traffic was handled by 3CCU, 3CCX, 3BBV, and 3API. 3BBV will increase to 50 watts.

PHILADELPHIA: The entire city is very inactive. 3VW, 3HX, 3OE, 3IH, 3BJY, 3HD, and 3FS are the only stations reporting and due credit is given for their consistent support to this big city.

CENTRAL DIVISION

R. H. G. Mathews, Mgr.

Despite the summer weather, traffic in certain parts of the division has held up. This is especially true in Michigan and Northern Indiana where daylight relaying has come into favor.

We are sorry to have to announce the resignation of our oldest assistant division manager, Mrs. Chas. Candler, ADM for Ohio, who is also one of the oldest relay operators in the country. We can well remember old 8ANH and 8ZL and we regret to have to record the passing of their prime mover. We want to take this opportunity of expressing to Mrs. Candler our appreciation of her years of hard work and faithful service, and to assure her there is always a place open for her in the Central Division Traffic Department. (All hands regret it—TM)

KENTUCKY: 9EP is spending a couple of weeks with the Louisville gang on the river. 9LH has gone to New Orleans and has gotten a RCA ship bound south. 9ASE is putting out 4 amps. with 2 five-watters, 9CON sent three 5-watters west and his mast blew down. Roper says he will put up a new mast and make it a 50-watter this time. (Some spirit OM.) 9DRI has gone to New York where he hopes to get a good ship.

OHIO: Traffic for the month of May has fallen to almost nothing compared with former months. This is due to several reasons, among which are bad QRN. Stations are out of commission for repairs and rebuilding, expiration of tubes, operators ceasing operation for the summer months, removals to other territory, in fact, all the ills and alibis prone to amateur stations and their operators.

Dist. No. 5. Walks off with the largest district total this month, while district No. 4 has the honor to have the star Ohio station, and it's a spark station, too; SAIB came in with a total of 424 messages.

Akron city manager, W. F. Warden, will move away from Akron about the first of September.

MICHIGAN: Chas. Holmes, DS of district No. 3., has resigned because of lack of time. His successor will be appointed shortly.

We have plenty of good stations now in Michigan. The next thing is to keep them on the job. Daylight is the time to handle traffic in this

state. Many stations, not heard at night come thru QSA in daylight.

Dist. No. 1. QRN, power line leaks and a craze to change antennas (and replace those blown down) seem to have knocked traffic this month.

Much DX work is being done during daylight in accordance with a plan worked out several months ago. Special tests are being planned to demonstrate just what can be done with short jump daylight relaying. Every station operator capable of handling traffic is urged to send his name and details of his station to the DS at 321 1st Ave., Flint, Mich. at once. There is plenty of traffic to be handled and we want more good stations that can be depended on to handle it.

NORTHERN INDIANA: Despite the fact that there have been only a few stations on the job for the month, there is quite a fair sized message total. With the coming of warmer weather there seems to be an added increase in activity due perhaps to the fact that many of the fellows have come back from school. Several of the best stations are off the air for the summer and are rebuilding their sets, others who are out of commission now will be on the air within a short time and are getting lined up for summer work.

9FS has returned from Purdue University and is back on the air. 9EHI has only been in operation for a short time, is a beginner at the game, yet has rolled up a total of 218 messages. 9CBA and 9AZE are off the air for the summer. 9BEC, same story. 9EJU and 9EG are on the air helping boost the message totals. 9BCB is doing good work and will have a 100-watt fone and C.W. set going by fall.

Mr. Dreisbach, 9DFB, newly appointed city manager of Ft. Wayne, besides doing good work on the air, is getting the city lined up for good work. 9UR will be back on the air just as soon as a new mast can be erected. Both spark and C.W. will be used.

Dist. No. 2. Activities in the district have livened up considerable and relay traffic is going thru in great shape.

9DVK is the star station for this month. Both 50 and 100-watt C.W. can be used and consequently very good work is being done. 9BON is doing good work and will have C.W. installed in the near future.

In South Bend very little activity has been reported. 9FP, 9EBI and 9AKD have not been on the job much. 9BBQ has a 10-watt set under scout supervision and is doing good work with it. 9AKD has been having some trouble with his set and has not been doing much work. 9BBJ and 9CXZ will be closed until fall. 9EFL will open up soon with 10-watts. 9RE is a new comer and promised to have a 10-watt set in operation as soon as he gets settled. 9CP has his set going fine but has very little time to use it as he is working. He has been heard on the west coast with 50 watts. By fall, 9CP, will have at least one 250-watt bottle and as CP says "Let fall come."

ILLINOIS: Dist. No. 1. DS Burke reports that summer static has been very bad and that all the ORS's seem to be overhauling or in some way endeavoring to avoid the QRN. Only two ORS's have reported this month; 9BWA and 9BZQ.

Dist. No. 2. The meeting at Starved Rock was a huge success with about 75 of the prominent nines there. The Chicago gang, and 2 ops. from 9EFC in Missouri were there and to say it tritely, "A good time was had by all."

Dist. No. 3. 9BYX is putting in more power and making friends of the BCL's?? 9CDU has the novel plan of two sets. The large set is personal and the 15-watt set, 9AFQ, is for junior ops. 9MC has a 100-watter in operation. The 500-watter and new shack are incomplete at date, but Hen says that WNP will need to ground the aerial when he opens up. 9AWQ is back from Chicago and is sending his thanks to the Chicago gang for the courteous treatment accorded him while there. 9CLZ will have 20 watts in his new ether buster. 9CXT reports he has handled 44 actual messages this month. No "Tx for CRJ stuff goes." 9CMC is working off the air. 9DJG

is constructing a 100-watt set for fall. 9CTK 9CMN, 9DBW are all rebuilding or overhauling.

Dist. No. 4. We open with a complaint from 9DEZ stating he has not rated space for two months now, although he reported. 9DEZ being the only spark in the district is listed by himself and was overlooked in the summary. (Sorry OM, to omit a consistent worker, and won't let it happen again.) 9BIT, 9BIL, and 9DQU made a trip to Chambana and with 9DGR and 9ASD spent the day inspecting the stations of that town. The next week a return visit was paid by 9DGR and 9ASD to 9BIT and 9DQU. A fine time was had by all with beaucoup eats, F.B. all around. 9BIT, 9CFH, 9COX, 9BIL, 9BPW are rebuilding for the winter. 9BPW mourns a 5-watter and reports nil handled. 9BXD has acquired the title of assistant division publicity manager and is thoroughly engrossed in ministering to the duties entailed thereby. 9CZL laughs at QRN with 520 for his second month in the "Brass Pounders". 9DQU also came thru with a big bunch. (Note:—Apparently part of this report was lost—nothing followed this—TM)

Wisconsin: Dist. No. 3. Traffic is moving fine for this time of the year. 9DCT is installing a 54-ft. mast, and will increase to 12 watts soon. 9BHQ is heard on the air with 100 watts. 9BRO is getting a 100-watter percolating and has another 50 on hand. 9BCH has two 50's on hand but is waiting for good weather. 9DHG has two 50's and 1500 V.D.C. He is testing on 15 watts. 9DLG using 1000 V. on 5 watts is vy QSA. 9ZL has 3 fifties and is waiting for 1500 V.M.G. 9CSX, Green Bay, is disturbing the ether again. 9DIU has been heard on fone. (Let's hear your code OM.)

DAKOTA DIVISION

N. H. Jensen, Mgr.

The amount of traffic handled the past month is not at all discouraging. The spring fever wave that so much is said about, should be on its last legs very soon and many of the fellows will be back at the key regularly. Another effort will be made to get monthly reports from all stations regularly. (Gang: Please help us out by mailing a postal card on the 16th day of each month to your DS.) The DM would like to receive suggestions from any or all amateurs in the division about the betterment of amateur radio either in the division or nationally. What have you to offer?

MINNESOTA: Dist. No. 1. William D. Wagner of Duluth has resigned as DS and James Hayes, 9GW, 705 East 5th St., Duluth, has been appointed in his place. W. M. Edmont, 9ADF, is the new city manager of Duluth.

9BAV and 9BAF continue to hold up their end of the traffic business. Heavy tornadoes sweeping over this state within the past week undoubtedly have put some of our stations out of commission temporarily. 9DUQ and 9EA were the only stations that managed to stay on the job through the "static-barrage" of old man QRN. 9EGF did good work considering the time of the year. But as he has just sold his rock crusher, he will be off the air until next fall, when he expects to be on again with C.W. 9CMI has moved from Audubon to Crookston. 9ZC finds that his license expired during May and he is having trouble in getting it renewed due to some sort of mix-up. So he is off the air for some time, but will be operating again as soon as possible. Another new station has started at Virginia. The call is 9DTR and he is handling traffic. It is regretted that 9DUQ, one of the best stations in the district, will be off the air from now until November. This is because both operators have taken jobs outside the city of Duluth. With the loss of a number of stations, traffic will not move as smoothly as before.

Dist. No. 2. A new station is being built at 9YAJ which will have an output of 500 watts of pure C.W. The new station will occupy a very good site on a hill which is practically clear of material. 9QF leads with traffic this month.

Dist. No. 3. 9ZT reports antenna current around 11 and 12 amperes and that the west coast was

worked 47 times during the month of May. (That surely is pleasant news OM—DM) 9DOT and 9BPN are out of spark for good, which means that on good nights the C.W. will be unhampered in traffic handling. 9AUL has been heard in Australia. 9BJV is back in town (it never fails). 9BLY is in the limelight at present by putting up a 90-foot mast. 9APW expects to be able to duplicate the "pure" D.C. on motor generator (real stuff) in about a month. This will be a 400 watt, 1500 volt, separately excited machine.

NORTH DAKOTA: Most of the stations in this district have closed down for the purpose of re-building their outfits. Hence there is not much to report. 9AHC is all through with his valedictory address, etc., that goes with being a class



president. 9ABU expects to attend the University of Minnesota next year. The ADM fully expected to get married this month, but the YL in the case met with a serious automobile accident, and therefore the big event had to be postponed for six months. Sorry, OM.

SOUTH DAKOTA: Dist. No. 1. 9YAK has come to life again and is using 100-watts A.C.C.W. The station is being operated by 9ALN. 9CKT is a new station in this district and is doing good work with 5-watts rectified C.W. 9BDH is doing good work on spark.

Dist. No. 2. 9LWN is ahead of the bunch again this month in traffic handled. He has been on regularly in spite of QRN. 9BRI comes next in amount of traffic handled. He has been reported many times from the west coast and once from the east coast during the past month. Worked stations 1000 miles several times. 9CGA has been doing good work and has been on quite regularly. 9AUI has been doing good work. He has worked 1500 miles during the past month on 20 watts. 9AVZ is rebuilding his station. 9COJ, a new station, at Webster has been on several times and has handled a few messages. 9NM is going with 5-watts I.C.W.

DELTA DIVISION

W. W. Rodgers, Mgr.

This marks the first appearance of the Delta in QST under the new management and is the first time it has been represented for several months. Therefore, the report is very slim this month.

An election is in progress in Arkansas for the purpose of selecting an ADM for that state to succeed Mr. R. L. Pemberton who has resigned. By the time this is read the name of this officer will have been announced to the Arkansas personnel. Therefore, we have no report from that state for this month.

W. L. Kennon, ADM of Mississippi, is actively engaged in lining up the gang in his state, but owing to the severe QRN prevailing there, the interest has been lagging for some time. 6YE, the only station reporting, handled 16 messages

and says he is lucky in that he has escaped being electrocuted by lightning.

Unable to effect connection with Mr. F. L. Pullen, ADM, of Louisiana, we will not have a report on Louisiana this month. 5KC has done good work on 20 watts, having reached down near the Australian Coast on this power (copied on detector, too) and handled 183 messages last month. (F.B., OM.)

Mr. B. F. Painter, 5MB, has been appointed DS of the second Tennessee district to succeed S. W. Wilkinson: as he was appointed during the last days of the month, he has no report this time.

City manager Brooks of Memphis, reports activity on the decline. QRN has hit this state in earnest, but we have had promises that our old stand-bys will carry on this summer. Traffic is being handled thru Memphis by 5NZ, 5NV, 5EK, 5BW, 5PV, 5ZB, and (on 250 watts) 5ZBA (ex-5LJ and 5ZABA). 5ZB reports trouble with his 250-watter, and we all wish him luck. We need him during this QRN season. 5AHJ's masts are down from a hi wind; ND here. City manager Lanier of Nashville reports very little activity there. 5FV, the only station operating handled 40 messages. 5AAB is rebuilding and will reopen with two regular ops.

EAST GULF DIVISION

B. W. Cochran, Mgr.

One of the outstanding features this month is the fact that three old-timers, whose signals had not been heard for many moons, are again on the air. 4GN, the valuable gateway for Florida traffic, is doing great work on spark, in mid-summer, too. 4II has been off at College, but is now back, and 4GL, 100-watts this time, is QSA most anywhere.

We realize that it takes considerable nerve and "stickability" to try to handle traffic in the face of the fierce atmospherics that are our lot during the summer months. We know that it is often impossible to even hear signals, much less read them, and only by taking advantage of the lulls that occur in the heavy QRN can traffic be moved. Our hat is off to the gang that has stuck and in spite of such conditions has put thru our traffic. (Fine work, men.)

ALABAMA: At 5XA, practically all the operators have gone home for the summer and in addition they had the bad luck to shoot all their tubes. 5AGJ leads the state in traffic handled: he is on regularly. 5CP and 5UP have handled quite a nice bunch this month, also. 5AME is reaching on "nice" and also handled some traffic. 5ACM has opened up and will handle traffic there as 5VV is moving to Birmingham.

GEORGIA: Atlanta: 4KU is leading the city and is doing the most consistent work. 4MB has rebuilt his set and gets out much better now. 4HW is moving to South Carolina. 4EQ has done some good work this month. 4MY is shut down for the summer. Most of 4HS's traffic was handled on spark. QRN has not stopped 4NA whose 50-watter is getting out great. 4DO is going strong. The ladies keep 4CG busy but he finds time to handle some traffic. 4AZ is doing good work with his 10-watter. 4FJ has been elected president of the Atlanta Radio Club, but finds time to handle some traffic. Other stations who are on occasionally are: 4BI, 4ME, and 4DN. 4GM is bothered by local QRM (ladies). The set at 4CY is being rebuilt. Fine work has been done by 4IO on spark. He has gone north to visit the hams he has worked. Savannah: 4EL has handled practically all the traffic this month. 4BY has been on, but not often. 4GL is installing 100 watts with generator supply and is oiling up that bug. Athens: 4AG has been on the air but little this month. 4FB is out of the game because of his college work. He has reported working most all stations he can hear. 4DB says he has been busy earning some ready cash but found some time for relay work. 4DT is on the air regularly and handled a nice lot of traffic. 4OD handled a few. A newcomer is 4AY at Macon. He should be a clearing point for traffic south from Atlanta.

4GN, on spark, is on the air again and is doing fine work for summer. 4BQ is off on a vacation.

FLORIDA: 4IL, an old-timer, is back from college and should do some great work in his section. 4HZ's activities are practically nil this month because of graduation. 4FS lost his antenna and counterpoise in a storm but got it rebuilt in time to operate for four days this month; reports better work now than he has ever done before. 4MT has been away from home and probably will not be able to operate before fall.

HAWAIIAN DIVISION

K. A. Cantin, Mgr.

With summer weather and OM static on the job it does not seem to effect the stations of the Hawaiian Division and messages handled for this month show a fairly good increase.

Dist. A. Honolulu: 6ASR after testing out many locations has at last found a site where coast signals come in QSA and fairly free from QRM and QRN. (It must be a ham's paradise). He is pushing his signals in hopes of raising the coast. 6CCR and 6TQ are still on the job.

Dist. B. Hilo, Hawaii: 6CEU with his C.W. is making so much noise that the fellows on the coast must be deaf if they can't hear him. 6AND is doing likewise with little success so he is taking a trip to the mainland to try reception of signals at that end of the Pacific.

MIDWEST DIVISION

G. S. Turner, Mgr.

IOWA: Traffic in Iowa slumped considerably during the past month. A total of 374 messages were handled, less by a whole lot than was ordinarily handled by one station last winter.

9AHH reports a new station in Eagle Grove. 9AKE is using 50 watts, and possibly 100 later on. This fellow was formerly a BCL but is now a real A.R.R.L. op. Bully for you! 9UL says everything is dead there at present. 9BIF is leaving on a summer trip to visit some of the eastern hams. 9ARZ now has his new antenna up and expects to continue his consistent work. "Smatter Davenport? 9CS as usual on spark, is doing good work. 9BPV and 9CWF both are doing nice work but could use a larger message total. 9BTX expects to have a 100-wattner going soon. 9AED is handling considerable traffic on C.W. 9DJJA and 9DXU are also helping some.

NEBRASKA: 9ASO is the star Omaha station this month. 9AQK is second and 9YU third. 9DNC of Lincoln is the only station handling traffic on spark. Hurrah! It is with regret that Mr. Rohwer, 9AYS, of Lincoln, has found it necessary to resign his position of CM. He is traveling this summer and will be unable to keep up his correspondence. Palmer, who is DS of South Nebraska, will do his work until a new CM can be located. 9EW, has been very ill with pneumonia but is now quite recovered. The DS of North Nebraska reports that on short daylight routes 9AED and 9JF are taking the traffic east and 9EAK, 9BWM, 9BCF, and 9CXF are handling the traffic in all other directions. All Communications to AA7, the Nebraska National Guard station, should be mailed direct to 9ATC. 9AQK reports that traffic is easily relayed in all directions but west. 9EHN, an Iowa station, is a good opening for all eastbound traffic. 9ATC is maintaining a daylight schedule at present and handled 96 messages during June. DS of South Nebraska reports 9DNC and 9BDU are the only active stations at Lincoln. Almost forgot to mention that 9AVC and 9YU deserve special mention for their efforts during this past month of storms and gay bathing suits. 9DXY is looking for another op. to push his key while he tries to keep on top of his publicity program. Don't need to worry tho for Quinby is the fellow who can do 'em both in fine shape.

MISSOURI: 9RR is visiting up north. A few stations are doing all possible to keep up traffic. The KC report this month has been handled by 9DJB. Six stations in Kansas City are active. 9RKO, 9ACX, and 9AYL are doing good work.

9DJB is having a deuce of a time with a sync rectifier. Can't some successful ham help him? 9SS is quite consistent and either he or some other KC station may be able to arrange an early A.M. schedule with Wichita, according to 9CWC. At St. Joseph, 9DIT was the only station who handled traffic. 9CTC has shut down waiting for it to let up a bit so he can hear something. 9BZH has gone to a radio school and expects to get back next fall. 9VB and 9EFB are the remains at Sedalia, others are shut down. The eastern half of the state is also in the throes of QRN and only a few of the stations are active. 9EKF gets appointed ORS this month. 9DXN and 9AAU are the only remaining consistently active stations left. 9BLG was active in the earlier part of the month but shut down in a few days 9BHI is doing some work and getting out fairly well. At the last moment, 9CAO, 9DAE, and 9EFB were heard from, via postal from 9RR.

KANSAS: No report was received from 9AOG, 9CWC at Wichita, however, has furnished much information as to what is going on in Kansas. From what he says, traffic is still being handled. He is working west regularly having a number of daylight routes in effect with stations west as well as east of Wichita.

NEW ENGLAND DIVISION

I. Vermilya, Mgr.

With the coming of warm weather and beautiful moonlight nights, our traffic has, of course, taken a slump. We suspect that some of our operators are subject to this sort of "moonshine" at least. "HRX" opines they probably are. But, with WNP on the air and our old friend Mix at the key, we will undoubtedly find that there will be a great deal more interest in our field and work than ever was in any previous summer. "WNP" will give all you DX hounds a chance to show your records as Mix is keeping an accurate log of all stations heard. We all know ITS of "calls heard" fame.

MAINE: 1CDO will be on duty every night after 10:00 P.M. 1BJS is another station heard quite regularly. 1ACO will be on from 5 to 7 P.M. and after 10:30 P.M. every night. 1BDI is temporarily out of order. Although 1KX is not doing volumes, he is doing some remarkable DX work. Mr. Edw. McShane is giving over active part of his work as assistant to M. Pierce, until next fall, and we feel mighty proud of his good work. 1FM is doing some good work with his new C.W. set. 1BNL has just passed his commercial license and is feeling pretty cocky.

VERMONT: While this state is not setting the world on fire with huge traffic reports, still, the fact that the division manager found R. P. Slayton on the job the other morning at 4:00 A.M. is proof enough that he is on the job. It's not his fault that no one in Vermont uses our relay system, and after this 4:00 A.M. experience, we expect to find "R.S." on the job ten years from now.

MASSACHUSETTS: Hot weather or something has hit this district an awful wallop. 1BSZ hasn't been heard from. Local amateurs have been handling messages between Boston Navy Yard and the Naval Reserve Headquarters here. 1AHI reports 60 miles on one UV-201 with a one inch coil. Says he will gladly QSR. 1CPN is reported heard at 7LR. 1DY had a visit from A. H. for 3HJ.

RHODE ISLAND: 1BVB with 207 and 1BQD with 102 seem to be the leaders of this section of New England. 1GV has moved, also 1IL. We understand that 1II has moved to his summer home at Chepachet and that his YL is running his 1II station. 1OW is rebuilding his station and will be going full swing shortly. 1BES is going again. 1BVB continues to be the most active station. None of the stations, however, got into the "Brass Pounders' League."

NORTHWESTERN DIVISION

Bird B. Bliss, Jr. Mgr.

Too much restriction, QRN and summer vaca-

tions are probably the major cause of our poor showing this month. However, the minor cause must be laid upon the eliminating of worthless messages. That is one old habit that seems to be dying out of the division.

OREGON: The ADM, Mr. Hoppe, is to be congratulated on the good work he is putting over in the reorganization of his state. New ORS appointments are soon to be given out and then we may expect more and better reports from the stations in this state.

Dist. No. 1. 7LR and 7SY are still knocking off traffic with their five-watters. 7HF has gone to sea. 7CQ is back from a recent voyage and will do his bit. 7IW is on quite regularly.

Dist. No. 2. 7OH and 7QT are handling their share of traffic. 7AGE is the new DS and will have a 50 working in the near future. 7ADJ is the only stand-by in Albany.

Dist. No. 7. 7IQ reports that nearly everyone is rebuilding and everything is practically at a stand-still. 7KI is constructing a 50-watter to replace his fiver. 7JE is handling most of the traffic.

WASHINGTON: No report from the ADM this month. Stations in this state have also got the spring-fever and are reconstructing their apparatus and falling for "dame nature." Thus, traffic suffers. The same stations as last month are holding down the traffic; namely: 7AJK, 7NS, 7JS, 7AHQ, 7GE, 7WA, 7SC, 7DC, 7AF, 7EB, 7SZ, 7ADO, 7UU, 7BJ, etc.

IDAHO: Mr. Wright, 7IO, has been appointed DS of Idaho district No. 2. He has been doing excellent work on 10 watts and is on the job nearly every night. 7LN is on again with five and a half amperes going in to a dandy new six wire cage. 7JF and 7AGU are still wiggling the key but are not on very often. 7PJ is off the air for a little while but will be back again soon with more power. 7ZI and 7ZN have not been on lately due to the new government restrictions, except Saturday nights. As a result traffic has fallen off through Boise, which used to be a relay center.

MONTANA: Most of the traffic handled through 7ZL, the ADM's station, has been handled during daylight. Other stations working are 7ZU, 7ZF, 7AGF, old 7HM, and 7AJX.

PACIFIC DIVISION J. Vance Wise, Mgr.

This division shows a scarcity of reports this month, due doubtless, to many reasons and the temporary absence of division manager, Wise.

CALIFORNIA: Dist. No. 1. 6ZH reports several stations still on the job for traffic. 6AVR will not be on regularly for some time on account of overhauling for next winter. 6ALK and 6EC are moving. 6NX reports installation of a 50-watter, and some good eastbound work. 6ABK says traffic is moving up and down the coast easily but bad weather has caused many stations to take temporary vacations. 6VK seems to be laid up with chicken-pox which may seem funny for some but not for him—HI. 6BRU does not expect to be on until next winter. 6CC and 6TC have been on the job more or less erratically, all the month; both are very busy just now and will not be on much steadier until later in the year.

Dist. No. 6. There are not a great many of the old stand-bys on the air now, due to the approach of summer weather. Traffic that is being handled is going thru in fine shape. The best route to the east seems to be by the north. 7ZN is handling a large amount of the traffic for east and northwest. The spark stations here do not cooperate at all with the C.W. and consequently there is a good bit of friction between them. Several Bay stations are changing to C.W. 6BOS and 6ASN are holding up the spark and very creditably. 6AOA is off for repairs to antenna. 6ASJ is doing fine work on 50 watts when he finds time to get on the job.

ROANOKE DIVISION W. T. Gravelly, Mgr.

Due to conditions, traffic has dropped off con-

siderably during the past month, but the outlook continues very satisfactory.

Assistant division manager Heck, of West Virginia, has found it necessary to resign; he will be succeeded by J. L. Bock, of Farmington, who will guide the destinies of that state. We all pledge him our best support, and will help him make West Virginia one of the leaders.

WEST VIRGINIA: ADM Bock has just begun to take hold, which necessitates a short report. He states that almost all of the stations are refining or enlarging their transmitters, and that very little traffic is being handled. DS Jones is off on a vacation. 8CHO has an acute attack of "Forditis," but gradually improving. 8BPU is installing 50 watts. 8AMO is down and out, temporarily, but has new tubes on the way. 8ATP and 8CHQ are handling traffic. DS Morris and 8BDA are silent due to the fact that Morris is working on line gang during summer. The ADM is progressing with his 100-watt set.

VIRGINIA: Dist. No. 2. 3SG is doing fine with one 5-watter. 3ABS using one fiver is doing fine daylight work. 3AUU, 3ATS, 3AOT, and 3BCH are all out of running. 3BMN is still hitting the high spots, but is having his troubles as well.

Dist. No. 3. Swimming holes have opened up, and other outdoor amusements have crippled this district. 3CFV is a new station with 100 watts. 3BVL has been on the air since Teddy got in from V.M.L. 3CDZ and 3BQX are on very little. 3AGJ handled a flock of traffic. 3CEL is doing the same thing. 3BJJ and 3MO are rebuilding their stations. 3NO is on with 10 watts. 3NF is learning to operate a bug. (Have mercy on us—TM) 3VO is on very seldom.

Dist. No. 4. 3TJ, the only station in this district, is sticking with the gang. He is building a new shack to take care of increased operation.

Dist. No. 5. 3IW has one of its operators on sea duty with Reserves. 3BUY is back again. 3BOF and 3SK are once in awhile.

Dist. No. 7. 3ASP is getting out in fine shape. Dist. No. 8. 3APR continues to pound brass to such an extent that he blows tubes of all varieties. Hard luck continues to follow him, but there is no more consistent station in the United States. 3AGJ is to be commended for his splendid traffic report. A report of 517 Messages is not bad for this time of the year. Commendations are also due to the entire state of Virginia for its performances.

NORTH CAROLINA: Reorganization is under way in several quarters. IBX, G. S. Smith, Wilmington, succeeds Donohue as DS for district No. 4. 4FT, Donald Parsley, goes in as city manager for Wilmington, and Mr. Donohue as city manager for Raleigh. 4ID is out of the running, having moved to a location where the erection of an antenna is out of the question, but says, "With a WILL there is a WAY." 4EA has his troubles, but continues to hit the distant spots. IBX and 4FT continue to be the leaders in this state, and always give good accounts of themselves.

PORTO RICO: Traffic with the states is at a stand-still. With a reliable schedule, two-way communication could be maintained between Porto Rico and the states with fair results.

ROCKY MOUNTAIN DIVISION N. R. Hood, Mgr.

The DM came closer to having nothing to report this month than ever before. QRN hits this part of the country with a bang and this reason has been no exception.

The following changes have taken place in the Operating Department personnel since last report: Paul M. Segal, Equitable Building, Denver, elected by popular vote as Supt. Dist. No. 1, Colorado, vice Philip Laskowitz, resigned account leaving state. Roger Howell resigned as DS district No. 1, Wyoming account of leaving state. No successor has been appointed as yet. 9EEA appointed ORS, also 6BUH and 6ZAM.

 9CAA (C.W.) 147 Msgs.
 C. R. Stedman, Denver

COLORADO: Traffic has dropped off in Colorado to an almost unbelievable point. (QRN. Gangl! Don't let up entirely.) 9BXM is operating at 9EEA, the station of the DS.

Dist. No. 2. M. O. Davis, DS, reports a good daylight route in that part of the state. Denver stations are heard down there in daylight and may be added to the new route.

WYOMING: Things moved slowly in Wyoming due to continued electrical storms, rebuilding, and the seasonal relaxation. 7LU and 7ZO have been off entirely rebuilding. Our stand-by's 7DH and 7ZV put most of the traffic thru this time. 7LU and 7ZO will be on the air by the time this appears in print.

The 7th district radio inspector made a trip thru this state the latter part of June and we were mighty glad to welcome him to give us all a good tuning up. The state is better off "radioly," for his visit. The southern part of the state is null and void when it comes to traffic reports or any other information.

WEST GULF DIVISION
 F. M. Corlett, Mgr.

Summer with all its trimmings has arrived! There's no doubt of it! Local HE electrical storms think nothing of parking for twelve hours, playing havoc in general, even to taking human life. This has been almost a daily occurrence.

NORTHERN TEXAS: Dist. No. 1. Fort Worth: 5AIF, leads the "Panther City" with 422 messages to his credit. 5QI helped out along with 5MN, the three totaling 613. 5MZ, Alton Graham, 808 W. Magnolia, is a new A.R.R.L. station, and is ready for traffic. Denton is at last on the relay map for the first time with 5NY (Edgar A. Fain) 5NW, and 5AMP (being operated by Wayland Groves) the last two are C.W.'s, and moving traffic right along like old timers. Dallas: 5HY, who has just recently converted to C.W., leads the crowd with 110. 5AIC with spark, is a close second with 100 even. 5HY works 10MK, 7WM, 9PTA, etc. 5IX is back on the air with a new mast, "n everything," and will lead 'em a merry chase. 5TC, at Vickery, just outside of Dallas, will take your Dallas traffic too. Terrell: 5FX pushed 128 along their way in the last two weeks and worked 3ADN, 4EB, 6BRH, five 8's, 9's galore. (Looks like a good relay point—DM) 5UD is a new A.R.R.L. station to help out. Give these fellows something to do. 5FX works regular and so does 5UD. Greenville: 5ACQ includes no "rubber stamp" messages in his report. (Why not call those "red card or h'rd y'r sig. QSA, etc.," SVC MSGS, and count 'em separate, or not at all?—DM) 5GN has handled the bulk of traffic for Greenville, 5AL and 5IS lending a hand now and then. Sulphur Springs: 5JH represents this point with a spark. Commerce: 5TU is out of commission, rebuilding. Texarkana: 5AER has shut down a month for repairs. Grand Saline: R. A. Eggert used to listen to the "one-way" stuff, but is now known as 5AIL, an A.R.R.L. station, and handled 8 messages his first month. Another town added to the A.R.R.L. relay game for the first time! Denison: 5AHC represents this place and says "tell 'em to shoot 'em along."

Dist. No. 2. (Minus a DS, but will have one soon—DM). Clearborne: Is also a relay point now. 5UY and 5AFH (while this is their first report) handled 31 and 35 respectively. 5UY will be off the air two or three weeks and 5AFH says his power transformer went west. They will be back by the time this is in print, no doubt. Waxahachie: Pass your traffic for this "tongue-twister" to 5AJT, he will handle it. Waco: 5ZAF will again be on the air for real traffic. Hurrah for Waco! Coming back with a 100-watter, 50, and a 20, D.C. C.W. Corsicans: 5FE, Roy Miller is a new A.R.R.L. station altho he has been in and out of the game off and on for some time. (Glad to have you with us Roy.—DM) West: Mr. Tom McGhee,

operating 5FA, takes 'em for and thru this little city. Jacksonville: 5FC will have another 10 watts added shortly, making it a 20-watter, also changing antenna and will be going strong shortly.

Dist. No. 3. 5UO, Wichita Falls, DS. Wichita Falls: 5LL, 5UO, 5CY, and 5UN are holding the fort here, 5UO with new mast, antenna, and a 50-watter, would appreciate reports on sigs. 5ZADA requested a better call and drew 5ZBC!!! (Hi.) 5HQ has "recovered" from the YL craze and has settled down to winding a hi. voltage trans. Dist. No. 3. has 112 messages. (Smatter Mineral Wells, let's hear from you—DS)

Dist. No. 4. 5XAJ, Dublin, DS. Dublin: Looks like 5XAJ did all the work and he was only on six nights on account of misunderstanding of some kind with a motor cycle in which 5XAJ did not win the entire argument, "horrible details lacking" but we assume he is recovering and the motor cycle will never look the same again. Grandbury: 5AJ, Jefferson McLean Cogdell, is a new A.R.R.L. station at this point. Thurber: Will now be in the relay game though 5AKM, owned by Mr. J. C. Walker, which is also a new A.R.R.L. relay station (Atta boy!)

Dist. No. 5. 5ZH, Amarillo, DS. Transmitter still out of commission but expects to be going

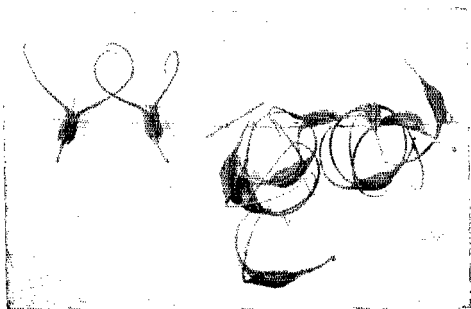

Some "Texas Static"—as submitted to us by 5IP

OK soon. Lubbock: Has two new A.R.R.L. stations; 5AMI, Robert N. McCollom, and 5AIJ, Paul M. Hargis. This should make a good relay point for points west with 5ABJ making the third station there to hold it down.

SOUTHERN TEXAS: Dist. No. 6. Houston: 5NN seems to have done all the work in handling 53 messages during the month. 5ZK reports 6, (Only 2 of our 6 official relay stations reported and a total of 27 A.R.R.L. stations—what's the matter fellows? No one to blame except yourselves, each individual does his own direct reporting to Division Headquarters; the ORS being furnished a stamped, addressed post card for the purpose. Come on, snap out of it, and let's go —DM) 5JQ, Albert L. Berthold, 1108 Arlington St., is a new A.R.R.L. station. (Welcome OM —DM) Galveston: 5VY is the only station reporting from the island this month; the route to Mexico is still open and he is looking forward to the opening of a station in Panama soon, then a route to Central America and South America—O! Man!!! 5AKO, Ora W. Chancellor, is a new A.R.R.L. station on the island, Port Arthur: 5XV relays for this point. His aerial is to be raised from 40 to 60 feet, altho he has worked Minneapolis and has been reported in Ithaca, N. Y. Orange: 5AMA is the 500-watt relay station of the First Presb. Church, owned by Rev. E. T. Drake, and operated by W. E. and Gordon Gray. "Traffic is moving OK." 5XAD is rebuilding at the edge of the town.

Dist. No. 7. 5YK, New Braunfels, DS. San Antonio: 5VO has a schedule with "BX" in Mexico, 5:30 to 6:30 A.M. Sundays, Tuesdays, and Fridays. 5VO and 5ZAE seem to be representing San Antonio this month. New Braunfels: 5YK is

(Concluded on page 57)



Greater Amateur Radio

Wherein Facts Are
Linked With Possibilities

Within the last few years rapid advancements have been made in amateur radio. Records have been made and broken and transmissions that a few years ago would have been considered impossible are now commonplace. Indeed, who can say how long it will be before some enterprising amateur comes out with the caption, "Our signals cover the world" in large letters across the top of his station card. Yet this day is not so far distant as it may seem. Our latest record is the reported ten-thousand-mile reception near Ceylon of 5IM. (see page 61, July QST.) This, coupled with the fact that calls of over a hundred amateurs from every district in the United States have been heard eight thousand miles away in New Zealand on a single tube leads our minds to thinking. What are the ultimate possibilities of amateur radio DX work?

We are fast reaching the stage where we speak of thousands of miles as though they were city blocks. Think for a moment of the earth as a whole and let us see what happens to the radio waves as they travel over the surface. The world is some 25,000 miles in circumference, making a little over 6,160 miles one quarter of the distance around. Radio waves, so the books tell us, travel outward in all directions from the sending station in ever-widening circles, following the curvature of the surface of the earth. As they travel outward their energy becomes spent and they weaken because of the large volume of ether they are putting into vibration. Once the 6,160 mile line is reached however, the waves no longer travel outward in increasingly greater circles. The roundness of the earth reverses the process, causing the waves to converge again and grow smaller in diameter instead of larger. If the losses due to absorption—and absorption over sea water is a minimum—do not increase at a greater rate than the convergence of the waves there is good reason to believe that the waves will actually build up and as the antipodes are neared, signals will become stronger. In

other words, as the distance between the transmitter and the receiver becomes greater, the strength of the received signals will increase! What is more, the above theory is borne out by operators who have copied amateur signals at exceptional distances from the transmitter and have had the opportunity to observe this very thing.

An important element that enters into the question when long distance amateur communication is undertaken is the seasonal difference between a station in the northern hemisphere and another in the southern hemisphere. From June to September is the period of the best radio weather of the year in the southern countries and Christmas day in South Africa, so we are told, is one of the hottest days in the year. Consequently, on account of the heavy summer static that is bound to prevail in one place or the other, long distance tests can be carried on with best success in either the spring or the fall of the year. In this way totally adverse conditions are not encountered at either end.

The difference in time between two places differing greatly in longitude needs careful consideration when thinking of extra long distance communication in an east-and-west direction. During the summer especially, it is only for a brief period of less than an hour a day, if at all, that it is dark both in New Zealand and the United States. It has been found that 200 meter signals carry signals best just at dawn or dusk. Perhaps this accounts partly for some of the recent ultra-DX records.

Notwithstanding the above factors which tend in part to discourage long distance amateur communication, results to date are truly wonderful. If radio transmission conditions are as good in all other directions as they are between this country and Australia, the signals of the scores of American stations who reached that continent successfully in the recent tests should be heard in Hongkong, throughout nearly all of Asia, and Northern Arabia. These signals would also go directly north over the north pole to Cairo, Egypt, besides covering the whole northwestern part

of Africa and taking in all of South America. An area is represented of over three-fourths of the earth's surface, leaving less than one-fourth unconquered by amateur radio. This is as much as to say that southern Africa and India are practically the only countries in the world where the signals of American amateurs cannot be heard—that is, at the present time!

What will International Amateur Radio be in the near future? Even now, amateurs in various distant countries have transmitters on the air, endeavoring to reach out and communicate with amateurs in other countries. The list includes radio

gets together and the amateurs of this country whole-heartedly extend the helping hand to the amateurs across the seas and cooperate with them in order that they will learn how to hook up a transmitter and receiver, and annihilate about six thousands miles, then we'll all get together and put through the ultimate in amateur radio a "round the world" relay.

In New Zealand

With the arrival at QST Factory of the May, 1923, issue of the "New Zealand Wireless and Broadcasting News," published at 115 Taranaki Street, Wellington, N. Z., we take off our hats to the New

Italian 11ER

Here's what the inside of an Italian amateur station looks like. 11ER puts $1\frac{1}{2}$ amperes into a low antenna; has worked 120 miles on C.W. to Italian ACD; and is planning to listen for American 'sigs. in the near future.

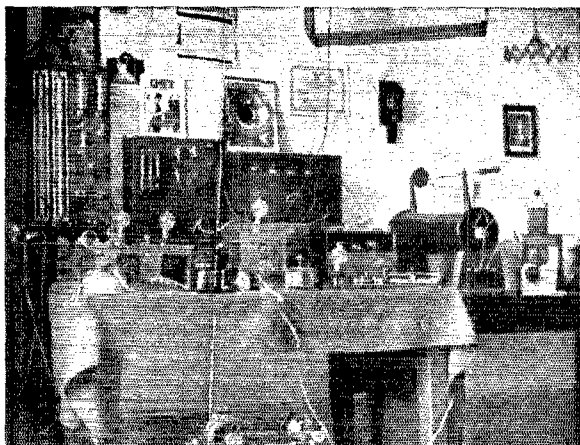

enthusiasts in England, France Italy, Czecho-Slovakia, Poland, Australia, Japan, New Zealand, the Argentine Republic, South Africa, and possibly India. The distance corresponding to that from any one of these stations to its nearest foreign neighbor has on many occasions been more than bridged by the signals of our own stations. It now remains for the amateurs of the United States to give all assistance to these fellows in other countries in order that they can perfect their equipment and cover the "big DX" we do. Those of us who are able to read a foreign language are particularly fortunate in this respect and will surely experience a great deal of pleasure in corresponding with an amateur in a foreign country. This is what should be done. Get hold of these foreign hams, compare circuits and equipment, arrange tests with them, give them the benefit of your experience and help them as much as you can. The A.R.R.L. now has over two hundred members in foreign countries, all of whom, to the extent allowed by their governments, are enthusiastic over the idea of linking together the countries of the world by amateur radio. Just as soon as everyone

Zealanders for being close behind if not right up with the U.S. in amateur radio.

The regulations there require the payment of a small fee for a receiving license and provide a penalty of ten pounds or imprisonment for three months for using a "single circuit tuner" or any other arrangement that unduly energizes the antenna. Three coil circuits with loose couplings are permitted, however, and it seems that those getting the best results in receiving are using some such circuit. Activity in transmission is limited, but even so, New Zealand amateurs have transmitting sets and "get out" even though the power is limited to 50 watts (presumably output) on a maximum wave length of 180 meters.

The signals of Mr. MacIurcan of Strathfield, Sydney, Australia, often bridge the 1400 mile gap to New Zealand, using a set with a plate input of 16 watts. On good nights the signals of New Zealand amateurs reach Australia and communication is established. Transmitting sets in New Zealand are small, though numerous; antenna currents ranging around 1.5 amperes are the average. Communica-

(Continued on page 58)

Who's Who in AMATEUR WIRELESS



DONALD H. MIX, WNP

We are justly proud to be able to tell the bunch this month about the operator of WNP, the polar exploration ship, "Bow-doin." It has already been related in the pages of *QST* how the A.E.R.L. was asked to furnish a radio operator for the Mac-Millan polar expedition; how the country was canvassed; and how one Donald H. Mix, an amateur of Bristol, Connecticut, was chosen as the radio man for the trip. A true amateur, he is just the man for the job and we can be sure that he will conduct this pioneer work in taking radio into the Arctic with typical amateur zeal.

Mix is an old-timer in the amateur radio game and during the six years that he has operated his own station, 1TS, he has been one of the most active and best known amateurs in the Eastern section of the country.

(Concluded on page 57)



NORMAN R. HOOD, 7ZO

Alongside of the Father of Waters, in the town of Burlington, Iowa, at a time when Marconi started to holler that flat galvanized iron strips were not good radiators of energy, Norman R. Hood began his radio career. The mast of his first station was a ten-foot length of galvanized iron down-spout flattened out and hung on a bracket placed on top of the time-old place for radio beginnings—the wood shed. Next, with a hay wire (actually hay wire) antenna with a $\frac{1}{4}$ inch spark coil and a silicon detector with six volts through it to get increased sensitivity, he made for greater DX. The set was sensitive all right, as every foot step in the block was registered on it, microphone fashion. This was in 1910.

Mr. Hood obtained the license for the Burlington High School 9XL in 1914 and

(Concluded on page 57)

Strays



Calibrate Your Receiver and Wave-meter on Aug. 15th and Sept. 13th

Due to an omission in the article "U. S. Will Send Standard Waves for A.R.R.L." on page 28 of the July, 1923, issue, no mention was made of the dates of transmission. Signals will be sent by WWV according to the schedule there given on the evening of August 15th and September 13th only.

While the signals begin at 11:00 P.M. E.S.T., the 200 meter signals are not sent until 12:30 A.M., 1½ hours later. All stations should QRX promptly at 12:30 or before in order not to interfere with operators who are making use of the standard waves in calibrating their receiving sets. WWV is using lots of power and should be heard over the greater part of the country.

Don't forget to let A.R.R.L. headquarters have a detailed report of your results with suggestions as to further schedules.

Page 28 of the July QST tells how to record the wave lengths accurately on your receiving set, and page 47 of May QST tells how to transfer the wave length readings from your receiver to your wavemeter, using a "siphoning wavemeter" (We can only guess who originated the term "siphoning wavemeter" as applied to Fig. 1 on page 47 of the July QST. It is probably called that because the wave lengths are picked up out of the receiving set and dumped or siphoned into the wavemeter. Don't you think so?)

Let's all listen for WWV on the above dates and calibrate our sets!!

During the recent Kiwanis Convention in Atlanta, Ga., the Atlanta Radio Club received some mighty fine comments from the visiting fellows on the way they co-operated in handling over a hundred messages from the visiting Kiwanians to their homes. F.B., OM's; show what amateur radio is good for.

In addition, here are congrats to the Atlanta gang and especially to 4HS, 4AP, and 4KU for that dandy "Column for the

Knights of the Key" maintained by them in the "Atlanta Journal." It's great stuff.

A. A. Kubiak of old 3VV and 3ZZ is laid up at the Catawba, Va., sanatorium, and would appreciate letters from the gang.

Incidentally, many of the questions received by our A.R.R.L. information service have signatures and addresses that are unreadable. What's your address, OM, so we can QSL?

3TF has received a confirmation on his reception of English 5MS. Perhaps if more of us would listen for English signals they would be glad to reciprocate.

QST to Lightning-Switch Makers

We amateurs are required by the Board of Fire Underwriters to protect our sets with a lightning switch. Yet that is not all. The amateur is very much interested in the insulation of the switch at radio frequencies, because every precious watt that goes into his antenna has a chance to be wasted at the lightning switch. Switches available at the present time are all imperfectly insulated for radio frequencies. A really good lightning switch, to be accepted by the amateur fraternity should be insulated with some kind of glass or porcelain (or hard rubber if kept dry). Who'll help to remedy this situation?

Radio: "Who was the first radio engineer?"

Wireless: "Adam, because the first loud speaker was made from his spare parts." Ooo—oh!!

We regret that thru error the name of the author of the article entitled "A Filament Lighting Transformer from an Old 'Thor'", was omitted from page 33 of July QST. The article is by our old friend M. H. Pancost, of 8ZF.

3VO and 5XAJ on five five-watters, and 6PL using two five-watters have also bridged the few thousand miles to New Zealand.

Next!!

Dear Eddy:

How can I eliminate the dots and dashes in my receiving set?

Wireless Willie.

Dear Willie:

Use the following circuit for eliminating the dots and dashes. The dots will be eliminated by falling through the meshes of the first sieve while the dashes will

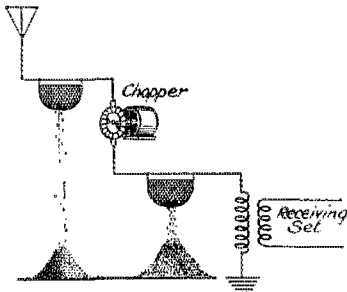

pass on to the chopper which will chop each dash up into three dots. They will then fall through the next sieve, and so when the music reaches the receiving set, both dots and the dashes will have been eliminated.

—Eddy.

6ZAC Returning

Cliff Dow of 6ZAC fame, who was the first amateur in the Hawaiian Islands to communicate by amateur radio to the states, wants to remind the gang that there's a wonderful new winter coming. There's going to be a new 6ZAC on the air too. "I'm getting ready to stick up a 100-foot mast in the rear of the building with a good big counterpoise under it, and we'll pull off that 'round the world' relay yet," says he. We can depend upon him to uphold A.R.R.L. prestige in the Hawaiian Islands. Welcome back, OM.

Anything to keep the old set on the air and push 'er to the limit. One fellow goes around and drops a piece of ice in each rectifier jar between messages. 7SC got the bright idea that an S-tube would stand a half a dozen fifty-watters if he submerged it in oil to keep it cool. Needless to say, the whole works blew up, oil or no oil. 7BJ takes the bases off of his five-watters and fills up the stem with castor oil and cotton, then puts in a cork, seals them up and puts the bases back on, and watches them shudder under 1600 volts.

Those Intermediate Signs

Operators in the Eastern half of the country, it seems are all mixed up on the distinguishing intermediate signals

used in amateur work. Here they are:

American calling or working American uses the interval DE' (— . . .)

American calling or working Canadian uses the interval AA (. — . —)

Canadian calling or working Canadian uses the interval V (. . . —)

Canadian calling or working American uses the interval FM (. . — . — . —)

Your co-operation in *always* using the above signals will prevent confusion and bring you more reports on your signals.

F. H. S.

Amateur Radio Furnishes Communication During Flood.

In Oklahoma a short time ago the Arkansas River overflowed its banks, inundating a great area and wiping out all communication between Tulsa, Okla., and the town of Sand Springs, seven miles away, except one telephone line and a few telegraph wires, communication was so demoralized that it frequently took over three hours to put a telephone call through.

Learning of the devastation caused by the flood, the owner of station 5XBF, with 5GJ as second operator, at Sand Springs, got in touch with 5GA, 5SG, and 5WX at Tulsa and offered their services during the emergency. On the first night the newspapers of Tulsa printed bulletins on the rise of the river and stories of the flood, received by amateur radio. In return, the people in the partly isolated town of Sand Springs welcomed news of the world's happenings which was also received via amateur radio. From then on, for three days and nights, 5XBF and 5GJ stood an almost continuous watch. Many important messages were handled, and amateur radio was utilized by newspaper reporters in giving long accounts of the flood to their newspapers, as they were unable to use the wire lines on account of the limited service.

The next day the waters receded and the communication lines were repaired, thus ending our story. Amateur Radio can now put another chalk mark down on the long list of occasions where it has shown its value in time of emergency.

H. F. M.

Everyone has been telling us how nice the 201-A and 301-A tubes are as transmitting tubes. F.B.; we'll agree, but with a filament so fine as to be hardly visible, how long will a tube last when used in this manner? The makers say that with a voltage of 400 on the plate of a 201-A tube the life of the filament will be around 90 hours while the same filament when the tube is used in a receiving set will burn over 10,000 hours.

No brother ham, Q. E. D. is not a new Q signal. Neither is it necessary to go slow when playing QRS player piano rolls.

9AUL's second op, sines "YS." Wonder if he is really the young squirt.

The Navy is taking steps to eliminate the arc mush and harmonics at Annapolis, NSS, so we are told. A new building to house the additional equipment is being installed in connection with loose coupling the arm to the antenna. This is already partially completed.

Leon Silvernail

On the very day he was to graduate from high school, May 25th, Leon Silvernail, formerly 9RH and one of the pioneer amateurs of Canton, Illinois, departed from this life. Within the past few years his radio efforts had been united with those of James Lewis, under the call of 9AZF, and the signals of this station were well known throughout the central part of the country. Up until a few months ago Leon Silvernail was apparently in very robust health, but was diagnosed as having tuberculosis, for which he was sent to the Pine Knoll Sanitarium at Davenport, Iowa, where he remained until the time of his death. The amateur fraternity mourns the loss of this real amateur and expresses the deepest regret at his passing.

Bryant Maynard

We also were very sorry to learn of the death, some time in February of Bryant Maynard, 5LA, of New Orleans. He was attending the Phillips Exeter Academy at Exeter, N. H., when he contracted the illness from which he never recovered. A true amateur, his passing is keenly felt by the many who knew him.

805 new amateur licenses were issued by the Department of Commerce during May—and amateur radio continues to grow.

V. M. Bitz, 6JD, who has been the chief operator for KHJ since the class B station was installed, is now in charge of the Public Service Bureau of the Radio Sales and Service, 820 West Seventh St., Los Angeles, giving all kinds of radio information to the public.

H. S. Gowan, of Kitchener, Ontario, has called to our attention the unfortunate practice common in Canada of mounting variable condensers inside of inductances. The eddy currents induced in the metal of the condenser when this is done causes a marked rise in the resistance of the

coil at radio frequencies. For this reason, such arrangements should be discouraged.

A letter just received from the Editor, K. P. Frederick, of the Radio Journal advises that the Transpacific tests, altho planned and started by the Long Beach Radio Club as explained in our leading article, was run with the co-operation of two organizations—the Long Beach Radio Club and the Radio Association of Southern California. Ol' fren' T. E. Nikirk of 6KA is president of the latter outfit.



Some Canadians We Hear

From left to right. Top row: F. A. Burgess, 9BH; W. Y. Sloan, 9BJ, and G. E. Pipe, 8IN. Lower row: T. H. Quipp, 3EY; C. M. Smith, 3GK; F. W. Hartley, 3JT; H. S. Gowan, 3DS-9BC. All of Toronto except Gowan, who hails from Kitchener.

The cut illustrates a good idea for keeping both your local standard time and Greenwich Mean Time always before you. Remove the minute hand from your clock and to the hour hand solder another hand at the correct angle to span the difference in time between your standard time and

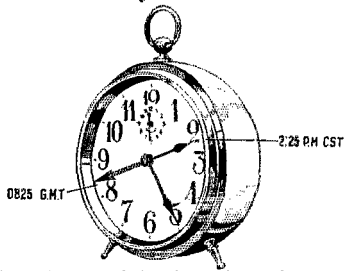

G.M.T. Greenwich time is 5 hours ahead of E.S.T., and 8 hours ahead of P.S.T. After replacing the minute hand, the additional hand may be painted some distinguishing color and you will always have G.M.T. before you. It is a great aid in making schedules and the like.

G. W. Harvey.

Once I fixed my storage batt,
And had it fixed to stay,
I brushed the red spots from my pants,
And brushed my pants away.

—Kickbacks.

Calls Heard



HEARD DURING JUNE Unless Otherwise Specified

When making up a list for *QST*, please observe the following rules:

1. List the calls on a separate sheet of paper; do not embody them in a letter.
2. Arrange the calls as they will appear in *QST*; numerically by districts, alphabetically in each district, Canadian and foreign calls listed separately, state whether spark or C.W. and give period of time covered by list.
3. Forms close on the fifth of the month preceding the date of issue of *QST*. Make your lists cover the period from the first of one month to the first of the next if possible but don't let your list come in late.
4. List only calls over 1000 miles distant.

F. D. Bell, Shag Valley Station, Waihemo, Otago, New Zealand.

Additional to previous list. C.W.: 3YO, 4MY, 6AAK, 6ABX, 6AHU, 6AWT, 6BBC, 6BED, 6BIC, 6BJQ, 6BVG, 6CN, 6CBI, 6CGW, 6TL, 6JD, 6AAU, 6AUL, 6APW, 6CUD, 6CVO, 6DGW, 6DPX, 6UW, 6ZT.

WNP. Aux. Sch. "Bowdoin" at Wiscasset, Me. June 1 to 22.

C.W.: 1ASF, 1SN, 1CPI, 1SI spk, 1FB, 1AYZ, 1(CDR), 1(CRW), 1(ANX), 1AQM, 1BES, 1ABY, 1RR spk, 1CPD, 1(ACO), 1(CGR), 1(AOL), 1(CKP), 1JV, 1(AJP), 1(AW), 1(BMF), 2CTL, 2CUR, 2(BRB), 2RSC, 2ATS, 2KF, 2EL, 2GK, 3AWF, 3AB, 3JJ, 3(BUY), 3(AUY), 3TA, 3AIS, 3AVM, 3SU, 3HH, 3APT, 3APB, 3CJZ, 3AIS, 3CCU, 3BOA, 3HV, 3DBY, 3VQ, 3KG voice, 3WX, 3HJ spk, 3VA, 4FT, 4LP, 4EA, 4BY, 5VK, 5CQL, 5ZV, 5DV, 5ADA, 5ZW, 5(CJZ), 5(ZZ), 5AWP, 5DAE, 5JJ, 5(ALF), 5CDI, 5BCY, 5DAT, 5BUT, 5BZC, 5JJ, 5BMF, 5APU, 5CBA, 5APE
Canadian: 1AR, 1(DD), 3KG.

2KV, Bronxville, N. Y.

5BAK, 5(BB), 5AAL, 5(AAW), 5(APS), 5APW, 5ARH, 5ARP, 5(AASO), 5ASE, 5AUD, 5AWF, 5AZX, 5BAK, 5(BCB), 5(BFB), 5(BIK), 5(BKJ), 5(BKS), 5(BRK), 5(BSH), 5(BWF), 5(BVG), 5(BDU), 5(DGV), 5(DIS), 5(DRI), 5(DXN), 5(DXO), 5(EAH), 5(CCS), 5(CDN), 5(CFZ), 5(CFE), 5(CHE), 5(KH), 5(CPA), 5(CRC), 5(CVO), 5(CWP), 5(EAK), 5(EJT), 5(EKF), 5(EF), 5(HK), 5(H), 5(MC), 5(UC), 5(US), 5(UU), 5(XN)
Can. 1AR, 1CG, 2BN, 2BP, 3HE), 3XN.

3BKL, York, Penna.

C.W.: 5AIX, 5AMH, 5APS, 5BFM, 5DIS, 5ESN, 5II, 5OF, 5CVO, 5UW, 5AAP.

5LG, Clouderoft, N. M.

6AHU, 6ALK, 6ALU, 6AOL, 6AQA, 6AUU, 6AWX, 6BH, 6BIC, 6BIH, 6BLU, 6CBI, 6CBU, 6CCD, 6CGD, 6CKZ, 6EC, 6OD, 6PL, 6RM, 6TN, 6ZU, 6AAU, 6AMB, 6APE, 6ARZ, 6AUS, 6AYL, 6BK, 6BEZ, 6BJK, 6BRI, 6BXQ, 6CAA, 6CCS, 6CFY, 6CKS, 6CME, 6CPU, 6CTG, 6CXK, 6CVO, 6DFH, 6EAE, 6SS. Spark: 6APL.

5JJ, 715 N. Beacon St., Dallas, Texas.

C.W.: 1ABB, 1AGI, 1AJP, 1AUG, 1AW, 1AWE,

1BES, 1BKQ, 1BRQ, 1CA, 1CAK, 1CKP, 1CME, 1CNI, 1IL, 1MY, 1TL, 1UM, 1XM, 1ZE, 2AAR, 2ABI, 2ACD, 2AF, 2AFD, 2ATS, 2AYV, 2BGR, 2BQH, 2BUM, 2BXP, 2CBW, 2CEI, 2CIM, 2CRW, 2DD, 2EL, 2FP, 2NZ, 2OM, 2WR, 2ZK, 2ZL, 3ACY, 3AJD, 3ALN, 3APR, 3ATB, 3AUL, 3AVA, 3BGT, 3BHD, 3BMN, 3BOF, 3BROU, 3BSS, 3CFQ, 3HG, 3JJ, 3PZ, 3VW, 3XAL, 3XM, 3ZO, 1AB, 4AJ, 4AJ, 4BQ, 4BK, 4EB, 4EH, 4FB, 4GG, 4GL, 4HG, 4JK, 4JL, 4JZ, 4MR, 4NA, 4OD, 4OV, 5* too numerous, 5ANH, 5AWX, 5BJQ, 5BSQ, 5BUH, 5CBI, 5CGW, 5EC, 5KA, 5TI, 5ZH, 5ZZ, 7DH, 7SC, 7WM, 7ZS, 7ZV, 7AAE, 7APD, 7AGO, 7ALE, 7ANR, 7AQV, 7AUV, 7AWP, 7BRR, 7BCH, 7BDA, 7BEK, 7BOG, 7BWA, 7BXX, 7BYO, 7RZQ, 7CP, 7CQX, 7CTP, 7FU, 7HN, 7JJ, 7MJ, 7UE, 7UF, 7VY, 7WX, 7XAB, 7XE, 7XZ, 7YAE, 7ZD, 7ZO, 7ZZ, 8AAH, 8AAP, 8ABU, 8ADF, 8AEC, 8AEY, 8AHH, 8AIM, 8AIN, 8AIX, 8AKU, 8ALV, 8AMX, 8ANF, 8AOI, 8ANE, 8ATQ, 8AQD, 8ATZ, 8AYD, 8BAK, 8BAW, 8BBP, 8BCL, 8BDB, 8BHO, 8BJC, 8BRI, 8BXT, 8BZE, 8BZL, 8CBA, 8CBZ, 8CCS, 8CVC, 8CFT, 8CGK, 8CIC, 8CKI, 8CMK, 8CND, 8CPA, 8CSR, 8CTE, 8CUI, 8CVO, 8CUO, 8CXT, 8CZU, 8DAP, 8DDY, 8DGO, 8DIO, 8DKV, 8DPD, 8DRI, 8DX, 8EBA, 8EKF, 8EF, 8FP, 8GI, 8LZ, 8MC, 8OX, 8PD, 8US, 8XAZ, 8ZL, 8ZT.

Canadians: 2AF, 2BG, 2CG, 3ADN, 3CF, 3DH, 3GB, 3HE, 3XN, 4CO, 4BV, 5GO, 5BS, 5BW.

E. L. Lamoureux, 60F, 3419 So. Hope St., Los Angeles, Calif. (detector only)

5ADO, 5AKY, 5LG, 5NW, 5ZA, 5ZAV, 7ABS, 7AHW, 7BJ, 7KS, 7QT, 9AMB, 9BJK, 9BXQ, 9CAA, 9CFY, 9CVC, 9DTM, 9EEA, 9ZT. Any-one hearing my A.C. C.W. please QSL. Also notice 80F new QRA.

8AGO, Pittsburgh, Pa.

Recd on LOOP with NO RF

9CP, 9HK, 9UR, 9US, 9AAP, 9AAU, 9AJH, 9APS, 9APV, 9AWF, 9AWP, 9AZX, 9BED, 9BGY, 9(BRY), 9CFK, 9CNO, 9CUI, 9(CWP), 9CXL, 9(CYW), 9BDU, 9DCR, 9DFW, 9DGV, 9(DIS), 9DUU, 9EKF.

Canadians: 3XN, 3ADN.

One week in June

8DKC, Kalamazoo, Mich.

Loop aerial with Reinartz, two Audio (1BWJ), 1CKI, 2AJA, 2BA, 3(CI), 3HE, 3(W), 3AFA, 3BLP, 3BNU, 3BUY, 3(BVA), 3(CEJ), 4FT, 5XA, 5AGJ, 5(OF), 5(UR), 5WC, 5AOG, 5APS, 5APV, 5ATO, 5AWK, 5(AWU), 5AZZ, 5BAK, 5BHR, 5(BRY), 5BUJ, 5BVP, 5(BWF), 5(BZ), 5CGT, 5CHQ, 5CIP, 5(CNO), 5C-V, 5(DDH), 5DFB, 5(DHN), 5DHR, 5(DSS), 5DVK, 5(DWF), 5(EFL), 5(EGW), 5EHI, 5(EF), QRA 8DKC is same as 8CPY in all books. Printed cards to all who QSL by card. Jas. A. Wilson.

9BFI, Minneapolis, Minn.

2CDD, 4AL, 4AM, 4CQ, 4EV, 4JR, 5ALP, 5GM, 5KC, 5MN, 5NZ, 5VF, 5ALP, 5AMF, 5ZAV, 6WI, 6WK, 7IW, 7UJ. Cards will be sent to any of above if they request by mail.

9DAW, Minneapolis, Minn.

(1ACB), 1AQU, 1ARP, 1ARY, 1ASI, 1AYZ, 1(BOQ), 1(BQL), 1(KL), 1(CMP), 1(CNI), 1KC, 1SM, 1(WC), 2(AD), 2(AGB), 2(CRT), 2CQZ, 2(CVU), 2FP, 2WR, 3AAY, 3ABW, 3ADY, 3ATG, 3ARO, 3BFU, 3(BHM), 3BIF, 3(BNU), 3GZ, 3IZ, 3(HJ), 3(PZ), 3SU, 3TJ, 3XM, 3(YO), 3(ZO), 4AG, 4AZ, 4BY, 4CY, 4DN, 4FA, 4FB, 4(FG),

4FN, (4MY), 4PU, (5ADO), 5AEC, 5AGG, 5AGJ, (5AHR), 5AIF, (5AKI), 5FC, (5FX), (5GA), 5GI, 5HL, 5KN, 5KW, 5MN, 5MO, 5NZ, 5OI, 5RE, 5RH, 5RL, (5VM), (5ZABA), 5ZAT, 6ALK, 6AOC, 6AQP, 6APW, 6AVR, 6BEG, 6BJJ, 6BOE, 6BQC, 6BRJ, 6BU, 6BUN, 6BUO, 6BUY, (6BVG), 6CBI, 6CGW, 6EB, 6HJ, 6IF, 6KA, 6PI, 6RM, 6UW, 6ZZ, 7ABB, 7ABS, 7ACST, (7BJ), 7DH, 7IY, 7LN, 7LR, 7SC, 7SF, (7ZU), 7ZV.
 Can.: (2BN), (5EH), (3EY), (3IN), 3TA, 3XN, (4CL), (4CN), (4DQ), (4HH), (5AL).

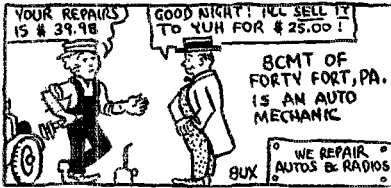

DON H. MIX

(Concluded from page 52)

A quiet chap, he never has much to say, but is whole-heartedly interested in radio. Many are the unusual records that have been recorded in the "Calls Heard" columns of QST under the call of ITS, and Mix bears the distinction of having picked up more West Coast amateur stations than anyone else in New England. He is a fine operator, and in the operation of ITS he has acquired a characteristic conciseness that so many amateurs lack. He is brief both in conversation and over the air. In this connection an instance is told of a few years ago when 1ZE transmitted fourteen messages, bug-sending at a 30-word-per-minute clip, to ITS without a single break. Mix came back with a single laconic "r."

He is 21 years of age, and a graduate of the Bristol High School, at Bristol, Connecticut. After finishing school, he entered the employment of the C. D. Tuska Company of Hartford, Conn., and at the time he left to accompany the Mac-Millan polar expedition, was in charge of the assembling department of this company.

Here's *bon voyage* and good luck to you, OM. WL CUL via WNP.

NORMAN R. HOOD

(Concluded from page 52)

was a member of the original Mississippi Valley Radio Association. He pounded brass at 9XL pre-war, until he got itchy

feet for the army and enlisted and went after Villa as far as Brownsville, Texas. Next came a period of over-sea duty with Uncle Sam where he smelled his share of powder smoke. Upon returning he hunted the wild and woolly West and in 1919 he erected a set made of honey-combs, etc., in a basement room in Casper, Wyoming, and got radio buggy again. In 1920 he took unto himself an OW and moved to a nest of his own. Here he proceeded to tear the place to pieces erecting masts and boring holes in the brand new floors. He soon burst forth with a 1K.W. set and the call of 7KX. He was issued a special license a few months later. Under the jazz craze, he locked up the rock crusher and installed twenty watts to disseminate a little jazz himself, but soon afterwards he announced that nothing but dah-de-dahs would radiate from 7ZO.

Hood is strong for the A.R.R.L. and amateur radio, and as Manager of the Rocky Mountain Division is a man of action and insists that everything be kept in first-class shape. Needless to say, he has been a member of the League since it was formed and he has on file every copy of QST that was ever printed. We admire Hood because he is a real "dyed-in-the-wool" amateur thru and thru; "100% or none," is his motto.

OPERATING DEPARTMENT

(Continued from page 49)

on week-ends only. He is attending Texas University at Austin. Austin: 5RN is spending a while in Dallas. 5ALR is moving 'em along and will do his share while 5RN is away.

Dist. No. 8. 5ZAE, San Antonio, DS. Yorkum: 5TM carries away the honors for message total for any one station this month, having sent 1,061, and received 925, a total of 1,986. San Benito: 5ADI—QRN. Pearsall: 5SS, while handicapped by receiver trouble, handled 107. Laredo: 5MT, QSR to Mexico via "BX" regular schedule. QRN bad. San Angelo: 5JF and 5GE are having considerable trouble getting traffic west of them. (Can't you fellows at Big Springs, Marathon, Roswell and El Paso help them out?—see if you can't get together on a schedule.) 5JC is a new A.R.R.L. station at this place.

Dist. No. 9. 5ADB, El Paso, DS. El Paso: 5ADB is the only station reporting and he is improving the trans, and will be going regular in a week or so. (Help San Angelo on clearing west—DM)

OKLAHOMA: Dist. No. 1. 5ZM, Enid, DS. Enid: 5ZM moving traffic OK. Oklahoma City: 5ZAV, station rebuilt, going regular most of the time, has been heard in New Zealand. 5KE works mostly in daylight and finds it's the staff. He wants a schedule north. 5ZAT's traffic fell off due to moving station. 5KW, also QSR, and is a new A.R.R.L. member.

Dist. No. 2. 5BM, Muskogee, DS. Tulsa: 5XBF has done some excellent work during the recent flood, and while only 35 messages are reported, most of them were long press; 170 and 200 words—handled for the newspapers. 5GA, 5WX, and 5SG, also did excellent work in maintaining communication during the flood. 5GA reports 36 messages handled.

Dist. No. 4. 5DS, Lawton, DS. Norman: 5VM,

the only station reporting, handled 12 and is re-building. Altus: 5AHD, Bartow H. Huff, 209 W. Commerce St. is a new A.R.R.L. relay station and puts Altus on the relay map for the first time.

NEW MEXICO: Cloudcroft: 5LG has moved to this place, we take it, from Alamogordo, N. M., and will help on the relays west. Fort Stanton: is now represented on the A.R.R.L. relay routes by 5AII a new member station owned by Alfred M. Turner, and R. Wornett, Marine Hospital No. 9.

MEXICO: While "BX" is the only station reporting from old Mexico, we know that others are doing some good work too. BX reported both by radio and mail. BX maintains a regular schedule with 5VO and 5MT, a daily morning schedule with 5MT and messages for Mexico routed thru 5MT will get thru OK. "AX," "BX," "DB," and "JH," all Mexican stations and members of the A.R.R.L. are QSR.

INTERNATIONAL AMATEUR NEWS

(Concluded from page 51)

tion both with phone and C.W. is carried on every evening thruout the islands. There are many radio clubs and steps are now being taken to form the New Zealand amateurs into a national society.

Mr. F. D. Bell, a prominent amateur in those parts, wrote in the magazine referred to above, an article called "Recent Progress in Radio," which reads surprisingly like our Operating Department reports. The late afternoon and early evening there is devoted to "Yank logging." "The results of Mr. Slade (page 65, July, 1923, QST.) have certainly astonished the hams in the U.S.A.," says Mr. Bell. (We'll say they have—Ed.) "His log contains a trifling list of 83 Yankee amateurs all copied on a single valve! Mr. Slade has been inundated with letters from the States since the publication of his results, for he has made history, and even if his achievements are not fully appreciated in his own country, they are elsewhere."

Mr. Bell also writes, "Since altering my tuner to go down to 200 meters, during ten evenings listening I have logged a total of 39 U.S. amateurs, situated in every district except the second. On the evening of Easter Sunday the QRM among the the Yanks on 200 meters was simply astonishing. The problem was not so much to hear them as to separate them. We bagged 11 for certain that evening in 3½ hours listening, using 2 high frequency valves, a detector, and 2 low frequency valves. The same evening Mr. Slade got busy with his old V-24 and bagged 10, listening for two hours only. It's a humiliating fact—for me—but there it is, and just goes to prove that high frequency amplification is often more bother than it is worth for receiving C.W. telegraphy with the receiver oscillating.

"Later in the evening the Australian amateurs get busy, usually between 200 and 300 meters with two letter calls; e.g.; 5BQ de 2CI. Most of them send dead slow and moreover they are working when it is about breakfast time in the States.

"The Americans deserve our heartiest congratulations. They have certainly demonstrated the efficiency of low powered valve transmission on short wave lengths to a marvelous degree."

With one kilowatt of C.W. on the air on 300 meters and the Call letters, JFWA, Mr. Hiroshi Ando, Address 13, Kitaigacho, Yotsuya, Tokyo, Japan, is preparing to QSO U.S. Mr. Ando is a leading radio experimenter in Japan and is listening for us with an eight tube receiver. He would like to hear from A.R.R.L. members and arrange tests.

International Intermediate Signals

The business of distinguishing the nationality of amateur stations whose calls have counterparts in some other country, is a problem which is growing more complicated all the while because of the issuance of new calls. There is a great need for an international agreement on this question. Seeing the need for something definite, the A.R.R.L. has sought the advice of the Department of Commerce regarding the legality of such an agreement. Upon their suggestion the matter has been taken up with the interested amateurs in every country we know of in order to establish some workable scheme. Several schemes have been suggested, so that we might present combined representation at the next International Radio Congress for that body to consider, if possible, adopt for international use. Replies to date from other countries favor the system of transmitting, as the intermediate sign, the initials of the country of the station being called and the station calling.

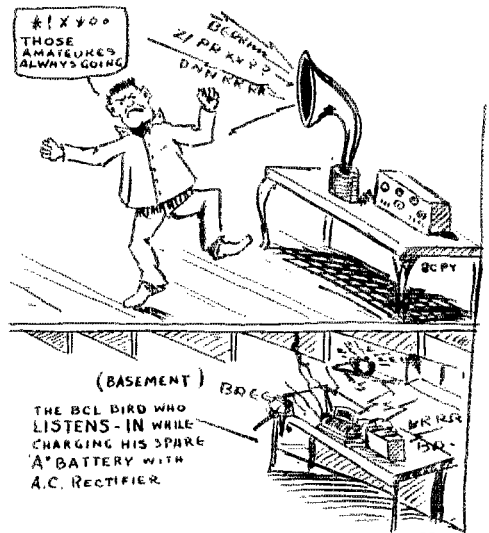

The fellow next door is also hearing this racket.

The Junior Operator

Elementary Radio Principles—I.

The Third of a Series of Articles of Helpfulness and Practical Value to Those Just Entering the Amateur Radio Game

By H. F. Mason, Department Editor

THE subject of elementary radio calculations and theory is likely to be dodged by the average amateur and amateur to be, as long as possible. Sooner or later, however, he will find that he is held up in experimenting with or building apparatus because he does not know the "reason why" nor is he able, with the aid of simple formulas, to figure out the constants and best proportions for his set. While the intensive study of radio engineering is very involved, the basic principles are really simple and no one dabbling in electricity and its allied subject, radio, should hesitate to put considerable study into this part of the game early in his experience.

The present article, the first of two dealing with the underlying theory, will be devoted to a study of elementary electricity, gradually working into radio and laying a foundation, so to speak, for next month's article dealing with the two most important implements of radio, inductance and capacity. Examples will be given throughout and every effort made to make things as clear as possible. If any point in these pages is not entirely clear to you remember that the A.R.R.L.'s information service* is at your command.

The Electric Current

Before one is able to understand the many rules governing the flow of electric current, and in particular the action of the vacuum tube, it will be necessary to obtain some idea of the nature of electricity itself.

The construction of matter is generally well understood. Matter is anything that occupies space. It is made up of very small particles called molecules, which in turn are made up of much smaller particles called atoms. Each atom is composed of a center or nucleus which is surrounded with a great number of electrons, revolving about it at great speed. An electron is the smallest possible quantity of *negative* elec-

tricity and is very small, even as compared to the whole atom of which it is a part. Each central nucleus is endowed with a *positive* electrical charge. In order that a balance or equilibrium may be maintained between the nucleus and its surrounding electrons, there are just enough electrons or particles of negative electricity

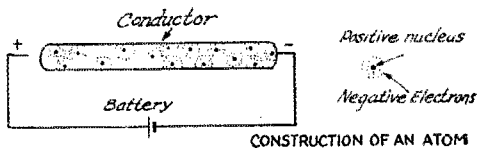

FIG. 1

associated with each central nucleus to neutralize its positive charge. This can be understood when it is remembered that like charges repel and unlike charges attract. As long as such equilibrium exists between each atom and its associated electrons, we say that there is no current of electricity flowing through the conductor.

With the aid of Fig. 1 the action that takes place when a current of electricity flows may be explained. In reality the whole of the circuit is formed of "conductor," but for ease of explanation the connecting wires are excluded. It is always necessary to complete the circuit and make a continuous path before the action which we term "a flow of current" can commence. The circuit is completed when the left hand wire from the battery (marked positive) is touched to the conductor. The positive charge on the end of the wire, caused to exist there by the battery, is stronger than the positive charge of its nearest atom. Because unlike charges attract, some of the negative electrons are attracted from the influence of the central positive nucleus of the atom. When these electrons have been removed, the equilibrium mentioned above is lost and the positive charge of the atom predominates. The atom then attracts a sufficient number of electrons away from the influence of the

*See page 26.

core of the atom to the right of it to regain its state of balance. That atom is similarly affected, and the process goes on, each atom "borrowing" electrons from its neighbor to the right. The result is that a current of electricity through a conductor is a drift or movement from negative to positive of the electrons within a substance, which are caused to so drift by the influence of the positive charges of their neighboring atoms.

Electrical Units

It will be noticed that the electrons flow from the negative pole to the positive pole

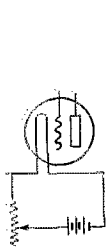

FIG. 2

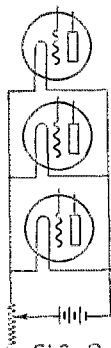

FIG. 3

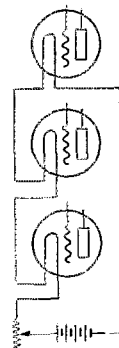

FIG. 4

—opposite to the usually accepted direction. This is because the terms positive and negative were assigned before scientists had thought out the electron theory. No confusion should result, however, and it is proposed when dealing with circuits in these articles to consider the flow of electricity as taking place from the positive pole to the negative pole, as is generally understood.

When a current flow is established in a conductor there occur numerous collisions between the electrons. Some are moving with the current and others are revolving about their atoms. Because of these innumerable collisions an opposition or resistance is offered to the electrons that drift through the material constituting the electric current. However, if the potential (in Fig. 1, the voltage of the battery causing the current to flow) is great enough, current will be forced to flow in spite of the resistance offered. In this case the agitation and immense activity of the electrons and molecules will cause the conductor to heat, or perhaps even melt. There are several ways in which the resistance may be lowered. One way is to use a wire of large cross section. Another is to make the length of the circuit shorter. Because the electrons in some materials are more active and move under smaller influences than in others, the resistance to the flow of current varies. Copper for instance is one of the materials that offers very little

opposition to the flow of current, and hence is almost universally used for that purpose.

In both radio and electrical work it is always well to run wires in as short and as direct a path as possible, using copper wire of a size large enough not to heat when the current is turned on.

When it is desired to make use of the resistance of a wire in cutting down the flow of current, wire of a material that has a large amount of resistance is used, usually of iron, German Silver, or some alloy. An ordinary rheostat for a vacuum tube is an example. The wire is long, and coiled for compactness, and is made of some high-resistance material.

In order that electrical pressure, resistance, and current may be spoken of conveniently, units of measure, are employed. The unit of resistance is the *ohm*. It is the resistance of a circuit in which a potential difference of one *volt* will produce a current of one *ampere*. The unit of current is the *ampere* and is that current produced by a pressure of one *volt* acting through a circuit having one *ohm* of resistance. The unit of pressure or voltage is the *volt*. It is the potential necessary to cause a current of one *ampere* to flow through a resistance of one *ohm*.

Because these three units are so inter-related, their effect on each other can be stated by a simple formula called Ohm's Law, which states that,

$$R = \frac{E}{I}, I = \frac{E}{R}, \text{ or } E = IR. \quad (1)$$

where *R* stands for the resistance in ohms, *E* for the potential in volts, and *I* for the current in amperes.

This means that the resistance of a circuit can be found by dividing the voltage by the current; the current may be found by dividing the voltage by the resistance; or the voltage may be found by multiplying the resistance and current. The value of Ohm's Law in electrical work lies in the fact that if any two of the above things are known, the missing one may be found.

Figure 2 shows the filament circuit of a vacuum tube. The battery, rheostat, and filament of the tube are connected in series. By varying the rheostat and changing the amount of resistance in the circuit the current is controlled. The filament of the tube becomes hotter as more current flows. All of the resistance is not in the rheostat, however; the filament itself has some, as do the connecting wires and the battery. In the present case, we will only consider the resistance of the filament and rheostat, as the other resistances in the circuit are very small in proportion and may be neglected. When current flows through a resistance there occurs what is known as a voltage drop across that resistance. The voltage drop is the voltage causing the current to flow through the resistance. If

the case in question the voltage drop across the filament will be, using Ohm's Law again, the resistance of the filament times the current through it. The sum of all of the voltage drops across the various pieces of apparatus in a series circuit is always equal to the voltage of the source. For this reason the combined drop across the rheostat and filament will be six volts, the voltage of the battery.

With the above relations in mind, the resistance of any part of a circuit can be found by applying Ohm's Law in the right way if the voltage drop across the resistance and the current through it are known.

An Example

What resistance should be connected in series with a WD-11 tube to enable it to be used on a six volt battery?

The makers specify a current of .25 ampere and a voltage of 1.32 for this tube. This is the terminal voltage or voltage drop across the filament of the tube when in operation. Because the combined drops in voltage in a circuit are equal to the voltage of the source, the drop across the rheostat must equal 6 volts minus 1.32 volts or 4.68 volts. We now know two things about the resistance; that the drop across it is 4.68 volts and that the current through it is .25 ampere. By Ohm's Law the resistance may be found:

$$R = \frac{E}{I} = \frac{4.68}{.25} = 18.72 \text{ ohms.} \quad (2)$$

Series and Parallel Connections

Apparatus, whether vacuum tube filaments, head phones, electric lights, or what not, may be connected in either series or parallel, although the individual case governs which way is the better.

Three tubes, with their filaments connected in parallel are shown in Fig. 3. In order that the correct current will flow through each filament, the total current through the battery and rheostat is three times the current for one tube. The wire used in making the rheostat must be large enough so it will carry the whole current without overheating. The resistance of the three filaments connected in parallel will be one third of the resistance of one tube alone. In order to make this more clear let us work out an example with the aid of Ohm's Law.

Example: Three WD-11 tubes are connected in parallel. It is desired to use them on a six volt battery. How many ohms resistance should the rheostat have?

Solution: The total current through the circuit should be three times the current for one tube or .75 amperes. The voltage drop across each filament is the same, 1.32 volts. The respective terminals of the three tubes are connected together, so that the drop across all three in parallel will be the

same as that across one tube. Subtracting the drop in voltage occurring across the tubes from the voltage of the battery will give the drop across the resistance, which will be 4.68 volts. We now know that .75 amperes is flowing through a resistance having a drop across it of 4.68 volts. Ohm's Law will give the resistance as follows:

$$R = \frac{E}{I} = \frac{4.68}{.75} = 6.24 \text{ ohms.} \quad (3)$$

Figure 4 shows three tubes connected in series. In this case the total current from the battery does not divide into three parts and supply each tube separately, but flows from the battery through each tube in succession, then through the rheostat and back to the battery. The total current flowing will be .25 ampere, as that is the maximum allowable current for the filament of each tube. There will be a voltage drop of 1.32 volts across each tube as before, but because of the series connection, these voltage drops must be added up and the drop across the three tubes will be 3.96 volts.

In order to find the resistance required for the rheostat, this value may be subtracted from six volts, Ohm's Law applied, and the value of the resistance will be found to be 8.16 ohms.

On many occasions the pieces of apparatus in a series or parallel circuit have different values of resistance and require different amounts of current. Let us say that in Fig. 3 the top tube required .25 ampere, the middle tube .65 ampere and the bottom tube .5 ampere. The total current taken from the battery would be equal to the sum of the currents through the branches of the circuit, in this case 1.4 amperes. The voltage drop across each tube should be that specified by the manufacturers, let us say 3.5 volts, and the drop across all tubes would be the same. If one required 1.5 volts instead of 3.5 it would have to have enough resistance connected directly in series with it so that the combined drop across the added resistance and the 1.5 volt tube would be 3.5 volts. It can be seen that as long as pieces of apparatus require the same voltage they can be connected in parallel. An instance of this is in our homes where lights, fans, cookers, etc., all require different amounts of current but all are built to operate on 110 volts.

If a number of different resistances are connected in parallel, the total effective resistance or joint resistance of the combination will be equal to the reciprocal of the sum of the reciprocal of the separate resistance. A reciprocal of a number is 1 divided by the number.

Example: Find the total effective resistance of the combination of tubes mentioned in the paragraph above.

Solution: These tubes require .25, .65,

and .5 amperes respectively. Their resistances would be the voltage drop 3.5 volts divided by the current, giving 14 ohms, 5.4 ohms, and 7 ohms, respectively. The total effective resistance of the combination would be

$$\frac{1}{14} + \frac{1}{5.4} + \frac{1}{7} = \frac{1}{\text{Total Resistance}} \quad (4)$$

This equals

$$.0714 + .185 + .143 = \frac{1}{.4} \quad (5)$$

giving $\frac{1}{.4}$ as the reciprocal of the total resistance. Dividing .4 into 1.0 we get 2.5 ohms as the total effective resistance.

This may be checked by multiplying it by the total current; the result should give

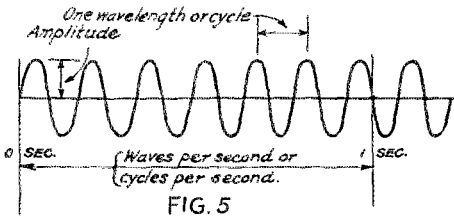

rent from a steady source, such as a battery; once started it continues to flow steadily as water from a faucet. An alternating current is of a different nature in that it is constantly changing both in strength and direction. The wavy line in Fig. 5 shows the variations of an alternating current. The part of the curve above the straight line represents current flowing in one direction, and the part below the line represents it flowing in the other direction. The straight line is the zero point. In the figure the current begins at zero and builds up to a maximum in one direction, then decreasing to zero. It then starts to build up in the other direction, passing the maximum and returning to zero. This constitutes one complete set of values and is called a *cycle*. The number of complete sets of changes that occur in a second is called the *frequency* of the current. Thus, a 60-cycle current such as is commonly used for house lighting undergoes 60 complete sets of changes per second.

Alternating currents of almost any frequency can be generated. Those having a frequency below 10,000 cycles per second are arbitrarily called *audio frequency* currents, (abbreviated a.f.) and those above 10,000 cycles are called *radio frequency* currents (abbreviated r.f.).

The rules governing the flow of alternating currents are the same for any frequency but the characteristics of the current and methods of handling it vary widely with the frequency. For instance a 60-cycle current can be transmitted along a wire for many miles, and the greater part of the losses will be due to the resistance of the wire. If it were attempted to transmit at current of 1,000,000 cycles along this wire, nearly all of the current would be lost by radiation into the surrounding air in the form of radio waves, and the part lost because of the resistance of the wire would become almost negligible. With currents of low frequency it is mainly the resistance of the wire that opposes the flow of current, but on high frequencies the inductance and capacity are the controlling factors in determining where the current will flow.

Wave Length and Frequency

The action that takes place when radio waves are transmitted from a station may best be described with the aid of an appropriate analogy. Everyone is familiar with wave motion as it occurs when a stone is thrown into a pool of water. Waves are produced which travel in all directions from the source. The size or amplitude of the waves (see Fig. 5) depends upon the disturbance that caused the waves, and will become less and less the farther the waves travel from the source. The distance from crest to crest of the waves is one wave

(Concluded on page 66)

the voltage if our calculations have been correct. In this manner $2.5 \times 1.4 = 3.5$, the voltage; thus proving the problem.

Measurement of Power

The flow of a direct current of electricity may be likened to the flow of a current of water through a pipe. The voltage may be likened to the head or height of water or pressure causing the current to flow. The combined effect of current and voltage is called power. Power is the rate of doing work; it is expressed in *watts*. The power being used in any electrical device may be obtained by multiplying the current through it by the voltage across it, provided that there is not an excess of inductance or capacity in the circuit.

Example: A transmitting tube is drawing 45 milliamperes (a milliampere is a thousandth of an ampere) in its plate circuit and the plate voltage is 550. What is the plate circuit input in watts?

Solution: The input in watts will be the voltage times the current. Since 45 milliamperes is .045 ampere, the power will be,

$$.045 \times 550 = 24.75 \text{ watts.} \quad (6)$$

Alternating Current—Radio and Audio Frequency

We now leave the subject of direct currents, the flow of which is governed by Ohm's Law, and turn to a study of alternating currents. Direct current is the cur-

Radio Communications by the Amateurs

The Publishers of QST assume no responsibility for statements made herein by correspondents



Coupled Filters

Chicago, Ill.

Editor, QST:

In the June issue of QST* there appeared an article by Mr. Melville Eastham of the General Radio Co., describing chiefly an inductively coupled wave filter. This article would give a reader the impression that this wave filter is a new development in wave traps, which in reality it is not.

This concern (Ferbend Electric Company) has been advertising and selling for nearly a year the Ferbend Wave Trap. This wave trap is manufactured in the inductively coupled type described by Mr. Eastham, as well as in the usual direct connected type.

Therefore, in view of the fact that we have been manufacturing this filter, we believe that in all fairness to us this letter should be published to inform your readers that our wave trap is not an obsolete type and that we have been making the same thing for some time.

Trusting that you will appreciate our position in this matter and publish this letter, we remain,

Yours very truly,
FERBEND ELECTRIC CO.,
By Spencer U. Ferbend.

The Best Working Wave for an Antenna

Comments of the author on the article on page 32 of May, 1923, QST. "A Method for Determining the Best Wave for an Antenna."*

Dayton, Ohio

Editor, QST:

In the editorial "paring" process on my short article that appeared in the May QST much was left out that I believe to be important in the method outlined.

The object of that paper was to show that in general the best working wave was not the fundamental nor was it the point of minimum resistance but at some point that lay near the fundamental, the exact point depending on the distribution of the losses.

Since it is impossible to separate the various losses I adopted a "dodge" that covered up to a certain extent the meaning of what I had done. It will be remembered that no assumptions whatever were made in regard to the losses that occur in an antenna for we determined the actual losses by subtracting the radiation resistance (as computed by Pierce) from actual measured values of the effective resistance. Statements to the effect that eddy current losses are negligible or that the loss resistance is constant over a fairly wide range, are untrue and conclusions reached upon those premises are false.

If we plot the ratio of the radiation resistance to the loss resistance as shown in my article it will be found that this ratio first increases and then decreases as we go away from the fundamental wave length and reaches a maximum ordinarily 5% to 15% above the fundamental depending on the care that has been taken to eliminate eddy currents and skin effect.

The writer is very much opposed to the practice of putting a series condenser in the antenna circuit to reduce the wave length, for unless it is a very good condenser indeed the gain due to increased radiation resistance is more than lost by the addition of loss resistance.

The following sums up in a word the reason why the best point for the average antenna is just above the fundamental instead of on it. Near the fundamental eddy currents and skin effect losses increase rather more rapidly than the radiation resistance (see Pierce's curves and note how they flatten off near the fundamental) so the ratio at this point is not so desirable as it is at some point slightly above.

This discussion applies to any antenna regardless of humps due to absorption or any other consideration. It also points to the fact that if one were successful in keeping the eddy current and skin effect losses down, the best point might easily be below the fundamental. Only actual measurement of the antenna in question and careful analysis somewhat along the line suggested will settle the question of "What is the proper wave length?"

Yours truly,

Ross Gunn.

*Can be obtained from the QST Circulation Dept. at the regular price.

The Phantom Circuit

Stockton, California.

Editor, QST:

I would like to call your attention to the fact that circuit diagrams pertaining to be the diagram of connections as used in the Oard Phantom Receptor, are being circulated by various concerns.

While it is not specifically stated that these diagrams are the Oard Phantom circuits, the fact that our concern is the only one that markets an instrument under such name, together with a heavy advertising campaign upon this instrument, leaves such an opinion open to inference.

One well known radio magazine publishes a circuit diagram this month, pur-

factured by this concern. The Phantom Receptor does not use a tuned plate circuit as is shown in these various diagrams, it is quite possible that we will in time issue the diagram of connections of this instrument, but if this is done, it will be authorized under our own name.

Sincerely,

Paul Oard.

For Oard Radio Laboratories.

Reception at Sea

San Francisco, Calif.

Editor, QST:

I was very glad to hear that I had been of service to the gang. The strength of most of the signals logged at sea would



Second NATIONAL American Radio Relay League Convention

Chicago, Illinois, September 12-15



This broke in here at the last minute—we had to “bust” a page and scrap some perfectly good type to make the August issue—but it purely had to happen 'cause we're shouting for the

Second All-American Reunion and Celebration of Radio Experimenters and Brass pounders.

Arrangements in hands of Chicago Radio Traffic Association, with approval of A.R.R.L. and the assistance of every American ham, from Porto Rico to Hawaii, and every Canadian.

Things are humming in Chicago-on-the-Lake and it's up to every Radio District, State and City to see that YOUR REGION contributes something that will be remembered.

Were you at the first convention? You need no invitation.

If you were not, take our word for it, hock the receiving set, sell the spare tubes, fill your pockets with railroad time-cards to pass to every radio experimenter and brass-pounder you meet. Root for the convention every minute you are awake and when the morning sun of September 12 sparkles across Lake Michigan and tints the antennas of the Second City WE'LL see you there with a delegation so large that it will make a stir even in the biggest, friendliest, happiest radio-amateur reunion the League ever held.

Send your bright ideas to the Chicago Radio Traffic Association, 959 Rookery Bldg., Chicago, Ill.

“Request that all who attend obtain receipt for transportation in purchasing tickets regardless of distance so that certified total may be reached and low fare rate obtained. R. H. G. Mathews.”

For Hotel and Banquet reservation, address W. E. Schweitzer, 4264 Hazel Ave., Chicago, Ill.

porting to be the Phantom Circuit. An ordinary single circuit, minus the ground, is shown. This diagram was marketed by a California concern (and still is) for sixty cents, which is a high rate for a circuit possessing the dubious originality of a deleted ground. This concern marketed this diagram following our advertising campaign on the Oard Phantom Receptor, and it is my personal knowledge that dozens purchased the diagram under the impression that it was our particular circuit.

“Phantom” is registered in the U. S. Patent Office by Oard Radio Laboratories, and applies only to the instrument manu-

surely surprise anyone. Never heard such DX at home in San Francisco in my life. They surely pour in from all points the minute you get about 2000 miles off the Coast.

The Trans-Atlantics must have been “pie” but how about those Australian records? I think it will be a long time before those records are busted. Huh? From the way signals rolled in out there in the Pacific I should think that in England, one detector bulb and tin phones would be literally burned up with American signals.

Sorry to say that I cannot promise any more off-shore lists as I am running coast-

wise now for a time. Expect to quit the sea soon and go down on the farm after that. Hi! To tell the truth, OM, I don't deserve a bit of credit as a fellow would have to be stone deaf to have missed them all. Reception is about 1000% better at 2000 miles west of San Francisco than at San Francisco behind the Coast Range and the Sierra Mountains.

G. R. Mackin, 600.

(600 is the operator who has been logging amateur signals while at sea in Oriental waters. See page 77, May, 1923, QST*—Ed.)

Bettering the CQ Situation

Minneapolis, Minn.

Editor, QST:

From time to time we have had tremendous kicks against the practice of sending CQ's. The bulk of these CQ's are undoubtedly not necessary, but in order to make a substantial kick, some constructive criticism must be forthcoming along with the kick.

We all know that it is practically hopeless to call a station unless we know that he is on the air. We also know that it is impossible to raise him unless his tuner is tuned to our wave length. The solution, then, is that the transmitting station must let the receiving station know when he is going to run his tuner. We know he does not tune while he is receiving from a particular station, and usually we do not find a chance to get in edgewise unless he gives a CQ. Following the CQ, the sender is bound to twist his dials, and listen in on all wave lengths. The solution of the problem would then seem to be to let every body know when this station is twisting dials.

The signal SK (or Morse 30) means nothing as it is now misused, as I have heard stations say SK, and then keep up the communication with the same station for over three minutes, saying SK after every transmission. SK should mean, "*I am now going to tune my dials.*" K should mean, "*I am in communication with you and wish you to go ahead.*" AR (the finish sign) should mean, "*I am calling you. Have now quit calling and will listen for you, but in addition will listen for any one else who may care to call me.*"

The number of calls should be limited to three separate "group calls" consisting of 3 calls and 3 signs, during a period of fifteen minutes. This prevents any one station from hogging the air by a long series of calls, and does not interfere with the efficient relaying of traffic. CQ's are carried on exactly as calls, and thus far it has been felt that these are very necessary in view of the fact that nothing is

*Can be obtained from the QST Circulation Dept. at the regular price.

now in use that takes their place. Observation of the above suggestions, however, will eliminate nine tenths of the present CQ's without decreasing the number of communications established. In addition, it will be noted that all of the above is in general accordance with the International Radio Regulations.

Sincerely yours,
D. C. Wallace—9ZT,

Gotcha!

Jamaica, N. Y.

To Ye Faithful Edditore:

Of Our Illustrious Monthly Periodical "Kew Ess Tea,"

In the Citie of Hartford, in the State of Connecticut.

Greetings from One of the Faithful:—

Upon returning from my daily labors on Friday last I beheld a vulgar postal card bearing upon its reverse side a most absurd insult. To think that I,—I, me,—should ever be accused of forgetting to renew my sub to QST, is at once outrageous and unbearable. I can stand no more, but taking it in the spirit that it was offered, I am returning by this mail two fish for the treasurer's locker and beg to be kept from the utmost depths of oblivion and obscurity for another year.

As yet, my efforts have not borne much fruit owing to the lack of negotiable collateral, but am slowly getting under way.

Had the OW ask me last night the difference between C.W. and D.C. and so have taken a fresh hold in the thought that she may turn out to be a brass-pounder yet, instead of asking pointed questions as to the way in which my weekly lunch money seems to disappear and why I am so hungry when I get home nights.

Every knock is a boost but why bother to knock when it's easier to boost first, so I have no criticism about QST except 30 days is a ding long time to wait.

Yours in a cloud of dust,

P. H. Manning.

Your Operation

Boonville, New York

Editor, QST:

I am one of the broadcast listeners who has taken an interest in transmitting and am now building a 10-watt "ham" set. I have been getting after the code lately and am almost ready to swear.

Last night I was rather discouraged. Trying to get a little code practice I listened in on 200 meters and thereabouts, and all I could hear up and down the scale was CQ, CQ. Several Canadians were coming in strong but nobody seemed doing anything but CQ-ing and adjusting their sets. Standing on the key, I should

say, or rather lying down and going to sleep on it.

Then I went up around 1800 and 2500 and got a little real good practice. Some of that stuff is a little faster than I can get but the sending is much more correctly done.

—Ray Schweinsburg

THE JUNIOR OPERATOR

(Concluded from page 62)

length. This term is related to the word "cycle" used above in connection with low frequencies. The number of waves that pass a given point during one second is the frequency of the waves in cycles per second. These same terms apply when speaking of radio waves, even though they cannot be seen and travel much faster than waves on water. Radio waves travel at a speed of 300,000,000 meters (186,000 miles) per second, the speed of light; so fast that they can go clear around the earth in one seventh of a second. No matter what the amplitude of the waves may be, the distance from crest to crest depends solely upon the transmitting set and antenna, and does not change as the waves travel away from the source.

There is a certain relation that exists between the wave length and the frequency of the waves. If for instance 1,500,000 waves pass a certain place during one second, and we do not know the wave length, we can find it as long as the speed at which they pass is known, by dividing the speed in meters per second by the number of waves that pass during one second. Stated mathematically,

$$\lambda = \frac{V}{f} \text{ or } f = \frac{V}{\lambda}$$

V stands for velocity, always 300,000,000 (meters per second) for radio waves.

f stands for the frequency in cycles per second.

λ stands for the wave length in meters.

Example: A station is transmitting on a wave length of 197 meter. What is the corresponding frequency in kilocycles? (One kilocycle is 1,000 cycles.)

Solution:

$$f = \frac{300,000,000}{197} \approx \text{approximately } 1,522,000$$

cycles or 1,522 kilocycles. (abbreviated k.c.)

(To be continued next month)

WIS-WIN

RADIO SWITCHES

Be up to date—Use our concealed types single hole mounting

Literature on request

WILLIS SWITCH & INSTRUMENT CO.
8 Kingsbury St. Jamestown, N. Y.

Bound Volume VI of QST

The July issue concluded QST's sixth volume, which is now available in bound form. This volume is too bulky to bind in a single book and so is appearing in two equal sections. Uniform in appearance with preceding volumes, handsomely bound in Red cloth with gold leaf imprinting.

This is the way to keep QST fresh and handy for immediate reference. The issues of the past year are a priceless storehouse of practical information for the telegraphing amateur. They are important enough to you to keep in bound form for the years to come.

In two sections, Part I and Part II

\$5.00 Postage Prepaid

Either section for \$2.50 postpaid

QST, 1045 Main St., Hartford, Conn.

HERE IT IS!

The real antenna insulator.

Manufactured by the Ohio Brass Co. Described in May QST on pages 25 to 28, illustrated in Plate No. 4.

Post paid 75 cents.

Two of these insulators in series at each end of your antenna form the ideal type of antenna insulation in C.W. sets where every atom of energy must be conserved to obtain maximum results.

The Baldwin Stewart Electric Co.
210 Pearl St. Hartford, Conn.

Get our new list on standard parts. Our prices can't be beat.

Radio Operators! Radio Operators! Radio Operators!

The shortage of Radio operators increases! During the past month we have been unable to find enough men for shipboard positions. More ships are in operation to all parts of the world and more Radio Operators are needed every month.

Join our SPECIAL SUMMER COURSE in Radio and prepare for an assured future with good pay and attractive opportunities for advancement.

Classes forming every Monday. Special Short Summer Course. Full particulars for the asking.

EASTERN RADIO INSTITUTE

399 Boylston Street, Boston
Tel. Back Bay 5964

Announcing Burgess "A" Dry Battery

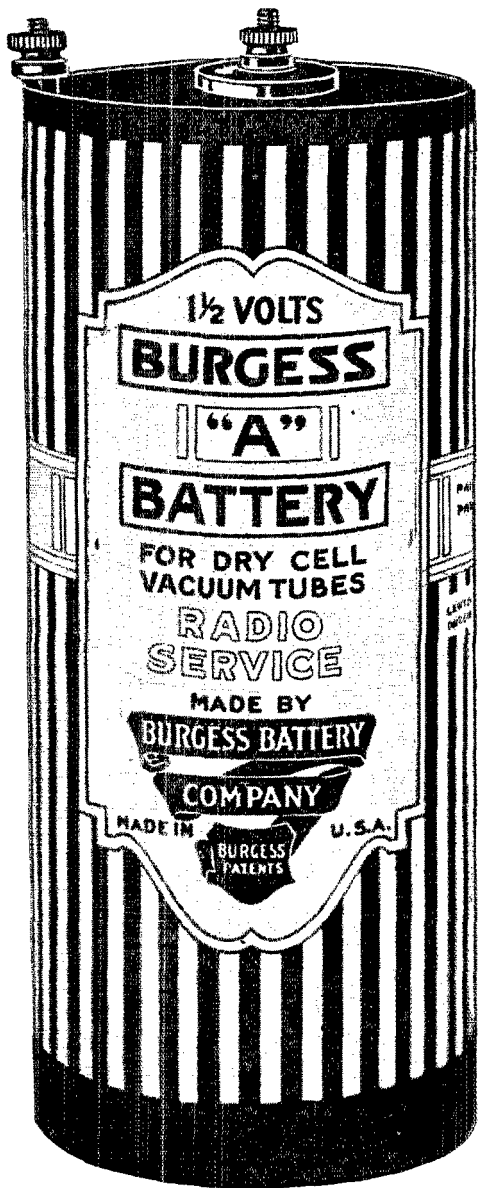

THIS new dry battery for the "A" or filament circuits of dry cell vacuum tubes is a Burgess achievement which will not soon be forgotten.

Burgess has perfected a dry "A" battery which will give over twice the life, on vacuum tube service, of any ordinary No. 6 Ignition dry cell. It has a rapid recovery to high voltage after short periods of rest and practically no voltage lost when not in use.

This Burgess "A" dry battery will lead the "A" battery field just as the Burgess dry "B" battery has led in the field of "B" batteries. Ask any Radio Engineer about Burgess "B" Batteries.

Made only in single cell units. This makes it possible to wire up convenient combinations for all types of dry cell tubes, and eliminates the hazards and expense of multiple cell units.

Ask for the Burgess "A" Battery

when you are equipping your new set or replacing your old dry batteries. Sold by all progressive radio dealers.

BURGESS BATTERY COMPANY

Engineers— DRY BATTERIES—Manufacturers
FLASHLIGHT—RADIO—IGNITION—TELEPHONE

General Sales Office: Harris Trust Bldg., Chicago
Laboratories and Works: Madison, Wisconsin

Branches:
New York Boston Washington St. Paul Kansas City New Orleans

In Canada: General Offices and Works: Niagara Falls, Ont.
Branches: Toronto Montreal Winnipeg St. John

"A Laboratory Product"

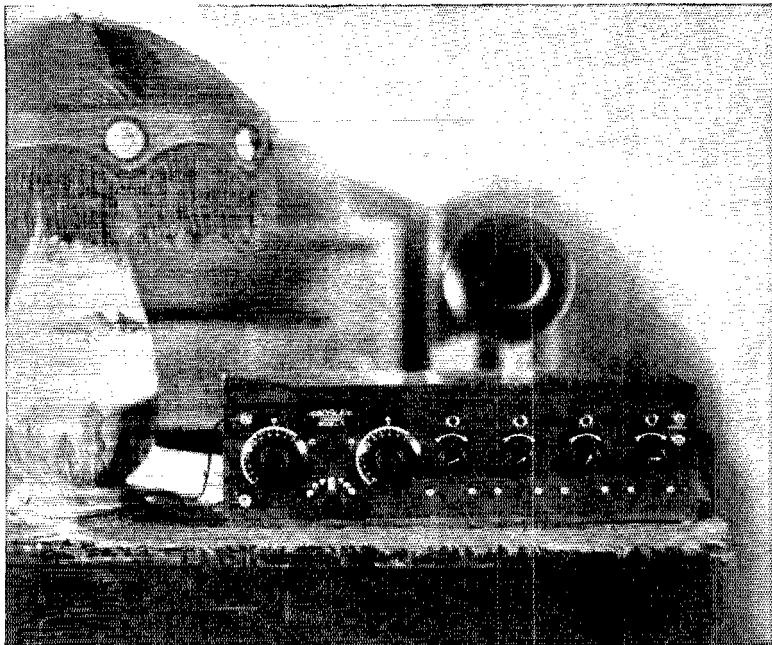

PERFECT PERFORMANCE

Crosley Model X Gives Better Radio Reception

The popularity of Crosley Model X is becoming more manifest each day.

This four tube set—still priced at \$55—maintains its marvelous record of bringing in distant stations. A man writing from Chatnam, Va., says, "First let me state I own a Crosley Model X and you couldn't buy it for the United States mint. I have picked up over 130 stations in the U. S. and have listened to Havana, Canada, North Dakota, San Francisco, all Texas and ships at sea. Keep up the good work!"

You can depend upon an instrument bearing the name

CROSLEY

This name has been accepted as a guarantee of the highest quality at the lowest cost.

All Crosley sets are equipped with the Crosley multistat, the universal filament control rheostat for all makes of tubes.

Wave length range 200 to 600 meters.

Other Crosley parts include: Variable Condensers, Knobs and Dials, V-T Sockets, Variometers, Vario Couplers Rheostats and the well-known Crosley Radio Frequency Amplifying Tuner.

A Crosley Instrument performs everything claimed for it—and more besides.

*For Sale By Best Dealers Everywhere
Write for Free Catalog*

We announce a new model—to be known as Model X-1. This has all the features of Model X and in addition—new molded sockets, new rheostats, new condensers, with molded plates and jack for head phones. Price \$63.

Crosley Manufacturing Company
818 ALFRED ST., CINCINNATI, O.

New York Office, C. B. Cooper, 1203 Tribune Bldg., 154 Nassau St., Phone Beekman 2061.

Boston Office, B. H. Smith, 755 Boylston St., Room 316.

Chicago Office, 1311 Slegel Bldg., 28 E. Jackson Blvd., E. A. Siemm, Mgr.

Philadelphia Office, J. H. Lyte, 65 North 63rd Street.

St. Louis Office, Robert W. Bennett Co., 1326 Syndicate Trust Bldg.

Pleasant Evenings in Camp With a Crosley Portable

No matter how far into the wilds you go on your vacation, you can keep in intimate touch with the outside world and enjoy its pleasures in the evening.

Crosley Portable Radio Outfits have made this possible. Absolutely complete in their compact cases, they may be easily carried and quickly set up.

After a hard day's motoring, fishing or canoeing what a pleasure to get out the old pipe, sit before the camp fire and listen to music, plays and innumerable other interesting things. Get a Crosley Portable and take it with you on your vacation. It will afford you the least expensive pleasure you have ever enjoyed.

CROSLEY
Better—Cost Less
RADIO

CROSLEY MANUFACTURING CO.
818 ALFRED ST., CINCINNATI, O.

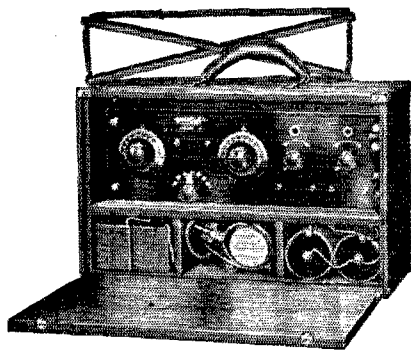

Crosley Model VI Portable

Consists of detector and one stage of tuned radio frequency amplification. Compact compartments are built into this set for batteries, phones, etc. Thousands of users have testified as to its satisfactory performance. Price without tubes, batteries or phones\$40.00

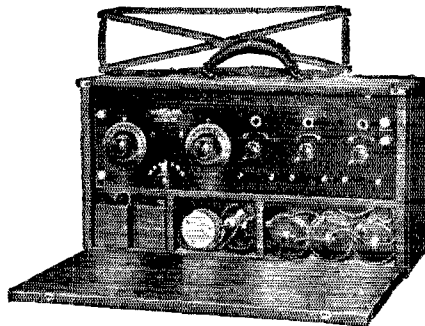

Crosley Model VIII Portable

Consists of one stage of tuned radio frequency amplification, detector and one stage of audio frequency amplification. This set has the same general construction as Model VI Portable, but performs even more efficiently.

Price, without tubes, batteries or phones\$60.00

Free Catalog on Request

Crosley Radio Parts

Popularity Proves Their Worth

The fact that innumerable favorable comments are received daily from people everywhere who have used Crosley parts with entire satisfaction leads us to believe that you too will find that they will fill your every requirement.

The Crosley V-T Socket has been pronounced by many radio engineers as the best socket on the market. Its popularity is based chiefly on its high quality, efficiency, service and practical unbreakability combined with its very low cost.

The Crosley Radio Frequency Amplifying Tuner consists of an inductance coil and a Crosley book type variable condenser. It can be tuned to any wave length between 200 and 600 meters. When used with non-regenerative sets it will increase the range many times.

The Crosley Sheltran is a completely shielded transformer. Embodied in it are all the characteristics so essential to obtain maximum amplification from the modern vacuum tubes used in radio work. Tests have proven the design to be correct to insure maximum efficiency.

For Sale By Good Dealers Everywhere

CROSLEY
BETTER-COST LESS
RADIO

CROSLEY MANUFACTURING CO.
818 ALFRED ST.,

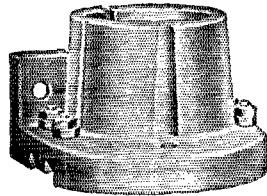

CROSLEY V-T SOCKET
Made of porcelain for base
or panel mounting.
Price40c

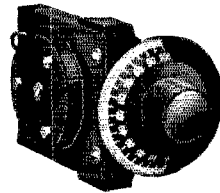

**CROSLEY AMPLIFYING
TUNER**
Price\$4.00

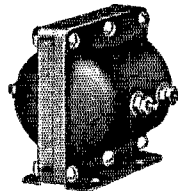

**CROSLEY SHELTRAN
TRANSFORMER**
Price\$4.00

CINCINNATI, O.

Three Beautiful Cabinet Models

The Last Word in Crosley Efficiency

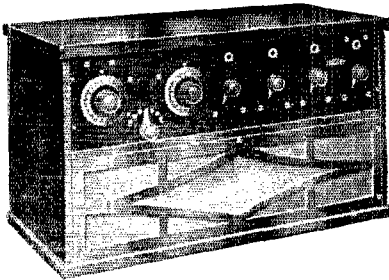

CROSLY MODEL XV
(Above)

The receiving apparatus in this model is the same as that in our cabinet Model XX. The cabinet contains no place for the batteries, however, placed on a mahogany table or stand, it forms an attractive piece of furniture. Price without tubes, batteries or phones.....\$70.00

CROSLY MODEL XXV
(Below)

We can conscientiously recommend this console model as the most beautiful and efficient model offered today. The receiving apparatus contains the same units as our model X though differently arranged. The cabinet, of mahogany, exceptionally well finished, is arranged to take the model R-3 Magnavox and also contains space for "A" battery, "B" battery and battery charger if desired. Guaranteed to bring in broadcasting stations 1000 miles or more distant so that they may be clearly heard all over the room. Price without tubes, batteries or phones.....\$150.00

CROSLY MODEL XX
(Below)

This attractive model is our model X built into a highly polished mahogany cabinet. A hinged lid, when raised allows the operator access to every part of the receiving apparatus. A sliding board under the receiving apparatus forms a desk for the operator when desired. The lower compartment is made to take care of the batteries and the middle compartment contains a loud speaker which makes it possible for music, speeches, etc. to be heard clearly by every one in the room. As a beautiful piece of furniture, this model is an addition to any room. Price without tubes, batteries or phones.....\$100.00

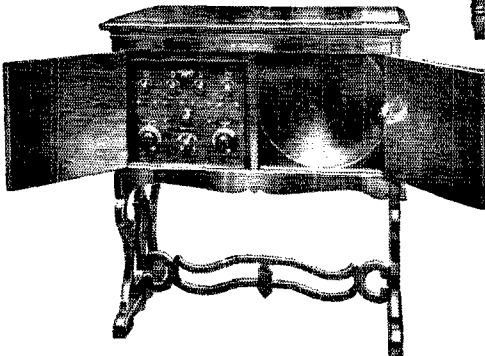
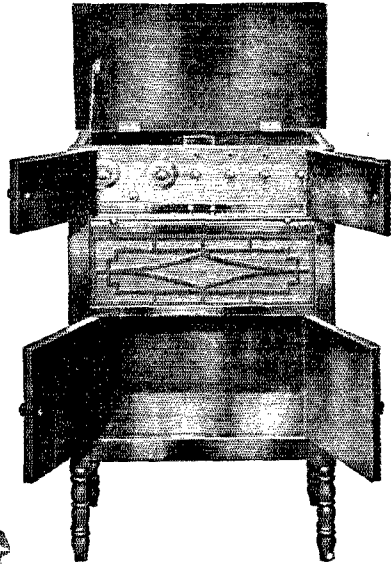

CROSLY
Better--Cost Less
RADIO

CROSLY MANUFACTURING CO.
818 ALFRED ST.,
CINCINNATI, O.



Perfect Performance Guaranteed

**A
ACE
E**

**Type V, Armstrong Re-
generative Receiver
\$20**

Formerly known as Crosley Model V. For performance no receiver at its price can equal it.

An Evansville, Ind. man writes, "The other night I tuned in Kamach, Hawaii and held the concert for one hour. The music was clear and the speaking distinct." This is indeed a tribute to efficiency.

Ace Receivers are licensed under Armstrong U. S. Patent 1,113,149.

All Ace sets are equipped with the Crosley multistat, the universal filament control rheostat, for all makes of tubes.

Wave length range 200 to 600 meters.

Ace Instruments perform all we claim—and more besides.

Live Jobbers and Dealers are eagerly taking advantage of the sales these instruments and the other Precision instruments and parts are bringing them.

We announce the Ace Type 3B—a new 3 tube Armstrong Regenerative set with filament switch, jack, new Crosley molded sockets and condensers with molded plates. This is one of the latest and most efficient sets on the market today for steady performance.

New York Office, C. B. Cooper, 1803 Tribune Bldg., 154 Nassau St., Phone Beekman 2061.
Boston Office, B. H. Smith, 755 Boylston St., Room 316.

Chicago Office, 1311 Steger Bldg., 28 E. Jackson Blvd., R. A. Stemm, Mgr.

Philadelphia Office, J. H. Lyte, 65 North 63rd Street.

St. Louis Office, Robert W. Bennett Co., 1326 Syndicate Trust Bldg.

Free catalog on request

THE PRECISION EQUIPMENT CO.

Powel Crosley Jr. President

818 GILBERT AVE.,

CINCINNATI, O.

ACE

MODEL V Formerly called Crosley Model VC REGENERATIVE RECEIVER \$20

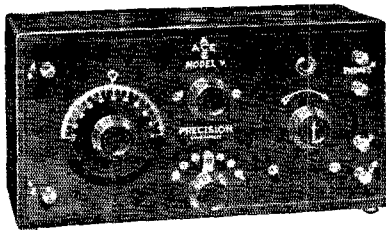

Licensed under Armstrong U. S. Patent
No. 1,113,149

Efficiency and moderate price have caused an enormous demand for the Ace Model V Regenerative Receiver. It is a wonderful set and its popularity is increasing daily. Thousands have been sold and all are producing remarkable results. Everyone knows the set will bring in far-away stations clearly and loudly. Hundreds of satisfied customers have written to us lauding the Ace Model V. Read what a few say:

"We have tested the Ace Model V with outside aerial, house wiring and bed spring and get excellent results on long distance reception. St. Louis, Kansas City, Fort Worth, Cincinnati, Omaha and many others come in fine. We consider the Ace Model V supreme.

CLOVERDALE MOTORS CO.,
Montgomery, Ala."

"I consider the Ace Model V a little wonder. Last night I tuned in Portland, Oregon and Los Angeles, Calif. The set performs like a well-bred horse. I have operated many expensive sets, but they are not in it with the Ace Model V.

R. H. RINES,
St. Paul, Minn."

"I am writing to tell you of a long distance record for the Ace Model V. The other night Mr. Blake D. Foster, who purchased the set from us, tuned Kamach, Hawaii, and held a concert from 10:45 to 11:45 P.M. He was using a lamp socket plug instead of an aerial. He told us the music was clear and the speaking distinct.

HAROLD FINK,
Evansville, Ind."

We do not claim everyone will be able to hear Hawaii, but the mere fact that certain owners have done so is evidence of the efficiency of the set.

For Sale by Good Dealers Everywhere

THE PRECISION EQUIPMENT CO.
Powel Crosley Jr. President
818 GILBERT AVE., CINCINNATI, O.

A New and Unusually GOOD PLUG

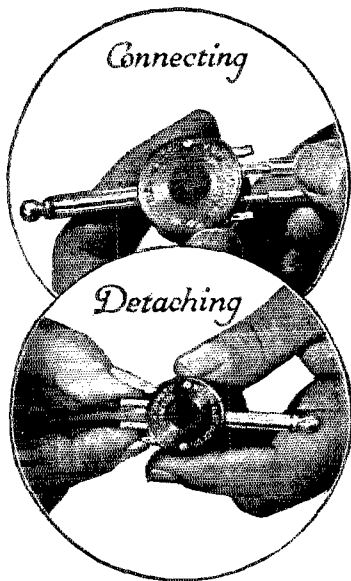

A radio plug originally designed for our own exclusive use—that has satisfied the critical demands of our own experimental laboratories—now offered to all Radio experimenters.

The simplest and quickest to operate—no tools required—no broken fingernails—assures perfect contact.

To connect, just shove terminals in—to disconnect, press the triggers and pull terminals out.

A unique design. Highest class workmanship and finish. Made with the customary Weston care. Individually tested before shipment.

Try one and see if this plug is not infinitely superior to any plug you have ever used.

Sent Post Paid for \$1.00

WESTON ELECTRICAL INSTRUMENT CO.

158 Weston Ave.,

Newark, N. J.

Electrical
Indicating
Instrument
Authorities
Since 1888

WESTON

STANDARD - The World Over

Thousands Acclaim Melco-Supreme!

Operation is simplicity itself. No aerial or loop necessary. Merely a 10 foot wire. By covering all Broadcasting Ranges, from 175 to 750 Meters, wonderful program selectivity is assured.

Write for our literature illustrating and describing our entire line of quality receivers and parts.

AMSCO PRODUCTS, Inc.

Fairbanks Bldg.
Broome & Lafayette Sts. New York



Mr. Cockaday endorses the circuit employed in the Melco-Supreme in his article on Tuned Radio-Frequency Amplification in August Popular Radio.

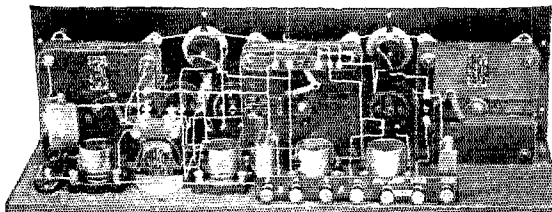



THE man who purchases a Magnavox for its *clearness* of reproduction, finds additional advantages in its use which contribute greatly to his enjoyment of Radio.

For instance, due to its extreme sensitivity, the Magnavox can reproduce distant signals which to ordinary reproducers would be indistinguishable. Ask your dealer for a demonstration.

Magnavox R2 Reproducer and 2 stage Power Amplifier (as illustrated) \$115.00

R2 Magnavox Reproducer with 18-inch horn: the utmost in amplifying power; requires only .6 of an ampere for the field \$60.00

R3 Magnavox Reproducer with 14-inch curvex horn: ideal for homes, offices, etc. \$35.00

Model C Magnavox Power Amplifier insures getting the largest possible power input for your Magnavox Reproducer
2 stage \$55.00
3 stage 75.00

Magnavox Products can be had from good dealers everywhere. Write for new booklet.

THE MAGNAVOX COMPANY
Oakland, California
New York Office: 370 Seventh Avenue

MAGNAVOX PRODUCTS
No Radio Receiving Set is complete without them

8-R



RADIO APPARATUS
for
INDICATION

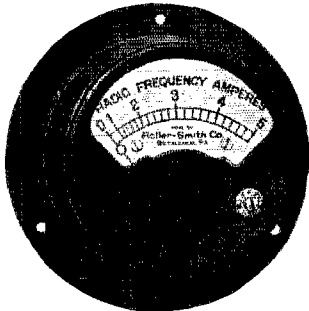

RECEPTION

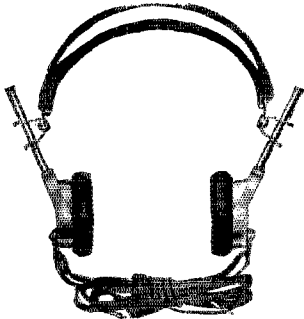

AMPLIFICATION

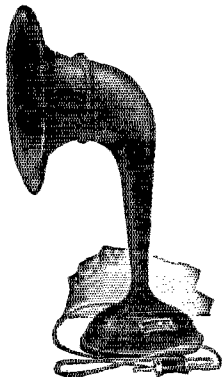

Send for Bulletins AG-10, AG-20 and AG-810.

ROLLER-SMITH COMPANY
16 Park Place, New York

Offices in principal cities in U. S. and Canada



Mu-Rad R-F
Amplifying
Transformers

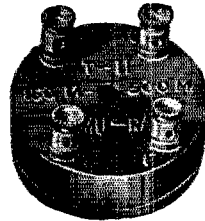

200-600
Meters
Air Core

Remarkable Results

Radio fans in Canada, California, North Dakota, Louisiana, New York and almost every State have written us unsolicited about the astonishing results they have attained with their sets in which they used Mu-Rad Radio Frequency Transformers. No wonder for these are the same transformers as are used in the famous Mu-Rad Receivers. If distance, distinctness of signal, and general dependability are more to you than the possible difference of a few cents in price, by all means use Mu-Rad Transformers.

No eddy current, iron losses, or capacity effects.

Big Profits
for the
Dealer

Who Handles
Mu-Rad Products

Three Types

Type T-11 for
the first stage
\$6.00

Type T-11A for
the second
stage \$6.50

Type T-11B for
the third stage
\$7.00

Send 10c for R.F. circuit diagrams and treatise on Mu-Rad R. F. Amplification.

MU-RAD LABORATORIES, INC.
804 FIFTH AVE. ASBURY PARK, NEW JERSEY

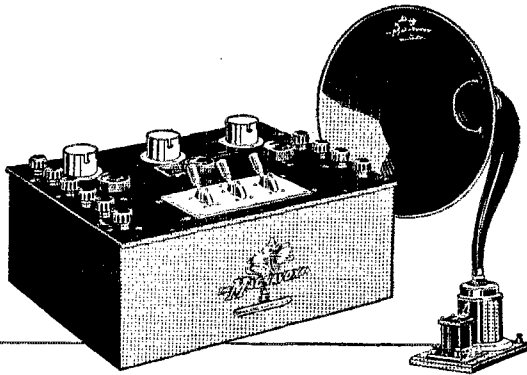

MAGNAVOX and FORMICA

THE radio engineers of the Magnavox Company have given their approval to Formica in the most sincere and convincing way—by using it exclusively in their apparatus for a long time.

Think over the list of great independent radio manufacturers whose standing and prestige in radio counts for something, and you will find almost every one among the regular users of Formica.

The only reason is that Formica is better looking, more uniform, more efficient than any other radio insulation of the kind. They have tested and tried them all and they *know*.

Your dealer will supply you promptly with a Formica panel in any of the standard sizes, or in any special sizes.

Dealers: Sell panels in the size your trade demands—not a few sizes that some one else wants you to carry. You will find Formica sales and advertising support and its wonderful nation-wide reputation a big help in building up your sales of panels and tubes.

THE FORMICA INSULATION COMPANY

4620 Spring Grove Ave., Cincinnati, Ohio

Sales Offices

| | | |
|--------------------------------------|--|------------------------------------|
| 50 Church St., New York, N. Y. | 1210 Arch St., Philadelphia, Pa. | 414 Finance Bldg., Cleveland, Ohio |
| 422 First Ave., Pittsburgh, Pa. | 1819 Lyndale Ave., S. Minneapolis, Minn. | 9 S. Clinton St., Chicago, Ill. |
| 1042 Granite Bldg., Rochester, N. Y. | Sheldon Bldg., San Francisco, California | 318 Title Bldg., Baltimore, Md. |
| 115 Ohio Bldg., Toledo, Ohio | Whitney Central Bldg., New Orleans | 47 King St., Toronto, Ontario |

FORMICA

Made from Anhydrous Redmanol Resins

SHEETS TUBES RODS

RADIO



PRODUCTS

USED IN COCKADAY
FOUR CIRCUIT TUNER

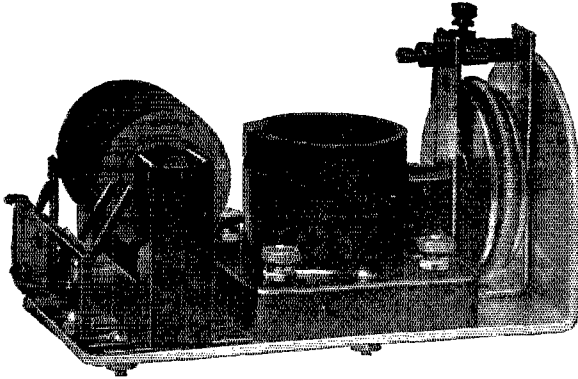

DETECTOR UNITS

- Cat. No. 139 Vernier \$3.00
- Cat. No. 206 30 Ohm 3.00
- Cat. No. 211 4 Ohm 2.40

AMPLIFIER UNITS

- Cat. No. 198.....\$7.50
(Acme Transformer)

MOUNTING BRACKETS

- Cat. No. 217.....\$0.30
- Cat. No. 218..... 0.35

R. MITCHELL CO.

255 ATLANTIC AVENUE,

BOSTON, MASS.

All-Ways
Better

MAR-CO



ARMORCLAD

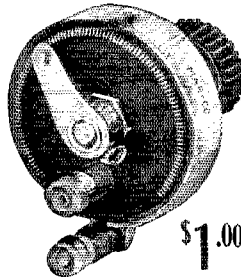

\$1.00

30
Ohm
Rheostat
FOR

199 and 201A Tubes

Solid, Strong, and of Extra
Good Appearance — Panel
Mounting

MARTIN-COPELAND CO.
PROVIDENCE, R. I.



Kellogg Radio Equipment
For Better Results

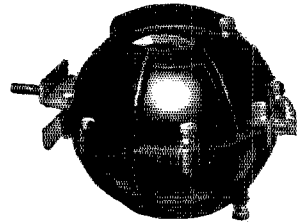

The Kellogg Variometer

The stator and rotor are of Kellogg Bakelite, with properly proportioned windings of well insulated copper wire.

Two terminals are provided for the rotor and three for the stator, permitting the variometer to be used in all known variometer circuits.

Kellogg variometers have no sliding contacts; nothing to wear or "short." A spring takes up all play and allows the rotor to turn with a smooth even motion.

No. 501..... Each \$8.00

KELLOGG SWITCHBOARD
& SUPPLY COMPANY
CHICAGO

CARDWELL "FOUR ZERO" CONDENSER

K. B. WARNER,
Editor QST, Says:

"I must say that all of us are filled with admiration and respect for the job you have done. It seems altogether excellent to us, and we particularly appreciate the efficiency of the thing as set forth in your recent literature."

Hartford, Conn.
January 22, 1923.

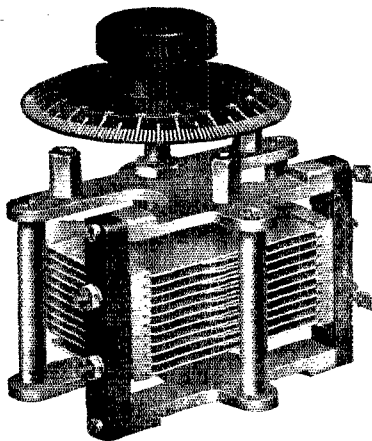

QST, June, 1923

"For 100 meter work the Cardwell Condenser is among the very few that work at all, and on 360 meters, on actual test signal strength was nearly doubled by substituting a Cardwell Condenser for the one previously used."

Refer to your June issue of QST and read again the article on page 65.

John L. Reinartz Says: "Comparative tests of condensers at radio 1QP." "Using a driving circuit coupled to a wave meter." "The zero capacity value of condensers tested, when shunted around the grid coil of circuit, showed the wave length rise to be from 147 meters without shunting condenser across inductance to

- 200 meters for a 23 plate "B" at zero
- *180 meters for a 23 plate Cardwell at zero
- 208 meters for a 23 plate "C" at zero
- 192 meters for a 23 plate "D" at zero

*This was the only condenser to stand up at 100 meters in tests—Bakelite end plates (on others) burned up." "For the broadcast wave the high zero value is not detrimental, but on 100 and 200 meters this is quite a factor and must be taken into consideration."

So. Manchester, Conn.
March 25th, 1923.

For Efficiency This Season—Equip Your Set With a
CARDWELL "FOUR ZERO" VARIABLE, AIR CONDENSER
Zero "Body Capacity" Effects, Zero Radio Frequency Losses, Zero Leakage and Zero Maintenance Trouble.

| | | | |
|-------|-----------|-----------------------|--------|
| Price | .00025 MF | Eleven Plate..... | \$3.75 |
| | .0005 MF | Twenty-one Plate..... | 4.75 |
| | .001 MF | Forty-one Plate..... | 5.75 |

IF YOUR DEALER CANNOT SUPPLY, ORDER DIRECT. MAIL ORDERS PROMPTLY FILLED.

BROCKWAY RADIO CORPORATION

DISTRIBUTORS



221 MASSACHUSETTS AVENUE,

BOSTON, MASS.



WATER

Water is a good conductor of electrical currents. When a panel absorbs moisture it loses a good part of its insulation value—it permits leaks and short circuits—it damages reception.

Radion Panels being a special grade of hard rubber are impervious to water. Even if immersed in water they positively could not absorb enough moisture to injure reception results. That's one of several reasons why Radion is the supreme insulation for wireless use.

18 STOCK SIZE PANELS

Radion, being an insulation material especially made for wireless use, has the lowest phase angle difference, lowest dielectric constant, highest resistivity and supreme moisture, gas and acid repelling properties.

Panels, Dials, Knobs, V.T. Sockets, Antenna Insulators, Phone Caps, Etc.

American Hard Rubber Co.,
11 Mercer St. New York

RADION

"The Supreme Insulation"

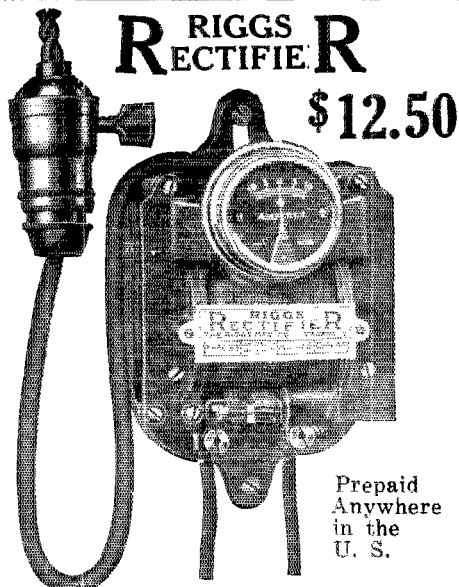

RIGGS
RECTIFIER R

\$12.50

Prepaid
Anywhere
in the
U. S.

MONEY BACK GUARANTEE
We guarantee the Type B-3 to please you. If it does not, return it and we will return your money.

THE RIGGS MFG. CO.

Urbana, Ohio,
Factories—Everett, Wash.

Here is where you can get
"Everything worth
while in Radio"

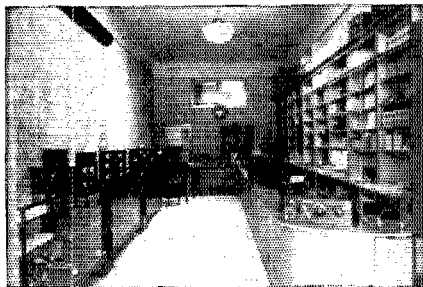

The Radio Store of
PAUL FRANKLIN JOHNSON
560 E. Colorado St.
Pasadena, California

REMLER

APPARATUS
THAT RADIATES
QUALITY

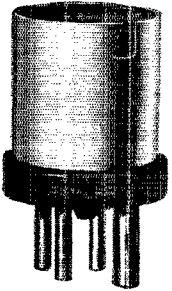

Remler
Socket
Adaptor
Type 499

For using C-299 or UV-199 Tubes in sockets designed for C-11 and WD-11 Tubes.

Price \$1.00

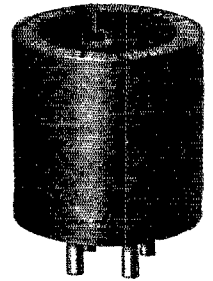

Remler
Socket
Adaptor
Type 599

For using C-299 or UV-199 Tubes in sockets designed for use with standard storage battery tubes.

Price \$1.25

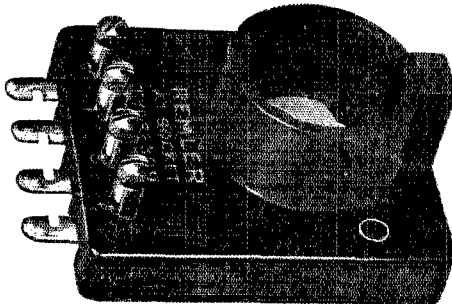

Remler Dry Battery Tube Socket, Type 399
For Table or Panel Mounting, Price \$1.00

Three New REMLER Items

of unquestionable merit, for use with C-299 and UV-199 Tubes

THESE three new appliances, a socket and two adaptors, for the C-299 and UV-199 dry battery tubes, are in every detail representative of *Remler Quality Apparatus*.

They are perfect not only from the standpoint of manufacturing quality and appearance, but from the standpoint of mechanical and electrical design.

Each of these items provides for the easy insertion of the tube in such a manner that it will not be jarred and become

damaged, and have that strong positive contact so essential in any tube socket or adaptor to insure quiet and efficient operation of the circuit in which it is used.

We are pleased to recommend these three items to the public as being representative of the quality of all Remler apparatus. We are confident that your use of any of these articles will make you permanent Remler customers. Ask your dealer to show them to you, or write direct for our complete descriptive bulletin.

REMLER RADIO MFG. COMPANY

Factory and Home Office
248 FIRST STREET, SAN FRANCISCO

Eastern Sales Office
154 W. LAKE STREET, CHICAGO, ILL.

When you push the plunger in, or --

Pull the plunger out, it makes all the difference between h--ll broke loose and a heavenly calm. Because Little Omega Durham and his friend Dubilier are *that* accurately adjustable! Old timers hush their tubes now with but one finger-tip motion—and bewail the hours and dollars wasted on lead pencils. But don't throw away the pencil! You'll need it to copy a longer list of stations.

Used as a muffler for transformers

Try a DURHAM Variable as a radio leak across audio primaries. It will cut out a whole lot of mysterious racket.

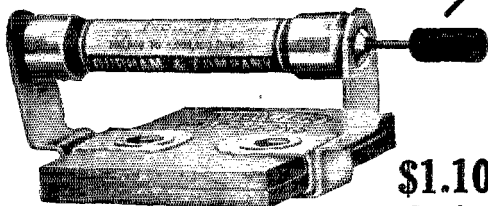

\$1.10
Complete

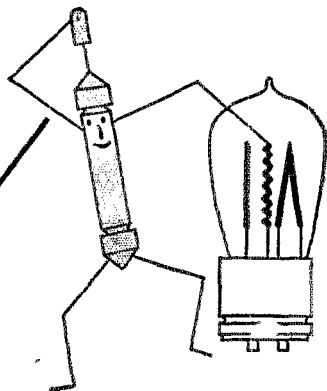

DURHAM Variables + DUBILIER Micadons

No. 101—to 5 megs.
No. 201A—to 10 megs.

.00025 mfd.
.00050 mfd.

There's a combination for your tubes

Manufactured by

DURHAM & CO.

1936 Market St., Philadelphia

Dealers and Jobbers—There's a good harvest of sales every summer—among the 40,000 readers of QST. For it's rebuilding time. And they're buying parts right now!

ATWATER KENT

RECEIVING SETS AND PARTS

are ideal for summer use due to their compact and rugged construction and the fact that they are moisture-proof.

Send for the illustrated folder

ATWATER KENT MFG. COMPANY
4945 Stenton Ave. Radio Dept. Philadelphia

Suppliers of
THE WORLD'S HIGHEST GRADE IGNITION
STARTING AND LIGHTING

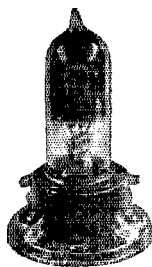

Na-aid Special Socket No. 499



DeLux Contact

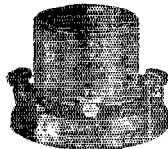

Na-aid DeLux No. 400

It's the contact that counts

A careful examination will show that each contact in Na-aid sockets and adapters is of a wiping nature on a broad surface, and of sufficient tension, and so designed that tension is permanent, no matter how often the bulbs may be removed and how much the connecting prongs in the tubes vary.

It is little realized that sockets are being sold which, owing to faulty choice or control of material, develop current leakages from plate to grid that rob many otherwise well-made sets of their efficiency. Na-aid sockets in their design avoid all these troubles.

NA-ALD SOCKETS

| | |
|--|-----------|
| No. 499 Socket, 199 tubes | .. \$0.50 |
| No. 429 Adapter, 199 tubes | .. .75 |
| No. 400 DeLux, 200 tubes | .. .75 |
| No. 401 Small Space, 200 tubes | .. .85 |
| No. 411 W.D.11 tubes | .. .75 |
| No. 450 Two in one, W.D. 11 or 200 tubes | .. .50 |

Bonket with diagram of Hazeltine's Neutrodyne Circuit and other selected circuits packed with each Na-aid product.

Alden Manufacturing Co.
Manufacturers of Sockets for Every Tube and Requirement
Dept. M 52 Willow St.
Springfield, Mass.



HERE!

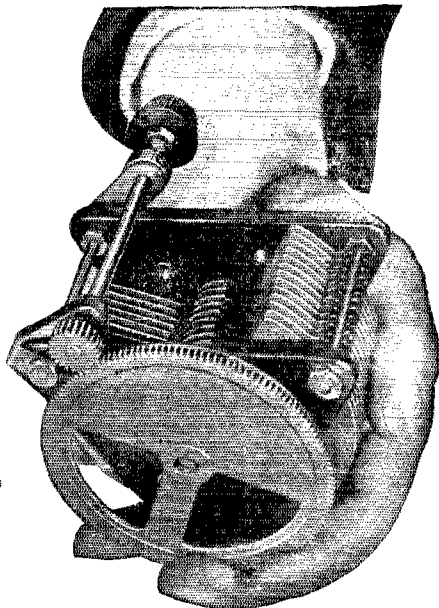
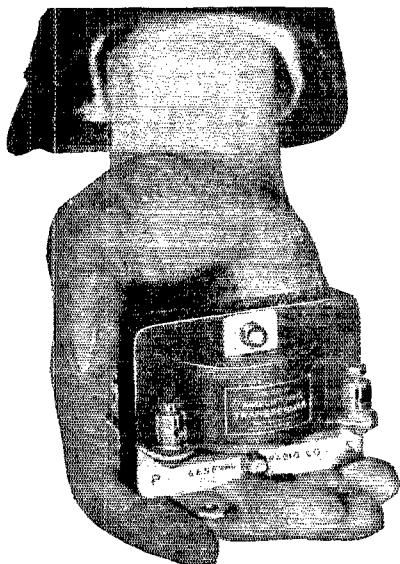

Use a Selective Condenser but a Non-selective Transformer

Good quality demands equal amplification for all frequencies within the voice range. The 3.7 to 1 ratio of the type 231A amplifying Transformer gives maximum amplification without distortion, in multi-stage as well as in single stage amplifiers.

High ratio amplifying Transformers are selective—and selective transformers have a resonant peak that causes serious distortion. Confine selection to the Condenser.

The General Radio Co.'s type 231A Transformer is suitable for use with UV-

\$5.00

201A, 201, 199, WD-11, 12 and tubes of similar plate impedance.

A selective receiver is now a necessity. The new wave length allotments to broadcasting stations have helped to reduce interference, but the large number of broadcasting stations and the fact that the available band of wave lengths is limited, render a selective Condenser a necessity.

For selectivity, sharp tuning and fine adjustment, use a General Radio Co.'s type 247, 500 MMF geared Condenser.

Type 247 supplied mounted or unmounted, with or without gear.

\$3.25 to \$7.25

At your dealers, or direct from us: Two educational folders, "Quality Amplification" and "Quality Condensers."

Send for free Radio Bulletin 914Q.

GENERAL RADIO COMPANY

Manufacturers of Radio and Electrical Laboratory Apparatus

CAMBRIDGE

MASSACHUSETTS

5420



ONCE YOU'VE USED A CHELTEN

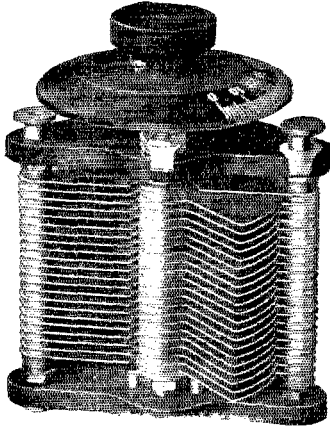

Catalogue No. 800M 43 Plate Type

You'll realize it is a precision instrument. Note how smoothly it turns, how clearly the signals come in, how accurate are its adjustments.

Every part, including spacers for plates is accurate to a thousandth of an inch. Heavy gauge aluminum plates are used. Bearings are over-size. End plates are thick and moulded from the best insulating material.

The spring tension on the rotor plates eliminates counterweights and secures positive adjustments.

Chelten Condensers are made in 43 plate (.001 Mfd.) and 21 plate (.005 Mfd.) and also in special sizes.

Other Radio Products

The Chelten Quality Line includes Midget Condensers—Rheostats—Tube Sockets—Switches—Dials—Jacks—Plugs—Crystal Detectors.

FOR SALE BY RELIABLE DISTRIBUTORS

Descriptive Literature on Request

*Since 1910 Manufacturers of
High Grade Electrical Specialties.*

Chelten Electric Company

4861 Stenton Ave., Philadelphia

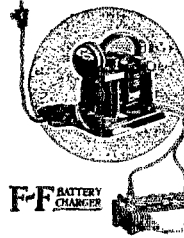

\$15.00

F.O.B. Cleveland

Type 6 charges 6 to 8 Volt storage battery from any 110 Volt 60 Cycle lamp socket at average rate of 6 amperes.

F-F BATTERY CHARGER

Contactors Can't BURN or STICK

They also permit a desirably high charging current that makes for quick and easy storage battery charging.

Buy from your dealer. There's a type for every need. If he cannot supply you, write for literature or enclose remittance covering express or postal charges on 9 lbs.

Dealers Write For Complete
Details in Bulletin No. 31

THE FRANCE MFG. CO.

10331 Berea Road, Cleveland, Ohio

Pioneer Manufacturers
of Patented Battery Chargers

Amplification Perfection

with an audio transformer means PURE
TONE QUALITY with MAXIMUM
VOLUME

The AMERTRAN

AUDIO TRANSFORMER

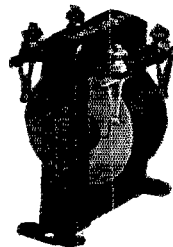

Price \$7

Ask your electrical dealer, or sent carriage charges collect. (Wt. 1 lb.)

is acknowledged by professional radio engineers to be the standard of excellence for audio amplification.

The reason for the popularity of the AMERTRAN among professional radio men is apparent in the Amplification Chart shown in our Circular No. 1005.

Turn ratio, 5:1. Amplification ratio, 30-40 times audibility in the flat part of the curve.

American Transformer Company

Designers and builders of radio transformers for over 20 years.

176 Emmet St., Newark, N. J.

Radio Instruments

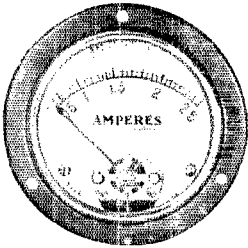

Type BX Radio-Frequency Ammeter, 2-in. Dials, 2-in. Scales.

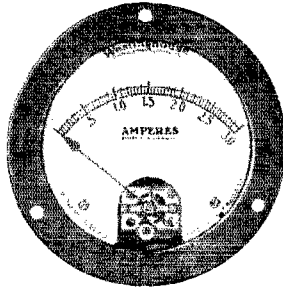

Type CX Ammeter
3-in. Dials, 2½-in. Scales.

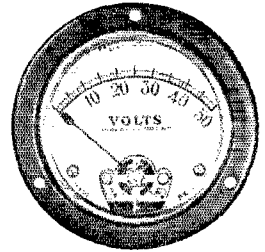

Type BX Voltmeter
2-in. Dials, 2-in. Scales.



A Type BX Radio Frequency Ammeter in the transmitting circuit will indicate the strength of the current in the antenna, which, in turn indicates the effectiveness and character of transmission.

A Type BX Voltmeter, in the "B" battery circuit, tells the condition of the battery and will also detect weak and dead cells of the battery.

A Type BX Voltmeter across the filament circuit will pay for itself by increasing the tube life. The vacuum-tube filament is designed for a certain amperage and voltage. Values of current or voltage below the standard will decrease the efficiency of the set. Values above the standard, even the slightest amount, will materially shorten the life of the tube.

Type CX Instruments have 3-inch dials and 2½-inch scales, otherwise they are the same as the type BX.

Folder 4471-B
gives full particulars

Accurate
Reliable
Economical

Westinghouse Electric & Manufacturing Company

NEWARK WORKS, NEWARK, N. J.

Westinghouse



Radio Accessories Are Up-To-The-Minute and Electrically Correct

Our thirty years' experience in designing and manufacturing telegraph, telephone and electrical apparatus and parts enables us to insure a high degree of electrical perfection in our large line of Radio Receiving and Sending Products.

"Signal" R75 Tube Socket. Only socket on the market that will take any of the 4-prong tubes: detector, amplifier or oscillator, without change or adjustment. Base is molded from solid Formica, tubing is brass, nickled, spun into the base in such a way as to make the control permanent. Socket springs are phosphor bronze, instead of sheet
Each 90¢
brass

"Signal" RI29 Tube Adapter. Allows you to use set for either standard or W D 11 tubes at will or
Each 75¢
interchangeably.

"Signal" RI28 Tube Socket for W D 11 Tube. Formica Base is mounted on four insulated feet. The four prongs of tube are inserted in accurately drilled and ferruled holes in base, and gripped firmly by Control Springs on the under
Each 50¢
side.

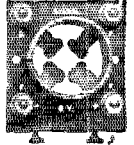

Send for our Catalog of Radio Sets and Parts. Liberal discounts to dealers.

SIGNAL Electric Mfg. Co.

Factory and General Offices:

1915 Broadway,
Menominee, Michigan.

Atlanta Cleveland New York St. Louis Boston Minneapolis Pittsburgh Toronto San Francisco
Montreal Chicago

(You'll find our branch offices in the Telephone Directory)

SEXTON CONDENSERS

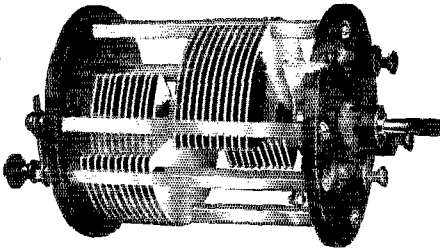

**Vernier and Rotor Plates
Controlled by Single Knob**

"Pigtail" connections replace all sliding contacts.

Templates of gummed paper are provided for drilling.

Balanced models are equipped with "half capacity" switch.

All Sexton condenser endplates are of mottled red and black bakelite.

Send for circular showing Prices

Manufactured by

**THE HARTFORD
INSTRUMENT CO., INC.**

308 PEARL ST., HARTFORD, CONN.

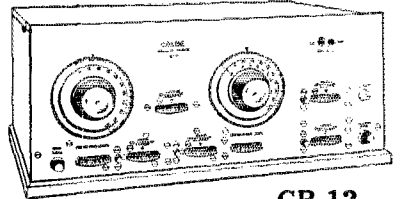

CR-12

The New Grebe Broadcast Receiver

Just the thing for your home.

A silk-covered wire but 20 feet long, supplied with this Receiver, does the work of the unsightly outdoor antenna, or loop. This wire may be concealed behind the picture moulding or run along the baseboard.

Send for illustrated booklet "Q"

**Philadelphia Wireless
Sales Corporation**
1533 Pine Street
Philadelphia



Are you the man

who will win one of the fifty prizes offered by Acme for the best results obtained with radio frequency this summer?

FOR the best article setting forth how radio frequency has helped conquer summer static and other forms of interference (such as radiating receiving sets and spark transmitting stations) the Acme Apparatus Company will pay \$250.00 in cash. To the second best, \$150.00 and to the third best \$100.00 in cash. To the next 47 best articles this company will give prizes of different Acme Apparatus ranging from \$80 for Acme phones to \$5 for radio and audio frequency transformers.

The article must narrate the personal experiments and experiences of the writer, in securing distant stations, in avoiding interference and distortion, and in securing volume and clearness of reception. Wiring diagrams showing the hook-ups used to secure the best results

will add greatly to the value of the article. The articles must not exceed 500 words in length. Radio frequency transformers of any make or brand will be eligible. The contest starts June first and ends September thirtieth. All articles must be postmarked not later than October first.

In case of a tie, each tying contestant will receive the full amount of the prize. Everybody outside the Acme organization is eligible. Do not stay out of the contest for fear that you are not an "expert." A novice with natural mechanical or electrical ability may capture first prize. Send the coupon below or apply to any radio dealer to secure complete details, including list of judges and prizes.

ACME

*for
amplification*

ACME APPARATUS COMPANY,
Cambridge, Mass.

Please send me detailed information on
Acme prize contest on radio frequency.

Name

Street

City

State

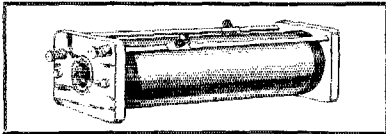

FROST-RADIO TUNING COIL

EVERY one of you amateurs knows the prestige of Frost-Radio. Many of you doubtless use Frost-Fones, Frost-Radio Plugs, Jacks, Jac-Boxes and other apparatus bearing the Frost name plate.

You will be interested in this big-value Frost-Radio Tuning Coil, also. It offers you higher quality for a lower price than any other similar product.

Made of the very best materials money can buy. Wound with silk-covered magnet wire, on an impregnated tube. Woodwork is hardwood, mahogany finished. Length: 11 inches. Metal parts are



triple nickel plated and hand buffed. Sliders are selective to a single turn. In short, as fine a coil as you ever saw, and at the remarkably low price of \$3.00.

Ask your dealer for a No. 410 Frost-Radio Tuning Coil today.

HERBERT H. FROST, Inc.
154 W. Lake Street, Chicago
30 Church Street, New York



Freshman FIX-O

*A Fixed Resistance Leak
Combination---4 in ONE*



Freshman Condenser
Leak Mounting
Freshman Fixed Leak
SAFE-T HANDLE

Complete
Price

65c

*Furnished in any value of resistance
from 45 to 10 Megohms*

Separate Condenser and Mountings 40¢

Separate Leaks with Safe-T Handle 30¢

At your dealers. Otherwise send purchase price and you will be supplied without further charge.

Chas. Freshman Co. Inc.
Radio Condenser Products

106 SEVENTH AVE.,

NEW YORK

RHAMSTINE*

Victophone

for your phonograph

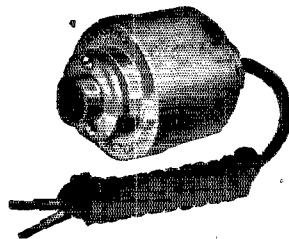

Price
7.50

Complete with
Cord

The Rhamstine* Victophone is easily attached to the tone-arm of any phonograph. This combination meets a recognized need for a perfect loud-speaker.

Because of its unsurpassed tone qualities, the Victophone has become universally popular.

You will be pleased with your Victophone.

Manufactured by

J. THOS. RHAMSTINE*

2162 E. Larned St., Detroit, Mich.

*Maker of Radio Products

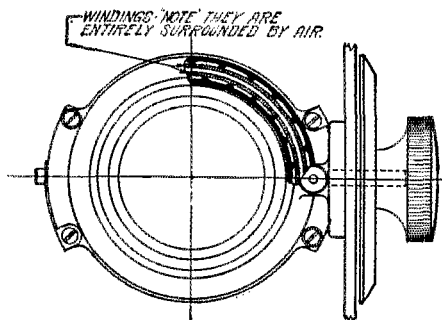
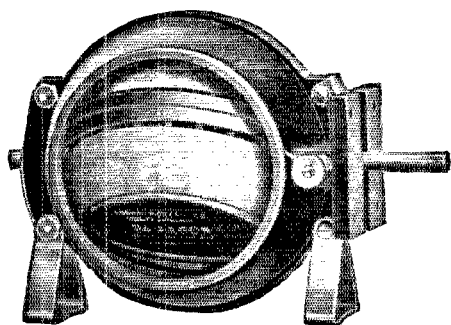

New Paragon \$5.00 Variometer

Assures Maximum Efficiency on
New High-frequency Wavelengths

The new band of wavelengths, recently enforced, involve radio currents of extremely high frequency.

This calls for an inductance unit of exceptional electrical and mechanical excellence.

Any amateur will quickly see why the ribbed design of our new No. 60 Paragon Variometer assures greatest efficiency at these high frequencies.

Material reduction of solid dielectric in the support forms permits us to offer this essential radio adjunct at an extremely reasonable price.

While comparatively lighter in

weight and considerably smaller than most variometers, our new Paragon No. 60 loses nothing in durability and gains much in overall (minimum to maximum) wavelength range.

In rebuilding his receiving equipment to conform with new standards, the radio-wise amateur will take these merits into account and will find it far easier to secure expected results on wavelengths of 150 to 200 meters with an inductance unit of this excellent design, than with any other.

Write for complete catalog of Paragon Radio Products.

ADAMS-MORGAN CO., 4 Alvin Avenue, Upper Montclair, N. J.

PARAGON

Reg. U. S. Pat. Off.

RADIO PRODUCTS

"ESCO" BATTERY CHARGERS

To meet an insistent demand for
RUGGED—RELIABLE
NEVER-FAILING
MOTOR-GENERATORS

For charging Batteries
Used in Wireless Operation
We have developed a complete line of
MANY SIZES.

With or Without panel Boards.
"ESCO" QUALITY thruout. You KNOW
what THAT means.
Ask for Bulletin 242.

ELECTRIC SPECIALTY COMPANY

225 SOUTH STREET,
STAMFORD,
CONN., U.S.A.

Pioneers in developing
Quality Wireless Apparatus

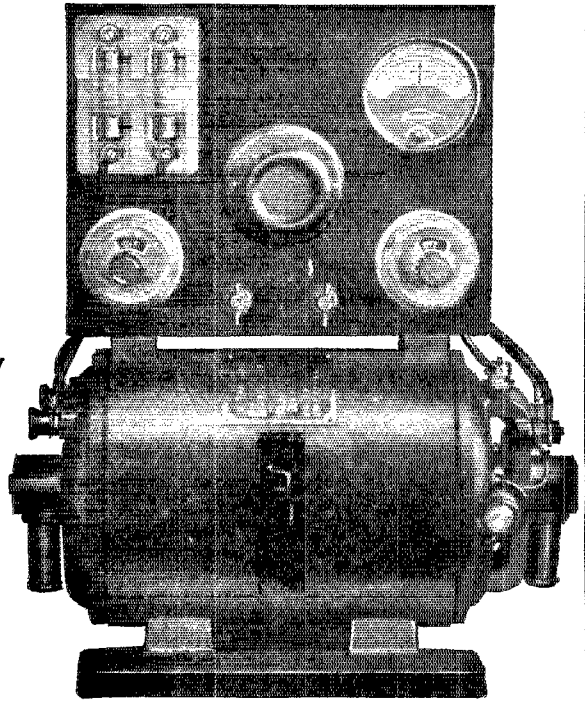

Actually A Daily Necessity

Regardless where you are or whether
it is for radio work, electrical testing
or around automotive jobs, the most in-
dispensible little device to have in your
pocket is a

Sterling

POCKET VOLTMETER

It is made accurately, carefully calibrated,
good looking and durable. It registers the
voltage instantaneously and is reliable
throughout. Also ammeters and volt-
ammeters.

No. 34B 0-30 Volts List Price \$2.25
No. 34C 0-50 Volts List Price 2.75

THE STERLING MFG. COMPANY
2849 Prospect Ave., Cleveland, O.

RUSONITE

CRYSTAL RECTIFIER
(Patent Pending)

**THE PERFECT SYNTHETIC
CRYSTAL DETECTOR**
SENSITIVE OVER ENTIRE SURFACE.
No Hunting for "Spots." Loud and Clear.
Endorsed by Thousands of Satisfied Users.
Sensitiveness Price
Guaranteed Mounted **50c**

14 K. Gold Supersensitive
RUSONITE CATWHISKER, Price
Permanent. Will not Oxidize. **25c**

RUSONITE REFLEX CRYSTAL.
Manufactured Expressly for Reflex Circuits.
Will Stand Up Under Heavy Plate Voltage
Price
Guaranteed Mounted **\$1.00**

Order from your dealer or direct from
RUSONITE PRODUCTS CORP.
15 Park Row, New York, N. Y.

KENNEDY

The Royalty of Radio

See your dealer for demonstration of Kennedy re-
ceiving sets or write us for descriptive literature.
THE COLIN B. KENNEDY CO.

Saint Louis San Francisco

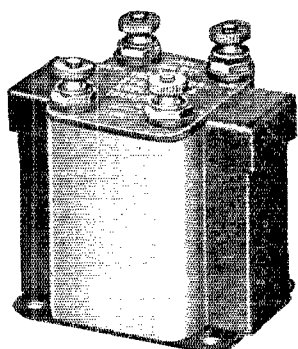

THORDARSON

Volume Selectivity Tonal Purity

Amplifying Transformers

Price, mounted only

6 to 1 ratio transformer (with Red Label) \$4.50

3½ to 1 ratio transformer (with Blue Label) \$4.00

The latest Thordarson developments in audio frequency transformers and variable condensers provide the experimenter and amateur with a positive means to increase the range, selectivity, and volume of broadcast reception. Distortion and internal

interference are entirely eliminated through exclusive Thordarson scientific principles, constant supervision and tests at every stage of manufacture and assembly. Local stations and stations broadcasting simultaneously are tuned in or out at will.

Thordarson Built the First 1,000,000 Volt, 25 Cycle Transformer

He has also constructed mammoth transformers for central stations and leading Universities of the United States. No one man is more responsible for the present day efficiency of commercial A. C. transformers than he and that same genius, and 28 years of practical experience has developed audio frequency amplifiers and variable condensers to a degree of efficiency never before attained by any manufacturer. A folder describing their specifications will be sent on request.

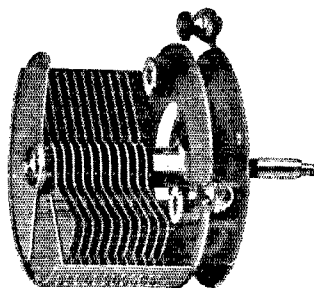

Variable Condensers

| | |
|-----------------------------|--------|
| 13 plate .00025 M. F. | \$2.00 |
| with vernier, knob and dial | 3.50 |
| 23 plate .0005 M. F. | 2.50 |
| with vernier, knob and dial | 4.00 |
| 43 plate .001 M. F. | 3.00 |
| with vernier, knob and dial | 4.50 |

Sold by all forward-looking radio dealers

THORDARSON

ELECTRIC MFG. CO.

Huron and Kingsbury Streets

Chicago

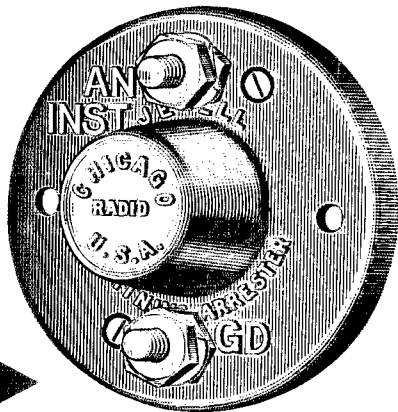

JEWELL LIGHTNING ARRESTER

APPROVED BY
UNDERWRITERS

The latest regulations of the National Board of Fire Underwriters call for a lightning arrester on every building having an outside aerial.

The Jewell Arrester has passed all the Underwriters' tests and carries their approval.

The case is made of porcelain with a brown finish that harmonizes with interior woodwork. The price is right.

PRICE \$1.10

ORDER FROM DEALER.

**JEWELL ELECTRICAL
INSTRUMENT CO.**
1650 Walnut St., Chicago

*Natural
Re-PRODUCTION*

**Atlas
AMPLITONE**
LOUD SPEAKER

No blast or distortion. Its exclusive, patented feature—the adjustable, double diaphragm—produces the radio programs in their original naturalness. Tunable to your set and receiving conditions.

Let your ears be the judge. Hear the Atlas Amplitone at your dealer's. Write for interesting booklet "D". **\$25**

Letters from Users Requested.
What have you accomplished with your Atlas Amplitone? Tell us about it.

Multiple Electric Products Co. Inc.
RADIO DIVISION
ORANGE ST., NEWARK, N.J.

RT-A 2

The Audio Frequency Transformer that gives you perfect Tone Quality and High Amplification without distortion. Moisture-proof—it is ideal for the seashore.

Letters received every day state that RT-A 2 passes every test and fulfills the most critical requirements of experts and amateurs.

Use RT-A 2 transformers at once and enjoy better radio reception.

Price \$6.50 at all good dealers.

RASLA SALES CORPORATION
National Distributors
Dept. B. 10 East 43rd St., New York City

LET RADIO EXPERTS BUY FOR YOU

This Service Is Free

Why hunt from store to store? Save time, trouble and money—a group of Radio Experts in New York will act as your *personal representative*, buy for you any standard make of radio equipment you want, from the smallest part to a complete set, either assembled or unassembled, and deliver it to you prepaid—all for less than if you did your own buying. Satisfaction guaranteed. Also disinterested advice on all radio problems—free. Write for plan.

PERSONAL SERVICE PURCHASING BUREAU
505—5th Avenue, Desk 13, New York

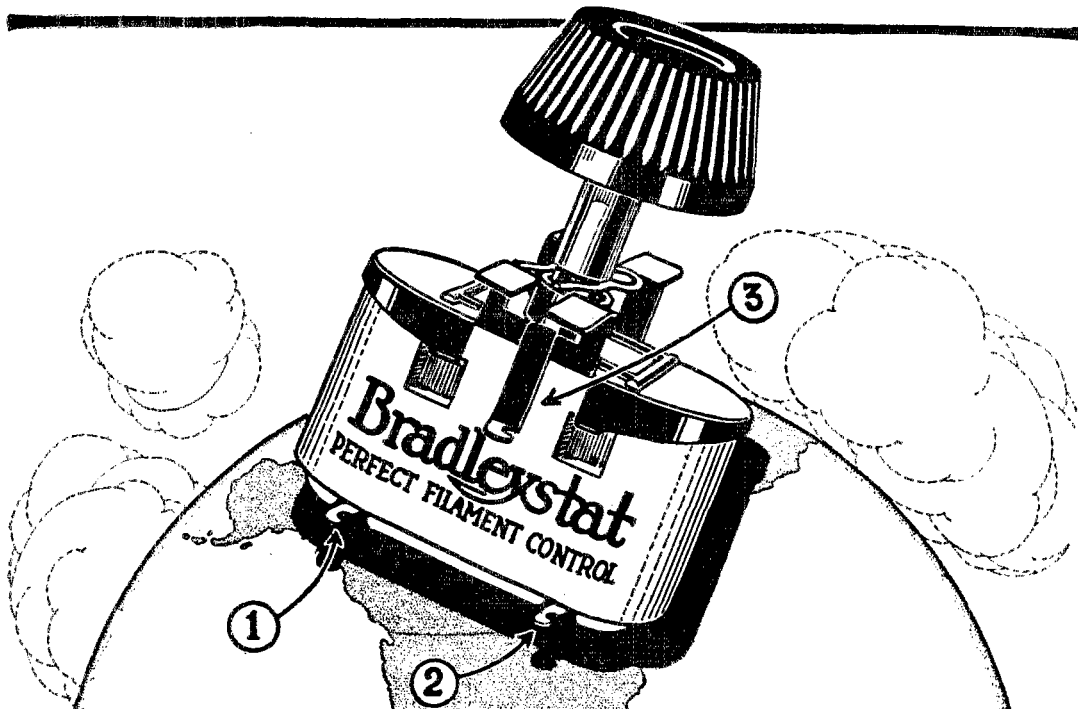

Use *Any* Tube with the Universal Bradleystat



A Letter from an Ohio Radio Dealer

"The Bradleystat has met with our entire approval. We have made it regular equipment on all Westinghouse R C sets sold by us and have installed many Bradleystats on Crosley and other receivers, with perfect satisfaction."

Dealers

New counter cards, technical folders and other sales helps are ready for you, explaining the wonderful opportunities of the Universal Bradleystat. Be prepared to meet the demand of thousands of radio set users who are clamoring for the Universal Bradleystat.

Price, \$1.85

Parcel Post, 10c extra

TRY any tube—old, new or foreign—in your radio set. The new Universal Bradleystat with three terminals will give perfect filament control for any tube you may select. There is no need of tearing down your set to install a new rheostat whenever you change tubes. A simple change of connections gives you noiseless, stepless, perfect control.

Bring your set up-to-date by installing the Universal Bradleystat with three terminals. It is for sale by all radio dealers at the same price as the old Bradleystat, now used in several hundred thousand radio sets. Remember, the Universal Bradleystat is guaranteed to give satisfaction.

Allen-Bradley Co.

Electric Controlling Apparatus

277 Greenfield Avenue, Milwaukee, Wis.

Manufacturers of Graphite Compression Rheostats for Twenty Years

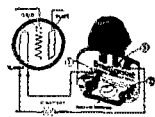

For 1/2 and 1 amp. tubes

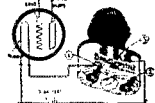

For 1/4 amp. tubes

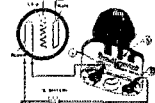

For .06 amp. tubes

Federal Audio Frequency Transformer No. 226

AMPLIFICATION WITHOUT DISTORTION

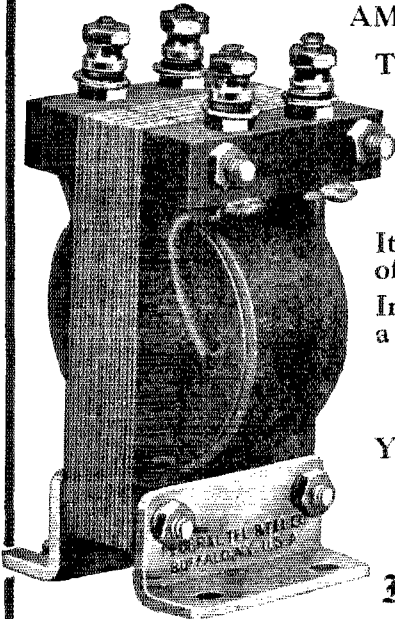

No. 226 actual size

This transformer pronounced by leading Radio engineers, after exhaustive tests, to excel in all essentials.

Federal A. F. Transformer No. 226 can be used with any vacuum tubes in common use.

It furnishes greater amplification and faithfulness of reproduction of both voice and orchestral music. Install a No. 226 on your present set. It will prove a revelation to you.

Every unit guaranteed. Send today for illustrated catalog, describing them fully.

YOUR DEALER SELLS FEDERAL No. 226

130 Guaranteed Radio Products

Federal Telephone & Telegraph Company

BUFFALO, N. Y.



STROMBERG-CARLSON RADIO HEAD SETS

Are balanced as to volume—both ears get the message. This means that the receivers are mated—a feature which permits the users enjoying the sensation of hearing equally well from both receivers. Stromberg-Carlson Head Sets have three more distinctive features, which you will like—

1. The receivers are layer wound and layer insulated—to stand up under high plate voltages.
2. The ear caps cover the ears—excluding outside noises.
3. The adjustment rod telescopes; therefore it does not catch the ladies' hair.

Order from dealer or write for bulletin No. 1029-Q.
Stromberg-Carlson Telephone Mfg. Co., Rochester, N. Y.



**"BUILD YOUR OWN"
With "RASCO" Parts!**
If you need small radio parts in a rush, "RASCO" will supply them cheaper, better and quicker than any one. Be sure to get our great 68-page catalog. Over 500 different parts, 300 illustrations. This catalog contains 75 Vacuum Tube Hook-Ups, all values being shown. Due to great cost, catalog sent only upon receipt of 15c, stamps or coin.
Radio Specialty Co., Inc.
380 Park Place, New York

CHARGE YOUR BATTERY.

(RADIO OR AUTO)
at HOME for a NICKEL
The **HOMCHARGER**
POPULARLY PRICED—PAYS FOR ITSELF
SEND FOR THE AUTOMATIC ELECTRICAL
DEVICES CO.
FREE BOOK: 27 N. THIRD ST.—CINCINNATI, OHIO.

Good news for the radio fan

Announcing a complete line of Exide Radio Batteries for all types of tube sets

EVERY radio fan who has tuned in with an Exide A or B battery will welcome the news that the popular Exide line has been extended to include two low-voltage A batteries. An Exide Radio Battery is now available for all types of vacuum-tube sets.

Whether you want a long-life storage battery for six-volt tubes, an A battery for low-voltage tubes, or a B battery, you can take your choice of Exide Radio Batteries and be sure of getting the right battery for your set.

For low-voltage tubes

The two newcomers in the Exide radio family are two- and four-volt A batteries for tubes consuming .25 amps. at 1.1 to 1.5 volts and those using .06 amps. at 3.0 to 3.5 volts. These sturdy little batteries were specially designed to meet the requirements of WD-11 and UV-199 vacuum tubes. Weighing less than 6 lbs. each, they are midgets in size, but giants in power.

Exide Radio Batteries give steady, dependable current with only occasional recharging. They make it possible for you to reproduce broadcast selections in clear, bell-like tones. When your set is hooked up with an Exide, you have ample power for maximum signal strength at all times. You can tune in distant stations with the most satisfactory results.

In service over a generation

For more than a generation the famous Exide Storage Battery has helped to turn the wheels of industry. Long before radio broadcasting achieved its present popularity, the Exide proved its worth in commercial and marine wireless; it is used today in a majority of all government and commercial wireless stations. When the American public found in radio a new form of entertainment, the Exide became by reason of superiority the leading radio battery.

You can get an Exide Battery from a nearby radio dealer or Exide Service Station. Ask the dealer for booklets describing in detail the complete line of Exide Radio Batteries, or write direct to us.



For six-volt tubes

Like all Exide Storage Batteries, the Exide A Battery for six-volt tubes is dependable and long-lasting. It is made in four sizes, of 25, 50, 100 and 150 ampere hour capacities.

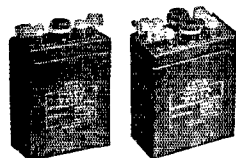

*Two- and four-volt
A Batteries*

The new Exide A Batteries consist of one and two cells, respectively, with rated capacities of 12 and 24 ampere hours. The two-volt A Battery will heat the filament for 96 hours; the four-volt A Battery for 200 hours.

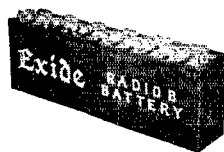

Exide B Batteries

give noiseless, full-powered service over a long period of discharge. Designed throughout to prevent electrical leakage. Capacity, 3 ampere hours.

Exide

RADIO BATTERIES

THE ELECTRIC STORAGE BATTERY COMPANY, PHILADELPHIA

Service Stations Everywhere

Branches in Seventeen Cities

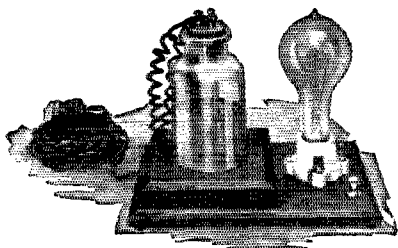

Kimley "B" Battery Charger

Storage Batteries

designed for

RADIO

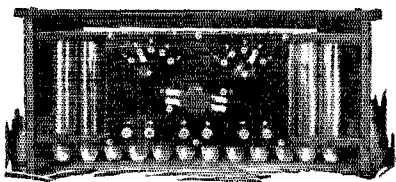

100 volt "B" Battery with Panel Control

Among the users of KICO Storage "B" Batteries are prominent engineers, the United States Government, many colleges and educational institutions and most of all, thousands have been sold to amateurs who understand radio.

A FEW REASONS

1. Alkaline type will not sulphate nor buckle.
2. Not harmed by short-circuiting, overcharging, or standing idle.
3. Panel switches afford single cell variations (Critical adjustments are essential for phone reception.)
4. Easily recharged from any 110 volt A.C. line by means of a small home rectifier.
5. Using a 100 volt battery on a detector and two or three steps of audio amplification, one charge lasts from two to four months.
6. Neat and compact.
7. Unlimited life.
8. All batteries are sold with the privilege of receiving your money back if not satisfied within 30-day trial.

Prices without rectifier

| | Plain | (With Panels) |
|--------------------------|--------|---------------|
| 16 cell 22 volt..... | \$5.50 | |
| 24 cell 32 volt..... | 7.25 | \$11.75 |
| 36 cell 48 volt..... | 9.50 | 14.00 |
| 50 cell 68 volt..... | 12.50 | 17.00 |
| 78 cell 100 volt..... | 17.50 | 22.50 |
| 108 cell 145 volt..... | 23.50 | 28.50 |
| Unmounted rectifier..... | 1.00 | |
| Mounted rectifier..... | 2.50 | |

F. O. B. Buffalo, N. Y.

Literature gladly furnished.

KIMLEY ELECTRIC CO., Inc.

2665 Main St.,

Buffalo, N. Y.

RADIO

TRANSFORMERS

REAL MERIT is what you expect and what you receive when you use STANDARD Radio Transformers.

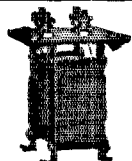

Type M



Type FL

PERFECTLY SHIELDED by virtue of the design MAXIMUM AMPLIFICATION by proper impedance.

Silicon steel cores, insulation test on coils 1500 volts. Bakelite Terminal Board.

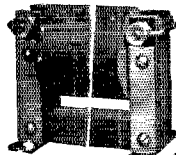

Type MR

Type M—Ratio 9 to 1.....\$5.00

Type MR—Ratio 4 to 1..... 4.50

Type FL—Filament Heating..... 3.00

Discount 10% for cash with order.

Designed by *Pickard* engineers, a quality name in Radio.

THE STANDARD TRANSFORMER COMPANY
WARREN, OHIO.

MAXIMUM



EFFICIENCY

Variable Condensers

Assure yourself of the best results by placing one of these high grade and reliable condensers in your Radio set. At new low prices

| | | |
|-----|-----------------------|--------|
| 201 | 3 plate Vernier..... | \$1.25 |
| 202 | 11 plate Vernier..... | 2.00 |
| 203 | 23 plate Vernier..... | 2.50 |
| 204 | 43 plate Vernier..... | 3.00 |

At your dealers or write direct to manufacturers

THE HIGGY-AVERY CO.

1199 Franklin Ave.,

COLUMBUS, OHIO

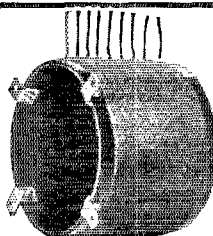

Here's another piece of

JUNK

Specifications: 3000 M. Bank Wound with 20/38 litz wire, 9 taps and all soldered on threaded bakelite tube, complete with 4 legs ready to attach to your variometer..

Price \$5.50 Postpaid

EFFICIENT ENGINEERING CO.

107-21 91st Ave., Richmond Hill, L. I.

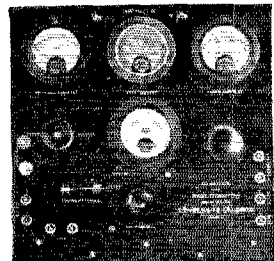
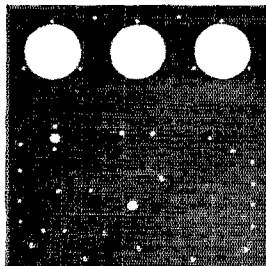
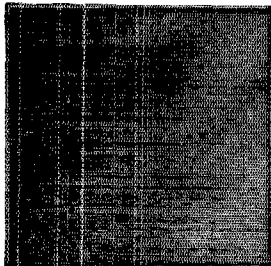

Radio Panels that will not deteriorate with age or use

A material suitable for Radio Panels that can absolutely be relied upon to retain its electrical and mechanical properties unimpaired, through wide variations in temperature, adverse atmospheric conditions and exposure to strong light.

Such is the phenol resin laminated product made and sold only by those licensed to use

BAKELITE Condensite *REDMANOL*

Phenol resin laminated material is used by all large manufacturers of radio equipment and by the U. S. Army and Navy Departments. It combines to an unequalled degree all of those properties essential to satisfactory radio performance.

Its high dielectric strength is unchanging—if anything it actually increases with age.

It is absolutely rigid, and will not warp, swell, shrink, or become brittle through exposure to moisture, heat, or cold.

It will not fade to a greenish grey even though exposed to the action of strong sunlight. It will not bloom under the most humid atmospheric conditions.

It is a standardized product obtainable in a variety of dimensions and thicknesses, and its quality does not vary.

It is readily machined, drilled, punched, threaded, and etched.

Write for a copy of Booklet B, describing phenol resin materials and their remarkable fitness for Radio Work.

Divisions of
BAKELITE CORPORATION

BAKELITE
General Bakelite Co.
8 West 40th St. New York

Condensite
Condensite Co. of America
Bloomfield, N. J.

REDMANOL
Redmanol Chemical
Products Co.
636-678 West 22nd St.
Chicago, Ill.

BAKELITE CORPORATION
Address the Divisions

The Material of a Thousand Uses

2 MILES OF WIRE

In this Little

"ALL-AMERICAN" Amplifying Transformer

Just think! 11,000 feet of No. 40 gauge enameled magnet wire are used in every type of "All-American" Audio Frequency Transformer!

"All-American" Transformers have also a very large iron core, made up of hundreds of high silicon laminations; and both winding and core are effectively insulated and impregnated by the vacuum process.

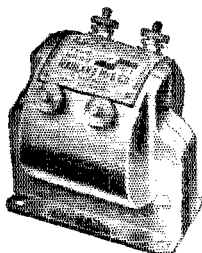

"All-American" Radio and Audio Frequency Transformers will INCREASE YOUR SUMMER RANGE. Use with Reflex, Neutrodyne, Cockaday or any of the reliable circuits.

AUDIO FREQUENCY TRANSFORMERS Amplify detected signals many-fold, permitting loudspeaker reception where otherwise only headphones would be audible.

R-12 Audio Frequency (Ratio 3 to 1).....\$4.50
R-21 Audio Frequency (Ratio 5 to 1)..... 4.75
R-13 Audio Frequency (Ratio 10 to 1)..... 4.75

RADIO FREQUENCY (Type R10 transformer has a non-magnetic core permitting it to be tuned accurately in a *Neutrodyne* circuit. Also adapted to all other circuits. Will bring distant signals to your detector thru either a loop or outdoor aerial. Fits into any standard tube socket. Range 250 to 550 meters. Price \$4.50.

Ask your dealer for FREE "All-American" Hand Book of Radio Hookups. If he cannot supply you, send two cent stamp for postage and name of your dealer.

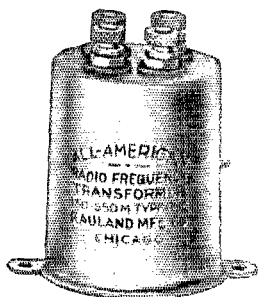

RAULAND MFG. CO.
200 No. Jefferson St., Chicago, Ill.



PANEL SERVICE

We offer to the amateur and dealer

REAL PANEL SERVICE

Our panels are cut to your order. Only genuine Condensite and Formica used.

1/8" per square inch \$0.02

3/16" per square inch .02 1/2

1/4" per square inch .03

We also carry a complete line of radio essentials. Dealers will find it profitable to have our latest price list and discount sheet.

PITTSBURGH RADIO

AND

APPLIANCE CO., Inc.

"Pittsburgh's Radio Shop"

Desk B

112 Diamond St., Pittsburgh, Pa.

WOC—TRESKO

Licensed Armstrong
U. S. Patent
No. 1113149

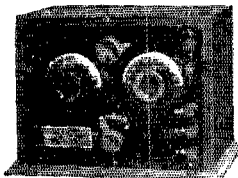

Two things that made Davenport famous. A complete 2000 mile Armstrong regenerative tuner for \$25.00. Use it with any make bulb W.D.11 or 12, or dry battery operation as well as storage battery. Portable set to use at camp or in your machine. Complete with bulb, batteries and phones, etc., \$37.50. Circulars free. This set received the Chicago American Regional Prize of \$350.00.

TRESKO

Tri City Radio Electric Supply Co.
Box 148, Davenport, Iowa

"EURACO" PRODUCTS

(Guaranteed)

Compact — Interchangeable
Most Efficient — Accurate:

60
Cents
per
Unit



60
Cents
per
Unit

**Mica Condensers — Grid Leaks
Mountings:**

Interesting Proposition for Dealers

EUROPEAN RADIO CO.

1342 East 22nd St., Brooklyn, N. Y.

WESTINGHOUSE

Radio "A," "B" and "C" BATTERIES

How often has your triumph in getting a distant signal been short-lived because of your inability to *hold* the signal? The batteries—have you looked there for the trouble? Get the best. Fine tuning requires batteries that are *even*-powered as well as full-powered. Westinghouse Batteries are built with that very important point in mind. They are as steady, even-discharging, noiseless as the highest radio and battery engineering can make them. And once you're equipped with Westinghouse Batteries your battery expense is virtually ended; they'll last indefinitely—can be easily, repeatedly and economically re-charged.

*At radio dealers and Westinghouse
Battery Service Stations everywhere.
Write for illustrated folder.*

WESTINGHOUSE UNION BATTERY CO.
Swissvale, Pa.

Westinghouse "A" Batteries
are full-capacity, slow-discharge, long-life batteries. Made in 4, 6 and 8 volt sizes, with 5, 9 and 13 plates per cell, to meet various filament-battery requirements.

Westinghouse "B" Batteries
The 22-MG-2 (22 volts) is a marvel for long, steady, noiseless service. Glass case; visible interior; sealed-in tops. Larger types, too; also 2-volt single "C" cells.

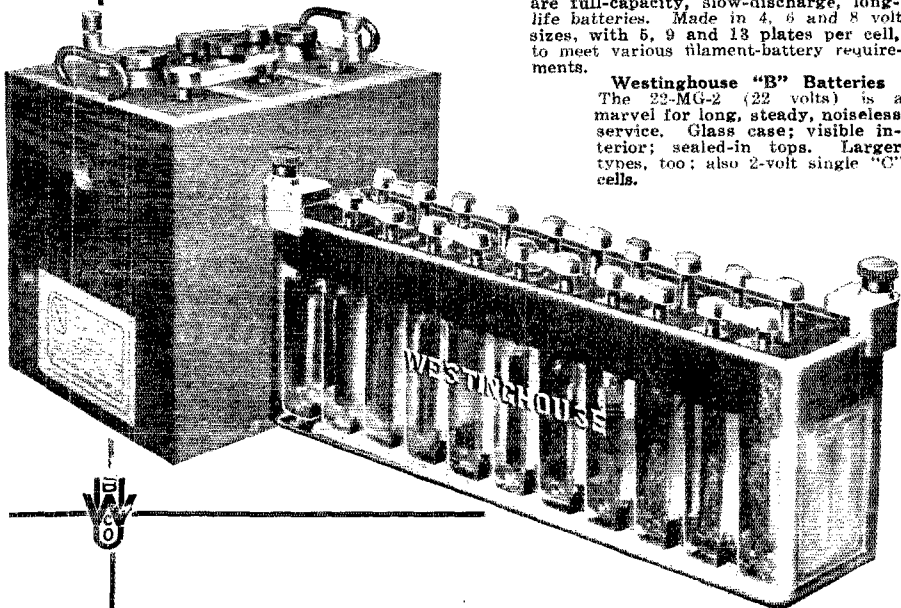

POSACO

RADIO

QUALITY AND EFFICIENCY

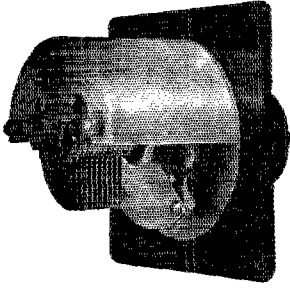

Patent applied for

ALDEN L. McMURTRY, License

VERNIER

(Single Knob Control)

- B-1 Capacity .001045 Mfd. \$7.50
- B-2 " .000545 " 7.00
- B-3 " .000295 " 6.50
- D-2 Highest Grade 4" Dial. 1.00

The "POSACO" condenser has made for itself an enviable reputation. It is a real instrument. The single knob controlled vernier is an absolute necessity for efficient tuning in radio frequency, super-regenerative and regenerative circuits. The regular variable is unexcelled for use in circuits which do not require a vernier adjustment.

MATERIALS used in the manufacture of these instruments are the finest obtainable.

WORKMANSHIP, the best. CONSTRUCTION and DESIGN, electrically and mechanically correct. Absolutely rigid. Minimum of dielectric loss.

Each instrument is tested before leaving our factory.

GUARANTEED to give satisfaction and to be free from any defect in materials or workmanship. If your dealer or jobber cannot supply you, send us your order direct, together with his name and address.

Circular sent free upon request.

Manufactured by

THE C. D. POTTER CO.
STAMFORD, CONN., U. S. A.

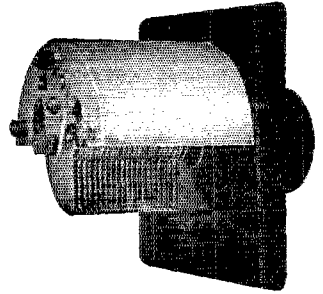

Patent applied for

REGULAR

- | | | |
|-----|---------------|-------------|
| A-1 | Capacity .001 | Mfd. \$4.50 |
| A-2 | " .0005 | " 4.00 |
| A-3 | " .00025 | " 3.50 |
| A-4 | " .000045 | " 3.00 |

POSACO

RADIO



*Make Your Set The Sensation
of Your Town!*
with

The RADIOXOR

Simple—Inexpensive—Certain

Can be attached to any set, operating head phones or loud speaker,—crystal or Vacuum Tubes,—Loop, Plug or Outdoor Aerial.

Send your name, address and type of set on a post card for details.

Selling like wildfire, so act promptly. Orders filled in order of receipt.

WILLART SALES COMPANY

Worlds Tower Building

110 West 40th St., New York City

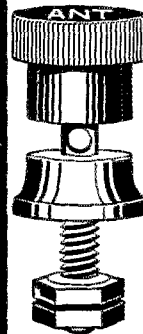

"Read'em" Binding Posts

With knobs that won't come off
Anyone can "read 'em." All popular styles—Antenna, Ground, Fones, A and B Battery plus and minus—abbreviations of different names engraved on knobs. Ask your dealer for "Read 'em"—the kind for real Radio fans. If your dealer does not have them—write direct.

The Marshall-Gerken Co.
Manufacturers
Dept. F. Toledo, Ohio



SOUTHERN RADIO CORPORATION

Radio Engineers and Jobbers

905 Realty Building,

Charlotte, N. C.



CONTINENTAL

"New York's Leading Radio House"

Radiola II—

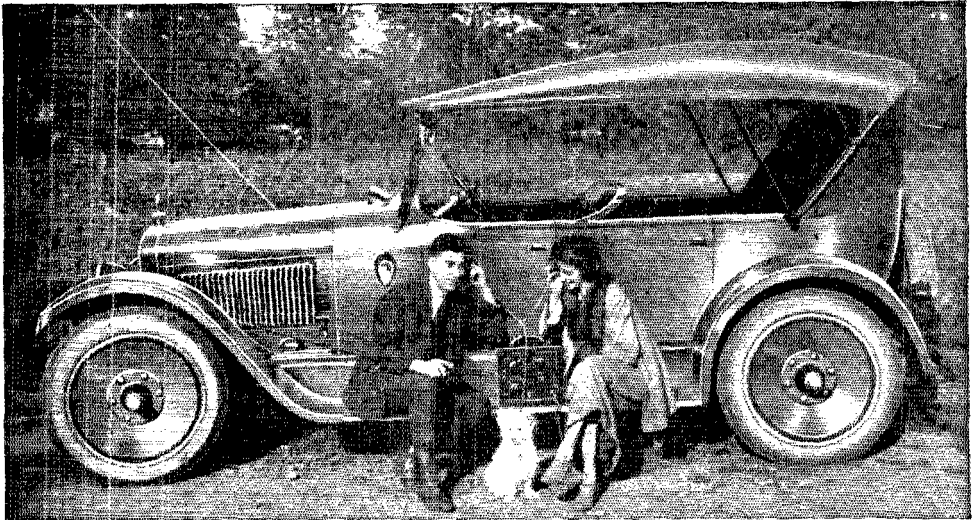

Equip your car with a portable radio set. Here's a Radiola II giving real vacation time service.

ON THE RUNNING BOARD

A sturdy portable Radiola II, just the thing to take away on your vacation. You can listen in on a wealth of wonderful concerts, new song hits and speeches.

It is light, compact and easy to transport from place to place, yet ideal for home use because of its beautiful finish and appearance.



Distributors for the Radio

Corporation of America.

2047-Q

CONTINENTAL RADIO and ELECTRIC CORPN.

6 AND 15 WARREN STREET

NEW YORK, U.S.A.

ALWAYS MENTION Q ST WHEN WRITING TO ADVERTISERS

101

LOWER HARMONICS

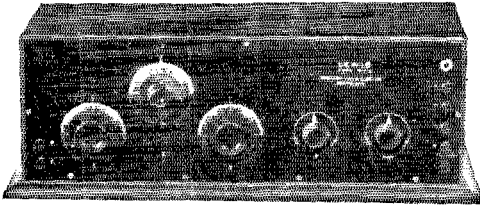

The W. C. 5

is so efficient on short waves that it has picked up many stations on their lower harmonics. If you will attempt this with some other receiving set you will soon find out how difficult it is.

You can depend on the W. C. 5 to operate without trouble or delay even under the most unfavorable conditions.

Price \$80.00

Wave Lengths 160 to 750 meters

The W. C. 5 is a 4 tube set. One stage of tuned radio frequency amplification is employed ahead of the detector to make it supersensitive. Two powerful stages of audio frequency are used to bring up the volume of signal strength. Simplicity of construction and the elimination of unnecessary parts make this set easy to operate and effective for receiving from long distances.

TO THE A.R.R.L.

We appreciate your efforts in Boosting W. C. sets and are always pleased to furnish full information about them to members who have not yet had an opportunity to operate a W. C. 5. We want every member to know the merits of this efficient outfit. If you are interested we will gladly send you a complete description of the W. C. 5 together with information as to where you can see one in operation.

Just drop us a line and we will see that your enquiry gets prompt attention

WESTERN COIL & ELECTRICAL CO.

304-Fifth St., Racine, Wis.

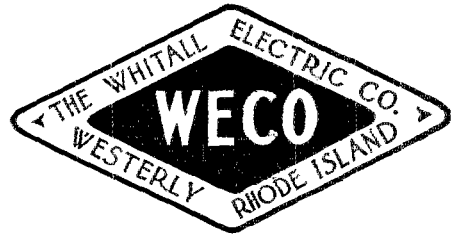

BARGAINS

In All Makes of Radio Material—
Send for Our Special Summer
Bulletin No. 30

We carry Radio Corporation, Federal, Magnavox, Acme, Frost, Chelsea, Electrose, Atwater-Kent, Cutler-Hammer and many others.

We are distributors for practically all the leading makers.

**PROMPT AND EFFICIENT SERVICE
TRY US AND SEE**

Whitall Electric Company
Westerly, Rhode Island

MARLE TRANSFORMERS

Audio Frequency
Radio Frequency

Superior Quality
Reasonably Priced
Ask Your Dealer

Manufactured by
Marle Engineering Co.
Orange, N. J.

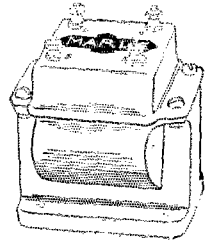

Why Pay More?

Genuine Tubes

W.D. 11 \$5.95 UV-199
W.D. 12 UV-201A

ALL NEW, NO STAMPS, NO C.O.D.
NO CHECKS

Send for our New Price List
with many other items.

Save Money By Buying From Us

CUT RATE RADIO CO.

P. O. Box 472

Newark, N. J.

HERE'S A PAIR OF WINNERS

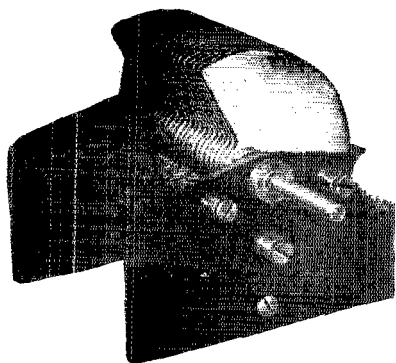

THE WIMCO CONDENSER

Made to meet a demand for quality — highest efficiency, 3 plate, 23 plate and 43 plate sizes.

Very low resistance and very low zero capacity. The phase angle does not depart from 90° sufficiently far to be detectable. Highly recommended for the fine tuning necessary in amateur apparatus.



THE CARCO COUPLER

Just the thing for the popular receiving set. Bakelite tube and rotor, silk covered wire, perfect contacts. Designed and developed by an amateur for the amateur.

Guaranteed to produce superior results. Range 150 to 700 meters. Not just "a coupler" but the real coupler—peer of all, the Carco.

We invite Dealer and Jobber inquiries.

**Send for literature and prices on the
WIMCO SOCKET FOR WD-11 TUBES**

THE WIRELESS MANUFACTURING CO.

CANTON, OHIO

Manufacturers—Distributors

Just Consider

—the essential features necessary to make an audio frequency transformer a good one—

1. High Amplification.
2. Minimum Distortion.
3. Low Interstage Linkage.
4. Convenient Mounting.
5. Compactness.

Cotoco transformers make these ideal features facts. And the finish will surely please you.

"Built First to Last"
\$5.00
At Your Dealer's

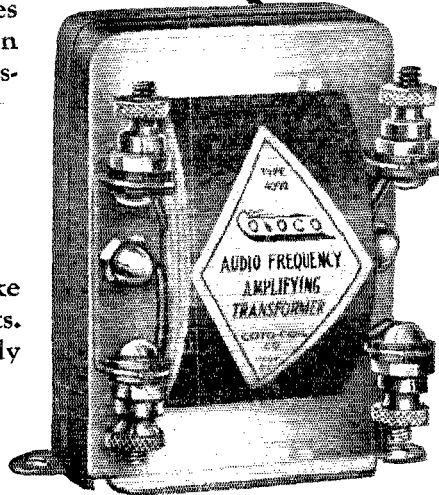

COTO-COIL CO. PROVIDENCE

"ILLINOIS" THE RELIABLE CONDENSER THAT IS MADE RIGHT AND STAYS RIGHT

| Size | Panel | Cased |
|--------------|--------|--------|
| 67 Plates... | \$7.00 | \$8.50 |
| 43 Plates... | 3.50 | 4.75 |
| 23 Plates... | 2.75 | 4.00 |
| 13 Plates... | 2.25 | 3.50 |

Vernier with single movable plate supplied to 13, 23 or 43 sizes, \$2.00 extra. Send for Bulletin.

This list is inclusive of Fine Black, Moulded Dial. We also furnish the Condenser with smooth $\frac{1}{8}$ -inch staff suitable for Dial at 15¢ off list.

Fully Assembled and Tested. IMMEDIATE SHIPMENT.

Money back if not satisfied. Just return within 10 days by insured Parcel Post.

Sent Prepaid on receipt of Price, Except: Pacific States, Alaska, Hawaii, Philippines and Canal Zone, add 10¢. Canada, add 25¢.

20% discount on orders of 6 or more; AMATEURS! Pool your orders and get benefit of discount.

G. F. JOHNSON, 625 Black Avenue, SPRINGFIELD, ILL.

HYGRADE SPECIALS

| | |
|--|--------|
| 200 ft. 7 strand No. 22 Copper aerial wire | \$1.25 |
| Morse Eureka Test Clips, per dozen | .50 |
| Skinderviken Transmitter Buttons | .95 |
| No. 763 Eveready 22½ V. Variable B. Bat. | 1.25 |
| No. 766 Eveready 22½ V. Variable B. Bat. | 1.98 |
| No. 767 Eveready 45 V. Variable B. Bat. | 3.98 |
| 2000 Ohm Murdock No. 56 Head Sets | 3.75 |
| 3000 Ohm Murdock No. 56 Head Sets | 4.25 |
| Federal or Brandes Head Sets Complete | 5.95 |
| Dictograph 3000 Ohm Head Sets | 5.98 |
| Fada or Framingham Rheostats | .65 |
| Acme Amplifying Transformers (new type) | 3.75 |
| Acme R. F. Transformers, Types R2-R3-R4 | 3.98 |
| 6 Volt Marko Storage Batteries | 8.95 |
| Firco (Bull Dog Grip) Phone Plugs | .75 |
| Federal Amplifying Transformers | 4.75 |
| 23 Plate Var. Cond. Bakelite Ends | 1.49 |
| 43 Plate Var. Cond. Bakelite Ends | 1.95 |
| No. 164A Fada Neutrodon Condenser | .98 |
| No. 163A Fada Neutroformer | 6.49 |
| No. 165A Fada Hazeltine Parts | 21.50 |

All orders must include Parcel Post charges.
HYGRADE ELECTRICAL NOVELTY CO.
41 West 125th Street New York, N. Y.

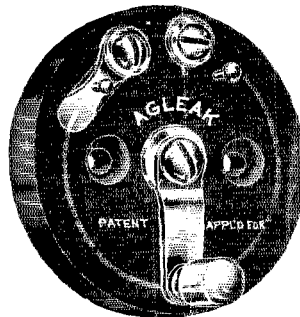

Flewelling Circuit

A continuously variable grid leak over a wide range of resistance is the most essential and critical instrument required in this circuit.

The **BUNNELL VARIABLE GRID LEAK** with a range of $\frac{1}{4}$ to 6 megohms fills the bill.

Furnished with or without japanned metal cover and screws for mounting.

Sample by mail, With cover \$1.00; Without cover 70¢.
Liberal discounts in quantities. Send stamp for catalog No. 46-Q
32 Park Place J. H. BUNNELL & CO. New York City

ALWAYS MENTION QST WHEN WRITING TO ADVERTISERS

**How Much DX
do you hear
thru QRN
and tube
QRM
???**

Summer DX relay work and reception can only be handled successfully by a true dyed-in-the-wool Boiled Owl under summer conditions. Fil-KO-stat was primarily designed to eliminate filament noises and to operate filaments at their highest efficiency.

If your filaments function noiselessly QRN becomes nil, but QRN and tube QRM means NDOM for DX work.

The filament kontrol of infinite adjustment

FIL-KO-STAT

PROVEN BEST — FOR ALL TUBES

The RADIO GUILD writes "comparisons with every reliable filament and current controlling device now available proved Filko-stat far superior to all other types of filament controls giving the closest possible adjustment of any type of filament tube and the only instrument which could be used for *all tubes* giving equal critical adjustment at the high resistance as at the low resistance."

You have no screws to tamper with on the Filkostat. No adjustments to puzzle you. Experts have taken care of this for you. The Filkostat is not just fabricated. It is a laboratory product triple tested before being sent out and scientifically adjusted to the ideal "off" position for UV200, 201, 201A, WD11, WD12, UV199, DV6A, W. E. Peanut, and other tubes including 5 watt Transmitting Tubes.

The makers of the FIL-KO-STAT express their confidence with an unconditional guarantee. FIL-KO-STAT is assembled by precision craftsmen. It contains a resistance element so finely divided that further resistance is impossible. *There is nothing to break or chip.* When you buy a FIL-KO-STAT you know that you are not only getting the finest filament control made but that, its reliability and durability are fully and completely—

GUARANTEED BY THE MAKERS
DX INSTRUMENT CO., HARRISBURG, PA.

FIL-KO-STAT cylindrical design is the outcome of extensive experimentation. It gives the resistance element sufficient radiating surface to eliminate excessive heating. This is one of the outstanding FIL-KO-STAT features.

FULL RESISTANCE 30 OHMS
Will take the place of other rheostat or filament control without redrilling panel.
At your dealers.

\$2

RADIO STORES CORPORATION

Sole International Distributors

Dept. Q8, 218-222 West 34th St., New York

ALWAYS MENTION Q8 T WHEN WRITING TO ADVERTISERS

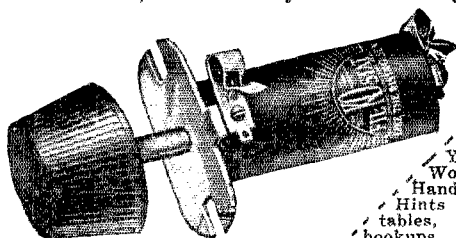

A
BOOK-
LET YOU
WILL WANT

By W. J. Merritt
Garvey, of New
York Evening
World's Radio Section,
Handbook of Helpful
Hints for Set Builders,
tables, charts, statistics,
hookups, diagrams, descrip-
tions. Reading this interest-
ing book we discovered Mr.
Garvey recommended the FIL-KO-
STAT. We bought an edition and
will gladly send a copy anywhere at
handling cost 10¢ postpaid.

Name
Address
Town
Station State.....

KEEP TO THE RIGHT
Quality Apparatus

We stock all makes and types of complete Radio sets and parts

Acme Apparatus Co.
Adams Morgan Co.
Andrea, F. A. D.
A. & P. Radio Supplies Co.
Baldwin, Nathaniel
Brach, L. S. Mfg. Co.
Brandes, C. Inc.
Bunnell, J. H.
Clapp-Eastham Co.
Corwin, A. H. & Co.
Cutler-Hammer Mfg. Co.
DeForest Radio T. & T. Co.
Dictograph Products Corporation
Dubilier Condenser Co.
Eby Mfg. Co.
Federal T. & T. Co.

Firth, John & Co.
Freed-Eisemann Co.
Frost, Herbert H.
General Radio Co.
Kennedy, Colin B.
Murdock, Wm. J. Co.
Radio Distributing Co.
Radio Corp. of America
Remler Mfg. Co.
Riley-Klotz Mfg. Co.
Sleeper Radio Co.
Ward Leonard Elec. Co.
Western Elec. Co.
Westinghouse Elec. Mfg. Co.
Weston Elec. Inst. Co.
Wireless Press, Inc.

Delivery same day order received

Pioneers in the Radio Field

Send 10¢ for Latest Catalog

ROSE RADIO AND ELECTRICAL SUPPLIES
129 Camp Street, New Orleans, La.

Ask Your Dealer

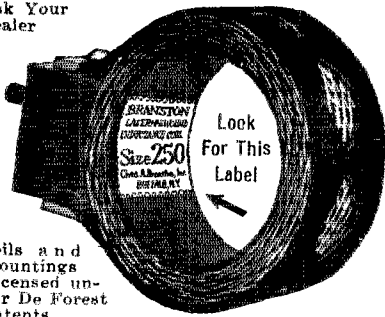

The 'Genuine' Duo-Lateral

We call them

Coils and Mountings Licensed under De Forest Patents

BRANSTON Lateral Wound Honeycomb Ind. Coils
No other method of tuning has approached the wonderful flexibility of the Honeycomb Coil in changing to different wave lengths. If you are in doubt, ask your "Old Timer" radio friend why sets using Honeycomb Coils are better.

With Branston Honeycomb Coils you can get closer tuning, greater selectivity, greater range. Two outstanding features of the Branston Coils are—no dead end losses and ease of operation.

Send 20 in stamps for Series 1 "Hook-Up" Circular showing five good Honeycomb hook-ups and Catalog of famous Branston Radio materials. Write today giving your dealer's name. If he can't supply you, let us know.

CHAS. A. BRANSTON, INC.,
823 Main St., Buffalo, N. Y.
In Canada—Chas. A. Branston, Ltd.
Toronto, Ont.



BRANSTON
RADIO

GIVE YOUR EARS A TREAT!—USE
'RED-HEADS'
Now \$6.50
At your dealers or direct on receipt of price.
3000 Ohms
With Military Head Band and Cord
A Triumph in Radio, Receiver Design
The Newman-Dorn & Stern Building Cleveland, O.

RADIO SCHOOL
Positions Guaranteed Graduates, Laud or sea. Our school has the best record in New England. Send for catalog.
MASSACHUSETTS RADIO & TEL. SCHOOL, Inc.
18 Boylston St., Boston, Mass.
G. R. ENTWISTLE, Radio Director

FIRST TO RECEIVE ACROSS THE SEA
A Tuska Radio Set at Station 1BU received the first British amateur code in trans-Atlantic tests. Finely built. Several models. Catalog \$18-C on request.
THE C. D. TUSKA COMPANY
Hartford, Conn.
TUSKA RADIO

The Perfect Filter Condenser

DUBILIER Type 612

DUBILIER Filter Condenser, Type 612 has an exceptional high factor of safety. Before shipment it is tested to withstand 4000 volts D.C.

Dubilier Filter Condenser, Type 612, is provided with three taps. Thus three capacities are obtainable:—.65, $1\frac{1}{4}$, and $2\frac{1}{2}$ mfd.

Dimensions: 3 inches x 10 inches x 11 inches.

Dubilier Filter Condensers of other types and capacities can be supplied to meet special requirements.

As in the case of all Dubilier transmitting condensers, the elements of Type 612 are tightly compressed (the patented Dubilier principle). Hence the capacity is absolutely constant. Moreover, there are no losses through brush discharges.

Price and further particulars on application.

Filter Type 612 is but one of many styles of Dubilier condensers supplied to the principal broadcasting, commercial and government stations of Europe and America. The name Dubilier is synonymous with successful transmission.

DUBILIER—STANDARD THROUGHOUT THE WORLD
DUBILIER CONDENSER AND RADIO CORP.

48-50 West Fourth Street, New York

DUBILIER DEVICES

CLASSIFIED ADVERTISEMENTS

Six cents per word per insertion, in advance. Name and address must be counted. Each initial counts as one word. Copy must be received by the 1st of month for succeeding month's issue. NOTE NEW CLOSING DATE.

EVERYTHING FOR THAT EDISON B. ASSEMBLED 100 VOLT 1 1/2 AMP. HOUR BATTERY GENUINE EDISON SOLUTION & RECTIFIER \$16. ALL PARTS EDISON SOLUTION ELEMENTS WIRED FRAME, \$14. 1 AMP. HOUR BATTERY \$12. CAN EDISON SOLUTION ENOUGH FOR 100 VOLTS. \$1.50. NEW DEP FOR YOUR C.W.—CHEAPER TO BUY & OPERATE THAN A MOTORGNERATOR—A 500 VOLT TRANSMITTING BATTERY FOR \$80. 2 BULB TRANSMITTING BATTERY CHARGER \$25. 100 VOLT RECEIVING BATTERY CHARGER \$14. COMPLETE WITH TUNGAR BULBS. 3/4 TEST TUBES 3¢ IN 100 LOTS. FOLLOWING PREPAID: TUBES 50¢ DOZ., PURE NICKEL WIRE FOR CONNECTORS 1 1/2¢ FOOT. PERFORATED HARD RUBBER SEPARATORS 1/2¢. 1 AMP. HOUR EDISON ELEMENTS, WIRED, 8¢ PAIR. LET SML HELP YOU ON THAT TRANSMITTER. RADIO CORPORATION PARTS SHIPPED PREPAID. RADIO SML, 4837 ROCKWOOD, CLEVELAND, OHIO.

PORCELAIN ANTENNA INSULATORS. A SINGLE PORCELAIN IS BETTER THAN A WHOLE STRING OF MOULDED MUD. THIS INSULATOR CAME OUT ON TOP IN QST'S INSULATOR TESTS. SEE MAY QST. 10" PORCELAIN, MADE BY OHIO BRASS \$1.75 PREPAID. WITHSTOOD OVER 25,000 VOLTS. 5" PORCELAIN, SAME MAKE, \$.75 PREPAID. RADIO SML, 4837 ROCKWOOD, CLEVELAND, OHIO.

SELL OR EXCHANGE—Movette camera and projector outfit complete. What have you? L. P. Authier, Willimansett, Mass.

ATWATER-KENT Detector and Two Stage Amplifier \$12. Westinghouse Aeriola Jr. portable receiver, Complete with Phones \$12. Both brand new in original cartons. Cash only. E. G. Baier, 253 Ninth St., Brooklyn, N. Y.

FOR SALE: Paragon R.A.10 with D.A.2 brand new condition used less than one month, \$90. A Super-Heterodyne is on the job now. Money back if you are not satisfied. H. E. Boughton, 5151 St. Clair Ave., Cleveland, Ohio.

BANKRUPTCY SALE: We have 300 of the well known John Firth & Co. 5 tube sets, 2 stage Radio detector, and 2 stage Audio with a built in loud-speaker using special loud-speaking units. These sets used to sell, less tubes, batteries and phones for \$285.00, each. We are offering these sets at an unheard of low price of \$95.00 each, which is one third of the original price. Coast to coast reception being done on these sets every night. Orders filled immediately. \$10 Money Order to accompany each order. Balance C.O.D. Brooklyn Radio Shop, 654 Quincy St., Brooklyn, N. Y.

REGENERATIVE RECEIVER, portable, designed after Grebe CR6 with two step. Parts cost \$80; sell \$30. Record. Barrett, 3150 Central Ave., Indianapolis, Indiana.

EDISON ELEMENTS. Less than 200 pair 4¢ pair. More than 200 at 3¢. Parts and instructions for 750 volt battery less solution \$40.00. Cheaper than generator. Request other prices. 4BX, 107 North Sixth Street, Wilmington, N. C.

1KILOWATT Packard transformer \$12; Benwood gap \$10; glass condense, \$.5. All for \$25. William Baxter, Seven Mile, Ohio.

WANTED: Jan., Feb., Mar., June, July, of Vol. 1 QST. Need these had some of you birds make me a price. Porter T. Bennett, 2725 Laclede St., Dallas, Texas.

WESTERN ELECTRIC 216-A Power-Amplifier Tube slightly used \$6.75. George Benz, 668 Cable, St. Paul, Minn.

SELL: Cino tuner detector \$45.00; 2 step \$25.00; detector one step \$25.00; \$125.00 Cino CT4 receiver \$65.00; Clapp-Eastham 43 & 23 plate balanced type,

43 plate table type, Murdock 43 oil condensers \$3.00 ea.; Jewell 0-10 front of panel type \$9.00. 0-5 flush type \$8.00; Clapp-Eastham 0-10 HW \$5.00; 150W Acme filament transformer \$10.00; 1KW old type Thor. \$12.00; 1KW Blitzen secondary burnt \$12.00; plate glass condenser 3/4" glass cost \$45.00 to build, \$20.00; 1800 RPM sink motor \$20.00; 900V 200W alternator belted 1/4HP heavy duty motor \$35.00; Homcharger \$8.00; 3 large lightning switches \$1.50 ea.; 6 RC 50W sockets \$1.50 ea.; 5 ampere magnetic modulator \$10.00; 50W CW report 5000 miles complete less tube \$60.00—Wanted 500V 1KW alternator. All apparatus guaranteed to be either new or in 1st class condition. Reason for selling 3EB-5UC combining stations. If interested write above stations. First come, first served CUL.

RUBBER STAMP with large call letters 50¢; Radiogram and Relay Radiogram blanks 25¢ per hundred, Post Card 60¢ hundred. Send us your orders. Carolina Printing & Stamp Co., Wilmington, North Carolina.

BARGAINS: Paragon RA-10 new, ship in original case, \$80. Paragon detector No. 70 \$4.00. Honeycomb regenerative detector two step 150-20,000 meters oak cabinet, fine workmanship, \$45. 80 ampere storage battery with Tungar charger \$28. Radiotron 200 \$4; 201 \$4.50. Brandes "Superior" phones \$5.00. Albert Clement, P. O. Box 673, Natrona, Penna.

SALE: One new 200 watt Phillips tube \$45.00. Cost me \$35.00 in Europe. Will exchange for good Corona typewriter. Portable hotwire ammeter \$4.00. Vibroplex \$9.00. All gear guaranteed perfect condition. Coburn, 4 Arlington Street, Cambridge, Mass.

FOR SALE: One Kennedy Type No. 110 Tuner with Type 525 amplifier, 150 to 25,000 meters, complete with tubes, phones, both batteries \$190.00. Grebe sets all types, 25% off list. Fada three tube receiver \$40.00. Aeriola Seniors complete, (shop worn) \$51.00. Western Electric Loud Speakers, regular \$161.00, for \$125.00. Acme Pot-Rheo's regular \$3.00, \$1.00. Willard Storage "B" Batteries, 24 volt, \$5.00. All merchandise guaranteed, good condition. Commonwealth Appliance Company, 373 Robert St., St. Paul, Minnesota.

FOR SALE Cheap: 8EW's 1KW Spark Set. Heard in every district. Write for information. G. B. Cramp, 11 Oregon Ave., Crafton, Pittsburgh, Pa.

COPPER BRAID—best conductor known for RF circuits. Surface is what counts. Many mechanical advantages over solid wire, ribbon or tubing. Ideal for CW inductances, loops, OT's, pig-tails, lead-ins, etc. Twenty sizes. No. 16 for wiring receivers, fifteen feet for 50¢. 9CZP.

WESTERN ELECTRIC AMPLIFYING OUTFIT—Tubes, Amplifier, Loudspeaker, \$110; Crosley Two Step Amplifier, \$18; Long Distance Ultraudion Tuner to match, \$15. Everything like new. F. Doleah, 314 N. Fairfield, Chicago, Ill.

SELL: 1KW, 25 cycle spark set. "Coffin" transformer. Dubilier condenser, etc. Amrad Electrolytic condenser and two "S" tubes \$15.00 Two DeForest rectifiers similar to Kenotrons \$8.00. SAXN.

FOR SALE: Miscellaneous radio receiving equipment. Frank Dargue, Kittanning, Pa.

RADIOPHONE DeFOREST OT-3 Complete with Hand Microphone. Brand new. Guaranteed. \$49.00 buys it. M. M. Fleron & Son, Inc., Trenton, N. J.

1BBO QRA now Harris Fahnestock, Jr. Lenox, Mass.

FOR SALE: 1 Aeriola Sr. Set and Amplifier complete with tubes. Excellent condition \$95.00. Address Russell Fetzer, 532 Shorb Ave. N. W., Canton, Ohio.

TRADE: Typewriter in good shape for transmitting apparatus. Verne Goldin, Mellette, So. Dakota.

EDISON ELEMENTS for storage B batteries, six to ten cents per pair postpaid, depending entirely upon quantity ordered. I handle only strictly first grade, full capacity elements. A. J. Hanks, 608 Montgomery St., Jersey City, N. J.

HAMS: Get our samples and prices on printed Call Cards, Letterheads and Envelopes. Hinds & Edgerton, 19 S. Wells St., Chicago, Ill.

GREBE CR-8 like new, \$55. SBOB.

FOR SALE: Paragon 2-5-U fone set, \$35. 500 volt 100 watt 1750 R.P.M. generator with field regulator, \$30. Acme 200 transformer, \$15. 2 Amrad S tubes, \$5 each. All above like new. 2AUY.

FOR SALE: 4-fifty watt tube transmitter complete with tubes, three microphones, 1000 volt motor generator, \$425, also a Westinghouse model TF lists at \$305, never been used our price \$185. IXL Radio Store, Wilmington, Del.

SACRIFICE: \$130 Grebe CR9 with tubes, \$95. Has received BOTH coasts, New Orleans, Canada, and Cuba. Lorin Kay, 1342 Richland Court, Milwaukee, Wisconsin.

FOR SALE: Two new UV1714 R. F. Transformers, two new UV201 tubes, \$5.50 each. Also a \$50 Wagner 15 ampere Battery Charger \$25. All sent prepaid upon receipt of price. Edgar M. Knepper, Maitland, Mo.

MAGNAVOX TYPE R3. Latest nationally advertised improved reproducers in original factory sealed cartons. List \$35. Introductory offer \$25. Radio Central, Dept. Q, Abilene, Kansas.

CW AND RADIOPHONISTS: Our new converters will satisfy your need for a more economical and reliable plate supply. Output seven hundred to two thousand volts at .4 amperes D.C. No generator armatures to burn out. Synchronous motors and other parts sold separately. Write immediately. Kimley Equipment Mfg. Co., 290 Winslow Ave., Buffalo, N. Y. Attention L. W. Kimley.

TRANSMITTERS AND RECEIVERS overhauled, repaired, rebuilt and made to "percolate." Any circuit. Twelve years experience and up-to-date. 9CZP.

FOR SALE: One Westinghouse type RC receiver one of first manufactured complete with Radiotrons \$100. Complete one K.W. Spark set 60 cycle with synchronous gap \$75.00. F.O.B. Johnsonwood, Kreetan Company, Station KUVQ, Johnsonwood, Drummond Isle, Mich.

BIG BARGAINS: Send for my bargain sheet, and mention what you want.

WANTED FOR CASH: Standard goods of all kinds. I buy, sell or exchange. F. Jos. Lamb, 2541 Baldwin Ave., Detroit, Mich.

FOR SALE OR EXCHANGE: Cutting Washington type 11 regenerative receiver two step slightly used \$75. Also Magnavox Tonearm and control box. Name Price. Will consider Cash and 12 gauge Remington automatic or pump, CW apparatus, Motor-Generator, Transformers, etc. WHAT HAVE YOU? Walter C. Leahy, Bogalusa, La.

FOR SALE: Receiving set; two filament single tune regenerative with 60 ampere hour battery and charger, \$20.00. F. B. Leonard, RFD 2, Chevy Chase, Md.

QRA, SAFS, Elton Love, 118 Baker St., Lansing, Michigan. All cards answered.

PRE-WAR AUDIOTRON, double filament, never used, \$6.00. "J" tubes, same price. VT sockets and other transmitting and receiving parts. Large chemical laboratory. All guaranteed. Send stamp for complete list. 10Z, Elmore Lyford, Park St., Bridgeport, Conn.

HEADSETS—BANKRUPT STOCK of Automatic Long Range phones 3200 ohms leather covered adjustable overhead. Special price \$5.00. Powell May, 134 Overton Place, Knoxville, Tenn.

SELL—Reinartz Tuner with detector and one stage amplifier. Filament control jacks. Also two stage amplifier. Foto on request, Daryl McClung, 1221-9th Ave., Huntington, W. Va. (8CQH)

A RADIO DESIGNER of receiving sets and circuits that is confined to his home desires connection with reliable firm or persons needing special problems or circuits worked out. Miniature portable tube sets a specialty. Write QST, Box M.

BIG BARGAINS: Paragon RA-10, DA-2 for \$100.00. Two Magnavox Type R3 \$20.00. Have new and slightly used transmitting parts at 40 to 50 per cent off. Write for list. Louis E. Metcalf, Greenfield, Illinois.

ALWAYS MENTION QST WHEN WRITING TO ADVERTISERS

RADIO GENERATORS—500 Volt 100 Watt \$23.50. High Speed Motors—Federal Phones \$5.50—Battery Chargers \$12.50. Motor Specialties Co., Crafton, Pittsburgh, Penna.

WANTED: Omnigraphs, Paragon RA-10 receivers, Grebe CR-12 receivers, Western Electric type 10-A loud speakers, and Rectigon chargers. Box L, care QST.

FOR SALE: 5 watt AC CW Transmitter including 200 watt transformer meters send receive switch Navy Key panel mounted efficient and beautiful design \$60. E. L. Norcross, Room 302, Hibbs Building, Washington, D. C.

SELL: \$65 Westinghouse tuner \$30; \$60 3 stage R.F. with tubes B bat. \$40; \$50 Honeycomb tuner \$25; 1 \$10.50 Variocoupler \$5.00; 1 Everready A bat. \$15. O'Connor, Cortland Ave., New Rochelle, New York.

FOR SALE: Wireless Specialty 1/2 KW 500 cycle transmitter, reconverted for ICW, less tube, \$95, including spare part box. All parts for panel mounted unwired 20 watt CW and phone including tubes, filament lighting transformer and D.C. 110-550 M.G. set, \$85. Two Westinghouse Dynamotors 30-350 volts, \$15.00 each. Grebe dials 4 inches \$1.00. 3 Radio Corp radio frequency transformers, \$3.00 each. Philip Rcin, (2BYK)

FOR SALE: 1/2 KW Crocker-Wheeler 500 cycle alternator \$75; new UV204 \$90; 250 watt P tubes \$70; .004 25000V Dubilliers \$10; Navy IP500 \$125; other CW apparatus; want five Jewell filament voltmeters. Edw. Page, Cazenovia, N. Y. SAQO. "XH."

WANTED: Omnigraph. David Prosser, Pleasant View, R. I.

QRA QRA QRA

GAGE is now S. T. Runyon, Walnut Grove, Calif. Anyone hearing my 5 watts pse QSL. All cards answered. Correct ur call book, OM.

PROTECT YOUR APPARATUS with small fuse wire in dangerous places. Eighth, quarter, half, three-quarter, one-ampere and larger sizes, three feet for two bits. 9CZP.

BUILD YOUR SETS with quality parts and get sure results. Radio Parts Co., Box 56, Dunellen, N. J.

FOR SALE: Practically new Paragon receiving set, RA-10, DA-2, \$80. Rabezana, 112 W. Baker St., Flint, Mich.

3 CIRCUIT AMRAD, detector and two step in original boxes. Brand new. Both \$80.00. List \$120.00. Two complete sets at this price. Send money order or check with order. G. Richard Shafto, Westhampton, Richmond, Va. 3NF.

WILL EXCHANGE Akron-Williams Tire Vulcanizing equipment in A1 condition for Radiophone or parts. All replies answered. R. H. Sullinger, Maryville, Tennessee.

BARGAINS: \$5.00 UV200 detector tubes \$3.95; \$6.50 UV201 amplifier tubes \$4.85; \$6.00 DV6 Deforest tubes \$4.65; \$28.00 Tungar rectifiers \$19.85; \$35.00 new type Magnavoxes \$28.75; \$55.00 Grebe two stage amplifier \$31.75; \$125.00 General Electric receiver \$79.50; \$4.00 variocoupler \$1.75; 45 volt "B" Batteries \$3.00; \$5.00 Frost fones \$3.75. All brand new goods. Terms Cash with order or C.O.D. 20% deposit with order. Swanson Electric and Manufacturing Company, Evansville, Ind.

BARGAINS while they last, brand new Remler-Giblin coils, 25, 150, 200, 250, 300, 400, 1000 and 1500 turns. 50% off list, postage 10¢ extra. Genuine Bakelite dials with knobs, 3 inch 25 cents; 3 1/2 inch 30 cents, 3 1/2 inch with 2 inch Knob 50 cents, postage 5 cents extra, postage and insurance free on any six assorted. Edgewise wound Copper Ribbon 7/8x9 inches, 17¢ turn. Flat Ribbon same size 7 cents foot. Cash with order. Geo. Schultz, Calumet, Mich.

SELL 1KW Thordarson, Benwood bakelite inclosed rotary gap, plate glass condenser, 3 inch ribbon O.T. All in good condition, \$25. 5SK.

BARGAIN: Single circuit receiver, complete, fones,

WD11 tube, Burgess B. Battery, dry cell, Cotoco condenser, Fada variocoupler, all in cabinet, \$35. Money refunded if not satisfied. Edward Schwarz, 605 Mattoax Ave., Petersburg, Va.

SELL: Signal Loose coupler \$5. Brand new Natrometer \$15. E. Schuessler, 2209 Wheeler St., Cincinnati, Ohio.

200—20,000 METER RECEIVER including Radiotron, \$35.00; Two-step Amplifier, \$22.00. Smith, 4416 Market, Philadelphia, Pa.

PHANTOM PORTABLE CIRCUITS. Used on train or automobile. Set of four \$1. or free with Radiotron or Cunningham tubes. Radio Central, Dept. Q, Abilene, Kansas.

BUILDING A RADIO SET? Write for monthly bargain list on parts, and sets. Postage paid on all orders. Taylor Radio Shop, Minonk, Illinois.

FOR SALE: Paragon RA-10, forty dollars and 15 dial Omigraph, twenty dollars. E. Thompson, 1301 Findlay Ave., New York.

BANKRUPT STOCK—Prices less than Manufacturer's costs. Variable condensers 23 and 43 plate, your choice \$1.50 Automatic Long range phones 3200 ohms \$5.00; Brach weatherproof suspension type lightning arresters \$1.50; FF Battery boosters, charges A and B batteries \$12.00; Homchargers \$10.00; Newyork efficiency variometers \$2.00; Dubilier mica condensers .00025 40 cents; Carter Plugs handles two headsets 50 cents; Federal four inch dials quarter inch shaft 75 cents; American hard rubber four inch dials quarter inch shaft 50 cents; Electrose six inch leadin bushings \$1.00. Every article guaranteed new and in original carton, postage prepaid. Powell May, 134 Overton Place, Knoxville, Tenn.

FOR SALE: New Grebe RORK 2 stage amplifier, \$45.00. Robert Van Osdol, Morrison, Ill.

INVENTORS: Protect your invention through A. M. Wilson, Inc., Washington, D. C. Over 25 years of efficient, expert, confidential service. Skilled in Radio-Electrical, Chemical and Mechanical fields. Our latest illustrated Patent Book, giving much necessary and know, will be sent free upon request. Prompt and very useful information which every inventor should careful attention. Highest references. Moderate fees. Send sketch or model for our careful opinion and preliminary advice. Write today to A. M. Wilson, Inc., (Radio 3ARH) 310-16 Victor Building, Washington, D. C.

SELL RADIO parts at one-third the price bought for. E. Schuessler, 2209 Wheeler St., Cincinnati, Ohio.

SELL CHEAP: Receiving apparatus. Want small battery charging generator. Claire Wooley, East Liberty, Ohio.

AGENTS WANTED in every city and town to sell standard radio apparatus. Attractive discounts given. If interested, write at once stating age and radio experience. Wilmington Electrical Specialty Co. Inc, 912 Orange Street, Wilmington, Delaware.

VIBROPLEX WANTED. Russell Martin, Mt. Carmel, Ill.

9AJP's 100 watt C.W. for sale complete and mounted. Best DX New Zealand. Details of set upon request. About 1/2 life of tubes expired. \$100. Weston AC DC switchboard type, Voltammeter, \$15. Upton, 2547 Ulysses, Mpls., Minn.

WANTED: 50 and 8 watt C.W. apparatus. Wendell Fletcher. Santa Barbara, Calif.

LIVE-WIRE SALESMEN WANTED

Men who have a practical knowledge of, and can sell Radio, can insure themselves of a steady and attractive income as local factory representatives of the manufacturers of one of the most popular Tuned Radio-Frequency Receivers on the market today, selling to jobbers and dealers. Sales come quickly as you are supported by a policy of intensive national advertising. Write giving detailed information about yourself to A. P. W., Room 908, 135 Broadway, New York City.

110

static?

John A. Burchrter, 207 E. Ohio St., Indianapolis, Ind. writes:

"My set is about ten blocks from one of the local stations and when they started broadcasting, it meant that ended everything for the evening. After your Wave Trap was installed, they were tuned out completely.

Had expected with approach of warm weather to take down my set until next fall, but while other local 'Listeners In' are almost entirely cut off by STATIC, I am enjoying the programs just as much as in the cold months.

Have covered distances that heretofore have been impossible and really consider the Wave Trap the greatest invention since radio."

THE ORIGINAL WAVE FILTER \$8.50
PREPAID

use
FERBEND
Wave Trap
TRADE MARK
PATENT APPLIED FOR

23 E. SOUTH WATER ST.
CHICAGO

AMATEURS

wanted all over the country to take charge of our agencies. Commission only, with a chance to earn a salary and bonus. Will reply to every inquiry.

R. R. GARRICK
Beechwood, Upper Darby, Pa.

W.T.501 DETECTOR TUBE

For Tube sets, use our Special Adapter, 75c. Extra. To convert crystal sets into tube sets, use Special Socket, 40c. extra.
RADIO RESEARCH GUILD
40 Clinton St. Newark, N.J.

\$2



NOVO

"B" BATTERIES

WITH INSULATED BINDING POSTS
& DETACHABLE WIRE CONNECTOR

NOVO MFG CO.

424 W 33rd ST NEW YORK - 531-50 DEARBORN ST CHICAGO

ALWAYS MENTION QST WHEN WRITING TO ADVERTISERS

—FOR YOUR CONVENIENCE—

QST'S INDEX OF ADVERTISERS IN THIS ISSUE

| | | | |
|--|----------------|---|--------|
| Acme Apparatus Co., The..... | 87 | Kellogg Switchboard & Supply Co..... | 78 |
| Adams-Morgan Co., The..... | 89 | Kennedy Co., Colin B., The..... | 90 |
| Alden Mfg. Co., The..... | 82 | Kimley Electric Co..... | 96 |
| Allen-Bradley Co., The..... | 83 | | |
| American Hard Rubber Co..... | 80 | | |
| American Radio & Research Corp..... | 4th Cover | | |
| American Transformer Co., The..... | 84 | | |
| Ameco Products, Inc..... | 74 | Magnavox Co., Inc..... | 75 |
| "A.R.R.L. Apparatus"..... | 2 | Marle Engineering Co..... | 102 |
| "A.P.W." 185 Broadway, N.Y.C..... | 110 | Martin-Copeland Co..... | 78 |
| Atwater-Kent Mfg. Co..... | 82 | Marshall-Gerken Co., The..... | 100 |
| Automatic Electrical Devices Co., The..... | 94 | Mitchell & Co., R..... | 78 |
| | | Massachusetts Radio & Telegraph School..... | 106 |
| | | Mu-Rad Laboratories, Inc..... | 76 |
| | | Multiple Electric Products Co., Inc..... | 92 |
| Bakelite Corporation..... | 97 | | |
| Baldwin-Stewart Elec. Co., The..... | 86 | Newman-Stern Co., The..... | 106 |
| Branston & Co., Chas. A..... | 106 | Novo Mfg. Co..... | 110 |
| Brockway Radio Corp..... | 79 | | |
| Bunnell & Co., J. H..... | 104 | | |
| Burgess Battery Co..... | 67 | | |
| | | | |
| Chelten Elec. Co..... | 84 | Personal Service Purchasing Bureau..... | 92 |
| Classified Advertisements..... | 108, 109, 110 | Philadelphia Wireless Sales Corp..... | 86 |
| Connecticut Telephone & Electric Co..... | 3rd Cover | Pittsburgh Radio & Appliance Co., Inc..... | 98 |
| Continental Radio & Elec. Corp..... | 101 | Potter Co., The C. D..... | 100 |
| Coto-Coil Company..... | 104 | Precision Equipment Co., The..... | 72, 73 |
| Crosley Mfg. Co..... | 68, 69, 70, 71 | | |
| Cunningham, E. T., Inc..... | 2nd Cover | | |
| Cut-Rate Radio Co..... | 102 | | |
| | | | |
| Dubilier Condenser & Radio Corp..... | 107 | QST, Bound Volume VI..... | 66 |
| Durham & Co..... | 82 | | |
| | | | |
| Eastern Radio Institute..... | 66 | Radio Corp. of America..... | 1 |
| Efficient Engineering Co..... | 96 | Radio Research Guild..... | 110 |
| Eisemann Magneto Corp..... | 112 | Radio Specialty Co., Inc..... | 94 |
| Electric Specialty Co., Inc..... | 90 | Radio Store of Paul F. Johnson..... | 80 |
| Electric Storage Battery Co., The..... | 95 | Radio Stores Corp..... | 105 |
| European Radio Co..... | 98 | Rasia Sales Corporation..... | 92 |
| | | Rauland Mfg. Co..... | 98 |
| | | Remler Radio Mfg. Co..... | 81 |
| | | Rhamstine, J. Thos..... | 88 |
| | | Riggs Mfg. Co., The..... | 80 |
| | | Roller-Smith Co..... | 76 |
| | | Rose Radio & Elec. Supplies..... | 106 |
| | | Rusonite Products Corp..... | 90 |
| | | | |
| Federal Telephone & Telegraph Co..... | 94 | Signal Elec. Mfg. Co..... | 86 |
| Ferbend Electric Co..... | 110 | Southern Radio Corporation..... | 190 |
| Formica Insulation Co., The..... | 77 | Standard Transformer Co., The..... | 96 |
| France Mfg. Co., The..... | 84 | Sterling Mfg. Co., The..... | 90 |
| Freshman Co., Inc., Charles..... | 88 | Stromberg-Carlson Telephone Mfg. Co..... | 94 |
| Frost, Herbert H..... | 88 | | |
| | | | |
| Garrick, E. R..... | 110 | Thordarson Elec. Mfg. Co..... | 91 |
| General Radio Co..... | 88 | Tresco..... | 98 |
| Grebe & Co., A. H..... | 4 | Tuska Co., The C. D..... | 106 |
| | | | |
| Hartford Instrument Co., The..... | 86 | | |
| Higgy-Avery Co., The..... | 96 | Westinghouse Union Battery Co..... | 99 |
| Hygrade Elec. Novelty Co..... | 104 | Western Coil & Electrical Co..... | 102 |
| | | Westinghouse Elec. & Mfg. Co..... | 85 |
| | | Weston Electrical Instrument Co..... | 74 |
| | | Whitall Electric Co..... | 102 |
| | | Willis Switch & Instrument Co..... | 66 |
| | | Willart Sales Co..... | 100 |
| | | Wireless Mfg. Co..... | 103 |
| Jewell Elec. Instr. Co..... | 92 | | |
| Johnson, G. F..... | 104 | | |

ALWAYS MENTION QST WHEN WRITING TO ADVERTISERS

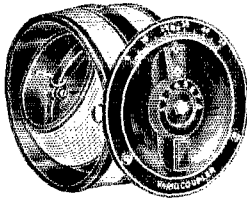

Speaking of Portable Sets—

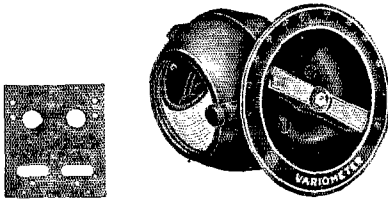

AN ideal vacation set may be built with these units.

No special packing case is required, owing to the absence of protruding knobs and smooth surface of panel.

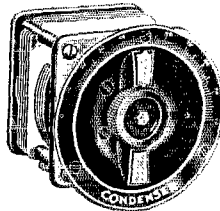

The concave dials, aside from adding attractiveness to a receiving set, increase its utility.

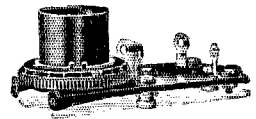
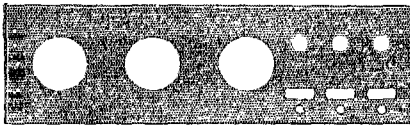
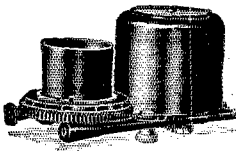
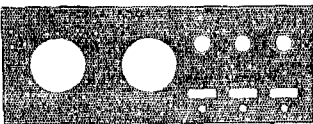
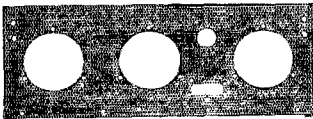

Descriptive literature on request.

EISEMANN MAGNETO CORPORATION

William N. Shaw, President
BROOKLYN, N. Y.

DETROIT

CHICAGO

SAN FRANCISCO

CONNECTICUT RADIO



Your Amplification will be as good as your Transformer

If you put performance before price, your search for a real audio-frequency transformer will lead you straight to the

CONNECTICUT J-121

Here is a real professional instrument. So well proportioned, so perfectly balanced, and so high in electrical efficiency is it that several radio research engineers are using it in their experimental and development work.

Here are its principal characteristics:

Highest grade silicon steel core, such as used on largest power transformers, to secure high efficiency.

Windings, impregnated to keep out moisture.

Carefully shielded to prevent stray fields.

Turns ratio, 4.25 to 1.

Perfectly balanced as to input and output—

Designed to match and give the best results with standard amplifier tubes.

Low losses, due to carefully tested windings and best grade of materials.

Convenient terminals, well spaced, mounted on CETEC insulation.

Excellence of exterior design and finish reflects the high electrical efficiency.

J-121 \$5.00

A. F.
Transformer

If your dealer cannot supply you, order direct

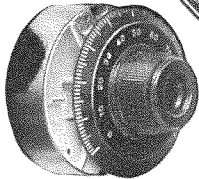

Panel Type Condenser
J-108 \$5.00

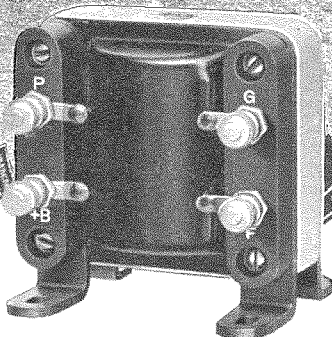

Bulletin A-12 illustrating and describing CONNECTICUT Variable Condensers, one and two stage amplifiers, vacuum tube sockets, rheostats, head phones, jacks, plugs, and battery switches upon request.

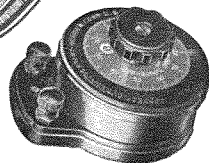

Portable Type Condenser
J-107 \$6.00



CONNECTICUT
MERIDEN

TELEPHONE
& ELECTRIC

COMPANY
CONNECTICUT



AMRAD

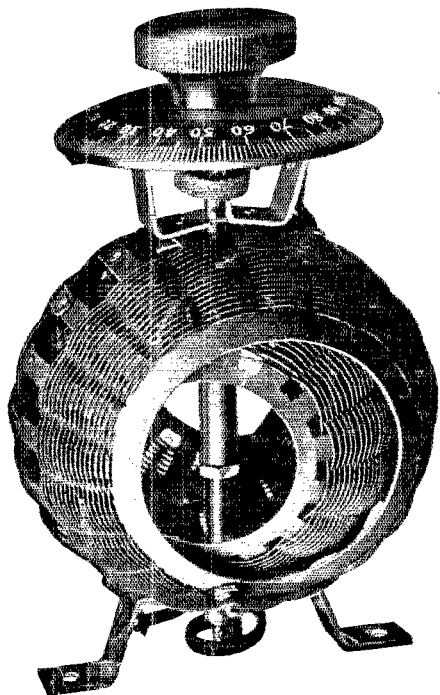

* less Knob and Dial.

The Famous
Basketball
Now Only

\$3.75*

We used to wind this variometer by hand, producing 120 per day per operator. By the development of special automatic machinery, production is now increased to 1,000 per day per machine. This saving is reflected in the price—now only \$3.75.

The patented Wavy-Weave winding eliminates the condenser effect of the conventional flat-layer type. Further, the use of light, spherical forms punched from Egyptian fibre, prevents loss of energy due to the wood or moulded composition construction of other designs.

If you want the most efficient Variometer selling for the least money, order from your nearest dealer and demand the AMRAD BASKETBALL, or remit to us direct, and we will see you are promptly supplied.

Bulletin C describing the AMRAD BASKETBALL and other AMRAD Specialties, sent free on request.

"S" TUBES FOR RECTIFIERS

More and more relay men are using "S" Tubes because of their extensive life and effective work. There is NO FILAMENT TO BURN OUT.

Write for Bulletin describing "S" TUBES.

We want operating data from "S" TUBE owners for our Research Records. Have you sent yours?

AMERICAN RADIO AND RESEARCH CORPORATION

205 College Ave., Medford Hillside, Mass.

New York District Office
13 Park Row

Chicago District Office
203 So. Dearborn St.

Dealers in Principal Cities and Towns

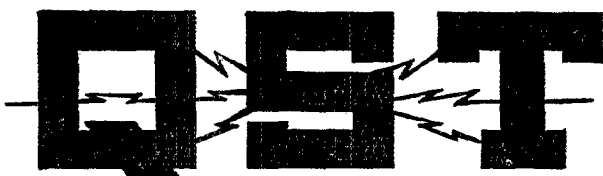

A Magazine Devoted Exclusively to the Radio Amateur

Index to Volume VI, August '22-July '23

Published as a Supplement to QST for August, 1923, Vol. VII, No. 1
Copyright 1923, by The American Radio Relay League, Inc., Hartford, Conn.

IN response to numerous requests from our membership for a QST index, the present abstracting of subjects and titles appearing in Volume VI is presented. It represents our first efforts along this line. A more comprehensive index of authors' names or an enlargement of subjects under which titles are grouped could not be provided on account of space and cost limitations but it is hoped this will serve the purpose of a ready reference to past articles and the basis for the enlarged index to Volume VII under preparation. Criticism and suggestions will be welcomed.

AMATEUR RADIO STATIONS

- BY4, New York City.....63, Jan. 1923
 "BX," Harold T. Mapes, Guanajuato, Mexico.....51, July 1923
 Holland Station, Dordrecht, Holland.....63, Oct. 1922
 "QSO Porto Rico." Photos and description of 4OI.....40, Nov. 1922
 "Un Poste Amateur 8AB." Description with circuits. (Lloyd Jaquet).....22, Aug. 1922
 1XM, Cambridge, Mass.....62, Feb. 1923
 1XZ, Worcester, Mass.....65, Dec. 1922
 1CMK, Holyoke, Mass.....57, July 1923
 2OM, Ridgewood, N. J.....55, June 1923
 3LR, Washington, D. C.....58, April 1923
 3OE, Philadelphia, Pa.....55, July 1923
 3OI, Portable station.....35, Oct. 1922
 4BQ, Rome, Ga.....62, Oct. 1922
 4EH, Atlanta, Ga.....61, Feb. 1923
 5WS, London, England.....50, June 1923
 6NX, San Jose, Calif.....59, April 1923
 6AWP, Santa Ana, Calif.....63, Nov. 1922
 7ZV, Douglas, Ariz.....56, July 1923
 8BO, Detroit, Mich.....64, Oct. 1922
 8UE, Lancaster, N. Y.....65, Dec. 1922
 8VY, Kalamazoo, Mich.....64, Nov. 1922
 8BAS, Antwerp, Ohio.....62, Jan. 1923
 9HY, Chicago, Ill.....43, Sept. 1922
 9ZL, Neenah, Wis.....66, Dec. 1922
 9ZN, Chicago, Ill.....60, Feb. 1923
 9ZT, Minneapolis, Minn.....62, Feb. 1923
 9AAU, St. Louis, Mo.....64, Dec. 1922
 9AAU's Tower, Aneta, N. D.....64, Oct. 1922
 9AVC, Hastings, Neb.....59, April 1923
 9XAQ, Boulder, Colo.....62, Nov. 1922
 9ZAF, Denver, Colo.....61, Jan. 1923

AMPLIFIERS— AUDIO FREQUENCY

- Amplifier Operation from A.C. Supply. Method of using 60 cycle supply for filament and plate. (P. D. Lowell).....32, Oct. 1922
 Inverse Duplex System of Amplification. Description of Grimes circuit with photos. (Boyd Phelps).....7, Mar. 1923
 Multi-Stage Amplifiers. R.C.A. paper. (M. C. Batsel).....25, Oct. 1922
 Paralyzed Transformers. Peculiar actions and connections of one type audio frequency transformer. (P. C. Oscanyan).....57, Sept. 1922
 Vacuum Tube Amplification. R.C.A. paper. (S. E. Anderson).....15, Jan. 1923

AMPLIFIERS— RADIO FREQUENCY

- Inverse Duplex System of Amplification. Description of Grimes circuit with photos. (Boyd Phelps).....7, Mar. 1923
 Multi-Stage Amplifiers. R.C.A. paper. (M. C. Batsel).....25, Oct. 1922
 Radio Amplification with the Reinartz Tuner. British method....14, Oct. 1922
 Radio Frequency Amplification at Amateur

- Wave lengths. Article on different types on market, with circuits. (K. B. Warner).....7, Sept. 1922
- R. F. Amplifier with Regenerative Detector. Description with circuit. (P. N. Emmich) 39, Feb. 1923
- Tuned Radio Frequency Amplifier. Description, photo and circuits of Grebe amplifier. (W. F. Diehl) .32, Jan. 1923
- Vacuum Tube Amplification. R.C.A. paper. (S. E. Anderson).....15, Jan. 1923

ANTENNAS AND MASTS

- Antennella. Chas. Freshman Co. New apparatus.....73, Dec. 1922
- Antenna Circuit. Discussion of electrical factors in antenna design. (Parker Wiggin).....36, May 1923
- Antenna Bibliography.....29, May 1923
- Antenna Resistance. Letter from A. F. Murray.....69, June 1923
- Antenna Resistance Measurement. Discussion of antenna resistance and measurements. (Boyd Phelps)....37, Jan. 1923
- Beverage Wire. Totem Radio Club results. (D. A. Cutler).....61, Aug. 1922
- More Beverage Results. (D. A. Cutler).....82, Oct. 1922
- Wave Antenna for 200 Meter Reception. Article. (H. H. Beverage) 7, Nov. 1922
- Capacity Coupling to Operate the Antenna at its Fundamental. Article with circuits. (V. D. & E. B. Landon) 22, June 1923
- From Antenna to Ground. Condensed directions combining numerous opinions on antenna construction.....40, May 1923
- How Long Shall We Make Our Antennas? Fundamental vs. above-fundamental operation.....31, May 1923
- Re "How" to Determine the Best Working Wave." (Ross Gunn) 72, July 1923
- How to Measure Antenna Resistance and Capacity. Article with photos, constants and circuits. (A. F. Murray) 18, May 1923
- It Pays to Measure the Antenna. Results at 3ABI.....70 July 1923
- Loops. See Loops-Transmitting, or Loops-Receiving.
- Losses of 200 Meter Antennas. Article with resistances and tables. (C. S. Ballantine).....7, May 1923
- Masts.
- Better Way to Save Your Neck. Kite for rigging mast head gear. (H. W. Leighton).....77, Apr. 1923
- Mast References and bibliography. 36, May, 1923
- Murphys Build a Mast. Directions for erecting. (F. M. J. Murphy) 34, May, 1923.
- Saving Your Neck. Replacing ropes and pulleys at mast heads. (N. R. Hood).....25, Dec. 1922
- Some Dope On Mast Construction. Building 80' wooden telescoping mast. (L. A. Bartholomew) 32, Sept. 1922
- 122 Foot Tower. Description and photos. (LeRoy Moffett) 18, Oct. 1922

Multiple Tuned Antennas.

- Multiple Tuned Roof Antenna at 1YK. Results. (H. H. Newell) 16, May 1923
- Multiple Tuning the Long, Low Antenna. Description with circuits. (L. C. Young).....15, May 1923
- Working Down to 100 Meters by Multiple Tuning. Method used at 9AUL. (L. C. Smeby).....17, May 1923
- Notes on the Resistance of Receiving Antennas. Article. (J. C. Warner) 43, May 1923
- Perfect Aerial. Fiction article. (M. Adaire Garmhausen).....23, May 1923
- Some Tests of Amateur Antenna Insulators. Report on various types tested, with photos and tables.....24, May 1923
- What Antenna Wire? Comparison of different wire. (C. P. Sweeny)....45, May 1923
- What I Found Out about Sending Aerials. Results of tests on 26 antennas. (J. L. Reinartz).....30, May 1923
- Your First Transmitting Antenna. General advice. (H. F. Mason)....46, May 1923
- Your Station According to Underwriters. List of approved lightning protection devices.....46, May 1923

BATTERIES

- Electrolytic "A" Battery Charger. Description with dimensions. (J. A. Miller) 39, Dec. 1922
- Hours of Service of "B" Batteries. Curves and specifications of. (W. B. Schulte) 31, Feb. 1923
- Magnetic Vibrator Rectifier for "B" Battery. Description of France Mfg. Co. rectifier.....72, Dec. 1922
- Making Edison "B" Batteries for C.W. Transmission. Construction data. (G. H. Hall).....23, Mar. 1923
- More on Edison "B" Batteries. (M. P. Sherwood).....69, July 1923
- Storage "B" Batteries. Constructional considerations. (J. Olsen)....83, Oct. 1922
- Thermo Battery for WD-11s. Constructional data for small thermopile. 80, May 1923
- Westinghouse Storage "B" Battery. Description.....73, Dec. 1922

BOOK REVIEWS

- "ABC of Vacuum Tubes, The." E. H. Lewis, pub. by Norman W. Henley Pub. Co., New York City, \$1.....29, Oct. 1922
- "Book of Radio." Chas. W. Taussig, pub. by D. Appleton & Co., New York City. 70, Feb. 1923
- "Elements of Radio Telephony." W. C. Ballard, pub. by McGraw-Hill Book Co., New York City, \$1.50.....20, Oct. 1922
- "Getting Acquainted with Radio Receivers." Publication by Paul F. Godley and Adams-Morgan Co.....62, July 1923
- "How to Make Radio Receiving Apparatus." Bulletin #125-W of Federal Tel. & Tel. Co.....62, July 1923
- "How to Retail Radio." Editors of "Electrical Merchandising," pub. by McGraw-Hill Book Co., New York City. 20, Oct. 1922
- "Ideas for the Radio Experimenter." M.

- B. Sleeper, pub. by Norman W. Henley Pub. Co., New York City. 75¢.
- 69, Feb. 1923
- "Letters of a Radio Engineer to His Son." John Mills, pub. by Harcourt, Brace & Co., New York City.....70, Feb. 1923
- "Modern Radio Operation." J. O. Smith, pub. by Wireless Press, Inc., New York City.....70, Feb. 1923
- "Radio Amateur's Handbook." A. F. Collins, pub. by Thos Y. Crowell Pub. Co., New York City.....70, Feb. 1923
- "Radio for All." H. Gernsback, pub. by J. B. Lippincott, Philadelphia, Pa., \$2. 69, Feb. 1923
- "Radio for Everybody." A. C. Lescarbours, pub. by Scientific American Pub. Co., New York City, \$1.50....47, Aug. 1922
- "Radio for the Amateur." Packer & Haugh, pub. by Goodheart-Wilcox Co., Chicago, Ill.....29, Oct. 1922
- "Radio Phone Receiving." Group author-ship, pub. by Van Nostrand Co., New York City, \$1.50.....54, Aug. 1922
- "Radio Telephony for Amateurs." Stuart Ballantine, pub. by David McKay Co., Phila., Pa., \$2. 23, Aug. 1922 and 69, Feb. 1923

CONTESTS, RELAYS, RECORDS, TESTS

- Contest for QST Readers Who Build their Own. Offering prize for best article on super-regenerator.....10, Aug. 1922
- December in Review. Outline of amateur accomplishments.....26, Feb. 1923
- Emergency Work by Amateurs.
- Amateurs Serve in Emergency. Storm in Miss. Valley.....12, May 1923
- Snowstorm Emergency and the A.R.R.L. Snowbound trains in Wyoming and Colorado.....30, Jan. 1923
- Hawaiian Tests. 1AW to 6ZAC and return.
- Summer Test to Hawaii..29, Sept. 1922
- Exact Route of Message. 35, Nov. 1922
- 10,000 Miles in 4 Minutes. Report on relay.....11, Jan. 1923
- Hoover Cup Contest.
- 5ZA's 1921 Hoover Cup. Presentation, inscription and announcing next contest.....32, Nov. 1922
- Department of Commerce's 1922 Cup. Announcing opening of contest and conditions.....27, Jan. 1923
- 20M Wins Hoover Cup for 1922. Award of judges....25, April 1923
- Hoover QSRs Cup to 20M. Letter of presentation.....24, June 1923
- QST Subscription Contest.
- Announcing Contest.....25, Sept. 1922
- Further Dope On.....21, Oct. 1922
- Last Call.....35, Nov. 1922
- Contest Ends. Results of. 40, Dec. 1922
- Transatlantics. See "Transatlantics."
- Trans-Canadian Relay.
- Announcement. By The Traffic Manager.....16, Mar. 1923
- Canadian Relay Fails. Report on results.....11, May 1923
- Transcons—Daylight.
- More Daylight Transcons. Announc- ing.....25, Sept. 1922

- Daylight Transcons Fail. Report on Transcons of July, 1922. (F. H. Schnell).....26, Sept. 1922
- Announcing new tests and arrange- ments. (F. H. Schnell) 30, Nov. 1922
- Preliminary report on tests. 29, Jan. 1923
- Transpacific Reception Records.
- Pacific Completely Bridged by Ama- teurs. Ship operators' logs. 27, Feb. 1923
- Some More Records. 6XAD's trans- mission to Australia...16, Dec. 1922
- Transpacific Amateur Reception. Ship operators' log.....24, Jan. 1923
- Across the Pacific Again. Further DX records.....11, Mar. 1923
- U. S. Sigs Heard in Iceland. Brief report. 47, Mar. 1923
- U. S. Will Send Standard Waves for A.R. R.L. Details and schedule of WWV transmission.....28, July 1923
- Working Every District in One Night. Re- port of ICCZ.....31, Nov. 1922

CONVENTIONS

- Canadian Convention. Report on First Convention.....33, Nov. 1922
- Dakota Division A.R.R.L. Convention. Re- port on.....66, Nov. 1922
- Fourth Annual New England Convention. Announcement of.....54, Mar. 1923
- Report on.....11, May 1923
- Fourth District Radio Convention. An- nouncement of.....65, Oct. 1922
- Michigan State A.R.R.L. Convention. An- nouncement of.....63, Feb. 1923
- Report on.....55, April 1923
- Northwestern Division A.E.R.L. Radio Convention & Show. Report on. 45, Aug. 1922
- Second District Convention Big Success. Report on.....63, Feb. 1923
- Second Ohio A.R.R.L. Convention at Colum- bus. Report on.....20, June 1923
- South Dakota Radio Convention. Report on.....63, Feb. 1923
- Third Radio District Convention. An- nouncement of.....54, Mar. 1923
- Report on. (M. Adaire Garmhausen) 13, June 1923

EDITORIALS

- "About This Lid." Re voluntary quiet hours.....42, Dec. 1922
- "All Set." Urging amateurs to enter Transatlantics.....41, Dec. 1922
- "Amateur Regulations." Recommendations of A.R.R.L. Board to Commerce. 35, June 1923
- "Broadcast Stations Co-operate." WFAA stands by during Transatlantics. 43, Dec. 1922
- "Bugaboo Nr. 1234567890." Anti-amateur ordinances and Atchison opinion. 52, May 1923
- "Canadian Manager, The." Appointment of W. C. C. Duncan....33, April 1923
- "Carrying On." Against giving RCLs en- tire evening.....32A, Sept. 1922
- "City Ordinances." How to combat anti- amateur propaganda....32, April 1923

"Clipping Coupons." Urging members to send in newspaper clippings.

32B, Sept. 1922

"Conversion of a BCL, The." Interest of code vs. broadcasts.....42, Feb. 1923

"C.W. Licenses." Spark license not good for C.W.....30, Mar. 1923

"December Transatlantics." Urging quiet during reception period....45, Nov. 1922

"Dern the Amateur." Re Bustan interference report.....36, June 1923

"Does This Shoe Fit You?" Interference during Transatlantic reception period.

41, Feb. 1923

"Exceisior!" Excellent records of preceding month.....39, Jan. 1923

"Exhibition Epidemics." A.R.R.L. policy re radio shows.....27, Aug. 1922

"Fall Reopening." Aspects of summer and fall merchandising.....32A, Sept. 1922

"Girding Up Our Loins." Against encroaching demands of BCLs..41, Oct. 1922

"Good Old Summer Time, The." Urging rebuilding of stations....38, July 1923

"Great Trip, A." Schnell's western trip.

29, Aug. 1922

"Hi!" Re article "Is the Amateur Doomed."

43, Nov. 1922

"How Cum?" Against the spark.

51, May 1923

"McWilliams vs. Bergman." Report on case and A.R.R.L. action...40, Jan. 1923

"National Radio Week." Interest novices in amateur radio.....43, Dec. 1922

"New Field, A." Re short wave work.

29, Mar. 1923

"Nuisance, A." Against unnecessary CQing.....42, Dec. 1922

"Ouch!" Radio pocket blamed on amateurs.....52, May 1923

"QST's Family." Re District amateur publications.....41, Feb. 1923

"Roanoke, The." Congratulating Division on good showing.....45, Nov. 1922

"San Diego." Re lack of co-operation.

28, Aug. 1922

"Sectional Organs." Urging support of District papers.....41, Oct. 1922

"Status of the Amateur." Detailed account of past and pending legislative changes.

35, July 1923

"Thanks." For articles contributed to QST.....43, Oct. 1922

"These Funny Numbers." Explaining page numbers of September 1922 issue.

32B, Sept. 1922

"To Be or Not To Be." Progress of White Bill in Congress.....29, Mar. 1923

"Unscrambling the Eggs." Advocating 7.30 to 10 P.M. voluntary quiet period.

31, April 1923

"Voluntary Lid, The." Announcing A.R.R.L. policy re quiet period.

44, Nov. 1922

"What Would You Do Without QST?" Urging support of QST advertisers.

43, Oct. 1922

"What's The Idear?" Against "rubber stamp" messages.....33, April 1923

"White Bill." Urging amateur support of.

40, Jan. 1923

"Why Not G.M.T.?" Advisability of using.

42, Oct. 1922

"Your Pen in Hand." Calling for contributions to QST.....29, Aug. 1922

EXECUTIVE COUNCILS

New England Radio Executive Council. Report on.....68, Oct. 1922

Poultney Executive Radio Council. Time division recommendations...65, Jan. 1923

Radio Council of Southern New England. Officers.....62, Dec. 1922

Second District Executive Radio Council. New developments.....67, Dec. 1922

Seventh District Executive Council. Report on.....64, Feb. 1923

— Council formed. (H. F. Mason)

25, Mar. 1923

Third District Radio Council. Preliminary announcement of.....64, Jan. 1923

GENERAL SUBJECTS

"Amateur Interference." BCL vs. amateur. Reprint from "Modulator."

13, Aug. 1922

Amateur Radio Again Proves Its Worth. Rescue of Cleveland Coast Guard man from crib.....50, May 1923

"And the Land Shall Be Visited by Plague." Fiction article by "The Prophet."

30, Oct. 1922

Annual Report of the Traffic Manager. Year ending Feb. 1923....27, April 1923

A.R.R.L. Message Traffic. Curves of spark vs. C.W. traffic. (F. H. Schnell)

19, Dec. 1922

Brush with the Cops. Troubles of 20M. (F. B. Ostman).....29, Dec. 1922

"Comment les Appeler?" Re identification of foreign amateur call letters. (Lloyd Jacquet).....20, Dec. 1922

Concerning Amateur Interference with Broadcast Reception. Digest of Bustan report.....33, June 1923

Death of James L. Autry. Announcement.

40, Oct. 1922

Ether vs. Magnetic Field. As applied to radio transmission. (J. E. Stuart)

80, Oct. 1922

Greatest of All Amateurs. Article on G. Marconi. (H. P. Maxim).30, Sept. 1922

"Ham What Am." Story of New York hamfest. Anon.....38, Dec. 1922

Learning the Code. Practical advice. (H. F. Mason).....52, July 1923

Listening for Europe. Re Transatlantics and receivers best suited for reception. (P. F. Godley).....33, Dec. 1922

On Being an Amateur. Why is an amateur and what. (H. F. Mason)

59, July 1923

Our A.R.R.L. Board of Direction. Photo of Chicago Board meeting..26, April 1923

Pioneer in High-Powered Stations. "SA" in 1904. Description and photos of San Juan station. By "An Old Timer."

39, Oct. 1922

QSO Porto Rico. Announcing traffic to P.R. with description of Station 40I.

40, Nov. 1922

Radio Hound. Description of radio controlled car at Seattle.....33, Jan. 1923

Radiophone Job in China. Robt. F. Gowen in China.....36, Nov. 1922

Reminiscence. (The Old Boy) 35, Jan. 1923
 "Rotten QRM." (The Old Man) 16, Nov. 1922
 "Rotten Rectifiers." (The Old Man) 23, July 1923
 Signal Report Cards. Different styles in contest. 17, June 1923
 "SOS—a la Wireless Willie." Fiction article. (C. A. Lowry) . . . 80, Dec. 1922
 "Un Poste Amateur 8AB." Description of French 8AB with circuits. (Lloyd Jacquet) 22, Aug. 1922
 Week in Baltimore with Portable Station 3OI. Description of trip and station. (John Evans, Jr.) 35, Oct. 1922
 What the Department of Commerce Thinks of Our A.R.R.L. Voluntary Lid. Letters from Radio Inspectors. . . . 19, Mar. 1923
 What to Hear Tonight. Burlesque on broadcast program. (1ZE) 58, Feb. 1923
 Which Way Does the Current Flow? Discussion on old and present theory. (S. G. McMeen) 68, July 1923
 Why Kilocycles? Advantages of kilocycles over wavelength. (A. N. Goldsmith) 32, June 1923
 Your Station. According to Underwriters. List of approved lightning protectors. 46, May 1923
 6ZH Graduates by Radio. Account of Picker's school graduation. 18, Apr. 1923

**GOVERNMENT DEPARTMENTS
 —LEGISLATION**

Bureau of Standards Calls Standardization Meeting. Announcement and purpose of. 10, Jan. 1923
 — Conference on Radio Standardization. Report on progress. . . 27, Mar. 1923
 "By Request." Petition of Plainfield Radio Association to Senate re alleged tube monopoly and tariff restrictions. 53, Sept. 1922
 QRM with Broadcasts. Question put to Department of Commerce re amateur liability in interference cases. 57, Aug. 1922
 Second National Radio Conference. Report on. 12, May 1923
 — Amateur Regulations. Editorial re recommendations of A.R.R.L. Board to Department of Commerce. 35, June 1923
 — Status of the Amateur. Detailed account of past and pending legislative changes. Editorial. . . 35, July 1923
 U. S. Will Send Standard Waves for A.R. R.L. Details and schedule of WWV transmission. 28, July 1923
 What the Department of Commerce Thinks of Our A.R.R.L. Voluntary Lid. Letters from Radio Inspectors. . . . 19, Mar. 1923
 White Bill. Editorial urging amateur support. 40, Jan. 1923
 — Hearings on the White Bill. Suggested amendments of A.R.R.L. Board and report of Hearings. (H. P. Maxim) 23, Feb. 1923
 — "To Be or Not To Be." Progress of White Bill. Editorial. . 29, Mar. 1923

LITIGATION

"Bugaboo Nr. 1234567890." Editorial re anti-amateur ordinances and Atchison opinion. 52, May 1923
 City Ordinances. How to combat anti-amateur propaganda. . . . 32, April 1923
 Important Litigation. Discussion of R.C.A.-Grebe-Bunnell suit. 38, Feb. 1923
 McWilliams vs. Bergman. Editorial presenting case and A.R.R.L. action. 40, Jan. 1923

LOOPS—RECEIVING

Receiving Loop Design. Dimensions for short wave loops. 17, May 1923
 Signal Corps Loop Set. Description with photo. 40, Feb. 1923

LOOPS—TRANSMITTING

Loops for Sending. Directions for operation. 38, May 1923
 — References and bibliography. 39, May 1923
 Loop Transmission. 1XP system with circuit. (L. W. Bishop) 7, Jan. 1923
 Signal Corps Loop Set. Description with photo. 40, Feb. 1923

**MACMILLAN
 ARCTIC EXPEDITION**

Amateur Radio Shoves Off for the Pole. Details of expedition. 7, July 1923
 Arctic Explorer to Communicate with Amateurs. Announcing MacMillan Trip. (J. K. Bolles) 9, June 1923
 Practical Operating Dope. Schedules. 12, July 1923
 Station WNP on Board the "Bowdoin." Description of installation. . . 9, July 1923

METERS

Ammeters vs. Voltmeters. Advantages and disadvantages of each for receiving and transmitting tubes. (R. O. Miles) 83, Oct. 1922
 — Favoring the Voltmeter. (J. L. Thompson) 77, Jan. 1923
 — Filament Adjustment. (S. L. Chisholm) 78, Dec. 1922
 — More On Filament Adjustment. (W. C. White) 77, Jan. 1923
 Application of Measuring Instruments to Radio. Various types of meters with good and bad points. (J. H. Miller) 20, Aug. 1922
 Hoyt Peep-Hole Meter. Photo and description. 70, May 1923
 Short-Wave Oscillator. Description, for calibrating. (Elliott White) 47, May 1923
 SOS to Meter Makers. Need for high voltage meter. 59, Mar. 1923
 100 to 3000 Meter Oscillator. From Bustan paper. 48, May 1923

POWER TROUBLES & WIRING

Induction from Telephone. Trouble caused by bell ringing magneto. (S. R. Wilson) 57, Sept. 1922
 Why Filament Transformers "Go West,"

"Clipping Coupons." Urging members to send in newspaper clippings.

32B, Sept. 1922

"Conversion of a BCL, The." Interest of code vs. broadcasts.....42, Feb. 1923

"C.W. Licenses." Spark license not good for C.W.....30, Mar. 1923

"December Transatlantics." Urging quiet during reception period.....45, Nov. 1922

"Dern the Amateur." Re Bustan interference report.....36, June 1923

"Does This Shoe Fit You?" Interference during Transatlantic reception period.

41, Feb. 1923

"Excelsior!" Excellent records of preceding month.....39, Jan. 1923

"Exhibition Epidemics." A.R.R.L. policy re radio shows.....27, Aug. 1922

"Fall Reopening." Aspects of summer and fall merchandising.....32A, Sept. 1922

"Girding Up Our Loins." Against encroaching demands of BCLs. 41, Oct. 1922

"Good Old Summer Time, The." Urging rebuilding of stations.....38, July 1923

"Great Trip, A." Schnell's western trip. 29, Aug. 1922

"Hi!" Re article "Is the Amateur Doomed." 43, Nov. 1922

"How Cum?" Against the spark. 51, May 1923

"McWilliams vs. Bergman." Report on case and A.R.R.L. action...40, Jan. 1923

"National Radio Week." Interest novices in amateur radio.....43, Dec. 1922

"New Field, A." Re short wave work. 29, Mar. 1923

"Nuisance, A." Against unnecessary CQing.....42, Dec. 1922

"Ouch!" Radio pocket blamed on amateurs.....52, May 1923

"QST's Family." Re District amateur publications.....41, Feb. 1923

"Roanoke, The." Congratulating Division on good showing.....45, Nov. 1922

"San Diego." Re lack of co-operation. 28, Aug. 1922

"Sectional Organs." Urging support of District papers.....41, Oct. 1922

"Status of the Amateur." Detailed account of past and pending legislative changes. 35, July 1923

"Thanks." For articles contributed to QST.....43, Oct. 1922

"These Funny Numbers." Explaining page numbers of September 1922 issue. 32B, Sept. 1922

"To Be or Not To Be." Progress of White Bill in Congress.....29, Mar. 1923

"Unscrambling the Eggs." Advocating 7.30 to 10 P.M. voluntary quiet period. 31, April 1923

"Voluntary Lid, The." Announcing A.R. R.L. policy re quiet period. 44, Nov. 1922

"What Would You Do Without QST?" Urging support of QST advertisers. 43, Oct. 1922

"What's The Idear?" Against "rubber stamp" messages.....33, April 1923

"White Bill." Urging amateur support of. 40, Jan. 1923

"Why Not G.M.T.?" Advisability of using. 42, Oct. 1922

"Your Pen in Hand." Calling for contributions to QST.....29, Aug. 1922

EXECUTIVE COUNCILS

New England Radio Executive Council. Report on.....63, Oct. 1922

Poultney Executive Radio Council. Time division recommendations...65, Jan. 1923

Radio Council of Southern New England. Officers.....62, Dec. 1922

Second District Executive Radio Council. New developments.....67, Dec. 1922

Seventh District Executive Council. Report on.....64, Feb. 1923

— Council formed. (H. F. Mason) 25, Mar. 1923

Third District Radio Council. Preliminary announcement of.....64, Jan. 1923

GENERAL SUBJECTS

"Amateur Interference." BCL vs. amateur. Reprint from "Modulator." 13, Aug. 1922

Amateur Radio Again Proves Its Worth. Rescue of Cleveland Coast Guard man from crib.....50, May 1923

"And the Land Shall Be Visited by Plague." Fiction article by "The Prophet." 30, Oct. 1922

Annual Report of the Traffic Manager. Year ending Feb. 1923....27, April 1923

A.R.R.L. Message Traffic. Curves of spark vs. C.W. traffic. (F. H. Schnell) 19, Dec. 1922

Brush with the Cops. Troubles of 2OM. (F. B. Ostman).....29, Dec. 1922

"Comment les Appeler?" Re identification of foreign amateur call letters. (Lloyd Jaquet).....20, Dec. 1922

Concerning Amateur Interference with Broadcast Reception. Digest of Bustan report.....33, June 1923

Death of James L. Autry. Announcement. 40, Oct. 1922

Ether vs. Magnetic Field. As applied to radio transmission. (J. E. Stuart) 80, Oct. 1922

Greatest of All Amateurs. Article on G. Marconi. (H. P. Maxim) 30, Sept. 1922

"Ham What Am." Story of New York hamfest. Anon.....38, Dec. 1922

Learning the Code. Practical advice. (H. F. Mason).....52, July 1923

Listening for Europe. Re Transatlantics and receivers best suited for reception. (P. F. Godley).....33, Dec. 1922

On Being an Amateur. Why is an amateur and what. (H. F. Mason) 59, July 1923

Our A.R.R.L. Board of Direction. Photo of Chicago Board meeting..26, April 1923

Pioneer in High-Powered Stations. "SA" in 1904. Description and photos of San Juan station. By "An Old Timer." 39, Oct. 1922

QSO Porto Rico. Announcing traffic to P.R. with description of Station 4OI. 40, Nov. 1922

Radio Hound. Description of radio controlled car at Seattle.....33, Jan. 1923

Radiophone Job in China. Robt. F. Gowen in China.....36, Nov. 1922

Reminiscence. (The Old Boy) 35, Jan. 1923
 "Rotten QRM." (The Old Man) 16, Nov. 1922
 "Rotten Rectifiers." (The Old Man) 23, July 1923
 Signal Report Cards. Different styles in contest. 17, June 1923
 "SOS—a la Wireless Willie." Fiction article. (C. A. Lowry) . . . 80, Dec. 1922
 "Un Poste Amateur 8AB." Description of French 8AB with circuits. (Lloyd Jacquet) 22, Aug. 1922
 Week in Baltimore with Portable Station 301. Description of trip and station. (John Evans, Jr.) 35, Oct. 1922
 What the Department of Commerce Thinks of Our A.R.R.L. Voluntary Lid. Letters from Radio Inspectors. . . . 19, Mar. 1923
 What to Hear Tonight. Burlesque on broadcast program. (IZE) 58, Feb. 1923
 Which Way Does the Current Flow? Discussion on old and present theory. (S. G. McMeen) 68, July 1923
 Why Kilocycles? Advantages of kilocycles over wavelength. (A. N. Goldsmith) 32, June 1923
 Your Station. According to Underwriters. List of approved lightning protectors. 46, May 1923
 6ZH Graduates by Radio. Account of Picker's school graduation. 18, Apr. 1923

GOVERNMENT DEPARTMENTS —LEGISLATION

Bureau of Standards Calls Standardization Meeting. Announcement and purpose of. 10, Jan. 1923
 — Conference on Radio Standardization. Report on progress. . . 27, Mar. 1923
 "By Request." Petition of Plainfield Radio Association to Senate re alleged tube monopoly and tariff restrictions. 53, Sept. 1922
 QRM with Broadcasts. Question put to Department of Commerce re amateur liability in interference cases. 57, Aug. 1922
 Second National Radio Conference. Report on. 12, May 1923
 — Amateur Regulations. Editorial re recommendations of A.R.R.L. Board to Department of Commerce. 35, June 1923
 — Status of the Amateur. Detailed account of past and pending legislative changes. Editorial. . . 35, July 1923
 U. S. Will Send Standard Waves for A.R.R.L. Details and schedule of WWV transmission. 28, July 1923
 What the Department of Commerce Thinks of Our A.R.R.L. Voluntary Lid. Letters from Radio Inspectors. . . . 19, Mar. 1923
 White Bill. Editorial urging amateur support. 40, Jan. 1923
 — Hearings on the White Bill. Suggested amendments of A.R.R.L. Board and report of Hearings. (H. P. Maxim) 23, Feb. 1923
 — "To Be or Not To Be." Progress of White Bill. Editorial. . 29, Mar. 1923

LITIGATION

"Bugaboo Nr. 1234567890." Editorial re anti-amateur ordinances and Atchison opinion. 52, May 1923
 City Ordinances. How to combat anti-amateur propaganda. . . . 32, April 1923
 Important Litigation. Discussion of R.C.A.-Grebe-Bunnell suit. 38, Feb. 1923
 McWilliams vs. Bergman. Editorial presenting case and A.R.R.L. action. 40, Jan. 1923

LOOPS—RECEIVING

Receiving Loop Design. Dimensions for short wave loops. 17, May 1923
 Signal Corps Loop Set. Description with photo. 40, Feb. 1923

LOOPS—TRANSMITTING

Loops for Sending. Directions for operation. 38, May 1923
 — References and bibliography. 39, May 1923
 Loop Transmission. 1XP system with circuit. (L. W. Bishop) 7, Jan. 1923
 Signal Corps Loop Set. Description with photo. 40, Feb. 1923

MACMILLAN ARCTIC EXPEDITION

Amateur Radio Shoves Off for the Pole. Details of expedition. 7, July 1923
 Arctic Explorer to Communicate with Amateurs. Announcing MacMillan Trip. (J. K. Bolles) 9, June 1923
 Practical Operating Dope. Schedules. 12, July 1923
 Station WNP on Board the "Bowdoin." Description of installation. . . 9, July 1923

METERS

Ammeters vs. Voltmeters. Advantages and disadvantages of each for receiving and transmitting tubes. (R. O. Miles) 83, Oct. 1922
 — Favoring the Voltmeter. (J. L. Thompson) 77, Jan. 1923
 — Filament Adjustment. (S. L. Chisholm) 78, Dec. 1922
 — More On Filament Adjustment. (W. C. White) 77, Jan. 1923
 Application of Measuring Instruments to Radio. Various types of meters with good and bad points. (J. H. Miller) 20, Aug. 1922
 Hoyt Peep-Hole Meter. Photo and description. 70, May 1923
 Short-Wave Oscillator. Description, for calibrating. (Elliott White) 47, May 1923
 SOS to Meter Makers. Need for high voltage meter. 59, Mar. 1923
 100 to 3000 Meter Oscillator. From Bustan paper. 48, May 1923

POWER TROUBLES & WIRING

Induction from Telephone. Trouble caused by bell ringing magneto. (S. R. Wilson) 57, Sept. 1922
 Why Filament Transformers "Go West,"

and How to Stop Them. Article with circuits.....27, June 1923
 Your Station According to Underwriters. List of approved lightning protective devices.....46, May 1923

RECEIVERS—DIRECT COUPLED

Another Reinartz Arrangement. Employing variometer inductance. (J. E. Stuart).....76, Dec. 1922
 Another Simple Tuner. Description and circuit. (D. H. Wallis)....71, April 1923
 Radio Lizz. Receiver on Ford. (H. F. Mason).....26, Dec. 1922
 Simple Audio Regeneration. Reinartz recommendations.....15, Oct. 1922
 Single Circuit Receiver. How to make tune sharply. Description and circuits. (L. W. Austin).....24, Aug. 1922
 Some Further Improvements in My Tuner. Introducing variometer tuned secondary. (J. L. Reinartz).....12, Oct. 1922

RECEIVERS—GENERAL

Adapt-O-Phone Loud Speaker. Photo and description.....26, Aug. 1922
 Amplitrol. Klosner interstage amplifier switch.....74, Dec. 1922
 Binding Posts. Eby. Description and photo.....26, Aug. 1922
 Bradleyometer. Non-inductive potentiometer.....69, May 1923
 Coils.
 — Giblin Coils. Description and photo. 24, Aug. 1922
 — Honeycomb Coils. Notes on operation of different sizes. ("A. Novice") 54, Sept. 1922
 — Long Wave Reception. Answering article by "A. Novice." (A. L. Groves).....77, Oct. 1922
 Condensers.
 — Cardwell Condenser. Description and photo.....65, June 1923
 — Chat About Variable Condensers. Considerations in good condenser construction. (N. A. Woodcock) 31, Dec. 1922
 — Re Variable Condensers. What mechanical and electrical considerations involved in good variable condensers. (B. B. Skeete).....72, April 1923
 — Variable Condenser. 3rd District Convention paper. Answers article "Re Variable Condensers." (E. L. Powell).....70, June 1923
 — Vernier Condenser of O. C. White Co. 72, Dec. 1922
 F-F Battery Booster. For charging 100 volt "B" batteries.....70, May 1922
 Klaus Rotary Switch. Description and photo.....25, Aug. 1922
 Pot-Rheo of Acme Apparatus Co. 73, Dec. 1922
 Potentiometer of Cutler-Hammer Co. 69, May 1923
 Receiver Plate Supply from A.C. Article. (S. T. Woodhull).....13, April 1923
 Recording Signals. "Dictaphone" recorder. 22, Dec. 1922
 Rheostats, Vernier.
 — Cutler-Hammer rheostat. New apparatus.....74, Dec. 1922

— Jenkins rheostat. New apparatus. 74, Dec. 1922
 — Jewell rheostat. New Apparatus. 73, Dec. 1922
 — Thordarson rheostat. New apparatus. 74, Dec. 1922

Series Parallel Switching. Circuits. 66, Jan. 1923
 Simple Audio Regeneration. Method advocated by Reinartz.....15, Oct. 1922
 Socket, tube, of Alden-Napier Co. New apparatus.....72, Dec. 1922
 Some Effects of the Distributed Capacity between Inductance Coils and the Ground. Conclusions from Bustan tests. 79, May 1923
 Some Tuners That Work Below 200 Meters. Description with circuits. (A. L. Budlong).....25, July 1923
 Tempometer. Time conversion chart. New apparatus.....69, May 1923
 Tube Supply from A.C. Description of French system.....40, Oct. 1922
 Variocoupler of Queens Radio Co. New apparatus.....26, Aug. 1922

RECEIVERS—LOOSE COUPLED

Coils for C.W. Reception. Further data on construction of Groves coils. Ref. 9, Jan. 1922
 (A. L. Groves) 18, Aug. 1922
 French Amateur's Circuit. Description of audio frequency amplifier of G. Perroux. 24, Dec. 1922
 Honeycomb Coils. Notes on operation of different sizes.....54, Sept. 1922
 Long Wave Help. Use of large honeycombs. (W. W. Lindsay) . . 79, Dec. 1922
 New Method of Controlling Regeneration. The Four Circuit Tuner. Article with photo. (L. M. Cockaday) . . 29, June 1923
 Simple Audio Regeneration. Reinartz recommendations.....15, Oct. 1922

RECEIVERS—NEUTRODYNE

Inductive Neutrodyne Receiver. Description with circuit. (A. E. Banks) 74, July 1923
 Notes on the Neutrodyne. Further practical operating data. (G. L. Bidwell) 19, June 1923
 Tuned Radio Frequency Amplification with Neutralization of Capacity Coupling. R.C.A. Paper. (L. A. Hazeltine) 7, Apr. 1923

RECEIVERS—SUPER-HETERODYNE

Building a Super-Heterodyne and Making It Work. Description with photo and circuits. (O. A. Kimball) . . 19, April 1923
 Notes on a Super-Heterodyne. Description, photos and diagram of Experimenters Information Service set. (C. R. Leutz) 11, Dec. 1922

RECEIVERS—SUPER-REGENERATIVE

Another Month of Super-Regeneration. Further developments. (K. B. Warner) 16, Oct. 1922