

QST

A MAGAZINE DEVOTED EXCLUSIVELY TO THE WIRELESS AMATEUR

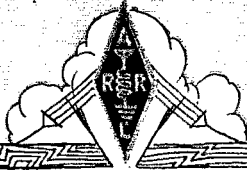

1
A
W

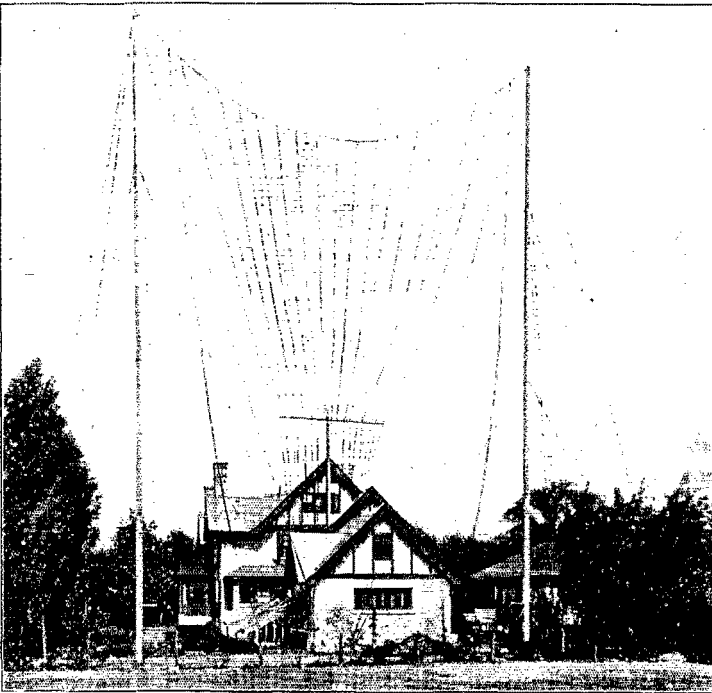

1
A
W

THE AERIAL AT 1AW, HARTFORD, CONN.
COMPLETE DESCRIPTION IN THIS ISSUE.

JULY, 1920

TWENTY
CENTS

H-R-HICK

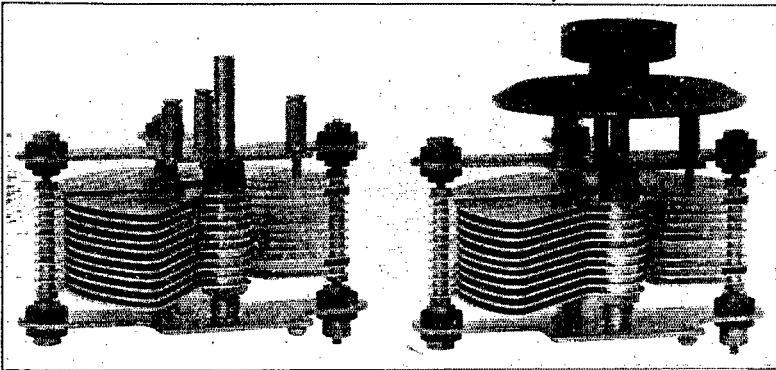

illustrated above is made in two capacities—.001 mfd. and .0005 mfd. and is supplied unmounted only but with dial and knob if desired. The rotary plates are rounded on one end affording straight line capacity. The dial is of moulded composition, scale in white—0—100. Bakelite Knob. We can guarantee this condenser in every way as to quality, reliability and satisfaction. The low price is decidedly an innovation.

Capacity
 .0005 mfd.
 .001 mfd.

PRICES :
 Unmounted
 \$5.00
 6.25

With Knob and Dial
 \$6.00
 7.25

POSTAGE 10 CENTS

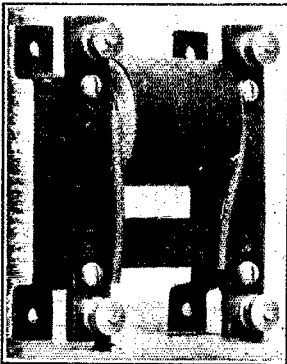

A new amplifying transformer designed for use with present type vacuum tubes. Special attention has been given to the Impedance Ratio to give especially satisfactory results. This amplifying transformer is adapted for either table use or back-mounting on a panel. The workmanship is good throughout. Nickel plated binding posts. Frame stampings in dull black with engraved lettering in white.

"A. R. CO." AMPLIFYING TRANSFORMER

Price, As Illustrated.....\$5.00

POSTAGE 10 CENTS

"BULLETIN 14"—describing and illustrating the best in **RADIO EQUIPMENT** will be mailed upon receipt of 10 cents in stamps—this amount may be deducted on your first order of \$1.00 or over.

No Seals - No Secrets

— But Service !

There is only one Relay Receiver, the



TYPE CR-3
**Relay
Receiver**

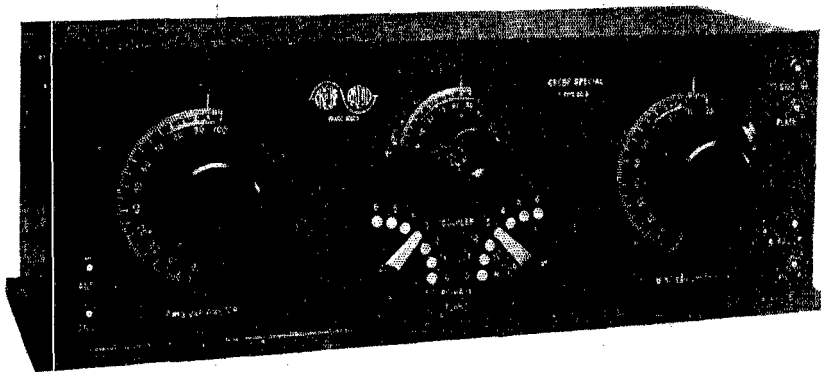

Inspection of the interior of this Receiver reveals design and workmanship fully in keeping with its outward appearance.

The circuits used are thoroughly explained in the instructions and blue prints which accompany each Receiver.

The use of this Receiver is licensed under the original Armstrong and Marconi patents.

The GREBE RADIO guarantee is absolute and unconditional. Each instrument manufactured by us must give satisfactory service. Our interest in the purchaser does not terminate with the sale.

The CR-3 Receiver may be inspected at any of the following progressive dealers':

Barker-Fowler Electric Co., Lansing, Mich.
Continental Radio and Electric Corp., New York
Doubleday-Hill Electric Co., Pittsburgh, Pa.
Holt Electric Utilities Co., Jacksonville, Fla.
Hurlburt-Still Electrical Co., Houston, Texas.
F. S. Katzenbach, Trenton, N. J.
Kelly and Phillips, Brooklyn, N. Y.

Manhattan Electrical Supply Co., New York,
Chicago, St. Louis
Facent Electric Co., Inc., New York City
Geo. W. Parezo & Co., Washington, D. C.
F. D. Pitts Co., Inc., Boston, Mass.
School of Wireless Telegraphy, Philadelphia, Pa.
Western Radio Electric Co., Los Angeles, Cal.

A. H. GREBE & CO., Inc., 74 Van Wyck Blvd., Richmond Hill, N. Y.

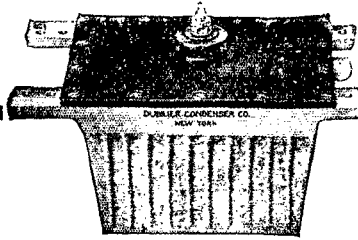

Does This Summertime Atmosphere Bother You ?

We all know that our best radio work is done during the winter—on those cold, crispy, dry winter evenings when the ether is as clear as a bell. And we also know—especially now that we are confronted with it—that the summertime is not over-friendly to radio work. The dull and muddled ether, surcharged with atmospheric electricity, is by no means an ideal medium for our radio waves.

So it comes right down to a matter of using every ounce that's in our transmitters if we are to maintain any sort of transmitting range during this warm weather.

Dubilier Mica Condensers stand for transmitter efficiency. They are employed by commercial, Government, and the leading amateur stations. The record-breaking transmitters all use **Dubilier Mica Condensers**, especially at this time of the year when atmospheric conditions are by no means favorable to long-distance work. If your transmitter does not enable you to carry on your share of relay work, or if it does not satisfy you with its summertime performance, it's high time that you installed a **Genuine Dubilier Mica Condenser**. Remember, there's a **Dubilier Condenser** for your particular requirements.

Type	Power Watts	Max. Tested Voltage	Capacity	Price
D100	250	10000 volts	0.007 mfd.	\$19.00
D101	500	14000 volts	0.007 mfd.	30.00
D102	1000	21000 volts	0.007 mfd.	45.00
D103	1000	25000 volts	0.007 mfd.	50.00
D110	250	10000 volts	0.01 mfd.	21.00
D111	500	14000 volts	0.01 mfd.	35.00
D112	1000	21000 volts	0.01 mfd.	50.00
D113	1000	25000 volts	0.01 mfd.	55.00

Prices on other sizes and capacities on application.

Bulletin D1 is yours for the asking.

One word of explanation regarding the advanced prices. The Dubilier Condensers have gained an enviable reputation for excellence of design, workmanship and materials. To maintain the old prices would have meant a lowering of Dubilier standard. Rather than change the quality, we have felt it incumbent upon us to advance the prices only in so far as was necessary to cover the increased cost of manufacture.

Pacent Electric Company, Inc.

Builders and Specialists in Radio, Electrical and Laboratory Equipment
 Sales Agents for A. H. Grebe & Co., Dubilier Condenser Co., Electrical Products Mfg. Co., Richter & Byrne, Rawson Electrical Inst. Co., The Magnavox Co., and others.

150 NASSAU STREET

Telephone
 Beekman 5810

NEW YORK CITY

THE OFFICIAL ORGAN OF THE A.R.R.L.

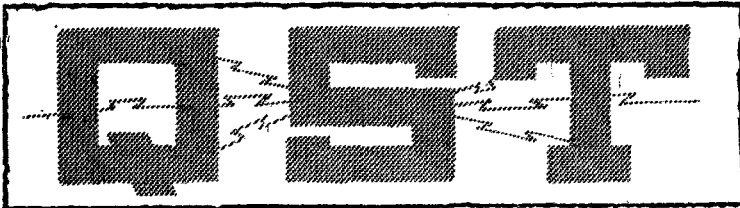

JULY, 1920

VOLUME III

No. 12

CONTENTS

The A.R.R.L. QSS Tests	5
Rotten Damped Spark Stuff	The Old Man 9
Navy Receiving Equipment	L. C. F. Horle 12
C. W. for the Amateur	Howard L. Stanley 15
The Underground Antenna Adapted to Amateur Waves	R. H. G. Mathews 18
The "V-24" Triode Valve	John O. G. Cann 19
Making a "B" Storage Battery	Dr. L. G. Van Slyke 20
An Interesting Loop	21
Editorials	23
The Operating Department	26
Amateur Radio Stations	35
With the Affiliated Clubs	38
QST's Directory of Calls	41
"Strays"	43
Calls Heard	44
The Junior Operator	47
Radio Communications by the Amateurs	49
"How to Build a Wireless Station"	M. Adaire Garmhausen 55
How to Make a .002 Mfd. Balanced Condenser	George Sturley 57
Oil-Cooled Step-Down Transformers	58

QST is published monthly by The American Radio Relay League, Inc., at Hartford, Conn. Kenneth B. Warner (Secretary, A.R.R.L.), Manager and Editor.

Subscription price, \$2.00 per year, anywhere. Single Copies, 20 Cents.

Entered as second-class matter May 29, 1919, at the post office at Hartford, Connecticut, under the Act of March 3, 1879.

Copyright, 1920, by The American Radio Relay League, Inc.
Title registered at United States Patent Office.

THE AMERICAN RADIO RELAY LEAGUE, Inc.
HARTFORD, CONN.

THE AMERICAN RADIO RELAY LEAGUE

INCORPORATED

"A national non-commercial organization of radio amateurs, bonded for the more effective relaying of friendly messages between their stations, for legislative protection, and for scientific growth."

OFFICERS

President
HIRAM PERCY MAXIM
Hartford, Conn.

Vice President
CHAS. A. SERVICE, JR.
Bala, Pa.

Traffic Manager
J. O. SMITH
73 Hillside Ave.
Rockville Centre, L. I.

Treasurer
A. A. HEBERT
Nutley, N. J.

Secretary
K. B. WARNER
Hartford, Conn.

DIRECTORS

A. E. BESSEY
Sunnyvale, Calif.
V. F. CAMP
Brightwaters, L. I.
J. M. CLAYTON
Little Rock, Ark.
J. C. COOPER, JR.
Jacksonville, Fla.
F. M. CORLETT
Dallas, Tex.
W. T. FRASER
Buffalo, N. Y.

W. T. GRAVELY
Danville, Va.
F. H. HAMILTON
Indianapolis
A. A. HEBERT
Nutley, N. J.
HIRAM PERCY MAXIM
Hartford, Conn.
C. R. RUNYON, JR.
Yonkers, N. Y.

C. A. SERVICE, JR.
Bala, Pa.
J. O. SMITH
Rockville Centre, L. I.
H. L. STANLEY
Babylon, L. I.
C. H. STEWART
St. David's, Pa.
K. B. WARNER
Hartford, Conn.
M. B. WEST
Waukegan, Ill.

OPERATING DEPARTMENT

TRAFFIC MANAGER
J. O. Smith

ATLANTIC DIVISION
Manager
Chas. A. Service, Jr.
Bala, Pa.
Asst. Mgr., Central Sec.
John DiBlasi
227 East 75th St.
New York City
Asst. Mgr., Southern Sec.
Chas. H. Stewart
St. David's, Pa.

EAST GULF DIVISION
Manager
J. C. Cooper, Jr.
Atlantic Natl. Bank Bldg.
Jacksonville, Fla.

CENTRAL DIVISION
Manager
R. H. G. Mathews
1816 Carmen Ave.
Chicago
Assistant Manager
Chas. H. Zeller
4732 N. Maplewood Ave.
Chicago

WEST GULF DIVISION
Manager
Frank M. Corlett,
1101 East Eighth St.
Dallas, Tex.

ALASKAN DIVISION
Manager
Theodore A. Stocking
Ketchikan, Alaska

ROCKY MOUNTAIN DIV.
Manager
M. S. Andelin
Richfield, Utah

PACIFIC DIVISION
Manager
A. E. Bessey,
Sunnyvale, Calif.
Assistant Manager
E. G. Arnold
181 No. 17th St.,
San Jose, Calif.

ST. LAWRENCE DIVISION
Manager
Albert J. Lorimer
243 Mackay St.
Montreal, Que.

ONTARIO DIVISION
Manager
A. H. Keith Russell
353 Markham St.
Toronto, Ont.

NEW ENGLAND DIV.
Manager
Guy R. Entwistle
187 Sutherland Road
Brookline, Mass.

ROANOKE DIVISION
Manager
W. T. Gravelly
854 Main St.
Danville, Va.

DELTA DIVISION
Manager
John M. Clayton
1301 Welch St.
Little Rock, Ark.

MIDWEST DIVISION
Manager
L. A. Benson
4942 Wiesehan Ave.
St. Louis

DAKOTA DIVISION
Manager
Russell H. Pray
Valley City, N. D.

NORTHWESTERN DIV.
Acting Manager,
Royal Mumford
Vancouver, Wash.

Address General Correspondence to Executive Headquarters, Hartford, Conn.

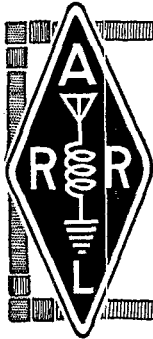

A Magazine Devoted Exclusively to Amateur Radio

The A.R.R.L. QSS Tests

THE interest aroused this summer by the fading tests is the greatest we have ever seen in amateur activity. The whole country is agog over it, and it promises big things, not only because of the interest it excites thru the mere novelty of the idea and the pleasure of participating, but because we are really producing some results of high scientific value.

Let us explain again, to clear the air of confusion, that the tests which started June 1st are being conducted for the Bureau of Standards and are participated in by a very limited number of A. R. R. L. receiving stations especially chosen on account of their location. These stations are supplied forms and instructions by the Bureau and are reporting their results weekly direct to the Bureau for analysis.

The transmitting stations in this test are using a wave length of 250 meters by special authority, and their transmitting schedule is at the following hours on Tuesday, Thursday and Saturday of each week.

1AW,	Hartford, Conn.	10:10 p. m.	Eastern Standard Time
2JU,	Woodhaven, L. I.	10:20 p. m.	Eastern Standard Time
NSF*,	Washington, D. C.	10:30 p. m.	Eastern Standard Time
8ZK,	Pittsburgh, Pa.,	10:40 p. m.	Eastern Standard Time
9ZN,	Chicago, Ill.,	9:50 p. m.	Central Standard Time
9LC,	St. Louis, Mo.,	10:00 p. m.	Central Standard Time

*8ZW on 250 meters, or WWV on 870 meters, may substitute for NSF.

All stations likely to interfere with recording are requested to confine their transmitting to a minimum during the periods mentioned.

Some ingenious schemes for recording these transmissions have been devised by amateurs who were not at that time aware of the system being used by the Bureau stations. The form is very similar to that shown on page 6 of the June QST. At this writing no comprehensive returns on these tests are available, but many extremely interesting features are being observed. In one case, for example, it was noted that the signals of 1AW were loud-

est at Baltimore and Washington at a time when they were at a minimum at 3BZ, Danville, Va., which is in almost straight line thru Washington, and vice versa. In one transmission from 2JU it was noted at 1AW that at the start of the test, signals were swinging slowly, but as transmission proceeded the rate of swing increased until, at the end, the entire swing from faint to very strong was made in sending one series of letters. Possibly 2JU slowed down somewhat in transmitting speed, but this shows us that individual recorders can get interesting data all by themselves, and led to the following idea. Why not arrange some mechanical device to mark intervals of time, say every two seconds, much as a metronome is used in teaching music, so that the abscissae on our graphs will be correct, and then log any station we desire and for as long as we desire, using the same Eccles' scale for ordinates, regardless of what kind of matter the station is transmitting, by checking the audibility at each click of the time-

marker? The Editor will be pleased to learn what records are secured by anyone pursuing this idea.

As announced in June QST, the A. R. R. L. has enlarged upon the idea originating in the Bureau tests, and schedules are being arranged in each Division whereby all of us may participate in the collection of fading data, and it is this scheme which is holding our interest so closely just now. Independent schedules are arranged in each Division, and everybody is invited to join. The following will serve as a guide:

(1) Make reports on 8½x11 inch paper ruled according to the form on page 6 of June QST, checking the average audibility for each group of letters as explained, and making a separate report for each station recorded.

(2) Record as many stations as you can, but mail your reports to the Fading Analyst of the Division in which the trans-

mitting station is located. There the data for each transmission will be tabulated and analyzed.

(3) Tune the transmitting station while he is calling, and then be sure to change no adjustments on your receiving set during the balance of the transmission, so your record will be a true comparative one. The schedules are as follows:

CENTRAL DIVISION
(Central Standard Time)

July 13th and 17th	9ZN	Chicago	250 m.	9:50 p. m.
	9AU	Chicago	200	10:10
	9DC	Cambridge, Ill.	200	10:20
July 20th and 24th	9ZN	Chicago	250	9:50
	8ER	St. Marys, O.	200	10:10
	9HQ	LaCrosse, Wisc.	200	10:20
July 27th and 31st	9ZN	Chicago	250	9:50
	9ZL	Manitowoc, Wisc.	375	10:10
	8DA	Salem, O.	200	10:20
Aug. 3d and 7th	9ZN	Chicago	250	9:50
	8CB	Detroit	200	10:10
	8ZV	Canton, O.	375	10:20
Aug. 10th and 14th	9ZN	Chicago	250	9:50
	9ZJ	Indianapolis	375	10:10
	8IK	Ashland, O.	200	10:20
Aug. 17th and 21st	9ZN	Chicago	250	9:50
	9CA	Minonk, Ill.	200	10:10
	9HR	Middlebury, Ind.	200	10:20

Address all reports to F. H. Schnell, Special Fading Analyst, 2220 Roscoe St., Chicago.

MIDWEST DIVISION
(Central Standard Time)

July 13th and 17th	9LC	St. Louis	250 m.	10:00 p. m.
	9EL	Council Grove, Kan.	200	10:10
July 20th and 24th	9LC	St. Louis	250	10:00
	9HI	Omaha, Neb.	200	10:10
July 27th and 31st	9LC	St. Louis	250	10:00
	9JA	Marengo, Ia.	200	10:10
Aug. 3d and 7th	9LC	St. Louis	250	10:00
	9DU	Independence, Mo.	200	10:10
Aug. 10th and 14th	9LC	St. Louis	250	10:00
	9KV	St. Louis	200	10:10

Address all reports to L. A. Benson, 4942 Wiesehan Ave., St. Louis, Mo.

DAKOTA DIVISION
(Central Standard Time)

July 13th and 17th	9ZX	Valley City, N. D.	375 m.	10:10 p. m.
	9ZT	Minneapolis	375	10:45
July 20th and 24th	9PI	Eureka, S. D.	200	10:10
	9ZT	Minneapolis	375	10:45
July 27th and 31st	9EA	Duluth, Minn.	200	10:10
	9WU	Ellendale, N. D.	200	10:45
Aug. 3d and 7th	9ZT	Minneapolis	375	10:10
	9EE	Ellendale, N. D.	200	10:45
Aug. 10th and 14th	9ZX	Valley City, N. D.	375	10:10
	9ZC	Baudette, Minn.	375	10:45
Aug. 17th and 21st	9EA	Duluth, Minn.	200	10:10
	9PI	Eureka, S. D.	200	10:45

Address all reports to R. H. Pray, 813 Fifth Ave., Valley City, N. D.

EAST GULF DIVISION
(Eastern Standard Time)

July 13th and 17th	4AG	Athens, Ga.	200	10:10
July 20th and 24th	4BL	Ortega, Fla.	200	10:10
July 27th and 31st	4AT	Ft. Pierce, Fla.	200	10:10
Aug. 3d and 7th	4AG	Athens, Ga.	200	10:10
Aug. 10th and 14th	4BL	Ortega, Fla.	200	10:10
Aug. 17th and 21st	4AT	Ft. Pierce, Fla.	200	10:10
Aug. 24th and 28th	4AG	Athens, Ga.	200	10:10
Aug. 31st; Sept. 4th	4BL	Ortega, Fla.	200	10:10
Sept. 7th and 11th	4AT	Ft. Pierce, Fla.	200	10:10

Address all reports for this Division to J. C. Cooper, Jr., 804 Atlantic National Bank Bldg., Jacksonville, Fla.

ATLANTIC DIVISION
(Eastern Standard Time)

July 18th and 17th	2JU	Woodhaven, L. I.	250 m.	10:20 p. m.
July 20th and 24th	8NB	Vineland, N. J.	250	11:10
July 27th and 31st	NSF	Washington, D. C.	250	10:30
Aug. 3d and 7th	3ZA	Bala, Pa.	250	11:10
Aug. 10th and 14th	8XK	Pittsburgh, Pa.	250	10:40
Aug. 17th and 21st	8ZS	St. David's, Pa.	300	11:10

Mr. Malcolm Ferris, 3BT, has been appointed assistant in tabulating and analyzing reports, and Mr. Bradford Smith, Jr., 3PS, to assist with the correspondence. Address all reports direct to C. A. Service, Jr., Bala, Pa.

NEW ENGLAND DIVISION
(Eastern Standard Time)

July 18th	1AK	Fall River, Mass.	200 m.	9:50 p. m.
	1AW	Hartford, Conn.	250	10:10
July 17th	1DR	Melrose, Mass.	200	9:50
	1AW	Hartford, Conn.	250	10:10
July 20th	1HAA	Marion, Mass.	200	9:50
	1AW	Hartford, Conn.	250	10:10
July 24th	1CK	Braintree, Mass.	200	9:50
	1AW	Hartford, Conn.	250	10:10
July 27th	1EK	Portland, Maine	200	9:50
	1AW	Hartford, Conn.	250	10:10
July 31st	1DQ	Brookline, Mass.	200	9:50
	1AW	Hartford, Conn.	250	10:10
Aug. 3d	1CM	Laconia, N. H.	200	9:50
	1AW	Hartford, Conn.	250	10:10
Aug. 7th	1AS	Milton, Mass.	200	9:50
	1AW	Hartford, Conn.	250	10:10
Aug. 10th	1DR	Melrose, Mass.	200	9:50
	1AW	Hartford, Conn.	250	10:10
Aug. 14th	1PG	Cambridge, Mass.	200	9:50
	1AW	Hartford, Conn.	250	10:10
Aug. 17th	1DQ	Brookline, Mass.	200	9:50
	1AW	Hartford, Conn.	250	10:10
Aug. 21st	1CK	Braintree, Mass.	200	9:50
	1AW	Hartford, Conn.	250	10:10
Aug. 24th	1KAY		200	9:50
	1AW	Hartford, Conn.	250	10:10
Aug. 28th	1WR		200	9:50
	1AW	Hartford, Conn.	250	10:10
Aug. 31st	1HAA	Marion, Mass.	200	9:50
	1AW	Hartford, Conn.	250	10:10

Mr. Lester A. Pulley has been appointed Fading Assistant. All reports should be addressed to him at 33 Porter St., Melrose, Mass.

DELTA DIVISION
(Central Standard Time)

Every Tuesday and Saturday beginning July 13th, as follows:

5ZL	Little Rock, Ark.	375 m.	10:00 p. m.
5EA	Baton Rouge, La.	200	10:20
5YE	University, Miss.	375	10:30

Address all reports to the Division Manager, John M. Clayton, 1301 Welch St., Little Rock, Ark.

ROANOKE DIVISION
(Eastern Standard Time—200 meters)

July 18th and 17th	3BZ	Danville, Va.		9:00 p. m.
	3FG	Portsmouth, Va.		9:15
July 20th and 24th	3GO	Norfolk, Va.		9:00
	4CC	Greensboro, N. C.		9:15
July 27th and 31st	4BB	Winston, N. C.		9:00
	8EF	Mannington, W. Va.		9:15
Aug. 3d and 7th	4AL	Winston, N. C.		9:00
	3EN	Norfolk, Va.		9:15
Aug. 10th and 14th	3CA	Roanoke, Va.		9:00
	8ZW	Wheeling, W. Va. (375 m.)		9:15

A special Technical Committee has been formed for this Division. Address all reports to A. L. Groves, Brooke, Va.

CANADIAN DIVISIONS

On account of scarcity of stations, no schedules have been arranged for the Canadian divisions. Canadian receiving stations will record as many tests as possible and report direct to the proper Divisional Committees.

WEST GULF DIVISION
(Central Standard Time)

Every Tuesday and Saturday beginning July 13th, as follows:

5ZZ	Blackwell, Okla.	375 m.	10:10 p. m.
5ZC	Dallas, Tex.	375	10:20
5ZU	Austin, Tex.	375	10:30
5AO	Houston, Tex.	200	10:40
5ZA	Roswell, N. M.	300	10:50

Mr. R. A. Holmes has been appointed Fading Analyst. Address all reports to A. R. R. L. Research Committee, Radio 5ZC, 1101 East 8th St., Dallas, Tex.

NORTHWESTERN DIVISION
(Pacific Standard Time)

Transmission at 9:05 p.m. as follows:

July 13th	7AD	Seattle, Wash.
July 17th	7CR	Portland, Ore.
July 20th	7YS	Lacey, Wash.
July 24th	7CW	Silverton, Ore.
July 27th	7CU	Vancouver, Wash.
July 31st	7BK	Seattle, Wash.
Aug. 3d	7BP	Portland, Ore.
Aug. 7th	7YS	Lacey, Wash.
Aug. 10th	7CW	Silverton, Ore.
Aug. 14th	7ZI	Portland, Ore.

Mr. Chas. Austin, 59th and East Taylor Sts., Portland, Ore., has been appointed Fading Analyst. All reports should be addressed direct to him.

PACIFIC DIVISION

Mr. D. B. McGown, 6ZE, 1247-47th Ave., San Francisco, has been given charge of the Fading Tests for this division. Further details will be broadcasted by California stations, complete schedule being not yet arranged, but will embody the following stations commencing 11 p.m., Pacific Standard Time, on the dates specified:

July 12th and 17th	6OH	Ukiah, Calif.
	6JD	Los Angeles
July 19th and 24th	6FE	Anderson, Calif.
	6CM	No. Glendale, Calif.
July 26th and 31st	6CV	Sacramento
	6IY	San Diego
Aug. 2d and 7th	6DK	Fresno
	6JI	San Diego
Aug. 9th and 14th	6DY	Richmond, Calif.
	6JM	San Fernando
Aug. 16th and 21st	6EJ	Walnut Grove
	6BQ	Reno, Nev.
Aug. 23d and 28th	6CP	Alameda
	6CS	Fresno
Aug. 30th and Sept. 4th	6BN	San Francisco
	6DP	Santa Cruz

In the case of incomplete schedules or the necessity for any changes, the information will be broadcasted from the station of the Manager of the Division concerned.

The importance of this work can not be overestimated and we are all set now to do a good job of it. All stations are urged to take upon themselves the responsibility of making consistent reports of these tests, so that our efforts can produce satisfactory results.

DON'T GIVE UP THE STATION!

Are you easing up in your radio work because summer is here and you think everybody else is doing the same? The dope is wrong—we're working right thru it with great success. Just take a look at this QST and consider the many interesting events taking place NOW in Amateur Radio. Sit in some night—you'll find the old gang still on the air.

Rotten Damped Spark Stuff

By The Old Man

In which our unknown friend, T.O.M., celebrates the Fourth with fireworks. Like many of his stories, there is a genuine lesson in this one on the subject of Rotten Wiring. But it has the usual number of hearty roars per paragraph.—Editor.

TAKE it away and bury it—sprinkle some saw dust on it and sweep it out—give it to the kids to play with—I'm through with it. After what I have seen to-night, it's me for C.W. Let the kids enjoy squarking at each other with their damped sparks; let them set fire to their houses, put their telephone companies out of business and blow up their electric light stations with their kick-backs. I am no longer interested. I am going to set my bulb oscillating, light the old pipe and sit back in gentlemanly comfort and push through relay traffic with the sweet little peep stuff. There will be others like me and soon we can get a message almost anywhere we want on C.W., judging by what is going on over east.

I've been fixing for this shift for some time. QRM has got so fierce that most of the time it is impossible to work any distance at all. With rotary gaps belching forth five amperes on any old tune, as loud at 2500 meters as at 200, and the unlicensed moonshine spark coil stuff from the what-nots going it every night, doing any relay work is like listening to a whispered life story in a night-life restaurant with the jazz band gone amuck close up on your starboard quarter. It is too hard work making sense out of what you get, and when you count up the hours and the number of messages and divide the latter into the former the answer is too darned many man-hours per message. And if what I saw over on the other side of town tonight is any criterion, it is not going to improve any.

While waiting for the fading tests to begin, let me jot down the jar I had to-night. It started with the telephone people insinuating that I was putting the telephone system on the blink with my wireless. The said their switchboard lights were popping in and out, their bells ringing steadily and buzzing businesses coming in on the lines until they were about crazy with the heat. To prove an alibi, I made a swift guess as to where the trouble probably was and proceeded to get their expert and myself invited over to the house of a certain young Marconi person who had been asking me to cure him of kick-backs. He had been having the trouble for some time, and hesitating to suggest Sloan's Liniment or Indian Swamp Root, I had

been holding him off. He was more than glad to have me come over, so taking Mr. Phone Expert, we went.

Approaching the young gentleman's house we discovered quite a nice little crowd outside and I realized we had stumbled upon some real stuff. It seemed that the young scientist was busy inside the house with his key, for the electric light hanging in the garage was giving off quite a fireworks display, which the crowd were enjoying. The lamp socket was having a helvetime all by its lonesome. It was shooting off fire and smoke and melted brass entirely regardless and suggested very strongly that six ampere fuzes had been thrown into the discard in that family in favor of the thirty ampere variety. Mr. Phone Expert had evidently never beheld anything quite like this before, for he became strangely silent. You could guess that he had been brought up in the old school where one was taught to believe that when an electric light fixture starts popping and snapping and arcing and dripping melted brass it is time to get from under and to look for something big to happen in the not distant future.

It seemed to me about time to notify somebody of something, so I beat it for the front door seeking for the push button as promptly as may be. Imagine my state of mind when I discovered the blame thing snapping and shooting fire on its own account and the bell ringing somewhere inside steadily. Not caring to monkey with a flaming push button but feeling that it was my duty as an American citizen to hasten before the whole blamed town got going, I knocked rather firmly on the door. Mr. Phone Expert was at my elbow and had seen all I had seen and was also impressed with the necessity for prompt action.

Mother opened the door and greeted us smilingly, sweetly and deliberately. She was one of those lovely little old ladies you like to talk to and wait upon. The last thing in the world in her mind was danger and vigorous action. You saw the whole story at a glance. If Harry was interested in wireless, why hinder him? Why disturb his scientific investigations? How happy we all should be that Harry was interested in such a wonderful science instead of idle amusements as were most

other boys. What if the light in the garage did behave like a Bessemer converter? What if the door bells did ring bloody murder by the hour? What if the push button on the front porch did electrocute somebody? What if the trouble department at the telephone station had been up all night for the past two weeks trying to stop subscribers' bells ringing all night? Was it any reason for interrupting Harry in his radio research work? No! Harry was a born leader and he must not be coerced into considering the rest of the town, nor into getting up to breakfast nor into going to school. He must have free play for his wonderful talents.

The boy wonder of the Wabash was found in a little back room surrounded by blue flame, submerged in deafening racket from a naked rotary gap, merrily pounding the key, and calling a ninth district station that was as far beyond his range as heaven is beyond mine. Flame and evil red sparks were chasing themselves across dry wood work all over the neighborhood. I hankered for a fire extinguisher and no one to interrupt while I distributed its contents as fancy dictated. With the instinct of self preservation uppermost, I touched him on the shoulder, and as I had hoped he stopped abruptly and rose to greet us. The fire hazard was at least reduced in part, although heaven only knew in what place some dry clapboard was smouldering. Suggesting that he shut down the crazy rotary so we could talk without straining our vocal chords, I introduced the dejected gentleman from the telephone company, took a chair, and proceeded to look around.

There were a couple of wires coming in from somewhere outside which led to a one KW Thordarson and to my horror they were noted as paraffine coated annunciator wire. The paraffine had drained down to the bottom in spots which suggested that at some time those wires had been warm. As I looked I thought I detected a wisp of smoke curling away from one of them. Probably carrying ten amperes or so at 220 volts and coming in through a window which had been shut down upon them. Glancing to see how Mr. Phone Man was getting along I caught him transfixed and staring at a telephone on the table beside the oscillation transformer, the flexible cord from the phone reclining up against the high tension wires of the Thor. What the poor phone missed from the radio frequency it got from the 10,000 volt secondary of the Thor and Mr. Phone Man knew it. I was willing to lay a bet with anybody that the phone was on the operating table for the sole purpose of conveniently calling the other fellow to ask "How do you get me?"

The Boy Wonder took a shot that we had come over to prescribe for kick-back, and he plunged into the symptoms. It seemed that ever since he had had his new one KW 110-volt Thor and hooked it onto the 220-volt wires he had been having kick-backs and fuze blowing. Did I think there was something wrong with the Thor, and was there any other way to connect it? The kick-backs were not so bad, as they did not shut him down, and the family and neighbors had gotten used to them; but the fuze blowing was rotten, for it interrupted his transmission. He said he had put in the largest size plug fuzes he could buy in the town—thirty ampere—but they were just as bad actors as the little ones. How big did fuzes come, and was it a fact that there was some kind of a law against jumping them with a piece of copper wire so they would not blow?

I am used to this sort of thing, but Mr. Phone Man was not. He thought he was in a trance and was for disbelieving his ears.

Mother sat in and beamed proud delight at the technical lingo of her hopeful. To her he was indeed a Boy Wonder. I asked him how many times he blew a fuze. "Oh it's terrible. Some nights a pocket full." What to him was worse, there were no more thirty ampere plug fuzes in town. He had exhausted the supply. He only had eight left and that was not enough to get in on the long-distance stuff and last out the evening. I had come in the nick of time. What was it I would advise? I wanted to advise the patrol wagon, but with poor little smiling Mother sitting there I had not the nerve.

Just then a stranger came in. He was introduced as the man living in the other half of the house. He wanted Harry to have Harry's sister send, while Harry himself went in next door and watched their gas stove. Gas stove! What in blazes could all the gas stove? Fearing a cataclysm of some sort I vetoed any more sending. The Phone man said he did too. Being urged, and sister promising faithfully that she would limit her activities to three short dots, I gave in, and we all filed out and into the other side of the house.

Here we ran against more trouble. In this family the man was a machinist during the day and a student of pyrotechnics at night. All hands were anointed by the sweet personality of Harry's mother, and anything Harry did was all to the good, because dear little smiling Mother wanted it that way. It mattered not that the door bells all up and down the street rang until two in the morning; that the lights blinked so it permanently impaired your eye-sight to read the evening paper; that fifteen or twenty times a night they went

out altogether. The point was the Harry was trying to get Peoria, and wouldn't that be just wonderful for a boy of seventeen! Peoria! Away over there in Illinois!

After pushing us all back from a galvanized wire run across the kitchen to dry clothes on in wet weather the stranger nodded to his wife and she gave a couple of raps on the wall. This was the signal to Sister to send the three short dots, and incidentally I found it was the signal every night for Harry to pull up a minute while they put out a fire in one of the electric light fixtures. The three dots came all right. The stranger kept his eagle eye on the galvanized wire because earlier in the evening he had walked under it, and being a tall man, an evil blue spark had hopped out of the wire and picked a hole in his bean, and it had made him timid. The first dot made a tea kettle on the coal stove shoot a fat blue sheet of fire to the snout of a coffee pot on the gas stove alongside. This had been discovered by accident by the machinist man, and it was to show Harry that he had a receiving station right there in the kitchen that we had been called over. He had been copying the dots and dashes and intended to learn the code so he could read what Harry sent out. The second dot caused the front door bell up over the door to explode and vomit a cloud of smoke, and nearly scare Mr. Phone Man to death. His nerves had gotten jumpy. The third dot caused the electric light socket in the kitchen to emit a report like a shot gun and proceed to go off like a Roman Candle, after which the lights went out and left us in inky blackness. Candles were handy, for this was a regular performance, and we soon had light enough for Harry to beat it back to his cellar and the machinist man to also beat it for his. In an incredibly short time the lights came on again, thanks to a couple of thirty ampere fuzes, showing how expert these people had become.

It seemed to both me and the overwrought Phone Man that the exhibition was most convincing and that more would be superfluous. He was entirely satisfied and the machinist man was quite pleased at the success of his venture. He related how the neighbors up and down the street had queer things also, such as all the lights blazing up at two-thirty in the morning and both front and back door bells going off like a fire alarm. But they had got used to it, and it did not bother them much. The only trouble was that the

telephones would ring at the wrong time and had been working badly the past month. Harry explained all this away by saying that that had all been since he got his new Thordarson transformer, and would be fixed as soon as he found out from me how to connect it properly. The Phone Man did not look convinced. He was speechless. You could see he was figuring out in his mind what would be the strongest language he could command for his report.

On the way back Harry insisted upon showing us where the paraffined annunciator wire came from. On the way down cellar he pointed with pride to each light fixture, showing us how every one was blackened or pierced with a big ragged hole where the 110 volt arc had melted out the brass. Down cellar it was explained the Thor had a binding post on the iron frame and the question was what to do with it. Of course it was the ground connection to keep the Thor from acting nasty if anything got into its frame, but I let this pass. When we reached the business end of the paraffined annunciator wires we found that they were across the 220 volt outside wires from the meter, merely being twisted around. There was a wire dangling from one side of the service system and I asked what might it mean. It was explained that this had been used to ground one side of the lighting circuit, in the hopes that it would cure the kick backs, but after having it in for a while and not getting any

improvement he took it out because he noticed it made the meter run backwards. As this might indicate that the electric light company owed him money and might bring on acrimonious dissension, he had taken it out. At this explanation Mr. Phone Man sickened. Walking over to an ash barrel he gazed hard into its dusty contents and then spat sincerely and copiously, even as I have been wont to do in happier days when our Maltese pet has been within range.

I noticed casually that the paraffined annunciator wires led the full length of the cellar and made their untimely exit through a cellar window, also shut down hard upon them. Also that they were not only parallel but attached at intervals to the ground wire that also came through the cellar window from the set up stairs. This of course brought radio frequency in intimate and friendly touch with the service wires for quite some little length,

(Continued on page 22)

SOME DAY

we are going to publish The Old Man's "Rotten Radio Yarns" in book form. Certainly his inimitable stories have added much fun to Amateur Radio, and should be preserved. What do you think?—Editor.

Navy Receiving Equipment

By L. C. F. Horle

Presented at meeting of the Radio Club of America, Columbia University,
March 26, 1920

EVER since radio has been in the Navy, the Navy Department has carried on development work in its own organization and at the same time has used apparatus designed and built by commercial companies.

For its high power stations it has always and does still depend almost completely on the commercial radio companies for the design and manufacture of its equipment, but very early in the application of quenched gap transmitters to the Service it started its own development laboratories wherein research, design, and development were carried on in co-operation with radio manufacturers. This brought about a standardization that is essential to so large a military organization. The need for this will be readily understood when it is realized that both the Atlantic and Pacific Coasts have Navy Yards and Naval Stations at frequent intervals along their lengths and that these yards must be prepared, particularly in times of war, to make replacements in part or completely of all radio equipment. The additional advantages which lie in the fact that the standardization of apparatus results in multiplying the sources of supply and, usually, in the cheapening of the cost of production, have shown quite positively that the investment required for the establishment of radio laboratories and experimental manufacturing plants is well justified.

It was not until the recent European unpleasantness had taken on a serious aspect to ourselves that the problem of receiver design was seriously undertaken by the Navy Department.

Until late in 1916 the major part of the radio receiving equipment in use in the Navy was designed and manufactured by the commercial companies and it was said that there were about as many types of receivers as there were receivers in service. This of course led to tremendous confusion in the maintenance of this radio equipment and made operation of this equipment by the continually moving personnel of the Navy quite difficult. In addition to this the radio problems of the Navy are in themselves quite characteristic of only the Navy and were not well appreciated by the commercial designers

of equipment. The tendency was, therefore, toward the establishment of a receiver design laboratory. Late in 1916 when funds were available the station at Washington Yard was made the residence of all receiver problems.

At that time the Navy was adopting the vacuum tube for general service use and was therefore confronted with the problem of making possible the use of the apparatus already in service with the tubes then available and the design of new and more efficient apparatus for operation with tubes.

The first design, which is in every detail the product of the Radio Laboratory, Washington Yard, is the SE-143 receiver. This was designed for reception on the wave lengths between 300 and 3000 meters of both damped and undamped waves.

The requirements to be met in the design of this receiver characterize all the design work that has been done in the service; that is, it is required of all receivers sent into the naval service that they have:

- (1) A wide wave length range
- (2) A high sensibility and selectivity
- (3) Ease of operation
- (4) Compactness and lightness in so far as it is compatible with the foregoing and with the conditions of transportation and storage of apparatus.
- (5) Ease and cheapness of manufacture in quantity.

Probably the most difficult of these problems lies in the design of equipment of high selectivity and sensibility over a wide range of wavelengths. Since in all Navy apparatus continuous variation of wavelength is secured by the use of stepped inductance and continually variable air condensers, the problem reduces itself to the design of an efficient stepped inductance system, having a high inductance-resistance ratio for each step at the wave lengths at which that step is used.

The difficulty in securing a suitable value for this ratio lies in the space limitations which determine the size and distribution of the conductor comprising the inductance system and, hence, the dead-end effects which arise from this condition.

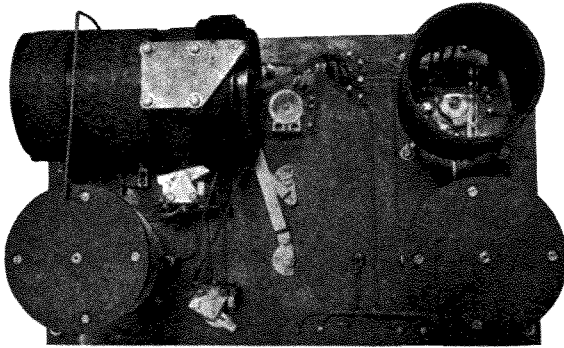

Fig. 1.
Interior View, SE-143.

This problem in general has been solved in two different ways and has given rise to two general types of receivers. The first of these is embodied in the type SE-143 receiver and those receivers developed on the basis of the SE-143 design. The second solution is typified by the SE-1420 receiver and those following it.

The SE-143 group is characterized in the electrical details of its design by the high values of the capacities of its tuning condensers and by the type of inductance systems used. In the mechanical details of its design it is characterized by the panel arrangements shown in the photographs, Figs. 1 and 2.

The controls for the antenna circuit inductance and capacity are located at the left, the controls for the secondary circuit inductance and capacity are located at the right, with the antenna coupling and tube coupling controls placed midway between these. A variable stopping condenser for use with the crystal detector is supplied with a control on the panel, as is the switch which makes possible the use of a crystal detector or vacuum tube detector. A buzzer and buzzer push-button are mounted on the panel for use in adjusting the detector.

Terminals are supplied for the connection of the antenna, ground, buzzer battery, crystal detector, loading coils in both the antenna and secondary circuits, and for the connection of the vacuum tube apparatus which will be described later.

The condensers as shown in Fig. 2 are supplied with metal dials, fastened to the shafts, which carry a wave length calibration from which the wave length of every possible combination of inductance and capacity is immediately evident.

This is accomplished by the use of as many circular scales on the condenser dials as there are inductance taps. The index is caused to point to the proper scale by the action of the inductance switch through a rack and pinion. The inductance switch shaft carries a pinion in back of the panel which engages a rack to which the pointer is secured. Fine adjustment of the condensers is secured by means of a separate "Fine Adjustment" knob connected through a train of bakelite gears to a metal gear secured to the condenser shaft.

The coupling between the antenna circuit and the secondary is secured by means of a section of the primary inductance which can be rotated relative to the secondary. Connection to this moving coil is made through flexible conductors. One terminal of this coupling coil is connected directly to the ground terminal with the result that the capacitive coupling between the primary and secondary is kept low.

The inductances, which in their design details typify the first group of receivers, are bank-wound of a conductor of three groups of 10 strands of No. 38 enameled wire with double covering of silk, and are sectionalized. By this is meant the spacing between the three sections of the secondary and between the two sections of the primary. A cam carried by the inductance switch separates a series of contacts which break the connection between the used and unused sections of the winding for any position of the inductance switch. By this means dead-end effects are avoided and great wave length range made possible, in the first group of receivers.

A special inductance coil is provided

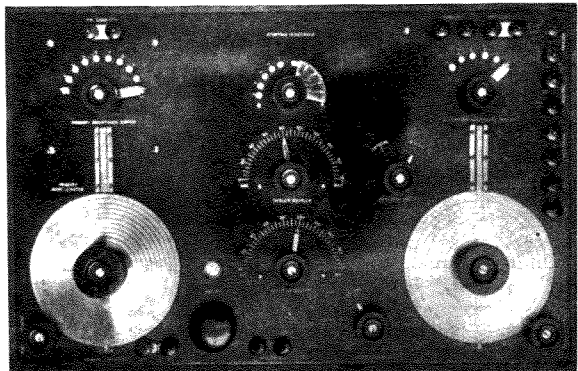

Fig. 2.
Standard Panel used on SE-952, SE-143, SE-1220, SE-712A

and mounted directly on the primary coupling unit for securing especially high values of coupling between the two circuits when the "Tuned-Untuned" switch is in the "Untuned" position. The function of this switch is to disconnect the secondary condenser and to connect the above mentioned inductance coil in series with the secondary inductance. This results in an untuned secondary system very closely coupled to the primary and is quite useful in picking up a station of unknown wave length in that it eliminates the need for the manipulation of the secondary condenser.

The tube coupling coil or "tickler" is mounted inside the secondary inductance coil and is rotated, as is the antenna coupling coil, by means of a link motion actuated by the coupling control knob.

Care is taken in the arrangement of the connecting wires to keep all conductors that are at high potentials away from points of ground potential and to eliminate capacity coupling as far as possible by their careful location. In general this type of receiver is efficient, easy to build and to operate, and quite accessible for inspection and repair.

It is to be noted that only the tuning and coupling systems and switching mechanism are included in the receiver, the vacuum tube apparatus being supplied separately. This resulted from the fact that the major part of the receiving equipment in service previous to this model was designed for crystal operation only and hence required the vacuum tube control apparatus to be separately mounted. In preparing this design it was, therefore, necessary to make operation with the standard "Audion Control Box" possible. The unit is comprised of shock-proof vacuum tube receptacle, filament ammeter and rheostat, bridging condenser, grid condenser, switches for short circuiting the tickler winding and for transferring from plate supply storage battery to the usual ship's supply. A filter system consisting of two iron-core inductances and two paper condensers is supplied for making possible the use of the ship's supply. Across this is connected a carbon sector potentiometer for the fine control of the plate supply voltage.

The next problem of importance came with the need for compact radio compass equipment for destroyers. As might be assumed from the size of this kind of craft, space is distinctly at a premium, so much so that special schemes and apparatus were necessary for radio operation on them. The radio compass equipment for destroyers was allowed even less space than the ordinary radio equipment since the use of compass equipment had not been contemplated in laying out this

craft, with the result that an especially small receiver was designed to meet this need.

This is known as the SE-1012 receiver. The general panel layout of this receiver is quite similar to that established as standard in the previous types. It differs quite radically from the previous types, however, in that the vacuum tube and its associated controls are included in the receiver. A compass switch for disconnecting the antenna for bilateral compass operation and a "Tuned-Untuned" switch for pick-up work are supplied. An exceptionally compact crystal detector is mounted on the panel.

The tube coupling is perhaps the most novel part of the receiver in that it comprises both inductive and capacitive coupling. The coupling condenser in this receiver is of a particularly ingenious type. It consists of two circular plates separated by a bakelite ring, with a moving plate which through the motion of the coupling control may be moved toward or away from one of the stationary plates and hence away or toward the other plate. The moving plate is connected to the filament of the tube, while the two outer and stationary plates are connected to the terminals of the tuning condenser and to the plate and grid of the tube. This arrangement constitutes an extremely ingenious method of varying the potential of the filament relative to the grid and plate.

This type of receiver was built in great numbers and installed on destroyers. The difficulties of undamped reception on such wave lengths as this receiver was designed for brought a new problem. It became necessary to adopt some method other than the ordinary "beat reception" method for this work since the change in capacity of the oscillating circuit with the motion of the operator's hands in the vicinity of the receivers of the early type was quite sufficient to cause the beat note to pass into inaudibility when his hands were removed from the condenser knobs. To eliminate delicacy of heterodyning on short waves the rotary tone condenser was devised. This in its essentials is merely a rapidly varying capacity which may be connected across the secondary circuit of the receiver and hence in parallel with the tuning condenser. In brief its operation is this: If resonance is established between the antenna circuit and the secondary circuit with the "Rotary Tone Condenser" at rest and at its mean value and if, then, the tone condenser is caused to rotate, it detunes the circuit at a frequency determined by the speed and the number of complete cycles of capacity variation per revolution. In the Type 999 rotary tone condenser these capacity vari-

(Continued on page 17)

C. W. for the Amateur

By Howard L. Stanley

Mr. Stanley is right in saying we've been after him to write up his experiments. Likewise we've been after his photograph for "Who's Who". And he sends us this "likeness"! The vein of the "biography" being not incompatible with that of the article, we've inserted it as an introduction—and it serves him right!—Editor.



The Author.

Subject: Howard L. Stanley, 2FS

Age: 38 Years

Height: 5 feet 11 inches

Weight: 185 lbs.

Born December 28th 1881, at Southampton, N. Y., of poor but honest parents.

Ambition up to sixteen years to be a locomotive engineer; after that no ambition. First radio experience at Babylon, N. Y., watching messages come in on the tape recorder of the Marconi plain aerial station.

Watched Mr. Round of the Marconi Company for two days trying to get signals from a ten-inch coil at two and one half miles without success. Decided that it was all wrong and went into the auto game.

Bitten by the radio bug again in 1912 and developed a bad and apparently incurable case. Erected a 5 K.W. station in Nicaragua in 1917 and went back there in 1919 to see why it would not work.

Life member of the A.R.R.L., member of the Radio Club of America, and associate member of the I.R.E.

Best known trade—Mason, Free and Accepted variety.

Very persistent oscillator and fair detector. Oscillated between Babylon and New York City every day for about ten years and detected some one to pay expenses during that time.

Main job at present is trying to get a workable relay line from eastern Long Island to New England; side line, trying to convince the Western Electric Company that Vacuum Tubes should sell for two bits—some job.

HAVE you ever heard that So-and-So had the only circuit that would transmit to Mars using one six-candle-power headlight bulb? Have you?

Now don't all speak at once; you have, and so has every other radio bug heard something similar. Would he give you the dope? He would.

Right there you began to have a great new urge.

Forgotten were the ground antennae and the loop receptors, forgotten were the high and low speed gaps and the ohmless condensers, forgotten were all the other things which are tried by many and used by few.

Some of us even went so far as to forget next month's rent and began to have visions of sparkless, kickless, noiseless, boneless transmitters to operate on three dry cells and the family sewing machine. That is how it started; how it will end is not known even by the O. M.

For the past year the writer has been pumped so full of dope of one kind and another on C. W. for the Amateur that he forgot that there was an income tax, interest on the mortgage, commutation tickets and the H.C.L., and began to have fits and draw diagrams and dream dreams.

Friend 2ZL had some tubes and a source of high voltage and there the first practical experiments were tried. There were inductive coupled circuits, loose and tight; conductive coupled, right and left; capacity coupled, large and small, and some of the circuits handed in as perfect were not coupled at all as far as the writer was ever able to find out.

The writer will never forget the first

sign of life on the meter which had been hopefully inserted in the antenna circuit. That was an event.

Friend Smith had become so Hard Boiled by that time that he promised a real drink if there was the slightest sign of radiation. We had the drink all right and it was not in proportion to the radiation, either.

From this first sign of life we have progressed to a point where we are nearly always sure of some radiation. Sometimes we have gone ahead one ampere only to slide back two but the average has been a steady increase.

First we had three coils, one for the grid circuit, one for the plate circuit, and one for the antenna circuit, and it was some fun to get them all properly adjusted and coupled to each other. Sweat blood? I'll say we did.

Next we consolidated the grid and plate coils and coupled them to the antenna inductively. Distinct advance; one less coupling operation.

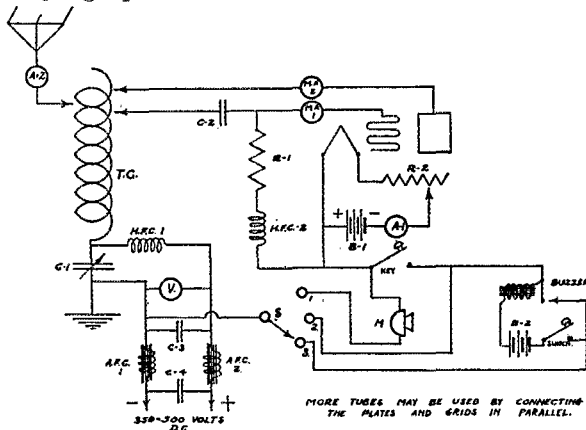

LEGEND

Antenna—100 feet long, four wires, 60 feet high at one end, 20 feet at other.
 A-1 —Filament Current Ammeter, 0-5 Amperes.
 A-2 —Antenna Current Hot Wire Ammeter, 0-2½ Amperes.
 M.A.-1 —Grid Current Milliammeter, 0-100 Milliamperes.
 M.A.-2 —Plate Current Milliammeter, 0-500 Milliamperes.
 V. —Plate Potential Voltmeter, 0-500 Volts.
 C-1 —General Radio .0006 Variable Condenser.
 C-2 —Murdock Stopping Condenser greater than .0005 M.F.
 C-3-4 —1 M.F. Condensers insulated for 1000 Volts.
 H.F.C. —500 turns No. 26 D.C.C.C. on

The next and final (to date) change was to a single coil for all three circuits and this method has been retained as the simplest, most efficient, and easiest handled of any of the many schemes tried.

The first coils were wound of No. 14 magnet wire but as there were so many reasons why "Litz" should be better, coils were made of the largest "Litz" that could be readily procured and strange as it may seem, this was one of the times that we slid back. Contrary to the best dope these "Litz" coils heated badly and actually set a celluloid coil form on fire. Hot Stuff. The latest dope on coils is ¼" copper tubing wound in a helix the same as the old spark sets.

From ¼ ampere radiation with three five-watt tubes, the writer's set has advanced to a point where the H.W.A. shows an honest two amperes with the same three tubes and we are sure that there is more to be had out of these little bottles which we are told have nothing in them.

When the place was reached where we could nearly always be sure of some radiation on a given wave length, the question arose as to what we could do with it. No one was supposed to listen for pure C.W. on amateur waves so some system of modulation must be used to make our signals audible to the crystals and straight spark receivers.

The writer had a very pet scheme of modulation which had been rattling around in his dome for long time and only needed a lot of expensive apparatus to give it a try. Well, one day the expensive apparatus arrived and he proceeded to prove to his own and Friend Smith's satisfaction that the scheme had been kept

Spool ½" diameter, ¾" long.
 A F.C. —1000 turns No. 26 D.C.C.C. on Iron Core, ⅜" diameter, 2" long.
 R-1 —2500 to 10000 ohms.
 R-2 —6 ohms.
 Key —Regular Morse key.
 M —Microphone No. 329, 50 ohms Resistance.
 Buzz —6 volt Mesco Buzzer with Resistance Shunt Removed.
 B-1 —Filament Lighting Battery.
 B-2 —Buzzer Battery, 6-8 Volts.
 S. —3 Point Switch, 1—Telephone, 2—C. W., 3—Buzzer.
 F. —Filament.
 G. —Grid.
 P. —Plate.
 T.C. —50 turns No. 4 or 6 Bare Copper, spaced ¼" on Form 4" in Diameter.

too long. In other words it had spoiled.

In any case it was not practicable, it was another case of seven foot boiler and a ten foot whistle. The tone circuit required more power to operate it than there was available for useful purposes.

Then there was the buzzer. Perhaps one or two of you have used buzzers at some time. Yes, they are all that you say and then some.

Buzzer modulation was tried in all forms known and unknown, unilateral, bilateral and rectangular connection to the grid, the plate, the filament, the antenna, the operator's left wrist and several other methods with indifferent results until the present dope of the buzzer used as a chopper in the common part of the plate-filament-grid circuit was tried. With the buzzer as shown the amount of chop can be regulated to suit and the modulation seems to be all that can be desired.

Now we had straight C. W. and a buzzer modulation which worked and Friend Smith had been trying a phone on the sly when the writer was not around. One fine day he sprung it something like this; "2FS 2FS 2FS de 2ZL 2ZL 2ZL pse qrx fone." The rest of it as heard at 2FS was something like this as near as it can be reproduced in words; "HUMMMMMMMM SQUEAKEEEE Z Z Z Z E E E E E E ZUMMMMMM LOODLEOODLEOODLE ZEEEMMM HUMMMMM"; then the buzzer again, "QRK? QSA? hw u like my fone k k k." Until this day he wonders why 2FS did not come back at him but the truth must be told that the writer had fainted and did not come to until the following morning in time to catch his train.

Some wise old owl has truthfully said that "Necessity is the mother of invention"; so also is the lack of power the incentive to all kinds of schemes to make the most of what you may have. Right here the writer wishes to make a statement: the limits placed on amateur wave length and power have done more good than would ever have been accomplished by the allowance of unlimited power and wave length. The writer is short on power and long on schemes. The shortness of power precluded the use of telephone circuits which included modulator tubes so he went in for something to get away from them. Modulation of grid leak was tried and did not suit; then ground and antenna connection of the modulating circuit; N. D. again. Eminent Authorities were then consulted and reported that there was no hope unless the particular modulator scheme fostered by them was used. These invariably required tubes and tubes and more tubes. All this time there was Friend Smith merrily phoning to all and sundry and giving concerts and ear-aches

to all who would listen to him with his oscillator-modulator circuit and the writer sewed up tight as far as a phone was concerned, all on account of the lack of a little more power to operate the extra modulator tubes.

Desperate things have been done for less than that and one fine evening a microphone was stuck in a new part of the circuit and the works started. There was little hope and less confidence, yet it looked like it might work and it sure did and does yet and for the low power tube set the connection is good, simple and effective. Friend Smith is now using the same dope. Can you beat it?

The writer's set has not been heard in Australia as yet but no station which has been asked to listen for it has failed to hear it if properly tuned to his wave. Most of the stations hearing us for the first time are surprised that so much noise has been going through their tuners and not been heard before. The wonderful sharpness of the emitted wave is a blessing and you will not be reported in "Calls Heard" as often as 8ER, for instance, but can work through QRM which will tee-totally put her out of business.

The accompanying diagram and table of constants of the circuit is made as plain and simple as possible so that he who reads can understand and translate them into a set without the use of three slip-sticks and four reference works on mathematics.

In closing the writer wishes to state that this note was not written of his own free will and accord but that he was egged on to do it and in fact was threatened with all kinds of QRM unless he did so.

NAVY RECEIVING EQUIPMENT

(Continued from page 14)

ations are accomplished by a toothed rotor and stator. The rotor, however, rotates near a stationary disc, being separated from it by a very short distance. The terminals of the device are connected to the toothed stator and the fixed disc and the capacity, therefore, resides in the space between the rotor and stator and between the rotor and the disc. By this means a rapidly varying capacity may be secured without resorting to moving contacts. A loop and an antenna are used, the loop being connected in series with the secondary inductance. Thus when the antenna is used unilateral operation is possible; that is, both the sense and direction of the signal wavefront may be determined, while with the antenna disconnected by means of the compass switch only bilateral operation is possible; that is, when the direction of the signal wavefront or the bearing of the transmitter can be determined.

(To be concluded.)

The Underground Antenna Adapted to Amateur Waves

By R. H. G. Mathews *

PART II.

IN our last article on the subject of underground antennae the method of installation of a system of this kind was outlined, together with general instructions for its tuning and operation. As was stated in this article, only signals from stations in approximately the same vertical plane with any pair of wires lying in a straight line are audible on those wires. This statement is subject to modification in the case of powerful local stations, the signals from which may be heard in nearly all positions except that at right angles to the listening wires. These undesirable signals may be eliminated by several methods, but before any of these methods may be applied a shielded receiving set must be used in order to avoid induction from the transmitter directly into the receiving set. This shielding may be accomplished either by surrounding the operating room with metal screening, properly grounded, or by using apparatus which is already supplied with an internal shield.

Perhaps the most satisfactory method of compensation is by means of a "rectangle" or loop similar to that used in ordinary loop receiving. The dimensions of such a loop vary with the wave length desired, but for 200 meter work, a wooden frame two feet square having ten turns of No. 20 wire wound on its edge will be found very satisfactory. This loop should be pivoted so it may be revolved, and should be connected in the circuit as shown in Figure 3. To eliminate the signals of an undesirable station, the plane of this loop should be adjusted toward that position including the station in question until the signals have been reduced in intensity sufficiently. The theory of this action is, briefly, that the loop picks up electrostatic waves which are 90 degrees out of phase with the electromagnetic waves picked up by the underground aerials, and therefore the two waves from any given station tend to cancel each other provided their amplitude may be properly adjusted. The amplitude of the electromagnetic waves is of course fixed, but the intensity of the electrostatic waves may be varied by the rotation of the loop until the two waves cancel each other. By this

*Chief Engineer, Chicago Radio Laboratory.

means the signals of powerful near-by stations which are not directly in line with the underground wires may be cut out, while distant stations which are in line may be copied with comparative ease.

Similar compensation is also possible by the use of adjustable vertical wires at the ends of the ground wires, although this method presents mechanical difficulties and inconveniences which render it impractical.

The subject of underground reception opens a broad field to the experimenter, inasmuch as practically all the work done on this method of reception was accom-

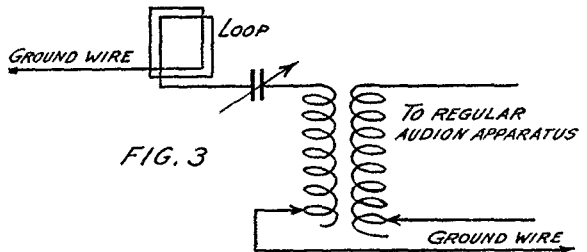

plished under the trying conditions of war time and there is no doubt that valuable points were passed over because of the necessity for speed. In addition to the methods of compensation and static elimination as outlined in this and the preceding article, many more complicated circuits have been devised, but most of these circuits are not suitable for amateur use. A station equipped with eight wires as suggested in these articles, together with a shielded regenerative receiver and a two-step amplifier should be able to accomplish long distance relay work throughout the summer months. In addition to their value in allowing the continuation of relay work through static, the underground aerials will be found of great value even in the winter long distance season in eliminating interference, both from local induction and from near by stations. In this connection it should again be mentioned that all leads from the underground wires to the set should be carried in either metal conduit, properly grounded, or in lead-covered cable, the sheath of which is grounded. The author's experiments would tend to show that the familiar fading which is so detrimental to amateur work is reduced, to some degree at least, by the

use of the under ground antennae, although more complete data will be necessary before this statement can be proved.

Underground wires are practical for transmission as well as reception when the transmitter used is one of the continuous wave type, which allows of a low aerial voltage. Experiments carried on between the Great Lakes Naval Radio Laboratory and a station in Chicago have shown that signals transmitted on underground wires are equal in intensity to those transmitted on any ordinary aerial, the only difficulty being the tendency of the underground wires to "ground" when any considerable voltage is applied. For this reason only

tube transmitters may be used with any satisfaction, although a low voltage quenched set was used in these experiments with fair results.

Aside from the experimental viewpoint, the ideal combination for an amateur relay station is that of an ordinary antenna (preferably of the vertical fan type) for transmitting, together with two sets of underground wires, each set comprising eight wires as outlined before, these two sets being of suitable length for 200 and 375 meter work respectively as given before. With such combinations in use in our important relay stations we can look forward to the day of year-round long-distance relay work.

The "V-24" Triode Valve

By John O. G. Cann *

THE old exasperating days of radio reception are past. We now have three element valves, or triodes as they are scientifically named, which have uniform operating qualities. This assures duplication of the performance of any valve by all of its brothers.

The "V-24" Valve has been given very little publicity up to date as its use has been more or less confined to professional work. Recently, however, it has been placed on the amateur market with gratifying results.

The main features of the "V-24" are its smallness, convenient shape for simple mounting; also, and more important, its stable operating qualities. No critical adjustments are necessary in either filament heating current or plate circuit voltage.

It is 3 inches in overall length, and, as will be seen from the photograph, has metal contacts which snap into spring contacts, making it possible to change tubes very easily and quickly.

As the name "V-24" indicates, the plate voltage is about 24. Used in a self-heterodyne circuit for undamped-wave reception, the plate circuit voltage may be anything from one to sixty volts.

However, no advantage is gained by using more than 24 volts; below this value a slight increase in filament current is necessary to maintain local oscillations.

The normal plate current at 24 volts is less than 5 milliamperes, therefore, as a power bulb this valve does not rate very

high. However, distances of a mile have been covered at readable strength, between similar one-valve sets using this valve as a "transmitter".

The filament connections are placed one at each end of the valve. The filament is about the same size as that used in the commercial 60 watt lamp, and is tungsten. One end is supported by a fine spring which applies enough tension at all times to keep it straight; thus the valve may be used in any position. Normal heating current is 650 milliamperes. Remarkably few of these valves burn out, as compared with older types.

The plate connection on one side is distinguished by a green mark on the metal contact. The other connection to the grid has no distinguishing mark.

What may be considered of special advantage in this valve is its operating characteristic, which is due to exceptionally careful design. It will be found that, for undamped-wave reception, no grid condenser is necessary, neither is potential control required. If, however, the grid-oscillating circuit is connected to the positive end of the filament, the set will oscillate feebly as compared with when connected to the negative end of the filament.

It is found that the simplest circuit is the best to use for undamped-wave reception, and also for spark reception, using the "reaction" or "feed-back" arrangement, as illustrated. The reaction coil, marked R.C., should be of about the same inductance as the grid-circuit inductance. The telephone condenser in-

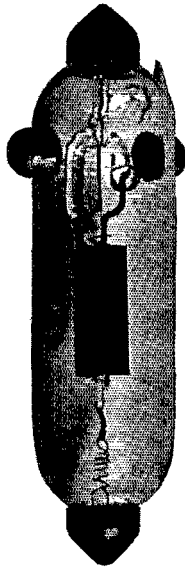

*Chief Engineer, Marconi Wireless Tel. Co. of Canada, Ltd.

creases the wavelength range of the circuit so much that it is worth while. The aerial circuit is, of course, ordinary.

Used as audio-frequency amplifiers, the "V-24" triodes will be found remarkably

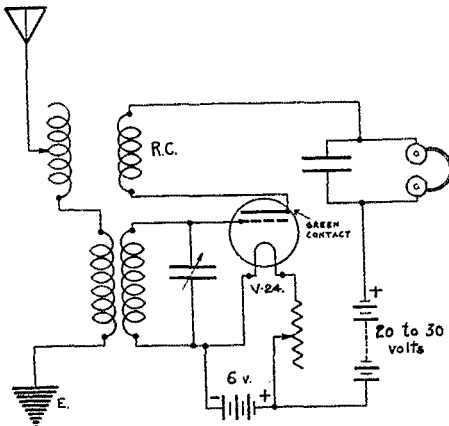

stable up to four in a bank; the addition of a fifth as a rule starts trouble, but no operator wants audio-amplification beyond a couple of stages.

As a radio-frequency amplifier the "V-24" is at its best. It gives wonderful stability of operation, and the uniformity of the valves renders possible the banking of hitherto unheard of numbers.

It is quite a common practice to use six radio-frequency amplifications, and sixteen amplifications are frequently used. By adding to the latter a detector and a four stage audio-frequency amplifier for megaphone use, we have twenty-one valves under control. It is surprising to note how simple is the control of such amplification, and all made possible by the little "V-24".

[Editor's Note: The V-24 was designed by Capt. H. J. Round, Chief Engineer for the British Marconi Co., to meet the critical wartime needs of the British in this field. It seems to be an indifferent detector and oscillator but a remarkably good amplifier, using negative potentials on the grid. It is in this field that American amateurs will mainly be interested in it. The V-24 has an extremely low internal capacity—so low that we know no reason why it should not make a satisfactory radio-frequency amplifier on amateur frequencies—something no American valve today will do. It is hoped that the V-24 can be made available in the States soon.]

Making a "B" Storage Battery

By Dr. L. G. Van Slyke

HERE is how to make a real storage battery for V.T. work at a cost of not over five or six dollars.

The battery has 20 cells, consisting of 1" x 6" test tubes. Make a rack for these, supporting them in four rows of five holes each, as shown at A in the figure, and boiling the wood parts in paraffine.

Next secure from a garage, where storage batteries are repaired, five positive and five negative battery plates, the best grade obtainable, also five wood separators. With a fine-toothed hack-saw cut these plates across the narrowest dimension into strips

as shown at B, taking care to preserve the lead grid with its contained paste undamaged. Some waste will occur, but each plate will make four elements, and it's more than worth it, for this battery is not approached by those employing formed plates and the nuisance of pasting your own plates is avoided. With a file smooth off the plates until they fit nicely in the tubes.

Then cut some lead strips about 4 inches long and as wide as the elements, and solder one end to a positive plate and the other to a negative plate, making 16 like

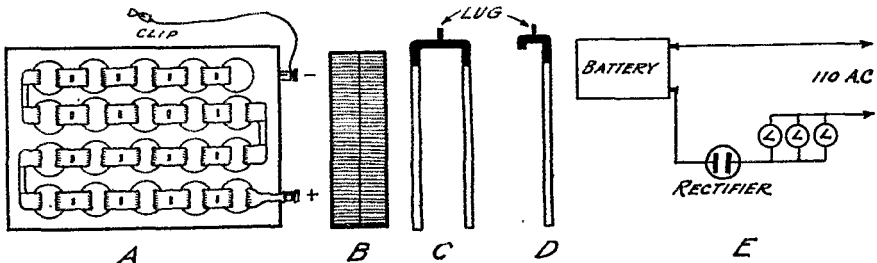

C, and 8 like D for the end tubes. There should be 4 positive and 4 negative plates like D. Assemble the cells in the rack, with little wood separators the width of the plates between the elements of each tube, and then connect the rows in series by soldering the positive end of one row to the negative of the next by small lead strips.

The battery is now ready for the electrolyte, which however, should not be placed in it until ready to charge. The electrolyte is a 10 to 20% solution of sulphuric acid, which may be mixed, bought from a garage, or, as the quantity needed is quite small, may be stolen with a hydrometer from a large fully charged battery. The tubes should be filled to within a half inch of the top, and charged at a rate, best determined by experiment, such that only moderate gassing takes place.

If D.C. is not available, the battery may be charged on 110 volt A.C. with a single-jar electrolytic rectifier as shown at E. Several types of these are available on the market, and their construction is generally

known to the amateur. Usually they consist of an iron and an aluminum electrode, or electrodes of lead and aluminum, in a solution of sodium phosphate. Such rectifiers fail to function when unduly hot, and so a sufficiently large one should be used to avoid overheating.

Remember that the positive pole of the charging supply goes to the positive of the battery during charge. After being on charge a short while the level of the electrolyte will drop, due to absorption by the plates. Fill again to proper level, and when fully charged melt some paraffine and pour a little on top of the electrolyte in each tube. Allow to harden and then with a hot piece of No. 12 wire make a small hole in the center to permit the escape of gas and to introduce distilled water to compensate for evaporation.

While this battery will hold its charge for several weeks, it is much better to keep it up near full charge by frequent "boostings"—short charges now and then.

The voltage may be varied in any manner
(Concluded on next page)

An Interesting Loop

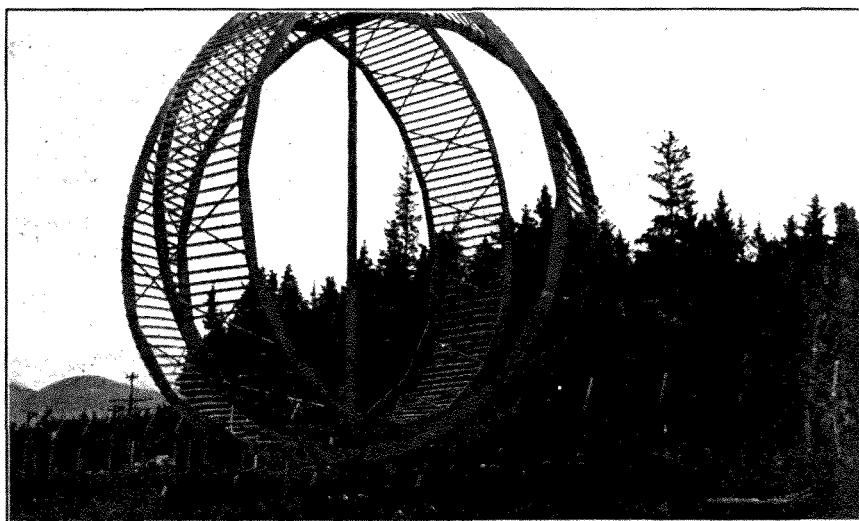

This loop was located at the Naval Radio Station at Otter Cliffs, Bar Harbor, Maine, and was designed and built by W. E. ("Bill") Woods of 9LC (and ex-9HS) fame, while stationed there, with funds furnished by Lieut. Fabbri, the Commanding Officer.

The outside loop was 22 feet in diameter, the inner one 20 feet, both were 4 feet wide, and each carried 14 turns of No. 12 insulated wire. Both were revolvable from the operator's booth while

actually receiving, and a swinging signal due to wave-front distortion could be followed by turning the loop. The inner loop was used as a static balance and many highly interesting experiments were conducted with it, including some data on whether or not strays possess directive qualities.

This loop was the wonder of the natives at Bar Harbor, and it is said they waited for days to see it "go around" like a Ferris-Wheel.

desired but I regulate mine by soldering a little lug of lead on the connecting strips as in C and D and having one binding post connected to a flexible lead terminating in a clip which may be snapped on to any number of cells desired.

I have 120 volts made up in this manner and they give complete satisfaction.

ROTTEN SPARK STUFF

(Continued from page 11)

and any one having had the advantages of a higher education in mathematics, as had been my good fortune, and also that of the Phone Man, knew that service wires thus exposed quickly lose their discipline and behave in divers scandalous manners

By this time I had seen enough. Ditto the Phone Man. So we returned upstairs, desiring to have Harry's mother hear our conclusions. With all hands assembled, I explained that the wireless station was fine—that was Harry's own—but the electric light end of the thing was rotten. They subscribed heartily. That it was like fooling around a powder magazine with a match, and that any minute not only would Harry be likely to go off in a puff of blue flame and never return to earth again, but most of this end of the town do the same, unless things were fixed.

The reference to Harry did the job. One of the things Mother was not in favor of was Harry leaving for parts unknown in a cloud of blue flame. She had not realized wireless was so dangerous. The rest of the town might take a crack at the journey, but if that was what was hanging over Harry, it were better that a halt were called until things could be fixed. I indicated that the authorities would probably have a few pointed remarks to make if the fire-works business kept up, and referred to the dejected gentleman who accompanied me from the Telephone Company. He thought the Telephone Company might have something to say

if the thing were not improved, as most of the town's phones had been out of commission for two weeks.

I suggested that it was also unhealthy to monkey with the fuzes and use thirties when the house wiring was only intended for sixes, and as for running the meter backwards, if the Electric Light Company ever got wind of such a thing as that, they would froth at the mouth. As for the paraffined annunciator wire, I made it plain that it was about on a par with lighting the kitchen stove with gasoline. Some real wiring by a real electrician was the proper way to attend to this, and if this wire were at right angles to the house lighting, it would cure the kick-back disease. All in all, it might be well if no more transmitting were done until the Telephone Company and the Electric Light Company had sent a man out to look the lay-out over.

Then we said good night all around, and little Mother smiled again and thanked us for stepping in at the critical moment and saving her boy from a flaming exit. She wanted to spend the rest of the night telling us about his wonderful talents, and how he was the centre of all things, a born leader, and took after her father, who built a patent umbrella out of kindling wood at the age of seven. When we got outside the Phone Expert heaved a deep sigh. With dreadful profanity he inquired if I could tell him what we were coming to anyway if kids could go on like that, flirting with fire, flame, and the public utilities. I told him he may have thought he had his troubles, but he did not know what trouble meant. Let him just try to operate a wireless station with a whole country full of just such ginks as that, and see how he liked it. That was what I had been up against for six months steady, and was there any wonder that I had formed bad habits.

(Concluded on page 40)

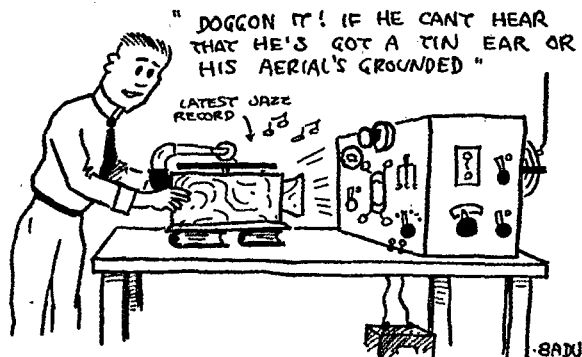

TRYING NOT TO APPEAR EXCITED
WHILE TRYING OUT A HOME MADE
WIRELESS CABINET ON A HAM
FRIEND ON THE NEXT BLOCK



Lost—A 1920 Summer Season

IT is hard to believe that such a thing could be lost, as the man said about his bath tub, but it certainly seems to have occurred. Up to this date, approaching July first, there is no sign of any summer season in amateur radio that we know anything about. We have searched diligently too, but when we put the phones on at night, it is very evident that things are going to be just as about as strenuous this summer as they were last winter. The usual summer season of bygone years is going the way of the crystal detector—discarded by all stations of the better class.

There are several queer things connected with this vanishing of the summer season. One is the surprising freedom from static on nights which you would swear would make working impossible. Some of the hottest days, with threatening-appearing clouds hovering around all afternoon long, we have found are followed by a night which is the equal of the finest winter nights. Usually it turns out that the static comes on around ten o'clock, and increases steadily until it is time to turn in, and then seems to disappear again about daylight, and remain away until ten o'clock again. This rule seems to follow with great regularity, and to represent average conditions.

Another queer thing is the amazing increase in signal strength from certain stations which have been either too faint to read all winter or not heard at all. It almost seems that some entirely new directional effects came into play at this season of the year. We can recall several stations in the First District which we could only occasionally hear faintly during the winter, which now come in so QSA they can be read easily with the phones on the table. And this with no changes at either transmitting or receiving station.

Still another queer one is the curious effects upon static of oscillating one's bulb at the ragged edge of oscillation, so to speak. There seem to be places where

static strength is materially reduced, and yet spark transmitters are still amply strong for reading. It makes a very pretty thing to play with, especially as it promises at any minute to uncover some discovery that may lead to fame and fortune.

And say, if this summer is to be as busy as last winter was, what will next winter be like? There is something to think about here.

The A.R.R.L. Emblem

SEVERAL months ago we solicited an expression of opinion on the subject of an A.R.R.L. Emblem. The response was instantaneous, and solidly in favor of it. Many were the designs and suggestions received, and from them we arrived at the device shown, which was officially adopted by our Board of Direction at its last meeting.

We all know that our Emblem must be chaste in design and color, distinctive, and symbolic of our work. These qualities, we feel, are well represented in this insignia, which is a diamond with slightly rounded corners, bearing in its corners the letters "A R R L", and containing in its center an elementary "hook-up" which is symbolic alike of transmission and reception, telegraph or radiophone, spark or C.W.—in other words, representative of us all.

This design will appear on everything A.R.R.L., but our immediate concern was a pin or button whereby one A.R.R.L. man might recognize another, and these our Board has arranged to supply, as stated in an advertisement elsewhere in this issue. In these, the design and border are in gold, and the background in black enamel—a neat and extremely good-looking insignia. Now we will know each other. As quickly as we can get these distributed they will become the sign of a Hail-Fellow-Well-Met in amateur radio—a Brother A.R.R.L. man.



Let us never forget the purpose for which we adopted this Emblem—that we may have a device for recognizing True Amateur Radio when we see it. May it ever stand for the highest in amateur affairs!

"C. W."

REPORTS from all over the country show the gradual but sure trend from spark to undamped in amateur radio, just as we thought would develop, and we are glad to see it.

We are very strongly in favor of C.W. transmission, and are going to do all we can to help it along. In previous articles we have discussed the advantages of this system, but we cannot think of all of its good points at once. It is wonderfully efficient, because the decrement is so extremely low and the energy all on practically one frequency; it is flexible, lending itself to three forms of transmission: C.W., modulated telegraphy, and telephony; it makes compliance with any contemplated radio laws a thing of ease; it is quiet; the potentials are low; it offers a most enticing field for the investigator; and we've never seen anything more entrancing to the experimenter. Another good feature is that it gives the isolated fellows a chance to get in the game—men who have been out of things because of the absence of a.c. or the inability to install their own generator for a spark set.

It has its disadvantages, too, but they are temporary in character. It is awfully hard to get hold of tubes, but this we may expect to straighten itself out soon. And it is not cheap. We can install quite a formidable spark transmitter for a hundred dollars and it will take two or three times that much to put in an undamped transmitter of similar range. The bulk of this expense, outside of the tubes, is in the motor-generator, and we believe it will be only a short time until some enterprising amateur discovers a cheap way of getting around this. And who said it had to be tubes? Not enough attention has been given the possibilities of the arc. Like every other such problem, when we amateurs take it up seriously and try hard to adapt it to our work, it will unravel itself. Another thing is that it takes a goodly amount of tinkering to get the results out of a tube set, because it is new ground for us amateurs. But wasn't that same thing true of the spark, and didn't we beat that game, and isn't this one going to be a more fascinating thing to take up and whip into shape for our needs?

We are on the eve of a great transition in amateur methods. We plead for the Undamped the serious consideration that its many advantages merit.

Daylight Work

ARE you getting in on this daylight work? If not, why not? It is good stuff. Do you know that daylight work is curing some dead-spot ills in various parts of the country, opening easy communication between points where traffic can never get thru at night? That QRM is very light then, because the total number of stations that can be open in daytime is small? That summer static is rarely bad before noon and that daylight work offers a wonderful opportunity to carry on communication over very respectable distances with no more QRN than we have on many a winter's night? And that QSS is at a minimum in daytime?

All of this is true. Those of you who are becoming disheartened by night after night of static, take a new lease on life—send out a CQ some lunch-hour or Sunday afternoon and get the jolt that is coming to you when you realize that there is "business as usual" and most of the old gang on the air, and that you've been missing it all. Don't forget the H-T-L Club; to join it, just sit in the first noon-hour you can, and let somebody know you're alive.

Legislative Affairs

FOR a good many months a large number of people have been working seriously on the matter of revising the radio legislation, both of our country and the International regulations. The matter is a very complex one, with many ramifications, including the coming International Communications Convention, the possibility of meeting of the Berne Convention, the study of the Allied Protocol dealing with communication, and several varieties of United States legislation designed for adoption separate from any of the international agreements. It would take a whole issue of QST to tell the story. We just want to say here that our Board of Direction is in intimate touch with conditions and, as always, actively at work in looking after amateur rights.

When the International Communications Convention meets, it will consider as a basis for new international regulation the protocol mentioned above, and for some months past the Department of Commerce, the section of our government most concerned in the enforcement of radio law, has been carefully studying this document to determine what changes are necessary to adopt it to the needs of our country. For this purpose the Secretary of Commerce has appointed an advisory committee of the best technical radio men in various branches of the art, and on this committee sits Mr. Charles H. Stewart, of

St. David's, Pa., member of our Board and Assistant Manager of the Atlantic Division, an old-time amateur with worlds of experience in the various legislative moves which have been up before, as representative of Amateur Radio. This insures us excellent representation, and we here acknowledge our gratitude to Mr. Stewart for his hard work and splendid effort.

Most of us do not realize the extent of the progress made in radio in the last few years; but, important as that is, we do not believe it a circumstance to the great advances which the next few years will see inaugurated in a practical way. This makes imperative some improvement in the present radio regulations, and we amateurs, in considering our rights under the law, must not lose sight of the fact that radio is being put to many more uses every day and that the rights of others have to be considered as much as ours. We must not oppose progress, and to adopt an unreasonable attitude on the question would not only get us nowhere but probably would prove fatal to our future. We believe we may expect that new legislation will be a little more strict; a little tightening in the decrement, which goodness knows it will stand; probably a little closer definition of our wave lengths. But we may be sure that we are being adequately provided for, because our government knows our worth to the country, we are represented on the bodies considering the question, and we have been treated with consideration all along the route.

Write Something

WHY don't some of you fellows write more about some of the interesting radio engineering data you collect? Every once in a while something drifts into the office about what So-and-So is doing or has done, and we just hanker to know more about it but never have this hankering satisfied. The opportunity is simply great, and you chaps who have done things make a great mistake in not taking the trouble to write it up and have it published. Not only would it be helpful to all your brothers interested in the same problems, but it would establish your name. There is a lot of prestige accompanying a good technical article, and it is surprising how few of them it requires to place a man upon a firm foundation as an authority upon the subject he covers. The only trouble is that most of us feel a little modest about it. Forget this modesty only once, write something covering some subject you have thought about, and the trick is turned. It will not be hard to write another and another, and

it will develop you mentally in a way you would not believe possible. We do not think we ought to pay each other for writing for QST, and so do not expect any cash return. It is part of our mutual scheme to throw everything into the common pot, and it has worked in everything we have done and it will work in these articles. So, sharpen up that old pencil, you fellows who have done things, and write us in something. It will be the best investment you ever made.

Date Your Messages

IT may be all right to shoot the "Greetings by wireless" stuff through without any date, but, fellows, we hear many messages go through which really ought to carry a date. It really is not much more work to put in the month and date right after the place of origin, and when the message arrives at its destination it means more and reflects more credit upon those who handled it. The class of message traffic we are handling now is very much different than it used to be, and many times we know that the one sending them places full confidence in their prompt delivery, because they specify meeting places and arrange understandings which might result in great inconvenience if the messages failed of delivery. We always do our best to get this kind of message through, but there are times when it is impossible to move one. The thing to do then is to forward by mail, noting upon the blank that no relay was obtainable beyond your station and that message was forwarded by mail to avoid delay. That is the kind of thing we would respect in the other fellow, and so let us command respect. Our message traffic is one of the forerunners of a great development in citizen communication, and thanks to the splendid work our Traffic Organization has done, we are looked to as the logical people to carry it forward. Let us therefore do everything we can to do a good job, and make the handling of our message traffic something which will compare with the best that is done anywhere, whether paid for or not. The first step to make our service more valuable is to date our messages as called for in the Operating Department regulations.



THE OPERATING DEPARTMENT

J. O. SMITH
Rockville Centre, L. I.
TRAFFIC MANAGER.



FROM present indications it would appear that the word "season" is no longer a part of amateur radio. At this writing, middle June, traffic is being handled over the various trunk lines in a volume equal to that of midwinter of many former years. True, static is with us to a certain degree, but it seems to be somewhat less than usual in many sections, but while this condition has contributed in large measure to the continuance of relay work into middle summer, a greater factor is increased efficiency. The average amateur installation, in both transmitting and receiving, is much superior to what we had before the war. The general adoption of regenerative receiving sets has done much, both in increasing the receiving range and in demonstrating that the signals of a sharply-tuned transmitter can be amplified to a greater degree by regeneration than is true of a broadly-tuned transmitter.

The long-heralded change from spark to continuous-wave transmission is now in full swing, and in quite a number of cases spark sets have already been discarded. The surprising results achieved with C.W. make it apparent that about 100 watts of C.W. energy in the antenna will do just as effective work as a full kilowatt of the damped product, and the flexibility of the former, allowing it to be used as straight C.W., modulated C.W., or as a radiophone, certainly gives it highly desirable advantages over spark transmission.

It is more than probable that at some time in the future it will become necessary to somewhat curtail the latitude now allowed spark transmitters, simply because of the ever-increasing degree to which radio communication is expanding. New regulations will probably be rather drastic, and will require a very careful adjustment of the transmitter to comply with them, but the use of C.W. will make compliance a comparatively simple matter. This is just one more advantage of the undamped.

Amateur radio is now in transition from spark to C.W., and a complete change-over is merely a question of time.

Reports from the Division Managers follow:

NEW ENGLAND DIVISION Guy R. Entwistle, Manager

The Division Manager is certainly encouraged by the reports from the various relay officials. The newly-appointed men have taken to the work with results that can be determined from their respective reports. The D.M. took a trip to 1YB, Dartmouth College, and lived like a king for three days under the careful eye of D. S. Hayes. 1AW, 1HAA, were worked and several DX stations were copied. Radio Inspector Gawler will inspect in that district soon and talk to the club members on tuning.

Asst. Division Manager Castner reports commendable work by 1KAY during the past month in working 8BB in Plattsburg. This is surely an important jump as it is only a short distance to Montreal from 8BB. Pomeroy, 1CAO, of Bath, has accepted the care of that section. The present trunk line from Boston is 1CK, 1RV, 1EK or 1KAY, 1FV, 1CAO, 1BK, on to Holton and Bar Harbor. E. T. Stubbs of Sanford, Maine, is erecting a fine 1 K.W. station. Fred Grindle, Chief at NBD, is going to put a ½ K.W. set and will make good material in that section.

Superintendent Hayes, of Northern New Hampshire, reports a quick change-over switch has been installed for the two waves 200 and 375 meters. Radio Inspector Gawler will talk on tuning and incidentally try out one of 1RN's new fish rods. Perhaps 1RN some day will get out a collapsible antennae mast resembling a fish rod, which all of us can try out.

Have published an article in eight papers telling about the A.R.R.L. (New England relay men please note and duplicate if possible.)

Superintendent McLane writes from Laconia, "Some traffic has been handled from Laconia to Concord and from there to 1OE and 1IT. Our big need is a station that can do some real relay work located in Manchester or Nashua". He adds to the peculiarities prevalent in this district in reporting both he and 1YB able to hear each other work 1TS or Boston stations, while often not able to work each other, and only fifty miles away.

1BH, Hardy, District Superintendent, reports traffic moving thru Northern Massachusetts, and regular schedules with 1HAA, and 1CK, 1EK, 1RY, 1KAY. He is developing to the westward and wants to hear from amateurs in that section.

Pulley has new laurels added to his list. His new appointment as fading assistant and analyst will keep him busy tabulating and studying the collected data on the QSS tests.

Robinson, Traffic Assistant, has done a little literary work so we have the following: With the coming of summer the distances between the stations will have to be made shorter. The line thru Eastern New England can be worked in daytime and is good for all summer. The problem of getting a message to Western Massachusetts is one that should have a solution. Springfield can only be reached by a round-about way and is then uncertain. 1RV, Carl Ricker, is a very welcome addition to our relay route. 1HAA has acquired a rotary gap and is much easier to copy. 1TS has also blossomed out with a rotary which is an improvement. 1TS and 1AW seem to have a reversible action. On nights 1AW comes in, 1TS disappears while the reverse is true other nights. Robinson worked 2ZL (C.W.) the 22nd, signals QSA. The C.W. signals waver somewhat but after getting used to the quivering note are O.K.

Assistant District Manager Mix of Bristol reports that District Superintendent Nichols, Bridgeport, states that traffic is slowly but surely on the gain. 1BM is QSO 1QN in New Haven who is QSO 1TS and 1FQ, and also working 2ZL and 2FS, C.W. sets. 1QN and 1FW have been appointed official A.R.R.L. stations. Springfield is the weakest point between here and 1CM or 1YB. Amateurs in the following named cities should report to 1TS for appointment in a new relay route: Coventry, E. Greenwich, R. I.; Norwich, Conn.

One significant fact that stands out as inspiring is the gradual C-W-izing of New England. The following have C-W sets: Wood, Arnold, Winchester; 1CK; 1XF, Providence; Mass. Radio School; 1YC; 1AY; 1QP.

ATLANTIC DIVISION

C. A. Service, Jr., Manager

Contrary to early indications, relay work in the Eastern part of the United States and especially in the Atlantic Division, has experienced a decided turn for the better, and long distance transmission has been unusually good for this time of year. Messages are being handled with little or no delay between the larger cities along the main Trunk Routes and

whatever delay is encountered is due more to the absence of operators at their stations than to bad relay weather.

However, we do not know how long it will be till QSS and summer static will get the upper hand, which again brings us face to face with the necessity of developing daylight routes. From New York southward to the Roanoke Division, this seems a possibility through New Jersey, as stations along the coast are able to clear New York fairly reliably, 3NB at Vineland can work the Coast and Philadelphia stations daytime and if Mr. Horn, District Supt. for Delaware, gets his station, 3PM, Rehoboth, Del., in communication with the Jersey stations, we feel that the rest of the route south will work itself out.

At the time of writing this report, the Division Manager has not received the complete details of the A.R.R.L. Division QSS tests which are to be carried on simultaneously with those of the Bureau of Standards, but later issues of QST will have all this and also the final schedules, so that every reader of QST will be familiar with this most important work before the commencement of the tests. The Division Manager cannot urge too strongly that all A.R.R.L. stations in his Division co-operate in taking observations and forward their reports to him for analysis. Further details will be given elsewhere in QST. If any information or advice is desired, the Division Manager stands ready to supply it to the best of his ability; suggestions are also welcomed.

When long distance relay work is cut down on account of QRN and QSS, it is a good opportunity for many of us to turn to improvement of our sets in preparation for next season. The Division Manager has made pilgrimages to several leading DX stations and almost without exception, there was room for great improvement. One station in particular, was a marvel of useless leads, poor connections, and old style apparatus. He gets there, but we suspect he would travel about twice as far if more care were given to details of correct design and the elimination of unnecessary parts.

Mr. C. H. Stewart, Assistant Division Manager, Southern Section, reports that there has been a continued improvement in the operation of transmitting sets in this Section during the past month, and in spite of the fact that atmospheric difficulties are encountered, stations in the Western part of the State of Pennsylvania have been heard in the Eastern part of the State, and vice versa, and some relay messages have been handled through to the West. However, there is much room for improvement, but what is most needed to bring this about is not so much more efficient operation, but additional relay

stations available to bridge the longer gaps which at present exist.

The report of the District Superintendent for Western Pennsylvania, Mr. R. C. Devinney, of Pittsburgh, shows encouraging progress, and he reports that the number of messages handled by the various official relay stations is greatly in excess of the number handled during the previous month. The Radio Inspector for that district recently held examinations in Pittsburgh, and Mr. Devinney states that all of the official relay station operators appeared for their examinations. Mr. Devinney also reports that at a banquet recently held at New Castle, Pa. a new club was organized, called the Eastern Ohio and Western Pennsylvania Amateur Radio Association, and the following officers elected: Rev. A. J. Manning (8DA) President; Paul Riley (8CH) Vice President and R. H. McConnell (8ADF) Secretary. Two of the above are station owners on Branch Line No. 3.

Mr. Devinney says that the situation as a whole is very encouraging, and that the work on Branch Line No. 2 is exceptionally good, the distances on this Branch Line being short enough to make daylight work an everyday occurrence, the operators working under a regular schedule, and traffic is being handled from Uniontown to Erie within a half hour.

Mr. Herbert M. Walleze, Traffic Assistant, who, in the absence of Mr. Cawley, is also acting District Superintendent for the Central Pennsylvania District, reports that some messages have been moving in his District, and that while conditions appear to be promising, the results are far from satisfactory to him, due to the lack of two or three necessary stations. Mr. Cawley, District Superintendent for this District has sailed as operator on the S/S "National Bridge" for Chile, and will be away for several months.

Marcus Frye, District Superintendent for New Jersey states that reports from Official Stations indicate that the traffic handled for the past month has narrowed down to the usual summer volume. For a period of about two weeks beginning May 3rd, an abnormal amount of long distance work was carried on, considering the lateness of the season, but outside of this, very little consistent long distance work has been done.

Branch Line A, (Philadelphia to Sea Shore Resorts) is in active operation, day and night, and it is hoped this condition will obtain thruout the summer months. Tests will soon be started to try to get the shore resorts in direct touch with stations in Philadelphia and vicinity.

The Radio Inspector has just completed a tour of all licensed stations in this district and, with few exceptions, has

found that the owners have made every effort to obey regulations, with regard to decrement and wave length.

Stations on Long Island, especially 2ZL, report signals from shore resort stations as being steady and readable both day and night. Tests will be carried out in order to try and open up a daylight route from New York City to Philadelphia via coast stations down to Ocean City and thence across Branch A to Philadelphia and vicinity. This will be a very useful route if once established.

Assistant Division Manager John DiBlasi reports that a combined "QRM" meeting of the East Side Y.M.C.A. (New York) Radio Club, and the Radio Traffic Association of Brooklyn, was held on May 13th. A set of rules and regulations regarding QRM was drawn up and copies are to be distributed to all amateur stations in the Second District.

W. T. Fraser, District Superintendent Western New York, reports that tests with Toronto, Ont. were very satisfactory. No trouble was experienced in working them, but since navigation has opened they are allowed only 50 meter wave length.

It is possible to work 8XU (Cornell University) any night. Rochester is worked occasionally. Any business for Buffalo should be sent via 8XU.

ROANOKE DIVISION

W. T. Gravely, Manager

The good old summer days are at hand, and with them have come the Chinese signals, static, but thus far, there has been little, if any, cessation of long distance operation by the amateurs, and the relaying of messages continues. Developments in this Division are splendid, and the organization is being perfected as rapidly as possible. All of the District Superintendents have been instructed to develop daylight lines all over the Roanoke Division, but as yet, we have a long way to go before our ideals, in this respect, may be realized. Yet the vision is ever present, and the materialization of our plans is an assured fact.

I am thoroughly in sympathy with the Staff's ideas of short jumps, and am hoping the lines may be worked out on this plan.

With the ever increasing number of stations, the jam becomes worse and worse, and the need for lines with stations linked up closer becomes more evident each day.

District Superintendent C. D. Blair, 3HO, Richmond, Va., reports satisfactory progress in the Central Virginia District. He states that he will soon have a line in operation between Washington and Richmond, and between Richmond and Danville, and also between Richmond and the Seaboard. Mr. Blair is an enthusiastic worker.

Mr. L. C. Herndon, 3FG, Portsmouth, Va., District Superintendent Seaboard, or Eastern Virginia, reports satisfactory progress. He states that the amateurs in his district are well organized.

Mr. T. C. White, Jr., 3EN, Norfolk, Va., City Manager, Norfolk, makes quite a lengthy report, which is very gratifying. He states that he and 3FG have been handling practically all of the relay messages in that district thus far, and that they will continue throughout the summer.

Mr. White attended the Convention in Philadelphia, May 8th, of the Third District radio amateurs, and is very enthusiastic over the meeting.

Mr. Jno. F. Wohlford, 3CA, Roanoke, Va., District Supt., Southwest Virginia, is spending a great deal of time on his lines. He will, personally, visit a number of points during the summer, and make effort to secure good stations at each. He says prospects are fine.

Mr. Jas. T. Moorhead, Jr., 4CC, Greensboro, N. C., District Supt. North Carolina, has his station in operation now, and we hope to have interesting news from him in his report.

Mr. A. G. Heck, 8EF, Mannington, W. Va., District Supt. Northern W. Va. will work, in conjunction with Mr. Jno. F. Wohlford, Roanoke, Va., toward opening up a reliable route between the two points. 8EF is sifting through the ether these sultry nights. He can be heard pounding away, manfully, quite often.

Will those interested in relaying, who live in the Roanoke Division, please get in touch with the various District Superintendents as speedily as possible? Let those interested come forward. Don't wait to be hunted up.

CENTRAL DIVISION

R. H. G. Mathews, Manager

During the past month the Division Manager has been very much pleased at the evidences of the continuance of long distance work throughout the summer season. From the results which have been obtained it would appear that the accomplishment of summer relay work depends entirely on the "sticktoitiveness" of the operators of the relay stations. Traffic with the East coast has been carried on regularly either direct from 9ZN to 3NB or by relays through 8ER or 8DA. The experience of handling these tests has shown that signals are coming through about as well as during the winter, the fading being even less, the only difficulty being due to static, and with modern improvements such as ground wires and loops this is not giving a great deal of trouble.

Excellent traffic work is being handled on the Lake Shore Route and on the route through Southern Illinois, as well as on

the Eastern trunk, but considerable difficulty has been found in forwarding messages West to and beyond the boundaries of the Central Division, this difficulty being mainly due to the fact that a great many of the stations have been closed for the summer. In this connection the Division Manager wishes to urge the operators of all such stations to give summer work a trial and it is believed that some surprising results will be secured which will convince them that a shut-down in summer is not necessary.

The station of the Central Division Manager has been equipped with a 2 k.w. 500 cycle Telefunken panel quenched set which is now in operation on wave lengths of 200, 250 and 375 meters, in addition to the old 2 k. w. non-synchronous spark set. The new panel set is the property of Mr. H. E. Rawson, formerly of 1RN, who is now located in Chicago but unfortunately is so situated that the erection of a station of his own is not possible. Mr. Rawson has very kindly loaned his set to the Division Manager for use in connection with the relay work in the Central Division.

Mr. Burhop, District Superintendent of Wisconsin, reports the continuance of relay work in his territory, and from the quantity of traffic passing through Chicago to and from Wisconsin, it is evident that his report is founded on facts. Mr. Burhop, together with the members of his Lake Shore Route, deserves great credit for the snappy manner in which Wisconsin traffic is being handled on Sunday morning schedule.

Mr. Darr, District Superintendent of Southern Michigan, reports that traffic is being handled in his District in short jumps and that no difficulty is being found in covering the lower part of the state in daylight. He reports that many of his stations are experimenting with continuous wave sets and hope to overcome summer difficulties in this way. We are very glad to see that considerable organization work is being done in Mr. Darr's territory, this being evidenced by the fact that a number of new radio clubs have applied for affiliation with the League.

Special fading tests will be run by the traffic department of the League, and a schedule, which will appear elsewhere in QST, has been prepared for this Division by which a number of the more prominent long distance stations will transmit at different times on different dates their signals being checked by receiving stations throughout the Division. Mr. F. H. Schnell, 2220 Roscoe street, Chicago, has been appointed Special Fading Assistant for the Central Division, and it is requested that all operators of receiving stations in this Division make careful note of the schedule of

the transmission of the fading tests and submit reports to Mr. Schnell. In order to make this work a success we must have the cooperation of every station in the Division, and we wish to impress upon the operators of all relay stations the necessity for active participation in this work.

Mr. Duerk, District Superintendent of Western Ohio, has found it impossible to keep up his work in his territory during the summer because of the pressure of other business and accordingly Mrs. Candler of 8ER has been appointed Acting District Superintendent of Western Ohio.

Mr. Ball, District Superintendent of Eastern Ohio, has accepted a position which requires his absence from his territory during a greater part of the time, and accordingly has requested that he be relieved and therefore Rev. A. J. Manning of Salem, Ohio, has been appointed District Superintendent of Eastern Ohio, relieving Mr. Ball.

A very gratifying evidence of activity in Northern Indiana has been shown of late, Mr. H. H. Moore of Elkhart and Mr. Hutchinson of Middlebury having under way the formation of the Northern Indiana Radio Association with the idea of organizing an operating route between Chicago and Ohio, passing through Elkhart, Middlebury and other Northern Indiana towns, insuring daylight communication between Chicago and the East. The Division Manager wishes to call the attention of all radio stations in Northern Indiana to this organization work and requests that all such operators get in touch with either Mr. Moore or Mr. Hutchinson at the earliest opportunity to participate in their work.

MIDWEST DIVISION

L. A. Benson, Manager

There has been very little traffic work handled in this Division the past month due to the continued queer weather conditions.

Mr. J. A. Fritz, St. Louis, District Superintendent Eastern Missouri, reports that he has been communicating with Mr. Turner, District Superintendent Western Missouri, regarding a route to Kansas City via Columbia. Mr. Corwin is at Columbia U. and expects to have a station working in the near future. He also reports a station at Sedalia and Lamoni that could be used to some advantage in the daylight relays. Mr. Fritz is working hard to build up his territory.

Mr. Turner also states that operating conditions in his territory have been very unfavorable lately. To keep the interest from lagging they have formed the Missouri Valley Radio Assn. with a large membership and a considerable sum in the treasury. C. Goddard of Shawnee, Kansas, ex-Navy man and late operator of

9ZK, is Chairman. This association has applied for affiliation with the ARRL and every member is a member of the league. He reports a bunch of live wires at Sedalia also got together and organized a Club which is now 100% in the League. A station at Holden is being erected and will be on for long distance soon. 9EX and 9FL of St. Joseph have been doing excellent work the past season. Mr. Turner is busy lining up a day light route across the state.

H. L. Owens of 822 East Main Street, Council Grove, Kansas, has been appointed District Superintendent Eastern Kansas, succeeding B. K. Trump of Topeka, who is at present located in Phoenix, Ariz. Mr. Owens requests all stations in his territory to get in communication with him, giving their sure daylight range, description of set, and hours they can work.

P. A. Stover, District Superintendent Iowa, reports that although QRN has been terrific it is still possible to get messages through to the western portion of his territory (that is to Des Moines) thru all four routes across the state. At the present these routes are as follows: Galesburg, Ill., Washington, Ia., Ottumwa, Des Moines or Lamoni. Clinton, Ia., Iowa City, Marengo, Des Moines. Dubuque, Oelwein, Ames.

North and South route as follows: Oelwein, Marengo, Washington, St. Louis. The route thru the southern part of the state runs from Lamoni to Council Bluffs or Omaha.

So far in May there have been three nights when 1AW was copied and on the same nights several other eastern stations were heard.

Mr. Stover is proud of the fact that he has induced all men composing his respective routes to become members of the ARRL. He has appointed Mr. G. R. Hammond, 9ZQ, 219 5th Ave., So. Oelwein, Iowa, as Assistant District Superintendent.

J. A. Wanek, 9IF, of Giltner, Nebr., has been appointed District Superintendent of Western Nebraska, and K. V. Nyquist, 9AFX, of Stromberg, Neb., his Assistant. Mr. Wanek reports that stations in his territory are rather scarce and practically all west coast traffic has been handled thru 5ZA direct. Traffic to Kansas via 9DU and 9RP is very uncertain at present due to fading in this section. A good station in western Kansas is badly needed. Stations in South Dakota are very steady and little difficulty is experienced with fading. On April 30th conditions were as favorable as in the middle of winter and 8ER was more QSA than any time during the past winter, and caused considerable QRM here.

John G. O'Rourke, 6406 Maple St., Omaha, Nebr., has been appointed District Superintendent Eastern Nebraska and Mr. Bullis, 9SC, his Assistant. Interest seems

to be entirely lacking in the northern part of this section and he would like to get in touch with reliable stations in the following towns: Norfolk, Niobrara, Fremont, Wayne, Columbus and Pender. Efficient stations are locating at Plattsmouth and Oakland.

DELTA DIVISION J. M. Clayton, Manager

Although regular summer QRN and bad radio weather have set in in this division, considerable work is being done thruout the division. No longer is the Early Morning work a novelty. Some few messages are going thru during the early morning hours, especially from the extreme southern stations of the division. By sticking it out till the "G. M." hours of night, traffic can even go through nightly except when the conditions are very bad.

It is with particular regret that the announcement comes from Mr. de Ben of New Orleans that he is leaving the amateur game temporarily at least. Mr. de Ben has left for the "deep blue" as a commercial operator. It is hoped that he pulls down some DX commercial work while his commercial experience is being had and when he comes back to the amateur game he will continue to "run" 5ZP in the record-breaking manner he used to operate it.

Mr. W. L. Barrow, of Baton Rouge, La., has been appointed Acting District Superintendent for Southern Louisiana. Mr. Barrow operates efficient 5EA and is a live wire at organization.

The Division has been particularly fortunate in securing the services of Captain N. L. Baldwin of Camp Pike, Arkansas, as District Superintendent of Arkansas. Captain Baldwin is the operator of station "XA3" at Camp Pike and has, even in this tropical Arkansas weather, done some excellent work using a 1 KW Acme on ½ KW. His radio experience dates back a couple of centuries and naturally he is a dyed-in-the-wool "ham". He is a live wire right, so some of you Arkansas fellows who are still in the backwoods come forward and get lined up for relay work.

If we had a few stations outside of Little Rock in this state we could do some daylight work. As it is now the nearest thing to us is St. Louis or Dallas, and both of those are a bit too far away for daylight work. Let's hear from some of the Arkansas fellows, if there are any of you.

Professor W. L. Kennon of 5YE continues to pound in all thru the division. Professor Kennon is lining up the stations in his state for some fine relay work next season. All the men in Mississippi who are interested in securing trunk line ap-

pointments will do well to get in communication with 5YE at once.

Mr. F. B. Beuhler, 919 Beauregard Street, Alexandria, La., has been appointed District Superintendent of Northern Louisiana. He seems to be the most enthusiastic amateur in the northern part of the state. He has been doing some very good work on his ½ K. W. set.

Mr. W. T. Hutcheson, 5DA, of Wind Rock, Tenn., has been appointed District Superintendent of Tennessee. All amateurs in Tennessee who are interested, please get in touch with Mr. Hutcheson. It is particularly regretted that the League has never had a station in Memphis. Certainly a city of the size of Memphis should boast of several DX radio men. Traffic has gone into Memphis via the Uncle Sam route ever since 5XC ceased to be.

Relay work has gone on further in the season this year than it has ever done before. Whether this is due to freak summer weather or increased efficiency in the stations down here, the writer is not prepared to say. It is to be hoped that the latter is instrumental in the length of this season. More probably it is a combination of fair weather and more efficient stations. However, it is a fair certainty that when summer radio weather DOES set in down in the south, relay work will be absolutely limited to those stations who are in daylight communication with each other.

Central Division Manager Mathews reports that he can get messages thru his division to St. Louis even in daylight. It is now the problem of this division to get them along from St. Louis south.

All amateurs in this division who haven't written the relay official in their section, will profit much by doing so. There are any number of vacancies on all the trunk lines going through this division.

WEST GULF DIVISION Frank M. Corlett, Manager

The Summer electrical storms which have always visited this section of the country must have held a convention somewhere in this vicinity with an unusually large attendance. ***\$?!@!\$*!!!@! That is about all one can hear if he attempts to listen in of an evening and it must have frightened all the relay stations so badly they are afraid to make a daylight try of it, for the District Superintendents all report that it is almost next to an impossibility to maintain a daylight schedule for the simple reason that the gang will not be at their sets. For those that have not tried it, they don't know what they are missing. It certainly is great to shoot the stuff over to the next station and hear him give it to the next, etc. As an example of what can be done, one afternoon recently, Pilot

Point, Texas, 5CD, gave Dallas, 5ZC, a msg at 2:40, 5ZC received a QSL from 5ZJ at Waco at 2:50 and 5ZU at Austin receipted for it at 2:55. Traffic moved off several hooks that afternoon and it proved that traffic can be handled throughout the division on a daylight schedule when stations are operated.

The Northern Texas District, Raymond L. White, Box 322, Ennis, Texas, in charge is making progress along organization lines. Mr. J. L. Martin, 605 East Fourth St., Amarillo, Texas, has been appointed Asst. Dist. Supt., and assigned the Amarillo Texas Territory, consisting of the following counties:—Dallam, Hansford, Hutchinson, Carson, Armstrong, Ochiltree, Roberts, Gray, Donley, Lipscomb, Hemphill, Wheeler and Collingsworth.

Clyde S. Mosteller, Pilot Point, Texas, has been appointed Assistant District Superintendent, and assigned the counties of Cooke, Denton, Montague, Wise, Parker, Clay, Jack and Palopinto, to be known as the Pilot Point Territory.

Mr. H. P. Heafer, 5AJ, 2603 Hibernia Street, Dallas, has been appointed City Manager of Dallas. He reports that in spite of the "Summer fire works" everything seems to be getting thru O. K. Mr. Heafer is working up a traffic schedule for the City and the near-by out of town stations and will be ready to give the details in next issue of QST. Despite the fact that the "bad season" is with us, the members of the Dallas Radio Club are still sticking it out and a good attendance and much interest is being shown at the regular meetings. Mr. T. G. Deiler, U. S. Radio Inspector from New Orleans, conducted examinations for both amateur and commercial grade licenses at the club's headquarters in the Y. M. C. A. here on the night of May 24th. About fifteen took the examination. Mr. Deiler stated that he expected to make another trip through Dallas about August and that all holders of amateur second grade licenses would be expected to appear for examination for amateur first grade. Those failing to appear for examination would have their second grade licenses cancelled.

The Southern Texas District, in charge of W. H. Tilley, 5ZU, reports that Austin works fine with Waco when Waco can meet the schedule.

An unknown station in Beaumont recently sent word to Austin amateurs by a visitor to listen on 400 meters for "W W". It seems that there is a law somewhere that says 200 meters is the limit and that a license is necessary before using a transmitter.

New Mexico District, Louis Falconi, District Superintendent, has not been heard from this month either by mail or radio so we take it that Old Man Static has just about isolated 5ZA. Don't let him bluff

you, 5ZA, there is a station "coming up" at Amarillo and before long we hope to work you during daylight, via the shorter jump plan.

Captain B. H. Mills, Post Field, Fort Sill, Okla., expects to help us out on Trunk Line "F" with a 1 K.W. 500 cycle set soon. Captain Mills is ex-2BF. We are glad to have him with us, and goodness knows Trunk Line "F" north of Dallas needs him bad. We 5's welcome you, Captain.

DAKOTA DIVISION R. H. Pray, Manager

There has been very little long distance work in this Division the past month as strays have generally been so bad after sunset that even local work has been difficult. However, there have been three nights without a sign of static with the distant stations coming through. 9ZX has handled traffic direct with Illinois and Iowa stations. There is no doubt that a large amount of message traffic could have been handled on these three nights BUT there were only a few stations on to take advantage of it. Of course it is not to be expected that anyone would sit in when there is bad QRN but if every one could listen in for five or ten minutes every night it would be possible to tell how much can be done and things could be kept moving until it is possible to get some "short jump" routes working. By "short jump" I do not mean it as they do in the more crowded parts of the country. A "short jump" in this Division can mean anything up to 100 miles.

The progress in summer routes has been very slow because of the scarcity of stations of any description. The local routes of the North Dakota Radio Assn., are practically all in working order and Mr. Boyd Phelps, Traffic Manager of the Minnesota Wireless Assn., is organizing a route that will connect with an N. D. R. A. route at Fergus Falls, Minn. It would help a lot if all the stations in Minnesota that will be able to take part write Mr. Phelps in care of the Minnesota Wireless Assn., 416 Court House, Minneapolis.

Mr. J. A. Gjelhaug, of 9ZC, Superintendent of the No. Minnesota District, is working hard at early morning tests and reports that he hears Winnipeg, JWD, QSA in daylight, so that no trouble is expected in handling traffic into Canada in the future.

Mr. E. S. Leavenworth, North Dakota District Superintendent, reports the forming of a radio club at Ellendale which has applied for affiliation with the A.R.R.L. Ellendale has another good station now with the call 9EE. Ellendale should be able to do its part with two such good stations as 9WU and 9EE.

We are still trying to organize daylight routes to all parts of the Division. We can do nothing unless every one will do his part. So will everyone with a station in working order this summer please write his District Superintendent telling him what time he can be on during the day.

NORTHWESTERN DIVISION

John D. Hertz, Manager,
Royal Mumford, Acting Manager,
Vancouver, Wash.

This announces the beginning of the recently created Northwestern Division. We feel that we have received the reward of our increasing activity in behalf of the A. R. R. L. Considering the scarcity of stations, remarkably good work has been done. The distance from Moscow, Idaho, to Los Angeles has been covered in one jump. Regular A. R. R. L. traffic has been handled direct from Portland to Los Angeles during the favorable months of the year. And a northern route has been opened up to the east. The work east was uncertain, to be sure, but once established the route is sure to grow more and more dependable.

Now it is noticeable that extremely long distance work is slowing up. The shorter and more dependable jumps are coming into prominence. These jumps are of necessity becoming smaller and smaller. A chain of short jumps necessitates a number of indispensable stations. We will soon see the time when relay work will be impossible without perfect organization and whole-hearted cooperation. We cannot make individual records; but we can make a record for the A. R. R. L. by establishing dependable communication under adverse conditions. We are justly proud of the A. R. R. L. and we will be proud of the records we help it to make.

John D. Hertz has been appointed manager of our new division. We know 7ZB as "The one who made 'em hear him". We will all be glad to have him with us again in the fall. As he is spending his summer vacation as a commercial operator in Alaska, the work in this division will be carried on by Assistant Manager, Lester E. O'Brien, 709 S. 10th St., Tacoma, Wash., and myself. We are in need of more activity and representation in Idaho and Montana. I am sorry that this part of the division is not covered more completely, but every effort to locate someone to represent that district has been of no avail to date. If anyone can help, let him be heard from.

Montana State College, Bozeman, Mont., has a full fledged station in operation. No data regarding its call or wave length is available at this writing, but college news will be broadcasted every Friday evening at 8 o'clock. Here's wishing the best of success to their Electrical Engineering department.

Relay work north and south has been cleared in spite of the rapidly growing volume of strays and increasing audibility of high tension QRM due to dry weather. At least six stations 7AD, 7YS, 7CR, 7BP, 7CW, and 7CU are working south over the static with more or less success. Except for temporary spasms of unfavorable weather 7CU has been in constant communication with 6EJ.

It is interesting to note that 6FE reports 7AH, 7AP, and 7AR, all of Seattle, which are seldom if ever heard in this vicinity. The way the fellows in the Seattle district carry over our heads is an interesting phenomenon.

A number of stations are bending every effort to put over A. R. R. L. traffic all summer. In Seattle 7AD, 7AN, 7BK, 7CK and 7FB are holding down their end of the line. In Tacoma we have 7CB and 7CE that have been copied in the sixth district. 7EV of Tacoma promises us a CW set in the near future. This is exactly what we need to work through the unfavorable conditions during the summer. In Kelso, Wash., 7BV is a promising station which will help on the short jump line from here to Seattle. In Vancouver 7FH and 7CU and in Portland 7CR, 7BP, 7DS, and 7DA all have sparks that carry south. At Silverton 7CW is remarkably free from high tension interference and static, accordingly he works north or south with ease. 7YB of Eugene, Ore., certainly has a notable L D spark. He would be just the ticket for a short-jump line south if he were only on the job more often.

Lester E. O'Brien, Assistant Manager, Tacoma, reports that trunk "A" will make an attempt to establish itself as a regular trunk line. 7CE at Tacoma will act as official traffic clearing station on trunks "A" and "F". Mr. Hoover, (7CH) is out of the ether until fall and I'm sure we will all miss his familiar "sigs". The present line up on the route east follows: Tacoma, reports that trunk "A" will make 7BF; Yakima, Wash., 7AX; Spokane, Gonzaga College; Boise, Idaho, 7CH or Moscow, Idaho, 7CC, and from there east. This line needs a few more stations and a lot more enthusiasm, but we hope to have it in good working order by next fall.

Amateurs of Portland and vicinity do not lack variety. When LD is dull we are treated with musical concerts to suit any taste, from latest Jazz to high class Grand Opera. The tests conducted by 7CR, 7ZB and 7CW with the Forestry service radio telephone sets have made us reluctant to hang up our phones. It is interesting to note that the CW radiating 0.46 amperes and spark signals radiating 1.5 to 2 amperes, both at Portland, are equal in audibility at 7CW, about 40 miles distant.

Chas. Austin of Portland has taken

charge of the fading tests in this division. It is expected that some good dope can be collected as we certainly have our share of QSS.

ONTARIO DIVISION A. H. K. Russell, Manager

Relay matters in the Ontario Division have been rather slack during the past month. This is not because of any slackening of interest in relay work, but because of the fact that amateur wireless in the Division seems to be in a transition stage, as will be explained later.

The reason this Division is not able to overcome the Summer fall-off is that with the opening of navigation the wave-length allowed amateurs automatically dropped back to the old 50 metres, thus pretty effectively cutting off any long distance work. This restriction remains in force until navigation is officially closed in the Fall, and practically coincides with the return of good wireless weather.

A great transition seems to be taking place in the Toronto district. Everything seems to point to the fact that CW and radio telephony are going to entirely replace spark telegraphy in this district with all advanced amateurs in the very near future. There are at present in Toronto four amateurs with CW transmitters, and several more have expressed the intention of starting up almost at once. All these stations are of course of small power as yet, but there is every likelihood that by the time the snow falls again Toronto district will be heard over several hundred miles by CW.

These experiments in CW and telephony have been very much stimulated by the tests from 2XJ, 2XX, and KQO, as it set dozens of amateurs listening who in the ordinary course of events would be shoving "How is my spark?" into the air with everything from a Ford coil to a 1 KW transformer. Once we get these fellows interested in CW, QRM is a dead one, for then they can't use a broad wave if they want to.

ST. LAWRENCE DIVISION A. J. Lorimer, Manager

District reports for the past month are very brief and show general cessation of activities throughout the division. This is undoubtedly due to the interference caused by certain local amateurs who persisted in operating their stations on or near 600 meters until stopped by VCA, and may also be true of others in vicinity of VCB and VCC. Many amateurs hearing VCA call "Amateurs stop you are interfering with Comml Work" believed they were implicat-

ed generally and ceased operating. As a matter of fact VCA cannot hear those stations tuned on amateur waves. The receiver (Mar. Type 2846) in use at VCA is specially selective. To ascertain the extent of interference experienced at VCA, several tests were arranged by the Canadian Marconi Co., and it was found that a set tuned 290 meters operating from XWA during VCA's reception from VCB caused no trouble at all, in fact could not be heard at VCA. There are yet hopes that the locals will try and keep on 200 meters, or thereabouts, with a fairly low decrement and avoid using full power for cross town work, hopelessly jamming all others. There are a few stickers who are still coming along in spite of many handicaps.

The station at Plattsburg, N. Y., (8BB) is not in regular operation at present but will later act as the main pass for our traffic south. Station 3Z at Farnham is undergoing considerable improvements and will soon commence regular work to Montreal and Plattsburg.

We find the Franklin, Vt., station mentioned in Mr. Entwistle's report is without any power for transmitting and cannot be any help in that direction except for short local relays by spark coil with our station 2AX at Standbridge east, who works regularly with Farnham using 1/2 inch coil.

So far no prospectives have yet been located in the direction of Toronto but three unlicensed sets were confiscated in Kingston, Ont. We hope the owners get licenses and try to make good as they are needed there to complete through traffic routes.

ALASKAN DIVISION Theo. J. Stocking, Manager

Several amateur stations will be installed in this division very shortly now, as school closes this coming week and the boys will have ample time to erect same. Among them is Paul J. Mather, a native, who has shown considerable interest in wireless and has had a set constructed which was delivered today. This station will be put into operation next week.

The writer has an aerial consisting of two wires 70 feet long, 10 feet above the roof of building in which he lives. With this he is copying the local station, Prince Rupert (Digby Island), B. C. Anyox, B. C., and ships at sea within range. He has installed a new receiving set and has copied stations as far as NPG, San Francisco, and ships at sea. He is endeavoring to pick up the Japanese stations. Their sending is heard regularly but cannot copy it.

Several other stations will be in operation in this division soon.



1AW, HARTFORD, CONN.

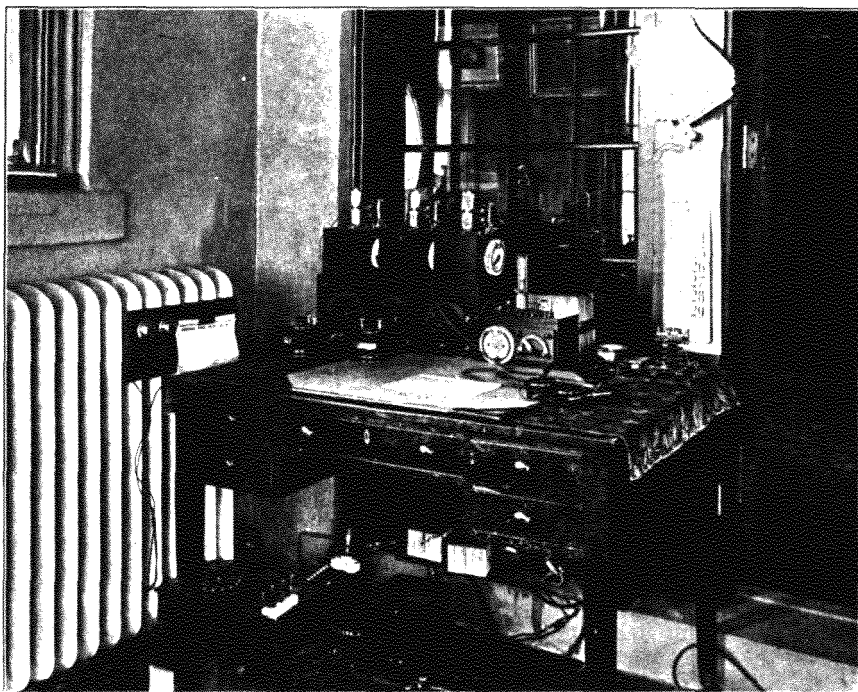

FOR this department this month we present a description of 1AW, the station of our President, Mr. Hiram Percy Maxim, at Hartford. The signals of 1AW are well known over the eastern part of the country, and we believe QST readers will be highly interested in learning some of the features of this station.

The most novel departure from regular practice is in the antenna, which is shown on our cover this month. This consists of a slanting flat-top of seventeen wires, 80 feet high at the open end and 50 feet high

at the lead-in end. The seventeen wires are spaced three feet apart along a cable at the open end, and supported by two 80-foot built-up wood masts 50 feet apart, while the spacing at the lower end (which is supported by a trussed spreader suspended from a pole on the rear of the house) is 15 inches. From the spreader the wires descend vertically, being gathered into a cable and led directly to the transmitter in the rear corner of the basement. The design employed is the nearest approach to a vertical fan that the disposition of the premises permit, and has given excellent results.

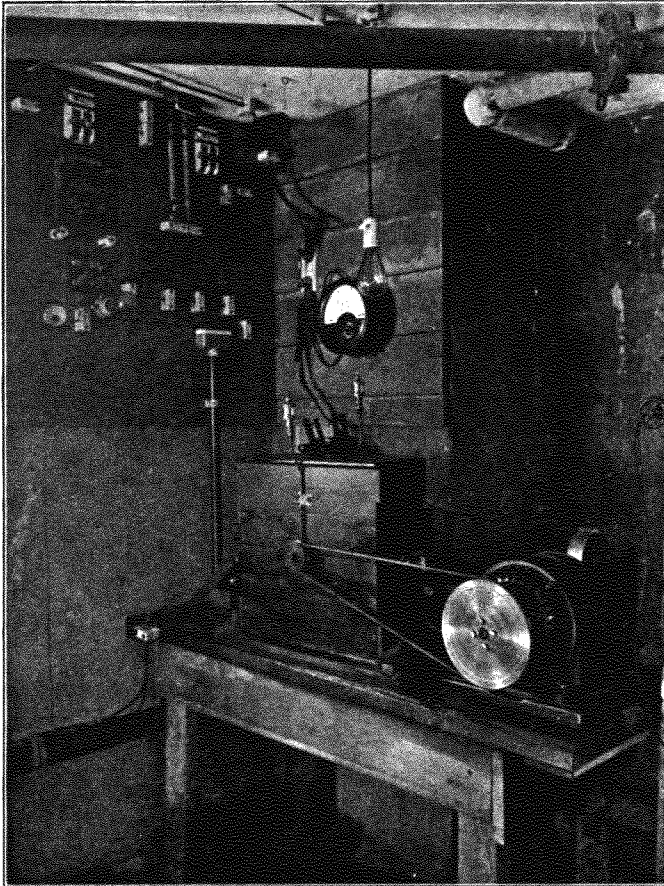

A conductive ground is used—water pipes, driven pipes, buried plates, and buried wire, there being considerably more wire in the ground system than in the aerial. That this job has been well done is attested by the fact that the resistance at 230 meters, measured by the substitution method, is but five ohms. The capacity of the system is .0011 mfd.

A very short anchor gap with large faces is used in the ground lead, and a single wire from the lead-in outside the house runs to the change-over switch (a Simon, with key on same base) at the receiving table, which is located in the library. As will be seen in the photograph, there is nothing unusual in the receiving equipment, which consists of a Paragon RA-6 regenerative tuner, a soft tubular detector with variable plate voltage, three stages of audio-frequency amplification in home-made units using Acme transformers and VT-1 tubes, and Baldwin phones.

An impedance in the power line is

located on the floor and makes possible the use of reduced power for short distance work. The anchor gap obviates the need for a distant-control device; the gap motor runs continuously and the power line runs direct to the key on the table without induction troubles—a simple arrangement as could be thought of.

Both an Acme and a Thordarson transformer are in this station. At the spark frequency used they give exactly the same antenna current. The balance of the apparatus consists of a non-synchronous rotary gap, a 24,000 volt Dubilier mica condenser of .01 mfd., and an oscillation transformer of heavy 2-inch ribbon. Switches, meters, and protective devices are located on the panel as shown in the third photograph. Chief interest in the transmitter attaches to the rotary, which has four revolving electrodes on a 15-inch circle, belt-driven at 7000 r.p.m. from a $\frac{1}{2}$

h.p. induction motor. This gap is the result of a number of years of experimenting. It was originally described on page 22 of QST for February, 1917, at which time it had 8 moving electrodes on a 12-inch circle, with a Bakelite center 8 inches in diameter, enclosed in an asbestos-lined box with the stationary electrodes mounted on Bakelite pieces on either side. Subsequent experimenting showed improved results by lessening the number of electrodes and increasing the speed to maintain the frequency, and the number was reduced to six, then to four. This season it was rebuilt with a solid metal hub and two solid arms in a cross, and the shaft and pulley are therefore "live", the insulation being furnished by the driving belt. Not the slightest trouble is now had with this apparatus and it definitely answers the question whether it is possible to do away with an insulating hub and rely on the driving belt. Because of the narrow electrodes and very high peripheral speed and its attendant air blast, it is believed that in this gap quenching is

secured far beyond that given by ordinary rotaries, so that a tighter coupling is possible in the oscillation transformer with purity of wave maintained.

The input on full power is 770 watts, and the antenna current at this input, 5.5 amperes. 1AW has been heard in Nebraska, Arkansas, Texas, and as far south as Cuba. In point of consistent performance we believe it ranks with the top-liners in the amateur world. It serves as a gateway station for traffic between New England and the west. Mr. Maxim's "sine" is "HP", and the Editor, when he can find a spare evening to sit in, signs "KB". QRU?

9AU, CHICAGO

These two views are of 9AU, the station of Mr. C. H. Zeller, Assistant Central Division Manager, located at 4732 No. Maplewood Ave., Chicago. Mr. J. F. Scholtes alternates nights with Mr. Zeller in its operation, Zeller signing ZO and Scholtes AM. Both are ex-Marconi operators and have worked ships together.

The aerial is a T with three 100 foot phosphor bronze wires spaced 3½ feet, well insulated.

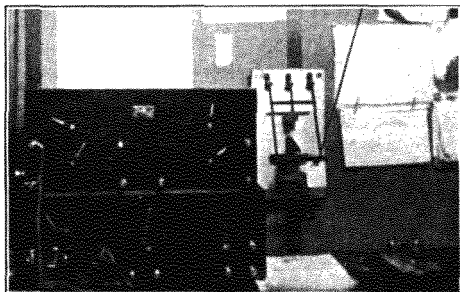

The receiving apparatus consists of a regenerative receiver in connection with a tron detector, single step amplifier, and Baldwin phones.

(Concluded on page 46)

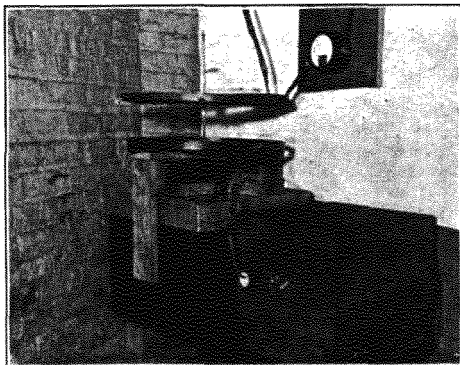

5AO, HOUSTON, TEX.

Amateurs who are crowded for station room can get some hints from this picture of 5AO, which is the station of Mr. Alfred P. Daniel in Houston, Tex. The receiving set is mounted in a desk, the front of which lets down to form the writing table, while the transmitter is on top and the antenna switch and H.W.A. on a nearby window facing, making a very compact station.

The O.T. is a Thor. but the transformer

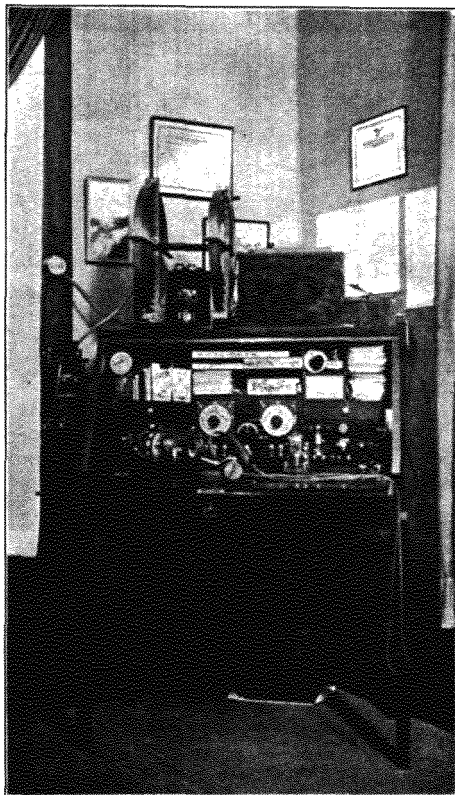

isn't, being homemade—of the open-core type, made from an old gas-lighter "make and break coil" for a primary with eight magneto secondaries strung on it in series. The condenser, plate glass in oil, and the enclosed six-point sawtooth rotary are also home-made.

The receiving set comprises, left to right—vario-coupler 200 to 600 meters; honeycombs for long waves; DeForest vernier condensers; Audiotron detector and two Marconi VT's for amplifiers; Baldwin phones, too.

5AO is reported QSA very in New Orleans (325 miles) and Eagle Pass (403 miles).



IN the list of clubs reported affiliated in the January QST, inadvertently the name of the Armour Villa Radio Assn., was omitted. This organization was formally affiliated with the A.R.R.L. on December 5, 1919.

The following additional societies have now become duly affiliated:

- Electric City Radio Club, Scranton, Pa.
- Lake Superior Radio Assn., Sault Ste. Marie, Ont.
- Bloomington High School Radio Club, Bloomington, Ill.
- The Radio Amateur Club, Carbondale, Ill.
- Elmhurst Radio Relay Assn., Elmhurst, Ill.
- Valley City Radio Club, Valley City, N. Dak.
- Sedalia Amateur Radio Club, Sedalia, Mo.
- Northwestern Radio Assn., Portland, Ore.
- New Haven Radio Assn., New Haven, Conn.
- The Radio Club, Irvington, N. J.
- Hampton Roads Radio Assn., Norfolk, Va.
- Portland Radio Assn., Portland, Maine.

RAVENSWOOD RADIO ASSN. Chicago, Ill.

The first annual banquet of the Ravenswood Radio Association was held at the Chicago Terrace Gardens on April sixteenth and to say that it was a huge success is putting it mildly. The attendance consisted of the club's members and a number of other prominent radio men who thoroughly enjoyed the splendid meal and entertainment afforded. The evening was not without the well known "HI", as it seems that our Mr. Hassell had sent in a bouquet of flowers to one of the very pretty entertainers, who came out and announced that inasmuch as she did not feel that she knew him very well, she would have to return them. This was then done, as the spotlight proceeded to follow Mr. Hassell thru the very embarrassing and heart breaking return of the flowers, which rated many a "HI" from all but him! The session was altogether a social affair

with no interruptions by dry technical talks. Mr. T. G. Seese, Social Manager, must be highly complimented on the splendid arrangements carried out single-handed by him.

The Detroit Radio Assn. is publishing a very peppy little monthly sheet under the title "Detroit Radio News". Mr. M. D. Lyons is the Acting Editor.

Y. M. C. A. RADIO CLUB New York

The Y.M.C.A. Radio Club of the East Side Branch at Lexington Ave. and 86th Street, New York City, which has recently become affiliated with the A.R.R.L., is now acting as the District Superintendent of New York City and Bronx District.

Our aim at present is to increase our membership and we are calling on all amateurs in our district to co-operate with us in our endeavor to bring all those interested together in a "Live Wire Radio Club Affiliated with the A.R.R.L."

Our recent meetings have been exclusively devoted to the question of eliminating QRM, which has been giving our operators considerable trouble in handling A.R.R.L. traffic. The Radio Traffic Assn., Central, and Prospect Radio Clubs, all of Brooklyn, have given us fine support in our effort to minimize interference.

Meetings will be held on the second and fourth Tuesdays of each month in Room 408. Amateurs who are interested in getting together for discussions of amateur interest are invited to pay us a visit on Thursday evenings or get in touch with our president, Mr. John DiBlasi, at No. 6 Warren St., New York City.

RADIO CLUB OF BURLINGTON Burlington, Iowa.

The Radio Club of Burlington was organized in March of this year, and is a lively and enthusiastic bunch. The officers are: R. V. Swearingen, President; Milo A. Bloomer, Vice President; Harry H. Waugh, Secretary.

On July 2d, 3d, 4th, and 5th there will be a Regatta held at Burlington under the auspices of the Mississippi Valley Power Boat Assn., and the R.C.B. has been given the duty of timing the speed races, which are to be held on a one-mile course be-

tween two bridges. The fact that some of the fastest racing boats in the world, such as "Miss Detroit III" and others capable of speeds of almost 70 miles per hour, will be entered, have created a desire on the part of the officials to employ the speed and accuracy of radio for the timing. The Club is erecting a ½ K.W. transmitting and receiving station at each end of the course, and there will be three official timers and two operators at each station, the operators being members of the Club. When the boats near the starting line a dash will be transmitted from the station located at this line, the dash ending as the boats cross the line, at which time all six official timers set their stop watches. When the boats cross the finishing line the order of things will be just reversed.

In addition to the timing stations the Club will have a 1 K.W. station (9ACZ) in operation with complete modern amateur equipment, and will handle free relay messages and broadcast an announcement of the winners of the various races, etc. These QST's will be sent daily from June 27th to July 5th a few minutes after the noon and 8 p.m. time signals from 9ZS. From noon until 8 p.m. each day during the Regatta will be set aside for Regatta business, but the station will be open continuously day and night during the balance of the period for general am-

ateur communication to and from Burlington, and connection with all amateurs within range is desired. The Secretary, at 1316 Perkins Ave., will be glad to hear from anyone copying their broadcasts.

The Editor regrets that lack of space prevents the publication in this QST of an excellent photograph of the Club.

**MILWAUKEE
AMATEURS' RADIO CLUB
Milwaukee**

Our club has really been in existence since January, 1917, but its ante-bellum activities were more along the line of a boy's club. When the war closed our stations, interest dropped and the membership fell. The club was changed into an electrical and social club in an attempt to keep it alive, but on January 9, 1918, the inevitable disbandment for the duration of the war was decided upon.

Soon after the close of the Great War, the slumbering interest in our radio club was awakened, and a meeting of all the former members who were still active was held at the Teschan Laboratories. A committee was appointed to alter the constitution so as to fit the new circumstances, an appropriation was taken up in order to put the club on its feet again, and officers were elected. A membership campaign was launched, which has never



been closed, and is still bringing in new members.

In a short time we had stationery printed, and carried on an extensive correspondence with other clubs and with manufacturers of radio apparatus. We met in the Parish House of the St. James Church, until we obtained permission to use the Trustees Room of the Milwaukee Public Museum, where we now meet every Thursday night.

We have a snappy business meeting, followed by a talk by some visitor, and then a general discussion of radio, conducted by all of the members, each giving suggestions and ideas to the club. Our main difficulty is the fact that certain "live wires" do all the talking, while the rest sit and listen. We are doing all we can to remedy this however, by inducing the bashful members to give their opinions.

Besides the board of directors, and the usual officers, we have very active committees on Relay and Interference, Research and Developments, Papers and Publications, and Membership, together with a catalogue distributing and magazine vending department, and an exchange for apparatus.

We invite all radio clubs to correspond with us. Address all communications to our Executive Headquarters, The Teschan Laboratories, 2319-2329 Wells St., Milwaukee, U. S. A.

ARMOUR VILLA RADIO ASSN. Bronxville, N. Y.

In response to your request this month for news, the doings of our club during the past season may be of interest. We have 18 members now after having started with 9 last fall. These members are mostly new since the war although there are some half dozen who were operating pre-war sets. The club has not as yet a transformer station, the members all using spark coils, from which good results are obtained. Particularly the Ford set at my station, 2KV, which has been heard at a distance of 90 miles with 6 watts input. 2KV expects to have a half kw. next season. We hold meetings every Friday evening at which papers are read, (at present we are reading the Junior Operator department), general discussions held, and last but not most important code practice. We have developed a method of teaching code that is very efficient, namely, we have a buzzer practice set and also a large practice table. The beginner is placed at the practice set and is taught the letters of the code. He is then sent to the practice table where speed is developed, messages being sent at speeds of 5, 10, 15 and 20 words per minute. By this method a member can read 10 words a minute with certainty within a month's time. The club has a wave meter and has offered to

tune all the transmitters in the vicinity, which reduces QRM. This combined with the fact that the members are instructed not to send after 10 P.M. is the reason why there is no interference from Bronxville. Also as an incentive and for good training the club has a trunk line system over which tests are made every week. In this way the members take an interest in relaying and are ready to aid the "big stuff" by keeping silent. We have a pretty good Paragon receiver at the club station with a one inch coil for a transmitter. Our call is 2AII and we would be pleased to talk via radio with any clubs with our limited range and with any clubs by mail.

Walter A. Remy, Desmond Ave., is the Secretary.

THIRD DISTRICT CONVENTION

Editor, QST—

Through the enormous circulation of your magazine we hope to reach the radio amateurs of the Third Radio District. It is desired that they shall organize themselves into Associations, no matter how small, and that they shall affiliate as soon as possible with the A.R.R.L., and so notify the officers of the Third Amateur Radio District. We also desire that amateurs who are in sympathy with the work this convention is doing and will do, shall send us their names and addresses. In this way we will be able to keep tab on the amateurs of the District and be able to notify them of the progress of the movement we are inaugurating. This is very important, because we can the better prepare for the next Convention which will be held in Philadelphia, January or February, 1921. Let one or two men from every locality begin this organizing, and get in touch with us. We are responsible to the A.R.R.L. and therefore our activities are co-operative with those of that organization.

Gordon M. Christine, M.D.,
President, Third Amateur Radio
District Convention,
2043 N. 12th Street,
Philadelphia, Penna.

ROTTEN DAMPED SPARK STUFF (Concluded from page 22)

No Sir, I'm through with the damped spark stuff. I understand that all you have to do to get out of the QRM is to find somebody who will snaffle a power bulb for you, wind some wire around something, hook in a couple of variable condensers and there you are with two amperes C.W. in the antenna which will reach out farther than twenty of the damped stuff. That's my size. May be I will have something to tell about when I get into it.

Well, it's about time for the alphabet practice to start. So long, and 73's to the gang.

QST'S DIRECTORY OF CALLS

In continuance of the policy recently announced, QST presents another two pages of calls, which may be cut out and kept with the January supplement if desired.

FIRST DISTRICT

Nathaniel B. Judkins	1474 Pawtucket Ave., E. Providence, R. I. (Correction)	1EM
Wm. L. Slaney	6 Gibson St., Dorchester, Mass. (Correction)	1FU
Willard F. Edwards	32 Cummings Ave., Wollaston, Mass. (Correction)	1IE
Robt. H. Cowan	20 Lamb St., So. Hadley Falls, Mass.	1JW
Vernal E. Fuller	11 Wescott St., Dorchester, Mass.	1KH
W. R. Entwistle	41 "C" St., Lowell, Mass.	1LG
D. H. Hanson	748 School St., Lowell, Mass.	1LI
Thos. F. Carden	185 Third St., Lowell, Mass.	1LO
Arthur D. Moulton	103 North St., W. Somerville, Mass. (Correction)	1PM
Boston College	Newton, Mass.	1PR
Wm. H. Connington,	5 West Emerson St., Melrose, Mass.	1RF
Mervin B. Hill	57 Liberty St., East Braintree, Mass.	1RK
Edith E. Rotch	157 Bay State Road, Boston, Mass.	1RO
Hollis E. Polk	27 Alder St., Waltham, Mass.	1RP
James R. Morse	17 Hawes St., Brookline, Mass.	1RT
Robert S. Miner	68 Quaker Lane, Hartford, Conn.	1RU
Carl G. Sicker	Northern Ave., Essex, Mass.	1RV
Geo. E. Sanders	34 Broad St., Nashua, N. H.	1RW
Fearing Pratt	120 Main St., Hingham, Mass.	1RX
Harry S. Holcomb	292 Clinton Road, Brookline, Mass.	1RY
John W. Hubbard	327 King St., Brookfield, Conn.	1RZ

SECOND DISTRICT

Leroy Clark	Chestnut St., Englewood, N. J.	2DS
J. J. Hallahan	180 Market St., Perth Amboy, N. J.	2DW
D. D. Hancock	Newman Spgs., Ave., Red Bank, N. J.	2DZ
Edwin S. Crane	47 Sinclair Ave., Flushing, N. Y.	2EA
Edw. V. Neuser	Ridge St., Pearl River, N. Y.	2EB
G. V. Lowe	262 W. 77th St., New York	2ED
Theo. Hurd	7 Tilton Ave., Red Bank, N. J.	2EF
Egmont Arany	62 W. 124th St., New York	2EG
H. C. Quick	471 75th St., Brooklyn	2EI
Russel Davis	601 Page Ave., Allenhurst, N. J.	2EJ
M. F. Roberts	17 Heights Terrace, Ridgewood, N. J.	2EK
C. F. Jacobs	279 Park Place, Brooklyn	2EM
Geo. B. Huss	30 Clifton Ave., Lakewood, N. J.	2EN
Samuel Leveille	255 So. Manning Blvd., Albany, N. Y.	2EO
Chas. P. Baulser	No. Main St., Pearl River, N. Y.	2EP
C. P. Bowyer	10 Van Reypen St., Jersey City, N. J.	2ER
Frank M. Ende	Arrochar Park, S. L. N. Y.	2ES
Harry Davis	520 Clinton Ave., Newark, N. J.	2EU
Edwin Lentz	5 Mertz Ave., Hillside, N. J.	2EV
J. C. H. Steinkamp	89 Hyatt Ave., Yonkers, N. Y.	2EW
Jas. McAnley	311 W. 54th St., New York	2EZ

THIRD DISTRICT

N. W. Meitzler	1532 Allen St., Allentown, Pa.	3GJ
E. J. Eckert	2303 N. Smedley St., Philadelphia, Pa.	3GK
H. W. Dempster	118 Cleveland Ave., Norwood, Del. Co., Pa.	3GL
L. W. Barnhart	1637 N. 6th St., Harrisburg, Pa.	3GM
A. J. Williams, Jr.	301 South Ave., Media, Del. Co., Pa.	3GN
R. L. Hopkins	426 York St., Norfolk, Va.	3GO
J. H. Weikel	900 Church St., North Wales, Montg. Co., Pa.	3GP
C. F. Kuder	2630 N. 33rd St., Philadelphia, Pa.	3GQ
Fred'k B. Ancona	1579 Mineral Spg. Rd., Reading, Pa.	3GX
T. B. Jack	5010 Reistertown Rd., Baltimore	3HH
H. and A. McNaughton	Cheswood Lane, Haverford, Pa.	3HJ
C. D. Blair	Box 859, Richmond, Va.	3HO
N. C. C. Higgins	Oldtown (Grayson Co.) Va.	3HL
Service Radio School	900-2 Penna. Ave., Washington, D. C.	3HR
J. W. Weaver	21 So. Main St., Pleasantville, N. J.	3HV

FIFTH DISTRICT

A. N. Dargan	Houston, Tex.	5BA
Wm. A. Hooks	Kountze, Texas	5BB
August J. Tete	1516 Kerlerec St., New Orleans	5BE
C. R. Taylor	Waurika, Okla.	5BF
Amos Harper	1803 29th St., Galveston, Tex.	5BH
Roy W. Layton	Corsicana, Tex.	5BJ
John P. White	Freeport, Tex.	5BK
D. M. Hester	Box 269, Dallas, Tex.	5BL
Orville Smitl	1103 East 8th St., Little Rock, Ark.	5BN
R. Newell Turner	Kountze, Tex.	5BP
H. E. Worthington	4909 Park Drive, Houston, Tex.	5BS
T. F. Smith, Jr.	4407 Caroline St., Houston, Tex.	5BU
LeRoy Hill	311 N. Oregon St., El Paso, Tex.	5BW
O. N. Thurman	1023 East 8th St., Little Rock, Ark.	5BX
A. Quina	Spring Hill Ave., Crichton, Ala.	5BY

SIXTH DISTRICT

W. C. Marsh	848 Main St., Albany, Cal.	6DJ
L. E. Martin	2413 Stanislaus St., Fresno, Cal.	6DK
C. I. Mayo	2828 Channing Way, Berkeley, Cal.	6DL
H. W. Milbralte	986 63d St., Oakland, Cal.	6DM
W. A. Morse	2029 Turk St., San Francisco, Cal.	6DN
F. M. O'Neill	1635 Addison St., Berkeley, Cal.	6DO
E. H. Harris	26 Washington St., Santa Cruz, Cal.	6DP
C. E. Ponnay	6516 Denver Ave., Los Angeles, Cal.	6DQ
S. E. Robinson	2829 Broadway, Oakland, Cal.	6DR
J. Sanderson	601 N. Stoneman Ave., Alameda, Cal.	6DS
D. B. McGown	1247 47th Ave., San Francisco	6ZE

SEVENTH DISTRICT

L. Smith	Tekoa, Wash.	7BI
Geo. Sturley	206 E. 17th St., Vancouver, Wash.	7BJ
M. Nelson	6446 So. Junette St., Tacoma, Wash.	7BL
C. W. Bull	Route 1 Bellingham, Wash.	7BM
D. X. Lavallee	4034 85th Ave. So., Seattle, Wash.	7BO
R. A. Willison, Jr.	765 Melrose Drive, Portland, Ore.	7BP
H. E. Allen	701 State St., Pullman, Wash.	7BQ
E. N. Swan	1416 Portsmouth Ave., Portland, Ore.	7BR
G. A. Nelson	4023 East K. St., Tacoma, Wash.	7BT
Morris Hoag	Sheridan, Wyo.	7BU

EIGHTH DISTRICT

Glyn H. Sees	727 Arch St., Williamsport, Pa.	8DB
J. Warren Wright	1119 S. Fountain Ave., Springfield, Ohio	8DC
Allan W. Palmer	125 S. Porter St., Saginaw W. S., Mich.	8DD
Roland F. Palmer	470 E. Buchtel Ave., Akron, Ohio	8DE
Cornell University	Franklin Hall, Ithaca, N. Y.	8DF
Franklin D. Johnston	1835 Hill St., Ann Arbor, Mich.	8DG
W. V. Shearer	307 16th St., Conneaut, Ohio	8DH
Wm. S. Burkhardt, Jr.	Cherry Hill, Reading, Pa.	8DI
Roy W. Waller	319 Wall St., Cambridge, Ohio	8DJ
Michael M. Weissensee	2624 Dennis St., Cincinnati, Ohio	8DK
Norden Wm. Daubenbis	2638 Dennis St., Cincinnati, Ohio	8DL
Paul L. Hexter	1543 East Boulevard, Cleveland, Ohio	8DM
Chas. C. Slocum	170 Annadale Ave., Akron, Ohio	8DO
Robt. F. Weinig	522 Wooster Ave., Dover, Ohio	8DP
Emerson L. Eissler	1227 California Ave., Pittsburg, Pa.	8DQ
John B. Coleman	323 Locust St., Edgewood-Pittsburg, Pa.	8DR
Francis M. Underwood	805 Main St., Monongahela, Pa.	8DS
Foster J. Demarest	811 Walnut St., Williamsport, Pa.	8DT
Harold L. Stecher	26 Oakley Ave., Monticello, N. Y.	8DX

NINTH DISTRICT

John Fetzer	328 Lutz Avenue, Lafayette, Indiana	9FD
Ewing Dunbar Nunn	725 Lake Drive, Milwaukee, Wis.	9FE
Paul G. Busey	1001 W. Nevada St., Urbana, Illinois	9FF
Jerry Raffensperger	719 Jefferson St., Goshen, Indiana	9FG
John B. Insdahl	Pitt, Minnesota	9FH
LeRoy Allen Degner	394 24th Avenue, Milwaukee, Wis.	9FI
Earl L. Dyson	2018 St. Joseph Ave., St. Joseph, Mo.	9FJ
Conrad S. Fritschel	c/o Wartburg College, Clinton, Iowa	9FK
John Carl Pilgram	2016 Olive Street, St. Joseph, Mo.	9FL
Hilary Doerfler	St. John's Univ., Collegeville, Minn.	9FM
Melvin Herman	1419 So. 9th St., Sheboygan, Wisconsin	9FN
Hector Gustav Eyth	2825 Arapahoe St., Denver, Colo.	9FO
T. J. Innis	Bellflower, Illinois	9FP
Lawrence Frederick Pfeiler	1810 North Fifth Street, Sheboygan, Wisconsin	9FQ
Henry W. McMillan	205 Leffler St., West Burlington, Iowa	9FR
Edward Everett Pippenger	806 S. Seventh St., Goshen, Indiana	9FS
George Addison Plank	101 N. Pleasant St., Independence, Mo.	9FT
Howard Lee May	4976 West Pine Blvd., St. Louis, Mo.	9FU
Howard H. Moore	922 Madison St., Elkhart, Indiana	9FV
Harry E. Bennett	1709 Leavenworth St., Omaha, Neb.	9FW
Hugo Klemm	2002 N. 8th Street, Sheboygan, Wisconsin	9FX
Wesley D. Correll	1811 1/2 Frederica Place, Milwaukee, Wisconsin	9FY
Nicholas Brauch	316 Court Street, Le Mars, Iowa	9FZ

CANADIAN

J. C. Hawley	King St., St. Stephen, N. S.	1AA
C. W. Alexander	Patterson St., Campbellton, N. B.	1AB
L. L. Smith	Main St., Yarmouth, N. S.	1AC
H. Holden	Bay St., Glace Bay, N. S.	1AE
G. D. Davidson, Jr.	124 1/4 Germain St., St. John, N. B.	1AF
J. F. C. Wightman	27 Queen St., Amherst, N. S.	1AG
G. A. Sandes	107 Queen St., Halifax, N. S.	1AH
P. L. Whitman	63 Victoria Rd., Halifax, N. S.	1AI
J. E. A. Demers	Canso, N. S.	1AJ
Harold Reid	179 Dundas St., Belleville, Ont.	3BK
C. M. Stork, Jr.	183 Bleecker Ave., Belleville, Ont.	3BO
Harry Woodley	56 Catherine St., Belleville, Ont.	3BR
Kenneth Henderson	95 So. George St., Belleville, Ont.	3BY
Wm. Connor	240 Pinnacle St., Belleville, Ont.	3CB
W. J. Sherry	Sidney St., Belleville, Ont.	3CC



Wife was trying to puzzle out what the letters on our I. R. E. pin stood for, and she remembered it was something about Radio. "I'm a Radio Expert", she guessed. If it were only true!

Recent Books—"The Radio Buyer's and Builder's Handbook", by R. U. Clark, III. Paper backed, 158 pp., 4½x6"; advertised by the author in QST. Chock full of advice which will help any amateur in the construction of a set; how to save money in buying; the utilization in a radio set of standard articles on the market for other purposes; the construction of many pieces of apparatus from such parts; particularly novel directions for constructing variable condensers, and the making of experimental vacuum tube detectors from standard bulbs such as automobile head-light lamps. A valuable little book.

Canadian, Montreal, XWA transmits damped spark sigs. What else could one expect, when his aerial is erected on Dawes' Brewery?

Marion, WSO, has a 24-hour schedule at present with LCM. Wave length 11,550 meters; 600 amperes antenna current in a multiple-tuned antenna; 200 K. W. Alexander alternator.

The amount of QRN experienced seems largely dependent on the average height of the aerial. A low aerial, of large capacity, and some amplification, is permitting work to be done in cases where other amateurs in the same towns are unable to copy at all on their transmitting aeri-als. Try it.

Mr. Entwistle reports the prize find of the year; a lad in New Hampshire who was saving his money to buy a 20-inch spark coil when he had A. C. in the house

The inspector at Norfolk is hot on the trail of all violators of the law. In addition to two stations under his direction, we understand 3FG is working as an Acting Radio Inspector. Ship operators have been troublesome in that territory, QRM-ing amateur work and hamming illegally on a lower wave. Violators of the law have small chance of getting by there now.

If you haven't already wised up to it, put down on your card this A.R.R.L. abbreviation: "QSS?—Do my signals fade?" "QSS—Your signals fade." Everybody is using it.

We can't restrain our amusement at the following "Simple Method to Procure a Vacuum", gleaned from one of our contemporaries.

"Many amateurs who are constructing their own experimental vacuum valves find much trouble in obtaining a good vacuum. Here is a simple way to exhaust your valve. Have a small glass tube projecting beyond the end thru which to draw the air. Get a rubber bulb, or ball, large enough to hold all the air contained in the valve and more, and which should fit on the glass tube. Squeeze all the air out of the bulb or ball, and holding it so squeezed, fit it on the glass tube. Now let go, and the air will be drawn out of the valve. Leaving the bulb on, seal up the glass tube by holding it over a bunsen burner."

Hi abt tt! But if anybody doesn't know better, let us say that it won't work—always providing our understanding of a near-vacuum is correct.

In England the Postmaster-General has now approved the erection of amateur stations, subject to the following restrictions: Aerial not to exceed 100 feet in length for single-wire aerial; or 70 feet for two-wire aerial; operator must be of British nationality and over 20 years of age; diagram of receiver to be submitted for approval, and valves shall not be used without special authority; power of transmitters not to exceed 10 watts. The restriction on receiving valves is because of the fear of QRM in congested areas from the radiated C.W. from an oscillating receiving tube. The American congregation will please kneel in prayer.

On May 6th, in the Cameo Ball Room of the Morrison Hotel, Chicago, the First Annual Aviators' Ball was held, under the auspices of the Allied Flyers Aviation Club of Chicago and the Radio Intelligence Service of the Air and Auto Pilots Association of America. The feature of the evening was dancing between 10:30 and 11:15 p. m. by music transmitted from Indianapolis by

radiophone, which was installed by members of the Ravenswood Radio Association. Mathews of 9ZN is Chief Executive Officer of the R. & I. S.

NAI, Philadelphia Navy Yard, is now sending a broadcast for amateurs every night at 8:30 on 756 meters. The transmission is in three parts: (a) News items at 10 w.p.m. (b) Code groups at 15 w.p.m. using Larrabee Code, code word "Radio"; and (c) Press news at 20 w.p.m. The object is to establish cordial relations between the Navy and amateurs, and was due to the interest of Lieut-Commander Cobb, U. S. N., who seconded the efforts of the Philadelphia Amateur Radio Assn., to secure this agreement. It is hoped amateurs will show their appreciation by standing by for the QST at the hour mentioned.

WOULDN'T IT BE WONDERFUL—

- If there were no static?
- If aerials grew on sky-hooks?
- If attics weren't hot in summer and cold in winter?
- If there were no spark coils?
- If there were no Fords to furnish them?
- If static was on a wave of 9,000,000 meters?
- If the strength of the received signal varied as the cube of the B battery potential?
- If Litz were seventeen cents a pound?
- If variometers were three for a quarter?
- If NPX were tuned, or didn't reradiate, or something?

- If Audiotron leads were made of Litz?
- If somebody invented a non-breakable rope for hoisting aerials?
- If we could all afford Dubiliers?
- If 2GR could have a better Victrola?
- If 2AJE would fix that rotary so it wouldn't sound as if it had only one stud?
- If you could work CW on electric light bulbs?
- If kids didn't get their kite tails caught in our aerials?
- If Woolworth's V & X sold ½ k. w. power tubes?
- If 8ZW sent slowly?
- If 3NB were a ham with a spark coil?
- If QST could come out daily?

Good Evening Mr. H-H-Ham.

- (Tune: "Good Morning Mr. Zip-Zip-Zip.")
 Good evening Mr. H-H-Ham
 With your wave length just as short as mine.
 Good evening Mr. H-H-Ham
 You're surely soundin' fine.
 But it's ashes to ashes and dust to dust
 If the de-da's don't get you
 Surely theory must.
 Good evening Mr. H-H-Ham
 With your wave length as short as—
 Your wave length just as short as—
 Your wave length just as short as mine.
 Written by A. Ham.
 With apologies to the author.

CALLS HEARD

On account of the vast quantity of calls reported we must ask your co-operation in the following or calls can not be published.

- (1) List the calls on a separate sheet of paper—do not embody them in a letter.
- (2) Arrange by districts from 1 to 9, and alphabetically thru each district; and run them across the page, not down a column.
- (3) Put parentheses around calls of stations also worked.
- (4) Omit initial or other unauthorized calls.

1AW, HARTFORD, May 3 to June 9.
 1AE, (1AZ), 1BJ, 1BB, (1BM), (1CM), (1DM), (1DY), 1EP, 1ED, (1FQ), (1FW), (1GB), 1IW, (1ML), 1QN, (1QP), (1RZ), (1SN), (1TS), 1YB, 1DAY, (1HAA), 1KAY, 1MAL, (1NAQ), 1NAP, 1TAA, (1UAF), 1EAV, 1BE, (1EK), (1VAD), (1AY), (1LAES), 1TAL, (1SZ), 1BAY, (1VAK), 1MX, (2BB), (2BM), (2BK), 2CS, 2DA, 2EF, 2FS, (2GR), 2FT, (2JE), (2JN), (2JU), 2ME, (2OA), 2OM, 2QV, (2RD), 2RM, (2RU), 2TF, 2X, (2YM), (2ZL), (2AJD), (3AK), 3AW, 3BZ, 3BS, (3DM), 3EF, 3GX, (3HJ), (3NB), 3NV, (3XG), (3ZA), 3BQ, (3BP), (3CB), (3ER), (3DY), (3DA), 3HP, 3LA, (3MI), 3LS, (3NI), (3MT), (3WY), (3XK), (3XU), 3ABG, 9ZN.

HEARD BY N. SHEARD

ABOARD S.S. "COURTFIELD"

May 20th, 180 mi. S.W. of Nantucket: 1AW, May 21st, 120 mi. NW of Hatteras: 1AE, 1AW, 3FG, 3HG, 3HJ, 3NC, 3NB, 3NV, 3LA, 3MT, 3ZW. May 22d and 23d at Hampton Roads, Va., 1AW, 3EZ, 3FG, 3BZ, 3HJ, 3JK, 3MQ, 3NV, 3ZC.

6EB, LOS ANGELES, additional

(6AG), 6AH, (6AK), 6AR, (6AT), 6BU, (6CC), (6CO), (6CP), (6CS), (6DK), 6FN, 6FU, 6GQ, 6GR, 6HH, 6JI, 6JJ, (6JQ), 6JR, 6KL, 6MZ, 6NE, 6XZ, (6ZA), 7BP, 7CC, 7CR, (7DK), 7YA, 7YB, (7ZB).

ITS, BRISTOL, CONN., to April 13.

(1AAT), 1AE, (AES), 1AK, 1AP, 1AR, 1AS, (1AW) spark and phone, 1AZ, 1BAN, 1BG, 1BM, (1CK), (1CM), 1CW, 1DL, 1DR, 1DU, 1DY, 1ED, 1EF, 1EI, 1EN, 1EP, (1FQ), (1GAI), (1GJ), 1HAA, 1HAG, 1HAL, (1HW), 1IZ, 1JAP, 1JAT, (1JD), (1JX), 1JZ, (1KT), 1MAD, 1MJ, 1NAQ, (1NAT), 1NO, 1QN, (1OP), 1SE, 1SEY, (1SZ), (1UJ), 1WE, (1ZA), 1ZC, 1ZK, 2AEG, 2AM, 2AR, 2BB, 2BK, 2BM, 2BO, 2BW, 2CE, 2CL, 2DA, 2DH, 2DZ, 2EJ, 2EV, 2FS spark and C.W., 2GR, 2IR, 2IT, 2JE, 2JJ, 2JN, 2JU, 2KM, 2LO, 2LT, 2MN, 2NP, 2NV, 2OC, 2OM, 2OW, 2PE, 2QF, 2QR, 2QV, 2RB, 2RM, 2RL, 2RV, 2SU, 2SZ, 2VA, 2WB, 2WD, 2XB C.W. and phone, 2XH, 2XX C.W. and phone, 2ZC, 2ZL spark and C.W., 2ZM, 2ZR, 2ZS, 3BB, 3BE, 3BZ, 3CE, 3DH, 3DS, 3EM, 3EN, 3EP, 3EY, 3FB, 3FN, 3GX, 3HJ, 2NB, (3NV), 3ZA, 3ABG,

8ASB, 8BB, 8BP, 8BQ, 8BV, 8CB, 8DA, 8DC, 8DI, 8DO, 8DV, 8DY, 8ED, 8EM, 8EN, 8ER, 8FC, 8FF, 8FG, 8FP, 8FW, 8GI, 8GU, 8HG, 8HH, 8HP, 8IK, 8IS, 8IV, 8LA, 8LF, 8LI, 8MB, 8MN, 8MT, 8WY, 8MZ, 8NI, 8OJ, 8PM, 8QM, 8RS, 8RW, 8SH, 8UB, 8UG, 8UM, 8VM, 8VU, 8WS, 8WY, 8XA, 8XL, 8XK spark and mod. C.W., 8XU, 8ZI, 8ZK, 8ZW, 8ZX, 8ZY, 9AJ, 9AU, 9GX, 9HW, 9KF, 9LQ, 9MH, 9MS, 9ZJ, 9ZL, 9ZN.

3CK, MADISON, N. J.

1AW, 1AAH, 2AB, 2AAF, 2AEC, 2AJ, 2AJG, 2AIM, 2AOI, 2BN, 2DR, 2DX, 2HU, 2JU, 2JN, 2JO, 2IO, 2LP, 2ME, 2MG, 2NB, 2OG, 2PL, 2RE, 2RB, 2RU, 2RK, 2TS, 2UE, 2CV, 2DY.

ON 3-FOOT LOOP, INDIANAPOLIS.

BY W. DODDS AND M. B. LOWE, Y.M.C.A. QSA ON ONE STEP.

1AE, 1AW, 3NB, 5XA, 8CB, 8CO, 8DA, 8ER, 8EJ, 8IK, 8NC, 8WY, 8ZL, 9AU, 9BR, 9CJ, 9FG, 9KD, 9LF, 9NQ, 9VT, 9WC, 9ZM, 9ZN, 9ZQ, 9ZT.

3EN, NORFOLK, May.

1AW, (1HAA), (2GRO), 2JE, 2JU, (3BZ), 3FD, 3HG, (3HJ), 3KM, 3NE, (3PB), (3ZA), (3ZS), 3ZW, 4AT, (4CC), (8DA), (8DI), 8EN, (8FD), 8IK, (8LA), (8NI), 8ZW, 9LF, 9LI, 9LQ, 9ZN.

6GQ, PHOENIX, ARIZ.

(5BO), (5BT), 5CX, 5ZU, 6AH, 6CC, 6CO, 6CT, 6CM, 6CV, 6DK, 6DP, 6EI, 6GM, 6HG, 6IQ, 6JV, 6JC, 6KH, 6ZC, 6ZA, 7CC, 7YA, (7YB), 7YS, 9CN, 9ER, 9FZ, 9FD, 9HI, 9LO, 9ND, 9PS, (9RP), 9ZU, 9ZL.

7CU, VANCOUVER, WASH.

(6AC), (6AE), (6AH), 6AI, 6AJ, (6AK), 6AL, 6AM, 6AN, 6AS, (6AT), 6BE, 6BK, 6BN, (6BQ), 6BR, 6BU, 6CC, 6CD, (6CI), (6CO), 6CP, 6CS, 6CC, 6CV, 6DI, 6DK, (6DY), 6EA, 6EB, 6ED, (6EJ), 6ER, 6FC, (6FE), 6FJ, 6FN, (6FS), 6FU, 6FY, 6GI, 6GN, 6GR, (6HO), (6HT), 6JD, *JI, 6JJ, 6JK, 6JM, 6JN, 6JQ, 6JR, 6KL, 6KM, (6KZ), 6LC, 6NE, 6NY, 6OC, (6OH), 6PG, 6PM, 6PQ, 6QR, 6QU, 6RQ, 6SV, 6UW, 6XZ, 6ZA, 6ZE, 6ZU, (7AD), (7AN), (7BK), 7CB, (7CE), 7CC, (7CW), (7YB), (7YS), exchanged greetings with 6RQ, 6JQ, and 6BR.

3FB, ATLANTIC CITY, N. J.

1AW, 1AZ, 1PW, 1RN, 1TS, (2BM), (2DA), 2DH, 2DT, 2GX, 2IR, (2IT), 2NE, (2OA), 2RL, 2RZ, (2TS), 2XJ (phont), (2ZL), 3AJ, 3BE, 3BM, 3CC, 3CN, (3DH), 3DS, 3EB, 3EN, (3GO), 3GR, 3GW, (3GX), 3HJ, 3JE, 3KM, (3NB), 3NC, (3NV), 3OR, 3RL, 3ZA, 3BB, 3DA, 3EN, 3ER, 3HP, 3IK, 9ZJ, 9ZL, 9ZN.

8JU, WASHINGTON, PENNA.

1AE, (1AK), 1AN, 1AS, (1AW), (1AZ), (1CM), (1DL), 1DR, (1KT), (1RN), 1UQ, (2ARJ), 2AVF, (2BM), (2CB), (2CS), (2DA), (2FG), 2GO, (2GR), 2II, (2IR), (2JE), (2JU), 2JZ, 2PH, 2PL, 2SH, (2SZ), 2WB, (2XG), 2YH, 2ZC, (2ZL), (2ZM), (2ZS), 2ZV, 3AB, 3AK, (3AN), (3BZ), 3CA, (3CC), 3CH, 3CV, 3DH, (3EN), 3EZ, 3FG, (3GO), 3KM, (3NB), 3XC, (3ZS), (4AE), (4AG), (4AI), 4AK, (4AL), 4AN, (4AO), 4AT, 4BB, 4BC, 4BQ, (4BZ), 5EJ, (5AC), (5AL), 5BC, 5BT, (5DA), 5DO, 5ED, 5EX, (5XA), 5YA, 5ZC, 5ZG, (5ZL), (5ZS), 9ABD, 9AES, 9AIK, 9ANO, 9ATR, (9AOR), (9AJ), 9AK, 9AP, (9AU), (9BR), (9BT), 9BY, 9BZ, (9CA), 9CN, (9CS), 9CV, (9CW), 9DH, 9EE, (9EQ), 9ER, 9FA, 9FG, 9FW, 9FR, 9FU, 9GK, (9GS), (9GX), (9HA), (9HD), 9HG, 9HI, (9HJ), (9HN), 9HR, (9HT), 9HU, (9HW), (9IT), (9IT), (9IX), 9JT, (9KF), (9KO), 9KV, (9LC), (9LQ), 9MK, (9NQ), 9QH, 9RP, (9SS), 9XK, 9XR, (9ZJ), (9ZL), (9ZN), 9ZW.

1BM, BRIDGEPORT, CONN.

1TAK, 1HAA, (1CK), 1JA, 1CJ, 1BAN, 1AK, 1BAY, (1AW), 1QN, 1DQ, 1CE, 1FAC, (1CM), 1SE, 1AL, 2OE, 2XS, 2JU, 2LZ, 2ZL, (2FS), 2RL, 2QR, 2JE, 2CS, 2XJ, 2GR, 2XX, 2QV, 3FB, 3ZX, 3NV, 3GO, 3GX, 3RO, 3NC, 3HJ, 3EN, 8XU, 8CB, 8NI, 8EN, 8MT, 8NX, 8XK, 8DA, 8ER.

HEARD IN DAYLIGHT AT BROOKE, VA.,

BY A. L. GROVES

2AE, 2FFG, 2HG, 3AN, 3BE, 3BH, 3CH, 3CJ, 3CR, 3CW, 3FG, 3GG, 3GO, 3HG, 3IB, 3KM, 3LL, 3LW, 3PV, 3RG, 3RP, 3TN, 3XH, 3ZW.

8JU, CANTON, OHIO

1AW, 1FG, 1IP, 1IR, 2AW, 2BA, 2BB, 2BM, 2BN, 2DA, 2FE, 2IR, 2JE, 2JK, 2PL, 2SH, 2XI, 2ZM, 2ZS, 3AN, 3AR, 3BZ, 3CU, 3DH, 3EN, 3HJ, 3IR, 3KM, 3NV, 4AE, 5AC, 5EX, 5ZJ, 8AA, 8ABG, 8ACF, 8AGY, 8AQ, 8AH, 8AY, 8BQ, 8BV, 8CB, 8CC, 8CI, 8CH, 8DR, 8DP, 8DA, (8DE), (8DW), 8DV, (8EN), 8EC, 8ER, 8ES, 8FI, 8FN, (8FD), 8GL, 8GQ, (8GW), (8HA), 8HP, (8GE), 8HG, (8IF), (8IK), (8IQ), 8LI, 8IP, (8JF), 8LA, 8MT, (8NI), 8OD), 8SH, (8VM), 8WY, 8XA, 8XK, 8XU, 8VI, 9AL, 9AJ, 9AU, 9CA, 9CC, 9CW, 9EG, 9FD, 9GS, 9HA, 9ED, 9HS, 9HW, 9IT, 9KF, 9KR, 9LL, 9LYL, 9PF, 9RD, 9VY, 9YA, 9ZN, 9ZJ.

5ZP, NEW ORLEANS

1AW, 2BM, 2BZ, 2DA, 2IN, 2IR, 2ZM, 2ZS, 3AN, (3BZ), 3CH, (3EN), 3GO, 3HJ, 3JK, (4AE), 4AG, 4AN, 4AO, 4AT, 4BC, 4BQ, 4BZ, (4YA), 5AB, 5AC, (5AG), (5AL), 5AN, 5AO, 5AP, 5AQ, 5AS, (5AU), 5BD, 5BG, 5BJ, 5BK, 5BL, 5BM, (5BO), 5BT, 5BX, 5BY, (5BZ), 5CD, 5DA, 5DO, 5DW, 5EC, 5ED, 5EJ, 5EO, 5ER, (5ZA), (5ZC), (5ZG), (5ZL), 5ZN, (5ZV), 5ZW, 5YA, (5YB), (5XA), 6IZ, 8AA, 8AH, 8ALE, 8AMN, 8ASF, 8BT, 8CB, 8CC, 8CD, (8DA), 8DC, 8DI, 8DO, 8EC, 8EF, (8EN), 8EQ, 8ER, 8ES, 8EV, 8EX, 8EZ, 8FH, 8FI, 8FP, 8FU, (8GB), 8GN, 8GO, 8GX, 8HG, 8HH, (8IB), 8IF, 8IK, 8IX, 8JF, 8JG, 8JJ, 8JQ, 8JZ, 8LA, 8MB, 8NL, 8NF, 8NH, 8NO, 8NQ, 8NZ, 8QJ, 8RQ, 8RS, 8ZY, 9AD, 9AH, (9AJ), 9AP, 9AT, 9AU, 9AW, 9AX, 9AA, 9AB, 9ABT, 9AIT, 9BJ, (9BR), (9BT), 9BY, 9CH, 9CA, 9CN, 9CS, 9CW, 9DC, 9DK, 9EG, 9EL, 9EM, 9EQ, 9ER, 9ET, 9EY, 9EX, 9FB, 9FE, 9FI, 9FN, 9FR, 9FT, (9FU), 9GA, 9GB, 9GC, 9GK, 9GO, 9GS, 9GV, 9GX, 9HD, 9HL, (9HN), 9HS, 9HT, 9HW, 9IT, 9IX, 9JA, 9JB, 9JT, 9JU, 9JW, 9KF, (9KM), (9KO), (9LF), 9KV, 9LC, 9LG, 9LH, 9LO, 9LQ, 9LR, 9MK, 9NE, 9NQ, 9PF, 9PO, 9PQ, 9QM, 9RP, 9RY, (9SS), 9TQ.

9DV, NEENAH, WISC.

2BM, 2JA, 2NC, 2XG, 2XH, 2ZG, 2ZS (heard at 330PM), 3BZ, 3DH, 3NB, 3NC, 4JE, 5AG, 5BB, 5BG, 5BT, 5BZ, 5DA, 5ED, 5YA, 5ZE, 5ZL, 8AB, 8BV, 8CB, 8DG, 8DI, 8DJ, 8DO, 8DZ, 8FD, 8GI, (8HA), 8HF, 8HG, 8HM, 8IK, 8KP, 8LA, 8IV, 8NG, 8NR, 8PP, 8SH, 8XU, 8YO, 8ZA, 9CL, 9CC, 9EQ, 9ET, 9FC, 9FL, (9FZ), 9GC, 9GM, 9GO, 9HE, (9HA), 9HJ, 9JA, 9JL, 9JT, 9JW, 9KI, (9KV), 9KY, (9LC), 9LH, 9LN, 9LU, 9MA, 9MC, 9MF, 9NY, 9OB, 9PL, 9PZ, 9QM, 9RP, 9SJ, 9UG, 9UQ, 9WI, 9XM, 9ZL, 9ZJ, 9ZQ, 9ZT, 9ZU, 9ZV.

9MH, MILTON, WISC.

1AW, 2JE, 2QF, 2XB, (3DH), (3EN), 3HJ, 3KM, 3NC, 4AE, 4BZ, 5AL, 5BO, 5BT, 5EA, 5ED, (5EJ), 5EN, 5FR, 5ZL, 5YA, (5YE), 5ZA, 5ZC, 5ZL, 5ZP, (5ZV), 5ZX, 5BP, 5CB, 5CG, (5DA), 5DC, (8DI), 8EN, (8ER), 8FI, 8FU, 8GB, 8HG, 8HN, 8IA, 8IF, (8IK), 8JJ, 8MT, 8NI, (8NZ), 8QJ, 8QK, (8RQ), 8UP, 8ZJ, 8ZW, 9AAS, (9ACV), 9AK, 9AT, 9AX, 9AZ, 9CA, 9CE, (9CS), 9DA, 9EE, 9EN, 9ET, 9FC, 9FP, 9FU, (9GC), 9GM, 9GO, (9GS), 9HI, 9HJ, 9HN, 9HP, 9HT, 9IX, 9IZ, 9JA, 9JJ, 9JN, 9JQ, 9KF, (9KM), (9KO), (9KV), 9LF, (9LC), 9LQ, 9LS, 9LU, 9ML, 9MS, (9NQ), 9NZ, 9OG, (9OK), 9ON, (9OV), (9PG), 9PN, 9PR, 9PS, 9QJ, 9QQ, (9QZ), 9RP, 9RV, 9RY, (9SU), 9UG, 9UJ, 9UQ, 9UY, (9VA), 9VP, 9WC, 9WU, 9WY, 9XA, 9XM, 9YA, (9ZC), 9ZJ, (9ZL), (9ZQ), (9ZT), (9ZV), (9ZX).

9FI, MILWAUKEE

1AW, 3CB, 3DC, (3EN), (3ER), 3'K, 9JA, 8MY, 8NI, 8NZ, 8QJ, 8WY, 8XA, 9AAN, 9CE, 9HQ, 9KV.

9ZL, MANITOWOC, WISC.

(1AE), (1AW), 2AN, (2BM), (2CB), 2DA, 2DO,

(8FH), (8FI), 8FP, 8FS, (8GB), 8GX, 8HA, (8HG), 8HH, (8IK), 8IT, 8JG, (8JJ), 8JQ, 8KP, (8LA), 8LJ, 8MT, 8NI, 8NZ, 8PR, 8RH, 8WY, 8VO, 8XA, 8XF, 8XK, 8XU, 8ZB, 8AD, 8AAV, 9AES, 9AII, 9AIT, (9AJ), 9AT, (9AU), (9AW), (9AX), 9ARX, (9BR), (9BT), (9CA), 9CE, (9CN), (9CQ), (9CS), (9CW), 9DC, 9DF, 9DP, 9DR, 9EE, (9EL), (9ER), 9ET, (9FB), 9FG, 9FM, 9FP, 9FU, (9FZ), (9GC), 9GH, 9GK, (9GS), 9GV, 9GX, (9HA), 9HD, 9HI, (9HN), (9HT), 9HY, 9IB, 9IF, 9IK, 9IN, (9IT), (9IX), 9JA, 9JJ, 9JL, 9JN, 9JK, (9JT), (9KI), 9KM, 9KO, (9KV), (9LC), 9LF, (9LH), (9LQ), 9LW, 9LV, (9MH), (9ND), (9NQ), 9ON, (9PI), (9PN), 9PS, 9RL, 9RP, 9RV, 9RW, 9RY, 9SS, (9UC), 9UM, 9UR, 9VA, 9VP, 9WG, 9WV, 9YA, (9ZC), 9ZJ, (9ZN), (9ZQ), (9ZT), (9ZV), (9ZX).

3EN, BALTIMORE, MD.

1AW, 1AE, 1AR, (2BM), 2CB, 2QF, 2JE, 2SZ, 3CK, 3EN, 3KM, 3NB, 3ZW, 3XF, 3DA, 3ER, 3CB, (3IB), 3HG, 3JL, 3XU, 9CL, 9IK, 9ZN.

6EA, LOS ANGELES, CALIF.

(5ZA), (6AE), 6AH, (6AK), ex-6AL, (6AM), 6AN, (6AT), (6BJ), (6BN), (6BQ), (6BR), (6BZ), 6CC, 6CI, 6CL, (6CO), 6CP, (6CQ), (6CS), 6CV, (6DH), (6DK), (6DY), (6EJ), (6EX), 6FE, 6FJ, (6FN), (6FU), 6GL, (6GQ), 6HH, (6HO), 6JJ, (6JK), 6JR, 6JU, (6KL), 6MZ, (6NE), 6ZA, (6ZE), (7CC), 7CR, (7DK), 7YB, (7ZB).

5AP, ENNIS, TEX.

(5AI), (5AJ), (5AL), 5AY, 5BD, (5BO), (5BT), 5DA, (5ED), (5EJ), 5ES, (5EV), 5YA, 5ZA, (5ZC), 5ZG, (5ZJ), 5ZL, 5ZU, 5ZV, 5ER, 9AM, 9HI, 9HT, 9KJ, 9LZ, 99NZ, 9SS, 9TQ, 9ZT.

6AE, STANFORD UNIV., CAL.

(6AY), (6BQ), (6CM), (6CS), (6DA), (6DF), (6DH), (6DK), (6EA), (6EB), 6EC, (6ED), (6EF), (6EK), 6EL, (6EN), (6ER), 6FD, (6FE), (6FU), 6GC, (6GH), (6GI), (6GQ), 6HH, (6HZ), (6IL), (6IQ), (6JD), (6JG), (6JM), (6KP), (6MZ), (6NY), (6TX), (6VS), (6ZA), (7AD), (7BP), (7CC), (7CR), (7CU), (7CW), (7DK), 7EC, (7YA), 7YB, (7YS), (7ZB), 6XZ, 6JU.

5ZL, LITTLE ROCK, ARK.

1AW, 2XG, 2YH, 3BZ, 3EN, 4AA, 4AE, 4AG, 4AI, 4AL, 4AN, 4BC, 4BK, 4BM, 4BQ, 4BZ, 4CH, 4CP, 4EJ, 5AA, 5AB, 5AC, 5AD, 5AG, 5AJ, 5AL, 5AO, 5AP, 5AQ, 5AS, 5AU, 5AX, 5AY, 5BB, 5BC, 5BE, 5BG, 5BJ, 5BK, 5BM, 5BO, 5BP, 5BR, 5BS, 5BT, 5CA, 5DA, 5DO, 5EA, 5EJ, 5EO, 5EV, 5EW, 5EX, 5XA, 5YA, 5YE, 5ZA, 5ZC, 5ZG, 5ZK, 5ZN, 5ZO, 5ZP, 5ZU, 5ZV, 5ZW, 8AA, 8AE, 8AH, 8ADX, 8AHI, 8ALE, 8AM, 8AMN, 8ASF, 8ASG, 8CB, 8CD, 8CC, 8CF, 8DA, 8DI, 8DO, 8DW, 8EC, 8ER, 8EX, 8EZ, 8FH, 8FI, 8FP, 8FR, 8FS, 8GB, 8GP, 8HG, 8HH, 8HM, 8IF, 8IK, 8IX, 8JJ, 8JQ, 8JZ, 8KF, 8LA, 8LS, 8MN, 8MT, 8NF, 8NO, 8NZ, 8QJ, 8RS, 8TF, 8US, 8VP, 8XA, 8XK, 8XU, 8ZY, 9AAN, 9ABD, 9ACV, 9AD, 9AES, 9AHW, 9AII, 9AJ, 9AK, 9ANO, 9AQB, 9AP, 9ASP, 9ASQ, 9AU, 9BB, 9BM, 9BR, 9BT, 9BW, 9CA, 9CE, 9CN, 9CS, 9CW, 9DC, 9DF, 9DH, 9DK, 9DO, 9DR, 9DU, 9DT, 9DV, 9DX, 9EE, 9EG, 9EL, 9ER, 9ET, 9EX, 9EY, 9FA, 9FB, 9FD, 9FG, 9FH, 9FL, 9FO, 9FR, 9FS, 9FT, 9FU, 9FZ, 9GC, 9GK, 9GO, 9GS, 9GV, 9GX, 9HA, 9HD, 9HJ, 9HN, 9HS, 9HT, 9HU, 9HW, 9IF, 9IT, 9IU, 9JA, 9JE, 9JJ, 9JL, 9JN, 9JO, 9JT, 9JW, 9KF, 9KI, 9KM, 9KO, 9KV, 9KY, 9LB, 9LC, 9LF, 9LH, 9LO, 9LP, 9LQ, 9LR, 9MS, 9NE, 9NH, 9NQ, 9NX, 9OE, 9OV, 9OY, 9PC, 9PF, 9PI, 9PO, 9PQ, 9PS, 9PY, 9PZ, 9QM, 9RK, 9RE, 9RY, 9SS, 9TY, 9UA, 9UG, 9VC, 9VF, 9VP, 9VY, 9WH, 9WI, 9WU, 9WW, 9WZ, 9XR, 9YA, 9YN, 9YO, 9ZH, 9ZJ, 9ZL, 9ZN, 9ZQ, 9ZU, 9ZV.

3FG, PORTSMOUTH, VA.

(1AW), 2BV, 2CM, (2XH), (2XM), 3IB, 3JC, 3NB, 3CC, (4LB), 3DM, 3DK, (3EN), 3FR, 3LH, 3LI, 3RQ, 3RS, (8WY), 8XK, 8ZQ, 8ZW, 9AD, 9HR, 9VR.

2FG, 2GR, 2XG, 2XH, (2ZC), 2ZM, (2ZS), 2ZV, 3AN, 3BZ, 3EN, 3EV, (3NB), 3HJ, 4AE, (4BZ), 4YB, 5AB, (5AL), (5BT), 5EJ, 5KK, 5YA, 5YE, (5ZC), (5ZG), (5ZL), 6GQ, 8AI, (8AA), 8AJ, (8AL), 8AW, (8AKY), 8AUX, 8BV, (8CB), (8DA), (8DI), (8DV), 8EJ, 8EK, (8EN), (8ER), 8EV,

6PQ, SANTA ANA, CALIF.

6AE, 6AJ, 6AK, 6AM, 6AT, 6BO, 6BQ, 6BR, 6CA, 6CC, 6CO, 6CQ, 6CP, 6CS, 6CV, 6CW, 6EW, 6EJ, 6FE, 6FI, 6FJ, 6FU, 6GQ, 6HH, 6HO, 6HQ, 6IY, 6JK, 6KL, 6KM.

5ZO, HOUSTON, TEX.

9AD, 9AI, (9AJ), 9AK, 9AP, (9AU), 9AES, 9AHW, 9ABD, 9AII, (9BR), (9BT), (9CA), (9CS), 9CE, 9CR, (9CN), 9CP, 9CW, 9DF, (9DC), 9DH, 9DU, 9DR, 9DL, 9DV, 9EE, 9ER, (9EL), 9ET, 9FC, 9FZ, (9FE), 9FU, 9GC, 9GV, 9GO, 9HA, 9HI, 9HJ, (9HN), (9HS), (9HT), 9HU, 9IF, (9IT), 9IH, 9IX, 9JA, (9JE), (9JW), 9JB, 9KF, 9KU, (9KV), 9KM, 9KO, (9LC), (9LQ), 9MJ, 9MK, (9NE), 9NO, 9NQ, 9OQ, (9PF), 9PO, 9PS, 9PQ, (9PY), 9QJ, 9RD, (9RY), 9RP, 9UG, (9VP), (9WH), 9WW, 9WU, (9YA), 9ZC, 9ZJ, (9ZN), 9ZT, (9ZU), (9ZV), (8AA), 8AH, 8AII, 8AMN, (8ER), 8EZ, 8DA, 8FI, 8GB, 8IF, (8IK), 8IN, 8JJ, 8JQ, 8NF, 8HD, 6AW, 6CS, 6JG, 6GQ, 5AA, (5AB), (5AD), (5AF), 5AK, (5AL), (5AS), (5AU), (5AV), (5BE), 5BC, (5BG), (5BK), (5BL), 5BM, 5BO, (5BT), (5DO), (ex-5EW), 5EJ, (5ED), 5EO, (5YA), (5YE), (5ZA), (5ZO), (5ZG), (5ZL), (5ZN), (5ZP), (5ZT), (5ZU), 4AE, 4BZ, 3JU, 2JU, 2ZV, 1AS.

3EN, NORFOLK, VA.

1AW, (2BK), 2BM, (2JE), 2JU, 2XH, 3BK, (3BZ), 3EV, (3HJ), 3IR, (8KM), 3NB, 3XF, (3ZA), 3ZW, (NSF), 4AE, (4AL), 4AT, (5BZ), 4CA, 4CC, (4YB), 5DA, 5TW, (5YE), 8AI, 8BV, 8BQ, 8CU, 8DA, (8DI), (8EN), 8ER, 8IK, 8LA, (8MT), 8MY, (8NI), 8NM, 8QJ, (8RQ), 8WY, 8XA, (8ZW), 9GX, 9KO, (9MH), 9XA, 9ZL, 9ZN.

WAVERLY, (N. Y.), Radio Research Assn.

1AK, 1DQ, 1AW, 1CK, 1BK, 1YB, 1KAY, 1HAA, 1TS, 1FW, 2XA (tel.), 2ZM, 2ST, 2JE, 2TF, 2XK (mod-tel.) (voice), 2BM, 2PL, 2JU, 2TS, 2BB, 2DE, 2OA, 2AN, 2MU, 2BZ, 2GX, 2HJ (QSA very), 3EO, 3EN, 3CC, 3IB, 3NV, 3FK, 3BH, 3EW, 3FG, 3KM, 3WY, 3AB, 3ZM, (3NI), (3ABG), 3FA, 3DI, 3QR, 3DV, 3MN, 3DA, 3MT, 3EN, 3ER, 3IP, 3SH, (3HJ), (3DY), 3ZK, 3ZO, 3JU, 3RD, 3XU, 3XA, 3ZW, 3RZ (2" spark coil), 3ED, 3ASB, (3VW).

9HY, HOBART, IND.

1AW, 2BM, 2CB, 2CH, 2CS, 2JU, 2LO, 2ZU, 2ZW, 3AN, 3GO, 3NB, 3ZW, 4AK, 4XK, 5AA, 5AB, 5AG, 5AL, 5DA, 5DO, 5CX, 5ZG, 8AA, 8BV, 8CB, 8DA, 8DW, 8EF, 8ER, 8EX, (8FH), 8FP, (8IB), 8IX, (9BT), (9FC), 9HL, 9HT, 9HW, 9KO, 9NO, (9NG), 9OY.

9AU, CHICAGO

(Concluded from page 37)

For transmitting 9AU has a 1 k.w. United Wireless transformer, a specially designed gap with electrodes having a one inch face and 1/4 inch wide directly connected to a 1750 r.p.m. induction motor; condenser of 1/2 inch plate glass 15 x 12 inches with tin foils 7 x 11 inches, immersed in ten gallons of oil; and an oscillation transformer of heavy brass ribbon and of the usual pancake type. The popular Chicago hookup wherein a small anchor gap is employed with a single lead from the aerial side of the gap to the change-over switch, is used here, and the transmitter is accordingly placed in a convenient corner in the cellar.

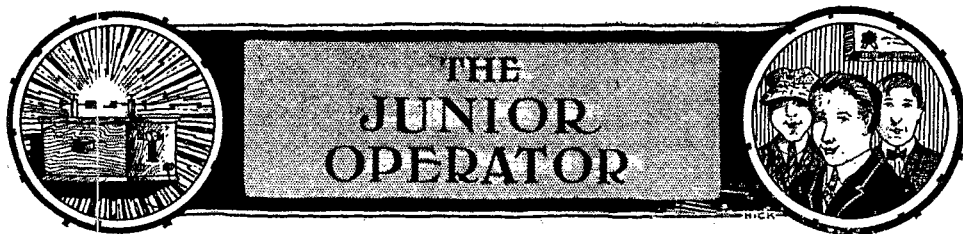

Conducted by Guy R. Entwistle

The Junior Operators will find here (and in the earlier articles mentioned) the very information wanted to construct a spark coil transmitter which will fulfill the requirements of the law, as well as giving a greater range than the improperly-rigged sets provide.—Editor.

IN previous articles receiving apparatus has been described. This month we deal with transmitters. A variety which is very popular with the beginner is the spark coil. Hence it will be taken up in detail. Unless you can send and receive at a speed of at least ten words per minute do not use any type of transmitter. It is not only illegal but bothersome to other operators. Send to yourself. Also both a station license and an operator's license are necessary. It is not sufficient as in the past to merely file an application for such; the licenses must be in your hands before your key is.

There are several reasons for the popularity of the "squeak box". It is cheap, low powered, and causes only local interference, and is adaptable to small antennas used for short waves. Contrary to general opinion there is less QRM caused by the spark coil operator than the transformer set that is still untuned, or in the hands of the willful interferer. We find it is not the apparatus but the individual who causes most of the QRM.

In the first installment of "The Junior Operator", November 1919 issue, the reader will find much of interest concerning the spark coil. Diagrams and hook ups are also given. An excellent article by S. B. Young has appeared in the columns of QST recently on this same subject. Review it. From here we will proceed.

One of the outstanding differences between this type of set and the transformer variety is in the amount of capacity used across its secondary. With spark coils we use less capacity than with transformers and also use a smaller and smaller amount as the size of our coil decreases. Below is a table giving the approximate value of capacity for the various size coils.

TABLE I

Size Coil	Secondary Voltage	Primary Volts	Capacity across Secondary
¼"	6000	6	.001 mfd.
½"	11000	6	.002 mfd.
¾"	15000	6	.003 mfd.
1"	20000	6-8	.004 mfd.
1½"	29000	8	.006 mfd.
2"	38000	10-12	.008 mfd.

Secondary voltages to be expected from these coils are also given. This is the OPEN CIRCUIT voltage without any condenser attached. The load voltage will be smaller. It is seen that as our coil gets larger we use more capacity across its secondary terminals.

Our next problem after selecting the proper capacity is to be able to build a condenser that will yield this capacity when assembled. Another table, II, has been added to assist the beginner in this work. All calculations have been made for him. He has only to use the tables.

TABLE II

Plate Dimens., inches	Foil Dimens., inches	Foil Area, sq. in.	Foil Thickness, inch	Capacity per sheet of glass
6x8	4x6	24	⅛	.0005
8x10	6x8	48	⅛	.0010
10x14	8x12	96	⅛	.0020
14x14	12x12	144	⅛	.0030
20x20	18x18	324	⅛	.0067

It will be seen from the table and also Fig 12 that one inch border has been left around the edges of all glass sheets. The student should note that twice the area gives twice the capacity. Also a standard thickness of glass has been chosen. Should glass twice as thick be used, then twice as many plates of the same area, or the same number of plates of twice the area must be used to give the same capacity as indicated in the table. Give this careful thought and you have a working knowledge of condensers.

Suppose you have a one inch coil. Table I shows a capacity of .004 needed. Table 2 shows that one sheet of 8x10 photo plate coated on both sides with a sheet of 6x8 foil will give .001 capacity. Hence we could use four of these sheets in parallel and get the desired capacity, .004. Another Table, III, is added for the benefit of those who may have different size plates on hand.

TABLE III

Corresponding area of foil for any capacity given in Table 2.

Cap.	24		48		96		144		324	
	sq. in.	sq. in.	sq. in.	sq. in.	sq. in.	sq. in.	sq. in.	sq. in.	sq. in.	sq. in.
.002	4	2	1	1	1	1	1	1	1	1
.004	8	4	2	1	2	1	2	1	2	1
.006	12	6	3	2	3	2	3	2	3	2
.008	16	8	4	3	4	3	4	3	4	3
.010	20	10	5	3	5	3	5	3	5	3

On the left the desired total capacity for any given case is shown. If for instance in the case of our one inch coil we needed .004 capacity and had no 8x10 plates but had some 6x8 plates whose corresponding foil area is 24 sq. in. per plate, we find that under the column reading "24 sq. in.", in Table III and opposite .004, is the figure 8, which means that eight of these plates will do just as well as four of the other 8x10 plates.

These tables have been prepared on the assumption that the dielectric constant for glass is 6. Should any reader use material having any other value, such as oil, with a constant of 5, then the resulting capacity with all other factors constant would be five-sixths of the capacity value given in the tables. The easiest way to do is to neglect this item until the finish and then take five-sixths of the total amount.

Our next problem is to assemble the condenser, the dimensions of which have been selected from the tables.

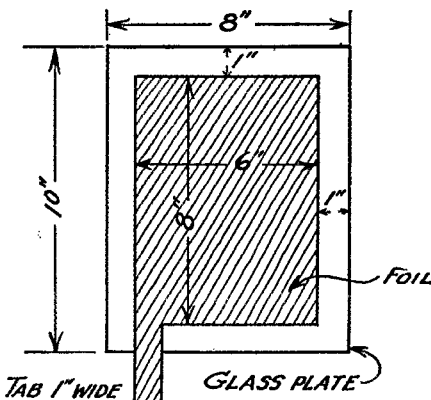
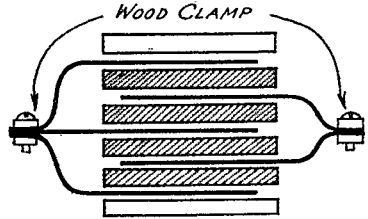

FIG. 12

Returning to the 8x10 plate, we will prepare it as shown in Fig. 12. Four plates are required. Lay one on the table with the tab toward you, the next one on top of that so the tab is away from you, or in other words have the tabs face alternate sides. BE SURE THE TAB IS ALWAYS ON THE TOP SIDE OF THE GLASS EACH TIME IN BUILDING UP THE CONDENSER. Otherwise you will



ASSEMBLY, .004 CONDENSER
ONLY THE 4 SHADED PLATES ARE ACTIVE IN GIVING THE CONDENSER CAPACITY THE OTHER TWO ARE FOR MECHANICAL PROTECTION

FIG. 13

short circuit the condenser. Before binding the assembled unit it is well to test for a short by trying to ring thru it with battery and buzzer placed across the leads, A and B. An extra plate is always added to cover any exposed foil to protect it from injury. This does not affect the total capacity and does not enter into the calculations. See Fig. 13 for the finished condenser.

After the capacity has been provided for, we next turn our attention to the Inductance. The theory of Inductance is out of place in an article of this nature. We can choose from two general types of inductance coil, the HELIX and the PANCAKE SPIRAL. The outstanding difference between the two is in the inductance value per turn. With a helix, every time you add a turn you add a uniform value of inductance. With the spiral this is not true, as the DIAMETER of the turns themselves varies and it depends upon whether you begin from the inside turn and work out or from the outside turn and work in, as to how the inductance varies.

CONTRARY TO GENERAL OPINION IT CAN BE SHOWN MATHEMATICALLY THAT THE INDUCTANCE OF A HELIX DOES NOT VARY AS THE SQUARE OF THE TURNS BUT MORE NEARLY DIRECTLY; that is, doubling the turns does not increase the inductance four times, but a little over two times.

Below is a table, IV, showing the proper amount of INDUCTANCE to be used with each value of capacity you may have selected for your condenser for wave lengths of 200 meters, also for 150 meters. The 150 meter data is given with the suggestion that the spark coil operators

(Concluded on page 56)

Radio Communications by the Amateurs



THE PUBLISHERS OF QST ASSUME NO RESPONSIBILITY FOR THE STATEMENTS MADE HEREIN BY CORRESPONDENTS

FADING WAVE-LENGTHS?

40 Stearns St.,
Bristol, Conn.

Editor, QST:

I have noticed something lately which I have not seen mentioned in QST or elsewhere on fading, and which I think might be of some interest. I have noticed that when a station which has a fairly broad wave, such as most of them have, fades out, by tuning to another part of his wave his signals come back in strong. As you know, I am at present using deForest honeycomb coils with shunt secondary tuning condenser. Here is an example. 1YB comes in at maximum audibility at about 23 degrees on secondary condenser but is audible (normally) over a range of about 20 degrees, or from 13 to 33 degrees on the scale. I tune him in at about 28 degrees and copy until he fades out and then quickly change to about 18 degrees and there he is again nice and loud again. When he fades there, I shift back to 28 and he is readable there. By shifting quickly back and forth in this manner it is possible to keep a station constantly readable. While I would not say that this positively works in every single instance, nevertheless it will work in a large majority of cases and is at least worth a trial. In this manner I have been able to copy several stations when fading was bad, where otherwise copying would have been hopeless.

I am wondering if anyone else has noticed this.

Yours truly,
Donald H. Mix, 1TS.

MORE SWINGING TUNES

272 N. Michigan Ave.,
Battle Creek, Mich.,
June 29, 1920.

Dear Editor:

Having read several articles in QST on fading, I feel at liberty to tell of some of my experiences. I have noticed the stations that do the most persistent swinging are stations that are broad-tuned or have two waves quite near each other. For example, 8ER used to fade here under all conditions. She had two waves, at least tuned that way at 8NZ, and I could copy her pretty well by swinging gradually from one wave back to the other. After

8ER was returned the trouble entirely disappeared and she comes in QSA even in daylight and very steady. 9ZN is the worst station to fade, but that I consider due to a pocket condition of some sort. I notice, however, that a station that is sharply tuned on one wave seldom swings badly and those tuned broadly are continually on the go and come.... I think it is easy to figure that on a broad tune a set will radiate on one wave stronger than another and will switch over from one to the other, which I have found to be true on my own set when using a wave-meter test.

Yours truly,
Elra E. House, 8NZ.

(Editor's Note: This letter, and the one from Mr. Mix, are interesting in suggesting that the cause of fading signals is not additive or neutralizing effects due to phase displacements caused by reflections, as is rather commonly believed to be the case, but can be caused by an actual switching of the radiated energy from one frequency to another. It will take a little more careful investigation to establish this, however, as it will be seen that if a station is not correctly tuned in in the first place, he will be received OK if the signals are loud enough, and upon commencing to fade he could be restored to strength by the securing of resonance. It is also to be noted that I.C.W. signals, such as those of NSF, which are extremely sharp, are not at all free from fading. The question of swinging signals certainly offers more encouragement to the investigator than anything else we know! The Editor wants to hear from anyone else who has noticed evidence of swinging TUNES. Question: could the air dielectric of a variable become temporarily ionized or otherwise changed in characteristic so as to effect its dielectric constant?)

"BROAD" C.W.

Bridgeburg Ont., Canada,
June 9, 1920

Editor, QST:

Almost every evening now we hear the hams testing out or trying to operate their C.W. sets. In QST and in other radio publications there is broadcasted the anxious questioning "Can we make C.W.

work? How is the other fellow going to 'tune in' to our almost too 'sharp' wave?" Most of us now have sets capable of extremely close tuning of the receptor circuits. The trouble is we have to be right on the other chap's wave or nothing is heard.

There is a most ridiculously simple solution of this trouble and it has been in use on certain stations for several years, right under our very noses, so to speak. Before going on to "spring the dope", I must concede that some amateurs may already have adopted such a scheme but they are not working within my range and will pardon me if I seem to presume.

When the British stations adopted a certain scheme to absorb the compensating wave on their C.W. sets, it was seen that some means must be taken to temporarily broaden the emitted wave, so that the receiving operator might catch it and tune in. Those who have listened to the British BZ—stations or to Canadian VAL, will remember the peculiar tone variations which occur in the note just before the station begins to send out a call. This tone variation is a purely local action in the receptor circuits and is caused by the change in frequency resulting from a gradual change in the wave length of the transmitting station. How this is accomplished in the case of sets of very large power is of course a secret of the admiralty; but any amateur can accomplish the same result by inserting a small variometer or vernier condenser in one of the valve circuits of his C.W. transmitter. Then, instead of using ordinary "spark procedure" as most amateurs (attempt to) do, start off with a long (20 second) dash and after the 5th second swing the variometer or condenser through its entire range and back again to its operating position. If all amateurs would adopt this scheme on their C.W. sets, they would be giving receiving stations a chance to pick them up and, I believe, would find a great deal of satisfaction in the use of C.W. for transmission.

A word of caution may not be amiss. Do not have the variometer or condenser too large or it will detune the set, not only too rapidly but will pass through a point where the valve will either operate at inaudible frequencies, or else not oscillate at all.

For 200 meter work a very small change in wavelength will do the trick.

Sincerely,
Chas. A. Lowry.

ON FREAK RECEPTION

Brooke, Va.

Editor, QST:

Noting the past few issues of QST

have contained considerable dope on the freakishness of short wave reception, I wish to offer the following personal experience along this line in the hope that we may at least determine if my observations hold good with others, and if so it should be of benefit to the relayers who carry out the idea.

From what I read, it seems almost universal that at each station there are certain "groups" of stations that come in more regularly and persistently than the others. To a great extent this holds true regardless of distance (within reasonable limits, of course) and, unless by chance, regardless of the direction of the aerial. That is, the aerial itself shows no appreciable directional qualities, as the group of stations to which it will respond best may be located at right angles to it, or at any other angle, and there may be more than one group to which any receiver may respond efficiently, but usually there is but one real BEST group.

With these things in view we will consider the following. "A" has a good receiver and receives over a considerable distance but there is a certain group of stations X, Y, Z, located approximately 500 miles from him that come in "over top" of everything else with persistent regularity, while some other groups of stations located probably not more than 100 or 150 miles from him will just as persistently keep out of his receiver or come only indifferently.

Now "B", who may be located in the same town or very close to "A" with as good a receiver and just as skilled an operator as "A", will not be able to hear the group X, Y, Z, at all or only indifferently, while he will hear another group U, V, W, just as persistently as "A" does the XYZ group.

"C" might not be able to hear either of the groups that "A" and "B" hear with any big success but he will hear all of the comparatively nearby stations much better than either "A" or "B" and in these nearby stations will also be another group that will come better than the others.

And so it goes, each amateur being able to hear certain groups and distances better than others, which naturally leads us to the question of what is the cause of it all.

My observations to date seem to show this peculiar condition is dependent upon the HEIGHT of the receiving aerial. Whether I am right or not I do not know, but I offer this as a probable cause and in the hope that others will experiment with different height aerials until the stations they most desire to relay with are brought in at their best.

I will give two examples of this as follows:

With an aerial about 65 feet high, amateurs in Indianapolis, Ind., Chicago, Ills., and Ft. Wayne, Ind. (9th district) and most all in Ohio except St. Mary's, try to climb all over any of the nearer-by 2nd and 3rd district stations, while comparatively nearby amateurs are hard to hear and come in very indifferently with lots of fading. Washington, Baltimore, Norfolk, etc., are conspicuous for their absence.

Now reducing this same aerial to about 30 feet, the following surprising results are noted.

Scarcely a sound from the 8th and 9th district stations, that were so good before, while we now find a spot way up in Massachusetts that seems to carry the day for the best long distance, while the amateurs around Baltimore, etc., that were so noted for their absence with the 65 foot aerial now come in by the dozens.

Other peculiarities, such as the changes in signal strength and regularity of individual stations, are also very noticeable, which leads me to the belief that signals from certain stations will pass right over a certain height aerial while another station either at a greater or less distance might find this same height aerial ideal to come in on. Which, so far as the individual stations are concerned, might be a combination of the different heights of both receiver and transmitter.

This leads me to believe that it might be possible for two relayers to work together with different height aeriels and thus improve their work with each other.

The one outstanding feature of my experiments is that with no combination yet tried have I been able to get St. Mary's, Ohio, with any satisfaction, although I hear others all around her (on the 65 foot aerial) and others comparatively close to me hear her, but so far as 8ER and myself are concerned there is evidently one of those pockets or something between us; still it may be possible that 8ER could be made to come good here by having the suitable height aerial. I do not mean to infer I never hear 8ER, but that considering the fact that she has such a good station and that I should hear her good, she comes very unsatisfactorily here on anything I have yet tried.

There is an answer to this amateur freakishness somewhere, in fact there are several answers; but from several years' experience, interrupted by the war, I am almost certain one of the answers is the height of the aerial.

It appears that nearby amateurs (75 to 100 or 150 miles) come in with most persistence on the lower aeriels and do not swing half as badly as on a high one, and as the nearby amateurs of these distances should be heard well, it seems

that to avoid freak work and establish a sure-enough relay route, the sets should be made to work best with the nearest stations practicable, and when this is brought about not only will freakishness be reduced, but regular daylight communication can be carried on over these distances, where it would be impossible to do so if your aerial is "tuned" to a bunch of stations way out of your possible daylight range, for it is impossible to avoid freakishness when working much over the possible daylight range of your set.

One cause of so much so-called freakishness is the fact that the amateur as a rule tries to work far in excess of the normal range of his set and calls it freakishness when he can't get through one night or one hour as well as he can the next, when in reality it was only freakishness that allowed him to get through at all.

We all like distance, 'tis true, and it is all right to sit down occasionally and see how far one can hear, but when it comes to the relay business I am sure that sets and aeriels designed for shorter distances will be far more reliable.

Let's think the matter over and see exactly where we do stand in this important matter.

With best wishes, I remain,

Sincerely,

A. L. Groves.

(Editor's Note: In another communication from Mr. Groves he suggests the use of an aerial wherein the horizontal wires are stretched between masts in a vertical plane, one above the other, instead of in a horizontal plane between spreaders, and with the lead taken from the center. If it is true that fading and other such phenomena are due to a variation in the conductivity of the atmosphere which in some manner "converts" the radio waves to a higher or lower altitude, such an aerial should take care of a considerable variation and result in much improvement. It will be interesting to learn what results QST readers note from experiments along this line.)

BUZZER TRANSMISSION

3414 Parkview Ave.,
Pittsburgh, Pa.,
May 14, 1920.

Dear Editor:

In regard to buzzer transmission I tried out the hookup by Mr. Jones in the May number of QST and secured good results for the amount of power I used. Using a "Century" buzzer operated on two dry cells with a Litz inductance composed of 160 turns on a tube 3½" in diameter, I was able to carry on communication for a distance of two miles and the receiving station was using a crystal detector. I also worked Carnegie Tech, which is over

$\frac{1}{2}$ mile, and was reported QSA, and I am still going to continue tests and see if I can get better results with different hookups.

73

Allan T. Machesney, 8EW.

MECHANICAL QUENCHING

Koko Head, Hawaii,
April 14, 1920.

Editor, QST:

Anent the discussion which has been carried on from time to time in QST regarding the possibility of securing quenching effects with rotary gaps, the following occurs to me:—

Even on wave lengths of several thousand meters, it has been found impossible to secure anything like perfect quenching by purely mechanical methods—that is, by making the gap speed so high that the electrodes separate quickly enough to quench the spark after a few oscillations. A powerful air-blast has proved a help to quenching, but has not made it possible to perfectly accomplish it. If this is the case on long wave lengths, how much more difficult will it be to secure mechanical quenching on short wave lengths, where the oscillations are much more rapid?

A system has been used in commercial work which accomplishes good quenching with a rotary gap by a novel method. This system is in use at the station from which "VN" writes so humorously about Mars and other things. I see no reason why it could not be put into practice by amateurs. It is a so-called "ignition" system, in which the spark gap electrodes are set so far apart that the spark will not occur of itself—that is, the condenser voltage is not sufficient to break down the gap. Then by an auxiliary "timing" arrangement, a sufficient voltage is added to the main condenser voltage at just the desired instant, and the gap breaks down and a spark occurs. By adjusting the instant of the "triggering" the spark may be made to occur when the rotary and stationary electrodes have passed each other and are rapidly getting farther and farther apart, thus securing mechanical quenching by the separation of the electrodes. Of course the losses due to the longer spark length will be considerable, but this fact will be compensated for by the close coupling it will be possible to use and the rapid transfer of energy into the aerial circuit.

In practice the triggering device consists of a small auxiliary gap wheel on the same shaft as the main wheel and having the same number of teeth. This auxiliary gap is connected in circuit with a small condenser and oscillation transformer, really a little set all of its own.

The secondary of the oscillation transformer of this little set is connected across the main condenser through a very small blocking condenser to keep the main condenser from discharging through it. The main gap does not break down by itself, and the small gap is set to spark just a little after the electrodes of the main gap have passed each other. The added voltage across the main gap from the oscillation transformer of the auxiliary set then triggers the main discharge.

A much simpler arrangement along the same lines which is more adapted to amateur use is the following:

An auxiliary gap is placed in the same shaft as the main gap as before, and is so located that the light from its spark shines directly on the main gap. The latter is set so wide that it does not break down of itself, as in the previous scheme. But when the air in the main gap is ionized by the discharge of the auxiliary gap, due to the ultra-violet light of the latter falling upon the former, the main gap breaks down with

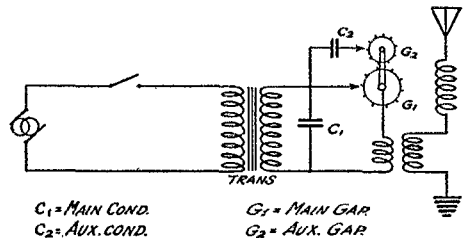

ease. Any desired "delay" of the main spark can be obtained by adjusting the relative positions of the two discs on the shaft or by moving the stationary electrodes. The connections are shown in the following figure:—

The condenser C_2 should be very small compared to the main condenser, and the leads of the auxiliary circuit should be short, so that the wave length of this circuit will be very short compared with the wave length of the main primary circuit. This is necessary so that the complete discharge of the auxiliary circuit may occur in less than one complete period of the main primary circuit. In practice the auxiliary circuit should be disconnected and the main gap opened until it just will not spark with full power on. Then the degree of delay is adjusted as desired, and the auxiliary gap connected. In tuning such a set, all the peculiarities of a quenched spark set will be discovered, such as sharp tuning and very critical coupling adjustment. Close coupling should be used, and whether or not true quenching is being obtained can be determined by a wave-meter, which will in-

dicate but one hump in the wave if quenching is being obtained.

Very truly yours,
S. W. Dean.

AS IF WE CAN'T TRAIN 'EM TOO !

Manitowoc, Wis.,
May 17, 1920.

Dear Warner:

Just a few words in warning. I am giving my wife code practice right along, and am going to have her stand a watch at 9ZL next winter. When she and Mrs. SER get chewing about Mrs. ZZZ's new hat, the rest of you might as well quit. 73.

Sympathetically,
H. J. Burhop, 9ZL.

GOOD CIRCUITS USING SLIDE TUNERS

39 Cameron St., S.,
3DS, Kitchener, Ont,
May 17, 1920.

Editor, QST:

I am enclosing a new connection with which some amateurs may be able to use old tuners, etc. For the peculiar use of the three slide tuner as a tickler circuit, I am indebted to Mr. Jones, an amateur of Brantford, Ont. The other circuit (No. 2) is one which we have been using all winter in connection with a rebuilt DeForest detector cabinet and "A" Moore-head tube. It is, however, rather troublesome to adjust, so we are using No. 1 now.

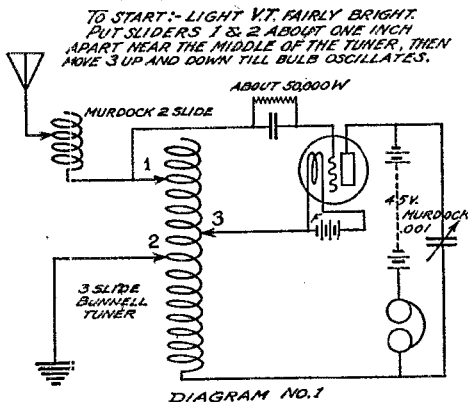

No. 1 brings in all kinds of 1, 2, 3 (Canadian and U. S.), 8 and 9 amateurs and brought 2XJ's fone in QSA every night without amplifier. The reader will note that there are no primary or secondary condensers in this hook-up, which, I believe, makes for its efficiency on short waves. We have, however, got some stations with a V.C. either across aerial and ground or in series with ground. A Murdock tuner used as a loader makes fone come in much louder.

The aerials, of which we have two, are as follows: one is a single strand No. 18 D.C.C., 200 feet long, 20 feet high. The other is two strands 500 feet long, 80 feet high, stranded of the same kind of No. 18 D.C.C. It consists of nearly one mile of wire. Theoretically this large aerial would not be any good for short waves, but with this circuit one can receive anything as far as wave is concerned. We can always listen to NSS, and one time I am quite sure I heard NFF. This does not sound reasonable, as the Alexanderson H.F. alternator is supposed to have no harmonics.

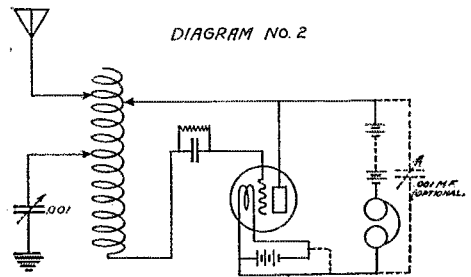

A strange feature of this set, more noticeable than in diagram No. 2, is that you have to tune apparently ABOVE NAA to get most amateurs. We have been unable to find any reason for this, so if any one can enlighten us as to why such a thing should take place please let him go to it (after he tries the hook-ups).

Yours truly,
Carl Rumpel, 3DS,
Per, H. H. Gowan.

C.W. STATIONS, SIGN !

546 Kitchener Ave.,
Detroit, Mich.,
May 23, 1920.

Editor, QST:

Using the circuit I sent in and which was published in the December 1919 number, I hear a number of amateurs using C.W. modulated telegraphy and phone. They are usually testing with some friend, usually in the same town or sometimes send out a CQ and sign off. That is all very well and proper, but for a fellow that hasn't the opportunity to put in a sending set to bust in and ask him QRA, how are we to know who the station is if he is not listed in the list of calls?

As an illustration, I heard an amateur in a city 385 miles from Detroit talking to a fellow in the same city using C.W. modulated. He gave the fellow his address and invited him over. I sent him a letter telling him he was heard by me and he answered and practically called me a liar. Said he was only radiating 6/10 amps and thought he should get a couple miles out

of the set but my letter was "too much".
Who is UM, GMA and 8GY? I hear them quite often on C.W. very QSA.

Respectfully,
H. V. Simmons.

(Note. UM and GMA are stations of the Glenn L. Martin Aircraft Co. at Cleveland, Ohio. See page 13 of April QST. 8GY is L. D. Coman, Jr., Chardon Rd., Euclid, Ohio.—Editor.)

OH LADY, LADY !

516 West 27th St.,
Baltimore, Md.,
May 21, 1920.

Dear Fellow Relayers:

Thank mightily for the membership certificate—I am certainly proud to own it. I am possessed with a mad impulse to paste it on my back that everyone may see it. I think this is just the splendidest organization in existence and I am looking forward to the time when I can be a useful member.

But please please, kind friends—spell my last name correctly! It ends in n (—) not r. It breaks my heart to see it misspelled.

Thanking you, I am,
Very truly yours,
(Miss) M. Adaire Garmhausen.

QSO TENNESSEE.

Copleville, Tenn.,

Editor, QST:

As I have not seen anything in QST about radio in Tennessee, I thought I would let you know about this section of the country.

As I am about twelve miles from the nearest a. c., (Memphis, Tenn.), I have to depend on a spark coil (1½ inches) and am heard by amateurs in Memphis. For receiving I am using a loose coupler and AudioTron bulb and get very good results, hearing stations with phones on the table often. 4AE is my most dependable station. Some of the fellows come in on 1,500 almost as well as on 200 meters.

The stations in Memphis are about ten in number and most of them are very inefficient with only QRM-kids to work them. Three are transformer sets and I am going to take it upon myself to get some of them in good working order so we can have a relay thru here. Why, some of these "hams" do not know what a QST is and objected to their "5" calls because they hated "numeral calls." Wouldn't that tickle you? But I will fix some of them up myself. One ham had a two-wire aerial fifteen feet high and forty feet long, parallel to a. c. wires, twisted lead-in wires along the roof, not soldered, ground to an iron pipe twisted around said pipe, not soldered, and his other connections

all twisted up in a solid mass, and then he wondered why he could not hear any sigs.

Well, anyone hearing 5FM please let me know and call me any night between 7 and 9 p. m. I will let you know if I hear you.

Sincerely yours,
Malcolm Richmond.

[Editor's Note. In the pre-war days Memphis was just about a hopeless proposition as far as relay activity went. There was never anything doing there in that line as far as we know, altho two colleges and one individual had good stations. The Editor would feel happy to learn of the existence of efficient and interested stations in that city.]

MISTAKE, WE'VE STILL GOT IT.

New Orleans.

Editor, QST—

The steamer Columbia docked at Puerto Barrios, Guatemala, April 10th. A typical Central American revolution was in the making, the total male population of the town having been called to the colors by the Commandante. Consequently it was necessary for the officers and crew of the Columbia to load the ship and yours truly and the junior operator checked cargo. On the morning of the eleventh while all hands were busily engaged the revolutionists swept down on us their sole object being to watch white men work and to lick up some of the sugar spilled in loading. There must have been five hundred of them and such a mob. They ranged from about 12 to 60 years of age and were dressed in a weird assortment of ragged clothes, straw hats and mostly no shoes. Each one carried a Machetta (Spanish term for a butcher knife approximately 3" wide and 24" long), a few had rifles dating far back in the eighteen hundreds, and there were some clubs in evidence. Lurking in the rear of the mob I noticed a tall lanky hombre in a faded blue jumper, a pair of trousers that were once white, both articles more or less holey, a broken straw sombrero covering a mass of long greasy black hair, and home made sandals. Believe me, in this outfit and a 30 day's growth of whiskers he looked wicked, and listen—what do you think? Grasped firmly in his right mit was the Old Man's Wouff Hong. I swear it was. Please, Mr. Editor, has the Old Man given up hopes of being able to use the Wouff Hong on some of these QRM Hams and sold it to the Guatemalan Revolutionists or was I asleep on the job instead of getting my traffic off to Swan Island and dreaming all this?

Very truly yours,
N. E. Holt,
Ex 8BC, Ex 8ZB.

“How to Build A Wireless Station”

By M. Adaire Garmhausen

No, we're not starting a Women's Auxiliary—not quite yet. But they're getting in the game, fellows, and soon it will be Marcelle Waves vs. the Hertzian brand. Mrs. SER should watch her laurels. In this story Miss Garmhausen gives an amusing account of how a “Ham (F.)” breaks in.—Editor.

WELL, it's just like this—these super-intelligent articles in QST are way over my head. After I swim thru an especially high-brow contribution such as “a generator for plate voltage” or “a voltage for plate generators”—whatever it was (apologies to the author)—I gaze out of the window and wonder if I will ever be able to appreciate these essays to their full value. Then perhaps I turn the page to where 8-somebody-or-other's highly efficient set is pictured or described and I look at my own collection here and laugh till the family comes running in, in wild alarm. So, just as a sort of reaction from the sublime to the ridiculous I shall proceed to describe my own efforts to “get in the game”.

To begin with—I belong to the so-called “fair sex”, and we are never expected to have brains. Also, my knowledge of radio telegraphy is decidedly limited. True enough I possess a commercial license, but it isn't hard to learn what the book says. When it comes to applying that knowledge—that is a “different matter”. However, there is nothing like trying, so one day when my ears got to itching for the gentle buzzing till I could stand it no longer, I knocked off work about four o'clock and waltzed up to the radio shop I had discovered on Calvert St. I didn't care much what I bought just so I could hear a little radio on it. That little simplest receiving set we draw for the examination came to my mind now, so I got a crystal detector and a pair of phones, also some copper wire. Of course everyone in the shop (about fifteen curious youths appeared from nowhere) took me as a huge joke and poured forth fabulous tales about hearing POZ on one wire and some insignificant apparatus, etc., and each offered suggestions to which I harkened not. Only one of them was civil and I appreciated his courtesy. My enthusiasm waves were still undamped so I proceeded homeward to erect my aerial. Here was a real problem! I had spent lots of thought on how I was to get it up, but had arrived at no conclusion in spite of the manifold suggestions from the shop, so I thought I would reconnoiter on the roof a bit and possibly work out an answer. I broached the sub-

ject to my father. He replied that if I put masts on the roof they would be a constant menace for fear of being blown down, and besides, the less I tramped around on the roof the better off I'd be. I tackled my mother. She informed me that walking on the roof might make it leak and that I certainly could not go up. So, having secured their permission, I borrowed a ladder from the lady next door and climbed to the roof. I found two chimneys ideally located and pressed them into service. I had some porcelain cleats on hand for insulators and in a short time I had a two wire inverted-L aerial erected, as good as any. My lead-ins are too long but I expect to try another kind of aerial soon, so shall fix them then. This much being done I went below. It was getting dark now and I was still in frenzied haste to hear some radio so I connected the end of the lead-in directly to the detector. My set is by the window so I led my ground lead out my window and into the kitchen window, directly below, where there is a water pipe. I had forgotten a ground clamp in my haste so I simply coiled the wire around the pipe. Rushing upstairs again I shunted the fones around the detector as per the diagram and—behold! thru the stilly night purred the beloved sounds into my eager ear. And I just want to say, if any of you remember the first signals you ever heard on your own set, AIN'T it a gran' and glorious feelin'? I sat up that night till all had been silent a long while, and early the next morning I was at it again. I was unable to obtain a ground clamp so I used a hose clamp, which is just as good and in fact almost the same thing. After I put that on the water pipe and made a neat connection, I retired to the set to see what was going on. Things were quite lively. NBZ and 3OU were both sending and I could read both on account of the difference in spark notes, even thru static. Suddenly above these came a rhythmic pulsation persisting with mechanical accuracy. Could it be—!! the time from Arlington!!—on only detector and fones!!—and my little aerial!!!! Breathlessly I waited while the pulsations continued—then a pause—and then—oh crown of fame—“QST-QST-QST-de-NAA-NAA-NAA.” Pop-eyed with joy I rushed

downstairs and embraced my startled mother. I danced a Highland Fling around the kitchen singing, "I heard Arlington—I heard Arlington". If the lad who had sent those gladsome words had known the excitement he caused in our camp he would have been amazed. Nightly thereafter I listened for the time. About nine o'clock one night I decided to make a tuning coil and see what effect it would have on my range. Any tuning coil I would construct would be just as liable to reduce the range as increase it. I had some bell wire on hand but nothing to wind it on. A tour of the cellar yielded a glass jar about three inches in diameter and about a foot long—just what I wanted—and upon this I wound about seventy feet of the bell wire. The diagram called for a fixed condenser, but I didn't have any so I used a variable. It served the purpose nicely and a lot more stations came in. So far everything was lovely—and then came a thunderstorm. It reminded me that I had no protection for my set and that lightning is no friend to radio hams. The family did not know how to disconnect the apparatus and if I forgot it and was away from home during a storm something was liable to happen. So I got me a switch. What I know about switches could be printed in scare-head type on a postage stamp. I wanted to connect so I could throw it one way and connect the set in and throw it the other way and just connect the aerial and ground. I had a suspicion I knew how I could do it so I brought my lead-in down along the window, screwed the switch to the wall, and made the whole connection so neat that the family wondered what had become of the wires. The wiring I learned from electricians I have watched at work. I hooked the set in but wasn't at all confident of results. With the fones on, I threw the set out. Silence reigned supreme. Then I threw it in, and the low rumble of static told me all was well. My delight knew no bounds! "Eureka!" I shouted "She does work after all—there's static—hurray"! My sister was in the room. "For pity's sake, shut up about static!" she said. "You have a fit every time that fellow sends. You must be in love with him"! Oh yes, I must be—we all are. But the connection was right, anyhow.

And that with a buzzer tester constitutes my entire set. Go ahead and laugh—I expect it. But wait till my audion and amplifier arrives that I sent for back in the dim ages. I shall defy a flickering smile to cross one face, for I expect to hear the soup chorus of the Esquimeaux at six p. m. every day. And when I have perfection in receiving sets I shall construct a transmitting set that will make the night hideous for the whole United States.

One thing I have discovered about radio

—it is never as hard as you think it is going to be. When you get started everything works out like magic. I hope this isn't just beginner's luck because I still have almost everything before me, but I'm learning more and more every day and that gives me hope that some day I will be able to appreciate to the fullest those super-intelligent articles.

THE JUNIOR OPERATOR

(Concluded from page 48)

slide down with their wave length and help themselves and others.

TABLE IV

Cap. Used with Coil	Units of Inductance for 200 m	Units of Inductance for 150 m
.002	5630	3160
.004	2820	1580
.006	1880	1052
.008	1400	790
.010	1126	633

Of this total value of primary inductance, allow about 500 units for the leads from the condenser to gap and inductance. These SHOULD UNDER NO CONSIDERATION EXCEED TWENTY INCHES.

Our one inch spark coil needed .004 capacity. This fixes the inductance of the primary not to exceed 2820 units for 200 meters and not to exceed 1580 units for wave length of 150 meters. Subtracting 500 units from the total amount, 2820, we have 2320 units for the primary itself.

Our next consideration is what size helix and how many turns will yield this value.

The helix will be made of ¼ inch brass or copper ribbon, six turns spaced three-quarters of an inch. The diameter will be seven inches. About four and one-half turns will be needed for 2820 units and about two-and-one-half turns for 1580 units, for 200 meters and 150 meters respectively.

The secondary of the oscillation transformer will be similar in dimensions and the full six turns can be used with an antennae whose total length, including lead-in and ground lead, does not exceed 140 feet for 200 meter radiation, and an antennae of not over 100 feet total length as before for radiation at 150 meters wave length.

It is hoped that the above data will be of service to the amateur in putting up a good spark coil set. He is cautioned not to split hairs on the Tables but to take the figures as a guide to his dimensions. The tables have been carefully prepared and can be depended upon.

How to Make a .002 Mfd. Balanced Condenser

By George Sturley

HERE'S a QST to all bugs who want a large variable condenser for tuning on long wave arc stations, for wave meters, etc. The following article explains how I built several large balanced condensers from regular 43-plate stock Murdock condensers. I have had very good success with them, and altho some rather particular machine work is necessary to build one, the experience and possession surely makes it worth while. As actual performance I have a 5 1/2" coil with 700 turns and with this .002 condenser get 4800 to 18,000 meters; with 500 turns, 4300 to 13,000 meters; with 350 turns, 3500 to 10,000 meters; with 200 turns, 3000 to 6000.

The accompanying photo shows all the parts of the condenser and also one of them all assembled. First get two interiors of Murdock No. 366 condensers and take them to pieces. Be very careful not to strip the thread in any of the holes in the moulded solder. Before putting screws back into such holes, put a little grease on the screws. Don't try to use the old top and bottom pieces as the moulded material is too brittle. Turn new discs out of 1/4" Formica, 3 3/8" diameter. While still in the lathe, center and bore a true 1/4" hole. Now take one of the old Murdock top or bottom pieces and locate three of the screw-holes in the Formica discs. Hold the Murdock piece on the Formica by passing a short piece of 1/4" brass rod thru. The holes should be 3/32" —or a No. 28 drill will do. Now look at Fig. 1. By scribing a line thru two of the located holes as shown, and scribing a line parallel to same but 3/4" distant, the position of two corresponding holes for the other side of the condenser will be

located. Swing the Murdock piece around until the two holes show the scribed line thru their centers, clamp in a vise, and drill these other three holes. When finished test with dividers to see that everything is symmetrical, and the completed disc can then be used as a jig in boring the bottom disc, which is just like it. Now turn out four pieces of brass

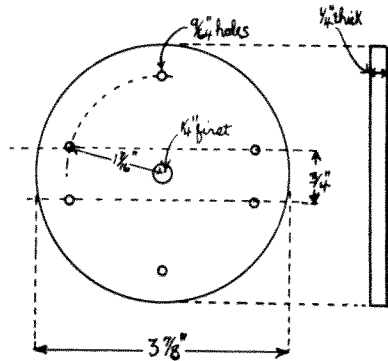

— FIG. 1. —
FORMICA DISCS

rod exactly 2" long, drilled and tapped for 6-32 screws at each end, and two pieces 2 3/8" long, similarly drilled and tapped, all from 1/4" stock. Then make two brass link pieces as in Fig. 2. Two brass discs, 1/8" thick and 1 1/4" diameter are bored 1/4" thru centers, are sweated on the rotary plate shaft ends, and by the screw holes shown two 8-32 flat-head screws hold the discs together and make a flange coupling. It must be said here that this coupling must be accurately done; otherwise you will invent a new vocabulary

of choice adjectives especially concerning variables!

Next come the bearings, Fig. 3. The bottom bearing is turned from 5/8" rod and is bored 1/4" to fit the bottom shaft end. For the head bearing make an extension piece that will fit tight over the short projection and also carry the handle. This is turned from 1 1/2" rod and if any old bronze is handy it will beat brass. Bore an

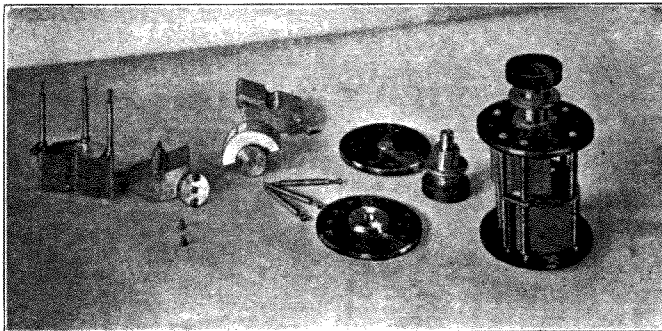

accurate $\frac{1}{2}$ " hole for the shaft, and three holes for screws. The holes in the Formica will now be reamed or turned out to $\frac{1}{2}$ " for bottom and $\frac{3}{4}$ " for top,

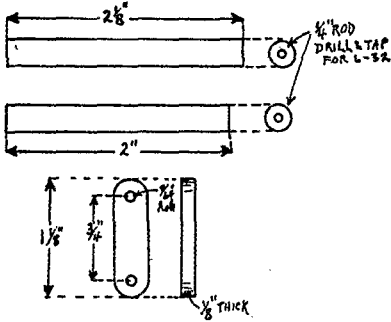

— FIG 2 —
SPACING RODS & LINKS OF
STATIONARY PLATES

to take the bearings. The shaft extension-piece for the handle end is bored with a $\frac{1}{4}$ " drill that has been ground a little undersize to insure a tight fit on the condenser shaft. The condensers I made carried $5\frac{1}{2}$ " brass dials $\frac{3}{16}$ " thick for calibrations, but if the reader omits these, the extension piece can be altered to suit individual requirements. Brass spacing washers turned from $\frac{1}{2}$ " stock held the top Formica piece the required distance behind the receiving set panel, and these can be made to suit the builder. In assembling, it will be found a shim about $\frac{1}{32}$ " thick will be necessary in the flange coupling of shaft. Electrical connections are made to the head bearing and any of the stationary plate screws. End play or vertical movement of shaft is limited by making a brass washer $\frac{3}{8}$ " diameter and bored $\frac{1}{4}$ " to slip over the head of the shaft. It will be about $\frac{1}{16}$ " thick.

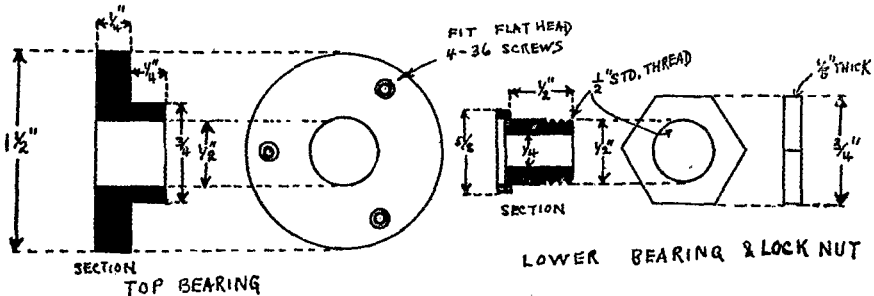

— FIG 3 —
BEARINGS

Oil-Cooled Step-Down Transformers

There are a great many amateurs who have trouble with their step down transformers of the open type heating up when there is a heavy pull on them. A good remedy to protect the insulation is to immerse the transformer in oil. Procure a tin can such as a varnish can (square); cut down to the height of the transformer. Next fasten rubber covered wires about 6 inches long to the low voltage posts. Then the transformer is set into the tin

and a piece of fibre or wood placed in front of the binding posts to prevent a short on the side of the tin. A good grade of transformer oil is poured in up to one half inch of the top. Paraffin is then melted on the oil. When cool, sealing wax is poured quick on the paraffin so the top of paraffin is covered. I find this very satisfactory in running my spark coil with a Tesla coil.

—Contributed by William C. Babcock.

CLUB OFFER

QST and Pacific Radio News

Both for one year for \$3.00
if ordered together.

QST, 721 Main St., HARTFORD, CONN.



PATENT-SENSE

"The Book for Inventors & Mfrs."

By Return Mail FREE. Write
LACEY & LACEY, Dept. Washington, D.C.

The "Sine" of the Fraternity



Ready for distribution July 15th—the new A.R.R.L. Emblem, officially adopted as the insignia of the League, as mentioned on another page of this issue.

We know that every member of the A.R.R.L. will want an Emblem. Wear this to let the fellows know that you are an amateur—in two weeks it will be the universal means of identification. When you see this pin on a man, you know he's all right—he's an amateur; more than that, a brother member of the A.R.R.L.

In extra-heavy rolled gold and black enamel, five-eighths of an inch high. Furnished with either pin or screw-button (lapel) mounting. In ordering specify which you desire.

Postpaid and insured

\$1.50

SECRETARY, AMERICAN RADIO RELAY LEAGUE,
61 Waverly Building, Hartford, Conn.

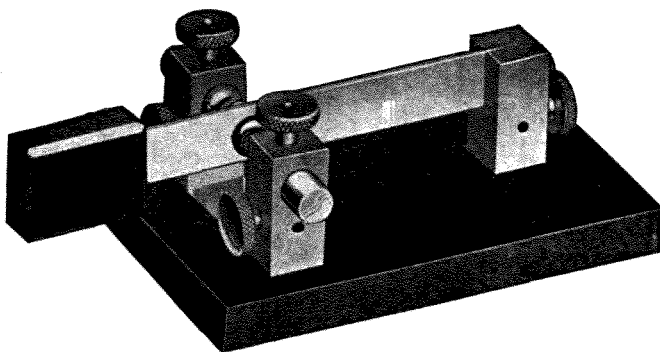

"COOTIE" KEY

Cat. No. YM6

The "Cootie" key is the snappiest sending device offered on the market for reliable spacing of characters. Listen to 9NV, 9LU, 9MS, 9UG, 9BY, and judge for yourself. Large standards, formica knob, substantial silver contacts suitable for use up to 2KW. The double action of the "Cootie" key lends an individuality to your sending.

Price

Nickel Plated \$5.00
Plain Brass \$4.50

Distributors for the

DeForest Radio Tel. & Tel Co.

Clapp-Eastham Co.

Amrad Products

Wm. J. Murdock Co.

—Immediate Deliveries—

Send for our
Fifty Page
Catalog,
4c.
in Stamps

Young & McCombs
L. P. BEST PRES.
ROCK ISLAND, ILL.

Address all
Orders to
Radio Dept.
No. 67

A Good Wavemeter AT A MODERATE PRICE



TYPE B. Q. WAVEMETER

Bulletins Z and F sent for 4c Stamps list our complete line of high grade, moderately priced apparatus for the radio laboratory. Bulletin R lists the Cambridge Rectifier for Storage Battery Charging.

CLAPP-EASTHAM CO., 114 Main St., Cambridge, Mass.

is accurate simple and rugged. Comprises a portable oak case $5\frac{3}{4}'' \times 8\frac{1}{4}'' \times 6\frac{1}{2}''$ with hinged cover, bakelite panel, balanced condenser, buzzer, detector, switch, binding posts, and two 2 unit inductance windings, range 200 to 2000 meters.

Price \$27.50

These meters are in stock for immediate delivery and are carried in stock by most good dealers.

The Man Who Builds His Own Wireless Apparatus

Are you one of the men who takes more interest in constructing his own wireless apparatus than in purchasing the complete set from the manufacturer? You have thousands of fellow enthusiasts all over this country. There surely is heaps of satisfaction in "making your own" apparatus and knowing exactly the kind and quantity of material that goes into each working unit.

Your insulation may be good or bad according to the material used. Ask any of the former amateurs and experimenters what satisfaction they secured from genuine

BAKELITE-DILECTO

then ask the modern wireless man what he thinks of this insulation. You will find **BAKELITE-DILECTO** used wherever insulation is needed in the better types of modern apparatus. It's so convenient to use because it is furnished in Sheets, Rods and Tubes. Waterproof, permanent and strong.

We manufacture Vulcanized Fibre, Conite and Continental Bakelite.

Let us show you how our Standard Products can be made to solve your insulating problems.

THE CONTINENTAL FIBRE CO. NEWARK, DELAWARE

233 Broadway, New York City
525 Market St., San Francisco, Cal.
301 Fifth Ave., Pittsburgh, Pa.
Canadian Office
Cor. King and Yonge Streets, Toronto, Ont., Canada

332 S. Michigan Ave., Chicago, Ill.
411 S. Main St., Los Angeles, Cal.

Important Announcement for Central States Amateurs

New Radio School with Apparatus Department in Connection Fills Long Felt Need

At last the hopes of central west radio enthusiasts for an adequate radio school and supply house, centrally located, are realized.

The Independence Radio Institute (thirty minutes ride on electric car from Kansas City) has been founded to meet this great need. Strictly speaking it is not a new concern, but is a combination of several interests, enlarged in scope. It is successor to the Graceland Radio Institute (9YO), the Independence Radio Laboratory (9ZH), and Arthur B. Church, Wireless Specialist. It is under the management of Messrs. Arthur B. Church and Paul E. Anway, experts well known in the radio field.

The radio school, featured by its complete modern equipment and experienced instructors, will be the best in the central west. Attractive tuition discounts are offered to amateur operators. New classes will be formed the first Monday in each month. A catalogue containing full information will be mailed upon request.

The Sales Department will carry a large stock of all leading makes of radio equipment. As exclusive distributor for A. H. Grebe & Company, it will handle the business of this concern in the central west. Experimenters in the vicinity of Kansas City and Independence are invited to visit the salesroom and inspect the apparatus on display. Mail orders will receive prompt attention. A catalogue of apparatus will be sent upon receipt of names and addresses of six live central west amateurs.

Independence Radio Institute INDEPENDENCE, MISSOURI

C W ACME APPARATUS

POWER TRANSFORMERS MODULATION TRANSFORMERS FILAMENT HEATING TRANSFORMERS 1½ HENRY CHOKE COILS

ACME C. W. POWER TRANSFORMERS are designed for use with rectifying tubes for supplying D. C. voltage and current and for heating filaments.

- 200 Watt C.W. Power Transformer, Mounted.....\$20.00
- 200 Watt C.W. Power Transformer, Core and Coils Assembled. 16.00
- 50 Watt C.W. Power Transformer, Mounted..... 15.00
- 50 Watt C.W. Power Transformer, Core and Coils Assembled. 12.00

The ACME A-3 MODULATION TRANSFORMER is correctly designed for Radio Telephony without distortion of speech and for maximum modulation.

- A-3 Fully mounted with engraved bakelite panel.....\$7.00
- A-3 Assembled with supports..... 5.00
- A-3 Core and Coil Assembled..... 4.50

The ACME FILAMENT TRANSFORMER is designed for 110 volts 60 cycles and to deliver current at two voltages of 8 and 10 volts each.

- Acme Filament Heating Transformers, 50 Watts,
Fully Mounted.....\$12.00
- Acme Filament Heating Transformers, 50 Watts,
Core and Coils assembled..... 9.00

ACME 1½ HENRY CHOKE COILS are designed for use in the D. C. circuit when modulating.

- 1½ Henry Choke, 500 milampere capacity, semi-mounted.....\$6.00
 - 1½ Henry Choke, 150 milampere capacity, semi-mounted..... 4.00
- With two separate coils \$2 extra in each case.

ACME APPARATUS COMPANY

26 Windsor Street,

Cambridge 39, Mass.

UP - T O - D A T E

TRANSFORMER AND RADIO ENGINEERS AND MANUFACTURERS

SAVE RADIO \$ \$ BY CONSULTING

THE

Radio Buyer's and Builder's Handbook

NOW

(by an Amateur of fourteen years experience)

The only book which
DESCRIBES AND SIMPLIFIES

OUT

many

New Radio Inventions and Improvements

including

NEW HOOKUPS to MAKE all the APPARATUS you use MORE EFFICIENT

This book contains nearly 200 pages, many diagrams, and over 30 full page half-tones of simple efficient apparatus. Inc. 16 scale cutouts—in black and white.

THE FIRST THOUSAND WILL BE \$1.00 PER COPY.

See Radio dept. June Popular Science for my first new stories.

PARTIAL CONTENTS.

A 90c EXPERIMENTAL VACUUM VALVE DETECTOR, sensitive and made in a few minutes from finished parts easily obtainable at any time.
Radio "Tricks of the Trade"—Solid Silver Switch Points for 3 to 5 cents each.
A NEW Combination Switching Key—Low Cost Amplifying Transformer. New! Variable Duplex Oil Condensers for Sending and Receiving with Switch.
How and Where to Buy Second Hand Radio and Electrical Apparatus Cheap.
A Rectifying Gap Motor which supplies "B" Battery current or "A" current.
A Simple Calibrated Hot Wire Ammeter, not affected by weather. Very Fine!
Many New and Good Ideas on "A" and "B" Batteries of Little Cost.
Commercial Type Rotary Quenched Gaps of Low Cost, Like the Above.
New Cheap Honey-Comb Type Receiving Coils for all Waves. Silver Contacts.
Second-hand Electrical Motor-Generators up to ½ H. P. for \$6.00. Modern Type.
Also many other methods of saving time and money on **BETTER APPARATUS.**

R. U. CLARK 3rd, or
11 Barnes Rd., Newton, Mass.

YOUR DEALER
Your Radio Club
Your Public Library

"COSRADIO"

Mark of Quality

The Radio Supply House of the
Middle West

IMMEDIATE DELIVERY

Transmitting Sets

Receiving Sets

Complete or Parts

RADISCO AGENTS

Satisfaction Guaranteed

THE COSRADIO CO.

WICHITA,

9-BW

KANSAS.



Stromberg-Carlson RADIO HEAD SET

A set that combines your ideal of extreme sensitiveness with a strong, durable construction that stands the gaff of continuous service ashore or aboard ship.

All operating parts housed in dust-proof and moisture-proof aluminum cases. The diaphragm is mounted metal-to-metal in such a way that temperature variation will not disturb the air-gap adjustments. Non-conducting spool heads and slotted pole tips eliminate 90 per cent of the eddy current losses that are found in other head sets.

Each set is wound to a resistance of 2,000 ohms with pure copper wire and furnished complete with 6-foot moisture-proof cord attached. Tested for matched diaphragm tuning and operating qualities in actual service before shipment.

Send \$12.00 for sample set for trial in your own station—satisfaction guaranteed or your money refunded upon return of set. Write for Bulletin 1106 giving full particulars.

Stromberg-Carlson Telephone Mfg. Co.
Rochester, N. Y. Chicago., Ill. Kansas City, Mo. Toronto Ont.



**EASTERN
RADIO**

TEL.
BACK BAY
5 9 6 4

899 BOYLSTON ST.
BOSTON, MASS.

INSTITUTE



An Open Letter ! !

This year we wish to announce that the EASTERN RADIO INSTITUTE will conduct their SUMMER CLASSES as usual. New students Day or Evening may now enter any Monday.

Special effort will be made to give every possible assistance to those who are desirous of accomplishing the work during the Summer months, and in this respect the Day school offers unusual advantages. These courses present splendid opportunities to High School students who are desirous of spending an enjoyable vacation travelling amid healthful and pleasing surroundings, at the same time providing funds for a College course later on.

To EVERY student who enrolls at the EASTERN RADIO INSTITUTE, THREE dominant factors are in his favor—We are the OLDEST, LARGEST, and BEST EQUIPPED radio and telegraph school in New England. This gives the student CONFIDENCE to start with!

We are the OLDEST when we say that the INSTITUTE was founded in 1913 and is now in its eighth successful year.

We are the LARGEST when we say that in that time the enrollment has grown from 2 to over 4000 different students.

We are the BEST EQUIPPED when we say that the INSTITUTE owns thousands and thousands of dollars worth of valuable radio and telegraph apparatus for instruction in the form of modern Commercial transmitting and receiving sets, storage battery apparatus, etc., etc. In fact the entire resources of the F. D. PITTS CO., INC., dealers in commercial radio apparatus, are at the disposal of this Institute.

To EVERY student who graduates from the EASTERN RADIO INSTITUTE, THREE more dominant factors are in his favor—We have ALWAYS placed EVERY graduate in a good position, have kept them employed and can GUARANTEE these positions. This gives the graduate SATISFACTION to finish with.

When you realize that our rates of tuition are reasonable, and that it costs no more to avail yourself of these VITAL ADVANTAGES, our years of EXPERIENCE and RESULTS, why not enroll for these classes? Do it today and you will not regret it!

Operatively Yours,

F. D. PITTS, Director.

Series No. 1

"Sparks" says

"Lasting Satisfaction

is measured to a great extent by the initial quality of the radio apparatus you purchase."

Our High Grade line of Standard-make Commercial and Amateur Radio equipment embodies the latest ideas in design and workmanship which assures you of lasting satisfaction under all operating conditions.

Our Specialty

is rendering you such Service that you may always know your interests will be looked after as to Quality and price.

Call on us when in town. Your wants will be Quickly and Satisfactorily looked after.

Our latest catalog is yours for 10 cents to cover postage. Write for it today.



"Quality Radio Apparatus
and Service"

The International Electric Company

EUGENE DYNNER, President.

226-B Fulton Street,

New York, N. Y., U. S. A.

Attention Amateurs !

**UTTMARK'S NAUTICAL ACADEMY
RADIO INSTITUTE**

Telephone
Bowling Green 8079

8 State Street,
New York City.

Let us prepare you for your first grade commercial license. We have just the kind of course you have been looking for. Modern apparatus and experienced instructors. Day or evening classes. Write, phone or call for our illustrated prospectus.

UTTMARK'S for RADIO
NAVIGATION

The Largest Radio Supply Stock In The South

**COMMERCIAL AND AMATEUR WIRELESS
APPARATUS OF ALL KINDS**

Holt Electric Utilities Co. Jacksonville, Fla.

Licensed by De Forest AUDIOTRON

The Original Tubular Vacuum Amplifier

The AudioTron vacuum tube is now manufactured and sold as a genuine audion licensed under DeForest Patents Nos. 841387 and 879532 to be used only for amplification in radio communication and only for experimental and amateur purposes and only in audio frequency circuits.

The Audiotron has a double filament of special thorium tungsten and the operating life is over 2000 hours. No special socket is required. The electrical and mechanical dimensions result in a heavy plate current and corresponding signal strength. Plate voltage under 40. Our guaranty insures satisfaction.

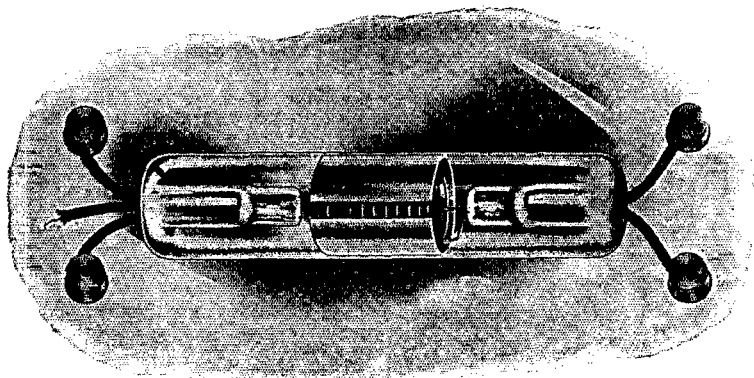

PRICE \$6.00 EACH

If your local dealer cannot supply you we will ship **postpaid** when cash accompanies order.

The AudioTron Exclusive Guaranty: Each and every Audiotron is guaranteed to arrive in good condition and to prove fully satisfactory. Replacement of unsatisfactory tubes will be made free of charge.

AUDIOTRON AUDIO-FREQUENCY TRANSFORMER.....\$7.00

Laminated closed core, two coil type.

DEALERS:—Write for our attractive trade Proposition.

AUDIOTRON SALES CO.

Lick Bldg.,

San Francisco, Calif.

G. A. STANDARDIZED SUPPLIES

NOTICE OF PRICE REDUCTION

The tremendous demand for G. A. STANDARDIZED B BATTERIES has made possible such quantity production with the accompanying use of labor saving devices, that the benefit of lower costs is now extended to the experimenters, in accordance with the G. A. policy of keeping all prices as low as is consistent with the high quality by which these batteries are known.

For the benefit of those not acquainted with the G. A. STANDARDIZED B BATTERIES, it may be said that these batteries, under direct comparison, have shown an operating life 20% to 30% greater than that of any other make, either when used for receiving or low powered vacuum tube transmitters. Moreover, their freedom from microphonic noises makes them especially adapted for use with the new low vacuum detector tubes.

SIGNAL CORPS TYPE: \$1.25, weight 1 lb. Mailing extra. Average operating life 3 months.

NAVY TYPE: \$2.00, weight 5 lbs. Mailing extra. Average operating life 10 months.

THE ESBRO RADIO COMPANY

Of Brooklyn, New York, the largest manufacturers of small condensers and portable radio equipment, has been consolidated with THE GENERAL APPARATUS COMPANY, under which name ESBRO products will be sold.

ESBRO GRID CONDENSERS: capacity 0.0005 mfd., fitted with screws for mounting, 35c each.

ESBRO TELEPHONE CONDENSERS: capacity 0.001 mfd., with screws for mounting, 35c each.

ESBRO RADIO RECEIVER: A complete crystal receiver with buzzer test, in a portable hinged cover case, furnished with materials for a G. A. STANDARDIZED long range antenna and a pair of 2,000 ohm Murdock 55 telephones. Receives Arlington time signals up to 500 miles. Price complete \$20.00, weight 10 pounds.

IF YOU ARE IN NEW YORK, GO TO THE NEW G. A. STORE, OPEN UNTIL 9:00 P.M.
DAILY AND SATURDAYS

MONEY BACK
GUARANTEE ON
EVERY ORDER



QUICK SERVICE
ABSOLUTE
RELIABILITY

The General Apparatus Company

4310-T Broadway at 183rd Street,

New York City

PARKIN RHEOSTAT \$1.00 POSTPAID

Why Pay More?

When this is the easiest mounted, smoothest running, best rheostat on the market.

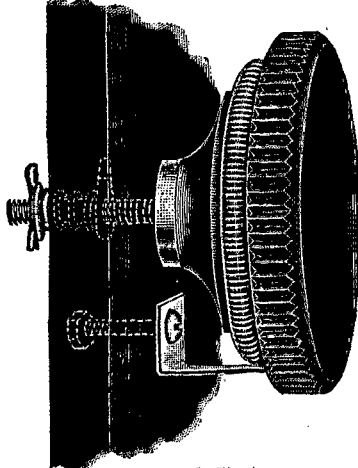

(Actual Size)

No. 35 PARKIN PANEL TYPE RHEOSTAT (Patented March 30 1920) has easily renewed resistance unit mounted on back of MOULDED BAKELITE KNOB. Shaft is moulded into knob, cannot come loose. "OFF" position provided. 360 degree rotation insures fine adjustment. Write for descriptive circular of audion panels, switches, binding posts, contacts, etc.
Dealers: Write for proposition.

PARKIN MFG. CO., San Rafael, Calif.

Vacuum Tube Socket

TYPE 156

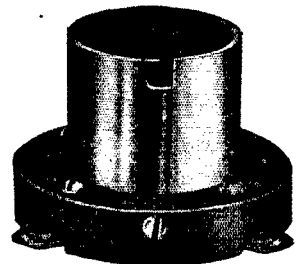

Positive contact springs
Base is of moulded bakelite
Metal parts polished nickel
Adaptable to either transmitting
or receiving tubes

Price - - \$1.75

Latest bulletins sent on request

General Radio Co.
WINDSOR STREET
Cambridge 39 Massachusetts

MAGNAVOX

Telemegafone

Most Efficient Telephone Receiver and Loud Speaker

FOR RADIO
RECEIVING



The most rugged, simple and reliable instrument yet produced for the reproduction of radio signals and sound.

It is not only a most sensitive receiver when used with the head-set, but is also the most powerful loud speaker.

The Magnavox Telemegafone fills the long felt need of both commercial and amateur radio stations.

By using this instrument in connection with your vacuum tube amplifier, signals will be reproduced with great volume. For weak and ordinary signals use the head-set. Strong signals can be heard a great distance from the horn.

PRICE \$75.00

Connect AA to your receiving set where your present head-set is connected

Connect BB to a 6-volt storage battery

Immediate Delivery—Order Early



PATENTED IN U.S.A. AND FOREIGN COUNTRIES

2701-2759 East Fourteenth Street, Oakland, California

To Obtain The Very Best Results USE

Federal Standard Accessories

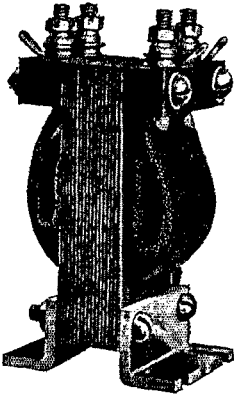

No. 226-W—Type A
Audio Frequency Transformer

They are Used by the Leading Experimenters, Manufacturers and by the Government.

The Standard 226-W Transformer is More Popular and Efficient Than any Other Because it Gives Results—You Should Use it.

Our New Bulletin No. 102 W-B, is now ready for mailing—Send 6c in stamps—Contains new information.

Our new line of Jacks—and Federal Duo-Lateral Inductances Just Out—If Your Dealer Does Not Have Them—Write to the

FEDERAL TELEPHONE AND TELEGRAPH CO.

1766 ELMWOOD AVE,

BUFFALO, N. Y.



Radio Electric Adapters

Postpaid - - \$1.50

PITTSBURGH AMATEURS and others are invited to call at our new store and inspect the latest radio instruments.

Send 10c for our new catalogue.

“We make or sell Everything Radio”

The Radio Electric Company
3807 Fifth Ave., Pittsburgh, Pa.

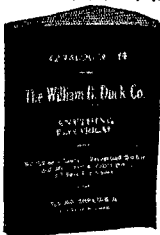

DUCK'S New Big 200 PP. Wireless and 100 PP. Electrical Catalog

Our 200 page exclusive wireless catalog mailed for 12c and our electrical catalog mailed for 6c, in stamps or coin. The largest, most elaborate and most complete radio catalog published.

Everything in wireless worth while is listed in this catalog. The experienced amateur will tell you to see our catalog before buying. You are thereby insured against an unwise purchase. It is the Beacon Light to guide you right in the selection of your wireless apparatus. No bigger or better values are obtainable elsewhere.

THE WILLIAM B. DUCK CO. 243-245 Superior St., Toledo, Ohio

RADIO APPARATUS

Distributors of reliable radio apparatus for experimenters in every branch of the radio field

"PITTS CO"

The sign of service and immediate delivery!
All we ask is a trial!



REMEMBER!

We carry an immense stock and can make immediate delivery on every item listed!

HONEY-COMB COILS

LITZENDRAHT WIRE.	(While they last.)	
LL-75 330-1030 meters	\$1.60
LL-100 450-1460 "	\$1.70
LL-150 680-2200 "	\$2.00
LL-200 930-2850 "	\$2.10
LL-250 1300-4000 "	\$2.30
LL-300 1550-4800 "	\$2.50
LL-400 2050-6300 "	\$2.80
LL-600 4000-12000 "	\$3.00
LL-750 5000-15000 "	\$3.20
LL-1000 6200-19000 "	\$3.50
LL-1250 7000-21000 "	\$3.90

Note:—these are the genuine DeForest litz coils.

INDUCTANCE COIL MOUNTINGS FOR HONEY-COMB COILS

No. LC-101 DeForest, mounted on oak base with gears to hold three coils...	\$13.00
No. LC-201 DeForest, same as above but with primary condenser switch mounted on base.....	\$15.00
No. LC-100 Same as LC-101 but without base.....	\$10.00
No. ULC-100 Same as LC-100 but mounted on unit panel.....	\$10.75
No. ULC-200 Single inductance coil mounting on unit panel.....	\$2.00
No. ULC-300 Double inductance coil mounting on unit panel.....	\$4.80
No. ULC-400 Triple inductance coil mounting on unit panel.....	\$5.60

AUDION CONTROL PANELS

No. P-400 DeForest audion panel without cabinet.....	\$9.95
No. P-401 DeForest audion panel, same as above with oak cabinet.....	\$14.25
No. P-402 DeForest audion panel with 40 volt "B" battery in oak cabinet.....	\$19.95
No. P-500 DeForest audion-ultraudion panel with 20-40 volt "B" battery with oak cabinet.....	\$25.00
No. RORA Grebe vacuum tube control panel.....	\$11.00
No. RORH Grebe vacuum tube control panel with 40 volt "B" battery.....	\$17.00

Important! Every article listed sent to any part of the United States postage prepaid or express prepaid. We want your business!

Series No. 2 (Keep this page and watch for next month's)

SEND 6 CENTS IN STAMPS FOR NEW CATALOG!

TELEPHONES (Pair)

No. 1 Type C Baldwins, standard Navy type.....	\$16.50
No. 2 Type E Baldwins, new type, smaller.....	\$18.50
Brandes, "Superior" 2000 ohms.....	\$ 7.00
Brandes, "Transatlantic" 2800 ohms.....	\$10.00
Brandes, "Navy type" 3200 ohms.....	\$14.00
No. 55 Murdock, 2000 ohms.....	\$ 4.50
No. 55 Murdock, 3000 ohms.....	\$ 5.50

OMNIGRAPHS

No. 2 Omnigraph, complete with 15 dials.....	\$28.00
No. 2-A Omnigraph Jr., complete with 5 dials.....	\$20.00
No. 5 Omnigraph, complete with one dial.....	\$12.00
Extra dials for No. 2 and 2-A.....	each \$.20
Extra dials for No. 5.....	each \$.10

REGENERATIVE RECEIVERS

No. CR-1 Grebe, 170 to 600 meters with tube control.....	\$100.00
No. CR-2 Grebe, 170 to 600 meters.....	\$ 46.00
No. CR-3 Grebe, 170 to 600 meters (new type just out).....	\$ 60.00
No. CR-4 Grebe, 170 to 600 meters (with series condenser).....	\$ 65.00
No. CR-6 Grebe, 170 to 600 meters with detector and 2 step amplifier self contained.....	\$180.00
No. CR-7 Grebe, 500 to 20000 meters long wave receiver.....	\$210.00

Note:—Each receiver is a creation in workmanship and performance.

INSULATORS (Antenna)

No. 0-2 4 inch antenna insulator.....	\$0.50
No. 0-3 10 inch antenna insulator.....	\$1.00
No. 0-4 16 inch antenna insulator.....	\$1.50
No. 0-5 22 inch antenna insulator.....	\$2.45
No. 0-6 3 inch porcelain strain insulator.....	\$0.15
No. 0-7 5 inch hard rubber antenna insulator.....	\$0.28
No. 0-8 10 inch hard rubber antenna insulator.....	\$0.57

F. D. PITTS CO., INC.

12 PARK SQUARE, Dept. A, BOSTON, 11, MASS., U. S. A.

Thermo-Ammeters, Milliammeters and Current-Squared Meters

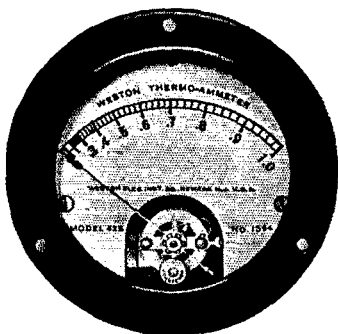

Weston

Model 425

Miniature Size Instruments for Radio Service

are the ideal Instruments for the amateur.

They are particularly adapted for use on small size Radio panels where space is an important factor.

Their characteristics of accuracy, large overload capacity, small current consumption and small size make them particularly desirable for use on amateur and other low-power outfits.

They are for use on Audio and Radio frequencies.

Complete information will be furnished upon request.

Weston Electrical Instrument Company

158 Weston Avenue, Newark, N. J.

Branches in all Principal Cities.

Radio Amateurs

We carry in stock a complete line
of the following Manufacturers:

J. H. Bunnell & Co.

Acme Apparatus Co.

Wm. J. Murdock Co.

Tremaine Mfg. Co.

DeForest

ADDRESS ALL MAIL
ATTENTION OF
MR. H. DUNBAR

Quaker Light Supply Co.

728 Arch St.,

Phila., Pa.

"ASK ANYONE WHO HAS USED IT"

USERS ARE PROVERS

"I have also asked some of my friends all of whom say, 'BRANDES? Sure, get them: They will positively pay for themselves'". (Name on request).

**BRANDES
WIRELESS
HEADSETS**



"Navy" set 3200 ohms
\$14.00

"Transatlantic" set 2800
ohms \$10.00

"Superior" 2000 ohms \$7

TRIAL OFFER Test out BranDES Wireless Receivers against any other make. Test them for sensitivity, clearness and distance. If within ten days you're not only satisfied but enthusiastic over them — back comes your money without a question.

Prove for yourself the fine quality, the "matched tone." The two diaphragms, toned exactly alike, strengthen the signals and prevent blurring. Used by many U. S. Government experts, and experts abroad; by colleges and technical schools; and by professionals and amateurs everywhere.

SEND 4c. FOR CATALOGUE TO

C. BRANDES, Inc.

Room 821, 32 Union Square, New York
WIRELESS RECEIVER SPECIALISTS

Here's a Receiver With Eight Distinct Advantages

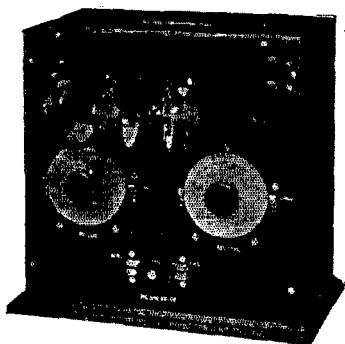

Tuner; Type T-200. Size 13 3/8" x 12 1/2" x 8". Price, \$77.50 Complete, without Coils.

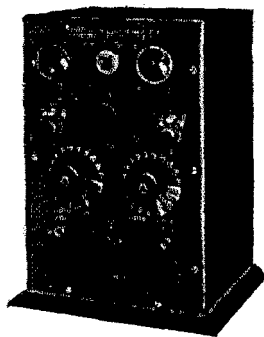

Combination Audion-Ultra Audion and One-step Amplifier; Type P-300 Size 12 1/2" x 9 3/8" x 7 3/8". Price, \$73.50. Audion Tubes, \$7.00 each extra.

A COMPLETE, compact and inexpensive Receiving Set having improvements and refinements which increase efficiency and eliminate many objectionable features of receiving apparatus.

No longer is it necessary for you to have two or three expensive, inconvenient and cumbersome tuners spread all over your operating table when working all wave lengths. With this new DE FOREST tuning system you can work any and all wave lengths with the one tuner shown above. This Set has distinct advantages of minimum table space and of convenience in coupling not equalled in any other type of apparatus. The entire Set is complete in the two cabinets shown here. The Genuine DE FOREST "Honey Comb" Coil System of Tuning is employed—no superior system has ever been invented.

This is a new DE FOREST production embodying a unique and superior tuning system. Possession of this Set means more efficient and satisfactory operation; more pleasure and practical benefit for every Amateur. Its price is remarkably reasonable for the quality of apparatus and the distinct advantages the Set offers. Find out more about it at once.

Send for a DeForest Manual

a 36-page book containing full information about this and many more DE FOREST instruments, as well as giving much useful information for the Amateur. Mailed anywhere upon receipt of 10 cents.

These Eight Advantages

ARE NOT DUPLICATED IN ANY RECEIVING SET AT DOUBLE THE PRICE:

- 1 Responds to any wave length, 150 to 25,000 meters.
- 2 More flexible in coupling.
- 3 Lower distributed capacity; less high frequency resistance and decrement values.
- 4 Eliminates cumbersome switches, inefficient taps and losses from dead ends.
- 5 Vernier Air Condensers of unusual design.
- 6 Signals come in louder and clearer.
- 7 Superior in efficiency, workmanship, convenience and appearance.
- 8 Requires minimum table space; note sizes of cabinets.

DeForest Agencies are located in all Principal Cities. Ask your regular Electrical Dealer to get you DE FOREST Apparatus.

DE FOREST RADIO TELEPHONE & TELEGRAPH COMPANY

Inventors and Manufacturers of High Grade Radio Apparatus
1407 SEDGWICK AVENUE, NEW YORK CITY

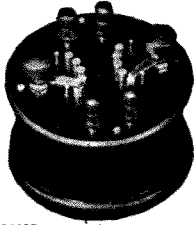

Hook 'er to yer bulb

The most wonderful tuner in the world for only \$15. Last month this tuner beat in a test one of the NAVY STANDARDS at Ketchikan, Alaska.

10 Captains of Ocean going ships have had their wireless operators install one of our tuners in the captain's cabin so the exact time by wireless can be had without using either tube, bell, or hand.

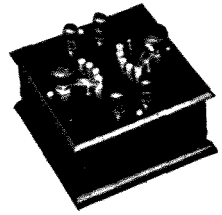

GREAT says one old sea dog. WHAT IN SAM HILL WILL YOU SMART ALECS GET UP NEXT? European stations copied in day time and no fancy aerial is needed. A single wire about 40 long by 25 high will do the trick. London amateur W. R. Wade, Clifton, Bristol, promises report for the magazines to publish showing how the amateurs there read our signs in England. Junk your funny wound coils and get a regular two pound tuner that you can use during the static season. 20000 meters maximum wave length. Hook up on bottom of tuner.

KNOCKED DOWN AND ASSEMBLED CONDENSERS.

Which kind do you want??? Made for panel mounting and are complete with scale pointer and knob. Used all over the world now and still going strong. No C.O.D. orders. Add parcel post. Buy from your dealers and send us his name if he can not supply you. Canadian amateurs buy from local dealers or write us for nearest dealer. Formica tops and bases. Movable plates are screwed on and not clamped.

11 plate Knocked down.	\$1.80
21 " " " ..	2.25
41 " " " ..	3.20

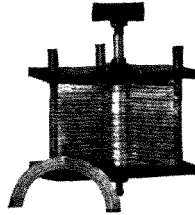

11 plate assembled	\$2.75
21 " "	3.25
41 " "	4.25

SOLD BY YOUR DEALER OR

TRESCO, Davenport, Iowa

RADIO-CRAFT PRODUCTS

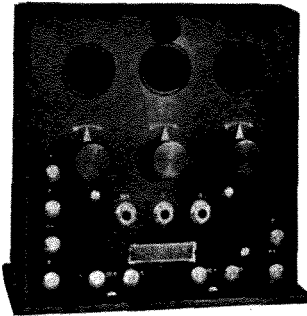

Detector and Two-Stage Audio Frequency Amplifier.

This instrument is made of the finest materials and workmanship, and gives perfect amplification without any interfering noises. Binding posts are provided for separate "B" battery connections, for Detector and Amplifier.

- Our Detector and Amplifier line consists of:
- Detector Unit \$20.00
 - Detector and One-Stage Audio Frequency Amplifier \$45.00
 - Detector and Two-Stage Audio Frequency Amplifier \$70.00
 - Two-Stage Audio Frequency Amplifier \$50.00

RADIO-CRAFT CO., Inc.

FRANK M. SQUIRE, Pres.

413 Third Ave., Brooklyn, N. Y.

BURGESS "B" BATTERIES

SEVERAL SIZES FOR SPECIAL WORK



SEND FOR CATALOGUE
BURGESS BATTERY COMPANY

HARRIS TRUST BLDG. - CHICAGO, ILL.

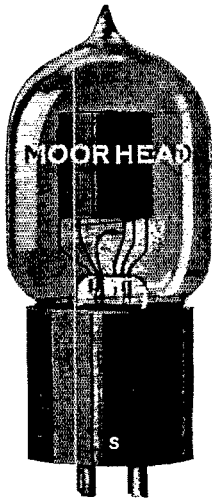

THE MOORHEAD
ELECTRON RELAY

PRESENTING TWO NEW TYPES OF VACUUM TUBES FOR EXPERIMENTERS

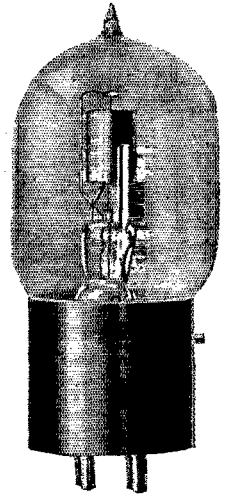

THE MOORHEAD VT
AMPLIFIER-OSCILLATOR

THE MOORHEAD PERFECT

VACUUM TUBE COMBINATION

—perfected to meet the increasing demand for tubes of superior efficiency, wherein all desirable characteristics are combined without subordinating any essential elements. A combination of two or more VT tubes as amplifiers with an Electron Relay as the initial detector or oscillator is the ideal receiving combination for long distance amateur or long wave reception. Both types of tubes are rugged in construction and unqualifiedly guaranteed.

Both Tubes Licensed Under The DeForest Audion and Fleming Patents

THE MOORHEAD ELECTRON RELAY

The Electron Relay is the original tubular vacuum valve brought out by this company in 1915, now supplied with the standard four prong base for convenience. This tube has the familiar "hissing" point and low B battery potential characteristic of the perfect vacuum detector. Of all vacuum tubes the Moorhead Electron Relay is the most efficient spark receptor.

Price—\$6 each. Immediate deliveries. Order from your dealer or remit direct to address below.

THE MOORHEAD VT AMPLIFIER-OSCILLATOR

The VT Amplifier-Oscillator is the Navy SE 1444 "hard" tube, and is designed and manufactured expressly for amplification and oscillation purposes. Particular attention is invited to the large amplification constant of this tube. Recent official Navy tests show conclusively that the Moorhead VT tube has a higher amplification constant than any other vacuum tube known to the radio art.

Price—\$7 each. Immediate deliveries. Order from your dealer or remit direct to address below.

DEALERS

*write for prices
and particulars.*

AMATEURS

*write for descrip-
tive literature.*

ATLANTIC RADIO SUPPLIES COMPANY

8 KIRK PLACE, NEWARK, NEW JERSEY, PHONE MARKET 1575

PACIFIC RADIO SUPPLIES COMPANY

638 MISSION STREET,

SAN FRANCISCO, CALIFORNIA

DISTRIBUTORS FOR MOORHEAD LABORATORIES, INC.

"SHRAMCO"

Specialties are needed for an efficient set

Switch Points

	BRASS	NICKEL
No. 626— $\frac{1}{4}$ " x $\frac{3}{8}$ " with screw	\$2.00 per 100	\$3.00 per 100
No. 627— $\frac{1}{4}$ " head, $\frac{5}{8}$ " shank, with nut and washer	2.25 per 100	3.35 per 100
No. 628— $\frac{1}{4}$ " x $\frac{1}{4}$ " with screw	1.75 per 100	2.60 per 100

Switches

No. 750—3-blade Laminated, $1\frac{3}{8}$ " radius	\$1.00 each
No. 751—Single Blade, $1\frac{3}{8}$ " radius	0.35 "
No. 800—Panel Binding Post, brass finish	0.10 "

Complete line reliable moderate priced apparatus.
Radisco Agency, Coils, "B" Batteries, Dial Indicators, etc.

Send 5c in stamps for Catalog J showing complete line.

Shotton Radio Manufacturing Company
P. O. Box 3, SCRANTON, PA.

O, What A Pal

was Mary, but say boy, do you know an up-to-the-minute radio installation is SOME pal too?

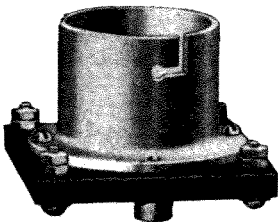

We manufacture high grade apparatus only. Here is a good value—The Ace V.T. Socket—
—with grid leak at

\$1.50 each

Better buy Ace equipment than be sorry you did not. Ask your dealer.

THE
PRECISION EQUIPMENT CO.

Dept. D

2437 Gilbert Ave., Cincinnati, Ohio.

STOP

\$15.

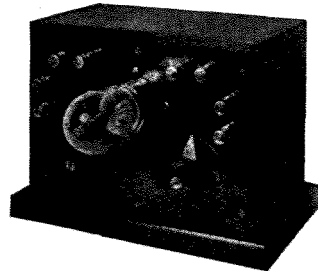

\$15.

AUDION CONTROL CABINET

Size 8" x 11" x 6", Mahogany Finish, 7" x 10" Bakelite Panel, Brass Fittings. Back Mounted Rheostat, Control Switch.

We have a Surplus Stock of These High Grade Cabinets, Original Price \$35.00. GET BUSY.

2 Step Amplifier, Same as Above
Nickel Fittings \$35.00 Worth \$60.00

Grid Condensers 35c

TREMAINE & CO.

1305 Arch St., Philadelphia, Pa.

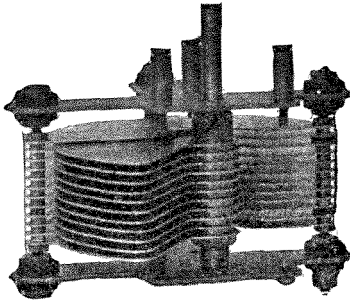

The New Arco Variable Condenser

We offer Radio Men something out of the ordinary in variable condensers.

This new model is a step ahead of its rivals in that the plates are made of aluminum and heavier than those found in the average condensers. The rotary plates are rounded at one end, not the usual semi-circular type, thus affording a straight line capacity, which is a very valuable feature in Wave Meter work. The zero capacity in an instrument of this type is considerably lower than that of usual condensers.

Shaft on which rotary plates are mounted is carefully machined from tool steel. Instrument can be quickly mounted in case or behind panel.

Made in two capacities, furnished unmounted only, with or without dial of fine black moulded composition and bakelite knob.

Backed up by Radisco guaranteed quality of workmanship and low price.

Capacity	Unmounted	With Dial and Knob
.0005 mf.	\$5.00	\$6.00
.001 mf.	6 25	7.25

Shipping weight 2 pounds.

Prices quoted do not include carrying charges to Pacific Coast or duty paid for Canadian use.

RADISCO AGENTS carry only apparatus of proven merit. Look for the Radisco trade mark on all parts you buy and be sure of getting efficient apparatus.

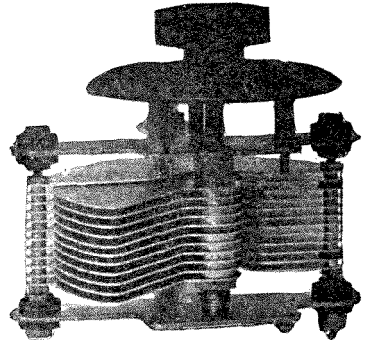

Below are listed a few of the reliable firms who carry the RADISCO COILS, Better "B" Batteries and are our Agents for all other standard apparatus of merit.

Communicate your wants to them

- | | |
|---|---|
| ALBANY, N. Y.
E. L. Long,
21 Magnolia Terrace | NEWARK, N. J.
A. H. Corwin & Co.
4 West Park Street |
| ATLANTIC CITY, N. J.
Independent Radio Supply Co.
118 So. New Jersey Ave. | NEWCASTLE, PA.
Pennsylvania Wireless Mfg. Co.,
507 Florence Ave.
"8HA" |
| BALTIMORE, MD.
Radio Engineering Co.,
614 No. Calvert St. | PHILADELPHIA, PA.
Philadelphia School of Wireless Telegraphy,
Broad and Cherry Streets |
| BIENVILLE, QUEBEC, CAN.
Canadian Radio Mfg. Co. | PROVIDENCE, R. I.
Rhode Island Elec. Equip. Co.,
45 Washington Street |
| BOSTON, MASS.
Atlantic Radio Co.
88 Broad Street | PITTSBURGH, PA.
Radio Electric Co.,
3807 5th Ave. |
| BROOKLYN, N. Y.
Kelly & Phillips Electric Co.,
312 Flatbush Ave. | SEATTLE, WASH.
Northwest Radio Service Co.,
1801 Sixth Ave. |
| BRONX, NEW YORK
Amateur Wireless Equipment Co.,
1390 Prospect Ave. | SCRANTON, PA.
Shotton Radio Mfg. Co.,
P. O. Box 3
Branch, 8 Kingsbury St.,
Jamestown, N. Y. |
| CHICAGO, ILL.
Chicago Radio Laboratories,
1316 Carmen Ave. | SPRINGFIELD, MASS.
Electric Service Co.,
585 Armory Street |
| EUREKA, PEORIA, ILLINOIS
Klaus Radio Co. | TORONTO, ONT., CAN.
The Vimy Supply Co.,
585 College Street |
| KANSAS CITY, MO.
McCreary Radio Supply,
4th & Delaware Sts. | WASHINGTON, D. C.
National Radio Supply Co.,
808 9th St., N. W. |
| LOS ANGELES, CALIF.
The Wireless Shop,
511 W. Washington St. | WICHITA, KAN.
The Cosradio Co.,
1725 Fairmount Ave. |
| MONTREAL, CAN.
J. B. Miller,
1600 Hutchinson St. | |
| McKEESPORT, PA.
K. & L. Electric Co.,
427 Olive Street | |
| NEW ORLEANS, LA.
L. A. Rose,
121 Camp Street | |

If none of the above agencies are in your vicinity, communicate with
RADIO DISTRIBUTING COMPANY, Newark, New Jersey

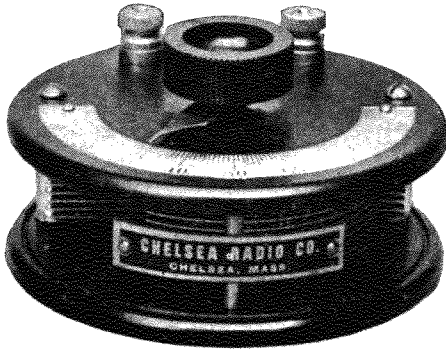

No. 2

Spark Load Coil

Range 0 to 3500 meters. Taps are in geometric progression, permitting exceptionally fine tuning on all the longer spark wave lengths. Ten active inductance steps. Base and knob moulded bakelite.

All "Chelsea" apparatus embodies highest degree mechanical construction, electrical efficiency and good appearance.

Purchase from your dealer; if he does not carry it, send to us. Catalog sent upon request.

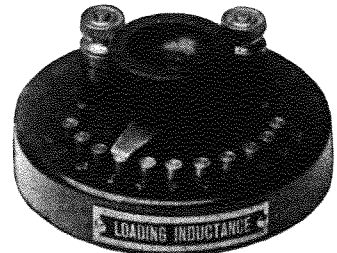

INDUCTANCE
Price \$3.50

CHELSEA RADIO CO.,

15 Fifth St.,

Chelsea, Mass.

THE JONES CABINET LONG WAVE RECEIVING TRANSFORMER

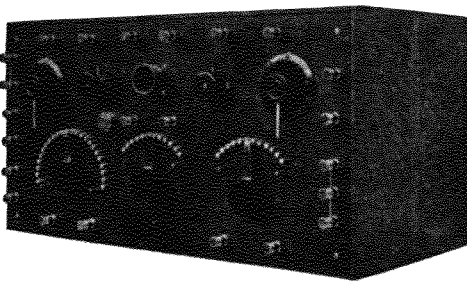

For DAMPED or UNDAMPED Wave Reception

A carefully wound Receiving Transformer with an approximate Wave Length of from 200 to 8000 Meters Equipped with Variable and Fixed Condensers Rheostat and Grid Leak. Fitted to take the latest MARCONI Vacuum Tube. Bakelite Panel, Silver Plated Switches and Contacts, Mission Oak Cabinet. Entire Apparatus built within Metal frame to permit easy removal. Model "D", as illustrated, SIXTY DOLLARS, Net. Model "E" fitted with Modern "DEAD END" Switch and High Grade Hot Wire Ammeter, Eighty-Five Dollars net.

New Bulletin sent on request.

THE JONES RADIO CO.,

384 Monroe Street,

BROOKLYN, N. Y.



CONTROL No. 7

EFFICIENCY ECONOMY ADAPTABILITY

Bulletin C-109 on Request

Radio Equipment Company

1525 N. FAWN STREET, PHILADELPHIA, PA.

NOTE: We Only Sell Vacuum Valves Licensed Under The Fleming Patents.

ANOTHER ACHIEVEMENT

LATTICE WOUND COILS

A concentrated inductance much superior to anything yet on the market.

No. turns,	25	35	50	75	100	150	175	200	350	500	750	1000	1250	1500
Price, p.p.,	\$.50	.55	.60	.70	.75	.85	.95	1.00	1.25	1.50	1.75	2.00	2.25	2.50

Special coils to order; taps made at 10c per tap.

	200-2,500 meters					
Pri. No. 200, tapped	25,	50,	75,	100,	150	
Sec. No. 500, tapped	25,	50,	100,	200,	350	
Tick. No. 200, tapped	25,	35,	50,	75,	100,	150

Price of above group, postpaid \$6.00

	2,500-20,000 meters				
Pri. No. 1000, tapped	175,	350,	500,	750	
Sec. No. 1500, tapped	350,	500,	750,	1000,	1250
Tick. No. 200, tapped	150,	300,	450		

Price of above group, postpaid \$7.50

Hard Maple Centers, to fit half-inch dowel, 2 for 25 cents.

VACUUM TUBES

The letter given below was recently received by us from a responsible amateur.

June 10th, 1920.

Jensen Electric Company,
Chicago, Illinois.
Gentlemen:—

This is an entirely unsolicited testimonial for the AudioTron. I am weary reading the "paid advertising" regarding the remarkable results and extreme sensitiveness of certain tubes, when every true radio experimenter with an iota of brains has demonstrated to his own satisfaction that for sensitiveness to radio signals, the AudioTron has all other tubes beat a thousand ways as a detector.

I will grant that certain other tubes I could name have the bulge on your product for amplifiers and transmitters. I do not recommend the AudioTron for transmitting purposes, after exhaustive experiments. But after trying out over fifty other well known tubes of other makes as detectors, put up against over a dozen of your standard tubes of both before and since the war, I have no hesitation in saying that the AudioTron is the only detector on the market today.

After ten years of experimenting (I started in at the "coherer" period) I would truly say that if I were starting at the present time, I would junk all receiving apparatus except a loose coupler, a couple of variable condensers and an AudioTron detector. I have seen better results from this outfit than from a modern cabinet containing a detector and two step amplifier of certain other tubes.

You are at liberty to use any or all of this letter at any time; without, however, using my name, of course.

Yours truly,

PRICES

AudioTrons, two filament type.....	\$6.00
Moorhead Electron Relay.....	6.00
Moorhead V.T. Amplifier-Oscillator.....	7.00
Moorhead Transmitting tube (150-600 volt).....	7.50
Western Electric VT-1's, few left.....	10.00

All bulbs are guaranteed perfect and are shipped post paid.

JENSEN ELECTRIC COMPANY

1949 HURON STREET, CHICAGO, ILL.

YOU Can Do Summer Long Distance !

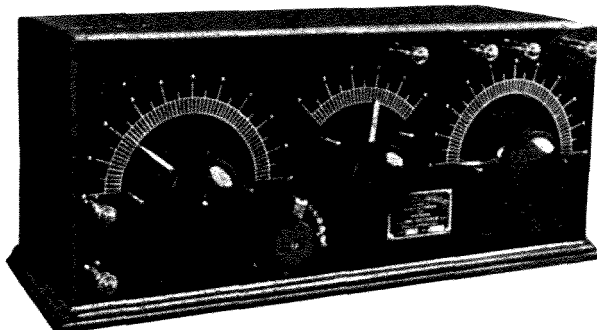

C.R.L. PARAGON REGENERATIVE RECEIVER.

The C.R.L. Paragon has solved the summer relay problem !!

Using one of these sets, the following is the short wave "log" of station 9ZN, Chicago, Ill., for **June 5th, 1920.**

Heard—NSF, (600 miles)—8XK, (400 miles)—8ER, (300 miles)—9ZX, (600 miles)—3NB, (750 miles)—8DC, (300 miles)—8WY, (400 miles)—8IK, (350 miles)—KO, (1100 miles).

Worked—NSF, 9ZX, 8XK, 8ER, 3NB, 8IK, KO.

(Above will be verified on request)

You can do as well if you equip your station with the CRL Paragon.

IMMEDIATE DELIVERIES

Price, F.O.B. Chicago.....\$55.00

Licensed under Armstrong U. S. Patent No. 1113149.

CHICAGO RADIO LABORATORY

1316 CARMEN AVENUE

CHICAGO, ILL., U. S. A.

PITTSBURGH, P.A.,

has a new Radio Supply house carrying a complete stock of every reliable manufacturer. Prices are right.

Drop in and see us.

Raphael Electric Company
at 1405 Fifth Avenue.

We are open evenings until 8:00 P.M.

CQ—CQ — — — QRW ?

The "R V A" Sales Plan which enables all responsible Amateurs to purchase Radio Apparatus, Parts, raw materials and supplies on the

INSTALLMENT PLAN

is the solution to your problem of obtaining the BEST there is manufactured without the usual large outlay of cash at one time. The new "RVA" Binders are ready. Send ten cents, stamps or coin, for the binder, back copies of the "RVA" BULLETIN, the Bargain Supplement and keep up with the times in the way of modern equipment for your station.

J. DONALD VANDERCOOK & CO.

139 South York Street

ELMHURST,

ILLINOIS

MEMORIZE CONTINENTAL CODE ALMOST INSTANTLY

This method THE short cut to success

COMPLETE CHART and full instructions TWO DIMES

C. K. DODGE

Box 210 Mamaroneck, N. Y.

800 Miles on 1-4 K.W.

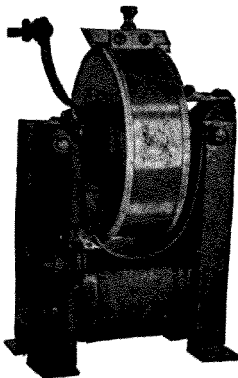

¼ K. W. Special.

Is the distance claimed by F. M. Prencil (9CF), 174 N. Scoville Ave., Oak Park, Ill. Who will be the first to transmit 1000 miles on this ¼ K.W. transformer ?
Send your records to this office.

Power Factor 91%

WRITE FOR OUR NEW CATALOG "T-21"

Thordarson Electric Manufacturing Co.
501 S. JEFFERSON STREET CHICAGO, ILL.

"THE RADIO TELEGRAPHER"

Official Organ

United Radio Telegraphers Association

ROOM 303, 44 BROAD STREET, N. Y.

keeps you posted on what's doing among the commercial telegraphers,

On Shipboard At Shore Stations At Home and Abroad.

\$1.50 yearly, U. S. and its possessions.

\$2.00 yearly in foreign countries.

\$1.75 yearly in Canada.

\$0.15 a single copy.

"P.W." HAS THE LATEST RADIO APPARATUS IN PHILA.

We have the "Radisco" agency for Philadelphia and vicinity; also distributors for

Clapp-Eastham, Murdock, DeForest, Acme Apparatus, A. H. Grebe & Co., Kilbourne and Clark, Benwood Rotary Quenched, Perfection Variables and Tuners, Universal Wound Inductances, Better "B" Batteries, and Endurance Storage Batteries.

Est. 1911. Radio Call "3PW"

PHILA. SCHOOL OF WIRELESS TELEGRAPHY
Parkway Bldg., Broad Street near Arch

Recognized as the largest and best

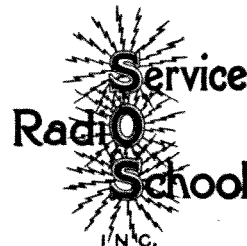

Send ten cents for descriptive catalog to Dept. C.
900-902 Penn. Ave., N.W., Washington, D.C.

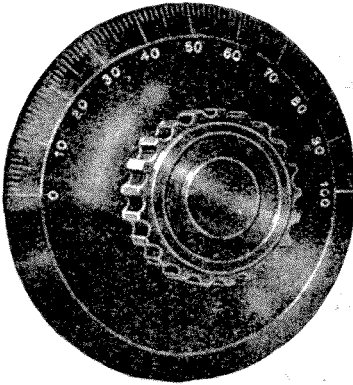

A More Improved INDICATING DIAL

This new dial made of same quality and workmanship as our famous smaller one, is marketed to fill the demand for a dial to fit the standard $\frac{1}{4}$ inch Shaft. Made of black polished composition with radial lines and figures accurately engraved and filled with brilliant white. Diameter is $3\frac{3}{8}$ inches; and $\frac{1}{8}$ inches thick. Bevelled edge. Knob has set screw to clamp shaft of instrument.

3 in. dial only 75c. With knob \$1.30
Postpaid
3 $\frac{3}{8}$ in. dial only \$1.00. With knob \$1.70
Postpaid

Moorhead Electron Relay New Style.....\$6.00
Moorhead V.T. Amplifier 7.00
Moorhead Extra Hard V.T..... 7.50
Shipping weight 1 pound. Guaranteed.
Licensed under Fleming and De Forest Patents.

OUR NEW CATALOG now ready for distribution contains 24 snappy pages of news and descriptions of all standard Radio parts, including the above indicating dial.

Sent anywhere upon receipt of 10c.

FOR SALE AT ALL RADISCO AGENCIES AND BY

A. H. Corwin & Co.

4 West Park Street

Newark, N. J.

LAST CHANCE To obtain Navy Type Dials

Thousands sold last month

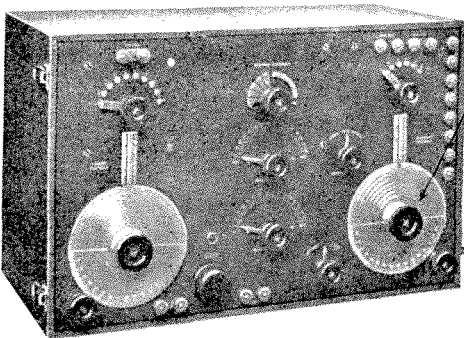

Since our announcement last month of the sale of 10,000 Navy Type Dials, to amateurs for the first time, over 7,000 have been sold to date. These dials are made of heavy white celluloid, 4" in diameter, highly polished, beautifully finished, and artistically engraved with two scales. One scale is divided into degrees; the other is calibrated for writing in station call letters at points at which station is received.

Put your set in the commercial class

Not only do these dials add dignity and beauty to a set, but they are also a real utility and a necessity for reliable work. Use them wherever you would an old fashioned scale and pointer.

Buy today — Tomorrow may be too late !

At the present rate of sale our stock will be exhausted within 30 days. If you don't need a few now, you will in the near future. So get the lead on the rest—lay in a supply now—while you can.

Price while they last 65c postpaid, Complete as described without knob (Stamps NOT accepted)

THE C AND S RADIO CO., Dept. USN8 OMAHA, NEB.

"Superlative Radio Engineering Productions."

R & M Special Rotary Gap Motors

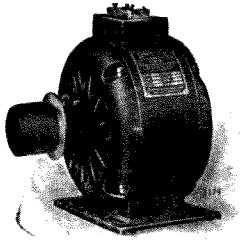

RUNS ON 110 AC OR DC
CURRENT. 1/10 H.P.
2,500 TO 8,000 R P M
VARIABLE SPEED.
SUPPLIED WITHOUT
PULLEY.

\$15.00
EACH

Only a limited supply is available. Place your order now for quick delivery.

DOUBLEDAY-HILL ELECTRIC CO.

RADIO DEPT.—DESK A

715 12th St., N. W., WASHINGTON, D. C. 719-21 Liberty Ave., PITTSBURGH, PA.

HIGH SCHOOL STUDENTS →

Special Summer Courses in Wireless during July and August.

SUMMER RATES to Students Only:

Day Course \$10.00 per month

Evening Course 5.00 per month

Comprehensive instruction in SPARK, "ARC" and other "C.W." Transmitters. Thorough instruction in Vacuum Tubes as Detectors, Amplifiers and Oscillators. Study under former U. S. Government Radio Inspector for New England District.

A course started this Summer and continued in the Evening school in the Fall will secure for you a first grade commercial license which is a ticket as well as a passport to all foreign countries affording opportunity for foreign travel. With the present high wage scale which will not drop there is an excellent opportunity for providing a means for a college education later on.

MASSACHUSETTS RADIO & TELEGRAPH SCHOOL.

18 Boylston St., (cor. Wash.)

ARTHUR BATCHELLER

R. F. TROP
Tel. Beach 7168

Boston, Mass.

G. R. ENTWISTLE

IMMEDIATE DELIVERIES

LEADING MANUFACTURERS PRODUCTS

WESTERN RADIO ELECTRIC COMPANY

ESTABLISHED

"FOR BETTER SERVICE TO THE WESTERNER"

512 East Ninth Street,

Los Angeles, Cal.

— INTRODUCING —

The "ARRANBEE JACK AND PLUG"—a miniature plug and receptacle that's inexpensive, new and useful.

Modernize your set by using "ARRANBEE JACKS AND PLUGS" where you desire convenient and rapid changing of connections for various circuits—just like a telephone switchboard.



"ARRANBEE JACKS AND PLUGS" can be used for connecting in additional head-sets, for opening or closing the "B" Battery-potentiometer circuit, as mountings for Universal Wound coils, and for many other uses as occasion may suggest.

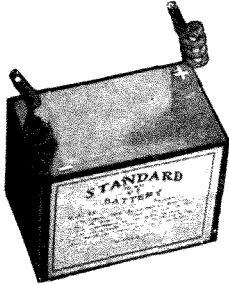

And for most satisfactory, efficient and economical vacuum tube service, use the "STANDARD VT BATTERY". Refuse the imitation or substitute.

- "ARRANBEE JACKS AND PLUGS" nickel plated, \$1.50 per doz.
- No. 7623 STANDARD VT BATTERY.....\$1.35 each
 - No. 7625 STANDARD VT BATTERY.....\$2.40 each
 - No. 7650 STANDARD VT BATTERY-VARIABLE, \$3.25 each

Get these products at your dealer's or send your order to any dealer distributing "Standard VT Batteries".

RICHTER & BYRNE, MANUFACTURERS

198 Roebling St.,

Brooklyn, N. Y.

PACENT ELECTRIC CO., Sole Eastern Agents, 150 Nassau St., NEW YORK CITY

FREE **POCKET** **HANDBOOK** **CATALOGUE**

Radio Handbook & Catalogue

Contains much valuable radio information, tables and data. Describes a remarkable line of wireless instruments including "Red Head" Phones, Arlington Tested Minerals, DeForest, Murdock and Signal Apparatus. Write for this book today.

The Newman-Stern Co.
Dept. Q S T Cleveland, O.

ARLINGTON TESTED CRYSTALS

Why buy minerals on a gamble? Be SURE when you put a crystal in your detector that it is EXQUISITELY SENSITIVE. Buy Arlington individually tested Minerals. Galena or Silicon, post paid on receipt of price.

35¢

THE NEWMAN-STERN CO.
Dept. Q S T Cleveland, O.

Red Head Radio Phone

The accepted standard in wireless receivers. If they are not BETTER than anything you've ever seen return them for full cash refund. Our Radio Handy Book and Catalogue, free on request, describes them, and many other instruments.

\$7.00

The Newman-Stern Co.
Dept. Q S T Cleveland, O.

BUILD YOUR OWN

Wireless Receiving Set

You can
SAVE
at least
\$25.00

by buying parts
and assembling
yourself.

Think of the pleasure and practical experience you will gain in making your own set, size 16"x8"x6", with wavelength range from 170 to 2,500 meters.

Send \$1.00 and we will send you the blue-print and instruction sheets—also prices of all parts. When you order at one time \$5.00 or more worth of parts you may deduct this \$1.00 from the total. Since the blue-print and instructions alone are worth \$1.00 and since we can save you money on wireless material, you cannot possibly lose. So send \$1.00 today before this slips your mind and start making your set as soon as possible.

Write today and get started

K. & G. WIRELESS SUPPLY CO.
Dept. 18D, 152 Chambers St., New York City.

Best of Everything in
Radio Apparatus and Parts.

Send Stamp for Catalog "Q"

J. H. BUNNELL & CO.

32 Park Place, New York

ARNOLD

Loose Couplers

Audion Detectors
Parts and Accessories

Send 4c stamps for literature which is sure to interest you

J. F. ARNOLD 2082 Lexington Avenue, N.Y.
Established 1910

MURDOCK

NO. 55



2000 OHM DOUBLE SET

\$4.50

3000 OHM DOUBLE SET

\$5.50

Made for long and
Useful service in
Radio stations where their
Dependable and sensitive
Operation makes them the
Choice of those who
Know GOOD 'phones.

ORDER YOUR SET NOW—
Try it out thoroughly.
IF IT DOESN'T SUIT, SEND
IT BACK AND GET YOUR
MONEY

Bulletin 19 shows a splendid line of the type of apparatus you want. Send for a copy.

WM. J. MURDOCK CO.

65 Carter St.

CHELSEA MASS.

221 SECOND ST., SAN FRANCISCO, CALIF.

SOME NEW

MODERN

RADIO EQUIPMENT COMPANY
TRADE MARK

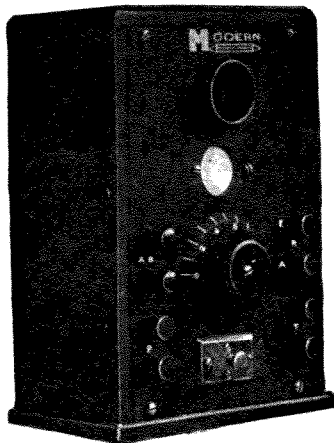

Type HBD

VACUUM TUBE CONTROL
CABINET.

\$15.00

Complete less battery and tubes.

Highly finished wood case with XX Bakelite panel. Metal parts of highly finished nickle-plate.

THE BEST THAT MONEY CAN BUY.

**DETECTOR AND TWO-STAGE
AMPLIFIER TYPE HBA**

Complete - - \$75.00

This is an entirely new instrument. It is the most up-to-date instrument and is sold at an extremely low price.

**"MODERN" APPARATUS ARE
ALL THAT THE NAME
IMPLIES.**

For sale at all "Modern" agencies—and

Modern Radio Equipment Co.

Designers and manufacturers of high grade radio apparatus.

Elizabeth, New Jersey.

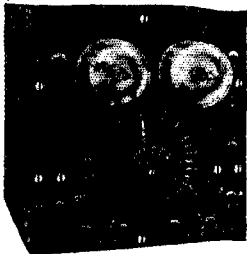

RADIO INTERNATIONAL RADIO

**VACUUM TUBE DETECTOR AND
AMPLIFIER, AND TWO STAGE
AUDIO FREQUENCY AMPLIFIER.**

This detector and amplifier unit is one of the series of interchangeable panel units for receiving, which the International Radio Telegraph Company is manufacturing as part of its new line of experimental and laboratory apparatus. The two-stage amplifier will multiply signal strength about 350 times. The units are all of the same size, having 6" by 6 3/8" panels, and are all fitted to standard well finished cases, so that they may be combined and connected in any way desired. These instruments include detectors, condensers, inductances, amplifiers, etc., as described in our various Experimental Apparatus Bulletins.

The detector-amplifier is priced at \$35.00, without tubes, and the two-stage amplifier at \$42.50, without tubes. Terms—cash with order, F. O. B. New York City.

Write to Department 23 for our new FREE six-page bulletin index.

INTERNATIONAL RADIO TELEGRAPH COMPANY
326 BROADWAY, NEW YORK CITY

AMATEURS DO YOU KNOW?

How far a Crystaloi Detector operates; that you are missing a lot without a Tresco 20,000 meter Tuner, and that you hear them good with Murdock Phones?

Rubber Knobs
Corwin Dials
Binding Posts
Murdock Phones

Variable Condensers
Crystaloi Detectors
Tuners and Cabinets
Audion Panels

We have Wilcox, Tresco, Murdock, A. H. Corwin and other first class manufacturer's stock. Just send 8c for all the data.

"ARK" RADIO SUPPLY

97 Hill St.,

Shelton, Conn.

NEW ORLEANS RADIO

APPARATUS AND SUPPLIES

L. A. ROSE

121 Camp St.

NEW ORLEANS, LA.

Send 10c for Latest Catalogue

PIRACO JULY SPECIALS

Latest Moorhead Vacuum Tubes. All provided with Standard Four Prong Base.

Electron Relay Detector Tubes.....\$6.00

Moorhead Amplifier-Oscillator Tube..... 7.00

Moorhead Transmitting Tube..... 7.50

Sockets for Above, with Grid Leak..... 1.50

Tubes Guaranteed and Sent Prepaid.

Catalog Delayed.

Pittsburgh Radio Supply Co.

Sixteen Eureka St.,

Pittsburgh, Pa.

THE AMERICAN RADIO SALES AND SERVICE COMPANY REPRESENTING

DeForest
Multi-Audi-Fone
Wireless Specialty
Chicago Radio Laboratory

QUALITY—SERVICE

WE PREPAY POSTAGE

Great American Bldg., Mansfield, O.

Fine Clothes May Make The Man

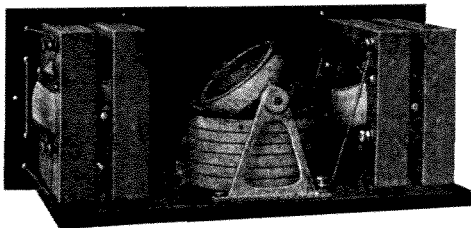

Back View

General Specifications:—Ball type Variometers and Vario-Coupler (described in detail in the June "QST"). Heavy "bus-bar" wiring with soldered connections. Genuine bakelite panel and dials (not composition). Mahogany cabinet. Range 140 to 500 meters. Shipping weight 15 pounds.

Price.....\$42.50

Variometers and Vario-Couplers identical with those used in the above regenerative receiver.

Variometers\$10.00
 Vario-Couplers 7.00
 Bakelite Dial and Knob..... 1.30
 Knob and Pointer......60
 Blueprint of instructions sent with set and parts.

IMMEDIATE DELIVERY.

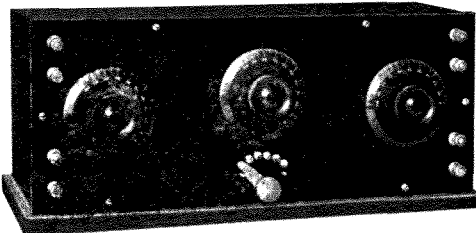

Front View

The Radio Shop

Bank of Italy Bldg.,

Dept. Q.

San Jose, Calif.

Give Your Spark A Chance

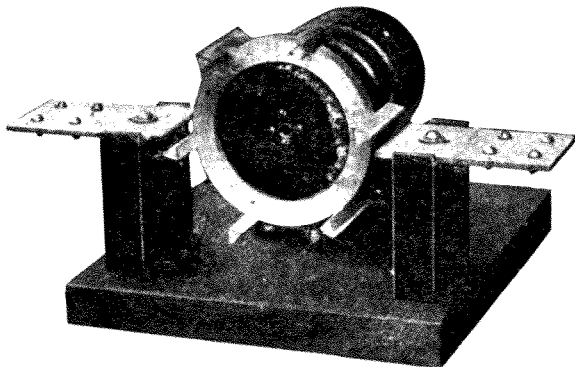

Our New Rotary allows all of the energy in the closed circuit a free discharge surface. Electrodes are $2\frac{1}{2}$ inches wide and $\frac{1}{8}$ inch thick accurately shaped on a milling machine. Made with 6 or 12 points for high or low note. You can't beat the combination of an Acme transformer and our 12 point rotary. Absolutely highest efficient gap ever offered, fully guaranteed.

Priced at \$50.00 with either rotor.

Literature ready for distribution June first and IMMEDIATE DELIVERIES.

Wireless Manufacturing Co. Canton, Ohio

CLASSIFIED ADVERTISEMENTS

Five cents per word per insertion, in advance. Name and address must be counted. Copy must be received by the 10th of month for succeeding month's issue.

TELEGRAPHY—(both Morse and Wireless) and Railway Accounting taught quickly. Tremendous demand. Big salaries. Great opportunities. Oldest and largest school; established 46 years. All expenses low—can earn large part. Catalog free. Dodge's Institute, R St., Valparaiso, Indiana.

FOR SALE: My transmitter and receiver, A1 condition. W. J. Brigham, 50 Hall Ave., West Somerville, Mass. Phone Somerville 2581-J.

BUSINESS OPPORTUNITY: Do you want a part of the profit from the sale and manufacture of radio equipment? Successful radio concern increasing capital. You can get in. Small shares. Write QST, Box No. 85, Hartford, Conn.

MARCONI V.T.'s. Class I and II \$6.50 postpaid. Double filament audiotrons \$5.00 postpaid. Tested and guaranteed. Limited offer. The Kehler Radio Laboratories, 901 West 1st St., Abilene, Kansas.

FOR SALE: 1/2 K.W. transformer coil, \$4.00; graphite rod potentiometer \$0.50; double slide Murdock tuner \$3.25; E. I. Co. sliding plate condenser \$0.75. All nearly new. F. L. Burgess, Central Village, Conn.

FOR SALE—1/4 K.W. Eck rotary converter with starting box, Clapp-Eastham 1/4 K.W. transformer, Murdock rotary gap, good condition. E. Cyriax, 219 East 71st St., New York City. Phone Rhinelander 2691.

EXCHANGE Duck's 16,000 meter coupler for 1 K.W. Thordarson or \$30 cash. Wm. N. Perry, (9JT) 815 Lake Ave., Racine, Wis.

SPECIAL—2 M.F. Condensers, slightly used, post paid Fifty Cents. Chas. Pierce, 221 West Peachtree St., Atlanta, Ga.

WANTED: 2 K.W. transformer. Will trade in or sell new 1 K.W. Thordarson. H. J. Burhop, Manitowoc, Wis. 9ZL.

FOR SALE or EXCHANGE for Graflex Camera: One Enfield rifle, army type, with 800 rounds of ammunition therefor. David L. Moore, Farmington, Conn.

FOR SALE: 1/2 K.W. transmitting set and audion receiving set. Write for list. K. Ross, 60 Warwick Ave., Rochester, N. Y.

SELL: Grebe—RORB 2 step amplifier, \$40.00; DeForest audion cabinet P-500, \$20.00. List free. George Sprouls, 5530 N. American St., Philadelphia, Pa.

BARGAIN: Western V.T.'s. and P. 11 3,200 ohms phones, large receiving transformers, tuner, flat cabinet receiving set, flat helix, 4" x 5" plate film pack camera with case. Write Edwin Mraz, 2214 S. California Ave., Chicago, Ill.

1/2 K.W. Clapp-Eastham Rotary Quenched Panel Transmitter, Complete Receiving Set, Audion Panels, Tubes, Phones. Send stamp for complete list of used apparatus. Lee A. Bates, No. 8 Moen St., Worcester, Mass.

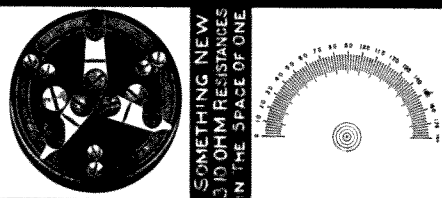

**SOMETHING NEW
3.0 OHM RESISTANCE
IN THE SPACE OF ONE**

TRIPLE RHEOSTAT 180° CONDENSER CONTROL 3 AUDIONS SCALE ON 4" CIRCLE FROM ONE BASE PRINTED FROM COPPER GENUINE BAKELITE PLATE ON BRISTOL BOARD POSTPAID \$2.50 POSTPAID .25

**SEND FOR CIRCULARS
WORCESTER RADIO LABORATORIES
16 WAYNE ST., WORCESTER, MASS.**

A Blow at the H. C. L.

Until August 1st we will continue to sell our No. 30 nickel-plated switch points, 1/4" x 1/4" beveled heads—complete with 3/8", 3/16 brass machine screws, for 30c per dozen—postpaid.

Orders filled in rotation.

Send 4c in stamps for circular.

The Pacific Radio Distributing Co.
Pomona, California

RADIO MEN

The

Mutual Purchasers Association
will save you money on all
WIRELESS APPARATUS

Write Dept. A12 for details.

MUTUAL PURCHASERS ASS'N
2-4 Stone Street, New York

WILCOX INDICATING DIALS

Of polished hard rubber, accurately engraved, filled with brilliant white, furnished complete with knob, shaft, tension spring, nuts and stationary pointer.

3" Diam., \$1.50 180° or 90° scale 2" Diam. \$1.25
Postpaid Same Price Postpaid

TYPE 104 PANEL SWITCH

A complete unit for back of panel mounting. The latest and best in panel switches, better looking, more efficient and easier to mount.

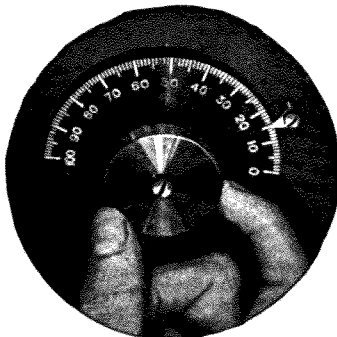
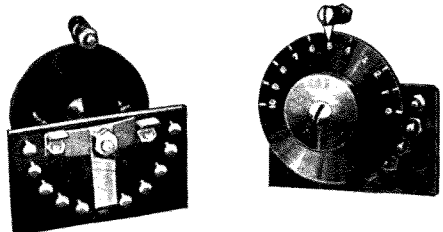

Complete as illustrated.....\$2.25 Postpaid
With pointer instead of dial.... 1.50 Postpaid
Five cents brings you our loose leaf catalog.

THE WILCOX LABORATORIES,

Dept. H,

Lansing, Mich.

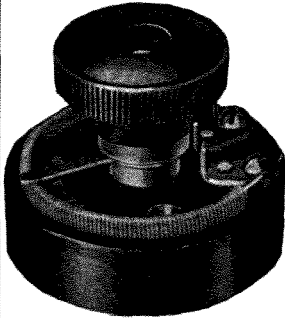

OUR NEW FILAMENT RHEOSTAT

For Back or Front of Panel Mounting.
\$1.75 Postpaid
 6 ohm resistance, fine adjustment on 4 or 6 volts.
 2 1/2" Diameter.
 Smooth action
IMMEDIATE SHIPMENT!

SPECIAL SUMMER SALE OF

GROUND WIRE

No. 4 Triple Braid, Rubber Covered
8c. per ft. plus postage
\$7.00 Buy the 100 Ft. Wt., 17 Lbs. 100 Ft. 100 Amp. 600 Volt Lightning Switches, \$4.

Nation-wide Use of Our 44 V. Variable "B" Battery Means Rapid Turnover and Absolutely Fresh Batteries. Supplied Ready to Use, with Wooden Case and Jiffy Connectors.

A Few 0-2 1/2 Amp. General Radio Meters Left—
 at Half Price, **\$5 Postpaid.**

Standard VT Socket—**\$1.** Why Pay More?

Our Original AudioTron Adapter Permits Use of your 'Tron in a VT Socket, **\$1.75 Postpaid.**
 Described in Our Bulletin.

Honey-Comb Coil Adaptors, **\$1.50 Per Pair Postpaid.**

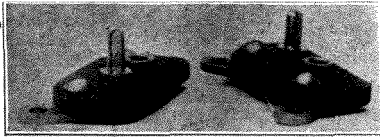

Attach to Binding Posts of a Variable Condenser. Insert H-C Coil, Making a Tuning Unit. Two Units Make a Loose Coupler, a Third Makes a Tickler Coil. One Makes a Wave-Meter.

RADIO EQUIPMENT CO.

630 WASHINGTON ST., BOSTON, 11, MASS.

TELEGRAPHY

(Both Morse and Wireless and RAILWAY ACCOUNTING taught thoroughly and quickly). Big salaries now paid. Great opportunities for advancement. Largest and oldest school, established 46 years. Endorsed by Telegraph, Railway, Radio, and Government officials. Expenses low - opportunities to earn large portion. Catalog free.

DODGE'S INSTITUTE

3 Street, Valparaiso, Ind.

"DON'T READ THIS"
 If you are NOT interested in improving your wireless set.
 Our **FIXED CONDENSERS** for AUDION CIRCUITS will stop those mushy signals.
 Style No. 1 - **\$0.65**
 Postage extra. Send stamp for circulars.
RADIO TESTING STATION
 25 Sturges St., Binghamton, N. Y.

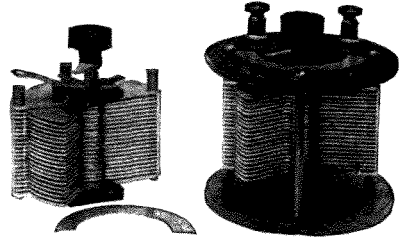

THE "ILLINOIS" VARIABLE CONDENSER

Hard Rolled Aluminum Plates
 Three Styles, No. 1. Panel, No. 2. Open Type as shown, No. 3. Fully Encased, Anti Profiteer. Less than pre-war prices. Fully assembled and tested.

Sent Prepaid on Receipt of Price.

Style No. 1	No. 2	No. 3	Money back if not satisfied. Just return condenser within 10 days by insured P.P.
43 Plates, \$3.00	\$4.00	\$4.25	
23 " "	2.50	3.50	
13 " "	2.25	3.25	

In Canada 25c additional.

These condensers are made by a watch mechanic schooled in accurate workmanship. Personally we will need no introduction to Amateurs who have "listened in" for "time" and "weather" from 9ZS.

Postscript.

We shall have to claim an even wider distribution of the "ILLINOIS" this month. Instead of placing our limits from the Penobscot to the Golden Gate, we will say from Shanghai to the Zuyder Zee. Commercial and Naval Operators have discovered us, and we expect Uncle Sam's Navy and new Merchant Marine will soon be large users of our "best ever" "ILLINOIS".

We again thank our friends for their generous words of appreciation.

You will notice a slight increase in our price list, on the "mounted styles only. This will be effective from May first. The fact is we could not quite "get by" with our first prices.

The "Star Spring" features of our design meets with great favor. We shall make this the subject of application for Patent as we think it marks a step forward in the construction of Variables. It has two important functions. It keeps the plates accurately and permanently centered; without "end-shake"; and provides sufficient friction to hold the "rotor" at any setting without liability of its dropping from its position by the unbalanced weight. It makes the Condenser in this respect as reliable as the much more expensive "balanced" type.

Kindly note: We issue no Catalog, and make no "trade discounts". We set our prices at the lowest limit, and leave the "middle man" out for the sole benefit of the consumer".

G. F. JOHNSON, 625 Black Ave., Springfield, Ill.

"JUPITER" STRANDED AERIAL WIRE

1 1/2c. PER FT.—\$12.00 PER M.
 7 strands No. 22 solid copper. The ideal radiator, Strong. Low resistance. Shipping weight 15 pounds per 1,000 feet. Send postage.

LEE A. BATES Sole Agent 8 Moen St. Worcester, Mass.

Save \$2. ! ARCO AMPLIFYING

TRANSFORMER is built for tubes now on market.

Mounted **\$5.10 Postpaid**

E. L. LONG

21 Magnolia Terrace, Albany, N. Y.

SHORT WAVE COUPLER

—170-625 Meters—

Wound with 20/38 Litz on Bakelite Tubing, Equipped with DeForest 1 1/2" Knob, Brass Pointer and Scale. Used by U. S. Government in SCR-54 Receiver.

PRICE \$4.50 UNMOUNTED

GOUSE & LORENSON

HUDSON, N. Y.

New Radio Products

and

Personal Service

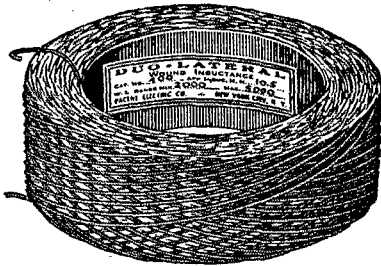

In endeavoring to give personal service to our ever growing clientele, we realize that new and more modern products make for the betterment and improvement of radio work and to this end we offer you the latest scientific achievement in radio

DUO LATERAL WOUND COILS

made in several different sizes covering every wavelength, these coils have staggered winding and a lower natural period, lower high frequency resistance, very low distributed capacity, lower D. C. resistance and higher self inductance, which makes it an ideal part of any set and superior to all other coils for amateur work.

Radio Engineers have made extensive tests of these coils and give them their highest recommendations.

ORDER BY CATALOGUE NUMBER AS LISTED.

CATALOG NUMBER	WORKING RANGE IN METERS	WAVELENGTH IN METERS	INDUCTANCE IN MILLI-HENRIES		LIST PRICE EACH UNMOUNTED
25	180 to	250	.045	.045	\$0.90
35	180 to	450	.075	.078	1.00
50	250 to	700	.156	.15	1.10
75	400 to	900	.36	.34	1.20
100	500 to	1400	.66	.57	1.30
150	600 to	2000	1.40	1.35	1.40
200	1000 to	2500	2.50	2.30	1.50
250	1200 to	3500	4.2	4.	1.60
300	1500 to	4500	6.25	6.1	1.80
400	2000 to	5000	10.62	10.2	2.00
500	3000 to	6000	17.6	17.3	2.20
600	4000 to	10000	25.0	22.0	2.50
750	5000 to	12000	38.0	35.3	2.70
1000	8000 to	15000	72.3	68.8	2.90
1250	10000 to	20000	116.6	112.3	3.50
1500	15000 to	25000	171.5	162.2	4.00

We also carry a large stock of high grade electrical apparatus, including a very complete line of heating appliances.

You have our most courteous invitation to spend a few moments in our spacious show rooms and look over our complete stock. We will gladly show you any instrument or part you may desire to examine. It will be a revelation to you, besides it is part of our service.

OUR WORD OF HONOR TO YOU IS
OUR GUARANTEE. LET US PROVE IT.

Write Dept. B-2, for literature and price lists

CONTINENTAL RADIO AND ELECTRIC CORP.

J. DI BLASI, Secy.

J. STANTLEY, Treas.

6 Warren Street

New York

CONNECTICUT RADIO

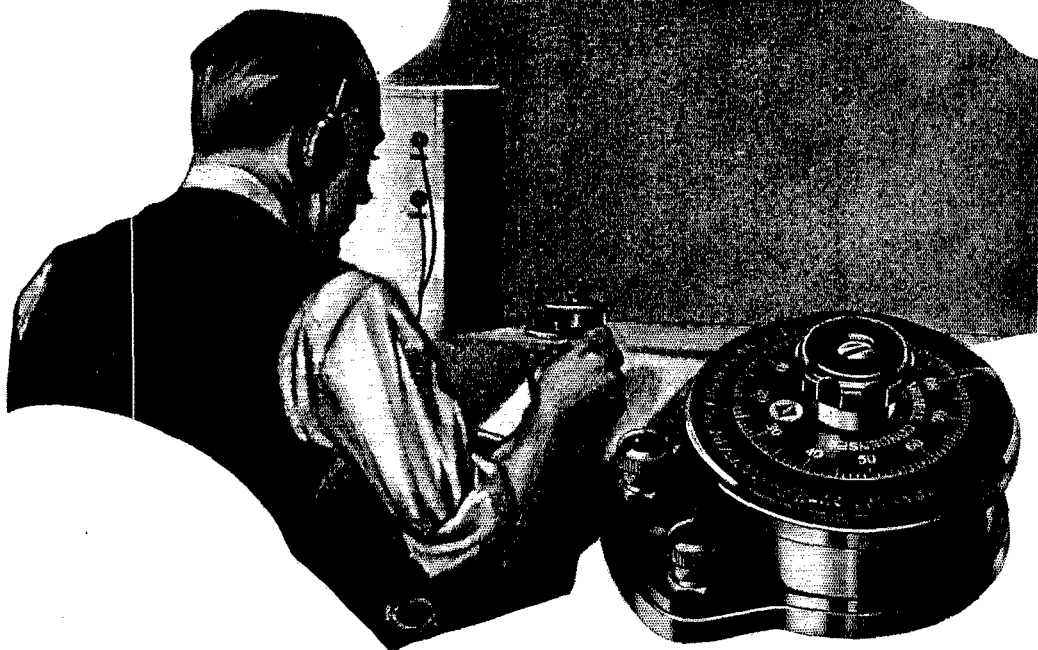
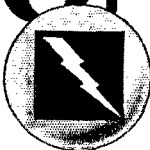

More Efficient Readings With The CONNECTICUT Variable Condenser

You can do efficient work near the ends of the scale if your readings are made in connection with the new CONNECTICUT Variable Condenser. Its wide range of capacity, its ease of operation, and security of adjustment mark it an important contribution to the science of radio. The simplicity of design means that the best way of doing the thing has been found.

Other points of advantage are explained in our booklet
"THE CONNECTICUT Variable Condenser". Send for it.

Mention your Dealer's Name

CONNECTICUT TELEPHONE COMPANY
Meriden & ELECTRIC Connecticut

AMRAD

The Recognized Symbol of Superior Performance



AS the number of radio stations increases by leaps and bounds so do the opportunities for violation of Federal regulations respecting wavelength multiply. The future of Amateur Radio is safe only as operators respect and comply with the radio law. The proportion of new operators who will not transmit until after carefully measuring the emitted wave, is growing; as is also the number of experienced operators who realize that the

making of accurate measurements leads to efficiency and consistent results. These observations indicate the fact that American Radio enthusiasts are approaching the problems of relay work and general communication more seriously, more conscientiously and with a deeper motive of co-operation than ever before. That the Amrad Wavemeter has fulfilled admirably its intended purpose and won instant recognition during the busy days of recon-

struction, is a source of great satisfaction to the makers, who will zealously maintain the high standard of accuracy which guarantees each instrument little short of perfect. As the Amrad Wavemeter is direct reading and requires no calculations, its operation is simplicity itself to the uninitiated and a great convenience to experienced operators. Range, 130-230 meters. Price \$7.50. Descriptive Bulletin W sent upon request.

RADIO OPERATORS: Send your station call letters and name of nearest dealer and we will mail you our catalog now ready. Latest bulletins for insertion therein will be forwarded you monthly.

RETAILERS: Our new trade proposition became effective last month. A request will bring all details and our complete trade catalog.

AMERICAN RADIO AND RESEARCH CORPORATION

13 Park Row
New York

Address all Communications to New York.

Factory and Laboratory
Medford Hillside, Mass.