

11

QST

A MAGAZINE DEVOTED EXCLUSIVELY TO THE WIRELESS AMATEUR



June
20 CENTS

THE A. R. CO. VARIABLE CONDENSER

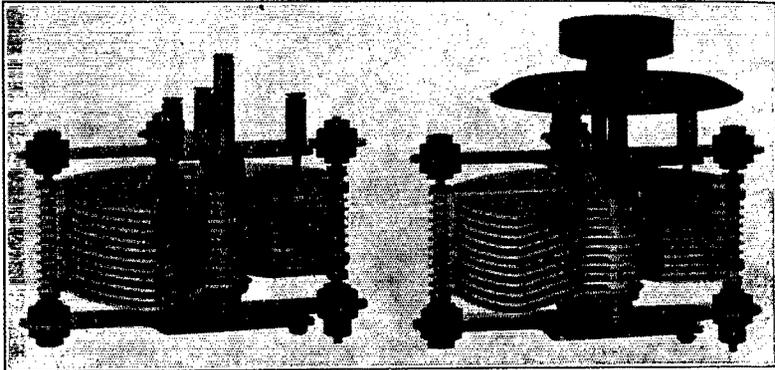

THE NEW "A. R. CO." VARIABLE CONDENSER

illustrated above is made in two capacities—.001 mfd. and .0005 mfd. and is supplied unmounted only but with dial and knob if desired. The rotary plates are rounded on one end affording straight line capacity. The dial is of moulded composition, scale in white—0—100. Bakelite Knob. We can guarantee this condenser in every way as to quality, reliability and satisfaction. The low price is decidedly an innovation.

Capacity
 .0005 mfd.
 .001 mfd.

PRICES:
 Unmounted
 \$5.00
 6.25

With Knob and Dial
 \$6.00
 7.25

POSTAGE 10 CENTS

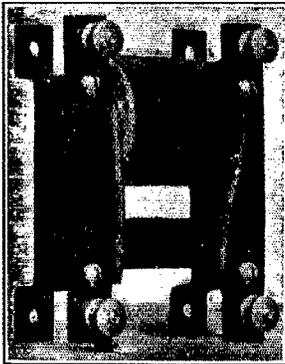

THE "A. R. CO." AMPLIFYING TRANSFORMER

A new amplifying transformer designed for use with present type vacuum tubes. Special attention has been given to the Impedance Ratio to give especially satisfactory results. This amplifying transformer is adapted for either table use or back-mounting on a panel. The workmanship is good throughout. Nickel plated binding posts. Frame stampings in dull black with engraved lettering in white.

"A. R. CO." AMPLIFYING TRANSFORMER
 Price, As Illustrated.....\$5.00

POSTAGE 10 CENTS

"BULLETIN 14"—describing and illustrating the best in RADIO EQUIPMENT will be mailed upon receipt of 10 cents in stamps—this amount may be deducted on your first order of \$1.00 or over.

ATLANTIC RADIO COMPANY, INC.

NEW ENGLAND DISTRIBUTORS "RADISCO" PRODUCTS

88 BROAD STREET

BOSTON, 9, MASS.

THE

ACME APPARATUS CO.

announces the birth of

Another Radio Transformer

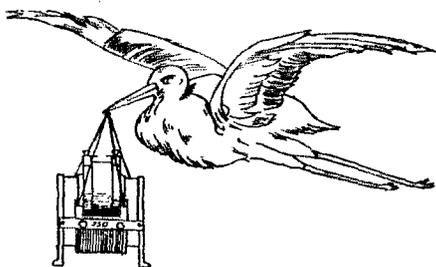

NAMED ACME 250 WEIGHT 13 POUNDS

250 WATTS, 250 MILES—A MILE PER WATT.

ACME 250 has inherited the high efficiency, excellent operating characteristics, rugged construction and attractive appearance of its older brothers, and has come to fulfill the demand for a transformer which, though it may not present as good a front, can make itself heard in any company.

The ACME cry is 800 cycles strong.

PRICE

\$16.00 Dressed

\$13.00 Undressed

110 volts 60 cycles $\frac{1}{4}$ K.W.



ACME APPARATUS COMPANY

26 Windsor Street, Cambridge 39, Mass.

SOMETHING NEW !
DUO-LATERAL
Wound
COILS
The Last Word in Inductances

MADE IN
STANDARD AND
SPECIAL
INDUCTANCE
VALUES.

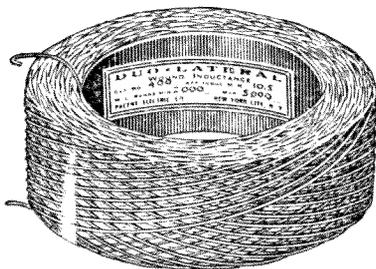

A DUO-LATERAL
COIL SHOWING
THE STAGGERED
WINDING.

THE DUO-LATERAL COIL now being offered for the first time is **not** to be confused with any other types of machine wound inductances that have been on the market for some time. The **Duo-Lateral Coil**, made in numerous sizes for general and specific application, has the following distinct advantages which make it superior to any other coil for amateur and commercial work alike.

1. **Lower Natural Period**
2. **Lower High Frequency Resistance**
3. **Very Low Distributed Capacity**
4. **Lower Direct Current Resistance**
5. **Higher Self Inductance**
6. **Stronger Mechanically**

DUO-LATERAL COILS have been tested by many of the most eminent Radio Engineers and have received their highest endorsement.

Bulletin P1Q, containing valuable engineering data, constants and prices of Standard sizes of **Duo-Lateral Coils** covering practically every wavelength used, is yours for the asking.

MANUFACTURERS, DEALERS, JOBBERS and DISTRIBUTORS—write for our proposition.

SALES AGENTS for:

Electrical Products Mfg. Co., A. H. Grebe & Co., Dubilier Condenser Co., Richter & Byrne, Rawson Electrical Instrument Co., The Magnavox Company and others.

Pacent Electric Company, Inc.

Builders and Specialists of Radio, Electrical and Laboratory Equipment

150 NASSAU STREET

Telephone
Beekman 5810

NEW YORK CITY

THE OFFICIAL ORGAN OF THE A.R.R.L.

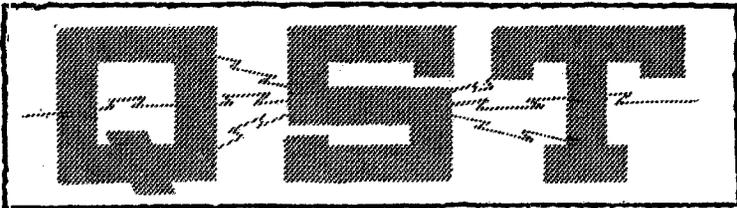

JUNE, 1920

VOLUME III

No. 11

CONTENTS

| | |
|---|---------------------|
| The A.R.R.L. QSS Tests | 5 |
| Recent Development of Radio Telephones | Walter S. Lemmon 7 |
| Rotten Air | The Old Man 12 |
| The Underground Antenna Adapted to Amateur Waves | R. H. G. Mathews 14 |
| Construction of a 500-Volt Rectifier Transformer for C.W. Work | Robert Muns 17 |
| Championship Chess by Radio | 19 |
| Editorials | 21 |
| The Operating Department | 24 |
| Who's Who in Amateur Wireless | 34 |
| QST's Directory of Calls | 35 |
| With the Affiliated Clubs | 37 |
| Amateur Radio Stations | 39 |
| The Junior Operator | 41 |
| "Strays" | 43 |
| Radio Communications by the Amateurs | 46 |
| Calls Heard | 52 |

QST is published monthly by The American Radio Relay League, Inc., at Hartford, Conn. Kenneth B. Warner (Secretary, A.R.R.L.), Manager and Editor.

Subscription price, \$2.00 per year, anywhere. Single Copies, 20 Cents.

Entered as second-class matter May 29, 1919, at the post office at Hartford, Connecticut, under the Act of March 3, 1879.

Copyright, 1920, by The American Radio Relay League, Inc.
Title registered at United States Patent Office.

THE AMERICAN RADIO RELAY LEAGUE, Inc.
HARTFORD, CONN.

THE AMERICAN RADIO RELAY LEAGUE

INCORPORATED

"A national non-commercial organization of radio amateurs, bonded for the more effective relaying of friendly messages between their stations, for legislative protection, and for scientific growth."

OFFICERS

President
HIRAM PERCY MAXIM
Hartford, Conn.

Vice President
CHAS. A. SERVICE, JR.
Bala, Pa.

Traffic Manager
J. O. SMITH
73 Hillside Ave.
Rockville Centre, L. I.

Treasurer
A. A. HEBERT
Nutley, N. J.

Secretary
K. B. WARNER
Hartford, Conn.

DIRECTORS

A. E. BESSEY
Sunnyvale, Calif.
V. F. CAMP
Brightwaters, L. I.
J. M. CLAYTON
Little Rock, Ark.
J. C. COOPER, JR.
Jacksonville, Fla.
F. M. CORLETT
Dallas, Tex.
W. T. FRASER
Buffalo, N. Y.

W. T. GRAVELY
Danville, Va.
F. H. HAMILTON
Indianapolis
A. A. HEBERT
Nutley, N. J.
HIRAM PERCY MAXIM
Hartford, Conn.
C. R. RUNYON, JR.
Yonkers, N. Y.

C. A. SERVICE, JR.
Bala, Pa.
J. O. SMITH
Rockville Centre, L. I.
H. L. STANLEY
Babylon, L. I.
C. H. STEWART
St. David's, Pa.
K. B. WARNER
Hartford, Conn.
M. B. WEST
Waukegan, Ill.

OPERATING DEPARTMENT

TRAFFIC MANAGER
J. O. Smith

ATLANTIC DIVISION
Manager
Chas. A. Service, Jr.
Bala, Pa.

Asst. Mgr., Central Sec.
John DiBiasi
227 East 75th St.
New York City

Asst. Mgr., Southern Sec.
Chas. H. Stewart
St. David's, Pa.

EAST GULF DIVISION
Manager
J. C. Cooper, Jr.
Atlantic Natl. Bank Bldg.
Jacksonville, Fla.

CENTRAL DIVISION
Manager
R. H. G. Mathews
1816 Carmen Ave.
Chicago

Assistant Manager
Chas. H. Zeller
4732 N. Maplewood Ave.
Chicago

WEST GULF DIVISION
Manager
Frank M. Corlett,
1101 East Eighth St.
Dallas, Tex.

ALASKAN DIVISION
Manager
Theodore A. Stocking
Ketchikan, Alaska

ROCKY MOUNTAIN DIV.
Manager
M. S. Andelin
1158 Harrison Ave.
Salt Lake City, Utah.

PACIFIC DIVISION
Manager
A. E. Bessey,
Sunnyvale, Calif.
Assistant Manager
E. G. Arnold
181 No. 17th St.,
San Jose, Calif.

ST. LAWRENCE DIVISION
Manager
Albert J. Lorimer
243 Mackay St.
Montreal, Que.

ONTARIO DIVISION
Manager
A. H. Keith Russell
853 Markham St.
Toronto, Ont.

NEW ENGLAND DIV.
Manager
Guy R. Entwistle
187 Sutherland Road
Brookline, Mass.

ROANOKE DIVISION
Manager
W. T. Gravelly
354 Main St.
Danville, Va.

DELTA DIVISION
Manager
John M. Clayton
1801 Welch St.
Little Rock, Ark.

MIDWEST DIVISION
Manager
L. A. Benson
4942 Wiesehan Ave.
St. Louis

DAKOTA DIVISION
Manager
Russell H. Pray
Valley City, N. D.

NORTHWESTERN DIV.
Manager
John D. Hertz
63 East 68th St.
Portland, Ore.

Address General Correspondence to Executive Headquarters, Hartford, Conn.

Q S T

A Magazine Devoted Exclusively
to the Radio Amateur

The A.R.R.L. QSS Tests

IN an Editorial last month we told of our idea whereby we could all collect data on fading signals, and since that time we have been busily at work endeavoring to get arrangements completed for starting the tests. Because of the small amount of time available before this issue of QST goes to press, however, it has been impossible to arrange schedules for the entire country and the actual start of the tests has therefore been delayed a month.

It is perhaps as well that this has occurred, as it will give us time to perfect our schedules, study over the methods to be used, and enable greater publicity to be given the tests so that the fullest benefit may be reaped from them.

Plans for the system have developed however, so that we can now announce them. The scheme is to have transmitting stations in various sections of the country send out an arbitrary QST which will be simultaneously logged by all A.R.R.L. men who care to participate in the tests, noting the rise and fall in audibility. Reports should be sent in promptly for each test, and when these are analyzed it is hoped and expected that valuable and intensely interesting information will be forthcoming. This is what the radio game most needs right now—reliable information on the subject. Attempts to correct it can have no chance unless based on a knowledge of the problem, and this we hope to develop. We know that fading is a transient phenomenon—signals fade at differing rates and different degrees and in different directions at the same station from night to night and on the same night, and conditions at two stations are probably dissimilar at any given instant, etc. All of which, and more, are things we will learn much about thru this work.

In the next QST complete transmitting schedules will be announced, and all amateurs are cordially invited to participate. We show here a form adopted as a standard for making reports for these tests,

which can be ruled or typewritten by every amateur. The form is based on one developed in collaboration with the Bureau of Standards for the fading tests some of our members are carrying out for that organization, as mentioned in the May QST, and answers our purpose admirably. It contains spaces for noting miscellaneous information, and a form for checking the fluctuation of audibility. The transmitting stations will send a broadcast entitled "ARRL QSS Test", consisting of each letter of the alphabet repeated five times at a smooth, even speed of 18 words per minute. Recording operators should gauge the average audibility of each group of letters according to the well-known Eccles scale, running from 0 to 9, as shown on the form, by making a check-mark opposite the proper value and under the letter in question. Promptly after the tests these should be sent in for analysis. It will be seen that a curve connecting the checkmarks will show graphically the swinging of the signals, and the interesting part is going to come in when reports from a whole circle of receivers around a given transmitter are compared, as we believe that they will show the fading to occur at different places in the alphabet in different directions from the transmitter.

The analyzing of this data is going to be a tremendous job—more than any one man or office could undertake. Consequently the work is being handled independently in each Operating Department Division. As announced elsewhere in this issue, the Operating Department has been sub-divided and now consists of seventeen divisions, in each of which the Manager is making arrangements for the tests, appointing assistants to handle the reports, and amateurs in each Division should mail their reports to their own Divisional Fading Committee. Additional points: Log as many transmitters as possible, but of course make a separate report for each.

If you log a transmitter outside of your own Division, mail the report on it to the Fading Committee of the division to which the transmitter belongs. Use standard letter-size paper (8½ x 11 inches) for the reports. See next QST for a complete schedule of transmitters and addresses of

the Fading Assistants for each Division. The work of the Division Fading Committees will be reported to Headquarters and reviewed in QST so that all may have the benefit of the observations. We believe we can make this epoch-making.
(Concluded on page 16)

A. R. R. L. FADING REPORT

Receiving station call _____ Location _____ Date _____

Time observations begin _____ General reception this date _____

_____ General character of strays
("static") this date _____

_____ Transmitting station call _____ Wave length _____ m.

Weather, wind direction, and strength, indicated by check mark below.

| | | | | | |
|----------|-----------|-----------------|----|----------------|--------|
| Weather: | Clear | Wind Direction: | N | Wind Strength: | Calm |
| | Cloudy | | NE | | Light |
| | Rain | | E | | Medium |
| | Snow | | SE | | Strong |
| | Sleet | | S | | Storm |
| | Fog | | SW | | |
| | Lightning | | W | | |
| | | | NW | | |

SIGNAL STRENGTH RECORD. Indicate average strength for each letter by a check mark (✓) in the proper square below.

| | A | B | C | D | E | F | G | H | I | J | K | L | M | N | O | P | Q | R | S | T | U | V | W | X | Y | Z | | |
|--------------------------|---|---|---|---|---|---|---|---|---|---|---|---|---|---|---|---|---|---|---|---|---|---|---|---|---|---|---|---|
| Very strong 9 | | | | | | | | | | | | | | | | | | | | | | | | | | | 9 | |
| Strong 8 | | | | | | | | | | | | | | | | | | | | | | | | | | | | 8 |
| Good 7 | | | | | | | | | | | | | | | | | | | | | | | | | | | | 7 |
| Fair 6 | | | | | | | | | | | | | | | | | | | | | | | | | | | | 6 |
| Rather faint 5 | | | | | | | | | | | | | | | | | | | | | | | | | | | | 5 |
| Faint 4 | | | | | | | | | | | | | | | | | | | | | | | | | | | | 4 |
| Just readable 3 | | | | | | | | | | | | | | | | | | | | | | | | | | | | 3 |
| Very faint, unreadable 2 | | | | | | | | | | | | | | | | | | | | | | | | | | | | 2 |
| Just audible 1 | | | | | | | | | | | | | | | | | | | | | | | | | | | | 1 |
| Nothing 0 | | | | | | | | | | | | | | | | | | | | | | | | | | | | 0 |
| | A | B | C | D | E | F | G | H | I | J | K | L | M | N | O | P | Q | R | S | T | U | V | W | X | Y | Z | | |

Receiving Operator

Recent Development of Radio Telephones

By *Walter S. Lemmon, E.E.*

Presented at meeting of the Radio Club of America, Columbia University,
February 20, 1920

SINCE the reopening of amateur stations there has been an increasing interest in the operation of radio telephones throughout the country, and it is the purpose of this paper to indicate the important strides accomplished during the war in this art, in order that the best forms of modern construction may be employed. Before proceeding to a discussion of the specific types developed it may be well to point out several fundamental features of the principles underlying the operation of this apparatus.

The transmission of radio speech is similar to that of radio telegraph signals, but, of course, the use of undamped waves is essential. This fact may be readily appreciated when it is remembered that in spark transmission a relatively long interval of time elapses between sparks or wave trains, and therefore any speech occurring between these wave trains would not be transmitted at all, as shown in Figure 1. Therefore it might be said that all present day apparatus utilizes a method of modulation or moulding of the continuously radiated wave by the voice frequency. The continuously radiated undamped wave will be referred to hereafter as the carrier, and the superimposed speech wave (of low frequency) as the voice wave or modulation.

In radio telephones, the receiving results do not depend entirely upon the total radiation of the transmitter, but upon how much this radiation is varied or modulated and also whether these variations closely respond to the pitch and amplitude of the voice wave to be transmitted. To receive radio speech the same general type of receiver is employed as is used for radio telegraph signals. It is important, however, to employ a detector which gives a response proportional to the received energy, and therefore a vacuum tube detector has been found to be excellent for this purpose. Another noticeable feature in receiving telephone signals is the sharpness of tuning required for clear speech. It must be remembered that the received signals consist not of a single wavelength, but of a narrow band of waves extending on each side of the

carrier wave. This point mainly affects the reception of long telephone waves and may generally be disregarded for short wave work. Without digressing into theory too far it may be stated that this band extends about 1000 cycles (the limit of voice frequencies) on each side of the fundamental or carrier wave.

The question of modulation is perhaps at the present time the crux of radio telephone development, and is a problem which affords plenty of latitude for experimentation. Unfortunately for the

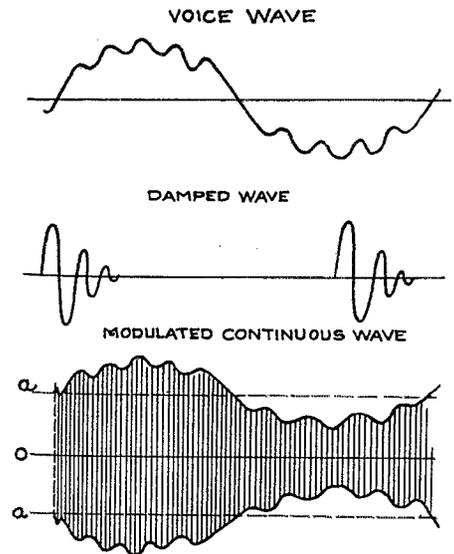

- FIG. 1 -

amateur, the only satisfactory means of studying modulation in detail is the use of an oscillograph, although, for purposes of testing, the results of the received speech at nearby stations will give roughly quantitative results.

The earliest method of modulating the radiated energy (applicable only to low powered sets) was to insert a microphone in the antenna or ground lead as shown in Fig. 2. Speaking into the microphone varied its resistance, hence the antenna current was also correspondingly varied.

However, the limited current carrying capacity and resultant heating of the microphone makes this scheme very wasteful of energy and it has long since been abandoned.

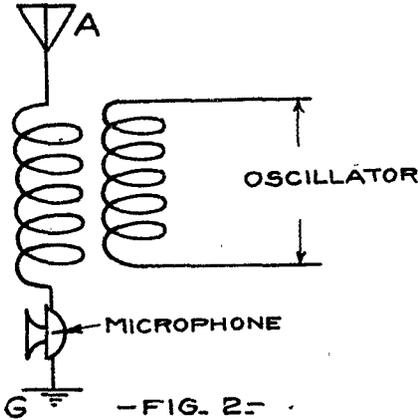

- FIG. 2 -

With vacuum tube sets the fundamental principle has been to vary, by some means, the characteristics of the oscillating tube and hence vary its output. This, of course, may be accomplished by control either of the grid or plate circuits.

In grid modulation, illustrated in Fig. 3, the microphone and local battery are coupled to the grid by a small transformer. The secondary of this transformer is shunted by a condenser to bypass the radio-frequency oscillations. In this scheme the tube oscillates in the usual manner and the amount of this oscillation is controlled by varying the grid potential slightly in accord with the voice frequency currents from the microphone circuit. While this system is simple and requires but small microphone currents, in practice it is very delicate and tends to be unstable. Due to these bad qualities and lack of easy adjustment, this method has also been superseded.

The form of modulation finding strong favor through war development is the plate system, also generally known as the

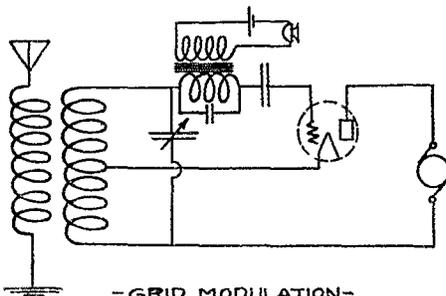

- GRID MODULATION -

- FIG. 3 -

Heising system. The basic principle of this method is illustrated in Fig. 4-a. Let us suppose that R1 and R2 are resistances in parallel connected to a DC source through the large choke coil X. Now if R1 is held constant and R2 is suddenly decreased, the choke coil will prevent any momentary change of the total current drawn from the source. Therefore for an instant the current through the branch R2 will increase, and that through R1 will decrease. Similarly, if R2 is increased above normal value the current through R2 will decrease and that through R1 will increase. Of course there are also other effects, but this will serve mainly as an illustration of the modulation system to follow. In Fig. 4b the oscillator tube may be considered connected up to any standard form of oscillator circuit. In its plate circuit, however, in series with the plate generator D, is a large choke X. To by pass the radio frequency oscillations a small condenser C may be used. In parallel with the plate of the oscillator tube is the plate circuit of the modulator tube. The grid of the latter is kept at the proper normal negative voltage by the grid battery, and changes in its

- PLATE MODULATOR -

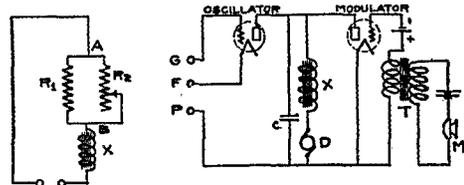

- FIG. 4 a -

- FIG. 4 b -

potential are produced by the secondary of the microphone transformer MT in accordance with variations of speech current in the microphone transmitter T.

Now when the grid voltage of the modulator tube is rapidly varied by the speech current in the microphone this causes the electron stream between filament and plate to vary and hence the effective resistance of the modulator tube plate circuit. Since, as in the above analogy, the total supply current fed to both plates is kept practically constant for short time intervals because of the choke coil X, the current through the oscillator tube branch varies corresponding to the modulator variations, and therefore the output of the oscillator is varied or modulated. Hence we may consider the modulator tube as a "speech operated resistance" in parallel with the oscillator tube. The choke coil X also has another function in this system which will be briefly touched upon here. Since it tends to prevent a sudden change in total current from the generator D, a counter

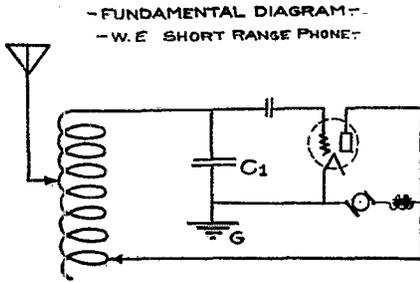

FIG. 5-

e.m.f. is produced across it called the counter e.m.f. (or voltage) of self-induction. This voltage at one time is added to the generator voltage, and at another time opposes it, depending upon whether the generator current tries to decrease or increase. Now the radio output of the oscillator tube depends upon the total voltage momentarily imposed upon its plate, hence this normal output may be much increased by the use of a proper choke coil in the plate circuit. This important part played by the choke coil is taken advantage of in the practical design of radio telephone sets and forms a feature of this modulating system.

WESTERN ELECTRIC SHORT RANGE SETS.

The latter part of this paper deals with a description of the important practical sets developed during the war period and will be confined to practical considerations of general interest. The apparatus developed for both the Army and the Navy was fundamentally similar although differing in construction and circuit details due to the special requirements of each service. Although the writer was directly connected with the Navy development, and hence more familiar with their construction,

there is not the slightest intention to belittle the splendid encouragement and effort put forward by the War Department in perfecting this most valuable means of communication.

The short range radio telephone set developed by the Western Electric Co. for both services was known to the Signal Corps as the SCR-67 and 68, and as the CW-936 set to the Navy. Its principal use was for communication between airplanes and the controlling ground station in the Army, and for communication between submarine chasers and other craft in Naval squadrons. The shipboard type set illustrated in the photograph showed many exclusive features interesting to amateur construction, and hence will be briefly described herein.

The set was originally developed for rapid communication and exchange of commands between submarine chasers during manoeuvres, and despite its hasty development and severe service, gave an admirable performance over the required ranges. Since the antennas on these craft were all of small size, the set was de-

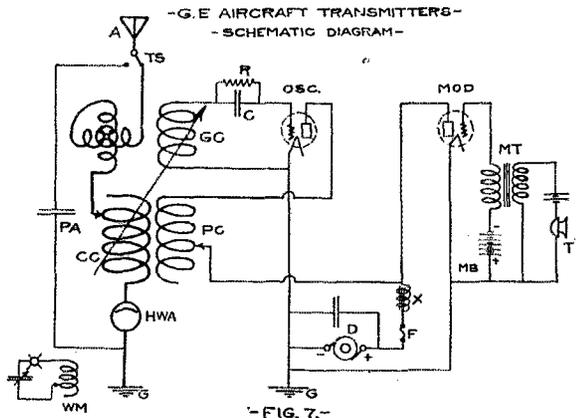

-FIG. 7-

signed to operate on low waves and was capable of quick adjustment to 256, 297, 300, 400, or 600 meters. Moreover, the antennas were well standardized and hence the sets were constructed for best operation on a standard antenna of approximately .0006 mfd. and a fundamental wave length of 190 meters, which corresponds closely to the size of the average amateur antenna used for transmitting. The same set with mechanical changes was later adopted for use on battleships, destroyers and transports, giving excellent communication over distances of 15 to 20 miles and in some instances exceeding 50 miles. All in all about two thousand of these sets were constructed for the Navy Department alone.

The transmitter is of the direct coupled type and employs one E type oscillator

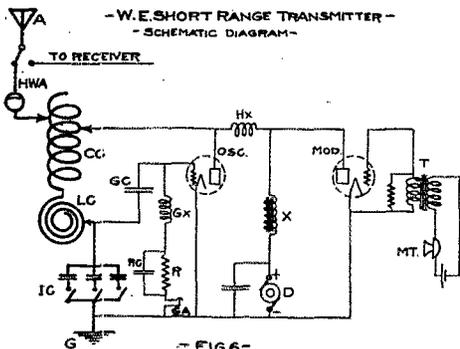

-FIG. 6-

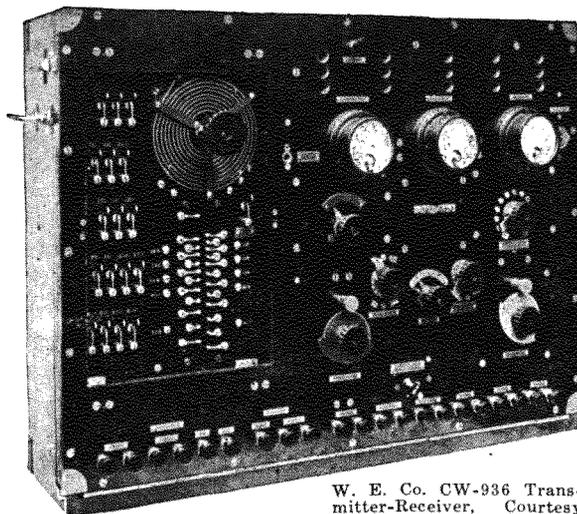

W. E. Co. CW-936 Transmitter-Receiver, Western Electric Co. Courtesy

tube and a similar modulator tube, the output being about five watts. Although both transmitter and receiver were located in the same box, they will be described separately for the sake of clearness. The elementary connection of the transmitter is shown in Fig. 5. In the actual schematic diagram, Fig. 6, the circuits are separated into the antenna and oscillator, and modulator circuits. The antenna circuit consists of the antenna connection (A), ammeter (HWA), coupling coil (CC), a special spiral inductance loading coil (LC), and an input condenser (IC), in the ground lead. The coupling coil contains taps to vary the wavelength, while the small spiral loading coil enables positions between taps to be obtained. The function of the input condenser (variable by steps from 500 to 4000 microfarads) is to insure the proper voltage on the oscillator tube grid for the various wavelengths employed. The grid voltage is important and should be approximately 90 volts for proper oscillation.

Coupling between the grid and plate circuits of the oscillator is obtained by a second set of taps on the antenna coupling coil. A grid stopping condenser GC of small capacity prevents the plate voltage from reaching the grid. A special grid leak circuit consists of the resistance R, (10000 ohms) in series with which is placed the choke coil GX of 3 milhenries while in parallel with the leak resistance is the 750 MMF. condenser RC. The series choke and parallel condenser prevent high frequency losses in the grid leak circuit and should prove

interesting to amateur constructors. A plug is also provided in the grid leak circuit, GA, in which a milliammeter may be inserted to note the operation of the set. For proper adjustment the grid leak current should be from 2 to 6 milamps.

For simplicity the filament connections will not be shown although it may be stated that all the filaments (including the receiving tubes) were operated in series from the 30 volt storage battery supply. When the set was operated for "stand by" receiving work the transmitter tubes were cut out and an equivalent resistance substituted to keep the total filament current constant thru the active tubes.

Voltage for the plate of the oscillator was obtained from a 350 volt dynamotor. The high frequency choke HX of 3 milhenries prevented high frequency from entering the modulator tube, while the main choke X of 1.3 henries acts as the modulation inductance. The modulator tube is connected as shown and also consists of an E type tube. Actually the voltage for its grid is obtained from the filament storage battery although it is here represented as a separate battery. The speech transformer has a ratio of 120 to 1 and consists of primary of low impedance with a secondary of very high impedance. Due to this high secondary impedance a resistance shunt is necessary to act as a grid leak for the modulator tube. The microphone is of a special type for low voltage operation.

The receiving set illustrated in the photograph does not contain any novel

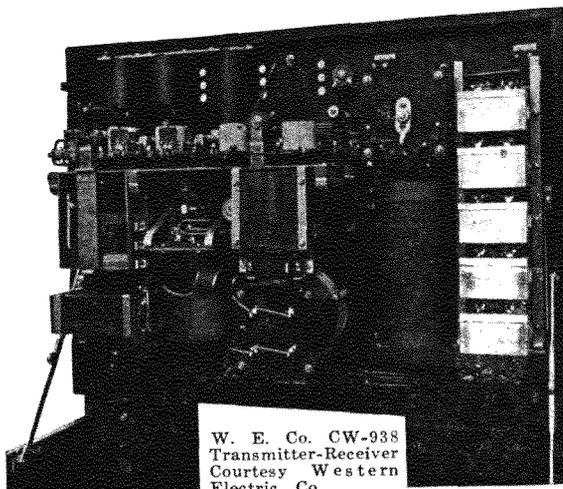

W. E. Co. CW-938 Transmitter-Receiver Courtesy Western Electric Co.

features of particular interest and therefore will not be described in detail. It employs an aperiodic or untuned circuit for "stand-by" work with an ordinary loose coupler for actual operation cover-

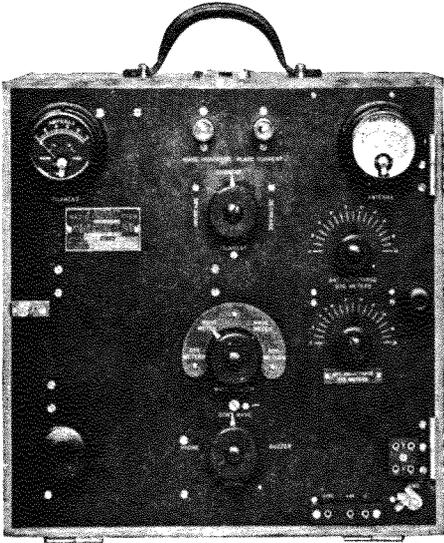

Aircraft Radio Transmitter (Navy) Item 14, Type CG-1410, Courtesy General Electric Co.

ing a wavelength range from 200 to about 1000 meters. The receiver is not regenerative but employs a two step audio-frequency amplifier for ordinary work. Since these sets were installed to be distantly controlled from extension stations in the chart house or fire control stations, a special amplifier was also supplied to operate a "loud speaker", mainly for calling purposes.

Considering the rapid development and severe service required, these sets operated, on the whole, remarkably well indeed. They allowed easy communication between commanders and other officers for the direct transaction of routine business while manoeuvring, and gave a personal touch and directness to such messages which was not obtained by telegraph. It may be interesting to know that in Brest harbor all communication between the dozens of transports, destroyers and other base craft was carried on by means of these small telephone sets which afforded flexibility and speed with minimum interference to high power traffic.

GENERAL ELECTRIC TELEPHONE SETS.

The many developments in this new art contributed by the General Electric Co. were mainly sets for use on Naval Aircraft and therefore contain many design

features peculiar to this type of apparatus. On the whole it may be stated that the sets were of vacuum tube type somewhat similar in operation to the sub-chaser set just described. Therefore details of construction will be omitted except those pertinent or interesting to the experimenter.

The distinguishing feature of these sets is the use of inductive coupling of the oscillator to the antenna instead of direct coupling. The fundamental diagram of connections is shown in Fig. 7 which is particularly applicable to the first small set known as the CG-1104. This transmitter was employed for communication between planes in flight and also to base stations over short distances of 25-30 miles with a trailing wire antenna. The apparatus is clearly shown in the photograph appended.

As will be seen from the fundamental diagram, Fig. 7, the antenna circuit consists of an antenna coupling coil CC provided with wavelength taps and a fine tuning variometer V. Since the wavelength of the oscillator is set by the antenna circuit alone it is important to have the setting correct. To check up the radiated wave a small wavemeter WM is incorporated in the set and indicates by a small pilot lamp. The antenna coil is coupled to both the plate coil, PC, and the grid coil GC. The former coupling
(Concluded on page 16)

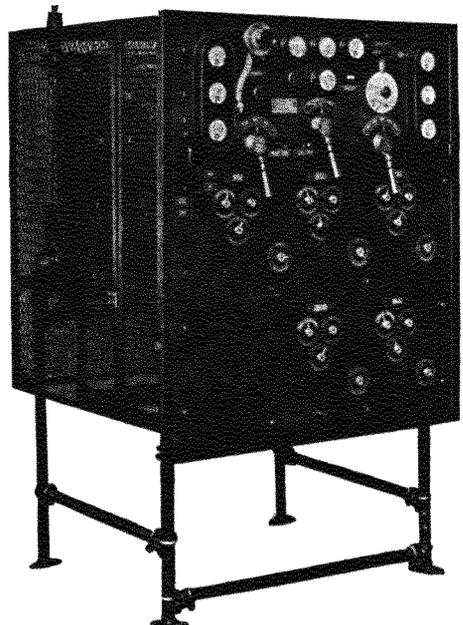

3½ KW 5-Wave-Length Navy Set (R. L. Model) Radio Telephone and Telegraph Transmitter, Courtesy General Electric Co.

Rotten Air

By The Old Man

The Old Gentleman's discomfiture provides us some more regenerative laughs this month, fellows. Certainly the air is rotten enough, and we had wondered if it would finally get T.O.M.'s dander up again. It has.—Editor.

GO it, you cripples! Crutches are plenty, juice is cheap, and I suppose you can't hurt the air any. Scratch and rasp and squawk your blame heads off. That seems to be what you enjoy most, so have your fill.

Oh hum! Getting sleepy again. Lucky that I am of a tender and forgiving nature. I would be up for murder otherwise. Tolerance! Tolerate anything. That's me all over, Mabel. Dear little boys, go on and bang-whack the ether with your miserable squeak coils on any old wave, any old decrement, and old power, and any old business that will make a scratchy sound at any old time of night. We, with the relay traffic waiting, just love to listen to your sweet little childish prattle. When you knock the sense of hearing out of one ear, we always remember the Sunday school lesson and offer the other. We never allow ourselves to think of black jacks, rat poison, lead billies nor sand bags. No indeed, we shun all such thoughts like a duck shuns water.

Oh hum! I wonder where the cat is? Must be two hours I have sat here now, waiting and waiting, swearing and swearing and smoking and smoking. This old pipe tastes like a rubber boot. Here, kitty, kitty, kitty. Gosh, listen to them scapel! Wonder if Mrs. SER acts like a perfect lady when she gets up against this sort of air. Eleven messages on that pin and no more chance of reading 9ZJ nor even 8DA than there is of this old critter getting to Heaven. I wonder if they have QRM up aloft? If not why not? How do they stop it? Why cannot we try the same medicine? Some of you spirits get busy and tell some of these Ouija boards what the hook-up is. Try drawing a neat diagram of a QRM filter such as is used by St. Peter, for example. Pete must have a good one by now.

Oh hum! Hear them clatter! Say, I thought it was said in QST that after nine o'clock the relays were to have an inning. Here it is eleven-thirty and the air so chock full of scratching and jittering about "How do I come in" and "How do you get me" and "Please send slower" that it is difficult to get a full breath. Oh dearie me! I wonder how much rat poison a man could buy for fifty cents? I wish

I knew where I could get a coal hod full at a reduced price. I wonder how much you could choke down a man's throat before he would gag and begin to refund and waste the material. There must be some make that gives a more lingering death than others. But hold! "Tolerance" was the subject under discussion a moment ago. Cut out the rat poison and the blood and vengeance. "A kind word turneth away wrath", some poor misguided gink said some where, and they have been hollering about it ever since. Let them scratch.

Mygawd what ails this pipe and where is that cat! Between the racket, the stink of old rubber boots and the tip of my tongue burning up, I'm getting panic-stricken. Go it, you sloopgilion! Scrape your blooming head off. You set my bulb oscillating. Oh wouldn't I like to oscillate something sharp and heavy over you for a while! You must be the head devil. Listen to him. He's asking somebody if his tone is smooth! Smooth as a rasp. I wonder how he goes to work to make it that ragged? Listen to that wet one sputter. Sounds like his mouth was full of spit. Heaven forbid! The poor thing is calling me. Nay, nay, son, not in this smother. I couldn't read you with these clothes on unless I had an apron. I wonder what he could possibly have for me? What's that he signed? What is dah—dah—dah—dit—dit—dit, dit—dah—dit—dah, dit—dit—dah—dit—dah! That first thing with the three tails was intended to be an 8, but gawdnose what the letters were intended to be. I wonder if it's his code or his key or his vibrator or his brains that are sticky? Something's gummed. And he stutters. Listen to him hang up altogether. Not rotten enough to clutter up the atmosphere with a lot of jittering with a sticky spark coil but here is a gazaybo who adds stuttering to his other crimes. He thinks I am reading him. Go chase yourself, brother.

Listen to the windy one. He hangs fire also. What's that he is trying to get off his chest? "FIZZZ ZZAT—VVVVVV—PULL ON SIZZZ ZZIP VVVVVVVVVV PULL ON BOTTLE FSSST VVVV BOTTLE PABST ZIFFFSST POP ZAP SQUAAK (silence for a minute)

VVVVVVVV YEAST PHFSSST
ZAPZAPP YEAST RADIO INSPECTORS
WHIFFSSISSK POP VVVVVV
INSPECTORS TUM TUM PUFF
SQUITSSICK K"

What would you guess that to mean? Pity he did not spit before he started to say it. It is something about the radio inspector, a bottle of Pabst, some yeast and a puffed up tum-tum. Sounds like some home brew. Got the yeast in his tum-tum or something. Bloats him probably and accounts for his tone being so windy. Lord! What stuff to put out on the air.

Oh hum! Let's get up onto 450 meters where the real rotten ones are. Maybe it will keep us awake. Gosh, listen to that one's dots! He spouts them around regardless of expense. Puts three of them on his 8's, wastes an extra one on the front of his F's and throws five into an H. How does he get them so fast? Has he got the palsy or what? By Heck, he has a bug key! Oh Pickle! Listen to him play with the dot business. Well, now isn't he just having a fine time all by himself! Never suspects there is another soul on earth who may have a wireless station. Never crossed his massive intellect that there may be someone who wants to get a message somewhere. Fluttering away with a bug key with his antenna switch in, just for the fun of tickling the key. Probably holding up twenty-five stations from hearing something worth while. Just a common, ordinary, garden variety of lily-livered—stop! Tolerance—Tolerance—TOLERANCE—if it chokes you!

Kitty, kitty, kitty. Oh kitty, where art thou? Come kitty, kitty, I need thee. Listen to the bug key spit. I will wager that kid is trying to make and break a full thousand watts in his power circuit with that bug and that his little shack is enjoying a nice display of fire-works and the spectacle of a perfectly good bug key being electrocuted. S'ficiency, as Sam would say. Next!

There's my call again. Smith over in Smithville. Says msgs 3. Heavens! Have I got to jump into that hornet's nest? I would rather take a licking. Smith is a good sort, his sigs seem to be getting through the mess pretty well, so maybe I better try. Let's give him GA and see what happens.

NR 1 PM BOSTON MASS TO JOHN SMITH APARDO 6 DENVER COLO CAT HAS FIVE GARGLES SWISSTT MASH SMELLS LIKHELZIT SWILL RAISINS LOVE SIG TICKLE HW? ARK

Guess better give him AS while I give this a little study. Something not exactly right. She is OK up to the time the cat started gargling her throat the fifth time, but from there on it is not clear whether

the reference is to moonshine or kittens. Guess I better tell him GA FIVE, STOP END. I do not want to make a mistake and have the cat have to gargle with a mixture that smells as this one appears to smell. I probably copied parts of two or three messages.

FIVE KIT TENS DAYS STINKS AWFUL DO I COME INZISST POP SQUISHT ZAP 7X3?HV7SIHSIVVLE—. Oh hum! I wish I were dead. Daggone that hooligan with the bug key. QRMed me at the same spot. It always does. Hey, somebody bring in the cat, or—. Did or did not the cat have five kittens, or is it something objectionable that happens at the end of ten days? There is part of one of those how-do-I come-in messages with the "how" lost off the front and there is something about home brew, judging by the stink. Nothing to it but to go back with an ND, QRM, QTA, GA FIVE, STOP END. This is the life, all right. Some gay little relay game.

FIVE KITTENS SMELL OK MEANS COMING ALONG WRITE SOON LOVE FISHSSSS SQUARKSHK BANG. Something's busted! Did you hear that business explode? Lord Harry, what are we coming to! Listen to them snarl and sizzle, will you. Static coming on worse and worse every minute. Oh, for a hod of rat poison, a lead pipe billy and a couple of wouff honges and about a hogshhead of boiling transformer oil, in the order named! Tolerance, TOLERANCE, my boy! Smile, by gravy, if it cracks your face. Back again with kindly benevolence radiating from the antenna, but a sand-bag within easy reach.

QRM FIERCE OM SORRY GA KITTENS STOP WRITE GA LOVE STOP END.

KITTENS TELL MARY AND SSSCCCHWISSSS ZAP SISSSS PLENTY OF KICK SIG TEDDY HW NW? 3 MORE K

I've got you Steve. The assurances about there being plenty of kick is from the home brew bunch with the smelly swill. The real message we have been struggling over for the past half hour is, "CAT HAS FIVE KITTENS TELL MARY AND WRITE SOON LOVE SIGNED TEDDY"

Phew! I'm as limp as a dish rag. Wait a minute till I see what the children have done with that blamed cat, and I think I will try a cool pipe. Smith says he has three more. I shall need stimulants. It will take until just 4:30 daylight saving time to get those three at the rate things are going.

I'm darned if I know where kitty went. Guess she has a hunch what's doing. I must go it alone. Well, by Heck, my dander is getting up, and if it is to be a

(Concluded on page 23)

The Underground Antenna Adapted to Amateur Waves

By R. H. G. Mathews *

PART I.

This article treats of a subject very dear to us at this time of the year—suggestions whereby we can successfully maintain relay communication through summer strays. This is one of the greatest problems before us today and QST will present all the information obtainable on the topic. Mr. Mathews has had much experience in underground antennae work at the Great Lakes Station. We believe this is the first time that reliable information on the correct length of wires to use for amateur work, etc., has been published.—Editor.

THE principle of operation of underground aerials has been explained at considerable length in various articles which have appeared from time to time, and accordingly no attempt will be made here to go deeply into the theory of their operation, but for more complete information the reader is referred to the papers of Lieutenant-Commander A. Hoyt Taylor appearing in the August and December issues of the Proceedings of the Institute of Radio Engineers.

The writer has never seen any attempts made to show the proper installation of the underground antennae for use on amateur wave lengths and accordingly this will serve as the object of this article.

A simple installation of underground wires consists of four wires of the proper length as determined hereinafter in the form of a cross, the receiving station being located at the center of this cross.

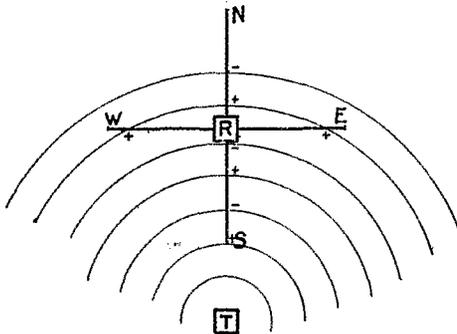

FIG 1

The wires are connected to the receiving set in pairs, each pair being along a straight line. To explain this a little more clearly, Figure 1 shows the receiving station "R" equipped with four such wires labeled respectively North, South, East and West. In receiving, two combinations are desirable, these being N & S and E & W, these wires being connected to

the set in the usual manner of ordinary aerial and ground wires, except that a condenser of about .001 mf. capacity should be connected in series with each combination. Directions on the installation of these wires in proper form will be given a little later. If desired, a second set of these wires may be added for more general and accurate work, and a station equipped with both sets is shown in Figure 2.

The directional effects of ground wires are very pronounced, and a station which lies directly along the line of one set of wires will be heard extremely loud on that combination, and will not be heard at all on a combination at right angles to it. Referring to Figure 1, the transmitting station "T" is shown in a direct line with the North and South wires, which are, of course, at right angles to the E and W wires.

As will be seen by this diagram, any given wave emitted by the transmitter T will cut the East and West wires at points of equal distance from "R", these points being of similar polarity at any given time. No current flow is therefore possible on these wires. In the case of the North and South wires, designated "N" and "S", however, the opposite condition from that at East and West is found. A current flow will therefore be set up in the N and S wires while none will be found in E and W. Signals from "T" will therefore be heard on N and S and will not be audible on E and W.

In Figure 2 is shown a second case in which the transmitter is not located along the line of any of the wires. In this case, by the same reasoning it will be seen that the signals will be heard on all wires with about equal intensity, this intensity not being as great as if "T" was in line with any pair of wires, as in Figure 1.

In this connection, it may be of interest to state that if it is desired to ascertain the direction of "T" the wires may be taken in quadrants rather than in straight lines and in this case signals will be heard louder on E and S than on any other pair of wires at right angles, thus showing that

*Chief Engineer, Chicago Radio Laboratory.

"T" lies in a quadrant between E and S, which gives its approximate location. If eight wires are installed, this direction becomes more accurate, and in Figure 2, taking into account all eight wires, signals would be loudest on E and SE than on any other combination.

The principal advantage of the underground system, in addition to its directional effects, which are of advantage in interference elimination, is its reduction or elimination of static. The underground

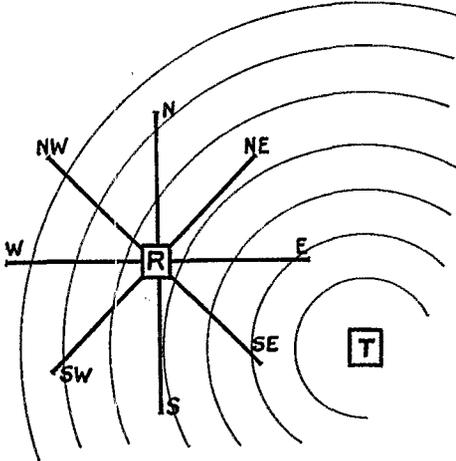

FIG. 2

wires are only affected by electro-magnetic waves and are not affected by electro-static waves, and therefore the only atmospheric interference heard on such wires is ground strays, which are by no means as plentiful or as loud as ordinary "static". For this reason the use of an underground antennae system is strongly urged as it is believed that summer relay work can be accomplished by this means.

The tuning of a ground wire set is very different from that of a set of the ordinary type. In a set connected to any ordinary aerial the fundamental wave of the antenna may be corrected to that of the incoming wave by means of the inductance and capacity of the receiver. This is not the case in ground wires, and accordingly a set of wires of a certain length must be installed for each wave length which is to be copied, and very little variation of this length is allowable, especially on the shorter waves. The correct length of wire for any given wave is ordinarily known as the "optimum length" of wire for that wave and this length depends inversely upon the capacity per unit length of wire used, which is regulated by the size of wire and the thickness and kind of insulation used.

For ordinary amateur work the writer would advise the installation of two sets of wires, one being suitable for waves of 200 to 250 meters and the other suitable for the 375 meter wave used by special stations. Using No. 12 rubber covered weather proof wire it has been found that the length of each wire, measured from its end to the point where it leaves the ground to enter the station should be as follows:

| Wave Length | Length of Wire |
|-------------|----------------|
| 200 to 250 | 47 feet |
| 375 to 400 | 77 feet |

These wires should be installed either under water or in damp ground at a depth of not less than two feet and not more than four feet. Greater depth than four feet does not add enough to render the additional work desirable. A combination of one wire and a ground may be used instead of two wires in the same straight line if the running of wires in all directions is not possible. This combination it not recommended, however, when the regular installation is possible, since the introduction of a direct ground has the effect of slightly reducing the signal strength as well as introducing additional strays. The wires should be tested for grounds frequently, using a volt meter and not less than 45 volts direct current, as a ground at any point along the wire tends to spoil the results.

The ability of the wires to resist moisture may be increased by treating them with ordinary asphaltum varnish and by the use of a pot-head on the end of each wire. This may be installed as follows:— The cloth insulation at the end of each should be carefully pared back, care being taken that the rubber insulation is not cut. The end of the wire should then be dipped into an ordinary glass test tube filled with melted sealing wax, the wax then being allowed to solidify. A coating of asphaltum over the tube and wire will then complete this part of the installation.

In laying the wires, care should be taken to keep them straight both horizontally and vertically, as any bends tend to introduce undesirable effects. Where the wires leave the ground to enter the station they should be carried in grounded metal conduit to the point where they are attached to the receiving instruments. The receiving set should be of a shielded type, preventing the picking up of static by the set itself. In this connection it might be mentioned that the CRL Paragon Short Wave Regenerative Receiver is now supplied with this shielding equipment when requested, which adapts it for use with the underground antennae.

Using a regenerative receiver, together with two steps of amplification, the writer

has been able to copy practically all the 600 meter Coast stations on an underground antenna, many of them being audible several feet from the headphones. Signals on the underground aeriels are, of course, not as strong, especially on the shorter waves, as on any ordinary aerial and ground. It will be found, however, that although all the signals are weaker, they are still readable and because of the elimination of static can be copied on the underground aerial under conditions where any ordinary set would be absolutely useless, and in fact regular work as been carried on with stations at distances as great as 200 miles during lightning storms.

The underground aeriels, in addition to static elimination, can be utilized, through their direction effects, for the elimination of any local interference which is not in line with the signals desired. There are several methods of compensation by which such undesirable local signals may be eliminated and these methods will be taken up in the second article on the underground antennae which will follow in the next issue of this magazine.

RECENT DEVELOPMENT OF RADIO TELEPHONES

(Concluded from page 11.)

is fixed but the coil is provided with taps while the grid coil coupling is variable by rotation of a fixed amount of grid inductance wound on a cylinder. The absence of condensers makes the operating adjustment quite simple and the phantom antenna PA allows testing of the set with the antenna disconnected.

The oscillator tube gives an output of 5 watts (T tube) while two similar modulator tubes are employed to give complete modulation. The plate voltage is supplied by a 350 volt generator with the usual choke coil X and a protective fuse F to prevent excess plate current. The set is equipped with a microphone T for telephone work and also a buzzer, not shown, for telegraphy. The battery MB supplies the proper negative grid voltage for the modulator.

In a later model several improvements were made of a detailed nature. A larger set employing two "P" tubes (250 watts) and a plate potential of 1500 volts was also developed which operated on 1600 and 600 meters with separate coil systems for each wavelength. This arrangement is electrically most efficient and was typical of subsequent developments. For operation at base stations and on battle-ships, a long range radio telephone was next developed which gave an output of over 1 KW and good modulation.

A most interesting development with which the writer was fortunate to be

intimately interested was in connection with the return of the President on the U.S.S. George Washington. A series of long range radio telephone experiments were carried on between the ship and New Brunswick, N. J., for several trips to determine the feasibility of "two way" communication. The installation at New Brunswick utilized the Alexanderson high power alternator with telephonic control from the ordinary wire telephone line to Washington. On shipboard a special General Electric high power tube set was used employing a master oscillator of two "P" tubes (500 watts), the output of which was then amplified by twelve amplifier tubes in parallel. The actual output of the set to the antenna was somewhat over 3½ KW with rather complete modulation at full power. This was the first large set equipped for duplex operation, that is both transmitting and receiving could be accomplished simultaneously. Space does not permit the writer giving detailed results herein, but it may be stated that reception of speech from New Brunswick was attained from Brest harbor in France although mid-summer static prevented the use of high amplification necessary to completely copy the conversation. From the ship conversation was clearly received on shore, over 2000 miles, and two way conversations with New Brunswick and Washington were interchanged up to 400 miles. These tests clearly showed the feasibility of radio telephone operation between ship and shore over moderate ranges and practically all conditions.

In conclusion the writer wishes to acknowledge with thanks the co-operation of the General Electric Co., the Western Electric Co. and the Navy Department for their kind permission to publish these details of the splendid developments which resulted from their united efforts during the recent World War.

THE A.R.R.L. QSS TESTS

(Concluded from page 6.)

Let us all pull hard on it. It is one of those things which depends upon co-operation for its value. Isolated reports are always interesting but we can not develop the complete information we want unless we all get together on this and collect data which interlocks. Every amateur should feel it a duty to help in this work. Tell all your neighbors about it, study the system, and be ready when the tests start.

Construction of a 500-Volt Rectifier Transformer for C. W. Work

By Robert Muns (2ACQ)

WITH the price of high voltage generators high and going higher, the possibilities of the average amateur owning a radio telephone appeared to be getting small, when a wireless manufacturer came to the rescue recently with a 500-volt transformer for use on 110 volts A.C. using rectifying tubes to obtain a direct current. Everything then appeared easy until they figured the cost of manufacturing these in small quantities and the time required to get a few pushed through the factory. It was a case of paying about \$40 (without tubes) and waiting six weeks or more for delivery. What amateur wants to wait six weeks when he has decided to make a wireless telephone? None of them do, and being one of them I collected enough data through the courtesy of Mr. Cole of the Wireless Equipment Co., Inc., New York, to go ahead.

The transformer is made up of a core, a 110 volt winding for the line, a high voltage adjustable winding, and a 24 volt winding to light the rectifying tubes.

The first thing an amateur wants to know is the cost, so I will start there in describing the transformer which I made over the week-end.

| | |
|---|---------|
| 7 lbs. 26 gauge stove-pipe iron | \$1.05 |
| 1 lb. No. 20 D.C.C. magnet wire | 1.00 |
| 1 lb. No. 14 D.C.C. magnet wire | 0.75 |
| ½ lb. No. 30 S.C.C. magnet wire | 0.90 |
| ½ pint Orange shellac | 0.60 |
| 7" Fibre Tubing 1¼" inside diameter | 0.42 |
| 15" ½" sheet fibre 3" wide | 0.25 |
| 24" Strap iron ⅜" or ¼"x¾" | 0.25 |
| 20" Brass rod, threaded 14-24 | 0.40 |
| 16 Hexagon nuts to fit brass rod | 0.16 |
| 6"x6" Bakelite top | 0.80 |
| 4 Large binding posts | 0.40 |
| 8 Small binding posts | 0.40 |
| 6 ¾" brass machine screws and nuts, 8-32 thread | 0.12 |
| 2 1" brass machine screws and nuts, 8-32 thread | 0.05 |
| 2 Sockets with Bakelite bases | 2.40 |
| <hr/> | |
| 2 Rectifying tubes, 12 volt filament | \$9.95 |
| \$7.00 | 14.00 |
| <hr/> | |
| | \$23.95 |

First build the core, which is rectangular in shape and measures 6"x4¼", and 1¼"x1¼" on a cross section.

If you use No. 26 gauge soft iron you will need about 120 pieces each of 4¼"x1¼" and 3"x1¼" or enough to

make a pile 1¼" high when compressed. I got the plumber to cut this into long strips 1¼" wide and then I cut it up with tin snips. If you can get the plumber to do all the cutting on his machine, so much the better.

Straighten out the corners with a hammer and shellac each piece separately with a thin coat of orange shellac, allowing them to dry thoroughly. Make a right angle box with a 6" inside measurement. (Fig. 1). Then pile up one leg of the

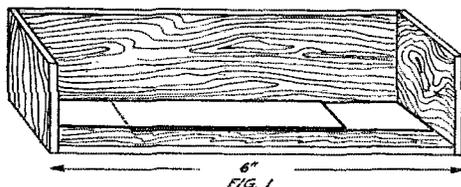

core by placing first one 4¾" strip to the right and then to the left until you have a pile which will be 1¼" when compressed. Take this pile out carefully, compress in a vise and bind tightly with friction tape. Make the other leg the same way and give each a good coat of shellac.

Next make the spools on which the wire is to be wound. Cut two pieces of the tubing, each 3¼" long, and square up the ends. Then cut the sheet of fibre into 5 pieces each 3"x3". In two of these cut

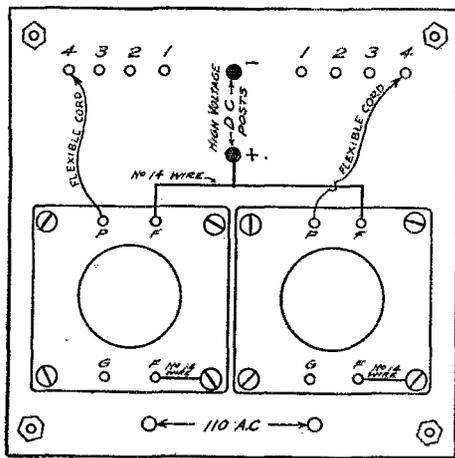

BAKELITE PANEL

FIG. 2

holes in the center $1\frac{1}{4}$ "x $1\frac{1}{4}$ "; cut holes in two more $1\frac{3}{8}$ "x $1\frac{3}{8}$ ", and in the other a round hole just large enough to make a tight fit over one of the tubes. This should be a good fit so that it will not be necessary to secure it except with shellac. Using cigar box nails, carefully nail an end with the $1\frac{1}{4}$ " hole on one end of a tube, and one with a $1\frac{3}{8}$ " hole on the other end, and shellac thoroughly. One hole must be larger than $1\frac{1}{4}$ " to allow the taped core to slip through. This is the spool for the primary winding.

The other spool is made the same way except that the other piece of fibre is slipped on the tube and placed in the center before the ends are nailed on, and

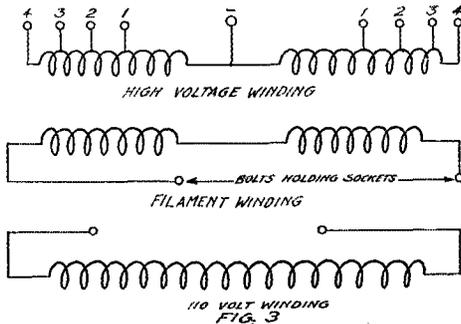

serves as a spacer to separate the sections of the secondary. It may be necessary to drill through the fibre ends for the nails, as these nails are very slender but they will go into the tube all right as they run with the grain there.

The primary winding is very simple. Carefully wind 407 turns of No. 20 D.C.C. wire on the spool without the spacer, shellacing each layer. This will wind about 66 turns to the layer and require about 15 ounces of wire.

It is advisable to drill small holes in the spool ends to slip the ends of the winding through.

Be careful to have the exact number of turns or the low voltage will not be right.

The secondary is slightly more difficult and is therefore wound in two sections. If you have no lathe a winding machine can be rigged up, many of which have been described in recent magazines. Some method of counting the number of turns of wire will be found very convenient, as there should be 1230 turns on each section. I used a cyclometer showing tenths of miles. Mine registered 20 turns to the tenth of a mile.

Using the spaced spool wind on 1230 turns of No. 30 S.C.C. wire, taking taps off on the first three layers. Do not make a regular tap but make a loop about four inches long, thus bringing out a tap with-

out disturbing the insulation inside the coil. If wound evenly there will be about 93 turns to the layer, and about 13 layers on a section are required. Each layer should be shellaced and a thin piece of paper wound around and shellaced in place for insulation. Even winding is best but it will work fairly well if wound unevenly provided plenty of shellac is used and the proper number of turns are put on each layer.

When the first section is wound, leave a loop about four inches long for a connection and start winding the second section without breaking the wire. This should be wound in the same direction, but ten layers are wound before any taps are taken. Then the last three layers are tapped. This makes one continuous winding with four connections on each end and one in the center. All taps should be run through small insulating tubes to prevent a short circuit with the heavy winding. This should be thoroughly shellaced and paper insulation shellaced on or, better still, wrap the windings with Empire cloth.

We are now ready to put on the low voltage winding. This is composed of 88 turns of No. 14 D.C.C. wire and is wound right over the secondary. Be very careful to get exactly 88 turns, as more will give too high a voltage for the rectifying tube filaments.

We can now assemble the core and windings. Slide a core leg through each coil, place them side by side, three inches apart and slip in the short laminations to form the ends, being careful to alternate and get the ends even.

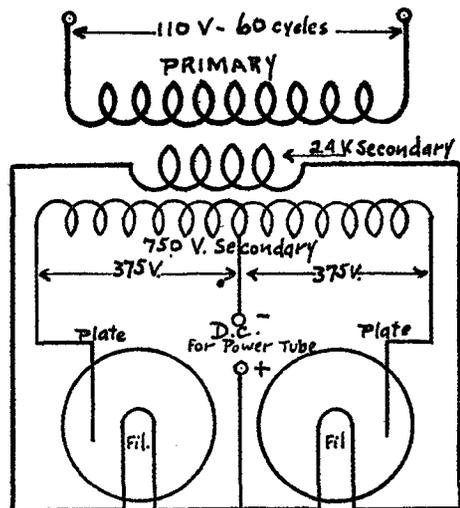

FIG. 4.

To clamp the core, cut the iron bar into four pieces each six inches long and drill two holes in each bar, five inches apart, just large enough to pass the threaded rod. Cut the brass rod into four pieces each five inches long, screw a nut on each rod to 1 1/4 inches from the bottom and make two clamps of each set of rods and bars to slip on the ends of the core. Screw the nuts down from the top and tighten. The short ends of the rods act as legs and will extend about a half inch below the coils. The upper ends are to

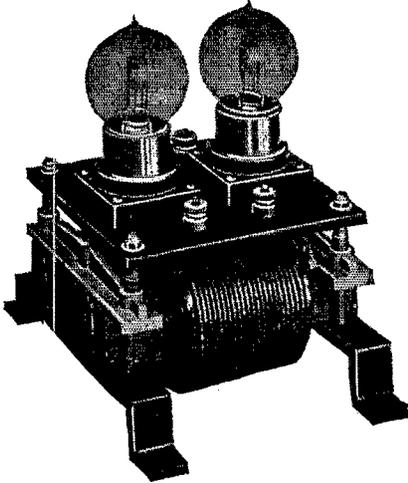

Fig. 5—The Completed Unit.

support the bakelite top which is made next, but first place the transformer in the oven for two hours to thoroughly dry it out. The oven should be as hot as it can be without scorching the insulation.

Next drill holes in the bakelite top to fit the four posts. These should be high enough to leave a space of at least an inch above the windings. The sockets are then mounted on the bakelite top and the set wired as in Fig. 2. Use the inch machine

screws on the lower right hand corner of each socket and connect the ends of the 24 volt winding to these underneath, completing the circuit on top. The rectifying tubes burn on 12 volts so they are connected in series and a tap between them furnishes the positive side of the direct current. Be sure to use sockets with a Bakelite base and not composition, as the heat from the tubes is great enough to melt the composition if used at long stretches. Connections are made as in Fig. 3. Fig. 4 shows the circuit schematically, and Fig. 5 the completed rectifying unit.

The following rectified direct current voltages may be had from the corresponding taps:

- Tap No. 1—350 Volts D.C.
- Tap No. 2—400 Volts
- Tap No. 3—450 Volts
- Tap No. 4—500 Volts

These voltages will not be exact but will be found close enough for general use. In order to change from one voltage to another it will be necessary to change both flexible cords to corresponding taps; otherwise the voltage would be different on each cycle. Care should be taken not to touch the high voltage wires, as 500 volts D.C. will give a serious shock.

If you hear 2ACQ at any distance from New York I would be glad to hear about it, as I am anxious to know how far this little transformer will work. My address is 99 Lincoln Ave., Ridgewood, N. J.

[Editor's Note: A filter is necessary to smooth out the voltage obtained from such a rectifying device. A choke coil in one of the d.c. leads, and condensers across the leads, will accomplish the purpose. The choke coil may be a standard make-and-break ignition coil, and the condensers ordinary paper telephone condensers—from 2 to 6 mfas. The arrangement of a filter was illustrated in Figure 3, page 7, of May QST, and described on page 8 of that issue.]

Championship Chess by Radio

THE Central Division of the A.R.R.L. has added another scalp to its collection by staging a professional chess game by wireless.

Mr. Mathews, the Division Manager, and Mr. Zeller, his Assistant, offered their facilities to the Illinois Athletic Club, of Chicago, who promptly took up the idea and challenged the Capital City Chess Club of Washington to play a game with the strongest player in each city conducting the fight, in consultation with the leading player of the

respective clubs. Washington accepted the challenge and Mr. Norman T. Whitaker, the Washington champion, represented his club, Mr. Edward Lasker, western champion, holding down the Chicago end. Arrangements were made by wire with NSF at Washington, but arrangements for umpires, referees, etc., were made by radio and the entire game was played on waves below 275 meters by messages between 9ZN and NSF, on the night of April 14th.

On account of induction troubles at 9ZN, a remote control arrangement was inaugurated, Mr. Mathews and Mr. Holst, president of the Ravenswood Radio Assn., doing the receiving on a Paragon at Station 9CH at Evanston, copying NSF's moves and shooting them rapid fire to 9ZN who would then answer NSF and OK, Mr. Karl Hassel and Mr. Zeller handling the transmitting at 9ZN and the telephone connection to the Illinois Athletic Club, which was kept open throughout the game. The co-operation worked so splendidly that NSF did not even know that his business was being handled in this manner.

The game started at 8:00 p.m. on schedule and lasted five hours, being finally adjourned in a difficult position with both sides claiming the victory. In the adjourned position Washington is still a pawn ahead, but Chicago has the better position for attack, and the match has been submitted for adjudication to J. R. Capablanca, the Pan-American champion. Publicity had been given the matter in Chicago and thruout the game there was no local interference, which strikes us as some co-operation in a city the size of Chicago. Weather conditions were poor, with warm rain and static, but the game was played without repeats, for which the operators deserve credit, particularly Mr. L. C. Young, who operated NSF successfully right thru Arlington's time and weather forecasts.

As this game was of championship calibre we believe the messages and moves will be of interest to the chess-players among our readers, and they are reproduced below. (N was used to indicate Knight, to avoid confusion with K for King.)

NSF to 9ZN 8:00 p.m.—Justice Pickney, U. S. Supreme Court, referee. Judge Ballou, Chicago umpire here. You toss for color. Greeting to you and members I.A.C. where I have had the pleasure of being a guest on several occasions.

Whitaker.

9ZN to NSF
Ready. You are white and get first move.
G.A.

| | WHITE (Washington) | BLACK (Chicago) |
|----|-----------------------|--------------------|
| 1. | P-K4 | P-Q4 |
| 2. | PxP | KN-B3 |
| 3. | B-N5 | P-B3 |
| 4. | PxP | PxP |
| 5. | B-B4 | P-K4 |
| 6. | P-Q3 | B-QB4 |

| | | |
|-----|---------|---------|
| 7. | N-QB3 | Castles |
| 8. | N-B3 | QB-N5 |
| 9. | Castles | QN-Q2 |
| 10. | B-K3 | B-N5 |
| 11. | N-K4 | N-Q4 |
| 12. | P-KR3 | B-KR4 |
| 13. | P-B3 | B-K2 |
| 14. | N-N3 | B-N3 |
| 15. | Q-R4 | NxB |
| 16. | PxN | Q-N3 |
| 17. | R-B2 | N-B4 |
| 18. | Q-B2 | N-Q2 |
| 19. | P-K4 | QR-Q |
| 20. | K-R | B-QB4 |
| 21. | R-K2 | K-R |
| 22. | N-R4 | B-K6 |
| 23. | NxB | RPxN |
| 24. | R-KB | B-B5 |
| 25. | R-B3 | Q-B2 |

(Game stopped at this point, since time limit had been set, and the next message was as follows:)

NSF to 9ZN. Lasker, Chicago. Whitaker claims win. Submit to Helms for adjudication unless conceded. Time here Time here 58:30. Your time please?

Whitaker.

9ZN to NSF. Whitaker, Washington. We also claim win and believe our position better and propose draw only on account of advanced hour. Will submit to adjudication or play out by telegraph or letter.

Lasker.

NSF to 9ZN. Lasker, Chicago. Will submit to adjudication. Suggest adjudicator. Whitaker.

9ZN to NSF. Whitaker, Washington. Submit for adjudication to Capablanca. Enjoyed game very much and hope you did. Many thanks to operator NSF and best regards to all.

Lasker.

NSF to 9ZN. Lasker, Chicago. We return greetings and best wishes. Good morning.

Whitaker.

The chess club members were much pleased with the remarkable service given by radio. They have been accustomed to playing by telegraph, which requires at least a half hour for each move, whereas the longest transmission in this game did not require two minutes, including calls. This was possible in Chicago only on account of the unusual co-operation of the amateurs there and Mr. Mathews wishes to express his appreciation to the local stations for standing by during the game and to Messrs. Zeller, Holst, Scholtes, Woodward, Fitzsimmons, Hassel and Marco for their active assistance.

Chess by wireless of course is not new but this is probably the first time it has been done over these distances and on amateur waves.



Summer Construction

THERE'S a little thought we want to get across to you. It's just a reminder that these summer months are the time to do your building, so that everything will be according-to-QST when cold weather comes.

We all learned a lesson when the lid went off in October. Nobody was ready, and in the big rush to get in on things almost any old kind of a job was done, and any old apparatus that had a ghost of a chance of serving was pressed into use. Is it any wonder there were breakdowns, stations out of the game for a week, stations who couldn't hear folks calling them, stations who burned up precious kilowatts in vain calling on a bum wave? Of course things have been improved gradually in every station—they had to be—but now is the time to do the big jobs, the annual house-cleaning, the rebuilding for Fall.

This summer will see many new masts develop from the paper stage to reality. Most of us need more amplification, and lots of us who are handy with tools have been awaiting just such a chance to get busy on regenerative receivers and other cabinet ideas that take spare time to develop. And our transmitters need overhauling—new rotary contacts, better condensers, more accurate tuning adjustments. And, more important still, this is the time to get busy on C.W. sets, for they generally require considerable tinkering to get the best results and the summer months will pass all too quickly.

So we urge you, fellows, to make these months of lightened traffic a period of reconstruction, that we may be better prepared than ever when Fall arrives. There's another side to the picture, too. It's to get supplies now than when everybody is yelling for stuff, and buying now will spread the business over the year and make better deliveries for everyone. And we don't want the business of our radio manufacturers and dealers to taper off, either. If it drops too much it will be reflected in our advertising and that means

a smaller QST. So let's all get busy now, purchase the materials we need, improve our stations—and never forget to mention our QST in writing. All set for summer reconstruction.

The Philadelphia Idea

THE champion enthusiastic, inspiring, and all-around-enjoyable amateur radio convention to date was the big one pulled off by the Philadelphia Amateur Radio Association in their home town on May 8th. Boston had what we thought was the best that could be put up, but Philadelphia put just a little more excitement into it, probably because the district was larger and amateurs from longer distances attended. The A.R.R.L had its President, Vice-President, Traffic Manager, and Director Stewart present, in addition to all kinds of District Superintendents and Assistant Superintendents. The Navy had Lieut.-Commander Cobb present, and the Department of Commerce had its Inspector and his Assistant. A detailed report of the convention will be found in another column.

What we want to direct attention to is the scheme of our Philadelphia and Third District brothers. It is a good one. They say, let us not have a meeting of some club, but instead let us have a convention of amateurs from all over the District. Let all the clubs take part and send as many of their members as they can. And let the unattached come and join hands and get acquainted with the splendid brotherly spirit of amateur radio. In order to make the thing solid, our Third District brothers organized on the spot the Third District Convention. The Convention elected officers and voted to have a big rousing meeting once a year. They affiliated with our A.R.R.L. and did the whole job up in finished style.

We cannot help but point out that this would be a mighty good plan for the other Districts to follow. It would be a stepping stone to that one grand ambition we have here at headquarters, which is some day to be strong enough to have a grand National Amateur Radio Convention, at

which all of the Districts would be represented from the entire country, and where we could meet face to face our friends of whom we have heard so much but whom we have never seen. Read the story of the Philadelphia Convention, fellows of the other Districts and talk the thing over. We will help from Headquarters.

Vacuum Tubes

GRADUALLY the vacuum tube situation is showing increasing signs of clearing up. There is much in the wind—countless rumors, some secrets, a little real information. We believe we can be confident, however, that in the very near future the entire V.T. patent status will be reviewed and definitely settled, and certainly it will be good to have this done. The unfortunate misunderstanding and lack of confidence which have permeated the art on this subject have been a great retarding factor, and we will be happy to see it settled so that everyone knows where they stand. The various interests are showing a mutual desire to get together now, and we expect interesting developments soon.

In Canada the British Marconi Co.'s V-24, a low capacity amplifier, and the Q valve, a current-limiting detector, are now supplied to amateurs, and we hope that soon they will be available in the States.

The biggest news, tho, is that one of our largest U. S. corporations, whose name we are asked not yet to divulge, will soon present to the amateur market a new line of tubes for every use, really including a splendid moderate-power transmitting bulb at a reasonable price. And it seems straight goods this time.

Altogether, the situation looks brighter and more interesting for us amateurs than it has for many a day.

Unlawful Transmitting

YOU young chaps using initial call letters and transmitting without a government license, watch out. The Government is after you. Probably in each district there will be a few selected for example purposes, and these poor unfortunates will be sorry. And those misguided ones who do not know any better than to act nasty in the matter will be given special attention. We have seen several instances already, and we can say that it is no joking matter.

It seems hard to believe that anybody knowing enough about amateur radio to rig up and operate a transmitting station would be so ignorant as to believe they could beat the United States Government. One must know something to build a

transmitter that will transmit, and why it is that this knowledge does not carry with it a little bit of information about Federal law violation is difficult to understand. Mr. Cadmus, Radio Inspector of the Third District, said in our presence the other night that his Third District was the largest in the country and yet there were not as many licensed amateurs in his District as there were amateurs in the city of Philadelphia alone. He said that every amateur who has the interest of amateur radio at heart should make it his business to exert every influence to see that the prevailing tendency to transmit without first taking out a license was stopped. One would never think of driving an automobile in the public highway without a license, and yet thousands of us are sending our radio signals and using unauthorized call letters without securing the proper papers.

When an amateur transmits without a license he automatically gets in wrong on several counts, and when he adds impertinence on top of this, he makes it possible for the Government to lock him up for a year, if thought desirable. Without a license an amateur cannot sign in unless he uses false call letters, for which there is a very severe penalty. Any combination of initials he may select represents a call which has been assigned, or is awaiting assignment, and when he makes use of them it is not only unauthorized, but it is **FALSE**. And look out for the false business in radio. It is only one step removed from false distress signals. Once in a while we find an amateur putting a numeral in front of some initials he has elected to take unto himself. He cannot escape using something which has already been assigned to some other amateur, or is awaiting assignment. We heard some calls here in Hartford recently which were being used by a local amateur regardless of the fact that these calls were assigned to stations in the vicinity of Boston. The United States Attorney in all of the different cities has it in his power to make matters very uncomfortable for any one indulging in this practice, and we cannot warn our younger brothers too strongly to beware. You can get a license if you can show that you can receive ten words a minute, and you ought not to transmit unless you can receive at this rate. You are hurting amateur radio more than you believe by violating the law, and arraying all the better class of amateurs and the United States government solidly against you. If you want to transmit, write your Radio Inspector for application blanks. When you get your license and your authorized call letters, you are as good as any of us and you are welcome among us.

Radio Literature

ONE of us dropped into the office the other day, made our acquaintance, and incidentally demonstrated that one of the most interesting parts of QST is our advertising. He said that when he got his QST he always began at the back cover and read forward. It took him one solid evening usually to soak in all the important information that was imparted by the different advertisers. When he had this salted away, he went to the list of calls heard to see how his signals had been getting out during the past month. After the surprises of this department, he usually sampled our humorous offerings and then went through the other stuff as he happened to feel. But he said the advertising was to him the most valuable radio literature he found anywhere.

This really is quite a thought. As a matter of fact our advertising pages contain the very best that the manufacturers in the country are able to present to us. Every line on those pages has been given most painstaking study. Every statement is known by its author to be subjected to the most searching analysis on the part of us sharks up and down the country. The result is that our QST advertising really is the very last word in amateur radio apparatus development. And, what is more, we do not have this valuable matter scattered all through our magazine. It is all together in one place where comparisons can be drawn easily and correctly. We do not know how you fellows regard this point, but we feel very strongly about it. If there is one thing that gives us QRM in the head, it is to chase the end of every article over into the back advertising pages, in and out among the columns, in order to finish it. We lose the punch of the reading matter, and we lose the value of the advertising.

We have seen and we personally know most of our advertisers. They are, to a

man, the same as we are. They tell us that they follow our activities, our hopes and our schemes as closely as we do ourselves. In other words, they are with us. They want to have the rest of us realize this, and they want to have us feel that we are all in the same boat and when anybody has any questions to ask, for goodness sake, write and ask them. They enjoy receiving a letter just exactly as much as we do. So take our advertisers into your confidence, fellows, write to them freely and often, and be sure and mention that you are an A. R. R. L. man and a reader of QST.

ROTTEN AIR

(Concluded from page 13.)

game to see who can show up the worst case of jitters, I guess I will take a hand. I can fix Old Betsy so she will swizzle and gizzle and ffwhissk and zap and squaak as good as any of them, and, by Golly, maybe they will have a taste of their own medicine. Here it is midnight, and I sitting here like a bump on a log with my pin full of messages and gawdnose how many more trying to get to me, and keeping quiet while these hooligans and slop-gulions and squaak artists have the air to themselves, swizzling and zapping, and bug-keying till the air screams for relief. It is time I got nasty. I am going to call Smith and send my whole darned pin-full one after another with Betsy on too low power to spark every time, and if I feel so inclined when the stuff is off will QTA the whole business. Smith will think I am full of home crew, but never mind. Here goes, and Tolerance be dashed. Me for blood, gurry, crime, and confusion to the police, and brass knucks, rat poison and any old thing else that will clear up this rotten air and give a decent man a chance.

Later: (Much later, in fact.) It worked.

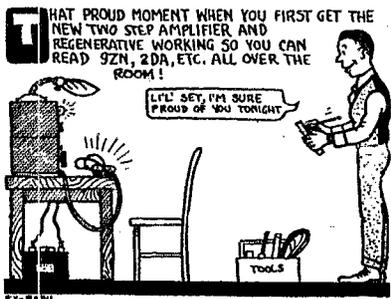

THE OPERATING DEPARTMENT

J. O. SMITH
Rockville Centre. L. I.
TRAFFIC MANAGER.

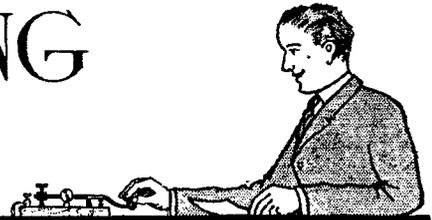

IN view of the great amount of work necessary on the part of some of the Division Managers of the League, which had caused their positions to become a burden rather than a pleasure, and for other reasons of equal importance, the Board of Direction of the League formally decided that a rearrangement of the various divisions, as formerly existing, should be made. This change affects only the divisions within the borders of the United States and increases, by a rearrangement of territory, the total number from six to twelve.

One reason for the rearrangement of territory, aside from the main one mentioned above, was that such an increase in the number of divisions would necessitate a large increase in the personnel of the Operating Department and so give many good men a chance to take an active part in the affairs of the League. Another point which had considerable bearing on the matter was that with a smaller territory to handle, each Division Manager could keep in closer personal touch with affairs in general than would be possible where the former large stretches of territory were concerned.

The twelve divisions of the League, with the names and addresses of their Division Managers, follow, the new divisions being indicated by *:

*NEW ENGLAND. (G. R. Entwistle, 18 Boylston St., Boston, Mass.) Maine, Vermont, New Hampshire, Massachusetts, Rhode Island, Connecticut.

ATLANTIC. (C. A. Service, Jr., Bala, Pa.) New York, Pennsylvania, New Jersey, Maryland, Delaware, District of Columbia.

*ROANOKE. (W. T. Gravely, 854 Main St., Danville, Va.) Virginia, West Virginia, North Carolina.

EAST GULF. (J. C. Cooper, Jr., Atlantic Nat'l Bank Bldg., Jacksonville, Fla.) South Carolina, Georgia, Alabama, Florida.

*DELTA. (J. M. Clayton, 1301 Welch St., Little Rock, Ark.) Arkansas, Tennessee, Mississippi, Louisiana.

CENTRAL. (R. H. G. Mathews, 1316 Carmen Ave., Chicago, Ill.) Wisconsin, Michigan, Illinois, Ohio, Indiana, Kentucky.

*MIDWEST. (L. A. Benson, 4942

Wiesehan Ave., St. Louis, Mo.) Iowa, Missouri, Nebraska, Kansas.

*DAKOTA. (R. H. Pray, Valley City, N. D.) North Dakota, South Dakota, Minnesota.

WEST GULF. (F. M. Corlett, 1101 East 8th St., Dallas, Tex.) Oklahoma, Texas, New Mexico.

ROCKY MOUNTAIN. (M. S. Andelin, 1153 Harrison Ave., Salt Lake City, Utah.) Wyoming, Utah, Colorado.

*NORTHWESTERN. (J. D. Hertz, Box 78, Route 3, Vancouver, Wash.) Montana, Idaho, Washington, Oregon.

PACIFIC. (A. E. Bessey, Sunnyvale, Calif.) Arizona, Nevada, California.

Mr. Theodore A. Stocking, Ketchikan, Alas., has been appointed Manager of the Alaskan Division. Appointments of traffic assistants in this division will be announced later.

The Traffic Manager has received many complaints during the last two or three months to the effect that messages continually go astray in some way and are never received at their destination. The attention of every individual is hereby called to the fact that he is violating one of the fundamental principles of the A.R.R.L. when he is guilty of accepting a message and then fails to forward it. In addition to violating one of the first principles of conduct of the League, he is also violating the Traffic Rules and Regulations, which distinctly provide that in cases where messages can not be forwarded promptly by radio they shall be mailed either to their destination or to some station that can promptly handle them. Messages should be forwarded by radio within 48 hours after receipt and if this can not be done they should be forwarded by mail as provided in the Traffic Rules and Regulations. It is hoped that every member of the Operating Department will observe this matter of general principle in the future and in this way obviate the many complaints now being received in connection with undelivered messages.

It is common knowledge that varying signal strength is a very important matter in amateur radio communication. Many causes have been assigned for this variation in strength, popularly known as

"fading", but the writer is not aware that any one has ever advanced a reason that would stand up in the face of actual occurrences. This has been fully covered in previous articles in QST and there does not seem to be any explanation for the variation in "fading" between stations in different parts of the country. The League believes that this is one of the most important things for consideration and a plan for making a thorough investigation of the whole matter has been in the hands of the Division Managers for some time for their information and approval and it is the intention of the League to carry out this investigation on the subject of "fading" during the summer months. Full information on the subject can be obtained from the various Division Managers and it is hoped that every member of the League operating a station of any kind will co-operate fully with them. This matter is of the utmost importance and if by means of our investigation we can show a definite result or reason for the varying strength of amateur signals, we will have accomplished a scientific fact that will be of the greatest value.

With the coming of warm weather and consequent QRN it is found that the longer distances covered in traffic work during the winter months are now accomplished only at intervals or are altogether impossible. This emphasizes the importance of what has been frequently requested in these columns to the effect that all traffic work of the League should be handled in short relays, which would insure dependable communication, day or night, during the entire year. It is hoped that all of the Operating Department personnel will make every effort to establish relay routes that will insure the regular year-round communication we have all so long desired. Until amateur radio achieves the ability to handle traffic the year around in a dependable manner it can not be said to be fully efficient. Let us make it so.

Reports from several of the newly appointed Division Managers are included in the following pages and show that there is not likely to be any letup whatever in interest during the summer months. The ability to handle traffic through static and other interference by means of C.W. transmission is undoubtedly going to be a big factor in the relay work of the League during the summer. Actual tests have proved that by means of C.W. transmission traffic can be handled through static and interference that would be impossible with the most powerful spark set an amateur could use, and with only a fraction of the power required for the operation of a 1 KW spark set.

The reports of the various Division Managers in detail follow:

NEW ENGLAND DIVISION

Guy R. Entwistle, Manager
18 Boylston St., Boston, Mass.

At the time of writing this report there are 1125 licensed amateur stations of the first and second class in the First Radio Inspection District with probably 90% of the total number of the former grade. Only one special amateur license has been issued, and that is located at Springfield, Mass., (Mr. Sabin). One additional School license has been issued, to Dartmouth College, call letters 1YB. The other technical school license was granted previously to the Rhode Island State College call, 1YA. Naturally the distribution of these stations varies from state to state and in different parts of the same state. Greater Boston has the greatest density per capita; Wollaston, the most of any one city.

The traffic department of the A.R.R.L. has undertaken the organization of these stations into a working chain for the purpose of relaying free messages from any one section of the country to any other.

At the present writing a trunk line from New York City, and connecting points, is IN ACTUAL OPERATION to Portland, Me. and with more or less regularity to Van Buren, Me. The jumps are long, but nevertheless it is a starter. 1AW is the collecting point for eastbound traffic and the present route is as follows: 1AW, 1AK, or lately 1HAA (Vermilya at Marion), 1CK (Robinson at Braintree), or 1AE (Young of Dorchester), to 1DU (Rogers and Castner at Portland, Me.) From here we are usually able to work 1BK (Alexander) or 1OT, in Bangor. 1GAG (rough stuff) in Houlton, and 1OY in Van Buren are the northern limits for 1BK so far. No QSO at the present time between Bangor and 2AB, Quebec, Canada, but this is a possible route in the future. There is also no QSO to Canada thru 1OY.

The shunt line thru Springfield and Worcester is not in commission. 1GY reports 1AW QRZ but 2's, 8's and 9's QSA and a few 3's.

1HAA, our old friend Vermilya (Amateur Number One) has been helping out in QSRing from 1AW to 1CK. Mr. Maxim reports more eastbound traffic than ever before.

City Manager Gisburne has taken work in another section of the country and has resigned. Mr. Sumner B. Young has been appointed city manager to succeed 1DI. Young, 1AE, has earned a reputation for himself as a relayer.

1CK, Robinson of Braintree, has been appointed traffic assistant. His duties are somewhat as follows. The Manager of the New England Division has decided on a QRM attack and 10 P.M. curfew, for which purpose he has selected in co-operation with 1CK, one man in each of the cities of greater Boston to act as a QRM representative. Sort of a father to the rest of the amateurs. When an amateur in Wollaston runs amuck with a squeak box and tells the rest of the world to go to H— (as his mother says he can stay up till 11 tonight) the fellow that is being QRM'ed does not deal direct with this man at any great length but puts it up to the QRM representative in Wollaston who can handle the situation more effectively. Nearness instills fear. In a like manner the whole section is so controlled. Get the wouff-hong.

CONNECTICUT—ITS, Donald Mix, Bristol, Conn., has been appointed Assistant Division Manager of the New England Division, Western Section.

Mr. Homer E. Nichols, of Bridgeport has been reappointed District Superintendent for Southern Connecticut.

The Division Manager would like to hear from Framingham, Springfield, Providence, cities between Fall River and Hartford, also any city in Vermont with a radio set. Let's get thru to Montreal or Quebec.

ATLANTIC DIVISION
C. A. Service, Jr., Manager
Bala, Pa.

The reports of the Assistant Division Managers show a general decrease in the amount of relay work handled, but notwithstanding the outlook both for the summer months and especially for the next relay season are encouraging. Static is cutting out reliable work over jumps of any distance, which in one way is a good thing, in that it will lead to the development of the short jumps, a condition which has been advised by everybody in the Operating Department from the Traffic Manager down.

Instructions have been issued the various members of the Operating Department to bend their energies toward developing the short jumps, at least between the larger centres and we believe this will work out in most parts of the Atlantic Division, with the exception of the cities of Baltimore and Washington. We even have hope for them by a somewhat roundabout route thru New Jersey, across to Rehoboth, Delaware, (8PM), to Snow Hill, Md. and thence to Baltimore and Washington.

The re-division of the six operating Divisions of the League into twelve will relieve the Division Managers of much extra work and allow them to devote a larger share of their time to the develop-

ment of relay lines coming within their immediate notice and we are heartily in favor of the action taken by the Board of Direction. The Atlantic Division Manager wishes to take this opportunity of thanking his Assistant, Mr. Entwistle, Northern Section, and all his District Superintendents and Operating personnel for the splendid work they did in the New England section of the old Atlantic Division, and wish them all success under Mr. Entwistle's guidance as the Division Manager for the New England Division. Also to Mr. Gravely, District Superintendent of Virginia in the past and now Division Manager of the Roanoke Division, belongs the thanks and good wishes of the Atlantic Division Manager for his steadfast work in the interests of the League under adverse conditions.

Two matters come to the attention of the Atlantic Division Manager at this time, one being false calls, the other, "rotten relaying". These have come up in past issues of QST but for goodness sake read them again and benefit.

Within the past month the Division Manager has worked three stations which gave the call and location of stations at a distance of two to three hundred miles but conditions of reception gave them dead away. One was a spark coil within several miles, one is still at large and the other was an operator aboard a ship up the Delaware. He unfortunately made a mistake in failing to realize he was breaking every radio law by signing a false call, giving a wrong location and working with an amateur station. The amateur station in question is operated by the Shipping Board Radio Supervisor in his leisure moments at home, which showed poor taste in the pickings of the ship's operator, especially as the Supervisor bit hard at the time and later found out his mistake. We would hate to wear the shoes of that operator when his ship returns and he is asked to explain.

The worst offense an amateur or ship operator can be guilty of, is sending a false SOS, the next is signing a false call willfully for the purpose of deception. No mercy should be shown the offender in either case and should any amateur know of such occurrences it is his duty to do utmost to bring the offender to justice.

Our next observation is on "rotten relaying". The Old Man hit it pretty square in one of his famous articles but still we are cursed with the newcomer who spends nine tenths of his time in calling and signing off, even when working long distances on high power, where seconds are precious and his tardiness may be holding up dozens of other DX stations. Why can't he learn the value of "short and snappy"? Does he think the other fellow will have any

sweeter dreams because he wishes him GN six times instead of once? Does he believe the station he wants to connect with is a mental telepathist that he must send the attention signal ten times before he gets up steam enough to shoot out the call? Why does he ask a faint station "Where'bouts in Massachusetts are you located, OM, will you please give me your location?" when he could have covered the whole thing with a simple "QRA?"

He makes himself no better understood by the longer method and on the other hand advertises the fact to hundreds of listening ears he is a "HAM" in every sense of the word. If he would take time off long enough to listen to the fellows who get the traffic thru and copy their style of procedure, he would earn the gratitude and regard of his suffering fellowman.

The Division Manager's hooks are cleared for this report: We hope to be able to show the successful operation of daylight routes thru the main centres of the new Atlantic Division by next report, so that some of you fellows who must stay at home while your girls leave for Atlantic City and Cape May can still stir up the ether with ardent QSR'd "love and kisses by radio".

Chas. H. Stewart, Assistant Division Manager, St. David's, Penna., reports there appears to be a gradual improvement in relay conditions over the entire Southern Section, but they are still not what they should be. The advances made have been more or less sectional, and through work on the trunk lines has not been done with any degree of regularity. Some of the old stations have been slow to come back into the work, but there are several stations being reconstructed, and when these get into active operation they will doubtless be of considerable assistance.

In the Western Pennsylvania District the District Superintendent, Mr. R. C. Devinney, reports that conditions on Branch Line No. 2, from Washington, Pa. to Erie, Pa. have improved very much, and that reliable work is being conducted via this Branch Line, messages going from one end to the other in thirty minutes, with as many as four relays. The situation at Washington, Penna. is bad due to the fact that the power company has required the installation of separate transformers at the expense of the station, and has cut off the current supply in such cases until the operation of the radio sets was discontinued. As regards Trunk Line B through this territory, reliable relay work has not been done, and Mr. Devinney states that about the only through work that has been done has been through 8EN and 8RQ in that District with 3HJ in the Philadelphia District, but remarks that

this distance is too long to be considered satisfactory. Attention is called to the fact that difficulty is experienced in working between Pittsburgh and 8BQ at Milton, Pa. due, in the judgment of Mr. Devinney, to the fact that both of these stations are located too close to the foot of the mountains on each side, and he is very anxious to hear of some station or stations situated on top of the mountains. A banquet is being arranged in that District to be held at New Castle or Youngstown, mostly by the fellows on Branch No. 2, and in this way they hope to get together. Most any of the stations on Branch No. 2 can be utilized as relay stations for Trunk Line B.

Mr. Cawley, Superintendent of the Central Pennsylvania District, reports that so far as his District is concerned no actual traffic has been handled over Trunk Line B. His Traffic Assistant has been in communication with 8RQ at Springdale, Penna. but owing to local QRM at Springdale it has so far been impossible to obtain reliable working conditions between these points. In regard to conditions to the east he states that he has been advised by 8PQ at Danville, Pa. that the latter has heard 3GX at Reading, but that his signals fade badly. This shows the necessity for a good station at Pottsville, Pa. and it is understood from the report of the Dist. Supt for the Eastern Penna. Dist. that the station formerly worked by Mr. C. M. Jackson at that point will be in operation in the near future. If this is the case it will largely solve the situation between Philadelphia and Milton, and the problem then will be to get stations between that point and Pittsburgh that can handle the traffic on Trunk Line B. The Traffic Assistant is laying plans to install a CW set, and, if this is done, it will doubtless be of considerable help.

Mr. Ferris, Supt. Eastern Penna. District, reports that Trunk Line B is in good operation as far as 3GX at Reading, Pa. and that as soon as station is completed at Pottsville, Pa. the gap between Reading and Milton will be easily bridged as noted above.

Mr. Duvall, Superintendent Eastern Maryland District, reports there has not been any great increase in activity in his District since the last report, beyond the fact that regular communication day and night is being done between Baltimore and Washington, which is a step in advance, as communication between these points was formerly very uncertain. He states that recently a joint meeting was called of the two local radio clubs, the Baltimore Radio Association and the Amateur Radio Club of Baltimore with the object of arranging a schedule for local operating and for long distance relay

4880 Margaretta Ave., St. Louis, Mo.
 Dist. Supt. Western Mo., G. S. Turner,
 124 S. Pearl St., Independence, Mo.
 City Mgrs., Aronson & Perkins, 3952
 Bellevon Ave., Kansas City, Mo.
 Dist. Supt. Kansas, R. K. Trump, 125 1
 VanBuren St., Topeka, Kansas.
 City Mgr., H. L. Owens, 822 E. Main
 St., Council Grove, Kansas.
 Dist. Supt. Iowa, P. A. Stover, Marengo,
 Iowa.

City Mgr., C. W. Patch, c/o Farley &
 Loettcher Mfg. Co., Dubuque, Iowa.
 District Supt. Western Nebraska, J. A.
 Wanek, Giltner, Nebr.
 Dist. Supt. Eastern Nebr., J. G.
 O'Rourke, 6406 Nebraska Ave., Omaha,
 Nebr.

Mr. Stover, District Superintendent of
 Iowa, reports that he has four routes
 across his state of which possibly two are
 complete all the way across and the other
 two complete to Ames and Lamonia. Mr.
 Stover is at present installing CW (modu-
 lated) to combat QRN this summer.

J. A. Fritz and G. S. Turner District
 District Superintendents Eastern and West-
 ern Missouri, are working together to
 establish an efficient route to Kansas City
 by way of Columbia, Mo. A lack of
 stations in Missouri makes it hard to
 accomplish this situation.

J. A. Wanek Dist. Supt. Nebr. operating
 9IF, is busy getting his territory in trim
 for the summer months. He expects to
 have a complete route across the state in
 the near future and a great deal of traffic
 for the west coast can be cleared through
 this source.

H. L. Owens, Council Grove, Kan., has
 been doing excellent work the last few
 months. Mr. Owens proves to be a sticker
 at the key and can be heard on the job
 any time from midnight to early sunrise.
 He figures the early bird catches the worm
 and has the right idea and west bound
 traffic can always be cleared thru 9EL
 when the rest have retired.

Storms, high winds and QRN have made
 it bad for relay work in this section the
 last few weeks. St. Louis stations are
 still at it hard and adverse weather con-
 ditions seem to make little difference.

CENTRAL DIVISION

R. H. G. Mathews, Division Manager,
 1316 Carmen Ave., Chicago, Ill.

This month the Central Division has
 been rearranged to include only the follow-
 ing states: Kentucky, Wisconsin, Ohio,
 Indiana, Illinois and Michigan. The
 Division Manager wishes to announce that
 appointments of District Superintendents
 made in these states are continued as
 before, no change being made in the
 personnel.

Special attention is being given the for-
 mation of active summer routes to con-

tinue traffic work throughout the summer.
 Schedules have been arranged on several
 of these routes for once-a-week daylight
 operation. Foremost of these routes is
 the Lake Shore Route for Wisconsin the
 schedule of which is included in this report.
 It is requested that other District Super-
 intendents take immediate steps toward
 the organization of similar routes oper-
 ating on similar schedules. It is believed
 that an arrangement of this kind which
 allows of clearing of all traffic at least
 once a week is not arduous and that
 sufficient interest should be maintained to
 allow of its operation.

Mr. Duerk, District Superintendent of
 Ohio, reports the following changes and
 additions in his territory. Mr. John Perry,
 8GQ, Defiance, Ohio, appointed alternate
 for 8ZY to handle traffic through Defiance.
 Mr. Earl Ensign, 8BO, Toledo, Ohio,
 appointed alternate with Mr. Kerstetter,
 8EU, Toledo, Ohio. 8GB appointed alter-
 nate to 8FP of Marion, Ohio. 8DZ of
 Van Wert, Ohio, and 8HD, Spencerville,
 Ohio, appointed official relay stations for
 their respective cities.

Mr. Darr, District Superintendent of
 Michigan reports traffic being handled as
 usual, although a falling off in quantity is
 noted. He also reports that the Detroit
 Radio Association, a live organization with
 about 125 members has become affiliated
 with the League. A number of new
 stations have broken into the long distance
 ranks in his District, notable of which is
 8OJ of Birmingham, Michigan.

The following is the schedule of the
 Lake Shore Route through Wisconsin which
 is called to the attention of District Super-
 intendents of this Division:

Effective Sunday April 18th, 1920.

9CT Menominee, Mich.
 9UL Menasha, Wisc.
 9DV Neenah, Wisc.
 9ZL Manitowoc, Wisc.
 9HP Plymouth, Wisc.
 9FQ Sheboygan, Wisc.
 9HW Milwaukee, Wisc.
 9JT Racine, Wisc.
 9MH Milton, Wisc.
 CEB Kenosha, Wisc.
 9ACU Oshkosh, Wisc.
 9VW Applton, Wisc.
 9ZN Chicago, Ill.

Traffic to be cleared every Sunday morn-
 ing as per the following schedule. It was
 found impossible at any other time of day
 account of conflicts at several stations.
 Stations are requested to please be on
 every Sunday and on time. Complete
 schedule:

9:00 A.M. 9HP clear to 9FQ.
 9:00 A.M. 9UL clear to 9DV.
 9:04 A.M. 9ACU clear to 9DV.
 9:05 A. M. 9FQ clear to 9ZL.
 9:07 A.M. 9VW clear to 9DV.

9:10 A.M. 9DV clear to 9ZL.
 9:15 A.M. 9CT clear to 9ZL.
 9:20 A.M. 9ZL clear to 9HW.
 9:23 A.M. 9HW clear to 9JT.
 9:26 A.M. 9JT clear to CEB.
 9:29 A.M. CEB clear to 9ZN.
 9:32 A.M. 9ZN clear to CEB.
 9:35 A.M. CEB clear to 9JT.
 9:38 A.M. 9JT clear to 9HW.
 9:41 A.M. 9HW clear to 9ZL.
 9:45 A.M. 9JT clear to 9MH.
 9:45 A.M. 9ZL clear to 9FQ.
 9:50 A.M. 9FQ clear to 9HP.
 9:50 A.M. 9ZL clear to 9DV.
 9:55 A.M. 9ZL clear to 9CT.
 10:00 A.M. 9DV clear to 9UL.

Return relay permits clearing all traffic both directions. Stations not completing traffic on schedule continue until finished. Other stations QRX and avoid jamming. 9JT and 9MH please QRX as per schedule time while 9ZL QRW with 9HW account QRM.

Prospective stations have been located at Stoughton, Madison, White-water, Juneau, Berlin, Antigo, Rhinelander and Superior. Extensions will be made as soon as possible and all stations notified.

Illinois and Iowa daylight routes are now being organized. As soon as practical this route will be extended to join others.

A route from LaCrosse, Wisc. to Winnipeg, Canada, via St. Paul, Mpls., Supr., Duluth, and Baudette, Minn. is expected to be in operation before long. An attempt will be made to run a branch from the Lake Shore route across state to LaCrosse, probably via Madison and Milton, thereby bringing us in on the Chicago-Winnipeg Canadian trunk. Co-operation of every station is requested. Criticisms and suggestions will be welcomed.

DELTA DIVISION

John M. Clayton, Manager
 1301 Welch Street, Little Rock, Arkansas

Professor W. L. Kennon, of the University of Mississippi, has been appointed Superintendent of the State of Mississippi. Professor Kennon is at the head of the Physics Department of the University of Mississippi, and has just recently installed station 5YE at the University. 5YE is doing some very good work and is going to be counted on as the main relay station between the East Gulf and Delta Divisions.

Professor Kennon reports that he is trying to secure the aid of station at Millsaps College at Jackson, Miss., which will be a good location for relay to 5ZP at New Orleans. He is also trying to get the services of a station thirty miles from him. This station has recently installed a type Q-S 500 Wireless Specialty Apparatus Company's 500 cycle transmitting set and is equipped with the latest type Grebe receiving sets.

He is also working to build up amateur work in his state to receive news letters proposed to be sent out to town and country schools in the state. The League is to be congratulated upon securing such a man as we have in Mississippi.

In the Louisiana section, Mr. Greenlaw, 5ZK, at Franklinton, has been appointed Assistant Division Manager. While Mr. Greenlaw has been in on the sending or relaying game very little this season he promises to be in on both feet next season. His town seems to be entirely void of the necessary "juice" with which to work a wireless transmitting set. He says though that if the necessary power is not secured by next season, he will put in a gasoline engine drive generator to supply 5ZK with unlimited "juice".

Mr. Hubert E. deBen of New Orleans (5ZP) has been appointed District Superintendent of Louisiana. Mr. deBen is well known as 5ZP and seems to be the liveliest wire in New Orleans. He reports the Nola Radio Club of New Orleans is steadily increasing both in membership and interest. However, there are few stations in New Orleans who seem interested in the transmitting end of radio other than local work. Mr. deBen attributes this fact to the bad local QRM caused by commercial work. He reports that he has handled 122 messages this season.

Stations are under construction at Alexandria, La., and Bogalusa, La. Both stations will have a power input of 1KW and will help out considerably in handling traffic to and from 5ZP.

Station 5EA, Mr. D. S. Reymond and W. L. Barrow, at Baton Rouge, La., has been doing some fine work.

No station has been raised in Tennessee yet, but the writer hopes to be able shortly to report that the services of 5DA at Wind Rock, Tenn. have been secured.

Communication thru this part of the Division will shortly be difficult until the summer static dies out. Possibly the conditions which exist down here are not generally known. It's just a case of plain tropical summer weather—weather.

DAKOTA DIVISION

R. H. Pray, Manager
 813 Fifth Ave., Valley City, No. Dak.

It is going to take a lot of hard work on the part of every member to keep things moving this summer. In fact, the hard work is first to get the routes working with short jumps so that we can handle traffic all summer.

There has been quite a lot of local traffic (up to 150 miles) handled through the station of the Manager (9ZX). But as yet we have not been able to lay out any definite routes as there is no outlet in any

direction. There is now a daylight route in regular working order from 9ZC the station of J. A. Gjelhaug, Dist. Supt. for Northern Minnesota, to 9ZX Valley City, N. D. (225 miles) to 9WU, E. S. Leavenworth, Ellendale, N. D. (75 miles) to 9PI, E. R. Isaak, Eureka, S. D. (70 miles). All Branch routes in the North Dakota District are working as usual.

Mr. E. S. Leavenworth of Ellendale, N. D. has been appointed District Superintendent for North Dakota and has taken up the work with enthusiasm. Mr. Leavenworth has done some very good long distance work with his station, 9WU, and should be very prominent in the relay field.

Mr. Wick, City Manager of Fargo now has his station working, call 9AEJ. It is fully equipt to do some good relaying with an up-to-the-minute transmitter and receiver. He should be able to handle traffic over a large territory.

Mr. Gjelhaug, Dist. Supt. for Northern Minnesota, reports that he has been testing with the station of the Radio Club of Winnipeg and expects soon to have a route across the border that can handle traffic regularly. He has had some correspondence with the Winnipeg Board of Trade, with some very good suggestions, regarding the status of radio relay work, which is expected to speed things up in that direction.

WEST GULF DIVISION

F. M. Corlett, Manager

1101 East Eighth Street, Dallas, Texas.

The following District Superintendents have been reappointed for the ensuing year:

Raymond L. White, P. O. Box 322, Ennis, Texas, District Superintendent Northern Texas.

Louis Falconi, P. O. Box 421, Roswell, New Mexico, District Superintendent New Mexico.

Mr. W. H. Tilley, P. O. Box 663, Austin, Texas, has been appointed District Superintendent of Southern Texas, succeeding Mr. James L. Autry, who has resigned due to lack of time to devote to League work.

Very little night relay work is being done now due to the heavy static through out this section of the country, however a number of stations are handling traffic during the day time when QRN is not near as bad and some times almost nil.

District Superintendent Louis Falconi of New Mexico District reports nothing of interest to make radio life one bit more exciting, such things as long distance communications, reaching the Pacific Coast, when QRN does not hold sway, have long since become every day occurrences hence are not very interesting. During the month of March 50 messages passed through 5ZA to or from the Pacific Coast, either direct

or via 6GQ at Phoenix, Ariz. Besides this traffic other messages were handled from Denver, Houston, Dallas, etc. On one occasion twenty-five msgs. were waiting to go West and only good old 6GQ to get 'em thru. No wonder he wanted to know if there were not some other route West. From what has been said, you fellows surely will have to admit that we have been busy, especially when the operating conditions are understood. Just as everything seemed lovely and things had arranged themselves for a dependable Trunk Line O.M. Static had to come along and once again we are left to hope and regret. The only solution seems to be MORE STATIONS and SHORT RELAYS. Several fellows have been heard from both in New Mex. and in Ariz., they are all enthusiastic and willing to help, but it seems that this section is somewhat slower than other sections of the U.S., but there is comfort in the hope that when we do get going we are going to be hard to stop. 5CX has installed a Thordarson 1 K.W. and his signals are much better. It should fill a long felt want for a route to El Paso, Texas, being only several miles from El Paso. Other stations promised are Clovis, N. M., East Las Vegas, N. M., Cochize, Ariz., and Douglas, Ariz., all so situated so as to help on the Trunk Line "C". Would be glad to hear from more fellows willing to help with good stations. The El Paso Texas Territory, including the Counties of EL PASO, HUDSPETH, CULBERSON, JEFF DAVIS, PRESIDIO, REEVES, LOVING, WINKLER and WARD, has been transferred from the Southern Texas District to the New Mexico District and I would like to hear from all station owners in that Territory. Have it from Bob Trump, now at Phoenix, that he will be located there next year and if he sells enuff chickens, (he is in the chicken business—feathered chicks), we will have another good relay station in Phoenix.

District Superintendent R. L. White, of the Northern Texas district has moved his station from near the Country Club to his residence in Ennis and of course is on the job pretty regular now and some good work is being done, also it is noted that his wave has been sharpened up considerably which is another great improvement. If only some more would use a "sharpenner" on theirs too. Mr. White reports the re-appointment of Cecil F. Butcher, 5AL, 1603 North Stonewall St., Greenville, Texas as Asst. Dist. Supt. Greenville Territory, Mr. Henry M. Harris, 5ZJ, Box 427, Waco, Texas, Asst. Dist. Supt., Waco Territory and the appointment of Mr. Max Pierce, 5AI, 1561 West Fourth St., Corsicana, Texas, Asst. Dist. Supt. Corsicana Territory. Daylight schedules are being arranged and put in effect between

many stations and it is hoped that Trunk Line "F" can be kept open all Summer, especially from Dallas and Greenville south to Houston.

Mr. John Rodriguez, of San Antonio, states that San Antonio will be on the job shortly; this will indeed be a great help as traffic is being turned down right along for San Antonio and besides we need a station there to close a gap to Eagle Pass.

PACIFIC DIVISION
A. E. Bessey, Manager,
Sunnyvale, Calif.

The following appointments have been made:

Garrett Arnold, 6AT, San Jose, Asst. Division Manager.

V. M. Bitz, 825 53rd St., Los Angeles, District Superintendent for Los Angeles district.

J. B. Wise, 6EJ, Walnut Grove, District Superintendent for San Joaquin and Sacramento Valleys.

C. Steffin, 6EX, Berkeley, City Manager for Berkeley.

Mr. Rheems, 6AH, City Manager for Oakland.

6CP for Alameda.

Harris, 6DP, City Manager for Santa Cruz.

Mr. Beedle, 6BQ, District Superintendent for Reno, Nevada.

Traffic and A.R.R.L. work is progressing very nicely. The stations all over the State are getting in good shape; stations all being tuned so that it makes the work much easier than before. Our Los Angeles routing is very good direct from the Bay district to Los Angeles and if QRM bothers it can be routed by 6EJ who has no difficulty whatever handling the Los Angeles district. San Diego district as yet has not opened up satisfactory so that the northern part of the state can work direct, as their stations are not in as good a shape as they will be later. The Eastern route must still go through Los Angeles and Arizona, as it has not been very satisfactory to work East through 7CC or any of the northern boys, although it is done, but not with any surety. The Coast works 6ZA very nicely but there seems to be a hard jump to bridge from Salt Lake on, but we are in hopes to get opened up soon. Where amateurs cannot work direct with the South their routing should go through 6EX Berkeley, 6AH, Oakland, 6HO, Oakland, 6AE, Palo Alto, 6AT, San Jose, 6CO, San Jose, or 6BR, Sunnyvale; all of these stations work Los Angeles direct. Also the inland routing for the South is through 6EJ or 6AK; routing for the north, 6EJ, 6AT, 6AE or 6BQ, which will give the most satisfactory results. 6GQ of Arizona is not being heard of late. In all probability

he is having some difficulty with sending apparatus, and at the present time all messages have to be routed north. The situation of QRM is being cleared up rapidly, owing to the fact of organization of the ARRL and shutting down local QRM at ten o'clock; all cities and radio clubs giving their support to this, which in a very short time will make very satisfactory relaying.

Report from Walnut Grove, 6EJ, J. B. Wise, is as follows:

There are two routes from the Bay section to Sacramento; one via 6AJ and the other via 6EJ or 6AK. The majority of the Sacramento business is done by 6CV and 6GR; also business can now be handled to Stockton, 6KM being able to handle a limited amount of business. The Oard Laboratories have resumed their press schedule on Saturday evenings at 8P.M. 6EJ or 6AK are able to handle business direct with Portland, Oregon; Silverton, Oregon; Moscow, Idaho; and Vancouver, Washington; and clear business with Los Angeles very well with following stations: 6EN, 6ER, 6EB, 6EA, 6JD, 6ED, 6HZ, 6EF and 6ER; also 6JM of San Fernando. There is no reliable route to Fresno only by Los Angeles; the same being true so far as 6EJ and 6AK are concerned. Routing to Reno from Sacramento and San Joaquin Valleys; done through 6EJ or 6AK to Los Angeles and from there back up to the opposite side of the Sierra Nevadas to Reno. Several Bay sections work Reno direct; 6AT, 6CO, 6BR, and 6AE, but taking it all in all the traffic is very satisfactory.

Mr. Rheems, 6AH, Oakland, one of our new boys, writes that his report is naturally small this time because of the unorganized condition of Oakland; quantities of stations being put in, but very few of them being tuned up and getting real work. It is proving to be a very lively center for the ARRL and many applications are being sent in for membership from the Oakland boys which shows that they are very anxious to get along the right lines. The interference problem is now under control with the amount of co-operation of the ARRL men. The relay messages are now easily accomplished by the ARRL stations. About a dozen long distance messages an evening are handled and an unlimited amount of local relaying. 6HO, 6KZ and 6AH are so far the best to handle Relay work from Oakland. The Tech Radio Club has a large membership and is giving every assistance to the boys.

6BQ of Reno, Nevada reports a lively interest in Nevada. Many new stations going in but at the present time not in sufficient condition to handle much traffic, but in a very short time will be able to handle Nevada in-coming traffic, as 6BQ, has been, up to the present time the only

one in Nevada to handle it. Routing from the Bay section through 6BQ is very satisfactory to the north as he works Portland, Seattle and Los Angeles, also 6ZA.

No official report from Los Angeles as yet, but they are co-operating in a very fine way in Los Angeles. Their Radio Club has decided to shut down on QRM after ten o'clock, and local QRM in the Los Angeles district is now practically nil. They have reserved Wednesday nights from 9:30 to 10:30 exclusively for East and West traffic. This is fine business and feel sure that in a very short time the Los Angeles district will be doing some wonderful work. They are organizing clubs and are showing a great interest in the work.

The Pacific Coast amateurs are all going in for amplifiers so that you may hear shortly of some very fine long distance work being done. Most of the long distance relayers at the present time have amplifiers. We are very glad to see the progress being made along these lines. Test messages are being sent out regularly and trust that the amateurs hearing them will QSL as we wish to know just what work is being done, and a card dropped will facilitate matters greatly, and assist us in getting the proper routing and appointing the official relay stations.

ALASKAN DIVISION

Theo. J. Stocking, Manager,
Ketchikan, Alaska.

We take pleasure in presenting herewith, our first official monthly report, covering the period from March fifteenth, to April fifteenth. In order that the report, when mailed, may contain the latest possible data, we have concluded to render same for the period above mentioned.

We are practically ready to accept traffic from the states, being held up only because of a lack of routes through Canada or British Columbia, to Anyox, B.C., which will be our most logical transfer point to Canadian territory.

A station has been established for the summer months at Nakat Inlet, thirty miles south of this point, using half kilowatt, five hundred cycle transmitter which readily works Canadian stations in British Columbia. Regular schedules are also maintained with a Ketchikan station, which is proof of Nakat's signals reaching both this point and British Columbia.

Letters have been written to points north of here in an effort to work up a route for inter-Alaskan traffic, but as yet no replies have been received. We believe a live assistant manager north of here would be valuable, and are accordingly looking out for a suitable man to appoint.

The writer's station here is making every effort, using two step amplifier, to

pick up a United States amateur direct. He will immediately notify the owner of any such station whose signals are heard. The United States border is but six hundred miles away, and 600 meter stations as far south as California pound in up here so it is quite possible that amateurs in the United States will be heard here.

ONTARIO DIVISION, (Canada)

A. H. Keith Russell, Manager,
353 Markham St.,
Toronto, Ontario, Canada.

Things are moving slowly in this division and, from present indications, a good Ontario relay chain will now be difficult to get going properly until sometime later on, owing to the fact that any Country Stations here are run by farming people who have little time to give to their hobby during the spring and summer.

However, there have been some promising developments in this division since last report, one of great importance being the formation of the Lake Superior Radio Association which is seeking affiliation with the A.R.R.L. This Association, the Manager is advised, is formed to make a relay chain along the shores of Lake Superior and already has stations in Sault Ste. Marie, Ontario, Cheboygan, Alpena, Saginaw and Battle Creek, and prospects look good for additional relayers in Sault Ste. Marie (Mich.) Drummond Island, Detour, Pellston, Petosky, Detroit and Bay City. The Secretary of this Association reports that conditions in Northern Ontario are not very promising at present, but it is hoped that more men will become interested in radio later in that vicinity.

Permanent daylight communication has now been established from Toronto to Buffalo via 8ZM, and the new Niagara Falls station should also be in working order by the first week in May. These two stations should furnish very good connections for this division. Many of the members in Toronto district have successfully worked across the border two or three hundred miles in the last month, and so prospects are excellent for good work from here. Mr. E. Rogers (3BP) of Toronto has agreed to assist the Manager in organizing the Toronto district.

Mr. Carter, the Southwest Ontario district Manager, reports that matters are slowly moving in his district, but that he does not expect to get a regularly working chain going till next Fall, owing to the men in the rural districts being so busy during this time of the year. There is an expectation that within a few months, there may be one or two continuous wave stations working in this district, and Mr. Carter himself hopes to take a fling at it.

(Concluded on page 45)

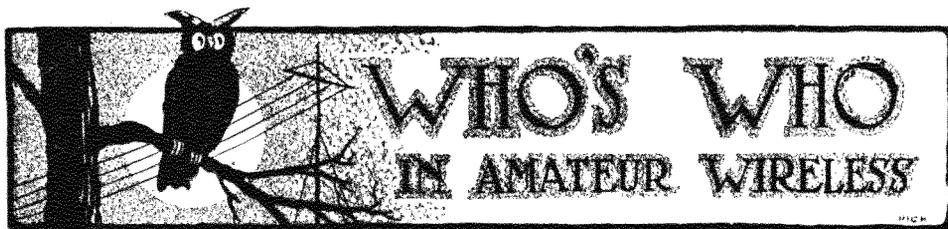

Francis Frazee Hamilton

Presenting Mr. Hamilton of 9ZJ, Indianapolis, owner of "the prettiest tone".

Mr. Hamilton started in wireless in 1905 when living on a farm near Connersville, Ind., and is a pioneer in amateur work. In 1906 he moved to Indianapolis and with another young man constructed a really workable receiving set using carbon-needle microphone detector, quite an achievement for those days. Later that year the "Scientific American" described a 100 mile transmitter and they went to work on it—a spark-coil thing that threw a heavy three-inch spark on 110 and if used today nobody could hear anything else this side of the Mississippi River.

Hamilton graduated from Purdue in 1914, taking a special mathematics course in radio and transient phenomena and the square root of LC, and in 1916 made his
(Concluded on page 45)



W. T. Gravely

This introduces to our readers Mr. Gravely of 3BZ, Danville, Va., long a member of our A.R.R.L. Board of Direction and the manager of the newly-created Roanoke Division.

Mr. Gravely was born on October 9, 1879, in Danville, which has always been his home. His interest in radio dates from 1913 and he says (with us) that it is the most fascinating game in the world. He had only a receiving station until 1916 when his transmitter with the call 3RO was installed and became a familiar spark to pre-war amateurs. 3RO shut down with the rest of us in April, 1917, and Mr. Gravely ate black bread, sweetened his coffee with syrup, and went without many things to please Mr. Hoover, also giving much of his time to the Liberty Loan, War Work, Red Cross, Y.M.C.A., and other campaigns in his territory. (Good organ-
(Concluded on page 45)

QST'S DIRECTORY OF CALLS

In continuance of the policy recently announced, QST presents another two pages of calls, which may be cut out and kept with the January supplement if desired.

FIRST DISTRICT

| | | |
|---------------------|--------------------------------------|------|
| E. G. Holbrook | E.F.D. 4, Attleboro, Mass. | 18E |
| E. N. Richardson | 25 Cumberland St., Boston | 18O |
| D. W. Parker | 95 Rutland Rd., Cambridge, Mass. | 18P |
| M. E. Wood | 14 Armory St., Wakefield, Mass. | 18R |
| R. F. Jefferson | 161 Washington St., Islington, Mass. | 18S |
| C. J. Egan | 956 Cambridge St., Cambridge, Mass. | 18T |
| J. A. Morris | 56 Cedar St., New Britain, Conn. | 18Z |
| E. D. Austin | 12 College Ave., Waterville, Maine | 1TK |
| Donald H. Mix | 40 Stearns St., Bristol, Conn. | 1TS |
| J. H. Washburn, Jr. | 9 Wesley St., Somerville, Mass. | 1UK |
| J. W. Whitmore | 64 Meadow St., Pawtucket, R. I. | 1WO |
| R. S. Quimby | 419 Y.M.C.A., Boston | 1AAG |
| Robt. Large | Central St., Bristol, Conn. | 1AAT |
| Alpha A. Learned | 76 Camp St., Providence, R. I. | 1AAU |
| Jos. F. Furey | 1 Magnolia St., Hartford, Conn. | 1VAD |

SECOND DISTRICT

| | | |
|--------------------|--|-----|
| C. H. Osborn | 97 Watkins Ave., Middletown, N. Y. | 2CI |
| W. E. Bathgate | 102 High St., Passaic, N. J. | 2CJ |
| G. L. Storm | 742 Highland Ave., Newark, N. J. | 2CL |
| H. Zimmerman, Jr. | 2590 Third Ave., New York | 2CM |
| E. T. Dickey | 1649 Amsterdam Ave., New York | 2CN |
| Peter Cooper | 512 Sewal Ave., Asbury Park, N. J. | 2CO |
| J. P. Devine | 1068 University Ave., New York | 2CP |
| Morris Lieberman | 524 Barbey St., Brooklyn | 2CR |
| H. G. Rowley | 107 Clifton Ave., Newark, N. J. | 2CV |
| Ernest K. Seyd | 531 Washington Ave., Brooklyn | 2CX |
| Wm. F. Diehl | Third St., Bayside, N. Y. | 2CY |
| F. V. Becker | 12 Callister St., New York | 2CZ |
| R. D. Zucker | 46 Clinton Pl., Mt. Vernon, N. Y. | 2DB |
| Julius Schmidt | 431-33 Center St., Schenectady, N. Y. | 2DD |
| H. G. Silversdorff | 641 Pavonia Ave., Jersey City, N. J. | 2DF |
| S. W. Knapp | 75 Cooper St., Brooklyn | 2DH |
| Wm. R. Chinn | 25 Westchester Ave., White Plains, N. Y. | 2DK |
| H. C. Nightingale | 349 18th Ave., Paterson, N. J. | 2DM |
| Arnold Brihart | 10 Cornell Ave., Yonkers, N. Y. | 2DN |
| L. J. Wadsworth | 1494 Bushwick Ave., Brooklyn | 2DO |
| Chas. Fucci | 606 Henderson St., Jersey City, N. J. | 2DP |
| T. C. Cooper | 269 Garfield Ave., Jersey City, N. J. | 2DR |

THIRD DISTRICT

| | | |
|--------------------|---|-----|
| J. L. Devlin | 2517 S. Dewey St., W. Philadelphia, Pa. | 3FP |
| W. Y. Evans | Walker Ave., Towson, Md. | 3FQ |
| K. K. Keck | 117 St. Cloud St., Allentown, Pa. | 3FR |
| C. Y. Benzing | 2425 S. 12th St., Philadelphia, Pa. | 3FS |
| J. H. Kennedy | 5010 15th St., Philadelphia, Pa. | 3FT |
| J. G. Grey | 1018 Tioga St., Philadelphia, Pa. | 3FU |
| G. A. Chech | 3418 N. 10th St., Philadelphia, Pa. | 3FV |
| C. F. Laager | 1029 Belmont Ave., W. Philadelphia, Pa. | 3FW |
| B. Lovett | 1627 Broadway, Baltimore, Md. | 3FX |
| D. C. Shotton | 1641 Sanderson Ave., Scranton, Pa. | 3FY |
| L. P. Dilg | 2841 Taylor St., Philadelphia, Pa. | 3FZ |
| R. C. Lowe | 385 W. State St., Media, Del. Co., Pa. | 3GA |
| O. B. French | 1717 S. 55th St., Philadelphia, Pa. | 3GB |
| J. R. Sexton | 81 W. Main St., Waynesboro, Pa. | 3GC |
| D. E. Goldsborough | 1904 Homewood Ave., Baltimore, Md. | 3GD |
| L. M. Markham | 5522 Paschall Ave., Philadelphia, Pa. | 3GE |
| F. Nickel, Jr. | 5716 Catharine St., Philadelphia, Pa. | 3GF |
| J. R. Dorsey | 1611 N. Eden St., Baltimore, Md. | 3GG |
| J. D. Tebo | 1812 W. Lexington St., Baltimore, Md. | 3GH |
| R. R. Boynton | 812 Water St., Meadville, Pa. | 3GI |

FIFTH DISTRICT

| | | |
|-------------------|------------------------------------|-----|
| H. P. Heafer | 2603 Hibernia St., Dallas, Tex. | 5AJ |
| D. G. Rupe, Jr. | 307 S. Akard St., Dallas, Tex. | 5AK |
| Cecil F. Butcher | Greenville, Tex. | 5AL |
| L. M. Blakey | Cedar Hill, Tex. | 5AR |
| John Oldaker | Albuquerque, N. Mex. | 5AT |
| D. R. Simmons | Shreveport, La. | 5AU |
| I. L. Bell | 2715 St. Charles Ave., New Orleans | 5AV |
| Wm. Leftwich, Jr. | 4214 Dumaine St., New Orleans | 5AW |
| F. A. Fort | Shreveport, La. | 5AZ |

SIXTH DISTRICT

| | | |
|-----------------|-------------------------------------|-----|
| C. F. Filkthead | 1240 Arapahoe St., Los Angeles | 6CU |
| E. Frazier | 1334 39th St., Sacramento, Cal. | 6CV |
| H. C. Hand | Carmel, Cal. | 6CW |
| G. A. Hatherell | 883 Idlewild St., Inglewood, Calif. | 6CX |
| C. E. Lundy | 692 N. 17th St., San Jose, Cal. | 6CY |

G. Hewitt
R. W. Hillen
W. Holladay
C. G. Isham
Philip Keast
S. P. Ingram
A. A. Kluge
R. E. Lake
W. E. Lauritzen
D. W. Appleton, Jr.

796 Delmas Ave., San Jose, Cal.
162 W. Alvarado St., Pomona, Cal.
301 So. Fir St., Inglewood, Cal.
1823 96th Ave., Oakland, Cal.
379 Mill St., Grass Valley, Cal.
95 So. 5th St., San Jose, Cal.
638 S. Figueroa St., Los Angeles, Cal.
401 Gates St., San Francisco, Cal.
R.F.D. A. No. 536, Fresno, Cal.
323 Larkin St., Monterey, Cal.

6CZ
6DA
6DB
6DC
6DD
6DE
6DF
6DG
6DH
6DI

SEVENTH DISTRICT

B. C. Ganer
B. W. E. Hagen
J. A. Solomon
M. C. Cookingham
N. R. Benoit
R. R. Atchison
H. H. Bitters
Ed. Rebman
K. W. Weingarten
Cleve Scott

3750 No. 30th St., Tacoma, Wash.
101 So. 11th St., Yakima, Wash.
7200 28th St., N. W., Seattle, Wash.
516 N. Cushman, Tacoma, Wash.
5046 So. L. St., Tacoma, Wash.
656 E. 44th St. N., Portland, Ore.
3015 So. 11th St., Tacoma, Wash.
3110 Sunderland St., Seattle, Wash.
3219 No. 24th St., Tacoma, Wash.
345 So. 14th St., Salem, Ore.

7AW
7AX
7AZ
7BB
7BC
7BD
7BE
7BF
7BG
7BH

EIGHTH DISTRICT

Norman P. Mason
Walter C. McKelvey
Wm. L. Galloway
Latimer L. Charmicky
Roy C. Ehrhardt
Chas. H. Katzenberger
Ellsworth A. Pierson
Paul A. Riley
C. Text Hewitt
F. J. Scupholm
Elmer E. Fancher
Harlan U. Bigalow
Wm. D. Alter
Gilbert L. Countryman
Branko Lazich
Orlo Palmer
Ralph R. Chartener
Harold M. Durham
F. M. Tarbox
Robt. I. Hazeltine
Maurice H. Panceost
Paul Schmidt, Jr.
Wm. Kunkelman
Frederick C. Marx
David G. Hopkins

85 Brinkerhoff St., Plattsburg, N. Y. (Correction)
802 Trumbull Ave., Detroit, Mich.
110 W. Main St., Kenia, Ohio (Correction)
9604 Sophia Ave., Cleveland, Ohio
117 S. Blakely St., Dunmore, Pa.
124 W. Main St., Greenville, Ohio
728 7th St., Niagara Falls, N. Y.
317 Main St., Greenville, Pa.
7942 Westmoreland St., Swissvale, Pa.
918 10 Ave., Port Huron, Mich.
507 Monroe St., Jamestown, N. Y.
1955 E. 107th St. No. 2, Cleveland, Ohio
627 E. 8th Ave., Tarentum, Pa.
42 2nd St., Geneseo, N. Y.
16 Eureka St., Pittsburg, Pa.
206 E. 13th St., Holland, Mich.
120 E. Grove St., Dunmore, Pa.
127 Cohasset St., Pittsburg, Pa.
47 Allen St., Pittsburg, Pa.
North Main Ext., Jamestown, N. Y.
318 Penn Ave. S., Lansing, Mich.
106 Excelsior St., Pittsburg, Pa.
211 Beech Ave., Cambridge Springs, Pa.
541 Evanswood Pl., Clifton-Cincinnati, Ohio
115 Clinton St., Greenville, Pa.

8BB
8CA
8CC
8CD
8CE
8CF
8CG
8CH
8CI
8CJ
8CK
8CL
8CM
8CN
8CO
8CP
8CQ
8CR
8CS
8CT
8CU
8CV
8CX
8CY
8CZ

NINTH DISTRICT

Russell Harvey Pray
George H. Machin
William D. Devore
Verne A. Wheeler
Irving T. Patridge
Walter Albert Franz
Charles Allen Kelso
Howard Lewelling Owens
Guy L. Beech
Clifton M. Utley
Eugene Joseph Krusel
John Winston Coleman, Jr.
Paul F. Ring
Jacob Jordan
Chas. Jaeger
Willard L. Thomson
Eugene C. Krug
Harry William Wahn
Erwin R. Anderson
Julius Abercrombie
Geo. M. Teter
William A. Groth
Lloyd A. Walker
Wilson Morgan Riley
Harlan Robert Hall

813 Fifth Ave., Valley City, No. Dakota
1218 N. Kennedy, Kokomo, Indiana
Melvin St., Gibson City, Ill.
East 2nd St., No. 502, Anamosa, Iowa
Milbank, South Dakota
311 Shea Ave., Milwaukee, Wis.
4769 Labadie Ave., St. Louis, Mo.
822 East Main, Council Grove, Kansas
214 W. Washington, Clarinda, Iowa
5629 Dorchester Ave., Chicago, Ill.
1710 Lackawanna Ave., Superior, Wis.
R.F.D. No. 7, Lexington, Ky.
1408 East Grand, St. Louis, Mo.
Ninth and Cincinnati, Lafayette, Indiana
1986 Cornelia Ave., Chicago, Ill.
1163 North Broad St., Galesburg, Ill.
2249 St. Louis St., St. Louis, Mo.
4946 N. Hoynes Ave., Chicago, Ill.
308 No. 27th Ave., Omaha, Neb.
3106 Felix St., St. Joseph, Mo.
R.R. 4, Sheridan, Ind.
1534 Locust St. W., Davenport, Iowa
1716 South 20th St., St. Joseph, Mo.
1014 Mississippi, Lawrence, Kansas
23 Merriam Place, St. Paul, Minn.

9EE
9EF
9EG
9EH
9EI
9EJ
9EK
9EL
9EM
9EN
9EO
9EP
9EQ
9ER
9ES
9ET
9EU
9EV
9EW
9EX
9EY
9EZ
9FA
9FB
9FC

CANADIAN

P. E. Lesage
H. Harries
H. Robitaille
Geo. H. Barnes
Ecole des Freres
G. Indie
H. W. Hughes
Father Hamel
A. Reed
A. J. Lorimer
T. H. Letts

Longueil, Que.
705 Grosvenor Ave., Montreal
Decourcelles St., St. Henry, Montreal
Stanbridge East, Que.
Nicolet, Que.
155 Desvillers St., Montreal
382 Gordon Ave., Verdun, Que.
Jesuit College, Bleury St., Montreal
177 Marcell Ave., Notre Dame de Gras, Montreal
243 Mackay St., Montreal
97 Quinn Ave., Longueil, Que.

2AF
2AN
2AW
2AX
2AY
2AZ
2BB
2BC
2BE
2BF
2BG

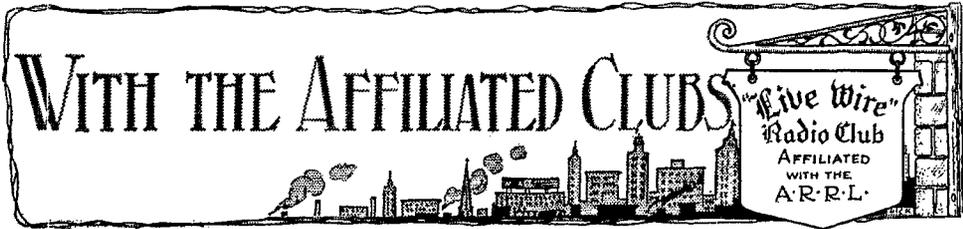

FIRST ANNUAL THIRD DISTRICT AMATEUR CONVENTION

A Convention of the amateurs of the Third Radio District was held in Philadelphia May 8th under the auspices of the Philadelphia Amateur Radio Association, an organization affiliated with the A.R.R.L.

Word had come from the A.R.R.L. that it was desired there should be a Convention of the amateurs of the Third District, in Philadelphia. The Philadelphia Amateur Radio Association had been having a strenuous winter in very active scientific programs in matters radio; but it did not flinch, and though the season was late and the officials were beginning to plan for a summer vacation, they took the matter up and appointed a Committee with Mr. William F. Wunder as Chairman, the President, Dr. G. M. Christine, cooperating. It was hard work, but when the nearly two hundred radio men filed into the banquet hall at Mosebach's Casino, with tags on their coats telling who they were, it was an inspiring sight, and awakened great enthusiasm among the speakers and those in attendance. During the banquet radio-grams were read, and some men there are who cannot now be certain whether they were real or written for the occasion. Whatever they were, they "took".

After the banquet Dr. Christine called the Convention to order and Mr. Wunder made a report of the local committee on arrangements, after which the following Resolution was adopted.

RESOLUTION

We, Radio Amateurs of the Third Amateur Radio District, here assembled, do herewith form and organize THE AMATEUR RADIO CONVENTION of the Third Amateur Radio District, for the purpose of furthering the study and practice of wireless communication and for the mutual interests and protection of its members.

It is also the purpose of the Convention to be in affiliation with the American Radio Relay League, to promote the formation of amateur radio Associations throughout the Third District, and to be in mutually beneficial relationship with similar Am-

ateur Radio Conventions in other Districts.

It is also the purpose of this Convention to be in accord with the laws and regulations of the United States Government relative to the radio amateur, and to assist in the observance of those laws and regulations by the radio amateur, as well as to insist on the preservation of such privileges as the Radio Amateur, in the practice and study of radio communication, should reasonably enjoy.

It is the purpose of the Convention to meet as a Convention yearly at a time and place to be chosen at the Annual Session preceding, the members of the Convention being, if possible, representative of the several radio associations, or regional groups of radio amateurs, in the District.

The business of the Convention, ad interim, shall be vested in a Board of Governors to be appointed by the President at the time of his election at the Annual Session. This Board shall report yearly.

The Officers of the Convention shall be a President, Vice-president, and Secretary-treasurer.

This Resolution tells the story of the purpose of the Convention. The officers for the ensuing year elected by the Convention are:

President—Gordon M. Christine, M.D. (President, P.A.R.A.)

Vice-President—Malcolm Ferris (Dist. Supt., A.R.R.L.)

Sec'y-Treas.—H. Paul Holz (Secy., P.A.R.A.)

The next Convention will be held at Philadelphia in January, 1921.

The routine business over, the whole attendance settled itself to hear the speeches of the evening and the Convention was fortunate in having as its speakers the most representative men of the District in addition to the League delegation composed of Mr. Maxim and Mr. Smith; we were sorry Mr. Warner could not attend also but he said he had just taken unto himself a wife and prayed he might be excused, as he "figgered" it was policy to stay around the home fire-side for a spell, till his better half sorta got used to the ways of a radio man.

The speeches were to the point, practical, inspiring. Mr. Maxim presented the viewpoint of the A.R.R.L. toward the amateur. Mr. Smith explained the importance of relay work. Mr. R. V. Cadmus, U. S. Radio Inspector, explained the law of 1912 and the regulations of the Department of Commerce relating to the amateur. Mr. W. E. Downey, assistant inspector, explained the matter of wave length and decrement prescribed by the laws. Mr. C. H. Stewart, Asst. A.R.R.L. Division Manager, referred to the legislative situation. Lieut. Comdr. Cobb, U.S.N., District Communication Supt. of the Fourth Naval District, represented the Navy Department and delivered an excellent speech in which he complimented the amateurs of the United States on the way they had volunteered their services during the recent war, and on the way in which they were conducting themselves at the present time. He reported that there was a minimum of interference with the Navy station by Phila. amateurs, although NAI is within several miles of a number of them, and that he was willing to cooperate with them in any way possible to reduce any unintentional QRM that they might cause.

With the termination of the speakers program, various prominent long distance station owners were called upon to rise and let the Convention admire their particular style of beauty, and finally radio clubs and organizations were called up for the same purpose. The "furtherest" visitor proved to be a gentleman from San Jose, California, who, while not a delegate from his section, nevertheless showed his interest by attending a meeting of amateurs on the Atlantic Coast. The long distance delegate for the Third District proved to be Mr. White, 3EN, from Norfolk, who had been sent from the Hampton Roads Radio Assn. as their representative. Other clubs from nearer cities and towns turned out to make the Convention a success and their presence proved of mutual benefit.

Time did not allow extensive preparations to be made, and the approach of warm weather and the consequent falling off of interest in relay work were decidedly unfavorable to a large attendance but nevertheless the success of the whole affair was assured from the start of the banquet and the wealth of good fellowship and pleasure experienced by all make next year's affair an occasion which will be looked forward to with anticipation both by the men who were present and those who will be added next January.

Adjournment was at a late hour. Result—a whirlwind success. Philadelphia did itself proud, and now let other Districts emulate the Quaker City and go it one better.

RADIO ASSN. OF WESTERN NEW YORK Buffalo, N. Y.

The Radio Association of Western New York, with headquarters in Buffalo, held its semi-monthly meeting recently at its new rooms, at 389 High Street, Buffalo. This Radio Club has a large number of members who live in surrounding towns and who attend meetings regularly. The new impetus given radio work since the war has enabled the club to expand, both financially and in membership. The constitution and by-laws of this club have worked out in a clear and efficient manner and the club will be glad to mail a copy upon written request to any amateurs desiring the same for organization purposes. Any other radio club granting the same privilege to this club will be gratefully thanked.

The constitution calls for the suspension of meetings during the summer months, but the members have decided to continue meetings for the purpose of a summer campaign for members. It is planned to have every radio enthusiast enrolled in the club before the fall relay work starts, so that Buffalo will again be on the radio relay map.

Plans were laid to hold a luncheon and to invite and interest the prospective members in the organization. Anyone wishing to do any long distance work is bound to give full co-operation in order to reduce to a minimum the troublesome interference of the past. This club is desirous of subscribing to a club directory giving the name of club, location of same and the name and address of the secretary.

Address communications to John G. Rieger, President, 15 Fairview Place, or Elmer H. Kumpf, Secretary, 41 Amsterdam Ave., Buffalo, N. Y.

NOLA RADIO CLUB New Orleans

The Nola Radio Club was organized in the latter part of December 1919. Its main object is the bringing together of amateurs of this city who are interested in the advancement of radio and who desire to become more familiar with the radio art.

The officers of the club are as follows:
Prof. A. J. Tete, (Tulane University) President.

Arthur H. Kopper, (U. S. Radio Inspector) Vice-President.

Hubert E. de Ben, (City Manager A.R.R.L.) Secretary-Treasurer.

The club has recently become affiliated with the American Radio Relay League, the greatest national amateur organization.

The club is very fortunate in having as members the "biggest" radio men in New Orleans, some are prominent country-wide

(Continued on page 45)



6ZA, SALT LAKE CITY, UTAH

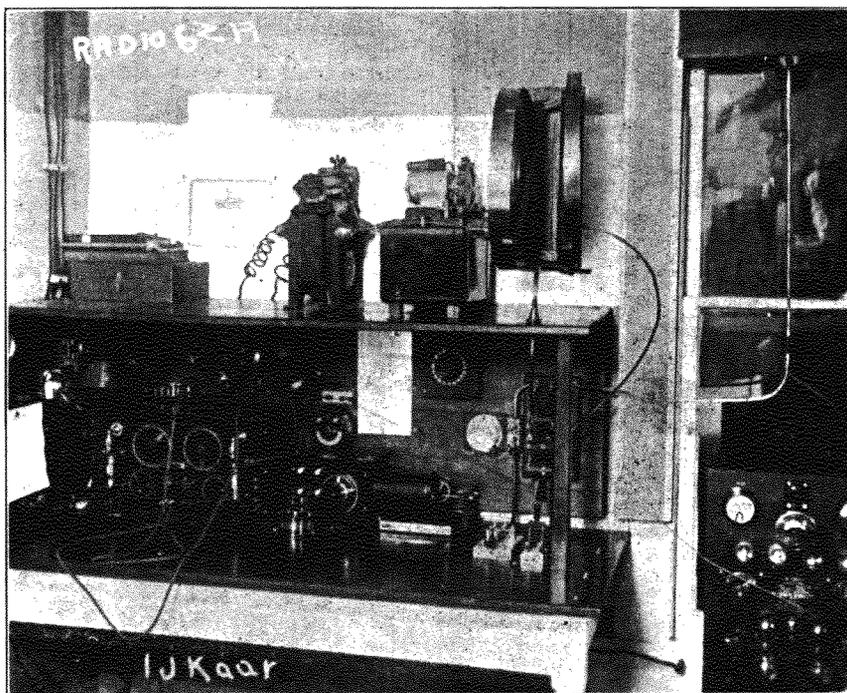

6ZA is the station of the Assistant Manager of the Rocky Mountain Division, Mr. Ira J. Kaar, at Salt Lake City, Utah, and this photograph shows it to be excellently outfitted.

The transmitter is a 1 K.W. "Thor", knife-edge rotary gap, copper-foil plate glass condenser in oil, and a healthy oscillation transformer with two-inch ribbon on the primary. The longest lead in the oscillating circuit is $2\frac{1}{4}$ inches. All of which constitutes splendid arrangement

and makes for increased efficiency. We don't see how it could be improved.

Receiver consists of the conventional tuning apparatus with single-step amplifier. A short wave regenerative set has been added since this picture was taken.

On the right will be noticed a DeForest panel telephone set.

6ZA can work nearly all the west coast amateurs, also 5ZA and 9JE to the east, and is doing excellent relay work. Communicating record to date, 850 miles; receiving record 8000 miles. Pretty good.

9ZV, ST. LOUIS

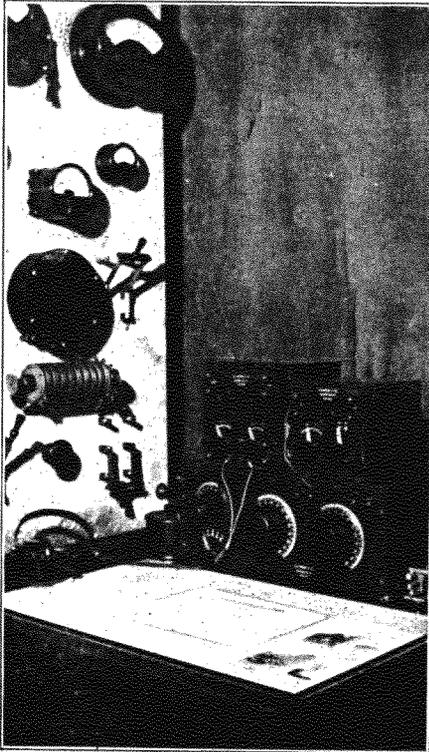

This is 9ZV, ex-9BR, and pre war 9HN, operated by Mr. J. A. Crowds, St. Louis. No, the owner is not a millionaire for the complete panel as shown set him back just \$23.00. At the outbreak of the war said panel (an old battery charging outfit) was picked up for the above mentioned sum, complete including the four upper meters and the switches. The lower center meter (which is a hot wire ammeter) and the quenched gap are war booty and formerly belonged to the Kaiser's navy. The center round black object is a housing within which is a Benwood rotary disc, driven by a motor from the rear. The knob at bottom controls a wave changer.

A Thordarson 1 K.W. transformer, 14 Murdock condenser sections in series parallel, oscillation transformer, short wave series condenser, and loading inductance for 375 meter wave complete the transmitter, all apparatus being in the rear of panel.

Receiver as shown includes a two stage amplifier and Baldwin phones. A Telefunken wavemeter, also a war prize, is not shown. This station has been heard from 1AW and 1TS to 7AY at Bear Creek, Montana, and has worked from 3DH east

to 5ZA west, and from the Canadian border north to the Gulf of Mexico south.

The aerial of this station is a 6 wire T, 55 feet high and 85 long. Ground system consists entirely of buried wires directly under the antenna.

A COMPACT STATION

Mr. Orlo Palmer, 8CP, Holland, Mich., here shows us how to get three receiving sets and one transmitter in less floor room than one commonly takes.

This kind of installation has a big advantage over panel mounting in that changes and additions can be quickly made. The apparatus is home-made, Mr. Palmer being a skilled mechanic, in which he is fortunate.

The largest tuner is for undamped and the small coupler on the table is used for waves from 200 to 700 meters. An Audio-tron detector is used, and three variables are visible. The aerial for receiving is 78 ft. high and 150 ft. long, four stranded wires.

No great amount of care has been expended on the transmitter, local conditions prohibiting any real distance work. On the top shelf are seen a ½ K.W. Thordarson, 3 Murdock sections, the oscillation transformer, and a box in which the rotary is housed to reduce noise.

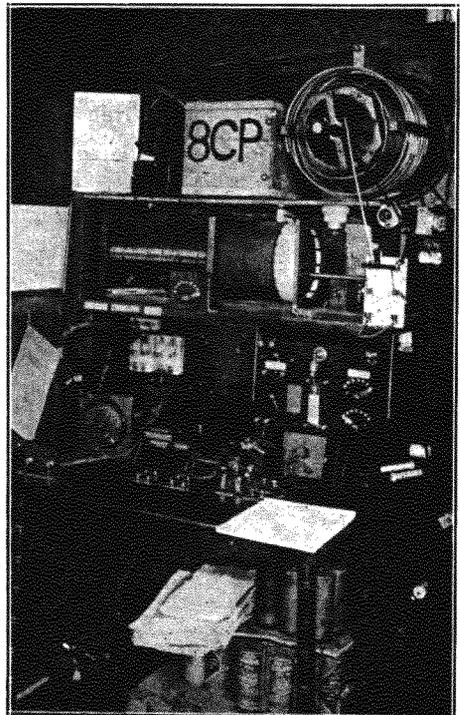



Conducted by Guy R. Entwistle

IN the minds of many beginners there lies a desire for an explanation of just why they cannot receive continuous waves, such as are sent out from the so-called "arc" stations, on a crystal detector. Others have the idea that any kind of a bulb will bring these stations in. To be sure, most of them will, provided one condition is fulfilled: that the bulb be made to oscillate. A bulb that will not oscillate, as we will learn later, is of no more use for this work than the crystal.

In order properly to understand why a crystal will not detect such waves we first must examine the two different wireless systems that exist to-day. The most common is the "spark" system in which groups of damped wave trains are sent out at regular intervals. This is represented at "A" in Figure 9. The other system, which sends out energy in continuous waves, is commonly referred to as the "arc" system. It is not so-called because an arc must always be used to produce them, but since the arc was first used commercially for this purpose and similar waves produced by different methods have often since been called "arc" in comparison to those sent out from a "spark" station. A much better classification is "undamped" and "damped," respectively. The undamped waves are shown in "B" in Figure 9. Note that "A" is broken up into groups, whereas "B" is continuous.

Above each set of waves is shown the action on the diaphragm of a telephone receiver at various times. In "A," each wave train or group of oscillations is seen to pull down the diaphragm, while in between the wave trains the diaphragm returns to its normal position, sending in front of it a puff of air which strikes the ear drum and produces a sound. Thus if we have 1,000 wave trains per second, as we do in the case of a five hundred cycle transmitter, we will get 1,000 puffs and a sound that has a note corresponding to a pitch of 1,000 vibrations per second.

Now let us examine the conditions in the undamped or continuous wave. In "B" it is seen that at the start the diaphragm is pulled down, and since the waves are continuous they exert a continuous pull on the diaphragm. Hence no puffs of air are sent

off at regular intervals as was the case where groups are present. When the C. W. stops, the diaphragm flies back and we hear a click. Suppose we are making the letter E, which is one dot. It might take us one second to make a dot. In this time with the spark system using a 500-cycle set, 1,000 groups or wave trains would have sent off and would have been faithfully reproduced in the receivers. If we were using the undamped and continuous wave, only ONE click would be heard. The writer is assuming for simplicity that energy passes thru the phone windings even at this high frequency. In reality no energy flows

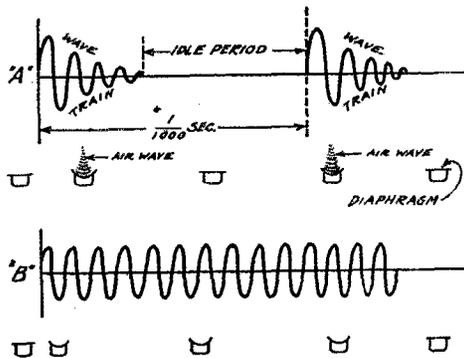

FIG. 9

thru them at this high frequency. In each case a detector would perform its function of rectification and in the case of the spark signals would split up each cycle and pass only one of its alternations and always in the same direction. In the case of the "arc" waves it would also pass only half of the alternations. These surviving alternations are, relatively speaking, still of too high a frequency to pass thru the phones. However, in the case of the spark transmitter this rectified current is piled up on the phone condenser in the form of a charge and finally discharges thru the phones in the intervals between trains; whereas in the case of the continuous waves there are no intervals between and consequently we do not hear even the rectified current. Many make the mistake of thinking that altho the incoming waves are of

too great a frequency to be used directly, after the detector has functioned and cut their number in half they can be heard. Take the case of a 200 meter wave. The frequency of the waves is 1,500,000, and after being rectified the frequency is 750,000, which is still away above the limit of audibility of the human ear. **THEREFORE, IT IS PLAIN THAT IT IS NOT THE EFFECT OF THE INDIVIDUAL OSCILLATIONS IN ANY GROUP, BUT RATHER THE EFFECT OF THE GROUP ITSELF, THAT COUNTS.**

Since our continuous waves do not permit the use of the ordinary methods of detection, we must resort to other means. The best way to accomplish results on C. W. is with an audion. The principle involved is as follows: The incoming waves of a very high frequency, which are inaudible, are im-

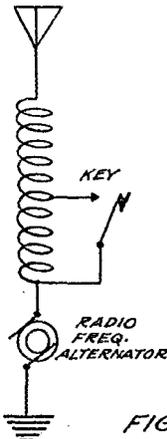

FIG. 10.

pressed on a circuit in which there has been set up by the action of the audion a frequency slightly different. As a result of these two very high frequencies trying to use the same path, there is produced a THIRD frequency which in amount is the difference between the other two. For instance, take a wave length of 10,000 meters, having a frequency of 30,000 cycles, coming in from a distant station. If we adjust our audion to oscillate at a frequency of 31,000, then the third frequency will be 1,000 cycles, which is in the audio range and can be heard. Many of us who have listened to undamped waves and have varied the capacity of the condensers and noticed a variation in the note will now understand that we were varying the frequency at which our audion was oscillating, which caused the tone of the note to change.

Unlike the damped wave generators, the undamped wave installations when once started are kept in operation until the termination of business. The dot and dash characters that go to make up the letters of words are formed in a unique manner.

Looking at Figure 10, we notice the generator is placed directly in series with the ground and that a number of turns of the tuning inductance are short-circuited by a key, at will. Assume the apparatus to be in an operating condition and that the key around the tuning inductance is open. Suppose energy is going out on 18,000 meters. Next let us press the key and send "NSS." Just as soon as we press the key and short the bottom turns we have changed the wave length—we have lowered it, say, to 17,000 meters. See Figure 11. It will be seen that the call NSS goes out on 17,000 meters, while in between letters and in fact in between characters that go to make up each letter the energy is being sent out on 18,000 meters. It is evident that if we wish to read these signals we must tune to 17,000 meters—"the spacing wave," as it is

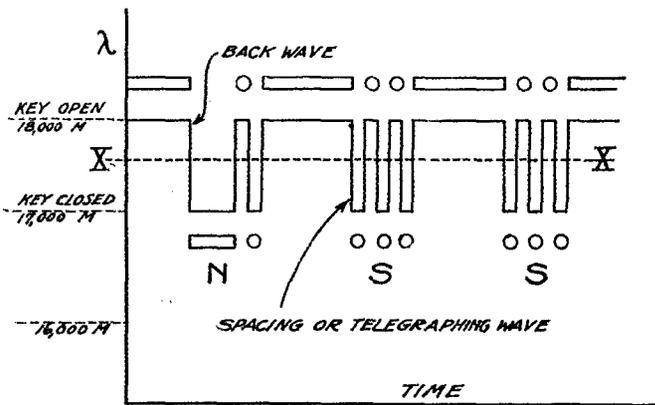

FIG 11

called—while if we tune too high we will get on the "back wave." We will be able to read the dots and dashes of the back wave, as the figure will show, but they will have no intelligible meaning. The line X-X is an arbitrary line below which we must tune in order to read the signals. This will probably clear up to many the origin of the strange signals that have been heard on the C. W. but which we have been unable to read. Their origin in the past has been ascribed to Japanese, Chinese, Hindu and many other foreign shores.

As a matter of comparison of the relative merits of the two systems the following idea may be of interest. Suppose we slow down the phenomena involved in the two systems to a value the mind can easily grasp. Assume it takes one second for a single wave train of the 500-cycle set to be completed. The interval of time that would elapse before the NEXT wave train occurred would be EIGHT MINUTES. Think of it! A set that works one second every eight minutes. Remember we have slowed

(Concluded on page 45)



STRAYS

The many acquaintances of Wm. A. Van Schoyck, of 9CW, Gibson City, Ill., will be grieved to learn of his death from pneumonia on Sunday, March 14th. 9CW was one of the Central Division's most prominent relayers, and we miss his spark.

When a cow is lost it "moos" and when a ship is lost it "MOes" too. Wonder who the joker is that suggested "MO" for the QTE signal?

One night this past winter about 2 a.m. NAJ called NAT and QRK?-ed him. NAT came back and wanted QRA? There was a pause at NAJ while the op was coming to, and then he gave NAT his QRA. How you like to have been that op at NAJ?

The Klaus Radio Co. of Eureka, Ill., has established a branch in Peoria, Ill., which will be in charge of N. D. Garver, of Radio 9KM. A full line of apparatus will be carried at both places.

Does your spark set interfere with the telephone service in your house? In cases where the trouble is by direct induction it has been found that by using a twisted drop on the telephone line, this drop consisting of three twisted wires of which two are used in the telephone circuit and third grounded "to drain the static", almost all of the difficulty can be overcome.

Know these 110-volt d.c. slow-speed ceiling fan motors? An old one can generally be picked up in any town for very little, and with a little work can be made into a generator which when driven by a 1750 or 3600 r.p.m. induction motor will furnish a very satisfactory supply of plate current for V.T. transmission.

New books received: "Elements of Radiotelegraphy", by Ellery W. Stone, Lieut., U.S.N.R.F., M.I.R.E., 267 pp., published by D. VanNostrand Co. An elementary text written primarily for the guidance of radio students in the Communication Service of the Navy during the war, and mainly a resume of a series of lectures employed at the Naval Radio Station school, San Diego. Theory explained from the physical rather than the mathematical standpoint in order that it may be readily grasped by the layman,

and accomplished in this book, we should say, without loss of technical accuracy. A good book for the Junior Operator. QST Book Department has it—\$2.50 post-paid.

5AO, Houston, Tex., sends time signals at 7 p.m. daily and Sunday, followed by a QST weather report; 200 meters, 1 k.w.

The Shipping Board vessels are to be fitted with 2 k.w. Federal-Poulsen arc sets, and 25 such sets are to be distributed among the various radio schools to facilitate the instruction of operators in arc work.

8MT, Uniontown, Pa., has arranged to broadcast information on entries, schedules, etc., for the races to be held at the Uniontown Speedway on June 19th, every evening starting June 5th.

"Squirrel Food" suggests an umbrella type antenna would be the kind to use in a rain storm.

Eddy Current and Molly-Cule were married today by Oscarlation, Justice of the Peace. The proceedings were carried on in a quenched tone until Ann-Tenna, who is a near relative of Molly-Cule, disturbed the scene by falling down. Miss-Ouri and Minne-Sota, bridesmaids, became frightened, but Lee-Din, best man, straightened matters out and Molly-Cule passed into the hands of the Receiver. The affair was considered a splendid Coupling by all present.—Radio Booze.

WOULDN'T IT BE WONDERFUL—

If 1AW could hear everybody who called him? (No; it would be awful.—H.P.M.)

If 2SO got a Maxim Silencer? (Suggested by 2EK, two blocks away.)

If The Old Man and Turnsback both slipped on a banana peel and each thought the other pushed him?

If 1VAMP was a real blonde?

If two sygyzy dogadjits and a wheel-puller in series would cut out QRN?

If it wasn't so hard for some folks to make a figure 1 on a bug?

If the New York-Boston boat had his radio sealed while he went thru VN's back yard every night?

If Ben Franklin and Morse could see the mess they started?

If the operator at NAF could make NAF twice in succession?

If the da-dit-dit-dit dit-dit-dit would die at exactly ten p.m. so we could relay a few?

If The Old Man got so mad he let out his identity?

If all the fellows who can hear POZ 200 feet from the phones would get into the relay game?

If QST increased to 5260 pages?

If 7AA really reached Pittsburgh on 1/2 k.w.?

If we could renew our burnt-out tubes at the electric light company free of charge?

If 3FG could send a 3?

If some guys in the vicinity of New York would take some morning to tune up their sets instead of wearing out their ammeters at night?

If 9LC was the only LD station in St. Louis?

If the 4th District would show a little more pep?

If Mr. Seyd of the R.T.A. could be induced to tune NAM too?

If we could have our apparatus and material delivered by radio?

If we could bust in and receive for some of the hams on shipboard?

If you could plant a time bomb under that squeak-box, set for 8 p.m.?

If you could burn up all the juice you wanted free of charge and the lighting company charged it up "to the advancement of science" and let it go at that?

If a great loud wireless 'phone shouted in your ear at 12 bells: "This is Mars—why the heck don't you boobs answer us?"

If Marconi would give deForest a medal for the invention of the Audion?

If Fleming had only put three elements in his wind-jammer?

If POZ called 1HAA and said "QSA OM"?

If Bill Woods would write a story about how the Belmar garrison captured his ham station there at Belmar during the war?

If Mars said: "Venus is going to pay you a visit. Hook 'er to your bulb"?

If Warner printed everything he received? (SOS de KBW!)

ABBREVIATIONS

There are a number of abbreviations in regular use among the fraternity, but they do not seem as well known as they should be. Often we hear a QTA asked for when the transmission has been clear and slow, the trouble obviously being that the text was not straight English and the receiving operator was not familiar with abbreviations. A great deal of time and energy can be saved by their employment, and below we present a few. Learn to use them.

CUL—see you later
 73—best regards
 AS—wait a minute
 OM—old man
 gn—good night
 ge—good evening
 gm—good morning
 gg—going
 bn—been
 hbn—have been
 hv—have
 tt—that
 wt—what
 es—and (Morse "&")
 nil—nothing
 hr—here or hear
 hi—I laugh
 wl—will
 wi—with
 wd—would
 shd—should
 tmw—tomorrow
 lv—leave
 nm—no more
 nw—now
 fr—for
 msg—message
 nr—number
 fm—from
 fld—filed
 sig—signature

sigs—signals
 vy—very
 sa—say
 tngs—things
 ts—this
 tnx or tnks—thanks
 u—you
 ur—your
 urs—yours
 gv—give
 em—them
 hw—how
 tre—there
 evy—every
 wr—where
 fb—fine business
 —or good
 abt—about
 spk—spark
 art—all right
 lsn—listen
 agn—again
 dx—distance
 wx—weather
 pse—please
 ges—guess
 nd—nothing doing
 fwd—forward
 enuf—enough
 tho—though
 thot—thought

thru—through

A HANDY KINK

ORDINARY PHONE-CORD TIP BEND

WILL PERMIT TIPS TO BE HELD SECURELY BY ORDINARY BINDING POSTS, AND LEAVE ENOUGH STRAIGHT PORTION FOR USE IN SCREW-HOLE BINDING POSTS

L. E. BRAYMER
CHICAGO

POLITICAL NEWS TO BE BROADCASTED

Commencing June 4th and lasting for about ten days, the stations of the Inter-City Radio Co. at Chicago, Detroit, and New York, will broadcast International

News Service free press reports of the Republican National Convention at Chicago. The broadcasts will commence at 6 p.m. and continue intermittently all evening.

Data on the stations are as follows: New York, WHB, 5 k.w. 500-cycle quenched, 2100 meters. Detroit, WDR, 10 k.w. 500-cycle quenched, 2250 meters. Chicago, call not yet assigned at time of going to press, 5 k.w. 500-cycle quenched, 1900 meters.

Amateurs can give citizen radio a boost and add to their local fame by supplying this service to local newspapers—they will be glad to get it.

THE AFFILIATED CLUBS
(Concluded from page 38.)

experts. Experiments are now being carried on radiophone, CW sets, and underground aerials, the results of these experiments are to be discussed at the meetings. Plans are now being made to control local QRM and it is expected that this will be well under control in a short time.

Meetings are held on Friday of each week at 8 p.m. Amateurs residing in the immediate vicinity are cordially invited to join.

THE OPERATING DEPARTMENT
(Concluded from page 33.)

There are now four or five C.W. stations in the Toronto district doing more or less testing out, and it is hoped that the Research Branch of the School of Practical Science at the University of Toronto will get their C.W. apparatus going and do some steady work.

ST. LAWRENCE DIVISION

A. J. Lorimer, Manager
243 Mackay St., Montreal, Que., Canada.

The route from this division to the United States was opened much sooner than had been anticipated and is now open for traffic.

The attempt to work direct with 2SZ at Troy, N. Y., failed. Normally the Albany stations are QSA here.

We have been advised by Mr. N. P. Mason of Plattsburg, N. Y., that his station 8BB could bring our route thru New York State to Albany, N. Y. A quick test was arranged from 2BF (Can.) and communication established with 8BB with little trouble.

8BB can route traffic east to 1VB at Hanover, N. H. and south to 2SZ and 2BM. As soon as an operating schedule can be arranged we will be able to handle traffic for points in Quebec.

District Superintendent Jarest reports considerable activity in the vicinity of Levis, with new stations coming along fast. He will attempt to work a route thru to Northern Maine which will connect with the Atlantic route north of Boston.

District Superintendent Buzzell is making a survey of prospectives in his district for short local relays thru the Eastern Townships.

THE JUNIOR OPERATOR
(Concluded from page 42)

things down, but everything is still in proper proportion. This is shown by the "idle period" in Figure 9. On the other hand our C. W. set is constantly sending out energy, and this is why it sets up a more persistent effort in our receivers and produces such sharp tuning.

After we have produced a train of continuous waves we can break it up in dot and dash characters, or we can impress a voice wave upon it to "modulate" it. This is what happens when we use a radio phone.

The amateur is encouraged to obtain any source of C. W. It looks as tho it is our only salvation in the future. Certainly it will help solve the QRM problem.

F. F. HAMILTON

(Concluded from page 34.)

first real receiving set. He had been studying Armstrong's circuits and believed "all those coils" were not necessary, and consequently did much experimenting, incidentally developing several new circuits, on one of which his thesis was written on which the degree of E.E. was awarded him by Purdue. Later he was called to Purdue as instructor in the Signal Corps radio school there during the war. On the signing of the Armistice he hurried to Washington and actively entered the amateur fight against HR-13159, being in fact the originator of the so-called Watson Amendments to that bill.

This season Mr. Hamilton has had an eminently successful station, 9ZJ—one of the stars of the A.R.R.L. system. He is District Superintendent for Southern Indiana and was recently elected a member of the League's Board of Direction. A hard worker, a splendid organizer, and a good radio man, long may he "wave".

W. T. GRAVELY

(Concluded from page 34.)

ization experience for a D.M., too!)

Mr. Gravely's motto is "Daylight Communication over the entire System" and 3BZ, one of the most consistent 3's, has done splendid work in this direction itself.

Radio Communications by the Amateurs

THE PUBLISHERS OF QST ASSUME NO RESPONSIBILITY FOR THE STATEMENTS MADE HEREIN BY CORRESPONDENTS

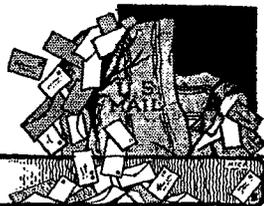

COMMENT ON MR. WEST'S ARTICLE ON IMPROVING TRANSMISSION

Cutting & Washington Radio Corpn,
6 and 8 West 48th Street,
New York, N. Y.,
13th of April, 1920.

Mr. Kenneth B. Warner,
Editor QST,
Hartford, Connecticut.

Dear Sir:—

I cannot refrain from pointing out a large number of theoretical errors in Mr. West's interesting paper "Notes on Improving Transmission" in April QST.

Taking these up in the order in which they occur:—

Mr. West remarks, "The two most important factors seem to be the height of the antenna and the voltage impressed on it. There are two ways of increasing the voltage.—First, to increase the voltage of the transmitter, and, secondly, to add inductance in the open circuits."

I gather from Mr. West's remarks that by voltage he means maximum voltage (not root mean squared), as he appears to use the brushing of the antenna as a test. Even if maximum voltage was what he desired, brushing is hardly an accurate test as it depends so tremendously on the shape of the conductor from which the brushing occurs, on barometric pressure, relative to humidity, etc. and brushing is, after all, an indication only of maximum-voltage which depends largely on the shape of the antenna current envelope and how the transfer is effected. If maximum voltage was the answer to long distance transmission, would it not be surprising to consider the tremendous distances done by interrupted continuous wave transmitters which have by far the lowest maximum antenna voltage of any group-transmitters? Perhaps I may more clearly show that the maximum breakdown potential has very little to do with the amount of energy radiated by the following comparison:

The antenna could be charged to a very high voltage ten times a second and would probably brush badly. The same antenna charged to one-third this voltage one hundred times a second would radiate the same energy per second, all things being equal, while if charged to one-third the

original voltage a thousand times a second it would radiate ten times the energy per second, and there might be no brushing whatever.

Mr. West takes no account whatever of "radiation resistance", which is perhaps the most important factor in transmission. Radiation resistance may be defined as a "quantity which multiplied by the square of the average current in the antenna expresses the power in watts that is actually radiated." It is desirable to have this radiation resistance as high as possible in a transmitting aerial. It is obvious that the current delivered to the antenna by any given transmitter is dependent upon the total resistance of the open circuit. This includes the radiation resistance, and the ohmic resistance of the ground, antenna, leads and secondary of the oscillation transformer. These latter should be reduced as much as possible by using plenty of conductivity properly arranged for radio frequency, suitable ground for local conditions, etc., but with our present knowledge of radio frequency conductance this objectionable resistance is always unfortunately a considerable sum. Therefore, the efficiency of the antenna circuit may be expressed as radiation resistance divided by total resistance. In other words, if we have two ohms of joulean (heat loss) resistance and $\frac{1}{2}$ ohm of radiation resistance and ten amperes in the antenna, the total power will be 250 watts, of which only 50 watts will be radiated. While if we improve the radiation resistance to 6 ohms, keeping 2 ohms in the helix, antenna, conductors, etc., and keeping the same total energy in the open circuit (250 watts), there will be 5.6 amperes in the antenna but 188 watts of radiated energy. This is after all the ordinary electrical engineering problem of trying to get your useful load the largest possible proportion of your total load.

A few remarks on the effect of different variables on this radiation resistance may not be out of place.

Dr. George W. Pierce in a splendid mathematical paper has developed this information, which has been shown to be along correct lines by innumerable experiments. The radiation resistance is dependent upon the shape of the antenna

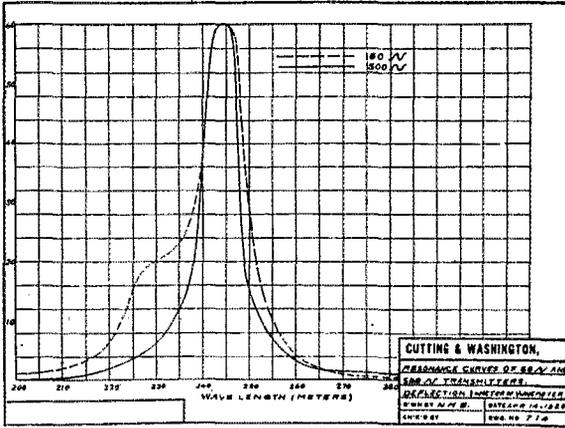

and the ratio of its natural wave length to the wave length used. A vertical antenna has the highest radiation resistance of any known type, a long low horizontal antenna the lowest (excluding, of course, the ground wires, loops, etc.) The radiation resistance is higher the nearer its natural period the antenna is worked. For instance, a vertical antenna at its natural period has a radiation resistance of 36.6 ohms; at 1.4 times its natural period a resistance of 25.0 ohms; at 2.5 times its natural period its radiation resistance is but 3 ohms. An inverted L type antenna, whose length is twice its height, at its natural period has a radiation resistance of 12 ohms; at 1.4 times its natural, of 5 ohms; at 2.5 times its natural, of 1½ ohms. It would, therefore, seem that it is desirable to work as near the natural period as possible up to the point where sufficient inductance cannot be included in the secondary or open circuit to obtain adequate coupling. The radiation resistance of an antenna of a given geometric shape (say an inverted L type whose horizontal length is three times its height) is the same at its natural wave length or at any given ratio of wave length to its natural wave length regardless of the size of the antenna, and it will, therefore, radiate the same energy with the same current. In other words, if the geometrical shape remains the same an antenna with a 100 meter natural worked on 200 meters will have the same radiation resistance as an antenna with a 1000 meter natural worked on 2000 meters. The number of wires in an antenna has some effect on the capacity, and, therefore, on the natural period. If the wires are arranged symmetrically, as in the cage type, their greatest value is to increase the conductivity.

Mr. West says if you improve your ground connection, greatly you will prob-

ably find it possible to decrease the number of wires in the antenna with good results. May I ask why it is desirable, when you have decreased the objectionable resistance in one part of the circuit, to immediately proceed to increase it in another part?

Later the remark is made that under certain instances the power per spark will be greater than any antenna of reasonable dimensions will radiate. There seems to be a general idea that there is some theoretical limit to the amount of power that a given antenna will radiate. This is not known to be the case. It is purely a function of the radiation resistance, times the square of the antenna current. The only engineering difficulty involved is that of insulation—and

as a corollary the difficulty of keeping the absolute dimensions of a powerful set such that short waves may be obtained in the closed circuit—and the amount of insulation necessary can be decreased by increasing the spark frequency. It must not be thought from this that running a rotary gap fast and with an impure note is necessarily more desirable than running it slowly with a good note; but assuming that the charge in the antenna for each spark is the same, that the note remains pure and is not carried to a point where the sensitivity of the human ear decreases, or beyond the sensitive point for the telephones, better results will be obtained. If somebody would pay for the insulation, the writer would guarantee to get two kilowatts into a good amateur antenna at a 240 spark rate.

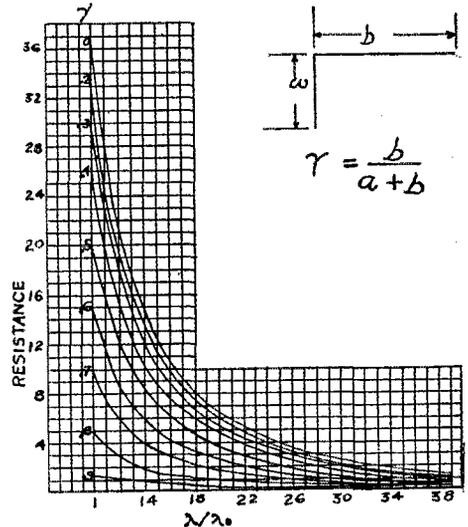

As a matter of fact it is very much easier to build a 500 cycle set for extremely short waves than a 60 or 120 cycle set. The writer some years ago put 4.6 amperes into an antenna 15 feet high and 25 feet long at a wave length of 80 meters and a spark frequency of 1000. This would not be impossible with a spark frequency of 120 but would be extremely difficult owing to the tremendous strain on all insulation.

I would also point out to Mr. West that ohmic resistance (dielectric hysteresis) of the condenser decreases as the frequency is increased, not the reverse as one would assume from his paper.

The writer at his own experimental station 2XH and 2QF at present has installed two transmitters—a $\frac{1}{2}$ KW 500 cycle multi-spark impulse transmitter, putting 5.8 amperes into a six wire cage antenna 90 ft. long and 75 ft. high at 245 meters, and a 1 KW rotary non-synchronous set consisting of an Acme transformer, Dubilier condenser, Benwood gap driven by a $\frac{1}{8}$ HP Emerson motor, and an oscillation transformer in which both coupling and secondary inductance are adjustable under load, which will put 4.2 amperes into this same antenna with the same counterpoise at the same wave length. The voltage in the case of the 500 cycle set is sufficient at maximum to jump nearly $\frac{1}{8}$ ", while with non-synchronous the brushing distance is nearly 3" and the actual jumping distance is $2\frac{1}{8}$ " between points. This station has only been used three or four nights as it has not been completed long. My policy has been to call any long distance station that I heard and when I got them shift from one set to the other. In perhaps a dozen cases of stations 200 miles away, or more, they have not been able to hear the non-synchronous set, while they could work the 500 cycle and in no case has a station distant more than 20 miles reported the 60 cycle as QSA as the 500. In this matter I can refer to 2QR, 2ZC, 2UK, 3DH, 2BX, 2IR, 2BK, 2EV, 2AQY, NSF, 8DA, 1CM, 1AK, 1CK, 1AE, 3FG, 3NB, 9JT, 8EV, 8EN, 8IK, etc. Some of these stations answered us on the 500 cycle when called, but when we came back with the 60 cycle non-synchronous a dead silence ensued.

Attached are resonance curves of non-synchronous and impulse transmitters. The non-synchronous shows the usual tendency to the "coupled circuit phenomena", that is, two waves.

I am enclosing, also, a radiation resistance curve-family from Dr. Pierce's paper for inverted L antennas which may be of interest.

It should be noted that a somewhat smaller antenna may be desirable for re-

ception, as if the radiation resistance is too high, much of the received energy will be lost by re-radiation.

Very truly yours,
Bowden Washington,
Chief Engineer.

EVERYBODY READ THIS SOME RECORDS

New York, N. Y.,
April 12, 1920.

Editor, "QST",
Hartford, Conn.
Dear Mr. Warner:—

It's a surprising fact that in this big city of New York, with its hundreds of newstands and news services, it's almost impossible to get a copy of QST after it's been on sale a week or so. I'll say it must be some seller here in the East. Of course it is out West as well. I know, for I slipped a dealer "four-bits" for his last "reserved" February copy. This was out in Oakland, Calif. Here in Manhattan, believe I've tried every wireless store, newstand, etc. in the place, since the 25th of last month and still can't get hold of the March number. I did succeed in glancing over a fellow operator's copy but he was as careful of it as he might have been of an ounce of radium, and anyway, certainly a glance at "QST" is not sufficient for an old time "ham". Hence the enclosed money order for a year's subscription.

In a late issue, January or February, I read with great interest, that letter from Lindley Winser out at Honolulu, especially the paragraph about his trip to the Islands with me on the good ship West Keene. During that eight day trip, we sure became fast pals after such a good old pre-war "Radio friendship". The loss of old 6ZW as a relay station is mourned by all the Pacific Coast fellows. Winser is one fine chap and although far out of the realm of amateur activity at present, he's still a full-fledged amateur at heart. I have occasion to know that for a fact!

Before the war I was situated in Phoenix Arizona. If you don't recall "6FD" surely you will remember station "6DM" operated by Robert C. Higgy (famous old Thordarson thunder-factory) now "8IB" of Columbia, Ohio. Higgy did some very remarkable radio work from Phoenix, and by the way I want to say Phoenix, Arizona in winter is the most wonderful "hole" for radio signals in the world, without a doubt. Perhaps you've heard the same remarks about the place from other sources. Ask Higgy, or Bob Trump "9BT", they know. Or better yet ask Mr. Irvin Harrison, operating "6GQ" there now. Believe me, Mr. Warner, he'll not leave a bit of doubt in your mind

as to the "super" qualities of that South-western "ether".

At present am on the Standard Oil tanker S.S. Hugoton which arrived in New York March 25th from San Francisco via Panama Canal and the following is an attempt at a condensed report of the first ten days of the trip south to Panama, including a list of stations heard on one especially favorable night. This list I believe contains same world's records for a number of amateurs.

The work was done with a shortwave coupler, (with doughnut secondary) one variometer in the grid circuit, and a 12 turn tickler coil in the plate circuit, this arrangement in conjunction with a very sensitive tubular audion, and a one step amplifier using a "VT-1" tube. I also used the primary condenser of the Navy SE143 receiver to reduce the natural wavelength of the big ship-antenna.

We left San Francisco at 4 P.M. March 3rd. By 9 P.M. all the sixth district stations were roaring in and my attention was attracted to a loud continuous musical "buzz" or drone tuned on about 375 meters. This night, I heard several other amateurs remark about the interference they were having from this source. Strange to say, this steady buzz played a perfect eight note scale up and down continuously and became louder as the night advanced. March 4th 265 miles south of San Francisco, one "five" blazed in through the "sixes", 5ZA of Roswell, N. M. and promptly at 7:30 P.M. that steady buzz commenced and continued thru the night.

March 5th 504 miles south, 5ZC roared in thru the QRM from some thirty sixth district stations. 7CC and the station at the University of Oregon "UO" were also "QSA very". The buzz was on louder than ever also.

March 6th 734 miles south of Frisco in Latitude 28°15' North, and Longitude 116°33' West. Fifth district stations 5BO, 5BZ, 5YA, 5ZA and 5ZC all QRK, QSA along with over 25 sixth district amateurs. An hour later heard 9RP and 9ZY QSA. The mysterious buzz all over the room tonight. A little after 1 A.M. I was astonished to hear 8ER very strong, working with 9CA. Copied the complete text of a msg. from 8ER, (for confirmation). 7CC was also QSA tonight, and QRN pretty bad. March 7,—980 miles south, besides twenty or more "sixes" the following were all "QSA":—5AB, 5BO, 5BS, 5BT, 5BZ, 5YA, 5ZA, 5ZC, and 9RP. Steady buzz on tonight, seemingly louder as the farther south we get. March 8,—1238 miles south, 5EJ, 5CX, 7CC, 9CA, 9EL, 9ET, 9RP, 9YN besides those heard the night before. This loud buzz was worse tonight, and I heard several six hundred meter ships,

one of which was nearly 2500 miles from me, at the time, remark about it. The character of the note was on the order of this 60 cycle induction hum except that it played, continuously, an eight note scale up and down etc. This nite I heard 6EA tell 6BR he had QRM from the "buzz".

March 9th—8 P.M. 1493 miles south of San Francisco. Latitude 19°49' North, Longitude 106°30' West. Heavy QRN and interference from this peculiar buzz. 4AD, 4AE, 4AL, 4AY, 4BQ, 5BL, 5BO, 5BS, 5BT, 5CX, 5DA, 5EW, 5EJ, 5XA, 5ZA, 5ZC, 5ZU, 5BZ, "WC", 6BR, 6BQ, 6CS, 6EI, 6EJ, 6GQ, 6HZ, 6ZA, 7CC, 7CR, "UO", 8CC, 8DR, 8DA, 9EC, 8ER, 8HG, 8ZY, 9CA, 9EL, 9ET, 9FA, 9FU, 9HT, 9LC, 9RP, 9ZL, 9ZN, 9ZT, 9ZV, 9ZJ. Also heard several "twos" and a "three" but due to some static was unable to get whole call.

March 15 we were 3009 miles south of S. F. Static was intense but a station, "NSF" which I believe is a modulated CW station in Washington, was roaring in all evening with 8DA. I copied this same station off Balboa Panama next evening. Beautiful clear note and sharp tuned as an arc.

Will leave it to you to figure out that mysterious buzz. It's beyond me. Perhaps its from Mars, probably not, but what it is, I'd like to know.

From Panama, north on the Atlantic side, static conditions made reception on 200 meters absolutely impossible.

I have a complete rough log of the trip around so if any of the fellows want dope on it a letter will reach me addressed F. G. Roebuck, % Radio Corporation of America, No. 109 Stewart Street, San Francisco.

Hope you can start my subscription with April issue and please address No. 333 West Victoria St., Santa Barbara, Calif.

Am afraid I've been too lengthy with this bunch of stored up "stuff" so will break off now. 73 and best wishes for future fame of QST.

Sincerely,
F. G. Roebuck,
Ex-6FD.

A VARIO-COUPLER.

299 Brackett St.,
Portland, Me.

Editor, QST:

I have just made a vario-coupler, which works so well and is so easy to construct that maybe some of the fellows would like to try it.

I made the rotor first, and not having a lathe, I cut the rotor out of ½-inch pine in two sections. I used a Quaker Corn Meal box for the primary, with a diameter of 3¼ inches, so the two halves of the rotor were made 3½ inches in diameter. Between the

halves is a disc of cigar box wood a little larger than the sides of the rotor. This disc has a strip $\frac{1}{4}$ inch wide, cut out of the middle to admit the shaft, which is in two pieces. I think the drawing will make everything clear. The primary is wound with No. 22 and the secondary with No. 24 magnet wire.

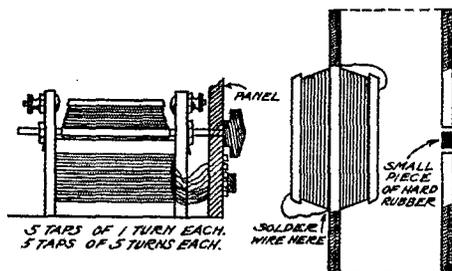
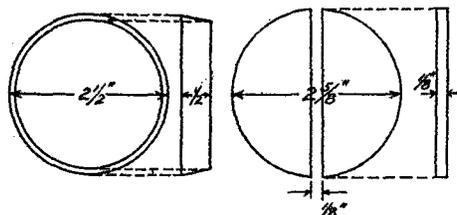

This rotor can easily be cut out of pine or any soft wood, using a coping saw. The two variometers for a regenerative set may be made on the same size forms, only they should be wound throughout with the same size wire either No. 24 or No. 26.

Yours truly,
Alton H. Goud.

THE POWER COMPANIES

Editor, QST:

I was quite interested in reading your editorial headed "Power Companies" in the April issue, but I believe you have attacked the power companies from the wrong angle.

It is not conceivable that reliable power companies who are governed by the National Fire Underwriters and who are striving to improve their their services for the benefit of the public will stand for a poorly designed amateur 1 kilowatt radio station obtaining power from an electric light attachment. Since the electric light socket is the most accessible point the tap is generally made here or directly behind the watt-hour meter. The reasons for their objections are several.

1—The current required to operate a 1 kilowatt radio station will vary from 8 to 15 amperes, which is in excess of that allowed by the Fire Underwriters and also

above the capacity of the average domestic watt-hour meter.

2—If the radio equipment is not properly installed, as you know, there will be a flicker on all secondaries connected to the same service transformer and the local wiring will be subjected to high potentials.

3—Even if the flicker is absent there will be a dimming of lights in the adjacent vicinity due to the R I drop of the service leads unless they are of reasonable size for the load imposed.

4—Due to relatively low power factor of a radio transformer a great many of the power companies do not care to take several such circuits on their system during the peak load which occurs in the evening.

I am a great believer in and a booster for amateur radio work but I believe the only means of correcting your trouble is the education of the amateur. My one great criticism of radio amateur magazines is the publication of non-technical and incorrect ideas. If they would publish more scientific articles in simplified language similar to the articles by Messrs. Clement and West of your April issue (but not like some of the other articles in the same issue), the amateurs would be able to attack their problems from an engineering standpoint rather than from the rule of the thumb. In so doing not only his time and money would be more profitably spent but the efficiency of the great amateur organization would increase at a surprisingly rapid rate. Although no doubt in some cases the power companies have imposed unreasonable hardships, it is no doubt the fault of a few amateurs with comparatively poorly designed transmitting sets that the difficulty you spoke of has developed.

I base the above remarks on observation of amateur stations and five years experience in the practical engineering field. I hope you will take the above as a suggestion and try to help the amateur in his great work by putting semi-technical articles in your little but mighty magazine, the QST.

Very truly yours,
A. Reader.

T'ANKS, BY GAR.

April 24, 1920.

Dear Eddy,

By Gar what you spose, de odder nite I'm go on top de radio shack and put de fones nex' to de ear, an' for a surprize shee's de fine nite, eddy. I'm not hear any foolish noise, lak what you call em static, an' for de long tam I'm not hear em anything, but by gar I'm stick on de job an' bime by shees come a peep from a fellair hees leave in de sam town lak me and hees use a ford engine to sen weeth. By gar shees de fine note—once shees high

an' once shees low an' pretty soon shees hit what hees call heem a gud tone. Shees a gud tone mebbie in hees mind but by gar I'm be please som day to have heem hear 9ZN or Mars. Well what you spose by gar hees call me, an I'm answeerr heem pretty queek an tell heem to QRT or by gar I'm report heem if he don't hurry an get hees license. Hees quit pretty queek also I'm telling you for I'm de terrible man so soon lak I'm get mad.

Bime by 9ZL shees come in lak hurricane weeth a CQ an I'm turn roun and call heem. Shees hear me by gar but shees advise QRX because 8ER hees communicate weeth POZ at present and no-bodee in de whole U. S. can DX when 8ER hees wrkg. I'm lay de fones on top de tabel and go down on top de basement where I'm sit and wait till 8ER hees finish. Pretty queek I'm hear heem clear an I'm runs up de four storees and mak de nex attemp on 9ZL. Shees answer an say, "Dear Fren I've got de MSG from St Paul please try and get heem to 9ZT Minneapolis for me". Dats de fine relay wrk by gar from St. Paul to 9ZL to me an bime by in two mebbly three months to 9ZT. By gar I'm tink Minneapolis shees got de barb wire entanglements around de whole citee. Shees de hard one to lan I'm telling you, eddy. Say by gar I'm tak lots of your tam now. I'm feenish dees storee some odder day mebbly if you lak to hear de res.

Shees de long storee, eddy but shees mebbly do some fellair some gud. Bime by I'm write you som more if de paper shees hold out.

So long dear fren till de nex tam.
9--.

ECLIPSE OBSERVATIONS

Brooke, Va., May 3, 1920.

Dear Warner:—

Did anyone notice any peculiarity in the operation of the 200 meter and 600 meter waves last night between about 8:15 P.M. and 9:25 P.M.?

As for my part, I went to the set about 7:45 P.M. and everything seemed to be working in about the usual manner and some signals seemed to come in unusually loud. I then went out and watched the moon disappear in a total eclipse, and came back just as the moon was completely covered by the shadow of the earth, tuned down to 3BZ, who has an 8 P.M. schedule with me, and he was there talking to me with signals pretty good and I copied just 14 words when he faded down so low I could get no more through the QRN. Tuned around to the various 200 meter waves and could hear nothing, tuned up on 600 and KSQ, KUPM and NAM were coming strong. This between 8:25 and 8:27 P.M. At 8:29 NAM told them to

QRT and his signals were much weaker than a minute before. At 8:29½ was on 200 again and heard 3KI fade in and then out as quick, and static was fierce. I stayed on 200 until 8:33 and didn't hear a sound of any amateur at all, which is a very unusual thing. I then tuned back to 600 and things were almost as quiet there, I having to wait until 8:35 before I heard anyone and that was NBZ extremely weak. At 8:37 NAM was heard, also exceedingly weak, and from this time until 8:55 I heard nothing on either 200 or 600 that could be deciphered. At 8:55 to 9 P.M. I heard two or three amateurs and one of them swung up loud enough to read a few words, and from that time until the moon again begin to appear at the bottom conditions gradually improved as to signal strength but static was fierce, and apparently even worse on 200 meters than on 600 meters. After the appearance of the bottom edge of the moon, about 9:20 P.M., I had no further time to listen for other tests.

Whether this was a coincidence or not I cannot tell, but it did seem strange that radio should act this way at the exact time of the totality of the eclipse; yet if we recall the freaks of radio when the seven planets were lined up on one side of the sun, only approximately, it would be reasonable to suppose that the sun, moon and earth lined up in EXACTLY a straight line should also be capable of causing a little stir up of their own in the radio field. Furthermore the disturbance was greatest at the time of greatest totality (between 8:35 and 8:55) at which time the three bodies were exactly in line, and before 8 P.M. conditions were practically normal and I heard amateurs in the 1st district as far as Portland, Me.

Did anyone else note any such peculiarities, or was it only a chance local condition that caused the phenomenon? The eclipse was too early in the night to be generally observed except by amateurs in the east and it would be interesting to note the experiences of other eastern amateurs.

Sincerely,
A. L. Groves.

QST SOUTHERN AMATEURS

P. O. Box 592, Ft. Pierce, Fla.
Editor, QST:

I have just installed a complete deForest Oscillation Radiophone Transmitter at my station here, 4AT, and will send out music, speech, and CW signals every Tuesday, Thursday and Sunday night from 10:30 to 12:30, also Sunday afternoons from 2 to 4 p.m., on 200 meters. Will stations hearing same please report to

Yours truly, O. A. Gulledge.

CALLS HEARD

On account of the vast quantity of calls reported we must ask your co-operation in the following or calls can not be published.

- (1) List the calls on a separate sheet of paper—do not embody them in a letter.
- (2) Arrange by districts from 1 to 9, and alphabetically thru each district; and run them across the page, not down a column.
- (3) Put parentheses around calls of stations also worked.
- (4) Omit initial or other unauthorized calls.

5ZU, TILLEY, AUSTIN, TEX.

5DH, (5YE), 5BK, (5ZO), (5YA), (5ZN), (5AL), (5ZG), (5ZA), 5AD, 5ZP, (5BS), 5BZ, (5BT), 5EA, 5ED, (5XC), 5BL, 5BM, (5ZL), 5ZV, 5ER, 5LA, 5DC, 9YO, (9HT), 9EL, (9HN), 9ZU, (9RP), (9LC), 9FS, 9ZJ, 9JB, 9AJ, 9JE, 9CA, 9ZO, 9ZH, 9FU, 9LK, 9FZ, 9ZN, 9HJ, 9HL, 9BT, 9YA, 9RY, (9ZV), (9FB), 9ZL, 9ET, 9YN, 9LQ, (9LH), 9NL, 9LV, 9ZQ, 9IP, 9IF, 9ET, 9NV, 9LF, 9LR, 9JE, (9OV), 9WZ, 9NQ.

8QM, ELMIRA, N. Y.

1AR, 1AW, 1BP, 1CD, 1CK, 1KK, 1QM, 2AF, 2DA, 2KA, 3BA, 3BU, 3HS, 3HV, 3IK, 3JQ, 3KA, 3SH, 3XU.

WORKED BY 5BT, BLACKWELL, OKLA.

5EW, 5EA, 5BO, 5ZV, 5LQ, 5ME, 5ZU, 5ZA, 5ZC, 5YA, 5GA, 5AG, 5AL, 5BZ, 5ZG, 5BG, 6GQ, 8ER, 9FB, 9EL, 9KV, 9RL, 9FW, 9CT, 9RP, 9GV, 9GU, 9KO, 9ZU, 9ET, 9LL, 9HN, 9FA, 9FU, 9BU, 9WU, 9GA, 9ZN, 9IT, 9HT, 9JA, 9CR, 9HI, 9YA, 9BU, 9AJ, 9BW, 9IF, 9CN, 9CA, 9BR, 9FZ, 9LC, 9LR, 9PS, 9GC, 9NX, 9ND, 9OE, 9NB; also heard 4AE, 5ZN, 9AX, 9QM, 9JM, 9JU, 9JB, 9LQ, 9IW, 9FA, 9ER, 5IL, 9ZA, 9AP.

1AE, DORCHESTER, MASS., to Mar. 22d.

Actual traffic handled with 1AK, 1DU, 1HAA, 2BM, 2CL, 2IR, 2JE, 2JU, 2KN, 2QF, 2ZC, 2ZS, 3ZW, NSF, 3DA; exchanged signals with 1AW, 1ZA, 2CB, 2DA, 2KH, 3NB, 3NV, 9ZL; heard 1BK, 1CM, 1FQ, 2AN, 2AR, 2AS, 2BB, 2CB, 2CL, 2CS, 2CT, 2EV, 2FE, 2GR, 2NB, 2SH, 2ZL, 2ZM, 3AK, 3BH, 3BZ, 3CC, 3CS, 3EN, 3EV, 3GX, 3HJ, 3NB, 3NV, 3AA, 3AH, 3AHL, 3ADK, 3ALE, 3ASG, 3BG, 3CB, 3CC, 3CD, 3DO, 3DV, 3EN, 3ER, 3ES, 3FH, 3FP, 3HH, 3IK, 3JQ, 3JV, 3LA, 3LI, 3VP, 9AD, 9ADL, 9AL, 9CA, 9EJ, 9HN, 9KF, 9ZN.

6MZ, DEL MAR, CALIF.

5ZA, 6AE, 6AT, 6BQ, 6BR, 6BY, 6CQ, 6CS, 6DP, 6DV, 6EA, 6EF, 6EJ, (6EN), 6FD, 6FE, 6FK, 6FU, 6GH, 6HH, (6IF), (6IX), (6IZ), 6JD, (6JI), 6JM, 6KP, 6ZA, 6CC.

4AB, WILMINGTON, N. C., ON CRYSTAL.

1AW, 2MQ, 3NB, 4AE, 4AN, 4AT, 4BQ, 4BB, 4YA, 5AQ, 5DA, 5EF, 5ER, 5ES, 5EV, 5DA, 5GB, 5IK, 5DB, 5LA, 5MI, 5NZ, 9AJ, 9ZJ.

9NQ, GALESBURG, ILL.

1AA, 1AT, 1AW, 1RN, 2BG, 2BM, 2JN, 2PL, 2XB, 2ZS, 3BZ, 3GB, 3EN, 4AE, 4AG, 4AI, 4BC, 4BA, 5AA, 5AB, 5AC, 5AG, (5AL), 5AN, (5BS), 5BO, 5DO, 5EX, 5GA, 5YA, 5ZA, 5ZC, (5ZG), 5ZN, 5ZO, 5ZP, 5ZL, 5ZV, 5AL, 5BK, (5CB), 5DA, 5EC, 5EF, 5EG, 5EN, 5ER, 5EX, 5EZ, 5FG, 5FP, 5GA, 5GB, 5GN, 5HG, (5IB), 5GK, (5JJ), (5JK), (5KP), (5NZ), (5ZY), 9AD, 9AP, 9AU, 9BJ, 9BT, 9CE, 9CN, (9DR), (9DX), (9EE), (9EL), 9ER, 9EY,

7AD, SEATTLE, WASH.

6AE, (6AK), 6AJ, 6AM, 6AT, 6AV, 6BM, 6BO, 6BR, 6BQ, 6CO, 6CP, 6CQ, 6CR, 6CS, 6CV, 6DY, 6EA, (6EJ), 6EX, (6FE), 6GQ, 6GR, 6JD, 6JG, 6JK, 6ZA, (7CC), (7CE), (7CU), (7CW), 7CR, 7DK, 7EC, 7FB, 7FC, (7ZB), 7YA, (7YS).

8DA, SALEM, O., Jan. 25-Mar. 1st.

(1AE), 1AS, (1AW), 1AY, 1EP, 1KT, 1PV, (1RN), (2AB), (2BM), (2BK), 2CS, (2DA), (2GR), (2JU), 2KN, 2GO, 2JE, 2FE, 2IR, 2LO, (2RB), 2WB (day-light), (2VA), (2XG), 2ZF, (2ZM), (2ZS), 2ZV, 2ZC, 3CA, 3CK, (3DH), (3FG), 3GQ, 3EN, 3GO, (3NB), 3KM, 3GQ, 3ZS, (3ZW), (4AN), (4AO), 4AL, 4AT, 4AG, 4AE, (5AL), 5BQ, 5DO, 5YA, 5ZC, 5ZU, 5ZG, 5AD, (5FH), 5BQ, 5FF, 5JJ, 5NF, 5BP, 5XU, 5KK, (9AU), 9AJ, (9CA), (9CW), (9CS), ex 9AES, 9EE, 9ER, 9EV, 9EL, 9ET, 9FZ, 9AK, 9HI, (9HN), (9HW), 9HT, 9IT, 9JE, (9KV), (9LQ), 9LC, 9LH, 9ME, 9NQ, 9UG, (9ZJ), (9ZL), (9ZN), 9ZV.

4BZ, ATLANTA, GA.

3BZ, 3CR, 3DH, 3DZ, 3EN, 3EZ, 3HJ, 3LD, 3NB, 3TW, 4AE, 4AG, 4AL, 4AN, 4AO, 4AT, 5AL, 5BT, 5CV, 5DA, 5ED, 5ER, 5ES, 5XA, 5YA, (5YE), 5ZA, 5ZC, 5ZC, 5ZL, 5ZO, (5ZX), 8CB, 8BK, 8DA, 8DI, 8DJ, 8DP, 8DU, 8DZ, 8EN, 8ER, 8FH, 8GB, 8HG, 8HH, 8HK, 8IJ, 8IK, 8JJ, 8JQ, 8KA, (8LA), 8LF, 8MB, 8MT, 8NL, (8NZ), 8QZ, 8RF, 8RQ, 8XK, 8ZY, 8ZW, 8ZY, 9AJ, 9AY, 9BT, 9DA, 9DU, 9ER, 9FJ, 9FU, (9GO), 9HG, 9HJ, 9HN, 9IV, 9KU, 9KW, 9LC, 9LF, 9LM, 9LQ, 9MH, 9NZ, 9PY, (9RP), 9VC, 9WZ, 9YN, 9ZJ, 9ZL, 9ZN, 9ZO, 9ZV.

6DH, FRESNO, CALIF.

6AB, 6AC, 6AD, 6AE, 6AG, 6AK, 6AM, 6AT, 6AY, 6BS, 6BQ, 6CC, 6CM, 6CO, 6CQ, 6HL, 6IH, 6JM, 6JD, 6KP, 6HZ, 6EA, 6EB, 6ED, 6EF, 6EJ, 6ER, 6EV, 6AY, 6GQ, 6FE, 7DK, 7CH, 7CW, 7CU, 7YS, 7ZB, 5ZA, 6ZA.

3BZ, DANVILLE, VA.

during March: 1AK, 1AS, (1AW), 1BA, 1FM, 1FX, 2AR, 2BM, 2DA, 2FG, 2SE, 2SU, 2NC, 2WB, 2ZC, 2ZL, 2ZC, 3BE, (3BK), 3CN, (3EN), 3EV, (3FG), 3JK, (3KM), 3NB, 3NC, 3SJ, 4AE, (4AG), 4AI, 4AN (4AT), 4AO, 4BB, 4BK, 4BQ, 4BZ, 4CD, 4CP, 4EJ, (4YA), 5AQ, (5DA), 5ES, 5DO, 5YE, 5ZC, 8AK, 8CB, 8CH, (8DA), 8DI, 8DF, 8DO, (8ER), (8EF), 8DR, (8EV), (8EN), 8EC, 8FH, 8FS, 8FF, 8GB, 8HH, 8HG, 8ID, 8LA, 8MN, 8MT, (8HL), 8NQ, 8NI, 8NM, 8NO, 8OM, 8RI, 8RQ, 8VP, 8ZW, 8ZY, (9AJ), 9AAK, 9AAN, 9DV, 9FE, 9GX, 9HN, 9HT, 9HV, 9HD, 9HR, 9IT, 9KV, 9KO, 9LQ, 9KF, 9OC, 9NC, 9QX, 9SS, 9VC, 9ZS, 9ZL.

3CA, ROANOKE, VA.

1AW, 2DA, 2ZL (damp and undamp), 2ZS, 3DK, 3BE, 3IB, 3EN, 3HJ, 3BZ, 3DM, 3BU, 3MQ, 3EZ, 4BQ, 4AN, 4AO, 4AG, 4AT, 4AE, 4AC, 5AQ, 5XA, 5MA, 5DU, 5ZP, 5DA, 5ZE, 5DA, 5AJ, 5ER, 5LA, 5ZJ, 8ZY, 8HG, 8CB, 8HH, 8EN, 8CI, 8HB, 8MT, 8GB, 8NZ, 8NI, 8CA, 8RQ, 8IK, 8HJ, 8ZW, 8XU, 8DI, 9ZY, 9ZL, 9AJ, 9HN, 9LQ, 9SS, 9KM, 9ZN, 9ET, 9HR.

HEARD BY 2QR, KEYPORT, NEW JERSEY

1AW, 1CK, 1RM, 2BS, 2CQ, 2CS, 2CV, 2AA, 2DA, 2DX, 2ES, 2RB, 2RE, 2TS, 2WA, 2WI, 2XG, 2XX, 2ZS, 2AH, 2CB, 3DA, 3EV, 3ER, 3FS, 3FS, 3LA, 3KK, 3ZN, 9ZY, NUU. Worked by 2QR: 2BW, 2DF, 2EE, 2IT, 2JG, 2JU, 2PL, 2RG, 2SH, 2TO, 2TX, 2WB, 2ZC, 2XU.

1ZA, DARTMOUTH, HANOVER, N. H.

(1AE), 1AK, 1AR, (1AS), (1AW), 1BK, 1CM, 1FF, (1FL), (1FQ), (1HAA), 1IC, 1IT, 1JZ, 1KAA, 1OE, (1SE), (1SZ), 1LZ, 2ACU, (2AIZ), 2AS, 2BB, (2BK), (2BM), (2CB), 2CL, 2CY, (2DA), 2EV, (2IR), 2JE, 2JG, 2JU, 2LO, 2LQ, 2MN, 2QR, 2RB, 2RE, (2UK), (2VA), 2WB, 2WK, 2ZC, 2ZL, (3BE), 3BH, 3BZ, 3CC, 3DH, (3EN), 3EV, 3FG, (3HJ), 3IB, (3NB), (3NV), 3VA, 4FH, 5DA, 3AD, (3BB), 3DA, 3DC, (3EN), 3ER, 3FL, (3FW), 3GB, 3KE, 3LA, (3LI), 3LV, 3MT, 3NI, (3NQ), 3QJ, 3RS, 3RW, 3XA, 3XU, 3XW, 9ZN, (9CA).

2CY, BAYSIDE, L. I.

1AE, 1AN, 1AS, 1CK, 1CM, 1DQ, 1CR, 1FW, 1HH, 1LA, 1RN, 1SE, 1UI, 1VA, 1ZL, 3BZ, 3CV, 3CH, 3DH, 3FG, 3GO, 3NB, 4AA, 4AO, 5AF, 5DA, 5AA, 5AH, 5BF, 5BV, 5CA, 5CB, 5CC, 5CN, 5DA, 5DR, 5DV, 5EM, 5ER, 5EX, 5FB, 5FL, 5FP, 5GB, 5HH, 5HH, 5HP, 5JQ, 5LA, 5LE, 5MN, 5XU, 5AUTX, 5AKY, 5IB, 5DY, 9AU, 9BP, 9FD, 9KV, 9MP, 9MS, 9ZL, 9ZN.

1BW, WOLLASTON, MASS.

1AK, 1AW, 1AZ, 1CM, 1FQ, 1JH, 2AM, 2AVF, 2BB, 2BC, 2BG, 2BK, 2BM, 2CB, 2CC, 2CS, 2DA, 2FE, 2FG, 2FS, 2GR, 2HZ, 2IR, 2IT, 2JE, 2JR, 2JU, 2JF, 2LO, 2LX, 2NB, 2OM, 2OX, 2PE, 2PK, 2PL, 2QF, 2QR, 2QS, 2QU, 2QV, 2RB, 2RL, 2RV, 2WB, 2WW, 2ZC, 2ZL, 2ZM, 2ZS, 3AE, 3AK, 3AMO, 3AN, 3AW, 3BH, 3CC, 3CV, 3DH, 3EA, 3EN, 3EV, 3GV, 3GX, 3NB, 3NC, 3ND, 3OW, 3ZM, 3ZV, 3ALE, 3KE, 3CC, 3DA, 3DC, 3EN, 3ER, 3ES, 3FH, 3JQ, 3KB, 3KC, 3LI, 3MP, 3RS, 3RW, 3XA, 3XU, 9HD, 9ZL, 9ZN.

3DH, PRINCETON, N. J.

9IT, 9CA, 9LC, 9KV, 9RP, 9EE, 9HW (who I understand uses a two-inch spark coil), 9ZN.

8JQ, WASHINGTON, PA., to Mar. 1st

1AN, (1AW), (1CM), (1AZ), (1AK), (1RN), 1UA, 1DR, (1DL), (1KT), 1AE, 1AS, (2IR), (2JU), (2ZM), (2ZS), 2ZV, (2ZL), (2DA), 2WB, (2BM), 2SH, (2CS), (2FG), 2GO, (2XG), (2ARJ), (2JE), 2IL, (2GR), (2SZ), 2PL, 2PH, (2CB), 2AVF, 3AK, (3CC), 3CH, (3BZ), (3NB), (3AN), 3XC, 3ZS, 3CV, 3FG, 3DH, 3EM, (3GO), 3EZ, 3AB, 3EN, (4AE), (4AE), (4AG), 4BC, (4AL), (4BZ), 4BQ, 4AT, 4AN, 4BB, 4EJ, 4AK, 4AO, 5ZC, (5ZL), (5AC), (5ZS), (5DA), (5XA), (5AL), 5ED, 5ZG, 5YA, 5BC, 5BT, 5DO, 5EX, 5BY, 5XR, (9ZN), (9AJ), 9ANO, 9ATR, 9HU, 9AIK, (9GS), (9KF), 9BZ, 9CV, (9LQ), (9GX), (9BR), (9IT), 9ABD, (9HA), (9HD), 9HG, (9ZJ), (9LC), (9H), (9CA), (9CW), (9CS), (9AD), (9KO), (9BT), (9HN), (9AOR), (9HJ), (9NQ), (9HW), (9RT), (9IX), (9ZL), (9SS), 9AK, (9KV), 9AU, 9RP, 9AES, 9AP, 9HI, 9XK, 9ER, 9CN, 9MK, 9DH, 9HR, 9EQ, 9EE, 9FN, 9JT, 9GK, 9FU, 9FA, 9FR, 9QH, 9FG.

6CS, FRESNO, CALIF.

(5ZA), (6AE), 6AG, (6AK), (6AT), 6AY, (6BQ), 6BR, 6CM, (6CO), 6CQ, (6EA), (6EB), (6EJ), 6EN, 6FE, (6GQ), 6HE, (6JD), 6JM, (6ZA), (7CC), 7CH, (7DK), (7YS), (7ZB).

8CB, HIGHLAND PARK, DETROIT,

1AE, 1AW, 1CM, 1DH, 1RN, 2AN, 2BH, (2BK), (2BM), (2CB), 2CS, (2DA), 2DH, 2FG, 2IR, 2JE, 2JU, 2NR, (2WB), 2XX, 2ZC, (2ZM), (2ZS), (2ZV), 2AN, 2AU, 2BZ, 2NB, 2NC, 2ZV, (NSF), 5AL, 5AA, 5AL, 5BD, 5BQ, (5BV), (5CC), 5CS, (5DA), (5DV), (5EN), (5ER), 5GB, 5GI, 5HG, 5IF, (5JQ), 5LA, 5RG, 5TL, 5AI, (5AJ), 5AK, 5AP, (5AU), 5AV, 5BJ, 5BU, (5BR), 5BW, (5CA), (5CC), 5CE, 5CF, 5CN, 5CS, 5CV, 5CW, 5DU, 5ER, 5FC, 5FE, (5FG), (5FU), 5FX, 5FZ, 5GC, 5GQ, 5GZ, 5HI, (5HN), 5HG, 5HU, 5HW, 5IC, 5IX, 5JT, 5KF, (5KO), (5KV), 5LC, 5LQ, 5NQ, 5NY, 5OV, (5PC), 5PN, 5PZ, 5RA, 5TJ, 5UY, 5ZC, 5ZF, 5ZJ, (5ZL), (5ZN), (5ZV).

8VB, MARLETTE, MICH., Feb. 22 to Mar. 18.

1AE, 1AK, 1AW, 2AN, 2FE, 2FM, 2RR, 2WB, 2ZC, 3AN, 3JK, 4AE, 4AT, 4BQ, 5AG, 5AL, 5AR, 5GP, 5YE, 6AE, 8AA, 8AD, 8AL, 8DA, 8DU, 8DW, 3EN, 3ER, 3EV, 3FP, 3FR, 3FV, 3GM, 3AAU, 9AD, 9AJ, 9AK, 9AP, 9AT, 9AU, 9CT, 9DF, 9EN, 9ET, 9FA, 9FG, 9FU, 9GC, 9GP, 9GX, 9HH, 9HW, 9IJ, 9JT, 9KO, 9EV, 9LQ, 9LX, 9MH, 9MM, 9NZ, 9NT, 9RP, 9VC, 9VP, 9ZN.

3CX, PHILADELPHIA.

1AJ, 1AN, 1AO, 1AP, 1AS, 1AW, 2AP, 2ZV, 3NB, 3AS, 3BE, 3CD, 3DA, 3DH, 3ES, 3AN, 3CC, 3DA, 3HP, 3XU, 9AJ, 9DJ, 9DN, 9ES, 9ZJ, 9ZN.

5AO, HOUSTON, TEX.

5AY, 5ED, 5EO, 5FA, 5GL, 5YA, 5ZA, 5ZC, 5ZG, 5ZL 5ZN, 9RP, 9ZV.

1HAA, VERMILYA, MARION, MASS.

(1AK), 1AN, 1AS, (1AW), 1BB, (1BG), 1BH, 1BM, 1BAB, 1CB, (1CC), 1CE (CK), (1CM), 1CP, (1CZ), 1DH, 1DA, 1DY, (1EK), 1EP, (1EZ), (1EAV), 1FG, 1FR, 1GZ, 1GAI, 1HD, 1HAF, (1HAL), (1HR), (1IAE), 1JB, 1JG, (1KAY), 1LE, 1LAX, 1MX, 1PE, 1QM, 1QV, (1RV), 1SE, 1SN, 1SU, 1SY, 1SZ, (1TS), 1UN, 1UR, 1WU, (1WZ), (1YB), (1ZA), 2ABM, 2BB, 2BK, 2EO, 2CY, 2DA, 2FE, 2FG, (2JU), 2NP, 2OA, 2PL, 2QR, (2RB), (2TF), (2ZL), 2ZS, 2ZV, 3BZ, 3CS, 3CV, 3EN, 3GK, (3NV), 4AE, (3BB), 3BG, 3BP, 3CO, 3DA, 3DC, 3EN, 3ER, 3EV, 3GB, 3GL, (3HH), 3IK, 3IQ, 3IZ, 3LA, 3MZ, 3NI, 3WY, 3XK, (3XU), 3ZA, (3ABG), 3ADJ, 3BQC, 9AJ, 9ZJ, 9ZL, 9ZN.

9AD, CHICAGO, ILL.

1AI, 1AW, 1IZ, 1RN, 2AK, 2BK, 2BM, 2BZ, 2CB, 2CS, 2CG, 2CQ, 2DH, 2JE, 2JU, 2JZ, 2KN, 2NB, 2SZ, 2WB, 2XB, 2XG (CW & PHONE VERY QSA), 2ZC, 2ZM, 2ZS, 3BZ, 3DH, 3EN, 3FG, 3GO, 3HJ, 3NB, 3ZV, 4AE, 4AI, 4AN, 4BZ, 5AB, 5AC, 5AL, 5AL, 5AY, 5BT, 5BM, 5DO, 5EW, 5XG, 5YA, 5YL, 5ZA, 5ZC, 5ZL, 5ZO, 5ZU, 6EA, 8AA, 8ALE, 8AG, 8AE, 8AM, 8AMQ, 8ASF, 8AH, 8AGO, 8AL, 8AE, 8BF, 8BL, 8BV, 8BP, 8CC, 8CX, 8CB, 8DA, 8DJ, 8DU, 8DV, 8ER, 8EX, 8EF, 8EN, 8EX, 8FL, 8FD, 8FP, 8FH, 8FS, 8FG, 8GA, 8GZ, 8GQ, 8GB, 8GN, 8HG, 8HH, 8HZ, 8HA, 8IK, 8IB, 8IN, 8IY, 8HJ, 8JQ, 8KN, 8KP, 8NF, 8NO, 8NZ, 8NG, 8NI, 8NB, 8RR, 8RQ, 8RP, 8RH, 8VK, 8VV, 8WS, 8XA, 8XK, 8XF, 8ZW, (Heard 8HG, QSA on straight gap), 9AJ, 9AW, 9AB, 9BR, 9BT, 9BD, 9BE, 9CS, 9CW, 9CA, 9CN, 9DR, 9DH, 9DU, 9DX, 9EG, 9EY, 9EX, 9EE, 9EL, 9ET, 9EN, 9FL, 9FU, 9FB, 9FZ, 9FQ, 9GS, 9GC, 9GO, 9HD, 9HT, 9HS, 9HN, 9HY, 9HJ, 9HI, 9HW, 9I, 9IF, 9IP, 9IT, 9IX, 9IG, 9JA, 9JB, 9JU, 9JT, 9KF, 9KO, 9KV, 9KD, 9KS, 9KM, 9LC, 9LQ, 9MH, 9NQ, 9OY, 9OS, 9PY, 9PC, 9PV, 9QR, 9RP, 9RQ, 9UY, 9VY, 9WV, 9WO, 9WU, 9YA, 9ZT, 9ZU, 9ZG, 9ZV, 9ZL, 9ZJ, 9ZC, 9ZP, 9ZX.

1AW, HARTFORD, April 5th to May 3d.

(1CK), (1CM), 1EK, (1JQ), 1KAY, (1QP), (1WP), (1YB), (1HAA), (2JU), 2XJ, (NSF), 3EH, (3BZ), (3FG), 3EN, (3GX), 3HJ, (8KM), (3NB), (3NV), (3NX), 3SJ, 3BO, (3CB), 3DU, (3DA), (3ER), (3EY), (3EN), 3FO, (3IK), 3IN, (3MT), (3ND), 3PP, 9QJ, 3RW, (8WY), (3XU), 3ABM, 3CHH, (9LQ).

8DJ, CAMBRIDGE, OHIO

1ZS, 2DA, 2DS, 3GX, 4AB, 4AE, 4AG, 4AT, 4BZ, 4YA, 5BH, 5BT, 5DA, 5BZ, 5BS, 5YA, 5YE, 5AG, 5AC, 5AD, 5AV, 5BC, 5BP, 5CB, 5CP, 5CV, 5DA, 5DE, 5DH, 5DR, 5DV, 5EC, 5EF, 5EO, 5ER, 5FD, 5GJ, 5GS, 5GT, 5HG, 5HH, 5HO, 5IK, 5JB, 5JT, 5KP, 5LA, 5LJ, 5LV, 5LX, 5MN, 5MT, 5QJ, 5TN, 5UD, 5UO, 5XA, 5XF, 5XU, 5YI, 5ZC, 5ZV, 8ZD, 9AM, 9BE, 9DF, 9HJ, 9HR, 9LV, 9RP, 9VC, 9WC, 9ZJ, 9ZL, 9ZN, 9ZW.

CANADIAN 3AB, TORONTO, additional

2XB (C.W. modulated C.W. and voice), 2XX (C.W.), 3BZ, 3DH, 3GX, 3HJ, 3DZ, 3LA, 3MA, 3MT, 3NR, 3SH, 3WY, 3XA, 3YV (C.W.), 3ZH, 3AU, 3CE, 3MH.

3EI, PHILADELPHIA

1AE, 1AK, 1AW, 1OW, 1RN, 1ZA, 2BM, 2IR, 2JU, 2PL, 2TF, 2XX, 3BZ, 3EN, 3NB, 3BP, 3CC, 3DA, 3EN, 3ER, 3ES, 3FF, 3HG, 3JQ, 3LI, 3LJ, 3MT, 3SD, 3WO, 3XA, 3XK, 3XU, 9HW, 9ZJ, 9ZL, 9ZN.

2AIZ, BROOKLYN

1AE, 1AG, 1DR, 2AN, 2AS, 2BK, 2CT, 2DA, 3EA, 3DM, 3DN, 4BC, 9DF.

Carry 'Em With You

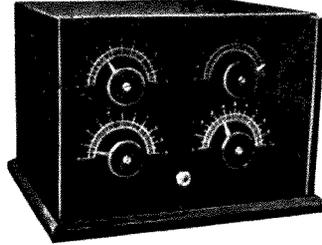

Portable Receiver Type PR-1.

When you go on that long-planned summer trip don't leave your radio friends behind. Take them with you by means of our portable regenerative receiver.

This instrument complete with Armstrong regenerative tuner, audion detector, tube, filament storage battery and plate battery.

Set it up on board ship, with the rail as aerial; in camp with a one wire aerial between trees or anywhere you may be located.

Its special regenerative feature makes it so sensitive that **REAL LONG DISTANCE RECEPTION IS POSSIBLE EVEN ON A SMALL ANTENNA.** Range 200-700 meters.

Price, Complete, F.O.B. Chicago.....\$60.00

Licensed under Armstrong U. S. Patent No. 1,113,149 and U. S. Application Serial No. 807,388.

Write for our new Bulletin J-20. Just out!

CHICAGO RADIO LABORATORY
1316 CARMEN AVENUE

5525 Sheridan Road (Testing Station 9ZN)

CHICAGO, ILL.,

U. S. A.

"JUPITER" STRANDED AERIAL WIRE

1AW
Uses
"Jupiter"
Wire



SPECIAL PRICE

Until July 1st

1c per ft., \$9.00 per M.

REGULAR PRICE

After July 1st

1½c per ft., \$12.00 per M.

Seven Strands No. 22 Solid Copper

Shipping Weight, 15 lbs. per 1000 ft. Be sure and include postage. No C.O.D.'s. Orders filled in order received until supply is sold.

LEE A. BATES, SOLE AGT. 8 Moen St., Worcester, Mass.

THE JONES CABINET LONG WAVE RECEIVING TRANSFORMER

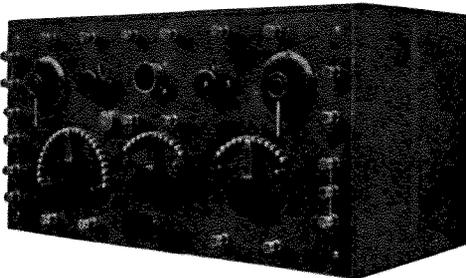

For DAMPED or UN DAMPED Wave Reception

A carefully wound Receiving Transformer with an approximate Wave Length of from 200 to 8000 Meters Equipped with Variable and Fixed Condensers Rheostat and Grid Leak. Fitted to take the latest MARCONI Vacuum Tube. Bakelite Panel, Silver Plated Switches and Contacts, Mission Oak Cabinet. Entire Apparatus built within Metal frame to permit easy removal. Model "D", as illustrated, SIXTY DOLLARS, Net. Model "E" fitted with Modern "DEAD END" Switch and High Grade Hot Wire Ammeter, Eighty-Five Dollars net.

New Bulletin sent on request.

THE JONES RADIO CO., 384 Monroe Street, BROOKLYN, N. Y.

Perfect Tone *Increased Range* *Low Decrement*

You have heard the piercing tone of a synchronous spark. You know the superior characteristics of synchronous spark transmitters. Heretofore the bulk and expense of a motor generator and the practical necessity of D. C. supply have prevented the use of such transmitters by amateur stations.

The



Synchronous Rotary Gap

Type TGAC

possesses all the advantages to be gained by the use of motor-generator equipment with none of the expense. You can use the Grebe Synchronous Gap on your A. C. Line.

Ask your dealer to show you this gap.

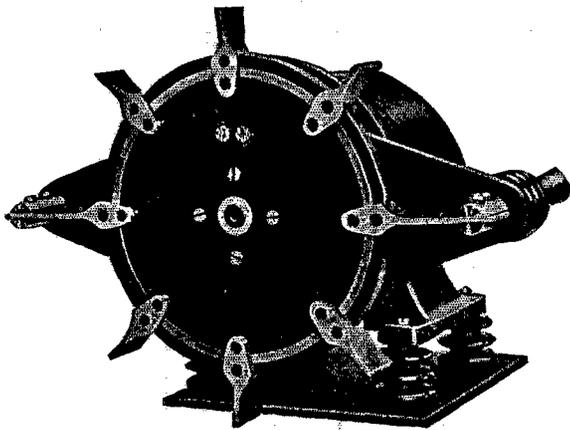

**Doubleday-Hill Electric Co.,
Pittsburgh, Pa.**

**Holt Electric Utilities Co.,
Jacksonville, Fla.**

**Hurlburt-Still Electrical Co.,
Houston, Texas.**

**Manhattan Electrical Supply Co.,
New York, Chicago, St. Louis.**

**Pacent Electric Co., Inc.,
New York City.**

**Geo. W. Parezo & Co.,
Washington, D. C.**

**F. D. Pitts Co., Inc.,
Boston, Mass.**

A. H. GREBE & CO., Inc.

74 Van Wyck Blvd.,

Richmond Hill, N. Y.

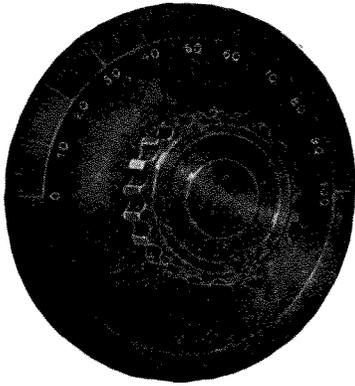

Indicating Dials

Make your radio apparatus up to date. Indicating Dials now available at a reasonable price.

Made of fine black polished composition with radial lines and figures accurately engraved and filled with brilliant white. Diameter of dial is 3 inches and they are $\frac{1}{8}$ inch thick. Have Bevelled edge. We can furnish dial alone or with fine Bakelite Knob mounted. This knob has a set screw to clamp shaft of instrument to which dial is to be applied.

3 inch Dial only75 cents
Postpaid
3 inch Dial with Knob mounted, \$1.30
Postpaid

If your dealer cannot supply you send us his name with your order. Immediate deliveries.

OUR NEW CATALOG, now ready for distribution. Contains 24 pages of real live, up to the minute illustrations, news and descriptions of all standard Radio parts, including the above Indicating Dial.

Sent anywhere upon receipt of 10c.

FOR SALE AT ALL RADISCO AGENCIES AND BY

A. H. Corwin & Co.

4 West Park Street

Newark, N. J.

Shoot Without Noise

Do away with that old fashioned report, and the disturbance. Avoid flinching, improve your accuracy and enjoy precision shooting anywhere at any time with a

MAXIM SILENCER

Price, .22 cal., \$6. Send 6c. in stamps for catalog and booklet of humorous stories of noiseless shooting.

MAXIM SILENCER

The
Maxim Silencer Co.
50 Homestead Ave.,
Hartford, Conn.



NEW ELECTRODYNE

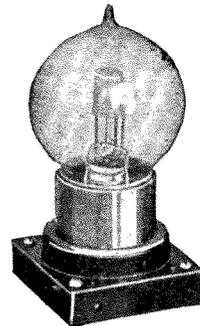

RECTIFIER TUBE

These tubes are used, generally in pairs, for rectifying commercial alternating current for supplying the plate circuits of Radio Telephone and C.W. Telegraph radio power tubes. They make

Motor Generator Unnecessary

These tubes will rectify up to 500 volts and carry 30 milliamperes each, normally, sufficient for most purposes.

Price, \$7.00 each.

Good delivery from stock.

Send at once for illustrated circular No. 14.

WIRELESS EQUIPMENT CO., Inc.
188-190 Greenwich St., New York, N. Y.

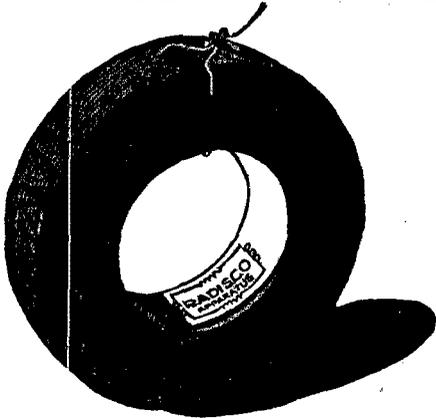

Two Famous Radisco Specialties

RADISCO COILS

conceded by several well known Radio Men to be far superior to any similar type of Inductances: Made in seventeen sizes, tapped and plain, Wave length range from 200 to 20,000 meters. Priced from 70c to \$4.85. Plentiful supply in stock at all Radisco Agencies.

RADISCO BETTER "B" BATTERY

is made according to Government specifications in two (2) sizes; $3\frac{1}{2} \times 2 \times 2\frac{1}{2}$ " and $6\frac{1}{2} \times 4 \times 3$ ". A first class 15 cell, 5 group battery. VARIABLE VOLTAGE (Pat. App. For) is a special feature of this battery which enables you to provide critical voltage regulation for your Vacuum tube by means of a switch connection with cells, taps of which have been taken off. Very economical and convenient. If one cell goes bad just test each group of 3 cells and short circuit the bad one. Price Small size \$1.40. Large size \$2.40 at any agency—or if ordered by mail include postage for 2 pounds on small size and 5 pounds on large size. Canadian prices somewhat higher. RADISCO AGENTS carry only apparatus of proven merit. Look for the Radisco trade mark on all parts you buy and be sure of getting efficient apparatus. Below are listed a few of the reliable firms who carry the RADISCO COILS, Better "B" Batteries, and are our Agents for all other standard apparatus of merit.

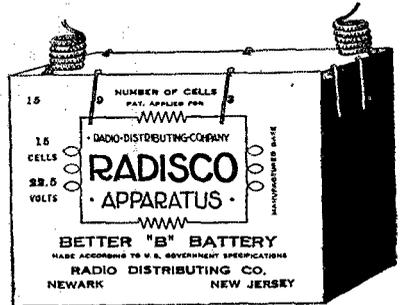

Communicate your wants to them

ALBANY, N. Y.

E. L. Long,
21 Magnolia Terrace

ATLANTIC CITY, N. J.

Independent Radio Supply Co.,
118 So. N. J. Ave.

BALTIMORE, MD.

Radio Engineering Co.,
614 No. Calvert St.

BIENVILLE, QUEBEC, CANADA,

Canadian Radio Mfg. Co.

BOSTON, MASS.

Atlantic Radio Co.,
88 Broad St.

BROOKLYN, N. Y.

Kelly & Phillips Electric Co.,
312 Flatbush Ave.

BRONX, NEW YORK,

Amateur Wireless Equipment Co.,
1390 Prospect Ave.

CHICAGO, ILL.

Chicago Radio Laboratories,
1316 Carmen Ave.

EUREKA, PEORIA, ILLINOIS

Klaus Radio Co.

HAMPTON, N. H.

De Lancey Felch & Co.

LOS ANGELES, CALIF.,

The Wireless Shop,
511 W. Washington St.

McKEESPORT, PA.

K & L Electric Co.,
427 Olive St.

NEWARK, N. J.

A. H. Corwin & Co.,
4 West Park St.

NEW CASTLE, PA.

Pennsylvania Wireless Mfg. Co.,
507 Florence Ave.
"8HA"

NEW ORLEANS, LA.

L. A. Rose,
121 Camp St.

PITTSBURGH, PA.

Radio Electric Co.,
4521 Forbes St.

PHILADELPHIA, PA.,

Phila. School of Wireless Tel.
Broad & Cherry Sts.

PROVIDENCE, R. I.

Rhode Island Elec. Equip. Co.,
45 Washington St.

SPRINGFIELD, MASS.,

Electric Service Co.,
585 Amory St.

SCRANTON, PA.

Shotton Radio Mfg. Co.,
P. O. Box 3,
Branch at 8 Kingsbury St.,
Jamestown, N. Y.

TORONTO, ONTARIO, CANADA,

The Vimy Supply Co.,
585 College St.

WASHINGTON, D. C.

National Radio Supply Co.,
808 9th St., N. W.

WICHITA, KANSAS,

The Cosradio Co.,
1725 Fairmount Ave.

If none of the above agencies are in your vicinity, communicate with
RADIO DISTRIBUTING COMPANY,
Newark, N. J.

CLASSIFIED ADVERTISEMENTS

Five cents per word per insertion, in advance. Name and address must be counted. Copy must be received by the 10th of month for succeeding month's issue.

BARGAIN: Mission cabinet receiving set, Bakelite panel, special regenerative circuit, 100 to 2500 meters, audion control incorporated, \$35.00, Davidson, 347 West 122nd, N. Y. City.

SELL—1 KW Clapp-Eastham, 1/2 KW Packard transformers, spark coils, interrupter, phones, amplifier, other apparatus. Clyde Delancey, Hampton, N. H.

MUSICIAN—Want Double-bell Euphonium, Typewriter and cash in exchange. Roy Waller, Cambridge, Ohio.

FOR SALE—Paragon Regenerative Receiver (used two weeks) same as new, \$40.00. Brandes Navy Phones, \$9.00, fine condition. C. R. Mathers, 206 Ave. D, Miami, Fla.

Use Luminous Paint on your instruments etc. and avoid shocks, 30c bottle, sample 2c. United Specialty Company, Department 20, Racine, Wisconsin.

AMATEURS—We will sell your radio apparatus for you on commission basis, or purchase outright. All goods sent us will be placed on exhibition in the used instrument department of our Boston retail store, where it will be seen by many customers. Send full description. Radio Equipment Co., 630 Washington, St. Boston, Mass.

WANTED—Cheap, Grebe CR-4 cabinet 1/2 KW Thordarson transformer and condenser. Henry Koch, Jr., 200 Stockholm St., Brooklyn, N. Y.

FOR SALE: Two Audiotrons, never used, \$4.25 each postpaid. Murdock variable, \$3.25; Knapp motor; V. P. Kodak; A-1 Autographic Kodak; Binoculars; other goods. All in perfect working order. S. B. Logan, Box 71, Little Rock, Ark.

CLUB OFFER—QST AND PACIFIC RADIO NEWS FOR ONE YEAR FOR \$2.75 IF ORDERED TOGETHER. QST, 61 WAVERLY BLDG., HARTFORD, CONN.

FOR SALE: Brand new shop-model regenerative receiver, Litz wound variometer type. Wavelength 150-600 meters. Robert Gallery, Bethesda, Md.

FOR SALE—Complete receiving outfit, new and perfect, consisting of one National Electric 250 to 3000 meter receiver with calibrated secondary value \$290., price \$100. One Navy type audion and oscillator cabinet with ammeter etc. value \$70, price \$35. One two stage amplifier value \$55, price \$25. One Baldwin Mica headset value \$20, price \$12. Five receiving vacuum bulbs value \$10, price \$5. Three transmitting bulbs value \$15, price \$7. Money refunded if not satisfactory. A. J. Phillips, P. O. Box 22, Boston 24, Mass.

FOR SALE—Robbins & Myers 5 K.W. 600 cycle generator, no motor, 110 volt 45 1/2 amperes, separately excited, can be had at a very attractive figure, A1 condition, revolving field type. If interested write Ralph Brooke Austrian, 694 Broadway, 12th floor, N. Y. C.

FREE **POCKET HANDBOOK CATALOGUE** **Radio Handbook & Catalogue**

Contains much valuable radio information, tables and data. Describes a remarkable line of wireless instruments including "Red Head", "Phones, Arlington Tested Minerals, DeForest, Murdock and Signal Apparatus. Write for this book today. The Newman-Stern Co. Dept. Q S T Cleveland, O.

ARLINGTON TESTED CRYSTALS

Why buy minerals on a gamble? Be SURE when you put a crystal in your detector that it is EXQUISITELY SENSITIVE. Buy Arlington individually tested Minerals, Galena or Silicon, post paid on receipt of price.

35¢

THE NEWMAN-STERM CO. Dept. Q S T Cleveland, O.

Red Head Radio Phone

The accepted standard in wireless receivers. If they are not BETTER than anything you've ever seen return them for full cash refund. Our Radio Handy Book and Catalogue, free on request, describes them, and many other instruments.

\$7.00

The Newman-Stern Co. Dept. Q S T Cleveland, O.

SPECIAL OFFER ON BACK COPIES OF QST

See ad on page 85, May number, 13 copies, postpaid for a \$1 bill. QST, 61 Waverly Bldg., Hartford, Conn.

WANTED—"Hyrad" rotary disc. New VT. Barrett, 3150 Central Ave., Indianapolis, Indiana.

FOR SALE: Complete sending and receiving set. Will take Morse omnigraph in part trade or sell. E. Siemssen, Alden, Minnesota.

AMRAD G-1 Quenched Gap, almost new, \$14.50. Order quick! Edw. C. Jones, Jr., Fairmont, W. Va.

FOR SALE—Following NEW radio apparatus: 4 Grebe CR-2 regenerative receivers, \$40.00 each. 3 Radio Apparatus type 36 valve detectors, each equipped with two audio-tron tubes, \$20.00 each. 3 type R, 1/2 K.W. Thordarsons, \$17.50 each. Every instrument carries full factory guarantee. Cash only. P. A. Stover, Marengo, Iowa.

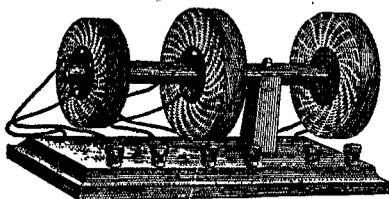

The B & H Mounting for Radisco, DeForest and other coils

THE single support allows easy change of coils with ample length of rod to allow very loose coupling. The square rod prevents coils from turning. Special Stands and Centers Made to Order.

THE MOST EFFICIENT STAND ON THE MARKET

| | Radisco | DeForest | Special |
|--|---------|----------|---------|
| No. 1R Complete with 6 Binding posts, flexible leads and 3 Coil centers, \$6.00 | \$6.00 | \$6.50 | \$7.00 |
| No. 2R Complete with 3 Coil centers, but without flexible leads or Binding posts | 4.00 | 4.50 | 5.00 |
| No. 3R Extra Coil Centers, (give size) | .35 | .40 | .50 |

Parcel Post Charges on 2 lbs.

HIGH FREQUENCY CABLE (LITZ)

| | FOR JUNE ONLY |
|---------|---------------|
| 10-38 | 1R.....\$5.00 |
| 16-2-38 | 2R.....3.50 |
| 16-3-38 | |

DSC, Enameled—any other size and covering to Order.

Send stamp for further particulars.

WIRELESS

A. T. HOVEY

SUPPLIES

61 BELVIDERE STREET,

Dept. B,

BOSTON-17-MASS.

Here's a Receiver With Eight Distinct Advantages

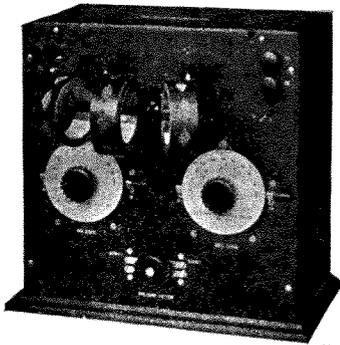

Tuner; Type T-200. Size 13 3/8" x 12 1/2" x 8". Price, \$77.50 Complete, without Coils.

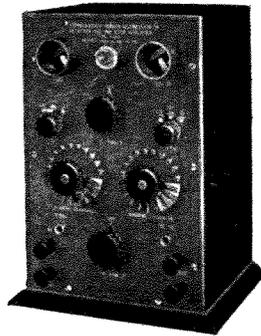

Combination Audion-Ultra Audion and One-step Amplifier; Type P-300. Size 12 1/2" x 9 3/8" x 7 3/4". Price, \$73.50. Audion Tubes, \$7.00 each extra.

A COMPLETE, compact and inexpensive Receiving Set having improvements and refinements which increase efficiency and eliminate many objectionable features of receiving apparatus.

No longer is it necessary for you to have two or three expensive, inconvenient and cumbersome tuners spread all over your operating table when working all wave lengths. With this new DE FOREST tuning system you can work any and all wave lengths with the one tuner shown above. This Set has distinct advantages of minimum table space and of convenience in coupling not equalled in any other type of apparatus. The entire Set is complete in the two cabinets shown here. The Genuine DE FOREST "Honey Comb" Coil System of Tuning is employed—no superior system has ever been invented.

This is a new DE FOREST production embodying a unique and superior tuning system. Possession of this Set means more efficient and satisfactory operation; more pleasure and practical benefit for every Amateur. Its price is remarkably reasonable for the quality of apparatus and the distinct advantages the Set offers. Find out more about it at once.

Send for a DeForest Manual

a 64-page book containing full information about this and many more DE FOREST instruments, as well as giving much useful information for the Amateur. Mailed anywhere upon receipt of 10 cents.

These Eight Advantages

ARE NOT DUPLICATED IN ANY RECEIVING SET AT DOUBLE THE PRICE:

- 1 Responds to any wave length, 150 to 25,000 meters.
- 2 More flexible in coupling.
- 3 Lower distributed capacity; less high frequency resistance and decrement values.
- 4 Eliminates cumbersome switches, inefficient taps and losses from dead ends.
- 5 Vernier Air Condensers of unusual design.
- 6 Signals come in louder and clearer.
- 7 Superior in efficiency, workmanship, convenience and appearance.
8. Requires minimum table space; note sizes of cabinets.

DeForest Agencies are located in all Principal Cities. Ask your regular Electrical Dealer to get you DE FOREST Apparatus.

DE FOREST RADIO TELEPHONE & TELEGRAPH COMPANY

Inventors and Manufacturers of High Grade Radio Apparatus

1407 SEDGWICK AVENUE,

NEW YORK CITY

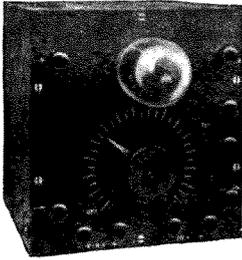

RADIO INTERNATIONAL RADIO

VACUUM TUBE DETECTOR or SINGLE STAGE AMPLIFIER

Single tube Detector and Amplifier Units are among the most useful of the Interchangeable panel instruments in the International Experimental Apparatus Line.

READY FOR IMMEDIATE DELIVERY.

AUDION DETECTOR RTD-102-A.....\$15.00

SINGLE STAGE AMPLIFIER RTA-104-A..\$26.00

F.O.B. NEW YORK CITY

Write to Department 23 for our new completely illustrated six page bulletin index.

International Radio Telegraph Company
326 Broadway New York City

The Largest Radio Supply Stock In The South

COMMERCIAL AND AMATEUR WIRELESS
APPARATUS OF ALL KINDS

Holt Electric Utilities Co. Jacksonville, Fla.

BAKELITE-DILECTO

the Standard Insulating Material on all Radio Work

Water-proof, permanent, strong, used by all important Manufacturers of Wireless Apparatus and others requiring the **utmost** in Insulation. Furnished in Sheets, Rods and Tubes.

THE CONTINENTAL FIBRE CO.

233 Broadway
New York City

525 Market St.
San Francisco, Cal.

119 Fairview Ave., West Toronto, Ont., Canada.

NEWARK, DELAWARE

332 So. Michigan Ave.
Chicago, Ill.

411 S. Main St.
Los Angeles, Cal.

316 Fourth Ave., Pittsburgh, Pa.

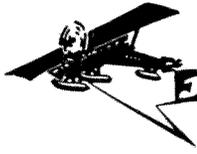

**EASTERN
RADIO**

TEL.
BACK BAY
5 9 6 4

899 BOYLSTON ST.
BOSTON, MASS.

**INSTITUTE
RADIO**



LEARN WIRELESS !!

Under former U. S. Government and Marconi Experts; men who have spent YEARS in the SUCCESSFUL training of THOUSANDS of Wireless operators. OUR GRADUATES now in all parts of the world as INSTRUCTORS, RADIO INSPECTORS, ENGINEERS, OPERATORS, etc., etc.

The following represents a portion of the modern high grade Commercial storage battery charging apparatus now in use at the Eastern Radio Institute.

Standard type, storage battery switchboard panel for Wireless Service.

REMEMBER !!

The EASTERN RADIO INSTITUTE is the OLDEST, LARGEST, and BEST EQUIPPED school of its kind in New England, has already thousands of satisfied graduates to its credit, has always placed EVERY graduate in a good position and kept them employed and can guarantee these positions. This speaks for itself.

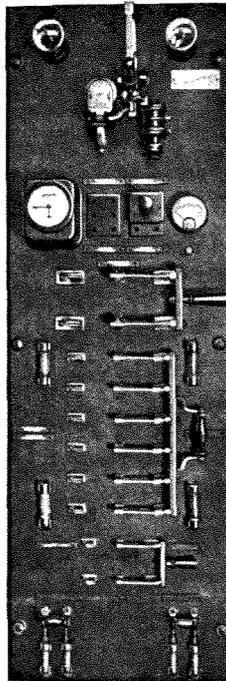

WHEN !!

you realize that our DAY or EVENING school prepares you quickly and efficiently for positions paying from \$100 to \$150 per month, food and quarters besides, and that the entire expense of the course can be more than returned to you in one month's salary, does not this appeal to you?

“Send in your enrollment today”

“Send in your enrollment today”

DAY AND EVENING CLASSES. ADVANCED CLASSES IN RADIO THEORY OR CODE. “SPECIAL SUMMER CLASSES”.

START ANY MONDAY. OUR PROSPECTUS FOR THE ASKING.

Series No. 3

SAVE RADIO \$ \$ BY CONSULTING

THE

Radio Buyer's and Builder's Handbook

NOW

(by an Amateur of fourteen years experience)

The only book which
DESCRIBES AND SIMPLIFIES
many

OUT

New Radio Inventions and Improvements

including

NEW HOOKUPS to MAKE all the APPARATUS you use MORE EFFICIENT

This book contains nearly 200 pages, many diagrams, and over 30 full page half-tones of simple efficient apparatus. Inc. 16 scale cutouts—in black and white.

THE FIRST THOUSAND WILL BE \$1.00 PER COPY.

See Radio dept. June Popular Science for my first new stories.

PARTIAL CONTENTS.

A 90c **EXPERIMENTAL VACUUM VALVE DETECTOR**, sensitive and made in a few minutes from finished parts easily obtainable at any time.

Radio "Tricks of the Trade"—Solid Silver Switch Points for 3 to 5 cents each.

A **NEW Combination Switching Key**—Low Cost Amplifying Transformer. New!

Variable Duplex Oil Condensers for Sending and Receiving with Switch.

How and Where to Buy Second Hand Radio and Electrical Apparatus Cheap.

A **Rectifying Gap Motor** which supplies "B" Battery current or "A" current.

A **Simple Calibrated Hot Wire Ammeter**, not affected by weather. Very Fine!

Many New and Good Ideas on "A" and "B" Batteries of Little Cost.

Commercial Type Rotary Quenched Gaps of Low Cost, Like the Above.

New Cheap Honey-Comb Type Receiving Coils for all Waves. Silver Contacts.

Second-hand Electrical Motor-Generators up to ½ H.P. for \$6.00. Modern Type.

Also many other methods of saving time and money on **BETTER APPARATUS.**

R. U. CLARK 3rd, OR
11 Barnes Rd., Newton, Mass.

YOUR DEALER
Your Radio Club
Your Public Library

"COSRADIO"

Mark of Quality

The Radio Supply House of the
Middle West

IMMEDIATE DELIVERY

Transmitting Sets

Receiving Sets

Complete or Parts

RADISCO AGENTS

Satisfaction Guaranteed

THE COSRADIO CO.

WICHITA,

9-BW

KANSAS.



Stromberg-Carlson RADIO HEAD SET

A set that combines your ideal of extreme sensitiveness with a strong, durable construction that stands the gaff of continuous service ashore or aboard ship.

All operating parts housed in dust-proof and moisture-proof aluminum cases. The diaphragm is mounted metal-to-metal in such a way that temperature variation will not disturb the air-gap adjustments. Non-conducting spool heads and slotted pole tips eliminate 90 per cent of the eddy current losses that are found in other head sets.

Each set is wound to a resistance of 2,000 ohms with pure copper wire and furnished complete with 6-foot moisture-proof cord attached. Tested for matched diaphragm tuning and operating qualities in actual service before shipment.

Send \$12.00 for sample set for trial in your own station—satisfaction guaranteed or your money refunded upon return of set. Write for Bulletin 1106 giving full particulars.

Stromberg-Carlson Telephone Mfg. Co.
Rochester, N. Y. Chicago, Ill. Kansas City, Mo. Toronto Ont.

RADIO APPARATUS

Distributors of reliable radio apparatus for experimenters in every branch of the radio field

"PITTS CO"

The sign of service and
immediate delivery!
All we ask is a trial!



REMEMBER!

We carry an immense
stock and can make
immediate delivery on
every item listed!

AMPLIFIERS

- No. P-200 DeForest 2 step with "B" Battery but without tubes.....\$69.50
- No. RORJ Grebe (new type) 2 step, with cam switch control.....\$45.00
- No. RORE Grebe single step audio frequency amplifier.....\$23.00

AMPLIFYING TRANSFORMERS

- No. A-2 Acme mounted.....\$7.00
- Acme unmounted.....\$4.50
- No. 226-W Federal.....\$7.10
- No. Y-739 Clapp-Eastham mounted.....\$7.50
- No. Y-739-A Clapp-Eastham unmounted.....\$5.00

ANTENNA CHANGE-OVER SWITCHES

- No. 463 Murdock, capacity 1 K.W.....\$4.50
- No. Y-658 Clapp-Eastham, new type bakelite base, three poles.....\$12.00

AUDION CONTROL PANELS

- No. P-400 DeForest audion panel without cabinet.....\$9.95
- No. P-401 DeForest audion panel, same as above with oak cabinet.....\$14.25
- No. P-402 DeForest audion panel with 40 volt "B" battery in oak cabinet....\$19.95
- No. P-500 DeForest audion-ultraudion panel with 20-40 volt "B" battery with oak cabinet.....\$25.00
- No. RORA Grebe vacuum tube control panel.....\$11.00
- No. RORH Grebe vacuum tube control panel with 40 volt "B" battery.....\$17.00

BUZZERS

- No. 178 General Radio pure tone.....\$1.95
- No. 77 Mesco High frequency.....\$2.05
- No. 5 Century High frequency.....\$1.95
- No. 9010 High pitch, watch case, brass.....\$0.70
- No. 9011 High pitch, nickel plated.....\$0.70

CONDENSERS

- No. CV-500 DeForest .0005 MF. unmounted suitable for panels.....\$6.25
- No. B-1 Bowman .001 MF. unmounted suitable for panels.....\$3.95
- No. B-2 Bowman .0005 MF. unmounted.....\$2.95
- No. 366 Murdock .001 MF. in solid case mounted.....\$4.75
- No. 368 Murdock .0005 MF. mounted.....\$3.75
- No. Y-300 Clapp-Eastham balanced unmounted .0006 MF.....\$7.50
- No. Y-800A Clapp-Eastham balanced unmounted .001 MF.....\$9.50
- No. Y-800B Clapp-Eastham balanced unmounted .0015 MF.....\$11.50

Important! Every article listed sent to any part of the United States postage prepaid or express prepaid. We want your business!

Series No. 1 (Keep this page and watch for next month's)

SEND 6 CENTS IN STAMPS FOR NEW CATALOG!

HONEY-COMB COILS

- LITZENDRAHT WIRE. (While they last.)
- LL-75 330-1030 meters.....\$1.60
 - LL-100 450-1460 ".....\$1.70
 - LL-150 660-2200 ".....\$2.00
 - LL-200 930-2850 ".....\$2.10
 - LL-250 1300-4000 ".....\$2.30
 - LL-300 1550-4800 ".....\$2.50
 - LL-400 2050-6300 ".....\$2.80
 - LL-600 4000-12000 ".....\$3.00
 - LL-750 5000-15000 ".....\$3.20
 - LL-1000 6200-19000 ".....\$3.50
 - LL-1250 7000-21000 ".....\$3.90

Note:—these are the genuine DeForest litz coils.

INDUCTANCE COIL MOUNTINGS FOR HONEY-COMB COILS

- No. LC-101 DeForest, mounted on oak base with gears to hold three coils...\$13.00
- No. LC-201 DeForest, same as above but with primary condenser switch mounted on base.....\$15.00
- No. LC-100 Same as LC-101 but without base.....\$10.00
- No. ULC-100 Same as LC-100 but mounted on unit panel.....\$10.75
- No. ULC-200 Single inductance coil mounting on unit panel.....\$2.00
- No. ULC-300 Double inductance coil mounting on unit panel.....\$4.80
- No. ULC-400 Triple inductance coil mounting on unit panel.....\$5.60

DE FOREST UNIT PANEL UNITS

- No. US-500 Primary condenser or vario-meter switch.....\$3.00
- No. UCS-1500 Loading or Bridging condenser.....\$6.25
- No. US-200 Master anti-capacity switch.....\$4.40
- No. S-200 Master anti-capacity switch unmounted.....\$3.00
- No. UD-100 Crystal detector with crystal, \$4.30
- No. UR-100 Audion tube receptacle.....\$2.95
- No. US-500 "B" battery switch.....\$3.00
- No. UF-100 "A" battery filament rheostat, \$3.80
- No. US-400 Tickler or audion-ultraudion 3 point switch.....\$2.25
- No. U-200 "A" battery switch and telephone jack.....\$3.25
- No. U-300 battery switch and telephone binding posts.....\$2.20

F. D. PITTS CO., INC.
12 PARK SQUARE, Dept. A, BOSTON, 11, MASS., U. S. A.

Just Like

Finding Money

An organization for wireless men rendering personal, intimate and humanized service with every article it sells.

We are distributing a high grade line of Commercial and Amateur radio apparatus including such well known makes as Kilbourne & Clark, DeForest, etc.,—apparatus in accordance with the latest designs and theories, quality, workmanship and materials—that guarantees you of maximum results under working conditions.

When in town drop in and see us. We will be here to greet you with a glad hand, ready to render a "Personalized Service" that makes you a satisfied customer.



"Quality Radio Apparatus
and Service"

Our new catalog is "different" and is well worth the 10 cents we ask for it. Send for your copy today.

The International Electric Company

EUGENE DYNNER, President.

226-B Fulton Street,

New York, N. Y.

Attention Amateurs!

UTTMARK'S NAUTICAL ACADEMY RADIO INSTITUTE

Telephone
Bowling Green 8079

8 State Street,
New York City.

Let us prepare you for your first grade commercial license. We have just the kind of course you have been looking for. Modern apparatus and experienced instructors. Day or evening classes. Write, phone or call for our illustrated prospectus.

UTTMARK'S for RADIO NAVIGATION

STORAGE BATTERIES FOR WIRELESS SERVICE

Batteries especially adapted for the amateur operator are described and illustrated in our new Bulletin No. 175, copy of which will be furnished on request.

THE ELECTRIC STORAGE BATTERY COMPANY

The largest maker of storage batteries in the world

1888 PHILADELPHIA, PA. 1920

New York Boston Chicago Washington Denver San Francisco Cleveland
Atlanta Pittsburgh Minneapolis Kansas City Detroit Rochester
Special Canadian Representative, Chas. E. Goad Engineering Co., Ltd., Toronto, and Montreal

Licensed by De Forest AUDIOTRON

The Original Tubular Vacuum Amplifier

The AudioTron vacuum tube is now manufactured and sold as a genuine audion licensed under DeForest Patents Nos. 841387 and 879532 to be used only for amplification in radio communication and only for experimental and amateur purposes and only in audio frequency circuits.

The Audiotron has a double filament of special thorium tungsten and the operating life is over 2000 hours. No special socket is required. The electrical and mechanical dimensions result in a heavy plate current and corresponding signal strength. Plate voltage under 40. Our guaranty insures satisfaction.

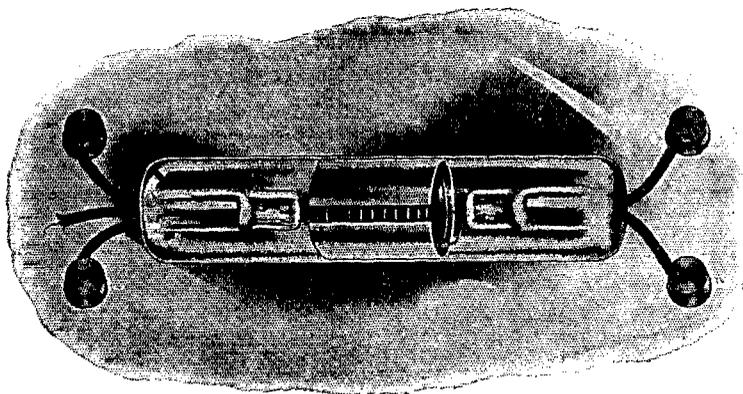

PRICE \$6.00 EACH

If your local dealer cannot supply you we will ship **postpaid** when cash accompanies order.

The AudioTron Exclusive Guaranty: Each and every Audiotron is guaranteed to arrive in good condition and to prove fully satisfactory. Replacement of unsatisfactory tubes will be made free of charge.

AUDIOTRON AUDIO-FREQUENCY TRANSFORMER..... \$7.00

Laminated closed core, two coil type.

DEALERS:—Write for our attractive trade Proposition.

AUDIOTRON SALES CO.

Lick Bldg.,

San Francisco, Calif.

The G. A. Standardized Condenser

Gives that degree of satisfaction and pride that you have a right to expect from an expensive instrument.

Designed for general use in receiving or vacuum tube transmitting circuits, it is at the same time a precision laboratory condenser. The mechanical design makes it easy to mount in a case or behind a panel. Sufficient tension is provided to keep the plates from turning when in a horizontal position.

The plates, of 1/32-inch aluminum, are widely spaced on extra heavy washers and supports. Both fixed and rotating plates are in units, so that they are not loosened when the end pieces are removed. Rotating plates are keyed to the shaft. The large bearings are adjustable.

Moulded composition end plates, or metal end plates with insulating bushings, often cause losses of 50% of the energy at 200 meters. The G. A. Standardized Condenser has solid extra grade Bakelite end plates 3/4 inch thick.

SPECIFICATIONS: Small size 0.00001 to 0.000585 mfd., 29 plates, overall height 3 1/2 inches. Large size, 0.000015 to 0.00115 mfd., 59 plates, overall height, 6 3/4 inches. Bakelite end plates 3 3/4 inches diameter. Shaft 3/8 inches diameter, protrudes 1 inch from end plate. Hole in end threaded for 6-32 screw. Will take Radisco or Grebe knobs.

PRICE: Small size—\$8.85, wt. 2 lbs. Large size—\$13.65, wt. 4 lbs. Calibration curve for either size—\$0.50.

To reach the G. A. Retail Store, take the Broadway Subway or 5th Avenue Bus to 181st Street.

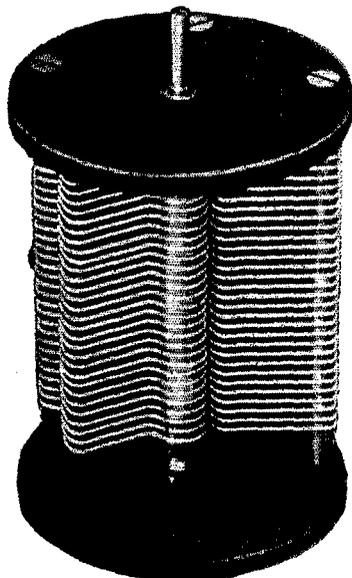

The new G. A. Bulletin is now ready or distribution. Audion Detectors, Amplifiers, B-Batteries, Bakelite, high frequency cable, wire, brass stock, screws, nuts, etc. are listed. Send 8c in stamps.



The General Apparatus Company
4310-T Broadway at 183rd St., New York City

PARKIN RHEOSTAT \$1.00 POSTPAID

Why Pay More?
When this is the easiest mounted, smoothest running, best rheostat on the market.

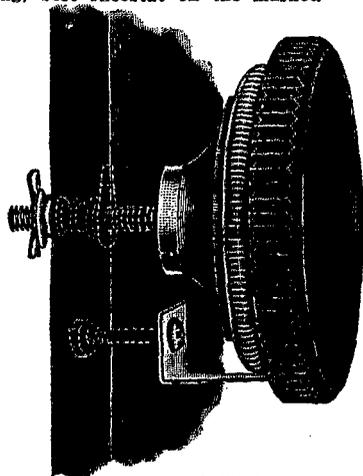

(Actual Size)

No. 35 PARKIN PANEL TYPE RHEOSTAT (Patented March 30 1920) has easily renewed resistance unit mounted on back of MOULDED BAKELITE KNOB. Shaft is moulded into knob, cannot come loose. "OFF" position provided. 860 degree rotation insures fine adjustment. Write for descriptive circular of audion panels, switches, binding posts, contacts, etc. Dealers: Write for proposition.

PARKIN MFG. CO., San Rafael, Calif.

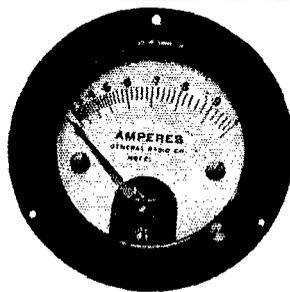

Unusual Opportunity

to secure a

General Radio Co. Type 127A

HOT WIRE AMMETER

Special Price \$5.00—Regularly \$10.00

A portion of these meters are 0-1 ampere and a portion 0-2.5 amperes. They are mounted in flush cases, new, in good condition, and were left on our hands by termination of the war. Exactly like a large number supplied by us to the U. S. Government.

Dealers send for proposition.

Have you received our new Bulletin 901?

General Radio Co.

WINDSOR STREET

Cambridge 39 Massachusetts

MAGNAVOX

Telemegafone

Most Efficient Telephone Receiver and Loud Speaker

FOR RADIO
RECEIVING

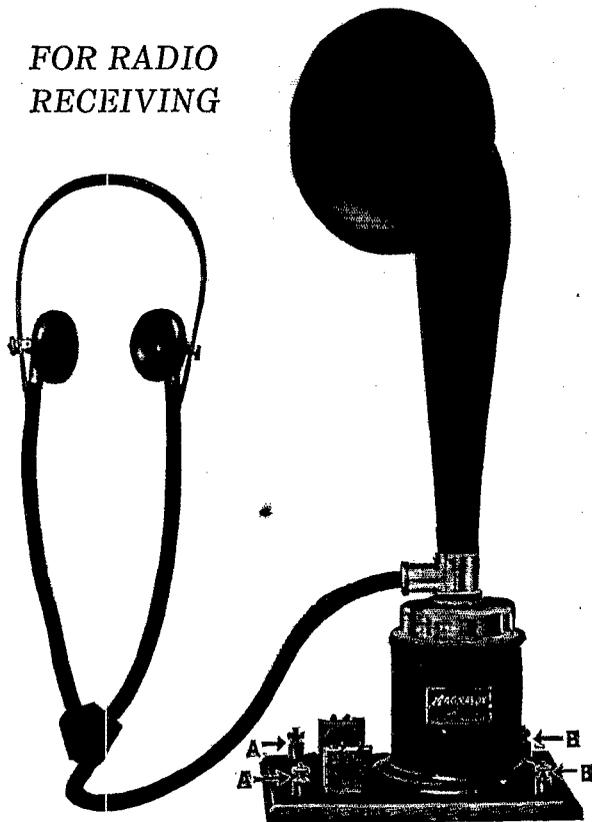

PRICE \$75.00

Connect AA to your receiving set where your present head-set is connected

Connect BB to a 6-volt storage battery

Immediate Delivery—Order Early



PATENTED IN U.S.A. AND FOREIGN COUNTRIES

2701-2759 East Fourteenth Street, Oakland, California

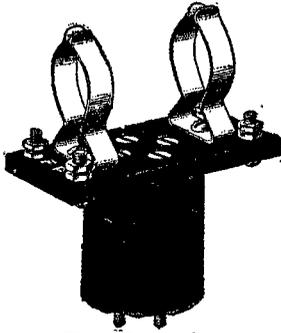

Pat. App. for.

Attention Amateurs!

This is the adapter which tubular bulb owners have been looking for

Price - - \$1.50

RADISCO AGENCY

We make special instruments to order



Eastern Agents

INTERNATIONAL ELECTRIC CO.

226 A Fulton St.,

Dealers write for propositions.

New York City

Amateur Wireless Equipment Co.

1390 Prospect Ave.,

Bronx, N. Y.

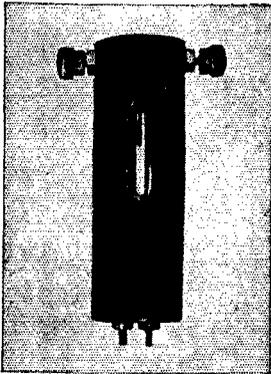

Radio Electric Adapters

Postpaid - - \$1.50

PITTSBURGH AMATEURS and others are invited to call at our new store and inspect the latest radio instruments.

Send 10c for our new catalogue.

"We make or sell Everything Radio"

The Radio Electric Company

3807 Fifth Ave.,

Pittsburgh, Pa.

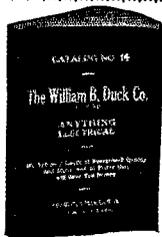

DUCK'S New Big 200 PP. Wireless and 100 PP. Electrical Catalog

Our 200 page exclusive wireless catalog mailed for 12c and our electrical catalog mailed for 6c, in stamps or coin. The largest, most elaborate and most complete radio catalog published.

Everything in wireless worth while is listed in this catalog. The experienced amateur will tell you to see our catalog before buying. You are thereby insured against an unwise purchase. It is the Beacon Light to guide you right in the selection of your wireless apparatus. No bigger or better values are obtainable elsewhere.

THE WILLIAM B. DUCK CO. 243-245 Superior St., Toledo, Ohio

**"WINN" PORTABLE
WIRELESS
SET**



\$50. "WINN" PORTABLE WIRELESS SET

WITH
MURDOCK
55-2000
OHMS
RECEIVERS

No.
149

It represents the very highest type of construction throughout, made complete in our own factory, of excellent materials, by expert workmen, under the direct supervision of R. E. Winn, each part being carefully tested to insure absolute reliability and dependability under all conditions of service in home station or field. Size of box, 8 x 9 x 11, handsome mahogany finish, all metal parts heavily nickel plated; weight, 16 lbs., handy carrying strap of heavy ribbed duck.

Sending Range 10 to 12 Miles

receiving range 200 to 300 miles under favorable conditions. Lightest portable set made of equal high quality. Offers amateurs and professionals alike a well made, beautifully finished, compact, efficient, Wireless set, which anyone would be proud to own and use.

Particularly valuable to Boy Scout organizations. Scouts in camp, on the march, or at home could keep in touch with other camps as well as the outside world. Calls for no special aerials. Complete instructions included, also copy of our binding guarantee—an insurance of satisfaction. PRICE, COMPLETE WITH PHONES, \$50.

"WINN" RECEIVING TRANSFORMER

This instrument gives good results, receiving wave lengths up to twenty-five hundred meters. To simplify the use of transformer for beginners, this one is to be used in place of tuning coil and tuning inductances where distances and sharper tuning are required. The aerial and ground are connected with the two binding posts below the primary. The secondary terminals connect with the two remaining binding posts. Contact is made by means of a slider mounted conveniently on top of the primary. All metal parts are heavily nickeled. Base and end pieces of birch highly polished.

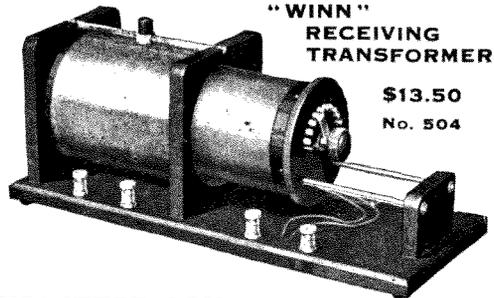

**"WINN"
RECEIVING
TRANSFORMER**

\$13.50

No. 504

"WINN" TRANSMITTER COIL

This coil is especially designed for wireless and high frequency work. Produces heavy, energetic spark. Capable of transmitting up to 25 miles under favorable conditions. Contact points on Interrupter extra large, of heavy platinum iridium. Interrupter is our own "WINN" design, and the most sensitive vibrator made. Transmitter complete with exception of Spark Gap and Key. Normal voltage required, 10 to 12 volts, although higher voltage may be used. Mounted in mahogany finished cabinet, with nickel plated mounting.

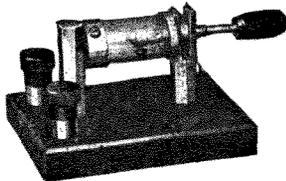

**"WINN" TRANSMITTER COIL
\$7.50**

No. 201

**"WINN" DETECTOR
No. 400 \$5.**

Our Detector is in a class by itself and is the outcome of long and careful experiments to produce an article which does away with all the objections of the ordinary Detector. Enclosed in glass, dust-proof cylinder, which keeps the mineral clean and free from vibrations. This feature alone bears out our claim for the general excellence of any and all "WINN" HI-GRADE apparatus.

Your dealer will supply you with any "WINN" HI-GRADE Wireless Apparatus. If not, send his name, and we will see you are supplied promptly. Write for our "Supplement A" advance catalog, which contains complete information about the entire "WINN" HI-QUALITY Radio goods, a valuable book for amateur or professional Wireless workers. Free to you.

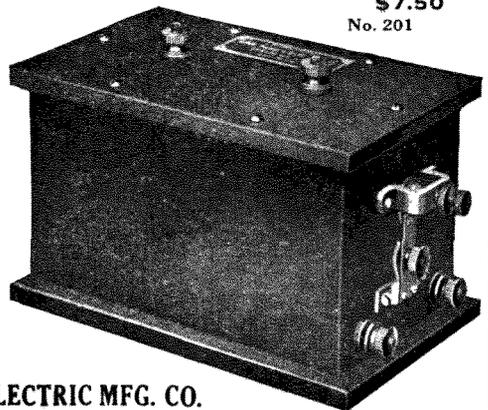

WINN RADIO & ELECTRIC MFG. CO.

537 So. Dearborn St., Dept 10, Chicago, Ill.

Thermo-Ammeters, Milliammeters and Current-Squared Meters

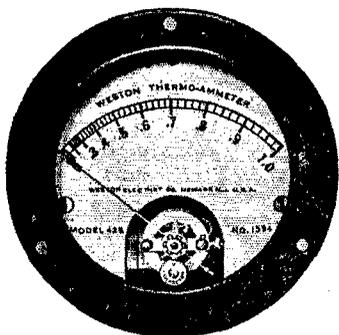

Weston

Model 425

Miniature Size Instruments for Radio Service

are the ideal Instruments for the amateur.

They are particularly adapted for use on small size Radio panels where space is an important factor.

Their characteristics of accuracy, large overload capacity, small current consumption and small size make them particularly desirable for use on amateur and other low-power outfits.

They are for use on Audio and Radio frequencies.

Complete information will be furnished upon request.

Weston Electrical Instrument Company

158 Weston Avenue, Newark, N. J.

Branches in all Principal Cities.

Radio Amateurs

We carry in stock a complete line of the following Manufacturers:

J. H. Bunnell & Co.

Acme Apparatus Co.

Wm. J. Murdock Co.

Tremaine Mfg. Co.

DeForest

ADDRESS ALL MAIL
ATTENTION OF
MR. H. DUNBAR

Quaker Light Supply Co.

728 Arch St.,

Phila., Pa.

Marconi V. T's.

Since our announcement in the April issue we have acquired the agency for Marconi V.T's and accessories and have in stock the tubes in Class I and II, leaks, sockets, transformers etc. Send stamp for circular.

Pioneer Electric Co.

137 E. 5th St.,

St. Paul, Minn.

Agency for DeForest, Acme, Bunnell, Thordarson, Murdock, Perfection, Remler Apparatus.

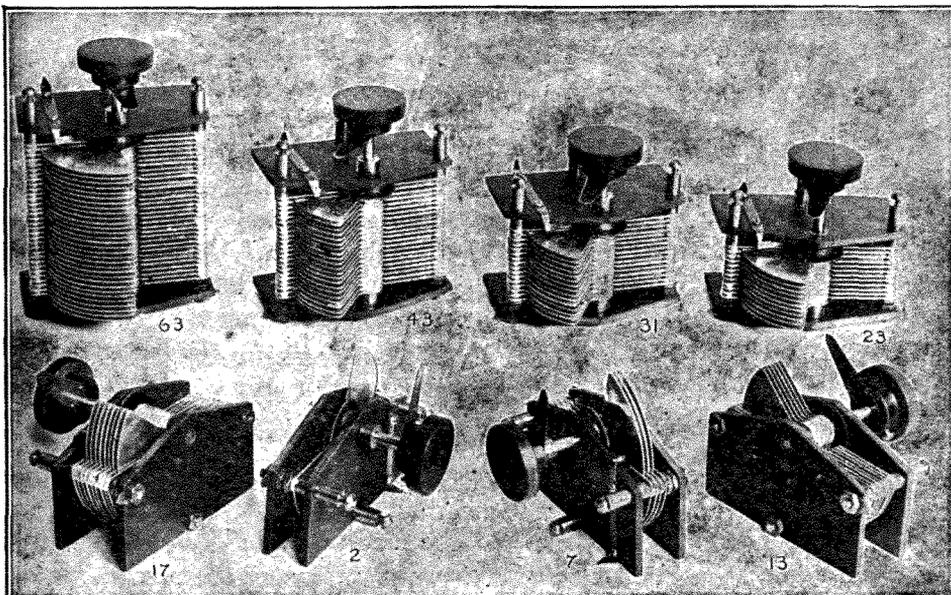

Variable Condensers — Series "S"

For the Radio man who wants instruments that are right, in all respects, we can recommend this instrument. It is not built to sell in competition with some of the low priced instruments offered, but we are offering it at very reasonable prices, quality considered.

Bakelite-Dilecto end plates support both the moving and stationary elements. Die stamped aluminum plates and spacers insure uniform and rigid construction. Copper Ribbon connection to Moving set of plates eliminating dirty, high resistance contacts. Steel shaft, accurately ground to size. Stop pin fitted to condenser. Moving plates will stay put in any position, although movement is very smooth and easy. Bakelite-Dilecto end plates are now fitted to front and back end of all sizes listed, insuring perfect alignment.

Fitted with lathe turned knob, pointer and set screw, and mounting screws. Made for panel mounting especially. Specify thickness of your panel and whether you want brass or nickle pointer and screws.

PRICES.

| | | |
|--------|------------------------------------|--------|
| No. 2 | 2 plate Vernier | \$1.85 |
| No. 7 | 7 plate, .0001 m.f. max. cap..... | 2.15 |
| No. 13 | 13 plate, .0002 m.f. max. cap..... | 2.50 |
| No. 17 | 17 plate, .0003 m.f. max. cap..... | 2.85 |
| No. 23 | 23 plate, .0005 m.f. max. cap..... | 3.25 |
| No. 31 | 31 plate, .0007 m.f. max. cap..... | 3.90 |
| No. 43 | 43 plate, .001 m.f. max. cap..... | 4.75 |
| No. 63 | 63 plate, .0015 m.f. max. cap..... | 6.75 |

If dial indicator is desired instead of pointer, add to above prices 75c.

Add to above prices, postage on one pound to your postal zone.

Our new catalogue is now ready for mailing. Send 5c in stamps, and your copy will be mailed at once. It is full of just what you are looking for.

SPECIAL

We can now furnish our condensers fitted with a fine indicating dial instead of pointer. Dial is 3 1/8" in diameter, of heavy brass, black dial with white graduations and numbers.

THE WIRELESS SHOP

511 W. Washington St.,

A. J. Edgcomb.

Los Angeles, Cal.

A Good Wavemeter

AT A MODERATE PRICE



TYPE B. Q. WAVEMETER

Bulletins Z and F sent for 4c Stamps list our complete line of high grade, moderately priced apparatus for the radio laboratory. Bulletin R lists the Cambridge Rectifier for Storage Battery Charging.

CLAPP-EASTHAM CO., 114 Main St., Cambridge, Mass.

is accurate simple and rugged. Comprises a portable oak case $5\frac{3}{4}'' \times 8\frac{1}{4}'' \times 6\frac{1}{2}''$ with hinged cover, bakelite panel, balanced condenser, buzzer, detector, switch, binding posts, and two 2 unit inductance windings, range 200 to 2000 meters.

Price \$27.50

These meters are in stock for immediate delivery and are carried in stock by most good dealers.

Recognized as the largest and best



Send ten cents for descriptive catalog to Dept. C.
900-902 Penn. Ave., N.W., Washington, D.C.

**MEMORIZE
CONTINENTAL CODE
ALMOST INSTANTLY**

This method THE short cut to success

COMPLETE CHART
and full instructions **TWO DIMES**

C. K. DODGE

Box 210 Mamaroneck, N. Y.

BURGESS "B" BATTERIES

SEVERAL
SIZES
FOR
SPECIAL
WORK



SEND FOR CATALOGUE
**BURGESS BATTERY
COMPANY**

HARRIS TRUST BLDG. - CHICAGO, ILL.



THE MOORHEAD ELECTRON RELAY

PRESENTING TWO NEW TYPES OF VACUUM TUBES FOR EXPERIMENTERS



THE MOORHEAD PERFECT

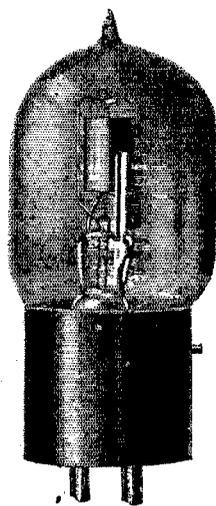

THE MOORHEAD VT AMPLIFIER-OSCILLATOR

VACUUM TUBE COMBINATION

—perfected to meet the increasing demand for tubes of superior efficiency, wherein all desirable characteristics are combined without subordinating any essential elements. A combination of two or more VT tubes as amplifiers with an Electron Relay as the initial detector or oscillator is the ideal receiving combination for long distance amateur or long wave reception. Both types of tubes are rugged in construction and unqualifiedly guaranteed.

THE MOORHEAD ELECTRON RELAY

The Electron Relay is the original tubular vacuum valve brought out by this company in 1915, now supplied with the standard four prong base for convenience. This tube has the familiar "hissing" point and low B battery potential characteristic of the perfect vacuum detector. Of all vacuum tubes the Moorhead Electron Relay is the most efficient spark receptor.

Price—\$6 each. Immediate deliveries. Order from your dealer or remit direct to address below.

THE MOORHEAD VT AMPLIFIER-OSCILLATOR

The VT Amplifier-Oscillator is the Navy SE 1444 "hard" tube, and is designed and manufactured expressly for amplification and oscillation purposes. Particular attention is invited to the large amplification constant of this tube. Recent official Navy tests show conclusively that the Moorhead VT tube has a higher amplification constant than any other vacuum tube known to the radio art.

Price—\$7 each. Immediate deliveries. Order from your dealer or remit direct to address below.

DEALERS—write for prices and particulars.

BOTH TUBES LICENSED UNDER THE DE FOREST AUDION AND FLEMING PATENTS.

AMATEURS—write for descriptive literature.

PACIFIC RADIO SUPPLIES CO.—SOLE DISTRIBUTORS FOR MOORHEAD LABORATORIES, INC.

Reference—The American National Bank—San Francisco, Cal.

638 MISSION ST., SAN FRANCISCO, CALIFORNIA.

EASTERN AGENTS—THE ATLANTIC RADIO SUPPLIES CO. NUMBER EIGHT KIRK PLACE, NEWARK, NEW JERSEY—PHONE MARKET 1575

"SHRAMCO"

Specialties are needed for an efficient set

Switch Points

| | BRASS | NICKEL |
|---|----------------|----------------|
| No. 626— $\frac{1}{4}$ " x $\frac{3}{8}$ " with screw..... | \$2.00 per 100 | \$3.00 per 100 |
| No. 627— $\frac{1}{4}$ " head, $\frac{5}{8}$ " shank, with nut and washer..... | 2.25 per 100 | 3.35 per 100 |
| No. 628— $\frac{1}{4}$ " x $\frac{1}{4}$ " with screw..... | 1.75 per 100 | 2.60 per 100 |

Switches

| | |
|---|-------------|
| No. 750—3-blade Laminated, $1\frac{3}{8}$ " radius..... | \$1.00 each |
| No. 751—Single Blade, $1\frac{3}{8}$ " radius..... | 0.35 " |
| No. 800—Panel Binding Post, brass finish..... | 0.10 " |

Complete line reliable moderate priced apparatus.
Radisco Agency, Coils, "B" Batteries, Dial Indicators, etc.

Send 5c in stamps for Catalog J showing complete line.

Shotton Radio Manufacturing Company
P. O. Box 3, SCRANTON, PA.

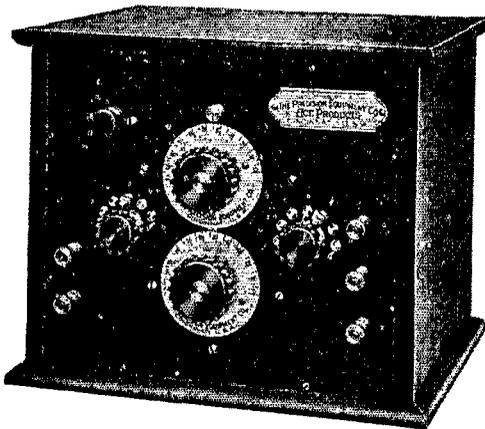

"YOU'D BE SURPRISED"

at the distance, strength of signal and freedom from QRM you get with Ace equipment. The type T. T. Tuner is the kind you want for that extreme long distance work thru the worst QRM. Doc Ace has the right dope when he says "You may pay more, but you can't buy better". Type T. T. Regenerative Tuner, range 150 to 2750 meters, F. O. B. Cincinnati, \$55.

The Precision Equipment Company

2437 Gilbert Ave., Dept. D, Cincinnati, Ohio.

STOP

\$15.

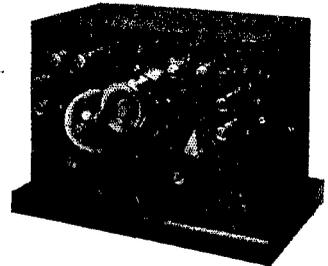

\$15.

AUDION CONTROL CABINET

Size 8"x11"x6", Mahogany Finish, 7"x10" Bakelite Panel, Brass Fittings. Back Mounted Rheostat, Control Switch.

We have a Surplus Stock of These High Grade Cabinets, Original Price \$35.00. GET BUSY.

2 Step Amplifier, Same as Above
Nickel Fittings \$35.00 Worth \$60.00

Grid Condensers.....35c

TREMAINE & CO.

1305 Arch St., Philadelphia, Pa.

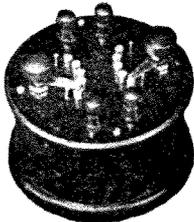

Hook 'er to yer bulb

The most wonderful tuner in the world for only \$15. Last month this tuner beat in a test one of the NAVY STANDARDS at Ketchikan, Alaska.

10 Captains of Ocean going ships have had their wireless operators install one of our tuners in the captain's cabin so the exact time by wireless can be had without using either tube, bell, or hand.

GREAT says one old sea dog. WHAT IN SAM HILL WILL YOU SMART ALECS GET UP NEXT? European stations copied in day time and no fancy aerial is needed. A single wire about 40 long by 25 high will do the trick. London amateur W. R. Wade, Clifton, Bristol, promises report for the magazines to publish showing how the amateurs there read our sigs in England. Junk your funny wound coils and get a regular two pound tuner that you can use during the static season. 20000 meters maximum wave length. Hook up on bottom of tuner.

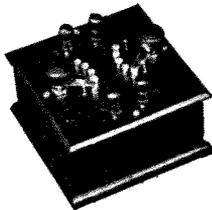

KNOCKED DOWN AND ASSEMBLED CONDENSERS.

Which kind do you want???. Made for panel mounting and are complete with scale pointer and knob. Used all over the world now and still going strong. No C.O.D. orders. Add parcel post. Buy from your dealers and send us his name if he can not supply you. Canadian amateurs buy from local dealers or write us for nearest dealer. Formica tops and bases. Movable plates are screwed on and not clamped.

| | | |
|----------|---------------|--------|
| 11 plate | Knocked down. | \$1.80 |
| 21 | " " " | 2.25 |
| 41 | " " " | 3.20 |

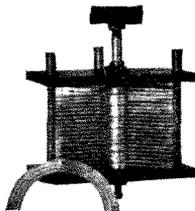

| | | |
|----------|------------|--------|
| 11 plate | assembled. | \$2.75 |
| 21 | " " " | 3.25 |
| 41 | " " " | 4.25 |

SOLD BY YOUR DEALER OR

TRESCO, Davenport, Iowa

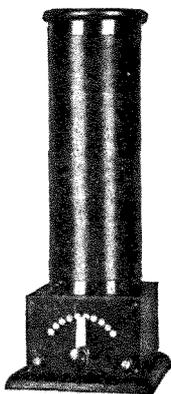

The ideal **Inductance** to use with your **Short Wave Set**.

Will enable you to hear Foreign Stations.

Write for Bulletin C-109.

Radio Equipment Co.

1525 N. Fawn St., Philadelphia

RADIO-CRAFT PRODUCTS

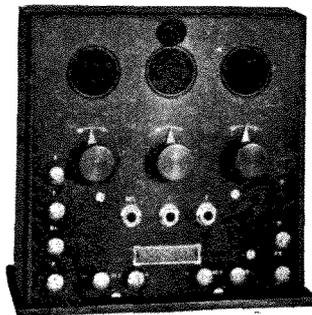

Detector and Two-Stage Audio Frequency Amplifier.

This instrument is made of the finest materials and workmanship, and gives perfect amplification without any interfering noises. Binding posts are provided for separate "B" battery connections, for Detector and Amplifier.

Our Detector and Amplifier line consists of:
 Detector Unit\$15.00
 Detector and One-Stage Audio Frequency Amplifier.....\$45.00
 Detector and Two-Stage Audio Frequency Amplifier.....\$70.00
 Two-Stage Audio Frequency Amplifier.....\$50.00

RADIO-CRAFT CO., Inc.

FRANK M. SQUIRE, Pres.
 413 Third Ave., Brooklyn, N. Y.

FACTS

The originals of letters below are deposited with the Editor of this Magazine. Name of customer is omitted to avoid possible annoyance.

Jensen Electric Co.,
1949 Huron St.,
Chicago, Ill.

Carlstrom Field, Arcadia, Florida,
April 8, 1920.

Sirs:

Send me at your earliest convenience one of your Audio-tron Vacuum Tube Detectors, C.O.D., as I wish to test its Post War sensibility.

I used one of the same make of tubes as Detector, one as Oscillator and one as Modulator on an amateur set before the war.

I may be able to place an order with you, later, for a large number of these tubes.

Send to _____ Headquarters Flight,
_____ Service Co., S. C., Carlstrom, Field, Arcadia, Fla.

Jensen Electric Co.,
Chicago, Ill.

April 23, 1920.
Carlstrom Field, Arcadia, Florida,

Sirs:

Your letter of the 15th at hand. I received the tube O.K. and will state that it comes up to all expectations.

You may ship, via Parcels Post, C.O.D., one Audio-tron, (list \$6.00.) If this is contrary to your business please advise the method to be used in ordering.

Hoping that you will advise me in this matter, I am
Respectfully,

Hq. Barracks, Carlstrom Field, Arcadia, Fla.

JENSEN ELECTRIC COMPANY

1949 HURON STREET, CHICAGO, ILL.

Have you samples of Multi-Flex Radio Ribbon? Samples 10c.

RADIO ENGINEERING AND SALES COMPANY, Inc.

7 West Madison St., Chicago.

EXPERT RADIO ENGINEERS.

Apparatus for commercial, school or amateur stations.

A complete line of DeForest apparatus on hand from which prompt shipments can be made.

Special apparatus designed, manufactured or calibrated.

Unbiased advice given free to amateurs who are planning new stations. Enclose self-addressed stamped envelope.

Here they are

Meraco Perfect "B" Batteries

Standard BA-2 TYPE The same type of a battery as used by the U. S. ARMY AND NAVY SIGNAL CORPS. Fully guaranteed on a money back basis. Once you use these batteries you will use no other. Meraco Perfect "B" Batteries are made in three sizes and should be ordered by Catalog No.

| Cat. No. | Cells | Volts | Sizes | Shelf Life | Price |
|------------|-------|-------|-------------------|------------|-----------------|
| BA-2XPR-1K | 15 | 22.5 | 3 1/2 x 2 x 2 1/2 | 4 months | \$1.20 Postpaid |
| BA-2XPR 2 | 15 | 22.5 | 6 1/2 x 3 x 4 | 8 months | \$2.20 Postpaid |
| BA-2-XPR | 30 | 45 | 14x6x8 | 1 year | \$4.50 Postpaid |

MERCURY RADIO APPLIANCE CO.

672 Broadway,

Dept. AI,

Brooklyn, New York

MURDOCK

NO. 55



2000 OHM DOUBLE SET

\$4.50

3000 OHM DOUBLE SET

\$5.50

Made for long and
Useful service in
Radio stations where their
Dependable and sensitive
Operation makes them the
Choice of those who
Know GOOD 'phones.

ORDER YOUR SET NOW—

Try it out thoroughly.

**IF IT DOESN'T SUIT, SEND
IT BACK AND GET YOUR
MONEY**

Bulletin 19 shows a splendid line of the type of apparatus you want. Send for a copy.

WM. J. MURDOCK CO.

65 Carter St.

CHELSEA MASS.

221 SECOND ST., SAN FRANCISCO, CALIF.

SOME NEW

MODERN

RADIO
EQUIPMENT
COMPANY
TRADE MARK

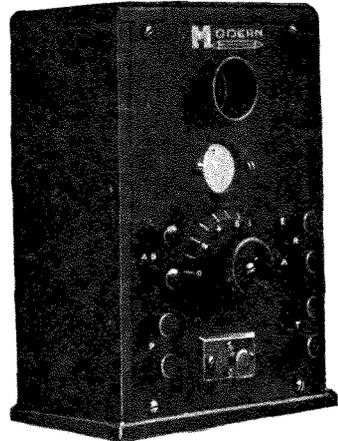

Type HBD

**VACUUM TUBE CONTROL
CABINET.**

\$15.00

Complete less battery and tubes.

Highly finished wood case with XX Bakelite panel. Metal parts of highly finished nickle-plate.

**THE BEST THAT MONEY CAN
BUY.**

**DETECTOR AND TWO-STAGE
AMPLIFIER TYPE HBA**

Complete - - \$75.00

This is an entirely new instrument. It is the most up-to-date instrument and is sold at an extremely low price.

**"MODERN" APPARATUS ARE
ALL THAT THE NAME
IMPLIES.**

For sale at all "Modern" agencies—and

Modern Radio Equipment Co.

Designers and manufacturers of high grade radio apparatus.

Elizabeth, New Jersey.

We're Prompt !



You don't have to wait from three weeks to three months, for the apparatus you order. On everything except apparatus specially constructed to order, you'll have the benefit of

Shipment Guaranteed Within Twenty-Four Hours

Audions and Amplifiers

- Audion Control . . . \$22
- Without bulb or B batteries
- 1 Step Amplifier
- Without Detector . . . \$28
- With Detector . . . \$33
- 2 Step Amplifier
- Without Detector . . . \$45
- With Detector . . . \$50

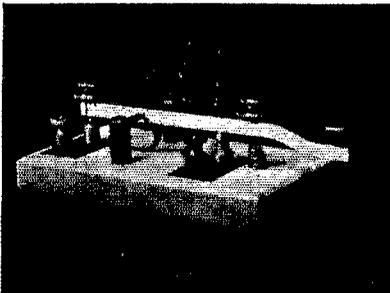

10-Ampere Reco Key

Mounted on Italian marble base, with solid silver bar contact points, finished in brushed brass or nickel. Absolutely no side play in this Key. A great big special at \$6.50 postpd.

If you want a bright, snappy, monthly bulletin that means something; send us 6c. in stamps.

NEW! An Adaptor for Tubular Bulbs—fits any socket; is rugged—simple and 100 per cent. efficient; and positively vibration-proof—Immediate Delivery

\$1.50

Radisco Agents **The Radio Engineering Co.**
for the South **Baltimore, Md.**

614 North Calvert Street

RADIO APPARATUS

The Mutual Purchasers Association offers you membership on a dividend paying plan whereby anyone buying thru the association automatically becomes entitled to a coupon check, which is a dividend and is acceptable as cash, upon the next order sent in.

Our membership is over 1900 and growing daily. Members are earning dividends on everything they buy.

We can furnish radio material and parts advertised in this magazine at manufacturers catalog prices.

No Application Fee.

Write Department Q-4 for detailed information

MUTUAL PURCHASERS ASSOCIATION

2-4 Stone Street

New York City.

LATTICE COILS

Just out—the right coil at the right price. Do not confuse our staggered wound coils with honeycombs. (Prices, Unmounted)

| Group 1 | | Group 2 | | Group 3 | |
|--------------------|-------|--------------------|-------|--------------------|--------|
| Turns | | Turns | | Turns | |
| 25 | \$.50 | 150 | \$.85 | 500 | \$1.50 |
| 35 | .55 | 175 | .95 | 750 | 1.75 |
| 50 | .60 | 200 | 1.00 | 1000 | 2.00 |
| 75 | .70 | 350 | 1.25 | 1250 | 2.25 |
| 100 | .75 | | | 1500 | 2.50 |
| Group price \$2.50 | | Group price \$3.50 | | Group price \$9.00 | |

Complete set 14 coils (unmounted) \$14.00. Taps taken off any coil at any place \$0.20 each. Make one coil do the work of several. TRY a 500 tapped at 25, 50, 100, 200 and 350 for \$2.50. Range 200 to 2,500 meters.

Wooden centers with 1/2 inch hole \$0.25 per pair. Coil mounting (sliding type) \$1.00.

LAMBERT & ASSOCIATES

102 N. Wells Street,

Chicago, Ill.

800 Miles on 1-4 K.W.

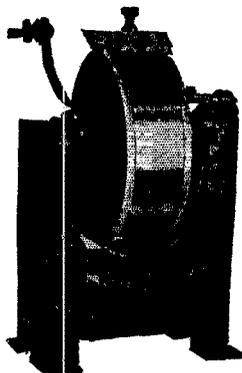

¼ K. W. Special.

Is the distance claimed by F. M. Prencil (9CF), 174 N. Scoville Ave., Oak Park, Ill. Who will be the first to transmit 1000 miles on this ¼ K.W. transformer? Send your records to this office.

Power Factor 91%

WRITE FOR OUR NEW CATALOG "T-21"

Thordarson Electric Manufacturing Co.
501 S. JEFFERSON STREET CHICAGO, ILL.

"ASK ANYONE WHO HAS USED IT"

WHAT OUR PATRONS SAY

"You manufacture a brand of phones that surpass all of equal price and most of higher price." (Name on Request.)

BRANDES WIRELESS HEADSETS



"Navy" set 3200 ohms \$14.00

"Transatlantic" set 2800 ohms \$10.00

"Superior" 2000 ohms \$7

TRIAL OFFER

Test out Brandes Wireless Receivers against any other make. Test them for sensitiveness, clearness and distance. If within ten days you're not only satisfied but enthusiastic over them — back comes your money without a question.

Prove for yourself the fine quality, the "matched tone." The two diaphragms, toned exactly alike, strengthen the signals and prevent blurring. Used by many U. S. Government experts, and experts abroad; by colleges and technical schools; and by professionals and amateurs everywhere.

SEND 4c. FOR CATALOGUE F

C. BRANDES, Inc.

Room #21, 32 Union Square, New York
WIRELESS RECEIVER SPECIALISTS

CQ — CQ — — — QRW ?

The "R V A" Sales Plan which enables all responsible Amateurs to purchase Radio Apparatus, Parts, raw materials and supplies on the **INSTALLMENT PLAN** is the solution to your problem of obtaining the BEST there is manufactured without the usual large outlay of cash at one time. The new "EVA" Binders are ready. Send ten cents, stamps or coin, for the binder, back copies of the "EVA" BULLETIN, the Bargain Supplement and keep up with the times in the way of modern equipment for your station.

J. DONALD VANDERCOOK & CO.

139 South York Street

ELMHURST,

ILLINOIS

"P.W." HAS THE LATEST RADIO APPARATUS IN PHILA.

We have the "Radisco" agency for Philadelphia and vicinity; also distributors for

Clapp-Eastham, Murdock, DeForest, Acme Apparatus, A. H. Grebe & Co., Kilbourne and Clark, Benwood Rotary Quenched, Perfection Variables and Tuners, Universal Wound Inductances, Better "B" Batteries, and Endurance Storage Batteries.

Est. 1911. Radio Call "8PW"

PHILA. SCHOOL OF WIRELESS TELEGRAPHY

Parkway Bldg., Broad Street near Arch

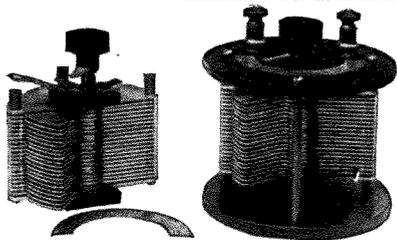

THE "ILLINOIS" VARIABLE CONDENSER

Hard Rolled Aluminum Plates

Three Styles, No. 1. Panel, No. 2. Open Type as shown, No. 3. Fully Encased, Anti Profitteer. Less than pre-war prices. Fully assembled and tested.

Sent Prepaid on Receipt of Price.

| Style | No. 1 | No. 2 | No. 3 | |
|-----------|---------------|--------|--------|--|
| 43 Plates | \$3.00 | \$4.00 | \$4.25 | Money back if not satisfied. Just return condenser within 10 days by insured P. P. additional. |
| 23 " | 2.50 | 3.50 | 3.75 | |
| 13 " | 2.25 | 3.25 | 3.50 | |
| | In Canada 25c | | | |

These condensers are made by a watch mechanic schooled in accurate workmanship. Personally we will need no introduction to Amateurs who have "listened in" for "time" and "weather" from 9ZS.

Postscript.

The above "Ad" certainly put "ILLINOIS" "on the map" in the Condenser Industry. Not only on the map, but scattered it all over the map, from Alaska to the Gulf, and from the Penobscot to the Golden Gate. The "money back" proposition seems to have been superfluous. Instead of having any instruments returned for credit, they ask for more. And, most satisfactory of all to us, our customers write to express their appreciation. All these, we take this occasion to thank heartily.

You will notice a slight increase in our price list, on the "mounted" styles only. This will be effective from May first. The fact is we could not quite "get by" with our first prices.

The "Star Spring" feature of our design meets with great favor. We shall make this the subject of application for Patent as we think it marks a step forward in the construction of Variables. It has two important functions. It keeps the plates accurately and permanently centered; without "end-shake"; and provides sufficient friction to hold the "rotor" at any setting without liability of its dropping from its position by the unbalanced weight. It makes the Condenser in this respect as reliable as the much more expensive "balanced" type.

Kindly note: We issue no Catalog, and make no "trade discounts". We set our prices at the lowest limit, and leave the "middle man" out for the sole benefit of the "consumer".

G. F. JOHNSON, 625 Black Ave., Springfield, Ill.

AMATEURS DO YOU KNOW?

How far a Crystallo Detector operates; that you are missing a lot without a Tresco 20,000 meter Tuner, and that you hear them good with Murdock Phones?

Rubber Knobs
Corwin Dials
Binding Posts
Murdock Phones

Variable Condensers
Crystallo Detectors
Tuners and Cabinets
Audion Panels

We have Wilcox, Tresco, Murdock, A. H. Corwin and other first class manufacturer's stock. Just send 3c for all the data.

"ARK" RADIO SUPPLY

97 Hill St.,

Shelton, Conn.



OUR NEW FILAMENT RHEOSTAT

For Back or Front of Panel Mounting.

\$1.75 Postpaid

6 ohm resistance, fine adjustment on 4 or 6 volts.

2 1/8" Diameter.

Smooth action

IMMEDIATE SHIPMENT!

SPECIAL SUMMER SALE

GROUND WIRE

No. 4 Triple Braid Rubber Covered.

8c Per Ft., \$7.00 Per 100 Feet.

Include Shipping Costs—16 1/2 Lbs. Per 100 Ft.

100 Amp. 600 Volt Lightning Switch \$4

\$6.50 Amrad Wavemeters Only \$5

\$17.50 Amrad Quenched Gaps \$15.75

\$14.50 Western Electric P-11 Phones \$12.50

A Few G-R Type 127-A, \$10.00 Hot-Wire Meters Left in Stock—Last Chance at \$5 Each, P.P. 0-1 Amp. Range for CW Transmitters, Also 0-2 1/2

Our Tron Adaptor will Permit use of Your Tubular Bulb, Vertically, in a "VT" Socket, \$1.75.

Standard "VT" Socket, \$1.00. Why Pay More? Electrodyne Rectifier Tubes in Stock, \$7 Special 45 V. Variable "B" Battery \$3.50 Mica-Copper Foil Grid Condensers 40c

We Stock Everything Worth While in Wireless—Drop In and Look It Over.

RADIO EQUIPMENT CO.

630 WASHINGTON ST., BOSTON, 11, MASS.

BUILD YOUR OWN

Wireless Receiving Set

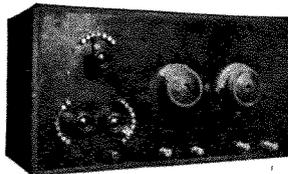

You can
SAVE
at least
\$25.00

by buying parts and assembling yourself.

Think of the pleasure and practical experience you will gain in making your own set, size 16"x8"x6", with wavelength range from 170 to 2,500 meters.

Send \$1.00 and we will send you the blue-print and instruction sheets—also prices of all parts. When you order at one time \$5.00 or more worth of parts you may deduct this \$1.00 from the total. Since the blue-print and instructions alone are worth \$1.00 and since we can save you money on wireless material, you cannot possibly lose. So send \$1.00 today before this slips your mind and start making your set as soon as possible.

Write today and get started

K. & G. WIRELESS SUPPLY CO.
Dept. 18D, 152 Chambers St., New York City.

R & M Special Rotary Gap Motors

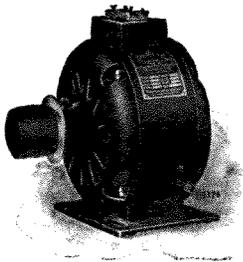

RUNS ON 110 AC OR DC
CURRENT. 1/10 H.P.
2,500 TO 8,000 R P M
VARIABLE SPEED.
SUPPLIED WITHOUT
PULLEY.

\$15.00
EACH

Only a limited supply is available. Place your order now for quick delivery.

DOUBLEDAY-HILL ELECTRIC CO.

RADIO DEPT.—DESK A

715 12th St., N. W., WASHINGTON, D. C. 719-21 Liberty Ave., PITTSBURGH, PA.

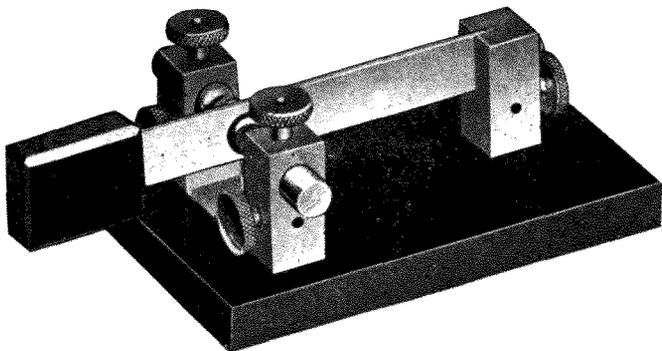

“COOTIE” KEY

Cat. No. YM6

The “Cootie” key is the snappiest sending device offered on the market for reliable spacing of characters. Listen to 9NV, 9LU, 9MS, 9UG, 9BY, and judge for yourself. Large standards, formica knob, substantial silver contacts suitable for use up to 2KW. The double action of the “Cootie” key lends an individuality to your sending.

Price . . .

Nickel Plated \$5.00
Plain Brass \$4.50

Distributors for the

DeForest Radio Tel. & Tel Co.

Clapp-Eastham Co.

Amrad Products

Wm. J. Murdock Co.

—Immediate Deliveries—

Send for our
Fifty Page
Catalog,
4c.
in Stamps

Young & McCombs
L.P. BEST PRES.
ROCK ISLAND, ILL.

Address all
Orders to
Radio Dept.
No. 67

Why "Standard VT Batteries" Are Best

1. The Type No. 7623 (small size) STANDARD VT BATTERY shows on test: Useful operating life of approximately 130 hours while discharged at the rate of 3 milli-amperes (the equivalent of the plate current consumption of 3 vacuum tubes) giving approximately 390 milli-ampere-hours of service.

2. STANDARD VT BATTERIES are of comparatively low amperage, meaning long shelf life and providing longer life for the battery.

3. STANDARD VT BATTERIES possess high recuperative powers.

4. Each STANDARD VT BATTERY is a solid unit, the sealing compound filling all spaces and interstices, and making it a "cast en bloc" battery unit in every sense of the word. No saw-dust or other moisture-absorbing material is used as a "filler," thus preventing untimely short-circuiting of the cells.

5. The "VARIABLE STANDARD VT BATTERY" is variable by steps of $1\frac{1}{4}$ volts by means of a plug, giving fine, convenient and positive variation. It is a successful new idea applied to a "cast en bloc" battery unit, on which a patent has been applied for.

6. STANDARD VT BATTERIES are distributed by responsible dealers who consider quality and their customers' satisfaction as well as price.

YOU CAN'T GET A BETTER "B" BATTERY AT DOUBLE THE PRICE OF THE "STANDARD VT BATTERY." YOU ARE THE LOSER WHEN YOU ACCEPT A SUBSTITUTE—INSIST ON THE GENUINE, AND SEE THAT THE LABEL BEARS THE TRADE-MARK "STANDARD VT BATTERY" WRITTEN IN ELLIPTICAL FORM AS SHOWN BY THE CUT IN THIS ADVERTISEMENT.

DEALERS:—Eventually—Why not now? Write for discounts.

RICHTER & BYRNE
Manufacturers
1377 40th Street
Brooklyn, N. Y.

PACENT ELECTRIC CO., Inc.
Sole Eastern Agents
150 Nassau Street
New York City

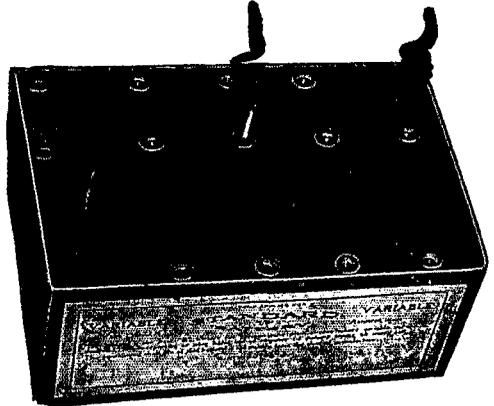

Patent Pending

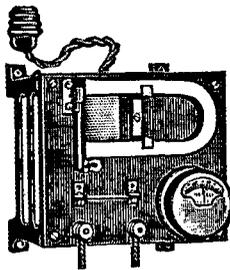

BENWOOD DISCS can now be supplied separate from the complete Gap as shown with 8, 10 or 14 points. Diam. 6", thickness $\frac{3}{4}$ " - - \$7.50
(State size of motor shaft)

BENWOOD RECTIFIERS keep your A battery ready for use. Puts your station in the ultra modern class.

As shown - - - \$20.00

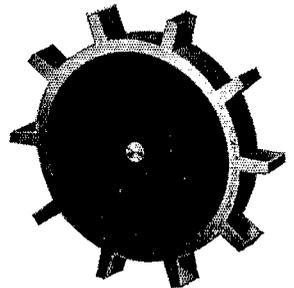

BENWOOD SPECIALTY CO., 3424 Olive Street, St. Louis, Mo.

HIGH SCHOOL STUDENTS

and others

Special Summer Courses in WIRELESS DURING JULY and AUGUST.

Day Course—Special Summer rate of \$10.00 per month.

Evening Course—\$5.00 per month.

Comprehensive Instruction in "Spark" or "Arc" and other CW Transmitters.

Special Course in WIRELESS TELEPHONY including thorough instruction in Vacuum Tubes.

Listen for our Wireless phone!

The RADIO-COMPASS also described.

Send in your enrollment early.

All Summer Courses begin JUNE 28th.

Best Equipped Radio School in New England.

MASSACHUSETTS RADIO & TELEGRAPH SCHOOL.

18 Boylston St., (cor Wash.)
ARTHUR BATCHELLER

(Lt.) R. F. TROP
Tel. Beach 7168

Boston, Mass.
G. R. ENTWISTLE

Tuska Tickler

HAVE YOU GOT YOURS?
Ask Your Dealer
 or
BUY DIRECT

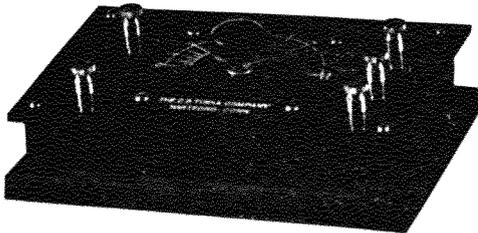

Type 160

Price \$10.00 Postpaid

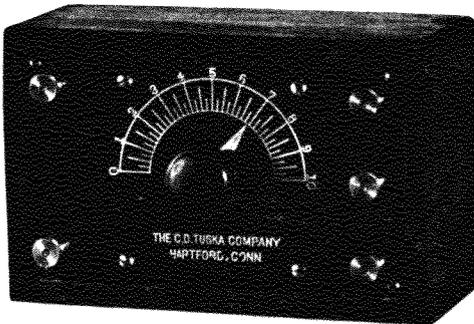

Type 161

A new device to make a regenerative receiver out of your loose coupler. Any ordinary receiver with any type of audion can be made the equal of any regenerative set you ever saw, by the use of THE TUSKA TICKLER.

That's all—not a wire in either tuner or audion has to be changed. Gives wonderful regenerative amplification of damped signals. Can also be used as an oscillator for the undamped.

DEALERS!

WRITE FOR TERMS TO

The C. D. Tuska Co.
 Hartford, Conn.

Mechanical Engineering

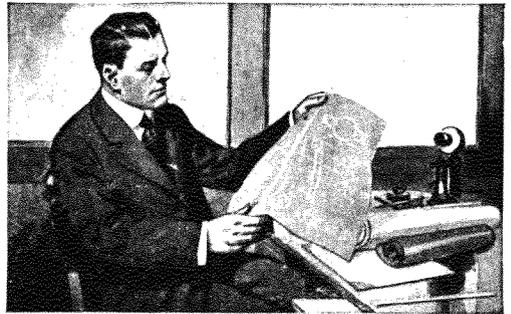

Learn at Home!

EMLOYERS everywhere are looking for men with mechanical ability. Splendid salaries and rapid advancement are offered those with special training.

There is an easy, delightful way in which you can learn right at home in spare time. For 28 years the International Correspondence Schools have been giving men and women just the training they need for success in mechanical engineering and more than 200 other subjects. Hundreds of thousands have stepped into good positions through I. C. S. help, but never were opportunities so great as now.

Let the I. C. S. help you. Choose the work you like best in the coupon below, then mark and mail it today. This doesn't obligate you in the least and it will bring you information that will start you on a successful career. This is your chance. Don't let it slip by. The most important thing you have to do is to mark and mail this coupon now.

TEAR OUT HERE

INTERNATIONAL CORRESPONDENCE SCHOOLS

BOX 6135, SCRANTON, PA.

Explain, without obligating me, how I can qualify for the position, or in the subject, before which I mark X.

- | | |
|--|--|
| <input type="checkbox"/> ELECTRICAL ENGINEER | <input type="checkbox"/> CHEMICAL ENGINEER |
| <input type="checkbox"/> Electrician | <input type="checkbox"/> SALESMANSHIP |
| <input type="checkbox"/> Electric Wiring | <input type="checkbox"/> ADVERTISING MAN |
| <input type="checkbox"/> Electric Lighting | <input type="checkbox"/> Show Card Writer |
| <input type="checkbox"/> Electric Car Running | <input type="checkbox"/> Outdoor Sign Painter |
| <input type="checkbox"/> Heavy Electric Traction | <input type="checkbox"/> RAILROADER |
| <input type="checkbox"/> Electrical Draftsman | <input type="checkbox"/> ILLUSTRATOR |
| <input type="checkbox"/> Electric Machine Designer | <input type="checkbox"/> DESIGNER |
| <input type="checkbox"/> Telegraph Expert | <input type="checkbox"/> BUSINESS MANAGEMENT |
| <input type="checkbox"/> Practical Telephony | <input type="checkbox"/> Private Secretary |
| <input type="checkbox"/> MECHANICAL ENGINEER | <input type="checkbox"/> BOOKKEEPER |
| <input type="checkbox"/> Mechanical Draftsman | <input type="checkbox"/> Stenographer and Typist |
| <input type="checkbox"/> Toolmaker | <input type="checkbox"/> Cert. Public Accountant |
| <input type="checkbox"/> Machine Shop Practice | <input type="checkbox"/> Traffic Management |
| <input type="checkbox"/> Gas Engineer | <input type="checkbox"/> Commercial Law |
| <input type="checkbox"/> CIVIL ENGINEER | <input type="checkbox"/> GOOD ENGLISH |
| <input type="checkbox"/> Surveying and Mapping | <input type="checkbox"/> Common School Subjects |
| <input type="checkbox"/> MINE FOREMAN OR ENGINEER | <input type="checkbox"/> CIVIL SERVICE |
| <input type="checkbox"/> ARCHITECT | <input type="checkbox"/> Railway Mail Clerk |
| <input type="checkbox"/> Architectural Draftsman | <input type="checkbox"/> STATIONARY ENGINEER |
| <input type="checkbox"/> PLEUMBING AND HEATING | <input type="checkbox"/> Textile Overseer or Supt. |
| <input type="checkbox"/> Sheet Metal Worker | <input type="checkbox"/> AGRICULTURE |
| <input type="checkbox"/> Ship Draftsman | <input type="checkbox"/> Poultry Raising |
| <input type="checkbox"/> Navigator | <input type="checkbox"/> AUTOMOBILES |

Spanish
 French
 Italian

Name _____ 7-28-19

Present Occupation _____

Street and No. _____

City _____ State _____

"DX" Relay Men Know Baldwin 'Phones are Best

We have just received a letter from an Ex-Sergeant of the 117th Field Signal Battalion, Rainbow Division, which shows the worth of Baldwins.

John Firth & Co.,
New York

4022 Wayne Ave.,
Kansas City, Mo.

Gentlemen:

Reading your advertisement of Baldwin phones in the January QST and having used several different pairs of these phones in the Signal Corps, I desire very greatly to obtain a pair.

I have tested Baldwin phones against almost every phone made, including several French, British, and even German-made receivers, and have found nothing to equal them. I used "a pair of Baldies" while on the U. S.-Mexican border, in conjunction with a Signal Corps mule-carried pack set, and can say they stood up under the severest jars and jolts a stubborn mule could give them. I also had a pair with me at the Aisne-Marne defensive, the Chateau Thierry offensive, St. Mihiel, The Argonne, and on our hike to Germany. The type phone I had I don't know and cared less—all I knew was that they had the others beat in a walk.

Awaiting your circular, I remain,

Respectfully,

B. F. Riggin

Any A.R.R.L. long-distance relayer will tell you there are no other phones as sensitive as Baldwins. The enormous increase in sensitivity over ordinary receivers is secured by the famous Baldwin construction—a mica diaphragm, removed from the constant pull of a permanent magnet, and a separate light iron armature. Write for interesting illustrated bulletin explaining the construction of these phones, and why they are BETTER.

**BALDWINS MEET THE EXACTING REQUIREMENTS
OF LONG DISTANCE AMATEUR WORK
FOUR MODELS—FOUR PRICES**

JOHN FIRTH & COMPANY

81 NEW STREET,

Sole Distributors

NEW YORK

RADISCO COILS—NEW PRICES

| Cat. No. and turns. | Apx. Inductance in Millihenries | Wavelength Range with .001 Variable | Price |
|---------------------|------------------------------------|--|--------|
| LRD 40 | .092 | 225 575 | \$0.70 |
| LRD 100 | .81 | 460 1480 | 0.95 |
| LRD 175 | 1.8 | 750 2400 | 1.15 |
| LRD 325 | 5.8 | 1375 4500 | 1.40 |
| LRD 550 | 18.0 | 2250 7700 | 1.65 |
| LRD 750 | 35.0 | 3000 11200 | 2.00 |
| LRD 1200 | 114.0 | 6000 20000 | 2.65 |

Radisco Coils may be obtained with taps, which allow them to be used for a larger wavelength range.

| Cat. No. and turns | Taps taken off at | Price |
|--------------------|-------------------|--------|
| LRD 325-3 | 40 - 100 - 175 | \$1.70 |
| LRD 750-3 | 175 - 325 - 550 | 2.30 |
| LRD 1200-3 | 325 - 550 - 750 | 2.90 |

Inside Diameter of all coils, 1 1/4 inches; Width, 3/4 inch.
Radisco B Battery No. 1, \$1.40. No. 5, \$2.40. Postage extra.

21 Magnolia Terrace

E. L. LONG

Albany, N. Y.

**We have 'Em
Send 4c for Sample Switch Contacts
and Circular B-14.**

Switch Points Dials
Rubber Knobs Binding Posts
Variometers Condensers
V.T. Tubes Sockets

**B-Batteries
and Other Supplies and Instruments
Dealers Write for Attractive
Trade Proposition.**

**THE RADIO SPECIALTY CO.
OF PITTSBURGH**

6243 STATION ST.,

PITTSBURGH, PA.

SOLDERLESS TERMINALS



You need these for your experimental work. Increase your electrical contact efficiency. Easily attached—NO solder required. Supplied with a variety of tips and red or black sleeve. Send stamp TODAY for circular and prices (L2). Distributors of high grade radio apparatus.

Write for SPECIAL BARGAIN Sheet.

Chicago Electrical Engineering Co.

1000 Diversey Parkway, Dept "L", Chicago, Ill.

RADIO SHOP VARIOMETERS

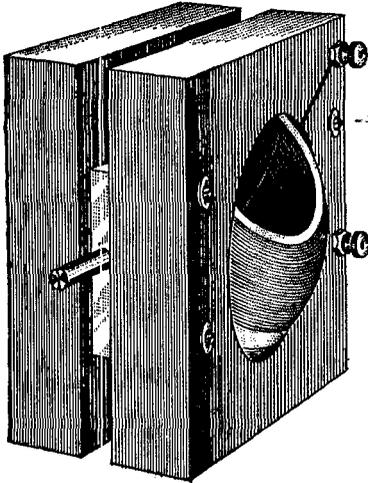

Will solve the greatest difficulty of those who desire to construct their own Short Wave Regenerative Receivers.

Expressly designed for the Grid and Plate circuits of such.

Electrically and Mechanically perfect. Especially adapted for panel mounting. Winding forms of seasoned Maple, accurately machined and wound for minimum of clearance between windings. Wound with large gauge wire to insure low resistance and fitted with special design spring bearings for positive contact at all points of rotation.

PRICE \$10.00 EACH

Used exclusively by one of the leading manufacturers of high-grade regenerative receiving sets.

VARIO COUPLERS

For use in connection with the above Variometers. Somewhat similar in design. Ball type secondary rotating within a cylindrical primary winding which is tapped for six values of inductance. Also designed for panel mounting.

PRICE \$7.00

For Electrose Knob and Pointer for either Variometers or Vario-Coupler add sixty cents.

Manufacturers and Dealers: Write for attractive proposition.

The Radio Shop

Bank of Italy Bldg.,

San Jose, Calif.

Carried in Stock

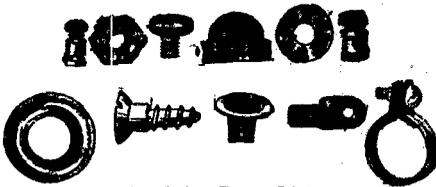

Send for Price List

Other Fittings Made to Sample or Sketch

CONTINENTAL ELECTRIC CO.

119 E. 129th St., New York

PROMPT DELIVERY

is assured if you place your orders with us. Our stock includes DeForest, Clapp-Eastham, Murdock, General Radio, Federal and Acme Apparatus, Marconi VT's, Burgess "B" Batteries, etc.

Exclusive Chicago distributor of TeCo Radio Specialties.

Order direct from DeForest catalog or send 10c for new one. Immediate delivery on all sizes HONEYCOMB Coils, Mountings, Unit Panels, Vernier Condensers, Audion Control Panels, etc.

Our Bulletin No. 4 just off the press explains fully our new Service Department and how we give "Special Delivery" on all orders—large or small.

Write for your copy NOW.

CHICAGO RADIO APPARATUS CO.

3400 S Michigan Ave.,

Chicago, Ill.

MOUNT YOUR RECEIVING SET IN ONE OF OUR CABINETS

and have it compare favorably with the best ready made cabinet set on the market.

Our Cabinets are built of 1/2 inch mahogany, 18 inches long, 12 inches high and 7 inches deep, with our novel drawer arrangement for exposing apparatus for inspection. Beautifully finished in dark mahogany.

- No. 1-Cabinet with genuine 1/4 inch Bakelite Panel.....\$12.00
- No. 2-Cabinet, with genuine 3/8 inch Mahogany Panel..... 7.50
- No. 3-Cabinet, with drawer bottom, but no panel..... 6.50

We also furnish switch points, knobs, terminals—in fact most anything in wireless apparatus at interesting prices. Special apparatus built to order—tell us your wants.

Penn Radio Apparatus Company

Dept. A, Box 110, Reading, Pa.



SOMETHING NEW
30 OHM RESISTANCES
IN THE SPACE OF ONE

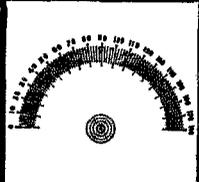

TRIPLE RHEOSTAT 180 CONDENSER
CONTROL 3 AUDIONS SCALE ON 4 CIRCLE
FROM ONE BASE PRINTED FROM COPPER
GENUINE BAKELITE PLATE ON BRISTOL BOARD
POSTPAID \$2.50 POSTPAID .25

SEND FOR CIRCULARS

WORCESTER RADIO LABORATORIES
16 WAYNE ST., WORCESTER, MASS.

SPECIAL: 10,000 Navy Type Dials

To be sold in 60 days

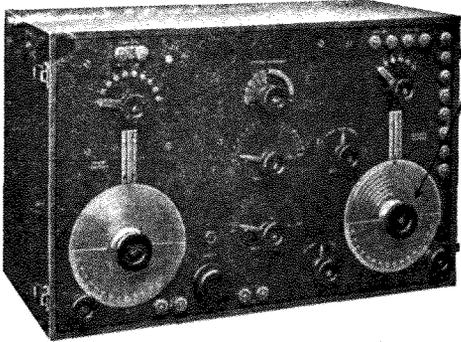

For Sale to amateurs for the first time

We have been very fortunate in obtaining 10,000 Navy Type Dial Indicators for sale to amateurs. These dials are made of heavy white celluloid, highly polished, beautifully finished, and artistically engraved with two scales. One scale is divided into degrees; the other is calibrated for writing in station call letters at points at which station is received.

Put your set in the commercial class

Not only do these dials add dignity and beauty to a set, but they are also a real utility and a necessity for reliable work. Use them wherever you would an old fashioned scale and pointer.

Buy today—Tomorrow may be too late !

At the present rate of sale our stock will be exhausted within 60 days. So get the lead on the rest—lay in a supply now—while you can.

PRICE WHILE THEY LAST 65c postpaid, COMPLETE AS DESCRIBED WITHOUT KNOB. Stamps NOT accepted.

THE C AND S RADIO CO., Dept. USN8 OMAHA, NEB.

"Superlative Radio Engineering Productions."

MESSAGE BLANKS

The new standard A.R.R.L. message form, based on the current Traffic Rules and Regulations, now ready for distribution. Printed on good quality paper. In pads of 100 blanks, postpaid, 35 cents.

American Radio Relay League
Hartford, Conn.

Improved Spark Gap

Saw Tooth design. Teeth removable and interchangeable. Supplied with 12 teeth. Can be used as 2, 3, 4, 6, 8, or 12 tooth by removing teeth not wanted. Aluminum alloy. Bakelite disc.

W. D. Mathews
Marlette . . . Michigan

TELL US YOUR NEEDS!

We will supply them immediately from a comprehensive stock of DeForest, Murdock, Clapp-Eastham, Brandes, Acme, Amrad, Remler, Federal, and our own apparatus and guarantee quick delivery, satisfaction, and courteous service.

We invite inquiries on any technical difficulties you may have.

Would you be interested in our new catalogue now being compiled showing the best products of the above manufacturers? Send us your name for our mailing list and keep in touch with us. It will be to your advantage.

Western Radio Electric Company
512 East Ninth St., Los Angeles, Cal.

Best of Everything in Radio Apparatus and Parts.

Send Stamp for Catalog "Q"
J. H. BUNNELL & CO.
32 Park Place, New York



PATENT-SENSE

"The Book for Inventors & Mfrs."
By Return Mail FREE. Write
LACEY & LACEY, Dept. Washington, D.C.

Give Your Spark A Chance

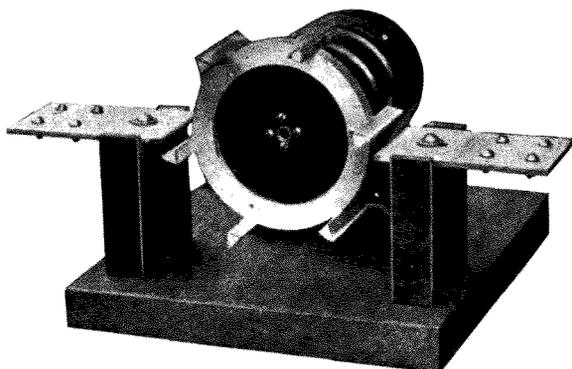

Our New Rotary allows all of the energy in the closed circuit a free discharge surface. Electrodes are $2\frac{1}{2}$ inches wide and $\frac{1}{16}$ inch thick accurately shaped on a milling machine. Made with 6 or 12 points for high or low note. You can't beat the combination of an Acme transformer and our 12 point rotary. Absolutely highest efficient gap ever offered, fully guaranteed.

Priced at \$50.00 with either rotor.

Literature ready for distribution June first and IMMEDIATE DELIVERIES.

Wireless Manufacturing Co. Canton, Ohio

ARNOLD Loose Couplers

Audion Detectors
Parts and Accessories

Send 4c stamps for literature which is sure to interest you

J. F. ARNOLD 2082 Lexington Avenue, N.Y.
Established 1910

RADIO TRAFFIC ASSOCIATION

An organization devoted to the improvement of Amateur Radio Traffic conditions.

Brooklyn, New York

AFFILIATED WITH THE A. R. R. L.

REBUILT BATTERIES

for Audion Lighting Batteries—6 Volts—20 to 60 Amp. Hr. Cap.

Built to order

\$5 to \$15

Guaranteed 1 year or new battery.

STATE AUTO ACCESSORIES CO.

196 Brighton Ave., Allston, Mass.
Tel. 3173 Brighton

—SNAP OUT OF IT, FELLOWS—

For June only, we are offering nickel plated switch points $\frac{1}{4} \times \frac{1}{4}$ inch head, with $\frac{3}{16}$ inch 6/32 brass screws, for the remarkable price of 30c per dozen—postpaid.

If you can beat this for value, you win the Crocheted V.T.

Send 4c for circular.

PACIFIC RADIO DISTRIBUTING CO.

Pomona, California.

ARE

YOU USING ONE OF OUR SHORT-WAVE COUPLERS?

PRICES:

In Oak Cabinet, 5x5 Bakelite Panel.....\$12.00

Unmounted, No Panel.....\$4.50

Prices Subject to Change Without Notice.

GOUSE & LORENSON, Hudson, N. Y.

NEW ORLEANS

WIRELESS SUPPLIES AND
MINERALS OF ALL DESCRIPTIONS

L. A. ROSE

121 CAMP STREET
NEW ORLEANS, LA.
SEND 6 CENTS FOR CATALOG

ANNOUNCEMENT

We are pleased to introduce to the amateurs a FIXED CONDENSER for audion circuits or mineral sets.

Style No. 1 for audion circuits.....\$0.50

Style No. 2 for mineral sets.....\$0.60

Always state style wanted. Send stamps for postage. Send Stamp for circulars.

RADIO TESTING STATION

25 Sturges St., Binghamton, N. Y.

WANTED

Copies of QST for AUGUST, 1919. An extension of subscription for three months, or fifteen cents in cash, for each copy returned in good condition to

QST, Hartford, Conn.

THIS—

the second

Announcement

since our entrance into the Radio and Electrical field, is published to acquaint you with the fact that we have been taken at our word as an organization specializing in

“Personal Service to the Consumer”

Our efforts will always tend to serve each one of you individually and promptly, thru our sales or mail order department, and to this end we have contracted with over ninety per cent of the leading manufacturers, which means that we will carry everything Radio from Contact Points to Complete Stations.

Among the serviceable and high quality Radio and Commercial Apparatus which we offer you are to be found the foremost products of

Radio Craft Co.; A. H. Grebe; Clapp-Eastham; International Radio Tel. Co.; DeForest; W. J. Murdock; J. H. Bunnell; Amer. Radio & Research; Manhattan Electrical Supply Co.; General Radio; Acme; Marconi; S. Cohen; Federal Tel & Tel.; Electrosee; Brandes; Pacent Electric; Wireless Equipment; Wireless Improvement; Cole & Morgan, Books; Wireless Press, Books; Endurance Storage Batteries; Marko Storage Batteries; Standard V.T. Batteries; Adams-Morgan; Dubilier Condensers; Firth; Omnigraph; Magnavox and others.

We also carry a large stock of high grade electrical apparatus, including a very complete line of heating appliances.

You have our most courteous invitation to spend a few moments in our spacious show rooms to look over our complete stock. We will gladly show you any instrument or part you may desire to examine. It will be a revelation to you, besides, it is part of our service.

OUR WORD OF HONOR TO YOU IS
OUR GUARANTEE. LET US PROVE IT.

Write Dept. C-3, for literature and price lists

CONTINENTAL RADIO AND ELECTRIC CORP.

J. DI BLASI, Secy.

J. STANTLEY, Treas.

6 Warren Street

New York

CONNECTICUT RADIO

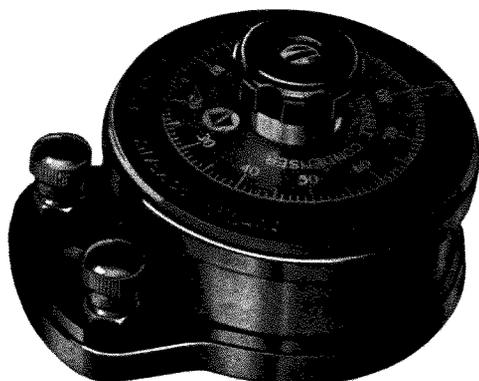

A New Variable Condenser —It Doesn't Get Out of Order

Your adjustments, once made with the new CONNECTICUT Variable Condenser, are secure—in any position. While delicate adjustments are easily obtained, the mechanism does not get out of order.

That's because of the simplicity of design—the kind of simplicity that comes from disregarding outworn tradition, and considering essentials only. And because that has been done, the CONNECTICUT Variable Condenser shows superiority not alone in design, but at every step in operation.

Our Booklet tells all about it and gives some interesting and important information about condensers in general. Send for your copy. Mention your Dealer's name.

CONNECTICUT TELEPHONE & ELECTRIC COMPANY
Meriden Connecticut

Announcing New Prices

(EFFECTIVE JUNE 15, 1920.)

AMRAD QUENCHED GAPS

are now built for all classes of amateur stations. No matter what your conditions you can cover more miles per watt using the Amrad Quenched Gap, than with any other type.

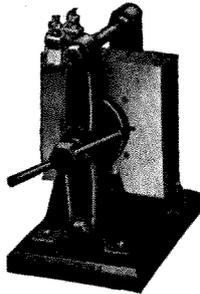

Type G-3

- Type G-1 20,000 volts up, 1 K.W. \$29.75
- Type G-2 10,000 volts up, ½ K.W. \$18.75
- Type G-3 5,000 volts up, ¼ K.W. \$13.50
(also for Induction Coils)

AMRAD RESISTANCES

Essential for obtaining highest efficiency and double frequency note with Amrad Quenched Gaps.

- Type A-1 for 1 K.W. transformers, \$9.50
- Type A-2 for ½ K.W. transformers, \$6.75
- Type A-3 for ¼ K.W. transformers, \$4.50

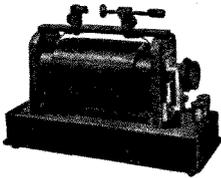

AMRAD INDUCTION COIL

Especially designed for radio work. In operation at 1AK, 1BM, 1GY, 4AI, 5ZC, 6BR, 6CS, 6HI, 8BQ, 8CB, 8HG, 9CA, and many other stations.

- Type C 6 volt primary.....\$35.75
- Type C-1 32 volt primary.....\$38.50

Type D



Price
\$7.50

AMRAD WAVEMETER

still leads all similar instruments in the important factors of low price, accuracy and ease of operation. Direct reading.

* * *

Type C



Price
\$6.50

AMRAD DETECTOR STAND

provides a positive and yet sensitive finger tip adjustment. Compact, rugged, neat. Single model, Type C-1.....\$3.50

* * *

Type B



Price
\$13.75

AMRAD LIGHTNING SWITCH

eliminates the usual weak point in antenna insulation. A standard 100 ampere switch mounted on 40,000 volt Electrose insulators. Meets Fire Underwriters' specifications.

SPECIAL NOTICE: Until June 15, 1920 the above equipment may be obtained from your dealer at prices published last month.

AMERICAN RADIO AND RESEARCH CORPORATION

13 Park Row
New York

Address all Communications to New York.

Factory and Laboratory
Medford Hillside, Mass.