

FEBRUARY

15 CENTS

QST

A MAGAZINE DEVOTED EXCLUSIVELY TO THE WIRELESS AMATEUR

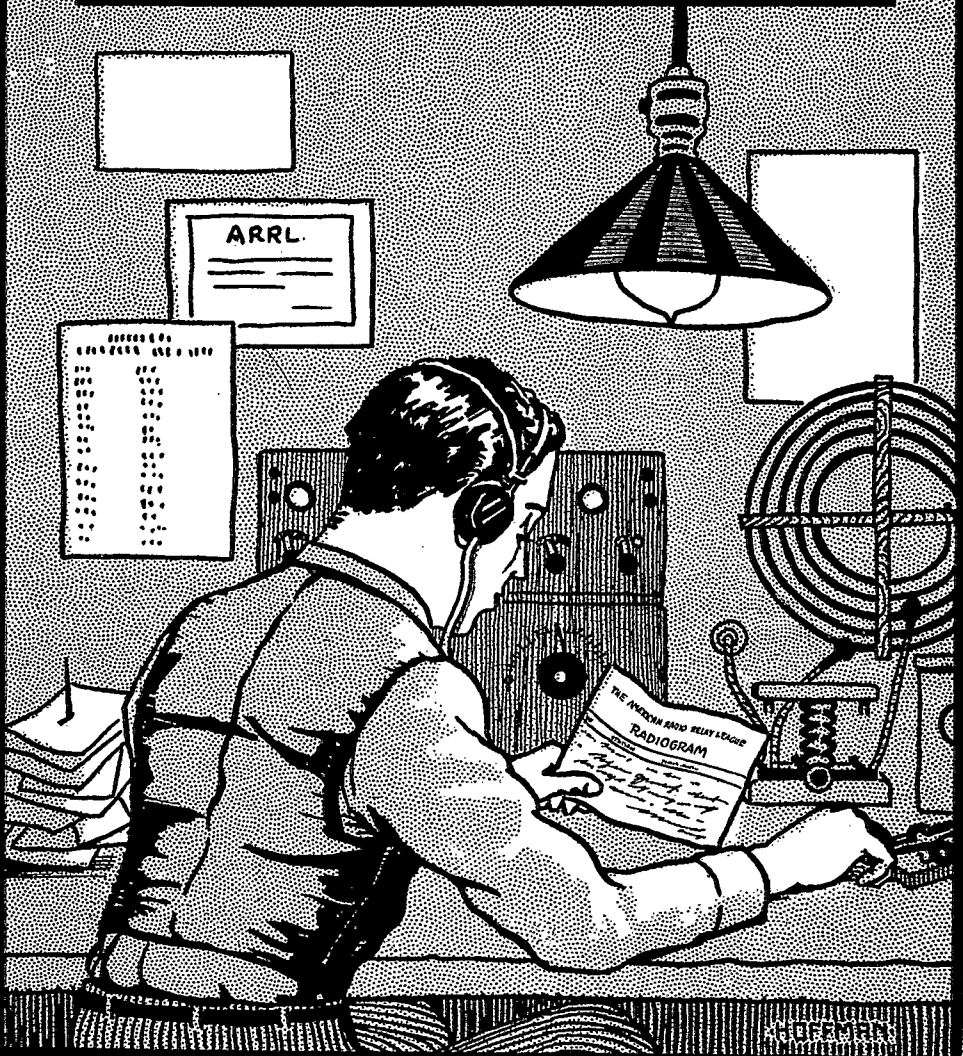

Dependability and Service

Every Condition of Service Encountered by Radio Apparatus is Borne in Mind During the Manufacture of all Equipment Sold by Us. Its Dependability is Assured by Skilled Workmanship and its Quality Guaranteed by Accurate Design.

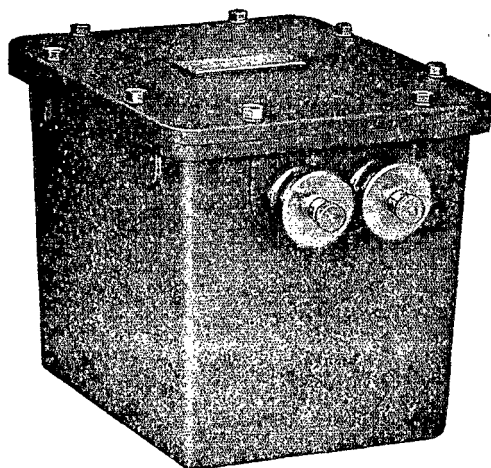

"ACME" OIL CONDENSER

Type M2 .0035 mf. 12000 volts - - - - \$28.00
Type M2 .007 mf. 10000 volts - - - - 30.00
Dimensions over all; 10" x 8". Net Weight 33 lbs.

The Possibility of a "Break-down" With This Condenser is Entirely Eliminated.

We Endeavor to Carry at all Times a Complete Stock of Quality Apparatus, Complete Outfits, Separate Parts, Boy Scout Equipment, etc., etc.

BULLETIN 10 SENT ON REQUEST

Exclusive Boston Agents for
WIRELESS SPECIALTY APPARATUS CO.
RADIO DISTRIBUTING CO. ("RADISCO")

ATLANTIC RADIO COMPANY, Inc.
34 BATTERY MARCH ST., BOSTON, MASS.

MAGNAVOX

Telemegafone

Most Efficient Telephone Receiver and Loud Speaker

**FOR RADIO
RECEIVING**

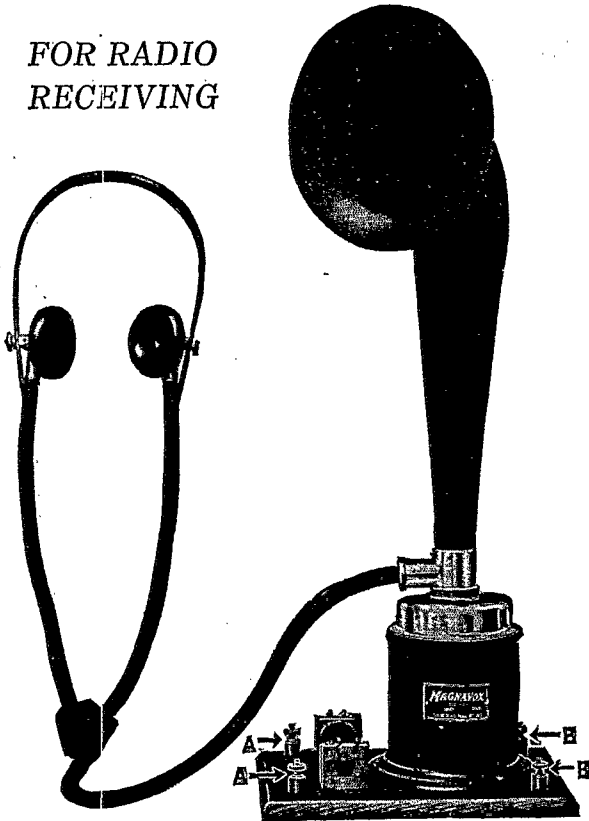

The most rugged, simple and reliable instrument yet produced for the reproduction of radio signals and sound.

It is not only a most sensitive receiver when used with the head-set, but is also the most powerful loud speaker.

The Magnavox Telemegafone fills the long felt need of both commercial and amateur radio stations.

By using this instrument in connection with your vacuum tube amplifier, signals will be reproduced with great volume. For weak and ordinary signals use the head-set. Strong signals can be heard a great distance from the horn.

PRICE \$75.00

Connect AA to your receiving set where your present head-set is connected

Connect BB to a 6-volt storage battery

Immediate Delivery—Order Early



PATENTED IN U.S.A. AND FOREIGN COUNTRIES

2701-2759 East Fourteenth Street, Oakland, California

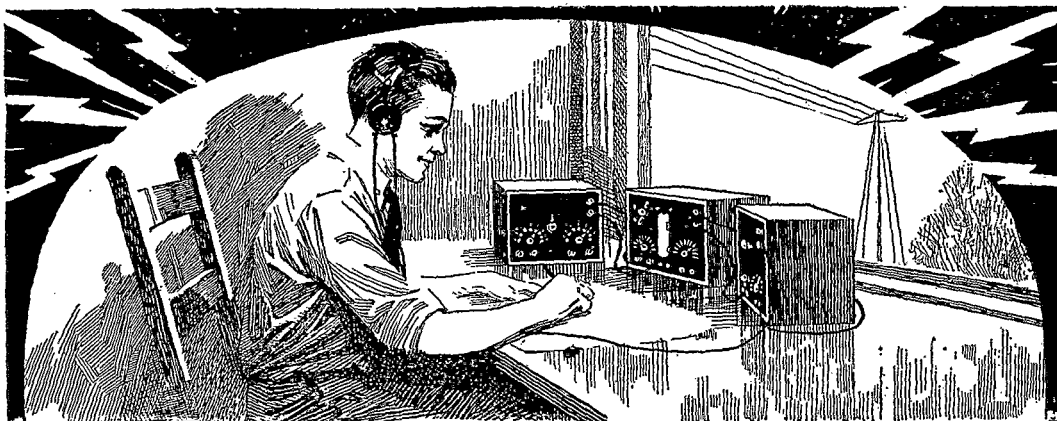

Have You Kept Pace With The Times?

Are you still operating the old style non-sensitive, poorly designed receiving apparatus? Or are you equipped with one of the new complete Gilbert Radio Outfits designed by an expert who was a Radio Officer in the U. S. Army during the war and who has incorporated all of the latest Army improvements in these new outfits.

Gilbert Radio Outfits are complete in every respect for transmitting, receiving or both. They are without doubt the latest and most scientific outfits. Each piece of apparatus is designed to operate in close harmony with every other part of the set.

The Loose Coupler used in the receiving sets is not the old Obsolete type that pulls out of the box but the new enclosed panel type. A highly sensitive instrument designed particularly to minimize distributed capacity and to eliminate dead-end losses. It is a very compact instrument in a quartered oak cabinet and is included in all Gilbert Radio Receiving Outfits.



These outfits can be purchased complete or each part separately. Our new Radio catalog No. 50 describes each one in detail. Write for it today.

THE A. C. GILBERT COMPANY

317 Blatchley Ave.,

New Haven, Conn.

IN CANADA

THE A. C. GILBERT-MENZIES CO., Limited
Toronto

QST

VOLUME III

FEBRUARY, 1920

NO. 7

CONTENTS

A New Method for the Reception of Weak Signals at Short Wave Lengths	Edwin H. Armstrong	5
More Hun Radio	Howard S. Pyle	10
Traffic Rules and Regulations of the A.R.R.L.		11
Spark Coil Transmitter Design	Sumner B. Young	13
Speaking of Grounds	H. E. Rawson	14
Editorials		17
Calls Heard		19
Amateur Radio Stations		21
The Priess Loop Transmitter		22
With The Affiliated Clubs		23
Who's Who in Amateur Wireless		25
The Clapp-Eastham Variable		26
The Junior Operator		27
Radio Communications by the Amateurs		29
QST! Boston District Radio Banquet		33
The Operating Department		34
QST Subscription Contest		43
"Strays"		43
Queries Department		46
Auto-Modulated C.W. Telegraphy		47

QST is published monthly by The American Radio Relay League, Inc., at Hartford, Conn. Kenneth B. Warner (Secretary, A.R.R.L.), Manager and Editor.

Subscription price, \$1.50 per year in the United States and possessions;
Canada, \$1.75; Foreign, \$2.00. Single Copies, 15 Cents.

Entered as second-class matter May 29, 1919, at the post office at Hartford, Connecticut, under the Act of March 3, 1879.

Copyright, 1920, by The American Radio Relay League, Inc.
Title registered at United States Patent Office.

THE AMERICAN RADIO RELAY LEAGUE, Inc.
HARTFORD, CONN.

"THAR SHE BLOWS"

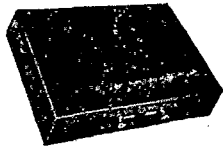

Did you ever make this remark or a bad one, when your moulded glass plate condenser blew? We offer a sectional glass plate condenser, .0015MF—high test glass, special lead filler, safety spark gap, tested to 15000 volts. Blow this all you want you won't lose the condenser. Hardwood box; H. F. cable to B. P. Fits any moulded rack and works with them. Guaranteed and delivered to you for \$2.00.

PERFECTION TUNERS

Round or square pattern, need little to be said. We will ship any one on approval to any secretary of any Radio Club, affiliated with A.R.R.L. **20000M.** tuner brought 7 letters in one week that LCM was being copied daily without any amplifier. XDA on first tap NSS on fourth. Wiring diagram on bottom.

3000M. Arlington tuner copies NAA in Alaska, Frisco, and New Orleans equally well on 25 x 40 foot aerial.

200M. tuner now in Relay service. Great say the boys. Arranged to use the latest hookup in December QST. Any tuner delivered to you —\$15—agents wanted.

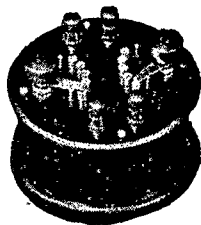

KNOCKED-DOWN CONDENSERS.

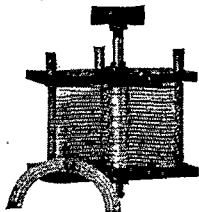

Assemble and save money. Full instructions. Formica top and bottom, hard rubber knob, scale, watch hand pointer, aluminum plates. 41 plate—\$2.75, 21 plate—\$2.25, 11 plate grid condenser—\$1.75. Thousands in use.

Panel mounting **RHEOSTATS** for filaments—\$1.50. We sell coils only for our tuners, in case you want to mount them back of your panel.

PERFECTION RECEIVING CABINET.

Any one of above tuners mounted in hardwood—piano finished cabinet, Formica front, nickel finish, 4 condensers, Panel rheostat, HV and LV switches. Arranged for VT or Tron bulb. Price without phones and HV Battery—\$60. (**Perfection Universal**) Receiving set, same as above only having all three tuners installed. Price on application.

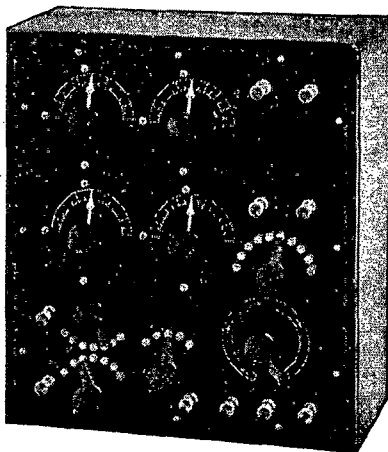

TUNERS LICENSED MARCONI PATENT
NO. 763772.

Made by Perfection Radio Laboratory,
Clinton, Iowa.

Sold by

TRESCO, Davenport, Iowa
OR THEIR DEALERS.

Q S T

A Magazine Devoted Exclusively
to the Radio Amateur

A New Method for the Reception of Weak Signals at Short Wave Lengths †

*By Edwin H. Armstrong, E. E.**

THE problem of receiving weak signals of short wave length in a practical manner has become of great importance in recent years. This is especially true in connection with direction finding work where the receiver must respond to a very small fraction of the energy which can be picked up by a loop antenna.

The problem may be summed up in the following words:— construct a receiver for undamped, modulated continuous and damped oscillations which is substantially equally sensitive over a range of wave length from 50-600 meters; which is capable of rapid adjustment from one wave to another, and which does not distort or lose any characteristic note or tone inherent in the transmitter.

It is, of course, obvious that some form of amplification must be used but a study of the various known methods soon convinces one that a satisfactory solution cannot be obtained by any direct method. In the interests of completeness we will consider the three well known direct means which might possibly be employed, and examine the limitations which apply to each. These three methods are:—

- (1) Amplification of the low frequency current after rectification;
- (2) Amplification of the high frequency current before rectification; and
- (3) Application of the heterodyne principle to increase the efficiency of rectification.

Consider first the method of rectifying the high frequency current and amplifying

the resulting low frequency current. Two limitations at once present themselves, one inherent in low frequency amplifiers and the other inherent in all known rectifiers. The limitation in the amplifier is the residual noise which makes it impractical to use effectively more than two stages of amplification. The second limitation lies in the characteristic of the detector or rectifier. All rectifiers have a characteristic such that the rectified or low frequency current is roughly proportional to the square of the impressed high frequency E. M. F. Hence the efficiency of rectification becomes increasingly poorer, the weaker the signal until a point is reached below which the detector practically ceases to respond.

The second method of attack on the problem is the amplification of the received high frequency currents before rectification to a point where they can be efficiently dealt with by the detector. This method is ideal on long waves and various methods of inductance, resistance and capacity couplings have been successfully used, but when the attempt is made to use the same methods of coupling on wave lengths from 200 to 600 it results in complete failure. This is because the low capacity reactance existing between the various elements of the tubes causes them, in effect, to act as a short circuit around the coupling means and thereby prevent the establishment of a difference of potential in the external plate circuit. It is, of course, possible to eliminate the short-circuiting by tuning with a parallel inductance but this introduces a complication of adjustment which is highly objectionable and the tuning of all circuits also leads to difficulty with undesirable internal oscillations.

*President, Radio Club of America.

†Presented at meeting of R. C. A. at Columbia University, Dec. 19, 1919. Publication courtesy R. C. A. Copyright 1920, A. R. L.

The third method which might be used is the heterodyne method to increase the efficiency of rectification. Great increase in signal strength is possible by means of this method, particularly where the signal

In spite of the great difficulties involved in a direct solution great success was obtained by Round in England and Latour in France in the production of high frequency amplifiers to cover effectively a

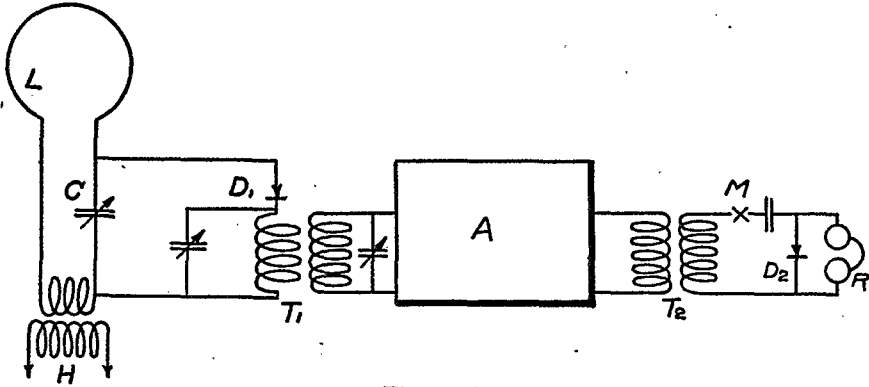

Figure 1.

is very weak but there are certain reasons why it cannot be effectively used in practice at the present time. The chief reason in receiving continuous waves of short wave length is the instability of the beat tone which makes operations below 600 meters unsatisfactory. This disadvantage does not apply to the reception of spark signals but here the loss of the clear tone and its individuality offsets much of the gain due to increased signal strength. In the case of telephony the distortion which always results likewise offsets the gain in strength. It is, of course, undeniable that there are many special cases

range from 300 to 800 meters. This result was accomplished only by the most painstaking and careful experiment and it represents some of the very finest radio work carried out during the war. Round secured his solution by constructing tubes having an extremely small capacity without increase in internal resistance above normal values and coupling the tubes by means of transformers wound with very fine wire to keep down the capacity and very high resistance to prevent oscillation at the resonant frequency of the system. The effect of the high ratio of inductance to capacity and the high resistance of the

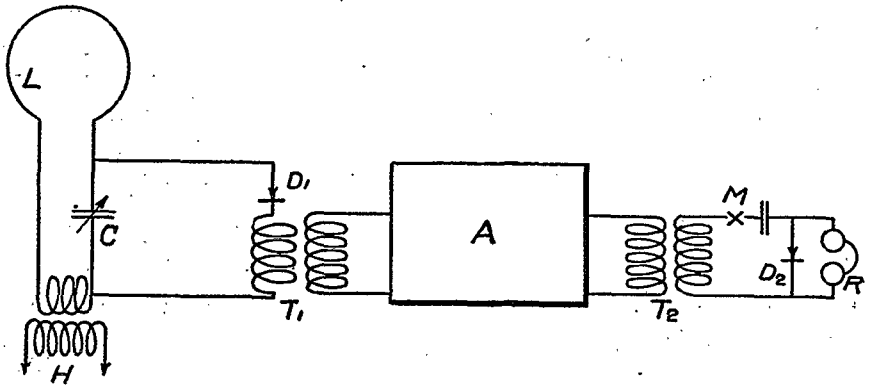

Figure 2.

where the use of the heterodyne on short wave length is of the greatest advantage but the foregoing remarks apply to the broad field of commercial working where the practical aspects of the case greatly reduce the value of the amplification obtained by this method.

winding is all to flatten the resonance curve of the system and widen the range of response. Latour solved the problem by the use of iron core transformers wound with very fine wire, the iron serving the double purpose of increasing the ratio of inductance to capacity and introducing

resistance into the system. Both these factors widen the range of response.

It is the purpose of this paper to describe a method of reception evolved at the Division of Research and Inspection of the Signal Corps A. E. F. which solves the problem by means of an expedient. This expedient consists in reducing the frequency of the incoming signal to some predetermined superaudible frequency which can be readily amplified, passing this current through an amplifier and then detecting or rectifying the amplified current. The transformation of the original high frequency to the predetermined value is best accomplished by means of the heterodyne and rectification, and the fundamental phenomena involved will be understood by reference to the diagram of Fig. 1. Here L C represents the usual tuned receiving circuit, loop or otherwise, H a separate heterodyne and D₁ a rectifier. A

detected or rectified by D₂. In order to get an audible tone where telephone reception is used some form of modulation or interruption must, of course, be employed in connection with this second rectification as the current in the output circuit of the amplifier is of a frequency above audibility. While this frequency is only 100,000 cycles and while it is therefore well within the range of practical heterodyning, its steadiness depends on the beats between 3,000,000 and 3,100,000 cycles per second and hence in any attempt to heterodyne it to audibility the same difficulties due to fluctuation would be encountered as in heterodyning the original high frequency to audibility. However, the inability to use the heterodyne on the second rectification is not of great importance because the amplitude of the signal to be rectified is large and hence the difference (as far as signal strength

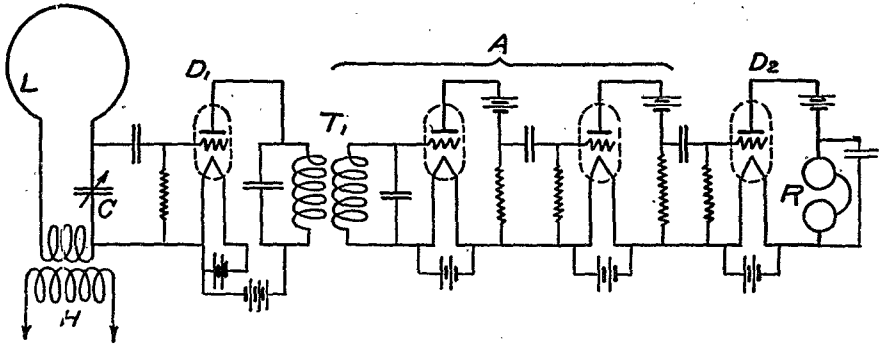

Figure 3.

is a high frequency amplifier designed to operate on some predetermined frequency. This frequency may be any convenient frequency which is substantially above audibility. The amplifier is connected on its input side to the rectifier D and on its output side to a second rectifier D₂ and a telephone or other receiver.

Suppose that the frequency to be received is 3,000,000 cycles or 100 meters and, for the sake of simplicity, that the incoming waves are undamped. Also, assume that the amplifier A has been designed for maximum efficiency at 100,000 cycles per second. The circuit LC is tuned to 3,000,000 cycles and the heterodyne H is adjusted to either 3,100,000 or 2,900,000 cycles either of which will produce a beat frequency of 100,000 cycles per second. The combined currents of 3,000,000 and 3,100,000 (or 2,900,000) cycles are then rectified by the rectifier D₁ to produce in the primary of the transformer T₁ a direct current with a riding 100,000 cycles component. This 100,000 cycles current is then amplified to any desired degree by the amplifier A and

in the telephone is concerned) between heterodyne and modulated reception is not great.

It is important to note here that the value of the heterodyne in the first rectifier should always be kept at the optimum value in order to ensure the carrying out of the first rectification at the point of maximum efficiency. This adjustment, however, is not a critical one and once made it is seldom necessary to change it. The amplifier A may be made selective and highly regenerative if so desired and a very great increase in the selectivity of the system as a whole can be secured. Fig. 2 illustrates the principle involved. This arrangement is substantially the same as Fig. 1 except that the primary and secondary coils of the transformer T₁ are tuned by means of condensers as shown and the coupling between them is reduced to the proper value to insure sharp tuning. This system of connection has all the advantages of tuning to the differential frequency in the manner well known in the art and an additional one due to the fact that since

it is above audibility the musical character of atmospheric disturbances so troublesome in low frequency tuning, does not appear.

So far, the reception of undamped waves only has been considered but this method of amplification is applicable also to the reception of damped wave telegraphy and to telephony with practically equal efficiency and without distortion of any

a minimum. In ordinary heterodyning the initial phase difference depends on the time of sparking at the transmitter and hence this initial phase difference will be different for each wave train. As the frequency of the two currents are substantially the same and as the duration of a wave train is short compared to the time necessary to produce a complete beat

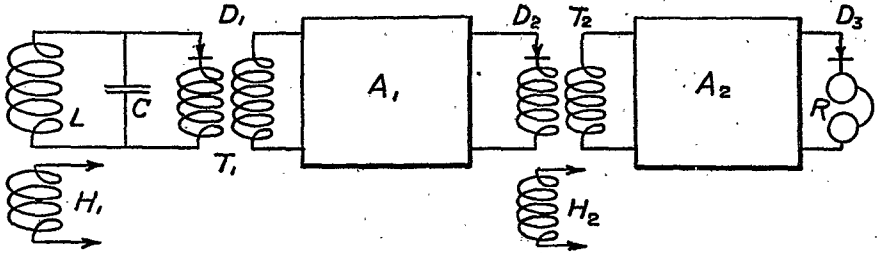

Figure 4.

characteristic of tone. It is somewhat difficult to understand this, particularly in the case of the reception of spark signals as in all previous experience the heterodyning of a spark signal has resulted in the loss of the note, whereas in the present case the individuality between stations is more marked even than on a crystal rectifier.

This is the most interesting point in the operation of the system and the reason will be understood from the following analysis:

at an audible frequency, this initial phase difference is maintained throughout the wave train. Hence, the different wave trains are rectified with varying efficiency, the telephone current becomes irregular and a rough or hissing tone results.

In the present method of heterodyning the beat frequency is high so that several beats per wave train are produced. As a consequence, the phase angle between the signaling and local currents varies through several cycles and the initial phase difference becomes a matter of minor import-

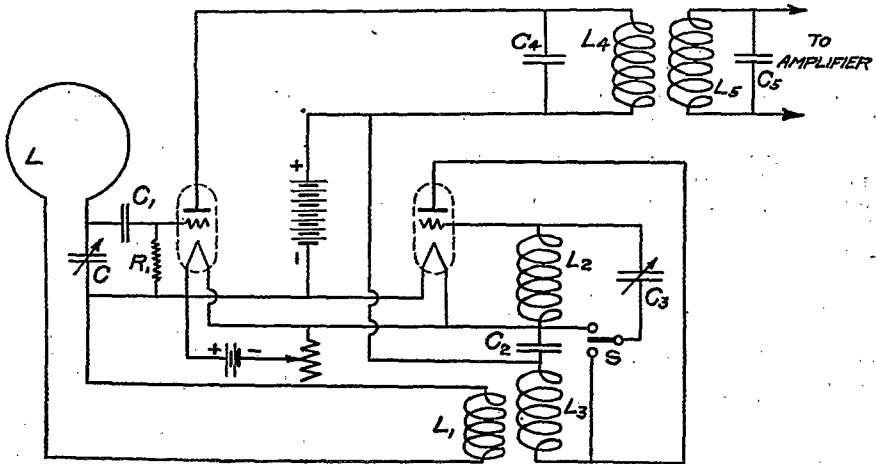

Figure "A"

In heterodyning, the efficiency of rectification of the signaling current depends on its phase relation with the local current. If the two currents are either in phase or 180° out of phase the efficiency of rectification is a maximum; if 90° out of phase

ance. The number of beats which actually occur in practice depends on the beat frequency, the damping of the incoming wave and the damping of the receiving circuit. As the damping of the receiving circuit is almost invariably much less than

the damping of the incoming wave it is the determining factor. In any practical case, however, where the beat frequency is kept above 20,000 cycles there is a sufficient number of beats to minimize the initial phase differences and maintain the characteristic tone.

The phenomena which occur in the reception of modulated continuous wave telegraphy and telephony are substantially a combination of those explained in the cases of undamped and damped wave reception. The adjustments are made in the same manner as for damped waves and the only precaution necessary in the reception of telephony is to damp the amplifier circuits somewhat to prevent distortion of the speech by excessive resonance.

The arrangement found most suitable for practical working is shown in Fig. 3.

strength is concerned and a great gain in simplicity, as adjustments have been reduced to the minimum of a single one.

It may be observed here that this method is not limited to one transformation of frequency with one subsequent amplification. If the frequency to be received is 5,000,000 cycles this may be stepped down to 500,000 cycles, amplified, stepped down again to 50,000 cycles, re-amplified and detected as illustrated by Fig. 4. The great advantage of this method of amplification is that the tendency to oscillate due to the reaction between the output of the amplifier and the input is eliminated as the frequencies are widely different. The only reaction which can take place is in each individual amplifier. Hence, the process of extreme amplification is best carried out in stages of several frequencies, the amplification

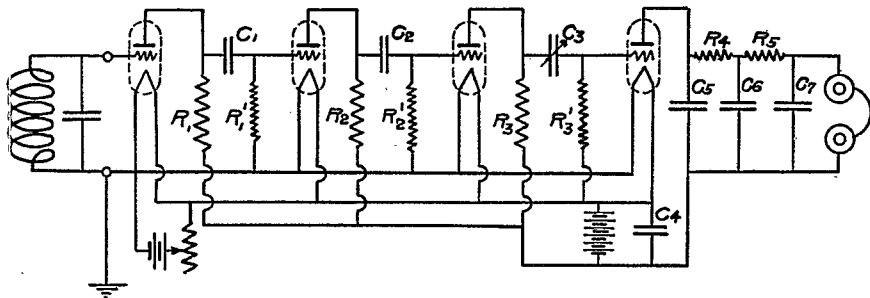

Figure "B"

Both rectifications are carried out by three element vacuum tubes. The amplifier here shown is resistance coupled, although any form of coupling may be used. The tuned circuits L_1C_1 and L_2C_2 are preferably adjusted to some frequency between 50,000 and 100,000 cycles. The circuit LC may be made regenerative if so desired by any form of reactive coupling but the practicability of this depends largely on the amount of time which is available for making adjustments.

In the diagram of Fig. 3 only two stages of high frequency amplification are shown but at least four and preferably six should be used to get the maximum advantage of this method. This is because the transformation of frequency is accomplished only by a certain loss so that something between one and two stages of amplification is required before this is overcome and it is possible to realize a gain. In this figure a separate heterodyne is shown and it will generally be necessary to use it on account of the mistuning which is involved in the use of the self heterodyne. This mistuning is considerable on 600 meters but on the shorter waves it is possible to use the self heterodyne method with equal efficiency as far as signal

on each frequency being carried as far as possible without loss of stability. As soon as the limit of stable operation is approached, no further amplification should be attempted until the frequency has been changed.

The foregoing descriptions and explanations do not pretend to any save a most superficial treatment of the phenomena present in this method of reception. Lack of time has prevented a careful study and quantitative data only of the roughest sort has been obtained. Sufficient work has been done, however, to demonstrate the value of the method particularly in the case of modulated continuous wave telegraphy and telephony. In this field neither the amplification nor the selectivity can be equalled by any direct method. The practice of this method involves the use of many known inventions but in connection with the production of a superaudible frequency by heterodyning I wish to make due acknowledgement to the work of Meissner, Round and Levy, which is now of record. The application of the principle to the reception of short wave is, I believe, new and it is for this reason that this paper is presented.

(Concluded on page 15)

More Hun Radio

By Howard S. Pyle

A little want-ad among the "Strays" in last month's number was the inspiration for this additional sidelight on the Kaiser's communication apparatus. We all envy Crowdus his opportunity to work the Heinie's layout under its original conditions and installation, but I'm satisfied I've gone him one better, for I had the good fortune to pick up the whole business and carry it home with me—transmitter, receiver and even antenna.

As Crowdus says, "Here's how it happened". We were discharging cargo at the dock in Antwerp, Belgium, about the middle of May, and being one of the first American vessels in that port since the outbreak of the war in 1914, had considerable of an opportunity to get first choice on numerous souvenirs in the way of German trench periscopes, machine guns, and various other Hun accoutrements. It was an advantage not to be lost sight of and the crew had soon gathered a vast array of various forms of helmets, breast plates, rifles, gas masks and countless other trophies.

The stuff that kept coming aboard to be promptly locked in ditty boxes and sea bags got to be too common-place to be really good souvenirs, for helmets, etc., were to be had by the carload. Accordingly, another Chief Electrician and myself hit it off on our own for a Belgian freight yard some three or four miles down the 'Railroad to Berlin' from where we were docked. It was rumored that there were all manner of technical and scientific apparatus stowed in freight cars down that way, and we were determined to investigate.

After pacifying several groups of Belgian guards at the various railroad bridges that we were obliged to cross, we sighted the freight yards, where there were all of three hundred cars standing on the several sidings. The majority were of the box type but several open flats gave us pretty good confirmation of the rumors we had heard, for crated up on one of the flats was a complete telephone exchange board, from which we lifted several phone plugs for a starter. Extreme caution was necessary as the yards were well guarded, but we soon discovered that one package of 'Humps' went a long way towards blinding the guards, and luckily we had taken that into consideration and filled our pockets with the '20 fer 10's.' After investigating the contents of at least half of the cars in the yards and finding nothing more interesting than machine gun parts and various forms of shells, we were becoming dis-

gusted, when Williams, my partner in 'crime', chanced to crawl into a box car through rather a large shell hole in the side.

After a few minutes on the outside, I sensed that something big was going on inside, so voiced my impatience and my reply was seeing William's face at the shell hole with eyes as big as saucers. I needed no spoken word, but crawled through, and investigated the contents of a huge packing case, sole occupant of the car. In a few minutes we realized what we had. A complete Telefunken field set!! What a prize! We set to work feverishly and lifted out the containing cabinet, which was of aluminum, camouflaged to resemble the color of the fields. Two glass doors confined the transmitting apparatus and the receiver was set into a little shelf projection which formed an operating desk, also holding the key and antenna switch. A separate frame contained a small gas engine but I was disgusted to find that some one had made off with the motor generator. The antenna masts and equipment were housed in a 'coffin' and contained material for a sixty foot antenna.

It was out of the question for us to carry the whole business three miles to the ship and past the numerous guards. A little resource to puzzled frowns and head-scratching led to the decision that we had better dismount the stuff and leave the containing cabinet, which was about ten by four feet. It seemed a shame to tear up such a dandy and compact unit, but we decided it was worth tearing up for the apparatus. A settlement was soon reached where Williams would take the receiving set as his share and I would take the transmitter. He being a newcomer in the amateur field, he had not as yet aspired to the joys of pounding it out as well as hearing it come in.

We set to work with pieces of thin steel for screw drivers and were making very unsatisfactory progress when we decided to leg it for the ship, grab a kit of tools and come back and do the job right. The Germans surely do, to quote brother Crowdus again, "—make apparatus to stay made" and further it wasn't intended to be removed from that cabinet, but perseverance won out and it was a curious pair that were to be seen marching down the railroad track in the twilight.

Around one shoulder I had swung the transformer. To this was tied the reactance coil. The other shoulder supported the oscillation transformer and loading coil with attached wave-changing switch. A

(Concluded on page 16)

Traffic Rules and Regulations of the A. R. R. L.

THE following rules and regulations for handling traffic have been adopted by the Operating Department of the American Radio Relay League and should be adhered to, not only by the Operating Department, in handling regular traffic, but by all members of the League operating transmitting stations:

1—The relay work of the League will be carried on only between 9 and 12 P.M. daily. Other stations not handling relay work should be requested to stand by between these hours when there is traffic to be handled.

2—All traffic of the League will be handled in short relays. Where stations are close enough together to allow it the jumps should be short enough to insure regular daylight communication.

3—According to the radio laws no more power should be used at any time than is absolutely necessary. All stations are bound to carry on service with the minimum of energy necessary to insure safe communication. Don't use 1 KW to work another station in the same town.

4—In calling another station the following procedure should ordinarily be followed: the preparatory signal, KA, followed by the call of the station wanted, repeated three times, then DE, followed by the sign of the station calling, repeated three times, and the close-off signal. Where stations are close together the call letters of the transmitting station and those of the station wanted need be transmitted only once.

5—If the station called does not answer after its call has been transmitted three times, at intervals of two minutes, the call should not be resumed until after an interval of fifteen minutes.

6—When one station has called another station, other operators in the neighborhood will not transmit until the first station has indicated that it is clear, by means of the regular conclusion signal . . . — or "clr". Other stations, however must not be held off unnecessarily. Inquiry as to whether other stations are clear should be made by the figure 4 transmitted once, unless the operator desiring to work is sure other stations are clear.

7—Messages should be transmitted singly, unless another arrangement is made with the receiving operator by the usual international signals QSF, QSG or QSH.

8—Do not repeat anything unless requested to do so by the receiving operator. Over long distances, however, or if the

receiving station is having difficulty in receiving, it is advisable to repeat the address and signature of each message; it is also advisable to repeat unusual words in the body under practically any circumstances.

9—When conditions make accurate work difficult or impossible, not more than three attempts should be made to handle a message. If a message cannot be handled in three attempts further effort should be abandoned until conditions are more favorable.

10—Send firmly and clearly and allow definite spacing between words. In sending unfamiliar proper names or words, slow down to half speed and make each letter clear and distinct. The same applies to figures. An easy, firm, clear "fist" is the trademark of a capable, experienced operator.

11—In transmitting messages the following form will be adhered to in all cases:

A—The number of message, followed by the call letters of the transmitting station.

B—Place of origin of the message, followed by the name of the month and the day when filed. (In special test cases only the time will be included).

C—The call letters of the previous station only which handled the message. A place has been provided on the new message blanks for this with the word "via". Include only one station after this heading.

D—Address (with routing where necessary).

E—Body.

F—Signature.

The double break . . . — will be used at the beginning and end of the body of the message.

12—Messages should in all cases be routed via the shortest line to their destination. If, for any reason, a message cannot be handled all the way to its destination by radio, the station nearest to that point should mail it with a note attached, explaining that owing to the absence of a station at the point in question it could not be handled further by radio.

13—Do not delay traffic by holding it. If it cannot be handled within forty-eight hours after receipt forward copies by mail to another station that can promptly handle it, or else mail direct to destination, as provided in Rule 12.

14—In accepting messages for transmission, be sure the place indicated as its

destination is on the map. When the destination is a small town, or unfamiliar place, a radio station or large city in its vicinity should serve as a routing point and such routing should be included between the address and the body of the message, prefixed by "via".

15—The traffic of the League is heavy and the day of the "greetings by wireless" message is past. Messages should not be accepted for transmission unless they contain something worth while and of some value.

16—Where there are several relay stations located close together, a division of time, such as alternate nights, or a division of work, as to locality, routes, etc., should be made, preferably by the traffic officers of the League.

17—If part of a transmitted message is lost because of interference, etc., the receiving operator will call once and sign once, then transmit the last word received before the break, then the interrogation sign, then the first word received after the break. For instance, if the body of a message read: "Will be home next Tuesday please notify my family" and the receiving operator got only "Will be home xxxxx notify my family", he should call the transmitting station once, sign once, and then "home notify", meaning that the intervening words between "home" and "notify" had been missed. The transmitting operator should retransmit that portion of the message commencing with the word "home" and ending with the word "notify".

18—In all cases when a message cannot be delivered or forwarded owing to incorrect or incomplete address; or when information of any kind concerning a

message is desired a service message should be addressed to the station from which the message was received. Traffic matters should not be made the subject of conversation.

19—Duplication of messages should be avoided. If a message has been sent to one station, do not under any circumstances send it to another station unless the first station it was sent to has been told to cancel it and the cancellation acknowledged. For the same reason no message directed to another station should be copied and forwarded unless receipt for it can be given the transmitting station.

20—The receiving station, in acknowledging receipt of traffic will make the call of the transmitting station once, sign the call letters of his own station once and make R once and end with K.

21—The international abbreviations are to be used in every case where possible. Every operator should memorize these abbreviations and use them.

22—No amateur station has any right whatever to use a wave in excess of 200 meters for any purpose, unless authority to use a longer wave has been given by the Radio Inspector, or by means of a special license. Using a wave in excess of 200 meters in the absence of authority to do so is a clear violation of the law, regardless of the location of the station.

23—Don't wait to be notified by the Radio Inspector that your decrement exceeds two-tenths. Keep your wave down and your decrement down for your own personal satisfaction and the good of amateur radio in general.

J. O. Smith,
Traffic Manager.

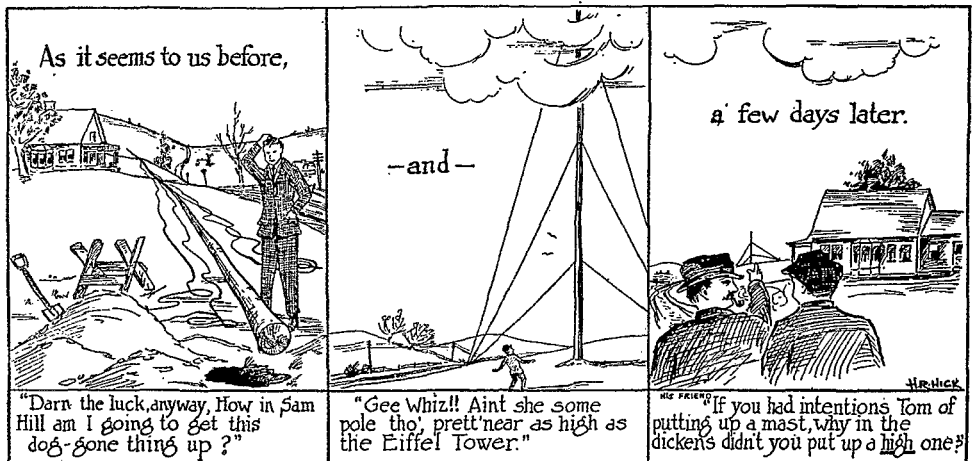

Spark Coil Transmitter Design

By Sumner B. Young

THE operators of spark-coils today are the long-distance amateurs of tomorrow, and every fair-minded person realizes that this great class of enthusiasts should be educated and encouraged, and not "Wouff-Honged" as some of our Western brothers and the Old Man sometimes advocate. True, the spark coil, untuned, and operated ad lib, is a nuisance; but its range is limited, and I firmly believe that our most serious problem today is to eliminate the far more serious interference due to the "air hogs" operating half K.W's., and the limelight-seekers who call "CQ" on full power for fifteen minutes, and then jump every time they hear the postman's ring on the front door bell to see if there isn't a letter from 5AF or 9ZN saying that their signals were very QSA on a single bulb. My object, then, is not only to try to eliminate some

to think back too many years to remember the thrill this gives him.

Now, if all stations in the neighborhood are tuned to 200 meters, the loudest man wins. That means that these conversations are frequently drowned out in the busy hours of the evening, and more interference results while the breaks are being patched together.

The spark coil man can't tune his set to 300 meters and soar above this bedlam, for if he does, some hard-hearted Government or Commercial operator will clip his wings. Furthermore, it would be unwise to reduce the wavelengths allotted to the more powerful stations, for relay work would suffer; and the scheme of installing a wavelength-changer on transformer sets presents serious practical difficulties. These difficulties are **not** present in spark coil sets, and the sensible thing to do is to

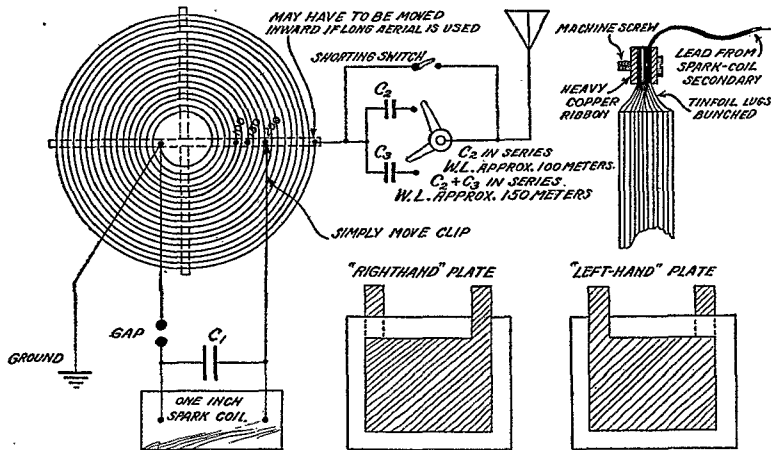

of the interference which spark-coils cause, but to protect the spark coil from the interference from the transformer stations.

I do not believe that I will have much trouble convincing you that your station should be tuned; I will merely tell you how this can best be done. My second point, however, is a radical departure.

It stands to reason that the spark coil operator cannot do relay work over great distances, and that the chief pleasure which he gets out of his set is in carrying on more or less lengthy conversations with other spark coils a few miles apart. Perhaps his conversation may not be very "meaty"; but what's the harm? He is trying out his new-found ability to speak in dots and dashes, and none of us have

tune such sets to 125 or 150 meters or arrange some scheme for shifting from the 200 meter wave to a lower wave at a moment's notice. The very small condensers which must be employed in connection with tuned spark coil transmitters make this practical.

I realize that there still exists some skepticism in regard to tuning a spark coil at all. I have made careful investigation of the methods used by some amateurs, and I therefore am not surprised that results were not all that were expected. Let me say right here and now that the secret of successful spark coil tuning lies in these two things: conductive coupling, and a very small transmitting condenser. The ordinary O.T. and the large-capacity-

only-one-turn-in-the-primary arrangement will not work. In a spark-coil transmitter, there will therefore be a number of turns in both primary and secondary, and this brings about new tuning problems which will be treated later on.

The helix which I have found most serviceable is a simple pancake of copper ribbon consisting of eighteen turns spaced one quarter of inch apart about an inner circle two inches in diameter. Experience covering four years has shown that the dimensions of the transmitting condenser should be as follows: six "right-handed" and six "left-handed" plates piled alternately, and bound with friction tape; dielectric, photographic glass plates size $3\frac{1}{4}'' \times 4\frac{1}{4}''$, emulsion removed. Coatings are of heavy tinfoil, a margin of $\frac{3}{8}''$ being left around the edges, and the lugs which protrude should be several layers of foil in thickness. Terminals are provided by simply clamping copper ribbon leads from the secondary terminals onto the tinfoil lugs by two short lengths of copper ribbon held together by a small machine screw in each end. The arrangement binds the lugs and the leads from the secondary together much as wood-clamps hold bits of wood which are being glued together.

For wiring the transmitter, copper ribbon can be employed to advantage, but for the leads terminating on the O.T., home-made Litz consisting of seven strands of No. 22 DCC wire is preferable. Simply stretch the strands tightly between two nails, then remove one end and twist.

Now for the tuning. Reference to the diagram will show approximate positions for the primary clips for the 100, 150, and 200 meter waves. Data for the position of the aerial clip on the secondary naturally cannot be given, as that will vary with the size of the aerial employed. This

holds too, in the case of the shortening condensers. Accordingly, my advice is this: For 200 meter wave, set the primary to the 200 meter position and vary the secondary until a receiving station reports loudest signals. In tuning to the lower waves, simply put a condenser of from 4 to 6 plates similar to the plates of the transmitting condenser in series with the aerial, and move the primary clip until best audibility is again reported. At my own station, I tuned to the lower waves in this manner, using a Murdock standard shortening condenser in the antenna lead, and results were on a par with those obtained by use of a wavemeter. Lest somebody jump on me for this, let me say that to obtain good readings with a wavemeter on a spark coil set where the current in the circuits is too small to allow the use of hot wire instruments in determining the resonance point is guess work personified, and that in circuits like these where large capacity is not present, the wavelength of the closed circuit does not vary so sharply with a given change in inductance. That is, with our small condenser, the change in wavelength brought about by cutting out or cutting in a few turns is nowhere near as great as the change in wavelength that would be brought about by a similar change in the number of turns in the primary if our condenser were three or four times larger.

The results obtained by the wavelength-changer have been very gratifying. Although I can work from ten to fifteen miles on the 200 meter wave with my one inch coil and have to sacrifice something in signal strength when on the lower wavelengths, I find that I can duck in under interference and carry on traffic with stations five or six miles away, when communication on 200 is impossible.

Speaking of Grounds

By H. E. Rawson

UNTIL a month ago my chest stuck out and threatened with disaster the buttons on my vest whenever anyone started "speaking of grounds". After conducting successfully a most strategic campaign aimed at my better half, which resulted in digging up the major portion of our entire lawn and burying therein a network of copper wires, spaced three feet apart, I felt justified in expanding with a gloating pride in SOME GROUND. So when a certain man, on my describing it joyously to him, threw up his hands with an "Oh! My God!", I was some peeved. The mere fact that he was Capt. H. W. Round, Chief Engineer of Marconi, Ltd., London, did not soothe

my feelings for a time. But when I learned subsequently that he has been doing intensive experimental work on grounds for the last three years, has made careful measurements on hundreds of kinds of them, and probably knows more about them than anybody else in the world, I signed the death warrant of my previous labor, and am getting ready to swallow the peculiar prescription he handed out. It sounds something like this, as he gave it to me.

"Set a post in the ground somewhere near under the middle of your antenna. Let it stick up a couple of feet above ground and put a nice big insulator on top of it. For your size of antenna (150 ft.

long), make a circle around this post with somewhere about a ten foot radius. Get a trench-tool, put a longer handle on it, and dig this circle down about four feet deep, not making the trench any wider

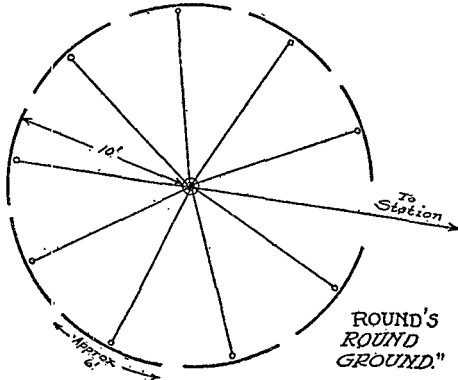

than necessary to get it down that far. Buy enough galvanized iron sheets 3' x 6' or thereabouts to fill the circle, standing on edge, the top edges a few inches below sod, spacing the ends of the plates apart somewhat. If you're a real sport you will then set a little post by the middle of each plate, with an insulator on top, bringing wires from the centers of the tops of the plates up to these insulators, and then to the central post where they are all joined, and from which your ground lead is run in the air to the station, insulated all the way. If you are not enough of a sport to set the additional posts, leaving the wires in the air, bring a high tension insulated wire from each plate under the sod to the central post, and proceed as before. Under no circumstances run bare wires under the sod to the plates, or the whole business will be spoiled."

Well, there it is, and I know for a fact it is used almost exclusively on the new stations over there, varying in diameter according to the antenna size. He gave me the reasons why my old ground was S. O. L., and why this one is perfect, but I was so flabbergasted it went in one ear and out the other. As near as I can gather, any buried bare wire grounds, leading to plates or not, allow of leakage the minute the bare wire hits the ground, so that the capacity of your ground is represented really by a series of parallel condensers, connected together through resistances, somewhat like this

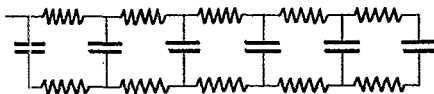

The point of putting the plates in a circle and insulating the leads of course

results in your plates all being at exactly the same potential, and the minute any current reaches the ground, why, slap bang it's ALL THERE, and no chance for leakage.

That's a stiff prescription, and perhaps a certain cat is due for a deluge, but if it will drop my resistance from 16 ohms to 4 or 5, which the Doctor guarantees, I'm game. Let's go!

RECEPTION OF WEAK SIGNALS

(Concluded from page 9)

While the fundamental idea of this method of reception is relatively simple the production of the present form of the apparatus was a task of the greatest difficulty for reasons known only too well to those familiar with multistage amplifiers and to Lieutenant W. A. MacDonald, Master Signal Electricians J. Pressley and H. W. Lewis and Sergeant H. Houck, all of the Division of Research and Inspection Signal Corps A. E. F., I wish to give full credit for its accomplishment.

ADDENDUM.

For the purpose of facilitating the construction of an amplifier suitable for short wave lengths, Figures A and B are added to the original paper, and such values as can be specified are given. The constants of the loop and heterodyne coils depend, of course, on the particular range which it is desired to cover, but this is readily obtained by trial.

Fig. A.

- C = .0005 mfd. max.
- C₁ = .0005 mfd.
- R₁ = 1 megohm
- L₁ = about 1/20 L
- C₄ and C₅ = .001 mfd.
- L₄ and L₅ = 50 millihenrys
- C₂ = .1 mfd.
- C₃ = .0005 mfd. max.

Fig. B

- R₁, R₂ and R₃ = 50,000 ohms
- R₁' R₂' R₃' = 1 megohm
- C₁ and C₂ = .0005 mfd.
- C₃ = .0005 mfd. max.
- C₄ = .1 mfd.
- C₅, C₆ and C₇ = .005 mfd.
- R₄ and R₅ = 12,000 ohms.

NOTE. The purpose of the filter is to keep the radio frequency currents out of the telephone cords and thereby prevent reaction on the input side of the amplifier with resulting oscillations. This filter is not always necessary and it will frequently be possible to cut out one or both stages.

With an amplifier consisting of six Type V tubes plus two tubes in the frequency transformer, or eight in all, it has been possible to receive the signals of amateur stations in Texas on a three foot loop.

Hartley Research Laboratory,
Columbia University.

MORE HUN RADIO

(Concluded from page 10)

piece of lamp cord around my waist held, suspended, the antenna switch, condenser units, variometer and various small parts which were yet too large for my pockets. They overflowed with small screws, etc., however. Williams was likewise equipped, and many times we cursed radio in general and Telefunken in particular in that weary three miles to the ship. The trip ended, however, as all things must and we were secure in the possession of a novel souvenir. For aught we know, it may be the only Telefunken field set in captivity—that is, for amateur purposes.

We gathered enough from the various German nameplates to know that we had a 500 cycle quenched, 500 watt transmitter, and believe me, its going to make some little relay set when I get where I can put it to that use. My chief trouble now seems to be in obtaining a 500 cycle generator at anything less than \$300. Can any one offer one or drop a hint?

The receiver was of the usual Telefunken loose coupled type, and had about the same degree of (in-)efficiency as Crowdus found. Our little Navy tuner spit signals all around it. Williams hasn't yet become enthused over long distance receiving so is satisfied with his Telefunken for the time being, but when he gets into the serious relay game, Telefunken will go in a glass case with the helmets etc. Not so my little half KW, for, again backing up Crowdus, "—their transmitters were as good as their receivers were bad." Just roughly throwing it together on the ship, for a trial, altho we tuned it carefully, she set up 8 amps on 600. Ammeter readings may not be reliable tests, but they show that there is juice there, if they don't indicate where it's going.

One feature of the receiver that was novel perhaps wasn't embodied in the set Crowdus had under his hand. That is a calibrated secondary condenser which was really a fairly good wavemeter, and by means of a few plugs and switches on the panel could also be used as an excitation wavemeter, using a buzzer transmitter.

I'm sorry I haven't interesting photos of the apparatus such as Crowdus exhibits, but will have some after I make the outfit up into a panel transmitter. Oh, about the key—I was lucky enough to get an excellent key, spring contacts which make for easy sending of pretty stuff, and a well made and well balanced little piece of brass. Guess brother Crowdus got one of the old Slaby-Arco type with a pump handle for a knob. Yea brother, my sympathy, I pounded one for six months on a Japanese outfit. Will tell you about Japanese sets some time. Nuff this time.

STATEMENT OF THE OWNERSHIP, MANAGEMENT, CIRCULATION, ETC., REQUIRED BY THE ACT OF CONGRESS OF AUGUST 24, 1912.

Of QST published monthly at Hartford, Conn. for October 1, 1919., State of Connecticut, County of Hartford.

Before me, a Notary Public in and for the State and county aforesaid, personally appeared K. B. Warner, who, having been duly sworn according to law, deposes and says that he is the business manager of QST and that the following is, to the best of his knowledge and belief, a true statement of the ownership, management (and if a daily paper, the circulation), etc., of the aforesaid publication for the date shown in the above caption, required by the Act of August 24, 1912, embodied in section 443, Postal Laws and Regulations, printed on the reverse of this form, to wit:

1. That the names and addresses of the publisher, editor, managing editor, and business managers are: Publisher The American Radio Relay League, Inc., Hartford, Conn.; Editor Kenneth B. Warner, Hartford, Conn.; Managing Editor (none); Business Manager Kenneth B. Warner, Hartford, Conn.

2. That the owners are: (Give names and addresses of individual owners, or, if a corporation, give its name and the names and addresses of stockholders owning or holding 1 per cent or more of the total amount of stock.) The American Radio Relay League, Inc., an association without capital stock, incorporated under the laws of the State of Connecticut.

3. That the known bondholders, mortgagees, and other security holders owning or holding 1 per cent or more of total amount of bonds, mortgages, or other securities are: (If there are none, so state.) Hiram Percy Maxim, Hartford, Conn.; John S. Dunham, Brooklyn, N. Y.; C. D. Tuska, Hartford, Conn.; W. S. Browne, Brooklyn, N. Y.; C. R. Runyon, Jr., Yonkers, N. Y.; Nicholas Roper, Youngstown, Ohio; Chas. C. Godfrey, Bridgeport, Conn.; Frank Conrad, Pittsburgh, Pa.; F. M. Bookwalter, Springfield, Ohio; Chas. A. Service, Jr., Bala, Pa.; Miller Reese Hutchinson, New York City; George M. Woodcock, Buffalo, N. Y.; C. Tefft Hewitt, Swisavale, Pa.; Leonard D. Fisk, West Hartford, Conn.; H. E. Rawson, Cambridge, Mass.; Emma Candler, St. Mary's, Ohio; Chapman Printing Co., Hartford, Conn.; Robert F. Gowen, New York City; E. C. Wilcox, Meriden, Conn.

4. That the two paragraphs next above, giving the names of the owners, stockholders, and security holders, if any, contain not only the list of stockholders and security holders as they appear upon the books of the company but also, in cases where the stockholder or security holder appears upon the books of the company as trustee or in any other fiduciary relation, the name of the person or corporation for whom such trustee is acting, is given; also that the said two paragraphs contain statements embracing affiant's full knowledge and belief as to the circumstances and conditions under which stockholders and security holders who do not appear upon the books of the company as trustees, hold stock and securities in a capacity other than that of a bona fide owner; and this affiant has no reason to believe that any other person, association, or corporation has any interest direct or indirect in the said stock, bonds, or other securities than as so stated by him.

5. That the average number of copies of each issue of this publication sold or distributed, through the mails or otherwise, to paid subscribers during the six months preceding the date shown above is..... (This information is required from daily publications only.)

K. B. Warner

Sworn to and subscribed before me this 6th day of January 1920

E. M. Evans
(My commission expires February 1923.)



A LESSON

What happened to amateur radio in that period immediately preceding and following the date set for "the end of the world"—December 17th? The world didn't end, we know, but something was wrong. For a couple weeks we here in the east were as completely isolated as though there were no amateur stations west of the Hudson. The conditions were really distressing—night after night of seemingly perfect weather, cold, crystal clear, no static, 600 meter stuff pounding in, but try as we might not a single amateur station over a hundred miles could be heard. This was not confined to one station—everybody in New England knows about it, and it lasted a couple of weeks. Really, fellows, we were beginning to wonder if something in the cosmic scheme hadn't been permanently put out of kilter so that perhaps never again would the old sigs come crashing through in the style that makes amateur radio worth while.

We wrote a number of our friends in the middle west to inquire their observations during this period. Without exception they report unusual conditions, and while the data does not dovetail in all cases, they say "no eastern stuff" with monotonous regularity. We couldn't hear each other! The stations in the interior, however, had

other directions left in which they could work, while we on the coast were completely hemmed in when our route went out. The point is, though, that the same conditions obtained in the west and, apparently, everywhere, in amateur wavelengths, though in varying directions.

What was the matter? Was there any connection between this "blanket" and the cosmic disturbances in progress at the time? The conditions were very similar to those existing on the night of our first attempt at a one-night coast to coast and return relay. Regardless of its cause, it must teach us one important lesson—that amateur radio is not infallible; that long distance work depends on the existence of temporary conditions peculiarly favorable to the transmission; and that the policy of our Operating Department in striving for relay stations not over fifty miles apart is the only way if we want to have a wholly reliable, dependable, and fool-proof relay organization. With such a system the recent trouble would have had no effect on our traffic—the fact that our traffic didn't get through shows pitilessly our dependence on etheric conditions and the imperative need of established routes of shorter relays if we are to put the business through every night.

REDUCING "LEGITIMATE" INTERFERENCE

A couple of suggestions here which, if adopted by the fraternity, we believe will greatly reduce QRM and make operating easier all around.

Cut down your power for short-distance work. Many stations seem to have just one power adjustment. Think of the unnecessary interference being caused when

you hear two chaps in the same town, five hundred miles away, chewing the rag. By short distance work, tho, we mean everything up to a hundred miles. Often it is necessary to use full available power for this, admittedly, to break thru the din. It's like the H. C. L.—one goes up and the other must, with a cumulative effect, and the loudest man gets thru. Co-operation, as in all amateur affairs, is the answer. Every station should have a low power adjustment. If your transformer isn't tapped for low power, there are several other methods. A hinged oscillation transformer is the simplest and most effective—loosen the coupling for short distance work and cut down the radiation. For distant-controlled sets, an impedance or resistance in the key circuit, arranged to be cut in by opening a short-circuiting switch, fully answers the purpose.

What we have mainly in mind, however, is the use of shorter wave lengths—150 and 175 meters. For some reason we all

seem bunched on as near 200 as we can get. Why? We believe a spark coil set will work just as far on 175 meters as on 200, and, sharp-tuned, local work can go on under the long distance work without causing QRM. But all of us can take a suggestion from this idea. Why not confine our moderately short distance work to the 175 meter wave, where maximum input is not necessary to get thru? If we did this it would remove a vast amount of traffic from the 200 meter tune, and long distance work would not be so often jammed by the kilowatt around the corner working the fellow in the next town.

We suggest the policy of cutting power and dropping to 175 meters for work inside a 150-mile radius. This will give the stations on distance work a 25 meter margin for tuning out, and the short range work will avoid the QRM from the high power traffic.

Think it over.

LOW NOTE VS. HIGH NOTE

As you listen each night to the whirl, what notes are the stronger, the low or the high? Absolutely no doubt about it, is there? The low notes beat the high all to pieces. And another thing. Did you ever hear a weak low note? Very seldom, and in nearly every case it is faulty receiving. What about the high notes? Ever hear any weak high notes? Well rather. It is almost safe to say you never hear any real high notes that are real loud. This concerns amateurs only. We amateurs almost universally make use of the rotary gap. It is cheaper because we can build it ourselves. Only a very few of us have 500 cycle sets. But even the few—what about them? Are they as loud as the low note rotaries? Decidedly no. What about 500 cycle generally? That's another matter. These naval and merchant ships whose operators have inserted series condensers and have got down to 200 meters come in strong and piercing. They cause QRM even in the Middle West. Now why are

they so loud and all amateurs 500 cycle so weak? We are talking 200 meters, remember. The ship has a wonderfully good ground for one thing. On the score of power, there is nothing, because no matter how much power you have there is a limit to what you can squeeze into 200 meters. It is a queer thing which is worth thinking about. When it comes to the rotary gap, however, the problem is a different one. The low notes have it all over the high. Many amateurs have a deep affection for the high note of the 500 cycle and strive to duplicate it by running their gaps at high speed. They never even approach the sharp, incisive, piercing mosquito sing of the 500 cycle, but they get a high note. But it is almost never loud. In fact most of them distinctly strengthen their signals when they shut off and finish the final sending while the rotary is slowing down. One often feels like writing the fellow and telling him how much louder his signals are when

his rotary is slowing down. If he could only understand how much improvement he

would effect if he would only throw away half the studs on his rotary!

DEAD SPOTS

What about these dead spots anyway? Years ago we used to think several parts of the country were insulated in some way so that radio signals could not penetrate. The Mississippi Valley used to be one of these and the New England district another. Since the war, with the vastly improved receiving apparatus and also the better antenna and better transmitting equipment generally, several of these dead spots have been shown to be myths. Signals punch through them now with ease and certainty. Every night in the week nowadays we in Connecticut can hear Mississippi Valley stations working each other, which we never were able to think of in 1916. But just the same we still think we notice some of the old queer tendencies. For instance, we recall especi-

ally the night of December 1st here in Hartford, when stuff seemed to be going over our heads. We were able to work west but could do nothing east and right in the middle of it we could hear 8CC working 1AK when we could not get a whisper from 1AK. Was it our fault or was 1AK going over our heads and coming down at Utica? Similarly we have been politely called by the Traffic Manager because of working 8th District stations over the head of 2nd District stations. The reason was that we could not hear any of the latter, and yet we knew they were on and going. Is there or is there not anything in these geographic myths and these so called dead spots? If there is, why and how? How about it, anyhow?

CALLS HEARD

In reporting calls, your co-operation is asked in the following:

- (1) Please arrange calls heard by districts, from 1 to 9, and alphabetically thru each district.
- (2) Put parentheses around calls of stations also worked.
- (3) Omit initial or other unauthorized calls.
- (4) Join the A.R.R.L. and get in on the traffic handling.

HEARD AT 1AW, HARTFORD, CONN.

(Maxim and Warner), Dec. 10th to Jan. 5th. 1AN, (1AS), (1CM), 1DL, 1EP, 1GJ, (1JQ), 1NY, 1RN, 2CS, (2DA), (2ZS), (2ZM), (3CC), (3CH), 3MN, 3NB, (5AF), (5AG), (5AL), 5BC, 5ZA, 5ZL, (8ADX), 8AB, 8AH, 8ALE, 8AKM, 8BO, 8CC, 8CB, (8DA), 8DW, (8EC), (8EX), (8EN), 8EZ, 8EF, (8FP), (8FA), 8FK, 8FI, 8FT, 8GJ, 8GP, (8HM), 8HP, (8IB), 8LS, 8LA, (8NF), 8NO, (9AP), (9AJ), (9AU), (9ABD), 9AL, 9AHW, (9BR), (9BT), (9CA), 9CS, 9CE, 9CW, 9DC, 9DK, 9DV, 9EE, 9EY, 9EX, 9EG, 9FU, 9GY, 9GS, 9GC, 9GV, 9HT, 9HS, (9MK), 9NE, 9NH, (9OY), (9PF), 9PO, 9JU, 9SX, 9UK, 9PQ, 9VP, 9WW.

8AA's DECEMBER REPORT

1AW, 1AG, (1KT), (1RN), 2BK, 2BM, (2CS), (2DA), 2IR, (2JU), 2SH, 2VN, 2WB, 2ZA, 2ZM, (2ZS), 3AN, (3BZ), (3CC), 3CH, 3MN, 3NB, (5AF), (5AG), (5AL), 5BC, 5ZA, 5ZL, (8ADX), 8AB, 8AH, 8ALE, 8AKM, 8BO, 8CC, 8CB, (8DA), 8DW, (8EC), (8EX), (8EN), 8EZ, 8EF, (8FP), (8FA), 8FK, 8FI, 8FT, 8GJ, 8GP, (8HM), 8HP, (8IB), 8LS, 8LA, (8NF), 8NO, (9AP), (9AJ), (9AU), (9ABD), 9AL, 9AHW, (9BR), (9BT), (9CA), 9CS, 9CE, 9CW, 9DC, 9DK, 9DV, 9EE, 9EY, 9EX, 9EG, 9FU, 9GY, 9GS, 9GC, 9GV, 9HT, 9HS, (9MK), 9NE, 9NH, (9OY), (9PF), 9PO, 9JU, 9SX, 9UK, 9PQ, 9VP, 9WW.

COPIED AT CANADIAN 3AB, TORONTO, DECEMBER.

2CS, 2IR, 2JU, 2ZL, 2ZM, 3BZ, 3RO, 5AF, 5AQ, 8AH, 8ALE, 8ASF, 8BM, 8BS, 8BV, 8CB, 8DA, 8DV, 8EN, 8ER, 8FO, 8FP, 8FS, 8GA, 8GQ, 8LE, 8NF, 8OT, 8RS, 8XX, 9AJ, 9CW, 9FU, 9GS, 9YA.

HEARD AT 5CD, PILOT POINT, TEX.

5AL, 5AS, 5BL, 5ZA, 5ZC, 5ZL, 9AB, 9AJ, 9FT, 9YA, 9YO, 9ZN.

HEARD AT 6FE, ANDERSON, CALIF.

6AC, 6AL, 6AN, 6AK, 6BQ, 6BR, 6CK, 6CO, 6FD, 6RK, 6XA, 7AC.

HEARD BY 8ARJ, C. A. INGALS, CRAFTON, PA. 2ZM, 2WV, 2JV, 2ZS, 2BG, 3AMO, 3GS, 5ZP, 8ER, 8AA, 8DA, 8ASF, 8ASZ, 8AAZ, 9ZN, 9ZS, 9GZ, 9AJ. Who hears 8ARJ?

REPORTED BY 9GS, NASHVILLE, ILL.

Worked: ex 9ABD, 9AP, 9BR, 9BT, 9DH, 9FU.

HEARD AT 3BZ DURING DECEMBER.

1AW, 1ZM, 1CM, 1AR, 1RN, 1SZ, 2BM, 2ZS, 2SH, 2ZM, 2DA, 2JU, 2WB, 2CS, 2BB, 2AW, 2IR, 2ZL, 2JZ, 3CC, 3AN, 3CH, 3GX, 4AO, 5AF, 5ZL, 5FA, 8ALE, 8CC, 8EX, 8CB, 8AA, 8FP, 8AB, 8DW, 8EF, 8ADX, 8FO, 8DA, 8CH, 8JZ, 8FK, 8AU, 8EF, 8AUM, 8DR, 8AMN, 8AJ, 8IC 8AN, 8ER, 8NF, 8NH, 8ZX, 8HG, 8EC, 8FR, 8FP, 8FS, 8GY, 8LS, 8AS, 8BEE, 8AF, 8AH, 8EK, 8FI, 8NO, 8RZ, 8AUF, 8ASF, 8GA, 8LG, 8SK, 8AUO, 8EN, 9AU, 9FP, 9BT, 9CC, 9AJ, 9DT, 9CS, 9ZN, 9VY, 9AA, 9WU, 9UU, 9GY, 9LU, 9BR, 9PC, 9VP, 9EG, 9ZS, 9GN, 9GH, 9GS, 9GX.

9GO, ex 9HS, ex 9HT, 9KF, ex 9OY, ex 9PQ, ex 9VP, 9ZN, 8AA, ex 8ALE, ex 8ADX, 8AH, 8BS, 8EF, 8ER, 8EX, 8GQ, ex 8HA, ex 8LS, ex 8VP, 8AC, 8AG, 8AL, 8BC, 8AS, 8ZA, 8ZC, 8ZL, 8AG, 2DA, 2ZS. Also heard: 9FT, 9AF, 9AU, 9AW, 9CG, 9DR, 9DU, 9ER, 9FS, 9FT, 9FZ, 9GC, 9HV, 9II, 9ID, 9IF, 9IX, 9JE, 9VY, 9WH, 9WA, 9YO, 9YA, 9FL, 8ASF, 8CB, 8CC, 8DO, 8DV, 8DA, 8DR, 8ET, 8FD, 8HG, 8NO, 8NF, 8GD, 8DO, 4AN, 8XC, 2BM, 1AG, 1AW.

REPORT FROM IRN, BELMONT, MASS.

"We are managing to relay a few messages at IRN in spite of the bad Q. R. M. which prevails here at Boston. From the 10th of the month, we relayed sixty messages, 38 to New York State in the following proportions: 2BM-4, 2DA-6, 2IR-5, 2JU-1, 2ZS-13, and 8CC-9. Stations heard but not worked were: 2CH, 2JZ, 3BZ, 8ER, 8FP, 8NO, 9AU, 9EG, 9VY, and 9ZN. Stations worked were: 2BM, 2DA, 2IR, 2JU, 2ZS, 8AA, 8AB, 8AH, 8CB, 8CC, 8HG, 9KF."

HEARD AT BURBANK, CALIF.

By Daniel Campbell, on crystal detector: 6AE, 6ACC, 6AT, 6AU, 6AV. 6AT, 6AE and 6AV come in loud enough to read thru Los Angeles QRM, 9 miles away.

HEARD AT 5XA, A. P. I., AUBURN, ALA.

1AW, 3BZ, 4EJ, 4AC, 4AN, 4AH, 4BC, 5AF, 5AL, 5AC, 5AG, 5AA, 5AD, 5BC, 5BO, 5AU, 5DO, 5AQ, 5ZL, 8EZ, 8EX, 8VP, 8FI, 8FK, 8AA, 8CB, 8NF, 8ER, 8DO, 8DW, 8GQ, 8FP, 8ASF, 8DA, 8ALE, 8EF, 9PQ, 9PF, 9AU, 9AJ, 9NE, 9VP, 9BR, 9WU, 9DK, 9AF, 9VY, 9ZN, 9BT, 9LN, 9GS, 9GX, 9FU, 9EG.

HEARD AT 2NS, PEEKSKILL, N. Y.

1CM, 1AN, 1CK, 1RN, 1AW, 2SP, 2JM, 2ZS, 2DA, 2BB, 2IR, 2ZV, 2BK, 2CH, 2ZL, 2JU, 2ZH, 2AB, 2FI, 2SV, 2OM, 2PO, 2PA, 2OM, 2ABF, 2WI, 2CS, 2JJ, 3CV, 3CC, 3ED, 3AK, 3CS, 3AI, 8AA, 8AH, 8NH, 8EK, 8AL, 8VP, 8ER.

HEARD AT 9IT, ANDERSON, IND.

9ZN, 9HN, 9AJ, 9NE, 9AP, 9AU, 9CS, 9BT, 9PO, 9BR, 9VY, 9AS, 9PF, 9HS, 9WU, 9WW, 9VY, 9AOB, 9KF, 9APR, 9APM, 9CE, 9WC, 9HR, 9EG, 9ER, 9CW, 9HH, 9EY, 9EF, 9HD, 9GS, 9CY, 8AH, 8JZ, 8GP, 8CC, 8ASG, 8NH, 8AA, 8EZ, 8ER, 8DA, 8EX, 8EL, 8GQ, 8NO, 8FS, 8FI, 8ASF, 8HG, 8FP, 8AH, 8VP, 8EC, 8CB, 8ADX, 8NF, 8BB, 8FT, 8DZ, 8AL, 8AF, 8AC, 8AS, 8BB, 8BC, 2WB, 2ZS, 2SH, 2SR.

WORKED BY ZZA, ROSWELL, N. MEX.

5AA, 5AC, 5AF, 5AG, 5AL, 5BO, 5DO, 5ZC, 6EA, 6IZ, 6TX, 9BT, 9CA, 9CS, 9BR, 9FI, 9HN, 9MK, 9NE, 9VP, 9WH, 9WU, 9ZD, 9ZN. Also heard 6FU, 6GQ.

HEARD AT HAMPTON ROADS, VA.

By C. D. Morris, Opr., S. S. Deepwater, Dec. 22d and 23d: 1AN, 1AW, 1ZS, 2DA, 2ZL, 2ZS, 3BZ, 3EZ, 3FG, 3AF, 3CS, 3SH, 3GO, 4AG, 5AF, 8AA, 8AH, 8AL, 8CC, 8EA, 8EN, 8ER, 8FI, 8HP, 8NF, 8VP, 9ZS, 9ZN, 9KF, 9PC, 9BA.

HEARD BY SHP, UTICA, N. Y.

(1AW), (1RN), (1AN), (1AK), (1FQ), (1DL), (1YA), (1AS), (2SH), (2ZV), (2ZS), (2ZM), (2IR), (2DA), (2ZL), (2JU), (2AB), (2BM), (3CC), (3AK), (4AX), (8AD), (8ER), (8AA), (8ZS), (8DA), (8AH), (8ALE), (8GQ), (8HF), (8DF), (8DY), (8CS), (8FG), (8FW), (8EX), (8CH), (8EZ), (9AOC), 9WU, 9ZN, 9GS.

HEARD AT ZEE, KEYPORT, N. J.

1AN, 1AS, 3AN, 3BZ, 3CV, 8AA, 8CC, 8JZ, 9AJ, 9ZN.

HEARD AT 7CH, BOISE, IDAHO.

6AT, 6AR, 6AZ, 6AC, 6AG, 6AX, 6AJ, 6AU, 6AN, 6AM, (6BQ), 6BO, 6BA, 6BF, 6BR, 6CC, 6CE, 6CK, 6CO, 6DR, 6EA, 6EJ, 6IZ, 6GQ, 6SX, 6TX, 6WR, 6XW, 7AD, 7GR, 7RB, 7YS, (7ZB), 9WH

REPORTED BY ZWB, BROOKLYN, N. Y.

1AF, (1AS), 1AW, 1DL, 2AR, (2DA), (8AN), 8CK, (8CC), (8AA), 8CB, (8CC), 8EX, 8ER, 8EZ, 8HG, 8DA, (8JZ), (8MC), (8AH), (8ADX), 9AJ, 9AF, 9AS, 9ANO, 9HN, 9JW, (9ZN).

HEARD AT 7AY, BEAR CREEK, MONT.

5AF, 5AV, 6GQ, 8AA, 9AJ, 9AHW, 9VP, 9WH, 9YL, 9VY.

HEARD AT 5AS, AUSTIN, TEX.

(5AC), (5AF), (5AG), (5AL), (5BM), 8EX, 8EZ, 8NR, 9AJ, 9AP, (9BT), 9BR, 9BY, 9HN, 9JW, 9WH, (9WU).

HEARD BY EX-9ARE, DULUTH, MINN.

8ER, 8QG, 9AF, 9AJ, 9CG, 9CO, 9CP, 9VY.

HEARD OFF LUBEC, MAINE.

most northerly point in U. S., by Pratt, Opr., S. S. Gov. Dingley: 1AW, 1NV, 2LO, 2ZS, 8ALE.

HEARD AT 8IB, COLUMBUS, OHIO.

1AW, 1AS, 1AU, 1KT, 1RN, 2AAN, 2BN, 2BM, 2CS, 2DA, 2IR, 2JU, 2LO, 2SH, 2WB, 2ZL, 2ZM, 2ZS, 3AN, 3BZ, 4AA, 4BC, 5AC, 5AF, 5AL, 5BM, 5DO, 9AD, 9AF, 9AJ, 9AT, 9AU, 9AP, 9AR, 9AO, 9ANO, 9AOB, 9ADL, 9ABD, 9EG, 9BK, 9BW, 9BT, 9BF, 9BR, 9CS, 9CR, 9CA, 9DC, 9DK, 9EE, 9GC, 9HU, 9HR, 9KF, 9LP, 9MK, 9NE, 9FF, 9PQ, 9VF, 9VY, 9VP, 9WJ, 9WU, 9ZN.

HEARD AT 9JA, MARENGO, IOWA.

1AG, 1AW, 1IR, 2EM, 2ZM, 2ZS, 5AC, 5AF, 5AG, 5AR, 5AS, 5DO, 8AA, 8AC, 8AH, 8ALE, 8CB, 8CC, 8DA, 8EF, 8ER, 8EZ, 8FI, 8FP, 8GG, 8GR, 8HG, 8IL, 8LS, 8ML, 8NF, 8SA, 8TU, 8WZ, 9AC, 9AM, 9AU, 9AP, 9AL, 9AJ, 9AN, 9AS, 9AW, 9ASF, 9ASB, 9ASR, 9BU, 9BT, 9BR, 9CS, 9CE, 9CR, 9DE, 9DR, 9HU, 9HS, 9LR, 9LN, 9MK, 9NE, 9PG, 9PQ, 9PO, 9VP, 9VY, 9WA, 9WW, 9WM, 9WN, 9WH, 9WJ, 9ZN, 9ZS, 9YR.

HEARD AT 9ZN, CHICAGO, DURING DECEMBER.

(1AW), 1RN, (2ZS), (2JU), (2CS), 2LO, (2ZM), (2WB), 2IR, 2SH, 2ZL, 2CB, 3AN, 3CH, 4GL, 4AL, (5AF), (5AC), (5DO), (5BM), 5AL, 5BC, (5ZL), 5AS, (5BG), (5ZL), 5ZC, 5AY, 6EA, (8CC), (8JZ), (8FI), (8EX), 8DC, (8DA), (8AMN), (8AH), (8ALE), (8EP), (8AA), (8AUM), (8EZ), 8GA, (8IF), 8AL, (8XK), (8EF), 8LP, (8CB), 8AEK, 8COO, (8ER), (8ADX), 8HG, 8ES, 8GQ, (8ASF), (8HI), (8NF), 8EC, (8FP), 8ASG, 8FS, 8DW, 8GA, 8AP, 8FD, (8IK), (8IB), 8AG, (8IN), 8NO, 8VV, 8JJ, 8AE, (9HA), (9EY), (9VP), 9DW, (9DU), (9HT), (9CW), (9GC), (9IT), 9WY, (9IX), 9YA, (9EG), 9II, (9HD), 9DR, (9QR), 9IF, (9JA), (9BT), (9CA), (9AP), (9DC), (9MK), (9BR), 9WJ, (9CS), (9PO), (9NE), (9HU), (9PF), (9HS), 9CR, (9ADL), (9LP), (9VY), (9WU), 9JO, (9OY), (9KF), (9ABD), (9AJ), 9GS, 9FU. During this period 200 messages were handled by 9ZN.

AT LITTLE ROCK, ARK., 5ZL, DEC, 12-JAN. 6.

1AW, 2XG, 2YH, (3BZ), 4AE, (4AG), 4BC, (5AA), (5AC), 5AJ, (5AG), 5AL, 5AP, 5AS, (5AU), 5AY, 5BC, 5BO, 5BM, 5BZ, 5DO, 5EX, (5ZA), (5ZC), (5HG), (8ER), (8ALE), (8AA), 8EZ, (8DO), 8CB, 8FI, 8DA, 8GP, (8EC), 8NO, (8NF), 8AH, 8VP, 8FP, (8DW), 8TF, 8FS, (8HM), 8ASF, 8ADW, 8ADX, 8EC, 8GB, 8IK, (9BT), (9ZN), (9BR), (9PQ), (9ABD), (9DH), (9MK), (9GS), 9VY, (9AU), 9WU, (9AP), (9AJ), 9WH, 9HU, 9PC, 9DF, (9KF), 9LP, (9HS), (9VP), (9OY), 9DX, 9RK, 9ER, (9CN), 9NH, 9JO, (9CA), (9IT), 9FD, (9FU), (9EY), 9FI, (9HD), 9GX (9EG), (9GC), 9EX, 9GV, 9YO, 9YA, 9HA, 9FP, 9CS, 9DU, (9FL), 9ATH, 9CW.

HEARD AT CANUCK BPS, TORONTO, ONT.

1AK, 1AJ, 1RN, 1AW, 2DA, 2ZS, 2YM, 2ZM, 2BM, 2IR, 2ZL, 5AF, 5ZL, 8JQ, 8FP, 8AK, 8AGO, 8EG, 8NO, 8DV, 8AA, 8LS, 8ADX, 8JJ, 8AP, 8AUM, 8JX, 8CB, 8AMN, 8BM, 8RH, 8ER, 8ALE, 8DA, 8AH, 8CH, 8CC, 8EZ, 8JZ, 8FO, 8WP, 8ASF, 8DO, 8DW, 8NF, 9YO, 9GS, 9AU, 9ZN, 9WO, 9BR, 9PF, 9CS, 9AP, 9KF, 9VY, 9YA, 9AJ, 9HO, 9ASF, 9NF, 9AGM.



SOME SPLENDID IDEAS HERE

Mr. G. Kenneth Thompson, 2PL, Maplewood, N. J. has favored us with a most interesting description of his station, three views of which are shown here. Several unusual features are embodied in its construction, but let Mr. Thompson tell of it in his own words:

Both transmitter and receiver are complete units, each mounted in its separate cabinet and employing separate antenna. In these days when one's house may be sold overnight this type of construction may prove a double blessing. The transmitter is located outside of the house at a point where the lead to the ground distribution point is less than three feet long. The antenna rises almost vertically from the set to a height of 75 feet and is made up of four wires spaced ten feet apart at the top.

Note the heavy oscillation transformer and ground lead. The latter terminates in a large plate from which radiate copper ribbons and leads to water pipes. A 3400 r.p.m. induction motor spins the gap disc

transformer. On the control board are mounted the fuse block, kick-back condensers and relays controlling the transformer primary circuit and gap motor.

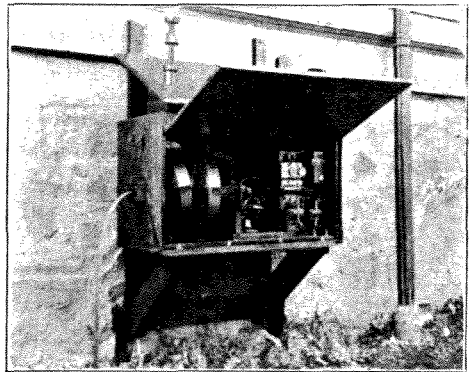

The entire assembly is mounted on a separate base which may be easily withdrawn from the cabinet after disconnecting a few leads. The cabinet is covered with two layers of oil cloth turned smooth side in and heavily varnished on the exposed side. A dozen screws clamp down the hinged lid making a tight joint all around. The set has endured heavy rains without showing any signs of leakage in the closed or open circuits. With fairly loose coupling four amperes are radiated on 190 meters. The close-up photo of the transmitter does not show an important adjunct of the balanced circuit burglar alarm which is warranted to give any curious prowler a prompt surprise.

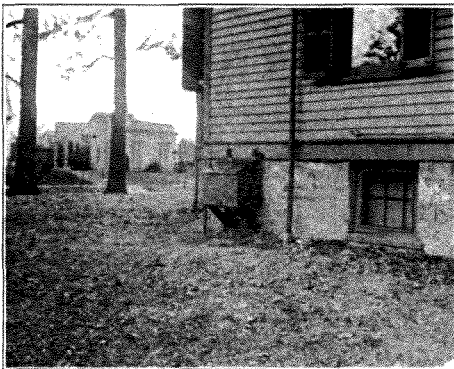

which has six electrodes $\frac{1}{8}$ " by $1\frac{3}{4}$ ". Behind the rotary is the glass plate condenser submerged in oil and behind the control is the one half K.W. Thordarson

The transmitting antenna, a vertical fan, is supported by two ninety foot oak trees one hundred feet apart. No, these trees were not awkwardly shinned and pulleys made fast to their lofty limbs. Nay, nay. A sky rocket carried a line over each tree, the line pulled over a small wire and the latter pulled over a wire cable which hoist-

ed the aerial. Contrary to popular theory this sort of aerial outlives all gales because the trees slide back and forth under the supporting cables and impose no severe strains on the cordage and insulators. Furthermore this type of antenna is spreaderless at the top, an important factor, since it eliminates the weight and

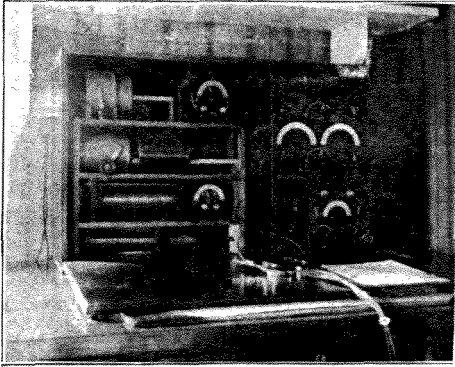

consequent inertia which every large spreader must have.

The operation of the plant is controlled in the comfort of the operator's room. The receiving set is installed complete in a cabinet having both sides hinged. In the left hand compartment are seen the primitive couplers and loading coils soon to be supplanted by a modern panel tuner which will fit the space. In the upper right compartment is a detector-one stage amplifier panel combining two variable condensers. Below is a compact two stage amplifier panel and in the cubby hole are a Morse key and switch controlling the transmitting relays. When not in use the phones slip into the cubby hole, the cabinet side swings up and the apparatus is fully protected from dust and moisture. Behind the coupling coils are mounted two storage batteries for the filament circuits. The vents of these batteries are modified to receive rubber tubes which terminate in bushings on the end of the cabinet. The arrangement precludes the evil effects of corrosive fumes within the cabinet and dispenses with the necessity of an additional cabinet for batteries. Unsightly connecting wires are excluded from view by mounting all binding posts on the rear of each instrument. Tuner, detector-amplifier panel and two stage amplifier panel are units complete in themselves and may be withdrawn from the cabinet in a few seconds for inspection or alteration.

To the right of the cabinet may be seen a telephone receiver which informs the operator of conditions within the transmitting cabinet wherein a telephone transmitter is mounted.

The receiving antenna is an angular fan directive West and is suspended in the same manner as the transmitting aerial but between different points. Many 1st, 2d, 3d, 8th and 9th district stations have been copied during the month of November.

No finished apparatus has been purchased except where absolutely necessary, the operator wishing to determine what strictly amateur design and construction can do. Throughout the installation great effort has been made to incorporate the latest accepted principles of 200 meter wave practice as expounded by QST. At this writing insufficient time has prevented enough transmitting to determine the possibilities of the set nor will a fair trial be had until the 1 K.W., 20,000 volt transformer arrives. Meanwhile however, those hearing 2PL may see for themselves from whence the sigs originate.

The Priess Loop Transmitter

Mr. Walter J. Henry, Sales Manager of the Wireless Specialty Apparatus Co., delivered an interesting and instructive talk on the Priess Loop Transmitter at the regular meeting of the N. E. A. W. A. in Boston on December 4th. At the time of the Armistice Lt. Priess had just been sent home from France to put this set on a production basis, as it had been selected to replace the T.P.S. and other S.C. field sets which were unable to meet the demands for this kind of work.

The Priess set uses a small loop, one meter square, of three turns spaced $1\frac{1}{2}$ inches, and with the transmitter and receiver comprises a single unit. The transmitter is a 500 cycle buzzer set operating on a 10-volt storage battery. An interesting feature is the use of three short wave lengths, 110, 123 and 148 meters, an idea which should be absorbed by the legion of spark coil operators and adopted in an effort to decrease QRM.

On 30 watts this set has covered a distance of 6 miles between covered dug-outs, while twice that is easily obtained in the open. It is compact, can be transported by one man, and offers a big advantage in ease of maintenance under fire as compared with a T.P.S. set, as may be readily seen. The front lines were threaded with sets of this type, being placed in threes with the shortest wave of one outfit adjacent to the longest wave of the next, to lessen QRM.

Mr. Henry's talk was well illustrated with lantern slides, and a similar type of German buzzer was exhibited, having been unwillingly donated by Fritz when beating a hasty retreat (one of them).

With the Affiliated Clubs

THE following account of the first Boston Inter-Club Convention deserves a careful perusal. Interference conditions in the Boston district are intolerable, and a co-operative policy is the only method which seems to have a chance of improving things. We hail this conference as a distinct step forward in amateur affairs and earnestly commend the idea to A.R.R.L. men everywhere as an example of the potentialities of the get-together spirit. Operating Department officers would do well to introduce the idea in their congested localities, and we believe that properly pursued it will result in a better understanding among the local cliques and inevitably produce better operating conditions for everyone.

In perusing this report the reader should get the following facts fixed in mind: The ether is and always will be a free medium for all amateurs. Amateurs have many divergent interests; some are relay enthusiasts, some are not. We have our experimenters and research workers, our damped and undamped exponents, long wavers and short wavers, 500 cyclers and 25 cyclers, squeak boxes and wireless phone owners—all entitled to equal consideration. The activities of the beginner must be given as much consideration as those of the veteran—the policy must be "live and let live".

However, the time has come when we must unite for the common good, and every man is appointed a committee of one to see that HE lives up to the recognized standards of amateur radio. Never mind the other fellow—see that YOU play the game square. Your suggestions and constructive criticisms of this report are invited.

REPORT OF THE RECENT RADIO CONFERENCE HELD IN BOSTON BY THE REPRESENTATIVES OF THE LEADING AMATEUR WIRELESS CLUBS AND ORGANIZATIONS, ON THE SUBJECT OF INTERFERENCE.

—Reported by Guy R. Entwistle—

The object of the conference was to analyze the amateur situation both locally and thruout New England, and suggest remedies for the existing QRM, both willful and legitimate.

The conference was marked thruout by its friendly attitude toward the beginner and operator of the so called "squeak box". The spirit shown thruout was that of co-operation and helpfulness, rather than that of elimination. "The squeak box owner of today will be the 1-KW bulb man of the future", was the way one man expressed the situation.

The following representatives were present: G. R. Entwistle (Chairman), Asst. Div. Mgr., ARRL; Pres., N. E. A. W. A.; (Lt.) E. A. Gisborne, Dist. Supt., A.R.R.L.; (Ensign) E. B. Dallin, 1FK; Lester Puley, Dist. Supt., A.R.R.L.; Sumner B. Young, Harvard College Wireless Club; Fullerton Webster, Mass. Inst. Technology Radio Club;

Wallace E. Heckman (Sec'y), Sec'y, N. E. A. W. A.; Arron Harris, Publicity Mgr., N. E. A. W. A.; Benj. Leo Ellis, G. Macintosh, and W. E. Edwards, Representing the amateurs at large.

The meeting was called to order at 8 p. m. promptly and a Chairman and Secretary were appointed. The plan of letting each delegate say all he had to say first, and then hearing from the next in order was adopted, and discussion was left till the last. It was found that nearly everyone had about the same general idea of the proper solution but many unique and practical suggestions were obtained from the delegates. Below is a brief summary of the proceedings.

Mr. Young: It is evident that before much can be accomplished we will have to appoint a control station to handle the local situation as well as regulate the more remote stations that are causing interference locally but whose receivers are not sensitive enough to reach the fellows very far away. Harvard has long been engaged in relay work and although we are at present out of commission owing to a burned out armature we will soon be running. Therefore before a control station is appointed I hope that a chance will be given Harvard to be heard from.

Chairman: The suggestion is very excellent and has the approval of all present without a doubt.

Mr. Young: Of course Tech and Harvard are the most logical stations for this work so I suggest that they be appointed as control stations with the authority to regulate traffic. (This suggestion was adopted unanimously.) Another point that I think should be considered is the use of two waves among the amateurs. Most every one is on two hundred meters (or above) and as a result QRM prevails. It is similar to having all the traffic go down one street in a crowded city. Why not use 150 meters as well, and put the "squeak box" on this wave?

Chairman: Why not three waves, 150, 175, 200? A wave of 175 meters is about 16% different from 150 meters and a wave of 200 meters is 33% off from 150 meters and 14% away from 175 meters, which is surely separation enough to allow tuning any one of the three out of all three.

This idea was also accepted as a possibility.

Mr. Gisborne: One thing that stands out in my mind as a cause of much of the unnecessary QRM is the calling of some local relay station just after he has called some fellow in the 2nd district, by local amateurs.

Chairman: This is a very true statement and one that must be noticed by the offenders.

Mr. Gisborne: Still another trouble lies in the fact that many amateurs have been able to transmit farther than they can receive and after calling some 2 or 8 station at great length are unable to hear them answering; and they go to it again, resulting in a general mix-up. Another thing I would like to suggest is a multi-control station along the lines of Mr. Young's idea.

Chairman: At this point may I not suggest still another idea along the line of control stations. There is no doubt that Tech and Harvard are the logical control stations for this district. It is the method of control that I am anxious of. There is a well known saying that distance lends enchantment. It also inspires bravery. An amateur ten miles away when told to QRT from a Boston amateur may show the attitude of defiance whereas if told by one of his local amateurs the psychological effect would no doubt produce the desired result.

Therefore I would further suggest that the local control stations Tech and Harvard have recourse to one prominent amateur station in each of the larger cities as a final means of regulating troublesome QRM. A local man can handle the situation better I think in extreme cases. This idea of one or two stations in each city all working under a main control station seems to me a possible solution of the existing problem.

Mr. Dallin: I think that is a fine idea.

Mr. Gisburne: There seems to be more or less general prejudice against spark coil or "squeak box" operators. It is not entirely this class of operator that is the cause of the worst brand of QRM. The other night or rather the other morning to be exact I was trying to copy 9BT, 9ZN, 9AU, when some local fellow with a pretty good sized transformer was sending the alphabet to himself over the air and when he got tired of this he proceeded to send one of the recent lists of call letters. It is this kind of QRM that we must eliminate.

Chairman: Then after all it isn't the fact of a fellow using his set at any time but the apparent lack of discretion showed by many amateurs.

Mr. Dallin: There isn't very much left to be said on the subject, as it has been very well covered by three other men. However, I would like to impress upon the amateur the necessity of improving his receiving set. Lots of amateurs call at great length the 8 and 9 stations knowing this can never hope to hear their reply as they do very poor receiving work locally.

Chairman: There is room for still more suggestions on the question of power used to carry on a COMMUNICATION. There should be a system adopted among the amateurs similar to that enforced by the commercial stations that the power used at any time should be only enough to insure reliable communication. Many amateurs use the same power to talk two miles that they use in long distance work. The result is obvious.

Mr. Heckman: I think that one of the disadvantages of the increase in the number of words in the speed test necessary before granting a license to the amateur is that it leaves us without a means of identifying the fellows with the spark coils who are still tardy about obtaining their licenses, either thru lack of knowledge of the code or lack of respect for the laws but who still persist in flooding the ether with two letter calls, and thereby evade recognition.

Chairman: There is food for thought in that statement. If there was some way to curb these moonshiners the amateur fraternity would be much better off. This is especially true inland where there is much more of this kind of interference than near the coast under the watchful eye of the Radio Inspector.

Mr. Pulley: In regard to control stations I would suggest they be selected so as not to have them too near together. Also it will be necessary to double up on them in order to have effective control every night in the week.

Mr. Gisburne: I might suggest that most of the long distance work has been done in the past on Saturday nights or the nights before holidays. Very little was done the first of the week.

Mr. Webster: One of the points that stand out in my mind is the QRM caused by amateurs who use their wireless as if it were a rattle. After talking for $\frac{3}{4}$ of an hour about nothing they spend the next $\frac{1}{4}$ hour on admitting there is nothing to talk about. At Tech we have 25 licensed commercial operators and Harvard has its share. It seems to me that when one of these experienced operators logs one of these "ether hogs" several times it is time for aid from the office of the Radio Inspector.

Mr. Dallin: At this point I might offer a suggestion of a schedule of working hours or a division of time. Why can't the owners of squeak boxes and others who are just burning up so much good ether close down at ten p. m. and give way to the relay work; that is, the long distance branch of it?

Chairman: In some of the other districts the long distance men have been known to retire early in the evening, or at least not be on the job, and come on about ten or eleven, clear whatever traffic they might have and turn in. This leaves the air clear up to this time for the collection of local traffic, which can be delivered to the local station or stations that have proved reliable to pass it on to the other districts. We must not overlook the policy of short jumps adopted by the League or at the same time hinder long distance communication. These matters will be taken up at a later time as they have no direct bearing on our subject. This

leaves plenty of time open to the other classes of amateurs who may not be directly interested in relay work.

Mr. Gisburne: It seems to me after listening to some of our local men handle traffic at the rate of about 25 or 30 words per minute on a bug to fellows in the 2nd district that better judgment should be used and a normal rate of speed adopted for sake of accuracy. In some cases the operators of these automatic keys are not as good as they might be.

(Note. Lt. Gisburne handled all of the traffic from the "George Washington", the Presidents ship, when that ship recently brought the President to Boston.)

Up till this time the three representatives of the amateurs at large had remained silent. It was here that Mr. Gordon Macintosh asked for a hearing.

Mr. Macintosh: I am glad to have been present at such a meeting as this to get the opinion of the older men in regards to the conduct of the younger fellows. I am sure I have been the cause of some of the QRM described here tonight. I have an entirely different view of the matter now and will do what I can to help. Why can't we have one of the local newspapers devote some space in their columns for our benefit and instruction? Let someone contribute articles on regulation and other information that will help us. Of course we have our monthly magazines but I feel that we need news more often.

Mr. Harris: I will look after this. It is a good suggestion.

Mr. Gisburne: It is not our intention to curb the work of any amateur. If he has any thing to say let him say it, and when he finishes then for the benefit of all let him stand by and give the other fellow a chance.

Mr. Dallin: I think it would be a good idea for the amateur to borrow a wavemeter and get his station tuned up. The waves are all over the map.

Mr. Chairman: I am glad to be able to announce the entry of a cheap wavemeter by one of the local radio concerns. One that will sell for \$5.00 and is direct-reading. It will be advertised in December issue of QST. With wave meters so cheap there should be one in every "kitchen". Another possibility along the lines of QRM elimination lies in the new circuits developed during the war. I refer to the rejector circuit.

Mr. Gisburne: I had the honor of using the first one of these brought ashore in the U. S. at WBF. They work fine. I will describe it in an article for QST.

Chairman: Also in the old ideas of group frequency tuning there may be hidden possibilities. These are called tone traps I believe. The rejectors are referred to as wave traps.

Mr. Pulley: There is also the acceptor that permits the reception of two or more waves simultaneously on the same aerial.

Mr. Ellis: I think the idea of wave changing for the amateur is a good one. I have learned a lot at this meeting. If the others could be here I think they would agree that there is room for much improvement among us.

Mr. Young: We have covered a lot of ground and I think we will all agree that something must be done and we have gone a long way tonight in starting the ball rolling. I have another suggestion. I think after an amateur has been told to QRT several times and still persists in ignoring the warnings of the control stations and becomes a nuisance in general that he should be given a trial by a suitable board of fellow radio men and if found guilty of disturbing the peace be elected to The Chamber of Horrors. This will consist of having his name posted in QST under the black list. Once a man has been so proscribed he will become a man without a country, so to speak. He will then, if the interference persists, be recommended for action by the local Radio Inspector, which in other words means he will be closed up for 3 months or so to learn a few fundamentals concerning the limitations of freedom when it interferes with the freedom of others. (Applause from all. Very good idea.)

(Concluded on page 26)

WHO'S WHO IN AMATEUR WIRELESS

We shall publish each month two pictures of amateurs who have become known to us in our work. This will draw us all closer together. We are often curious as to just what the other fellow looks like, and here's our chance to see.—Editor



IRVING VERMILYA

This month we have with us a couple of amateurs, who, while not just now engaged in the amateur game, remain amateurs at heart.

Mr. Vermilya was one of the first, if not the first, to get into the amateur game in this country. The old-timers remember his 5KW spark with the sine VN, in the days of fixed gaps and any old wavelength. His wireless days date back to Marconi's first visit and experiments on this side of the ocean, when he was trying to get the letter "S" across to Nova Scotia. VN's early doings were chronicled in a story appearing in QST under the title "Amateur Number One." He has been in the commercial side of the art with Dr. De Forest, United Wireless, and Marconi, and is still at it, being now Shift Engineer at the Radio Corporation's station at Marion, Mass. He is the author of "S. O. L.," the amusing war-time story now running in QST. He says he'd rather fuss with wireless than eat, and his record shows it.



JAMES F. RAU

Mr. Rau is another amateur who is now away from his home set, being still in uniform. His early interest in wireless commenced with the accidental discovering of a book on the subject in a public library. His first transmitter was a spark coil, like with most of us, and then came 3AEP, a Philadelphia station with a splendid record in pre-war long distance relay work. With Mr. Service he did some commendable missionary work in personally visiting amateurs in their territory in an effort to establish working routes, in the old days.

Mr. Rau enlisted as Electrician 2nd class in the U. S. Coast Guard at the beginning of the war, and was promoted to Chief in September, 1918, still serving in that capacity aboard the U. S. S. Seminole, sailing from the Charleston Navy Yard. By radio he has worked every station on the Atlantic Seaboard from Maine to Panama and had some good sport hunting subs during the war.

His discharge is expected soon, and then

we will look for old 3AEP to blossom forth in relay circles with more pep than ever. His new call is 3FM.

WITH THE AFFILIATED CLUBS

(Concluded from page 24)

Chairman: One thing we will have to be careful of is prejudice of certain amateurs against certain others. A fair trial must be assured. We will ask for remarks on this from the amateur fraternity at large.

Mr. Dallin: I would like to emphasize the importance of keeping a log. If we log these offenders and can check up satisfactorily among the experienced operators, we have much in our favor when trying to bring into effect the Chamber of Horrors Mr. Young referred to.

Mr. Webster: Before the war there was a certain element among the amateurs that was rebellious even to the extent of using profane language. One of the amateurs was detected in the act of calling himself and then answering a few seconds later on a different note. When told to QRT he simply requested the one that exposed him to go to that place where the temperature is always high; further adding that "the air is free and I will send as long as I want to." Something must be done in the future to this kind of an amateur.

Chairman: This brings up several points that should be made clear. First and foremost is the fact that the air is surely free. It is still one of the few things that are. As has been mentioned before, we are not attempting to monopolize the ether. Every one has an equal right to it. But only an EQUAL right, not a sole agency. When we stop to think of all the amateurs there will be soon, and all working on the same wave length at the same time, it doesn't take a master mind to see how much time each of us can use it. All that we have said this evening is only an attempt at proper regulations and control based on justice and consideration of all parties concerned. We have not the power to say an amateur shall not do this and he shall do this but we can lay down a few unwritten laws and hope that along the lines of a gentlemen's agreement amateurs will try to observe them for the good of all. We are starting early before our numbers are multiplied so much as to render regulation almost impossible.

Mr. Hardy (Communicated): I regret exceedingly that I was not able to attend the meeting. I haven't much to say on the matter but one idea presents itself. I think there should be a right-of-way for relay messages. If we called a station and after signing off, followed by "A. R. R. L.", indicating we had relay work to transmit, I think the amateurs would give way.

Chairman: A very good suggestion. The A.R.R.L. is the only established relay communication chain in the country. It serves a practical purpose. It accomplishes something. The various amateur stations throught the country are lined up for effective use, rather than having them exist without a definite object in mind. It represents an organization, the largest and oldest in the country. Its officers and operators represent the cream of the amateurs. Its network of chains, interconnecting every state in the Union and Canada, serve as a means of free communication by anyone to anywhere. We are the most logical organization to undertake the work of control and regulation. We ask the help of all. Let's all get together and settle this QRM problem. There are many phases we haven't considered tonight. Time is short and it is our first meeting. We would like to have the suggestions of all the interested parties.

A motion to adjourn was seconded.

QST TO PHILADELPHIA AMATEURS.

Within the last few weeks there has been some congestion of traffic in Philadelphia after ten o'clock due to unnecessary transmitting. The attention of new members in our city is called to the local agreement that transmitting after ten o'clock be confined to long distance work only, and that spark coil and power sets alike keep the air free of QRM. Only those who think they can raise a distant station are to transmit. Remember that silence is golden.

If transmission is necessary, the following procedure is recommended, and its use will obviate much interference. If a power station desires to transmit, it will please send the following before starting:

IE IE IE IE

Anyone listening and desiring silence for a few minutes need only then send

— . . . — . . . — . . .

This will insure silence. However, if no one desires silence, no reply is needed and the station can then assume that the air is free and can begin transmission. In the above, no call letters are needed whatever; just the above signals. In any local transmission after ten o'clock be as brief as possible. Remember that you don't own the air and there are probably hundreds of others listening in for distance, many having multi-stage amplifiers. There is no punishment for offenders, only the scorn of the offended and a damaged reputation.

John Mooney, Jr.

Chairman Broadcast Committee,
Phila. Radio Amateur Ass'n.

THE CLAPP-EASTHAM VARIABLE

Through the courtesy of the Blackstone Valley Radio Assn., of Pawtucket, R. I., we are publishing the result of measurements made at the Massachusetts Institute of Technology of the capacity of the Clapp-Eastham Variable Air Condenser, Type 43. This information will be of value to QST readers owning condensers of this make, for calibrating wavemeters, receiving circuits, etc.

Scale Settings	Microfarads
0	0.000823
10	.0001135
20	.0001667
30	.0002509
40	.0003178
50	.0003963
60	.0004508
70	.0005233
80	.0006032
90	.0006738
100	.0007440

THE JUNIOR OPERATOR

Conducted by Guy R. Entwistle

In our December issue we gave a brief introduction of just how Wireless Telegraphy is accomplished. We were speaking in a general sense. In this paper some actual data will be given so as to enable the beginner to construct his own apparatus, or better understand the "why and wherefore" of the apparatus he may already have or be planning to purchase.

The simplest in construction but by no means the best for all-around work is the double slide tuner. This instrument is probably the starting-point of most amateurs; hence it will be described fully.

The function of any tuning coil is to permit the reception of wave lengths longer than those corresponding to the natural period of the antenna. Roughly speaking, our antenna alone, without condensers or coils in series, receives only waves of one length; that is, its own. Hence, to receive longer waves, we must add length to our antenna, electrically speaking. Of course we do not alter the dimensions of the antenna itself, but accomplish the same thing by coiling up many hundreds of feet of wire on a cylindrical drum. This coil, in series with the antenna, makes it possible to absorb waves of a greater length. We also construct our coils so that we can use any fractional part of it that we may wish. This is done by using bare wire and a slider that runs along the top of the coil, or by using insulated wire and scraping off a part of it on which the slider has to make contact with the wire.

Now, our problem is just how large a tuner we will have to build, to get the best results. This, of course, depends on what range of wave lengths we wish to receive. Suppose we wish to receive everything from 200 meters, representing amateur wave lengths, up to and including 2500 meters (Arlington's wave length), representing about the limit of spark sets except Glace Bay in which very few are interested. Such a tuner will be most efficient on its longest wave, or when all the wire on it is in use. For all other wave lengths it responds, to be sure, when properly adjusted, but its effectiveness grows less and less, as we drop to the shorter wave lengths.

There are, roughly speaking, four prominent regions in this broad band of waves, ranging from 200 to 2500 meters—four regions that are used more than all the others. They are 200, 600, 952, and 2500

meters. An ideal spark tuner would then be so divided or proportioned as to be capable of being split up into sections corresponding to these four regions. With the double slide tuner we are about to describe, it is not practical to do this, but in the case of the more efficient tuner, the loose coupler, such a division is possible. This, however, will be taken up in a later article. If we wish to absorb waves of 2500 meters and the antenna (described in QST December) has a natural period of 160 meters, it is evident that our tuner must supply the other 2340 meters. This will require a coil of certain dimensions. Just what size wire should be used, what diameter of tube, and just how long it will be is a question asked many times by the beginner. The answers to these questions depend directly upon the size of the antenna. The larger the antenna, the less tuning inductance is required. Remember, our wave length depends upon the amount of inductance and capacity used. Although a tuning coil has some capacity, as well as inductance, it is so small as to be negligible, and hence we will not consider it and think of all our capacity as being supplied by the antenna alone. Similarly, our antenna has inductance as well as capacity, and for short waves, this inductance must be considered when designing the tuner; but for our 2500 meter tuner, we can also omit this and therefore think of all the inductance being supplied by the coil. For instance, for an antenna whose natural period is 160 meters, the inductance value will be about 35,000 units including the lead in, and the capacity value .00033 units. At first glance it would seem, relatively speaking, the capacity of the antenna is the lowest factor. This, however, is not the case when we stop to consider that the unit of capacity, the farad, is such an enormous quantity as compared with the unit of inductance, the henry. With this capacity of .00033, it will be necessary to supply 5,870,000 units of inductance in order to get a wave of 2500 meters with this small antenna. This is about 170 times as much inductance as is given by our antenna. Do not lose sight of the relation between inductance and capacity, and wave length, as pointed out previously. (In this paper, no further mathematical calculations will be given on this subject. These will be reserved for future articles when the students are prepared for advanced instruction.)

These units of inductance will be supplied whenever we wind wire into a coil on a suitable drum. Generally speaking, and from the standpoint of the beginner, the greater the diameter of the drum and the more turns wound on it, the more of these units will be obtained. Since we have a certain definite number of units to supply, our problem becomes whether we shall use a coil of large diameter and short length, or small diameter and greater length. It is immaterial which course is adopted, being governed wholly by mechanical limitations, and personal point of view of the amateur. The coil to be described will be of relatively small diameter and greater length.

Materials required for home-made double slide tuner.

- 1 tube (cardboard) $3\frac{1}{2}$ " outside diameter, 12" long.
- $\frac{1}{2}$ lb. single cotton covered magnet wire, No. 24.
- Small quantity of white shellac.
- 2 (brass) square rods 13 " long $\frac{1}{8}$ " or $\frac{3}{16}$ " stock.
- 2 sliders for same.
- 2 wooden end supports, $4 \times 4 \times \frac{1}{2}$ ".
- 6 small size brass binding posts.
- 1 wood base, $5" \times 14" \times \frac{3}{8}"$.
- 2 Wooden Discs. $\frac{1}{2}$ " thick and diam. equal to inside diameter of tube.
- 4— $\frac{3}{4}$ " No. 8 wood screws.

one-fourth the way around on the side of the coil, for the second slider. The spaces to be scraped or burned should be carefully marked beforehand, and only this neat job. Next, make two end pieces for supports, $4" \times 4" \times \frac{1}{2}"$, then make two area should be exposed, so as to make a cylindrical wooden supports just the size of the inside diameter of the cardboard tube, about $\frac{1}{2}$ " thick. These can also be made of several layers of thick cardboard—cutting out little discs and building up to this thickness, fastened to the end supports. These are to support the tube. The two end pieces containing the wooden or cardboard supports should be fitted into the tube after the leads have been fastened to a binding post to be placed at the center of each end piece. Next, after placing each slider on its respective rod, the latter are screwed, one to the top and the other to the side of each of the end pieces. Next, the base is fastened on with 2 wood screws for each end piece.

Last all wooden parts of the whole tuner can be sandpapered and shellaced (or stained) to suit the taste of the owner. The tuner can then be hooked up as per diagram in the December QST. The question is asked frequently, "How much wire will I need to buy to wind a certain tuning coil?" Here is how to find it. Whatever the diameter of your tube may be, multiply the same by 3.14 to get

MAGNET WIRE TABLE
Turns per lineal inch of winding.

B. & S. Gauge	Enam.	S. C. C.	D. C. C.	S. S. C.	D. S. C.	S. C. C. Ft. per lb.
22	36	31	28	34	32	514
24	45	37	33	42	39	817
26	56	45	39	52	46	1300
28	71	54	45	63	56	2067
30	88	64	56	77	67	3287
32	112	75	60	93	78	5226

DIRECTIONS. Obtain a cardboard tube $3\frac{1}{2}$ " diameter, 1 ft. long, wind to within $\frac{1}{2}$ " each end with No. 24 S. C. C. wire. In starting to wind, leave 6" or 8" of wire for leads, making the end fast by forcing two small holes through the top of the tube and threading the wire through. Make two more holes $\frac{1}{2}$ " from the other end, just large enough to allow the wire to pass through. Next, wind on wire as tight as possible, along the entire length until you get to the two holes at the other end, then cut the wire, leaving about 1 ft. for leads, and thread end thru as before. The coil is now ready to be covered with white shellac. After it is thoroughly dry, scrape or burn off the insulation on the top along the entire length, just wide enough to allow whatever slider is to be used, to pass freely to make positive contact with the exposed wire. Do the same thing just

the circumference. This, then, will be the length of wire necessary to go around once, or the length of **one turn**. In our case, we multiply 3.5 by 3.14 which is 11 inches. Think of it! It takes nearly a foot for just one turn. Next, determine what size wire you are going to use and find out how many turns per inch of winding will result by using this size wire. In our case, No. 24 S. C. C. was used. Look in B, in column under B. & S. gauge, for No. 24, then go directly across in line to the right to the figure given under column S. C. C. It shows there are 37 turns for every inch of winding in our tuner, but each turn has 11 inches of wire, therefore, 37 times 11 inches or 407 inches, will be required. If it takes 407 inches of wire for each inch of length, we will need 11 times 407 inches, our tuner being 11" long
(Concluded on page 42)

Radio Communications by the Amateurs

The Publishers of QST assume no responsibility for the statements made herein by correspondents.

A PLEA FOR 500-CYCLE SETS

NOW that relay work is coming along, it behooves every one of us to get together and help minimize QRM by the proper selection of apparatus whose inherent characteristics are properly adapted for amateur use. We need a set that will carry far, respond quickly to the operation of the key, produce a clear musical note, be compact and yet powerful—a set, in short, whose various parts have been so designed that each bears a definite relation to the others, so that the entire combination of instruments produces the best possible results.

It would be well to stop here and reflect on the actual condition confronting the amateur who would like to transmit. His wave length has been limited by law. This limits the antenna to certain short dimensions. Such an antenna has a small capacity. When it is remembered that the power you can put in the antenna varies directly as the condenser capacity, directly as the SPARK frequency, and as the square of the voltage impressed on it, it is at once evident that we can look for little improvement in changing the physical dimensions of our antennae.

However, we have two other sources to control. We can increase our spark frequency and charge the antenna oftener in a given length of time. This has been done in the case where a rotary gap is used, but the rotary gap has the disadvantage of permitting only ten per cent coupling, so we lose out here also. Any tighter coupling will produce a radiation which is not within the law. Hence we must look still further for our solution.

The use of a quenched gap permits closer coupling—20 per cent for best results—and also adds to the purity of the emitted wave. But this type of gap, while helpful on 60 cycles under proper conditions, is better adapted for the higher frequencies, and right here lies our secret.

A 500-cycle quenched spark set has been the fond hope of many of us for some time. Listen in on 600 meters and see how many you hear in comparison with the other types. There must be a reason for their abundance. At once the cry goes up that it can't be done, as the motor-generator and gap cost too much. The latter prob-

lem has been solved by one of the American radio companies whose advertisements appear in QST and the only drawback now is a small, low-power, cheap but serviceable alternator of a frequency from 250 to 600 cycles. Will the American Amateur let it be said that he is unable to overcome this only obstacle? Will he prove worthy of the credit that has been bestowed upon him under the name of a "serious experimenter"? Remember only the ALTERNATOR is needed. The market is flooded with suitable motors to run it. In fact, any other means such as a water motor or a gasoline engine can be brought into use. Get after the alternator! Some of the standard stampings of the inductor type alternator of $\frac{1}{4}$ k.w. can be well adapted to this work.

Remember only low power is needed—say $\frac{1}{8}$ k.w.—as the frequency and increased coupling will make up for this reduction in power. One of low power also simplifies the construction. Just think, if we produce an alternator of 500 cycles we have increased our frequency over eight times with respect to the usual 60-cycle current and can decrease both voltage and capacity, as the square root of the inverse ratio in the former case and in the first power of the inverse ratio in the latter.

A book called "The Principles Underlying Radio Communication", published by the Government Printing Office for the U. S. Signal Corps and costing only 55 cents, has some helpful information for anyone who is seriously inclined along these lines.

The market is flooded with the older types of apparatus. Let's all get together and produce a cheap but serviceable ALTERNATOR of higher frequency and open new fields of investigation for the amateur. The writer has had much experience along the lines of 500-cycle work and can assure his fellow amateur workers much instructive and practical experience arises from any testing and development of this type of set. If you think you would like to adopt a 500-cycle transmitter for your station, write the Editor of QST and I am sure he will devote some space in his valuable magazine to the topic if enough of us are interested.

G. R. Entwistle,
Boston, Mass.

PHOTO-ELECTRIC CELLS.

The Director of Military Aeronatics,
Washington, D. C.,
November 17, 1919.

Editor, QST:

The article by Lt. Metcalf on photo-electric cells was of great interest to me as I made a study of such cells prior to the war. The type of cell shown in Fig. 1 is very sensitive and has been used for some time for the purpose of measuring light radiations. The cells used by myself had calcium amalgam mirrors and were very sensitive. Our first experiments were made in order to devise a method for receiving telephone messages over a beam of light. For this purpose and, as the action of the valve is due to chemical rays, we made use of uviolet lamps and, later, quartz mercury vapor lamps. It is interesting to note that a construction similar to that shown in Fig. 5 was made use of, finally, for telephonic reception tests. In the crude state, a fine copper screen was used as anode and a zinc amalgam plate as cathode, the two being spaced at variable distances by means of gaskets. The trials made covered voltages up to the break-down point and pressures varying from atmospheric to fairly good vacuums. Fairly promising results were obtained but work was discontinued, owing to the outbreak of the war. The detector action of the valves was found to be very good and the rectification is assumed, qualitatively, to be as perfect as is the case with two or three element tubes. The use of a controlling element was not considered at that time, although it was thought of at a later date while I was working on valve manufacture with the Marconi Company.

Yours very truly,
W. H. Murphy,
Captain, A.S.A.

GREENLAW COMES UP FOR AIR.

Hotel LaSalle,
Chicago.

American Radio Relay League,
Hartford, Conn.
"Dear Boys"

Just wanted to tell you I was thinking about you, and don't you say "that guy is lying", because were I lying I would not be addressing you. My wife used to say that, and get off with it, but don't you try.

Well you "wonder what Greenlaw is doing in Chicago". I will tell you some of the things or rather the main issue—he is just visiting some of your big northern cities and wondering just where the bugs are.

Now there are some things Ex-5BB is doing, that any of the rest of the guys would be doing, and like the rest of you, "5BB aint-er gonner tell it."

Now comes the real reason I wanted to talk to you. It was to tell you of a visit I made to the Hon. Arthur H. Kopper, Radio Inspector of the 5th district as I passed thru New Orleans.

Well you know how weak our legs get when we call on one of the inspectors of bugs, and how we stutter when we try to say something. "That was Me" and about the biggest and only thing I could say was that "I am a member of the A.R.R.L." Well that were enuf; I said a mouth full. His heart was with the A.R.R.L., boys. He believed in us, and we had his co-operation in every way possible, and he wanted the same out of the American Radio Relay League.

And I told him he certainly would get it; and boys, what is it we wouldn't do for a guy like that?

I move from here tomorrow to take in some towns in Michigan, then I guess I will turn south again where I can get out of these fuzzy, tickling under garments and get my receivers on my ears again.

P. E. Greenlaw,
Sup., South La. Division,
(Franklinton, La.)

ABOUT THE A.R.R.L.

Because the following correspondence admirably presents certain data about the League which is of general interest, the Secretary presents it here as general information to our readers. It is self-explanatory.

1105 E. 23d st., N.,
Portland, Ore.,
Dec. 4, 1919.

Mr. K. B. Warner,
Secy., A. R. R. L.,
Hartford, Conn.
Dear Sir:

I would like to join the A.R.R.L., get on the inside, be a booster, and line up the whole Northwest.

But first please put me at ease by telling me if it is possible to get on the inside. Who owns the A.R.R.L.? How and by whom are the officers and directors of the A.R.R.L. elected? How many men are on its pay roll? What becomes of the surplus income? Would it be possible for men living on the West coast to become officers? If so what are the qualifications?

I think I have a right to ask all these questions because I really don't feel like giving a lot of time and energy to a certain few individuals but on the other hand I would be very glad to help the A.R.R.L.

Hoping this impresses you favorably,
I am

Respectfully yours,

C. B. Hempel.

C. B. Hempel,
1105 E. 23rd St. N.,
Portland, Oreg.

Hartford, Conn.,
Dec. 12, 1919.

Dear Sir:

I have your favor of the 4th and it gives me pleasure to furnish you with information along the line you are interested in.

The A.R.R.L. is a national non-commercial organization of wireless amateurs. It was organized in Hartford, by former members of The Radio Club of Hartford. It is incorporated, being an association without capital stock, granted a charter under the laws of the State of Connecticut. The executive offices are here and the general business is conducted from this office. The members comprise the leading amateurs of the country who are interested in relay work. It is they who own the A.R.R.L. None of us here claim to, I assure you. Our Constitution provides for a Board of Direction of seventeen men, to be elected by the membership at large, these directors to then elect five officers from their number. The next election will be held in Feb. 1920 and we are now preparing a slate of candidates which will be sent with ballot to all A.R.R.L. members and the 17 receiving the highest number of votes will be declared elected.

The A.R.R.L. is fraternal and non-commercial. It has no capital stock and is in no sense a money-making organization. The \$2.00 annual dues, to include QST, have always been the only charge and have never sufficed even to pay routine administrative expenses. The League now owns and operates QST. That is to say, QST absolutely belongs to those amateurs comprising the membership of the A.R.R.L. and we here at headquarters are merely their representatives, discharging our duties to the best of our ability. The members of the Board and the officers with the exception of the Secretary serve without any compensation, the same as the Operating Dept. personnel serve in their various territories—FOR THE GOOD OF AMATEUR RADIO. The Secretary is a paid officer, devoting his entire time and ability to the furtherance of League work and the editing of QST, and being the Secretary I assure you it is some job. QST is now conducted on a strictly business basis and is making a moderate profit. In former days it was not possible to conduct it upon a self-supporting basis and it resumed in June of this year with an indebtedness of several thousand dollars. Any surplus which we can accumulate in the next several years will be utilized for the discharging of these old debts which had been assumed personally by a few enthusiastic members on our Board of Direction, and for retiring our recent bond issue which was floated for the purpose of securing enough capital to operate QST.

When these debts are discharged there will be no incentive for QST to make any profit and the money will be wholly utilized in printing a larger and better magazine, with any possible surplus retained in the Treasury for such educational work and expenditures in legislative protection, etc. as may become necessary from time to time in the judgment of the Board. I desire to impress upon you strongly that we, the amateurs of the country, own and run the A.R.R.L. and QST. We are the A.R.R.L. and we have no connection whatever with any money-making schemes, such as the selling of apparatus, etc. Our directors are men of prominence in amateur affairs, and persons engaged in the manufacture or sale of amateur equipment are not eligible to membership on the Board.

As to having West Coast men on the Board Mr. H. C. Seefred, of 6EA, Los Angeles, is now a member, and Capt. W. H. Smith, of Denver, old 9ZF, has just tendered his resignation on account of withdrawal from amateur affairs, creating a vacancy. It is our desire that membership on the Board be distributed in proportion with the thickness of amateur stations, and the method for the election of directors is calculated to carry this out.

Indeed I agree that you have a right to ask these questions. The information is available to anyone and I supposed that the nature of the A.R.R.L. was pretty well known, but from your letter I am inclined to feel it would be advisable to give greater publicity to this feature for the information of men who are not familiar with the work of the League in the pre-war days. I presume you are fully familiar with QST where the A.R.R.L. activities are chronicled. You will know, then, about our system of trunk lines and routes, and cannot have failed to note the wonderful A.R.R.L. spirit which characterizes the activities of all our men. Our very motto is "Of, By, and For The Amateur" and we continue to be the only relay organization which can truthfully say this. I attach an A.R.R.L. application blank and will be glad indeed to have you come in with us. In particular I would like a description of your station and the work you are doing as we need some active personnel in your territory to undertake organization work which will improve relaying. I will be glad to have you give me particulars of your qualifications in this respect, in order that I may pass it along to our Operating Department, and have you considered for an appointment in that work. I, therefore, await your reply with much interest.

Sincerely yours,
(Signed) K. B. Warner,
Secretary.

ANYBODY EXPLAIN?

220 West 4th St.,
Duluth, Minn.

Editor of QST,
Hartford, Conn.
Dear Eddy,

Inclosed please find audion circuit that may remedy some amateurs' troubles.

The main feature of this hook-up is its ability to amplify signals. When switch S in the diagram is on contact one the circuit is the improved ultra-audion familiar to many amateurs. When the switch S is on point two, the bulb oscillates very readily, bringing in distant stations on the "hiss" very strong. When on contact three, the natural tone of a station is amplified from three to five times. All these amplifications are over and above what the ultra-audion brings in.

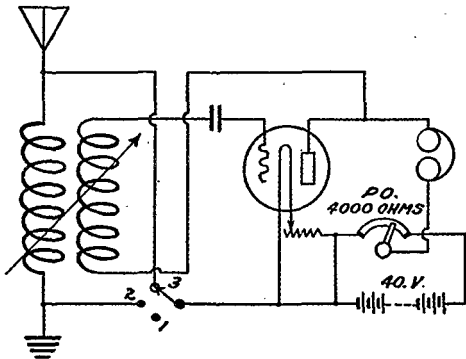

I have found this hook-up to be "NG" on commercial stations when switch S is on points two or three, but all right for commercials when S is on contact one. When on points two and three, this hook-up works best on stations above 1000 meters.

Hoping that this hook-up will help out I remain,

Yours truly,

James E. S. Hayes.

PS. Will you please inform me why this hook-up amplifies the stations? All I know is that it works, but why? I am in the dark.

J.H.

WHO WANTS TO ANSWER THESE QUESTIONS?

Battle Creek, Mich.,
Nov. 23d.

Editor, QST:

I am wondering who to get peeved at—The Editor, the writer, or myself.

Here's what it is all about. I read several articles in QST regarding four series gaps. It looked good to me. So I proceeded to build one and spent one whole day building it. I hooked it up to my 3600 r.p.m. synchronous motor and called a few fellows, finally getting hold of 8JZ,

but this particular gap knocked all the theory out of 4 series. Instead of reducing the discharge it put it all over the place. It jumped from $\frac{1}{2}$ " to $\frac{3}{4}$ " at each gap and didn't stop at jumping to points but jumped clear to the frame. Talk about voltage. Figure it—four times $\frac{3}{4}$ " is 3". Now something is wrong. I have 15,000 volts, 60 cycle AC, and generally break down the condenser when potential goes over 25,000, and here it goes to 60,000. Now what would have been the result if I had 40,000, as 8AEZ used on his?

Talking of gaps, I have an old-standby that knocks the theories all to pieces. It is 6" diam., 8 studs, and 4 stationary electrodes, 2 in parallel, giving 960 sparks per second at a synchronous speed of 3600. The funny part is it is built of bronze, and rang like a bell when it was in the sheet. It is constructed like a wind-mill and takes a half horse-power to run it. Have it enclosed now but when open it plays freeze-out with me and beats me to it. I tried aluminum on it and cut my radiation down 1 amp.

The queer feature of the four series gaps was I only got $4\frac{1}{4}$ amps radiation. On the standby I get $5\frac{3}{4}$, and with aluminum dischargers get $4\frac{3}{4}$. Now someone please explain the difference. This is all at the same settings of O.T. at $5\frac{1}{2}$ " coupling, and test on wavemeter wouldn't allow any changes.

There is another thing that is bothering me and that is I read that a "high speed gap of large dimensions is preferred, giving speed and low tone. Use high voltage and charge condenser at resultant low current capacity. Why? Why not charge condenser with heavy current capacity and build up the voltage to what the condenser plates will stand, when discharging at a slow rate gives a gap tendency to lead. I notice that most of these low-toned stations are heard very broad range on condenser tuning. Now if charging at heavy current at say not over 12,000 volts and discharging at a speed that will keep down the condenser voltage to about 20,000 or less, are you not giving a higher pitch less gap lead on less gap speed and more discharges per second, and, naturally, the lead being less, will you not gain the same results as the four series gap?

My experience with this is lower voltage, 3000 to 4000 r.p.m. gap 6 to 7" diam., $\frac{1}{2}$ to $\frac{5}{8}$ " points, flat and $\frac{1}{16}$ " thick, 640 to 840 sq. in. of foil on $\frac{1}{8}$ " glass, will give me more distance, more radiation, and as to tune I will leave that to those hearing me.

Now what's the trouble—is it my head or just plain ignorance? It seems I am in wrong somewhere, anyway.

Yours truly,

E. E. House.

THE PASSING OF OLD "WCC"

Marion, Mass.
Dec. 15, 1919.

Editor, QST:

Have received several letters from amateurs asking why they do not hear old WCC any more, so thought it might not be amiss to write a few lines explaining the reason.

It's a good reason, but a sad one, boys. None other than that the U. S. Navy purchased this station from the Marconi Co., and instead of using it, they entirely dismantled it. Yes, flat to the ground. The

engines were frozen up and allowed to burst the water jackets during the last few days of the Navy's work there, and now all that remains there are the two buildings, the bare station, and the bungalow.

Every article was positively taken out and junked. The engines, generators, batteries, d.c. machines, lathe, transformers, etc.,—even the door knobs taken off and the water pipes pulled up out of the ground. The towers are all down. They were given away for the wood that was in them, as payment to the man who took them down. It's quite apparent the Navy decided this station should not be heard again, for they sure made a complete job as far as a wreck was concerned.

Could that station talk, it would tell many interesting tales, and it is my intention some day not far distant to tell of its complete career. It did transatlantic work in its early days and was a home for many, many old-time operators. It spoke for Marconi and it spoke for Roosevelt. It was the amateur's friend. Many of the operators of today learned copying old WCC. "Old Reliable" was sure the name for it. The idea was to start at ten fifteen or die in the attempt. It never died while Marconi had it.

Irving Vermilya.

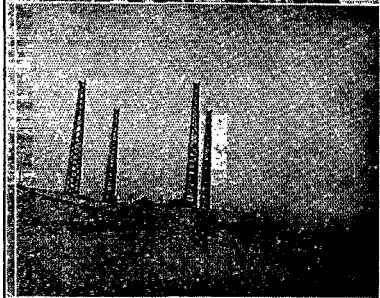
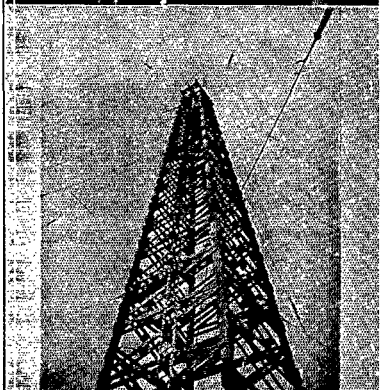
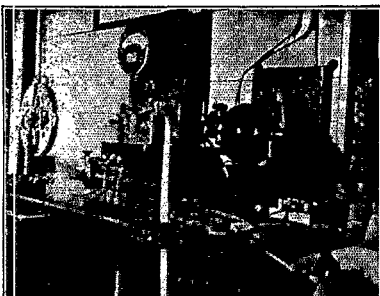

Top: The Automatic Sender.
Center: Looking up one of the Towers.
Bottom: Old WCC.

QST!

All aboard for the Second Annual Boston District Radio Banquet, absolutely the "affair" of the radio season. Here's the dope, in a way you can't miss:

Under direction New England Amateur Wireless Assn. and Massachusetts Institute of Technology Wireless Club—a joint N. E. A. W. A.—M. I. T.—A. R. R. L. radio social.

The time: 6:30 p.m., February 12, 1919.

The place: Walker Memorial Building, M. I. T., Cambridge.

How to get there: Surface car to Park St. Subway. Change to any car going to Massachusetts Ave. Station of the New Subway. Transfer to Harvard Square car on surface. Get off at first stop over the bridge (Harvard).

Tickets: \$1.50 a plate. Sale closes Feb. 10th. Obtainable from Sec'y of M. I. T. Wireless Club, Cambridge; Wallace E. Heckman, Sec'y, N. E. A. W. A., 119 Windemere Rd., Auburndale; G. R. Entwistle, Room 20, 18 Boylston St., Boston; Radio Inspector's Office; or any radio supply store in Boston.

A good feed—five speakers—Keith vaudeville—music—Bray movies—the fellowship of all the gang. This is the one big radio event of the year. Let's all turn out, fellows, and make this be one gran-n-n-d time. At least three hundred expected. CU there!

The Operating Department

J. O. Smith, Traffic Manager
Rockville Centre, L. I.

THE reports so far received from the division managers all indicate that there are many gaps to be filled in our relay routes before anything like reliable service can be maintained. This lack of efficient stations has been discussed frequently by the traffic officers of the League, and the conclusion has been that this condition is due to a variety of causes, but it is hoped that in a short time pre-war conditions can be restored.

The matter of relaying messages all the way across the continent, which before the war was considered a remarkable accomplishment, is now becoming a more or less routine matter. The principal connecting link between the east and west coasts has been the station of Mr. Louis Falconi at Roswell, N. M. Both 5ZL (Little Rock) and 5ZC (Dallas) can work Mr. Falconi pretty regularly, and the latter is frequently able to work over the long desert-mountain distance to 6EA (Los Angeles). Relaying a message occasionally across the continent in thousand-mile jumps is, of course, a very creditable performance, but it is not a reliable method of handling traffic for two reasons—it is only possible under the very best conditions, which occur once in a blue moon, and in addition works against the established rule of the League to handle traffic in short relays in order to give all of our stations an opportunity to take part in the work, instead of a few. The policy of the League as to short relays is well known and should be adhered to by every member of it who has the good and welfare of amateur radio at heart. Much more can be accomplished and a better general feeling created if all stations are given an opportunity to participate in relay work and conditions are such that a message can be handled without repeats, in contrast to long gaps where some stations find it necessary to QRX the whole North American Continent in order to handle one message, and then by means of numerous repeats.

The short wave CW set has arrived. There is no doubt but that the development of these short wave CW sets will greatly add to the interest and welfare of amateur radio. A few of these sets are now in operation in the Atlantic Division.

The Houston, Tex., newspapers record the fact that one of the League's traffic officers, Mr. C. W. Vick, 1918 Smith St., Houston, had the distinction of working the NC-4 on her recent flight between New Orleans and Galveston. It is stated that Vick was in communication with the plane during the entire flight, and that Commander Read, through Radio Operator Rodd, kept Vick informed of all developments during the flight. It is a source of much gratification that one of our traffic officers has been so honored.

One serious matter has developed entirely outside of relay work but which should nevertheless receive the attention of stations engaged in long distance work, and that is a number of stations which are relaying messages and working long distance before they are licensed. If a station owner is too far from the radio inspector to go to him for an examination, he can take it by mail and put in his application for station license. If he is near him, there is no excuse for his neglecting this important point. If he fails to pass, he has no business working till he is competent to handle a radio set, as shown by his license. In any case, he shouldn't be working, using false or two letter calls. Stations who come under this class should consider it a point of personal pride to get a license and not show others they are behind the time; stations who work with them should realize the offender is not living up to the law and that by accepting traffic or sending it, they are only injuring the general cause of the amateur. If this business of using false or unassigned calls continues, steps will be taken to eliminate it; however, it is hoped that this will be unnecessary.

Another surprising thing is that the operators of some stations occasionally resort to the use of profane language over the air. This is inexcusable and the offender is liable to drastic punishment. There are many of the gentler sex now operating stations, and entirely aside from the legal aspect of the thing there is no excuse for the use of profane or indecent language on the air.

Another is the use of false calls. Mr. Entwistle reports being complimented from Portland and Fall River on his spark and also kidded about being QRT-ed by WBF on a certain night when he had no appar-

atus whatsoever in the house. The party in question was QSO with 1BG, and should take this as a warning against repetition of the act. Several similar instances have come to our attention. The radio laws provide a penalty for this, and if a few of the culprits realized the risk they run, they would be less inclined to the commitment.

ATLANTIC DIVISION.

Mr. C. A. Service, Jr., Manager,
Bala, Pa.

A few points are yet uncertain along the Trunklines, principally in New England and from Philadelphia southward and westward, but the District Supts. are working hard to overcome the difficulties of long jumps and unfavorable geographic conditions and it is hoped that next month's report will show this has been remedied.

For the information of stations in the Atlantic Division, the following list of the operating personnel of the Traffic Department is given, and should any stations, not already signed up for official relay work, wish to get in on it while there is yet time, they should write to the nearest traffic official and he will do the rest if possible. Only one absolute requisite is necessary in making application for a place in the relay scheme and that is, the applicant must be a member of the League in good standing. This does not mean that if he is a subscriber to "QST" he is eligible.

For the information of all official stations already appointed, a circular letter has been sent out in this Division, stating that the above men must become members in one month from date of notification, and failing in that they will be asked to resign their appointments till they have complied. The fact they are not already members, in the majority of cases, has been due entirely to their having let it slip, rather than from any disinclination to join.

The personnel of this division follows:
Division Manager, Atlantic Division, C. A. Service Jr., Bala, Penna.

Asst Div. Mgr. (Northern Section), G. R. Entwistle, 18 Boylston St., Boston, Mass.

City Mgr. Boston, L. E. Pulley

City Mgr. Boston, E. A. Gisburne

Dist. Supt. Lower Mass. and Rhode Island, H. C. Bowen, 168 Belmont Ave., Fall River, Mass.

Dist. Supt. Upper Mass. and Lower Maine, W. H. Hardy, 776 Hale St., Beverly Farms, Mass.

Dist. Supt. Central Mass., L. A. Bates, 8 Moen St., Worcester, Mass.

Dist. Supt. Northern Maine, D. F. Alexander, 209 Elm St., Bangor, Maine.

Dist. Supt. New Hampshire, H. R. McLean, 342 Union Ave., Laconia, N. H.

Asst. Div. Mgr. (Middle Section), M. A.

McIntire, 1127 Avenue "G", Brooklyn, N. Y.

Dist. Supt. Brooklyn and Staten Island, C. J. Goette, 1624 Hamilton Ave., Woodhaven, L. I.

Dist. Supt. N. Y. City and Bronx, John DiBlasi, 227 E. 75th St., N. Y. City.

Dist. Supt. Northern New Jersey, Lester Spangenberg, 25 S. 4th St., Paterson, N. J.

Dist. Supt. Eastern Long Island, H. L. Stanley, Babylon, Long Island.

Dist. Supt. Western N. Y. State, W. T. Fraser, 48 Glenwood Ave., Buffalo, N. Y.

Dist. Supt. Eastern N. Y. State, C. R. Runyon, 544 N. Broadway, Yonkers, N. Y.

Dist. Supt. Connecticut, H. E. Nichols, 513 Pequonnock St., Bridgeport, Conn.

Asst. Div. Mgr. (Southern Section), C. H. Stewart, St. David's, Penna.

Dist. Supt. Eastern Penna., Malcolm Ferris, 3409 Baring St., Phila., Penna.

Dist. Supt. Central Penna., W. A. Cawley, R. D. No. 3, Milton, Penna.

Asst. Dist. Supt. Central Penna., H. M. Walleze, 234 Vine St., Milton, Pa.

Dist. Supt. Western Penna., R. C. Devinney, 1224 Boyle St., N. S., Pittsburgh, Pa.

Dist. Supt. Delaware, C. S. Horn, Jr., 909 Monroe St., Wilmington, Del.

Dist. Supt. Eastern Maryland, E. B. Duvall, 4004 Park Heights Ave., Baltimore, Md.

Asst. Dist. Supt. Eastern Maryland, Donald Primrose, Elkridge, Maryland.

Dist. Supt. District of Columbia, R. L. Schaefer, 139 B. St., S. E., Washington, D. C.

Dist. Supt. Central Virginia, W. T. Gravely, 503 Main St., Danville, Virginia.

Besides the regular work of the District, a special test message was sent from the Radio Inspector, Chicago, to Mr. Chamberlain, of the Department of Commerce, on the night before Thanksgiving Day, as a test of our organization. The stations along the route were only given twenty-four hours notice of this test and on the night of the test, atmospheric conditions were about as bad as could be gotten for that time of year, every station in the southern part of the Division reporting heavy static. The messages was broadcasted from 9ZN and picked up in parts by a number of stations in the East, viz; 2ZS, 3ZS, 3CC, 3BZ and others who have made no report on it, but owing to the heavy static and jamming, it was held up at numerous points before it could be forwarded. However, Mr. Bruce, 3BK, of Washington, D. C. received it direct from 9ZN and was able to deliver it to Mr. Chamberlain the next morning in correct form. A great deal of credit is due Mr. Bruce and all others concerned for their

handling of this test message under adverse conditions.

ATLANTIC DIVISION (Northern Section)
Mr. Guy R. Entwistle, Ass't Division Mgr.,
136 Sutherland Rd., Brookline, Mass.

The following is a list of stations that have been conspicuous in actual relay work since the reopening. It is by no means the final analysis of our situation but merely a guide to be used as a basis for future activities. The existing routes are marked by long jumps but nevertheless traffic in and out of New York connecting with all points North, South and West is being cleared by 2JU, 2JS, 2BA, 2ZM, 2DA. These stations are in direct communication with 1AW, 1AU, 1RN, 1AN, 1AF, 1DL, 1AS, 1GK, 1CZ, 1CM, 1AK, 1DK. Our Southern route in charge of 1AK, is as follows. 1AN, 1CE, 1AK, 2JU.

Our "Main" route is 1AN, 1RN, 1AF, 1AS, 1DL, 1AU, 1AG, 1GY, 1AW, 1AZ, to 2JU, 2JS, 2DA, etc.

Going Northward from Boston, we have 1DK, 1CM, 1FV, 1EK, 1BK, to Lubec, Maine, where Mr. Henry Tucker connects with our Canadian brothers, 2AB, 3AT.

Vermont is our weak point. Won't some native son come forward and enjoy the privilege of pioneer work in that state? It is directly in the path of our Boston-Montreal chain.

1AK, Bowen, reports 1PB, 1PU, 1II, 1OW, as being assigned to their respective cities as relay stations. Schedules are existant with each one. He wants results thru 1YA and 1AW. Stations between 1YA and 1AW are wanted.

A good radio club has been formed. The Worcester County Radio Assn. headquarters at Room 24, 174 Main Street, Worcester. Secretary is A. S. Waite. Meetings held every Tuesday Eve. Membership over fifty is already reported.

The local organization has been slightly changed during the last month.

Mr. (Lt.) E. A. Gisburne, has been appointed City Manager with territory comprising cities South of The Charles River to Weston within a radius of 15 miles, while Mr. Pulley's title has been changed to City Manager with territory North of the Charles River, to Weston and within a 15 mile radius also.

IDR's address is 33 Porter St., Melrose, Mass.

IDP's address is 12 Oakley St., Dorchester, Mass.

Mr. Gisburne has met the amateurs around Atlantic, where every male child seems to be the proud possessor of an amateur set, and has obtained the following concessions. No testing will be done after 7:30 p.m. After 10 p.m. none but actual message traffic will be handled.

Winthrop and Revere amateurs please note. IRN is suggested as the collecting point for West bound traffic.

ATLANTIC DIVISION (Middle Section)
M. A. McIntire, Ass't Division Manager
1127 Ave. "G", Brooklyn, N. Y.
Brooklyn, N. Y.

No definite trunk lines have been established as yet due to the fact that a definite list of call letters and owners of stations cannot be obtained. But nevertheless, we are getting the stuff through.

2ZS in Yonkers and 2JU in Woodhaven, L. I. are doing a lot to get long distance traffic through. 2ZS has been handling the western traffic and 2JU the New England traffic. Both of these stations have been helped considerably and effectively by various other stations throughout the states of Connecticut, New Jersey and New York.

Local New York and Brooklyn traffic has been handled in fine shape through 2QL in New York and a number of Brooklyn Stations as follows: 2SU; 2WB; 2MG; 2KU; 2EC; 2UU; 2PF and others.

Work through New Jersey has been handled by 2JN; 2ZM; 2JA; 2LO; 2CB; and others. 2CS on Staten Island has been able to push considerable work through to 3CS in Trenton, and we would feel lost without the help of 2LO in New Brunswick.

It is the desire of the writer that the District Superintendents formulate their own plans as to trunk lines and submit them to him, so that we can get up a definite schedule of stations, power, time of operation, etc. and have same published in the near future. Station operators are requested to get in touch with their District Superintendent if they care to be put on a trunk line.

ATLANTIC DIVISION, (Southern Section)
Chas. H. Stewart, Ass't Division Manager,
St. David's Pa.

Mr. Malcolm Ferris 3409 Baring Street, Philadelphia, Pa., has been appointed District Superintendent for Eastern Pennsylvania.

Mr. Robert C. Devinney, 1224 Boyle Street N. S., Pittsburgh, Pa., has been appointed District Superintendent for Western Pennsylvania, in place of Mr. McSwigan, resigned.

By the next report I hope to be able to show that considerably more progress has been made on Trunk Line B than has been the case heretofore, as I fully realize the importance of getting this trunk into active operation, and there is no reason why it should not be able to do its share of the relay work.

The following Branch Lines are being planned for in the State of Pennsylvania at the present time:

BRANCH LINE NO. 1

From Trunk Lines B and D at Philadelphia, via Phila., St. David's or Norristown, Emaus, Bethlehem, Bangor, Wilkes Barre, Scranton (Dunmore) and Binghamton, N. Y., connecting for Central New York and Line A. The average distance between stations on this Branch Line as at present planned is 26 miles, with the greatest distance 45 miles.

BRANCH LINE NO. 2

From Trunk Line B (Southern Route) at Washington, Pa., via Pittsburgh (connecting with Trunk Line B (Northern Route) at that point), thence via Butler, Grove City, Meadville, Cambridge Springs, Edinboro, Sterrettania to Erie, Pa. connecting for Western New York and Line A. The average distance between stations as planned would be about 19 miles, with the greatest distance 30 miles. The distances of other points from Erie, mostly over water are as follows: Buffalo, 95 miles; Cleveland, 100 miles; Toronto, Can., 130 miles; Detroit, Mich., 150 miles.

BRANCH LINE NO. 3

From York, Penna. (Trunk Line B—Southern Route) via Harrisburgh, Sunbury, Milton, Williamsport, and Sayre, Pa. connecting through Elmira, N. Y. for Central New York points and Line A., with an average distance between stations of 29 miles.

BRANCH LINE NO. 4

From Trunk Line B (Northern Route) at Curwensville, Pa. via Dubois, Brockwayville, Ridgway, Bradford, to Olean, N. Y., and connecting for Western New York points and Line A. The average distance between stations on this Branch Line would be about 20 miles.

It should be noted that the organization of these Branch Lines will in no way be allowed to interfere with the organization of stations on Trunk Lines, but can be carried on coincident with the other organization work.

Mr. Cawley, Supt. Central Penna. Dist. reports that he is actively at work in the organization of Branch Line No. 3, and he has already appointed the following Official Relay Stations on this Branch Line, viz: F. J. Demerst, (8DJ) and Glyn H. Lees, (8DB) at Williamsport, Pa. He has also appointed L. W. Barnhart of Harrisburgh, Pa. on Trunk Line B (Southern Route). He states that the stations of himself and Mr. Walleze at Milton, Pa. will be in operation about January 1st, and that Mr. Irvin, at Curwensville, Pa. expects to be in operation shortly before that time. He also states that he has appointed Mr. Earl Thomas of Williamsport, Pa., as a duplicate station at that point, and he adds that on the whole everything is looking very bright for A.R.R.L. interests in Central Pennsylvania.

Mr. Gravely reports that there are a number of good stations ready for operation in Norfolk, Va. and vicinity, and it would seem that there is a great deal of interest taken in radio work at that point. Mr. Gravely reports having connected up with 1AW, the station of Mr. Maxim at Hartford, and other stations at long range, and there is no doubt that Mr. Gravely will be doing good work soon, as he always did in the past.

EAST GULF DIVISION

J. C. Cooper, Jr., Manager,
Atlantic National Bank Bldg.,
Jacksonville, Fla.

No relay work reported handled as yet. Conditions here about the same, my station being the only one in the City capable of any long distance work. I have been in communication with a number of distant stations but not in as satisfactory manner as would have liked, mostly on account of adverse conditions and local "jamming".

EAST GULF DIVISION (Eastern Section)

W. B. Pope, Ass't Division Manager,
Athens, Ga.

The monthly reports from both Supt. Wall and Supt. Bangs have been received, but Supt. Wall reports practically no progress in his district. States little or no interest shown in radio work, and that he has been unable to connect with any amateurs. The tests he was to conduct with a party in Miami failed to produce expected results and he has been totally unable, to date of his report, to establish communication with any amateur station.

Mr. Bangs, of Atlanta, sends an encouraging report. The Atlanta Radio Club has secured the use of the powerful radio equipment at the Georgia School of Technology, and some of the members are hard at work putting the station in a first class shape. It is expected to be in constant operation shortly, and should be a most valuable aid in handling relay work.

At a recent meeting of the Atlanta Radio Club Mr. Bussy, Consulting Engineer for the Southern District of the General Electric Company, and a great radio enthusiast, by the way, was unanimously elected President, Mr. A. D. Whitaker elected Vice President and Mr. Robert Flowers Secretary-Treasurer. Flowers is an ex-Navy operator, with considerable radio experience.

The Club sends out QST press twice a week for local copying, so far different members using their sets for this purpose.

Mr. Pope also advises me that he has worked direct with Mr. Clayton of Little Rock, Arkansas, which seems promising to further relay work East and West in this District. No further steps have been taken

to organize the Carolina Section of this Division and there is nothing new to report from the Western Section of Division.

WEST GULF DIVISION,

F. M. Corlett, Division Manager
1101 East Eighth Street, Dallas, Texas.

Even if the "G-G" (getting going) was very slow the GOING seems to be worth at least a part of the delay.

To "LF", Louis Falconi, of Roswell, N. M. and 6EA, of Los Angeles falls the distinction of bridging the gap between the Pacific Division and the West Gulf Division and actually handling traffic from Los Angeles to Hartford, Conn., via 9ZN at Chicago. There were some long jumps made on this relay and its success was no doubt due to the excellent stations, experienced operators and favorable conditions. The Division Manager knows that it CAN be done SOMETIMES and unhesitatingly gives the operators and their stations due credit.

What we want to be able to do however is to get traffic thru ALL THE TIME; as many messages as are hung on our "hooks", and not just a message or two SOMETIMES. In short we want A. R. R. L. to have a secondary meaning as dear to us as the original, i.e., Always Reliable Relay Lines.

In order to make our relay lines reliable we must work them in the most practical way and to my mind, the short jump rule of the League solves the problem. Of course at present there are localities where there are no intermediate stations and our only chance is the long jump, but when a dependable intermediate station "shows up" route your traffic through that station. In other words handle traffic within normal range of each station, and under the most favorable conditions reduce your power to a value to just consistently work the next station in line thereby reducing the unnecessary QRM. When this is done traffic can be handled with certainty, in series of five, ten, or as many as we happen to have. The numerous repeats we now hear every night will be reduced many, many times; messages will be moving with certainty; in a few cases, perhaps, not as fast as with the long jumps, but the ultimate result will be a great improvement in traffic conditions.

Trunk Line "C", Jacksonville, Fla., to Los Angeles, Calif., seems to be holding its original route across this Division, Houston, Tex., 5AC, or Austin, Tex., 5AS, or Dallas, Tex., 5ZC, thence to Roswell, New Mex., LF, thence to Phoenix, Ariz., 6IZ. It will be noticed there are a number of long gaps to be bridged, waiting on good dependable stations to develop.

Trunk Line "F", Grand Forks, N. D., to Dallas, Texas is beginning to show signs of life. Clarence M. Selby, Muskogee, Okla., 5BM, and Burle R. Jones, Muskogee, Okla., 5BR, are making themselves heard. Mr. R. W. Walton and Henry Steddum have consolidated their stations at Oklahoma City. It will be a 1K.W. set. They are all ready to go and are waiting on the Power Co., to connect the service mains. Geo. McButts, formerly an operator at NBA will be associated with them and the League is promised a first class station. Mr. Harold Schonwald of Blackwell, Okla., also promises us a first class relay station at that point in the near future. This will put Line "F" within 5 miles of the Central and West Gulf Division boundary line.

The Div. Mgr. is awaiting further developments in Oklahoma before appointing a Dist. Supt., but hopes to select one before the next issue of QST.

We certainly need an outlet North and East. At this writing there are 16 messages on the "hook" at 5ZC waiting a chance to work some station North or East.

Arizona is still without a District Superintendent. The Div. Manager had 6IZ, Irvin Harrison, Phoenix, Ariz., in mind for this job but he states that his school work will not permit him devoting the time necessary to accept the appointment.

Mr. Ben Emerson, 3730 Wendelkin St., Dallas, requested that he be relieved of the duties of District Superintendent of Northern Texas as he could not devote the time necessary to perform the duties of his office and a further continuance would only be a detriment to the organization work of the district.

Mr. Raymond L. White, Box 322, Ennis, Texas has been appointed District Superintendent of Northern Texas, vice Mr. Emerson. Mr. White, has done some excellent work in connection with the organization of the Ennis Texas Territory and I am sure he will make equally as good a Dist. Supt., as he did an Asst. Dist. Supt.

An Asst. Dist. Supt. for the Ennis Territory will be announced in the next issue of QST; meanwhile Mr. White will continue to handle the work of that Territory in addition to his present duties.

Mr. R. W. Goddard, Las Cruces, New Mex., has been appointed Asst. Dist. Supt., New Mexico District, Las Cruces TERRITORY.

Mr. C. W. Vick, 1918 Smith Street, Houston, Texas, 5AC, Asst. Dist. Supt., Southern Texas Dist., HOUSTON TERRITORY.

NORTHERN TEXAS DISTRICT

Raymond L. White, Dist. Supt.,
Box 322 Ennis, Texas.

Time did not allow me to prepare a report suitable for the occasion as Mr.

Emerson's resignation and my appointment followed so close on to the time for submitting reports, therefore I beg you fellows to let me off light this time with the understanding that I will do better.

At last I have my station 5AP going and traffic is being handled with 5ZC at Dallas and others.

5BG is in full swing at Waco, Texas and is working regular with 5ZC Dallas and 5AS at Austin. This completes an intra-district line from Dallas in Northern Texas District to Houston, Texas in the Southern Texas District with jumps well within the normal range of the stations.

Mr. Harris, Asst. Dist. Supt., in charge of Waco, Texas Territory reports that the Club there is making progress under the supervision of Mr. Westmoreland, City Manager.

Our old friend Roy Layton of Corsicana, Texas is with us again and has been assigned the call letters 5BJ.

Mr. C. F. Butcher ("ZEKE"), 1603 N. Stonewall St., Greenville, Texas, Asst. Dist. Supt., in charge of the Greenville Territory reports very few stations operating in his Territory and few known to be under construction. The $\frac{1}{4}$ K.W. set of writer, 5AL, is in constant operation and communication has been established with Dallas, Austin, Roswell, N. M., St. Louis, Little Rock, etc., but owing to the low power and interference from stations all through the middle West, this station is not very effective for relay work outside of a 150 mile radius.

Publicity is being given the A. R. R. L. thru the news papers in this Territory and it is hoped a number of stations added to our League will result.

SOUTHERN TEXAS DISTRICT

James L. Austry, Jr., District Superintendent
5 Courtlandt Place, Houston, Texas.

Mr. C. W. Vick has been appointed Asst. Dist. Supt., and placed in charge of the HOUSTON TERRITORY, which includes the Counties of Waller, Harris, Galveston, Brazoria, Montgomery, Liberty, Chambers and Fort Bend.

5ZN at Eagle Pass is in operation. This looks good for we need stations in that section of the Southern Texas District.

Some heavy work is being done in this part of the country now and traffic is going thru in great shape. The atmospheric conditions have made it possible for regular work to be carried on with stations as far north as Chicago with certainty.

Austin now has two stations which open that section and these can be depended upon every night, altho the Assistant District Superintendent for that territory reports that the country around Austin offers little in prospect.

Mr. C. W. Vick the recently appointed Assistant District Superintendent for the Houston, Texas Territory has been doing some exceptional work himself, having handled nearly one hundred messages to date. He has further the distinction of working the NC4, which recently was in these parts, beginning at a distance of over two hundred miles and relayed messages from the officials of the City of Houston to the plane regarding the arrival of that plane in Houston. This is quite a notable achievement for an amateur.

Station 5BK of Freeport is now working and will form a starter for a proposed route to Brownsville. This station is quite new and has not had time to do much in the way of long distance.

NEW MEXICO DISTRICT

Louis Falconi, District Superintendent
Box 421, Roswell, New Mexico.

Things are moving very slowly in New Mexico. The air here does not seem to breed wireless germs. However as the season progresses it is hoped that more amateurs will be located.

Mr. R. W. Goddard of Las Cruces has been appointed Assistant District Superintendent and his territory will include the counties of Socorro, Grant, Sierra, Luna and Dona Anna, to be known as the LAS CRUCES TERRITORY. It is my plan to divide N. M. into four sections and have an ASSISTANT DISTRICT SUPERINTENDENT in charge of each section. Amateurs of New Mexico, please write me so that these positions may be filled.

The actual work is limited to the station of the District Superintendent using the call LF until an official call is received. Another station at Las Cruces is to be opened at any time now. On the 4th and 5th two coast to coast msgs went thru LF. The first originated at 6EA and was addressed to 1AW at Hartford, Conn. The second came as an answer to the first and the record made is interesting. 1AW sent the msg to 9ZN who gave it to LF and then to 6EA. The distances are 1AW to 9ZN 775 miles, 9ZN to LF 1035 miles, from LF to 6EA 775 miles. This I think is pretty good for a starter. 6IZ at Phoenix has started operating and traffic to the Pacific Coast should be going thru soon constantly.

All amateurs in New Mexico are requested to write me and get lined up for serious work.

PACIFIC DIVISION

Seefred Bros., Division Managers
343 So. Fremont Ave., Los Angeles, Calif.

In Southern California, especially at Los Angeles, we have three efficient amateur radio stations, 6TX (Pre-war call), 6EB,

and 6EA (Post-war calls), who to date are handling relay traffic to the North via San Francisco Bay City amateur stations and 6BQ (Ex-6AV) at Reno, Nevada, also to the East via "LF" (License Pending) at Roswell, New Mexico. Station 6EA has already handled two messages direct with 7ZB (Ex-7MC) at Portland, Oregon; 10 messages with "LF" at Roswell, New Mexico. One message was relayed via this station to Mr. Maxim at Hartford, Connecticut in one night and an answer was received the next night. Station 6EA has also been heard by "CA" (License pending) at Portland, Oregon; 7CH at Boise, Idaho; 6IZ (Pre-war call) at Phoenix, Arizona as well as working 6BQ at Reno, Nevada and the San Francisco Bay City amateurs. The following amateur stations were heard or worked: 7CM, "CA", 6AE, 6DK, 6RN, 6BA, 6AT, 6BB, 6BR, 6BZ, 6CI, 6CO, 6WZ, 6EJ, and "LF". Stations 6TX and 6EB are doing long distance relay work equally as good as Station 6EA. All the long distance amateur relay stations we have heard or communicated with are doing fine long distance radio work, especially Stations 6AT and 6BQ.

Amateurs on the Pacific Coast, who are now licensed, should not communicate with any unlicensed amateur station as they are apt to get into trouble. About a dozen amateurs have gotten into trouble, some have been only warned, others had their stations closed for either thirty or sixty days. We received a request from the "RI" office requesting identity of a certain station not using official call. The most distant amateur who has so far gotten into trouble is about 70 miles from San Francisco, as far as we have learned. All amateurs using transmitters must secure licenses.

PACIFIC DIVISION, (California Section)

**H. L. Newnan, Ass't Division Manager
Alameda, Calif.**

Trunk Line B from San Francisco east to Rocky Mountain Division is practically complete, but is not working as regularly as it could be. Traffic goes via 6AE, 6AT, 6BA, or some other local S.F. district station direct to 6BQ at Reno or via 6EJ at Walnut Grove. Sacramento is not heard on the air yet. 6RN (old call) at Napa is now in communication with the S.F. bay district stations and 6EJ. 6BQ at Reno, Nev. has been troubled by "QRM" caused by leakage from high tension power lines. He is in communication with 7ZB and 7CH at Boise, Idaho, which is in the Rocky Mountain Division. 6BQ has heard 6QQ (old call) at Salt Lake City, Utah, but due to the interference from power line leakage has been unable to work

him so far. 6CS, R. C. Denny of Fresno, Calif., who is on the S. F.—L. A. Route has made a number of tests but so far is not in reliable communication with the S. F. bay district stations.

Mr. L. L. Hoyt 7AQ at Seattle, Wash. has been called home unexpectedly to Hayward, Calif. (New station 6FN). He has placed the work in the hands of Mr. Webster, 7AU at Seattle.

OREGON DISTRICT,

**J. D. Hertz, District Superintendent,
63 East 68th St., Portland, Ore.**

The appointment of Mr. Cameron at Portland, Oregon as District Superintendent for that State has been cancelled and Mr. J. D. Hertz has been appointed in his place.

The station of Mr. Hertz at Portland was opened night of November 28th. Using 1 K.W. New call, 7ZB, used after Dec. 2nd. Total number of days that relay work was carried on up to December 20, or conditions were such that could handle it, about six or seven. Was rebuilding set for a week and then a snow storm stopped all traffic for over a week.

Stations worked: 6AE, 6AT, 6BQ, 6EA, 6EJ, (Ex-"WG"), and 7CH.

Stations heard to date: 6BZ (Ex-6ACC), 6AG, 6BA, 6BB, 6EG, 6KL, 6TX, 6EB, (Ex-"LY"), "PND", and 7AD.

Have worked with 6EA at Los Angeles, California. That is the greatest distance so far covered.

7AD is the only station to the north that has been heard.

Messages handled through this station. Six transmitted and four received. A. R. R. L. relay work.

Stations here have been trying to work through to Tacoma and Seattle, but the stations up there do not seem to come through. An attempt to get into communication with some of the Canadians will be made.

Radio clubs have been organized at some of the High Schools in the city, and the former radio association of the city has re-opened.

TACOMA WASHINGTON DISTRICT

**Mr. L. E. O'Brien, District Superintendent
Tacoma, Washington.**

Up to date the response to the S. O. S. in the November issue "QST" was "nil". However several communications have been received from the Eastern side of Washington which will be appointed Relay Stations as soon as they conform to the regulations.

A club has been organized in Tacoma and has 35 members so far and a fair percentage of them are A.R.R.L. men, too. It will affiliate with the A.R.R.L. soon.

St. Martin's College, Lacey, Washington—call 7YS has been appointed Official Relay Station on Trunk Line "F" to San Francisco. He has been heard by Portland and Tacoma, but so far no one here at Tacoma has been able to raise him.

Local work is being controlled here at 9 P. M. All sets are being tuned by a club wave-meter so QRM will be small around here.

CENTRAL DIVISION

R. H. G. Mathews, Manager,
1316 Carmen Ave., Chicago, Ill.

During the month of December a very considerable advance has been made in traffic handling. Branch routes have been put in working order by the various District Superintendents, as shown in their reports, given herewith. The Trunk Lines have been operating in excellent shape, and have been successfully handling a large amount of traffic. It is noted that the "Regards by wireless" type of message has almost disappeared, the greater number of messages being of a more or less important nature. It is also noted that the delays of days and sometimes weeks which formerly elapsed between the original filing of a message and its delivery at the destination have been considerably cut down. This is no doubt due to the greater interest of the operators handling the traffic, as well as to their increased operating ability and the increased efficiency of their apparatus. The Division Manager wishes to express his appreciation of the efforts of all those stations which have so commendably handled the holiday traffic under the extremely unsatisfactory weather conditions which have prevailed in this part of the country for the past month.

A point worthy of mention in this connection is the fact that every District Superintendent in the Central Division, with one exception, is able to communicate direct with the Division Manager.

A lack of enthusiasm is noted in several of the states in the western part of the Division, such as Nebraska, South Dakota, Missouri and Kansas. This condition is not the fault of the District Superintendents of this territory, but is apparently due to the lack of interest of the amateurs of this section. Good relay stations are needed here, and owners of such stations are urged to communicate at once with the proper Superintendent, as shown in the last two issues of QST.

Mr. A. G. Heck, 301 Highland St., Mannington, W. Va., has been appointed District Superintendent of West Virginia. Mr. Heck is operating station 8EF, and has been doing some excellent relay work.

Mr. C. E. Boardman, Kenosha, Wis., has

been appointed City Manager of Kenosha, Wis.

Mr. J. A. Gjelhaug, Superintendent of Northern Minnesota, reports that Duluth now has a radio club affiliated with the League, known as the Duluth Radio Association, with Wm. D. Wagner as President. Mr. Gjelhaug also reports that the route is clear from Chicago to Baudette, and also reports that he has a western outlet through 9EE, at Valley City, N. D. Canadian messages can be relayed through Mr. Gjelhaug to a number of cities, among which are Winnipeg, Manitoba, and other nearby towns. It is believed that the Canadian routes will be extended in the near future, as the Winnipeg Radio Club, which is seeking affiliation with the League appears to be a live organization and is making an attempt to further relay work in that territory. The Division Manager was favored very recently with a visit by Mr. E. F. M. Parker, a member of the Winnipeg Club, who was interested in securing information relative to our relay system, and the plans for co-operation between the two countries.

Mr. Pray, 9EE, of Valley City, N. D., District Superintendent of North Dakota, reports that things are coming along rather slowly up in his cold territory. He is able to take messages for his territory through the Chicago stations, and can also handle South Dakota traffic through Eureka, S. D. He has not been able to get a western outlet as yet.

Mr. Taylor, 9CA, Superintendent of Illinois, reports that routes have been laid out for handling traffic in and out of Chicago, but that stations for handling traffic for southern portion of state, also for Rockford, Ill., Freeport, Ill., Dixon, Ill., Streator, Ill., Ottawa, Ill., Springfield, Ill., are needed.

A club has been organized at Bloomington and has already 20 members, every one a live booster for our A.R.R.L. The club has requested affiliation with the League. Other Radio Clubs forming or already organized within this state are requested to write, giving name, address, what they have been doing in the radio art, and whether they are affiliated with the League or not.

Mr. Trump, 9BT, District Superintendent for Kansas reports that the amateurs in his district do not seem to be showing very much interest, and are very slow in starting up. Operators of good stations in Kansas are requested to communicate with Mr. Trump at once, as he can make good use of them in his traffic organization.

Mr. H. J. Burhop, Superintendent of Southern Wisconsin, has been given charge of the entire state of Wisconsin, due to the resignation of Mr. H. I. Crawford, former Superintendent of northern Wis-

consin. Mr. Burhop is now located at Manitowoc, Wis., where he is erecting a special station, in conjunction with his assistant, Mr. Cecil Bridges, whom the old timers will remember as 9ZL of Louisville, Ills.

Mr. Burhop reports his Lake Shore route in operating order from Chicago to Neenah, Wis. Mr. Burhop is looking for some stations for a cross-state route between Milwaukee and Dubuque. Direct work is frequently possible, but several good relay stations are needed.

Unusual and commendable co-operation has been exhibited between the Superintendents of Wisconsin and Iowa on an attempt to form routes from Duluth and Superior to St. Paul and Minneapolis, Ferryville, LaCrosse, Praire du Chien, Dubuque and on down.

Mr. C. T. Schrage, City Manager of Madison presents a very interesting report on the activities in that city. He states that both the University of Wisconsin (old 9XM) and the Madison High School sets will be in operation soon. 9XM will operate with both damped and undamped sets, the spark set using waves of 750, 900, 1300, and 1700 meters. The undamped set will operate on waves of 1300 and 1700 meters.

Mr. K. A. Duerk, 8AA, District Superintendent of Western Ohio, reports a rapid increase in the interest in his territory and also reports the following changes in his routes as published in the last report.

"Cancel 8AMJ 8ARL Toledo, add 8EU. Alternate and preferable route from 8AA to Columbus is via 8ER to 8EC and 8IB. Mr. J. W. Wright, of Springfield, O. 8NP (old call) appointed branch station off 8EC and 8IB, Columbus. Station 8ASF (old call), Lima, Ohio, Stolzenbach Brothers and Mr. Clausinig, of ex-8YL, is appointed intermediate station on Columbus route, working with 8FP and 8AA."

Mr. C. W. Patch, of Dubuque, Iowa is brim full of pep and enthusiasm, and reports his state coming along in fine shape.

Mr. Darr, Superintendent of Southern Michigan, got appointed and then not to be outdone by the other Superintendents, he has put up 8CB and is putting Detroit on the radio map.

Mr. Hamilton, District Superintendent of Indiana has been doing his organization work in his usual efficient style, and in addition has succeeded in getting an efficient relay station in operation.

Mr. Turner, 9DU, of Western Missouri, reports his district coming along slowly. His assistant, Mr. Pilgram, of 9FL is also a prominent long distance man.

Mr. Ball, Superintendent of Eastern Ohio, reports good progress in his district, with the exception of Cleveland. It seems impossible to get traffic into that city, due apparently to a lack of enthusiasm on the part of the station owners there. We have a lot of Cleveland traffic, and will appreciate someone's coming forward with a good station to handle it. Messages to Pittsburgh can be handled by Mr. Ball, who is, with the rest of them, doing long distance work with 8AH.

Traffic to any of the Districts may be handled through the various District Superintendents, or through the station of the Division Manager, 9ZN, which is able to communicate with all the Superintendents direct, and which is acting as Division Distributing Station.

Mr. Page, 9BP, of Evanston, Ill., recently appointed City Manager of that town, has been doing good work in handling traffic as an alternate for 9ZN, together with 9AU, the station of the Division Manager's Administrative Assistant. 9AD, the station of Mr. D. N. Buck, Traffic Assistant, has been doing some excellent work of this kind, too.

THE JUNIOR OPERATOR

(Concluded from page 28)

(as we only wind to within $\frac{1}{2}$ " of each end). This will be 4477 inches of total wire required, or 373 feet. The next point is, what part of a lb. is 373 feet of No. 24 S. C. C. wire. Turning again to the table we find there is roughly speaking, 817 feet in every lb. of No. 24 S. C. C. Therefore there will be needed 373 divided by 817, or 0.45 lb., or slightly under $\frac{1}{2}$ lb. of wire. These calculations should not be depended on too closely, as allowance must be made for not winding tight enough, length of lead, etc. It merely serves as a rough guide for the amateur, and the wire necessary for any coil can thus be approximated from this table.

If the amateur has a very small antenna, he can substitute No. 26 wire for No. 24 and follow out all other instructions. Most antennae are larger than the one described and hence he will have no difficulty in getting Arlington. A small condenser across the secondary of 0.001 mfd. is suggested.

The loose coupler will be taken up next month.

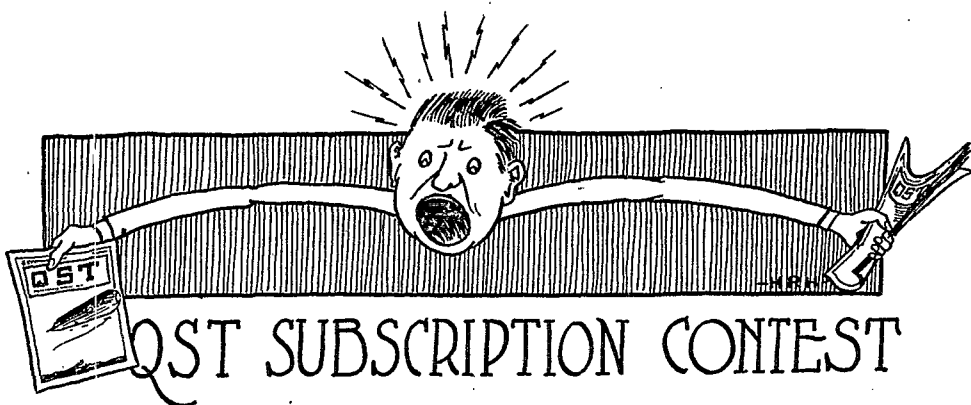

QST SUBSCRIPTION CONTEST

FINAL BULLETIN

Dear Contestants:

When this reaches you just a few more days will remain in which you can put in the licks that will win a prize for you.

The time for the whirlwind finish is at hand. Things have been "whirlwindy" here for some time, as it is, with reserves being rushed in by various contenders at a rate that makes it impossible to say from one mail to the next who is in the lead. A good many men seem to have a few up their sleeve, and I want to warn you who are on top today not to feel smug and contented, because somebody is sure to jar loose a high frequency discharge and you'll wake up with a punctured condenser and your radiation down to zero. It will be necessary for you to work hard up to the last mail to Hartford, to cinch your place in the contest.

Let me urge you all to a final energetic effort—I know there are just thousands upon thousands of subscribers to be had. Knock off a day and work for it—you can't get apparatus any cheaper way.

You fellows with the smaller scores—what's the matter? Takes ten subs. to qualify, you know. Don't let your effort so far be lost by failure to pile up a total of at least ten. A little move on, O.M., and let's see you get somewhere.

The score on January 15th was as follows:

Anderson, E.	48	McDougall, C. E.	0
Arnold, E. G.	12	Miles, S.	0
Adams, J. E.	0	Myer, Dwight	36
Buchanan, Joseph	0	Metzler, Silas J.	0
Burlingame, E. B. S.	0	McVay, S. Bernays	12
Barnard, H.	12	Manly, Edw.	12

Burhop, Harold J.	12	Mathes, Richard	0
Comneau, Lawrence	0	Nelson, Heber S.	0
Cohen, Joseph W.	12	Otterholm, C. J.	0
Carpenter, J. L.	0	O'Donnell, Robt. A.	0
Clark, Ed.	36	Ogden, Gordon	0
Carter, Robt.	0	Progressive Radio Assoc.	12
Carson, Robert M.	24	Paulus, W. H. A.	72
Clayton, Robert	0	Place, Samuel	120
Day, Jno. W.	24	Quick, Robert D.	12
Davis, Oscar L.	42	Rose, Earl E.	0
Doty, Chas. R.	12	Richter, Herbert	92
Demmer, Harold	24	Reiter, Jno.	0
Dimock, S. K.	0	Ross, Elmer P.	0
Engel, Norman	0	Rowley, Welton D.	0
Emmer, Joseph	0	Service, C. A., Jr.	12
Freeman, Robert J.	0	Steere, Walter E.	0
Foster, Robt. H. K.	228	Simonson, Henry	0
Fass, Harry	24	Swain, Earl	0
Farlow, A. C.	0	Sawyer, W. G.	0
Gardiner, E. C.	36	Smith, Zarak	0
Getz, Joseph	0	Stevens, Ezra F.	0
Grieb, C.	12	Shorey, G. Faxon	60
Humphrey, O. J., Jr.	24	Shalkhauser, C.	12
Hertz, J. D.	96	Tuttle, Norris	36
Horns, K. E.	156	Trivelpiece, Alvin	0
Hunter, Thomas F.	120	Troy Y. M. C. A. Radio Asso.	0
Hertzberg, Robt.	48	Taylor, W. S.	168
Heck, E. L.	0	Van Kirk, Geo. W.	0
Independent Radio Supply Co.	0	Van Orden, Geo. O.	0
Johnson, Earl	0	Wapples, Dolph	0
John, George	0	Wolfson, David	0
Keller, Asa S.	0	Welch, H. F.	24
Kirby, R. B.	0	Waldie, Thomas G.	24
Kulick, Jno.	0	Wankel, F. A.	24
Lustig, A. M.	0	Wireless Assoc. of Ont.	24
Lindauer, J. H.	0	Worner, Urban D.	24
Markoe, J. M., Jr.	0	Zeyn, Paul V.	24
McCommon, R. D.	144		
Machesney, Allan L.	0		
Midgley, H. C.	24		

A final word: the contest ends at midnight February 10th. Be sure you get everything in by then, if you want it to count. I'll be looking for that final "special delivery" from you.

And I wish you all luck!

THE CONTEST MANAGER.

"STRAYS"

Some amateurs don't seem to get the results they are looking for from the variometer regenerative sets like the Grebe and Paragon. These sets remain the last word in efficient short wave reception, and if the results are not far above what are obtained with a non-regenerative set it is

because they are not properly operated. It takes some time to get the hang of one of these sets and a few words of instruction may not be amiss.

Fine tuning in the primary circuit is accomplished by a series condenser. Sufficient inductance should be used so that, in

general, at least one-third of the condenser capacity is in the circuit. The grid variometer tunes the secondary circuit and is the only variable element, outside of variable mutual inductance, in that circuit. The plate variometer is the means for giving the regeneration, the theory for which, as expounded by Armstrong, is rather complex although the results are certain. In operation, primary and secondary circuits are tuned as usual and amplification secured by rotating the plate variometer until just under the point where oscillations commence, as indicated by a click in the phones. This adjustment is critical. A most important feature of the operation of this set is that the amplification obtainable seems to be proportional to the looseness of the coupling employed and to the exactness of tune. This accounts for its very high selectivity. With a signal picked up with moderate coupling, the coupling should be reduced and primary and secondary carefully adjusted to compensate for the decrease in mutual inductance, and this may be done to the point where the signals are practically inaudible; the plate variometer is then adjusted and the signals come back with high amplification and generally with no interference.

In late November the Navy Seaplane NC-4, of transatlantic fame, made a trip up the Mississippi River on a recruiting tour, and the enterprising Mr. Crowdus of 9BR, St. Louis, arranged to establish communication with her operator, Lieut. Rodd. From St. Louis to Hannibal, the next stop, uninterrupted communication was maintained. From the looks of Crowdus' log we are sure it must have been great sport. This is the first time we have heard of an amateur station working a plane, and much regret that lack of space makes it impossible to publish 9BR's log in full.

Some awful things happened to the amateur equipment which was stored away for "the duration." We just heard of one amateur who owns one of the QST regenerative sets which he opened up recently for an examination and found a mouse had built a fine nest in the secondary of the loose coupler. Whether Mr. Mouse's presence had any capacitative effect has not been determined. If he could be induced to lie still and not scamper around, perhaps it would not make much difference, and it is possible that the continual adjustments of the coupling suffice to lull him to sleep, but how about hysteresis losses?

Many small troubles crop up incident to high amplification. At one station we recently visited, an experimental two-stage amplifier was in use and the phones were very noisy and trouble seemed hard to locate. The B batteries were replaced to

see if they were noisy, but with no change in result. Finally the tubes were removed and the four prongs sandpapered to clean the contacts. This made a big improvement but quite a bit of noise remained, and after about an hour's work the operator succeeded in locating the cause of the trouble. Would you believe that it was dirty rheostats! The resistance windings on these were sandpapered clean and bright and then the system was beautifully quiet.

Many amateurs seem under the misapprehension that if they have a low power transmitter which they believe cannot transmit beyond the limits of their state, they don't require a license. This is not the fact, inasmuch as the law includes stations which can interfere with messages arriving from outside the state in which the station is located. This proviso, therefore, makes it necessary that every transmitting station have a license.

Gradually the ARRL's 9 o'clock curfew for small talk and local work is coming into general adoption. The other night we were much amused to hear one of the younger fraternity call down an offending member with the following: "QRT; don't you know it is 9 o'clock?"

You can't keep a good man down. The recent hurricane through Ohio blew down both of 8AA's 60-foot poles. The next day he had up a temporary aerial 30 feet high from a tree to a short pole, hoping that he might be able to do some receiving but expecting he would be out of the relay game until after Christmas; but he continues to pound in everywhere from 9BT to 3BZ just the same as on the old aerial.

The younger amateurs around greater Boston have formed a radio club with over 50 members already. It is called The Greater Boston Radio Club. Meetings are held every Saturday morning at ten o'clock at 18 Boylston Street. The officers are: Frank Chickering, president; Louis Gates, secretary; 19 Mountain Ave., Malden Mass.

Why do QST advertisers get so much higher returns per thousand circulation than from other mediums? It is because we of the A.R.R.L. hang together and support our advertisers. We are delivering the goods, fellows; let us keep it up and make our QST grow. Never forget to mention QST when you write to advertisers, and buy your stuff from the folks who help us.

Do you New England amateurs hear the wireless phone on 200 meters? Mr. A. H. Wood, Jr., of Winchester, is sending out music to the boys on one loaned by the Atlantic Radio Co. Bring in the Queen and let her hear it. Concerts Sunday at

3 p.m., also weekday evenings. The set has a range of about 100 miles and Mr. Wood would like to hear from amateurs outside of Massachusetts who hear it.

In response to numerous requests for a diagram of connections for employing an amplifier with one of the modern "three-binding-posts" variometer regenerative tuners, we present here the hookup for using a detector and V.T. amplifier with the Grebe or Paragon set, with all the tubes operating on one A battery and one B battery. Better results generally will be secured with an independent B battery for the detector. In explanation it is necessary only to say that the input transformer of the amplifier system is connected where the phones would normally go.

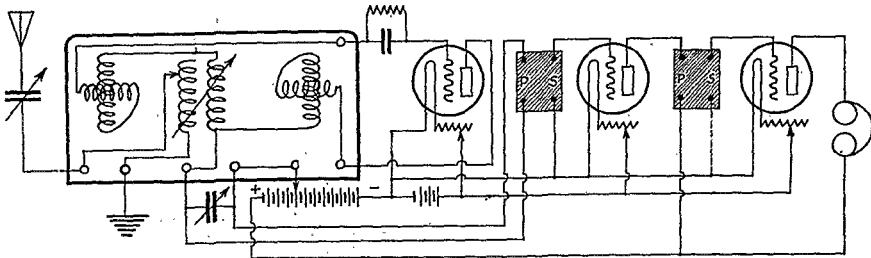

Worn-out dry cells have one genuine use; the zinc shells are excellent for a ground. Improve your ground by saving your old cells and burying them in strings in moist earth, soldering at intervals along a strip metal lead.

Among our prominently-mentioned "cranks on gaps" is Treasurer Runyon, of 2ZS. He's gone thru eight so far, and can't find one that will hold up on his 30,000 volt United transformer. At present 2ZS is using a synchronous spark frequency of 120—a heavy gap mounted on a 60-cycle synchronous motor. Some day QST hopes to have a picture of this combination of "Runyon Among the Burnt-Out Rotaries" which we feel should be regarded as a classic and considered a companion-picture of "Moses in the Bulrushes."

The lower vacuum tubes seem to make more sensitive detectors than the high vacuum ones but have the disadvantage of instability and, on coming back to receiving after a period of transmission with the filaments turned off, it is generally necessary to readjust. Here's a way to beat that game: Let all your filaments burn continually and shut off only the high voltage when transmitting. Then you are back right away instead of having to wait for the bulbs to get warm each time.

The United Young Men's Christian Assn. Schools announce the distribution of scholarships for vocational training at their various schools, free to ex-service men who show ambition, earnestness and ability, as an extension of the governmental policy of vocational training which unfortunately ceases upon discharge from service. A great number of interesting courses in the various branches of applied electricity are among the subjects available. Scholarships will be apportioned to various states in proportion to population, and award will be made by special local committees of competent men. Part of these scholarships will be available in the nearest United Y. M. C. A. School. A large number will be open thru correspondence courses, and a small number

will be offered in special technical schools. Further information can be secured from the nearest "Y", or by addressing Headquarters, United Y. M. C. A. Schools, 347 Madison Ave., New York.

Mr. Louis Gerard Pacent, the well-known manager of the wireless department of the Manhattan Electric Supply Company, with headquarters in New York City, has left the Mesco stores and launched into business for himself under the name of the Pacent Electric Company, with offices at 150 Nassau Street, New York.

Mr. Pacent will be the exclusive agent of the Dubilier Condenser Company in the United States; will have the Eastern distribution of block B batteries for Richter and Byrne, and will be distributing agent in the states of New York, New Jersey, and Connecticut for A. H. Grebe & Company and the Rawson Electrical Instrument Company. Besides handling most reliable domestic instruments, including the Western Electric VT's and Lavite resistances, etc., he is importing several foreign-made radio instruments, including the Seibt Variable Condensers and Buzzers, etc.

Mr. Pacent is a well-known figure in the amateur world and we join with his many other friends in wishing him success in his new endeavor.



In asking questions, observe the following.

- (1) Number each question
- (2) Write on one side of paper only
- (3) State each question clearly
- (4) Be as brief as possible

No queries answered by mail.

Deforest Rimbach, Ohio:

Q. Can the short wave set described in December QST be used with an AudioTron bulb?

A. Yes, but a B battery adjustment will be necessary.

H. M. Huston, Calif.:

Q. Are Western Electric VT's obtainable?

A. Yes, for non-communication purposes. See advertisement in this QST.

Q. Are genuine AudioTrons being manufactured?

A. Yes; almost any dealer can supply you.

Q. Are dead-ended long wave couplers as efficient as short wave couplers on short waves?

A. No, not by any means. A small coupler will give several times as good service on 200 meters as a tuner capable of reaching 2500 meters.

E. Manley, Ohio:

Q. Who is MO?

A. MO is not a station. This is a signal given by vessels while land compass stations are taking bearings on them to ascertain their position. It is an arbitrary signal.

Q. Is the hinge-type pancake O.T. as good as the type sliding on a rod, both of the same dimensions?

A. There is no difference electrically. Mechanically, everything is in favor of the hinge type, as coupling can be adjusted much more conveniently and while the set is in operation.

G. E. Stone, New York:

Q. What size wire is used on the DeForest coils and what is the natural wave length of each coil?

A. This data is shown in detail in the DeForest catalog. We suggest you write for a copy.

E. C. Smith, Illinois:

Q. Has no "juice" and inquires whether we recommend a gas engine and alternator to operate a one-half KW transformer set, or larger spark coil and more batteries, in order to increase his transmitting distance.

A. In such circumstances we recommend neither of the above. Instead, we suggest vacuum tube transmission, either undamped or modulated, with a small 500-volt DC generator for the plate current. This is the most efficient transmission possible for a given input.

A. S. Keller, Wash.:

A. It makes no difference on which side of the B batteries the phones are placed in a receiving circuit. It is conceded better practice, however, to connect the positive terminal direct to the plate, with the phones on the negative side.

N. R. Hood, Wyoming:

Q. Inquires value of inductance in coils in hook-up shown on page 7 September, 1919, QST.

A. Coils of 30 millihenries inductance will cover the desired wave length range when shunted by a condenser of .001 mfd. For best results, however, it is better to have changeable inductances of such value that the desired wave length for any station can be obtained in the primary and secondary circuits when using not to exceed 15 degrees on the scale of a .001 variable.

C. L. Reynolds, N. Y.:

A. Your lead-in should by all means consist of as many wires and have the same gauge as your antenna itself.

A. The $\frac{1}{2}$ " and $\frac{3}{8}$ " ribbon on the primary and secondary, respectively, of your O.T. are ridiculously small for 1 K.W. See answer to E.G.C., page 45, December QST.

Q. Inquires for data on the design of a small rotary of good efficiency.

A. For a rotary of simple construction and low cost which will give a very fair degree of efficiency and better than many gaps supplied the amateur market, we suggest the following: A 9" disc of $\frac{3}{8}$ " Bakelite, mounted direct on the shaft of a

1/15th H.P. induction motor, turning 1750 RPM. On a 4" radius on this disc place 8 "spark-through" electrodes, equally spaced. These may be of 3/8" threaded brass rod with a brass nut on each side to hold them in place. If the faces of the plugs are filed down to present a width of only 1/16" in the plane of rotation, operation will be improved.

G. C. Sprouls, Jr., Pa.:

Q. Describes his layout wherein antenna lead runs down the side of two-story house to transmitter in basement with buried wires in the cellar forming ground and inquires for an arrangement whereby a receiving set can be satisfactorily operated on the second floor of the house.

A. Insert an anchor gap of large flat surfaces adjusted as closely as possible, in the antenna lead just above the oscillation transformer and run a carefully insulated lead from the upper side of this gap to receiving switch, with independent ground lead from the receiving set.

G. W. VanKirk, Pa.:

Q. Can a primary and secondary of a 1" spark coil be used as an amplifying transformer in conjunction with one Audio-

Tron bulb and one Marconi VT? Give a hook-up showing one storage battery and one B battery.

A. The primary and secondary of a spark coil will not make a good amplifying transformer. Remove the primary and fill the entire center space of the secondary with a core of iron wire and use this winding as an impedance repeating transformer as per figure 2, page 9, August, 1919, QST. Use your AudioTron as detector and Marconi VT as amplifier. It will be necessary to adjust the plate potential for the AudioTron. Figure 2, page 11, November, 1919, QST shows how this may be done by a potentiometer across the same B battery.

P. F. Peterson, Iowa:

Q. Is it practical to take taps from multi-layer coils?

A. Only over a small percentage of the total inductance—we should say not to exceed 10%; otherwise, wind separate pies with taps in between.

Q. How can I arrange my coupling to be rotary but still get close coupling?

A. The maximum coupling provided by a doughnut tuner wound on flat tubes will be found more than sufficient.

Auto-Modulated C. W. Telegraphy

IN that excellent and justly-famous radio text, Circular 74 of the Bureau of Standards, entitled "Radio Instruments and Measurements", appears an idea for the modulation of undamped which is proving quite successful in some amateur experimentation in the east along the lines of C.W. telegraphy. The novel feature of the article is the insertion of an audio-frequency tone circuit in the oscillating circuit, so that the audio frequency is superimposed on the radio-frequency oscillations. The circuit oscillates, therefore, at two frequencies—the radio, or carrier wave, and the audio or tone frequency. In other words, the carrier wave is electrically modulated at a tone frequency determined by selecting values of L and C in the audio circuit to give a wave length equivalent to the desired tone.

The modulation envelope by this method will be approximately sine-form, and much superior in efficiency to buzzer modulation, to say nothing of reliability and steadiness of the note. It gives an absolutely pure and beautiful tone, much more pleasing than the familiar buzzer note.

While applicable in principle to any oscillating circuit, our diagram shows the suggested Bureau of Standards arrangement. This circuit is being used with

highly satisfactory results by Mr. Minton Cronkhite, of New York, to whom we are indebted for the constants here given. L1 and L2 are honeycomb inductances, .04 milhys. C2 is an ordinary 0.0008 variable air condenser. The coil L1 is common to

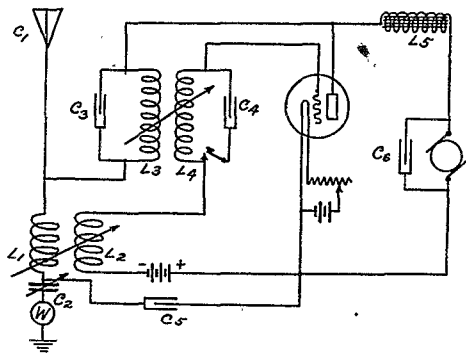

the plate circuit and antenna circuit, and L2 is the grid circuit feedback inductance. C5 and C6 are 2 mfd. paper by-passing condensers, and L5 an iron-core choke of 1.3 henries. Thus far the circuit presents nothing unusual. L3C3 and L4C4 are the

audio-frequency circuits, and each consists of a honeycomb coil of an inductance of 100 milhenries, shunted by a paper condenser of 1 mfd. capacity—a combination having a wavelength of 600,000 meters, equal to a frequency of 500 cycles.

Note the grid-circuit battery and the location of the key. The battery is for the purpose of impressing a negative potential on the grid sufficient to shift its axis of oscillation to the centre of the "straight portion" of the control characteristic curve, and its value will vary with different types of tubes. The key in the location shown does not stop the tube from oscillating, but merely interrupts the modulation, the carrierwave being radiated continuously. It could not safely be placed at any different location in the grid circuit, for if the negative potential on the grid were interrupted, in many types of tubes the grid potential would reach such value that excessive plate current would flow and the tube be destroyed. It could be put in the ground lead if it were desired to interrupt all radiation, but small dynamotors heavily loaded are apt to "whine" with an intermittent load of this nature—and it is obviated by locating the key as shown.

For a while at least it seems we amateurs will have to employ C.W. modulated at the transmitter. To our mind, it is practically impossible to heterodyne a 200 meter wave with any degree of reliability or constancy, because at this very high frequency the slightest deviations in the frequency of either the signal or the local oscillations will produce distressing tone changes in the resulting beat note even if they do not drive it "clear off the scale." Another feature deserving consideration is the heterodyne interference which may result should C.W. transmission become very general on 200 meters. However, for the very reason that heterodyning such a high frequency is extremely difficult, this may not prove a very troublesome problem.

Some features of C.W. telegraphy are most promising. The very high efficiency because of the low damping is the most important one. C.W. work gives us an excellent example of the unreliability of the H.W.A. in close-coupled damped transmission, where we know that its reading is no criterion of the energy in one wave and that looser coupling with less reading is concentrating the energy in one wave so as to produce better response at the receiver. This is carried to its zenith in C.W., where the decrement is only that of the antenna system itself. Therefore, in comparison with spark work, seemingly marvelous distances can be worked with antenna currents barely sufficient to move the needle of a big H.W.A. As an example of this 2AB, in New York City, while re-

cently working 3ZH at Trenton with a buzzer-modulated C.W. telegraph with a radiation of 1.1 amperes, was called by 8DA in Ohio who reported "sigs QSA very", and successful communication was had. This 1.1 amp. was undoubtedly the equal of several amperes by spark excitation.

Another tremendous possibility in V.T. transmission is in the use of the same tube for transmission and reception, as was mentioned in a recent article in QST. An unlimited vista is opened up by this proposition. If A calls B on 185 meters, when B replies his transmission is on 185 because that was the tune to which he adjusted his 2-way set to receive A at first. A has no adjustments to make to receive B. But suppose QRM develops from a similar set, and can be cut out by dropping down to 175 meters. When A comes back, he can do it on 175, and B will have to drop down to get it and his (B's) reply accordingly will be on 175 thenceforth also. Thus can be realized the dream of many years—to make the other fellow change his transmitting tune at your pleasure to meet your own interference problems!

The Editor will be pleased to receive reports of amateur V.T. transmission.

Are You Satisfied

with a double-slide tuner, crystal detector, and 80-ohm phones?

If you are, don't waste your time reading this—but if you want to get the maximum range from your set, we have the instruments that will give you this range at all times. Our instruments are real professional quality.

The two step amplifier illustrated, will give the maximum amplification and has "B" Batteries included. It uses standard V.T. Tubes. Further information on request.

Price without tubes \$50.00

THE PRECISION EQUIPMENT CO., Inc.

Manufacturing Engineers.

2437 Gilbert Ave., Dept. D, Cincinnati, Ohio.

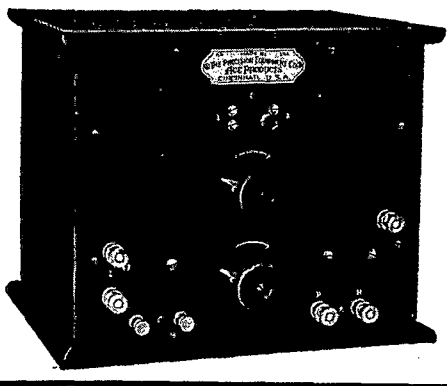

Thermo-Ammeters, Miliammeters and Current-Squared Meters

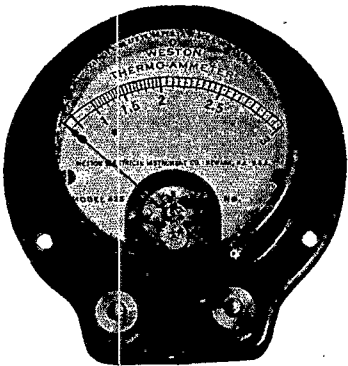

Weston

Model 425

Miniature Size Instruments for Radio Service

are the ideal instrument for the amateur.

They are provided as back-connected or front-connected instruments, and can be mounted on small panels or be used as portable instruments.

Their characteristics of accuracy, large overload capacity, small current consumption and small size make them particularly desirable for use on amateur and other low-power outfits.

Complete information will be furnished upon request.

Weston Electrical Instrument Company

158 Weston Avenue, Newark, N. J.

Branches in all Principal Cities.



IMMEDIATE DELIVERY WESTERN ELECTRIC VT-1

PRICE \$10.00

PERFECT SOCKET \$1.00

For measurements in a laboratory these tubes are unequalled by any others. They are the only tubes having oxide-coated filaments, insuring greatest emission of electrons and longest filament life. They are sold only for uses other than the transmission or reception of messages.

Rawson Electrical Instrument Co.

CAMBRIDGE, MASS.

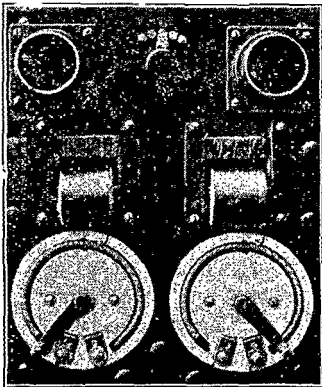

TWO-STEP AMPLIFIER

\$25.00 With Step Control
Shipping Weight 5 Lbs.
Adequate spacing of VT's and
coils eliminates howling, etc.

A NEW FILAMENT RHEOSTAT
Rugged—Compact—
Good Looking.

The 6 OHM Resistance permits the use of either a 6 or 4 volt battery with fine variation of current. Made of black heat-proof condensite. 2 1/4" dia., heavy bearings—smooth action. Either back or front mounting.

Radio Equipment Co.

630 WASHINGTON STREET
BOSTON, MASS.

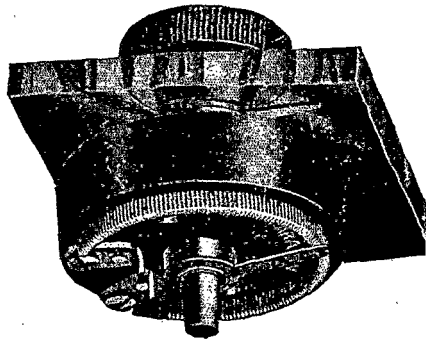

\$1.75 POSTPAID

STORAGE BATTERIES FOR WIRELESS SERVICE

Batteries especially adapted for the amateur operator are described and illustrated in our new Bulletin No. 175, copy of which will be furnished on request.

THE ELECTRIC STORAGE BATTERY COMPANY

The largest maker of storage batteries in the world

1888 PHILADELPHIA, PA. 1920

New York Boston Chicago Washington Denver San Francisco Cleveland
Atlanta Pittsburgh Minneapolis Kansas City Detroit Rochester
Special Canadian Representative, Chas. E. Goad Engineering Co., Toronto and Montreal

Audion Detectors

\$10.90—\$13.25—\$21.00

WITHIN THE
LIMIT OF
EVERY AMATEUR

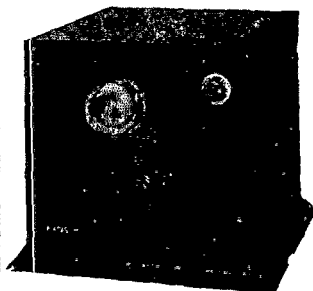

REMARKABLY
EFFICIENT
AND HANDSOME

Everything POSTPAID
Prompt Deliveries
SEND YOUR ORDER NOW
DEPT. B-3

THE RADIO APPARATUS
SERVICE
UNION SAVINGS BANK BLDG. WASHINGTON, D.C.
"A SUPPLY COMPANY FOR THE RADIO AMATEUR"

REDUCED PRICES EFFECTIVE NOW

The following partial list taken from our
Feb. Bulletin. This knocks the H. C. W.

- Binding Posts with Hard Rubber Tops,
Washers, and Nickel Bushings \$0.15
- Tested Audio-Tron Tubes with 4 of
above Posts and Panel Clamps \$5.25
- Standardized pol. Formica Panels,
4 1/2 x 4 1/2" (same size as De Forest
units) \$0.35
- 15 Ampere D. P. D. T. Wireless Switch
on Porcelain Bases \$0.50
- D. P. S. T. Switches as above \$0.35
- Flexible, Stranded R. C. Wire for Con-
necting Receiving Instruments, per
foot \$0.02
- 1 1/4 inch Moulded Knobs \$0.14
- Nickel Plated Watch Case Buzzers \$0.65
- Panel Rheostats \$0.75
- Stamped Metal Push Buttons \$0.14
- Nickel Plated Filament Switches \$0.33
- 3/8" Copper Tubing (more efficient than
strip, or flat braid) per foot \$0.19

POST EXTRA

A full line of Apparatus for every Amateur
requirement. Satisfaction guaranteed or money
refunded. Prices apply to stock on hand. To
insure prompt service order NOW.
Catalog 6c

KLAUS RADIO APPARATUS **Eureka, Ill.**

MURDOCK

NO. 55

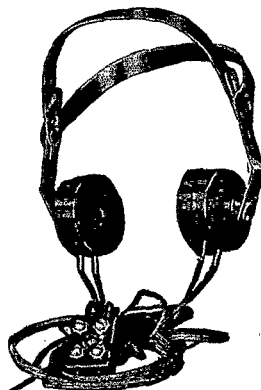

2000 OHM DOUBLE SET

\$4.50

3000 OHM DOUBLE SET

\$5.50

Made for long and
Useful service in
Radio stations where their
Dependable and sensitive
Operation makes them the
Choice of those who
Know GOOD 'phones.

ORDER YOUR SET NOW—
Try it out thoroughly.
IF IT DOESN'T SUIT, SEND
IT BACK AND GET YOUR
MONEY

Bulletin 19 shows a splendid
line of the type of apparatus
you want. Send for a copy.

WM. J. MURDOCK CO.

65 Carter St.

CHELSEA MASS.

221 SECOND ST., SAN FRANCISCO, CALIF.

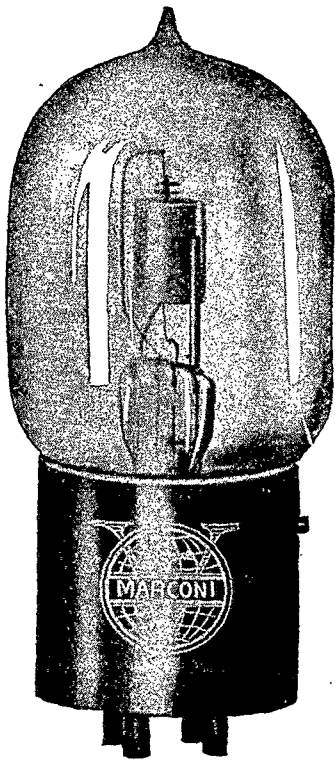

Fleming Pat. No. 803,684
De Forest Pat. Nos. 841,387-879,532

selling, importing or using them alone or in combination with other devices, infringe upon the Fleming patent and are liable to a suit for injunction, damages and profits. And they will be prosecuted.

THE AUDIOTRON AND THE LIBERTY VALVE ARE NOT LICENSED UNDER THE FLEMING PATENT

The price of the genuine Marconi V. T. delivered is \$7.00 each. The standardized socket is \$1.50 additional. The standard resistance, complete, costs \$1.00 and is made in the following sizes: 1/2 megohm, 1 megohm, 2 megohms, 4 megohms, 6 megohms.

Do not take chances by making, importing, selling, purchasing or using vacuum tubes for radio purposes not licensed under the Fleming patent. By selling, purchasing or using licensed tubes for radio purposes you secure protection under the Fleming patent and avoid the risk of litigation for infringement thereof.

This warning is given so that the trade and public may know the facts and be governed accordingly.

Send all remittances with order to **COMMERCIAL DEPARTMENT**

**MARCONI WIRELESS TELEGRAPH CO. OF AMERICA
RADIO CORPORATION OF AMERICA**

227 Broadway

New York

Sole Distributors for De Forest Radio Telephone & Telegraph Co.

Retail Office and Exhibition Rooms, 25 Elm St., New York
Schofield Bldg., Cleveland, Ohio
American Bldg., Baltimore, Md.
Insurance Exch. Bldg., San Francisco, Cal.

136 Federal St., Boston, Mass.
301 Commercial Bank Annex, New Orleans, La.
109 South 2nd St., Philadelphia, Pa.

A WARNING

to **Manufacturers**
Importers
Dealers
Jobbers

Agents
Amateurs
Purchasers
Users of

VACUUM TUBES

The Marconi V.T. Patent is Basic

United States Letters Patent to Fleming, No. 803,684, November 7, 1905, has been held to be valid by Judge Mayer of the United States District Court for the Southern District of New York, and by the United States Circuit Court of Appeals for the Second Circuit. It is a basic patent and controls broadly all vacuum tubes used as detectors, amplifiers or oscillations in radio work.

No one is authorized to make, sell, import or use such tubes for radio purposes, other than the owners of the patent and licenses thereunder. Any others making,

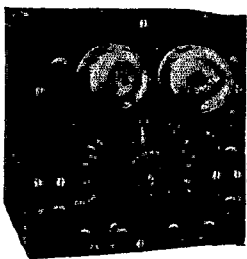

RADIO INTERNATIONAL RADIO

**VACUUM TUBE DETECTOR AND
AMPLIFIER, AND TWO STAGE
AUDIO FREQUENCY AMPLIFIER.**

This detector and amplifier unit is one of the series of interchangeable panel units for receiving, which the International Radio Telegraph Company is manufacturing as part of its new line of experimental and laboratory apparatus. The two-stage amplifier will multiply signal strength about 350 times. The units are all of the same size, having 6" by 6 $\frac{3}{8}$ " panels, and are all fitted to standard well finished cases, so that they may be combined and connected in any way desired. These instruments include detectors, condensers, inductances, amplifiers, etc., as described in our various Experimental Apparatus Bulletins.

The detector-amplifier is priced at \$35.00, without tubes, and the two-stage amplifier at \$42.50, without tubes. Terms—cash with order, F. O. B. New York City.

Write to Department 23 for new Experimental Apparatus Bulletins.

INTERNATIONAL RADIO TELEGRAPH COMPANY
326 BROADWAY, NEW YORK CITY

Announcement

A. H. Grebe &
Company

Rawson Electrical
Instrument Co.

Dubilier Condenser
Co.

Richter & Byrne

Imported Selbt Con-
densers
and others.

May we send you our
pocket ruler which
contains valuable
measurements and
calendar? It's yours
for the asking.

IN ORDER to serve radio amateurs and others interested in radio work to the best advantage, Louis Gerard Pacent, for the past ten years connected with the Manhattan Electrical Supply Company of New York as their radio departments manager and consulting engineer, has now identified himself with a true radio organization—The Pacent Electric Company. In the capacity of President and General Manager of this company he is now in a position to specialize on radio and electrical laboratory equipment.

While the Pacent Electric Company are wholesale distributors of radio and other electric apparatus, radio men, experimenters, professors, instructors, Government authorities and other interested persons are at all times invited to visit the show rooms at the address below, where at all times a complete line of the latest equipment will be on exhibition. A radio reference library, complete files of current technical periodicals, special reports—these and Mr. Pacent's years of experience will be at the disposal of all interested persons.

PACENT ELECTRIC COMPANY, Inc.

Telephone: BEEKMAN 5810

150 NASSAU STREET

NEW YORK CITY

STARTING WITH A BIG IDEA, WE ARE GROWING ALL THE TIME

Realizing the great need of a single supply house that could furnish all makes of radio apparatus, the National Radio Supply Company was organized in March, 1919. When our Bulletin No. 1 was issued, on April 15th, we had the sales agency for 40 different concerns. When Catalog No. 2, issued in July, this list had grown to 62 Companies. Today there are 83 firms whose radio apparatus we handle. Those companies whose goods we do not sell can be counted on the fingers of your right hand. Think of the convenience this means to you.

Our 74 page Catalog No. 2, shows more radio apparatus than any other heretofore published. Ten cents in stamps will bring it to your door. New price bulletin "C" forwarded upon request to those who already have this wonderful book.

Our radio expert will answer your questions without charge, if a stamped and addressed envelope is included with your queries.

NATIONAL RADIO SUPPLY CO., "The Nation's Clearing House"
Dept. 120, 1405 "U" St., N. W., Washington, D. C.

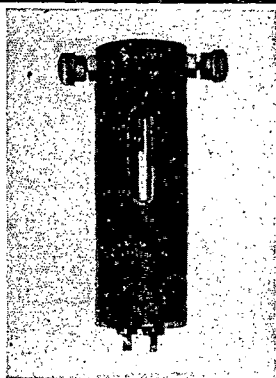

Get One Immediately

This is the only device on the market which allows you to use a tubular bulb in a standard socket. Dealers write for price schedule.

PRICE \$1.50 POSTPAID.

THE RADIO ELECTRIC COMPANY
4614 HENRY STREET PITTSBURGH, PA.
"We make or sell everything Radio"

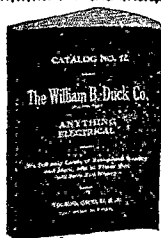

DUCK'S BIG 300 PP. Wireless and Electrical Catalog

Is now as it always has been, the largest and most complete and dependable Wireless Catalog published. Mailed for 12c. in stamps or coin which may be deducted on first order of one dollar. Catalog not sent otherwise. This catalog costs us twice the price of other catalogs.

Everything in wireless worth while is listed in this catalog. The experienced amateur will tell you to see our catalogue before buying. You are thereby insured against an unwise purchase. It is the Beacon Light to guide you right in the selection of your wireless apparatus. No bigger on better values are obtainable elsewhere. Send for revised price list. It is yours for the asking.

THE WILLIAM B. DUCK CO. 243-245 Superior St., Toledo, Ohio

ATTENTION! Iowa and Central States Amateurs

You will get most prompt service by purchasing your apparatus from a dealer in your territory. I handle all leading makes. Immediate deliveries on AudioTrons and B Batteries. Send for new bulletin of VACUUM TUBE EQUIPMENT.

Arthur B. Church, Wireless Specialist
LAMONI, IOWA.

"Distributor of high grade radio equipment since 1914"

MR. AMATEUR

HIGH FREQUENCY CABLE—(LITZ).
16-3-38 and 16-2-38 D. S. C. Enameled
GREY SEAMLESS CARDBOARD TUBES
Bakelite and rubber panels. Radio Call 1FJ.
Write for circular on Honeycomb Coil Mounting
—it will interest you. Wholesale and retail.

A. T. HOVEY

61 Belvidere Street, Near Mechanics Bldg.,
BOSTON, MASS. (Open Evenings)

CONTRARY to RUMORS

Spread by a Competitor

The Radio Distributing Co. is still manufacturing their unmounted universal wound inductances and will continue to supply their agents these very efficient coils. That the RADISCO COILS are superior to any similar type of inductances is the opinion of several well-known radio men who have received signals from very remote stations.

The RADIO DISTRIBUTING COMPANY will assure all purchasers that they will experience no inconvenience by reason of any action now pending or to be started by reason of patent on coils purchased. These coils are in stock at all RADISCO AGENTS.

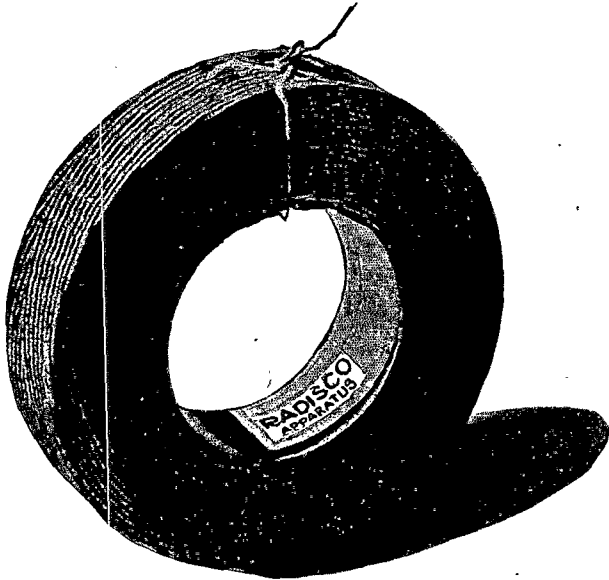

RADISCO AGENTS carry only apparatus of proven merit. Look for the RADISCO trade mark on all coils you buy and be sure of getting efficient apparatus. Below are listed a few of the reliable firms who carry the Universal Wound Inductances and are our Agents for all standard radio apparatus of merit including OUR now famous BETTER "B" BATTERY.

Communicate your wants to them

ALBANY, N. Y.

E. L. Long,
21 Magnolia Terrace

ATLANTIC CITY, N. J.

Independent Radio Supply Co.,
118 So. N. J. Ave.

BIENVILLE, QUEBEC, CANADA,

Canadian Radio Mfg. Co.

BOSTON, MASS.

Atlantic Radio Co.,
34 Batterymarch St.

BROOKLYN, N. Y.

Kelley & Phillips Electric Co.,
312 Flatbush Ave.

BRONX, NEW YORK CITY,

Amateur Wireless Equipment Co.,
1390 Prospect Ave.

CHICAGO, ILL.

Chicago Radio Laboratories,
1316 Carmen Ave.

HAMPTON, N. H.

De Lancey Felch & Co.

LOS ANGELES, CALF.,

The Wireless Shop,
511 W. Washington St.

McKEESPORT, PA.

K & L Electric Co.
427 Olive St.

NEW CASTLE, PA.

Pennsylvania Wireless Mfg. Co.,
507 Florence Ave.

NEWARK, N. J.

A. H. Corwin & Co.
4 West Park St.

NEW ORLEANS, LA.

L. A. Rose,
4323 Magnolia St.

PITTSBURGH, PA.

Radio Electric Co.,
4614 Henry St.

PHILADELPHIA, PA.,

Phila. School of Wireless Tel.
Broad & Cherry Sts.

PROVIDENCE, R. I.

Rhode Island Elec. Equip. Co.,
45 Washington St.

SPRINGFIELD, MASS.,

Electric Service Co.,
585 Amory St.

SCRANTON, PA.

Shotton Radio Mfg. Co.
P. O. Box 3,
also at 8 Kingsbury St.,
Jamestown, N. Y.

TORONTO, ONTARIO, CANADA,

The Vimy Supply Co.,
585 College St.

WASHINGTON, D. C.

National Radio Supply Co.,
1405 U St., N. W.

If none of the above agencies are in your vicinity, communicate with

RADIO DISTRIBUTING COMPANY,

Newark, N. J.

Hear 'em All Over The Room !

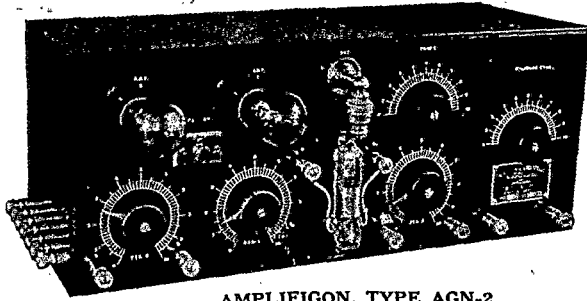

AMPLIFIGON, TYPE AGN-2

The Chicago Radio Laboratory Amplifigon, shown above, brings in ordinarily faint signals so loud that they can be heard "all over the room". Used at many prominent long distance stations. Made primarily for use with the Paragon regenerative receiver, but can be used equally well with ANY tuner or set of tuning devices.

Type AGN-2, as above, comprises detector and EFFICIENT two step amplifier both steps of which actually AMPLIFY, using our famous three-winding amplifier coils. Special circuit employed by which but one "A" and one "B" battery are used for all tubes, without impairing signal strength. One step of amplification with our coils is equal to two with the ordinary type.

Type AGN-1, detector and one step amp., . . . \$60.00

Type AGN-2, detector and two step amp., . . . 90.00

We can also supply Vacuum Tubes.

Our apparatus licensed under DeForest patents Nos. 841,387 and 879,532.

Our new Bulletin J-20 out soon. Watch for it!

CHICAGO RADIO LABORATORY, 1316 Carmen Avenue, Chicago, Ill., U. S. A.

BURGESS "B" BATTERIES

THREE
SIZES

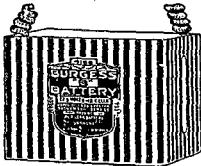

15 CELLS
22½ VOLTS

BURGESS "B" BATTERIES proved so successful in Government apparatus that they are being used by the progressive amateurs.

They are now available for general use. For further information write to

BURGESS BATTERY COMPANY
Harris Trust Bldg. Chicago

NOTICE

Effective Dec. 1, 1919 the AudioTron Vacuum Tube is manufactured and sold as a genuine audion licensed under DeForest Patents Nos. 841387 and 879532 to be used in radio communication only for experimental and amateur purposes and only in audio frequency circuits. All tubes, advertisements and literature must carry this notice or words conveying the same meaning.

Can We Send You One C. O. D.?

Marconi grid leaks, not mounted, postpaid, each, \$0.60

Special high grade storage battery, 6v. 60AH. guaranteed, \$15.00.

Remler panels and parts in stock.

Circulars sent on request.

Jensen Electric Co.

1949 Huron Street

CHICAGO, ILL.

Is Your Transmitter Really Tuned ?

You may think it is but you don't know unless your station is equipped with a reliable Antenna Ammeter.

These Roller-Smith Hot-Wire Ammeters were made for the U. S. Army Air Service for use on fighting planes.

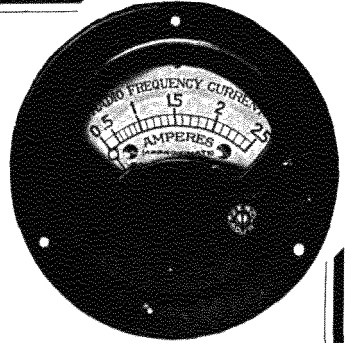

Regularly \$13 Our Special Price \$7

With the Armistice came a cancellation of contracts and these Ammeters, which had successfully passed the exacting Government tests, were returned to the manufacturers. Each is in perfect condition, packed in its original carton and ready for immediate shipment.

The scale reading is: 0-2.5 Amperes. Shunt giving double or triple this range, 75c extra.

By buying the entire surplus we are able to sell these Ammeters at less than the Government paid for them, in lots of one thousand. Better order one today as this may be your last opportunity. Remit by check or money order.

A. H. GREBE & CO., Inc., 74 Van Wyck Blvd., Richmond Hill, N. Y.

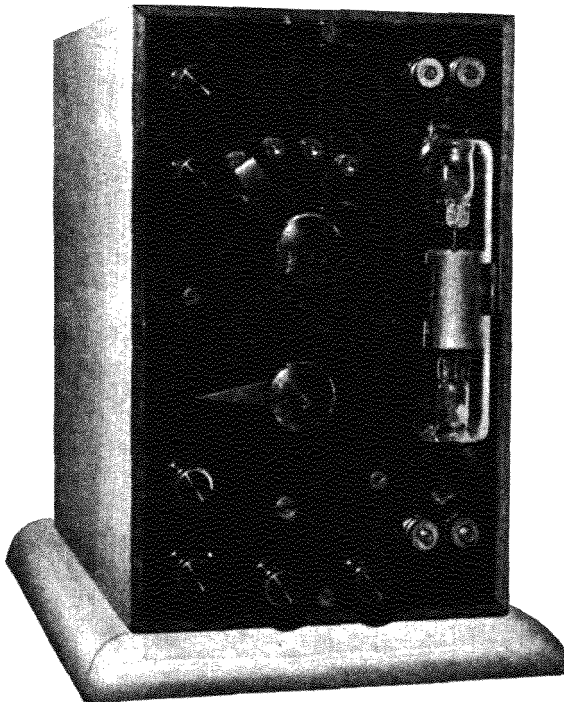

Double
"A"
Quality

ILLUSTRATION
Scale 3" to 1'

**Audion
Control
Panel
No. 4**

Specifications
on Request.

**Radio
Equipment Co.
1525 N. Fawn St.,
Philadelphia**

You Fellows Outfitting Your Long Distance Stations —

Do you know that Baldwin Mica Diaphragm Telephones are many times as sensitive to weak signals as the ordinary 2000-ohm 'phones with iron diaphragms?

And that if you want to get the utmost range from your station you absolutely cannot get along without Baldwins?

Ask any long distance relay man!

The ordinary telephones fail to meet the exacting requirements of long distance radio reception in many ways; Baldwins have been designed to fill this need. In the ordinary form of receiver, the armature or diaphragm is at all times under strain due to the constant pull by the permanent magnet. In our type the armature is under no magnetic strain whatever, until a current flows through the windings—a feature unique in telephone construction. By the employment of a mica diaphragm and a separate light iron armature of small dimensions, the sensitivity is increased enormously—a most important factor in the efficient reception of weak signals.

Four models—types C, D, E, and F—four prices. Write for our interesting literature, and arrange to get your orders in now, for prices will advance January 1st on account of higher costs of material and manufacturing.

SOLE DISTRIBUTORS

JOHN FIRTH & CO.
81 NEW STREET NEW YORK



The Biggest, Busiest and Best Radio Supply Store in New England

Our expert advice is yours for the asking.

We can give you prompt and courteous attention.

Our stock is complete from the "Tower to the Key".

A. P. MERCHANT CO. 9 Avery Street, Boston

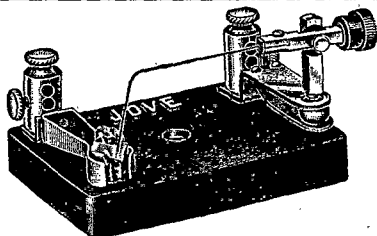

(Ghegan Patent)

Bunnell Keys, Transformers, Condensers, Spark-Gaps, Receivers, etc. are High Grade but Inexpensive.

Send Stamp for New Edition, 40 Q Catalog.

J. H. BUNNELL & CO.

BUNNELL *Instruments*
Always Reliable

THE JOVE DETECTOR
HANDIEST, HANDSOMEST AND BEST

Sample by Mail, \$1.44

Tested Galena Crystal 25c.

32 Park Place, New York

RADIO APPARATUS

Distributors Of All Prominent Makes
Largest and Best Stock of Any House in New England

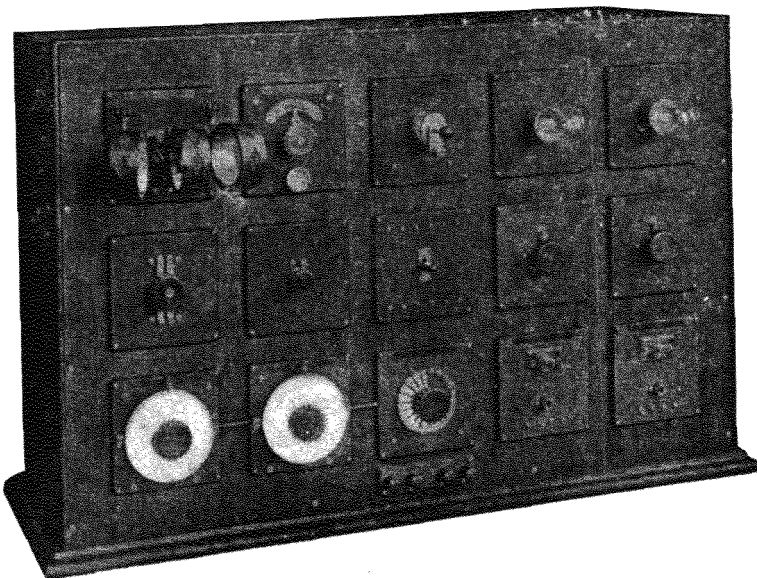

A 15 panel cabinet type typical "de Forest Receiving Set," consisting of a tuner with wave length range of 150 to 25,000 meters, a crystal and audion detector, and a one step amplifier. The most efficient complete receiving apparatus ever put out under \$150.00.

Cat. No.	ULC-100 Inductance coil mounting on Unit Panel.....	\$10.00
" "	U-100 Grid condenser and leak on Unit Panel.....	7.50
" "	UD-100 Detector complete with crystal on Unit Panel.....	4.00
" "	UR-100 Audion tube receptacle on Unit Panel.....	2.95
" "	US-100 Primary condenser or variometer switch on Unit Panel.....	2.40
" "	US-400 Tickler, audion-ultraudion three point switch on Unit Panel.....	2.20
" "	US-200 Master anti-capacity switch on Unit Panel.....	4.00
" "	UF-200 Filament battery rheostat on Unit Panel.....	3.80
" "	UCV-1003 .001 MFD. Variable condenser with vernier on Unit Panel.....	15.50
" "	UCV-1500 Loading or bridging condenser on Unit Panel.....	5.75
" "	U-200 "A" battery switch and telephone jack on Unit Panel.....	2.95
" "	ULC-200 Single inductance coil mounting on Unit Panel.....	1.90
" "	ULC-300 Double inductance coil mounting on Unit Panel.....	4.30
" "	ULC-400 Triple inductance coil mounting on Unit Panel.....	5.30
" "	UCV-500 Variable air condenser .0005 MF. on Unit Panel.....	6.75
" "	UCV-1500 .0015 MF. Variable condenser without vernier on Unit Panel.....	14.90
" "	UCV-1503 .0015 MF. Variable condenser with vernier on Unit Panel.....	16.75
" "	UCV-1000 .001 MF. Variable condenser without vernier on Unit Panel.....	13.60
" "	U-300 "A" battery switch and telephone posts, on Unit Panel.....	2.00
" "	US-500 "B" battery switch on Unit Panel.....	3.00

Any or all of these unit panel items postpaid to any part of the U. S. or Canada.

REMEMBER:—All this material is carried right in stock and orders filled the same day. GIVE US A TRIAL.

EXCLUSIVE DISTRIBUTORS IN NEW ENGLAND FOR A. H. GREBE & CO.

Some good territory open to live dealers. Write for proposition.

Send 6 cents in stamps for NEW CATALOG JUST OUT! EVERY AMATEUR should have it.

F. D. PITTS CO., INC.
12 PARK SQUARE, Dept. A, BOSTON, MASS.

“SHRAMCO”

MAKE YOUR SET UP-TO-DATE AND EFFICIENT. OUR PARTS AND INSTRUMENTS ARE STANDARD. NEW CATALOG H CONTAINS COMPLETE LINE, INCLUDING MATERIAL LISTED BELOW, NECESSARY FOR A MODERN WIRELESS STATION.

**4 Styles Switch Points,
Brass and Nickel
15 Types Composition Knobs
Panel Binding Posts and Switches
Copper Terminals
Dial Indicators
Plain and Threaded Brass Rod**

**Plugs and Jacks
KD Variable Condensers
“B” Batteries
“Radisco” Coils
Switches
Meters
VT Tubes and Sockets**

Send 5c in stamps today for your copy and we will place your name on mailing list for future bulletins without charge.

SHOTTON RADIO MFG. CO., P.O. Box 3, Scranton, Pa.

BRANCH: 8 Kingsbury St., JAMESTOWN, N. Y.

LOUD SPEAKING HORN

\$10.00



SPECIAL THIS MONTH ONLY.

A big bargain for QST readers. Horn is of copper, black lacquer. This is our standard horn which is used with all our amplifiers.

The special price of \$10.00 guaranteed until February 29th when price advances to \$12.50.

Order NOW.

Modern Radio Equipment Co.
27 South Broad Street
ELIZABETH, N. J.

3 Inch Dial Indicator

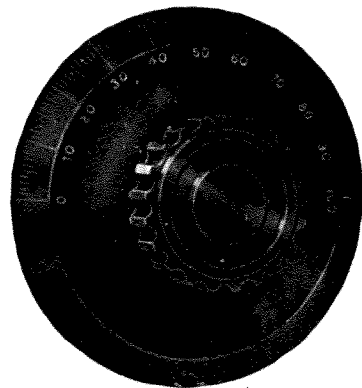

FINE BLACK COMPOSITION DIAL

No. 66 without Knob **\$0.75 postpaid**

No. 67 with Bakelite Knob **\$1.30 postpaid**

FOR SALE AT ALL RADISCO AGENCIES
AND BY

A. H. CORWIN & CO.
4 West Park Street, Newark, N. J.

The Latest Audion Control Cabinet

Here is a compact and highly efficient unit that may be used with any and all receiving circuits.

The



**Audion Control Cabinet
Type RORH**

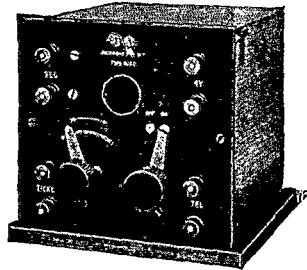

Price,
\$17.00
Without Tube

contains the grid condenser, grid leak, filament rheostat and two 20-volt dry batteries. Socket accommodates the standard 4-prong tube. There are binding posts for secondary, tickler, phones and filament battery.

Direct and simple connections may be made to all types of receivers.

Free bulletin R-117 describes this unit. Complete catalogue 10 cents.

A. H. GREBE & CO., Inc., 74 Van Wyck Blvd., Richmond Hill, N. Y.

BAKELITE-DILECTO

the Standard Insulating Material on all Radio Work

Water-proof, permanent, strong, used by all important Manufacturers of Wireless Apparatus and others requiring the utmost in Insulation. Furnished in Sheets, Rods and Tubes.

THE CONTINENTAL FIBRE CO.

233 Broadway
New York City

525 Market St.
San Francisco, Cal.

119 Fairview Ave., West Toronto, Ont., Canada.

NEWARK, DELAWARE

332 So. Michigan Ave.
Chicago, Ill.

411 S. Main St.
Los Angeles, Cal.

316 Fourth Ave., Pittsburgh, Pa.

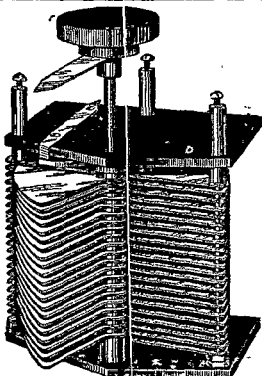

A. R. R. L. OPERATORS—THE VARIABLE CONDENSER
you have been looking for—at a price you can afford to pay. The best of materials and workmanship—and look at the prices. Bakelite-Dilecto End Plates—heavy aluminum plates—accurately machined spacers—assembled with care and fully guaranteed. Copper ribbon connection to movable plates which are adjusted to stay in position—but operates smoothly in any position without counterweight.

Complete as shown—PRICES.—include postage for one pound.

No. 2—2	Plate Vernier	\$1.85
No. 7—7	Plate .0001 m.f. maximum capacity	2.15
No. 13—13	Plate .0002 m.f.	“ “	2.50
No. 17—17	Plate .0003 m.f.	“ “	2.85
No. 23—23	Plate .0005 m.f.	“ “	3.25
No. 31—31	Plate .0007 m.f.	“ “	3.90
No. 43—43	Plate .0010 m.f.	“ “	4.75
No. 63—63	Plate .0015 m.f.	“ “	6.75

Specify Thickness of Panel and whether Brass or Nickle Screws and Pointer.

THE WIRELESS SHOP

A. J. EDGCOMB.

No. 43—.001 m.f. \$4.75.

511 West Washington St.,

Los Angeles, California.

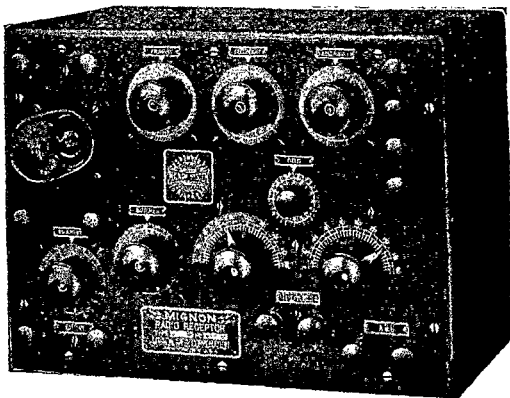

RW 4"—SIZE 12" x 9" x 6½"

Mignon "RW4" Undamped Wave Receptors

NO LOOSE COUPLERS
LOADING COILS
VARIOMETERS
AMPLIFIERS

Strongest, most distinct signals

— IMPORTANT NOTICE —

Ernest C. Mignon, Inventor of the famous disc-core Undamped Wave Receptor, is no longer connected with the Mignon Wireless Corporation of Elmira, N. Y. or their successors, The Universal Radio Manufacturing Corporation.

Address all communications for Mignon Apparatus to
MIGNON MFG. CORP., NEWARK, N. J.

Damped and undamped wave apparatus for all purposes
Endorsed by Radio Dept. of D. L. & W. Ry. Co.

WRITE FOR LITERATURE

MIGNON MANUFACTURING CORPORATION, Newark, N. J.

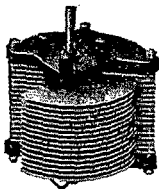
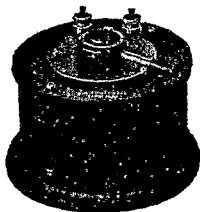

Variable Air Condenser TYPE 182

A high grade condenser with plates designed to give approximately even variation of wavelength throughout the scale.

Made in two sizes: .0007 M. F. at \$10.00 and .001 M.F. at \$13.00.

Full data on request.

General Radio Co.
WINDSOR STREET
CAMBRIDGE MASS.

"ASK ANYONE WHO HAS USED IT"

WHAT OUR PATRONS SAY

"Out of six different makes of receivers I find yours are the best. They do all and more than you claim for them." (Name on Request)

BRANDES WIRELESS HEADSET



'Superior' 2000 ohms \$7

TRIAL OFFER Test out Brandes Wireless Receivers against any other make. Test them for sensitiveness clearness and distance. If within ten days you're not only satisfied but enthusiastic over them — back comes your money without a question.

Prove for yourself the fine quality, the "matched tone." The two diaphragms, toned exactly alike, strengthen the signals and prevent blurring. Used by many U. S. Gov't experts, and experts abroad; by colleges and technical schools; and by professionals and amateurs everywhere.

SEND 4c. FOR CATALOGUE F

C. BRANDES, Inc.

Room 821, 32 Union Square, New York
WIRELESS RECEIVER SPECIALISTS

The Easiest Way to Get a Radio Receiving Set

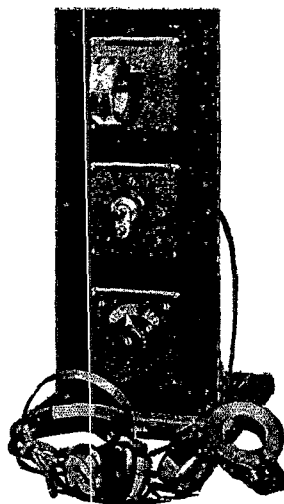

DeForest Simplified Radio Receiving Station.

If you are a Radio beginner, or even an experienced Amateur, here is the simplest, easiest and least expensive method of securing accurate, efficient and scientific receiving apparatus of the usual deForest high quality, on the most economical basis.

We have just completed two new Unit-System Receiving Sets specially designed and assembled to give beginners and others complete outfits of the most advanced type. Both these Sets are designed as part of the deForest Unit-System and arranged so additions may be made at any time without discarding apparatus previously purchased.

De Forest Simplified Radio Receiving Station

A three-panel Set complete in every respect and including short, medium and long wave-length deForest "Honey-Comb" Inductance Coils, Detector, Condenser, Head Telephones, Antennae wire, insulators, etc.,—everything needed to set up and operate an efficient receiving Station, including the back board and base. Complete instructions also included. This complete outfit is especially adopted for the beginner who wants to start right and add to his equipment as he progresses.

De Forest Audion-Unit Radio Receiving Station

A larger and more efficient Set with Audion Detector, and larger assortment of "Honey-Comb" Coils giving greater receptive facilities; six panels in all, with six-panel back board and all other necessary apparatus complete, including "B" battery. Also arranged for expansion when the owner desires to add to his apparatus. Send for our new book—

"How to Set up an Amateur Radio Receiving Station"

which tells all about these new Sets. Book sent to any address for 10c in stamps.

De Forest Radio Tel. & Tel. Co.

*Inventors and Manufacturers of
High Grade Radio Apparatus*

1407 Sedgwick Avenue New York City

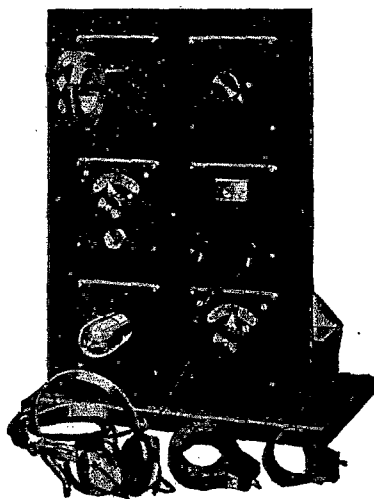

DeForest Audion-Unit Radio Receiving Station.

DeForest Apparatus is sold by Leading Electrical Dealers Everywhere. Ask for it at your store.

CLASSIFIED ADVERTISEMENTS

Five cents per word per insertion, in advance. Copy must be received by the 10th of month for succeeding month's issue.

WANTED—Bound volume one, QST, must be in good condition. G. L. Hight, Rome, Ga.

FOR SALE—Arnold Navy Coupler, Murdock 7 plate Variable 1/4 KW. Moulded condenser, stationary gap, oscillation transformer, .5 hot wire ammeter, Marconi-Victor phonograph code teacher. All apparatus in perfect condition. E. H. Hartnell, Salem, Wis.

FOR SALE: Vibroplex key \$7.50, fine condition; 1,200 meter Navy coupler \$6.00; Brandes 1,000 ohm receiver and head band, \$2.25 Tigerman bulb \$4.00. K. Ross, 60 Warwick Ave., Rochester, N. Y.

RADIO APPARATUS AND SUPPLIES. Send 6c for lists. J. J. Young, 717 W. Gray St., Elmira, N. Y.

FOR SALE: Pathoscope moving picture machine in good condition. Write Science Club, Bellevue High School, Bellevue, Pa.

FOR SALE:—Good condition. Receiving and transmitting units. W. J. Brigham, 50 Hall Ave., West Somerville, Mass. Phone Somerville 2581-J.

AMATEURS: Add refinement to your home-made apparatus. Gold lacquer for brass parts, 50 cents a bottle; also white cement for engraved panels, 30 cents a box. Radio Equipment Co., 1525 N. Fawn St., Philadelphia.

THE AUDION. Its early history and development, Electron Theory and Trigger Action, compiled by a Chief Electrician Radio who was stationed at the Naval Radio School as Instructor for two years, written by an old amateur for the amateurs in words that they can understand. Also blue print diagrams for hook ups for receiving damped signals, using both air exhausted and gas bulbs. Receiving undamped signals and regenerative circuits. Two-step amplifier, using same (A) and (B) batteries for both steps. Wireless telephony with power bulb. Working blue prints on how to build a "One to One" transformer for use with Audion Amplifier. All for \$2.00. Address T. O. McKenzie, 104 Warburton Ave., Yonkers, N. Y.

FOR SALE: 1 K.W. 60 cycle transmitter. Same includes 1 K.W. Marconi transformer. Harry S. Weber, 1113 Walnut St., Dover, Ohio.

STANDARD AERIAL WIRE: One cent per foot. Audiotrons, new, two filament, \$5.50 licensed. Bargains in used apparatus. Let me know what you need. Send stamp for answer. Lee A. Bates, No. 8 Moen St., Worcester, Mass.

FOR SALE:—One K.W. sixty cycle generator with 1/4 K.W. exciter, condenser and Thordarson transformer for same. Perfect condition. Ross Gunn, Oberlin, Ohio.

ANTENNAS BUILT AND ERECTED. Masts put up. All kinds of Antenna construction work done. Will go anywhere in New England. J. Limone, 53 Granville Ave., Medford, Mass.

BARGAINS: Transmitting and receiving apparatus or exchange. Write Bartsch, Marlboro, N. Y.

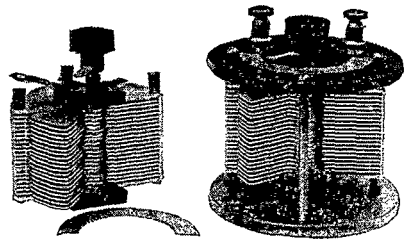

THE "ILLINOIS" VARIABLE CONDENSER

Hard Rolled Aluminum Plates
Three Styles, No. 1. Panel, No. 2. Open Type as shown, No. 3. Fully Encased, Anti Proffeer. Less than pre-war prices. Fully assembled and tested.

Sent Prepaid on Receipt of Price.

Style No. 1	No. 2	No. 3	Money back if not satisfied. Just return condenser within 10 days by insured P. P.
48 Plates, \$8.00	\$3.50	\$3.75	
28 " "	2.50	3.00	
13 " "	2.25	2.75	3.00

These condensers are made by a watch mechanic schooled in accurate workmanship. Personally we will need no introduction to Amateurs who have "listened in" for "time" and "weather" from 9ZS.

G. F. Johnson, 623 Black Ave., Springfield, Ill.

AUDION CONTROLS

- No. 84 B. P. Filament Control
- No. 83 Switch; switch, 3 contacts, 2 end stops, \$0.65
- No. 82 B. P. Battery Control Switch; switch, 6 contacts, 2 end stops 1.00
- No. 81 Filament Rheostat 1.75
- No. 82 Switch, 1 1/2 in. radius 0.60
- No. 83 Switch, 1 in. radius 0.45
- No. 91 Switch, 1 1/2 in. radius 1.25

F. C. MYERS

P. O. Box 906, Albany, N. Y.

AUDIO frequency amplifying transformers, \$4.00 P.P. One transformer with one Western VT-1 gives an energy amplification of 450 times. Adams & Hilliard, 5410 Fulton St., Chicago, Ill.

PAPER TUBES

For constructing loose couplers, loading coils, variometers, etc., smooth, round, gray, seamless, tubes.

- FOR 3500 METER COUPLER**
- Primary 3 3/4" outside dia. 7" long—25c
 - Secondary 3 3/4" outside dia. 6" long—20c
- FOR VARIOMETERS**
- Primary 4 3/4" outside dia. 2 1/2" long—12c
 - Secondary 3 3/4" outside dia. 2" long—10c
- FOR LOADING COILS**
- 3 3/4" Outside Dia. 14" long—40c
 - 4 3/4" Outside Dia. 14" long—50c
- Special Lengths Cut to Order
To 15" long 3 3/4" dia.—4c per in.
3 3/4" dia.—5c per in.; 4 3/4" dia.—6c per in.
All tubes have 3/8" wall.

IMMEDIATE SHIPMENTS, POSTPAID.

THE TAYLOR COMPANY, BOX 1043C, LOWELL, MASS.

Laboratory Signs

Attractive 8" x 10" signs printed on high quality coated white cardboard in selected wordings for the electrical experimenter.

1. DANGER! HIGH VOLTAGE
 2. EXPERIMENTAL RADIO LABORATORY
NO ADMITTANCE
 3. GOVERNMENT LICENSED RADIO
STATION
 4. DO NOT TOUCH THE INSTRUMENTS
 5. PLEASE BE QUIET WHILE THE
OPERATOR IS RECEIVING
- 15c EACH, ANY TWO FOR 25c
ALL 5 FOR 50c

Audiotron Adapter



Patent Applied For.
Price \$1.75
Post Paid.

Stop-Look-Listen !

The TeCo Specialists enter the wireless field with products not known to the Amateurs.

Our aim is to make more flexible the present apparatus.

The cuts here show how they can be applied.

Let us supply your wireless wants at a moderate price.

Dealers write us for proposition.

Honey Comb Coil Adapter

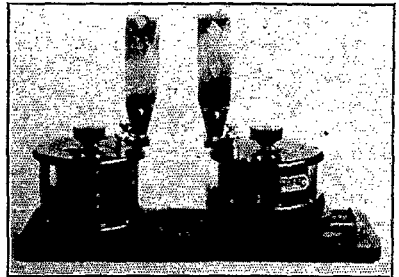

Are You Listening to Norway?

200 to 20,000 Meters
Post Paid.
Price \$1.50 per pair.

The TeCo Radio Co.,

P. O. Box No. 3362,

Boston, Mass.

Albany and Capitol District Amateurs

Troy, Schenectady, Hudson, Johnstown

Buy your apparatus of

E. L. LONG,

Agent for all Reliable Radio Apparatus,
21 MAGNOLIA TERRACE, ALBANY, N. Y.

New PARAGON 6 Ohm Reversible Rheostat—the latest word in fine filament control. The turns can't touch. \$1.75 each; postpaid \$1.80.

Please take notice: Owing to the Printers Strike and other unforeseen circumstances my catalogue has been delayed. All those who have sent in inquiries will receive my catalogue about the time this is published or soon thereafter.

ARNOLD

Loose Couplers
Control Panels
Accessories and
Hard Rubber

Send 4c. stamp for literature which is sure to interest you.

J. F. ARNOLD,
2082 Lexington Ave., N. Y.
Established 1910.

Our New Catalog

OF
COMPLETE
RECEIVING APPARATUS

IS NOW READY

Send Today for Your Copy

AudioTron Sales Co.

Lick Building
SAN FRANCISCO, CAL.

PERFECTION TUNERS AND CONDENSERS

EASTERN REPRESENTATIVES

GOUSE & LORENSON

Radio Apparatus and Supplies

519 CLINTON ST., HUDSON, N. Y.
Send Stamp for Bulletin.

FREE We are giving away hundreds of expensive wireless instruments, electrical apparatus, supplies, etc., for selling a household article that goes like wildfire because it is a genuine necessity and because it sells so cheap. All of our premiums are guaranteed new and perfect. We give you no junk. Send us your name and address and we will send you twelve articles prepaid, complete information, and premium catalogue.

LEONARD BECK NOVELTY HOUSE
1298 Carroll St., Brooklyn, N. Y.

ALWAYS MENTION Q S T WHEN WRITING TO ADVERTISERS

NEXT MONTH

WATCH FOR OUR ANNOUNCEMENT
SOMETHING NEW IN RADIO SUPPLIES
WE HAVE SOME CIRCULARS ON THE PRESS
THEY ARE YOURS FOR THE ASKING
WORCESTER RADIO LABORATORIES
16 WAYNE ST., WORCESTER, MASS.

Two Stage Amplifier Type O. Z.



Every feature of modern engineering design has been gathered together to make this two stage amplifier remarkably efficient and capable of producing extraordinary increase in strength of signals.

The instrument is complete on one panel of Bakelite, measuring 7 inches by 7 inches and is fitted with all controls, including filament rheostats, tube sockets, amplifying transformers, etc.

A switch is provided to give one or two stage amplification, as desired. A post is provided for connecting in a negative "C" battery if desired, in addition to normal voltage drop across filament.

The type "O. Z." amplifier will please, both as regards degree of amplification and as to freedom from "squeals" and other extraneous sounds.

Cat. Z7393 O. Z. two amplifier complete, as illustrated, but without bulbs or batteries.....\$50.00

Bulletins Y and Z, sent for 4c stamps show our complete Line of High Grade Moderately priced apparatus for the Modern Radio Laboratory. Our apparatus carried in stock by most Good dealers.

CLAPP-EASTHAM COMPANY

141 MAIN STREET

CAMBRIDGE, MASS.

The "BENWOOD" Silent Rotary Quenched Spark Gap

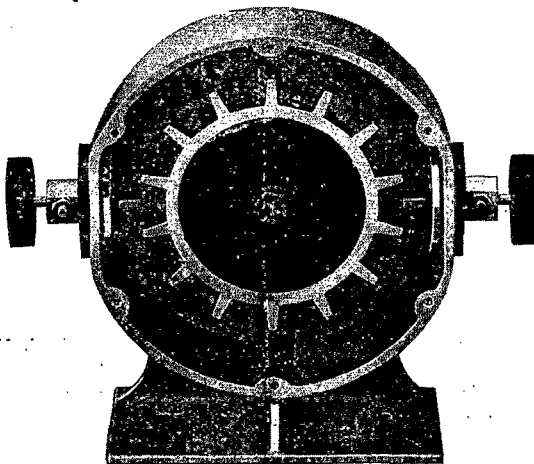

BENWOOD GAP-OPEN
PRICE \$27.50

Accorded a reception by the Amateur Field that surpassed our highest expectations.

Polished ALUMINUM housing.
Balanced aluminum disc $\frac{3}{4}$ " x 6".

Absolutely air-tight. Practically noiseless. Pulley-driven—or direct coupled. Dimensions 10" x 11" x 5".

Supplied with 10 or 14
Point Disc.

Discs Separate - \$7.50

BENWOOD SPECIALTY CO., 3424 Olive St., St. Louis, Mo.

VACUUM TUBES REPAIRED

We repair the filaments and other elements in all types of vacuum tubes and guarantee them to operate equally as well as a new tube. In most cases they operate better. We produce wonderful oscillators, detectors and amplifiers.

**MARCONI VT
DE FOREST VT
MOORHEAD TUBES
WESTERN ELECTRIC
REPAIRED AT FOUR DOLLARS AND FIFTY CENTS EACH.
ELECTRON RELAYS
OSCILLAUDIONS
AND ALL OTHER TUBULAR TYPES
REPAIRED AT FOUR DOLLARS EACH.**

All foreign made receiving tubes repaired at SIX FIFTY and power tubes depending upon size.

**WE HAVE PURCHASED A LARGE QUANTITY OF BURNED OUT
MARCONI VTs AND ELECTRON RELAYS WHICH
WE OFFER FOR SALE AT FIVE DOLLARS.**

**REMEMBER THESE TUBES ARE GUARANTEED GOOD AS NEW.
DEALERS WRITE US**

THE VACUUM TUBE REPAIR COMPANY

511 Perry Building

OAKLAND, CALIFORNIA.

STUDY WIRELESS

The Marconi Wireless Telegraph Co. is the largest and strongest wireless company in America. Recently they have pooled their interests with the General Electric Co., controlling their radio rights. The new company is known as the Radio Corporation of America. This corporation has under way the establishment of a chain of high powered land station interconnecting all countries of the globe. This project has opened up greater opportunities for the radio operator on land. Since the ship operator is the starting position in the radio profession, these men will be selected from ships controlled by the Marconi Co. (R. C. of A.) Why not get in on the ground floor by enrolling at this school? We can place all our graduates with the Marconi Co. Our Radio Department is under the direct supervision of a former U. S. Government Department of Commerce Radio Inspector. We have the latest Marconi 500 cycle ship apparatus in operation at the school. Ships are sailing today without operators, who are paid \$125 per month besides being fed and lodged with the ships officers. We invite your inspection of our school. Write for literature. We also teach Telegraphy. **POSITIONS GUARANTEED. ENTER ANY MONDAY.** Men holding first grade commercial licenses are invited to enroll in our employment bureau, regardless of where they obtained instruction.

MASSACHUSETTS RADIO & TELEGRAPH SCHOOL.

18 Boylston Street, Boston.
(Lt. R. F. TROP

ARTHUR BATCHELLER

Telephone Beach 7168.
G. R. ENTWISTLE

LEARN WIRELESS TELEGRAPHY

Fascinating and Educational Work—Big Salaries—Prepare Now

The United States Shipping Board is making heavy demands upon us for **Dodge-trained** wireless operators. Travel all over the world, secure, free, unsurpassed living accommodations and earn a big salary.

We Also Teach Morse (Wire) Telegraphy and Railway Accounting

School established 45 years. Endorsed by wireless, railway and telegraph officials. Low rates. Students can earn living expenses while attending school. **Catalog Free. Write Today.**

Dodge's Telegraph and Wireless Institute

27th St.

Valparaiso, Indiana

NEW ORLEANS
WIRELESS SUPPLIES AND
MINERALS OF ALL DESCRIPTIONS
L. A. ROSE
4323 MAGNOLIA STREET
NEW ORLEANS, LA.
SEND 6 CENTS FOR CATALOG

**RADIO
TRAFFIC
ASSOCIATION**
BROOKLYN, N. Y.

The Klitzen Rotary Gap

offers the most efficient Gap for the progressive amateur. Only 2" of current travel means a saving of about 15 meters in the wave-length of the closed circuit. Perfect cooling means low decrement.

Price \$22.00

Send stamp for catalogue "C" now ready for distribution.

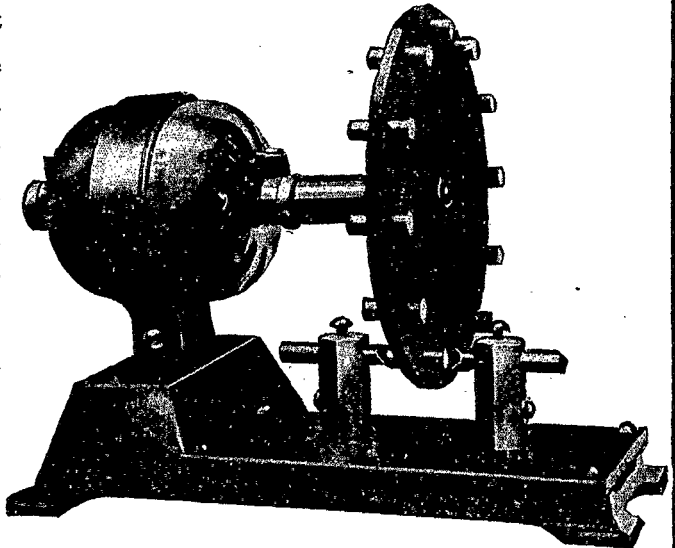

KLITZEN RADIO M'F'G CO., 1501 Flett Ave., Racine, Wis.

A Wireless Message from Detroit

Licensed Radio Operators are in constant demand by the Commercial Land Radio Service, Telegraph Companies, Merchant Marine, Lake and Ocean Steamship Lines, etc.,

Minimum Salary of \$125 per Month, Plus Board and Room

is now being paid. Many operators are receiving much more than that.

Our course in Radio Telegraphy, under the direction of S. W. Edwards, U. S. Radio Inspector, offers the highest class instruction available. New, complete equipment. Day or evening classes. Opportunity to earn expenses while here.

Our day class prepares for First-Class Radio Operator's examination in three months, night class in 18 weeks.

Before deciding where to get your Radio training, write for our Free Illustrated Booklet.

Detroit
Institute of Technology
 303 Y.M.C.A. Bldg., Detroit

"Cosradio"

Mark of Quality

New Catalog Coming
 You will want one

Our Short Wave Regenerative Receiver
 Gets Them
 200 to 3000 Meters

Cosradio Amplifiers
 Make them Strong

Distributors of all high grade apparatus.

THE COSRADIO CO.

(Formerly Watkins Mfg. Co.)

WICHITA,

KANSAS

The High Water Mark of Efficiency

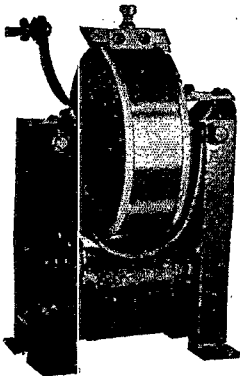

¼ K. W. Special.

A distance of more than 200 miles has been covered when using our ¼ K. W. special wireless transformer. The transformer is a machine of efficiency with proper design

Power Factor 91%

OUR NEW CATALOG "T-21" READY FOR MAILING.

Thordarson Electric Manufacturing Co.

501 S. JEFFERSON STREET

CHICAGO, ILL.

STANDARD V. T. BATTERIES

the most dependable, satisfactory and reasonably priced cast en bloc "B" batteries on the market, will be distributed exclusively in the East by the

PACENT ELECTRIC CO., Inc. 150 Nassau Street, New York, N. Y.

Have you seen the new "VARIABLE STANDARD V.T. BATTERY?" Affords convenient and excellent single cell variation of the unit.

Descriptive literature sent upon request.

LIST NO.	SIZE	VOLTAGE	OPERATING LIFE	PRICE
7650 Variable	6½" x 4" x 3"	1½ to 22½	1200 hours	\$3.25
7625	6½" x 4" x 3"	22½	1200 "	2.40
7623	3¾" x 2" x 2½"	22½	230. "	1.35

RICHTER & BYRNE,

182 Lafayette Street, New York, N. Y.

The Newest Radio Supply House

In America But The Best

WRITE! WRITE! WRITE!

FOR OUR VALUES

CENTER OF SUPPLIES AND MATERIAL

A. G. PEOPLES & CO.

1446 E. 111th ST. CLEVELAND, OHIO

AERIAL WIRE

7 strands No. 22 pure copper. High tensile strength and 100% Radiation. Shipping weight 15 lbs. per 1000 feet. Postage extra. No C. O. D's. at this low price. Immediate delivery.

1 CENT PER FOOT
\$9.00 Per Thousand

GENUINE AUDIO TRONS

Now licensed under DeForest Pat. No. 841,387
Two filaments, Guaranteed Super-Sensitive
\$5.50 Postpaid

LEE A. BATES

8 Moen Street, Worcester, Mass.

Call 1GY—A.R.R.L. Supt., Central Mass.

THE NEW AUDIO FREQUENCY AMPLIFYING TRANSFORMER

To meet the demand for an amplifying transformer for tubes of higher impedance than the usual Marconi V. T. and for the experimenter who wishes to try various ratios of transformation, we offer the Type A-5 Laboratory Instrument. Both primary and secondary have three variations of the number of turns. The impedance between taps 1 and 2 on primary and 5 and 6 on the secondary is the same as our well known Type A-2 transformer. The maximum number of turns is between taps 1 to 4 on primary and 5 to 8 on secondary. For laboratory work, this instrument is ideal.

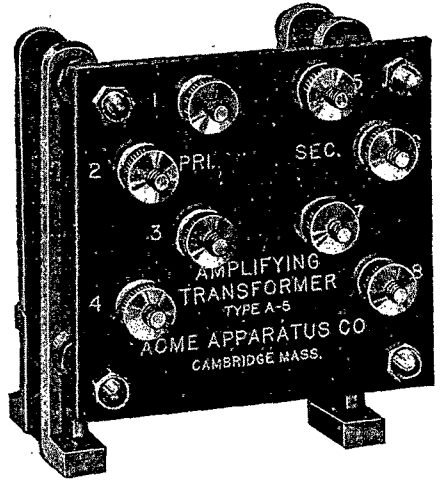

- Type A2 Amplifying Transformer completely mounted.....\$7.00
- Type A2 Amplifying Transformer without binding posts and panels... 5.00
- Type A2 Amplifying Transformer without binding posts, panel or castings..... 4.50
- Type A5 completely mounted.....11.00
- Type A5 without binding posts or panel..... 7.50
- Type A5 without binding posts, panels, or supports..... 7.00

Modulation Transformers for radio telephony work supplied at same prices as either type of amplifying transformers.

ACME APPARATUS CO., 26 Windsor St., CAMBRIDGE, MASS.



STROMBERG-CARLSON

Radio Head Set

A set that combines your ideal of extreme sensitiveness with a strong, durable construction that stands the gaff of continuous service ashore or aboard ship.

All operating parts housed in dust-proof and moisture-proof aluminum cases. The diaphragm is mounted metal-to-metal in such a way that temperature variation will not disturb the air-gap adjustments. Non-conducting spool heads and slotted pole tips eliminate 90 per cent of the eddy current losses that are found in other head sets.

Each set is wound to a resistance of 2,000 ohms with pure copper wire and furnished complete with 6-foot moisture-proof cord attached. Tested for matched diaphragm tuning and operating qualities in actual service before shipment.

Send \$12.00 for sample set for trial in your own station—satisfaction guaranteed or your money refunded upon return of set. Write for Bulletin 1106 giving full particulars.

Stromberg-Carlson Telephone Mfg. Co.

Rochester, N. Y. Chicago, Ill. Kansas City, Mo. Toronto Ont.

DID YOU KNOW THAT THE RADIO ENGINEERING CO. MANUFACTURERS OF



RADIO APPARATUS

Manufactures Short Wave RECEIVERS

AUDION CONTROL AND AMPLIFIER CABINETS

AT SUPRISINGLY LOW PRICES

Apparatus made to your own design and all parts furnished for variometers and short wave regenerative receivers.

Watch for your copy of our new Catalog, now on press, describing RECO products, parts and raw materials. Mailed on receipt of 6c in stamps.

ORDERS RECEIVED VIA RADIO

Call 3EM or relay thru 3AN

"The RECO Transformer, just produced, and immediate delivery: ¼ KW, \$14.00; ½ KW, \$20.00; 1 KW, \$30.00. Watch for next month's issue further describing these wonderful little transformers."

Burgess "B" Batteries and Genuine Licensed AUDIO-TRON VACUUM TUBES \$6.00

Shipped day order is received, postpaid

THE RADIO ENGINEERING CO.

827 Madison Avenue, BALTIMORE, MARYLAND

Federal Audio Frequency Transformers

AND

Radio Head Telephones

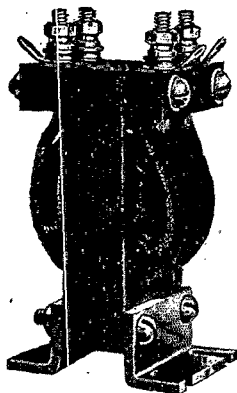

TYPE A
No. 226-W
\$7.10 EACH



LIBERTY A & N TYPE
No. 53-W 2200 ohms
\$12.50 PER SET

Radio Apparatus You will
Enjoy Having Because of
ITS

QUALITY and EFFICIENCY.

SEND 6c IN STAMPS FOR
BULLETIN No. 102 W.A.
IT CONTAINS VALUABLE
INFORMATION AND DATA.

"ONE 226-W Transformer with ONE Marconi V. T. gives an energy amplification of 400 times. (Audibility amplification of 20 times.)

TWO 226-W Transformers with TWO Marconi V. T's. give an energy amplification of 160,000 times. (Audibility amplification of 400 times.)"

Federal Telephone and Telegraph Co. Buffalo, N.Y.

MESCO RADIO BUZZER

With Shunt Resistance—U. S. Navy and U. S. Army Standard

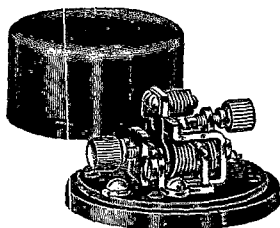

The Radio Officers of the NC Planes, after testing all other buzzers, decided to use the "Mesco" on their equipment. The R-34 was equipped with two Mesco Radio Buzzers.

Why? Because of its reliability and constancy in operation; greater output efficiency; ease of adjustment; unaffected by extreme variations in weather conditions; exposed wires eliminated.

Sparking is almost entirely eliminated, so that the energy lost in light and heat in the operation of other buzzers is here conserved and radiated in the form of oscillating energy.

This buzzer maintains a constant note and is recommended as an exciter for checking wave-meters where pure note and ample energy are required.

List No. 55

Mesco Radio Buzzer

Price \$2.05

We carry in stock at all times a complete line of radio apparatus made by the leading manufacturers, with competent wireless experts at stores to demonstrate their uses.

Q-10 Wireless



Manual Q-10

About March 15th we will have ready for distribution a new Manual and Catalog of standard radio material illustrating and describing in detail the various instruments used in connection with the transmission and reception of wireless messages. No expense has been spared to make this Wireless Manual complete and up-to-date in every way so as to be of assistance not only to the amateur, but also to the professional user and experimenter in the most fascinating of all modern arts.

The size of the Manual will be 5 1/4" x 9" and will contain approximately 180 pages.

If interested send in your name and address and a copy will be sent to you as soon as issued.

MANHATTAN ELECTRICAL SUPPLY CO. Inc.

NEW YORK—17 Park Place

110 W. 42d St.,

127 W. 125th St.

CHICAGO

ST. LOUIS

SAN FRANCISCO

114 So. Wells St.

1106 Pine St.,

604 Mission St.

Wireless expert at all our stores

90c. Vacuum Tubes and Time Tested Apparatus

VARIABLE CONDENSER
NEW TYPE, COST \$2.00
TO MAKE & AT ONCE
CAPACITY .0005 M.F.

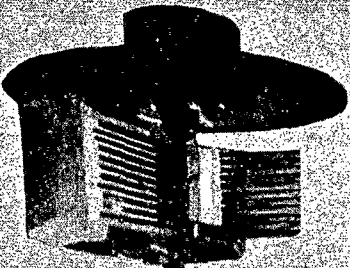

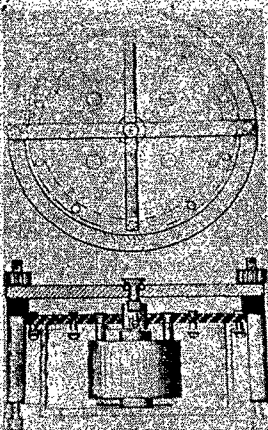

TWO FILAMENT
EXPERIMENTAL
VACUUM VALVE
90% DETECTOR

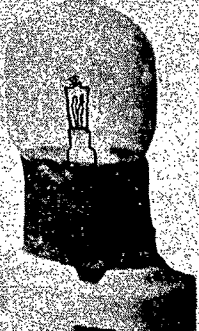

WIRELESS AGE MAGAZINE'S
FIRST PRIZE AMATEUR GAP
COSTS \$2. TO \$6. TO MAKE

as described in

RADIO BUYER'S AND BUILDER'S HANDBOOK

(by an Amateur of fourteen years experience)

The only book which
DESCRIBES AND SIMPLIFIES

many

New Radio Inventions and Improvements

(Some of which have never been made public yet)

including

NEW HOOKUPS to MAKE all the APPARATUS you use MORE EFFICIENT

This book will contain nearly 300 pages, many diagrams, and about 30 full page half-tones of simple efficient apparatus.

THE FIRST THOUSAND WILL BE \$1.00 PER COPY.

Send now for **FREE SAMPLE ILLUSTRATED** pages, like the above, and look over some of the **REAL NEW IDEAS** that they help describe, without cost or obligation. All the material illustrated in them will be on a par with the **PROVEN APPARATUS** shown above.

PARTIAL CONTENTS.

- A 90c **EXPERIMENTAL VACUUM VALVE DETECTOR**, sensitive and made in a few minutes from finished parts easily obtainable.
- Radio "**Tricks of the Trade**"—**Solid Silver Switch Points** for 3 to 5 cents each.
- A **NEW** Combination Switching Key—**Low Cost Amplifying Transformer**.
- Variable Duplex Oil Condensers** for Sending and Receiving.
- How and Where to Buy **Second Hand Radio and Electrical Apparatus**.
- A **Rectifying Gap Motor** which supplies "B" Battery current.
- A **Simple Calibrated Hot Wire Ammeter**, not affected by weather.
- Many **New and Good Ideas** on "A" and "B" Batteries.
- Commercial Type Rotary Quenched Gaps** of Low Cost.
- New Cheap Honey-Comb Type Receiving Coils** for all Waves.
- Second-hand Electrical Motor-Generators** up to ½ H. P. for \$6.00.
- Also many other methods of saving time and money on **BETTER APPARATUS**.

R. U. CLARK 3rd, 11 Barnes Road, NEWTON, MASS.

The CRYSTALOI Detector

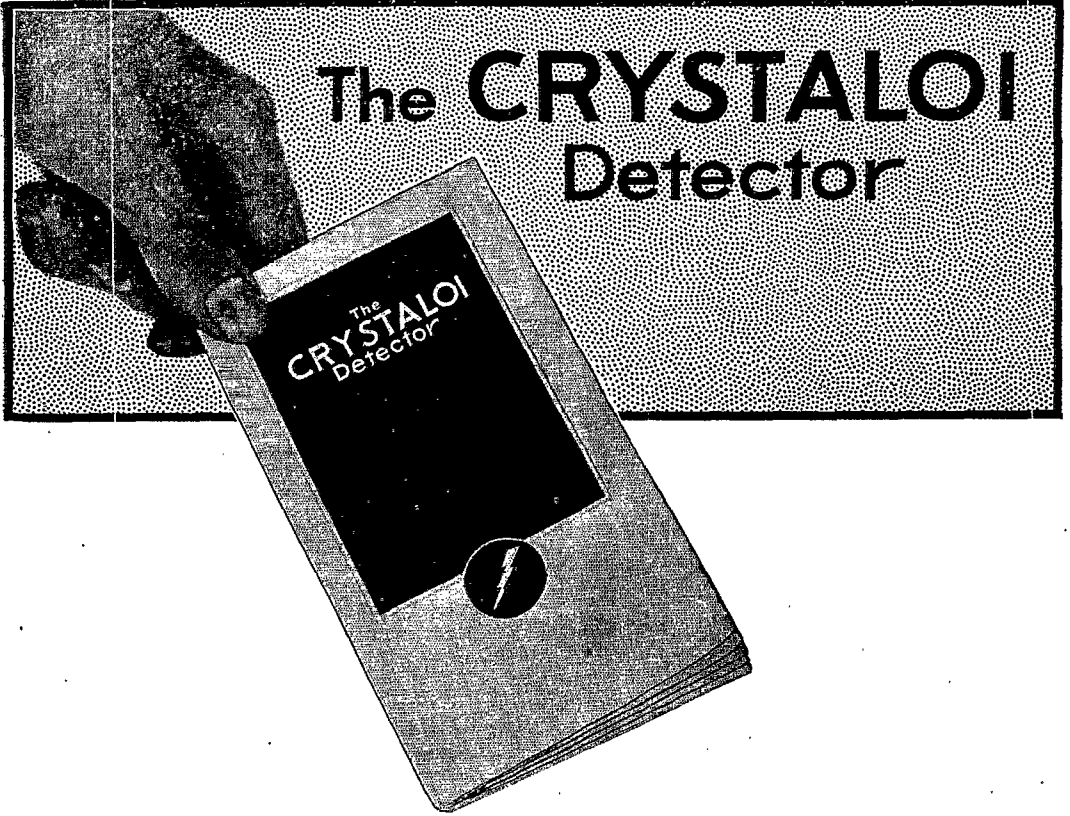

This booklet is yours for the asking. ¶ It explains the principle of CrystalOI design. ¶ Tells how to hook it up. ¶ Gives full particulars as to how it operates. ¶ And describes the advantage of working with it. ¶ Complete with illustrations, wiring, diagrams, etc. . . . ¶ Send for it

PRICES

Type O. CrystalOI Detector \$3.50 Type A.A. CrystalOI Detector \$6.00
By parcel post prepaid 3.60 By parcel post prepaid 6.20

MANUFACTURED ONLY BY
CONNECTICUT TELEPHONE & ELECTRIC COMPANY
INCORPORATED
MERIDEN, CONNECTICUT

All rights and patent under which the CrystalOI is made were purchased from the inventor, Eugene A. Turney

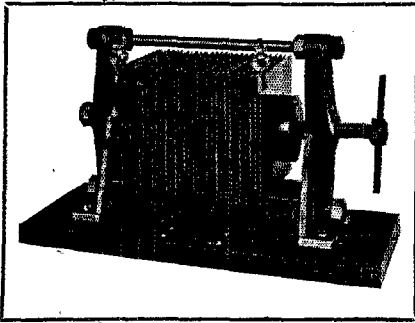

\$17.50

Folder giving complete specifications sent on request.

Ask your dealer today to show you the AMRAD Quenched Gap. If he does not have it, order direct from us but send us his name

A 240 Spark Note on 60 Cycles

with three to four times the energy in your antenna and with a low decrement entirely inside government regulations—all possible with the

“AMRAD” QUENCHED GAP

Our bulletin No. 12 sent on request explains

Altho within the reach of every amateur's means, this GAP is on par in performance with the finest commercial quenched gap. Not only does it increase the efficiency of your station three to four times, but is economical to use because it can be operated without a motor generator and also because it affects a saving in current.

Keep out of trouble

You can measure your wave length with absolute accuracy and no difficulty with the

“AMRAD” WAVE METER \$5.

In this very simple and reliable device a flashlight bulb and direct reading dial give instantaneous and precise measurement of your transmitting wave. It does entirely away with danger of violating government rules.

*Your dealer can supply you.
Descriptive folder sent on request.*



Makes DC like AC

For the amateur who operates where AC is not available the

“AMRAD” INDUCTION COIL \$28.50

Works as consistently as a transformer

Adapted for amateur use from the designs for the army signal corps coil, the AMRAD induction coil entirely overcomes difficulties found in all other coils.

A special model is made for use with 32 volt farm lighting outfits.

Ask your dealer to show you the AMRAD induction coil.

Folder giving complete details mailed on request

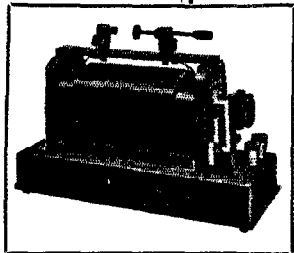

AMERICAN RADIO AND RESEARCH CORPORATION

21 PARK ROW, NEW YORK, N. Y. Laboratory and Works, Medford Hillside, Mass.