

# DX News

Serving DX'ers since 1933



Volume 68, No. 10 - December 11, 2000 (ISSN 0737-1659)

## Inside ...

2 .. AM Switch  
3 .. DDXD

12 .. IDXD  
16 .. DX'ers' Notebook

19 .. Three-Loop Antenna  
23 .. Musings of Members

### CPC Test Calendar

KNUS	CO	710	January 7	0200-0300
KRKS	CO	990	January 7	0200-0300
KBJD	CO	1650	January 7	0200-0300
WILM	DE	1450	February 4	0000-0200

*Tests ...* From Patrick Griffith: "I met with Director of Engineering Jeff Garrett and Program Director Gregg Cassidy from Crawford Broadcasting / Colorado ... they have authorized me to release an 'official announcement' that we are planning to run simultaneous DX tests on all 3 of their Denver AMs (KNUS/710, KRKS/990, KBJD/1650) the morning of Sunday, January 7, 2001 from 0200 to 0300 EST.

"The discussion indicated that we will probably run day power/non-DA the first half hour and standard night power/patterns the second half hour. Programming will include code, unusual music, and other readily identifiable programming. It sounds like the programming will be simulcast.

"They also expressed an interest in live feedback from listeners by telephone and internet during this event. The web address will be [DJ@1650thebeat.com](mailto:DJ@1650thebeat.com) and the telephone numbers will be 303-631-2328 and 303-696-1971.

"The mailing address for reception reports is 3131 S. Vaughn Way, Suite 601 - Aurora, CO 80014-3510, ATTN: Gregg Cassidy.

"I plan to create and issue a special QSL for this event. I'll keep you posted of any changes or updates that develop."

*From the Publisher ...* Since I pretty well shot my wad last issue, let's just turn over the rest of this page to Glenn Hauser.

### World Of Radio And Continent Of Media ... Shortwave-only Schedule Effective December 1, 2000

New RFPI time schedule in effect from Dec 1, but not yet frequency schedule; 7480 soon to be activated; 15049 will later switch to 15065. While 15049 continues, it will be 24 hours; when 15065 comes on, no transmissions are scheduled in the 0400-1200 period. For latest update see our Anomaly alert page: <http://www.angelfire.com/ok/worldofradio/Anomaly.html>

### Days and times are strictly UT

Thu 0030 WOR WBCQ1 7415  
Thu 2130 WOR WWCR 9475  
Fri 1030 WOR WWCR 7435  
Fri 1900 COM RFPI 21815-USB 15049  
Fri 1930 WOR RFPI 21815-USB 15049  
Fri 2215 MR WWCR 9475 [Mundo Radial, Spanish]  
Sat 0100 COM RFPI 21815-USB 15065/  
15049 7480

Sat 0130 WOR RFPI 21815-USB 15065/  
15049 7480  
Sat 0130 WOR WWCR 3215  
Sat 0700 COM RFPI 15049  
Sat 0730 WOR RFPI 15049  
Sat 1230 WOR WWCR 15685  
Sat 1300 COM RFPI 21815-USB 15049  
Sat 1330 WOR RFPI 21815-USB 15049  
Sat 1730 COM RFPI 21815-USB 15049  
Sat 1800 WOR RFPI 21815-USB 15049  
Sat 2330 COM RFPI 21815-USB 15065/  
15049

### DX Time Machine

#### From the pages of DX News:

50 years ago ... from the December 9, 1950 DXN: Jim Critchett, San Francisco, CA reported on "a week of strenuous DX'ing" during his Thanksgiving holiday. At the dials every AM for a week, stations were heard from Cuba, Puerto Rico, Mexico, Canada, and Hawaii, along with many domestics.

25 years ago ... from the December 15, 1975 DXN: Ted Fleischaker, Louisville, KY reported "about 225" for his total, after starting over in September, with KWRG, New Roads, LA having "reported in just a week".

10 years ago ... from the December 10, 1990 DXN: Bill Hale's "Graveyard Totals" column showed Gene Allen, Vallejo, CA, on top with 639 stations heard, followed by Stan Morss, Boxford, MA, with 605; Don Kaskey, Galva, IA, with 585; Charles Reh, Leamington, ON, with 439, and Bob Knox, Newton, NJ, with 403.

# AM Switch

**Jerry Starr** w8jv@yahoo.com  
c/o WHOT Radio  
4040 Simon Road  
Youngstown, OH 44512-1320

Status changes in AM stations, supplied by the FCC and listeners

## CALL LETTER CHANGES

	Old call	New call
540	WZER WI Jackson	WYLO
730	WLIM TN Lenoir City	WKZX
840	WCTG SC Columbia	WCEO
910	WYLI OH Marietta	WBRJ
970	KAFY CA Bakersfield	KZPM
1020	KCKN NM Roswell	KXEM
1050	WJXY SC Conway	WIQB
1100	KZPM CA Bakersfield	KAFY
1270	WLSM MA Louisville	WIRL
1290	WIRL IL Peoria	WWFS

## Are you expiring?

We hope not! To avoid expiration, mail your remittance to the **DX News Membership Center** early. Allow at least three weeks after mailing your check or money order for new renewal data to appear on your mailing label.

## APPLICATIONS/GRANTS FOR NEW STATIONS

None

## APPLICATIONS FROM EXISTING FACILITIES

600	CKCL NS Truro: to 99.5 FM
1540	WSIV NY East Syracuse: 2500/400 U1, city of license to Dewitt, NY
1550	WDLR OH Delaware: 4000/210 U4

## GRANTS TO EXISTING FACILITIES

780	WPNP FL Mulberry: modify CP to show 250/250 U3
-----	--

## OTHERNESS

770	WTOR NY Youngstown: CP for 9000 D1 is on
1220	CJUL ON Cornwall: new station is ON THE AIR
1450	WHRC RI West Warwick: CP to relocate transmitter is on (station has an application for 500/1000 U5 which was shown as 5000/1000 in error last week)
1490	KYFO UT Ogden: CP to relocate transmitter is on
1520	WTRI MD Brunswick: station is SILENT
1570	WGLL IN Auburn: station is SILENT

*Jimmy & BKF*

THANKS: Bill Hale, Shawn Axelrod, Blaine Thompson, Andy Rugg, Ed Krejny, and MSJ 73 and Good DX, Jerry Starr & Buffalo K. Foonman

**Expiring? Time to renew? Not sure when? Need to call or e-mail someone? Check the back page - it's all right there!**

**The NRC AM Radio Log, 21st Edition, including cross-referenced listings from 530-1700 Khz., is compiled from both listeners' reports and official sources, making it the most accurate listing of U. S. and Canadian AM stations available. Unbound, three-hole punched for standard binders. Still only \$16.95 to U. S. and Canadian members; \$22.95 to U. S. and Canadian non-NRC members. Airmail to members: Latin America, \$24.00; Europe, \$25.00; rest of the world: \$28.00. Order from: NRC Publications - Box 164 - Mannsville, NY 13661 (NY residents, please add sales tax).**



# Domestic DX Digest

West: **Bill Hale** phantom2@eaze.net

6124 Roaring Springs Drive - North Richland Hills, TX 76180-5552

East: **Michael Shaw** mshaw002@tampabay.rr.com

455 Alt. 19 S., Apt. 176 - Palm Harbor, FL 34683-5931

(Division line is between East and Central time zones)

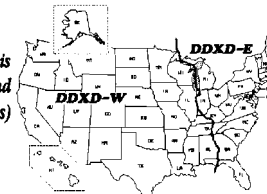

**DX Catches in the U. S. and Canada, with 24-hr. ELT**

## DDXD-West

### MEDIUM WAVE RAMBLINGS

- I've received an inquiry asking: "Aren't we on EST now, instead of ELT at the top of page 3 of the latest DX Digest??" We are ALWAYS in ELT. "ELT" is "Eastern Listening Time" and is whatever mode we are in. So our time reporting standard never changes.
- Wonder of wonders! A postcard mailed by **Ken Onyschuk** on October 26 just arrived November 22nd. Musta got stuck during a stage coach holdup. A word of caution to those who send post cards . . . (Ken's was fine, however) . . . the post office has a nasty habit of attaching a label to the bottom of the address side. This covers up most, if not all, of what is written on the bottom 1 inch. So print small, and keep the address up above this 1 inch area.
- Contributors' Comments: "After an up and down season, mostly down, stuff is starting to come in. KVOZ was station #1971 and I hit my year 2000 goal. On 1/1/01 I'll set a goal for 2001 and try for that goal. This year I've heard 15 new stations, which gets more and more difficult with time, but I'm not quitting yet, hi!" - JJR-WI; . . . reserved for yours!
- See you in a week!!!

### REPORTERS

JAC-TX	<b>John Callarman</b> Krum Optimus STA795 and RS 15-1853 loop <JohnCallarman@email.msn.com>
GJ-CA	<b>Gary Jackson</b> Sacramento FRG-8800 + Kiwa Loop
JEL-MO	<b>J.E. Lewis</b> Kansas City Grundig Satellit 800 + Select-A-Tenna
BM-SD	<b>Bill Moser</b> Fort Pierre barefoot Superradio II <wcmfort@dakota2k.net>
KO-IL	<b>Ken Onyschuk</b> Joliet
JJR-WI	<b>John J. Rieger</b> South Milwaukee FRG100, Kiwa loop, MFJ 959B tuner-preamp <johnrieger@webtv.net>
KR-AZ	<b>Kevin Redding</b> Mesa Radio Shack DX375 and RS 18-1533 loop <ldwxer@juno.com>
MS-MB	<b>Morris Sorensen</b> Winnipeg Drake R-8 with McKay Dymek loop, Hammarlund HQ-150 with SM-2 Space Magnet loop <urbanat@hotmail.com>
RT-CA	<b>Rich Toebe</b> Davis Sony ICF-2010, Barefoot <richtoebe@jps.net>
Ed.-TX	<b>Editor</b> North Richland Hills

### STATION NEWS & NOTES

- 1340 WJOL IL Joliet - A 58-year era ends! On Friday, October 27, WJOL moves from 601 Walnut Street to 2410 Caton Farm Road, Joliet 60435 along with the transmitter and satellite links. Reception reports go to **Scott Slocum**, the morning host, sports and program director. Herald-News radio columnist and NRC member **Don Hazen** tells me the "old, rustic transmitter sends out only about 650 watts, instead of 1000! Takes over ownership soon, and there will changes soon. Currently, the station is live only from 6-10 AM, during some of the noon hour, and for some emergencies. Otherwise, it's satellite MOR. Also they carry ABC News and local sports. (KO-IL)

W O J R

### UNIDs and UNID HELP

- 860 UNID ?? - 11/24 0506 - Heard weakly, but clearly, under KTRB/XEMO in a very tight null. Several mentions of AM 860, News for our area, a 39 degree temperature check. Any idea who this might be? KPAM maybe? (RT-CA)
- 1390 UNID ?? - 11/25 2017 - Good in WGCI null, with bluegrass music. One break in music with . . . on next week's show heard. Fade out at 2031. I've never heard bluegrass on 1390. Stumped! (JJR-WI)



- DX AND EQUIPMENT TESTS
- 1570 WGSR+ FL **Fernandino Beach - 11/23 0106-0200** - Up late to do pre-Thanksgiving party preparations and when we were done, I tuned to 1570, nulled XERF and found solid copy on WGSR for about 4 minutes, 0106-0110, and then in and out through 0200. Got a lot of WGSR taped IDs, some music, but the best tape, when Mr. G goofed, said *It's called disk jockey error* and called it proof that it was live radio on WGSR. Didn't work because I left the volume down at zero. Surprisingly good signal, but who was the station **0143** to **0146** with network sports score program? (JAC-TX)
- 1570 WGSR- FL **Fernandina Beach - 11/23 0014** - Test not heard. Semi-local CKMW very dominant. (MS-MB)
- TIS & OTHER STUFF
- 1610 TIS CA **Sacramento - 11/23 0700** - Strong signal, giving fog advisory of 100 foot or less visibility on Highways 99, 5 and 80 in Sacramento and San Joaquin Valleys. Two beeps between transmissions, used to turn on sign telling people to turn on 1610 kHz and listen to transmission. (GJ-CA)
- MIDNIGHT TO MIDNIGHT ELT
- 690 WOKV FL **Jacksonville - 11/21 0657-0700** - Fair, over/under an unID, possibly Coffeyville. Mention of cold weather, especially inland, mention of golf course, CLs, but no network feed on the hour. Rare here, as Coffeyville and/or Birmingham usually dominate. (JEL-MO)
- 730 KBSU ID **Boise - 11/26 1131** - With real acoustic jazz and *Ella Fitzgerald* singing *Sittin' and a-rockin'* during the daylight hours. It's winter! (KR-AZ)
- 840 KTIC NE **West Point - 11/25 2057** - Very good, with full ID and C&W/Christmas music. WHAS buried. (JJR-WI)
- 880 KRVN NE **Lexington - 11/25 2054** - Very good, with old C&W music, ad and weather . . . on KRVN. Not heard in a while here. (JJR-WI)
- 890 KVOZ TX **Del Mar Hills - 11/27 0302** - Poor, but steady in WLS null, with l-o-n-g string of IDs (in TX, NM). Heard SS and *Glory, Glory Hallelujah* and others. NEW! For #1971, and Texas #75. First new one on 890 in 14+ years! (JJR-WI) [This station has, without any doubt on my part, been operating U1 10000/10000 for several weeks, now. They barrel in here (389 miles) at night with a dominant signal over WLS. If anyone at WLS is reading this, I wish you'd get on their case!! Same thing with KSAH - 720. By the way, the AM Log continues to list this as "Laredo" while the FCC says "Del Mar Hills" - Ed.-TX]
- 900 KFAL MO **Fulton - 11/28 1804-1806** - Female reporting closing stock market info, ID with slogan *Nobody plays more classic country*, then a tune. Good signal, alone on frequency. First time heard at this QTH but previously verified. (BM-SD)
- 930 WTAD IL **Quincy - 11/25 2300** - Fair, on top briefly, with ID by man: *This is Sports Radio 930, WTAD*. Format change or just a slogan? (MS-MB)
- 970 WWIT NC **Canton - 11/27 0342** - Very good and alone, with Cool 970 non-IDs. 30 watts? (JJR-WI)
- 980 WONE OH **Dayton - 11/23 0003** - Fair, with ABC News, ID mentioning . . . *more great music on WONE, AM 980 and 1340*. Nostalgic music such as *Tuxedo Junction*. (MS-MB)
- 990 KWAM TN **Memphis - 11/26 2338-0000** - Lady announcer with, *Hello, this is Georgie Moore* (or sound-alike) and *you're listening to Sunday night jazz on AM-990, The Light*. In and out, but at Midnight was strong atop with call letter ID: *Memphis' gospel choice is The Light, AM-990, KWAM, Memphis*. Super strong for 450 watts, heh heh! (JAC-TX)
- 1020 KJJK MN **Fergus Falls - 11/25 2043** - Poor, tho steady in KDKA null, with *KJ Oldies* 'til 2045 fade out. (JJR-WI)
- 1090 KMXA CO **Aurora - 11/25 1744** - Good, with Spanish music, fast talking male announcer with many *Radio Tricolor* IDs and mentions of Mexico and Futbol. (MS-MB)
- 1150 CKOC ON **Hamilton - 11/25 2040** - Fair, in WEAQ null, with *Oldies 1150 CKOC* and into mush. (JJR-WI)
- 1200 KFNV ND **West Fargo - 11/25 2037** - Very good and unusually loud, with WLXX nulled. Local chatter. (JJR-WI)
- 1210 KGYN OK **Guymon - 11/27 0330** - Good, with WPHT buried. C&W. Uncommon here.

- (JJR-WI)
- 1260 WWJQ MI **Zeeland - 11/26 0734** - Fair, with WJQ-1260 non-IDs. Contemporary Christian. (JJR-WI)
- 1360 KBKB IA **Ft. Madison - 11/27 1749** - Poor, with Dr Laura on *NewsTalk 1360 KBKB*, over others. (JJR-WI)
- 1370 KGNO KS **Dodge City - 11/27 0337** - Good, with 1370 KGNO and satellite oldies. No WSPD. (JJR-WI)
- 1390 WFIW IL **Fairfield - 11/27 1752** - Poor, tho distinct, with 1390 WFIW in WGCI null. Christmas music. NEW! (JJR-WI)
- 1410 WRMN IL **Elgin - 11/27 0334** - Poor, tho clear, with WRMN-WJKL promo and weather. C&W. (JJR-WI)
- 1410 CFUN BC **Vancouver - 11/25 0306** - Faded up over jumble with *C-Fun, a new kind of talk station*, then into *Mike Siegel's Coast to Coast AM*. New from Davis. (RT-CA)
- 1450 KFLS OR **Klamath Falls - 11/23 1028** - Faded up over jumble of signals with *Your favorites from the 50s, 60s and 70s, KFLS*, then a spot about the *Oregon Insurance Plan*, then OLDies song *Do You Believe In Magic?* Great signal while it lasted. New from Davis. (RT-CA)
- 1460 KDMI IA **Des Moines - 11/23 2359** - Poor, with end of Christian religious program, call letter ID, and weather. In KLTC null. (MS-MB)
- 1510 KIRV CA **Fresno - 11/24 0945** - Sitting on the jumble that is 1510 at sunrise (KGA/KFNN/others), when suddenly out of nowhere: *You are listening to the Sound of the New Life, KIRV* boomed in, followed by Classical type music. REL after the hour, but now about even with KMZT/KFNN/KGA. New from Davis. (RT-CA)
- 1520 WWKB NY **Buffalo - 11/23 2258** - Poor-to-fair, in KOMA null, with talk show, and *WWKB-1520 Weather*. (MS-MB)
- 1560 KLNG IA **Council Bluffs - 11/27 1753-1800** - *Fourth and Goal* prison ministry broadcast, sign-off announcement, instrumental music. Heard many times before, but this was the first time I had enough information to report reception. Man I spoke with on the phone said they are preparing an application for a power increase to 5000 or 10,000 watts. (BM-SD)
- KQVO-FM • KICO-AM  
Eduardo A. Medel  
General Manager
- 1620 WHLY IN **South Bend - 11/25 0103** - Fair, in KAZP null, with end of ABC News, instrumental music, and ID as *Radio Hollywood, WHLY*. (MS-MB)

### DDXD-East

Rick Shaften writes: "This is my first report in 25 years. I was an NRC member in the mid-70's when I lived in NYC. Now I am up here 40 miles NW of NYC. All stations reported are new and my total from here in Sparta is 439 since 1/1/99." Welcome and welcome back, Rick!  
It's a longer report this week; let's get to it!

### STATION NEWS

- 740 UNID — — 11/16-17 - Huge open carrier heard tonight. I suspect this is the new Toronto station testing. (JR-NY)
- WBFB NY **Rochester - 11/16 2014** - Now ID'ing as "93 BFB", reflecting the new operation on 93.3 FM. (JR-NY)
- 900 WKDW VA **Staunton - 11/28 1427** - C&W with Johnny Cash and "Ballad of Ira Hayes"; ID at 1431 as "Five Decades of Country Classics . . . from WKDW". I'm reporting this semi-local only because of Jeff Falconer's report in DXN #8 giving WKDW as call for 1630 kHz in Augusta, GA. (PFC-VA) [Guess that settles the RDW/KDW confusion in 6808 - MS]
- 950 WEZO NY **Rochester - 11/20 1925** - Good at times with oldies // WBFB-98.9 and "BFB 99" slogans. New format, still WEZO? (JF-ON) [Apparently not... - MS]

### UNID, UNID HELP & PRESUMED

- 810 UNID — — 11/24 1658 - Religion under WGY; Carquet. (RKS-NJ)
- 830 UNID — — 10/09 0000 - Trinity Broadcasting Network. (RKS-NJ)
- 860 WNOVp WI **Milwaukee - 11/22 1805** - Presumed with rap and hip hop, CST time check; poor under partially nulled CJBC. (MKB-MI)
- 920 UNID — — 10/21 1800 - David Essel. (RKS-NJ)
- 950 UNID — — 10/21 1815 - Oldies under WPEN to 1815 pattern change. (RKS-NJ)
- 1010 UNID — — 11/25 1755 - Unidentified C&W station up and down. Could have

			given ID at Top of Hour but I could not catch it. Went into music till fade out at 1806. (FV*MI)
1100	UNID	—	— 10/25 1815 – Standards; Pattern Change at 1815. (RKS-NJ)
1130	UNID	—	— 11/23 1812 – Oldies format; several songs back-to-back with Cre- dence Clearwater Revival song "Down on the Corner", followed by The Mamas and the Papas song "Monday Monday". They gave out a 1-800 re- quest line, also mentioned a website hosted by Captain Trivia. The program I was listening to was hosted by Ron Foster at Good Time Oldies. Fantastic signal. I listened for 4 minutes but never heard an ID. I believe it might be WKRY but not sure. (RCP-IN)
1150	UNID	—	— 11/04 1700 – House of Blues Radio Network. (RKS-NJ)
	UNID	—	— 11/23 0915 – Non-ID as "The Valley's non-stop Christmas station" into a C&W-ish version of "Pretty Papers", then faded out. (MKB-MI)
1280	WSVEp	FL	Jacksonville – 11/12 2120-2150 – UC music, no ID heard; poor. (DT-JAM)
1300p	WTMM	NY	Rensselaer – 10/24 1757-1810 – Sports-talk show. (DT-ON)
1450	WKIPp	NY	Poughkeepsie – 10/26 2058-2100 – Bruce Williams talk show, closest News Talk to Toronto. (DT-ON)
	WLEC	OH	Sandusky – 11/15 1830 – Mentioning Cleveland Cavs coverage; ID as AM 1450 and 100.9. There is a 100.9 in nearby Clyde OH. (JR-NY)
1480	CHRDp	QC	Drummondville – 10/24 1901 – French on top. (RKS-NJ)
1530	UNID	—	— 11/24 1751 – Country u/WSAI. (RKS-NJ)
1540	UNID	—	— 11/03 1710 – Spanish, then Chinese after 1715; maybe CHIN.
1580	UNID	—	— 10/24 1757 – ESPN Radio. (RKS-NJ)
	WCCF	FL	Punta Gorda – 11/07 2110-2229 – Election results, only close news station to here; poor. (DT-JAM)
	KXZZ	LA	Lake Charles – 11/07 2122-2234 – UC music, no ID heard; only Urban Con- temporary close; over/under WCCF. (DT-JAM)
1600	UNID	—	— 10/23 1805 – Spanish. (RKS-NJ)

## LOGGINGS

540	CBEF	ON	Windsor – 11/23 1646 – Music with announcements for station shows, and ID in FF. (Normally I would not submit this as DX, as it's a semi-local, how- ever this station had the strongest signal of all on the dial). (FV*MI)
550	WSVA	VA	Harrisonburg – 11/24 1619 – Call in with calls. (RKS-NJ)
560	WLLZ	MI	Monroe – 11/23 1650 – Distorted church program. Preacher's voice was clipped at times. (FV*MI)
570	WKBN	OH	Youngstown – 11/23 1655 – Psychic program with occasional mentions of phone numbers along with "WKBN", and promo for next week's show. This one surprised me. (FV*MI)
580	CKWW	ON	Windsor – 11/23 1658 – Christmas music with ID into Tony Bennett song. (FV*MI)
	WCHS	WV	Charleston – 11/14 0603-0615 – (TLK) "...on WCHS talk radio sixty eight". (DL-MD)
600	WSNL	MI	Flint – 11/23 1700 – Music into top of hour ID: "Michigan's Salt & Light. WSNL, Flint, Midland, Bay City, Saginaw"; into music. (FV*MI)
610	WNTW	VA	Winchester – 11/21 1815 – REL music; ID. (WM-MD)
630	CFCY	PI	Charlottetown – 11/23 1834 – C&W song, female vocalist; male DJ says "...from CFCY...where did the week go? 7:37...Cory's going to drop in"; mentions Top 30 Countdown show; "Your CFCY weather forecast and Alan Jackson, next"; ad for "The CFCY Top 30 Countdown". (GL-NY)
	CFCO	ON	Chatham – 11/23 1701 – Music into ID: "This is Chatham-Kent's 6-30 Solid Gold, CFCO"; into news. (FV*MI)
640	WOI	IA	Ames – 11/25 1900-1908 – Alone with "A Prairie Home Companion" show. Quick "WOI, Ames, Iowa" legal ID at 1904 and back to program. (JF-ON)
680	CJOB	MB	Winnipeg – 11/18 1200 – Weak but 100% readable in CFTR phase null with end of "Money Talks" program, ID, and into local news. First midday recep- tion of MB here ever! (JF-ON)
	WCTT	KY	Corbin – 11/19 2215 – NOS music; spoken ID. (WM-MD)
690	WOKV	FL	Jacksonville – 11/19 1909 – Ads for State Farm Insurance and Arby's, men- tion of Jacksonville; then Jaguars Football pregame show. (WM-MD)
	WNZK	MI	Westland – 11/23 1704 – ID "WNZK" into what sounded like Arabic music.

			(FV*MI)
710	WOR	NY	New York City – 11/25 1742 – Cat food commercial with locations in Brook- lyn & Queens. Jingle "Radio 7-10, WOR"; health food spot (I would have spaced this a little further than the cat food commercial), and then into pet store commercial. (9 of 10 LEDs lit on the 2010 with no fading. If CHYR-710 were around, they would have been in serious trouble). Note: All the NY state clears on 660, 710, 770, 810, 880, + 1010 have better signals here than in Lima. (FV*MI)
	CKVM	QC	Ville Marie – 11/23 – Fair to good with FF paid political announcement for Liberal party. (MKB-MI)
720	WGSE	GA	Hogansville – 11/23 1716 – Station ID heard "WGSE", then into a talk pro- gram hosted by a male and female. Poor signal and way under WGN. (RCP- IN)
730	CKDM	MB	Dauphin – 11/23 0718 – Fair-good with C&W, ID as "Today's hot country, CKDM", local weather; ad for Roundup Ready Canola. (MKB-MI)
	KLOE	KS	Goodland – 11/25 1930-1936 – Good on west wire mixing with CKDM, with ad cluster during a break in Jayhawks basketball game. Lots of info for a report. Likely on day power. New. (JF-ON)
740	KRMG	OK	Tulsa – 11/18 1145 – Fair on west wire with promo for NASCAR on KRMG Sunday nights. Nice midday reception. (JF-ON)
	WNOP	KY	Newport – 11/02 1750 – Jazz, local ads. (RKS-NJ)
750	WWKK	MI	Petoskey – 11/22 1828 – Fair at times after KBNN sign off mixing with WSB and UNID Latin station with oldies music and "Kool 750" slogans. New. (JF- ON)
790	CIGM	ON	Sudbury – 11/20 2320 – C&W song "Take the Money and Run"; spoken ID. (WM-MD) + 11/20 1721 – C&W format in with a very impressive signal. Allan Jackson song "WWW.memory" followed by slogan "Hot New Country on CIGM". Followed by a Reba McIntyre song. (RCP-IN)
820	WOSU	OH	Columbus – 11/23 0800 – Breaking through nulled CHAM with ID as "Morn- ing Edition is next on 820 WOSU". (MKB-MI)
850	WRMR	OH	Cleveland – 11/25 1748 – Promo "...and thanks for listening to the Music of Your Life on WRMR"; into Christmas music. (FV*MI)
860	WACB	NC	Taylorsville – 11/23 0109 – Alone in CJBC null with PSA to prevent forest fires, promo for the Alexander County Baptist Association's Christmas toy collection (donations may be brought to the Taylorsville National Guard Ar- mory). Slogan "You found it, lock it in, B-86" into "Joy to the World" (the Christmas carol, not Three Dog Night). If their night power is really only 8 watts, this is a totally awesome catch! (MKB-MI)
	WLBG	SC	Laurens – 11/03 2318 – ID, supposedly 10 watts. (RKS-NJ)
880	KRVN	NE	Lexington – 11/22 1750 – Fair-poor in fight with WCBS & WRFD, promo for Real Audio webcast on <a href="http://www.krvn.com">www.krvn.com</a> web site, C&W music. Heard in Toronto in 1978; QSL took almost 5 years to arrive! (MKB-MI)
	WMEQ	WI	Menomonee – 11/22 1739 – Breaking through nulled WRFD with sports re- port talking about upcoming Minnesota Wild and Timberwolves games. Nothing in MN on 880; this is presumed since Menomonee is close enough to the MN state line that the Wild and T-Wolves would be "home" teams. (MKB- MI)
	KRVN	NE	Lexington – 11/25 1753 – Song "PT-109" back sell with ID of KRVN, into "ITT" commercial, and weather where it was 38 degrees (28 in Inlay City <grin>). WCBS very dominant, but I was able to hold the radio for enough null to bag this one. (FV*MI)
900	WFRO	OH	Fremont – 11/22 1711 – Wiping out CHML with local news and funeral an- nouncements, promo for Fremont Chamber of Commerce Christmas dance at Fremont Country Club. (MKB-MI)
920	WPET	NC	Greensboro – 10/21 1839 – Carolina Panthers, Greensboro ads. (RKS-NJ)
	WBAA	IN	West Lafayette – 11/22 0600 – Over CKNX with promo for wbaa.org web site; into NPR Morning Edition. (MKB-ON)
	KARN	AR	Little Rock – 11/22 1736 – Fair with ID as "News radio 920 KARN", into talk about George W. Bush's cocaine habit ("at least he admitted it"). (MKB-MI)
	CKNX	ON	Wingham – 11/22 1817 – Mike Reagan talk show in progress followed by a

KIDQ63

- "Country 920 CKNX" ID. Poor signal in a mix of stations. (RCP-IN)
- 930 WEOL OH Elyria – 11/22 1654 – Very good with ad for Loraine County Transit, local weather and promo announcement: "Your up-to-the-minute weather advisories on your news station, AM 930 WEOL". (MKB-MI)
- 940 WCPC MS Houston – 11/22 1734 – Fair and alone on frequency with ad for Frank Schmidt Body Shop in Houston, local weather; ID as "currently it's 53 degrees at WCPC". (MKB-MI)
- 950 WSPA SC Spartanburg – 11/23 2158 – ESPN Radio on top of WPEN. (RKS-NJ)
- 960 WRNS NC Kinston – 10/21 1841 – Panthers. (RKS-NJ)
- 1010 KSIR CO Brush – 11/14 1740 – Good-fair with C&W music, ad for Sudafed; calls. Taped report sent. New. (MB-IN)
- 1020 KJJK MN Fergus Falls 11/22 1810 – Beatles song "Day Tripper" followed by slogan "Your Home for the Oldies All The Time, AM1020". This was followed by local Minnesota news then into an ad for Harrison Smith Funeral Home, and another slogan "Your Good Time Oldies Station, AM1020". Great signal in partial KDKA null until apparent power cut at 1815. (RCP-IN)
- 1030 KCTA TX Corpus Christi – 11/23 1720 – Religious program called "Understanding the End Times". Mention of free brochure by calling 1-800-endtime. Several KCTA ID's plus "Thank you for listening to KCTA Corpus Christi". Great signal but eventually lost to WBZ. When I verified them several years ago they responded in less than a week and were quite generous with the freebies. (RCP-IN)
- 1070 WCSZ SC San Souci – 11/14 2107 – Fox Sports with calls. (RKS-NJ)  
+ – 11/23 2205 – Fair in WIBC null with ID as "1070 The Sports Zone, WCSZ" into Fox Sports talk. (MKB-MI)
- 1110 WMBI IL Chicago – 11/22 1729 – good with sign off announcement "You have been listening to WMBI Chicago, broadcasting since 1926"; inviting listeners to tune to WMBI-FM 90.1. (MKB-MI)
- 1120 WKCE TN Maryville – 11/17 1828-1836 – Good at times mixing with KMOX with NOS music, ID as "You're listening to The Music of Your Life on WKCE". New. (JF-ON)
- 1130 KWKH LA Shreveport – 11/22 1727 – Poor but steady in WDFN null with C&W music; ID as "AM 1130 Country Gold, KWKH". (MKB-MI)
- 1140 WKWM MI Kentwood – 11/18 1648 – Oldies song heard; "Groovin' 1140, KWWM". Good in WRVA null. (WM-MD)
- KSOO SD Sioux Falls – 11/26 1647-1703 – Excellent with "Money Talks" program, promo for "Imus in the Morning" on "The Talk of Sioux Falls, KSOO", ID, and ABC News. UNID with REL program underneath; WVLE? (JF-ON)
- 1150 WCUE OH Cuyahoga Falls – 11/23 1759 – Good with ID as "Providing food to the spiritually hungry, this is WCUE Cuyahoga Falls"; into Family Radio program. (MKB-MI)
- WEAQ WI Chippewa Falls – 11/23 0727 – Fair with local weather; Thanksgiving Day sports trivia contest, sponsored by Eau Claire Optical. (MKB-MI)
- 1180 WXLA MI Dimondale – 11/23 0742 – Dominating nulled WHAM with hip hop music, ID as "Mix 1180 WXLA. We're staying true to the mix. Lansing's urban adult radio." (MKB-MI)
- 1190 WBIS MD Annapolis – 10/25 1800 – Calls. Solid on top of channel. (RKS-NJ)
- 1210 KGYN OK Guyton – 11/26 0026 – Good with no WPHT on west wire with local weather, into C&W music. (JF-ON)  
+ – 11/13 1956 – Poor but readable with calls; C&W music. New. (MB-IN)
- 1230 WJOY VT Burlington – 11/20 1950 – "1230 WJOY"; "America's Best Music". Popped in during an ID on a peak in heavy co-channel. WAVA nulled with new loop. (DL-MD)  
+ – 11/23 1620 – Faded up with end of Peter Paul and Mary song with "AM 1230, WJOY". Gets out quite well for a graveyarder. (JF-ON)
- WJOI VA Norfolk 11/21 2045 – After Sergio Mendes song, "Hampton Roads' Best"; ID; NOS music. (WM-MD)
- 1240 WIOV PA Reading – 11/21 2015-2155 – "...ESPN on WIOV..." in heavy co-channel. (DL-MD)
- WWCO CT Waterbury – 11/9 0230 – AM 1240 WWCO, Waterbury's Radio Station. (RKS-NJ)
- WJIM MI Lansing – 11/22 1706 – Fair with PSA for Girl Scouts, local weather; "...that's



- my latest WJIM forecast". (MKB-MI)
- 1250 KBRF MN Fergus Falls – 11/23 0918 – Fair over WGL with run-down of local job openings in Fergus Falls, Battle Lake and Elbow Lake, MN. (MKB-MI)
- WGL IN Fort Wayne – 11/23 1700 – ID as "Fort Wayne's talk radio is 1250 WGL" into CBS news. (MKB-MI)
- WGHB NC Farmville – 11/23 2300 – Christian Radio 1250 WGHB. (RKS-NJ)
- 1270 WLBR PA Lebanon – 11/20 2200 – ID; mention of Lebanon. (WM-MD)
- 1360 WDRC CT Hartford – 11/19 0045-0103 – (NOS) At the top of the hour: "WDRC AM thirteen sixty, Hartford"; heavy co-channel. (DL-MD)
- WNJC NJ Washington Township – 11/18 1900 – GOS program heard: "Faith and Healing Ministries"; female preacher heard saying ID. (WM-MD)
- WOEN NY Olean – 11/20 0700 – All alone on frequency with top of hour ID, "Your station for news, weather and sports, now CBS news on your hometown station, 1360 WOEN, Olean", into CBS news. (MKB-ON)
- WMNS NY Olean – 10/25 1951-2002 – Talk show, promo for show "on WMNS", and ad for advertisers on WMNS; poor. (DT-ON)
- WDTT PA McKeesport – 10/31 2012-2025 – MRN Network with coverage of Ford Motor Sports show in CA. ID as "Whitehouse 1360"; poor. (DT-ON)
- 1370 WSPD OH Toledo – 11/22 0545 – "News Radio 1370 WSPD" caught through co-channel noise with loop in WXXI null. (DL-MD)
- 1380 RADIO CKPC ON Brantford – 11/22 0602-0615 – (OLD) "CKPC"; "...here in Brantford". (DL-MD)
-  + – 11/10 1815 – Musical ID by female singer "CKPC", then into a Jimmy Buffet song "Margaritaville"; mention of an upcoming Righteous Brothers song. Poor in a mix of stations. First time heard. (RCP-IN)
- WTJK IL S. Beloit – 10/31 2002-2007 – Milwaukee Bucks/Texas basketball, start of game, WTJK mentioned for tickets; local ads; Poor. (DT-ON)
- 1390 WRSC PA State College – 11/22 1730 – (SPT) "News Radio WRSC, State College..."; Paul Harvey and sports talk prior to the half hour. Local co-channel and NOS UNID station. (DL-MD)
- WNIO OH Youngstown – 11/22 1900 – "...on 1390 WNIO" in co-channel with loop. (DL-MD)
- 1400 WOND NJ Pleasantville 11/09 0301 News Talk Radio 1400 WOND (RKS-NJ)
- WICK PA Scranton – 11/09 0333 – Calls and local promos. (RKS-NJ)
- 1410 KQV PA Pittsburgh – 11/18 2100 – Weather forecast; ID; time check; CBS hourly news. (WM-MD)
- 1430 WFOB OH Fostoria – 11/24 0917 – Good with local obituary announcements. (MKB-MI)
- 1440 WMAX MI Bay City – 10/26 1946-2035 – Sports-talk show, play-by-play basketball: Detroit Pistons v. MN Timberwolves. Poor, over/under WMKM. (DT-ON)
- 1470 WTKO NY Ithaca – 10/27 1929-1934 – Old pop music (OLD ROK); ID as "You are on the right spot at the right time, WTKO"; poor. (DT-ON)
- WPAO PA Farrell – 11/21 0643 – ID as "Weather and more on AM 1470 WPAO", then lost under WLQR. (MKB-ON)
- WLMC SC Georgetown 10/07 0100 Ad for North Charleston; calls at 0100 with request for \$. (RKS-NJ)
- WJDY MD Salisbury – 10/23 1810 – AM 1470 Radio Disney. (RKS-NJ)
- 1490 WUBR MI Whitehall – 11/19 2315-2330 – On top from time to time with NOS music and ID as "You're listening to 'The Music of Your Life' in stereo on 'The Bear', WUBR, 1490". New. (JF-ON)
- WBZO NY Watkins Glen – 10/27 2000-2009 – Local Elmira High School football game; poor; interference from WBTA. (DT-ON)
- 1520 WWKB NY Buffalo 11/19 – 0945-0956 – (BIS) "Business Talk, this is WWKB Buffalo"; long slow fades. Do not usually hear this one during the daytime. (DL-MD)
- KHRW MO Sikeston – 11/26 0030 – Mixing with KOMA with GOS music and "Solid Gospel 1520" slogans. (JF-ON)
- 1530 WCTR MD Chestertown – 11/19 0958-1010 – (NOS) "...WCTR Chestertown". (DL-MD)
- WSAI OH Cincinnati – 11/19 1803-1820 – (OLD) "Cincinnati's original hit's station, 1530 WSAI" Steady; no fading. (DL-MD)
- WRTP NC Durham – 11/03 1702 – Promoting 95.3 FM. (RKS-NJ)
- 1540 KXEL IA Waterloo – 11/19 1835-1855 – (TLK) "News Talk fifteen-forty, KXEL...". (DL-

- MD)
- 1550 **WTTC PA Towanda** – 10/26 1817 – “Northeast PA’s Oldies Station”. (RKS-NJ)  
**WDLR OH Delaware** – 11/23 2121 – Creaming CBE with Ohio State vs. Florida State basketball, ad for Best Western Delaware Hotel. (MKB-MI)
- 1570 **WFLR NY Dundee** – 11/03 1637 – “Kiss This” and calls. (RKS-NJ)  
**WXLN NY New Albany** – 11/22 2357-0007 – Kentuckiana ad for Hometown Buffet. “WXLN” spoken ID at top of hour, then lite religious music. Looking for WGSR test but no luck. Fair over mucho QRM. (HF-MI)
- CKMW MB Winkler** – 11/24 0859 – Fair and virtually alone on frequency with ad for Southland Honda; time check “One minute before 8 o’clock on CKMW”; into C&W song. (MKB-MI)
- 1590 **WPWA PA Chester** – 11/25 0206 – IDing as “Global Catholic Radio” for #440. (RKS-NJ)  
 1620 **WTAW TX College Station** – 11/23 2334 – Ad for Oliver Brothers Transmission (in Bryan). (RKS-NJ)
- 1630 **WRDW GA Augusta** – 10/07 2133 – One on One Sports. This one makes it in as early as 1500, IDing with WAWX. (RKS-NJ)  
 1640 **WKSH WI Sussex** – 11/23 2357 – SRN News, calls and PO Box in Milwaukee. (RKS-NJ)  
 1650 **KDNZ IA Cedar Falls** – 10/10 2353– Talk show; WWI ID as “KDNZ Cedar Falls”, into CBS news; poor. (DT-ON)
- 1660 **KQWB ND West Fargo** – 11/18 1150 – Poor, mixing with WQSN with NOS music; Fargo mention. Good daytime skywaves this day with good signals on all X-Band channels. (JF-ON)
- KZRX TX Waco** – 11/21 1806 – Station slogan heard “Newstalk KZRX, it’s 5:05 PM here at Newstalk 1660 KZRX”. Great signal with discussion on college football. First time heard. (RCP-IN)
- WMIB FL Marco Island** – 11/21 1810 – NOS format; dual ID’s heard for 1480 and 1660, followed by songs by Anne Murray: “I Want to Sing a Love Song” and Dean Martin “That’s Amore”. Fair signal at times but mixing with KZRX and WQSN. First time heard. (RCP-IN)
- 1700 **WEUP AL Huntsville** – 11/22 1750 – Station faded up briefly and I was able to hear station slogan “WEUP Traffic and Weather Together”. Then was dominated by KBGG. First time heard. (RCP-IN)



#### OFF THE INTERNET

Frederick R. Vobbe (FV\*MI) writes that his loggings are “from my trip to Lapeer County (MI). All loggings were made in Imlay City, Michigan, corner of M-53 & M-21...did not get to set up at the farm in Almont MI as it rained the whole weekend. DXing was confined to the pool room of the Days Inn while watching Jon & Connie get tired of swimming. The funny moment of the day (11/25) came when I was showing my brother my 2010, and while listening to 1340 we heard him doing a commercial on WLEW-1340. He is the CE and does mornings at the station. 1230 WMPG had a real good signal in Lapeer and Macomb county. Very clear and good strength. Contrary, WLSP was under modulated, distorted, and I needed to drive some 12 miles closer to get a better signal from the station. That’s two stations that I worked for in the past that at one time sounded good, but now are pitiful”.

#### ADDRESS UPDATES

- 1570 **CKMW MB Winkler** – 300-561 Main Street, Winkler, MB R6W 1G3 as in Log. P.O. Box 1570 no good. (JF-ON)

#### REPORTERS

- |        |                 |  |
|--------|-----------------|--|
| MKB-ON | Mike Brooker    | Toronto – Panasonics RF-2200, & RFB-45.  |
| MKB-MI | Mike Brooker    | DXing in Ann Arbor, MI – Panasonic RFB-45.   |
| MB-IN  | Mark Burns      | Terre Haute – Drake R-8; Kiwa loop; 80’ RW.  |
| PFC-VA | Perry Crabill   | Winchester – R8; Kiwa loop.  |
| JF-ON  | Jeff Falconer   | Clinton – Drake R8B; pair of noise reduced/terminated wires (east and west), modified MFJ-1026 phasing box, Timewave DSP-599zx audio filter. |
| HF-MI  | Harold Frodge   | Midland – Drake R8B + 85’/215’ RW’s; 125 ft. single loop.  |
| DL-MD  | Dave Larrabee   | Columbia – ICOM IC-706 & R8500 with longwires.   |
| GL-NY  | Ginnie Lupi     | Ithaca – DX-398; Select-A-Tenna.   |
| WM-MD  | William McGuire | Cheverly – DX-398.   |
| RCP-IN | Robert C. Pote  | Greenwood – Drake R8A receiver and Kiwa loop.  |

- |        |                 |   |
|--------|-----------------|---|
| JR-NY  | Jim Renfrew     | Byron – Drake R8, 500’ E/W longwire; Radio West loop.                                   |
| RKS-NJ | Rick Shaften    | Sparta – Hammarlund HQ-180A, RS DX-392, two longwires, Sarserino loop; MFJ 1026 phaser. |
| DT-JAM | Don Trelford    | St. Ann’s Bay, Jamaica – Grundig Yacht Boy, whip, long “short” wire.                    |
| DT-ON  | Don Trelford    | Ontario – No details given.   |
| FV*MI  | Frederick Vobbe | Imlay City – Barefoot SONY ICF-2010.  |

## International DX Digest

Jim Renfrew renfrew@localnet.com  
 6988 Bank Street Rd.  
 Byron NY 14422-9702 Jim

Foreign DX Catches. Times are UTC; for ELT, subtract 5 hrs.

I’ve been experiencing some e-mail problems this week. I’ve got a new computer in my church office which I’ve been using to access my home e-mail account. One result has been a “frozen” IDXD disk, which I’ve only been able to recover partially. If you think I missed one of your reports, please send me another copy!

I felt like Shawn Axelrod in the frozen tundra today, when I went out to add five hundred feet to my east/west longwire. Although it was bone-chilling, the ground was actually still wet under the frost, so I finished with about twenty pounds of mud caked onto my shoes. I also added a 300 foot wire aimed SSW. As Captain Kirk might say, “set your phasers on DX”!

#### TRANS-ATLANTIC DX

- 177 GERMANY DLR Zehlendorf, NOV 28 0615 - Very weak with distinctive flute music, clearly parallel to same music on 6005 kHz. Signals also evident from 153, 162 (strong), 171, 183, 207, 216, 234. [Renfrew-NY]  
 252t IRELAND Atlantic 252, NOV 28 0622 - EE DJ and dance music, weak under NDB interference. [Renfrew-NY]

Jim speaks: “My tentative report to Iceland 189 (lots of distinctive details, but no ID) resulted in a QSL card in today’s mail. Yay!”

#### PAN-AMERICAN DX

- 380 CUBA UCY, site unknown, DEC 1 0548 - Non-directional beacon. 6[Renfrew-NY]  
 580 MEXICO. XEMU, La Rancherita del Aire, Piedras Negras, COAH. NOV 30 0259 - ended a light, romantic norteña ballad by baritone, well atop past 0300 station break, woman DJ, I’m guessing, closes her segment of the program on “La Rancherita del Aire,” says “Buenos Noches,” then man takes over and leads into a long string of local commercials with a Christmas motif, including one with a deep-voiced Santa going “Ho, ho, ho.” (Or is it Jo, jo, jo?) Several mentions of station slogan, “en Piedras Negras” heard during the commercials, but heard no call letters. I’ve logged this one from Pampa, Texas, in the ‘60s and Mt. Vernon, Illinois, in the ‘70s and ‘80s as the dominant Mexican on 580. [Callarman-TX] (This is the station that WIBW hates -pls.)  
 642 UNID, NOV 30 0407 - strong het, no audio on this auroral night. [Renfrew-NY]  
 670 MEXICO. XETOR, Radio Ranchita, Torreon, COAH. NOV 30 0231 - Finally got good tape on this one, with female vocal group singing “Radio Ranchito me gusta mas,” then male announcer with “XE-Tor, Radio Ranchito, 670 kilohertz, desde Torreon, Coahuila ...” and ID mentioned affiliation with a “grupo,” the name of which I could not pull out. This must be a successful station, because I’ve heard this call, slogan and format on this frequency at least a quarter century ago. First time here, though. [Callarman-TX]  
 690 MEXICO XEN Ondas del Lago, Mexico DF, NOV 30 0359 - MYL format (US tunes), call letter ID at 0359, then more music (included an “Ondas del Lago” voice-over). [Renfrew-NY]  
 700 MEXICO. Unid., probably XEGD, Hidalgo del Parral, CHIH, NOV 29 0354 - String of commercials heard weakly but readable in hard-to-obtain WLW null when music ended. Several mentions of Parral among the local retail commercials heard. If I were still sending reception reports, I’d not hesitate to send a 75-percent positive tentative on this one. [Callarman-TX]  
 740 MEXICO UNID, NOV 28 0700 - Mexican anthem (at local midnight), and then



signal gone. Los Mochis is the only station, as far as I can see, in the UTC-7 time zone. [Renfrew-NY]

740 VENEZUELA UNID, NOV 30 0257 - anthem, then gone. Radio Maracaibo is shown in the 1999 WRTH with a 0400 sign-off. [Renfrew-NY]

770 MEXICO. Unid. Tried to pull out identification NOV. 30 0201 by going over tapes where one station emphasized the "H" at the end of its call, but I could not determine in the production announcement earlier letter or letters. (Don't think he used the "XE".) There are at least three Mexicans audible on this frequency in KAAM null. [Callarman-TX]

780 MEXICO. XEMF, Que Bueno, Monclova, COAH. NOV. 29 1654, got to this one early enough to find loud and clear in weak WBBM null. Ended what was almost a ranchera/rap combination and gave identification. Problem earlier with production ID is that it's done by two voices, one through carbon mike (like an old telephone tape) and the other a soft-voiced man, but got clear XEMF call mentioned several times "Radio Sona (uncertain of this word) la Que Bueno, desde Monclova, Coahuila, capital de la ...". The first part did not sound like Radiodifusora ... and it did not say "capital del estado" which, incidentally, is Saltillo. Woman announcer, who appeared to be live, gave time check and continued with slow-paced romantic tune. This station had been on 970, with different slogan. [Callarman-TX]

790 MEXICO. XEBI, Radio BI, Aguascalientes, AGS, NOV 30 0240 -. I've been tracking several signals on this frequency, mostly a garbled graveyard sound, but at 0240 a string of commercials was heard dominating the channel, short announcement including "Radio BI, la estacion ..." and gave telephone number 91-50-790, el telefono de "Buenos Noches, Aguascalientes." That, it turns out, is the name of the production newscast that XEBI runs in this time block. Primary anchor is a woman and a light drumroll/fanfare is heard between each news item. At 0250, there was another string of local commercials, another "Radio BI" announcement, and program identification, "Esta es Buenos Noches, Aguascalientes." [Callarman-TX]

800 MEXICO. XEROK, Radio Canon, Juarez, CHIH, NOV 20 0102 - Full identification taped in passing. This former border baby (as XELO) has been weaker than expected here and I noted a second Mexican in its null 24 hours earlier ... but nothing else tonight. [Callarman-TX]

810 BAHAMAS ZNS3 R. Bahamas, Freeport, NOV 11 0240 - Some sort of rally with woman speaking in an echoey hall about social conditions in the Bahamas. Then the Prime Minister of the Bahamas was introduced. Just over, even with, or just under WGY. Neither was very steady or strong. There were only a few Cubans noted, so this is a welcome surprise. [Kennedy-PA]

830 MEXICO. XEIK, Piedras Negras, COAH, nov 30 0035-0100 - Loud, steady signal with regional newscast, lots of reporters in different Coahuila communities including Piedras Negras and Acuna. Last item on the newscast had a San Antonio dateline and reported the death of veteran Texas Congressman Henry Gonzalez. The newscast is presented by "Nucleo Radio Socola," apparently a network of Coahuila stations, and, after a drumroll, this identification was heard: "La Norfeña, 830 en la banda amplituda modulada, transmitiendla desde Piedras Negras, Coahuila." I had done some extensive taping of this one last year in Mt. Vernon, Illinois, and heard this newscast several times, and noted no call letter ID at 0100, but had heard XEIK ID later when the station was in its music programs. This station has not been heard later in the evening HERE, and thus it may be paying more attention to its night power than it was last year when I heard it on the car radio on the newspaper parking lot well into the night on auroral nights when WCCO was gone. [Callarman-TX]

840 MEXICO. Unid. NOV. 30 0224-0226 briefly broke through difficult WHAS null and gave quick announcement including something that sounded like "La Palanta." I played tape several times to see if I could pull out either "Pachanga" or "Papantla" but could not. This station's music was more Tropical than Norfeña. [Callarman-TX]

*John speaks:* "I'm continuing to explore the lower part of my Mexi-dial and am coming up with some interesting catches, including one state I've never heard before, from either the Panhandle of Texas or Southern Illinois. I think I'm having a little more trouble than I should with some of these stations because neither 1) my ears nor 2) mi español are as good as they were 25-35 years ago. But I'm having fun, and that's what counts. It also whets my appetite for what I could hear with a good receiver and a phased antenna system."

*Steve speaks:* "I've been avoiding this south of the border stuff because there's very little to be tuned that's not in Spanish. I waste a lot of time trying to ID them only to discover that it's one I don't need. But when you get something new, like the Bahamas, how can you say no?"

#### CONTRIBUTORS

@John Callarman, Krum, TX; Optimus STA795 an RS 15-1853 loop. <JohnCallarman@email.msn.com>  
Steve Kennedy, Coal Township PA.

@Jim Renfrew, Rochester NY; Drake R8, 500' E/W longwire, Grove antenna tuner, SM-1 loop.  
<renfrew@localnet.com>

# DX'er's Notebook

*Shared tips, topics, and Internet info*

**Dave Braun** [dcbraun@delanet.com](mailto:dcbraun@delanet.com)

863 Allabands Mill Rd.

Camden Wyoming DE 19934-2132

R-1000 HELP

First off, can anyone help Phil with his request?

**Phil Bytheway** <phil-bytheway@teknologic.net>: I have an R-1000 with a big crack in the front panel (about 4 inches in the lower left side). Any ideas on where I can get a new one or one off a "dead" receiver? Kenwood tells me they no longer sell parts.

DX CONDITIONS

This continues last week's thoughts about the state of the ionosphere.

**Patrick Martin** <mwdxer@webtv.net>: Yes, I do think that MW transmitting sites are not what they used to be. Here in the USA many stations do not have the "punch" they used to have. There are exceptions to the rule like KGO-810, KNBR-680, KFI-640. But stations like 970-Portland, that used to be KOIN for years. They get out very poorly now. Stations QRM with them 15 miles out of Portland at night. That never used to be the case. Maybe more than atmospheric conditions may be the transmitting systems in the year 2000.

**Ben Dangerfield** <ben-dangerfield@email.msn.com>: Here is my .02 on the subject. Most of my TPs were heard and verified during low sunspot years when there were much less frequent auroral cycles. These were New Zealand on 660 [Oct 64] and 780 [Feb 64]; Australia on 740 [Oct 62] and 1510 [Apr 64]; China-1525 [1974]; North Korea on 655 [Apr 65]. Only Tarawa-844 was logged and verified in what seemed to be a high sunspot year, [Mar 70], and that is more in the direction of Tahiti which Bruce recently heard. Of course, in those distant times we had far more open frequencies in the early morning hours, mostly on Monday mornings. Now nothing is ever open or clear.

**Russ Edmunds** <wb2bjh@nrcdxas.org>: Interesting points! I, also, heard Tarawa-844 from Northern NJ in relatively unspectacular conditions. China-1525 was heard many times, most during the minimum years in the 1973 area, but that one's a bit different in terms of the propagation involved. I tried numerous times during that period for 4QD-1550 without result.

**David Hochfelder** <hochfeld@rci.rutgers.edu>: Hello, I've been following the discussion about the ionosphere being somehow maxed out in recent years, and I have to admit I'm a bit baffled. Granted: it's been almost ten years since I abandoned electrical engineering for history, but I did specialize in electromagnetic field theory. Two points: First, I would be very surprised if the ionosphere has some sort of saturation point with respect to incident power density beyond which its ability to refract radio waves is degraded. Or at least, that that limit, if it in fact does exist, is somehow being reached now when it hadn't thirty years ago. Although, to be sure, that would be a difficult proposition to test and even more difficult to determine experimentally some sort of mathematical relationship between incident power density, frequency, and refractive ability. Throw in latitude and you've got quite a research project. Secondly, as far as Harry Helms' point about generating a lot more RF radiation from light dimmers and PC power supplies, I would be very surprised if items like that would affect the ionosphere at all, just from sheer inverse-square considerations. Certainly an individual light dimmer or power supply would have no effect on the ionosphere. While they might radiate a lot of power in aggregate, their collective power density (W/m<sup>2</sup>), not total power, would appear to be the governing parameter. Because of this I just don't see how they would affect the ionosphere at all. If MW signals just don't have the oomph they used to, it's something more down to earth, like more stations on the band, or it's something to do with this solar maximum being less intense compared to past ones. We've only been observing the sun for a couple hundred years or so, and with respect to radio propagation for eighty, and it wouldn't surprise me if the solar cycle is much more complex than we know now. Another controversy: does the ionosphere actually somehow boost southerly signals in absolute terms during auroral events as compared to their usual received signal strength, or does the aurora simply block interfering northerly signals, making the southerly signals stronger only in relative terms... My opinion on this is that the ionosphere would act to increase absolute signal strength at the receiver only if a geomagnetic storm made the ionosphere in southerly latitudes a better "conductor" at the frequency in question. The real issue is how to test that. Any geophysicists out there? Does anybody know what the HAARP project up in Alaska is all about? Is their research relevant to these questions? But, hey, I can discuss the fine points of radio propagation forever, but until I upgrade from the Superadio 3 it's all academic. Not that I'm complaining: it's the best sixty bucks I've spent as far as the fun I'm getting out of it.

**Patrick Martin:** What an interesting point Dave made on the atmosphere. One point is that I do believe that when AU conditions exist, there is a "boost" to signals to the South. The reason I say this is that many frequencies (splits) like 1017 kHz



(Tonga) has much better signals than normal as most of the Pacific has. There is the boost alright, no doubt about that. Oh course knocking out signals to the North is a plus when there is interfering signals, too.

**Patrick Griffith** <AM-DXer@webtv.net>: I was wondering when someone was going to bring up HAARP. For those that don't know, HAARP is the High Frequency Active Auroral Research Program. It is still under construction and presently running power levels somewhere around 1 million watts. When completed it will be capable of pumping 3.6 million watts of high frequency energy into the ionosphere above southeast Alaska. But HAARP is not the only such project. UCLA has been running another project in Alaska called HIPAS, the High Power Auroral Stimulation Project. They are reportedly pumping out 1 million watts at ELF/VLF frequencies. There are also high power ionospheric stimulation projects operating in Peru, Norway, Russia, and other locations and there is reportedly a similar project called HISCAT being planned in Sweden that will put out 1 billion watts (1 gigawatt) of RF! If you think about the billions of watts of RF that is being radiated into the ionosphere every day from 'normal' broadcasting as compared to a far lesser amount being radiated 20, 30, or 40 years ago, you've got to wonder if there isn't a correlation in the apparent decrease in coverage we all have noticed.

**Mark Durenberger** <mark@durenberger.com>: In fact there has long been predicted a form of ionospheric intermodulation or sky-wave cross-modulation known as the "Amsterdam" or "Luxembourg Effect." It has been demonstrated that high-power RF actually changed the levels of ionization in the atmosphere and even caused plasma wave generation. I believe it was Consultant Ted Schober who told me of his calculations that a super-power station in the Caribbean would wreak serious havoc with 1560 out of New York. So there's been a bit of thinking about this.

**Harry Helms** <ak6c@earthlink.net>: That was part of my thinking. We are putting so much RF, at all frequencies, into the ionosphere today that I wonder if we are not degrading its refractive properties. Let's rewind to a century ago. On this night in 1900, the only excitation of the ionosphere would have been from purely natural sources, such as solar activity and thunderstorms. Contrast that with the RF the human race is radiating on a wide range of frequencies. Clearly the ionosphere is being "unnaturally" excited. The question is whether this is playing a role in the degraded MW DX reception many of us are noticing. My remarks about man-made RF generators were not as precise as they should have been. True, the radiation from light dimmers and power supplies is not sufficient for skywave propagation, but that is not true of other RF noise sources such as power lines. For example, there are powerlines which parallel Highway 395 here in California for several miles, and MW reception of even LA powerhouses like KFI-640 is impossible for several miles; there is a constant broadband "buzz" that blankets the AM band and is especially powerful near the transmission towers. I wouldn't be surprised if the collective radiation from those lines could be measured in kilowatts. Ditto for the electrical noise in urban areas. It's like the BBC and NHK synchronized transmitters heard in North America; the individual power of each transmitter may be low, but the combined strength is impressive. I'm convinced that some of the noise I hear at night is being propagated from the SF Bay Area, Phoenix, or Salt Lake City. Doubtless the deterioration in transmitting facilities, especially ground systems, is playing a big role in reduced signal levels. However, the decline has been so across-the-board, affecting so many stations in various areas and nations, that I think something more is involved. Radio propagation is a science very much in its infancy; available data only goes back a little over 80 years. Imagine how many erroneous conclusion we would have in astronomy if we only had data going back 80 years! I suspect there is far, far more to radio propagation than we currently know. Maybe the ionosphere is being degraded by all the RF we're asking it to propagate. Maybe there is a decades-long cycle in solar activity that we haven't noticed yet that is producing these conditions. Or maybe it's a combination of these and other factors. Hopefully researchers will notice what we DXers are observing and conduct research into this question.

**Russ Edmunds** <wb2bjh@nrcdxas.org>: "I was wondering when someone was going to bring up HAARP." Nor are these a new thing. Scientists in Russia and Alaska have been conducting such experiments for a good 25 years - the number of transmitters and the powers have increased, and new projects replace old, but this is and has been one of the primary methods used in investigating the effects of geomagnetic activity on radio signals of all types. It's become particularly important in view of the increased amount of earth-to-satellite-to-earth radio communications of all kinds.

#### WORLDWIDE MW COVERAGE

**Mark Connelly** <MarkWA1ION@excite.com>: "my best-ever logging of Saudi Arabia-1521 here in Missouri was in January 1995 right at the onset of a monster geomagnetic storm. It totally OBLITERATED 1520 at their 0300 sign-on." This station must have close to worldwide MW coverage. I remember hearing Saudi-1521 from El Paso, Texas when I was there on a business trip in late 1986. I was just using a Sony ICF-2010 and Palomar Loop from a room at the Residence Inn near the airport. When I turned the loop to reduce KOMA-1520, Saudi slipped right by. I think Neil Kazaross and/or Tim Hall heard this in California on a desert Beverage. The station has also been heard by Richard



Wood in Hawaii both via "long path" and "short path". In what must be an all-time MW DX distance record, DXers at a beach in New Zealand heard Saudi-1521 coming in circa 0300-0400 UTC (a bit pre-sunset at their end and post-sunrise in Saudi) on a super long path across the Pacific, roughly across Panama, and then over the Atlantic and North Africa. For US stations with global "get-out-ability", WBZ-1030 Boston, with its salt-marsh transmitting site, is logged often in Europe (not a big deal) but, more interestingly, has been heard by Dave Orley in Australia, Paul Ormandy in New Zealand, and other DXers "Down Under" even with KTWO and other closer US signals on the channel. I have a tape of WBZ recorded by a ham buddy who was in Vietnam in the US Navy in 1965. The signal was quite good for 9000+ miles.

**Robert Foxworth** <rfoxwor1@tampabay.rr.com>: "WCBS New York at 880 with a non-directional signal is another one that seems to be logged on a regular basis by DXers down-under." The WCBS-880 and WNBC-660 site (shared tower) is on High Island, a 5-acre island adjacent to the north end of City Island, part of the borough of the Bronx, New York City, adjacent to Pelham Bay Park. You need a really detailed map to see this island as a named entity. There is a footbridge connecting the two islands (or was when I was there). There is an overwater path for a long distance over Long Island Sound heading to Europe, which may encourage good groundwave for a distance before the signal takes off at a grazing angle to become skywave. This opportunity exists towards the southwest as well, but to a lesser degree. There are several miles of mainly overwater path, leading from the WCBS site, before crossing land, and this probably helps the grazing signal achieve maximum hop distance towards N.Z. as well (but less so towards Australia which is nearly due west from NYC and blocked immediately by land) I believe the WBZ site has a similar situation. Perhaps the tower height is really optimum for 880. They use a resonant gap about 4/5 of the way up, WNBC uses the entire 500-foot height. I don't think WNBC is reported as often as WCBS so perhaps this is partly why. Here in central Florida, reception of WNBC and WCBS don't always occur well at the same times. Sometimes and other times not, which is interesting as the path is identical and frequencies not.

**Frederick R. Vobbe** <fredv@nrcdxas.org>: Here in Ohio (western side), I can count on WCBS to be in here better than WNBC ever was, and that goes back to the mid 60's when I started DXing. I know they are on separate sites, but the path from Chicago to Lima, 890 is best, with 670, 780, 720 being the next in line. It would be interesting to take hourly field strength readings from various locations in the US on 660/880 and see what the strength does at various times 2 hours before sunset to midnight.

**Kevin Redding** <lwdxer@juno.com>: I can tell you that as late as 1987 I could hear WCBS, WNBC, WBZ, WBAP and KMOX as far east as the Straits of Gibraltar using a Sony ICF-6500W. I was aboard the USS Caron DD-970 on the way to Lebanon when I heard them. I have no idea if they can be heard there today. The signal that amazed me back in those days was that KTRH was always with a HUGE signal into Central and South America back then.

**Patrick Martin**: Back in the 60s and 70s, before all the QRM, WCBS was always better than WNBC out here in OR. WABC had QRM from KOB, but WCBS was common.

**Robert Foxworth**: 1987 was a good solar minima year. In that year I could hear CBN atop 640 at 5PM, DXing from Long Island, Portugal-720 atop WGN, Soviets on 171 LW signing on, etc. all in December of course. KTRH is hard to hear here, sometimes I can get them at local sunrise behind Orlando but I never hear them at night. In recent days I have been hearing KKYX-680 with Radiomundo WRMD nulled (a local) late nights, and KGNC-710 under the two Spanish signals on 710 at sunrise last week I've been trying for KFI at sunrise but this year WGST is turning out to be a real nuisance. I had KFI a few times at 7 AM last year once Cuba is knocked down with looping..

**Randy Stewart** <jrs555t@smsu.edu>: My dos centavos' worth on the NYC clear channel outlets... (that's 2 cents, y'all) I've never gotten the 660 New York station as well as WABC-770 or WCBS-880 here in southwest Missouri. Actually, these days WFAN is more of a regular than it was in its WNBC days for some reason, though the multiple Mexican station QRM kills it most of the time. And WHAM-1180 in Rochester has always been the strongest of ANY signal from New York state.

**John Tudenham** <w0jrp@earthlink.net>: Same here in Joplin 70 miles west of Randy. Have heard WOR but very difficult in KCMO null and Cuban station.

**Randy Stewart**: Yeah, they're not really a regular, but certainly audible here in MO. I've also heard the Bloomfield financial-news station (WBBR? Not sure of the call off the top of my head...) on 1130 on sunset skip, and WQXR-1560 (i.e. while they were still all-classical). Also WGY-810 Schenectady does okay here on occasion. I have a tentative reception of Yeah, I know, folks, this ain't exactly "rare DX" we're talking about here, but hey, we don't receive NY state out here with the same regularity that we do, say, WLS or WBBM!)

**Ronald Gitschier** <1570wyhi@bellsouth.net>: I recall hearing WNBC 660 in Lowell, MA during the daytime better than WABC 770 during the daytime. Lowell, MA is about 25 miles NNW of Boston, about a couple of miles south of the first 'crook' going W to E in the MA/NH state line. This is back in 1978 to 1981 time frame. And using car radios and also a really nice radio; a Panasonic RF 1150 (or was it 1180). I'd put this against the GE Superadio, nice AM section, FM section, SW, and CB. Audio is sweet w/ sepa-

PO Box 2020  
Paradise, CA 95967

930AM



(916) 877-3872  
343-3808

BUTTE BROADCASTING, L.L.C.



rate bass and treble controls. I still have it, though it's in ragged condition and can't ever part with it with the hopes of rebuilding it. Also has a signal/meter. External AM ferrite rod antenna that rotates off the top of the radio, looks just like a handle of sorts, and antenna input screws, multiplex out via 1.8" jack, earphone jack, and line out. And a (manual) timer too. Bought for about \$110 in or around 1978. Musically between WABC and WNBC, I liked WABC better at the time. But WRKO would be my first choice. To get WNBC, I'd have to null WRKO which was about 11 miles directly south of my home in Lowell, within sight of 680's tower lights. To my recollection I got WCBS 880 about the same as WNBC 660. I have a coverage map or two from WNBC's engineering department and a short note from Greg Aull intern typed on a Bill Krause memo pad. Also I used to listen to WFAN 660 during the dawn and daylight hours commuting from Barco, NC to Norfolk, VA with a great signal. I don't recall in detail WCBS 880's signal because I used to listen to Imus from '92-'95 driving into work, and occasionally back home. For news I'd listen to the former WNIS 850 (now WTAR) or WTAR 790 (now WNIS... lol) when they were competitors. Worldwide coverage, I don't have a candidate. I loved listening to Radio Luxembourg on 1440khz in the Persian Gulf during the war when the Saudi 2MW 1440 was off the air, heard on an aircraft carrier with a Kenwood TS-430 and a Cushcraft R-5 Antenna hung off the side of the flight deck. Barefoot the Kenwood transceiver proved to be useless for MARS, but me being me, that station was pressed into different, personal uses as the World's most heavily fortified 11m mobile marine station and AM DX listening post. What? Can't work that station in Malta, no problem, wait patiently and you'll get 60db over 9 when you're sailing by. Or listen to Rap music with all the swear words on Algerian AM stations... This was between bombing missions, of course...

**Richard Toebe** <richtoebe@jps.net>: I agree with Pat; when I started DXing in Pleasanton CA in 1970, WCBS was an almost nightly reception, WNBC not as common or strong. WABC was mainly heard during KOB silent periods. In the late 70s when I lived in Reno, I had WLS set as a button on my car radio, and got a kick out of listening to it driving home from night school. The other interesting thing is, how TP's just aren't there anymore. Hawaiians used to be common, now in the last two years the only Hawaiian I've heard was KHLO-850. Of course I'm not talking about beverage coastal receptions, but at home with a loop. You can point out the loss of 650 because of KSTE, and 830 because of KNCO, but what about 550, 590, 690, 760, 870, 900, 1040? All were heard at least occasionally. In all the discussion about the ionosphere, I wonder if the antennas have been rejiggered to cut down on skywave.

**Patrick Martin**: I do think many "newer" stations like KAPS-660-Mt. Vernon, WA have been set up to cut down on skywave. That is true, but I do also think something else has changed to weaken signals, no matter what direction they come from. I remember back in the late 60s, when the band was clear on MMs, only a few NSP stations. Many clear channels. Oh course that has changed, but even when KDWN is off on 720 on MMs, WGN is generally very poor. They used to be armchair copy with a loop, let alone a beverage aimed at them. I remember a old time DXer told me that sometime in the late 40s or early 50s, there was a period when DX on MW was terrible for a number of years. Has the same thing happened today? The only reason some of the DXers are hearing more is because of coastal locations and better antennas?

**Russ Edmunds**: I really do think that the answer is the simple one - greatly increased numbers of stations everywhere and greatly increased numbers of noise sources, also everywhere. And secondly, not every sunspot cycle is identical to the prior one, or the one before that. If a comparison were done using, say, smoothed mean A- or K- indices over a period of 3-4 cycles, I think the results might well show that the differences also account for some of the observations. These two together could explain some pretty substantial differences in observations over time, and remember, too, all we're dealing with here is anecdotal evidence comparing what we remember to what we hear now, or maybe in some cases, comparing tapes.

**Richard Toebe**: But Russ, what I think about is that I can still hear WLW even with all the new 700ers here on the Left Coast, but it's been years since I've heard KDKA, which used to come in even with Roswell NM on 1020.

**Russ Edmunds**: And to me, that is evidence of the variability of things - for you there are probably more signals on 1010-20-30 to interfere than there are on 690-700-10. Of course it could also be — and depending on how far back you're going, may very well be — a result of changes at the stations themselves. I know that KDKA scrapped their old tower during that period, as a for instance.

#### DX NEWS PUBLICATION

This is the continuation of the discussion on the future of the club's publications.

**John Tudenham** <w0jrp@earthlink.net>: I also miss the old days when we had many musings. Paul and others doing a great job to produce the current DX news. As far as DXing the most difficult thing to ID a station on the AM dial is the lack of ID's. When most stations had local programming and played music you could catch an ID between every song.

**Steve Francis** <Pellisipi@aol.com>: Speaking of songs, I remember DXing frequency checks, nearly all of which ran a quarter-hour of tone, breaking for an ID every five minutes. You'd hope against hope that the station with the frequency check would stop for that ID while the dominant station was running commercials. You knew

**KVLI radio**  
1140 kHz  
4120 Barlow Drive  
POST OFFICE DRAWER "T"  
LAKE ISABELLA, CALIFORNIA 93240  
(619) 379-4146

when the top dog went back into music, you'd have no hope of an ID from the frequency checker for the next two and a half minutes!

**Frederick R. Vobbe** <fredv@nrcdx.org>: Let me also offer something to this "On Line DXNews". While it's cool to us, let us not forget the people who do not have access to the Internet, nor the ones that have any use for it in their "radio hobby". On the DX Audio Service side... it would be MUCH EASIER for me to publish web only, and produce just audio files. However, 90% of our membership does not have, nor would they want to get their magazine off the web. You have to keep this thought in the back of your mind. Just because you can do it, does not mean everyone can. What you have as a cool tool on your desktop means nothing to 99.9% of the rest of the folks. I would not support moving to an Electronic version. Unless you are just trying to save a few cents a week, it's easier to get a magazine than use a web page, in my humble opinion. You know, I wonder how many listeners and readers Media Network will have compared to last year at this time now that they are Web Only. <grin>

**Patrick Griffith**: I've been trying to stay out of this but I have to say that I agree 100% with the above. I know that the majority of my co-workers, both older and younger than myself, are not internet capable and are not computer literate. I don't understand this because I don't know how I would survive without web access today. But it's a fact. If you take a look at the magazine racks in a Barnes & Noble store or a Borders Books store you will realize that there are hundreds of periodicals in print. This wouldn't be happening if people weren't buying them. No profit, no production. Why haven't all of these magazines swarmed to the net and e-publishing? It's because most people can't or won't read them there. I am very active on the web yet I personally read between 15 and 20 periodicals monthly. I don't think that's going to change for a long time. And look at the NRC. The fraction of members that you see here on the web is a very small percentage of the membership. Why? Because the majority do not have internet access. Those of us who are internet capable and are computer literate sometimes tend to think that everyone is. And that's not true. I suspect that we are still a minority in this country and I am sure we are in the rest of the world. So I agree that if you went to an e-version you would still have to maintain the hard copy version as well. I think that the e-version presently would serve a minority. <soap box off - 2 cents deposited>

**Mike Pietruk** <pietruk@shellworld.net>: In an electronic form, my personal favorite is a straight text file as it gets away from the need to be concerned whether or not all computer platforms can deal with it. As an aside, the ultimate answer to the question of how DX News is to be distributed ought to rest not with the board but rather those in the field who actually use the publication. Obviously, the IRCA has wrestled with the issue finding the practical compromise of providing 2 versions - a more frequent and cheaper email format and the traditional print. Where the IRCA will go from here in the years to come, only time will tell. The NRC board needs to accept the notion that the world evolves over time just as radio has. The trick is getting the comfort zone expanded as, if it is not, over time the club may not be able to best serve a major contingent of its members both existing and potential. I can only imagine the fears that the DXAS initially created in some; yet, it has served the club over the years. I can also imagine the fears the email list has had; yet, it too has served the group well. And serving the group and its members as a whole should be the first concern.

**Doug Smith** <w9wi@bellsouth.net>: True, but there's no way to distribute pictures/graphics in a text file. HTML is a good alternative though. Web browsers exist for every reasonably recent OS (I suppose C64 and Apple II users are out of luck<g>) and just about everyone has one. Plus, browsers exist which are friendly for the visually-impaired. (I doubt a voice-capable PDF reader exists) There's no need to buy composing software to create HTML files. Both Netscape and Internet Explorer include a composer that could do a credible job of creating an electronic DXN. Indeed, with a few well-written macros one could really compose an electronic DXN with a text editor. Is there a PKUNZIP for MacOS? Because an "EDXN" would consist of multiple files, (and because many of those files would compress very well) it would be sensible to zip them all up into one file, but only if everyone could expand the zip.

**Mike Pietruk**: Doug, You are right in the problems that .pdf files can cause for blind users. And, yes, you are also right that html files likely present the best possibility of combining flexibility of platform with ease of use. I just hope that PLS and the rest of the NRC hierarchy can become willing to at least experiment with the possibilities not at the expense of getting rid of the print publications (that would be a major mistake) and see what new opportunities that might present for the NRC.

**Wayne Heinen** <Nrdog@aol.com>: "As an aside, the ultimate answer to the question of how DN News is to be distributed ought to rest not with the board but rather those in the field who actually use the publication"... "And serving the group and its members as a whole should be the first" Mike, The point being? A few people indicate that they would like an electronic DXN, they're on the list and on line. If and when a large quantity of dues paying NRC'ers approach the board, it may be something to consider. I frankly prefer to have DXN the way it is, much easier to read a nicely printed bound magazine while laying in bed than a fuzzy .pdf off the IIP+. By your own statements the board is doing its job. We respond to the membership, we also realize that most change requires someone to volunteer who has the time, knowledge and desire to do a job. Most NRC project,

The Beat 1650  
KBJD-AM

including the major publications, DXAS and this list are managed by volunteers who fit that description. When the paying membership has a wish to change, the board will act to facilitate the wished in the manner best suited to the benefit of the club and the hobby...

**Russ Edmunds** <wb2bjh@nrcdxas.org>: "As an aside, the ultimate answer to the question of how DN News is to be distributed ought to rest not with the board but rather those in the field who actually use the publication. Obviously, the IRCA has wrestled with the issue finding the practical compromise of providing 2 versions - a more frequent and cheaper email format and the traditional print. Where the IRCA will go from here in the years to come, only time will tell. The NRC board needs to accept the notion that the world evolves over time just as radio has." The above misses one very essential point! As a volunteer club, what gets done is always a function of the abilities, time, and, yes, sometimes even preferences of those who are doing the work. I don't wish to put words into Paul's mouth, so let me try to say this as clearly as I can. \*If\* it were determined to also do an E-DXN, and \*if\* this would add work for Paul, then I think Paul should have a major part of the decision. The same would be true for the Log and for Wayne. That is the way this club has been run, with a couple of diversions such as one we've mentioned here a few times in this thread, and has, along the way, been in divergence with the way IRCA has been run, even though both clubs have changed along the way. But in my mind, as I've said here before on this - a major gating factor is "who's going to do the additional work, and does it work logistically?"....

**Phil Bytheway** <phil-bytheway@teknologic.net>: Russ/Folks, I volunteered to do an email version of DXN back when I started the SDXM. The NRC BoD said NO. You are correct, however, that it would require more work by Paul no matter how it is approached, even something simple can take up a lot of time... right Paul?

**Russ Edmunds**: And I think Wayne made the other very critical point, probably more directly than either Fred or I or others did - looking at a membership of hundreds, there hasn't been, and is not yet a sufficient number of members asking for an E-DXN to constitute a significant demand. (And that does not preclude the possibility that this very discussion may not somewhere along the line lead directly to such a demand coming about). One more thought here - I would personally be very happy to have \*both\* an E-DXN and a CD-ROM Log. But I recognize that there is still only a minority of the club who feel that way now, and for some unpredictable time going forward.

**Paul Swearingen** <PlsBCBDXER@aol.com>: "No disrespect intended, but anyone who thinks keeping material in strictly hard copy is some sort of protection against infringement is kidding themselves." You may be quite right; and the problem is more of a moral than a technical issue anyway, and possibly moot, as the world now knows that the NRC isn't going to stand by idly whilst being ripped off. Interesting that the rip-off individual in question called us a "bunch of hicks" when he didn't get his way and threatened that "the NRC will be history inside a year." Well, we "hicks" are still firmly in charge; the NRC is more sound than ever; and HE is history! Also ironically, we think that there are far more copies of DXAS tapes being passed around than copies of DX News. And, yes, no one has dared to copy the NRC AM Log since that sorry episode 8 years ago. Perhaps I'm just happy that IRCA has found a niche market with SDXM, and I don't want to get into the business of running competition to Phil Bytheway's fine efforts with SDXM and AMDXNF? "I'm not trying to get rid of Paul - NOT YET ANYWAY!:-)" Go ahead! Make my day! Not really - I'm far from wanting to retire - and even at the ripe old age of 55 I could still learn how to handle .pdf publications. There may even be some future in offering entire volumes of DXN on CD-ROM's, for example. "but I did want to raise this issue as I think most radio clubs will have to eventually consider going to electronic bulletins to compensate for rising costs and declining membership (fortunately, the latter is not a serious problem for NRC at this time). Bob Grove at Monitoring Times has seen the future and is being very smart about offering MT in .PDF form." We're stabilized, for now, at between 690 and 710 members/comp copies, although it was only 3 years ago that we boasted 820 members, our all-time high membership point.

(? -pls.): "I have been scanning and saving issues of 1960s electronics magazines I own (like *Electronics Illustrated* and *Radio TV Experimenter*) because the paper they are printed on is getting discolored, brittle, and is clearly not much longer for this world." Copies of DXN from '88 on are printed on better-quality paper than most magazines. I don't know the exact rag or acid content, but I do know that they are NOT fading or decomposing. I may be generalizing a little too much, but low-budget letterpress printing was usually done on cheaper stock, whereas the offset process allowed for the use of longer-lived paper. (Again, ironically, the best-quality printing is done on slow letterpresses.)

## NRC's Antenna Manuals

Now completely revised and up-to-date!

Antenna Reference Manuals, Vol. 1 and 2,

\$6.95 each (\$9.95 to non-members)

Loop Antenna Design & Theory,

\$8.50 (\$12.95 to non-members)

Order from NRC Publications - P. O. Box 164 - Mannsville, NY 13661. NY orders, please add sales tax.

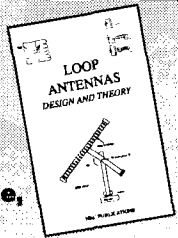

## Three Loop Antenna Array with Electrically-Rotatable Nulling

Mark Connelly, WA1ION

By using three broadband loop antennas set up at 120 degree bearing differences, a fully rotatable single-null (cardioid pattern) can be achieved by combining given pairs of loops. Furthermore, the three inherent figure-of-eight (double null) patterns produced singly by each loop can be "slewed" by as much as 30 degrees off their normal axes when the loop in question is phased against one or both of the remaining loops.

Good broadband results may be obtained with each loop element consisting of a 2.5 m (8.2 ft.) per side square: 10 m of wire total per loop. This is mounted in the vertical plane with the bottom side of each square no less than 0.5 m (1.6 ft.) above ground level. The wire comprising the loop may be formed on a non-metallic frame structure or simply held in place with ropes to tree branches or other supports. The feedpoint of the two wire ends is usually at the center of the bottom side (1.25 m from each low corner) and these wire ends connect to the primary of a 1:1 balun transformer, Mini-Circuits T1-6-X65 or a suitable homebrew equivalent. The balun should be mounted in a weatherproof connectorized box for permanent installations. The balun's secondary winding connects to coaxial cable which goes back to the operating position. Satisfactory results should be possible with cable runs up to 50 m / 164 ft. and perhaps longer. The minimum distance between the winding of any one loop and the nearest part of any other loop should be at least 5 m / 16 ft. to reduce unintended pattern alterations.

The maximum pick-up of each loop element is in the two directions obtained if one extends an imaginary line from the top or bottom (horizontal) parts of the square. Nulls are at a right angle to the plane of the loop. Figure 1 (after this article's text) shows the inherent pick-up patterns if the three loops are set up for 0:180, 60:240, and 120:300 degree peak orientations. (Note: 0 deg. = north, 90 = east, 180 = south, 270 = west.)

At the operating position, the coaxial cables from each of the three loops go to inputs of the Loop Switch / Amplifier box (figures 2, 3). This box has a fourth input jack, the auxiliary (AUX) input, that may be used for an omnidirectional horizontal loop, a vertical whip, a random wire, or any other antenna that the operator feels would enhance the usefulness of the set-up.

Switches on the box allow any of the four inputs to be directed to the Line 1 amplifier or to the Line 2 amplifier. Low noise amplification of about 15 to 25 dB is usually necessary with the relatively small broadband loops being used. One could connect two or more inputs to a single line amplifier for potentially unique null solutions, but I won't try to figure out when that could be helpful: that's better left to the end user.

The box's Ground Switch connects loops' coaxial shields to "station ground" (common) or allows them to float. Different locations will exhibit different results in terms of which Ground Switch setting yields the better ratio of desired signals to local electrical noise.

A cardioid pattern, or a close approximation thereof, can be produced with a given pair of loops having a minimum of 60 degrees and a maximum of 120 degrees between the peak pick-up axes of each. Optimum (truest cardioid) nulls will be on the bisector angle between a maximum pick-up lobe of the first loop and that of the second loop. If two loops were oriented so one pointed north-south and the other east-west (90 deg. spread), cardioid nulls would set up best on northeast, southeast, southwest, and northwest axes. As you choose bearings farther from bisector values and closer to inherent loop nulls, the patterns produced by phasing two loops would more closely resemble the figure-of-eight patterns of a single loop because one of the two loops is doing most of the work creating the null and only minimal added signal from the other loop is needed to move null depth from moderate to maximum. There are some situations in which a somewhat rotatable figure-of-eight is the desired pattern instead of the fully rotatable cardioid. The three loop system gives both options.

Looking at the 0:180 loop combined with the 120:300 loop may be instructive.

The 0:180 loop has inherent figure-of-eight nulls at 90 and 270 degrees. By coupling in a little RF from one or both of the other loops, slewed figure-of-eight nulls can be obtained +/- 15 degrees from 90 degrees and from 270 degrees, i.e. in the 75-105 and 255-285 degree ranges. The 120:300 loop has nulls at 30 and 210 degrees that can be similarly "stretched" to 15-45 and 195-225 degree ranges.

Bisectors for cardioid nulls are at 60, 150, 240, and 330 degrees. These are halfway between lobes at: 0 and 120, 120 and 180, 180 and 300, 300 and 360(0). Cardioid null ranges can be stretched to be 45-75, 135-165, 225-255, and 315-345 degrees. At the edges of the stretched ranges, the cardioid starts to degenerate into an asymmetrical figure-of-eight with one major null and one or more minor ones at

bearings not quite opposite the major one. If a true cardioid is desired and a certain pair of loops is causing reduction of desired direction DX as well as signals to be nulled from the opposite direction, use a non-directional antenna (whip or horizontal loop) at the AUX input to phase against one of the loops for better results.

Pairs of loops to be used for movable nulls (cardioid pattern, figure-of-eight pattern) are shown in Figure 4. Loop #1 is oriented for maximum pick-up on the 0:180 axis, loop #2 is aligned for peaks at 60:240 degrees, and loop #3 has peaks at 120:300 degrees.

A simple-to-use (preferably broadband) phasing unit should be used on the two outputs of the Loop Switch / Amplifier box. The DXP-3 model should work well for this, at least in medium frequency (300 kHz - 3 MHz) applications. Links to design documentation for DXP-3 and several other suitable phasing units may be found at my RF Circuit page "http://www.qsl.net/wa1ion/index.html". (If, at a future time, this URL becomes unusable, contact me for updated information.) Some phasing unit construction articles may be obtained in paper form from the National Radio Club reprints service.

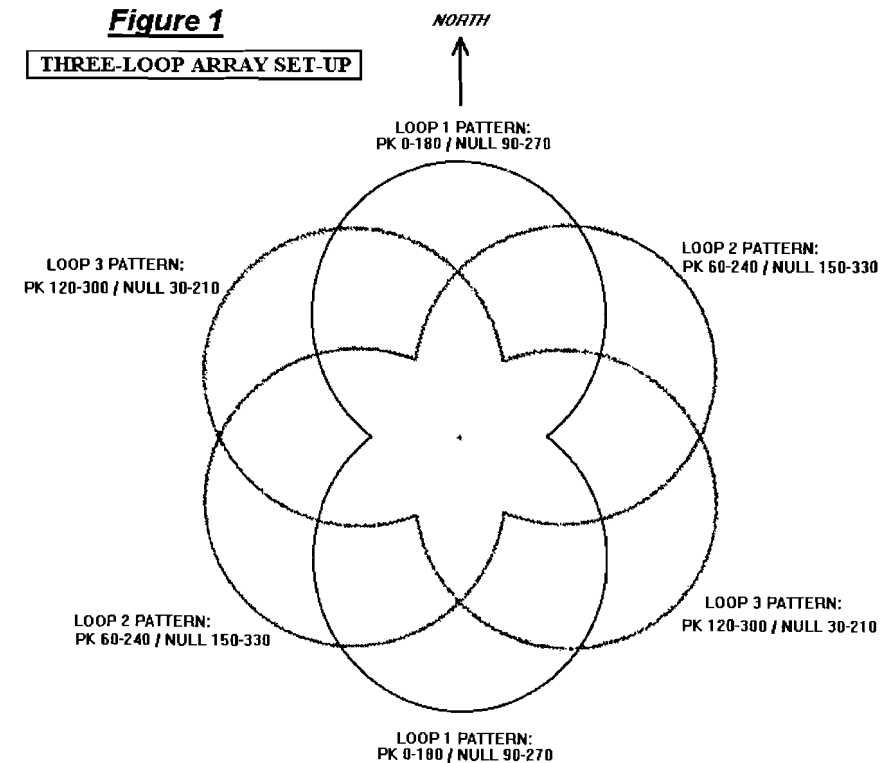

Figure 1 (above): 3-Loop Array Set-Up showing each loop's inherent pattern

**The DX'Pedition Handbook** ...

is simply all you need to plan your next DX'pedition. \$8.95 to NRC members, \$12.95 to non-members. Order from NRC Publications - Box 164 - Mannsville, NY 13661. NY orders, please add sales tax.

**THE DX'PEDITION HANDBOOK**

Figure 2 (left): Switch and Amplifier Box for 3-Loop Array

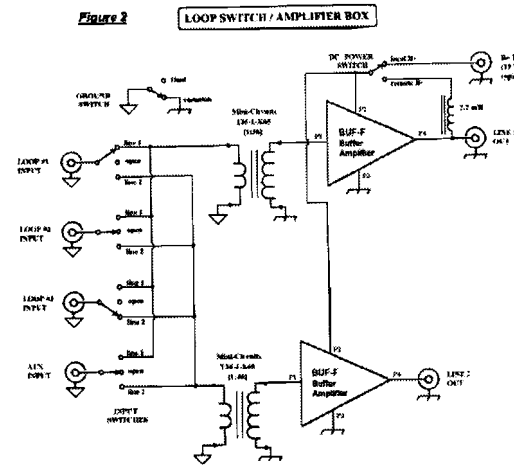

Figure 3 (left): BUF-F Amplifier Schematic (two per Switch / Amp. Box)

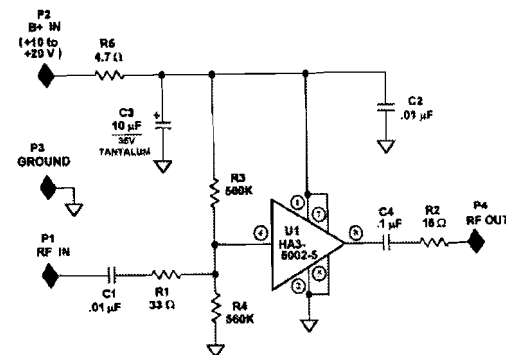
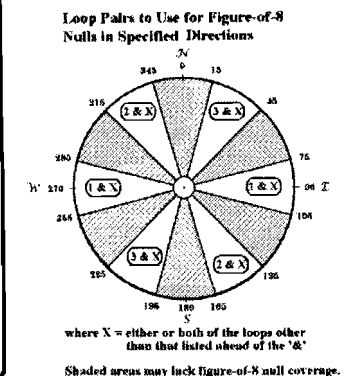
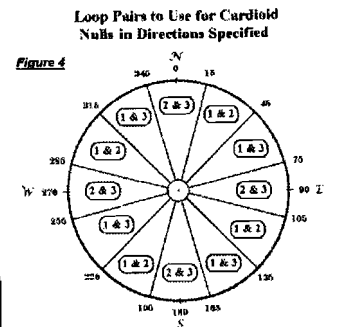

Figure 4 (below): Loop Pairs to Select for Desired Directionality



## NRC Station Location Map Book

**6th edition - \$12.00 to members (\$17.95 non-members), postpaid.**

Compiled by Bill Hale, this 239-page edition shows the location of all U. S. and Canadian broadcast stations (except TIS/LPRT) as well as latitude/longitude coordinates, plus instructions by Dave Sundius enabling users to calculate distance and bearing to any station. This 8.5x11-inch-sized book is three-hole punched for a letter-size ring binder. Order from NRC Publications - Box 164 - Mannsville, NY 13661. NY orders, please add sales tax.

# Musings

## of the Members

Thoughts from NRC members ... the opinions expressed in this column are those of the individual writer and do not necessarily reflect those of the editors, publishers, or the National Radio Club, Inc.

**Dave Schmidt** NRCMusings@aol.com  
P. O. Box 3111  
Scranton, PA 18505-0111

Times are local per Muse; submit double-spaced only.

**Karl Jeter - 1890 Abinger Lane - Lawrenceville, GA 30043 (jeterk@worldnet.att.net)**

After a two-year absence from these pages, I finally decided to check-in. A brief re-intro might be in order: I am 47, married to Nancy, and have two sons, Kevin(16) and Aaron (6). I am self-employed, with a drafting/design business, which I have been involved in for almost 10 years now. This is my 27th year of continuous membership in the NRC, having joined in 1973 while I was in college. I actually began DXing in 1969, when a friend told me about QSLs, and I was hooked. I had, even before that, often sat at my dad's big console radio during my high school years in NC just to see how many cities I could hear. I moved to GA in 1971 and have been in and around the Atlanta area ever since. My unofficial totals are 1984 heard/1604 verified; I would like to break that lofty 2000 heard plateau this season, as I broke the 1600 mark in verifications earlier this year. DXing for me has become more and more a "seasonal" pastime, as I spend very little time at the dials in the

warmer months now. Being self-employed also cuts into DX time, but on the other hand, sometimes I can listen while I work too! My "workhorse" is a Hammarlund HQ-150, purchased many years ago second-hand from Dick Truax, and it is complemented by a Sangean ATS-803A. Antennas are a Kiwa MW loop and a Quantum Loop. Although I continue to try for veries, I find myself for the first time in 30 years questioning if the poor return rate is worth the effort...but I am just stubborn enough to keep trying anyway. Not trying for those elusive veries would take a lot of the "fun" out of DXing for me! Finally, I was a co-host of the 1978 Atlanta Convention, and filled NRC Reprint orders for about 10 years from the late 70's to the late 80's. I have been spending some time at the dial this fall, with modest results. The expanded band keeps me interested, and have been trying to log/verify as many as possible before they start to sound like GY's! Most recent X-banders logged are WTTM-1680 Princeton, NJ and KBTX-1700 Dallas, TX. A few veries have dribbled in lately: KOLM-1520 (email), WTAW-1620 (Card), WPSL-1590 (form), WTIR-1680 (nice certificate) and #1600 was KDYS-1520 (letter). A full report of recent DXploits has been emailed to DDXD-E. I hope I'll check-in more often than I have been, we'll see! 73

**Philip Boersma - 15570 Cleveland Street - Spring Lake, MI 49456**

OK, time for MR. PHIL to give his 2 cents worth on the on-going debate about electronics vs. paper delivery of DX NEWS. First, a few pertinent facts: I do not own a computer and have no plans to purchase one. I have never been on the Internet except for a few business related things. While I am marginally computer literate, I stink compared to the many tech. Heads, and I have no desire to improve myself. Nevertheless, I have no objection to the NRC continuing to expand its WEB services as an adjunct to a printed DX NEWS. But I require, ultimately, my information to be on paper. In other words, the day the NRC stops printing on paper and mailing out a DX NEWS is the day I stop being a member. Nuff said. As to the future of the AM band, 15 years ago (when I was still working in radio), I was sure the AM band would be vacant by the 21<sup>st</sup> century. Well, here we are and my radio still has plenty of stations on it (the quality of the programming may have slipped, but I'll let that slide). I really doubt I will see a conversion to digital in my lifetime, especially as long as the NAB and FCC continue to beat the dead-horse known as In-Band, On-Channel. I have not experienced the Canadian variety (ie: new band, etc.) but from what I have read of it, I doubt DXing that Digital Band will be much of a hobby. For me, the fun of hearing a far-off station through static, other stations, and fading in and out are still a thrill, looking up that stations Website and streaming its audio is not. I certainly hope AM radio survives (although if the number of stations were reduced, I wouldn't complain too loudly!). Happy Holidays!

**Ken Onyschuk - 331 Pine Street #1 - Joliet, IL 60435**

My AM local WJOL-1340 moved out of town last week, but only to neighboring Crest Hill, after I checked in with our radio columnist at the Herald-News, Don Hazen. The station is local 6-10A, then Atlanta based Neal Boortz is on 10A-Noon, local from Noon-1P, Boortz again 1P-2P, then a consumer and financial advice period 2P-4P, Mark Vasko

# KNTI

is local 4P-6P, local sports 6P-7P, then Mike Gallagher 7P-Midnite. It's a nice change. I'm not DXing seriously now due to other interests. 1160 is still WXRT-FM simulcast; I've read of no changes yet. Chicago-based News-Web Corp. which owns CH. 50 and WSBC-1240/WCFJ-1470 has agreed to buy WYPA-820, our Catholic Family Radio affiliate and change it, to of all things, ethnic. So I'll have to move to WZLZ-540 which dominates here. I've been working a couple of part time jobs, doing consumer satisfaction reports for car dealers and newspaper 'stuffing', and assembling Catholic rosaries. Along with that, I enjoy listening to NBA Games of interest and follow the professional bowlers tour heavily. That's it for now, Enjoy The Holidays!

**Dave Schmidt - P O Box 3111 - Scranton, Pa 18505-0111**

Having read the above notes from PHIL BOERSMA regarding the electronic distribution of DX NEWS, I'll have to agree, when it goes as a printed-matter item, then I'll no longer be a member (which I have been since 1964!). For those who do want electronic delivery of DX NEWS, this is fine, but it should be an additional option at this time, and the club should look into having the service made available at a subscription to those who prefer it that way. The NRC did it with the DX Audio service, so this should be another avenue that the club should look into to generate revenue to keep the organization financially alive. But yet, have I seen any offers of anyone stepping forward to actually DO THE WORK? FREE? AS A VOLUNTEER? I hope that those who are in the loop in wanting this service available are in a position to help and MAKE it happen. My job with Digital Radio Engineering has taken me to some of the stations in NY's 'Southern Tier'; it's really amazing to see a station that you have a verification in your collection then find out 'you'll be working on this one'. And the area includes Long Island, where I was this past week. I still haven't been able to get actively involved in listening again, but still do scan the band in my travels and listen to WINR-680 when I'm up in the Binghamton, NY area. Yes, I still have reports to answer for WMBT for the DX TEST from last February, they WILL BE answered, shortly. Hopefully I can get a few more stations on the DX Calendar list this year also. Your support to this column is the only way it can survive, so make sure you do YOUR part and show some support! Happy Holidays!

**1400 KTUC**  
NEWS / TALK / SPORTS

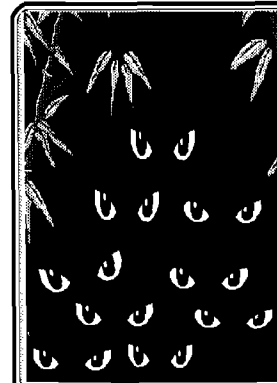

From NRC's DX Audio Service ...

## 'After Dark 9'

Now available, it includes longer articles not able to be included in normal DXAS programs ... including John Bowker's "1400 Travellog", "Sex and Deception", "Screening Calls", "A Visit to WODI-1230", "Radio from L. P. B." and much more. Two C-90 tapes in a cassette case, only \$5.00 postpaid to members in the United States, \$9.00 to non-NRC/DXAS members. Other areas, please write for pricing. Order from NRC Publications - Box 164 - Mannsville, NY 13661. NY orders, please add sales tax.

## AM Broadcast Station Antenna Systems A Basic Guide

Written by NRC'er Patrick Griffith, this book makes it easy for the non-technical DX'er to understand everything about AM broadcast antennas. Over 35 photos. \$13.95 to NRC members (\$17.95, non-members). Order from: NRC Publications - Box 164 - Mannsville, NY 13661 (NY residents, please add sales tax).

