

DX News

♦Serving DX'ers since 1933♦

Volume 63, No. 4 - October 23, 1995 (ISSN 0737-1659)



Inside...

2 .. AM Switch
4 .. DDXD

15 .. Report from Colorado
17 .. MWT-3S: Regenerative Tuner Design
22 .. Musings

CPC Test Calendar

WDJL	1000	Oct. 23, 1995	0200-0230
WAMR	1320	Oct. 23, 1995	0300-0400
KREW	1210	Oct. 28, 1995	0330-0400
KFAY	1030	Oct. 30, 1995	0300-0400
KVON	1440	Nov. 5, 1995	0300-0330
WSEZ	1560	Nov. 6, 1995	0100-0130
WVAM	1430	Nov. 13, 1995	0130-0200
KNXN	1470	Nov. 13, 1995	0200-0230
KATD	990	Nov. 13, 1995	0300-0330
WKBO	1190	Nov. 20, 1995	0000-0030
WOON	1240	Nov. 20, 1995	0100-0200
KLCL	1470	Nov. 20, 1995	0330-0400
WJYM	730	Nov. 27, 1995	0000-0030
WPWA	1590	Dec. 11, 1995	0000-0030
WCGW	770	Dec. 18, 1995	0100-0130

From the publisher ... Jerry Starr is back from bringing rain to Florida, or so he says, and so is his "AM Switch". But Jim Renfrew is out with the boys, DX'ing exotic stations, and so he plans to return "IDXD" to these pages next week.

Why was #3 late? Well, when I take it to the printer at about 6:45 am Monday, the boss isn't in. So I put the pasteup where they tell me to. And that was a mistake, as that issue didn't get noticed nor printed until Friday that week. We think we've got our procedure straight, so look for it to be on time from now on.

Want to play in the FCC database, online? Rick Robinson notes that it's available at

<http://radio.aiss.uiuc.edu/~rrb/fccdb.HTM>

but he says that a graphics based Web progra, such as Netscape, Mosaid, or the AOL or CompuServe netware is needed.

Speaking of online communication, don't forget to send your E-mail address to Paul Mount at PMountNJ@AOL.com so that he can update the NRC E-mail list and publish it soon.

Keep an ear on 1660 from now on. Mike Hardester says that several people have reported hearing what they think is WJDM, Elizabeth, NJ, although one DX'er heard programming on 1640 from his location in Missouri. And NRC's Al Merriman heard rock music and an OC on 1660 on 10/10, and Dave Braun heard the same programming on 10/13 at 2035, but it was gone by 2100.

Ken Chatterton is compiling the verie signers list, and if you have information on verie signers that don't fit Ken MacHarg's requirements for his "Confirmed DX'er" column, send them directly to Chatterton. He'll pass along any pertinent to MacHarg, anyway, if you're not sure whether or not your list should go to Ken or Ken. (!)

DXChange ... Denis Picard - 3830 St-Germain - Trois-Rivières-Ouest - PQG8Y 6L8, 819-379-5647 is selling a Quantum loop for \$135 CAN (approximately \$100 US).

Welcome to these new members ... Gary Durbin, Massillon, OH; Frank Latos, Farmington Hills, MI.

DXN Publishing Schedule, Volume 63

#	Deadline	/Pub. Date	#	Deadline	/Pub. Date
5.	Oct. 20	Oct. 30	18.	Jan. 26	Feb. 5
6.	Oct. 28	Nov. 6	19.	Feb. 2	Feb. 12
7.	Nov. 3	Nov. 13	20.	Feb. 9	Feb. 19
8.	Nov. 10	Nov. 20	21.	Feb. 16	Feb. 26
9.	Nov. 17	Nov. 27	22.	Feb. 23	Mar. 4
10.	Nov. 24	Dec. 4	23.	Mar. 8	Mar. 18
11.	Dec. 1	Dec. 11	24.	Mar. 29	Apr. 8
12.	Dec. 8	Dec. 18	25.	Apr. 12	Apr. 22
13.	Dec. 15	Dec. 25	26.	Mar. 10	Mar. 20
14.	Dec. 29	Jan. 8	27.	June 7	June 17
15.	Jan. 5	Jan. 15	28.	July 5	July 17
16.	Jan. 12	Jan. 22	29.	Aug. 2	Aug. 12
17.	Jan. 19	Jan. 29	30.	Sept. 6	Sept. 16

DX Time Machine

From the pages of DX News:

50 years ago ... from the October 27, 1945 DXN: Phil Nichols, E. Hartford, CT, reported that he had reports out to 21 stations, including Toulouse, Limoges, 2PK, TI4NRH, TIEP, WVUR Canal Zone, Sottens, Hilversu, KIT, KALL, and KSRO.

25 years ago ... from the October 31, 1970 DXN: Dave Schmidt was to join the engineering staff of WHOT as an audio engineer at the end of November, making a record of three active NRC members at one station, and six NRC'ers within a five-mile circle ... Paul Hart's "Patterns" article explained the technicalities of directional patterns of AM stations.

10 years ago ... from the October 28, 1985 DXN: Doug Beard, Springville, IA was "just about as mad" as he could get because the FCC's new agreement with Canada, which replaced NARBA, allowed for no protection of that portion of a Canadian clear-channel stations's secondary (sky-wave) coverage area in the U. S.

AM Switch

Jerry Starr
c/o WHOT Radio
4040 Simon Road
Youngstown, OH 44512-1320

Status changes in AM stations, supplied by the FCC and listeners

CALL LETTER CHANGES

	<i>Old call</i>		<i>New call</i>
1150	WNTA	IL	Rockford
1330	WRRR	IL	Rockford
1330	KNOW	MN	Minneapolis
1520	WITM	TN	Elizabethton
1600	KQRO	TX	Cuero
			WRRR
			WNTA
			WMNN
			WKPP
			KTXC

APPLICATION FOR NEW STATION

1020 FL Kendall: 8900/980 U4

APPLICATIONS FROM EXISTING FACILITIES

660 KSKY TX Balch Springs: night power to 660 watts
790 WAEB PA Allentown: night power to 1500 watts
930 WSLI MS Jackson: reduce night power to 3600 watts
1050 KPXE TX Liberty: city of license to Brookshire, TX
1280 CHRB AB High River: to 1140 kHz with 50000/46000 U4
1400 WGIL IL Galesburg: reduce powers to 740/740 watts
1510 KVCJ TX Mineola: city of license to Canton, TX
1540 KTNO TX Fort Worth: reduce powers to 45000/925 watts

GRANTS TO EXISTING FACILITIES

810 WISZ MI Rockford: power to 3500 watts
1140 WNHA NH Concord: power to 2500 watts (new CP, not on)
1150 WTMP FL Temple Terrace: relocate transmitter site

OTHERNESS

620 KAAM TX Plano: station continues with on-the-air testing but as of this date has not yet begun their regular schedule
710 KXMR ND Bismarck: new station has been noted testing with KBMR-1130 programming, call and format swap will be facilitated when engineering on the 710 site is completed.
740 WMIN WI Hudson: CP for 850 D3 from new site is on
990 KRMO MO Monett: CP for move to Cassville, MO is on
1050 CFGP AB Grande Prairie: requests move to 97.7 FM and will operate the 1050 facility for six months, then surrender the license for the AM if approved
1060 KHYM TX Gilmer: silent station is ON THE AIR
1120 WKCE TN Maryville: silent station (as WCGM) is ON THE AIR
1150 WCEN MI Mount Pleasant: CP for 1000 D1 is on
1200 WDCQ FL Pine Island Center: station is SILENT
1270 WLAW MA Fairhaven: CP for new station has expired but they have petitioned the FCC for reinstatement
1360 KFFA AR Helena: CP for 1000/90 U1 is on
1470 WRBD FL Pompano Beach: CP for 50000/2500 U4 is on
1520 WKPP TN Elizabethton: silent station (as WITM) is expected to return to the air "soon" and will relay programming from WKPT-1400 along with WKTP-1590 (note the sound-alike calls)
1530 KKCM MN Shakopee: CP for 8600/10 U3 is on
1540 WPTR NY Albany: station is SILENT and rumored to be returning soon with a new format, possibly REL
1560 KNZR CA Bakersfield: CP for 25000/10000 U3 is on (FCC reports the new facility as U2 but we believe this is an error; do we have a member in this area who can check it out?)
1590 WQQW CT Waterbury: ad in trade magazine offers their towers for sale, can this indicate that this station, silent since 6/92, may not be returning? (If you're interested in owning two 194-foot self-supporting towers, they are yours for \$12,000. And, oh yes, you have to take them down, too)



1660 WJDM NJ

Elizabeth: in answer to the question we posed in Issue 1, WJDM's STA to move to 1660 kHz is still in effect since they were the first priority station and the only station in the country guaranteed a spot in the expanded band. They are still planning to begin their 1660 operations in the near future. But what is NOT guaranteed is that they will still be assigned 1660 kHz once the newly engineered allotment plan is finalized. The new plan may very well find WJDM assigned to a different expanded-band frequency. How this will affect their plans is unknown. See "FLASH" in AM Switch, Issue 1, for background on this situation.

THANKS: B.B. McClurkan, Ed Krejny, Wes Boyd, Shawn Axelrod, Ron Dadue, Eugene Orr, Les Johnson, Mike Rafawnic, John Mercer, and MSJ

73 and Good DX, *Denny & BKF* Jerry Starr & Buffalo K. Foonman

FEDERAL STING OPERATION ANGERS RADIO STATION

The US Marshall's Office in Georgia came up with an interesting "sting" operation last month. They sent letters to 800 Georgia residents with outstanding warrants against them. The letter promised a payment of \$150 if the person would come to a radio station and fill out a survey. When the scofflaw showed up they were promptly arrested. To make the deception as authentic as possible they invented a station called WLYU and printed up official looking letterhead with those calls and the address of the sting operation in Warner Robins, GA. In a bit of inside humor the phony calls stood for "We Lock You Up". While the operation was successful in rounding up some of the criminals it didn't sit very well with at least one legitimate station. Evidently the Marshall's Office failed to check out their chosen call for, if they had, they would have discovered there was a real WLYU only 80 miles away in Lyons, GA. WLYU is the FM affiliate of WBBT-1340 in Lyons. According to MSJ the Georgia Association of Broadcasters has made complaints alleging criminal violations of federal mail fraud statutes and deceptive trade practices that caused substantial harm to a member station. Georgia Senator Sam Nunn has promised an investigation.

VIRGIN ISLANDS STATIONS

Concerning Doug Smith's comments following the newspaper article about the Virgin Islands, the station in the NRC AM Log is WSTA, not WSTX. WSTX is on 970 kHz. And the newspaper had the freqs screwed up. WVWI is on 1000 kHz, and WSTA is on 1340 kHz. Neither is in St. Thomas. People should understand that the average newspaper junior editor has less than zero knowledge of the ECB or probably radio in general. This sort of info offered as an aside in a newspaper article should never be taken as being close to correct. The Log entries for all of the stations ARE correct.



Music Grade audio cassettes
C-90 tapes: retail value \$4.00 each; just \$9.00 per 10, \$22.00 per 25, or \$42.00 per 50. C-12 tapes, perfect for airchecks: 10 for \$7.50. Order from NRC Publications - Box 164 - Mannsville, NY 13661. NY orders, please add sales tax.



The NRC AM Radio Log, 16th Edition, compiled from members' reports and from official sources so that it is the most accurate listing of AM stations on the market. Cross-referenced, 3-hole punched for standard binders. Only \$16.95 to U. S. and Canadian members; \$22.95 to U. S. and Canadian non-NRC members. Airmail to members: to Latin America, \$21.00; Europe, \$24.00; rest of the world: \$28.00. Order from: NRC Publications - Box 164 - Mannsville, NY 13661 (NY residents, please add sales tax)

Domestic DX Digest

West: Bill Hale billhale@micron.net
495 Creekview Drive - Meridian, ID 83642-3241

East: Dave Braun DPHT10A@Prodigy.com
863 Allabands Mill Road - Wyoming, DE 19934-9523

(Division line is
between East and
Central time zones)

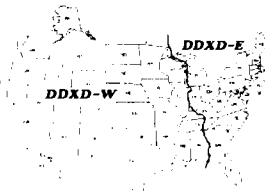

DX Catches in the U. S. and Canada, with 24-hr. ELT

DDXD-West

MEDIUM WAVE RAMBLINGS

- * In Issue One I mentioned some small electronic parts and old electronic books that Ron Donath had accumulated. Well . . . I am now in possession of these items. What am I bid? Seriously, here is a list of the book titles: *Transmission Line and Transformers*. It's an ARRL book (1990) by written by Jerry Sevick, W2FMI and lists for \$20.00; *Basic Radio - The Essentials of Electron Tubes and their Circuits* by J. Barton Hoag, Ph.D. (1942). It appears this book may have been used as a textbook for a U.S. Navy school during WWII; *UHF Radio Simplified* by Milton S. Kiver (1945); *How To Build 78 Radio and Television Sets* published by Popular Science Publishing Co. (1950); and *Elements of Radio* (1943) by Abraham and William Marcus. I will ship them to you for \$3.00 each, or \$15 for the lot, postpaid. The tuning capacitors all are in good condition, individually-packaged, and most come with a tuning string wheel and/or tuning knob. One unit has a companion capacitor, maybe used for fine tuning? None are marked as to their value, but I imagine they are of the standard AM radio-type. There are nine of these. Any hobbyist worth his salt should grab them. How about \$5 for the entire collection, including postage? Any items left over will be shipped to the host of the 1996 NRC Convention for auction material. Any money left over from what it costs for postage will be sent to Dick Truax to be added to NRC coffers. Write first to stake your claim. Do not send any money up front, as I'll just have to send it back if there aren't any of these jewels left.
- * **John Malicky** sets a good example by gracing this week's column with DX garnered on the western portion of his trip to and from the Aurora Convention. Lots of slogans and other local mentions which aid us all in IDing that distant catch. We hear many stations mentioned for the very first time in DDXD. We should have instituted **Don Trelford's** suggestion of last week for this report, hi. **John Wilkins** reports hearing . . . audio on 1314, undoubtedly Norway, so this may be a harbinger of good things to come this winter, **Dale Park** adds several "Special" items highlighting talk show affiliations, **John Reed** answers my "challenge" (Issue 30), and thanks to **Bob Pote** and **Neal Perdue** for phone calls.
- * As I once lived in the Fort Walton Beach area, I was concerned not only about old friends who reside there, but our NRC members along the Gulf Coast region ravaged by Hurricane Opal. Thanks to the magic of E-Mail, we have our first report (October 8) from the region. **Gerry Bishop** of Niceville, Florida says: "Regret to say I've been a little busy this week to DX, something about a storm coming through. You may have heard of it. Here's the current status of local radio, as best I can tell, as of 9:15 a.m., CDT, October 8, 1995.
WFSH 1340 Niceville, was off from sometime Wednesday, Oct 4, until midday, Oct 7. Now on and operating with normal programming.
"WFAV 1400 Ft Walton Beach went off Wednesday, Oct 4, and has not yet returned. This may be power related or there may be damage. I have not been to FWB yet, and am loathe to bother anybody still trying to recover with questions about how it's going. I know firsthand the aggravation of well-meaning friends calling in the middle of cleanup, interrupting the ongoing work yet again.
"WFTW 1260 Ft Walton Beach was still on as we cleared the signal area Wednesday (10/4), and we found them on upon return Friday. If they ever went off, I have no evidence. This station is part of the emergency broadcast system locally, and has generators. It is possible they rode it out without problem.
"WZEP 1460 Defuniak Springs was off 10/6 and the morning of 10/7. I don't think the scheduled test took place, but frankly didn't try.
"All other Okaloosa and Walton county stations were off only briefly, if at all. None of the silents (e.g. WCNU 1010, WBZR 1120) remained silent." [I think he meant All of the silents remained silent. (?) - Ed.]
"Lost the outdoor antenna in the hurricane, but overall damage here was minimal. I see the bright side, in that I have at least a cord of oak for the fireplace on hand that was in the tree until

Wednesday afternoon, and just a few shingles will need replacing. The lights are back on, the water is running, and most important, all our friends and neighbors here are safe and their homes are habitable. I'll have a new antenna up late this afternoon, and be back on the dials tonight. Time to get the gloves on and go to work around the neighborhood, there are still a lot of trees to clear and trash to collect." We're all thankful you are in one piece and able to get on with life, let alone DXing!

- * Thanks to **Ernie Wesolowski** for included material with his report. One item being a list of '95 NRC Convention attendees. Now if I can remember what names go with what faces! And **Mike Sanburn** sent a picture of **Phil Bytheway** and me taken at the IRCA Convention here in July. Phil will have his picture taken with anyone, hi. Thanks, Mike!
- * Welcome to all new NRC members!! Let's hear from you guys and gals in the Central, Mountain and Pacific Time Zones and points west. This is your spot on the dial to report your DX activities.

REPORTERS

- JRM-MO1 **John Malicky** (Pittsburgh, PA) DXing westbound on I-70 thru St. Louis to Mid-Missouri Delco C-Quam AM\$/FM\$ car radio
- JRM-MO2 **John Malicky** I-70 from western MO thru Kansas City same equipment
- JRM-MO3 **John Malicky** I-70 eastbound; Kansas City thru central MO same-oh, same-oh
- JRM-MO4 **John Malicky** I-70 eastbound; central MO & St. Louis same car, same radio
- JRM-IL/IN **John Malicky** I-70 eastbound; Illinois and Indiana Vanna, spin the dial
- M/S-KS1 **John Malicky/Paul Swearingen** I-70 westbound; Topeka to central KS 'nuff said
- M/S-KS2 **John and Paul** (not the saints) (you got that right! -pls) I-70 westbound; central KS thru western KS ditto
- M/S-KS3 **JM & PS** I-70 eastbound; western KS to central KS & Topeka you guessed it
- M/S-CO **The Malicky & Swearingen Caravan** I-70 in and east of Denver head 'em up, Ma
- EJW-NE **Ernie Wesolowski** Omaha
- BBM-TX **BB McClurkan** Irving Kenwood R-2000 + KIWA Loop
- DP-HI **Dale Park** Honolulu AT5-803A, Select-A-Tenna
- BW-OK **Bruce Winkelman**, AA5CO Tulsa R8, 90 ft "long" wire
- MS-CA **Mike** (Mr. Convention) **Sanburn** Bellflower GE Superadio II
- TB-TN **Tom Bryant** Nashville
- JW-CO **John Wilkins** Wheat Ridge Drake R-8 + 4 foot box loop
- BR-CA **Bruce Reynolds** San Jose Superadio II, III
- KW-WI **Kent Winrich** Waukesha
- NAP-AL **Neal Perdue** Madison ICF-7600G + McClintock Black Box
- DM-AB **Deane McIntyre** Calgary GE Superadio I barefoot
- JR-OK **John Reed** Ponca City W-J HF-1000 receiver, a Kiwa loop and noise reduced wire antenna.
- GB-FL **Gerry Bishop** Niceville
- Ed-ID **Editor** I-84 Meridian to Boise Delco AM\$/FM\$ ETR or *TRF at home



SPECIAL

- 560 KWTO MO Springfield - 9/23 - Adds **Art Bell**, per show this morning. Note that some stations (like 610 WGIR-NH) air his show only on weekends. (DP-HI)
- 630 KHOW CO Denver - 9/29 - **Art Bell** mentioned this as being his Denver affiliate, so apparently his show has moved from 760 KTLK. (DP-HI)
- 640 WNFN MI Zeeland - The Fan, with **One On One Sports**. A change from WISZ and Radio Ahs! (KW-WI)
- 690 KRGS CO Rifle - 9/25 0956 - Now here, Ex: 810. Fair-to-poor, with KOAQ/KRMX QRM, with C&W mx, KRGS AM 690, Hot New Country and your All-Time Favorites. Faded, then heard later at 1004 with Back-to-back 3-Pack. Actually on 689.3. CO #91. (JW-CO)
- 710 KMPC CA Los Angeles - 9/28 - Brings back repeats of **Tom Leykis Show** at 0300-0800 ELT, per **Leykis** today. This move done apparently at the behest of my fellow Leykis-sers (hi) who didn't like **Art Bell** during this time slot. But see 790 below. (DP-HI)
- 790 KABC CA Los Angeles - 9/29 - Adds **Coast To Coast AM with Art Bell** at 0200-0700 ELT per show, apparently bumping **Ira Fistell**. This is, I believe, the first outside talk programming KABC has ever carried, excluding its days on the old (K)ABC Talkradio Network in the 1980s. This used to be **Ray Briem's** old timeslot, prompting the retired talk show host to call up fellow amateur radio operator **Bell** on the air! (DP-HI)

- 840 KOOK OR Eugene - 10/5 0200 - Former KDBS is now satellite country. IDed as O-K Country is KOOK Eugene and Springfield. (BR-CA)
- 930 WTNR TN Waynesboro - 9/16 - Adds Coast To Coast AM with Art Bell at 0200-0700 ELT, per show. (DP-HI)
- 1220 KDFC CA Palo Alto - Press reports say this one was to drop classical for Kidstar kids programming on 10/12. (BR-CA)
- 1320 KCNR UT Salt Lake City - 9/18 - Adds The Tom Leykis Show per program, apparently moving from 630-KTKK. (DP-HI)
- 1400 KQMS CA Redding - 9/18 - Adds The Ken Hamblin Show, per program. (DP-HI)
- KYLR TX Huntsville - 9/23 - Adds Coast To Coast AM with Art Bell per show. (DP-HI)
- 1420 KBBX NE Omaha - Ex:KESY, now black oldies with local news three times per hour. With lady announcer from 0900-0915. This station is U-3, not U-4 as listed in logs. (EJW-NE)
- 1500 KRIG OK Pawhuska - Ex: KXVQ. ON AIR as noted in AMS. Slogan is Real Country and seems to be simulcasting FM 94.3. FM IDs as Nowata-Bartlesville while AM IDs as Pawhuska. (BW-OK)
- 1550 WCTZ TN Clarksville - 9/25 - Adds "The Tom Leykis Show, per program. (DP-HI)
- 1570 KMYZ OK Pryor - Children's programming noted as per Formats column in DXXN 63-1. Noted slogan of Radio Oz numerous times. Much stronger now than in the past. Should be a good SSS target in the East. (BW-OK)

UNIDs and UNID HELP

- 530 UNID KS - 9/4-9/5 2245 - Strong CIDs. Leaving Topeka and still heard the next day nearing Columbus, OH! (JRM-MO3) (Most likely 526-OJ, Olathe, KS; or 521-TO, Topeka; there may be others close to 530 - pls)
- 570 UNID ?? - 10/2 2011 - Utility station, second ticks with beep on the minute mark. RR sent in code on the minute mark. (JR-OK)
- 1020 UNID ?? - 8/31 & 9/5 - Good, over/under KDKA, with preacher heard thru IL, IN, MO & KS. Around midnight. (JRM-IL/IN) [Could have been KCKN-NM, as they run REL after 2200 local - Ed.]
- 1270 UNID ?? - 9/22 2350 - Good, with dominant signal, with hockey between Hurricanes and Tigers. Suspect CHAT or KLXX. (JW-CO)

DX AND EQUIPMENT TESTS

They're BA-A-A-ACK

- 560 KLZ+ CO Denver - 10/2 - Two Morse code segments made it under semi-local KSFO. Nothing else readable. (BR-CA)
- KLZ+ CO Denver - 10/2 0207 - 560 is usually dominated by KMON Great Falls, (day and night) and the night of the test was no exception. When I tuned in at 0200, KMON was heard with ABC News, and music from another station faintly in the background. At 0207 the KLZ ID was heard plainly several times in Morse code under KMON. Those CID's sure cut through the QRM! (DM-AB)
- KLZ- CO Denver - 10/2 0200-0230 - Not heard. (TB-TN) Nothing heard. Gave it maximum effort, but this one got away. (GB-FL)
- 1320 WOBL+ OH Oberlin - 10/5 0026 - CID @ 0026, and CID with city @ 0030. Weak, with heavy QRM from WAGG Birmingham, which appeared to be on day power and pattern, and WJAS Pittsburgh. (TB-TN)

TIS & OTHER STUFF

- 1250 WPHG284 TX Duncanville - 9/18 1745 - Legal ID, then Duncanville Informational Radio. Called them, and . . . besides saying he would enjoy hearing from DXers, Alan Powell said they operate 24 hours with 10 watts. Mailing address is: P.O. Box 380280, Duncanville, TX 75138. (BBM-TX) [Update from last week - Ed.]
- 1620 WPGG527 CA Lakewood - 9/24 1400 - Has added an extra 'G' to their call letters. Now carrying regular info-oriented programming. (MS-CA)

MIDNIGHT TO 0800 HOURS ELT

- 550 KSD MO St. Louis - 9/5 0520 - NOS/BBD music and On the air because we care. We're Unforgettable 550 KSD-M, 93.7 FM, the Classic Rock Station and Voice of the Rams slogans. (JRM-MO4)

- 690 KSTL MO St. Louis - 9/5 0500 - REL music and promos with KSTL - The Soul of St. Louis and Reaching the Soul, AM 690, KSTL. (JRM-MO4)
- 730 KWRE MO Warrenton - 8/31 0750 - C&W and 73 Country KWRE IDs with DJ Buffalo Jody who later interviewed me on the air while visiting! Also, station has two large billboards on I-70 West leaving St. Louis. (JRM-MO1)
- 750 CKOM SK Saskatoon - 9/27 0750-0801 - In the clear, with no sign of WSM. Local news and ID, C&W music oldies. ND at this time. (EJW-NE)
- 850 KOA CO Denver - 9/5 0016 - Strong, with Dean Kirkman on Sportsradio 85 KOA. 85 KOA, home of the Rockies and Broncos. Mike Rosen Show rule #1 promo. (JRM-MO4)
- 910 KBIM NM Roswell - 10/4 0651 - ID and ad for Roswell Ladies Business Club. (JR-OK)
- 990 CBW MB Winnipeg - 10/2 0648 - Canadian news, ID. (JR-OK)
- 1020 KDKA PA Pittsburgh - 9/5 Midnight - Good-to-strong, with Someplace Special - KDKA & Mike Raleigh Show. 15 miles east of Kansas City. (JRM-MO3)
- 1240 KSOX TX Raymondville - 9/23 0045 - ID and discussion of football at the high school level. (BBM-TX)
- 1500 WAKE IN Valparaiso - 9/5 0716 - Good, with moderate QRM, with WAKE Newstalk, the station where news comes first. Local and state news & WAKE Newstime checks. Nearing Terre Haute, IN. (JRM-IL/IN)

0800 TO 1600 HOURS ELT

- 630 KHOW CO Denver - 9/1 1153-1208 - Very good, with Tom Artino consumer report The Troubleshooter on testing of Rocky Mountain car radar, ads, ABC News and ID: On top of everything, including complete news coverage from the ABC and KHOW news teams, we're Newstalk 63, KHOW, Denver, a Noble Broadcasting Station. 285 miles east of Denver on I-70 at Exit 107. Even with KOA, then gone 10 miles later when Sun came out & clearing skies! (M/S-KS2) [John also went on to say he was interviewed for 12 minutes on KHOW on 9/3 at 1705 and he plugged DXing and the NRC - Ed.]
- 790 KXXX KS Colby - 9/1 1216 - Good, with C&W music and K Triple X slogan. (M/S-KS2)
- 850 KOA CO Denver - 9/1 1200 - Good, with Colorado's 24-Hour Newsroom, it's 10 O'Clock at Newsradio 85, then weak and gone. With Sun out and Paul's favorite noise, Mr. Buzz taking over! (M/S-KS2)
- 880 KRVN NE Lexington - 9/1 1015 - Good, with agricultural reports. (M/S-KS1)
- 890 KDXU UT St. George - 9/27 0810-0815 - In the clear, on daytime (ND) pattern, with local news and POL announcements. KDXU Newstime 6:14. (EJW-NE)
- 900 KFAL MO Fulton - 8/31 1010 - Local signal, with Mike Mason & AM 900 KFAL - Best darn radio station in Central Missouri!, then Brownfield Radio Network & C&W music. (JRM-MO1)
- 910 KINA KS Salina - 9/1 0950 - In passing, with Your Memory Station & NOS music. (M/S-KS1)
- 920 KLMR CO Lamar - 9/1 1505 - Strong, with ID Serving Colorado, Kansas, Nebraska, New Mexico, Oklahoma and Texas, we've got the High Plains covered. We're the Giant AM 920 KLMR! C&W music and 92 Country KLMR, The Giant of the High Plains. A Giant of a signal! (M/S-CO)
- 950 KJRG KS Newton - 9/1 0955 - Good, with REL music. (They are) approximately 65 miles south of I-70. (M/S-KS1)
- 990 KRSL KS Russell - 9/1 1300 - Good, with legal ID, ABC News & prior dedications on Polka Party. Polkas in Kansas?! (M/S-KS2) [There are lots of emigrants from Milwaukee there, hi - Ed.]
- 1010 KSIR CO Brush - 9/1 1415 - Good, with local news and sports and data Transmission Net on 9/4. (M/S-KS2)
- 1060 KLMO CO Longmont - 9/1 1459-1500 - Strong, with legal ID, ABC News mentioning the opening of Cleveland's Rock 'n Roll Hall of Fame. (M/S-CO)
- 1070 KFDI KS Wichita - 9/4 1506 - Strong, with C&W music and Kansas Country is 1070-KFDI. (M/S-KS3)
- 1090 KYBC CO Aurora - 9/1 1530 - Strong, less than 100 miles to Denver. Many "big" IDs like: The weather is big on . . . , K-Big Radio Sports . . . and K-Big Sportstalk. (M/S-CO)
- 1150 KSAL KS Salina - 9/1 0855 - Nearing Salina. With Friday Morning Sports Magazine, local news. (M/S-KS1)
- 1190 KVSU KS Beloit - 9/1 1032 - Good, with community calendar and new sign dedication at Highway 24 & County Road 194. Wow! (M/S-KS1)



- 1220 KBET CA **Canyon Country** - 9/30 0846 - Fair-to-poor, in null of KBNO's OC (off for some reason; back on around 1200), with *Can't Hurry Love* and other oldies. CID and phone # (1-800-595-7525) at 0853, a couple of ads, the AM 1220 KBET. *Today's Hits and Yesterday's Favorites*. 0900 legal ID and CNN News. (JW-CO)
- 1240 KKLA CA **San Bernardino** - 9/16 1128 - Ex:KLFE. Good, over KSON, simulcasting FM 99.5 in Los Angeles, with ad for Biola University, Bergman and Johnson. ID: KKLA, *The Talk of Los Angeles*. (MS-CA) ["Biola" University? You mean Loyola, don't you? - Ed.]
- 1240 KIUL KS **Garden City** - 9/1 1140 - Fair-to-good, with ID in passing. (M/S-KS2)
- 1330 KFH KS **Wichita** - 9/1 0945 - Good, with *Inus In The Morning*, no ID. Non-local programming surprised Paul and me. (M/S-KS2)
- 1340 KXEO MO **Mexico** - 8/31 1105 - In passing, with *The only 24 hour news source for the Mexico area* . . . into ABC Info News. (JRM-MO1)
- 1350 KMAN KS **Manhattan** - 9/1 0848 - In passing, with *NewsTalk 1350, KMAN*. (M/S-KS1)
- 1360 KHNC CO **Johnstown** - 9/1 1159 - In passing, with *Serving the right-minded listener, 1360-KHNC Johnstown and 1370-KTMG Deer Trail*. (M/S-CO)
- 1390 KGER CA **Long Beach** - 10/3 0915+ - Slogan: AM 1390. Local REL programming, ads, 1-800-266-1390 number given. Was unsure who they were when called, but lady said "KGER" and we had a nice conversation. All Log data is spot on, as I inquired. Good signal, over others and KSRV-1380 slop. [Ed-ID]
- KJME CO **Denver** - 9/1 1550-1600 - Strong, approximately 100 miles east, with local ad/other mentions in SS. Caught EE ID just before the hour as Paul was our interpreter! *La Jota Mejicana* - KJME slogan. (M/S-CO)
- 1400 KAYS KS **Hays** - 9/1 1145 - In passing, with *Oldies 1400*. (M/S-KS2)
- KFRU MO **Columbia** - 8/31 1110 - In passing, with *NewsTalk 1400 KFRU* and Missouri Network News. Also on 9/5 0132 with *Sportsbreak at :15 and :45 past the hour, mornings and afternoons on the one yo depend* . . . into Jim Bohannon Show. Visited on 9/1 and met NRCer/owner Al Germond! (JRM-MO1) [A station owner and an NRCer!? That's the guy I'd like to work for - Ed.]
- 1420 KJCK KS **Junction City** - 9/1 0851 - In passing, with C&W music & 1420 *Country*. Also on 9/5 with . . . *Wildcats, (KSU) Royals and Chiefs, your station for live play-by-play sports is 1420 Country, KJCK*. (M/S-KS1)
- 1430 KEZW CO **Aurora** - 9/1 1600+ - 95 miles east of Denver, with legal ID as *KEZW 1430 Aurora/Denver* and *KEZW News Update*, weather as 94_ and 12% humidity! Then referred to NOS music. Closest station to motel . . . dropped by briefly on Sunday. (M/S-CO)
- 1440 KRDZ CO **Wray** - 9/4 1424-1437 - Local signal, with local ads, AC music and *Swap Shop* address as P.O. Box 466 and ZIP 80758. Also mentioned *KATR-FM 98.3* in Yuma at 804 South Ash. *KRDZ is located two miles east of Wray on Highway 34 . . . KRDZ/KATR, your good neighbor to the High Plains . . .* (M/S-CO)
- 1490 KKAN KS **Phillipsburg** - 9/4 1530 - Good, with AC music and *This is your regional information center, KKAN/KQMA*. (M/S-KS3)
- 1510 KDKO CO **Littleton** - 9/3 1430 - UC, *Power 1510*. At 608 26th Street in downtown Denver. Drove by, no visit. (M/S-CO)
- KANS KS **Larned** - 9/4 1500 - Good, with ID as *Thirty years old and better than ever, K-A-N-S is Kansas Radio* and *KANS Larned* (pronounced Lrned) *Your information station*. Grain prices and message from Kansas DOT, AC music. (M/S-KS3)
- 1530 KQNK KS **Norton** - 9/4 1440 - Good, with AC music, slogan *Continuous Favorites on KQNK, AM 1530 FM106.7*. 98_ presently. (M/S-KS3)
- 1580 KTER MO **Columbia** - 8/31 1140 - In passing, with *Kicks 96.7* ID simulcast. *Your choice for Number 1 Country and Young Country - Mid-Missouri's Number One Choice* slogans. AM studio site is empty as is moved to FM in Columbia. (JRM-MO1)
- 1590 KVGB KS **Great Bend** - 9/4 1500 - Just caught legal ID, right after hearing KANS, as *The station you grew up with, 1590 AM and 104.3 FM KVGB Great Bend, an Eagle Communications Station*. Also heard a B-104 mention about 100 miles east. (M/S-KS3)

KGTO AM 1050

1600 TO 2400 HOURS ELT

- 550 KFRM KS **Salina** - 9/4 1705 - In passing, with C&W music, *KFRM 550 Gospel on the Plains and The Best of country on The Voice of the Heartland, 550 KFRM*. (M/S-KS3)

- 560 KLZ CO **Denver** - 9/1 1630 - With *The best of contemporary Christian music, 56 KLZ*. Heard 70 miles east. (M/S-CO)
- KWTO MO **Springfield** - 9/4 2305 - Strong, with *Live from Spanky's in the Holiday Inn in Columbia, Deerfield Sports presents Tiger Talk with Head Coach Larry Smith*. Heard between Topeka and Kansas City. (JRM-MO3)
- 590 KCSJ CO **Pueblo** - 9/1 1635 - In passing, with *Live talk Coast-to-Coast*. (M/S-CO)
- 600 KIIX CO **Wellington** - 9/1 1640 - In passing, with *Unforgettable music on 60 KIX*, then Bert Kemplert's Happy Feeling (Paul's favorite song, hi). Town is home to WWV, north of Fort Collins. (M/S-CO)
- 610 KAVL CA **Lancaster** - 10/7 2225-2234 - Poor, fighting KFRC, with high school football (Marauders vs ??). Ad for a car wash and two mentions of *Antelope Valley*, and but call to them cinched it. Guy who answered phone *Sports Radio 610* confirmed the Marauders were on, the address in Log is correct, and they are now U4 5000 4910, so make that update. [Ed-ID*]
- 680 KFEQ MO **St. Joseph** - 8/31 1746 - In passing, with 8/31's football game (?? Griffins vs. Drake) . . . on the sports leader, 68 KFEQ. (JRM-MO2)
- 710 KNUS CO **Denver** - 9/1 1646 - In passing, with *710 K-News*. (M/S-CO)
- 750 KMMJ NE **Grand Island** - 9/4 1830 - Strong coverage throughout Kansas on I-70, with *You're listening to AM 750 NewsTalk* and announcement from Del Myer, General Sales Mgr . . . *has an advertising sales position open for the Hastings area. Call 1-308-382-2800 or stop in at 3280 Woodbridge Blvd., Prairie States Broadcasting*. We called, but couldn't get through, hi. (M/S-KS3) [Hah! They were probably swamped with calls, hi hi - Ed.]
- 910 KPOF CO **Denver** - 9/1 1645 - In passing, with CLA music, which confused us, but I know some REL stations play CLA in the afternoons. Also AM 910, *KPOF Denver, your station for family inspiration. The Pillar of Fire*. programs and music. Studios north of Denver in a semi-castle! Visited Sunday AM 9/3. An immaculate structure! (M/S-CO)
- 950 KKFN CO **Denver** - 9/1 1650 - In passing, with *Sportsradio 95, The Fan*. Stopped by Sunday afternoon for a peek. No visit, but a staffer gave out a few stickers. Amongst the three groups of Denver's Quad stations (this is soon to be the state of radio in the 21st Century?). Others in this group are KYGO-98.5, KWMX-107.5 and KYGO-1600. Many network programs, some local. America's love for sports grows. Soon, every major U.S. city will have a sports station! [And some single-station markets, too - Ed.] *The Fans'* bus benches and billboards are all over town! (M/S-CO)
- 980 KGLN CO **Glenwood Springs** - 10/1 2050 - With OLD and *Oldies 98* slogans. Legal ID at 2100. Ex: NOS format. (JW-CO)
- KMBZ MO **Kansas City** - 8/31 1750 - In passing, with ads, newsbreaks, IDs during mid-afternoon drivetime. (JRM-MO2)
- 1060 WLNO LA **New Orleans** - 9/30 2000 - With REL. New CLs heard in legal ID just before power down. Ex: WNOE. (NAP-AL)
- 1090 KYBG CO **Aurora** - 9/1 1705 - In passing, with *K-Big Sportstalk*. (M/S-CO)
- WCRA IL **Effingham** - 10/1 1953+ - In nicely, with A/C, alternative music (Jimmy Buffet, Bruce Springsteen, Hootie & The Blowfish). Many mentions of *Hot 104 point 3*. Legal ID at 2001:30 sign-off. New. (NAP-AL)
- 1110 WBCA AL **Bay Minette** - 10/2 1952 - C&W music, local ads, ad for salespersons for station giving phone # as per AM Log #15, but with new area code (334). Legal ID. New. (NAP-AL)
- 1140 KCXL MO **Liberty** - 8/31 1748 - In passing, with *Your station for Good Time Oldies*. Visited six years ago during NRC Topeka '89 when they were UC. (JRM-MO2)
- 1180 KOIL NE **Omaha** - 9/4 1835 - Good signal for a good distance in mid-Kansas, with *EZL and 1190 KOIL* slogan. Visited three years ago during NRC Omaha '92. (M/S-KS3)
- 1190 KFEZ MO **Kansas City** - 9/4 2340 - In passing, with *Dining with Bobbi, NOS/BFL music and Eleven Hundred and Ninety, Continuous Easy* and *KFEZ 1190 Easy*. (JRM-MO3)
- 1250 WREN KS **Topeka** - 9/4 2000 - Waited in Paul's driveway for :00 ID, and heard *You're listening to the station that plays the best in Southern Gospel music, this is Spirit 1250 WREN Topeka and Your gospel voice*. (M/S-KS3)
- 1300 KMMO MO **Marshall** - 8/31 - In passing, with license plate contest on 102.9 (10 minutes, 29 seconds to win . . . *Radio KMMO*) to C&W music. (JRM-MO2)

WEZI

WLVS

- 10
 1360 KSRX KS El Dorado - 9/4 1802 - Fair, with KMAN-1350 slop, with Jerry ??? with KSRX news, any news. call us at 321-1360. (M/S-KS3)
 1430 KAOL MO Carrollton - 8/31 1735 - In passing, with We're Missouri's Farm Voice, 100.7 KMZU... and AM 1430 KAOL Carrollton. C&W music. (JRM-MO2)
 1440 KMAJ KS Topeka - 9/4 2359 - Caught part of legal ID into CBS News. (JRM-MO3)
 KMAJ KS Topeka - 9/23 2310 - With postgame show of Washburn University Ichabods vs Northeast Missouri State Bulldogs football game (final: NEMS 41, WU 17). The Voice of The Ichabods. (JW-CO)
 1460 KKCS CO Colorado Springs - 9/1 1610 - C&W music. Simulcast with 101.9. (M/S-CO) [Do they put Colorado springs in Colorado mattresses? - Ed.]
 1480 KZSN KS Wichita - 9/4 1806 - In passing, with Kicks 102... Solid half-hour of country... Kizzin' Country slogans. // KZSN Hutchinson. (M/S-KS3)
 1540 KNGL KS McPherson - 9/4 1658-1716 - AP Network news and AC music with Brigitt on Your Good Listening Station. 99_ and 37% humidity. GS the DJ next on KBBE (96.7). Sign-off mentioned at 6:45 CDT. (M/S-KS3)
 1560 KABI KS Abilene - 9/4 1740-1800 - Good, with local news and What's happening around Dickerson County, then ID: It's 5 O'Clock. Time now for 30 minutes of news, sports and information on KABI Abilene into CBS News. (M/S-KS3)
 1590 KXSP CA Ventura - 9/16 2300 - Ex:KAHS, etc. Loud, with Esta es KXSP Ventura-Oxnard-Santa Barbara. SS music mixed with EE oldies ranging from Sugar Sugar by the Archies to Stairway to Heaven by Led Zeppelin. (MS-CA)
 KROYt CA Victorville - 9/16 2123 - Trying to log call change. Ex: KGIN. Had C&W music. Fading in with Good Hearted Woman by Waylon Jennings and announcement by Ricky Skaggs. (MS-CA) [KROY, huh? Must be in tribute to Roy Rogers, who lives in nearby Apple Valley. I visited his museum while "living" there in '91-'92. And by golly, Trigger is indeed in attendance - Ed.]
 KPRT MO Kansas City - 9/4 1704 - Local signal in Topeka, with Gospel 1590. (M/S-KS3)
 1600 KYGO CO Lakewood - 9/1 1625 - In passing, with C&W. (M/S-CO)

GRAVEYARD DX UPDATE

* indicates North American record

1230 kHz:

WNVY	FL	Pensacola	Steve Francis	Alcoa, TN	415
WMFR	NC	High Point	Steve Francis	Alcoa	223



ABBREVIATIONS USED IN DDXD

/ :parallel to :00: on the hour AC:Adult contemporary AP:Associated Press BBD:big band BRN:Business Radio Net C&W:country & western CCR:contemporary Christian radio CHR:contemporary hit radio CID:code ID CL:call letter EZL:easy listening EE:English FF:French GOS:gospel IRN:Interstate Radio Net LSR:local sunrise LSS:local sunset NBA:National Basketball Assn NFL:National Football League NPR:National Public Radio OC:open carrier POL:political PRI:Public Radio International PSRA:pre-sunrise authority PSSA:post-sunset authority QRM:man-made interference QRN:natural interference QTH:location PRI:Public Radio International REL:religious ROK:rock 'n' roll RS:regular schedule \$:stereo SID:singing ID SRS:sunrise skip SS:Spanish SSB:Star Spangled Banner SSS:sunset skip TC:time check TT:test tones UC:urban contemporary UPI:United Press International

DDXD-East

NEWS AND VIEWS

Welcome to new member and first time reporter Don Cassel, Bramlea, ON! Good to hear from you Don; let us know what you hear this season!

SPECIAL

- 1200 WKOX MA Framingham - Switching to an all-talk format as of Oct. 2. Schedule details to follow. (SF-MA)
 1300 WXPX PA West Hazelton - As of the week of 9/25 this becomes the latest addition to the "WILK Network" as it's called. Simulcasts WILK-980 and WGBI-910 talk format. Is allowed to break away though for local sports games. (HJH-PA)

UNID AND UNID HELP

- 530 UNID 9/28 0640 - SS station very powerful here. Sounded like a SS talk show. Very strong signal for about 15 minutes, then faded. (RCP-IN) (If it was on 530, CIAO-ON, if it was 532, Turks & Caicos - db)
 910 UNID 9/30 2318 - "910 CNN" ID into ESPN Sports Radio, nothing else local heard. (DB-DE)
 960 WATS PA Sayre - John Dunn's UNID in Vol. 62. No. 30 is WAVR-FM. They use the "Choice 102" slogan. (SF-MA)
 1140 UNID 9/30 2344 - EE talk under WRVA, but nothing to help ID it. Rare to hear anything else here, especially in EE! (DB-DE)
 1180 UNID 9/28 2110 - WHAM nulled by SS station, first time encountered here. May be Cuban? (RCP-IN) (I think so - db)
 1540 UNID 9/26 2130 - KXEL effectively nulled by ethnic program. Female announcer speaking in EE, plays music of India, listened for 30 minutes, never heard a station ID. Might this be WNWR? (RCP-IN) (Maybe, but I think more likely CHIN-ON - db)
 1570 WFLR NY Dundee - John Dunn's "Country 1570" in Vol. 62, No. 30 is WFLR. (SF-MA)

0000 to 0800 ELT

- 560 WQAM FL Miami - 9/21 0220 - Sports call-in talk show, ad for car dealer. (WM-MD)
 570 WAAX AL Gadsden - 9/29 0530 - "News Talk 570", discussion of US Constitution, much fading with SS station under. (RCP-IN)
 640 WBOW IN Terre Haute - 9/5 0755 - Inside Indiana while watching the morning sun rise (after an all night drive!) through this city noted in passing "Your Wabash Valley Sports Voice - 640 WBOW", also Jack Whitaker Reports and ABC news. (JRM-IN)
 770 WLWL NC Rockingham - 9/28 0649 - Golden oldies country music program with "Country Bob and Miss Lee". Great reception till sunup. (RCP-IN)
 900 WCPA PA Clearfield - 9/21 0005 - SSB, then call-in talk show. (WM-MD)
 990 CBW MB Winnipeg - 9/27 0642 - Station came in like gangbusters. The host was discussing the David Letterman Show and a guest named "Dick Assman" who owns a service station in Saskatchewan. (RCP-IN)
 1230 WBFX? IN Terre Haute - 9/5 0736 - In passing with FM IDs "WZZQ 107.5" and music from U2. (JRM-IN)
 1300 WJSH IN Terre Haute - 9/5 0725 - In passing with "AM 1300 WJSH Smoldy(? or Moldy?) in the Morning" jingle and "6:25 at Real Country AM 1300", 62 degrees and Dave Taylor with "Real (not fake!) news on Real Country". (JRM-IN)
 1490 WAZL PA Hazelton - 10/2 2229 - On top with sports report on baseball playoffs, "WAZL news time..." then faded. (DB-DE)
 1530 WSAI OH Cincinnati - 9/5 0745 - In passing with "Don Herman on AM 1530 WSAI" - I still can't get used to CKY not being on 1530! (JRM-IN)

0800 to 1600 ELT

- 550 WCKY OH Cincinnati - 9/5 1300 - In passing top of hour ID straight up "Attitude, right we have attitude, what else would you expect from a state that brings you the Rock 'n' Roll Hall of Fame, Talkradio 550, WCKY, Cincinnati" into ABC news, "Next news at 2:00, bulletins at once." Cincy's Rush Limbaugh station. (JRM-OH)

 810 WSYW IN Indianapolis - 9/5 0825 - In passing with Radio Aahs programs. Three years ago en route to NRC Omaha '92 AM had classical music. Now only FM "107.1 Danville-Indy" and "Classic FM" mentions. (JRM-IN)
 960 WKVX OH Wooster - 9/5 1400 - Just east of Columbus, OH, with "Hang on tight...there's another hour of Rush (oh no!)...coming your way right after the news on WKVX Stereo 960 in Wooster". (JRM-OH)
 980 WONE OH Dayton - 9/5 1400 - Right after WKVX with "Superstars of music, Star 98 AM 980 WONE, Dayton-Springfield, an American Radio System station". (JRM-OH)
 1130 WCTM OH Eaton - 9/5 1150-1200 - In passing with top of hour ID "Easy listening music and news all day long on WCTM Eaton", "Holiday Radio", USA Radio Network news and computer generated time check and temps. 250 watts daytime. (JRM-OH)

- WCTM OH Eaton - 9/23 1448 - Easy listening music, first time I've received this daytime. Much fluttering with WSDM underneath. (RCP-IN)
- 1210 WDAO OH Dayton - 9/5 1202 - In passing with "Docs Dunbar, the rhythym master on WDAO, the station first in Rhythm and Blues", UC music and "AM 1210 WDAO, where the best just keeps on getting better". (JRM-OH)
- 1260 WNDE IN Indianapolis - 9/5 0030 - Thru ludy listened to "Bob and Tom on the Sports Station WNDE". (JRM-IN)
- 1460 WBNS OH Columbus - 9/5 1345 - In passing with "Sports Radio 1460 WBNS", WBNS 20-minute ticker, "The flagship station of Ohio State football" and ESPN's The Sports Babe - a semi-gruff sounding woman who knows sports, but who is she, Dave, any ideas? When did she start? Didn't hear her out in Denver, but saw billboards and benches with her nickname, on 950 "The Fan". (JRM-OH) (She's been on at least two years, I'd say, started as a local in Seattle(?), I think it was, may know sports but the way they run the show you'd never know it - a ten-second wisecrack per call and on to the next sucker - db)
- 1490 WKBV IN Richmond - 9/5 1000 - In passing nearing Richmond with legal ID "1490 WKBV Richmond, the sports tradition of Richmond and Wayne County", local news, weather, AC music, ABC news, at 1006 a statewide talk show with host Mike Pantz. Stopped in later for a quick visit en route home. (JRM-IN)
- 1580 WLIM NY Patchogue - 9/29 0857 - Ella Fitzgerald tune, weather, traffic, ID and ABC news. Strongest I've heard it here ever. (SF-MA)
- 1600 WBLY OH Springfield - 9/5 1232 - PSA and returning to "The Sports Babe on WBLY". (JRM-OH)



1600 TO 2400 ELT

- 610 CKTB ON St. Catherines - 9/24 2132 - Excellent, commercials for *Radio India*, Asian features, Hindi headline news, and *Star Furniture*. (DC-ON)
- 620 WZON ME Bangor - 9/23 2030 - Fair but noisy signal. *Red Sox vs. Blue Jays* game. Station IDed as "The Sportsland - WZON." Local commercial for *Discount Auto Parts*. (DC-ON)
- WTMJ WI Milwaukee - 9/15 2105 - Fair, *Blue Jays vs. Brewers* game, local ad for *Joe's Amoco* station. Station identified as "News Radio 620 WTMJ." (DC-ON)
- 680 WPTF NC Raleigh - 9/22 2240 - Ad for car maker, promo for upcoming event at *Convention and Visitors Center*, ID. (WM-MD)
- 790 CIGM ON Sudbury - 9/20 2040 - *Blue Jays vs. Yankees* baseball. (WM-MD)
- 830 KTOC MO Kennett - 9/24 2003 - Country music. Apparently they changed format from AC. IDs as "New Top Country 830". Lady DJ played *George Jones* tune. Received here first time at local sundown after which WCCO moved in. (RCP- IN)
- 850 WYDE AL Birmingham - 9/22 2252 - Ad for *C&C Homes* and *Bloomfield Chevrolet* and *Geo*, ID, CW music, *Roger Miller King of the Road*. (WM-MD)
- WYDE AL Birmingham - 9/30 2229 - *Samford vs. Nicholls State* football game on the "Samford Bulldogs Radio Network", on top of channel for the most part for over an hour, but no ID until game was over at 2315. (DB-DE)
- WYLF NY Penn Yan - 9/18 1955-2000 - NOS music followed by "AM 850 WYLF Penn Yan" ID, then into news. (JR-NJ)
- WJAC PA Johnstown - 9/2 2200 - Fair. Interference from WRMR. Talk in progress about Johnstown baseball and thanking fans for their support. Football game wrap-up and score given for Johnstown and visitors. (DC-ON)
- 920 WBAA IN West Lafayette - 9/24 2101 - Fair. This station is located at *Purdue University*. Station ID "WBAA" was given followed by the weather and "Temperature at Greater Lafayette...". (DC-ON)
- 930 WBEN NY Buffalo - 9/28 2145 - "News Talk 930", discussion of upcoming *Buffalo Bills-Cleveland Browns* game. IDs as "Voice of Buffalo Bills". (RCP-IN)
- 980 WWRC DC Washington - 9/23 2134 - Fair. The station ID was given as "WRC." Program of football talk. Listeners invited to call 202-WRC-1. ID given again as "WRC on AM 980." (DC-ON)
- 990 WNTY CT Southington - 9/23 2145 - Fair. A football game between *New Britain* and the *Golden Hurricanes* was in progress. Commercial for "Fritz Miller striving for excellence in Bristol." (DC-ON)

- KNIN TX Wichita Falls - 9/28 2240 - Good with call letters, GOS music, ad for *New Life* long distance carrier. Legal ID at 2300. Log says 1000 watts at night. Taped report sent. (MB-IN)
- 1060 WFLE KY Flemingsburg - 9/25 1957-2000 - CW music followed by ID, "This is WFLE Flemingsburg, Kentucky". (JR-NJ)
- 1100 WHLI NY Hempstead - 9/26 1710-1730 - Big band music to sign-off. (SF-MA)
- 1200 WAGE VA Leesburg - 9/6 2138 - Fair. Station ID was heard "Your sound choice for sports - WAGE." Also on 9/7 with a football game. Considerable interference from WBZY. (DC-ON)
- 1240 WHIZ OH Zanesville - 8/30 1945 - In passing with "Reds baseball on your sports leader in southeast Ohio". (JRM-OH)
- 1270 WCBC MD Cumberland - 9/30 1917 - Very strong with ad for *Daley's Deli* and coverage of a game at *Greenwood Avenue Stadium*. (HJH-PA)
- WILE OH Cambridge - 8/30 1930 - In passing with "The station you can count on for great songs and great memories" to *Johnny Mathis' Chances Are* (I'll get to Denver by Friday!). (JRM-OH)
- 1280 WFAU ME Gardiner - 9/25 1921 - "AM 1280 WFAU" ID followed by brief weather report, another ID and then into music. (JR-NJ)
- WKST PA New Castle - 9/30 1916 - Loud with details of "Meet the President" contest. (HJH-PA)
- 1310 WDKD SC Kingstree - 9/29 2010 - Good signal, mostly alone with *Star Warriors vs. Jaguars* football. (HJH-PA)
- 1390 WEOK NY Poughkeepsie - 9/28 1935-1943 - Big band music (a satellite format), ID with calls, over/under WDCW. (SF-MA)
- WRTK OH Youngstown - 9/22 2000 - Loud with local ads during *Irish vs. Raiders* football. Overtaken by WDCW. (HJH-PA)
- 1460 WBNS OH Columbus - 9/30 1941 - Weakish-fair with ad for *Majestic Paint Center* and coverage of the *Buckeyes*. Tonight conditions to west were very enhanced. (HJH-PA)
- 1480 WODX FL Marco Island - 9/25 2300 - News update, menmton of boating accident, weak. (WM-MD)
- 1500 WFIF CT Milford - 9/29 1900 - Loud with weather and power reduction announcement. Still quite audible past power cut. (HJH-PA) (Thought they were just a daytime? - db)
- 1570 WBUG NY Amsterdam - 9/23 2021-2033 - Fair with "Real Country AM 1570" ID, "WBUG and WLFH" ID, promo for contest drawing on Monday 10/2 with winner getting a stay at the *Pittsburgh Marriott*, call-in number given as 800-962-5590. (JR-NJ) (Now don't all rush to the phones at once! - db)
- WYTI NC Rocky Mount - 9/27 1920 - Commercial break with mentions of Rocky Mount and Martinsburg, "WYTI encourages you to support the Eagles and attend high school sports." (SF-MA*)
- 1580 WONZ NJ Hammonton - 9/28 1930 - "Radio 14 and Radio 1580" ID with own calls and 1400 WOND, into talk show Your Latina Connection, over WPGC. (SF-MA)
- 1590 WSMN NH Nashua - 9/23 2016 - Surfaced briefly with "WSMN 1590 Nashua" ID, then into ballgame and gone! (JR-NJ)
- WAKR OH Akron - 9/25 2330 - "Home of the Indians" ID, time check, local news. (WM-MD)
- 1600 WLNG NY Sag Harbor - 9/29 1844 - Loud with *Beatles' I Wanna Hold Your Hand* then song by REM. AM-FM ID then ad for *John Duck's Restaurant*. (HJH-PA)

OTHER STUFF

- 530 TAR DE - 9/29 1010 - Weak. Since the move of area Maryland Highway stations to 1290 this channel open all summer and always a weak-fair signal. NRC mentions Rehoboth Beach here - that's 76 miles from my QTH. Would think this would be Woodenhawk at MD/DE border. But at times seems to be two stations here. (HH1-MD) (There is definitely one in Rehoboth, and usually during the summer there is one somewhere near the MD/DE border, but I've never pin-pointed it - db)
- KRIL
- 530 WPGU595 OH Hillard - 9/5 1245-1305 - Continuous loop noticed about 25 miles west of Columbus (Hillard is just west of Columbus) with message from Hillard's *Park and Recreation Department* and *Visitors Bureau* welcoming new residents, and mention of Hillard Day 9/16 asking persons and/or groups to be involved. (JRM-OH)

VA Fairfax - 9/8 1559+ - George Mason University, good within 5 miles of campus. Attending soccer game between American U. and Air Force Academy. (HH2-MD)

Dave

REPORTERS

MB-IN Mark Burns, Terre Haute, IN: Drake R-8, Quantum Loop, 80' longwire (Thanks for the sticker - db)

DC-ON Don Cassel, Bramalea, ON: GE Superadio III with built-in loop

SF-MA Scott Fybush, Waltham, MA: Sony 2003, McKay-Dymek DA5

SF-MA* Scott Fybush, Waltham, MA: Delco AM/FM ETR in dented 1987 Buick

HJH-PA Harry J. Hayes, Wilkes-Barre, PA: GE Superadio with Superloop

HH1-MD Hank Holbrook, Dunkirk, MD: Drake R8, 120' random wire

HH2-MD Hank Holbrook, Dunkirk, MD: Toyota 1990 AM/FM radio with standard whip - mobile

WM-MD William McGuire, Cheverly, MD:

JRM-IN John R. Malicky, on I-70 west to east thru Indiana: GM Delco C-QUAM car receiver

JRM-OH John R. Malicky, on I-70 east to west thru Ohio: GM Delco C-QUAM car receiver (Thanks for the enclosures, John - db)

RCP-IN Bob Pote, Greenwood, IN: Realistic DX-392 with Select-a-tenna, GE Superadio III, GMC Sonoma truck radio

JR-NJ Jeff H. Ross, Flemington, NJ: R8, 135' wire, loop

DB-DE Dave Braun, Wyoming, DE: R-5000, Quantum Loop

AM Station Map Book

3rd edition - \$9.50 to members, \$10.50 non-members, postpaid.
Edited by DDXD editor Bill Hale, this book of station location maps is a must-have companion to the AM Radio Log. The 170-page book is three-hole punched for a ring binder. Order from NRC Publications - Box 164 - Mannsville, NY 13661. NY orders, please add sales tax.



THE DX'PEDITION HANDBOOK

The DX'Pediton Handbook ...
is simply all you need to plan your next DX'pedition. \$8.95 to NRC members, \$12.95 to non-members. Order from NRC Publications - Box 164 - Mannsville, NY 13661. NY orders, please add sales tax.

Official NRC Stationery
Professionally-printed with a new design ... just what you need for those verie requests, or for any correspondence. Sold in 100-sheet packs for \$5.00. Order from NRC Publications - Box 164 - Mannsville, NY 13661. NY orders, please add sales tax.

Report from Colorado ... by Wayne Heinen

Let's begin with the attendees. From places other than Colorado the following NRC'ers of both the DXN and DXAS persuasions came to participate: Ron Bailey, Dan Bartek, John & Linda Bowker, Ken Chatterton, Ernest Cooper, Chris Cuomo, Rick Dau, Steve Francis, Roger Giannini, Warren Greenberg, George Green, Bill Hale, Craig - Kiwa Electronics, Ed Krejny, Mike Lantz, John Malicky, BB & Leigh McClurkan, Frank Merrill, Al Merriman, Ken & Jo Ann Onyschuk, Mitch Pomerantz, Chuck Rader, Mike Sanburn, Jerry & Bonnie Starr, Paul Swearingen, Don Trelford, Dick Truax, John & Betty Tudenham, Fred Vobbe, Ernest Wesolowski, Dave Whatmough. Member Larry Fussell from AL just happened to be in Denver for Friday, but had to leave before the festivities began.

The Colorado Contingent: Wayne & Joan Heinen, Craig Barnes, Ron Kashner, Paul Origlio, John Pirnat and Loyal Richmond. In addition non-member Ron Downing from CO, former member Jeff Kadet from IL and IRCA'er Bill Nittler from Colorado. What a GANG! Forty seven in attendance.

The basic convention agenda was go see Colorado, and see Colorado they did. All day Saturday and Sunday from the summit of 14,000 feet high Mt. Evans to Cripple Creek and the Royal Gorge NRC'ers were everywhere. Sunday John Malicky was out and about visiting local AM stations and wound up with a 10-minute interview on News-Talk 63 KHOW, a fine promotion for the hobby and the convention.



Wayne Heinen (right) awards Al Merriman a can of an identified substance after the annual NRC Quiz while Ernie Wesolowski records the event for posterity.

Craig of Kiwa (pronounced Kee-wa) Electronics set up a Kiwa loop with a Lowe 150 receiver that was available for demonstrations through Sunday. It was good to see Craig again, and I do thank him for his demonstrations and display!



Jerry Starr (left) receives the NRC Convention Plaque for his contributions to the NRC AM Log and for his many years of editing columns for DX News.

The organized events began with a banquet at Grisanti's Italian Restaurant, a choice of entrees, cash bar and lively conversation. We returned to the hotel where it was Door Prize time. I'd like to thank the following hobby oriented businesses who supplied the following door prizes:

- National Scanning -- Coffee Mugs inscribed with the motto "In God We Trust, All others we Monitor"
- Grove Enterprises -- One year subscription to Monitoring Times
- RSM Enterprises -- 3 copies of the 3rd edition of Receiver History Book
- Universal Electronics -- Coffee Mugs & Key Chains
- C. Crane & Co. -- Crystal Radio and a Select-tenna

Many other companies supplied catalogs and product information for our conventioners. The only notable drawing was IRCA revenge against the Convention host. At the 1993 Billings IRCA convention I walked away with the top door prize, a Sony Walkman. This year IRCA'er Bill Nittler walked away with the Select-tenna, our top door prize!

The business meeting was brief. Ken Chatterton discussed the expansion of NRC Publications to include many volunteers including his daughter Debbie Quick, Bill Hale, Wayne & Joan Heinen, Fred Tankersley, Shawn Axelrod and Mark Connelley. All of which have contributed to revamping old publications and producing new ones.

This year the Convention Plaque was awarded to Jerry Starr for his many years of service to the NRC as an editor of numerous columns over the years and his long standing commitment to the accuracy of the NRC AM Log.

In addition, a Certificate of Appreciation was awarded to Fred Vobbe for an outstanding 10 years of editing and

publishing the NRC's DX Audio Service.

The end of the organized portion of the convention was the very popular NRC Auction. I was, by my own admission, pretty tired on Saturday evening. I'd been running around getting pop and ice and generally on my feet the entire day. I asked two people that I have seen work auctions before to conduct the auction. Anyone can read anything into my choices that they want BUT, they made a fine team and conducted a funny and profitable auction. To them both we'll throw in a Robert W. Morgan. Many thanks to DX News editor and publisher Paul Swearingen and "DXAS" editor and publisher Fred Vobbe for a job well done. I want to give a GREAT BIG THANKS to Gerry Thomas for his donation of a Radio Plus Quantum Loop to this years auction, definitely the premier auction item.

Sunday morning found a seminar about ANARC presented by our former ANARC rep Paul Swearingen followed by the NRC Quizzes both oral and written. John Bowker created some real toughies this year! Winners included

With the sightseeing done and the activities completed, Monday was check-out

and on our way home. My thanks to all who provided rides to others and who helped me maintain the hospitality suite during the weekend and again a special thanks to John & Linda Bowker and Ken Chatterton for their hard work. Next year, Steve Francis has volunteered and I'm sure Knoxville will be a fine site, and Steve will be putting together another NRC show to remember.



Fred Vobbe (left) receives an NRC Certificate of Appreciation from NRC Board Chairman Ken Chatterton for his ten years of heading up the DX Audio Service.

A DX'ers Technical Guide

Now in its 2nd edition, this 120-page book answers questions on receiver and antenna theory (how to improve their performance), how audio filters and loop antennas can improve DX (and hints on their construction), how to build a beverage and phasing unit, and much more. Only \$5.50 for NRC/IRCA members, \$6.50 for non-members (overseas airmail add \$2.50). Order your copy today from

IRCA Bookstore - 9705 Mary Ave. NW - Seattle, WA 98117-2334

IRCA Almanac Updaters 5.6 and 5.7 Are Now Available!

Two new updaters to the *IRCA AM-FM Almanac* are now available from the IRCA Bookstore. Updater 5.6 features the most complete listing of Travelers Information Stations (TIS) ever produced. The 32-page listing includes every known TIS station in the US and Canada between 530 and 1710 kHz and even some on FM. Updater 5.6 also includes the FCC Allotment List for stations assigned to the new expanded AM band, 1610 to 1700 kHz. Stations are listed by new frequency, old frequency, and city/state. Those who DX the band from 1600-1710 kHz will find this reference indispensable. Updater 5.7 features a complete 42-page AM and FM station slogan list, plus current station lists for the Tom Leykis, David Brenner, Pat Buchanan, and Larry King talk shows. Special prices for these two updaters: \$3 each in the U.S. and Canada, \$4 elsewhere. Order either or both updaters from the IRCA Bookstore, by sending the correct amount (in US funds) to:

IRCA Bookstore, 9705 Mary N.W., Seattle, WA 98117-2334. Thank you!

IRCA Mexican Log, 3rd Edition

The 1994 edition of the *IRCA Mexican Log* lists all AM stations in Mexico by frequency, giving call letters, state, city, day power, night power, slogans, schedule in UTC/GMT, formats, networks, and notes. Stations that have changed frequency since 1990 are cross-referenced on the old frequency.

The call letter index gives call, frequency, city and state. The city index (listed by state, then city) gives frequency, call, day and night power. There is even a guide to the Spanish alphabet and numbers.

The log has been completely updated from the 1990 edition and carefully cross-checked by IRCA members in Mexico and the U.S. This will be an indispensable reference for anyone who hears Mexican radio stations.

The price, payable to IRCA in U.S. funds: IRCA/NRC Member: \$6 U.S./Canada/Mexico/seamail, \$7 rest of the Americas airmail, \$7.50 Europe/Asia airmail, \$8 Australia/New Zealand airmail. Non-Member: \$8 U.S./Canada/Mexico/seamail, \$9 rest of the Americas airmail, \$9.50 Europe/Asia airmail, \$10 Australia/New Zealand airmail.

Order from Phil Bytheway - IRCA Bookstore - 9705 Mary N.W. - Seattle, WA 98117-2334

Investigation of Regenerative Tuner Design The MWT-3S

by Bruce A. Conti; edited by Mark Connelly, WA1ION

Abstract: The MWT-3 regenerative tuner is simplified specifically for use with the MWDX-5 phasing unit. The basic theory of regeneration is explored, and experimental data illustrates how receiver performance is improved. This article is meant to be a companion to the original MWT-3 article by Mark Connelly. Readers are encouraged to refer to previous articles on regenerative tuning by Mark Connelly, available as NRC reprints.

Introduction Regeneration, or positive feedback amplification, dates back to the early days of radio, when Armstrong first proposed the method for achieving high gain out of triode vacuum tubes.¹ However, regeneration is little used today due to the inherent instability of positive feedback, and technological improvements that led to the higher gain of the more stable negative feedback amplifier. Applications of positive feedback are generally limited to oscillators and digital phase-lock loop designs in modern circuitry. Mark Connelly began regenerative tuning research around 1978, after being inspired by the work of Ken Cornell in the Longwave Club of America. One of the first tuners Mark built was used between the car whip antenna and analog car radio back in the late '70s. The tuner worked like a champ and turned TA hets into readable audio by beefing up weak signals from the whip and sharpening the "broad as a barn door" front end of the car radio.²

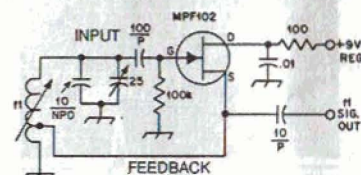

Figure 1: Common-drain Hartley VFO.

Regeneration Theory The common-drain Hartley VFO is an example of a tuned positive feedback regenerative oscillator (Fig.1).³ The output is fed back non-inverted to the input. This positive feedback path adds to the input which results in a larger output. The larger output once again follows the feedback path to add to the input. The even larger input produces an even larger output, continuing to reinforce the input, and so on. In theory, this signal regeneration process should continue

with the output increasing to infinity. In practice, the amplifier output is limited by the power supply and operating range of the electronic components, so the output stops increasing at this limit. As the output stops increasing, so does the positive feedback signal. Now the output signal decreases as the positive feedback decreases, until the signal can go no lower. This completes one cycle as the signal now begins to increase and start another cycle. The operating frequency, or number of cycles per second (hertz) produced by the Hartley oscillator, is determined by the resonant frequency of the parallel L-C tank circuit. The resonant frequency is the frequency at which the impedance across the L-C tank to ground is the greatest, while the impedance is essentially a short-circuit to ground at all other frequencies. So if the L-C tank circuit were to be coupled to an antenna, only RF at the resonant frequency would pass. Lower frequencies would be shorted to ground through the inductor, and higher frequencies through the capacitor to ground. For an L-C tank circuit, the resonant frequency is determined by the formula:

$$f = \frac{1}{2\pi\sqrt{LC}}$$

where L is the inductance in henries, C is the capacitance in farads, and f is the resulting frequency in hertz. Using the formula, the resonant frequency of an L-C tank with L = 122uH and C = 149pF is calculated to be 1180 kHz. Figure 2 shows the frequency response of the L-C tank resonant at 1180 kHz. Note how quickly the gain rolls off on either side of the resonant frequency.

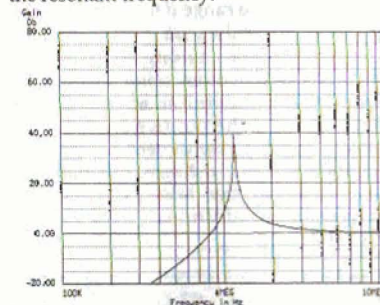

Figure 2: Frequency response of L-C tank resonant at 1180 kHz.

This completes a basic overview of tuned positive feedback regeneration theory. From here, we can leap into an actual regenerative tuner design.

MWT-3S Regenerative Tuner Design The original inspiration behind this technical paper was to present a simplified version of Mark Connelly's MWT-3 design, for use with phasing units such as the MWDX-5.4,5. Features such as the remotely tuned loop or active antenna inputs were removed, the tuning range and input impedance selections were reduced, and the input level control was removed (since the MWDX-5 also has a level control). The result is a more compact, cost-reduced, and easier to use design. The new design is given the model number MWT-3S; "S" for simple. One of the most significant discoveries during the design and assembly was the cost and availability of the various low-noise line drivers or buffer amplifiers. Most were in excess of \$30 each, and some were no longer available. This led to independent investigations of alternative sources by Mark Connelly and me, both arriving at the same conclusion. The essential requirements for the buffer amplifier are wide bandwidth and low noise for RF applications. The National Semiconductor LH0002 fit the bill, based upon availability and the relatively low cost of \$9 each. The LH0002 is actually a current amplifier, which can be configured as a buffer amplifier per National Semiconductor application notes.⁶ The rest of the re-design is rather straight-forward. Most noticeable is the reduction in the number of switch positions required which in turn simplifies the wiring and operation. The final circuit design includes a 4P2T switch to combine selection of regeneration/power-on and bypass/power-off modes, a 1P2T switch for input impedance selection, and the 2-pole rotary switch to select inductor values for different frequency ranges. A standard single-section 10-365pF variable capacitor is used for tuning the L-C tank frequency within the range determined by the selected inductor value. A geared vernier knob is used on the tuning capacitor to smooth out what would otherwise be an extremely sensitive control to adjust. Coarse and fine control of the positive feedback are provided by the two potentiometers. Figure 3 is a complete schematic diagram of the final design. Refer to the MWT-3 article for comparison and additional assembly or operational details.



Figure 4: Final design fit neatly into a 5 x 3 x 2 chassis, but you may want to use a larger chassis for easier assembly.

Test Results The MWT-3S regenerative tuner input was connected to a random length of wire (~10-ft. indoors), and the output was monitored on a spectrum analyzer. Tests were performed in Lowell, Massachusetts, in the vicinity of WCAP-980 and WLLH-1400. Figure 5 shows the ambient signal levels of WCAP and WLLH with the MWT-3S in bypass/power-off mode. Figures 6 and 7 indicate over 50 dB of gain could be achieved with the MWT-3S in regen/power-on mode and tuned to the respective frequencies. Similar results were achieved with the MWT-3S hooked up to a Lowe HF-225E receiver, observing 50 to 60 dB of gain on the receiver's S-meter before breaking into oscillation when the feedback was cranked too high.

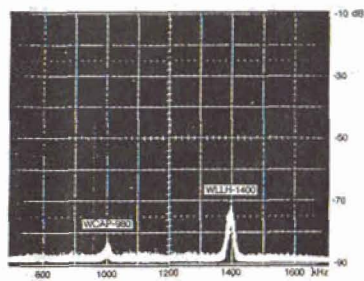

Figure 5: Ambient signal levels of local radio stations WCAP-980 and WLLH-1400 as observed on a spectrum analyzer.

Conclusions: Laboratory and field results have proven regenerative tuning to be another valuable weapon in an arsenal of equipment

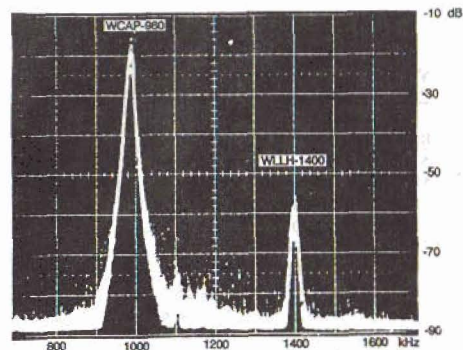

Figure 6: MWT-3S output, peaked for WCAP-980.

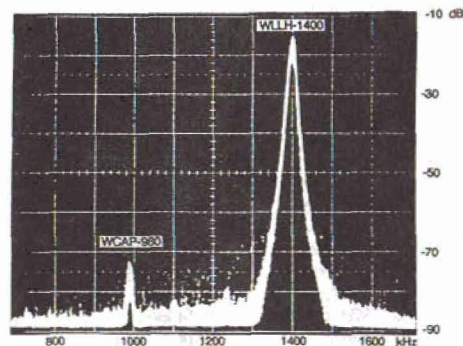

Figure 7: MWT-3S output, peaked for WLLH-1400

available to enhance mediumwave DX. Signals within 1kHz of each other could be easily separated with regeneration. However, if the feedback was adjusted for too high of a gain and too narrow bandwidth, then the audio became unintelligible. This is to be expected, much like switching to 1.8 kHz or CW filters on a high-end receiver. Reasonable care needed to be taken when approaching peak adjustment, as too much feedback resulted in the circuit breaking into oscillation and overloading the receiver. Perhaps further modification of the circuit is needed to limit the feedback. (Feedback was rarely adjusted beyond half of its range for optimum reception.) Of course, using the level control on the accompanying MWDX-5 also helps. And finally, it's hoped that the relative ease in which one of Mark Connelly's designs was customized for this author's specific application will inspire others to experiment,

perhaps leading to further modifications or improvements in the design of outboard DX gear.

References 1. Jacob Millman and Arvin Grabel, *Micro-electronics*, 2nd ed. (McGraw-Hill, 1987), 567. 2. Mark Connelly, e-mail conversation, 1995. 3. Doug DeMaw, ed., *ARRL Electronics Data Book* (Newington, CT: The American Radio Relay League, 1976), 96. 4. Mark Connelly, "MWT-3", *DX News* (National Radio Club, Vol. 61). 5. Mark Connelly, "MWDX-5", *DX News* (National Radio Club). 6. "Application of the LH0002 Current Amplifier (AN-13)", *Linear Applications Databook* (Santa Clara, CA: National Semiconductor Corp., 1986), 16-19.

Mark Connelly's articles are available through NRC Reprints; Ken Chatterton, Manager, P.O. Box 164, Mannsville, NY 13661-0164.

The Challenging Crystal Set

For hobbyists demanding the ultimate DX challenge, Ray Cole's publication detailing step-by-step procedures in building a crystal set is for you! Only \$3.50 ... order from NRC Publications. (NY residents, add sales tax)

How to place mail orders ...

Write to NRC Publications - P. O. Box 164 - Mannsville, NY 13661-0164. Enclose check or money order; NY residents, please add state and local taxes. Please allow 3-6 weeks for shipping.

Table 1: Parts list and last price paid.

Item No.	Schematic Reference	Description/Value	Vendor Code	Part Number	Price
1		Chassis, 5-1/4 x 3 x 2-1/8"	RS	270-238	\$2.79
2	C1	Variable capacitor, 10-365pF	AES	CV-231	\$7.95
3	C3	Capacitor, tantalum, 10uF	MOU	581-10K35	\$0.83
4	C4, 7, 8	Capacitor, ceramic, 0.1uF	MOU	147-72-104	\$0.13 each
5	C5, 6, 9	Capacitor, ceramic, 0.01uF	MOU	147-72-103	\$0.13 each
6	C10	Capacitor, ceramic, 18pF	MOU	140-CA50N180J	\$0.14
7	C11	Capacitor, ceramic, 30pF	MOU	140-CA50N300J	\$0.14
8	C12	Capacitor, ceramic, 82pF	MOU	140-CA50S820J	\$0.13
9	J1, 2	BNC jack, female, chassis mount	RS	278-105	\$1.49 each
10	L1	Inductor, RF, 470uH	MOU	43LR474	\$0.46
11	L2	Inductor, RF, 220uH	MOU	43LR224	\$0.46
12	L3, 7	Inductor, RF, 100uH	MOU	43LR104	\$0.46 each
13	L4, 9	Inductor, RF, 22uH	MOU	43LR225	\$0.46 each
14	L5, 10	Inductor, RF, 10uH	MOU	43LR105	\$0.46 each
15	L6	Inductor, RF, 4.7uH	MOU	43LR476	\$0.46
16	L8	Inductor, RF, 47uH	MOU	43LR475	\$0.46
17	L11	Inductor, RF, 2.2uH	MOU	43LR226	\$0.46
18	L12	Inductor, RF, 1.0uH	MOU	43LR106	\$0.46
19	R1, 11	Resistor, 5 1-ohm, 5%, 1/4-w	MOU	30BJ250-5.1	\$0.14 each
20	Q1	FET, VHF, MPF102	RS	276-2062	\$0.99
21	R2	Potentiometer, 5K-ohm, linear	MOU	31CN305	\$1.02
22	R3	Potentiometer, 500-ohm, linear	MOU	31CN205	\$1.02
23	R4	Resistor, 10M-ohm, 5%, 1/4-w	RS	271-1365	\$0.49 /pkg of 5
24	R5	Resistor, 1M-ohm, 5%, 1/4-w	RS	271-1356	\$0.49 /pkg of 5
25	R6, 7	Resistor, 2.2K-ohm, 5%, 1/4-w	RS	271-1325	\$0.49 /pkg of 5
26	R8, 9	Resistor, 560K-ohm, 5%, 1/4-w	MOU	30BJ250-560K	\$0.14 each
27	R10	Resistor, 47-ohm, 5%, 1/4-w	MOU	30BJ250-47	\$0.14
28	SW1	Switch, rotary, non-shorting, 2P6T	RS	275-1386	\$1.39
29	SW2	Switch, toggle, on-on, 4P2T	MOU	10TC290	\$7.03
30	SW3	Switch, toggle, on-on, 1P2T	RS	275-326	\$2.99
31	T1	RF transformer, 4:1	MCL	T4-6T-X65	\$4.45
32	U1	National Semicon. LH0002CH	DK	LH0002CH-ND	\$9.45
33		9v battery snap-on connector	RS	270-325	\$1.39 /pkg of 5
34		9v battery holder	RS	270-326	\$0.99 /pkg of 2
35	C1	Knob, vernier dial	MOU	45KN100	\$14.98
36	R1, SW1	Knob, 1/4" shaft	RS	274-416	\$1.99 /pkg of 4
37	R2	Knob, 1/4" shaft	RS	274-415	\$1.69 /pkg of 4

Table 2: Vendor Information.

AES = Antique Electronic Supply
 P.O. Box 27468
 Tempe, AZ 85285-7468
 1-602-820-5411

DK = Digi-Key Corporation
 P.O. Box 677
 Thief River Falls, MN 56701-0677
 1-800-344-4539

MCL = Mini-Circuits
 P.O. Box 350166
 Brooklyn, NY 11235-0003
 1-800-654-7949

MOU = Mouser Electronics
 2401 Highway 287 North
 Mansfield, TX 76063-4827
 1-800-346-6873
 (Also east & west coast locations.)

RS = Radio Shack
 (Several locations, check the phone book for the store nearest you.)

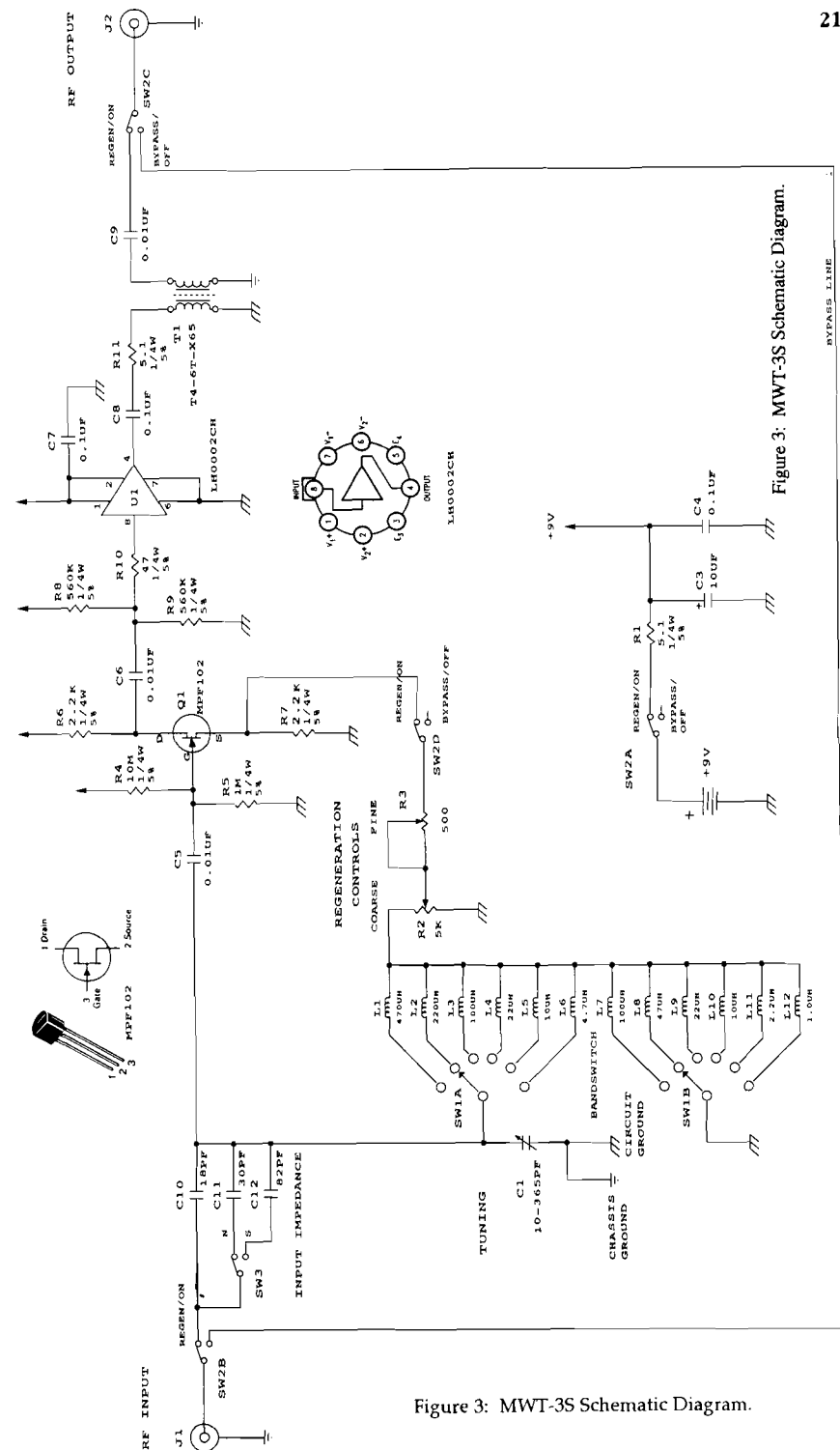

Figure 3: MWT-3S Schematic Diagram.

Figure 3: MWT-3S Schematic Diagram.

Musings of the Members

Thoughts from NRC members ... the opinions expressed in this column are those of the individual writer and do not necessarily reflect those of the editors, publishers, or the National Radio Club, Inc.

KEN ONYSCHUK - 1016 LOIS PLACE #204 - JOLIET, IL 60435

Hello again! I had a hard time figuring out how to write this MUSE, too many things to write about! (We should all have that problem!-DWS) Anyway, my wife, Jo Ann, and I had a memorable time at the NRC Convention. I met members I had not seen since 1987 and 1979, and enjoyed meeting Denver area non members also. Sports addict RICK DAU and I had fun recalling our 1993 get together. But I was glad to spend time with our editors again. Some of the time, I used the KIWA antenna to DX the graveyard frequencies. We also attended the DX Audio Service taping with JOHN BOWKERS' TRAVELOG on Saturday afternoon. We took MITCH POMERANTZ and ROGER GIANNINI to the banquet, later on we had a great time at the auction. I bought one cap only and taped part of it. Sunday morning there was a business meeting with KEN CHATTERTON, PAUL SWEARINGEN, and ERNIE WESLOWSKI before we had to leave for an area resort. The weather was very pleasant, 95-100 with low humidity. We rented a car and listened nostalgia primarily on KEZW-1430, rock oldies on KXKL-1280 (KOOL 105 simulcast); the 3 news-talk stations on 630-710-850 are OK, only 710 is CNN. Who forgot to alert us about the KHOW interview Sunday afternoon? I heard the tail end of it, never caught the name of the member being spoken with to promote the NRC. (John Malicky -pls) It was nice to spend some time at the Amtrak station with KEN CHATTERTON Monday night and discuss club doings. The only thing I regret is forgetting the cassette recorder under the car seat at the rental car place, while unloading luggage. I lost only the DXAS tape I made for JOHN BOWKER (later found it wasn't taped properly, a Night Bandscan, but I did tape an AM-FM bandscan and the NRC auction). Now we can plan for the NRC convention at Knoxville in 1996. I received a letter from *Broadcasting* magazine that they were not doing an NFL article in '95 or listing local

Dave Schmidt

P. O. Box 11502

Wilmington, DE 19850-1502

Times are local per MUSE; submit double-spaced only.

radio or TV stations; nor are they planning one for '96. So as the DXAS Sports Editor, I am asking NRC members in cities with pro teams to send me a postcard prior to the start of the basketball and hockey seasons listing flagship stations and announcers if possible. Hockey News is maybe for station info and I hope the NBA will be as dependable as in the past. Locally, the IHL Chicago Wolves are on WCBR-92.7 and WLLI-96.7. I've read nothing lately on the pending WSCR-820 nite CP for 1200 watts, and I was surprised to read the article on the errors the FCC has made in compiling the 1610-1700 station list! A new list won't be available until next spring at the earliest. To finish, my White Sox had a disappointing season and hope to rebound in '96 on AM 1000! The Bears, I try to ignore, I look forward to the NBA season. I enjoyed the latest *DX News*; great job, fellas! 73

JOHN D. BOWKER - 1811 FORT DUQUESNA DRIVE - SUN CITY CENTER, FL 33573

Like so many others, I find it has been about a year since I checked in on these pages. That means this should be my 19th MUSE if my records are right. To re-introduce, I retired in 1987 after 35 engineering years with RCA and, largely since then, wife Linda and I have been travelling around the 48 states in our motorhome whenever we're not in our FL house. It's a great lifestyle and gives us a chance to visit and make air-checks of radio stations all over the place. The Aurora Convention was a LOT of fun, a personal thanks to PAUL SWEARINGEN for his reflections on the years of work with ANARC. I'm sure editor DAVE SCHMIDT will be able to make a real contribution as our new representative to ANARC. I felt bad that RICK DAU came away empty from the quizzes during the convention, he answered all but a couple of questions in each quiz section, only to find FRANK MERRILL or STEVE FRANCIS or CHRIS CUOMO doing him 1 better. RICK and ERNEST COOPER fought it out in a tie breaker by naming stations starting with the call letters WL--, ERNEST won. Maybe next year, Rick! And yes, we'll be Knoxville bound for next Labor Day if the creeks don't rise. Best of 73's from RADIOJOHN@AOL.COM (Next year, John, next year-DWS)

DAVID A. GASQUE - 1027 LAKEWOOD DRIVE - ORANGEBURG, SC 29118-9396
1st time Greetings from Orangeburg, SC. JD STEPHENS got me involved in the CPC program last year, so I thought I'd 'pay my dues' and join the NRC and the IRCA this season. This area is fairly dead as far as high-powered AM stations in close proximity, and the power lines in the neighborhood are buried underground, making for pretty good DX possibilities in the AM band. I use an Icom R71A and Kiwa loop for 90% of my monitoring activities, and a DX440 and Select-a-tenna when I'm too lazy to hook up the former. The Duke University TIS WPHE-255 has been coming in with a fair to good signal after sunset here for the last month or so (reported previously by MIKE HARDESTER). On football Saturdays, they change the loop to give information about the parking situations in and around the stadium and updated info on construction around I85. John LeMay, verifier and tech who helped install the station passes on this info.: transmitter is a Digital Recorders, Inc., model DR-34-366, with an output power of 6.5 watts. He says there are at least 5 other TIS's around the area. One of those confirmed, call letters unclear, operated by the Greensboro COC, Jaycees and Coliseum Complex and my prepared card was returned, signed by Linda McCarthy, PR Director, but she failed to fill in the call letters! Both this station and WPHE-255 transmit off-frequency (1610.88) so I assume that the Greensboro system is also a Digital Recorders model. Received a real nice surprise in the mail a few days ago in the form of a prepared card from Radio Free Ybor, a TIS originally reported in

Larry Van Horn's MT column on 1/94. He speculated this to be a pirate and he was right, the builder of the transmitter never applied for a license and was subsequently shut down by the FCC! Ybor is a district of Tampa, FL, originally settled by the Dutch in the 1700's, and is going through a revitalization project. Radio Free Ybor may resume activity if the FCC grants a license, unsure if the original frequency of 1620 will be used. That's it from here, good luck to all this DX season, it looks like its going to be a good one! Oh yeah, I'm always looking for someone in the area for possible micro-DXpeds, feel free to write at the above address! (And we welcome you to the NRC, David, we'll look forward to your future reports!)

DAVE SCHMIDT - P O BOX 11502 - WILMINGTON, DE 19850-1502

As I write this, I'm sitting in an office I've set up in Conway, SC but I've still not settled at an official 'den' yet so the DE address is still active and my wife will be forwarding me all the stuff each couple of days, plus trips back and forth will be taking place for a while. I've been to a number of the AM stations in the area so far, some of the FM's, and have even set up a listening post using the HQ129X mentioned last issue, a Stewart-Warner R390A ('59 vintage) and the MWDX5 using 2 175 LW's at 180 degrees. Locals include WJXY-1050 (5 miles away), WPJS-1330 (8 miles away) and WKZQ-1520 (15 miles away), and they can all be knocked out. More as the saga continues. 73's

Archived Publications

... are still available and listed in the "NRC Archived Publications List". If you're interested in older technical articles, computer programs, receiver reviews, bandscans, station profiles, and foreign DX information, order ZAL-1 (40¢ with your next reprint order over \$2.00, 90¢ by itself). From NRC Publications. (NY residents, add sales tax)

UNCUT: the highlights of the 1995 NRC Convention on video!

Four hours, 20 minutes from the Aurora, CO convention, and more, including a visit with the FCC, on a T-130 VHS tape, taped by Ernie Wesolowski. \$20.00. Order from NRC Publications; NY orders, please add sales tax.

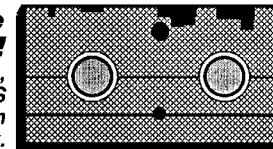

NRC's antenna manuals ... Now completely revised and up-to-date!

Antenna Reference Manuals, Vol. 1 and 2, \$5.50 each (\$6.50 to non-members)
Loop Antenna Design & Theory, \$7.95 (\$9.95 to non-members)
Order from NRC Publications - P. O. Box 164 - Mannsville, NY 13661. NY orders, please add sales tax.