

# Ham Radio TODAY

## reviewed:

- Icom IC-Q7 miniature dualband handheld
- DSP add-on for IC-706 Mk II
- MFJ-969 HF 1.6m ATU



## plus:

- Multimode interface unit
- Dayton report

If the CD-ROM is missing from the cover, please contact...  
 free cd-rom  
 free cd-rom  
 the Ham Radio Today Sales office on 01747 85330

www.rsgb.org/hrt

Volume 16 No. 7 July 1998 £2.50



# Lowe Electronics Ltd

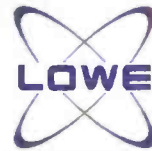

## Clear Digital Sound with the NEW JRC NRD-545 DSP Receiver

The latest model in the JRC range, the new NRD 545, which is their first receiver using DSP (Digital Signal Processing) from the IF stages onwards.

The DSP enables a wide choice of digitally implemented filters to be provided, together with IF shift and continuously variable passband width. The combination of these facilities gives the NRD 545 a level of performance than has previously been unheard of in a receiver costing less than £10,000.

Every equipment reviewer that has had the opportunity to try the NRD 545 to date has been amazed at the performance that JRC engineers have managed to cram into this small box.



**A STUNNING receiver... here are just a FEW of the OUTSTANDING features:**

- 0.1 to 29.999999MHz
- USB, LSB, RTTY, AM, FM
- 1Hz Tuning Steps (selectable)
- Huge Memory Capability
- DSP All-Mode Detection
- DSP Digital IF Filter
- DSP Pass-Band Shift
- DSP Noise reduction
- DSP Beat Canceller
- DPS Noise Blanker
- DSP Notch Filter
- DSP AGC
- DSP BFO
- DSP RF Gain
- DSP Squelch
- DSP Tone Control
- DSP S-meter
- High Sensitivity
- Wide Dynamic Range
- Variable Tuning
- Multiple Scan Modes
- Clock Timer
- Sleep Timer
- RTTY Fine Tuning

### What Chris Lorek, G4HCL says about the NRD-545\*

"sometimes has a dream, and it came true when he tried the NRD-545 in his shack"

"I believe the NRD-545 to be the very best HF receiver I've ever had the pleasure of using in my amateur shack"

"feel safe in the knowledge that the performance was well up to that of the very best receivers available"

"being able to narrow the IF bandwidth right down gave superb results"

"exceptionally good filter responses"

**"Ham Radio Today Review", April 1998**

**Low Price**  
**£1595.00**  
including VAT

## NEW CATALOGUE

### Lowe Electronics Catalogue

*Yes, its true. Due to the outstanding success of our first catalogue which we delivered to 15,000 customers, we've decided to bring out the next issue -*

*Full of interesting products with comprehensive descriptions, and still FREE! We've added new products that are JUST shipping! Plus of course, the usual fantastic LOWE deals and our service back-up which is second to none.*

Don't be left out - order yours today

- Communications
- Amateur Radio
- GPS Navigation
- Short Wave Listening
- Airband Radio
- Scanners
- Weather Monitoring

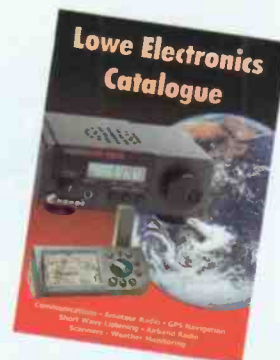

*Just send four first class stamps to receive your own catalogue!*

## Lowe Electronics Ltd

Chesterfield Road, Matlock  
Derbyshire, DE4 5LE  
Telephone (General Enquiries) 01629 580800,  
Fax 01629 580020

**Orders FREEPHONE 0800 174749**

**Email: info@lowe.co.uk**  
**URRL: http://www.lowe.co.uk**

Showroom opening hours are 9.30am to 5pm Mon-Fri and 10am to 4pm on Sat, but check with our local branches as times may vary

#### Branches

- Bristol & Wales, 79 Gloucester Road, Patchway, Bristol BS12 5QJ,  
Tel 0117 931 5263 Fax 0117 931 5270
- North East, Unit 18B, Airport Industrial Estate, Newcastle, NE3 2EF,  
Tel 0191 214 5424, Fax 0191 214 0761
- South West, 117 Beaumont Road, St Judes, Plymouth PL4 9EF  
Tel 01752 257224 Fax 01752 257225



**regular columns**

<b>book browser</b>	<b>20</b>
The best Amateur Radio publications available to <i>Ham Radio Today</i> readers	
<b>'tone' burst</b>	<b>21</b>
Take an oblique look at the world of Amateur Radio through the eyes of Tone Burst	
<b>net communication</b>	<b>36</b>
Jeremy Boot, G4NJH, takes a look at Amateur Radio microwave sites on the Internet	
<b>vhf / uhf message</b>	<b>38</b>
Microwave records and a possible new type of 50MHz propagation are reported by Geoff Brown, GJ4ICD	
<b>qrp corner</b>	<b>40</b>
Dick Pascoe, G0BPS, with more tips for low-power fans plus details of the Yeovil QRP Convention	
<b>satellite rendezvous</b>	<b>42</b>
Will the Phase 3-D satellite be launched this month? Richard Limebear, G3RWL, with the latest AMSAT-UK news	
<b>data connection</b>	<b>44</b>
Details of a new Windows version of JVFAX and lots more from Chris Lorek, G4HCL	
<b>hf happenings</b>	<b>46</b>
Don Field, G3XTT, turns the spotlight on island expeditions for the IOTA Contest which takes place this month	

**construction feature**

<b>multimode data pc interface</b>	<b>10</b>
Chris Lorek, G4HCL, shows you how to build a low-cost interface to transform your PC and transceiver or receiver into a multimode communications system	

**reviews**

<b>mfj-969 hf to 6m atu</b>	<b>19</b>
With many rigs now covering 6m as well as HF, this 300 watt ATU could be just the ticket for some operators	
<b>yaesu ft-100</b>	<b>24</b>
A preview of this remarkable new ultra-compact HF / VHF / UHF mobile transceiver	
<b>icom ic-q7e</b>	<b>26</b>
A full Chris Lorek review of Icom's new tiny dualband handheld, which is also a full-featured scanner.	
<b>dsp add-on unit for icom ic-706 mkII</b>	<b>31</b>
Chris Lorek, G4HCL, tests Icom's new plug-in board which upgrades the receiver in the IC-706MkII to a DSP unit	



**ham radio today contents**  
 volume 16 no.7 july 1998

**news and views**

<b>radio today</b>	<b>5</b>
The latest Amateur Radio news	
<b>trade topics</b>	<b>8</b>
Hot news from the Amateur Radio trade	
<b>ham radio today coffee table</b>	<b>12</b>
Focus on some exciting new radio books	
<b>letters</b>	<b>21</b>
Our readers have their say	
<b>ham radio this month</b>	<b>22</b>
The latest rally and events news	
<b>this month at the clubs</b>	<b>52</b>
Details of club events round the country, plus useful contact information	
<b>free readers' ads</b>	<b>56</b>
For Sale, Wanted or Exchange, they're all published - free of charge!	

**readers' information**

<b>subscription form</b>	<b>49</b>
<b>advertiser index</b>	<b>58</b>
<b>editorial &amp; reader services contact information</b>	<b>58</b>

**features**

<b>all in a day's work</b>	<b>16</b>
More thrifty tips from Harry Leeming, G3LLL	
<b>dayton report</b>	<b>25</b>
A look at what happened at this year's popular Stateside Amateur Radio event	
<b>our ham in havana</b>	<b>34</b>
Henryk Kotowski, SMOJHF, lifts the lid on the Amateur Radio scene in Cuba	

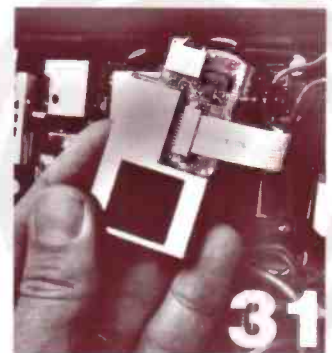

All reasonable care is taken in the preparation of the magazine contents, but the publishers, nor the Editor, cannot be held legally responsible for errors in the contents of this magazine, or for any loss arising from such errors, including loss resulting from negligence of our staff. Reliance is placed upon the contents of this magazine at readers' own risk.

# Ham Radio TODAY

## Editorial

### Editor

Steve Telenius-Lowe, G4JVG

Tel: 01707 853300

Fax: 01707 645105

e-mail: hrt@rsgb.org.uk

### Technical Consultant

Chris Lorek, G4HCL

## Production

### Designer

Wai-Yee Man

### Technical Illustrator

Bob Ryan, 2E1EKS

### Senior Designer

Jennifer Crocker, 2E1ENT

### Production Assistant

Dani Angel

### Editorial Secretary

Samantha Ralph, 2E1GGK

### Printer

Hearon Gate, Langley Mill,  
Nottinghamshire

### Origination

JJ Typographics, Southend, Essex

## Sales

### Subscriptions

Sylvia Manco, 2E1CYL

Tel: 01707 853300

e-mail: subscriptions@rsgb.org.uk

### Advertising

Malcolm Taylor Associates

PO Box 3241,

Bournemouth BH8 8WT

Tel: 01202 777852

Fax: 01202 317902

e-mail: adman@mcm.com

## Management

### General Manager

Peter Kirby, G0TWW

### Publications Manager

Mike Dennison, G3XDV

### Sales and Marketing

Marcia Brimson, 2E1DAY

## Subscriptions

12 issues: UK £26.50. Europe and Eire  
£36.50. Rest of the World (surface mail)  
£38.50, (air mail) £54.00. Cheques should  
be drawn on a UK bank and made payable  
to the Radio Society of Great Britain.

Subscriptions and back issues hotline:  
01707 853300.

Published by the Radio Society of Great  
Britain, Lambda House, Cranborne Road,  
Potters Bar, Herts EN6 3JE.

© RSGB Publications 1998.

All rights reserved. ISSN: 0269-8269

The publisher's written consent must be  
obtained before any part of this publica-  
tion may be reproduced in any form  
whatsoever, including photocopiers and  
information retrieval systems.

Undoubtedly the single biggest topic of Amateur Radio conversation throughout the world during the last ten years or so has been 'the Morse debate' - in other words should it, or should it not, be necessary to have to take a Morse code examination before being 'let loose' on the bands below 30MHz? I have no personal axe to grind: I passed my Morse code test nearly two decades ago, but nevertheless I have long held the view that the days when an obligatory Morse code test was necessary have long since gone.

As you will see from the news story opposite, the Radio Society of Great Britain now also supports this point of view. This is a change of policy, as the RSGB has for many years been *pro*-mandatory Morse testing. Of course the decision on whether or not we need to have a Morse code test is not the RSGB's to make - but the UK licensing authority, the Radiocommunications Agency (RA), does listen very carefully to the RSGB's opinions before making its decisions. Because a Morse code examination, in one form or another, is an international requirement, laid down in the ITU Radio Regulations, it is not possi-

ble for the RA simply to withdraw the requirement. However, the *speed* of the examination is not laid down anywhere in the Regulations: hence the RSGB proposal of a 5 words per minute (WPM) Morse test to allow full access to the HF bands in the UK.

## no change overnight

The *earliest* requirement could be withdrawn completely is the year 2001, when the Radio Regulations are discussed at a World Radio Conference (WRC). However, it is possible that the conference may be postponed by a year, to become WRC-2002. It is also possible that there may be insufficient time to discuss this particular subject at the conference, whether it is in 2001 or 2002, in which case it would be put on the agenda for the following WRC, in 2003 or 2004. And at present it is still far from clear what the opinion of the majority of administrations would be. So the Morse requirement is *not* going to disappear overnight - this could still be five or six years away, or even longer.

The RSGB's proposal, therefore, is to be seen as an interim measure - an opportunity to give



Editor  
G4JVG

existing class B licensees (some of whom have 25 or more years operating experience on the VHF / UHF bands) who can pass the Novice 5WPM test the opportunity to experience the HF bands. It is also a giant step towards an eventual full code-free HF licence.

## fears unfounded

The news of the RSGB's change of policy 'leaked' whilst the President, Ian Kyle, G18AYZ / M10AYZ, and General Manager Peter Kirby, G0TWW, were represent-

ing the Society at the Dayton Hamvention in Ohio. Whilst there, they were interviewed by the ARRL on the subject and took the opportunity to dismiss some misunderstandings. "We're not trying to get rid of Morse! No way!" insisted Ian. The RSGB will continue to support Morse code and the CW subbands on HF "as core elements of Amateur Radio globally." But, he said, "Mandatory testing of Morse is going to go, whether we like it or not." Peter Kirby said there no longer is any good reason to insist that applicants pass a Morse code test to operate on HF. "It's stopping growth in the hobby," he said, adding that he disagrees with those who think it will be the death of the hobby or would lead to lower operating standards. Peter, a former Royal Navy professional CW operator, said that making someone pass a 12WPM test "doesn't make one a good operator."

In my first editorial, in the March 1998 issue of *Ham Radio Today*, I stated that the magazine would "continue to portray Amateur Radio as a young and exciting hobby for all, and that includes continuing the campaign started by Sheila and Chris [Lorek] to make it easier and more rewarding to hold an Ama-

teur Radio licence". Certainly if the RSGB's proposal is agreed by the RA it would make it easier to hold an HF Amateur Radio licence. There will be opposition, though. In the immortal words of Sir Humphrey in *Yes, Prime Minister*, it is a "courageous" move, and there will be many who view it as the beginning of the end of Amateur Radio as they know it.

I think their fears are unfounded and that, on the contrary, making it easier to gain an HF licence will bring more new people into the hobby. This is how the hobby will grow, not by

preserving a redundant requirement which, whatever the merits of CW as a mode, is certainly turning people away from the hobby. I personally know of two people who use communications equipment professionally, and know quite a lot about Amateur Radio, but who have never taken up the hobby simply because of the need to learn the Morse code to get on to the HF bands.

It is ironic that, far from spelling an end to Morse code, the proposal is bound to encourage thousands *more* to learn Morse, at least to the 5WPM level, in order to gain access to HF.

I am sure *Ham Radio Today* readers will be quick to inform us of their opinion. It is interesting to note that the RSGB statement also says that it is "seeking ways of making the qualifications for the amateur licence - be this the RAE or a new qualification - more accessible and less expensive." What do you think? Have you been put off taking the RAE because it is too expensive, or because there is no examination centre near you? More fundamentally, do you think the RAE is too difficult for you to master? Or perhaps not too difficult, but simply asking the wrong sort of questions? Do let us know what you think.

# A new UK licence category?

Ham Radio Today Editorial by Steve Telenius-Lowe, G4JVG

# rsgb changes policy on morse testing

A Leader article published over the name of Ian Kyle, G18AYZ / M10AYZ, President of the RSGB, and published in the June issue of *RadCom*, outlines a change of thinking by the Society on the subject of mandatory Morse testing. We can do no better than quote from the article:

"... At its meeting in April, Council [RSGB Council, the governing body of the Society - Ed] agreed that it would open discussions with the Radiocommunications Agency to begin a process of liberalising access to the HF amateur bands. Council sees the first step in this as an additional licence category giving full access to the HF bands to existing Class B licensees, subject to a 5WPM Morse capability. The Society hopes that the RA will support this approach. If agreed, however, this licence would only be available for use within the United Kingdom, and would not grant privileges on HF bands in other countries under the CEPT arrangements.

"The maintenance of Morse as a mandatory requirement for access to the HF bands is IARU policy. Council, however, now believes that this position cannot be sustained in the longer term and will be opening discussions with IARU societies and other interested bodies to reconsider the position to be adopted at the WRC in 2001, when the matter of Morse as a necessary qualifier for access to HF bands is likely to be considered. The current IARU policy was determined some years ago, since when circumstances have changed and will no doubt change further by the time of the next WRC at which Amateur Radio will be discussed.

"In taking its position on Morse, Council is mindful of the strength of feeling around this issue. Morse has many advantages, including spectrum utilisation, relative simplicity of equipment and cost. The Society wishes to see Morse (and Morse segments of the HF bands) preserved as core elements of Amateur Radio globally. However, Morse is but one mode among many in current use, and it should take its place alongside the others as an equal.

"Council is also seeking ways of making the qualifications for the amateur licence - be this the RAE or a new qualification - more accessible and less expensive. Also under discussion are proposals that might lead towards an acceptable system of progressive licensing.

"Our hobby is in need of stimulation. The numbers of Radio Amateurs are falling in many parts of the world and this trend is an unhealthy one for the future of Amateur Radio. We must be seen as progressive and forward looking. We believe that this position will be welcomed by the majority of radio amateurs in the United Kingdom who share the view that the Society should take a forward looking and progressive stance on the future of our hobby."

# radio today radio today

latest news on ham radio today

# free cd-rom

Once again, *Ham Radio Today* readers receive a free CD-ROM on the cover of the magazine this month. This month's free CD-ROM contains hundreds of the latest freeware, shareware and public domain multimode data programs for Amateur Radio use, including packet, SSTV, fax, RTTY, PacTOR, AmTOR, and CW programs. It includes a time-limited version of the new *JVFAX for Windows* program.

The CD-ROM may be read on any current version of DOS, Windows 3.1x and Windows 95, although some programs require certain minimum PC specifications. The files and software on the CD-ROM are offered 'as is' with no warranty of suitability for any particular purpose. The files and software have been virus checked using regularly-updated proprietary software, but you should also carry out your own checks.

To operate the CD-ROM, place it in your CD-ROM drive, log on to that drive and run the 'GO' file, ie in DOS type GO followed by your PC's enter key, in Windows click on 'GO.COM'.

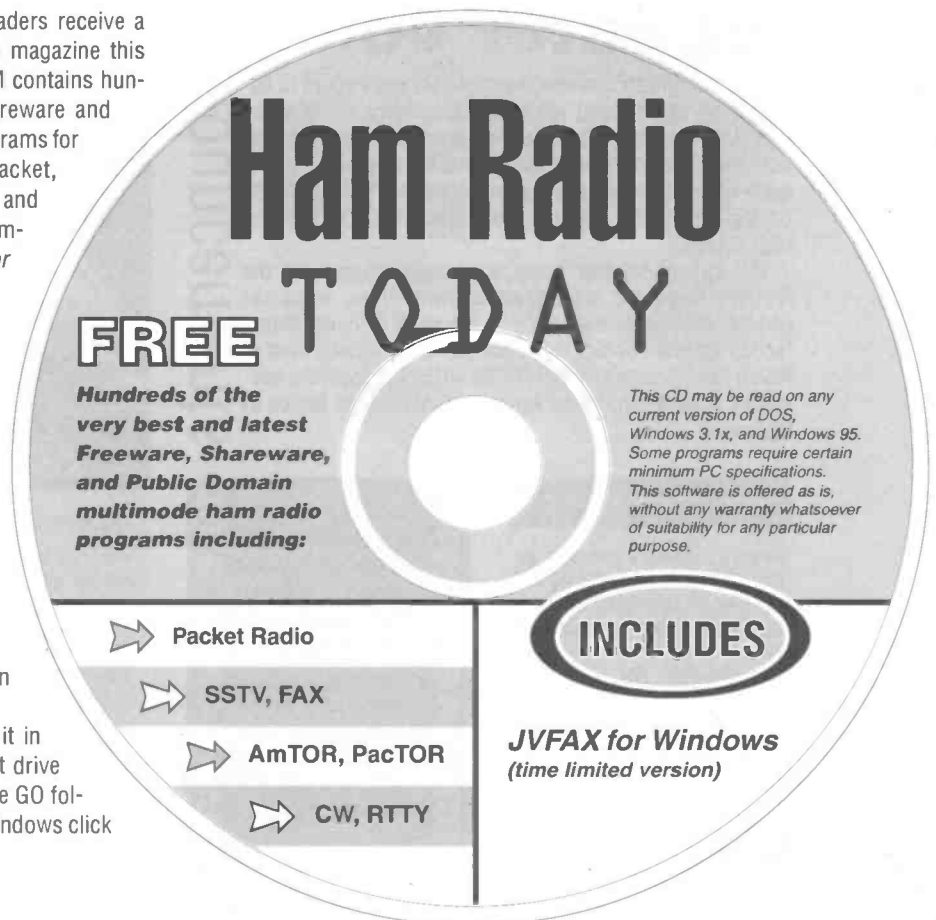



# if only . . .

A new Amateur Radio antenna law in the state of Virginia made a major story in the influential US newspaper the *Washington Post* on 4 May. According to the article, 'Virginia Hams to Reach New Heights', "a new Virginia law allows amateur radio owners to erect towers of up to 75ft in residential . . . areas, while rural counties must let them go as high as 200ft." The writer, Dan Eggen, says the new legislation "makes Virginia the most permissive state in the nation when it comes to Amateur Radio antennas."

However, Frank Mackey, K4EC, is quoted in the article as saying that, "darn few hams" can afford to put up a 200ft tower. "All anybody was looking for was an reasonable solution, and I think this is reasonable", he says.

Thanks to *Ham Radio Today* reader Derek Thom, G3NKS, for sending in the press clipping.

# uk iaru experts

The International Amateur Radio Union (IARU) Executive Committee has appointed Julian Gannaway, G3YGF, and Peter Chadwick, G3RZP, as members of the IARU Group of Experts. This will enable the IARU to make use of their experience in the various areas of their expertise.

# record books

The library of the late Len Newnham, G6NZ, consisting of around 2000 books, was sold by Phillips Auctioneers in New Bond Street, London, on 15 May. The 31 lots made over £11,000. Much of the collection was of practical material on radio telegraphy and included periodicals and trade catalogues from the 20s and 30s. Len Newnham died in 1994, and his former callsign, G6NZ, is now held by his widow, Margaret.

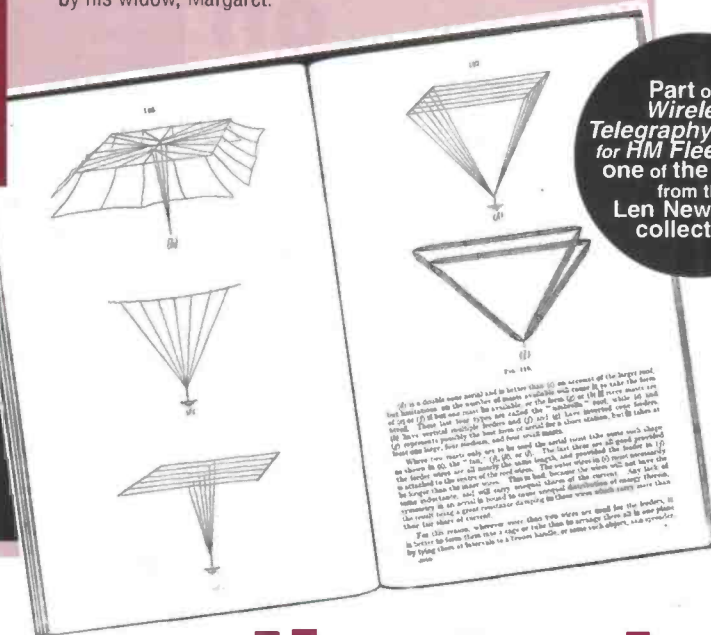

Part of the *Wireless Telegraphy Manual for HM Fleet, Vol 1*, one of the books from the Len Newnham collection.

# radio today radio today

latest news on ham radio today

# repeater voice

The Radiocommunications Agency (RA) has agreed to automatic or synthesised voice announcements on UK voice repeaters. Two identification messages and four information messages have been authorised for use, and the first such officially-recognised announcements will be made on the 2m Bristol Channel area repeater, GB3BC, in the near future.

The agreement was made after negotiations with the RSGB's Repeater Management Committee. Repeater groups wishing to make use of the voice announcement facility should contact the Amateur Radio Department at RSGB headquarters (tel: 01707 659015) to obtain the necessary amendment to the keeper's NoV (licence Notice of Variation).

announcements

# new countries on lf

Belgian amateurs are now on the 136kHz band, bringing the number of countries with access to the LF band up to at least 16 (the seven UK countries, EI, DL, HB9, HB0, OH, OH0, OJO, LY and now ON), although there is no activity in some of the smaller countries. ON7YD has already been received in the UK, at a distance of some 350km.

# new countries on lf

nice one, kevin!

Congratulations to Kevin Nice, who has been appointed as Editor of *Short Wave Magazine*. Kevin, who was formerly the Assistant Editor, takes over from Dick Ganderton, who is retiring. Zoë Crabb also receives promotion and takes on the rôle of News and Production Editor.

nice one, kevin!

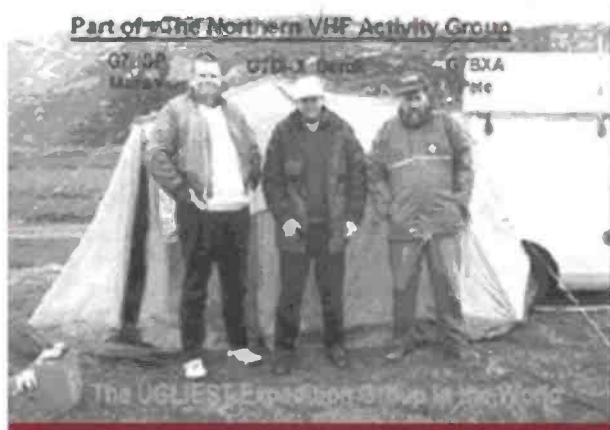

Part of the group on an earlier trip to the isle of South Uist.

The Northern VHF Activity Group, perhaps better known as the 'Ugly Expedition Group' (the name comes from the callsign, not for any other reason) is off on its travels again. G7BXA, G7HSP, G4YQW and GONES will be activating GS7UEG/P from the Isle of Barra, the most southerly inhabited island in the Western Isles, between 5 and 12 July. They will be based at IO66HX, but plan to also set up a portable station in IO67, as well as activate several WAB squares. This year, the group will also be active on HF, using its new callsign MS0BPG/P. Equipment consists of 100W on all bands to two 13-ele Yagis on 2m, 5-ele Yagis on 6m and a 3-ele triband beam, verticals and wire antennas for HF.

uglies on the road again

## civil war on the radio

A series of special event stations are commemorating battles of the English Civil War, 350 years ago. GB350BOP will operate from a number of locations including the site of the final battle at Fishwick Bottoms in Preston. The first event took place in May, and other stations in the series are: 18 July, from the flag market, Preston town centre, 25 July and 3 August Priory Club, Leyland; 2 August Fishwick Bottoms; 8 / 9 August from Grimsargh Hall battle site, Preston; 15 - 17 August from Brownedge St Mary's High School, Bamber Bridge, Preston.

The Society of the Sealed Knot will be re-enacting battle scenes at some of the sites, which will provide an interesting backdrop to the Amateur Radio operations.

The events are being run by the Central Lancs Amateur Radio Club, and more details are available from Peter, G3UCA, tel: 01772 494474.

## the brits are coming

Congratulations to top UK contester and DXpeditioner Roger Western, G3SXW, who was inducted into the CQ Contest 'Hall of Fame' at the Contest Dinner in Dayton, Ohio, on 16 May. Roger won recognition from his peers for his over 25 years of top contest activity, culminating in recent years with a series of highly successful contest expeditions to Togo, West Africa. Three US amateurs were also inducted into the Hall of Fame: Glenn Rattmann, K6NA; Gene Walsh, N2AA; and Dick Frey, WA2AAU.



Roger Western, G3SXW, returns from one of his expeditions to find a pile of direct QSLs for answering.

# radio today radio today

latest news on ham radio today

## marconi special events

Members of the Wicklow Wireless Society will be operating a series of special event stations using the callsign EI1M from 18 - 20 July to celebrate the centenary of Marconi's experiments in Dublin Bay. One hundred years ago, Marconi boarded a launch, the *Flying Huntress*, to report on yacht races of Kingstown (now Dun Laoghaire) Regatta. Over the two days of the regatta, around 400 messages were exchanged at distances of up to six miles in what is now regarded as the first use of radio in journalism and the first sports outside broadcast event.

On 19 July, the 1898 regatta will be re-enacted, and once again CW signals reporting on the race will be transmitted from a boat to the original shore station. Dun Laoghaire Council has agreed to establish a permanent memorial to Marconi, and this will be unveiled in the presence of Princess Elettra, Marconi's daughter, on 20 July.

The EI1M stations will be active on all bands 10 - 80m on CW and SSB between 18 and 20 July. QSL direct or via the bureau to EI2WW.

And the Ynys Môn Amateur Radio Users Group will be putting on special event station GB4HMM, at the new Maritime Museum at Holyhead, Anglesey, on 18 / 19 July. The station commemorates the Marconi centenary and the opening of the new Maritime Museum. GB4HMM particularly hopes to contact many Maritime Mobile stations.



## nrd-545 dsp winner

The lucky winner of the joint *Ham Radio Today* / Lowe Electronics JRC NRD-545 DSP receiver competition, which was in the April issue of the magazine, is Thomas Bates, G4MZS, of Wallasey, Merseyside. When told of his success in the competition, Mr Bates said he was overwhelmed and that he'd "have to pick myself up off the floor". He said he never won any competitions - well, there's always a first time and you know the saying, "it could be you!" Mr Bates is 59 and had promised himself that he would buy a "decent" receiver when he retires shortly. Well, he's just saved himself nearly £1600 by winning the *Ham Radio Today* / Lowe Electronics competition prize. Congratulations - the receiver has already been despatched to Mr Bates.

All *Ham Radio Today* readers who completed the readers' survey form with the competition are thanked for their input.

## council of europe award

To help celebrate the 50th anniversary of the Council of Europe, the Council of Europe Radio Club has issued a new award. It's open to all Radio Amateurs and SWLs who have confirmed contacts with all 40 member countries of the Council of Europe, plus

club station TP2CE. For full details of the award, contact Francis Kremer, F6FQK, 31 rue Louis Pasteur, 67490 Dettwiller, France, or e-mail: f6fqk@ref.tm.fr



## asaps v4.0

Version 4 of the professional grade **HF propagation prediction program ASAPS** (Advanced Stand Alone Prediction System), produced by the Australian IPS Radio and Space Services, is now available in the UK.

The program generates predictions for any HF circuit in the world and outputs them in the form of graphs or frequency plans. Probability, field strength, path losses, take-off angles etc can all be predicted. The program includes a unique solar 'T-index' database, allowing predictions to be made several years into the future.

ASAPS v4.0 is available in the UK from Simon Collings, 46 St Michaels Road, Cheltenham, Glos GL51 5RR; tel / fax: 01242 514429; e-mail [simon.collings@cablenet.co.uk](mailto:simon.collings@cablenet.co.uk) for £150 (plus £2.50 P&P). An upgrade from DOS v2.0 or previous Windows versions is £21.50 (plus £2.50 P&P). A demonstration of ASAPS can be downloaded from [wkweb4.cablenet.co.uk/simon.collings](http://wkweb4.cablenet.co.uk/simon.collings) or may be obtained by sending three 3.5in disks and return postage to the above address.

## kenwood sstv

Already out in Japan, but yet to be seen here in the UK, is the **Kenwood VC-H1** 'Interactive Visual Communicator'. This is a handheld miniature SSTV unit, which includes both a colour camera and tiny monitor. It can be used on any mode or with any transceiver, from a VHF FM handheld to SSB HF rigs. More details when we have them.

## new contact number for smc

**South Midlands Communications (SMC)**, the Amateur Radio and communications dealers based in Eastleigh, Hampshire, have new telephone and fax numbers: 01703 246222 for the Amateur Radio shop; 01703 246200 for general enquiries, and fax: 01703 246206). The old Amateur Radio shop number (01703 251549) will work in parallel with the new number for a while, but will soon be phased out.

## powabeam antenna

**PowAbeam Antennas** have launched the **2M-2.5WL Ultra Max**, a 144MHz nine-element beam with a claimed 14.9dBi gain. The boomlength is 5.3m and the manufacturers say that it offers an outstanding polar pattern, suitable for EME as well as terrestrial DX work.

Priced at £84.95 (plus £10 carriage in UK), full technical specifications are available from PowAbeam Antennas, Hazeldene, Bridgerule, Holsworthy, Devon EX22 7EW; tel: 01288 381289.

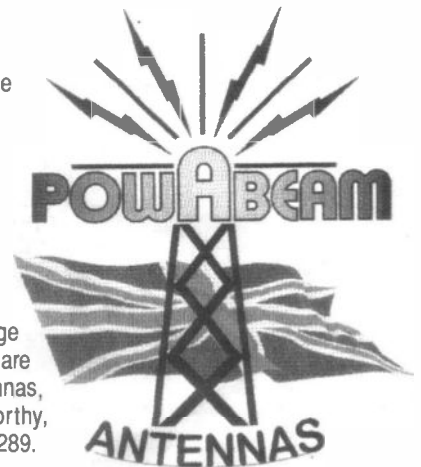

# trade topics trade topics

the following information is based upon submissions by suppliers we cannot be responsible for false

## chelcom antennas

The **Chelcom LP270** is a 12-element log periodic antenna which covers the 2m and 70cm bands. Designed for amateurs who are looking for directional dual-band coverage from a single antenna, the LP270 offers remarkably good forward gain (8.5dB claimed) and front-to-back ratio (19 - 25dB) for an antenna of its size. For those not needing the ultimate DX performance that two large, monoband, high-gain Yagis would provide, the LP270 could be the answer. It's easy to install, requires only a lightweight rotator, and because it's a single antenna, it has low visual impact and requires just a single coax feed ('N' type connector).

The boom length is 1.44m and longest element 1062mm. It will handle 500 watts and the LP270 costs £79.99 inc VAT.

Also new from Chelcom is the **CL80**, a centre-loaded quarter-wave vertical for 80m, tuneable for the CW or SSB ends of the band. The aluminium antenna is 11.5m (37.5ft) long, weighs 12kg, and will handle up to 2.5kW. No section is longer than 2m, making it ideal for DXpeditions or field day use.

The centre high-Q loading inductor is wide-spaced wound on a heavy fibreglass former. A capacitance hat is incorporated in the inductor design, to reduce the number of turns needed, thus keeping losses to a minimum. An impedance matching transformer is housed in a weatherproof box on the mounting assembly, providing a near perfect match when the antenna is used with four raised, quarter-wave wire radials (recommended installation), or when mounted at ground level with a good earth radial system (full size, and pre-tuned loaded half-size, quarter-wave groundplane kits are available).

Phasing units for two and four antenna arrays should be available from Chelcom soon. The CL80 comes supplied with mounting 'V' bolts etc and costs £199.95.

Chelcom have also recently released the **FS40** and **FS30** full-size (unloaded) quarter-wave verticals for 40 and 30 metres. They each cost £175.

Coming soon is the **Chelcom TL80**, a capacitance hat top-loaded (no coil) quarter-wave vertical for 80m, also 11.5m (37.5ft) long. Chelcom describe it as "a big hefty antenna, with a performance to match!"

Chelcom, Riverside House, Homecroft Drive, Cheltenham, Glos GL51 9SN; tel: 01242 680653; Internet: [www.chelcom.com](http://www.chelcom.com)

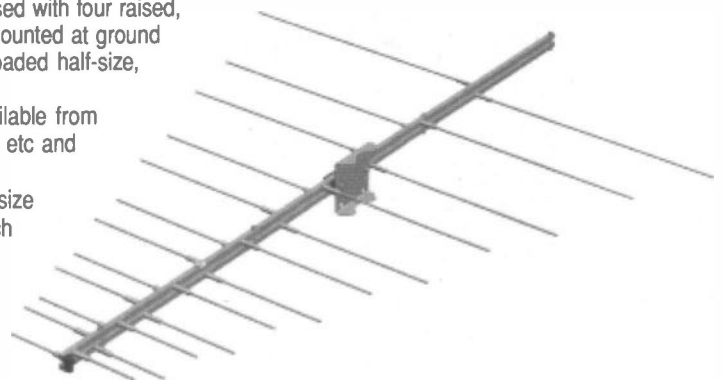



## exhibit in november

The AMS '98 Computer & Electronics Show takes place on Saturday 14 November at Bingley Hall, Staffordshire Showground, Weston Rd, Stafford. Organisers Sharward Promotions wish to expand the Amateur Radio side of this mainly computer show. There are already a number of Amateur Radio traders at the show, but Sharward Promotions are prepared to offer some great deals to new traders who wish to exhibit at this event. Contact Ray Gamble or Sharon Alward at Sharward Promotions, tel: 01473 741533 or e-mail ray@sharward.co.uk for further details.

## dsp-rtty

timewave

A new RTTY program has been released by Timewave for existing owners of the Timewave 599zx and 59Y DSP units. **DSP-RTTY** and the DSP-599zx dig into the noise for really weak signals, to reduce errors by up to a hundred-fold.

You can operate 'contest-quality' RTTY with just the DSP-RTTY program and DSP-599zx or DSP-59Y, *Windows 95* PC, and radio. Minimum specifications are 486PC, *Windows 95, 98 or NT 4.0*, 5MB free disk space and 8MB RAM (16MB recommended).

This is a full-featured package which costs £79.95. Further details can be obtained from Nevada, 189 London Road, North End, Portsmouth, Hants PO2 9AE; tel: 01705 662145; fax: 01705 690626.

## w&s's silver anniversary

Congratulations to Waters & Stanton PLC, who celebrate 25 years of trading this month. To celebrate this milestone, they are holding a special anniversary sale in their store at 22 Main Road, Hockley, Essex, between 9.00am and 6.00pm on 25 July. Some "fantastic offers and massive discounts" are promised.

It may not be generally known amongst Amateur Radio enthusiasts that Waters & Stanton PLC are also actively involved in the supply and installation of commercial radio equipment. Their most recent success is the completion of an order to supply 400 Motorola handheld radios to a national retail chain. This side of the business is growing significantly and Waters & Stanton have plans to launch a new range of products aimed at the commercial user.



# trade topics trade topics

liars, and is not necessarily endorsed by ham radio today. misleading claims by suppliers.

## lowe's enter antenna sites business

Lowe Electronics Ltd, based in Matlock, Derbyshire, have acquired the antenna sites business formerly operated by Relcom Communications Ltd. The 20 prime nation-wide sites range from hilltop locations in Scotland to the roof of the Park Lane Hilton Hotel in Mayfair. Several of the sites are ideally situated to give coverage of the City and Metropolitan London, and all have expansion space available to permit the addition of further customers.

The acquisition represents a further diversification for Lowe, who after many years in the Amateur Radio business have recently expanded into the supply of a range of low-cost branded communications accessories to PMR companies and the emergency services.

For further information, contact Steve Quarmby, Aerial Sites Manager at Lowe Electronics; tel: 01629 580800.

## new GM for Yaesu uk

Yaesu UK have a new General Manager: David Peaty, who is the former Sales Director of SMC. He took up his new position on 20 May.

### STOP PRESS:

The Yaesu FT-847s have arrived in the UK and there will be a full review in the next issue of the magazine.

## cushcraft r6000

We received news of Cushcraft's new vertical for 20, 17, 15, 12, 10 and 6m, the R6000, just in time for last month's magazine - but there was no picture available then. The picture has now arrived, as has news that the antenna is available from Waters & Stanton PLC in Hockley, Essex, in addition to Nevada. The Cushcraft R6000 is a 5.5m long vertical with no traps on 6, 10 and 15m for maximum efficiency. It weighs 5.6kg.



## w&s

new from

Icom have just released details of their new 160 - 6m 1kW solid-state amplifier, the IC-PW1. It has a detachable desk-top control console which measures just 205 x 82 x 75mm, whilst the remainder of the unit, which includes a 230 / 115V AC PSU) can sit out of sight under the desk. It's priced at around £3500.

The very popular MFJ Antenna Analyzer has been updated and the MFJ-259 Mk II is now out. It features an expanded LCD display with both analogue and digital readouts of impedance and SWR and a battery saver circuit. Every antenna experimenter should have one.

Waters & Stanton PLC, 22 Main Road, Hockley, Essex SS5 4QS; tel: 01702 206835; fax: 01702 205843; e-mail: sales@wsplc.demon.co.uk

On this month's front-cover CD-ROM, you'll find plenty of predominantly DOS-based programs like *HamComm*, *MScan*, *JVFAX* and so on, which use an external circuit on your PC's RS-232 port for the communication interface. Some programs allow you to use a specific type of sound card as an interface, but not everyone has such a PC system.

These days, basic two-speed CD-ROM drives can be found at £2 each, so there's little excuse for saying, "I don't have a CD-ROM drive and I can't afford one". Now that lower-specification PCs like 386s and even 486s can be purchased at Amateur Radio and computer rallies for around £5 - £25 (less than the cost of an add-on sound card - yes, just take a look!) you can get going with full-blown PC-based data communications for typically less than the price of a new Morse key.

With the programs on the CD-ROM, and this cheap to build

multimode data PC interface, you can receive - or transceive - modes such as fax, CW, RTTY, AmTOR, and SSTV.

The following details are based on earlier projects published in *Ham Radio Today*, but with a new PCB design for greater compactness and track accuracy. I claim no originality whatsoever for the circuit arrangement, in fact it's the very same circuit as featured by the *HamComm* 3.1 author in his documentation file. My only input is the design, layout, and checking of suitable PCBs, and a few ideas regarding component types and voltages. For the home constructor with a suitable component 'junk box', I hope these details are of use.

### receive or transceive?

The interface described here can be used for either receive only with a smaller number of components fitted as detailed, or for a full transmit and receive sys-

tem with all the components fitted.

I've given two circuit options here. The first, with fewer components, is for a receive-only arrangement, ie where your receiver audio output only feeds the interface (Fig 1).

For receive-only operation, you can use the PCB and just populate it with the receive components as described in the first section of the parts list. This allows for future expansion to add transmit capability, for example when you obtain an Amateur Radio transmitting licence, if you're currently a listener.

### circuitry

The circuit board I've designed here is just the width of a 9-way D-type PC RS-232 connector shell. Fig 2 shows the track side of the PCB layout, and Fig 3 the PCB components side, shown with the tracks beneath.

If you wish to transceive, the complete circuit, with the addition of transmit components for

the PTT (push-to-talk), and a multi-section low pass filter to shape the harmonic-rich square wave from the PC into a cleaner sine wave to feed to your mic socket, is shown in Fig 4.

There's no need to etch and build a PCB of course, instead you can easily use stripboard such as Veroboard to build the circuit if you wish, as the layout isn't critical.

Func	9-way	25-way
TXD	Pin 3	Pin 2
DTR	Pin 4	Pin 20
GND	Pin 5	Pin 7
DSR	Pin 6	Pin 6
RTS	Pin 7	Pin 4

Table 1: 9-25 way RS-232 connections

I've used a 9-way board-mounting RS-232 D-type connector in this design, so the unit can either plug straight into the

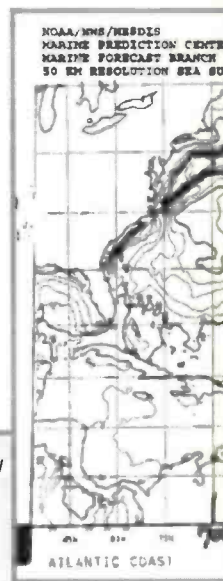

Typical SSTV (left and far right), and fax (centre top) images received by software on CD-ROM.

# Multimode Data

Integrate many of this month's cover-mounted CD-ROM, our Technical Corner, into your PC and transceiver / receiver into a multimode data interface.

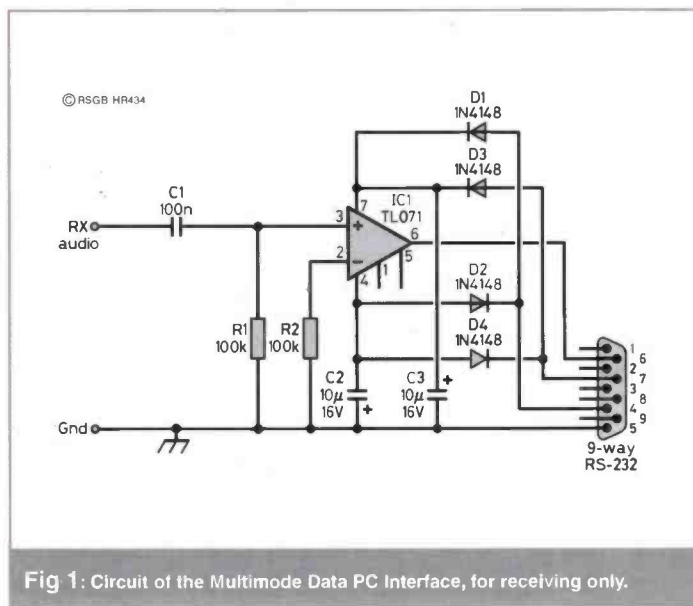

Fig 1: Circuit of the Multimode Data PC Interface, for receiving only.

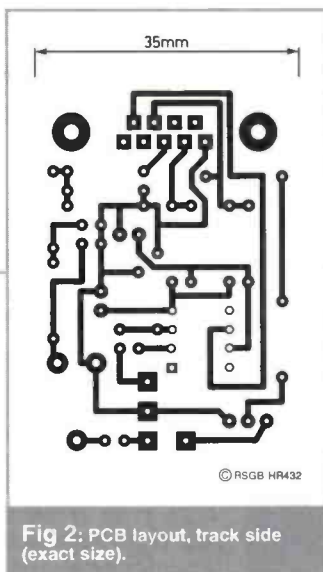
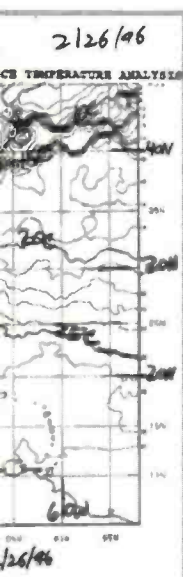

Fig 2: PCB layout, track side (exact size).

back of your PC or alternatively be fitted into a case and used with a standard RS-232 cable. If your computer uses a 25-way connector, a commonly available 9 to 25-way adapter may be used, or you can easily wire up a 25-way connector as shown in Table 1.

I've tested the circuit with both 741 and TL071 op-amps, however, I'd advise against using the 741 even though it's often more commonly available. This is because the RS-232 serial interface circuitry on some computers can't supply enough drive current for a 741. The TL071 has a lower current requirement and this is the type I'd recommend. The interface should operate correctly with 16V working electrolytic capacitors, which after several months of testing I've now





found to have no problems with (I've built up and tested over 50 of these interfaces). But it is preferable to use 25V working types if you have these in your junk box, in order to cope with maximum possible RS-232 voltage

### Components list

- All resistors 1/10W or 1/8W  
 All electrolytic capacitors 16-25V working
- C1 100nF disc
  - C2, C3 10uF electrolytic
  - R1, R2 100k
  - D1 - D4 1N4148 or equivalent
  - IC1 TL071
- 9-way D-type RS-232 connector
- The following components are required for the transmit sections, and may be omitted for a receive-only unit:
- C4 100nF disc
  - C5, C6 22nF disc
  - R3 10k horizontal preset
  - R4, R5 15k
  - R6 10k
  - R7 1k
  - D5 - 7 1N4148 or equivalent
  - TR1 BC108 or equivalent

### in use

Before plugging the assembled unit into your PC's RS-232 port, do take a few minutes to check your solder joints, being especially careful to ensure there are no solder bridges between tracks. Check that you've inserted the diodes the right way round, as this is a common cause of non-operation.

The outputs of RX AF (Receive Audio), TX AF (TX mic connection), PTT (TX ground to transmit) and GND (common ground). I hope are all reasonably obvious. If you have a 'line out' or 'record out' on your receiver, try this to start, otherwise you'll need to use your receiver's external speaker connector, adjusting the volume carefully for correct operation. I've found the 'spectrum

scope' on the HamComm program is an excellent tuning aid when you're on the air. The board-mounted potentiometer is used as an audio output level control on transmit, adjust this to provide the required drive to your transmitter, setting it so that it doesn't drive the transmitter into clipping.

For more information on testing and using the interface with your program and PC system, refer to the comprehensive documentation supplied on the front-cover mounted CD-ROM with the HamComm and JVFAX communications programs; there are plenty of hints and tips to be found there.

### alternatives

A number of Ham Radio Today advertisers can also supply complete kits and even ready-assembled PCBs for a similar interface. Companies such as Waters & Stanton PLC in Hockley, Essex (tel: 01702

206835) can supply a Watson ready-made and boxed unit, whilst South Midlands Communications (SMC) in Chandler's Ford, Hants (tel: 01703 246222) sell the Multimodo multimode interface unit.

If you do choose to go down the 'homebrew' route, it just remains for me to wish you good constructing, and to have fun on the air with your interface and data software on your free Ham Radio Today CD-ROM!

Please note that any queries regarding the construction of this project should be addressed to the Technical Consultant, c/o the Ham Radio Today editorial address (shown on page 58).

Please enclose an SASE if you require a reply.



# data PC Interface

Technical Consultant shows how to build a low-cost RS-232 interface to transform multimode communications system

swings on some PC I/O boards.

The values of most of the resistors and capacitors components isn't critical, eg if you only have 'near values' in your junk box these will usually suffice nicely. The only critical components are R4, R5, R7, C5 and C6, as these give a defined filter response, so don't stray too far off these values. I've used a BC108 transistor, but any common NPN switching transistor may be used in its place, such as a BC547 or similar. Just be careful to connect the base, collector and emitter leads correctly if you use a substitute, the pin-out details are shown on the component overlay. Even if you buy all the components new, they shouldn't cost more than £5 including the RS-232 connector (which is often the most expensive part!)

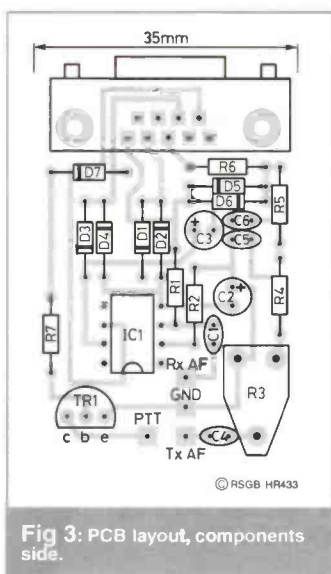

Fig 3: PCB layout, components side.

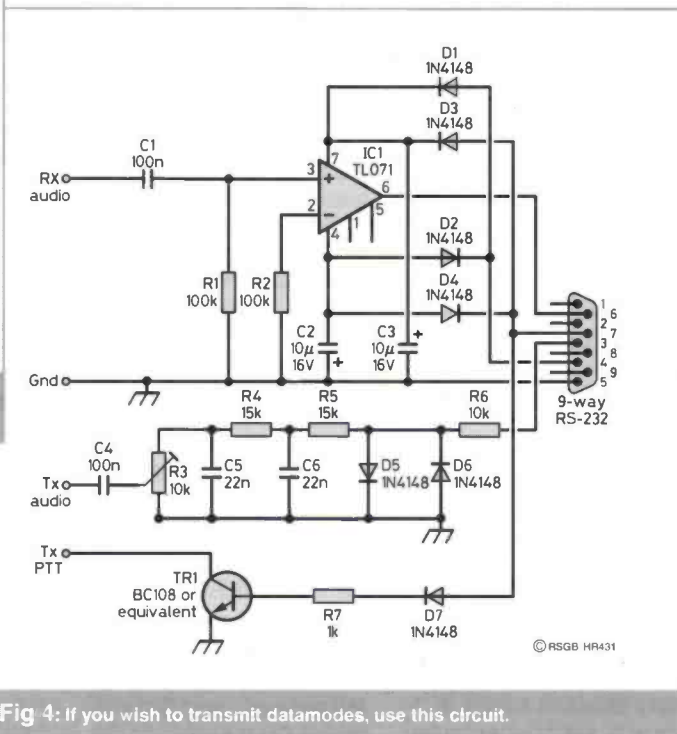

Fig 4: If you wish to transmit datamodes, use this circuit.

# Coffee Table



A number of exciting new radio books have been published in the **Book Browser** section.

## The Ham Radio Today

### World Radio TV Handbook 1998 (Billboard Books, £22.94)

Even bigger than ever - at over 600 pages this year - the *World Radio TV Handbook* is familiarly known as *WRTH* by generations of broadcast SWLs and DXers. Editor Andy Sennitt has crammed a vast amount of information on radio broadcasting, both domestic and international, into the book. The largest section, at around 300 pages, is devoted to domestic broadcasting: national, regional and local. There is an immense amount of data for each country, including full details of every known radio station in the country - frequency, power, and hours of transmission.

International broadcasters appear in a separate section of over 50 pages. Each station's current transmission schedule is given, listed by language, then time and frequency. Typical station announcements in numerous languages are given in many cases, to aid listeners in identifying what they are hearing (eg "Laparakobs Tbilisi" for Radio Georgia in Georgian). Another section lists all the international English-language broadcasts from each country in the world by time, target area of the world, and frequency.

Other major sections of the book are given over to long, medium and short wave frequency listings - essential reference for the broadcast band DXer. The previous edition of the book had decreased the amount of television information to just eight pages, but in 1998 the world television section is restored to a comprehensive list-

ing of broadcasters and terrestrial TV transmitters, including the colour system used, the standard, channel numbers and frequencies, powers of transmitters and programme transmitted.

In addition to the listings, there are articles about DAB (digital audio broadcasting), the AM synchronous detection technique, shortwave broadcast DXing in Hawaii, and on propagation by two of the world's foremost experts on the subject, George Jacobs, W3ASK, and Mike Bird. The book includes its now famous 'test bench', a section devoted to impartial reviews of receivers and active receive antennas.

If you're in any way interested in short wave, medium wave, long wave, or VHF broadcast listening or DXing, or in long-distance TV reception, the *WRTH* will be indispensable to you.

### Ferrell's Confidential Frequency List (PWP, £19.95)

Have you ever wondered what is to be found *between* the HF amateur bands? Yes, most people are aware of shortwave broadcast stations, but what about all those other signals?

*Ferrell's Confidential Frequency List* provides the answer. Subtitled 'the definitive guide to utility stations 1605 to 30,000kHz' this 10th edition, compiled by Geoff Halligey, consists of over 450 pages, made up primarily of utility station listings in frequency order. A typical entry reads:

8764 USB NMG COMMSTA Boston, MA FC USCG

...which means that on 8764kHz there is an upper sideband station, callsign NMG, in Boston, Massachusetts, operating in the Marine Coast Station service.

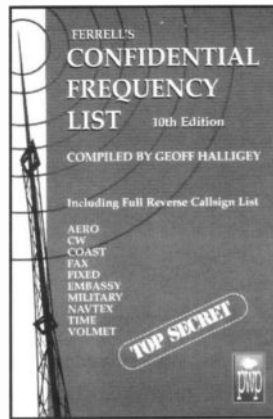

Useful abbreviations lists explain that it is a US Coastguard Communications Station.

However, it is not only this station which is on 8764kHz: there are similar coast sta-

tions in Barbados, Panama, Argentina, Alaska, Guam, Indonesia, Russia and China, as well as several others in the USA, sharing the frequency and the book gives a similar amount of detail for all these.

Aero, CW, fax, fixed, embassy, military, navtex, time and Volmet stations are included in addition to coast stations.

*Ferrell's Confidential Frequency List* contains a 'Reverse Listing', the same information provided in callsign, rather than frequency, order. This is useful if, for example, you identify station NRV by callsign. The 'N' should tell you that the station is an American one, but the book will inform you that it is in fact located at Apra Harbor in Guam, and it also provides a list of several parallel frequencies on which NRV operates.

There are a number of useful tables listing the international allocation of callsigns, maritime service frequency allocations etc, as well as a series of continental charts showing the ICAO HF areas and their frequencies.

Spiral bound to lie flat on the shack desktop, *Ferrell's Confidential Frequency List* is the essential reference guide for utility listeners.

### LF Experimenter's Source Book (RSGB, £7.50)

When the 73kHz band was released I was working in the ham radio business with an eye to making a kit for the new band. After the variation for the licence

arrived I started looking around for published material on the subject and found very little available. Even my pile of American books had little on these low frequencies. One thing I did know: it wasn't going to be easy. I eventually forgot about the band, except when I read about experiments in the magazines.

Access to the 73kHz band was limited to those who wished to experiment and could show a need. Now the new 136kHz band is open for use by *all* UK amateurs. To get access to a new band is exciting, but where does one start? All is not lost. Peter Dodd, G3LDO, has edited a collection of articles written by amateurs who have overcome many of the problems found on 73kHz; many new articles have been written with the newer 136kHz band in mind.

The opening preface says quite a lot, and one paragraph must be remembered whilst reading the book. It says, "No attempt has been made to make this book into a work of art." It is not designed to show off the coffee table in the lounge, it is designed to be used opened up, flat on the workbench. Many of the photocopied photographs are not perfectly clear, but with the descriptions they don't need to be.

I spent a lot of time reading this book and found it fascinating. It is obvious to even the casual reader that

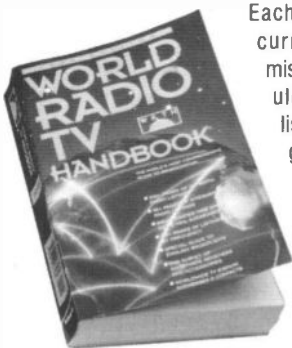

## ham radio today

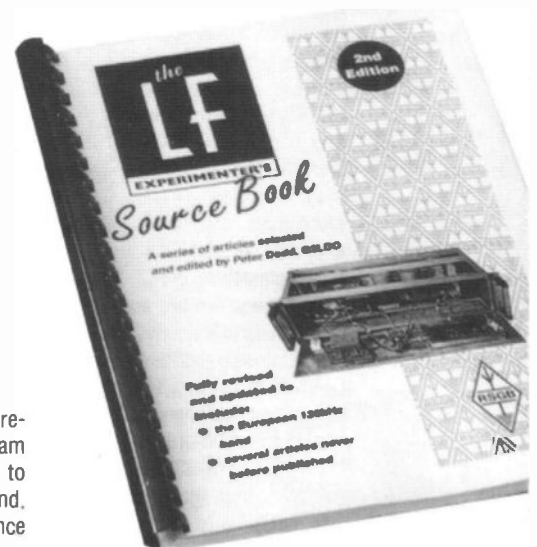



ned recently. Most are available from the Ham Radio Today  
vice (see page 20)



## Coffee Table

there is a huge amount of information encapsulated in these covers. A few new ideas creep in that to many will seem horrendous: G4JNT writes, "The earthing system now appears to be more critical than the antenna", and then goes on to prove his point.

The 'Getting Started' article is a good place to start (though it is not at the beginning of the book): Peter explains that even some modern commercial receivers can be used on the band with some limited success. The transmitter is more of a problem. It is not so easy as taking a simple crystal oscillator to generate some RF. Low power sources such as signal generators have been used with some form of power amplifier.

Realistic antennas at this frequency are very inefficient. Some enthusiasts have used coils wound on dustbins to help load the antenna. Some use loops, some inverted-Ls, some traditional Marconis. Whatever you choose, do read the antenna section thoroughly.

To get the maximum permitted power output of one watt may seem easy, but this book soon dispels that idea. Transmitter levels of 5kW have been used, ie 5kW from the transmitter, giving less than 1 watt ERP! This should give readers some idea of the difficulties encountered.

One advantage of the band is that amplifiers are fairly cheap compared with their HF cousins. Most operators use audio amplifiers, eg the BK Electronics MF300, rated at 300 watts, provides a good 150 watts on 136kHz. A circuit diagram is given to show the safety modifications that should be made.

For anyone interested in getting on the band but not sure where to start, this book will help. I found it fascinating reading and had to be dragged away by my wife.

Dick Pascoe, G0BPS

### Shortwave Receivers Past & Present (Universal Radio Research, \$24.95)

This new, third, edition of Fred Osterman's popular receiver index goes much further in the number of receivers described, the number of illustrations and the number of pages. With 473 pages compared with the 351 in the second edition, the book details over 770 receivers manufactured between 1942 and 1997, another increase over the 1945 to 1996 coverage before, from numerous manufactures in many countries. US-produced sets dominate, but British, Japanese, German, Norwegian, Dutch and various others are also covered.

Amateur, military and commercial sets are covered, the increased time period bringing in many war time sets. British sets covered include Eddystone, Racal, Marconi, KW, Murphy, along with such Japanese sets as Trio, Kenwood and Yaesu. Each receiver has a black and white photograph, a detailed description of frequency coverage, specifications, weights and dimensions, additions to the circuitry or any unusual features, and notes on 660 model variations. A guide to new and second hand costs is

given for many of the sets along with the typical availability of sets on today's market (the availability is given from a US viewpoint, and many of the older British and Japanese sets may in fact be more readily available here than in USA).

Despite this, the book is a treasure of information, an ideal reference book and a very enjoyable read, regardless of being a collector or not. It is a book that should be on every SWL's shelf and many a Radio Amateur's as well. Well worth the price in my opinion and an ideal gift. It should be available from most radio magazine and society book departments immediately.

Ben Nock, G4BXD

### RSGB IOTA Directory and Yearbook 1998 / 99 (RSGB, £8.95)

This book, edited by Roger Balister, G3KMA, and Martin Atherton, G3ZAY, is the essential guide to participating in the Islands on the Air (IOTA) awards programme. It is also a thoroughly good read. There are two distinct parts: the Yearbook and the Directory.

The Directory lists thousands of islands, grouped by Continent, and (new this year) indexed by prefix. It also details the award rules, and includes application forms and masses of in-

formation and advice for the 'island chaser'.

It is the Yearbook section which makes it worth buying this particular edition - even if you already have an earlier version. Completely revised, this section contains Annual Honour Roll listing, articles on 'IOTA and the Environment', Internet sites, and new certificate holders.

New this year is a colour section which includes the results of last year's IOTA contest and the rules of this year's event (which takes place on 25 / 26 July), plus a 'DXpedition Roundup', describing the major IOTA expeditions which have

taken place since the previous edition. The colourful new IOTA Award Certificates are also shown for the first time.

This section is illustrated by over 60 colour photographs and maps.

The book is 17% bigger (but only 50p more expensive!) than the previous edition, and vouchers are included with each book which are worth £5 off new RSGB membership, and £2 off the award administration charges. If both of these are used the book will cost you less than £2, so it's just got to be good value!

The IOTA Directory & Yearbook 1998 / 99 will be enjoyed by serious DXers, those who operate just for fun and anyone interested in finding out just why the IOTA award programme is the fastest growing aspect of Amateur Radio worldwide.

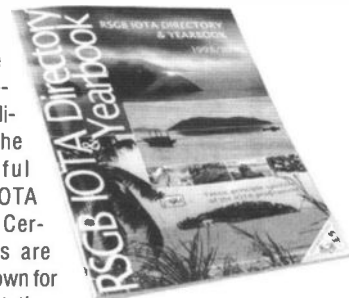
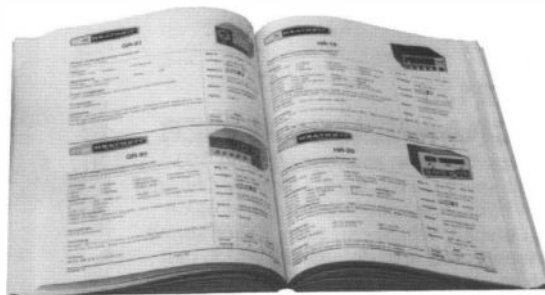

ham radio today

RSGB

1686 Bristol Road South  
Rednal  
Birmingham B45 9TZ

# SRP TR

**(COM213)  
100 CHANNEL SCANNER**

A high-specification scanner offering 100 channels in 10 banks, with 1 Priority Channel in each bank. For speed and ease of use it offers Jetscan, which can scan 100 channels per second, and also Jetsearch, which can search at up to 100 steps per second. It also features programmable band search, lock-out for up to 10 frequencies, channel look-out, 2 second scan delay, data noise/birdies skip, a key lock and a green back-lit display. 66-88, 108-174, 406-512, 806-956.

**£119.99** + £5 P&P.



**(COM102)  
10 CHANNEL SCANNER**

This state of the art 10 channel scanner is fully programmable and can receive a variety of PMR communications. It is robustly designed and offers a full frequency LCD display for ease of use. Also features an in-built circuit for recharging Nicad batteries. 66-88, 137-174, 380-512.

**£49.99** + £5 P&P.



**(COM205)  
400 CHANNEL SCANNER**

The B111 is the last word in programmable scanners. A free standing desk top unit covering nine radio bands in the 25-512MHz and 806-1300MHz ranges. Operates from AC mains or car cigar lighter via suitable adaptor. It incorporates a microprocessor avoiding the need to change crystals and gives special functions such as scan delay, memory back-up, priority channels and many more.

**£249.99** + £5 P&P.



**(COM215)  
200 CHANNEL SCANNER**

A highly-featured desktop scanner offering 200 channels arranged in 10 scanning banks, with one Priority Channel in each bank. For ease of use it offers Turbo Scan at 100 channels per second max with Autosort for maximum scan speed and Turbo Search at up to 100 steps per second. Other features include direct search programmable band search, auto station program mode, lock-out for up to 10 frequencies, manual frequency sort, programmable auto-recording and optional CTCSS tone squelch. The unit is powered by AC mains or 13.8Vdc. 66-88, 108-174, 216-512, 806-956.

**£219.99** + £5 P&P.



**SANGEAN ATS 909 FM-Stereo/MW/LW/SW PLL Synthesized receiver**

The ATS-909 is a continuously tunable receiver from 153kHz-29999kHz. This receiver is capable of receiving and tuning all the short wave bands and any stations in between

- 307 memories (261 in SW, 18 each in MW/FM, 9 in LW plus priority station)
- Five tuning methods – direct frequency tuning, auto scan, manual tuning, memory recall and rotary tuning
- ATS (auto tuning system) – auto scan and preset in priority of signal strength in FM/MW/LW bands
- E2 PROM for memories back-up
- FM stereo via earphones
- 29 pages SW stations name memory, 9 memories in every page
- Automatic search strongest signal station within SW station pages
- SSB (USB/LSB) 40Hz/step on fine tuning
- AM RF gain control
- Built-in 42 world cities time plus D.S.T. device
- 3 individual timers
- Adjustable sleep timer
- Alarmed by radio or HWS (Humane Wake System) buzzer
- Battery and signal strength indicator
- Direct key to recall favourite station in one button
- Dual conversion device
- REC out and standby control output
- Pre-programmed station name and frequency according to customer's requirements before ex-factory
- AM wide/narrow filter and FM mono/stereo selector
- Optional features for European market
- RDS (Radio Data System) on PI, PS and CT for station name and clock time
- Size in mm: 215 x 133 x 37.5
- Weight: 850g without batteries



**£169.95** + £5 P&P.

- ★ Free batteries
- ★ Free SW frequency book
- ★ Free SW antenna
- ★ Free headphones



# RADING

Telephone: 0121-457 7788

0121-460 1581

Fax: 0121-457 9009



**Super Syncro 1100** – 1100mAh Nickel Metal Hydride (NiMH) AA size rechargeable cells. No memory effect. Twice the capacity of NiCds. **£3.00** inc P&P.



**Skyscan DX-V1300 base discone** – Most discones only have horizontal elements and this is the reason that they are not ideal for use with a scanner. Most of the transmissions that you are likely to receive on your scanner are transmitted from vertically mounted antennas. The DX-V1300 has both vertical and horizontal elements for maximum reception. Constructed from best quality stainless steel and aluminium and comes complete with mounting pole. **£49.95** + £3 P&P.



**Skyscan Desktop Antenna Model Desk 1300 discone** – Built and designed for use with scanners. Coverage: 25 to 1300MHz. Total height 36" and 18" wide at widest point. Comes complete with 4m of RG58 coax cable and BNC connector. High performance antenna, ideal indoor or as a car antenna when vehicle is stationary. **£49.00** + £3 P&P.



**Airband mini-mag antenna** – Civil (108-137MHz) and military (225-400MHz) dual band receive antenna featuring super strong miniature magnet and coax cable terminated in BNC connector. **£24.95** + £3 P&P



**Wideband mini-mag antenna** – Wideband (25-1300MHz) receive antenna featuring super strong miniature magnet and coax cable terminated in BNC connector. **£29.95** + £3 P&P.



**Yaesu FRG-100 communications receiver** – Award winning 50kHz to 30MHz base station AM, CW, USB, LSB, FM (optional) communications receiver. Features include two clocks and timer, 50 memories, FM option, remote control jack. Superb value at **£449.95** + £7 P&P.



**Roberts R861** – compact digital world band receiver – Fully featured 153kHz to 30MHz (AM, SSB) and 87.5MHz to 108MHz (FM) portable digital world band receiver. Features include RDS, world time clock, 306 memories, RF gain control, direct frequency entry. Comes complete with free PSU, antenna, frequency guide and case. **£199.00** + £5 P&P.



**Radio shack DX-394 communications receiver** – 150kHz to 30MHz base station AM, CW, USB, LSB communications receiver. Features include clock and timer, signal meter, 100+ memories, RF gain control and direct frequency entry. A steal at **£149.95** + £7 P&P.



**Uniden Bearcat 9000 XLT** – AM/FM/WFM switchable base station HF/VHF/UHF scanning receiver. Covers 25-550 and 760-1300MHz. Features 500 memories, auto sorting, backlit orange LCD display. Scan rate of 100/300 channels/sec. **£249.95** + £10 P&P.



**AKD Target HF3 communications receiver** – 30kHz to 30MHz mobile or base station AM, USB, LSB communications receiver. Very simple to operate. Ideal for the novice, but with a performance more demanding listeners will appreciate. **£159.95** + £5 P&P.



**Yupiteru MVT-7100** – All mode switchable handheld HF/VHF/UHF scanning receiver. Covers 0.5-1650MHz. Features 1000 memories, over 500 pass memories, 10 limit search banks, 12 step sizes. Comes complete with earpiece, belt clip, wrist strap, rechargeable batteries, PSU, in-car adaptor and telescopic antenna.

**£199.99 + P&P (10 only)**



**Commтел COM 206** – AM/FM handheld VHF/UHF scanning receiver. Covers 66-88MHz (FM), 108-137MHz (AM), 137-174MHz (FM), 380-512MHz (FM). Full civil airband coverage, comes complete with free case and rechargeable batteries. **£129.95** + £5 P&P.



**Realistic PRO-2042** – AM/FM/WFM switchable base station HF/VHF/UHF scanning receiver. Covers 25-520 and 760-1300MHz. Features 1000 memories, 100 monitor channels, backlit orange LCD display. Scan rate of 50 channels/sec. **£249.95** + £10 P&P.

**WE ALSO HOLD A LARGE RANGE OF SECOND USERS SHORTWAVE AND SCANNING RECEIVERS. PLEASE CALL WITH YOUR REQUIREMENTS**

Clarence was just in the right place at the right time. Two local illegal 27MHz operators had just been 'busted', whereupon another decided to unload his gear in a hurry. £125 for an FT-902 that looked mint was just too tempting, but it wasn't till he got it home that Clarence found out that the 10 and 40m bands were a little non-standard! Not to worry, and he sent off a cheque to one of the national crystal suppliers for the correct crystals. Once these arrived they were fitted in the correct holders to replace the CB crystals. Clarence had hoped that this would restore the set to its original condition, but it was not to be.

The 40m band tuned OK over the amateur section, but refused to tune any higher than 7.2MHz, whilst only the 28.0 - 28.5MHz section of the 10m band would tune at all. Further tests alerted Clarence to the fact that on 80m the rig would go no higher than 3.7MHz, and so he decided to bring it to me for attention.

Unlike most other Yaesu rigs of the same era, the FT-902 (and

The first thing to do when aligning the FT-902 is to check the output of the crystal oscillators. A diode probe and valve voltmeter, or a high impedance 10/1 oscilloscope probe, should be connected as shown in Fig 1. On each band the relevant oscillator core should be adjusted to give about 100mV output. It is important that the cores are *not* peaked for maximum, as the PLL will not lock in over the full width of some bands, if it is fed with too much injection. (Fig 1 shows the position of the adjustments in the FT-902, if in doubt which trimmer is which on the FT-901, tune to the calibrator, when it will be found that touching the circuit near to the active coil will alter the receiver beat note.)

Having set up the crystal oscillators, test the rig on all bands tuning the full 500kHz spread, noting which bands give full coverage. On any range which needs aligning, the tuning will either not alter the frequency on the digital display at all, or it will 'stick' at one end of its range. Correct operation entails first adjusting the relevant VCO oscillator coil



# All in a Day's Work

Harry Leeming, G3LLL, with plenty of advice to ke

its earlier version the FT-901) use a phase lock loop in addition to individual band crystals. For some odd reason there are no alignment instructions for the PLL in either the user or service manuals, and so owners are rather left rather in the dark.

core until the display locks in at the frequency the rig is tuned to. Having done this, adjust the coil slightly by trial and error, until lock is maintained over the whole band. If it proves impossible to maintain lock over a whole band, try increasing or decreasing the

oscillator injection by adjusting the relevant crystal trimmer as mentioned previously. Fig 2 shows the positions of the cores on the VCO unit.

The actual work of doing the alignment is much simpler than it sounds, and Clarence was still more than happy with his bargain, even after he had paid for my time and the crystals.

## bent meter needle

Joe brought his FT-102 in with the complaint that the meter had gone hard over, and that it would no longer transmit. As a 'by the way', he also mentioned that he had found a little burnt coil loose in the bottom of the unit, but he hadn't bothered to bring it in.

Later when I got the unit on my bench I decided that it would be wise to have a good look around before switching on. I removed the panel meter and tested it. The pointer was badly

bent, but otherwise all seemed well, and so I carefully straightened this and re-zeroed the movement. Why had the pointer hit the stop so hard? I was not going to switch on to find out!

From previous experience I suspected thermal run away. Thermal run away is very common on the FT-102. Three 6146B valves are mounted very near to each other, and are prone to overheat. As they get hotter they pass more current, which makes them get hotter, which makes them pass more current . . . and so on, until there is a bang, or the fuse blows.

In the case of Joe's rig the excess current had not blown the fuse (guess what - a 13 amp mains fuse had been fitted in place of the normal 3 amp fuse!) but had made the meter shunt in the common cathode lead of the PA valves so hot that it had unsoldered itself. This had pushed the entire PA current via the panel meter's coil, hence the bent pointer. Fortunately the meter coil had a resistance of several hundred ohms, and so this had limited the current.

I telephoned Joe, and got him to put the 'little coil' in the post,

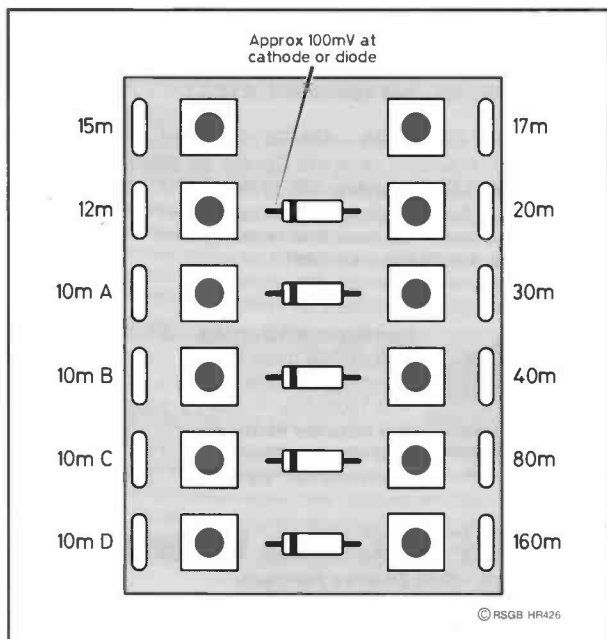

**Fig 1:** The Yaesu FT-902 crystal unit (under the VFO). When aligning, adjust each band's oscillator core for about 100mV.

**Alignment of the FT-902, and the earlier FT-901, is much simpler than it sounds (see text).**



coax is likely to be anything but 50Ω. It might not be quite as high as that at the end of a 'long wire' an exact multiple of half-wave-lengths long, but it can still place an unacceptable strain on the insulation of an ATU.

The practical answer is to be careful when tuning up for the first time after making any changes to antenna, power level, or ATU. Let your ears be the judge: if any sparking noises come from the ATU, back off the power, and alter feeder or antenna lengths by trial and error until operation is satisfactory.

### new valves needed?

Simon telephoned to try and find out if he needed a new set of PA valves. Diagnosis at a distance is notoriously difficult, but in the case of suspect driver or PA valves, there are some quite good guidelines.

1) Low power on all bands. Speak into the microphone and note the ALC meter. If this is active you have plenty of drive, if not suspect the driver valve. Next

tuned circuit, or the PA HT feed choke has short circuit turns. Don't continue to use the rig in these circumstances, as most of the input power will be disappearing as heat into the output valves, and will cook them.

2) Low power on the higher frequencies. The gain of most equipment does fall off naturally at the HF end of the spectrum, so that any fault causing a slight reduction of drive tends to show up there first. If you have plenty of output at the lower frequencies, you can take it that there is nothing wrong with the PA valves. A driver valve that is on the way out can cause low drive at the extremes of the frequency range, but it is more likely that the rig needs a little realignment.

### ft-101zd receive audio

Terry brought his FT-101ZD in for a general service, and mentioned that the receive audio sounded rather 'hollow' when receiving weak SSB signals.

This is a very common fault with the Mk2 and Mk3 FT-

# All in a Day's Work

## ep those old rigs ticking over smoothly

as this was obviously the missing shunt. I re-soldered this in place, fitted three new PA valves (and a 3 amp fuse!) and everything was OK.

I did not want to risk a repeat performance, and so I also cleaned and lubricated the fan, and then left the unit on soak test for a few hours transmitting at about 10 watts into a dummy load, while I kept a careful eye on the PA current.

### 300 whats?

Peter came in with his ATU, "It's supposed to be rated at 300 watts," he complained, "I only ran it with a hundred watt rig and it's arced over". A quick look showed that the main band switch had tracked over, and would have to be replaced. I wondered what had caused the trouble and asked Peter a few questions. It soon transpired that he had been using the ATU with a 'long wire', and that he had frequently heard 'fizzing' noises when he had been tuning up.

Ratings on ATUs are very vague, and, as in many walks of life, makers tend to quote figures taken under the most favorable

circumstances. I can remember one rather small ATU, which was surprisingly rated at one kilowatt. When one got round to reading the small print, however, it was rated at "one kilowatt into a 50Ω load". It didn't seem to have occurred to the makers that if your antenna did present an exact 50Ω load, you would not need an ATU at all!

When considering ratings of ATUs, remember that the voltage that will be present at its output depends on the impedance at the end of the antenna's feedline, as well as the power level. Feed 50 watts into an exact 50Ω load and you get 50 volts, feed it into a 5000Ω impedance and you develop 500 volts. The problem is that in a practical set-up the impedance varies not only when switching band, but when one varies frequency within a band. Even when using an antenna such as a coax fed G5RV, the impedance at the rig end of the

check the current with the PA stage's I/C meter on CW transmit at full drive (for not more than one or two seconds or you may cause damage). If this current is low and all the voltages are OK, the PA valves are probably faulty. If the current is high and the output is low, there is possibly a fault in the anode

101ZDs when they are fitted with an AM or FM unit. The problem is either that the wiring to these boards moves around and comes close to the IF board, or that one of the phono plugs' shields does not make proper contact. Tighten up the plugs, and move the wires around and the trouble always goes away.

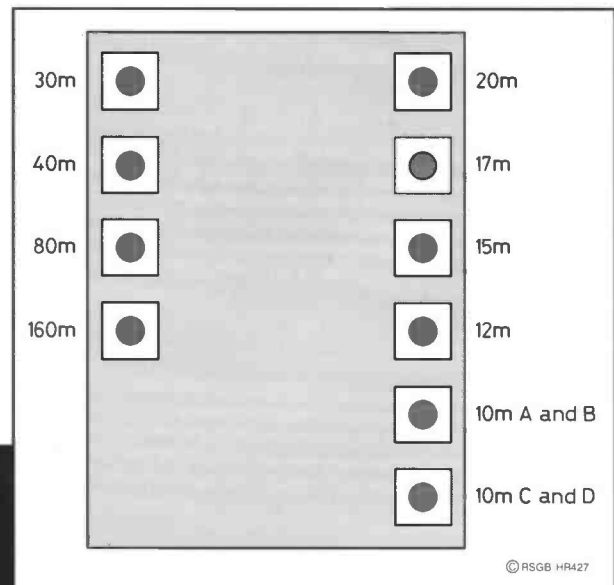

**Fig 2:** The positions of the VCO unit cores on the FT-902. The FT-901 is almost the same - touching the circuits with a screwdriver will show which one is active.





# RSGB Scottish Convention

A date for your diary  
**Don't miss it!**

SPRINGWOOD PARK SHOWGROUND, KELSO

SUNDAY 20 SEPTEMBER 1998

- Massive Trade Exhibition
- Lectures
- Large RSGB Stand Area
- RSGB Morse Tests on Demand – don't forget to bring two passport-size photos and appropriate fee with you
- Talk-in on 145.550 and 433.550MHz
- Facilities include restaurants and a snack bar
- Bring and Buy Stall
- Accommodation at attractive rates

*Doors open 10.30am (10am for disabled visitors)*

## LECTURE PROGRAMME TO BE ANNOUNCED

All enquiries should go to: Gavin & Margaret Chambers, c/o Kelso Amateur Radio Society  
**01573 226372**



## JOIN THE RSGB - Your National Society and we'll show you how to make a 12-month year grow!

**W**hen it comes to amateur radio we have a wealth of experience and background advisers to call upon to help you enjoy your hobby to the full - but YOU are the most important ingredient in the formula - without you there is no amateur radio. Together we are a winning combination and will ensure that amateur radio continues to thrive and grow into the next millennium.

We put you, the radio amateur and short wave listener first - help us to fight your cause, protect your amateur radio bands, and keep this hobby alive.

Sign up for Direct Debit, and we will give you an extra three months' membership completely **FREE!**

*That's how we make a 12-month year grow!*

To: Radio Society of Great Britain, Lambda House, Cranborne Road, Potters Bar, Herts EN6 3JE. Tel: 01707 659015,

Fax: 01707 645105. Web: [www.rsgb.org](http://www.rsgb.org). E-mail: [Sales@rsgb.org.uk](mailto:Sales@rsgb.org.uk)

I would like to join the RSGB. My payment for £36\* is enclosed with this form.

Name ..... Callsign (if licensed) .....

Address .....

..... Post/Zip Code: .....

Credit card number:

Expiry date:    Switch Issue No:   Start date:

Please send Direct Debit form for my 3 **FREE** months

Signed: ..... Date: .....

HRT7/98

# MFJ-969 HF to 6m ATU

With a number of rigs now covering 6m as well as the HF bands, this new 300 watt ATU will be of interest to many operators

Most ham shacks need an antenna tuning unit (ATU) at one time or another. Although many modern transceivers now have ATUs built in, they are not very versatile, only being able to match moderate VSWRs on coax lines. On the other hand, an external ATU usually has a much wider capability and is able to match virtually anything from short lengths of wire to balanced feed systems and coax-fed arrays.

Probably the world's largest manufacturer of Amateur Radio ATUs is MFJ of the USA. The introduction of the new MFJ-969 ATU merits a closer look, particularly as it covers the wide frequency range of 1.8MHz to 54MHz and includes some useful features.

## design

The MFJ-969 measures 268 x 242 x 95mm, can handle up to 300 watts of power and includes a 300W dummy load. The tuner circuitry is based around the traditional 'T' network with variable series capacitors feeding an inductor that is connected between the junction of the two capacitors and earth. This is a popular circuit arrangement with most commercial designs using a switch to select different inductance values. Now whilst this arrangement works well enough, clearly the optimum inductance value will more often than not fall somewhere between the switched positions. In the design of the MFJ-969, a roller-coaster inductor replaces the traditional switched coil. This, together with the two variable capacitors, makes for a very versatile arrangement that is able

to match precisely a wide range of impedances. The inductor is fitted with a front-panel turns counter, enabling it to be quickly returned to a predetermined value.

However, there are two problems with variable inductors of this type. The first is the risk of poor contact by the wheel as it runs along the turns of the coil when adjustments are being made. The second is the problem of self-resonance. MFJ claims to have overcome both these problems by careful mechanical construction and by the inclusion of an 'anti-resonance switch' that is automatically switched in and out of circuit according to the inductance value selected.

## metering

An ATU needs some form of metering in order to show the results of the control adjustments and to indicate when optimum settings have been achieved. The meter fitted to most MFJ models is the cross-needle type. To most operators this offers a visual advantage over the alternative of employing separate meters where one reads the value of the VSWR whilst the other reads power output. The cross-needle system is very easy to read and can make adjustment of the unit that much quicker.

The MFJ-969 meter provides both average power and PEP readings, with switched full-scale ranges of 30 and 300 watts. A new innovation in this

design is the inclusion of an active PEP meter circuit that claims to provide far more accurate indications of PEP than the normal passive designs. The meter can either be powered from an internal PP3 battery (which MFJ claim will almost last its shelf life) or an external supply voltage of 13.8V, which is also used to illuminate the built-in meter.

The tuner is provided with terminals for end-fed wire and tuned feeder connections, and SO-239 sockets for coax fed systems. Balanced line and end-fed wire matching is achieved by using an internal 4:1 balun which MFJ have placed between the antenna terminals and the ATU tuning section. Purists may yearn for the more traditional approach of link coupling (commercially made famous by KW Electronics in the 1960s). However, such an arrangement does not make front-panel band switching very easy to achieve and testimony to the performance of the balun arrangement is the large number of commercial tuners using this method.

## dummy load

Also included inside the MFJ-969 is a 'short-burst' internal dummy load that can be selected by the front panel switch and is ca-

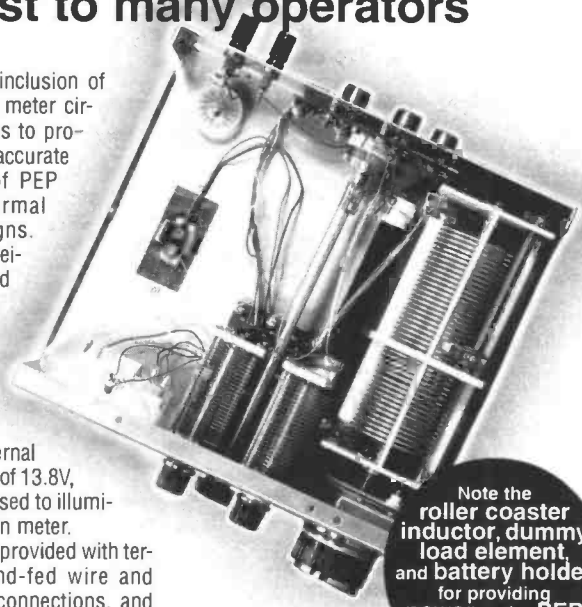

Note the roller coaster inductor, dummy load element, and battery holder for providing power to the PEP meter circuit.

able of withstanding 300 watts for 30 seconds, before being allowed to cool. For a power level of 100 watts the load can be operated for 90 seconds before resting. The front panel includes a four-way antenna switch, marked COAX-1, COAX-2, WIRE/BALANCED, and DUMMY LOAD. A further four positions repeat the sequence, but this time the tuner section is bypassed.

Because there is a 'THRU' position, the tuner can be left permanently in circuit and used in effect as an antenna switch to select different antennas. When switched to the normal tuner position, any internal tuner in the transceiver should be switched out of circuit.

MFJ equipment is distributed by Waters & Stanton PLC, 22 Main Road, Hockley, Essex SS5 4QS, tel: 01702 206835, and the MFJ-969 costs £179.95

Front panel of the MFJ-969 ATU.

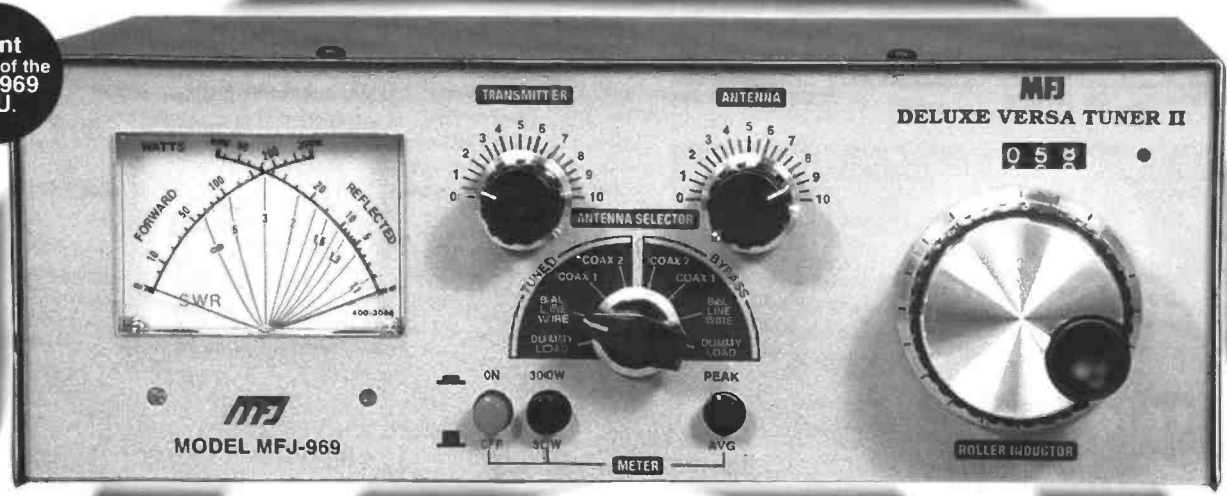

# Book Browser

Ham Radio Today's great new service to readers. You can order by e-mail, phone, fax or post. See below for details.

## Radio Communication Handbook

edited by Dick Biddulph, G8DPS

A comprehensive guide to the theory and practice of Amateur Radio communication. If you're into Amateur Radio, this is the book to buy!

6th Edn, 763 pages **£21.00 (plus P&P)**

## PMR Conversion Handbook

by Chris Lorek, G4HCL

Private mobile radio (PMR) equipment rapidly appears on the surplus market and can be acquired very cheaply at rallies. Often it can be converted to amateur bands quite easily and without expensive test equipment. This book tells you what to buy and how to convert it.

1st Edn, 192 pages **£15.28 (plus P&P)**

## VHF / UHF Handbook

edited by Dick Biddulph, G8DPS

Guide to the theory and practice of Amateur Radio reception and transmission on the VHF / UHF bands including antennas, EMC, propagation, receivers and transmitters, together with constructional details of many items of equipment. One of the most complete guides around for VHF / UHF operators. See the review in *Ham Radio Today* December 1997!

317 pages **£18.80 (Plus P&P)**

## VHF / UHF DX Book

edited by Ian White, G3SEK

VHF / UHF DX is one of the growing points where Amateur Radio shows that it still has a real future - and that's what this book is all about.

1st Edn, 447 pages **£18.00 (plus P&P)**

## Amateur Radio Operating Manual

edited by Ray Eckersley, G4FTJ

This book covers the essential operating techniques required for most aspects of Amateur Radio, taking the reader from the principles of basic contacts right through to the secrets of working DX and winning contests.

4th Edn, 249 pages **£12.23 (plus P&P)**

## RSGB Yearbook - 1998

edited by Brett Rider, G4FLQ

Formerly known as the RSGB Callbook, the Yearbook has been enhanced to include a wealth of information for all Radio Amateurs. Includes all UK and Republic of Ireland callsign listings, plus over 120 information pages. Reviewed in *Ham Radio Today* December 1997.

1998 Edn, 517 pages **£13.95 (plus P&P)**

## Ham Radio Today Binders - NEW

Red hard-cover binder, designed to keep your copies of *Ham Radio Today* safe and accessible. A label to denote each year is supplied free with each binder.

**£7.40 (plus P&P)**

## World Radio & TV Handbook

edited by Andrew Sennitt

See review on page 12/13.

1998 Edn, 608 pages **£22.94 (plus P&P)**

## Radio Logbook - Receiving

Spiral bound 100 pages **£3.67 (plus P&P)**

## Radio Logbook - Transmitting

Spiral bound 100 pages **£3.67 (plus P&P)**

## Your First Amateur Station

by Colin Redwood, G6MXL

How to set up a station and get on the air as cheaply and effectively as possible. It covers all bands, with special emphasis on VHF / UHF. A 'must' for everyone who has just passed the RAE or NRAE. (See the review in *Ham Radio Today* December 1997)

1st Edn, 124 pages **£5.74 (plus P&P)**

## Your First Packet Station

by Steve Jelly, G0WSJ

How to set up a basic packet radio station and enter the world of data communications from your shack. Explanations are kept as simple and non-technical as possible, making this book an ideal choice for the beginner.

1st Edn, 76 pages **£5.74 (plus P&P)**

## The Antenna Experimenter's Guide

by Peter Dodd, G3LDO

Take the guesswork out of adjusting any antenna, home-made or commercial, and make sure it's working with maximum efficiency. An invaluable companion for everyone who wishes to get the best results from their antennas.

2nd Edn, 160 pages **£15.00 (plus P&P)**

## Practical Wire Antennas

by John Hey, G3BDQ

A 'down to earth' guide to the construction of many different types of wire antennas, ranging from simple dipoles to ingenious multi-wire systems. Boring and unnecessary theory is kept to a minimum - instead the author shares his years of experience, offering advice for beginners and enthusiasts alike.

1st Edn, 96 pages **£8.92 (plus P&P)**

## Practical Receivers for Beginners

by John Case, GW4HWR

Contains a selection of easy-to-build receiver designs suitable for amateur bands, together with simple 'fun' projects and test equipment. The theory and practice of receiving techniques is outlined to help with understanding the circuits presented. This book is of value to anyone who is building receivers for the first time, or who is considering moving up to microwaves.

1st Edn, 165 pages **£12.50 (plus P&P)**

## Ferrell's Confidential Frequency List

Compiled by Geoff Halligey

Including full reverse callsign list: aero; CW; coast; fax; fixed; embassy; military; Navtex; time; Volmet. Published by PW Publishing. See review on page 12/13.

10th Edn, 450 pages **£19.95 (plus P&P)**

## LF Experimenter's Source Book

edited by Peter Dodd, G3LDO

This book brings together source material from all over the world covering antennas, propagation, receivers, transmitters, special modes and test equipment. See review page 12 / 13.

2nd Edn, 146 pages **£7.50 (plus P&P)**

## RSGB IOTA Directory and Yearbook 1998 / 99

edited by Roger Balister, G3KMA, and Martin Atherton, G3ZAY

The Directory lists thousands of islands group by continent and, new this year, indexed by prefix. It also details the award rules and contains the application forms needed. See review page 12 / 13.

1998 Edn, 112 pages **£8.95 (plus P&P)**

to order

fax

01707 645105

telephone

01707 659015

e-mail

[hrt.sales@rsgb.org.uk](mailto:hrt.sales@rsgb.org.uk)

internet

[www.rsgb.org/books/bookmenu.htm](http://www.rsgb.org/books/bookmenu.htm)

and packing

UK

For one item £1.25, two items or more £2.50. Delivery by Parcel Force (7 - 10 working days). For next day service (on orders received before 12 noon): £4.85.

OVERSEAS

For one item £2, two items £4. Extra books over two items, an additional 50p per book. Delivery by surface mail. Air mail rates available on request.

NB:

all prices include VAT (where applicable) and are subject to change without notice.



**Do you have something constructive to say on the state of amateur radio today? Perhaps you'd like to put your viewpoint to the readers, get some discussion going, or give an answer to one of the issues raised? We'll pay £10 for the best letter we publish each month (paid 6-8 weeks following the publication date). So write in with your views to; Letters Column, ham radio today, Lambda House, Cranborne Road, Potters Bar, Herts EN6 3JE or send an e-mail to hrt@rsgb.org.uk We reserve the right to edit letters for length, grammar and clarity for publication. Letters must be original and not have been sent to any other magazines, and must include name and address plus callsign if held (name and callsign will be withheld from publication if requested). Reader's views published here are not necessarily those of the magazine.**

**"TONE" BURST**  by GMBMEN



**letters letters letters**

£10 for letter of the month

**letter of the month letter of the month letter of the month**

Dear Ham Radio Today,

Here's one that's been bugging me for a while: when is a headset most useful / desirable on a rig?

In a 'contest' situation, ie lots of noise etc? Yes, I'd go for that one.

On a 'handie', allowing the user to walk, cycle, jog, write etc (like a typical 'security guard' setup)? Yes, that's a good one too.

Now come on, what's a *really* good application for a headset? On a mobile rig, in a car perhaps?

Perhaps I haven't looked very far, but I cannot find a dual band VHF / UHF mobile rig which has a headset option. Yes, I would make a homebrew - 'spirit of the hobby' - but I have had enough of making 'lash-ups' for various rigs. In the world of 'all-singing, all-dancing' rigs with numerous options, I am amazed how hard it is to get one with a 'plugin and go' headset option.

I was at a dealers the other day who didn't really force himself to find out if he had a rig which supported a headset option. Strange, as that was the only obstacle which would have liberated my wad of hard-earned cash.

So come on all you rig manufacturers / agents, I challenge you to provide a list of your mobile 2m / 70cm rigs which support a proper headset option, or at least can be used with a compatible, 'off the shelf' headset.

**Andy King, G7MIJ**

Editorial comment:

*Remember that when operating mobile you should never use a set of headphones which covers both ears or otherwise impedes your concentration. There used to be a UK firm which made a single-ear headset with boom microphone for safe hands-free mobile operating. Does anybody know if these are still available?*

Dear Ham Radio Today,

With reference to the May news item, about the Trinidad and Tobago 9Z4 no-code HF licence, I have also been told by a German operator that this is the case there also.

I, like many other amateurs, have been under the impression that the CW test was a worldwide requirement that was not even being discussed until 2002. But that cannot be the case. Indeed, if some countries are introducing a no-code licence and not others, I think we should prepare for all hell to erupt from the one and sixpences!

Kind regards.

**Alan G Taylor, MOAUR**

Editorial comment:

*We believe you have been mis-informed about the situation in Germany. However, you will be interested to read the news story on page 5.*

# ham radio today event news

ham radio today this month

## rallies

### 14 June

Elvaston Castle National Radio Rally, Elvaston Castle Country Park, Elvaston, Derby. On the B5010 between the A6 and A52, 5 miles southeast of Derby. The event includes the WAB awards group AGM. Details from Brian, G1CUH, tel: 01332 751412.

Bangor and District Amateur Radio Society Amateur Radio Rally, Clandeboye Lodge Hotel. The event is open 12 noon to 4.00pm and 'full catering facilities' are promised this year. Details from Roy Finlay, G10WVN, tel: 01247 460716.

Aldershot Amateur Radio Rally, Mytchett Community Centre, Mytchett Road, near Camberley, Surrey - easy access from J4 / M3, talk-in on 145.550MHz FM. Doors open 10.30am, entrance £1. Details from Roland Brade, G3VIR, tel / fax: 01252 837860; e-mail: rally@venusww.demon.co.uk

Barford Radio Rally, Village Hall, Barford, on B1108 Norwich to Watton Road, Norfolk. Trade stands, car boots welcome, bring and buy, Raynet supplies, raffle etc. Talk-in on 145.550MHz FM. Details from Tony, G1ULE, tel: 01760 338938.

### 20 June

RSGB Headquarters Summer Saturday Opening, Lambda House, Cranborne Road, Potters Bar, Herts EN6 3JE. RSGB bookshop, GB3RS station, National Amateur Radio Museum and Library. Morse tests on demand (11.00am to 12.30pm only). Doors open 10.00am - 2.00pm. Details: Marcia Brimson, 2E1DAY, tel: 01707 659015 (office hours).

### 21 June

Newbury & District ARS Annual Radio Car Boot Sale, Cold Ash Playing Field, near Newbury. Sellers / traders to arrive at 8.00am, no earlier please. For further details contact Ian Trusson, G3RVM, tel / fax: 01635 826019; e-mail: G3RVM@compuserve.com

Please note that the Denby Dale (Pie Hall) Amateur Radio Rally Computer and Amateur Radio Fair, which was due to take place at Shelley High School, near Huddersfield on 21 June, has been *cancelled*.

### 25 - 27 June

Ham Radio '98 Friedrichshafen, Germany. See 'Rally of the Month' above.

### 28 June

Horncastle Rally, Horncastle Youth Centre, Lincs. Joint venture between youth centre and Fenland Repeater Group. Good access for disabled. Tables £2 (bookable and payable in advance), entrance £1. Further information from Tony Nightingale, G6CZV, tel: 01507 522482 or e-mail antony.n@virgin.net

### 5 July

York Radio Rally, Knavesmire Building, York Racecourse. Amateur radio, electronics, computers, repeater groups, Morse code tests, refreshments and licensed bar. Talk-in on 145.550MHz

FM. Doors open 10.30am, admission £1.50 (children accompanied by adult free). Free parking. Further details from Pat Trask, GODRF, tel: 01904 628036.

Harlow and District Amateur Radio Society rally and car boot sale, at Mark Hall School, Harlow (A414) First Avenue (please note this is a *new venue*). Talk-in on 145.550 and 433.550MHz. Free entrance and parking. For further information, or for booking tables or car boot plots, contact Len, G7UFF, tel: 01279 832700; fax: 01279 864973; e-mail: len.brackstone@virgin.net

### 11 July

Cornish 35th Radio Rally and Computer Fair at Penair School, Truro. Large hall, bring and buy stand, Morse code tests etc. Doors open 10.30am and talk-in on 145.550MHz FM. Further details from Robin Worsley, GOMYR, tel: 01209 820118.

### 12 July

Sussex Amateur Radio and Computer Fair, Brighton Racecourse, East Sussex. Doors open 10.30am. Information from Ron Bray, G8VEH, tel: 01903 763978.

### 18 July

RSGB Headquarters Summer Saturday Opening, Lambda House, Cranborne Road, Potters Bar, Herts EN6 3JE. RSGB bookshop, GB3RS station, National Amateur Radio Museum and Library. Morse tests on demand (11.00am to 12.30pm only). Doors open 10.00am - 2.00pm. Details: Marcia Brimson, 2E1DAY, tel: 01707 659015 (office hours).

### 19 July

The McMichael Mobile Rally, the Haymill Youth and Community Centre, 112 Burnham Lane, Slough. Includes car boot sale at £10 per pitch on the day (no advance bookings). Doors open 10.00am. Admission: adults £1.50, children accompanied by adult: free. Talk-in on 145.550MHz. Trade bookings to Min Standen, G0JMS, tel: 0118 972 3504. Further details from Dave Chislett, G4XDU, tel: 01628 625720.

Humber Bridge Radio and Computer Rally, Costello Sports Stadium, Boothferry Road, Hull. One large hall with bring and buy, Morse tests. Details tel: 01482 837042.

### 26 July

Colchester Radio and Computer Rally, St Helena School, Sheepen Rd, Colchester. Adjacent to Colchester bypass, Avenue of Remembrance. Wide range of radio and computer traders in two halls, Amateur Radio car boot sale, bring and buy, Morse code tests on demand (two passport size photos required). Free tea and coffee. Doors open 10.00am to 4.00pm. Admission £1.50, free parking, good access for disabled visitors. Details from David Mageehan, 2E1FRO, on tel: 01206 369226.

Rugby Radio Rally at the BP Truckstop, A5 Watling Street, near Rugby. Details from Arthur, M0ASD, tel: 01788 550778.

**To include your rally in this section, please make sure you send us details of your event in time: the deadline for the September issue is 13 July; for October, 14 July, and for October, 14 August, and for November, 10 September. The address for submissions is: The Editor, Ham Radio Today (Rallies), RSGB Publications, Lambda House, Cranborne Road, Potters Bar, Herts EN6 3JE; fax: 01707 645105. We would be grateful if Ham Radio Today readers would ask their local rally organiser to send information on their rally to this address. If you're travelling a long distance to attend rallies, we recommend you contact the organisers of the events first, to check if there has been any changes since this magazine went to press.**

# rally of the month



**25-27  
June**

Neville Cheadle, G3NUG, and Martin Atherton, G3ZAY, on the RSGB / IOTA stand. Martin will be taking over as *Ham Radio Today* HF Happenings columnist next month.

*Ham Radio Today* QRP columnist, Dick Pascoe, G0BPS, and Sheldon Hands, manufacturer of Hands QRP transceiver kits, on the G-QRP Club stand at Friedrichshafen.

The Friedrichshafen Ham Radio 98 exhibition is Europe's largest Amateur Radio exhibition. This year is the 23rd annual show, which takes place at the usual venue, the Friedrichshafen Exhibition Centre, in the town of that name, in southern Germany.

This year, for the first time, visitors can enjoy two exhibitions for the price of one. The Ham Radio exhibition has combined with a 'HAMtronic 98' computer hardware, software and hobby electronics exhibition, to form an even larger event taking up a combined area of 24,000m<sup>2</sup> and occupying several halls of the giant Messe Friedrichshafen complex.

Another change is that this year the exhibition takes place from Thursday to Saturday, instead of Friday to Sunday. The change was made after feedback from both exhibitors and visitors, who were increasingly preferring to visit on the Friday instead of the Sunday of the show. The new times are to be piloted for an initial three years' trial and will be reviewed after the exhibition in the year 2000.

Ham Radio 98 features a wide and varied selection of interests and an immense trade presence with around 260 exhibitors from 40 countries. Over 20,000 visitors from all over Europe - and further afield - are expected to attend. Amongst those exhibiting will be *Ham Radio Today*, sharing the RSGB stand with an IOTA (Islands on the Air) display. The magazine will be introduced to European readers for the first time, and we hope they will enjoy what they see and will want to take out a subscription.

The 'QSL Collection', run by Wolf Harrant, OE1WHC, of ORF (Austrian Radio), now has more than 1 million QSL cards and will, as usual, be exhibiting at Friedrichshafen. They are still collecting unwanted QSL cards: so rather than throwing away your old cards, donate them to the QSL Collection instead. If you wish to donate any cards, send them to RSGB headquarters by 19 June and they will be shipped to the QSL Collection free of charge (packages should be marked 'QSL Collection, for the attention of Marcia Brimson, 2E1DAY').

In addition to all the major manufacturers, such as Icom, Yaesu, Alinco and Kenwood, displaying all the new equipment, Hall 6 is devoted to a giant 'flea market', with tables measuring a total length of 2km!

Other events taking place at the exhibition include a mobile competition and a direction-finding competition. For the non radio enthusiast, Friedrichshafen is located in one of the most picturesque areas of Germany, on the shores of Lake Constance (Bodensee), with good access from France and Switzerland. On-site camping and caravan facilities are provided at a nominal charge.

The Ham Radio and Hamtronic 98 exhibition is open from 9.00am - 6.00pm on all three days, and entrance costs DM12 per day. A discounted entrance 'badge' for all three days is available for DM25. There are discounts for children, OAPs and disabled people. For further venue / rally details tel: +49 7541 7080; fax: +49 7541 75290; accommodation / tourist information tel: +49 7541 21729.

ham radio today news

## other events

- |                         |   |                           |   |
|-------------------------|---|---------------------------|---|
| <b>13 / 14 June</b>     | Scarborough Special Events Group, GX0000, 10th anniversary activity weekend.  | <b>8 July</b>             | <i>Ham Radio Today</i> August publication date.   |
| <b>14 June</b>          | Worked All Britain awards group AGM, Gothic Hall, Elvaston Castle, starting at 1400. G8UYD QTHR.                        | <b>11 / 12 July</b>       | IARU HF Championship (10 - 160m SSB / CW, 1200 - 1200UTC).  |
| <b>20 June</b>          | RSGB HQ Summer Saturday Opening, Potters Bar, Herts. Details: Marcia Brimson, 2E1DAY, tel: 01707 659015 (office hours). | <b>12 July</b>            | RSGB 2nd 50MHz Backpackers Contest (1100 - 1500UTC).  |
| <b>21 June</b>          | RSGB 2nd 144MHz Backpackers Contest (0900 - 1300UTC) - please note this is a <i>change of date</i> .                    | <b>12 July</b>            | WAB 50MHz Phone Contest (0900 - 1500UTC). Details from G8UYD QTHR.  |
| <b>21 June</b>          | RSGB 432MHz FM Contest (1800 - 2200UTC)   | <b>18 July</b>            | RSGB 144MHz Low Power Contest (1400 - 2200UTC).   |
| <b>21 June</b>          | PW 144MHz Contest.  | <b>18 July</b>            | GB350BOP special event, 350yrs English Civil War.   |
| <b>21 June</b>          | WAB 70MHz Phone Contest (0900 - 1500UTC). Details from G8UYD QTHR.  | <b>18 July</b>            | RSGB HQ Summer Saturday Opening, Potters Bar, Herts. Details: Marcia Brimson, 2E1DAY, tel: 01707 659015 (office hours). |
| <b>28 June</b>          | Longleat Rally.   | <b>18 / 19 July</b>       | Special event station GB4HMM at Holyhead Maritime Museum, Anglesey.   |
| <b>28 June</b>          | WAB 144MHz QRP Contest (0900 - 1500UTC). Details from G8UYD QTHR.   | <b>18 - 20 July</b>       | Special event stations E11M at Dun Laoghaire.   |
| <b>29 June - 3 July</b> | Lions International Convention, NEC, Birmingham, inc special event station.   | <b>19 July</b>            | RSGB 432MHz Low Power Contest (0800 - 1400UTC).   |
| <b>3 - 5 July</b>       | ARIM 30th anniversary, Morokulien, Swedish / Norwegian border. Details LA7TIA, tel: 00 47 628 26920.                    | <b>24 - 31 July</b>       | National Guide Jamboree, Wirral, inc special event station.   |
| <b>4 July</b>           | RSGB 2nd 432MHz Backpackers Contest (1300 - 1700UTC).   | <b>25 July</b>            | Waters & Stanton PLC 25th anniversary sale, 22 Main Road, Hockley, Essex (9.00am - 6.00pm).                             |
| <b>4 / 5 July</b>       | VHF National Field Day (1400 - 1400UTC, 70, 144, 432 and 1296MHz)   | <b>25 July</b>            | GB350BOP special event, 350yrs English Civil War.   |
| <b>5 July</b>           | RSGB 3rd 144MHz Backpackers Contest (1100 - 1500UTC).   | <b>25 / 26 July</b>       | RSGB IOTA Contest (10 - 80m SSB / CW, 1200 - 1200UTC).  |
| <b>5 - 12 July</b>      | Northern VHF Activity Group expedition to IO66 and IO67, Isle of Barra.   | <b>31 July - 2 August</b> | AMSAT-UK Colloquium, University of Surrey, Guildford (details: Fred Southwell, G6ZRU, tel: 01273 495733.)               |

ham radio today news



# Yaesu FT-100 Previewed

First with the **new** product news, Ham Radio Today looks at Yaesu's amazing new ultra-compact HF / VHF / UHF mobile transceiver



Even before the Yaesu FT-847 HF / VHF / UHF 'base station' transceiver became available in the UK, came news of Yaesu's latest creation. In fact, we hinted as much back in the April issue, when we reported that Yaesu were "developing something interesting for the car". Well, this is it. Although it won't be available for several months yet, the FT-100 is set to be the most talked-about rig since the Icom IC-706.

## in brief

So, what will you get for your money? In effect, the FT-100 is a mobile version of the FT-847, and basically covers the same bands, ie 160m to 70cm (although there is no word yet as to whether the UK version of the FT-100 will cover the 4 metre band - as the '847 does).

Although clearly intended as a mobile rig, it is certainly not a 'basic' transceiver and there are sufficient built-in 'bells and whistles' for it to be used as a base station transceiver. In appearance, it looks very similar to the Icom IC-706, but is slightly smaller and lighter.

The front panel looks clean and uncluttered, with a large, bright, LCD multi-function display, which is light blue in colour and reminiscent of the FT-847's display. The relatively few buttons and switches belie the number of functions provided, the FT-100 using a 'menu' system, as with many similar rigs, to provide these facilities.

## specs

The FT-100 has a very wide band general coverage receiver which tunes from 100kHz to 970MHz, although cellular / digital telephone frequencies are blocked. On transmit it covers all the HF bands from 160 to 10 metres, plus the 6m and 2m VHF bands, and 70cm on UHF. Despite its tiny size, the rig is quite a power

house. It puts out 100 watts on HF and 6m, 50W on 2m, whilst on 70cm the power output is 20W.

Of course, all modes are provided - including AFSK and both 1200 and 9600 bps packet radio operation, in addition to the usual SSB, CW, FM and AM. CW operators, however, may be disappointed that narrow filters are an optional extra: the FT-100 comes with a 2.4kHz SSB filter, but a wide AM 6kHz filter, as well as 500Hz and 300Hz CW filters, are options. Against this, CW operators will be pleased that a built-in electronic memory keyer is included.

200 memory channels are provided.

Incredible as it may seem on a rig this size, DSP (digital signal processing) on the receiver is standard [the UT-106 add-on DSP unit for the Icom IC-706 Mk II, which is reviewed on page 31 this month, is now being fitted on new '706 Mk IIs sold in the UK - Ed]. The DSP facilities in the FT-100 include an audio bandpass filter with independently-variable upper and lower frequency cut-off, automatic notch filter to remove annoying heterodynes and other unwanted 'whistles', and digital Noise Reduction facilities. Other QRM-busting facilities provided include an IF shift control and IF noise blanker.

For the SSB operator, a speech processor is included, as well as VOX (automatic voice-operated transmit switching) operation.

Around the back of the case, there are two antenna sockets, one used for the HF bands plus 50MHz, and the other for 144 and 430MHz. The Yaesu hand microphone provided, which looks conspicuously large compared with the size of the set itself, plugs into a socket on the side of the front panel. A limited number of functions can be controlled from the microphone.

In such a small transceiver there is, of course, no AC mains power supply built in: the rig is, after all, primarily intended to be used whilst mobile or portable.

## mobiling

So what does the FT-100 offer for the dedicated mobiler? In addition to the obvious - size, convenience, frequency coverage etc - the FT-100 has built-in CTCSS (sub-tone) encode and decode for repeater access and quiet band monitoring. All the UK 6m repeaters are CTCSS controlled (rather than using a 1750Hz tone burst), and more and more 2m and 70cm repeaters are going over to CTCSS access too, so this is a real plus.

DCS (digital coded squelch) encode and decode, as used on a number of Yaesu's other VHF / UHF transceivers and the FT-847, is also provided, to allow for quiet monitoring of FM channels.

Automatic repeater shift is included, and, according to the Yaesu web site, facilities such as 'Auto-Range Transponder System', 'Smart Search Automatic Memory Channel Loading System' and 'Quick Memory Bank (QMB)'.  
**is size important?**

It is if you are a DXpedition operator and so want the smallest, most easily transportable, rig possible. When you first look at the picture of the FT-100, it looks like it could never fit all 12 bands in!

As far as we can tell, the FT-100 is the smallest, lightest weight, 100W HF rig yet available. Add to this the three VHF / UHF bands in the same box and Yaesu undoubtedly have another winner. Thanks to its tiny size and light weight, the FT-100 is bound to be popular with DXpedition operators.

Its small size will also find favour with many owners of modern cars. Many mobilers already have a dualband VHF / UHF rig in their car and are unable to fit in another rig, no matter how small, for HF use. The FT-100 overcomes this problem by providing almost every possible band required in one box.

## options

In addition to the three IF filters already mentioned, an FC-20 external antenna tuner is available as an option (due to the small size of the transceiver, there is no internal ATU).

The FT-100 is compatible with Yaesu's ATAS-100 'Active-Tuning Antenna System' - basically an up-market mobile whip. The ATAS-100 is described as a 'revolutionary new mobile antenna system', and automatically adjusts itself to the best SWR on HF and 50MHz, by changing the length of the antenna's unique motorised 'accordion' tuning section. On 144 and 430MHz, the ATAS-100 requires no tuning, functioning as a quarter-wave and five-eighths wave antenna respectively.

## summing up

Don't go rushing off to your local store to have a play with an FT-100 just yet. According to the Yaesu USA web site, they are not expected to be available in the USA until the autumn, and - because of the additional time required for CE approval - it will be later here in the UK. Expect to see the first examples at the Leicester Show in September, with stocks a little later in the year.

The UK price has yet to be set, but according to Martin Lynch it will be about £1299. To this must be added the price of a 20A 13.8V DC power supply if you wish to operate the rig as a base station, although it is fair to say that most Radio Amateur's shacks already contain a suitable PSU.

Information on the rig is already on a number of web sites, including in this country the ML&S (Martin Lynch & Sons) site at: [www.mlands.co.uk/product/guide/ft100.htm](http://www.mlands.co.uk/product/guide/ft100.htm) If you're not on the web, give ML&S a call on 0181 566 1120 for further information.



# Dayton Hamvention - Wish You Were There?

A report on this year's Dayton Hamvention, with contributions by Neville Cheadle, G3NUG; Marcia Brimson 2E1DAY; and ARRL HQ staff

The Dayton Hamvention is the world's largest Amateur Radio gathering, with over 30,000 hams from all over the world descending on the small town in Ohio, USA (famous for the Middle East peace meeting). Many go to socialise with friends they usually only meet on the air. Others go to attend the forums and special-interest events, such as the QRP Amateur Radio Club International 'Four Days in May' event, the DXers dinner and the Contest Dinner, sponsored by the American *CQ* magazine. For many others, the giant flea market is the thing.

This year's Hamvention took place between 15 and 17 May, and, as usual, the weather was hot and sticky. For the first time, *Ham Radio Today* was there. The magazine was for sale on the joint RSGB / IOTA / *Ham Radio Today* stand, where the sales team of Marcia Brimson, 2E1DAY, and Sylvia Manco, 2E1CYL, were doing great business. RSGB General Manager Peter Kirby, G0TWW, and President Ian Kyle, G18AYZ / M10AYZ, were also representing the RSGB in an official capacity; whilst IOTA Manager Roger Balister, G3KMA, and IOTA Committee Chairman Martin Atherton, G3ZAY, looked after the Islands on the Air display.

In all, around 300 exhibitors were open for business in the halls, and another 2700 set up shop in the flea market area, for which Dayton is really famous.

The ARRL (American Radio Relay League - the US national society) were selling their *TravelPlus for Repeaters* CD-ROM and updated *General Class License Manual*. They were also demonstrating a new *QST View* CD-ROM, which includes issues of the ARRL's magazine going all the way back to 1930.

Dayton is typically the time for manufacturers to show new equipment for the first time. What is shown at Dayton often comes over to the UK several months later.

## icom and yaesu

Icom wowed the crowds with its new IC-PW1 1kW amplifier for

HF and 6m, and the tiny new dualband mini-power radio, the IC-Q7, reviewed in this issue of *Ham Radio Today*. Icom's new IC-2100 2m mobile (reviewed last month), the IC-T8 triband handheld, and the IC-746 HF plus 6m transceiver (both reviewed in March) were also on show.

This year, Yaesu was not saying what it had in store for Dayton before the event, but surprised everyone with the amazing little FT-100 all-band (160m to 70cm) transceiver. *Ham Radio Today* is able to bring you full details of what will surely be a major talking point - see page 24 in this issue.

Also attracting a lot of attention on the Yaesu stand was the fully-equipped Honda Goldwing motorcycle owned by Bob Curry, KC3VO. He has equipped the bike with a Yaesu FT-900AT HF transceiver, FT-530 dualband handheld, GPS navigator, cellular phone, CB radio, and CD player with 100W audio amplifier and subwoofer. In the trailer he tows behind the motorcycle is a Yaesu FT-847 and VL-1000 kilowatt amplifier for 160 - 6m. How does he power all that equipment? Not from a standard motorcycle battery you can be sure: Bob has even installed a petrol generator in the trailer.

## around the stands

The long-awaited SGC-2020 compact HF 20W transceiver was on display at the Hamvention, whilst at the Alinco booth, following the success of the DJ-C1 and DJ-C4 single band 'credit card-size' transceivers for 2m and 70cm, Alinco introduced its new dualband 'credit card' handheld, the DJ-C5 (see 'Trade Topics' in May issue).

The American firm Ten-Tec was expected to debut its new PC-based model RX-320 'black box' HF receiver at Dayton. Their Titan II, a single-tube, full-legal-

limit, HF linear which will be available this autumn, was also on show. The commercial RX-340 DSP HF receiver was also there.

ADI had its new compact 5W handheld for 6m on display, whilst on the combined MFJ / Ameritron stand, the new Ameritron ATR-30 'true legal-limit' (ie 1500 watt plus) HF ATU was on sale at around \$600. From MFJ a pair of lightweight switching power supplies proved popular with DXpedition operators. The Mississippi company also had their updated MFJ-259 Antenna Analyzer on show at Dayton. MFJ founder, Martin F Jue, also stopped by at the *Ham Radio Today* / RSGB stand to say hello.

There were new antennas on display from both Butternut and Cushcraft, including the latter's X-9 beam, the 'big brother' of the X-7 reviewed in the May issue of *Ham Radio Today*.

Although not known here in the UK, the American Elecraft firm had its K2 HF 160 - 10m SSB / CW transceiver kit, designed by



Martin F Jue, founder and President of MFJ, with RSGB President Ian Kyle, G18AYZ / M10AYZ and General Manager Peter Kirby, G0TWW.



Bob Curry, KC3VO, with his Yaesu-equipped Honda. Riding pillion is Sylvia Manco, 2E1CYL, of the *Ham Radio Today* / RSGB Sales team.



The IOTA Manager Roger Balister, G3KMA, on the joint IOTA / RSGB / *Ham Radio Today* stand.

N6KR and WA6HHQ, on display. This is a fully-synthesised, microprocessor-controlled radio with 'no wires' construction. The CW-only version sells for about \$600 in USA.

As usual at Dayton there were terrific bargains to be had in the 'flea market'. Computer books, normally retailing at \$25 each, were on sale at two for \$10. Second-hand transceivers usually fetch only low prices in USA, and there were plenty of bargains for UK amateurs, providing they could physically carry them back on the plane!

There's a Dayton Hamvention website with more information for those who may be considering a trip next year: see <http://www.hamvention.org>

Transceivers are getting smaller almost by the day, and Icom's IC-Q7E is the latest to join the group of tiny fully-featured handhelds having a 'footprint' size that of a credit card or even smaller. Measuring 58W x 86H x 27Dmm you can easily cover it with the palm of your hand, and its smooth rounded corners make sure it fits comfortably in your palm as well as in your pocket.

You won't need expensive or hard-to-get batteries for it either, because the IC-Q7E is powered by two AA cells - you can use low-cost AA nicads or nickel-metal hydride cells, together with your own AA battery charger, or of course batteries such as alkalines for standby use or more capacity for a given operating event.

Like many other miniature transceivers, the IC-Q7E is designed for local contacts, the transmitter offering 350mW on 2m and 300mW on 70cm when it's powered from a 3.0V supply (ie using dry batteries), and slightly less when using nicads.

The front panel has a minimum number of push button

lect step, duplex shift and offset, scan settings such as individually programmable pause and resume times, together with several 'priority watch' modes, dial tuning speed, auto power off, power save and so on. There's full CTCSS encode and decode fitted as well as a 1750Hz toneburst for repeater access, there's even a handy CTCSS 'tone scan' facility to let you find which sub-tone (if any) is present on the channel you're tuned to.

Yet the IC-Q7E isn't just a 2m / 70cm transceiver. The receiver covers 30 - 1300MHz continuously, with reception modes of FM, AM, and Wideband FM. 200 memory channels are provided, together with two 'call' channels, giving you plenty of available memories to store your favourite frequencies for scanning as well as for quick manual selection. To find new activity, you can program 20 'search bands' - ie lower and upper frequency limits - in any of the memory channels, for the receiver to scan in your programmed VFO steps.

Like many 'top-range' scanners, the IC-Q7E also has a 'frequency pass' facility, where if

top panel for use with an external speaker microphone. A plug adapter cable is available as an option to convert this socket to the more usual twin 2.5mm and 3.5mm jack sockets. An earphone, carrying case, headset, speaker microphone and nicad charger plus battery set are also available as options for the transceiver.

### in use

After fitting a couple of charged batteries, I found I was up and running with a simplex contact in less than a minute, without even reading the instruction book. It took me a while to work out how to switch in a repeater shift though - here's where I *did* need to take a good read of the supplied 38-page manual!

The IC-Q7E's receive audio level is controlled by the up / down volume buttons, and the small front panel 'SQL' button acts as a squelch defeat, either momentarily or an on / off toggle, depending on your preferences. This also acts as a 'listen on input' monitor on channels I'd programmed a repeater offset



prised again to be able to get into my local repeater when I was in a noted 'black spot', specifically in my back garden where I normally have to position carefully even a 2W 70cm handheld to get in.

Using the set at night highlighted the excellent LCD backlight, which automatically illuminated for a few seconds each time a front panel control or the click-step tuning knob was

# Icom IC-Q7E Reviewed

Is it a scanner, is it a handheld? It's both - it's Icom's!



the scan or search halts on some unwanted frequencies, such as beacons, they can be programmed to be skipped on subsequent searches. This facility automatically uses the upper memory channel allocations (ie channel 200 downwards) for storage of the 'frequency skip' channels.

### accessories

The transceiver comes supplied with a detachable belt clip and hand strap as carrying aids, and a

wideband rubber whip antenna is supplied for portable use. This screws on to an SMA coaxial connector on the top

panel, which allows you to connect an external antenna if you wish for home or mobile operation. A four-conductor 3.5mm jack socket is also fitted on the

into. Used together with the rotary channel knob this presets the squelch level, to either 'Open', or 'Auto' which uses a noise pulse-count technique, or to one of nine preset squelch levels. I invariably kept this in 'Auto' mode, as I found that even the '1' squelch level was a little too high for my liking - I prefer never to miss even weak but readable signals!

Despite its small size, I found there was ample audio from the front panel speaker; I could turn it up to quite a reasonable level for outdoor use before distortion set in.

### portable

Out portable around my locality, I found the sensitivity of the receiver to be, surprisingly, a little 'down' on what I'd have expected on both 2m and 70cm, and despite the fairly long set-top antenna. I presume this is because it's optimised for wide-band coverage rather than just the two specific ham bands it will transmit on.

However, on 70cm I was sur-



The four-conductor 3.5mm jack socket is for connecting an external speaker microphone, whilst the SMA coaxial connector allows you to connect an external antenna for home or mobile operation.

controls for easy operation, these being complemented by a click-step rotary knob on the top panel. But don't let the apparent simplicity fool you; the in-built 'set' mode has no less than 25 different pre-programmable functions to make the transceiver extremely versatile. With this you can preset operating functions such as the tuning step, dial se-



used, no need to fiddle about with extra buttons here. A further nicety was a small battery indicator, which showed two segments (replicating a small battery in shape) when the battery voltage was OK. This went down to one segment when it was getting low, and started to flash when it was nearly discharged to warn that it's time to finish the contact or to be prepared to pop in a freshly charged pair of batteries. During the review period I normally used a pair of 1300mAh nickel metal hydride batteries (£2.50 each from Strikalite, who exhibit at several

mounted PTT to 'double up' the number of functions, such as scan initiation. But this is often a two-handed affair in operation, which is sometimes a little difficult if you're carrying something else like a briefcase (as I often do) while you're walking along with the set. For example, switching the repeater shift out in VFO mode (eg after moving from a repeater to a simplex channel) entails keeping the V/M button pressed for a couple of seconds, then rotating the channel knob until 'DUP' is displayed, then holding the function button in whilst simultaneously rotating the channel knob to read 'OFF', and then pressing one of the other keys such as SQL, V/M, or the PTT. But then, I suppose it does save having to have a large number of buttons on the front panel.

tenna plug adapter naturally brought in signals from far and wide and, surprisingly for a set of this size, I found few problems from strong out-of-band signals. I did occasionally get interference from very strong nearby stations on the same band on a weak on-channel signal, but otherwise hardly any problems at all.

Having the wide-band facility added greatly to the use of the set, for example, it also covered the 6m, 4m, and 23cm amateur bands on receive. The band button cycles between 30 - 90, 90 - 142, 142 - 250, 255 - 383, 383 - 770, 770 - 940 and 940 - 1300MHz sub-band ranges, automatically retrieving the last-used frequency etc on each range. For tuning around, the top-panel click-step control can if you wish be programmed to automatically 'speed up' its tuning when it's turned quickly, also a press of the 'function' button lets you move in larger frequency steps (eg 1MHz or 10MHz) to get from one part of the set's wide frequency coverage to another.

The AM receive capability is useful for airband reception

on my local repeater at the same time, to make sure I didn't miss anything! In all, a full-featured wideband VHF / UHF receiver as well as being a handy transceiver for local use.

### lab results

The measured receive sensitivity was reasonable, although a little down on 70cm compared with other bands on the set, possibly explaining the on-air results. The intermodulation rejection wasn't as good as some other dual-band handhelds, although the image rejection levels were excellent, the set using a high first IF of 266.7MHz which undoubtedly helped here.

I did find some spurious responses at multiples of plus and minus 100kHz from the tuned frequency. These were around 50 to 60dB down, depending on how far away they were from the wanted carrier, although they disappeared after 400kHz and more away. It's surprising what comes up in lab tests which you don't always find on the air, although it must be remembered that the IC-Q7E is intended as a

The tiny size of the set can be gauged from the batteries.



# Icom IC-Q7E Reviewed

latest tiny dualband handheld, tested by Chris Lorek, G4HCL

ham rallies). I found these easily gave me a full weekend's worth of listening with the occasional period of transceiver operation thrown in.

### operation

There were only a couple of things I didn't like about the IC-Q7E. One was the four-pin jack socket, which you can't use with a normal mono or stereo jack plug for earphone listening. Have you tried to buy a four-contact 3.5mm jack plug anywhere? I have, several times, and have failed dismally. Thus it's down to buying the optional adapter for earphone or extension speaker use, or indeed for packet. The antenna connector, although being a small SMA type, one can, however, easily find adapters for, I picked one up in my local high street.

I sometimes wished the front panel buttons were a little larger, although I suspect that if they were, they would get pressed accidentally when the set was carried inside a pocket.

The transceiver uses a small 'function' bar beneath the side-

I did eventually find an easier way, though, so I mustn't moan too much: Icom have allowed the contents of any of the memory channels, including channels steps, mode etc, to be transferred to the VFO with a quick press of the 'Band' button. So I eventually stored a number of 'default' channels into successive memories, which I could then use as a multi-band and multi-parameter 'recall', tuning away from these in VFO mode whenever I wished. For one-handed operation I was also pleased to find that, although the 'call' button acted as a 1750Hz toneburst on transmit, a quick double-press of the PTT also transmitted a toneburst for the duration of the second press. This also kept the transmitter keyed for a fraction of a second when released, which then let me put a call out without 'phantom bleeping' ('kerchunking') the repeater.

### greater horizons

At home, connecting my rooftop 2m / 70cm collinear via an an-

where this is allowed, whilst WFM allowed me to listen to my local Band II broadcast stations when the amateur bands were quiet, with the dual watch 'priority check' automatically keeping a periodic ear open for activity

small handheld - like similar sets it's not designed to offer full-blown base station performance.

The transmit harmonic levels were adequately suppressed for a set of this power, and the peak







# Waters & Stanton PLC

FREE-PHONE ORDER LINE  
**0500 73-73-88**



**22, Main Road, Hockley, Essex. SS5 4QS**  
Open Mon-Sat 9.00AM - 5.30PM  
Web Site:- <http://www.waters-and-stanton.co.uk>

**25<sup>th</sup> YEAR** of Service to UK Amateurs

Read the latest Hot News on our Web

Orders: 0500 73 73 88  
01702 206835  
Enquiries 01702 206835  
01702 204965  
FAX 01702 205843  
E-mail [sales@wsplc.demon.co.uk](mailto:sales@wsplc.demon.co.uk)



**NEW Watson W-25AM 25 Amp Power Supply**  
Variable Output - Dual Meters **£95.95**



In Stock

**NEW C-408** From HORA  
70cms Handheld Full CTCSS  
**£89.95!**  
FREE Postage



**The NEW FT-100**  
1.8MHz - 430MHz!  
**£1295 approx.**



Coming Soon

Send for advanced data sheet

**Hora C-150** **£99.95**  
2 Metre Handy



**Amazing Offer!**

- \* 25 / 12.5kHz Steps
- \* 1750Hz Tone
- \* Scanning
- \* 5W (Ext 12V)
- \* Keypad Entry
- \* Antenna
- \* 12 Month Full Warranty
- \* 130 - 170MHz Rx
- \* 20 Memories
- \* Battery Save
- \* LCD Readout
- \* 6 x AA cell case
- \* Manual

This really is a superb performer. Don't be fooled by the price. Offers with our usual 10 - Day approval.

SPECIAL OFFER PRICE

Full CTCSS; 20 memories; 1.6MHz repeater shift; Priority channel, Scanning; Dual watch; Dual mode squelch; PTT lock; 12.5/25kHz steps, 230mW output - all from just 2 x AA cells

## 1998 Catalogue



- \* Largest in Europe
- \* 176 Colour Pages
- \* 1000 Photographs
- \* 1400 Products
- \* Technical Specifications
- \* News Snippets

Now established as the foremost equipment guide this edition is completely new with every page in full colour and almost every item illustrated. For the cost of a magazine you can get the best guide ever.

**£2.95 plus £1 postage**

## Kachina 505DSP HF Transceiver

**PRICE DOWN**

**PC controlled HF Review this issue**



**Main Features £1899 auto atu version**

100W HF All bands + Receive 100kHz - 30MHz  
Filters for SSB 3.5, 2.7, 2.4, 2, 1.7kHz  
Filters for CW 1kHz, 500Hz, 200Hz, 100Hz  
Band Scope, DSP filter, Memory keyer, log book, VSWR meter, Smith Chart, pre-amp, 20dB attenuator, plus many software controlled functions.

## SGC-2020 QRP HF Transceiver



**Limited Stock**  
**£599**

1.8 - 30MHz  
0 - 20 Watts SSB and CW with full break-in. Can run from 12 volts or internal pack. Delivery expected at the end of March

**ADI AT-600 Dual Bander**  
**New Low Price £249**



PW says: "an incredibly well priced radio - amazingly sensitive - audio - worked very well with 12.5kHz channel spacing - An Absolute Cracker"

- \* 2m / 70cm
- \* CTCSS encode/decode
- \* Full DTMF + 1750Hz tone
- \* Alphanumeric memories
- \* Full duplex
- \* CTCSS tone reader
- \* 29 programmable features
- \* AM airband receiver
- \* Rx up to 990MHz
- \* Ni-cads and charger

**ADI AR-146 2m 50W FULL CTCSS**  
**£199**



- \* 3 Power levels - Wideband receive
- \* 40 Memories plus call channel
- \* 7 Programmable steps
- \* Channel or frequency display
- \* The best sensitivity in the business
- \* Keypad mic and mounting kit
- \* CTCSS Encode and Decode!

**KENWOOD TM-451E 70cms Mobile** **LAST FEW** **£459**



A chance to purchase this top range 70cms mobile at a silly price! 35 Watts output, 41 memories and CTCSS encoder gives you all you need to enjoy mobile or base station operation. 12.5kHz/ 25kHz steps are featured together with a clear LCD.

## VHF & UHF Band Pass Filters

**2m & 70cm**

**NO MORE PAGER PROBLEMS**  
We guarantee this will kill all QRM caused by strong out of band signals - - - or your money back!

**DCI-145** £89.95  
Passband: 144 - 146MHz  
Loss: Less than 1 dB  
Selectivity: -68dB at 136MHz  
-55dB at 155MHz  
Power: 200 Watts

**DCI-435** £119.95  
Passband: 430 - 440MHz  
Loss: Less than 1 dB  
Selectivity: -47dB at 415MHz  
-50dB at 455MHz  
Power: 200 Watts

## WATSON Hunter Frequency Counter

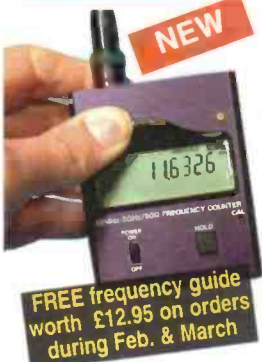

- NEW**
- Features:**
- 10MHz - 3GHz
  - Ni-cad Pack
  - AC Charger
  - BNC Antenna
  - Full Instructions

**£59.95**

Add £2.50 Post & Ins.

Check your base or handheld transceiver, or hunt out frequencies of nearby transmitters or handhelds. The "hold" button lets you lock on and store the frequency.

**UK's Top Dealer for YAESU, KENWOOD & ICOM**





**£1599**  
1.8MHz to 432MHz

Plus FREE PSU & Base Mic

**Includes 70MHz Transceiver**

100W 1.8 - 50MHz \* 50W 2m/70cm \* SSB - CW - FM - AM \* CTCSS \* Alphanumeric \* 0.1Hz steps \* Packet ready 1200 & 9600 \* DSP filtering \* Dual display \* squelch \* IF shift \* Notch filter \* Power control \* Tx monitor \* Electronic keyer \* 12.5 / 25kHz switched FM filtering \* Switchable pre-amp \* Size 260 x 86 x 270mm \* weight 7kg

**YAESU FT-920 1.8 - 54MHz £1299**



+ Free FM board & AM Filters

\* 1.8 - 54MHz 100W \* DSP filter \* MOSFET PA \* Internal ATU \* Auto notch \* Twin VFOs \* Auto glow display \* Shuttle jog \* Digital voice memory \* Electronic keyer \* RS-232C converter \* Quick memory bank + lots more phone or e-mail for colour leaflet

**YAESU FT-1000MPDC (AC £2199) £1899**



\* 1.8 - 30MHz 100W \* SSB - CW - FM - AM \* Rx 100kHz - 30MHz \* Message memory \* Dual in-band rx \* EDSP filter \* RF processor \* RF pre-amp \* Electronic keyer \* IF shift width \* Collins filters \* Comprehensive menu system \* RS-232 interface and more - send for details

**ICOM IC-746 1.8MHz - 146MHz**



Superb HF Performance

Replaces IC-756

Free PSU Free Base Mic **£1595**

**ICOM Dual Bander New IC-Q7E £215**

2m & 70cms FM & AM Rx In Stock about NOW

This pocket handheld provides 300mW of FM on 2m & 70cms plus wideband receive FM AM WFM from 30MHz - 1300MHz - no gaps. Runs from 2 x AA cells



**ICOM IC-706 Mk II 1.8 - 146MHz £995**



DSP Module for existing owners £59.95

The IC-706 Mk II transceiver as the best compact hf mobile bar none. It out performs and out specifies any other model. The only choice left is which dealer you buy it from! We offer you an unbeatable price and an unbeatable back-up service plus optional extended 5 year warranty for an extra £98!

**ICOM IC-746 1.8 - 144MHz £Phone!**



Amazing Value & Performance

\* 100W 1.8 - 146MHz \* SSB - CW - FM AM \* Electronic keyer \* Gen. cov receiver \* Spectrum scope \* DSP noise filter \* Notch filter \* IF pass band tuning. Delivery from stock.

**YAESU FT-840 1.8 - 54MHz £659**



Phone for Crazy Price!

If you are looking for a good, reliable 100W transceiver, then this is just the job. Supplied with FREE Base Mic.

**YAESU FT-8100 Dual Bander Mobile £399.95**



Yaesu's top selling dual band mobile transceiver. everything you could wish for including wideband receiver

**ICOM New IC-2100 2M Mobile £269**



The IC-2100 Mobile transceiver from ICOM features switched filtering, 55 Watts with 113 memories. And all this at a very competitive price. In stock NOW

**Alinco DX-70 HF Base / Mobile**



\* 1.8 - 54MHz \* SSB CW FM AM \* 100W HF 10W 50MHz \* CTCSS Tone unit **£599.95**

**ICOM IC-207H 2m/70cm Mobile £339**



\* 2m & 70cm \* 50W / 30W \* Detachable head

**Rechargeable Alkaline Cells For Starter Kit**



In stock now! \* Note: you must use the special charger supplied with Starter Kit.

Starter Kit: Comprise 4 x AA cells and dedicated AC wall charger **£13.99 + £2 p&p**

4 x AA cells (ready charged) £5.99 (£1.00 post)  
8 x AA cells (ready charged) £10.99 (£1.50 post)  
4 x AAA cells (uses standard charger) £6.25 (£1.00 post)

**KENWOOD Phone THG-71E Dual band £279**

\* Dual Band 2m/70cm \* 200 memories \* Alphanumeric Display \* Full CTCSS \* DTMF \* Up to 6W out \* Wideband Receive \* Illuminated Keypad \* PC Compatible \* Windows Programming Send For Brochure



**YAESU VX-1R Dual band**

The world's Smallest HT From the UK's Biggest Dealer! **£239**

Our best selling dual bander and one we would be happy to own.



**ICOM IC-T8E Dual Band handy £319**

6m 2m 70cms

All in one small package.

\* 5W output (13V) \* 25 / 12.5kHz ready \* Wideband Rx \* Nickel Hydride batt \* Wide FM broadcast \* AM for airband \* Rapid scanning \* Alphanumeric





# laboratory results

All measurements taken using fully charged internally fitted AA nicad cells

## receiver

### sensitivity:

Input level required to give 12dB SINAD:

51MHz	0.20µV pd
70MHz	0.17µV pd
145MHz	0.12µV pd
435MHz	0.26µV pd
1297MHz	0.14µV pd

### squelch sensitivity:

	145MHz	435MHz
Auto	0.11µV pd (10dB SINAD)	0.24µV pd (9dB SINAD)
Min (1)	0.24µV pd (20dB SINAD)	0.55µV pd (21dB SINAD)
Max (9)	0.75µV pd (36dB SINAD)	1.34µV pd (35dB SINAD)

### blocking:

Increase over 12dB SINAD level of interfering signal modulated with 400Hz at 1.5kHz deviation to cause 6dB degradation in 12dB SINAD on-channel signal:

	145MHz	435MHz
+100kHz	57.6dB	56.4dB
+1MHz	82.8dB	86.3dB
+10MHz	87.0dB	91.4dB

### intermodulation rejection:

Increase over 12dB SINAD level of two interfering signals, spaced at 25 and 50kHz off-channel, and 50 and 100kHz off-channel, giving identical 12dB SINAD on-channel 3rd order intermodulation product:

	145MHz	435MHz
25 & 50kHz signals	44.2dB	44.7dB
50 & 100kHz signals	44.1dB	45.1dB

### adjacent channel selectivity:

Measured as increase in level of interfering signal, modulated with 400Hz at 1.5kHz deviation, above 12dB SINAD ref level to cause 6dB degradation in 12dB on-channel signal:

	145MHz	435MHz
+12.5kHz	38.8dB	38.9dB
-12.5kHz	26.4dB	30.1dB
+25kHz	53.9dB	59.7dB
-25kHz	53.8dB	58.1dB

### image rejection:

Increase in level of signal at 1st IF (266.7MHz), 2nd IF (19.65MHz) and 3rd IF (450kHz) image frequencies, and half 1st and 2nd IFs, over level of on-channel signal, giving identical 12dB SINAD signal:

	145MHz	435MHz
1st Image	>100dB	>100dB
Half 1st IF	>100dB	>100dB
2nd Image	87.9dB	79.9dB
Half 2nd IF	98.8dB	65.7dB
3rd Image	>100dB	>100dB

### s-meter linearity:

	145MHz		s435MHz	
	Sig Level	Rel Level	Sig Level	Rel level
S3	0.34µV pd	-7.0dB	0.79µV pd	-5.8dB
S5	0.41µV pd	-5.3dB	1.07µV pd	-3.2dB
S7	0.53µV pd	-3.1dB	1.14µV pd	-2.7dB
S9	0.76µV pd	0dB ref.	1.53µV pd	0dB
S9+	0.89µV pd	+1.4dB	2.27µV pd	3.3dB

## transmitter

### harmonics:

	145MHz	435MHz
2nd Harmonic	-51dBc	-59dBc
3rd Harmonic	-72dBc	-67dBc
4th Harmonic	-54dBc	-64dBc
5th Harmonic	-65dBc	-
6th Harmonic	<-80dBc	-
7th Harmonic	<80dBc	-

### tx power output:

145MHz	291mW (nicads fitted), 352mW (3.0V supply)
435MHz	244mW (nicads fitted), 305mW (3.0V supply)

### peak deviation:

145MHz	4.89kHz
435MHz	4.71kHz

### toneburst deviation:

145MHz	3.76kHz
435MHz	3.63kHz

### frequency accuracy:

145MHz	-150Hz
435MHz	-54Hz

deviation, tone deviation were accurately set. The frequency accuracy was excellent. The transmit power output measured using fully charged nicads was lower than the 350 / 300mW level typically specified for a 3V supply, as I always attempt to replicate 'typical use', nicads being nominally 1.2V per cell rather than 1.5V as for a dry cell. However, the power level measured was still quite reasonable, and it certainly didn't drop substantially with this lower supply voltage.

Opening up the transceiver reveals a well-screened inner circuit arrangement on the RF side. Two small potentiometers,

marked 'V' and 'U' are visible next to the synthesiser VCO, I'd imagine these to be the peak deviation controls (although I could be wrong!), thus suggesting that eventual adjustment to a lower deviation setting for 12.5kHz channel spacing should be reasonably easy.

## conclusions

Icom have combined a tiny but feature-packed wideband VHF / UHF handheld scanner with a 300mW dualband handheld. It's a small and easily-carried size, both in your hand or clipped to a belt, and it can be operated easily in memory mode using the

top panel knob with an instant shift to fully-tuneable operation from memory with a single front panel button push. The set's initial and operational cost is kept down by using readily-available AA cells for power which you supply yourself. These are invariably much cheaper than having to buy a dedicated battery pack.

The IC-Q7E costs £215. My thanks go to Waters & Stanton PLC, 22 Main Road, Hockley, Essex SS5 4QS; tel: 01702 206835, for the loan of the IC-Q7E for review.

In addition to being a dualband handheld transceiver, the IC-Q7E is also a full-featured scanner, covering 30 - 1300MHz.

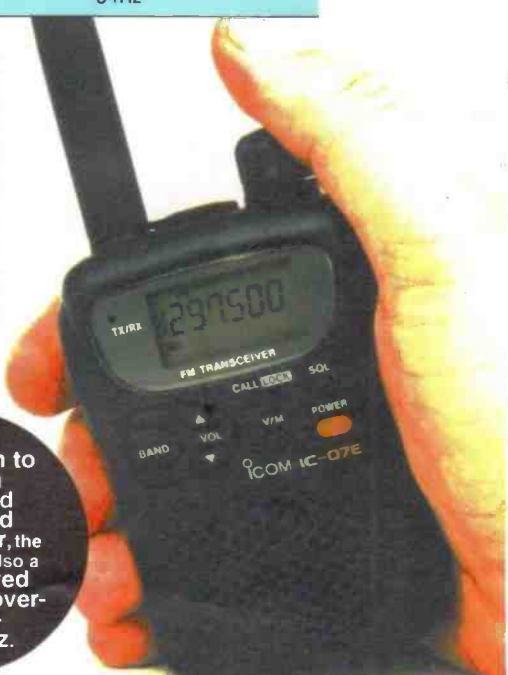

# DSP Add-On Unit for Icom IC-706MkII

Chris Lorek, G4HCL, tests Icom's new plug-in board which upgrades the receiver in the IC-706MkII to a DSP unit



The Icom IC-706MkII with the UT-106 unit fitted. Note the 'ANF', 'NR' and 'NRL' in the display.

The Icom IC-706MkII is already a very popular transceiver, offering all-mode coverage of HF, 6m and 2m in a very compact unit. Many amateurs use it as their main rig, as well as finding it a handy size for mobile and portable operation.

Several 'top of the range' base station HF transceivers are now equipped with DSP (Digital Signal Processing) facilities, offering DSP-based noise reduction and automatic notch filtering. I've personally used an external W9GR DSP filter for some time with my Yaesu FT-990, finding this extremely useful in supplementing the built-in upper / lower cut audio filtering - I wouldn't be without it now when DX chasing.

Despite the innards of the IC-706MkII being absolutely packed, the designers have left a small space, just big enough for the new UT-106 DSP receive unit. The same unit also integrates with Icom's PC-controlled IC-PCR1000 wideband receiver, offering similar facilities.

## installation

Although it's a 'plug-in' unit, I found that fitting the UT-106 into the IC-706MkII was slightly fiddly due to the very compact nature of the construction. The transceiver top and bottom lids need to be removed, and one of the wired connectors on the upper side needs to be unplugged and carefully routed back through the side of board to the lower side of the set's chassis, where the UT-106 fits. This

connector plugs into the DSP unit, with a further wired connector from this unit plugging into the original connector position, which again requires careful routing. I found it easier to do this by first removing the adjacent PCB ribbon connector lead from the chassis. Finally, a further short connection cable fits between the DSP unit and a connector on the set's PCB, next to the DSP unit. A double-sided sticky pad is supplied to fix the unit to the chassis. A careful routing of the set's displaced leads, a refit of the lids, and the upgraded IC-706MkII was ready to go.

## operation

The DSP unit is controlled from the 'Menu' facility on the transceiver, using the 'S4' sub-menu display. The soft keys below the LCD switch the ANF (Automatic Notch Filter) and NR (Noise Reduction) on or off, and either or both can be used at any time. The final button (indicated 'NRL') changes the display to give you an indication of the NR level, the adjacent click-step 'M-CH' varying this in 16 pre-set steps.

The ANF automatically attenuates beat tones, tuning signals etc, even if these are varying, and this functions in SSB, FM and AM modes. The NR function reduces noise components and is designed to help you pick out signals that would otherwise be masked by noise. The received audio components are converted to a digital stream and then the

'correlated' (ie desired) signals are separated from the 'uncorrelated' noise.

## on the air

The IC-706MkII already has a sensitive receiver for weak signal work on the higher bands, and switching in the NR made it even better. I found the background noise on all modes could be nicely reduced, although if I set the NR level greater than around the '8' (mid-point) setting, the resultant audio did tend to become rather 'nasal' sounding and hollow. This is typical of virtually every audio-based DSP system I've used. I particularly found it useful for weak-signal reception on 2m and 6m, as I tend to suffer somewhat from neighbouring noise sources on 6m. The NR facility did help with this. Likewise, whilst monitoring for signals on the 'centre of activity' frequencies on 2m and 6m SSB, the NR helped to reduce listening fatigue.

The automatic notch facility was also useful, mainly on the crowded HF bands. Being an audio-based system, it could not prevent 'monster' carriers blotting out the wanted signal when the receiver's AGC cut in, but in these

cases the set's normal IF shift control came in useful.

## conclusions

The IC-706MkII is already a well-featured, compact and very versatile set. The addition of the UT-106 adds audio-based DSP filtering to this, making it even better, at a cost considerably less than you'd have to pay for a typical external DSP unit.

Thanks to South Midlands Communications Ltd (tel: 01703 251549) for the loan of both the IC-706MkII and the UT-106 to test. The UT-106 is available for a round £59.95.

Fitting the UT-106 board can be a little fiddly - but the results make the effort worthwhile.





# THE ML&S BUDGET PLAN HAS

**CALL TODAY FOR THE LARGEST SELECTION OF NEW & USED EQUIPMENT IN EUROPE**

- TEL: 0181 - 566 1120 ■ FAX: 0181 - 566 1207
- CUSTOMER CARE: 0181 - 566 0 566
- WEB SITE: MLandS.co.uk
- E-MAIL: sales@MLandS.co.uk



### ICOM IC-T8E

**FREE FINANCE on this product**  
The only **TRIPLE BAND 2/6/70** Handie on the market. Fortunately it's brilliant.  
**RRP £349 OR £49 DEPOSIT & 12 X £25 P/M**  
**ZERO FINANCE CHARGES**



**N**ow in its second year, the ML&S "BUDGET PLAN" has proved to be the most popular method of paying for your new radio equipment. Unlike other "Hire Purchase" agreements, the Budget Plan makes it very easy to plan your monthly repayments at a fixed rate, requiring a very low deposit.

- Deposit from as little as £20
- Repayments can be fixed at between £25 - £100 increments
- APR is low - only 19.9% Compare that with your Bank

**ALL ITEMS ARE AVAILABLE ON THE ML&S BUDGET PLAN**

### NEW KENWOOD TMG-707E

The latest Twin Band 2/70 Mobile from Kenwood. Removable Front Panel, Built In CTCSS Encode/Decode, 180 memories including Alpha tag, 1200/9k6 Packet input, WB RX 118-174/300-524MHz plus 800-1000MHz.  
**ONLY £329 OR £24.15 DEPOSIT & 12 X £28 P/M**



### YAESU FT-847GX

If you are a Radio enthusiast and you haven't heard about the new FT-847GX then perhaps you live on an island that I should sponsor the next CDXC expedition too! The only Transceiver to offer HF + 4M + 6M + 2M + 70CM in one box. Bloody amazing I say. If you have a deposit with us (and you got in early) you probably already have yours by now. Stocks arriving throughout May. Get your deposits in quick!!



**RRP £1695.**  
Deposits from only £25. No cuddly toys or furry dice. We will price match though. Call now.

### ICOM IC-2100H

The latest in a long line of High Power FM Mobiles. 55 Watts on 2 Metres FM will ensure that you are heard. This one features a selectable yellow or green display should you be fussy about matching your cars dash illumination!  
**Only £269. In stock now.**



### ICOM IC-746

**PRICE MATCH ON THIS PRODUCT**  
Guess which HF Transceiver has sold more this year than any other? You guessed it, the new IC-746. 100 Watts on HF, Six Meters and Two Metres with DSP. This is the serious choice if your priority is HF operation. Buy on our Budget Plan with the matching PSU and Desk Microphone and receive £200 worth of matching Icom accessories.  
**IC-746 £1695 MATCHING PS-85 PSU £245, MATCHING SM-8 DESK MICROPHONE £109 DEPOSIT £95.08 & 60 X £50 PM**



### ICOM IC-706MK11DSP

Now fitted with the DSP UT-106 as standard, HF, 6M, 2M all mode in a package not much bigger than a car radio.  
**RRP £1099 ML PRICE £999 OR £22.03 DEPOSIT & 60 X £25 P/M**



### KENWOOD TH-G71E

Excellent value Twin Band Handie featuring 200 memories, a monster 6 Watts out (using 13.8VDC) & built in CTCSS.  
**RRP £279.95 ML PRICE £249 IN STOCK NOW.**



### STOP PRESS

**RS-746 Control Software for IC-746 £59.95**

**IC-Q7E Micro Handie from Icom £215.00**

**IC-PW1 1kW Icom HF Solid State Linear £3695.00**

### MyDel antennas

**M-DEL MULTITRAP**  
Built exclusively for MARTIN LYNCH, the new wire antenna is trapped for 80 through to 10 metres, uses heavy gauge multi strand plastic-sheathed wire, heavy duty 1 kW traps and totals only 20 metres in length. It's very easy to install, takes minutes to tune, guaranteeing an SWR of less than 1.5:1 on spot frequencies throughout the entire 5 bands. A far better alternative to the old G5RV antenna. Impedance: 52 Ohm. Overall length: 20m. Power Handling: 1kW. Max SWR: 1:5:1. Weight: 2.5Kg. Input socket: S0239.

**£79.95**  
p&g £7.50

**M-DEL MEGATRAP 160M - 40M**  
**£99.95**  
p&g £7.50

### STANDARD C5900D

Still the very best (and only!) Triple band 2/6/70 FM Transceiver available. A stonking 50W out on Two, 45 Watts on Six and 35W on seventy. We have probably sold more to RayNet than individual users! Just look at the super new LOW price!  
**RRP £799 ML PRICE £599 OR £16.99 DEPOSIT & 29 X £25 P/M**



### STANDARD C156

Competition for 2M handhels is fierce. There are many unknown makes on the market and STANDARD isn't one of them!  
**RRP £149.95 ML PRICE £129.95**



**140-142 NORTHFIELD AVENUE, EALING, LONDON W13 9SB**



# WORLD WIDE APPEAL!

- Finance can be instantly offered over the telephone or in the store (subject to status)
- The loan can be tailored to suit you - you tell us what deposit & how many months to pay
- We can take your trade-in as a large deposit leaving the balance to finance
- We can even pay cash for your trade-in and still finance your new or used purchase!
- Payment protection is available - giving you peace of mind on paying the loan. (subject to status)

## NEW LINEAR AMP UK - RANGER 811H

800W OUTPUT,  
1.8 - 30MHz  
(AMATEUR BANDS)  
You will be VERY impressed. **£895**  
OR **£25.77 DEPOSIT & 50 x £25 p/m**

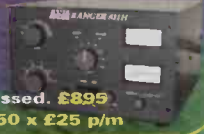

## YAESU FT-920AF

A superb HF plus Six Metre Base Transceiver with DSP and Internal Auto Tuner. No available with FM and AM options fitted as standard. **RRP £1499 ML PRICE £1299 OR £18.99 DEPOSIT & 54 X £35 P/M**



## YAESU VX-1R

The worlds smallest sexiest DualBander available! 0.5-1.7MHz (AM) & 76-99MHz with 2/70 Transceiver. Lithium Ion Battery & Charger supplied. **RRP £269 ML PRICE £239 IF YOU FIND IT CHEAPER CALL!!**



## ICOM IC-T7E

Simple Twin band Handie that works! Supplied with NiCads & Charger **RRP £299 ML PRICE £199**



## NEW!! YAESU FP1030A

If you want a power supply to be built properly then I guess you have no choice but to turn to the "big three." Yaesu have just introduced a high quality Regulated DC PSU specifically designed to work with their current (including the FT-847GX) range of HF Transceivers.

- 13.8 Volts DC at up to 25 Amps continuous Duty
- OverLoad Protection.
- High RFI Immunity, including extensive internal filtering
- Multiple DC Outlets including Cigar Socket for Handies
- Metres for Volts & Amps
- Only 250Wx150Hx240Dmm (9.8"x5.9"x9.5")

**RRP £229 Special Introductory Offer £149.00**

## YAESU FT-1000MP/AC

FREE FINANCE on this product!

After two & a half years, I cannot think of another HF Transceiver that has sold consistently each month. When the chips are down the FT-1000MP is the benchmark to which others are compared. Full DSP, Internal ATU & PSU. Now think about owning one on Interest Free Finance. **RRP £2499 ML Price £2199 or £183 deposit & 18 x £112 p/m ZERO FINANCE CHARGES**



## Microwave Modules

Martin Lynch & Son are the UK distributor for Microwave Modules products. The range currently consists of a of VHF & UHF linear amplifiers, linear transverters, plus a number of other useful accessories.

### Amplifiers

All amplifiers utilise a state of the art power transistor, guaranteeing a reliable and linear output stage, thus making them suitable for all modes of operation. The PA transistor is thermally tracked against temperature variation

Model	Band	Input	Output	Price
MML432-30-3	70 Cms	1/3 Watts	30 Watts	£179.95
MML432-50-3	70 Cms	10 Watts	50 Watts	£189.95
MML432-100-10	70 Cms	10 Watts	100 Watts	£339.95
MML144-200	2 Metres	3/10/25 Watts	200 Watts	£339.95
MML144-100-10	2 Metres	10 Watts	100 Watts	£199.95
MML144-100-3	2 Metres	3 Watts	100 Watts	£219.95
MML144-30LS	2 Metres	1/3 Watts	30 Watts	£99.95
MML70-30-3	4 Metres	3 Watts	30 Watts	£99.95
MML70-100-10	4 Metres	10 Watts	100 Watts	£199.95
MML70-100-25	4 Metres	25 Watts	100 Watts	£199.95
MML50-30-3	6 Metres	3 Watts	30 Watts	£99.95
MML50-100-25	6 Metres	25 Watts	100 Watts	£199.95
MML50-100-10	6 Metres	10 Watts	100 Watts	£199.95
MML50-100-3	6 Metres	3 Watts	100 Watts	£219.95

## HIGH PERFORMANCE LINEAR TRANSVERTERS

Model	I/F Freq.	Output Band	Power	Price
MMT 50-28HP	10 Metres	6 Metres	10 Watts	£299.95
MMT 70-28HP	10 Metres	4 Metres	10 Watts	£299.95
MMT 144-28HP	10 Metres	2 Metres	10 Watts	£299.95
MMT 220-28HP	10 Metres	1.3 Metres	10 Watts	£299.95
MMT 432-28HP	10 Metres	70 Cms	10 Watts	£TBA
MMT 1296-144HP	2 Metres	23 Cms	10 Watts	£TBA

## 20% PLUS OFF TONNA PRICES!

To ease the burden of putting up new antennas during spring, check out our LOW prices on TONNA

### ANTENNAS!

20505 5 ele	50MHz	RRP £86.95	ML £69.50
20804 4 ele	144 MHz	RRP £44.95	ML £35.95
20809 9 ele	144 MHz	RRP £52.95	ML £42.25
20811 11ele	144 MHz	RRP £79.95	ML £63.95
20817 17ele	144 MHz	RRP £97.95	ML £77.95
20818 9 ele X	144 MHz	RRP £87.95	ML £69.95
20438 21 ele X	432 MHz	RRP £81.95	ML £49.50
20909 9 ele	432 MHz	RRP £45.95	ML £36.75
20919 19 ele	432 MHz	RRP £53.95	ML £42.95
20921 21 ele	432 MHz	RRP £69.95	ML £55.95

Plus selection of 23cm antennas in stock!!!

## ACCESSORIES

A full range of accessories for all main equipment is always in stock or on order with the manufacturer. You can include a selection of filters, a power supply or Tuner in the new finance deal.

## WIDEST CHOICE

As the official U.K.'s largest dealer of Yaesu, Icom, Standard & Kenwood products, you'll find everything you could ever dream of under one roof. Our friendly (and non pushy) sales team will be delighted to show you around and supply you with as much coffee as you can drink.

## SELLING YOUR EQUIPMENT

We're always short of good quality used gear and currently have £150,000 to spend on increasing our used stock. So if you're wanting to sell your current transceiver (or accessory) for cash we would be pleased to hear from you.

## FIVE YEAR EXTENDED WARRANTY

ML&S was the first company to introduce a meaningful 5 Year cover plan for your equipment. Don't let high servicing costs put you off!

## £25 DEPOSIT

Most of the products advertised by ML&S are available from a small £25 deposit and if you choose to pay more you can enjoy a reduced monthly payment.

## DELIVERY TO YOUR DOOR

Our next day couriers are waiting to safely deliver your new purchase direct to your door, anywhere in the U.K. or most overseas locations.

## FLEXIBLE FINANCE

Let our professional sales team tailor a finance package to suit your individual requirements. Our super new Budget Plan makes paying for your new purchase so much easier.

## PART EXCHANGE

We desperately need your part exchange right now - top prices paid. Don't let it depreciate over another twelve months, we'll take your current transceiver now at an agreed CASH price and still have your new rig on finance if you wish!

## CASH-IN

If the value of your part exchange is greater than the value (or deposit) of the new purchase, we'll give you back the difference! Turn the value of your old gear into cash for the start of the year.

## DIAL-A-DEAL

Call any of our sales hot lines now - we're eagerly awaiting your call - everything sorted over the phone, model, trade-in, collection, delivery and finance! Even if you do not live locally you can still have the peace of mind feeling when dealing with ML&S!

## OPENING TIMES

Open 6 days a week - 9:30-6:00

Call now  
**0181-566 1120**

Martin Lynch can also offer finance terms up to 60 months. Deposits from a minimum of £25. We welcome your part exchange against any new (or used!) product, provided its clean and in good working order. Call the Sales Desk today. APR: 19.9%. Payment protection is also available up to 36 months. All units are brand new and boxed and offered with full manufacturers RTB warranty. All prices quoted for cash/cheque or Switch/Delta card. No additional charges for credit cards. Martin Lynch is a licensed credit broker. Full written details are available on request. Finance is subject to status. E&OE. £10 p&p on all major items.

\* Budget Plan requirements: Full time employment (or disabled/retired), over 18 and below 71, Current bank account (or building society). For instant finance please ensure you have UK driving licence and cheque guarantee credit card or Electricity/Gas/BT bill with your current name and address. Finance subject to status. APR: 19.9%.



**N**ovember 1992. A two-week holiday in Florida with my children. Having passed the FCC USA Amateur Radio licence test at a VE (Volunteer Examiner) session in Hollywood, Florida, I drove south to Key West. At the marina there I heard someone say, "Think, it is only 100 miles to Cuba" and I said to myself, "I'll go there one day".

**5 years on**

November 1997. Some of my friends from Stockholm had gone to Cuba to participate in the CQ World Wide CW contest as T49C. I caught them finally on Sunday afternoon on 15 and 20 metres: it seemed that everything was OK (ie, they hadn't been imprisoned). On Monday I spotted an offer at one of the travel agents: a package tour from Stockholm to Cuba, including visa and two weeks at a three-star hotel for US\$500. Did I hesitate?

I checked 15 metres: no



At the Varadero radio club, CO5ENA: Albert, CO5AM; Yandis, CL5ENB; and Osmani, CL5ENC.

Antonio, CO2AA, on his rooftop in Havana. He uses an extensive set of wire antennas.

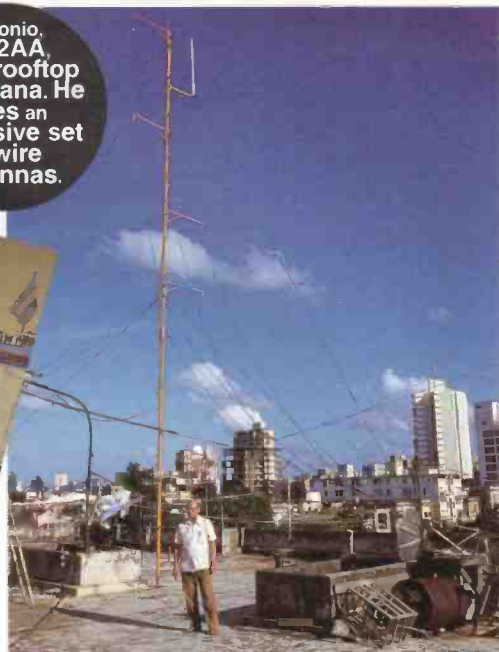

oil rigs scattered along the coast, I felt like I was somewhere in the Persian Gulf. There is, however, a basic difference: there are thousands of enthusiastic hams in Cuba.

I walked the streets of Varadero and spotted some wires on the roof of a block of flats a few hundred metres away.

# Our Ham in Havana

There's an awful lot of hams in Cuba, so why don't you t  
the Caribbean isla

The FRC headquarters in downtown Havana, where the CO2FRC station is located.

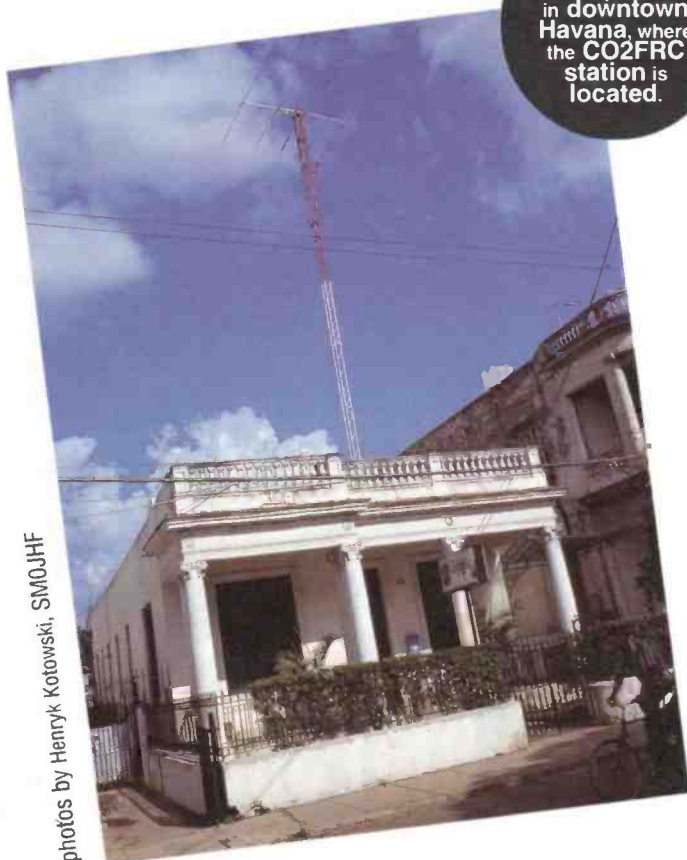

All photos by Henryk Kotowski, SMOJHF

propagation at all. The next afternoon I heard someone working a CO2 on CW, but with no trace of the Cuban station. Finally, on the Thursday, I found CO2WF on SSB. He came back. Winston gave me his phone number in Havana and told me that the club meetings are on Saturdays. I felt better.

The flight was delayed: someone in Copenhagen changed his or her mind just before take-off and their suitcase had to be removed from the plane - you never know in such cases. 11 hours airborne. What a change from the snow and frost of Stockholm to the subtropical rain of Varadero, Cuba.

**varadero**

Varadero - a strip of beaches and hotels some 85 miles east of La Habana (Havana). Closed to common Cubans, and everything is priced in US dollars. Canadians, Italians, Spaniards, Germans and recently Scandinavians come here to get shocked when they get charged a dollar for a glass of water, four for a beer. With the smell of crude oil and natural gas coming from the

I approached the building and saw dipoles, an inverted-Vee and some verticals. I followed the coax cables to a window on the top floor and knocked on the door.

I don't speak Spanish, but just said "¿Radioaficionado?" Yes, come in, the woman who opened the door called someone and I met Jose, CM5MA. His shack is quite well equipped, with Yaesu and Kenwood rigs, a PC, and a car battery on the floor. There are frequent power black-outs, so using a back-up battery is common. Jose speaks some English and told me of his activities. He also got on 2 metres and announced my visit.

We agreed that I should return the next day at 9.00pm, when his friend from Havana, who speaks better English, would be there. I also got the address of the local club from Jose - 24th Street, between 3rd Avenue and the motorway. The next evening, I went with my cameras, flashlights and a bottle of wine. Well, the friend from Havana had already left: Jose meant 2 o'clock in the afternoon!

Another friend dropped in,

Winston, CO2WF, with his three-element beam in the centre of Havana.



(some 45 cents) for three years. The licensing authority, Radiocuba, has its official presence at the tests, which take place every month.

I met many hams at FRC. The president himself, Pedro Rodriguez, CO2RP; the grand ole' man of Amateur Radio in Cuba, Oscar, CO2OM, who is 78 and on the DXCC Honor Roll; and his son CO2OJ, also Oscar. The vice-president Francisco, CO2HA; Cristian, CO2WW; Antonio, CO2AA; Juan

Carlos, CO2WZ; and Conrado, CM2CO. In some cases it seems that the 'vanity call' programme - recently introduced in the States - has been effective in Cuba for many years, as many

Victor, CM5VV. He works in Varadero, but has no shack, only a 2m handheld. Victor speaks English better and better, it is obvious that he studied English and just needed practice. Victor

it is in the family, explained Winston. His father was CO2WR but now lives in the USA, and his Uncle Nelson is WQ3N in Pennsylvania, USA. It is the uncle that helps Winston with the equipment, so he is quite fortunate in Cuban terms. He likes DXing but getting QSL cards is tricky. With a salary the equivalent of US\$15 - 20 a month, one cannot meet the demands of some DX stations and QSL managers.

### mystery solved

I am back in Varadero. I insist on solving the mystery of the radio club in Varadero, especially since even the president of the FRC mentioned that it is there. So one evening I go and search for 22nd Street. Finally I take a brave step - I cross the motorway. When I come to one of the houses I can hear voices and typical 80-metre band noise through an open window. I see the callsign CO5ENA on the door.

equipment is obsolete and not always in good shape (just like the vintage cars on Cuban roads). The other reason, in my opinion, is that too little emphasis is put on antennas there. The majority of hams use wires that are not effective. However, once they gain access to modern gear and better appreciate the importance of efficient antennas, there is going to be a lot of on-the-air activity from CO-CM-CL: the potential is certainly there.

There is a wind of change blowing over Cuba. Christmas was celebrated last year for the first time since the revolution. Over one million tourists visited Cuba in 1997. The use of the US dollar is widespread. Yet, the majority of Cubans do not want to be a part of the USA. They are disillusioned with the economic experiments, but they still worship Fidel Castro and Che Guevara.

Someone asked me why I decided to visit Cuba. I lived 30 years of my life in post-war communist Poland and remember very well what every visit from 'the West' meant to us

# Our Ham in Havana

hear them on the air? Henryk Kotowski, SM0JHF, visited and tells us why

was helpful and mentioned that he could give me a ride to Havana during the week in the company car.

But first, I was still trying to find the local club station, CO5ENA. I walked, I asked, but no-one knew, and there were no antennas to be found. I managed to reach Albert, the club's president and custodian, on the phone. Ah, the address I had is wrong (oh, Jose!)

### havana

In Havana I easily found the headquarters of the Cuban national Amateur Radio society, Federacion de Radioaficionados de Cuba (FRC). A 90ft tower supports a triband beam just opposite the Italian Embassy. Of course, I met Winston, CO2WF. He is 26 years old. With him were his wife Lizett and brother Edwyn, who were to take the amateur licence test together with 30 other candidates. So it was noisy and crowded, with young boys and older men queuing for different tests. There is no code-free licence in Cuba. To us, the licence fee seems very low - 10 pesos

callsigns are made up of their owners' initials.

The atmosphere was very informal - a ham who's a barber gave a haircut, some guys offered me rum and cola, and a meal was served to everyone. I received a special treat - the typical Cuban dish of rice with black beans, malanga root with garlic, some tomatoes and green cabbage.

Antonio, CO2AA, allowed me to visit his home and see the shack. I wondered how equipment such as he has come to be in Cuba. Antonio explained that Cuban troops were in Angola in the 70s and they brought the Yaesu FT-101 with accessories back with them. I didn't ask if the equipment was used by the troops or was a war trophy. I then recalled my meeting with a few hams in Lisbon, Portugal, earlier in the year and how they told me about their past in Angola.

The next day I visited Winston, CO2WF. His wife and brother Edwyn, who is a ballet dancer, passed the test the day before and were hoping to receive their callsigns soon. Well,

I am welcomed by Alberto, CO5AM, and his wife Belgica, CL5NN: the club is in their home. Two young newly-licensed boys talk on 80 metres with a station in the eastern province of Cuba, Oriente. Yandis, CL5ENB, and Osmani, CL5ENC, are both 18 years old and received their licences just a week earlier. They are so enthusiastic they go to see Alberto every evening. Both speak English with ease. One wants to be a businessman, the other an electronics engineer, but right now they're radio-crazy.

### reflections

There are over 2500 licences issued in Cuba. Yet it is not easy to work them on the air. One reason is certainly the lack of equipment and that the existing



Winston, CO2WF, has access to modern equipment thanks to his relatives in USA

there. At the hotel in Varadero I watched CNN TV and I saw William Schneider talking. Isn't he the same person who visited our radio club in Warsaw, Poland, as Bill, K2UYG, in the early 70s?



This month we are back to themes. I wondered for some time what aspect of radio would be a good idea to examine this month. First I want to tackle Microwaves. Although I am an HF man at heart, I have always had a lot of respect for those who go, not just to the heady heights of VHF, or even UHF, but onwards and upwards to the world of microwaves.

I confess I know little at all about these frequencies. My impression is that only small amounts of power are required, that at such frequencies plumbing is more the skill required than electronics, and that direct signals are required between two points. So, having shocked the microwave fraternity rigid with such culpable ignorance, let's dive in to the Internet sites and see what we can find. As usual, I refer in particular to the G7KPF and the Equinox pages for guidance. These two URLs should be in your bookmarks ready for action for any Radio Amateur linked sortie. As usual now, the URLs for pages referred to are listed in Table 1 to avoid cluttering up

ticularly at the higher frequencies with construction and parabolic antennas very much the norm, whereas at 1.3GHz, a Yagi is still feasible and there is some commercial equipment available for the faint-hearted. It is the higher frequency too where mW are used. Find out about Gunn Oscillators. Gosh. I'm hooked on this.

On satellite working I can do no better than to quote direct from the page: "Mode S requires a 70cm SSB / CW transmitter and a 2.4GHz SSB / CW receiver and supports CW and voice. Many people use a 2.4GHz to 2 metre converter with a 2 metre SSB / CW receiver. Satellites using 2.4GHz are AO-16 and DO-17, which both have 2.4GHz beacons, although in both cases they are usually not switched on. AO-16 has a beacon on 2401.14280MHz, trans-

**HB9DLH operating portable on the microwave bands in Switzerland.**

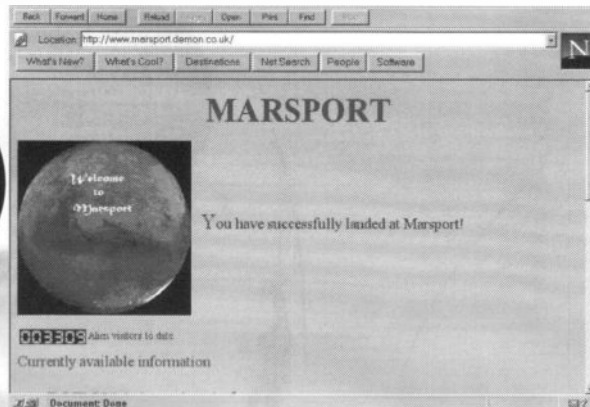

# Net Communication

This month, our web browser Jeremy Boot, G4NJH, looks at

the main page with lengthy and difficult addresses.

## rsgb pages

The first page I came across was the UK Introduction to Amateur Radio Microwaves (UK). This referred me to the RSGB's Pages. This initially disappointed me a bit. I was hoping for more than Regs and Bandplans, but I was disabused of my doubts, as the pages on Microwaves are very helpful. In fact the RSGB pages are really little gems these days: full of useful stuff and good links to other pages.

Five scenarios are put to the aspirant microwaver: it's great for construction; it's a boon if you're a serious contender; you could be into ATV; you might wish to work satellites; perhaps you are already into UHF and fancy going the whole hog (please note, I am trying my best to avoid the expression 'the Full Monty'), and you could build a transverter.

There seems to be one thing I need to take on board: the difference between 1.3GHz and 10GHz. The remark I made about plumbing seems to apply par-

mitting 1200 BPS data and DO-17 on 2401.22050MHz, transmitting 1200 BPS BPSK data. Note that circular polarization is used."

I find that a bit hard-going for an introduction. But this is no doubt a valid way to explain what happens. There is also a reference to the AMSAT-UK pages.

What would you do with microwaves anyway? Well, it seems that they are ideal for data using FSK and should be good for much faster throughput, but also there is scope for digital encoding of voice signals which would wipe out cross-channel interference or malicious use of repeaters by call barring. "This is a very exciting future for Amateur Radio, and the microwave bands are the place to do it," enthuses the writer.

There are other publications, especially the *Microwave Newsletter*, but these need a subscription. They do not appear on this Internet site (but see below under G3PHO).

## arrrl

Turning next to the ARRL, they seem to have revamped their site

since I last looked and have a useful search engine now. However on microwaves, there was only a list of articles that have appeared in *QST*. It seems to be possible to request them, but not to invoke them directly. Disappointing. I know *QST* does have quite a bit on microwaves, but you have to look elsewhere for Internet access.

The *Microwave Journal* requires registration and is a bit intimidating, I found. It was

accessed eventually and contained very technical, but doubtless very erudite, information and articles on microwaves. Definitely not a starting point for the beginner. I found articles on every aspect of microwaves, but no specific reference to Amateur Radio. I am beginning to think that microwaves are not as easy to find out about as I thought.

## a british gem

Thank goodness then for Peter Day, G3PHO, in Sheffield, whose pages are a breath of fresh air. His pages are full of enthusiasm, and above all they are both encouraging and readable. Now I find out there are good results to be had at 24GHz and 47GHz and many times conditions allow even continental working. Construction isn't an insurmountable problem after all. It also transpires that Peter is the RSGB *Microwave Newsletter* Editor.

The site contains photos and maps of microwave achievements and details of contests, news and events and is of interest to the beginner and more

experienced user alike. Now I know I should be talking about the "millimetric bands." I am feeling more encouraged. At this site under Software, you can FTP useful articles, detailed database of references to microwave technical articles from the *RSGB Microwave Newsletter*, *DUBUS*, *VHF Communications*, etc. Really useful.

It seems that microwave technology is in fact 50 years old and the record for 10GHz is 1912km, which is somewhat more than line of sight! Read about Klystron transmitters, waveguides and a very creditable record of experimentation and development by many G stations over the years. In particular, it seems, Charlie Suckling, G3WDG, almost single-handedly changed the face of 10GHz operation. There are quite a few other names in the annals of microwave history.

## european news sites

Let's move on to the European Microwave News (EMN) site, whose webmaster is Simon

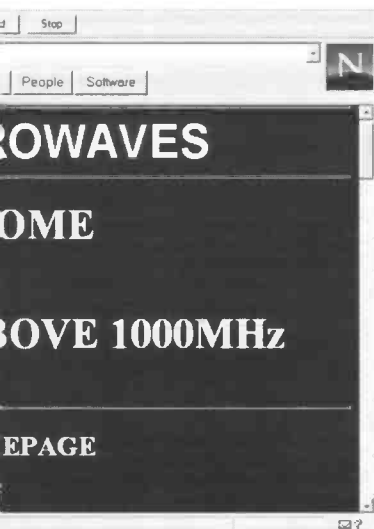

**G7KPF's Pages of Ham Links:**  
<http://www.users.zetnet.co.uk/kama/hamlinks.htm>  
**GJ4ICD Equinox Pages of Ham Links:**  
<http://user.rtl.net/~equinox>  
**RSGB Microwave:**  
<http://www.rs.gb.org/society/mc.htm>  
**ARRL Microwave:**  
<http://www.arrl.org/>  
**GM4PLM's European Microwave News Page:**  
<http://www.pacsat.demon.co.uk/>  
**AMSAT-UK Pages:**  
<http://www.mcc.ac.uk/AMSAT/>  
**G3PHO's Pages:**  
<http://freespace.virgin.net/p.day/ghz.htm>  
**The Microwave Journal:**  
<http://www.mwjournal.com/mwj.html/>  
**European Microwave News:**  
<http://www.pacsat.demon.co.uk>  
**Marsport / DUBUS (UK):**  
<http://www.marsport.demon.co.uk/>  
**Swiss ATV Pages:**  
<http://www.cmo.ch/swissatv/index.html>  
**San Bernadino Microwave Society:**  
<http://www.ham-radio.com/sbms/sbms.html>  
**Cluster Page:**  
<http://oh2aq.kolumbus.com/dxs/1g2.html>

Table 1: URLs of pages mentioned in the text.



A collection of microwavers in the US from the San Bernadino Microwave Society's page.

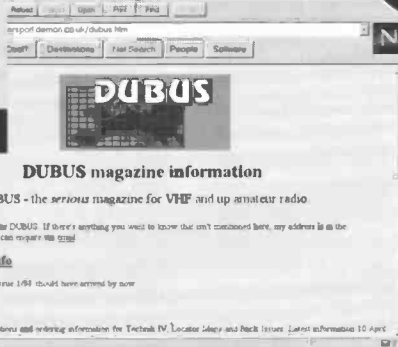

# Net Communication

## Amateur Radio Microwave sites on the Internet

Lewis, GM4PLM. This is a good set of pages also: informative, interesting with an EMN Construction database, Newsletter, information on propagation and recommended book list. So I now discover from my initial very poor grasp of the subject, that propagation at microwaves can be Line of Sight (LOS), Refractive, Reflective, Tropospheric, or even aircraft scatter can come into it. Weather and atmospheric conditions can also have a marked effect.

"The microwave bands are still new ground and we are constantly discovering new information about them. Experimentation is still playing a major part of our operating on these bands and we can all play a large part in the discovery of new propagation modes and techniques." This is the real stuff of Amateur Radio: microwaves seem very much to be in this pioneering mould.

### marsport and dubus

Simon's EMN pages have a good links page. One name I keep

hearing is *DUBUS*, so I followed the *DUBUS* UK Link and ended up at Marsport pages run by Roger, G4PMK. It seems *DUBUS* is a Anglo-German newsletter for the 'serious' VHF-and-up operator. It is something one subscribes to. From what I saw, it would appear to be for the experienced rather than the beginner. There are other useful pages on the Marsport pages, including software links for antenna design, propagation etc. All good stuff. Read it.

The Swiss ATV site, to which I linked, is principally in French, but with some articles in English. I looked therefore for Microwaves (or even Micro-ondes) and came up with *Nouveau relais-balise ATV lémanique sur 10GHz* (an ATV 10GHz Repeater / Beacon: this article is not in English). There is a world record page and I now discover someone even plays at 241GHz and attained a record of 2.1km. My great-grandmother described the gas oven as "flying in the face of the Almighty." This surely comes into the same category! The site, by the way,

is very well presented. I suppose having all those mountains must be useful for microwavers. The emphasis is on ATV, and whilst some may find the language bias to French difficult, it's worth a visit.

San Bernadino Microwave Society's page is well laid out and interesting. They run a newsletter all of whose archives seem to be included in the pages. Look at the pictures of their equipment and operating. One notes with a smile: "all of the rumors about big foot operating in the last contest aren't true . . ." from the pages. The intriguingly titled 'Comments, Rebuttals and Opinions' was empty! Not a deal here for the beginner. I note the most useful page they link to is Peter's, G3PHO. Well deserved too.

### clusters and newsgroups

There is a Cluster Page which supposedly gives five minute updates of microwave activity (a bit like the *PacketClusters* system I suppose) but when I visited it, it was days adrift, unless there

was no activity worth reporting. During contests, perhaps it is more used.

Of the NewsGroups, I found alt.ham-radio.uwave; alt.ham-radio.vhf-uhf; as well as anything that appears in the general groups. I did note a specific group in Fidonet, but most of us will not have access to it unfortunately.

This was intended to be another voyage of discovery via the Internet. As I said at the beginning of this themed series of articles, often I start out quite in the dark about a subject, which makes the discovery all the more enjoyable. I might not yet be ready to start building microwave equipment tomorrow, but I do have a new appreciation of the pioneer work done and still being done, particularly by British amateurs. There are some good pages out there and I hope you will enjoy following the thread. Now that summer is upon us (I write this during a rather tenuous spring), those hills are waiting and no doubt many of them will soon be crowned with parabolic devices! Happy surfing.

Graham, F/G8MBI, reports that he now has his little 70cm experimental EME ('moonbounce') station active on receive, and partially so on transmit. The antenna array consists of 4 x 4.5-wavelength MBI-designed crossed Yagis with simple V and H switching. His intention is to see just what such a small antenna can do on 432MHz. Until the amplifier is in place he only has 60W and can only contribute SWL reports and the odd 'big gun' QSO.

In February Graham either heard or worked: DF3RU, DL5FN, UR5LX, JA9BOH, JA5OVU, K1FO, DL9KR (QSO), SM2CEW (QSO), NC11, ON4KNG, DL4XX, DK3WG, K3HZO, K0RZ, SV1BTR, K4QI, DL9NDD, JH1EFA, I5TDJ, HA1YA, DL80BU, DL4MEA and some others. Graham says that his ears are still adjusting from 144MHz-type signals and operating techniques. In March he heard OH2PO, 7M2PDT (Japan), JA2TY, HA1YA, SM2CEW, UR5LX, JA5OVU, JH4JLV,

OE5EYM, DL4XX, K1FO, NC11, VE1ALQ, DL9NDD, SV1BTR, N21QU, I2COR, WB0GGM, VE6TA, JA9BOH, G3HUL and ON50F.

The *DUBUS* contest seemed to be not too well supported, but the activity was nevertheless welcome, as it was a good chance to see what the antennas will hear. Thanks to Allen, K2UYH, for the above news.

### microwave records

On 22 March, F6BVA/P and F5CAU/P made their first two-way contact on 47GHz between Notre Dame des Anges (JN33DG) in departement 83 and Mont Doublier (JN33KQ), departement 06. The path length was 67km. Reports of RS59 were exchanged. These reports indicate a potential for even greater distances for future contacts. Both operators used a DB6NT transverter, feeding a 75cm dish at F6BVA, and a 50cm dish at F5CAU.

Back in January, Neil Sandford, VK6BHT/P at Separation Point near Geraldton, worked Walter Howse, VK6KZ/P, at Point Louise near Green Head (north of Perth) over a 143km sea path on 24GHz SSB. Conditions were not conducive to good propagation on that band, with the temperature and humidity at each end of the path being 22 degrees Celsius and 98%. Reports of RS 31 each way were exchanged, along with serial numbers for the Ross Hull Field Day contest. There was severe QSB, and maintenance of the five-minute transmit cycles (Neil the even five minutes, and Wally the odd five minutes) was vital to the contact.

Signals from VK6BHT/P were initially heard at 1124UTC (1924 local time, just after sunset) and the contact was completed between 1310 and 1323. Both stations were using about 20mW to 570mm diameter dishes. The path on 10GHz was very solid. This contact will be claimed as a new Australian distance record,

exceeding the previous one of 120km.

Attempts prior to this contact from Jurien Bay (a 172km path) were unsuccessful on 24GHz and also unsuccessful the following morning again from Jurien, despite strong signals on 10GHz. This was the last contact between these two operators for some time, as Neil has now moved to VK2 (New South Wales), although his QTH has not been finalised. Thanks to Peter Day, G3PHO, for the information.

### sporadic e

At last the Sporadic E season is under way. The first reasonable opening of any nature was on 9 April at 0930UTC, when 50MHz opened to Italy from the UK. At that particular time the Italian stations had an opening to South Africa and at last the Sporadic E link-up made it into the UK.

G40BK (I094) reported strong ZS stations on the band that day and ZS6WB, ZS6XJ, ZS6PJS and ZS6AXT were all

# VHF / UHF Message

Geoff Brown, GJ4ICD, reports on new microwave records





logged into the UK at up to S9+. On the 16th, another minor event happened and produced propagation from DL to YO / YU, SP to I, and CT to PA0. At the same time this linked up with Eric, TT8JE, in JK72MC (Chad, Central Africa), and several stations in the Netherlands were lucky enough to make the grade on 50MHz.

The 18th also produced a mini opening and again linked up with South Africa. Norman, G3NVO, logged the 50MHz ZS6 beacon for 15 minutes at 1715UTC. On the 19th there was more 50MHz Sporadic E on the 'top end': TT8JE was reported into I083 by Neil Carr, G0JHC, at 1642UTC after a tip-off from yours truly. I was hearing TT8JE just on a dipole at 100ft at my works location. That day, Eric, TT8JE, worked stations in OE / I / S5 / F / DL / 9A.

Close-up of the OX3SIX transmitter under construction.

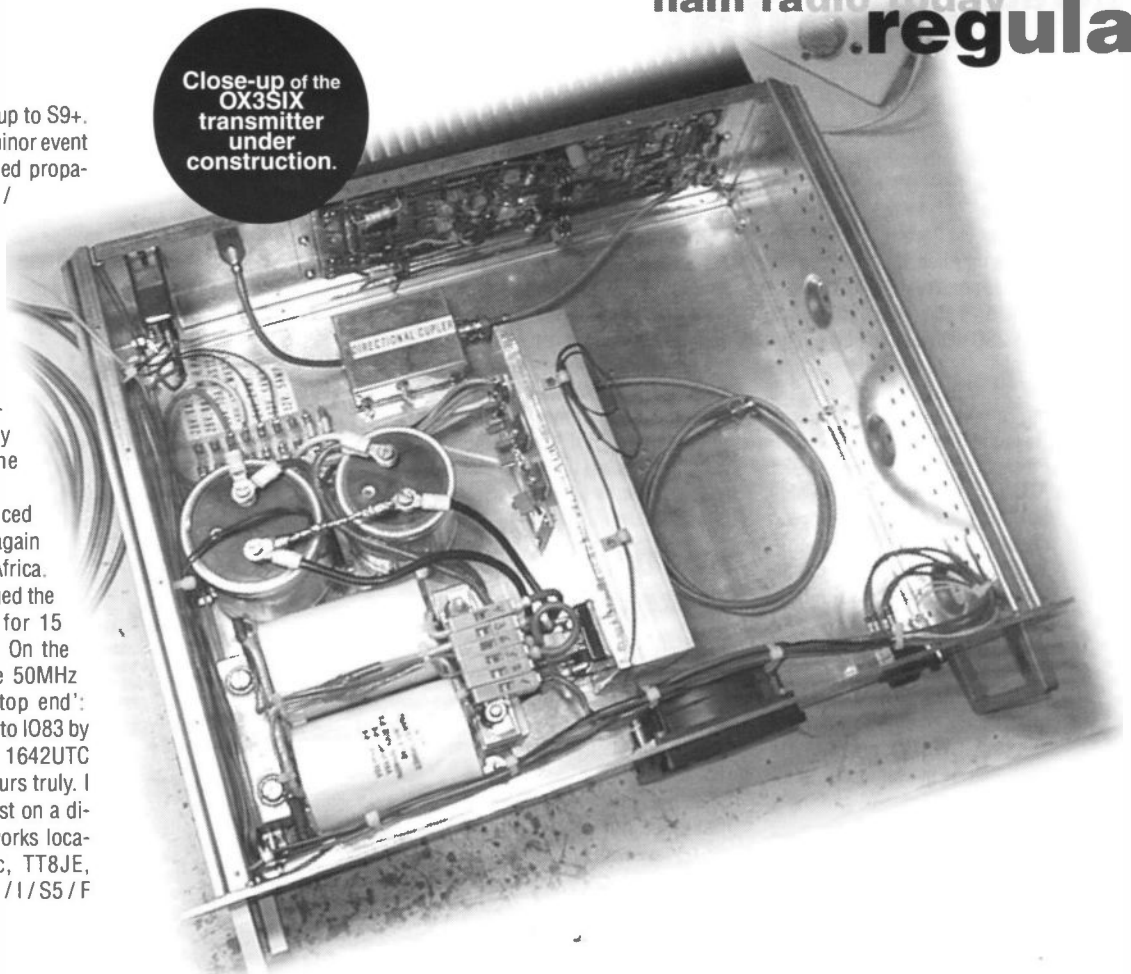

# VHF / UHF Message

and describes a new type of 50MHz propagation

## new 50MHz propagation mode?

As many of you may be aware, Eric, TT8JE, in Chad had been experiencing openings into the Mediterranean area on 50MHz during March and early April. Please note that these openings are *not* trans-equatorial propagation (TEP) as others are reporting! Eric is located at around 15 degrees *north* of the equator.

On a few occasions during his openings it was noted that Sporadic E was prevalent in the Mediterranean area, and this produced a continuation of his signals into mainland Europe.

At 1330UTC on 1 April, Eric was heard in Jersey at S9+ on SSB. His signals were audible for over 1 hour, but there was no Sporadic E reported on the cluster or otherwise, which leads us to the question of what type of propagation this was? Eric worked stations in S5 / YU / I / OK / DL / ON / PA / F / EA and GJ. Also, the same day, Alan, 3C5I (Equatorial Guinea), was heard

in Jersey, albeit weakly, on CW.

After looking at the MUF maps on the Internet, it was noticed that the MUF within the tropics was at 40MHz plus. So as not to become confused with TEP this other 50MHz propagation mode from now on will be termed as TZP (Tropical Zone Propagation).

Here is a list of TT8JE's 'firsts' on 50MHz since 1 March:

IW5BML, F5BYM, EH5BZS, 9A3FT, IS0AGY, SV1UN, OD5RAK, 4X1IF, LZ1DP, 3C5I, YU1EU, YO7VJ, CT3FT, CT1DYX, CN8LI, EH9IB, PY2WG, 7Q7JL, TT8SD, SV9ANK, EH6SA, S57AC, V51KC, EH8BPX, 9G1BJ, TR8XX, 9H1EL, HB9SJV, SU3AM, OE2UKL, 5B4/EU1AA, PA3GAN, DL2GBT, EK6AD, GJ4ICD, ON5SE, ZP6CW.

Eric, TT8JE, has worked 117 grids, 37 countries and 15 fields up to 1 April.

Alan, 3C5I, who is also within the tropical zones, reported his daily activities on 6m, although he is still suffering from QRM from the local TV transmitter. Alan installed two vertical 5-element beams and reduced the QRM by about 30db. However,

his S-meter still reads S8 when the TV transmitter comes on at around 1500UTC daily. So far he has worked about 20 countries on the band, his best DX being stations in PY and ZP, although up to mid-April Alan had still not worked into the UK. The best time to look for Alan will be in September or October and the time slot should be around 1330 to 1430UTC.

## greece now on 6m

As from March 1998, the 6m band is generally released to all SV hams on a secondary basis for an indefinite period. Particular rules are still in force, like submitting propagation reports at the end of every year.

It is hoped that many new Grid Squares will be activated within the country.

## 144MHz tep

JH4JPO reported the first cycle 23 144MHz TEP opening on 16 April when he heard the Australian Darwin 2 metre beacon on

144.480MHz at 2304UTC. Sadly, no stations were worked, but it now puts everybody in both countries on full alert.

There were other 144MHz openings earlier in the year between WP4 (Puerto Rico) and Argentina (LU), also via this mode.

## vhf beacon news

Two new 50MHz beacons have been activated. They are: OZ2VHF on 50.062MHz, which runs 10 watts into a dipole and is located in JO45FL, and XE3RCM/B, on 50.0536MHz in EL50 running just 0.75 watts into a dipole. On 2m, 10A is reported operational again on 144.449MHz.

News and views plus any photos of your shack or antenna system are welcome please to: Geoff Brown, TV Shop, Belmont Rd, St Helier, Jersey, Channel Islands JE2 4SA, via fax: 01534 877067, or e-mail: equinox@itl.net If you send large transcripts or reports, please put them on a floppy disc to save re-typing - thanks!

**G**raham, G4VUX, has recently completed a new homebrew rig for 80m with his first CQ call bagging Mike, G3ZJJ. Mike was using a Lake TRx at 2 watts out. Graham used a massive 400mW from his crystal-controlled TRx. He explained, "I still get a thrill from a first QSO with a bit of new equipment."

Carl, GW0VSW, writes to tell me of what he has been doing. He is the proud owner of a QRP Plus connected to an MFJ-971 ATU. He joined in on the Fireside Sprint (these are short duration contests, hence the name 'sprint'). He tells me that conditions were poor on 40m but he still managed to work six stations. He only has a half-size G5RV antenna at 9m. On 20m he bagged VE2DOH near Montreal, and a change to 17m got him UA2, CT3, W1, and SP5. He says that 15m was more challenging, with just 9X and WP3 added to the log.

Dieter, DL5NFZ, uses a monoband 20m rig and a dipole. He also enjoys bicycling tours,

below for the princely sum of £3.50, which includes postage. Please make cheques payable to R Pascoe.

Recent discussions about the use of the Shakespeare fishing poles as antennas have been going the rounds. Several operators, including myself, like to use a fishing pole to keep the antenna up when away from the shack. I have been told that Shakespeare not only makes fishing poles but they also make antennas for us amateurs. Sorry Shakespeare!

### ne602 sources

My recent comments ('QRP Corner', *Ham Radio Today*, May 1998) about the demise of the NE602, prompted a comment by John from Mainline Electronics (tel: 0116 2777 648). He told me that he still has a few thousand in stock and

# QRP Corner QRP Corner

Dick Pascoe, G0BPS, with a round-up of QRP news and a full report on an e

and he and his wife Monika, DL1NFZ, often take their rig with them and throw a wire between a couple of trees. Their best DX so far is W1, 9K2, Y1, 4K, 4L, TF, EZ and 4X. They are quite disappointed that most of the UK is under the skip, although they often get into GM and GW.

Peter, G3XJS, was struggling recently to complete a contact with VK2BO, who couldn't quite get Peter's callsign. Peter was using his Sierra set at one watt out. A swap to his GQ-20 at 3 watts made sure that he was heard - just. Peter told me he "had a solid two-way QRP contact".

I recently made mention of the original *Hot Water Handbook* produced by Fred Bonavita, W5QJM. This small booklet is "a collection of articles on the modification of the Heath HW8 QRP transceiver". There have always been readers asking about this 1985 booklet. I managed to contact Fred as promised and he gave me permission to make copies for anyone interested. A limited number of copies are available from me at the address

to check with them for current prices. Another supplier of these is JAB Electronics. Peter's, G7JAB, current price for the NE602 is £2.60, with postage and packing at £1.00. I can also recommend the JAB catalogue to any builder. There is a good range of components including a few obsolete ones that are getting quite rare. If you would like

a copy of the JAB catalogue send a note enclosing £2.00 to JAB Electronics, PO Box 5774, Great Barr, Birmingham B44 8PJ or tel: 0121 682 7045.

In a recent column I also mentioned the difficulty of getting dual pots and mentioned a com-

pany called Electro Value. I can now add JAB to that list, they also stock a limited range of dual pots from 4.7k to 1M at £2.30 each plus postage.

### yeovil convention

The Yeovil QRP convention took place at the Digby Hall in Sherborne in Dorset over the weekend of 18 / 19 April this year. Readers may remember my comments that I had not been able to attend for many years, I think my last visit had been almost ten years ago. The convention always seemed to clash with the Dayton HamVention in Ohio which both Rev George Dobbs, G3RJV, and I always attend each year.

The organisers had been trying for years to get George to attend, even changing the date of the convention a couple of times to accommodate him. Murphy's law struck each time, though. As quickly as Yeovil changed dates to accommodate him, the Dayton HamVention

dates changed too. It seemed to some that there was a conspiracy about. At last the Yeovil club picked a date that missed the American event by several weeks, and their ambition was achieved.

It is usual for many visitors to arrive early and join in on the club's annual dinner. This year it

on my stand discussing arrangements for the Friedrichshafen HamRadio 98 exhibition. As usual, the G-QRP club will be attending Friedrichshafen, with George and I taking our wives for a well-earned break. Whilst I was talking to Jo-Anna, a chap popped up and asked her callsign. He explained that he was GOOWS and how he often

and he has always belied his grey hair and age. He is an avid collector of Morse keys and I have helped him out on several occasions when he wanted a particular model. He always stops for a chat and exchange of news as he makes his way around.

Imagine my pleasure when he arrived at the convention with a 'young lady' in tow, and my huge delight to find they had recently got married. His new wife, Cynthia, was proudly showing off her shiny new wedding ring. Dawson told me that she knows only a little about the hobby but is learning fast, and he hoped that she may get a licence soon. My hearty congratulations to them both.

### the epiphyte

Peter, VK1PK, is considering building an Epiphyte look-alike, but explains that

site his 33ft wire antenna to stop it.

### cuban correspondent

An e-mail from Arnie, CO2KK, in Havana, Cuba, came with some information. He mentions the 'Jaguet', which he says is "a DSB rig that looks much like the one designed in ZL, but the local boys that designed it never knew about the ZL DSB rig. We were amazed when we saw the circuit in *Sprat* [the G-QRP Club magazine - *Ed*], as they are look-alikes. Geniuses do coincide! We have received lost of support from G3RJV, G3LDO, and other British hams, as well as the boys at NorCal. . . I am trying to design a very simple transceiver for 40 metres. . . DSB and CW, capable of 10 watts, which is the minimum you need for reliability here when static crashes are bad. . . but that can be cranked down to about 2 to 5 watts for real fun QRP".

Arnie goes on to say, "Our

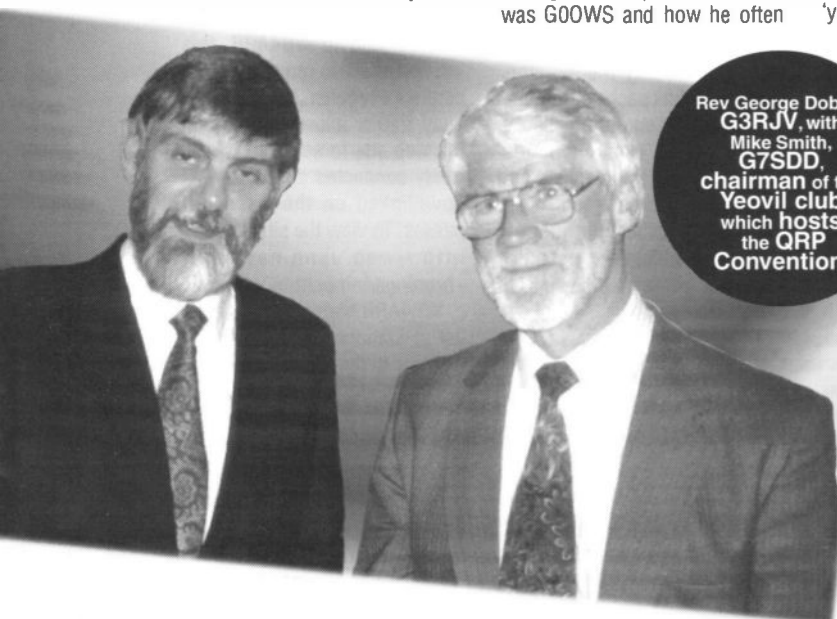

Rev George Dobbs, G3RJV, with Mike Smith, G7SDD, chairman of the Yeovil club which hosts the QRP Convention.

# QRP Corner QRP Corner

essential date in the QRP calendar: the Yeovil QRP Convention

was held at the Three Wishes restaurant in central Sherborne. An excellent evening with very good food. About 70 visitors enjoyed the evening with the club chairman, Mike Smith, G7SDD, standing to welcome all those there and especially George, G3RJV, and his wife, Jo-Anna, GOOWH. It was not a particularly late evening - just as well, as the convention doors opened to the early birds at 7.30am, with the public arriving at 9.00am the next day.

The weather deteriorated through the day, starting fine but heavy rain crept in, keeping some away. The 250-plus visitors who did attend all enjoyed themselves. The lecture stream was well attended, with George as usual packing the lecture hall for the final talk of the day.

The display of home-made equipment in a side hall was excellent. Unfortunately, by the time I managed to get there with my camera there was very little left. The talk-in station was using homebrew equipment with large displays stating 'high voltage - keep clear'.

Jo-Anna Dobbs, GOOWH, was

got called 'OWH' on the air. Jo-Anna is a petite, good-looking lady of about 5ft 3in and quite slim: the other chap was about 5ft 9in and of a girth almost double Jo-Anna's. Copious amounts of laughter as we told others that they were separated by a mere 'dit'.

The hall was laid out in a similar manner to the Rochdale convention, where tables for vendors are spread out around the edges of the hall, and with a small area in the middle. Tables and chairs where visitors could sit and chat about their homebrew projects and much, much more surrounded the cafeteria. Another surprise was to find the same nice couple who owned the restaurant we had visited the previous night serving the bacon butties from the hall kitchen. If required there was even a full English breakfast available, and on real plates too!

One of the 'regulars' that I always seem to bump into at any rally I attend is Dawson Thompson, G3AHS. It will be noted from his callsign that Dawson is no 'spring chicken'. I have known him for several years

the only filters he has are the 455kHz Collins mechanical filters. The Epiphyte is an 80m single-band SSB transceiver described by George Dobbs, G3RJV, in the July 1997 issue of *RadCom*. They were made available in kit form for donation to third world countries. Many UK builders have also built this little rig and may wish to make changes. The answer to Peter's question came from the designer of the Epiphyte, Derry Spittle, VE7QK. Derry is a regular at the Rochdale convention and is well known over here.

He told us via the Internet that the 455kHz SSB filters are 200Ω and thus are suitable for matching to an NE602, but he suggested not using a 9MHz filter as the attenuation on receive was unacceptable because of the resulting mismatch. He would like comments from anyone who has built an Epiphyte via e-mail to: jds@vcn.bc.ca

Peter also mentioned that when staying with his sister near Adelaide, every time he keyed his Index QRP Plus transceiver the bedside light lit up! He had to re-

main source of components are old TV sets, both valves and the first generation of discrete components Russian TV sets electron 416 that have lots of usable parts. No problem with power supplies for 5 to 24 volts. . . But, output transistors of more than 1 watt are hard to find, as well as crystals for making filters. . . There is a tremendous interest in building amateur equipment in the island, and it's nice to see the enthusiasm.

"Also, I worked the UK on 21MHz both ways QRP for the first time the other day. It was nice! Today conditions are also good, worked several W stations using just 250 milliwatts."

Arnie is the host of the English-language programme *DXers Unlimited* at Radio Havana Cuba, and you can contact him there by e-mail at: inforhc@mail.info.com.etecsa.cu

That's it for this month. News and views to me via the editor, by packet to GB7RMS, e-mail to: Dick@kanga.demon.co.uk or 'snail mail' to Seaview House, Crete Road East, Folkestone, Kent CT18 7EG.



**A** O-10 command station W4SM says that solar illumination appears to be way down and the satellite is nearly 'comatose'. This is in keeping with his best guess regarding attitude, which shows less than 50% illumination at the moment. Given the ageing solar panels, that's probably enough to cause significant performance degradation. Things should improve again later in the summer and peak in August.

More information about the satellite can be found on W4SM's web page, at: <http://www.cstone.net/~w4sm/AO-10.html>

## phase-3d

Ariane flight 503, conducted under European Space Agency, ESA, responsibility, will be the last of the Ariane-5 qualification flights. The launcher used will be the first production-series unit ordered by Arianespace from European industry. 15 July is the date that I have heard and Hot Bird 5 and the Atmospheric Reentry Demonstration are cur-

veloped will still be used on flight 503.

The studies and tests conducted since flight 502 have also shown that the premature main stage shutdown that occurred during that flight was caused by the excessive roll torque. Action to overcome the torque problem will therefore also prevent a recurrence of the premature shutdown.

Ron Broadbent, G3AAJ, said recently that the 'Callsign to Fly Award' for Phase 3-D is still open for more donations from around the world in any currency.

Those individuals that contribute a large amount will receive a personal engraved plaque and have their name and callsign engraved on a plate fixed to the spacecraft. A photograph will also be sent to each contributor. Information on the 'Callsign to Fly Award' can be obtained from G3AAJ or via the AMSAT-UK office, c/o Fred Southwell, G6ZRU, 40 Downsview, Small Dole, near Henfield, West Sussex BN5 9YB.

Ron had a computer crash re-

## russian satellites

The Russians have reported that they are unable to command the RS-16 transponder to 'on', despite several tries. They are continuing, but with little hope of success. RS-10 also still refuses to come on.

WB4APR reports that the MIRMOM program, which is designed to simplify the monitoring of downlink packets from the Mir space station during special MIREX school experiments, is now available for downloading. It includes a demonstration of an experiment earlier this month, showing students the potential for future, similar, tests using UI packet frames.

The program is available from the TAPR FTP Web site using the following directory: `tapr/SIG/aprssi/files/dosstuff/APRSdos`

This program is a test version, which has not been thoroughly tested on the air, so users are cautioned to use it for receive monitoring only and familiarisa-

linked ground stations to provide almost continuous coverage for some of the current digital amateur satellites along with the Mir and Shuttle flights. Now the first Internet-linked Mir ground station is on line and capturing all Mir passes over the east coast of the United States; posting the information on the world wide web.

According to WB4APR, this Internet site also removes all the connect / request / disconnect / busy traffic, allowing those on the web site to see who is currently connected and what was downlinked on the last eight passes. To view the site, look at: <http://web.usna.navy.mil/~bruninga/mirex.html>

WB4APR hopes to expand the list of stations reporting to the web site in the future, eventually providing world-wide coverage.

To permit maximum participation by schools and students in a joint Mir communications experiment, the MIREX team authorised a special MIREX School Day test on 27 April. The purpose

# Satellite Rendezvous

Will the Phase 3-D satellite eventually be launched this mor

rently manifested. However, the rumour is that Hot Bird will not be ready and so Phase 3-D may have a flight opportunity here.

ESA has issued a press release with the results of detailed data analysis of the Ariane 502 flight. The analysis confirmed that the launcher performed well overall and did not reveal any anomalies that had not previously been identified. The most significant anomaly, namely excessive roll torque during cryogenic main stage flight, has now been explained.

Three test firings of the Vulcain engine were performed on a test stand equipped with a roll torque measurement device. Throughout engine running time on all three tests, roll values very similar to those encountered in flight 502 were recorded. The excess roll torque phenomenon will now be countered by repositioning the turbine exhausts.

As a precautionary measure, and to obtain in-flight confirmation of the cause of the roll problem, the additional attitude control unit that has already been de-

cently and lost quite a lot of data, so he requests all who have asked him for information about the above Award to repeat their messages.

tion with the user interface. Any transmit testing at this time should be done locally on a simplex digital frequency.

There is also a network of

of the test was to improve the understanding of students about the space station and demonstrate the factors involved in space communications using



In addition to lectures, the colloquium features displays of satellite equipment and antennas.



The AMSAT-UK Colloquium attracts visitors from all over the world: here are the German delegates a couple of years ago.

Amateur Radio. Any Amateur Radio station at any school in the world could monitor the downlink of the test. All stations were able to capture and log communications from both Mir itself and the other schools authorised to transmit. Due to the limited capacity on the uplink, however, the number of stations authorised to transmit was limited to under 100 per footprint area.

### digital satellites

DOVE is currently non-operational, with the 145.825MHz downlink off the air. WDOE reports he will attempt to correct the situation as time permits. It could still be worth listening for the S-band beacon on 2401.221MHz plus / minus Doppler (of about plus / minus 55kHz on a high pass).

WEBERSAT is also non-operational, being in MBL mode after a software crash. Attempts are being made to find and correct the cause of the suspected seasonal crashes.

IO-26 (ITAMSAT) is reported operational: listen for telemetry

on 435.822MHz at 1200 baud PSK.

G3CWV's *Oscar-11 Report* says he has now added a package of information to his web site. The web site also contains some software for capturing data, and decoding ASCII telemetry and WOD. There is also an archive of raw data (mainly WOD) for analysis, which is continually being expanded, as new data is captured.

There are also some audio

11's S-band transmission is left-hand circular polarised. Doppler at mid-pass can be as high as 1kHz per second.

### short bursts

The FO-29 command station announced that FO-29 was switched into mode JA on 20 April because they detected bit errors in the on-board-computer. Resetting and reloading software into OBC will take a while. The bird will stay in mode JA till then.

The Celestial web page announces a change of address: it's now on <http://celestrak.com> and Keplers can be downloaded from here.

G0ORX has announced the release of Satellite Ground Station Software using the Java language; a preliminary release can be found at: <http://www.qsl.net/>

The Israeli Amateur Radio satellite Techsat II and UoS's TM-Sat are due for launch (from Kazakhstan) around the end of June. Techsat has a packet store-and-forward mailbox operating at 9600 baud. TM-Sat will have 2m uplinks at 9600bd, and downlink on 70cm at 9600 and 38k4 bps; initially it will be on 9600, but this will be changed to 38k4 some time after launch. The orbit is 821km sun synchronous (similar to UO-22).

Last month I mentioned the offer for UK amateurs to obtain the Drake 2400MHz converter which lots of the gang in the USA and elsewhere are buying up like they're going out of style. These have now been received and distributed; profits (of about £120) from the exchange went into the Phase 3-D funds.

### amsat-uk colloquium

The AMSAT-UK 13th Colloquium is now almost with us. The Final Call for papers has been issued, though I still have room for

# Satellite Rendezvous

Read the AMSAT-UK news compiled by Richard Limebear, G3RWL

files, including a recording of mode-S which plays for 20 seconds. The other audio files are examples of each type of data transmitted by Oscar-11, and each one plays for about 10 seconds. All the audio files are zipped, so that they can be played off-line. They should help listeners identify the various types of data, and give an indication of the signal quality required for successful decoding. The URL is <http://www.users.zetnet.co.uk/clivew/>

The mode-S beacon is still on, transmitting an unmodulated carrier, but telemetry indicates that it has partially failed, and is delivering half power. This beacon is a useful test source for those testing mode-S converters, prior to the launch of Phase 3-D. It is considerably weaker than DOVE, which should be used for initial testing. Any reports of reception on 2401MHz would be most welcome. Please e-mail [g3cwv@amsat.org](mailto:g3cwv@amsat.org) I understand that the frequency range to listen in is between 2401.540MHz with Doppler down to 2401.430MHz. Note UO-

n6lyt WINZIP is required (PKZIP won't do) to extract.

This software implements a fully automated Digital Store and Forward Satellite Ground Station including: KISS Protocols; AX25 Protocols; Pacsat Broadcast and File Transfer Protocols; Message Composer; Message Viewer; Orbit Propagation; Satellite Scheduling; Radio Control; and Rotator Control.

The software has been successfully run on *Windows 95*, *Linux* and *Solaris*. The documentation is not complete yet, but there should be enough to get you going.

W2RS reports that the SEDSAT launch has been delayed until October at the earliest.

The spare Sputnik satellite that was delivered to Mir along with the Sputnik model that was deployed from Mir late last year is expected to undergo an upgrade and be deployed from Mir in the latter part of 1998. The upgrade will consist of replacing the battery and control boards, and installing circuitry that will allow the satellite to make voice announcements in French, Russian and English.

more. The Colloquium will be held at the University of Surrey, Guildford, from **Friday 31 July to Sunday 2 August**. This year's event will include technical and operational matters, as well as an IARU forum.

The talk by an astronaut has fallen through - has anyone got any suggestions for a big name?

Anyone wishing to attend the Colloquium should ask for full details as soon as possible from Fred Southwell, G6ZRU, 40 Downsvie, Small Dole, near Henfield, West Sussex BN5 9YB, tel: 01273 495733.

The AMSAT-UK web pages have a new address: [www.uk.amsat.org](http://www.uk.amsat.org) in order to give them a more memorable URL.

A copy of the latest Keplers is available on request by mail or packet; my mailbox is GB7HSN but please note that AMSAT-UK Keplers are put out on packet weekly anyway and sent to [KEPLER@GBR](mailto:KEPLER@GBR). When asking me for Keplers please say which satellites - 'all' means about 250 satellites ('all amateur sats' is adequate, if that's what you want).



A number of amateurs have asked me if I could confirm a 'rumour' of a version of the very popular *JVFAX* software now being available for *Windows*. Well, it's not a rumour any more, you'll find it included on the free front cover CD-ROM with this issue! See also Fig 1. At the time of writing, the latest version is Beta 0.91 which

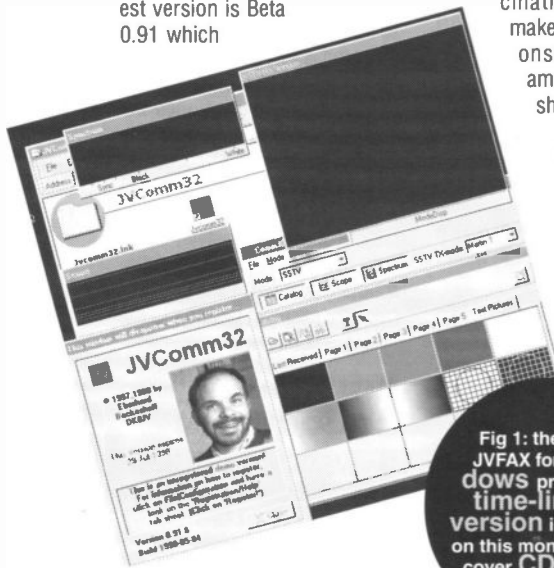

Bruininga, WB4APR, at <http://web.usna.navy.mil/~bruninga/mirex.html> [there's more on this in *Satellite Rendezvous* on pages 42 / 43 - Ed].

The US Space shuttle has also used APRS in the past, and I have a recorded file here tracking the progress of the shuttle for a number of minutes, it's fascinating to watch and makes an excellent demonstration for non-amateur visitors to my shack.

### aprs book

If you'd like to read up on APRS, then I'd certainly recommend the

Fig 1: the new JVFAX for Windows program. A time-limited version is available on this month's free cover CD-ROM.

dicted in last month's column! and there are many happy amateurs around the world using it. Alan, G0FUM, has already created a new 'splash screen' for this (Fig 2), which he's sent out on the packet network in 7-plus format as a bitmap file. A further, and very useful, add-on for *WinPack*, is the freeware logging program written by Mike, G0OPC, called *WINPLog* (Fig 3). It's a simple log program that reads the *AUTOLOG.TXT* text file from *WinPack* and lets you view your activity with a number of options, as well as offering a print facility. It's been sent on the network in a number of 7-plus files, but if you'd like a copy on disk by post you can send a 1.44Mb disk and return package and postage to: Mike Marriott, G0OPC, Morning Dew, 188 Leverington Common, Wisbech, Cambs PE13 5BP (add a note telling Mike it's *WINPLog* you want). Mike originally released V1.00 on the network, but unfortunately he found this had a bug in it (the printer routing gave an

AX25 network, allowing users of the TCP/IP system to send and receive personal and bulletin mail from the existing AX25 BBS network. This uses a 4m packet link to GB7HPH in Portsmouth running at 1200 baud. The user ports will operate on 433.625MHz and 144.925MHz using 1200 baud, and 432.625MHz at 9600 baud for faster user access.

Plans are for a real-time link into the World Wide Conference server enabling users of the hub to chat with other Radio Amateurs around the world. At present, it's possible to connect to other chat systems, eg in London, which currently gives access to the World Wide Conference system - although this can be slow at the moment. GB7BIP hopes to provide, on start-up, SMTP and POP3 mail access for

Fig 2: *WinPack V6.4* is now out!

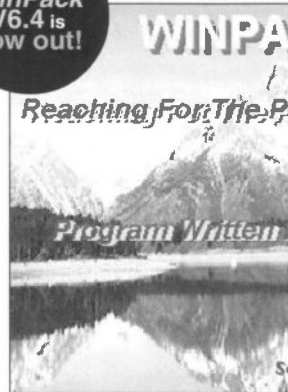

# Data Connection Data Connection

Chris Lorek, G4HCL, brings details of a brand new Windows version of JVFAX

can use your PC's Sound Card (as well as other hardware, such as a PTC controller) as the interface. You'll need a reasonably powerful PC to use it though, eg a minimum of a 486DX2/66 with at least 16Mb of RAM and *Windows 95* or *NT*, preferably a 90MHz Pentium or better. It's not freeware though; it's a time-limited version which you'll need to register if you wish to continue using it - full details are contained within the program's software files.

### aprs on mir

If you've been following the latest news regarding the Automatic Packet Reporting System, or APRS for short, you'll know it's in use by a number of terrestrial stations. But even if there are no stations in your area, all is not lost if you'd like to 'give it a go'. MIREX, the experimental amateur station on board the orbiting Mir space station, has recently been conducting tests using APRS, primarily for school participation. You can find further details on the results of this on the web, courtesy of Bob

ARRL book, *Getting on Track with APRS* by Stan Horzepa, WA1LOU. Stan offers an easily-digested 'hands-on' guide to using APRS software, for DOS, *Windows* and *MAC*, including step-by-step details on how to configure it for your own location, even if you don't have a GPS receiver. You'll find out how you can use APRS for plenty of things you may have never thought possible, like direction finding, weather tracking, 'jammer hunting'; as well as seeing where your packet radio partners are located whether they're operating from home, or out portable, or on the move. The book provides inter-connection details for many packet TNCs and advice on GPDS receiver interfacing. In the US, it's priced at \$14.95, although I purchased my copy just a few days ago from Poole Logic, 49 Kingston Rd, Poole, Dorset BH15 2LR (tel: 01202 683093) for £9.90 plus £1.00 P&P.

### winpack add-ons

*WinPack V6.4* from Roger, G4IDE, is now with us (as pre-

error) and promptly released V1.01. So if you're having problems with a version you downloaded, take a look for the updated version. The very latest version of *WINPLog* as well as the 'Splash' bitmap file (and of course *WinPack V6.4*, APRS etc) are contained on the current monthly-updated QSP73 'Gold' CD-ROM (don't confuse this with this month's free cover CD-ROM), so if you have a copy of this you'll already have the programs!

### south coast tcp/ip hub

There's a new TCP/IP hub, GB7BIP, coming on line to cover Portsmouth, Chichester and surrounding areas. It's being set up to fill in for GB7HIP, which recently shut down. GB7BIP will be run by Richard, M1BNG, who's 16 years old and has held a Novice call since he was 12, and Alex, M1BSX, who's just 15 years old and has also held a Novice call from the age of 12. GB7BIP's Mail system, although TCP/IP based, has a mail feed from the

users with TCP/IP mail software. Other planned services will include space for user's packet web pages as well as ftp space for users who wish it. GB7BIP will also carry TCP/IP software and configuration files, for users to download and use. The SysOps are hoping to set up many other services as well and would welcome any suggestions. More information from Alex M1BSX@GB7PFD or e-mail: alex@mayfamily.demon.co.uk (<http://www.mayfamily.demon.co.uk>) and Richard M1BNG@GB7SUN.#48.GBR.EU or e-mail: m1bhg@wings.demon.co.uk (<http://www.wings.demon.co.uk>).

### yeovil bbs

If you're in the Yeovil area, you may be interested to know that GB7YEO has been applied for in Yeovil by Lee, G7OGG. It's to be a new AX25 BBS, operating with 1200 baud user ports on 144.8625MHz and 433.650MHz. In the meantime you can get further information from Lee: G7OGG @ GB7TJF.

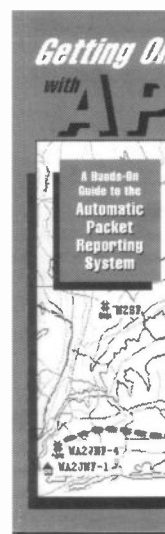

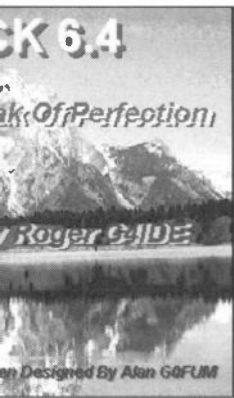

**kantronics year 2000 fix**

Although my KAM isn't affected, I'm told that a number of Kantronics TNCs may appear to have a problem handling dates from the year 2000 onwards. This can be overcome by using the DAYSTR

command to preset the first two digits of the year to 20. For example; DAYSTR TIME hh:mm DATEL mmm dd, 20yy. My thanks go to Peter, G6JNS, for this information.

**data down under**

If you fancy doing some HF data DXing, here's some news of Australian data stations:

Don, VK2DW, has advised that the 30m frequency on his WW PacTOR Gateway in Kempsey, Australia (VK2DW.NSW.AUS.OC)

VHF Node Gateway, which lets you in on the local VHF scene in Tasmania, VK7. Phil, VK7PU, who is the SysOp of the BBS, says, "You can access the VHF port node on 14080.0kHz Mark PacTOR by connecting to VK7PU. The VHF node port is open to anyone who would like to experiment with this facility. To access the VHF node's port once connected and entered in the BBS, at the command prompt type "NODE" (in upper case) which will take you through to the VHF gateway on two ports. It is good policy before connecting to any VHF station to type the "J" command at the command prompt which will bring up the heard list of VHF stations. From there type in "C2 VK7\*" or "C3 VK7\*" and you will be connected via PacTOR to a VHF station." The BBS also has a dedicated 40m port on 7045.0kHz mark, and VK4GKM who is on the same mark frequency also has this facility, so there's no reason why you shouldn't try both! More info via packet from

ilities as soon as finances permit. The BBS also operates on 2m packet, on 144.825MHz and 147.575MHz. More information from VK5RQ@VK5RQ.#SYP.#SA.AUS.OC

The VK5ATB BBS now has a number of additional frequencies which are scanned, to allow anyone wishing to connect to have a little more choice. The following are all Mark frequencies, and are scanned 24 hours a day: 3629.9, 3633, 7035, 7040, 10143, 14076, 14078, 14080, 18107, 21072, 21074, 21076, 21078, 24925, 28078, and 28080kHz. This BBS forwards to the Australian packet system as well as to the international PacTOR forwarding system, and mail can be left there for forwarding or direct collection. Gateway facilities are also

Pablo, LW7EDS, says that there's a network of activity on 28180kHz LSB 1200 baud, with PY, PP, KP4, CP, LU, LW, EA and I active. He suggests you take a look here especially if you're active on 10m FM packet, to link America with Europe. If you're interested in more details, you can send a packet to Pablo at LW7EDS@LW7EDS.MDP.BA.ARG.SA

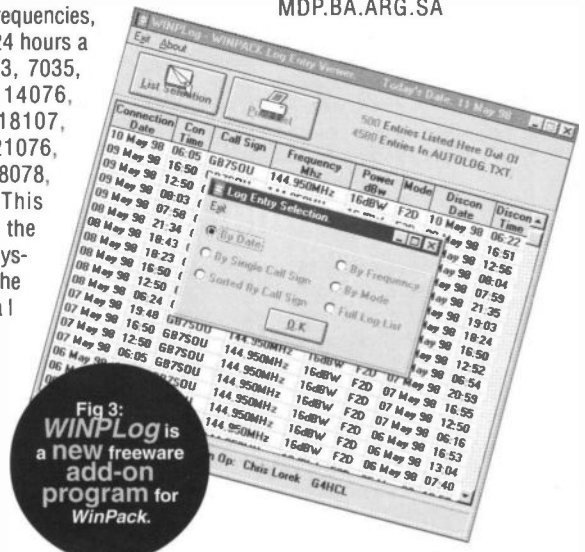

**Connection Data Connection**  
and shows how you can visually track the MIR space station on packet



This new book is recommended for those wanting to learn about APRS.

has now changed to 10126kHz Mark. The 20m frequency remains unchanged. It operates as usual between 0600 and 2100UTC, and you can get further information on Don's Web page at <http://www.midcoast.com.au/~vk2dw/index.htm> or via packet with a message to VK2DW@VK2DW.NSW.AUS.OC

Nev, VK4TX, says he has some HF PSK frequencies available for those who want to play with 1200 baud PSK on HF. These are all USB: 7030, 10144kHz, 14120 and 18102kHz. To connect to the BBS you need firstly to connect to the router (VK4WIA-0), and once connected you then need to send "BBS" (without the " ").

A beacon is sent every 20 to 30 minutes, so you can take a listen even if you don't have connection facilities. The reason for USB rather than LSB use is because a commercial, rather than amateur, transceiver is used for the HF rig. Further information from VK4TX@VK4WIA.#BNE.QLD.AUS.OC

The VK7PU BBS has an HF /

VK7PU@VK7PU.#BUR.TAS.AUS.OC

The 10m port of the VK4TUB BBS in North Queensland is now fully operational on 29150kHz, FM, 1200 baud. The PACLEN length has been shortened but other than that, the settings are as you would normally use for VHF packet, and the system beacons every 10 minutes. The radio is a commercial General Electric Model MLS160a with a power output of 60W into a four-element Yagi at 10m AGL. The antenna is directed towards the south-east, beaming over New Zealand, South America, and Europe. More information from VK4TUB@VK4TUB.#NQ.QLD.AUS.OC

Contrary to reports in some packet listings, I'm told that the VK5RQ PacTOR I BBS is still in operation (it has just been re-organised). You'll find it operational 24 hours a day on 14072.5kHz Mark and 21076.0kHz Mark, both frequencies being in use simultaneously for true 'dual frequency' operation. The SysOp Joe, VK5RQ, hopes to upgrade it to also provide PacTOR II fa-

enabled through the FBB-based BBS software. More info from Pops, VK5ATB@VK5ATB.#BVL.#SA.AUS.OC

**10m packet**

Giovanni, IK0ZIZ, in Lavino, Rome (QTH locator JN61HL) says that he's installed an experimental PMS on 10m FM, operating on 1200 baud packet on 29250kHz. It operates under the callsign IK0ZIZ, using an MFJ-1278B into an Icom IC-736 and a quad antenna. Giovanni says, "Please give it a try and tell me what you think about it". He can also be contacted via the packet BBS system with a message to IK0ZIZ@IW0FEF.ILAZ.ITA.EU

Ferdi, DD0KT, in Bornheim near Cologne (in JO30LS) tells us the LX0PAR digipeater is operational from Luxembourg on 10m. It's on 29210kHz using 1200 baud FM, so with increasing sunspot activity it could be worth trying this to connect to the European packet network. The system runs 10W into a vertical. More information from DD0KT@DKOMWX.#NRW.DEU.EU

or via e-mail to lw7eds@htc.statics.com.ar

**hf sstv bandplan**

Further to comments in this column, and on the packet network, regarding SSTV frequencies on the various HF bands, here's the very latest 'official thinking', courtesy of my friend Colin Thomas, G3PSM, in his role as the RSGB's HF Manager. Colin says, "The frequencies 14230, 21340 and 28680kHz should be used as calling frequencies by SSTV operators. After contact is established they should QSY to a spare frequency in the telephony part of the band (ie SSB sections)." My thanks go to Colin for this information.

That's it for this month. Please do drop me a packet, e-mail, letter or fax with details of what you or your group is doing on data modes, or indeed what you'd like to see covered in this column in the future. My contact details are given every month in the Regular Contributors' contact information section of *Ham Radio Today* on page 58.



DL7UCW/p

After I wrote last month's column, propagation took something of a down turn, but conditions were still better than at the same time last year, and will no doubt pick up again. Unfortunately there seems to be a major problem on 10 metres with pirate activity, mainly CB operators operating above their authorised band. This has been a problem in the Far East for some years, but now it seems to have become an issue in Europe during the sunspot minimum years while amateur activity has been low. Let's hope that as ham activity returns to 10m, we can reclaim the band as our own.

**contesting**

I tend not to give a lot of coverage in this column to the various contests which take place on the HF bands, although most weekends you will hear some sort of contest activity. As in most hobbies, there is a strong element of competition in Amateur Radio, and some hams take contesting very seriously indeed.

However, the nice thing about ham contesting is that it is like

I wanted particularly to draw your attention to two contesting events which take place during July. Firstly, the IARU Contest sponsored, as the name implies, by the International Amateur Radio Union. This is a 24-hour event (1200UTC on 11 July to 1200UTC on 12th), in which participants try to contact other hams throughout the world. The idea is to collect points for every contact made, but also to collect 'multipliers', which are ITU Zones (for administrative purposes the International Telecommunications Union divides the world into 74 zones). Your final score is the sum of QSO points on each band multiplied by the sum of ITU zones which you contact on each band. QSO points are scored as follows: one point for contacts within your own zone, and with IARU HQ stations, three points for contacts in your own continent but different zone, and five points for contacts with other continents. You also get additional 'multiplier' credit for contacting the HQ sta-

the way).

So all you need to do to make a contest QSO is to call someone who is calling "CQ Contest", note the signal report and zone number which they give you, and in turn give them a signal report and your zone number. Simple as that. Or, indeed, you can call "CQ Contest" yourself and wait for people to call you. Use any of the bands 160, 80, 40, 20, 15 or 10 metres. By common consent, no contests take place on the so-called 'WARC' bands (30, 17 and 12 metres), which leaves these free for hams who want to steer clear of contest activity.

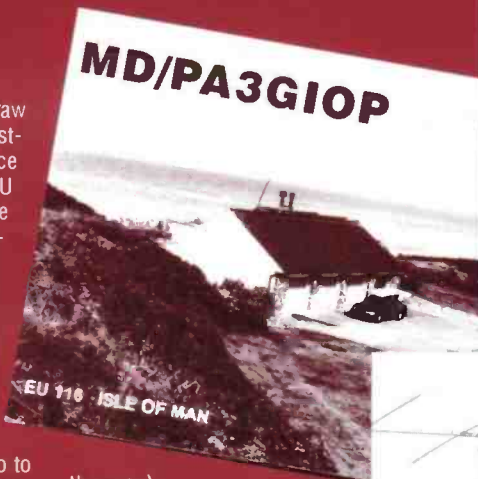

POEL ISLAND - IOTA EU-091

**KHOA**  
ZONE 27



after the event to the organisers. Most contest organisers also require you to submit 'dupe sheets' for each band, which are an alphabetic listing of all stations worked on that band, so that it is

**HF Happenings HF Happenings**  
Summer's the time to look for island expeditions, particularly du

marathon running. Everyone can take part and, although there will be strong competition for the top places, for most entrants it is simply a fun event.

tions and officials of the various IARU member societies (such as the RSGB in the UK). The contest 'exchange' is RS(T) plus ITU Zone (the UK is in zone 27, by

As with all contests, you keep a log (time, band, mode, callsign, contest exchanges sent and received, points and multiplier credits claimed) which you send

clear you haven't contacted the same station twice on the same band and mode. You should also submit a 'cover sheet', which consists of a breakdown of your totals (QSOs, points, multipliers) by band, a brief description of your station, and a signed declaration that you have abided by the results of the contest. You should also indicate the section you have entered. In the case of the IARU Contest, this is basically CW only, Phone only, or Mixed Mode.

Many contest organisers, including the American Radio Relay League who administer the IARU contest, make 'official' log sheets and cover sheets available to those who want them (usually in return for an SAE and return postage), but will generally be happy to accept entries on any suitable stationery, such as the RSGB's standard HF logsheets and cover sheets. More and more contest organisers are also happy to accept logs either on floppy disc or via e-mail. Indeed, many positively encourage this

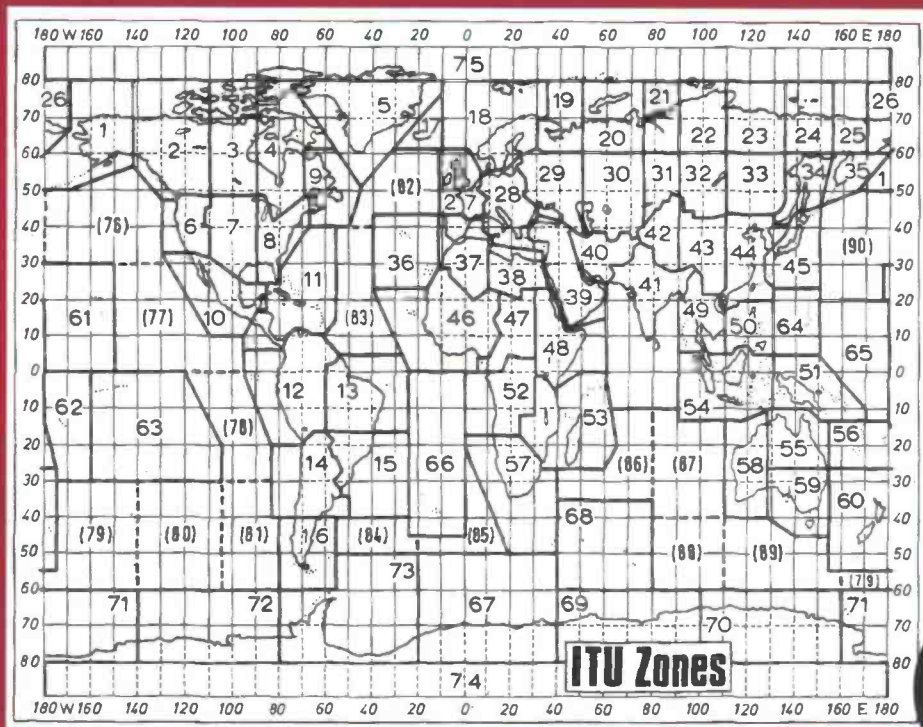

The multipliers in the IARU contest are ITU zones, as shown in this map.



A selection of QSLs from stations active in last year's IOTA contest.

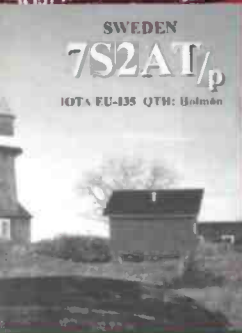

nowadays as they have computer programs which can then cross-check logs for accuracy, rather than having to do the job manually (which, with thousands of entries to major contests such as the IARU one, is a mammoth job).

Because most con-

test has grown out of the increasingly popular Islands on the Air awards programme, started many years ago by British Short Wave Listener Geoff Watts, and taken over at his request by the RSGB. Although you can work anyone during the contest, it is designed to encourage working island-based stations by giving more points for such contacts. Because it is in the middle of summer (at least, for the northern hemisphere) many hams go off on holiday expeditions to islands off the European and North American coasts, so you will find lots of interesting island activity.

The contest exchange consists of signal report, serial number and, if you are on an island, the IOTA reference number (which, in the case of mainland UK, is EU-005). There are many categories you can enter, including 12 and 24 hours, CW, Phone, or Mixed Mode. Score 15 points for an island contact, 5 points for non-islands, except that contacts with your own country or IOTA reference count 2 points. Multi-

of mini-expeditions out for the IOTA contest, so it is a great opportunity to make some interesting contacts and collect some nice QSLs. At the time of writing, expeditions which have been announced include: B13H, Shijiuto Island in the North China Sea; Vestmannaeyjar Island, off Iceland, by DL3KUD; Chausey Island (off the Brittany coast) by a large group of Belgian hams; Bute (off Scotland) by members of the Otley Radio Club; MW8Z, Anglesey; V26VG, Antigua, by a Scottish group; and Kambal'nitskiye Koshki Islands (off Russia) by two Russian hams. I am sure there will be many more. Many of these operations will start several days before the contest, or continue for a few days after the contest.

## other news

While still on the island theme, during the period 8 - 24 July Bert, F6HKA, and Didi, F6ELE, expect to spend 24 - 48 hours operating from each of the following island groups (IOTA reference in brackets): Anticosti

when he gets the opportunity. He hopes to get on the air from South Georgia, VP8/G, sometime between December 1998 and February 1999. Carl particularly enjoys 160, 80 and 40 metres.

Marc, ON4AVO, who was very active from Nigeria as 5NOMVE, has moved to India and received the callsign VU3MVCV from the WPC (Ministry of Communications, Amateur Licensing). This licence is good for CW only but he hopes to obtain permission for SSB soon. He has not been on the air yet but plans to be in the near future. QSL via ON7LX.

From 1 - 14 July a team of eight amateurs from the Eindhoven Student Radio Amateur Club (ESRAC) will stay at the mountain restaurant in Malbun, Liechtenstein, at 2010m ASL. They will operate all bands and modes as HB0/PI4TUE.

Finally, if you happen to be a lottery winner, you might be interested in an advertisement which appeared in the 9 April *Wall Street Journal*, listing Palmyra Island, "Privately-

# Opening HF Happenings

## ring this month's IOTA contest, as Don Field, G3XTT, explains

test rules are fairly lengthy when reproduced in full, you will normally only see an extract in the various monthly magazines, but the organisers can always provide a set in return for an SAE. If you have Internet access, you will also find that there are many sites on the web which carry contest rules and, frequently, the previous year's results. For example, the IARU maintains a web site at <http://www.iaru.org> where you can find the full rules of the IARU event. Incidentally, if you do decide to take the plunge, even if you only make a few contacts, the organisers welcome your log, if only to be able to check the logs of the high scorers for accuracy. Send it to IARU HQ, Box 310905, Newington, CT 06131-0905, USA or via e-mail to [contest@arrl.org](mailto:contest@arrl.org). Logs should be submitted within 30 days of the end of the contest.

## iota contest

The other contest I wanted to mention is the RSGB's Islands on the Air Contest, which takes place over the weekend of 25 / 26 July (from 1200UTC Saturday, for 24 hours) on the 80, 40, 20, 15 and 10 metre bands. This

ply this total by the number of IOTA references contacted on each band (Mixed Mode entries can work multipliers on both modes). As with the IARU Contest, logs can be submitted on paper or electronically. Just to make things even easier, Paul O'Kane, EI5DI, has an IOTA contest version of his popular *Super-Duper* contest logging program which is available free of charge, and can be downloaded from his web site at <http://www.iol.ie/~okanep>. Logs, postmarked no later than 1 September, go to RSGB IOTA Contest, PO Box 9, Potters Bar EN6 3RH, or can be e-mailed to [hf.contests@rsgb.org.uk](mailto:hf.contests@rsgb.org.uk). There are many certificates and awards available for leading stations in the various categories, and each entrant receives a copy of the results booklet. It's worth mentioning, by the way, that most contest organisers take several months to publish the results, so you have to learn to be patient.

If you intend to make a serious entry to either of these contests, you really need to get a full copy of the rules. I can help, if required, in return for an SASE.

As I said, there will be plenty

(NA-077), Harrington Harbour (NA-084), Seven Is (NA-125), Mingan (NA-176) and Bonaventure (NA-177). All are in the VE2 call area of Canada.

And Steve, N4JQQ, will be active from Treasure Cay, Abaco, Bahamas, from 10 July to 2 August, signing C6AFP. QSL via N4JQQ, Steve Rutledge, 199 S Grove Park Road, Memphis, TN 38117, USA.

The following special event stations were due to be active during the World Cup (10 June to 12 July), using the suffix CMF (Coupe du Monde de Football): TM1CMF from Marseille; TM6CMF Nantes; TM2CMF Toulouse; TM7CMF Lens; TM3CMF Bordeaux; TM8CMF Lyon; TM4CMF Montpellier; TM9CMF Paris; TM5CMF St Etienne; and TM0CMF from St Denis. Amateur Radio operators from Tourcoing, France, will operate special event station TM0BB from 13 to 23 July.

Carl, G4VFU, was very active from the Falkland Islands during April, signing VP8/G4VFU. He then went back to operating Maritime Mobile, and will be in the area for many months. He will operate from land as and

owned US possession, 1000 miles south of Hawaii, fee simple". The asking price is \$47,000,000, for which you could buy your very own DXCC country!

## signing off

This will be my last *HF Happenings* column for *Ham Radio Today*. I have thoroughly enjoyed writing the column, and appreciate the feedback I have had from readers over the years. I took over from Steve Telenius-Lowe, G4JVG, back in 1991 when he left the UK to work in Papua New Guinea. Steve is now, of course, *Ham Radio Today* editor, so some things come full circle! I am now writing the HF column for *RadCom*, the RSGB magazine, and I felt it inappropriate to continue with *Ham Radio Today*, but have been happy to keep up *HF Happenings* for the past few months during *Ham Radio Today's* transition to new ownership. My successor will be Martin Atherton, G3ZAY, a very knowledgeable HF operator, and a good friend of mine for over 25 years. I know Martin will do an excellent job, and wish him well.

# WANTED: Young, talented Radio Amateurs



**REWARD OFFERED: Cash and Industry Prizes to winner and runner up**

The great hunt has begun for this year's Young Amateur of the Year. Sponsored jointly by the Radiocommunications Agency and the RSGB, exciting prizes are awarded to both the winner and the runner up - the lucky pair will be invited to visit the Agency's Monitoring Station in Baldock, Herts, and will receive other prizes from the RA, RSGB and from industry.

This highly prestigious and coveted award is presented at a special lunch at the RSGB's HF & IOTA Convention in October 1998.

So if you are under 18, keen on amateur radio and are helping to get other people interested in the hobby, send for an application form *now* from Marcia Brimson, 2E1DAY, Radio Society of Great Britain, Lambda House, Cranborne Road, Potters Bar, Herts EN6 3JE, or tel: 01707 659015, e-mail: sales@rsgb.org.uk

- Must be under the age of 18 on 31 July 1998
- Resident in the UK, Channel Islands, or the Isle of Man
- Must be nominated by an adult sponsor
- Must have shown a talent in any of the following areas:
  - DIY radio construction
  - Operation of radio
  - Community service (eg helping in emergency comms or helping disabled people)
  - Encouraging other radio amateurs into the hobby (eg through the Novice Licence Scheme)
  - School or club projects
- Applications must be received by 31 July 1998

*A Date for your Diary*

# RSGB NATIONAL MOBILE RALLY

**Sunday, 2 August**

**WOBURN, BEDS**

Trade Enquiries to Norman Miller, G3MVB, 01277 225563.

## advertise hrt

To advertise in

## Ham Radio Today

Phone 01202 777852 Fax 01202 317902

Email: [adman@mcmail.com](mailto:adman@mcmail.com)

**STORNO 6000 UHF** mobiles for 70cms dashmount 12V, 25W, supplied with pre-programmed Eprom and input connector no mic's or L/S but wiring diagram supplied.....£95

**EX-MOD** test set universal No. 1 similar to AVO 8 supplied checked with batts, case and some leads.....£45

**STORNO 5662 UHF** synthesised 12V. Dash mount mobiles supplied with pre-programmed EPROM, BCD switches etc and full info to make 100ch, 70 cms mobile 15w O/P just needs 2 crystals (not supplied) to complete the kit.....£45

**PYE M293 L/B A.M.** (68-88MHz) for 4m or the RAC Rally Channel supplied with Mic and L.S.....£25

**PYE 5002 'E'** band (68-88Mhz) h/holds no batts or ants but supplied in ex MoD packing, 2 units for.....£25

**VINTAGE** – new/unissued hand microphones for wireless sets No. 18 in original ex MoD packing, 2 units for (last few).....£18

**EX-MOD** Quartz panel clocks in brass cases (painted). 4.5 inch dial sweep secondhand-checked.....£80

**PHILLIPS PRF 1060** – UHF (up band) base stations 25W O/P fully checked supplied with handbook and programmer. 3 units for.....£2,400 inc.

Please send self addressed stamped envelope for mail list.

**NOTE CLOSED ALL DAY ON WEDNESDAYS**

All goods are supplied in "as is" condition but are checked for completeness before despatch.

All goods include UK mainland p/p and VAT.

Technical Modification enquiries after 4.30p.m. please.

Most credit cards accepted.

## G.W.M. RADIO LTD



40/42 PORTLAND ROAD, WORTHING, WEST SUSSEX BN11 1QN  
TELEPHONE: 01903 234897 FAX: 01903 239050



Leicester Amateur Radio Show Committee  
presents the

## 27th LEICESTER AMATEUR RADIO SHOW

at a NEW VENUE

## CASTLE DONINGTON INTERNATIONAL EXHIBITION CENTRE

near junction 23A M1 motorway  
on NEW DATES

25th & 26th SEPTEMBER 1998

All the usual features but even bigger  
than ever

For further details contact  
Geoff Dover, G4AFJ, on  
tel: 01455 823344, fax: 01455 828273

For stand and table bookings  
contact John Theodorson, G4MTP,  
on tel/fax 01604 790966  
email: jtheotlc@aol.com

# Subscribe to Ham Radio Today!

Now you've seen the new-look *Ham Radio Today*, we're sure you'll want to read it every month. To be certain of being able to get hold of a copy every month, the best way is to subscribe. That way, you'll have *Ham Radio Today* delivered to your door as soon as it's published. At £26.50 per year (for UK readers), including postage, it's also cheaper than buying each copy at the newsagent.

All you have to do is fill in the form and send your cheque or credit card authorisation to the address below. If you do not want to cut your copy of *Ham Radio Today*, please feel free to photocopy this page.

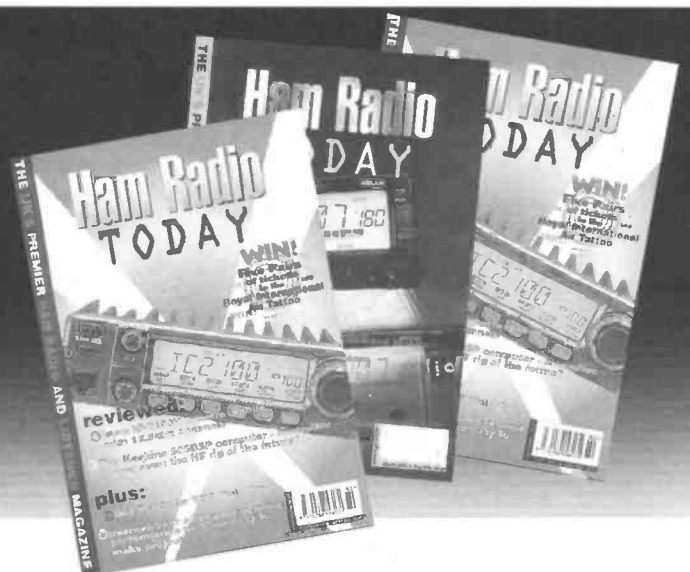

To: Ham Radio Today Subscriptions, RSGB Publications, Lambda House, Cranborne Road, Potters Bar, Herts EN6 3JE.

Subscription rates (12 issues/year) UK - £26.50; Europe & Eire - £36.50; Rest of the World - Surface £38.50, Air Mail £54.

Name \_\_\_\_\_ Callsign (if appropriate) \_\_\_\_\_

Address \_\_\_\_\_

Post Code \_\_\_\_\_

Credit Card No \_\_\_\_\_ Exp Date \_\_\_\_\_ Switch Start Date \_\_\_\_\_ Issue No \_\_\_\_\_

Signature \_\_\_\_\_ Date \_\_\_\_\_



# RSGB YEARBOOK



**1998 EDITION**  
(incorporating all UK callsigns)

This new edition of the ever popular RSGB Call Book and Information

Directory has been further enhanced with the inclusion of even more information on amateur radio than ever before!

- 100 page information directory providing essential information for the radio amateur - all in one place!
- UK Callsign listing
- WAB Square/locators
- Irish Callsigns
- Trade information
- Plus, much more . . . .

**£13.95**

Plus P&P

And by  
special  
demand

## CallSeeker '98

For the first time - the complete RSGB 1998 Yearbook, including the latest UK callsigns on CD-ROM available as a companion product to the 1998 Yearbook! Windows 95 version.

### System requirements:

- PC with a 486 or higher processor and a CD-ROM drive.
- VGA or high-resolution screen supported by Microsoft Windows
- 10-15MB spare hard disk space
- Windows 95 or later with 8MB of RAM (16MB recommended) or Windows NT Workstation version 3.51 or later with 16MB of RAM (24MB recommended)



**£13.95**

Plus P&P

**BUY THEM**

**BOTH**

**TOGETHER AT**

**THE SPECIAL**

**PRICE OF**

**£22.90 (plus P&P)**

**A SAVING OF**

**£5.00 ON THE**

**INDIVIDUAL**

**PRICES!**

**CALL RSGB SALES ON 01707 660888 TO ORDER**

## Harlow & District Amateur Radio Society

### Rally & Car Boot Sale

5th July 1998 – Free Entrance & Parking

*New & Better Venue*

Mark Hall School Harlow (A414) First Avenue.

Tables inside £15. Car boot plots £7 –

*For the best plots book early.*

Talk in on S22 & SU22. Morse tests on demand.

Fax Back

Contact Len G7UFF Tel: 01279 832700

Fax 01279 864973

Email: len.brackstone@virgin.net

## Sussex Amateur Radio And Computer Fair

Sunday July 12th 1998 10.30 am to 4.00 pm

### BRIGHTON RACECOURSE

Trade stands for: New and used Amateur and  
CB Radio Equipment, Computers and  
Component Sales, Bring and Buy Stall,  
Picnic Area, Refreshments and  
Free Car Parking.

Admission £2.00 – For Details: 01323 485704

## ronal COMPUTERS LTD.

161-163 Bispham Rd.,  
Southport PR9 7BL  
**01704 507808**

### CASES

Mini Tower - £27.00  
Midi Tower - £32.00  
Midi Towers ATX - £59.00

### MAINBOARDS

Gigabyte S2 - £67.00  
Gigabyte TX3 - £79.00  
Gigabyte LX - £105.00

### CPU's

Intel P233MMX - £113.00  
Intel PII-233 with fan - £170.00  
Heavy Duty Fan/Heatsink - £6.50

### MEMORY

16Mb EDO - £17.55  
32Mb EDO - £32.90  
32Mb SDRAM - £33.50

### DRIVES

3.5" Floppy - £12.75  
2.1Gb IDE UDMA - £99.00  
3.2Gb IDE UDMA - £109.75

### GRAPHICS CARDS

2Mb S3 Virge - £26.20  
4Mb S3 Virge - £38.50  
Matrox M3D - £54.65

### COMMUNICATIONS

External 33.6 Modem - £52.90  
Diamond 56e Modem - £83.85

### KEYBOARDS/MICE

Windows 95 keyboard - £8.99  
Windows 95 PS/2 - £9.99  
Ergonomic keyboard - £16.50  
Mouse Serial or PS/2 - £4.75

### MONITORS

14" (3yr On-Site) - £101.00  
15" (3yr On-Site) - £129.75  
17" (3yr On-Site) - £285.00

### MULTIMEDIA

24 speed CD-Rom - £42.90  
16-Bit Soundcard - £12.75  
Soundblaster 16 - £39.50  
60W PMPO Speakers - £8.50

### OTHERS

3.5" Disks (box of 10) - £2.00  
CDR (box of 10) - £10.80  
Flatbed Scanner - £63.00  
Joystick - £7.99  
Zip Disk - £9.00

*This is only a small selection of  
our stock, please phone for  
prices of items not listed. Come  
and visit our stand at Elvaston  
Castle on June 14th.*

E.&.O.E.



All prices include V.A.T. but exclude delivery.



# advertise hrt

To advertise in

# Ham Radio Today

Phone  
**01202 777852**  
Fax  
**01202 317902**

Email:  
**adman@mcmail.com**

## The **SHORTWAVE** Shop

18 FAIRMILE ROAD,  
CHRISTCHURCH, DORSET BH23 2LJ  
Phone/Fax 01202 490099 • Mobile 0836-246955

KENWOOD  
Authorised  
Dealer

KENWOOD  
Communications  
Centre

### THE SCANNER & RECEIVER SPECIALISTS

Scanners & Receivers from £75 – £5999.

Call & discuss which part of the Radio Spectrum you wish to monitor & we will advise you on the most cost effective way of doing it.

● Full range of New & Second Hand Equipment Available.

● We Stock All Famous Brands.

AOR, YUPIITERI, BEARCAT,  
SCANMASTER + ALL THE ACCESSORIES



### AMATEUR RADIO

We are the Kenwood main dealer for the  
South Coast and appointed dealers  
for Yaesu & Icom equipment

Same day despatch on all postal  
sales quoting your Visa / Access  
number. Call for best prices on  
equipment.

4 MILES FROM BOURNEMOUTH INTERNATIONAL AIRPORT ON B3073.

300 YARDS FROM CHRISTCHURCH RAILWAY STATION. FORECOURT PARKING FOR DISABLED

## RADIO + TELECOMMUNICATIONS CORRESPONDENCE SCHOOL

AT OUR NEW OFFICE  
2 SOMERSET PLACE, TEIGNMOUTH  
DEVON TQ14 8EP

START training now with the specialists for the  
following courses:

**Telecomms Tech CG 2720, Radio Amateur Licence "A" or  
"B", Micro Processor and introduction to Television.**

FOR our FREE Brochures write to the above address or call

**01626 772414**

**To include your club in this section, please make sure you send us your events details in time: deadline for September issue is 13 July, for October, 14 August; November, 10 September. We only list active clubs, ie those who send us their diary of planned talks / events. Send your club event details to: The Editor, Ham Radio Today (Club News), RSGB Publications, Lambda House, Cranborne Road, Potters Bar, Herts EN6 3JE; fax: 01707 645105.**

**Aberdeen ARS**

Meets Fris. 12 Jun antenna basics, Maurice Hateley, GM3HAT. 19 Jun VHF 'foxhunt'. 26 Jun quiz. 3 Jul junk sale. Details from Robert Duncan: 01224 896142.

**Appledore & DARC**

7.30pm 3rd Mon of month at the Appledore Football Club room. For details contact new Acting Hon Sec Brian Jewell: 01237 473251.

**Aylesbury Vale RS**

8.00pm on 1st & 3rd Wed of month, at Hardwick Village Hall, 3 miles north of Aylesbury on A413. 17 Jun discussion evening. 1 Jul multi lectures, 20min each. 15 Jul discussion evening. Secretary Gerry, G7VVF: 01296 432234.

**Ayr ARG**

7.30pm fortnightly Fris. Garry Olesen, GM3MQO, 01292 479245.

GOTLK: 0181 777 0420; e-mail: alangm@clara.net

**Bromsgrove ARS**

8.00pm on 2nd & 4th Tue of month at Lickey End Social Club, Alcester Rd, Burscot, Bromsgrove. 23 Jun mobile DF. 14 Jul night on air. 27 Jul on foot DF event. A Malcolm, G8DEC: 01527 875573.

**Burnham Beeches RC**

8.00pm 1st & 3rd Mons at Farnham Common Village Hall, Victoria Rd, Farnham Common, Bucks. 15 Jun IOTA DXpeditions, Don Beattie, G3OZF. 6 Jul rally preparations. 20 Jul digital TV. Secretary G4XDU, e-mail: bbrc@argonet.co.uk

**Bury Radio Society**

7.45 for 8.00pm Tues at Mosses Centre, Cecil Street, Bury, Lancashire. 14 Jul pedestrian excursion with radios. Keith Rothwell, G8EAP, keith@g8eap.demon.co.uk

**Chesham & DARS**

each Wed. 17 Jun members' forum. 24 Jun pedestrian radio treasure hunt. P Blakeney, G8BLB: 01494 784811.

**Cheshunt & DARC**

8.00pm Weds at the Church Room, Church Lane, Wormley, Herts. 17 Jun natter night. 24 Jun portable on Baas Hill Common. 1 Jul member's forum. 8 Jul 9MOC Spratly DXpedition, Steve Telenius-Lowe, G4JVG. 15 Jul member's forum. 22 Jul portable on Baas Hill Common. 29 Jul junk sale. Details John Crabbe, G3WFM, 47 Torrington Dr, Potters Bar EN6 5HU or at G87HSN.

**Chester & DARS**

Meets Tues (but not 1st Tue of month, and no meetings in Aug). 14 Jul video night. 21 Jul bring & tell. 28 Jul discussion night. G Landen-Turner, G00XA, 0151 608 3229.

**Coventry ARS**

8.00pm Fris at Binley Church Hall, Brinklow Road, Coventry. 19 Jun VHF NFD discussion. 26 Jun rig test night. 3 Jul VHF NFD preparation. For further details contact the Secretary, Robin Tew, G4JDO: 01203 673999.

**Cray Valley RS**

1st & 3rd Thus of month at Progress Hall, Admiral Seymore Road, Eltham, London SE9. 18 Jun DF hunt. Tony Fishpool, G4WIF: 0171 739 5057 (office hours).

**Devizes & DARC**

8.00pm Fris at Hare & Hounds Inn, Hare & Hounds St, Devizes. 21 Jun 'spending your money wisely'. Noel, G4TIX: 01380 724533; e-mail: NoelW@mcmall.com

**Dragon ARC**

7.30pm 1st & 3rd Mons of month at Ebenezer Hall, Foel Graig Lane, Higher Village, Llanfairpwll. 15 Jun

**This Month at the Clubs**  
ham radio today latest club news

**Bolsover ARS**

Meets Weds. 8 Jul quiz. 22 Jul computer night. 29 Jul CW night, G0WLP. Colin, G0RXT, 01246 822856.

**Bristol (RSGB) Group**

7.15 for 7.30pm last Mon of the month at Avon Combined Services Club, St Pauls Rd, Clifton, Bristol. 29 Jun QSL bureau, John Densem, G4KJV. 27 Jul quiz chaired by G3RFX. Robin Thompson, G3TKF: 01225 420442; e-mail: robin@g3tkf.demon.co.uk

**Bristol (South) ARC**

7.30pm Weds at Whitchurch Folkhouse Association, Bridge Farm House, East Dundry Road, Whitchurch, Bristol. 17 Jun NFD training. 24 Jun Longleat preparation. 1 Jul Lundy info and advanced RAE. 8 Jul horticulture. 15 Jul barbecue. 22 Jul bring & buy. 29 Jul home construction. Jean Fletcher, G0AWX: 01275 834282 (24hr answerphone).

**Bromley & DARS**

7.30 for 8.00pm on 3rd Tue of month, at Victory Social Club, Kechill Gardens, Hayes, Kent. 16 Jun DF hunt, Graham, G4NPD & Alan, GOTLK. 21 Jul practical electricity fundamentals, Ian Daniels, G4VTD. Alan Messenger,

**Buxton Radio Amateurs**

2nd & 4th Tue of month. 28 Jul video. Derek Carson, G4IHO: 01298 25506; G4IHO @ GB7DAD

**Cardiff RSGB Group**

2nd Mon of month. 13 Jul RSGB video. David Thomas, GW3RWX: 01222 620939.

**Carmarthen ARC**

7.00pm 1st & 3rd Tue of month at Hill House, Picton Terrace, Carmarthen. The club was formed in 1981 and has now grown into one of the largest in Wales: visitors welcome any club night. Islwyn Hughes, GW4ZXL: 01267 231359.

**Chelmsford ARS**

1st Tue of month. 7 Jul talk by Fred Wright, G6FXM. Charles Shelton, G0GJS: 01245 256654.

**Cheltenham ARA**

7.45 for 8.00pm on 1st Fri of month at Prestbury Library, The Burgage, Prestbury, Cheltenham. 3 Jul testing rig deviation, G6AWT & G0LGS. Mrs Patricia Thom, G1NKS: 01242 241099 (9.00am 9.00pm); e-mail: g1nks@g3nks.demon.co.uk

**Chichester & DARC**

7.30pm 1st & 3rd Tue of month at St Pancras Hall, St Pancras, Chichester. 16 Jun, 7 Jul, 21 Jul: free / open evenings. John Stratfull, G3IJS: 01243 861578.

**Christchurch ARS**

8.00pm Thu in the radio club room, behind the Sports & Social Club, Grange Road, Somerford, Christchurch. Secretary K P Harris, G7WSN: 01202 484892 (evenings).

**Cockenzie & Port Seton ARC**

has 'normal club nights' on first Fri of month at the Thorntree Inn, High Street, Cockenzie, from 1900 'till late'. Bob Glasgow: 01875 811723.

**Cornish RAC**

7.30pm on 1st Thu of month at Perranwell Village Hall, near Truro. 2 Jul pre-rally meeting. Robin Worsley, G0MYR: 01209 820118.

**Coulsdon ATS**

7.45pm on 2nd Mon of month at St Swithun's Church Hall, Grovelands Road, Purley. 13 Jul quiz vs other societies. Alan Bartle, G6HC: 0181 684 0610.

ATV demo, John Lawrence, GW3JGA. 20 Jul hydroelectricity in N Wales, Dewi Thomas. Tony Rees, GW0FMQ: 01248 600963.

**Droitwich Spa ARC**

7.30pm on 1st Thu of month at Ye Olde Shoppe, 17 Ombersley St W, Droitwich Spa. Edward, G4PQZ, tel / fax: 01905 773181.

**Dudley ARC**

7.45pm at Dudley Central Library, St James Rd, Dudley. 27 Jul digital TV, Geoff Cooper, G0KVK. Tony, G4LVA: 01384 277925.

**Dundee ARC**

Details from Macdonald Black, GM0PIV, 01382 465771.

**Dunstable Downs Radio Club**

8.00pm Fris at Chews House, 77 High Street South, Dunstable, Beds. The club has 'library nights' on 1st Fri of month, plus: 17 Jul on the air. Paul McVay, G7TSJ: 01582 861936.

**Edgware & DRS**

8.00pm 2nd & 4th Thus at Watling Community Centre, 145 Orange Hill Rd, Burnt Oak, Edgware. 11 Jun RadCom, Steve White, G3ZVW. 25 Jun VHF Field Day briefing. Julian, G4ZOD: 0181 958 6178.



**Exeter ARS**

7.45pm 2nd Mon of month at Moose International Centre, Blackboy Road, Exeter. 3rd Mon is committee / open meeting. 13 Jul mobile equipment evening. 20 Jul on air. Theo, G3EQM: 01392 875498.

**Exmouth ARC**

1st & 3rd Wed of month. 17 Jun 12.5kHz channel spacing. 1 Jul Exe repeater / node cluster. Details: 01395 271880.

**Fareham & DARC**

7.30pm Weds at Portchester Community Centre. 17 Jun natter nite. 24 Jun modern rig theory, Mick, G4ITF. Andrew Sinclair, G0AMS: 01329 235397.

**Felixstowe & DARS**

8.00pm at Orwell Park School, Nacton, Ipswich. 29 Jun special events, what to do, Paul, G4YQC. 27 Jul on air experience for RAE students, Paul, G4YQC. Paul, G4YQC: 01394 273507.

**Gloucester AR&ES**

Mons. 22 Jun on air. 29 Jun Morse practice. Details: 01452 618930 office hours.

**Hoddesdon Radio Club**

8.00pm alternate Thus at Conservative Club, Rye Road, Hoddesdon, Herts. 11 Jun gliding, Mike Hodgson. 25 Jun barbecue at Tolmers Scout camp, Cuffley. 9 Jul RSGB, General Manager, Peter Kirby, G0TWW. 23 Jul First Aid in the shack. Don, G3JNJ: 0181 245 8119.

**Horndean & DARC**

7.30pm 1st & 4th Tue of month at Lovedean Village Hall, 160 Lovedean Lane, Lovedean, Hants. The 1st Tue is usually a social evening. 23 Jun vintage radio, Douglas Byrne, G3KPO. 28 Jul American supper. Stuart Swain, G0FYX: 01705 472846.

**Horsham ARC**

8.00pm on 1st Thu of month at Guide Hall, Denne Road, Horsham, West Sussex. 2 Jul how aeriels work, Ron, G3PYC. David Miller, G4JHI: 01403 252101, or e-mail: davidmiller2@compuserve.com

**Itchen Valley ARC**

2nd & 4th Fri. 12 Jun static electricity, Mike Homer, G6AIQ. 26 Jun 'treasure hunt' from Netley Marsh Community Hall. Sheila Williams, G0VNI: 01703 813827.

**Keighley ARS**

8.00pm Thus at Ingrow Cricket Club, Hainworth Rd, Ingrow, Keighley. 1st

fax: 01394 420795; e-mail: word.factory@zetnet.co.uk

**Lincoln Short Wave Club**

7.45pm Weds at Railway Sports & Social Club, Ropewalk, Lincoln. Cliff Newby, G3EBH: 01522 750637.

**Lothians Radio Society**

7.30pm on 2nd & 4th Weds of month at Orwell Lodge Hotel, Colinton Road, Edinburgh. 24 Jun social. Tommy Main, GM4DCL: 0131 663 8501, or GM3HAM@GB7EDN

**Loughborough & DARC**

at Science Lab, Hind Leys Community College, Forest St, Shepshed, on Mon evenings for general chat / operating & on Tuesdays as follows: 16 Jun DF. 23 Jun TVI & breakthrough. 30 Jun annual fun golf competition. Ian, G8SNF, on tel: 01509 218259.

**Louth & DARC**

8.00pm 1st Wed of month at Woodman PH, Eastgate, Louth, Lincs. 1 Jul organising special event station. Roger Wilson, G4IPE: 01507 602220; e-mail: g4irc@lincom.demon.co.uk

**Maidstone ARC**

holds Morse tuition Tues and Fris and Novice classes Weds. Mike Grainger, G0VQB: 01634 856765.

**Moray Firth ARS**

RAE and Novice RAE courses available. Geoff Crowley, GM7SJC, 01542 882818.

**Newbury & DARS**

7.30pm on 4th Wed of month at Memorial Hall, Upper Bucklebury, near Newbury. 21 Jun NADARS Amateur Radio Boot Sale, Cold Ash, near Newbury. 24 Jun radio in aviation, Mike Grierson, G3TSO. 22 Jul no meeting. Ian Trusson, G3RVM, 01635 826019, g3rvm@compuserve.com

**Norfolk ARC**

Weds at Ugly Bug Public House, Colton. Informal evenings, including night on air, construction QRP & Morse practice, on 1st, 3rd & 5th Weds, plus: 24 Jun 'foxhunt'. 8 Jul cheap off air frequency standard, Mike, G4EOL. 22 Jul surplus equipment sale. Hon Sec, Sandra Simpson, 2E1FOF.

**North Ferriby United ARS**

Thu (note change of day) at the Football Club, Church Road. David, G7PER, 01482 656324.

**North Kent RS**

8.00pm 1st & 3rd Tue of month at Pop-in-Parlour, Graham Rd, Bexleyheath. 16 Jun on the air night.

**This Month at the Clubs**  
ham radio today latest club news

**Goole R&ES**

7.30pm Fris at West Park Pavilion, Goole. 19 Jun DF competition. 10, 17 Jul log fill. 24 Jul 'HF basics'. G6YYN: 01757 638539.

**Halifax & DARS**

7.30pm on 3rd Tue of month at Tap & Spile Pub, Wards End, Halifax, for committee & Morse tuition. 16 Jun HF propagation, Gerald Edinburgh, G3SSY. 21 Jul the sun, L M Dougherty. D Moss, G0DLM: 01422 202306.

**Hambleton ARS**

7.30pm at Allertonshire School, Northallerton. 18 Jun junk sale. 2 Jul operating night. 16 Jul CB in '98, G0TYM. John Hampson, G0VXH: 01845 537547, or packet: G0VXH @ GB7CYM.

**Hastings Electronics & RC**

7.30pm on 3rd Wed of month at West Hill Community Centre, Croft Road, Hastings. 17 Jun engineering experience for Orange. 15 Jul auction. Doug Mephram, G4ERA: 01424 812350.

**Hereford ARS**

19 Jun Rob Mannion, G3XFD, Editor *Practical Wireless*. Eddy, G0UDF: 01432 263575.

Thu is on air night, except where shown. 11 Jun antennas for 21st century, G3OTE. 18 Jun natter night. 25 Jun RAFARS, Peter Lewyn. 2 Jul propagation, Gerald Edinburgh, G3SDY. 9 Jul on air night. 16 Jul natter night. 23 Jul packet on air night. 30 Jul 'dead centre', talk / slides. Ann, M0BLZ: 01274 499733.

**Kent Repeater Group**

holds its AGM on 19 Jun at Electronics Building, University of Kent, Canterbury.

**Kidderminster & DARS**

8.00pm first Tue of month at Sutton Arms, Sutton Road, Kidderminster, Worcs. Geoff Philpotts, G0RJP, tel: 01299 822206.

**Leicester Radio Society**

meets every Mon. 15 Jun quarterly progress meeting. 22 Jun mains power generation, Vic Ward, G3MXV. 27 Jul fingerprinting, Leicestershire police. On air' nights are held on Mons not shown above. John Alexander, G7GCK: 0116 231 3194.

**Leiston ARC**

at 7.30pm at Leiston Town Athletic Association, Victory Rd, Leiston. John Rabson, G3PAI: 01394 460298;

**Malvern Hills RAC**

8.00pm 2nd Tue of month at Town Club, 30 Worcester Road, Malvern. Club call is G4MHC. 14 Jul Micro Stamp Controllers, Mike Ward, G4GHL. Secretary Dave Hobro, G4IDF, 60 Linksview Crescent, Newtown, Worcester WR5 1JJ; 01905 351568 (evening / weekend), e-mail: DHobro@aol.com

**Mid Cheshire ARS**

8.00pm Weds at Cotebrook Village Hall on A49 north of Tarporley. 17 Jun trends in modern radio equipment, Waters & Stanton. 24 Jun VHF on air night. 1 Jul construction & HF on air. 8 Jul ATUS, David G4XUV. 15 Jul 'foxhunt'. 22 Jul construction & VHF on air. 29 Jul video night. Ted Bannister, G0RBA: 01606 592207; e-mail: G0RBA@aol.com

**Mid Sussex ARS**

Meets Fris. 12 Jun on air. 19 Jun annual party. 26 Jun NFD discussion. 3 Jul NFD preparation. 10 Jul rally preparation. 17 Jul rally & NFD post moretm. 31 Jul annual barbecue. Philip Baldwin, G3LCF: 01273 557878.

**Milton Keynes & DARS**

7.30pm Mons at Faulkner House, Bletchley Park. Details from Dave McQue, G4NJU, tel: 01908 378277.

23 Jun 2m DF hunt. 7 Jul HF / VHF Field Day post mortem. 14 Jul barbecue. 21 Jul quiz vs Darenth Valley. Secretary G8MLQ.

**North Wakefield RC**

8.00pm Thus at East Ardsley Cricket Club, Wakefield. 11 Jun semi-conductors, Dr Robert Kelsall. 25 Jun barbecue. 4 Jul US independence day with Darley ARC at Menwith Hill. 16 Jul role of the RA. 30 Jul barbecue. Further details: 0113 253 9087.

**Nunsfield House ARG**

Fris at Nunsfield House Community Association, 31 Boulton Lane, Alvaston, Derby. 12 Jun preparation for Elvaston Castle rally. 19 Jun rally *post mortem*. 21 Jun Derbyshire fire & rescue. 26 Jun on the air evening. 3 Jul VHF NFD preparation. 10 Jul VHF NFD *post mortem*. 17 Jul fire safety demo at Kingsway fire station. 24 Jul junk sale. 31 Jul great egg race, Ken Clarke. Neil Davison, M1AFB: 01332 736362.

**Plymouth Radio Club**

7.30 for 8.00pm 1st & 3rd Tue (summer schedule until Sep). 16 Jun Dartmoor Prison, Bill Green. 7 Jul forward planner update, Den. 14 Jul 7.00pm sharp visit N Hessary Tor. 21 Jul talk by Pat Marshall, harbour master. 23 Jul visit to Stonehouse Barracks

7.00pm sharp. Den Perryman, G7HMA: 01752 346158 (before 9.00pm).

## Poldhu ARC

7.30pm 2nd Tue of month. 9 Jun VHF 'foxhunting', John, G0GUO. 14 Jul question time. David Barlow, G3PLE: 01326 240738.

## Salop ARS

Details from Trevor Davies, G0JIX: 01743 365818.

## Shefford & DARS

8.00pm Thus at Church Hall, Amptill Road, Shefford, Beds. CW practice from 7.30pm. 11 Jun pedestrian DF hunt. 18 Jun VHF NFD planning, briefing for flying evening. 25 Jun flying evening at RAF Henlow. 2 Jul final planning for NFD. 9 Jul planning session. 16 Jul mobile DF hunt. 23 Jul barbecue at Summerfield Farm. Derek Clarkson, G4JLP: 01462 851722.

## South Birmingham Radio Society

on 1st Wed of month at West Heath Community Centre, Hampstead House, Fairfax Rd, West Heath, Birmingham. The club is "generally" open Mons, Thus & Fris from 8.00pm. 1 Jul Field Day planning.

## Stevenage & DARS

7.30pm Tues at the Day Centre, Chells Way, Stevenage. 16 Jun 'K9 on Patrol', dog handler PC Paul Miller & friend. 23 Jun final preparations VHF NFD. 30 Jun video. 14 Jul 9MOC Spratly DXpedition, Steve Telenius-Lowe, G4JVG. Peter Bell, 2E1CRK: 01462 674505.

## Stourbridge & DARS

8.00pm on 1st & 3rd Mon of month (except Bank Holidays & no meetings in Aug), at the Radio Shack, Oldswinford Hospital, Heath Lane, Stourbridge. 15 Jun air ambulance. 6 Jul on air & natter night. 20 Jul main meeting. Gordon Bryant, G0TZV: 01384 395206.

## Stratford upon Avon & DRS

7.30 for 8.00pm on 2nd & 4th Mon of month at Home Guard Club, Main Road, Tiddington, Stratford upon Avon. 22 Jun visit (TBA). 13 Jul social evening. 27 Jul construction competition. Secretary Jeff Porter, G4OHJ: 01789 773286.

## Stroud RS

7.30pm alternate Weds at Minchinhampton Youth Club, nr Stroud, Glos. 8 Jul video. Stuart, G0GNM: 01453 752411; e-mail: stuart.g0gnm@gifford.co.uk

## Torbay ARS

7.30pm Fris at ECC Social Club, Highweek, Newton Abbot. Informal meetings most Fris & talk / event once a month. 19 Jun 'watts on the radio', Peter, G4VFG. 24 Jul Paul from Bekra Radio Control Models. Peter Tanner, G4VTO: 01803 864528 (working hours).

## Tynemouth ARC

Details from Harry Purves, G6UQX, 0191 262 7335.

## Verulam ARC

7.30 for 8.00pm at RAF Association HQ, New Kent Road, St Albans. 23 Jun packet repeaters, Ken Ashcroft, G3MSW. 28 Jul barbecue. Walter Craine, G3PMF: 01923 262180.

## Wakefield & DRS

8.00pm Tues at Community Centre, Prospect Road, Ossett, West Yorks. 16 Jun pitch & putt. 23 Jun on the air. 7 Jul 'foxhunt'. 14 Jul rally meeting. 28 Jul talk by Gordon, G0ISJ. Ian, M0BFO, 01924 216502.

## Warrington ARC

8.00pm Tues (Morse classes Weds) at Grappenhall Youth & Community Association, Bell House Lane, Grappenhall, Cheshire. 16 Jun

## Wirral & DARC

8.00pm Weds at Irby Cricket Club. Other Weds are social evenings. Andy: 0151 677 4448 or packet CLUB @ GB70AR.

## Wisbech AR&EC

8.00pm at RAFA club, Old Market (next to the TSB). Further details from Bill, G3XZF: 01945 588102.

## Wolverhampton ARS

8.15pm Tues at Wolverhampton Electricity Sports and Social Club. 16 Jun DF hunt. 23 Jun homebrew competition. 30 Jun social. 7 Jul committee meeting. 14 Jul video, Gordon, G4DGM. 21 Jul DF hunt. 28 Jul social. Joy Smith: 01902 751936.

## Worthing & DARC

17 Jun discussion. 24 barbecue. G4GPX: 01903 753893.

## national and international

### British Amateur Radio Teledata Group (BARTG)

has a quarterly magazine, *Datacom*, and holds a rally and HF RTTY contest each year. For more details about the group contact Membership Secretary Bill McGill, G0DXB, 14 Farquhar Road,

# This Month at the Clubs

ham radio today latest club news

Secretary Don Keeling tel: 0121 458 1603.

## Southdown ARS

First Mon of month. 6 Jul commercial radio in the community, Sovereign Radio. Brian Gauntlett, G4LYU: 01323 840530.

## South Manchester RC

Fris. 12 Jun computers in radio, G4HON. 19 Jun DF hunt. 26 Jun sonic hedgehogs, G8APB. G E Spark, G7FQY: 0161 969 1964.

## South Notts ARC

7.00pm Weds at Fairham Community College, Farnborough Rd, Clifton, Nottingham. 17 Jun on air. 24 Jun video evening. 1 & 15 Jul on air. 22 Jul SSB Field Day preparation. Vice Chairman tel: 01509 672846.

## Spalding & DARS

7.30pm Fris at Old Fire Station, Spalding, Lincs. Details: 01775 750382 or 0976 271796.

## St Austell ARC

1st & 3rd Mon of month at Polstair School (PS) or SkyWave, Charlestown Harbour (CH). 15 Jun CH. 6 Jul junk sale (PS). R A Pears, G4TRV: 01726 72951.

## Submarine ARC

Weds at RNARS HQ, HMS Collingwood, Hants (please note this is a new venue). Colin McLean, M1ANC, packet @ GB7SUN.

## Sudbury & DRA

on 1st Tue of month at the Old School on junction of Head Lane, Wells Hall Rd, Great Cornard, & on third Tue of the month, at a new venue: The Brook PH, Bures Road. Jul BBC Radio Suffolk, David Butcher, BBC engineer. Secretary Mark Bean, G7UTC, on tel: 01787 377493.

## Sutton & Cheam RS

7.30 for 8.00pm on 1st Thu (natter night) & 3rd Thu (formal meeting), at Sutton United Football Club, Borough Sports Ground, Gander Green Lane, Sutton, Surrey. 18 Jun junk sale. 16 Jul VLF operating, Derek Atter, G3GRO. John Puttock, G0BWV: 0181 644 9945.

## Thornton Cleveleys ARS

Meets Mons. 6 Jul VHF SSB, Brian Seedle. 13 Jul surplus equipment sale. 20 Jul transformers, Charlie, G4FWM. 27 Jul mining experiences, Colin, G0EPY. J Duddington, G4BFH, 8 The Grove, Thornton Cleveleys, Lancs FY5 2JD.

'foxhunt'. Secretary John Riley, G0RPG: 01925 762722.

## Welland Valley ARS

7.15pm 1st Tue of month at Great Bowden village hall, The Green, Great Bowden, Market Harborough.

## West Somerset ARC

7.30pm 1st Tue of month in Room GB7, Gibbs Block, West Somerset Community College, Minehead, Somerset. 7 Jul video. Alan Elliott, M0AOJ: 01643 707207.

## Wimbledon & DARS

2nd & last Fri of month at St Andrews Church Hall, Herbert Rd, Wimbledon SW19. 12 Jun digital radio. 26 Jun handhulfs. 10 Jul 2-stroke engines, G7UVF. J Gale, G4WYJ: 01737 356745.

## Wirral ARS

8.00pm at Club Room, Ivy Farm, Arrows Park Road, Birkenhead, opposite Landican Cemetery. Activity nights 1st & 3rd Weds; 'natter nights' Tues from 7.30pm; Morse tuition Thus. 18 Jun construction project, Mike Tyrell, G6GAK. 24 - 31 July special event station at National Guide Jamboree. John Phillips, G3PXX: 0151 336 4452, @GB70AR, or e-mail: vectis@nordee.u-net.com

Maltby, Rotherham, S.Yorks S66 7PD, tel: 01709 814010 (Tues, Thurs & Fri, 7.00pm to 9.00pm. Sat/Sun before 9.00pm), or via GB7WRG. Internet: <http://www.bartg.demon.co.uk>

## British Amateur Television Club (BATC)

produces a quarterly magazine, *CQ-TV*, and holds its own rally each year. BATC has an Internet site at <http://www.batc.org.uk> For details contact: Dave Lawton, G0ANO, Grenehurst, Pinewood Road, High Wycombe, Bucks HP12 4DD.

## CDXC (Chiltern DX Club) - the UK DX Foundation

membership is open to all amateurs and SWLs who have worked (or heard) more than 100 DXCC countries. It is the UK's first and largest grouping of amateurs interested in HF DX / contesting. Internet site: <http://www.cdxc.org.uk> For prospectus and further details please contact the Secretary, Alan Jubb, G3PMR, 30 West St, Gt Gransden, Sandy, Beds SG19 3AU.

## G-QRP Club

publishes a quarterly journal, *SPRAT*, devoted to low power communication, and holds regular get-togethers at their rally stands throughout the

country. For membership details, contact their Secretary, Rev G Dobbs, St Aiden's Vicarage, 498 Manchester Road, Rochdale, Lancs OL11 3HE; tel: 01706 31812 or see their web site at <http://www.btinternet.com/~g4wif/ggrp.htm>

**International Short Wave League (ISWL)**

who, as well as running an international QSL bureau for amateurs and SWLs, has a monthly magazine (*Monitor*) and regular get-togethers at their rally stands plus on-air nets on HF and VHF. For more details send an A4 sized SAE to: ISWL HQ, 267 Pelham Road, Immingham DN40 1JU. Internet: <http://www.aber.ac.uk/~srj5/iswl.htm>

**Irish Radio Transmitters Society (IRTS)**

publishes regular newsletters giving details of local activities, and the yearly IRTS Callbook. They also have a video library. For further details of IRTS, contact Joe Ryan, EI7GY; tel: (Eire) 01 2854250 or by e-mail: [jryan@iol.ie](mailto:jryan@iol.ie) Book Sales: Dave Moore, EI4BZ, 12 Castle Ave, Carrigtwohill, Co Cork; tel: (Eire) 021 883555.

**Radio Amateurs' Emergency Network**

can be contacted at Hunters Moon, Newton-le-Willows, Bedale, N Yorks

DL8 1SX. 24hr emergency national contact line: tel: 0141 621 2121; Raynet supplies enquiries: tel: 0141 620 1000; Training Team, PO Box 2, Chinnor, Oxon OX9 4SR; Packet BBS: GB7NRC; Telephone BBS: +44 (0) 1296 393737; Internet web site: <http://www.sgi.leeds.ac.uk/raynet/>; HF news net: Sun 0830 local, 3663kHz.

**Radio Amateur Invalid and Blind Club (RAIBC)**

is a registered charity which raises money for radio / computer equipment, and audio cassette courses for home study, for blind, deaf and disabled amateurs. The club attends rallies throughout the year, and collects surplus equipment for resale. Please contact Honorary Treasurer / Membership Secretary Mrs Shelagh Chambers, 78 Durley Ave, Pinner, Middx HA5 1JH. Web site address: <http://www.gurney.co.uk/raibc>

**Radio Amateur Relief Expeditions (RARE)**

is a registered charity made up of radio amateurs and friends who take aid to Eastern Europe and organise summer camps for young people to learn about amateur radio, English language and life in the UK. New members are required to support

this work both at home and by taking part in expeditions. Please contact: The Secretary, RARE, 1 Allfield Cottages, Conover, Shrewsbury SY5 7AP; tel: 01743 873815; fax: 01743 874729; packet: G6FHM@GB7PM8; e-mail: [rare@donsun.demon.co.uk](mailto:rare@donsun.demon.co.uk)

**Radiocommunications Agency (RA)**

is the licensing authority for all UK radio amateurs. They have a large number of free publications, including the booklet *How to Become a Radio Amateur*, and their *Novice Licence Information* sheet and can offer advice on many aspects of licensing. New Kings Beam House, 22 Upper Ground, London SE1 9SA. Amateur Radio line, tel: 0171 211 0160. General enquiries, tel: 0171 211 0211. Answerphone service, tel: 0171 211 0591.

**Radio Society of Great Britain (RSGB)**

is the internationally-recognised national society, which has been representing UK Radio Amateurs and short wave listeners for 85 years. Members of the RSGB receive a 100-page colour magazine sent to their home each month, and also have the advantage of free QSLing, automatic entry in RSGB contests,

and help in obtaining planning permission for antennas, and much other technical support. A network of over 2000 volunteers is on hand to help the Radio Amateur and short wave listener with any enquiry. Address is: Lambda House, Cranborne Road, Potters Bar, Herts EN6 3JE; tel: 01707 659015; Internet site: <http://www.rsgb.org> and e-mail: [info@rsgb.org.uk](mailto:info@rsgb.org.uk)

**Subscription Services Ltd (SSL)**

handles the issuing of amateur licences in the UK on behalf of the Radiocommunications Agency. SSL can help regarding enquiries concerning individual licences (rather than general licensing matters, which the RA handles, see above). Contact details: The Radio Licensing Centre, SSL, PO Box 884, Bristol BS99 5LF; tel: 0117 925 8333.

**United Kingdom Radio Society (UKRS)**

is a new society for UK Radio Amateurs. They can be contacted at Box 100, Meadow Street, Northwich, Cheshire, CW8 1FA. tel: 01606 783270, or 0115 925 6597; packet: UKRS@GB7OAR, or e-mail: [admin@ukrs.org](mailto:admin@ukrs.org); Internet: <http://www.ukrs.org>

**This Month at the Clubs**

ham radio today latest club news

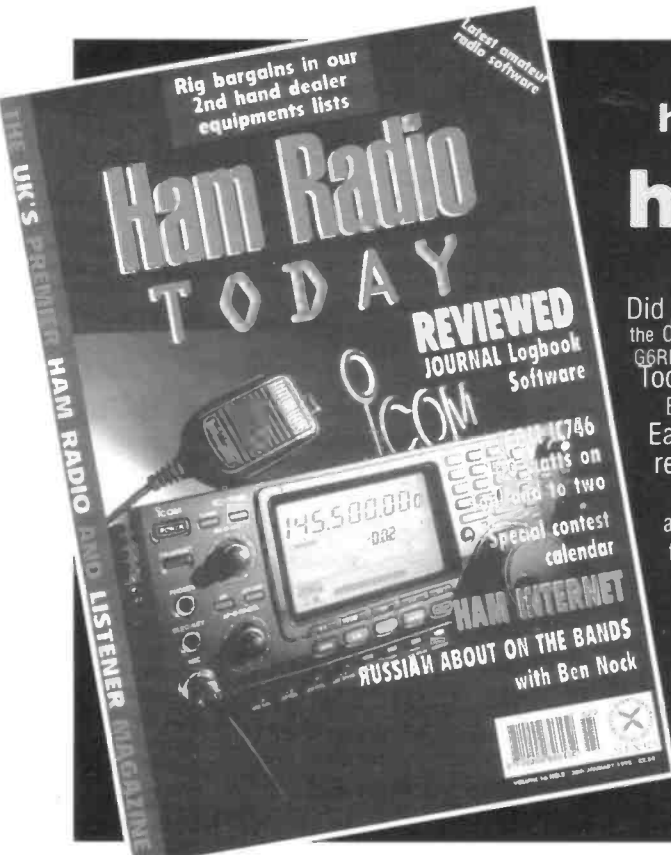

**back issues**  
ham radio today  
back issues  
ham radio today  
back issues  
ham radio today

Did you miss that Kenwood TH-G71E review (Vol 15 No 13)? Or perhaps the digital controller project for converted PMR transceivers by G6RHB (Vol 15 No 7). If so, you'll want to take advantage of the Ham Radio Today Back Issues service.

Back numbers are normally available for 12 months after publication. Each issue costs £3.20 inc P&P, but please check the issue you require is available before sending your cheque.

If the issue you require is not available we can photocopy individual articles for you. The cost is £2.75 for the first article, and £2.00 for further articles. Multiple parts count as separate articles. Please add £1.25 (UK) and £2 (overseas - surface mail) P&P.

**to order**  
post: Sales Department, Ham Radio Today, RSGB Publications, Lambda House, Cranborne Road, Potters Bar, Herts EN6 3JE.

Tel: 01707 659015; fax: 01707 645105 or e-mail: [hrt.sales@rsgb.org.uk](mailto:hrt.sales@rsgb.org.uk)



**for sale**

●**KENWOOD TS-850SAT** with record unit and MC-60 base mic, mint cond, boxed with instructions, £950. John, tel: 01704 506008 (Southport).

●**ICOM 765** with SM8 mic and manual but no box £1100. Trio 530S with mic, manual and box £300. John, G00ID, tel: 01249 892314 (Lyneham, Wilts).

●**PSION 3A 2MB 1MB RAM** disk, mains PSU, PSI Win app Chesn SSD case, stand, books as new £200 plus postage. Tel: 01276 709083 (evenings) (Camberley).

●**YAESU FC-707 ATU** £70 include postage. Tel: 0141 632 5408 (Glasgow).

●**VECTRONICS VC-3000** antenna tuner, 1.8 - 30MHz, 300W continuous, cross needle, forward, reflected, SWR meter, plus 21 segment bar graph. Built-in dummy load, manual, unmarked excellent condition £50. Tel: 01256 473715 (Basingstoke).

●**DX70 PLUS 50MHZ** and CTCSS £500. TH-75E extended Rx coverage, BC II charger HD battery £200. FT-5200 plus info on extended coverage £295. All items boxed books etc. Try and buy from Ron. tel: 01980 862489 any evening (Salisbury).

●**FT-77 100W** fitted FM and narrow CW filter £295. MFJ-941E ATU £50. FT-470 2m / 70cm handie, vgc, never used out of case, boxed c/w charger, nicad, manual etc £155. Steve, tel: 01603 880190 (Norwich).

●**FT-480R MULTIMODE** £215. Standard C8800 2m mobile £105. Instant Morse CD-ROM £15. Post paid above. Ex-PMR AM mobiles, AM suitable 4m, £5 ea. A200 amps 4m £10. Both plus post. Tom, G1LXU, tel: 01472 602335 (Cleethorpes).

●**MCL 1100 DECODER** with monitor, decodes RTTY, ASCII, CW, NAVTEX, auto baud rate, auto speed, auto lock on to signal, printer on / off, Baudot, easy to use £120. Icom IC-R10 handheld scanner 500kHz to

1300MHz no gaps, boxed £140. Tel: 01295 670108 (Warwick).

●**FOR SALE: LOWE** communications receiver HF-225 with Wharfedale speaker. £350. Tel: 0115 9135389 (Nottingham).

●**CREATE 318-B** five-ele triband Yagi £320. TS-700 vgc £210. 4CX-1000A £100. Tel: 01974 251420 (Dyfed).

●**FOR SALE: CUSHCRAFT A4S** four-ele beam for 20, 15 and 10. Try it here if you wish £300 ono. 01758 740712 (Pwllheli).

●**YAESU FT-900AT** all filters, boxed, as new, surplus to req £725. Calcomp A3 drawing tablet DOS W3.1 W95 software £50. Icom 3220E mobile 2m / 70cm £195. Richard, tel: 01234 781862, e-mail: rsmithy1@aol.com (Beds.)

●**HEATH HW9 QRP Tx / Rx** choice of two, both fitted with WARC bands, no mods, £200 each. Heath matching ATU and SWR bridge units HFT-9, HM-9 to match HW9. With HW9 £275. Pete, tel: 01452 741036 (Glos.)

●**YAESU FT-747 HF station**, PSU, ATU, vert ant, speaker, odd bits, £550 ono. Yaesu FRG-7 HF Rx £70 ono. Wanted working or scrap CB rigs for spares. Pete, G1SFS, tel: 0117 9633306 (Bristol).

●**REALISTIC 50 ch/held scanner**, exc cond, £95. Nicads and new boxed spare battery pack, instruction manual, VHF, air, amateur, UHF, 70cm, with charger, rubber duck ant, post paid to you. George, tel: 01443 437345 (Mid Glam.)

**wanted**

★**ATUTO USE** with FRG-7, also any recordings of Radio Berlin International during the 80s until its final broadcast. Paul, tel: 01782 751660 any time (Cheshire).

**exchange**

❖**ICOMIC-706 Mk II** with both voice synthesiser and DSP units fitted, boxed, like new, exchange for best Pentium II PC offered, or swap for Icom IC-475H 70cm base station with accessories etc. Barry, M0APO. tel: 01274 880895 (Bradford).

**free readers ads**

sell your equipment fast with ham radio free private ads

**free readers' ads**

name \_\_\_\_\_

signature \_\_\_\_\_

address \_\_\_\_\_

date \_\_\_\_\_ send this coupon to: Free Readers' Ads, Ham Radio Today, RSGB Publications, Lambda House, Cranborne Road, Potters Bar, Herts EN6 3JE.

The above details will not be published. Enter all that is to be published, including contact information, in the boxes below (Amateur Radio and electronic equipment only please).

(BLOCK CAPITALS OR TYPED PLEASE, ONE WORD PER BOX)

FOR SALE / WANTED / EXCHANGE / HELP NEEDED\*

\*Delete as appropriate

July 1998

**free readers' ads conditions**

- Free Readers' Ads will be inserted as and when space becomes available, on a first-come, first-served basis, subject to these conditions. If you require a *guaranteed* immediate insertion of your ad, please use the pre-paid Classified Ads section at the rear of this magazine.
- These advertisements are offered as a free service to readers for the sale, exchange, wants, or help with, privately-owned amateur radio and electronics equipment. Ads from traders, or apparent traders, will be rejected. Readers should use our Retail Network and Classified Ads section for ads not fulfilling these conditions, our Advertising Department (tel: 01202 777852) will be pleased to accept prepaid ads.
- All submitted free ads must be on a recent form printed in Ham Radio Today. Photocopies are not acceptable. Include your name and / or call sign, and either a contact telephone number (with STD code) and location (eg town or country) or a full address, or both, for readers to reply. These details must be included within your advertisement. Advertisements must be no longer than 40 words. Only one advertisement per section ('For Sale', 'Wanted' etc) per reader per month. Each advertiser must also fill in their name and address in the space provided (these details will not be published), and must sign the form to indicate acceptance of these conditions.
- We cannot be held responsible for transcription errors, however, we will attempt to ensure that legible submissions are reproduced correctly. Please write clearly and include punctuation. In the event of a gross error, at the request of the advertiser and at the editor's discretion, a corrected version of the advertisement will be printed in the earliest issue in which space is available.
- Neither the magazine nor its publishers will accept any responsibility for the contents of the advertisements, and by acceptance of these conditions the advertiser undertakes to indemnify the publisher against any legal action rising out of the contents of the advertisement.
- Advertisements are accepted in good faith; however, the publisher cannot be held responsible for any untruths or misrepresentations in the advertisements, nor for the activities of advertisers or respondents.
- As this is a free service, postal or telephone communication regarding publication of ads *cannot* be accepted unless an error is involved. Please remember, all ads received fulfilling these conditions will be published as space permits.
- Advertisements which are suspected of including illegal equipment will not be published. The magazine reserves the right to either refuse to accept entirety, or to delete any sections, or the entire text, of any advertisements not fulfilling the above conditions.

## LANCASHIRE

### AMATEUR ELECTRONICS/HOLDINGS G3LLL.

YAESU, AOR, ICOM, ETC. FT 101 EXPERTS

6JS6C 6146B 12BY7A Original type approved valves and our own Double Balanced Mixer and new band WARC Kits for original FT101 MK1-E. S.A.E. List Full Yaesu range. 15 mins Junction 31 M6. Free parking. Call and consult G3LLL without obligation. Holidays? Phone, check we are open before calling. Lunch 12-1.30pm.

45 JOHNSON STREET, BLACKBURN BB2 1EF  
(01254) 59595. OPEN: Thursdays, Fridays and Saturdays ONLY from July '96

## NORTH WEST & NORTH WALES

### AMATEUR RADIO COMMUNICATIONS LIMITED

OPEN  
Tues to Sat  
10-5pm

We are official factory appointed stockists and approved Service Centre for all the major brands.

ICOM - YAESU - KENWOOD - ALINCO

TEL/FAX: 01925 229881/2

We are 1 mile from J23 M6,  
4 1/2 miles off J9 M62



38 Bridge Street, Earlestown, Newton le Willows, Merseyside WA12 9BA

## CORNWALL

### For All Your Marine Radio Communications

Try us first for all your Radio  
amateur and marine  
communications

ICOM YAESU NAVICO JAYBEAM

Give Mike G1DDK a call today!

SKYWAVE MARINE SERVICES, SQUARE SAIL BOAT YARD, CHARLESTOWN HARBOUR, ST AUSTELL, CORNWALL. P25 3NT. TEL: 01726 70220

## SCOTLAND

### JAYCEE ELECTRONICS LTD

20 Woodside Way, Glenrothes  
Fife KY7 5DF  
Tel: 01592 756962

NEW OPENING HOURS:

Tues-Fri 9 am to 5 pm, Sat 9 am to 4 pm. Closed Sunday & Monday  
Good range Kenwood, Yaesu & Icom etc, plus quality secondhand equipment

PLEASE MENTION  
HAM RADIO  
TODAY  
WHEN REPLYING  
TO ADVERTISEMENTS

### £50 BT INSTRUMENT FOR ONLY £7.50

We refer to the BT insulation tester and multi-meter with which you can read insulation directly in megohms, AC volts up to 230, 4 ranges of DC volts up to 500, 3 ranges of millamps and one 5A range and 3 ranges of resistance. These are in perfect condition, have had very little use, if any, tested and fully guaranteed. Complete with leads and prods £7.50, Order Ref 7.5P4. Carrying case which will take small tools as well, £2 extra. Postage £3 unless your order is £25 and over.

J & N Factors

Dept HRT, Pilgrim Works, Stairbridge Lane, Bolney,  
Sussex, RH17 5PA  
Telephone: (01444) 881965

## KENT

### KANGA QRP KITS

Our books: Introducing QRP £7.95  
Pascoe's Penny Pinchers £5.95  
(All about wire antennas)  
QRP crystals from £1.00

Send an SAE now for our free Catalogue to:

Seaview House, Crete Rd East, Folkstone, Kent CT18 7EG  
Tel/Fax 01303 891106 (0930-1900)  
<http://www.kanga.demon.co.uk>

## CAMBRIDGE

### CAMBRIDGE MULTICOMM 2000

- Wide range of new and used equipment always in stock
- International mail order service
- Fast friendly service

Unit 3, 86 Cambridge Street,  
St Neots, Cambridgeshire

PE19 1PJ

Tel: 01480 406770

## CHARITY RADIO

### CQ CHRISTIAN AMATEURS!

The World Association of Christian Radio Amateurs and Listeners actively promotes Christian fellowship worldwide, regular nets, activity days, Annual Conference, handbook, magazine etc. Call our UK Sunday 55B nets 3747 kHz at 8am and 2pm, or 144.205 MHz at 3pm.



For full info write to our  
Membership Secretary  
WACRAL  
51 Alma Road, Brixham,  
South Devon TQ5 8QR

See Web [HTTP://www.GOPPOQ.DEMON.CO.UK/](http://www.GOPPOQ.DEMON.CO.UK/)

## VALVES



### WILSON VALVES

(PROP JIM FISH G4MH)

Over 50,000 valves stocked,  
2000 different types,  
vintage, military, audio, etc.

Fast service. Send SAE for list

VALVES WANTED FOR CASH

28 Banks Avenue, Golcar, Huddersfield,  
West Yorks HD7 4LZ  
Tel: 01484 654650  
Fax: 01484 655699



## HOLIDAYS

NORTH WALES HOLIDAYS -  
Caravan - bunkhouse - camping.  
Elevated rural site, two miles  
from beach, use of shack and  
antennas, open all year, Tynrhos,  
Mynytho, Pwllheli. Tel: 01758  
740712. Packet GW4VAG@  
GB7BAY#55.GBR.EU

# advertise hrt

To advertise in

# Ham Radio Today

Phone 01202 777852 Fax 01202 317902

Email: [adman@mcmail.com](mailto:adman@mcmail.com)

## advertiser index

Amateur Electronics .....	57
Amateur Radio Communications .....	57
GWM Ltd .....	49
Harlow Rally .....	51
ICOM UK Ltd .....	IBC
Jaycee Electronics .....	57
Kanga QRP Kits .....	57
Leicester Radio Rally .....	49
Lowe Electronics Ltd .....	IFC
Martin Lynch & Son .....	32, 33
Multicomm 2000 .....	57
Radio & Telecomms School .....	51
Ronal Computers .....	51
Radio Society of Great Britain .....	18, 50
RSGB Scottish Convention .....	18
Skywave of Cornwall .....	57
SRP Trading .....	14, 15
Sussex Amateur Radio Fair .....	51
The Shortwave Shop .....	51
Waters & Stanton .....	28, 29
Woburn (National Mobile Rally) .....	48
Yaesu (UK) Ltd .....	OBC

# Ham Radio TODAY

## publication dates

Make a note of these dates so that you can be the first with all of the news, reviews and features in Ham Radio Today.

Issue Date	Publication Date
August	Wednesday 8 July
September	Wednesday 5 August
October	Wednesday 9 September

**Don't Miss Out - Place a regular order with your newsagent.**

Dear Newsagent, Please deliver / save me a copy of *Ham Radio Today* magazine every month.

Name: \_\_\_\_\_

Address: \_\_\_\_\_

Ham Radio Today is available from: Comag Magazine Marketing, Tavistock Road, West Drayton, Middlesex UB7 7QE. Tel: 01895 444055. Fax: 01895 433602. ISSN No 0269-8269

# Ham Radio TODAY

## contact information

**Ham Radio Today Editorial:** RSGB Publications, Lambda House, Cranborne Road, Potters Bar, Herts, EN6 3JE. E-mail: [hrt@rsgb.org.uk](mailto:hrt@rsgb.org.uk). Tel. 01707 853300. Fax 01707 645105.

**Ham Radio Today Advertising:** Malcom Taylor Associates, PO Box 3241, Bournemouth BH8 8WT. E-mail: [adman@mcm.com](mailto:adman@mcm.com) Tel: 01202 777852. Fax: 01202 317902.

### regular contributors:

**Data Connection:** Chris Lorek, G4HCL. E-mail: [g4hcl@qsp73.demon.co.uk](mailto:g4hcl@qsp73.demon.co.uk). Packet: G4HCL@GB7SUN. #48.GBR. EU. Post; via Editor.

**HF Happenings:** Don Field, G3XTT. E-mail: [g3xtt@lineone.net](mailto:g3xtt@lineone.net). Post: 105 Shiplake Bottom, Peppard Common, Henley on Thames, Oxon RG9 5HJ.

**Net Communication:** Jeremy Boot, G4NJH. E-mail: [asperges@innotts.co.uk](mailto:asperges@innotts.co.uk). Post: via Editor.

**QRP Corner:** Dick Pascoe, G0BPS. E-mail: [dick@kanga.demon.co.uk](mailto:dick@kanga.demon.co.uk). Packet: G0BPS@GB7RMS. Post: Seaview House, Crete Road East, Folkestone CT18 7EG.

**Satellite Rendezvous:** Richard Limebear, G3RWL. E-mail: [g3rwl@amsat.org](mailto:g3rwl@amsat.org). Post: via Editor.

**VHF/UHF Message:** Geoff Brown GJ4ICD. E-mail: [equinox@itl.net](mailto:equinox@itl.net). Post: TV Shop, Belmont Road, St Helier, Jersey, Channel Islands. Tel/Fax 01534 877067.

### subscriptions:

**Subscription rates:** 12 issues (1 year) - UK £26.50. Europe and Eire £36.50. Rest of the World (surface mail) £38.50, (airmail) £54.00. Cheques should be drawn on a UK bank and made payable to the Radio Society of Great Britain. Available from: RSGB Publications, Lambda House, Cranborne Road, Potters Bar, Herts, EN6 3JE. E-mail: [subscriptions@rsgb.org.uk](mailto:subscriptions@rsgb.org.uk). Tel. 01707 853300. Fax 01707 645105.

### Back Issues:

Back issues are normally available for the last twelve months, at £3.20 per issue inc post and packing. Please telephone or E-mail first to check availability of the issue you require. Cheques should be drawn on a UK bank and made payable to the Radio Society of Great Britain. Available from: RSGB Sales, Lambda House, Cranborne Road, Potters Bar, Herts, EN6 3JE. E-mail: [sales@rsgb.org.uk](mailto:sales@rsgb.org.uk). Tel. 01707 659015. Fax 01707 645105.

### Article Photocopies:

If the back issue you require is not available, we can photocopy individual articles for you. The cost is £2.75 for the first article, and £2.00 for follow-up articles. Multiple parts count as separate articles. Post and packing is £1.25 (UK) and £2.00 overseas by surface mail. *Note: when requesting photocopies, please specify Ham Radio Today and give the article title and which issue it appeared in.* Cheques should be drawn on a UK bank and made payable to the Radio Society of Great Britain. Available from: HRT Photocopy Service, RSGB Sales, Lambda House, Cranborne Road, Potters Bar, Herts, EN6 3JE. E-mail: [sales@rsgb.org.uk](mailto:sales@rsgb.org.uk). Tel. 01707 659015. Fax 01707 645105.

### Ham Radio Today Distribution:

UK newstrade distribution by Comag Magazine Marketing, Tavistock Road, West Drayton, Middlesex UB7 7QE. Tel. 01895 444055, Fax. 01895 433602. Overseas and non-newstrade sales by RSGB Sales, Lambda House, Cranborne Road, Potters Bar, Herts, EN6 3JE. E-mail: [sales@rsgb.org.uk](mailto:sales@rsgb.org.uk). Tel. 01707 659015. Fax 01707 645105.



ICOM

# IC-706MkII - the mobile that just keeps on moving on!

ICOM's latest IC-706MkII pushes mobile communications even further the road!

**Exciting NEW Options:**

- UT-106 DSP Receive Unit.
- AH-4 Automatic Antenna Tuner.

**Other Great Features:**

- Crossband Split.
- Band stacking register memorizes preamp/attenuator settings and tuner on/off condition as well as frequency and mode.
- 'S' menu has 3-band quick access.

- Enhanced 30kHz~200MHz broadband all-mode receive.
- Slots for 2 optional crystal filters.
- Tone-squelch available (option UT-86 required).

- Sub dial for easier access to RIT/second VFO.
- 20 watts on 2 meters and individual band change key.
- Narrow FM deviation is set for 2.5kHz, ideal for new 12.5kHz channels.

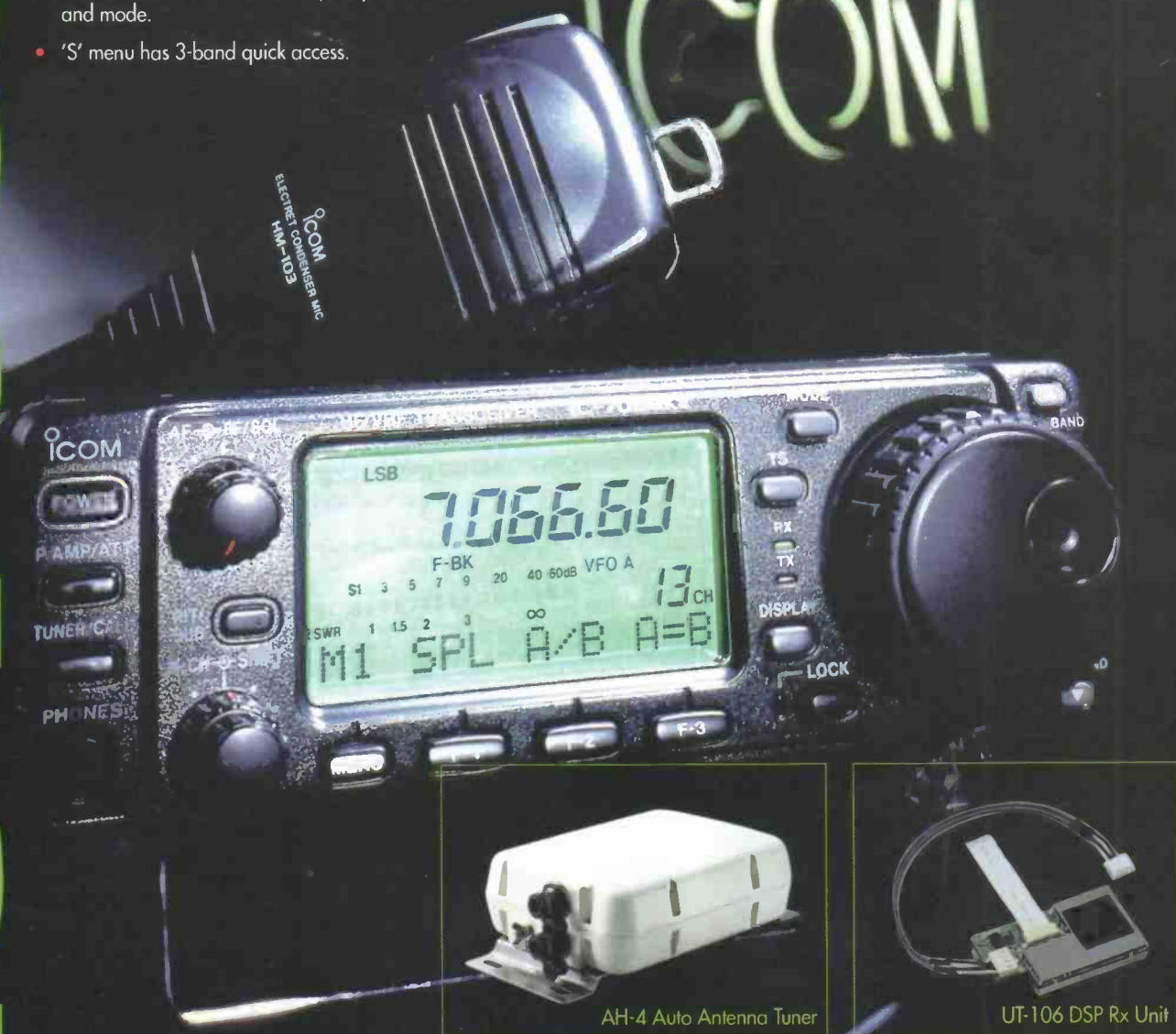

Icom (UK) Ltd. Sea Street Herne Bay Kent CT6 8LD. Telephone: 01227 741741. Fax: 01227 741742.  
internet: <http://www.icomuk.co.uk> e-mail: [icomsales@icomuk.co.uk](mailto:icomsales@icomuk.co.uk)

**Count on us!**

# FT-847

Ultra-Compact Satellite  
and All Mode Transceiver

## FEATURES

- All band performance (SSB, CW, FM, AM)
- 100 Watt output on HF/50MHz bands
- 50 Watt output on 144/430 MHz bands
- Cross-band full Duplex operation
- Normal/Reverse tracking for satellite operation
- CTCSS & DCS encode/decode built-in
- High resolution 0.1Hz tuning steps for ultra smooth tuning
- Digital Signal Processing filters (Bandpass, Notch, Noise Reduction)
- Simplified tuning with Shuttle Jog control
- Direct frequency keypad entry
- Dedicated satellite memories, with 8-character Alpha Numeric Labels
- TX Freq. (MHz): 1.8 - 50 (amateur band) 144-146/430-440
- RX Freq. (MHz): 0.5-30/50-54 108-174/420-512
- Emission modes: LSB, USB, CW, AM, FM, PACKET(9600/1200bps: External input.)
- Freq. Steps(Min): 0.1Hz for SSB and CW 10Hz for AM and FM
- Modulation Types:
  - SSB: J3E Balanced, filtered carrier
  - AM: A3E Low-level (early stage)
  - FM: F3E Variable reactance
  - FSK: J1D, J2D, F2D Audio frequency shift keying (external input), F1D Frequency shift keying (V/UHF: external input)
- Options:
  - FC-20 Automatic Antenna Tuning Unit (External)
  - FVS-1A Voice Synthesiser
  - ATAS-100 Active Tuning Antenna System

## 4 into 1 does go!

Technology moves inexorably onward, evolving, adapting, forever changing. At the same time, today's Radio Amateur puts even more demands upon designers to build quality, sophisticated, but easy to use stations for Voice, Packet, Satellite, CW, VHF, UHF, HF, just to mention a few. Yaesu's designers took on that challenge, and following in the footsteps of the revolutionary FT1000, FT1000MP and FT920 are now proud to offer today's Radio Amateur the station in a box - the all new FT-847!

The Yaesu FT-847 Ultra-Compact Satellite and All Mode Transceiver has jumped the technology with a transceiver ready for the new millennium. With it's high-tech design

and revolutionary features, the FT-847 is truly the one radio that can do it all! Massive band-width coverage from a single unit, the FT-847 has many features to keep it at the top of the evolutionary pile. These include crystal clear 100 watts on HF and 50MHz, a massive 50 watts on 2 meters and 70cms, Yaesu's effective DSP for bandpass, noise reduction and notch filter, and direct input of frequency on the supplied keypad. Silky smooth tuning with 0.1MHz tuning steps, Cross band and full duplex, CTCSS and DCS encode and decode built in. And for Satellite reception, normal and reverse tracking. A matching ATU (Automatic Antenna Tuning Unit) is also available as an option.

**YAESU**  
...choice of the World's top DX'ers



<http://www.yaesu.co.uk>

Specifications subject to change without notice. Specifications guaranteed only within amateur bands. Some accessories and/or options are standard in certain areas. Check with your local Yaesu dealer for specific details.

### FT-920

The highest performing HF 6 meter rig in its price class with Yaesu's renowned Omni-Glow™ display

