

# THE HAM RADIO TODAY

Incorporating  
**SCANNERS**  
INTERNATIONAL

MARCH 1991

£1.60

BN

'M' Band  
Westminster  
Conversion  
to 2m

London  
Show Guide

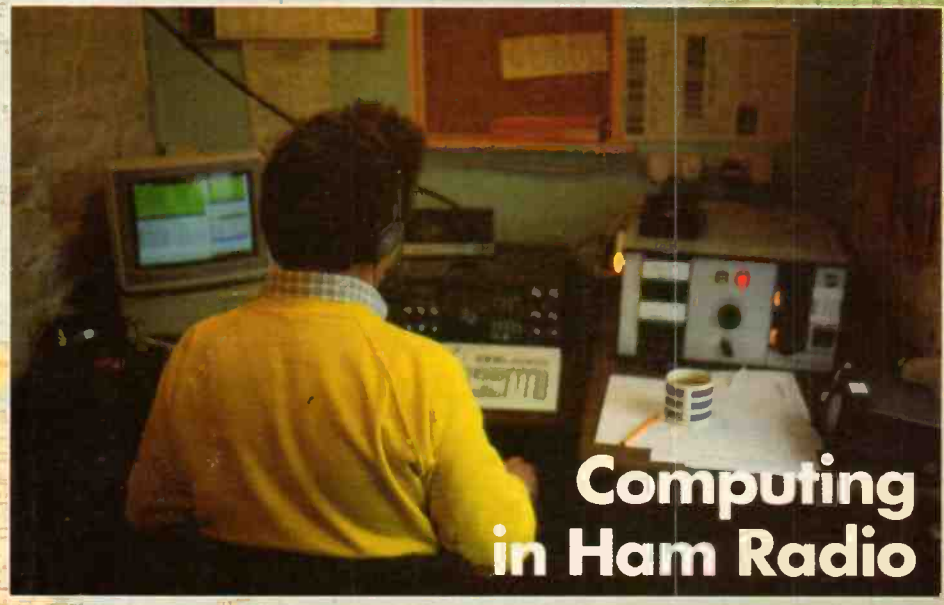

Computing  
in Ham Radio

**KENWOOD  
TH-77E  
REVIEWED**

DXCC Countries List (1987)

**WORLD PREFIX MAP**  
Published by the Radio Society of Great Britain  
Lambda House, Cranborne Road, Totton, Hampshire EN6 3JW.

The new WorldPrefix Map is a 25 degree longitude by 10 degree latitude map. This is divided into 25 by 10 grid of squares. A number is printed in the middle of each square. Using these numbers you can find the 10 by 10 grid and have a rough estimate of the 25 by 25 sub-grids. Thus, the city of London has the number 2025P. Note the map shows 10 degree bands are shown on the map.

**EUROPEAN  
EXCLUSIVE  
TS-850S**

CDXC Newsletter



AN ARGUS SPECIALIST PUBLICATION

**NOVICE • PACKET • REVIEWS • PROJECTS • SATELLITES**

# RAYCOM BRINGS YOU THE LATEST TECHNOLOGY - FIRST!

SALES HOTLINE 021 552 0073 and HELPLINE 021 552 0051 (Office Hours)  
FULL RANGE OF ICOM, YAESU, BEARCAT, NAVICO, MFJ AND MANY MORE

The **TOKYO HX240** HF Transverter when coupled to an all-mode 2m rig will give you 50 watts on 80 to 10m. RAYCOM have put together this unique unit with the new YAESU FT290R II inc. DC and COAX leads!!!

**SPECIAL THIS MONTH ONLY!!!**  
HX 240 - £229



FT290R II ..... £429.00  
TOKYO HX240 ..... £249.00  
1/2 Size G5RV ..... £ 14.95  
12 Amp PSU ..... £ 59.95  
Nicads & Wall Charger ..... £ 31.30  
**Total regular price ..... £784.20**

**RAYCOM PACKAGE DEAL £699.00**

**YOU SAVE £85.20!!**

## HP100E/AR1000

### FAIRMATE HP100E

Since its launch a few months ago, this has become the UK's most popular scanning receiver. The HP100E covers 25 to 550MHz and 830 to 1300MHz with selectable channel steps of 5, 10, 12½ or 25KHz. You can also program channel steps in any multiple of 5 or 12½ KHz up to 100KHz. With 1000 memory channels arranged in 10 banks of 100 the scanning functions are really versatile.

Three modes are available - AM, WFM and NFM. this means that you can also listen to your local FM radio station as well as Heathrow approach or your local VHF repeater.

If that's not enough, **Raycom** have an exclusive British made shortwave converter. The converter and a small mod are all that's needed to add 200KHz to 30MHz coverage to your HP100E (or your AR1000!)

HP100E/AR1000 ..... £249.00  
SW Converter ..... £59.00  
Modifications ..... £15.00  
**Total regular price ..... £323.00**

**SAVE MONEY - SAVE £24!!**  
**RAYCOM PACKAGE DEAL £299.00**

## THE UK SCANNER EXPERTS

### LATEST NEWS FROM ICOM! WE HAVE THE SCANNER!!!

Demand for the new IC-R1 handheld and the IC-R100 base/mobile scanning receiver is extremely high, with the result that supplies have been sporadic. We are the only dealer in the UK to have consistent supplies of the IC-R1/R100. **RAYCOM's buying power wins!**

IC-R1 500KHz to 1300 MHz ..... £399.00  
IC-R100 500KHz to 1800MHz ..... £499.00

**Ring our hotline now to order your R1 or R100!**  
**Buy it now! e.g. R1 £40 deposit, payments £15/month (APR 36%)**

### OTHER HIGH QUALITY SCANNERS FROM RAYCOM

BEARCAT UBC 50/55XL 66-88/136-174/406-512MHz ..... £99.95  
10 memories, channel review, including **FREE** charger worth £4.95  
BEARCAT BC 70XLT 66-88/136-174/406-512MHz ..... £149.99  
20 memories, full frequency display, with **FREE** car charger kit worth £4.50  
BEARCAT UBC 100XLT 66-88/118-174/406-512MHz ..... £199.99  
100 memories, airband, search, including **FREE** car charger kit worth £4.50  
BEARCAT UBC 200XLT 66-88/118-174/406-512/806-956MHz ..... £229.99  
200 memories, top of the range, including **FREE** car charger kit worth £4.50  
BEARCAT UBC760XLT 66-88/108-174/350-512/806-956MHz MOBILE ..... £229.99  
100 memories, 5 search bands, including **FREE** mains adapter worth £4.95  
JUPITER MVT 5000 Hand-held ..... only £249.00  
25 to 550MHz and 800 to 1300MHz, 100 Memories  
NEW JUPITER MVT 6000 mobile ..... **SPECIAL OFFER £319.00**  
25 to 550 MHz and 800 to 1300MHz, 100 Memories

MANY OTHER TYPES & MODELS STOCKED - SAE FOR DETAILS & USED LIST

## AOR AR-3000



There are many scanning receivers to choose from today but several features make the AR3000 stand out from the others. Frequency coverage is from

100KHz to 2036MHz - **NO GAPS!** It is truly multi-mode, covering WFM, NFM, AM, USB, LSB and CW. Frequency steps are programmable in 50Hz steps from 50Hz to 100KHz (so you do get 9KHz steps on MW). It has 400 memory channels in four banks of 100 so can store all your favourite frequencies and can search through these at 20 channels per second. It can also perform a limited scan in each of the four banks and an accessory socket can control a tape recorder remotely, and a built in clock/timer helps. For computer buffs, full control over all functions is available via a built in RS232C interface. Details of operating protocols are in the manual and best of all, **it's in stock now!!!**  
AOR AR3000 ..... £740.00

## CHARGE IT!

Why not take advantage of the **RAYCOM Credit Card** and spread the payment for that scanner you've always wanted. Example: Yaesu FRG9600 MKV package £70 deposit and £28 per month (APR 36%). Call for a quote and written details! Licensed credit broker.

## YAESU FRG9600



9600 standard 60-905MHz ..... £469.00  
9600 MkII 60-950MHz ..... £499.00  
9600 MkII pack 60-950MHz .. £545.00  
9600 MkV 0.2-950MHz ..... £625.00  
9600 MkV pack 0.2-950MHz ..... £699.00  
Standard to MkII upgrade ..... £ 40.00  
Standard to MkV upgrade ..... £149.00  
MkII to MkV upgrade ..... £129.00  
All packs include PSU and ROYAL 1300 discanel

RAYCOM COMMUNICATIONS SYSTEMS LIMITED, INTERNATIONAL HOUSE, 963 WOLVERHAMPTON RD, OLDBURY, WEST MIDLANDS B69 4RJ. TEL 021-544-6767, Fax 021-544-7124, Telex 336483 IDENTI G.

**RAYCOM**  
COMMUNICATIONS SYSTEMS LIMITED

Telephone 021-544-6767

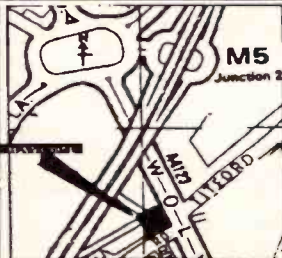

### RAYCOM gives you more BUYING POWER

ALL MAJOR CREDIT CARDS ACCEPTED. BC, ACCESS, DINERS. INSTANT CREDIT UP TO £1000 (SUBJECT TO STATUS) WITH RAYCOM CREDIT CARD (APR 36%). INTEREST FREE CREDIT ON CERTAIN ITEMS AT MRP. CALL FOR MORE DETAILS.

### ORDERING INFORMATION

WE STOCK ICOM, YAESU, BEARCAT, MFJ, BUTTERNUT, CUSHCRAFT, AEA, NAVICO, STANDARD, TEN-TEC AND WELZ AMONG MANY OTHERS. SEND SAE FOR FULL LIST.

TEL: 021-552-0073

PHONE BEFORE 4PM FOR NEXT DAY DELIVERY BY COURIER (£15.00) - OR 2PM FOR DELIVERY BY POST (£10.00). PLEASE ALLOW TIME FOR CHEQUES TO CLEAR. MANY OTHER ITEMS IN STOCK. PLEASE CALL FOR MORE INFO AND FOR EXTRA SPECIAL DEALS!

INFOLINE 0836-771500 5-9pm (weekdays)

OPENING HOURS 9-5.30 MON TO SAT.  
73 DE RAY GAKZ4, TOM G6PZZ  
COLIN and JOHN on the hotline.

# HRT CONTENTS

## HAM RADIO TODAY

VOLUME 9 NO 3 MARCH 1991

Editor  
Sheila Lorek, G8IYA  
Consultant Technical Editor  
Chris Lorek BSc (Hons) AMIEE G4HCL  
Technical Illustrator  
Jerry Fowler

Editorial Address:  
PO Box 73, Eastleigh, Hants, SO5 5WG  
Tel. 0703 262105  
(Mon-Sat, 9.30am-8.30pm)  
Fax. 0703 263429 (24hrs)

Creative  
Design Manager; Peter Kirby  
Designer; Sally Stray  
Photographer; Manny Cefai

Advertising  
Advertisement Manager; Kaye Ellis  
Advertisement Sales; Donna Wells  
Advertisement Copy Control;  
Anne-Marie Quilter

Management  
Managing Director; Terry Pattison  
Circulation Manager; Debra Stuppel  
Group Editor; Mark Webb  
Group Advertising Manager;  
Sharon Shaw



Ham Radio Today, ASP Ltd  
Argus House, Boundary Way,  
Hemel Hempstead, Herts HP2 7ST  
Tel. 0442 66551  
Fax. 0442 66998

Printed in Great Britain by Acorn Web  
Offset, Bradford

Subscriptions and back issues:  
Ham Radio Today Subscription Dept,  
Select Subscriptions Ltd, 5 River Park  
Estate, Berkhamsted, Herts HP4 1HL  
Tel: (0442) 876661/4

Subscription rates:  
UK £19.20, Europe £24.00,  
Middle East £24.35, USA \$48.00  
Far East £26.70, Rest of World £25.75  
Airmail rates available on request.

USA Subscription Agent:  
Wise Owl Worldwide Publications,  
4314 West 238th Street,  
Torrance CA90505

Member of the  
 Audit Bureau  
of Circulation 

Ham Radio Today is normally published on the first Friday in the month preceding cover date. The contents of HRT including all articles, designs, plans and photographs and all copyright and other intellectual property rights therein belong to Argus Specialist Publications Ltd. All rights conferred by the Law of Copyright and other intellectual property rights and by virtue of international copyright conventions are specifically reserved to Argus Specialist Publications and any reproduction requires the consent of the Company © 1990 Argus Specialist Publications. All reasonable care is taken in the preparation of the magazine contents, but the publishers cannot be held legally responsible for errors. Where mistakes do occur, a correction will normally be published as soon as possible afterwards. All prices and data contained in advertisements are accepted by us in good faith as correct at the time of going to press. Neither the advertisers nor the publishers can be held responsible, however, for any variations affecting price or availability which may occur after the publication has closed for press.

### REGULAR COLUMNS

<b>QRP CORNER</b> .....	34
G0BPS shows us how to make the 'OXO' transmitter	
<b>FROM MY NOTEBOOK</b> .....	41
Geoff Arnold looks at block diagrams	
<b>SATELLITE RENDEZVOUS</b> .....	44
Richard G3RWL gives an update on the satellite scene	
<b>PACKET RADIO ROUNDUP</b> .....	46
G4HCL with the latest on keyboard comms in amateur radio	
<b>HF HAPPENINGS</b> .....	48
Don Field joins HRT to bring us the latest HF DX news	
<b>VHF/UHF MESSAGE</b> .....	50
Ken Ellis G5KW tells us of pioneering work on VHF	
<b>FREE READERS ADS</b> .....	55
Bargains galore	

### REVIEWS

<b>KENWOOD TS-850S REVIEWED</b> .....	12
European Exclusive, the latest Kenwood HF transceiver	
<b>IF-100 SATELLITE TRACKER REVIEW</b> .....	18
The first of our 'Computing in Radio' series	

### FEATURES

<b>LONDON SHOW GUIDE</b> .....	29
<b>SCANNERS INTERNATIONAL</b> .....	35
<b>AMATEUR TELEVISION</b> .....	52
G8ZYZ details 70cm TV and G60KB details 24cm ATV reception	

### PROJECTS

<b>PYE WESTMINSTER CONVERSION</b> .....	25
G4HCL converts the M band Pye Westminster to 2m	
<b>AUDIO PROCESSOR</b> .....	39
G4NLA describes the Audio Peak and Notch filter sections	

### NEWS AND VIEWS

<b>EDITORIAL</b> .....	5
Do we progress forwards or backwards?	
<b>LETTERS</b> .....	6
Repeater groups to pay more repeater charges	
<b>RADIO TODAY</b> .....	8
RAE courses, QSL cards and a new 50MHz handheld	
<b>CLUB NEWS</b> .....	52
Friendly faces waiting to meet you	
<b>RALLIES</b> .....	53
Where to meet more friendly faces	
<b>SUBSCRIPTIONS</b> .....	43
<b>ADVERTISERS INDEX</b> .....	55
<b>BACK ISSUES</b> .....	57

*Due to space limitations beyond the Editor's control, it has been necessary to hold some planned features over to next month's HRT, including the TH-77E handheld review. We're sorry about this, and we'll try to squeeze it all in for next month's bumper issue!*

**FOR ALL YOU BUDDING  
SCANNING ENTHUSIASTS!  
A very special message**

We have just published our very latest FREE CATALOGUE containing some very exclusive frequency listings. Everything from 25MHz to 2000MHz is contained within this catalogue.

Send today for this very special catalogue which is both reliable and a lot cheaper than any possible competition. Also included with all orders, a superb info pack which includes among other items reviews and tests on the latest scanner imports.

Our lists are not available from any other source. We also buy and sell all types of radio equipment including hand-helds and aeriels.

All orders dispatched by return post. To order our free catalogue write to:

**RADIO DATA SYSTEMS**  
P.O. Box No. 1135, St Osyth, Clacton-on-Sea, Essex CO16 8PY  
Enclosing large SAE

**ENTERPRISE  
RADIO APPLICATIONS  
LTD.**

ERA LTD  
5 CLARENDON COURT  
WINWICK QUAY  
WARRINGTON WA2 8QP  
Tel: (0925) 573118

Price £99.50

**BP34**  
The BP34 audio filter helps you hear weaker stations by eliminating adjacent channel & wide band noise interference. A must for SWLs/Contest groups/CW operators/Weather Fax users.  
Easy to connect & use but despite its apparent simplicity, the BP34 has the highest performance specification of any filter you can buy. Exceptionally sharp cutoff, 80dB of stopband rejection & less than 0.3dB passband ripple makes the BP34 more versatile than a whole set of expensive crystal filters.

SEE REVIEW PW SEPT 85

**MKII MICROREADER**  
£154.95

The Microreader is a small compact unit that allows anyone equipped with a suitable SW receiver, to read Morse & RTTY signals simple and without fuss. No computers, interfaces or program tapes are needed, just connect the Microreader to the ear or speaker socket & switch on. The decoded words appear on the built-in 16 character LCD display screen.  
The Microreader contains all the filtering & noise blanking needed to allow reception even under bad conditions. A three colour bargraph tuning indicator makes precise tuning simple, while shift indicators take some of the guess work out of RTTY. Despite the fact the Microreader contains two fast processors (12MHz), it is extremely quiet generating virtually no RF. The Microreader can also if you wish, transfer the decoded messages to any printer, computer or terminal unit equipped with an RS232 port.  
In the tutor mode, the Microreader will send random groups of characters with variable speed & spacing, or plug in your own Morse key to check you're sending. In both cases the characters are shown on the display.  
The MKII Microreader comes complete with audio lead & demonstration tape. Full technical support & advice upgrade service.

**K. W. COMMUNICATIONS  
LIMITED**

**COMMUNICATIONS CENTRE,  
CHATHAM ROAD, SANDLING, NEAR MAIDSTONE,  
KENT ME14 3AY**

Visit "The Emporium" at Sandling (near M20/A229 turnoff) or fast delivery by our mail/phone order service.

Visa/Access/MasterCard

ALL YOUR REQUIREMENTS UNDER ONE ROOF

We stock:

TenTec, Kenwood, Icom, Yaesu, Navico — HF/VHF/UHF Transceivers

Kenwood, Icom, Yaesu, Lowe — Receivers

TenTec, Kenwood, Amp, Icom, Yaesu — Linear Amplifiers

Butternut, CushCraft, Hy-Gain, Jaybeam, CTC, KW — Antennas

MFJ, TenTec, Kenwood, Icom, Yaesu, KW — Antenna Tuners

Accessories:

Antenna Switches, Dummy Loads, Power Supplies, Wire, Cables,

Hardware, Keys and Keyers, Microphones, KW Trap Dipoles,

G5RV's, Insulators, Test Meters, VSWR/Watt Meters, Plugs,

Sockets, Baluns, Books (RSGB-BABANI), etc etc.

**WRITE OR PHONE STATING YOUR INTEREST AND WE SHALL  
BE PLEASED TO SEND PRICE LIST AND BROCHURES.**

Phone: (0622) 692773 Fax: (0622) 764614

Telex: 965834

**LOWE — AT PICKETTS LOCK FOR TWO DAYS  
— LOCAL TO LONDON EVERY DAY**

To further improve our service to radio amateurs and short wave listeners in the London area we have recently opened a new Lowe Communications Centre by Heathrow. This is in addition to our well-established Amateur Radio Centre at Eastcote. Both these centres have ample free parking and are designed to be comfortable places to visit and chat about things radio — technical and non-technical! Places where you have time and space to see, transmit, listen and compare before deciding whether or not to buy. We hope you'll drop in and enjoy the warm welcome we look forward to offering you.



TS-850S

**LOWE ELECTRONICS LTD**

6 Cherwell Close, Langley, Slough, Berks SL3 8XB  
Telephone: 0753 45255

223/225 Field End Road, Eastcote, Middx HA5 1QZ  
Telephone 081-429 3256



TH-27E



TH-77E



TH-26E

In the meantime, please come and say hello to us at the London Amateur Radio Show at Picketts Lock on March 9/10. We will be on Stand M in South Hall where amongst other things (too early to mention!) will be the new, superb quality NRD-535 receiver from JRC and the TS-850S from Kenwood. We will also have available a wide range of HF and VHF transceivers from Kenwood, the AOR range of receivers and a wide choice of really attractive handhelds. Plus, of course, those nice little extras which, when you buy, make you feel like the cat that's been at the cream!

# CQ de G8IYA

Right now, we're seeing a new era of communication. The UK public think nothing of using a small box to talk to people on the other side of town, or the other side of the World. Hand-held communicators aren't very far away, with plans already in hand for DSRR (Digital Short Range Radio). Low cost Personal Emergency Locator Transmitters will help injured hikers and the like get immediate rescue through automatic satellite relays, and elderly people can be assured of help through the use of cordless transmitters if they fall ill or become injured in their homes. But what would have happened in, say, the middle ages if someone like myself were to have been able to use a device to communicate with people long distances away — "Burn Her" would have been the shout of the witch hunting party!

Through time we progress, normally for the better, if it was generally accepted as being for the worse we

exploring different propagation methods which we never thought possible. Sounds just like the old days!

Many amateurs lead the world in radio communication technology, Argus Specialist Publications (those nice people who bring you Ham Radio Today and other radio and Electronics magazines) of course being pioneers in 'Wireless' publishing in the UK. Remember, it was ASP who published wireless articles right from the beginning of this century, and it is to our credit that other magazines decided to also follow our pioneering lead. Don't let anyone kid you otherwise! Through the pages of HRT, we're proud to be carrying on our pioneering tradition, as well as providing you with the articles you want! Other amateur organisations around the World, from 'wealthy' and 'third world' countries, have started catching onto this, and we're now proud to be allowing them to reproduce articles from HRT.



a bit more difficult with a VFO.

Add a single amplifier stage, such as a VN66AF MOSFET for HF, or a low cost block PA module for VHF/UHF, and you have a complete transmitter. We've already got such a system lined up for a forthcoming HRT project, I wonder who else will again follow our pioneering lead in this? Remember where you read it first. We don't need to go backwards to make things simple, especially for newcomers to the hobby.

## *The G8IYA Editorial — Do we progress forwards or backwards?*

wouldn't be doing it, would we? That's why we don't still live in caves. As the forthcoming WARC conference approaches, many groups are looking at our frequencies with envy. With recent proposals to 'sell' the spectrum in the UK, at several thousand pounds per 12.5kHz channel on VHF/UHF, how much do you think 2m and 70cm would be worth to the commercial lads? The VHF private mobile radio band in the London area is already full up, anyone requesting a channel for their business is simply being told 'Sorry, there's no room left'. Makes you think, doesn't it? But wait a minute, let's have a look at 2m. What are all these funny noises around 144.650MHz? Oh — that's packet radio, the type of communication amateurs pioneered to show us that World-wide error-free radio communication is possible using portable equipment. What's this around 145.825MHz? Ah, that's one of the many amateur micro-satellites which have been put together using 'modular' techniques and placed into Low Earth Orbit, yes they're the type which are being considered for use with the next generation of portable communicators for the public. 6m? Not much use for reliable communication that, let's give it to the amateurs so they can see what they can do with it. Oh look, they're

### Simple Gear

'Simple' doesn't always mean 'backward'. Let's take an example of a tunable transmitter. Two ways of going about this are the 'traditional' way of VFO control, or that of a frequency synthesiser, many amateurs building a rig may think the VFO approach is the simpler of the two. But let's look again. We need a decent quality variable capacitor, together with a well made, mechanically stable coil. Then add some band switching with crystal mixers and the like or possibly switched coils (remember the switches together with the wiring to these must also be mechanically sound). Then we come to the alignment, dial calibration and the like to make sure we know what frequency we're on so as not to operate on frequencies we're not supposed to. Now let's take a frequency synthesiser. We connect a crystal, half a dozen resistors and capacitors, and a few cheap switches to a single IC. We have a rock-stable system with no alignment needed, the whole thing probably costing around half that of the coil/capacitor VFO. Junk box components you say? My junk box is full of synthesiser bits from old CB rigs. Alignment? Well all I need to do is tune a coil or capacitor until an LED lights, if it doesn't I know the synthesiser is operating out of band, it's

### Computing in Radio

It won't have escaped the notice of many amateurs that computers are playing an increasingly larger part in Ham Radio. With this in mind, HRT will be featuring several uses of a PC to add to radio communication, such as an introduction to Logging programs by Don Field G3XTT, and a review of an automatic amateur-designed satellite tracking system for Oscar communication use. This can make satellite use even simpler! If you're visiting the London Show, on the HRT stand you'll see a 'live' demonstration of the use of computers in radio, so do come and say hello. You'll be able to meet the HRT staff, and we'll again be hosting facilities on the stand for our regular contributors you can meet and chat with them also.

### Welcome Back

This month we welcome back Geoff Arnold G3GSR, who's now recovered after his illness. Geoff has had a widely respected career in amateur radio publishing, and we're proud to have him again contributing to HRT each month. I'm sure we echo the sentiments of our readers in wishing him a continued long career, see you at the London Show Geoff! (he'll be there on the Radio Bygones/Morsum Magnificat stand).

# LETTERS

Dear HRT,

When I first got my ticket I eagerly started to set up a 2m station. I spent nearly 12 months on the band before I decided it wasn't for me, at times I thought it was worse than the 11m band. I decided to take the Morse test and go onto HF, having managed that, I sold all my 2m gear without any regret. Years have passed and because of my job I rarely manage to work HF any more, so I decided to purchase a 2m handheld to travel with.

I had barely had it for a week when I found myself stuck in a major traffic jam which was to delay me for one and a half hours, my sister was to meet me at my destination which was a dark lonely bus station. I could envisage her waiting there alone and possibly being

attacked, so I checked through the frequencies and found G1SJK. I would like to say a big *thank you* to him, he didn't hesitate in phoning my sister to let her know I would be late. This has really put my faith back into 2m, and I realise I may have been too quick to judge the band because of a few idiots who insist on ruining it for everyone. Again thanks to G1SJK for showing the true amateur spirit.  
73's Mick G0EIG

**Editorial comment:**

Well Mick I would also like to thank G1SJK for what he did and I am sure your sister would as well. I can imagine, being a woman myself, what it would have been like waiting all that time on the dark bus station, I know it could have been very

frightening for her. It is nice to hear about the good amateur radio can do and I know there are a lot of people out there who would have done the same. It is a shame we have a minority who with their childish attitude try to spoil it for everyone else. I don't acknowledge them when they are on, as they only carry on more, I would also advise everyone to ignore them and they will get fed up and go away. Acknowledge that they are there and they will carry on, and indeed you break your licence conditions by doing so! Maybe one day things will get better on 2m. As per your request, we'll be sending your £10 award for 'Letter of the Month' direct to G1SJK.

## £10 for the Letter of the Month

Do you have something constructive to say on the state of amateur radio today? Perhaps you'd like to put your viewpoint to the readers, get some discussion going, or give an answer to one of the issues raised? We'll pay £10 for the best letter we publish each month. So write in with your views, to HRT, P.O. Box 73, Eastleigh, SO5 5WG.

Dear HRT,

As a member of a repeater group I feel I should bring to the notice of the many repeater users the recent action taken by the RSGB which has not been reported either in their own magazine or in the GB2RS broadcasts.

In the October issue of a news-sheet circulated by the Repeater Management Group to repeater and beacon keepers, the RSGB announced that it had decided to pass onto the repeater groups the full costs of each repeaters licence fee and insurance, a charge that currently stands at £25 per repeater, per year. I understand that even the Repeater Management Group which is the group that does all the vetting and liaison work, was not consulted by the RSGB on this matter, but was just informed that it was being implemented. Not only have the RSGB decided to levy these charges but it has backdated them to July 1990, and

demanding that groups make the full payment in January 1991.

Repeater groups that have a 2m repeater will probably find it relatively easy to find the money as these often cover a greater geographical area, and hence have large user groups. For those groups who run only 70cm and 23cm repeaters covering single towns and rural areas, the user groups are often small and the income limited.

I feel that the RSGB has not given this matter adequate thought, but as I consider, reacted on impulse to try and solve its own financial problems. For those repeater groups that have already budgeted 1990 funds, and are not due to collect 1991 funds for several months, this situation may cause an ongoing debt problem. I forecast that this will be the last straw for some repeaters, probably the least used will go first, namely 23cm and

above, followed by 70cm. For those of you who rely on beacons, these may start disappearing as well, as these charges also apply to them.

One must ask the question, why did the RSGB pick on repeaters? It costs two persons salaries to run the QSL Bureau. Would it not have been better to charge users of that a fee for cards sent out? I would encourage all repeater groups and users to write with their comments on repeater charges to a member of the Repeater Management Group. I personally intend to continue to support my local 70cm repeater, my £30 RSGB membership will pay its yearly fees. You can't have it both ways RSGB! Doug F Ash, G1BWW.

**Editorial comment**

The running costs of my local 23cm repeater are borne by just two or three people, and the financial state

# 'TONE' BURST



of one of my local 70cm repeater groups is already worrying, hence I can sympathise for such repeater groups. The request for payment of a repeater licence by the group itself could arguably not be unreasonable, as long as it is made clear the RSGB are no longer funding the running of these in any of their publicity material. Some users are under the mistaken impression that all, (quote) "RSGB Repeaters", throughout the country are financed by them, which many of us know is most certainly not the case! The Consultant Technical Editor used to look after a number of repeaters a while ago, these were at one time all in grave danger of being shut down due to lack of finance. Intervention and the production of a regular newsletter combined with fund-raising events by a small number of active enthusiasts not willing to accept such action changed this, and this of course is the way many repeaters groups will need to go. The most important thing to emphasise to the repeater users however, is *who* indeed pays for the repeaters, and what happens when the funds are no longer there! Many FM mobile users would find their expensive rigs sadly lacking without 'the box on the hill'.

Dear HRT,  
I enjoy the packet roundup and other packet articles. Other UK mags either don't bother with much packet or don't have the ability or resources for writers. Packet is a very fast growing area of interest and is poorly catered for. Keep up the good work.  
John G3HTA/GB7WDX Cluster Sysop.

## Editorial comment

Thanks for those kind words John, many of us know that Packet Radio usage is increasing by leaps and bounds, with one typical radio club newsletter showing 30% of their members being active on the mode. As always, we're trying that bit harder to give our readers up to date information on what they like to read about!

Dear HRT,  
With reference to the complaint in your January issue by a reader that a competitor 'overcharged him' by demanding £3 handling and carriage on an item that carried a 30p stamp.

Ham radio retailers are in the main, small concerns with few if any, staff, the proprietors doing most of the work. After the essential business work has been done, (how many hours a week do you think are spent doing calculations and filling in forms just to keep tax, VAT, and DHSS happy?) not much time is left to get down to the basics of earning a living. This time must be costed, as are repairs — something in the range of £20 to £30 an hour if the business is to pay its way without working excessive hours.

No one can be expected to open and read a letter, process the cheque or credit card, make out the paperwork, find and pack the goods and then take them to the post in less than 15 mins. If, therefore, Mr. Briscoe's supplier had *really* charged for the cost of the parcel it would have been more like £6 — £10 plus VAT and not £3 inclusive.

Most of us *do* subsidise postal transactions to some extent, but there is a limit. Why is it so difficult to buy components? Simply because so few

people can *afford* to sell them, I certainly can't! To be honest there is so much ill-informed criticism about carriage and handling charges that on our price list we try and build in a margin to allow for it. If customers would rather pay £39 post paid for an FT101ZD CW filter, than £35 + £4 postage and handling, who am I to argue?

People will always complain whatever you do, but there is a simple answer to those who insist that running your own business is an easy path to riches. You will need £20,000 — £30,000 to start up a ham radio business, so take a second mortgage on your home and get started. I might caution, however, that any fool can sell, but running a business at a profit whilst keeping most of your customers happy is not quite so easy. Still I'll always make your liquidators a low offer for the remains of your stock!  
Harry Leeming G3LLL  
for Holdings Amateur Electronics.

## Editorial Comment;

In last month's issue (which of course 'overlaps' the production of this issue), a further reader had a similar viewpoint on service charges, and we at HRT did a few calculations as to the *real* cost of servicing — it isn't cheap! It's nice to receive a commercial viewpoint confirming this, and it's also nice to still see local dealers offering a personal service and not just being large 'box shifters'. I wonder if you remember a very young SWL (later to become G8IYA) around 17 years ago, buying their very first amateur band receiver from your shop, Harry? Some of us still remember excellent service for many years!

# RADIO TODAY

## Stolen Equipment

Due to a break-in over the period of the 28th/29th November, a quantity of radio equipment was stolen from the Luton area, including;

Yaesu FT 902DM, Serial No. 1H200025

Yaesu FC 902 ATU, Serial No. 1H220210

Yaesu FTV901 Transverter, 70cm, 6m, and 2m modules, Serial No. 9K050644

Yaesu FT901DM Scanning VFO, Serial No. 1C060241

Yaesu Power supply unit, Serial No. 0L060489

Yaesu FT290R and Bnos 30W amp, Serial No. 4F360950

Yaesu world time clock.

F50 30MHz frequency counter.

A reward of £100 on the return of the equipment has been offered by the owner, any information please to Luton Police station on 0582 401212, or indeed any police station.

Also stolen, this time from the Pigs Ear Beer Festival in London recently, a Yaesu FT73R 70cm portable Serial No. 8H350413 complete with leather carrying case and it is in a leather carrying case. Details to Ivor G6URP either through the editorial address or direct on packet @ GB7BIR.

## Test Equipment needed by YAGIS

The members of YAGIS (Young Amateur Group I Scotland) tell us they have

obtained some elderly PMR equipment but have a complete lack of test equipment to tune these radios up with. They are looking for cheap but functioning test equipment, such as a signal generator capable of operating on frequencies to 150MHz or above. They are not too worried about the age of the equipment nor its physical appearance, as long as it can provide a stable variable signal source. If you'd like to help young people to learn about radio by doing, you can contact Hughie GM0HSC either through the editorial address or direct on packet @ GB7SAN.

antique wireless newsheet no. 138

Category	Model No.	Quantity	Price
Amplifier	1A 14	1	10
Receiver	1A 15	1	10
Transmitter	1A 16	1	10
Power supply	1A 17	1	10
Antenna	1A 18	1	10
...	...	...	...



## Antique Wireless News-Sheet

The Vintage Wireless Company who cater for the needs of enthusiasts of early radio equipment send out a regular and very useful newsletter including lists of sales and wants of vintage equipment and parts, their recent newsletter extending to 24 pages. You can contact them at Tudor House, Cossham St, Mangotsfield, Bristol. BS17 3EN, Tel. 0272 565472.

## RAE Course by Mail

Not all readers can get to an evening class to study for the RAE, and self-study from just a book without a structured course isn't to everyone's taste of course. The Rapid Results College tell us that would-be radio amateurs searching for a way to gain their Radio Amateur Licence can study with The Rapid Results College to sharpen their skills before taking the exam. The RRC City and Guilds programme covers both parts 1 and 2 of the syllabus, and prepares

students for the exams which are held in May and December of each year.

The RRC programme covers the following subjects: Licensing Conditions, Transmitter Interference, Operating Practices and Procedures, Electrical Theory, Solid State Devices, Radio Receivers, Transmitters, Propagation, Aerials and Measurement.

If you're interested, tell them you saw their details in HRT when you contact them c/o Robin South, RRC, Tuition House, 27/37 St George's Road, London SW19 4DS. Tel 081 947 2211.

## RADIO BYGONES

No. 8 - Christmas 1990

A RADIO BYGONES COLLECTION IN NORTH YORKSHIRE



The Capture of the Superhet - 1941  
Magnetic Wave Receiving Machine  
Saved by Radio!  
The Evolution of Air-Sea Rescue Transmitters

## Radio Bygones

The latest copy of the bi-monthly magazine 'Radio Bygones' edited by regular HRT contributor Geoff Arnold G3GSR has just landed on the editorial office doormat. Very professionally produced in A4 format with lots of glossy pictures and information of interest to vintage radio enthusiasts, the HRT editorial department (who have been reading it from issue one) always find it an interesting and nostalgic read. The latest issue features the Coming of the Superhet, the First Use of Radio in a Marine Emergency, a feature on servicing equipment of bygone days, and 'Wireless Tales from the Loft' — a heartwarming story of times when wireless was King. Radio Bygones is available on subscription, and you can contact their office on 0202 658474.

## RSGB National Convention

The date for the RSGB National Convention, again held at the National Exhibition Centre near Birmingham, has been announced as the 27th and 28th April this year. Ample car parking will be provided near to the venue, with a courtesy coach ferrying pas-

sengers to and from the exhibition hall. Note that jet-setters will find this occurs at the same time as the Dayton Exhibition in Ohio USA, so you'll have to make up your mind which one to go to! Further details of trade stands, disabled facilities etc. from Norman G3MNV on 0227 225563.



# INTERNATIONAL G4NKH



BUYERS • SELLERS • WANTED  
RADIO & ELECTRONICS  
REGISTER



## Buyers, Sellers, Wanted Register

Brian Smith G4NKH has now started an International equipment register where for a registration fee you can advertise your equipment for sale, or any items you want or would like to exchange. To introduce this service he is providing via HRT £3 vouchers to each person registering, thus reducing the regular subscription from £8 to £5. Regular advertisements will be provided for all the leading radio and electronic magazines, ensuring national and international coverage of his service. A prospective purchaser just sends a 230mm x 100mm SAE to receive their latest list of items available, under the defined specification of receivers, computer equipment, test equipment etc. In addition to the register, there is a QSL card design and customised club or presentation certificate service (and printing) available. For further details contact G4NKH Brian Smith, 42 Arnott Road, Blackpool, Lancashire UK, FY4 4ED. Tel. 0253 62925.

## Got an open system? No, but I know a man who has!

We all know the problem of different computer systems not being able to run machine-dependent software, such as Packet and RTTY programs. Open Systems however allow different types of computer hardware and software from different suppliers to be used together, and recently, Corporate Affairs Minister John Redwood launched an Open Systems Demonstrator project with the Automobile Association.

Mr. Redwood said "This is an excellent example of the competitive advantages to be gained by the introduction of Open Systems. I urge other businesses to learn from the AA and other demonstrator projects and to reap the benefits which are available".

Simon Dyer, Director General of the AA said, "Without Open Systems, we would be operating in handcuffs and could not expect to continue to provide the level of service which our customers have every right to demand." So know you know, there could be light at the end of the tunnel!

## Low Power 50MHz Portable

Icom have recently announced their low power, low cost 50MHz portable, named the IC-Alpha6E. Operating on FM with 5 channels in the 51-54MHz range, it provides typically 50mW output in duplex mode and 150mW output in simplex mode. Measuring 58(W) x 75(H) x 30(D)mm the set weighs 160g

with the three AA nicads internally fitted. Icom tell us in use an operating range of 150-200m in duplex mode and 600-900m in simplex mode is provided. With the latest licence regulations allowing remote control (including 'wireless speaker/microphones') of our amateur stations by using low ERP sets in amateur bands, this set looks rather interesting!



## Glossy postcard style QSL cards

The printing company of Interprint are now offering making new glossy QSL cards, postcard quality in full colour. If you send them the colour picture of your choice (max. size 153mm x 102mm) and a brief description for the

back they do the rest. The cost for the standard cards is £99 per 1000, with variations at extra cost. For further details, tell them HRT told you to contact Interprint, Market Flat Lane, Scotton, Knaresborough, North Yorkshire HG5 9JA. Tel 0423 868011.

# ICOM

See the Full Range of Icom Equipment at Stand S, South Hall at The London Amateur Radio Show 9/10 March 1991

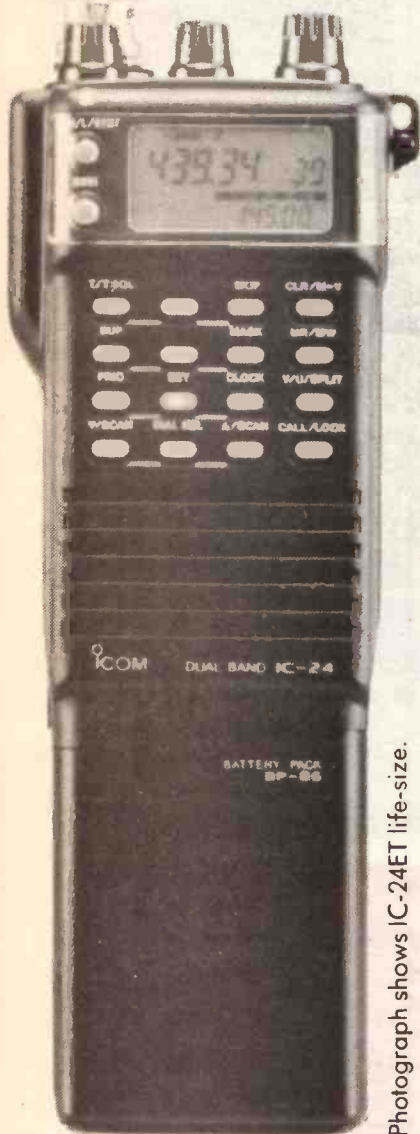

Photograph shows IC-24ET life-size.

## IC-24ET DUAL BAND FM HANDPORTABLE COMPACT, DUAL BAND, AND MULTI-FUNCTIONAL

The demands from discerning Radio Amateurs throughout the world increase as technology breaks new barriers.

ICOM's answer to these demands is the new IC-24ET. One of the most compact dual band transceivers in the world. Designed to fit easily and comfortably in your hand, the transceiver weighs only 340g, and measures just 52(w) x 136.5(h) x 24.5(d) mm.

The IC-24ET is so lightweight but has many features not found in larger bulkier handportables. Make telephone-style calls by using the crossband duplex function, simultaneous transmitting on the 144MHz band receiving on the 430MHz band and vice versa.

Enjoy operating with the many other features which are easily activated via the convenient keyboard. Frequency setting, Band selection, Memories, simplex/duplex scan functions, priority watch clock/timer and many other settings.

By connecting a 13.8v D.C. supply to the transceiver directly a full 5W of output power is available on both bands. A reduced power output occurs when operating with the supplied BP-82 nicad battery pack.

A dual band function display shows operating band frequencies with a lighting function for night operation. The power saver circuit ensures lower current drain during standby conditions and can be programmed without internal modifications.

### Options and Accessories:

- BA-11** Bottom cap
- BC-72E** Desktop charger
- CP-12** Cigarette lighter cable
- HM-46** Speaker/Microphone
- HS-51** Headset
- MB-30** Mounting bracket
- UT-50** Tone squelch (C.T.C.S.S.)

A variety of battery packs and carry cases are also available to suit your operating needs.

For more detailed information on the IC-24ET contact your nearest ICOM stockist.

Datapost: Despatch on same day whenever possible.

Visa & Mastercards: Telephone orders taken by our mail order dept. instant credit & interest free H.P.

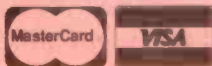

# Count on us!

## IC-726 HF/50MHz ALL MODE TRANSCEIVER HOT ACTION ON THE HF AND 50MHz BANDS

Now that the HF and 50MHz bands enter a period of intensity, conditions for long distance communications have never been better.



The new ICOM IC-726 is a compact, easy to use transceiver which covers the amateur bands from 1.8 to 50MHz. It can be used in your home, car and in portable locations on SSB, CW, AM and FM modes.

With minimal switches and controls enjoy uncomplicated operating for beginners or veterans alike. And ICOM have incorporated their superior DDS (Direct Digital Synthesizer) system, a feature that enhances PLL lock up times. The same feature is built into ICOM's state-of-the-art IC-781 advanced H.F. Transceiver.

Other features include a general coverage receiver, dual VFO's, band stacking registers, attenuator, pre-amp, noise blanker, RIT, memories and much more. R.F. output is 100W on the H.F. band and 10W on 50MHz band from separate antenna sockets.

An optional AH-3 H.F. Automatic Tuner will allow you to operate on the H.F. bands in any location. Just push the tuner switch on the IC-726 and the tuner automatically adjusts for a minimum VSWR. The tuner can match a 12M longwire across the 160-10M bands. Use the weather resistant AH-3

in your car (with AH-2b mount and whip) boat, at home or in the field.

### Options and Accessories:

<b>AH-3</b>	H.F. Automatic tuner
<b>AT-150</b>	A.F. Automatic matching tuner
<b>PS-55</b>	AC power supply
<b>CR-64</b>	High stability crystal
<b>FL-100</b>	CW narrow filter 500Hz
<b>FL-101</b>	CW narrow filter 250Hz
<b>SM6/SM8</b>	Desk microphones
<b>SP7</b>	External loudspeaker

Icom (UK) Ltd.

Dept HRT, Sea Street, Herne Bay, Kent CT6 8LD. Tel: 0227 741741 24 Hour. Fax: 0227 360155



# Kenwood TS-850S Review

*European Exclusive — G4HCL Tests the Kenwood TS-850S HF Transceiver*

Around the world, there is a 'breed' of HF DXer — the type who wants the utmost in performance to winkle out those elusive DX stations. There are, of course, a selection of transceivers produced by the 'big three' to meet this need, with the performance of each increasing with each 'generation'. The latest transceiver from Kenwood in this class is the TS-850S, and here we test the very first sample to have arrived in Europe.

## Features

The TS-850S is indeed rather similar to the TS-950S but without the twin receiver, the TS-850S retaining many of the same features. As with many HF transceivers, the set offers a general coverage receiver and a transmitter restricted to the normal WARC amateur bands. The transmit power provided is 100W, with the set requiring 20.5A maximum from an external 13.8V power sup-

ply such as the Kenwood PS-52. Like the TS-950, you can if you wish add a Digital Signal Processor option to generate the transmit IF signal and provide additional filtering of the 'back end' receiver stages, in this case the DSP unit comes as an optional separate unit with its own case and internal power supply.

## Modes and Filters

Modes of operation provided are LSB, USB, CW, AM, FM and FSK/AFSK, with selectable receiver bandwidths for each. The filters in both the second (8.83MHz) and third (455kHz) IF stages can be selected from those fitted in each stage to provide 12kHz, 6kHz, 2.7kHz or optionally narrower 500Hz and 250Hz bandwidths, apart from FM which just switches in 6kHz and 12kHz bandwidths. Separate concentrically mounted upper and lower 'slope tune' controls are also provided, so you can 'narrow in' the receive bandwidth as needed for when adjacent signal QRM starts coming up. For those who want narrower selectivity, optional 500Hz and 250Hz CW filters may also be added, as well as a narrower 1.8kHz SSB filter added to the second IF. For CW use, a front panel 'pitch' control lets you choose a receive beat note of between 400Hz and 1000Hz in 50Hz steps, the IF filtering and transmit signal carrier injection then being centred on this offset.

## Receiver

The receiver front end uses a pair of switchable paralleled single-gate FETs/ Dual Gate MOSFET followed by a quad-



The TS-850S

rupture single-gate FET mixer stage to provide good strong-signal handling, a front panel 'AIP' (Kenwood's 'Advanced Intercept Point') providing the choice between high sensitivity or around 10dB less sensitivity but better strong signal handling. Cascadable 6dB and 12dB front-end attenuators may also be switched in if the going gets tough. In terms of other QRM-fighting features, as well as the variable slope filtering a tunable IF notch is provided, together with two noise blankers with a variable level control. The first of these is designed for the usual type of impulse interference, the second being a wider type having a variable width control which is designed to reduce the level of Over-The-Horizon radar interference. The AGC may be switched to either Slow/Mod/Fast or indeed completely switched off if you prefer to use the manual RF gain control.

### Transmitter

The transmitter section uses a solid-state PA with its heatsink integral to the transceiver case, an auto ATU is also fitted inside the case which is claimed to match impedances from around 20-150ohms to the 50ohm required by the PA. For CW use, both full and semi break-

in modes are available, and a built-in keyer is also fitted. As well as the usual speed and weight controls, an 'auto weight' mode may also be used, this altering the weighting (i.e. the dot/dash ratio) as you change the keying speed. A built-in speech processor with a variable processing level is fitted for SSB use, and in addition to this a front panel 'high boost' switch adds audio tailoring into your transmitted audio signal to increase the high frequency content of your microphone audio. VOX is provided for automatic transmit/receive switching, and a multi-function meter provides a simultaneous indication of the relative transmit output power together with a choice of the transmit ALC, processing level, or SWR.

### VFOs and Memories

Two digital VFOs are fitted, tuning in selectable steps down to a resolution of 10Hz using either the main front panel knob or the microphone up/down buttons. Split frequency operation between VFOs may of course be used, either for DX working or for 10m FM repeater operation, a sub-tone encoder being fitted for repeater use when needed. Together with this, both RIT and XIT controls are

provided for small offsets between selected receive and transmit frequencies.

100 memory channels are available, and memory channels 90-99 may be used to store upper and lower frequency limits for programmed scan modes. The remainder of the memories may store the operating frequency, mode, filter information, sub-tone frequency data (for FM use), and AIP on/off selection.

### DSP Option

The matching DSP-100 Digital Signal Processing unit may be used with the TS-850S in the home station, this being a separately cased unit which plugs into the transceiver rear panel via four leads, the processor having its own built-in mains power supply. The DSP-100 acts by converting the audio waveform for transmission into a digital signal through the use of A/D converters, from then on microprocessors are used to shape and process the signal. Hence a defined audio response may be achieved together with slightly better carrier and sideband suppression, also on CW and direct FSK the transmitted waveform can be shaped to provide the required rise and fall times of the waveform. On receive, more defined audio filtering can also be achieved by sampling at the IF and performing the digital processing at this stage.

The DSP-100 has switched controls for LF and HF audio tailoring, these being 100/200/300/400Hz and 2600/2750/2900/3100Hz respectively, a pair of In/Out switches being fitted for independent selection of RX, TX, or RX/TX filtering actions. Next to these, a Fast/Slow switch allows you to change between 'Hard' and 'Soft' CW keying by switching between fast and slow rise/fall times of the keying waveform. Round the back, a row of small DIP switches are used to pre-set the various internal functions, and it is interesting to note that a DSB (Double Sideband, Suppressed Carrier) signal can also be transmitted in place of SSB if required.

### Internal Options

A few further options may also be added to the transceiver, including the internal Speech Synthesiser and Digital Recording Unit options. The speech synthesiser upon a press of the front panel 'voice' button announces the memory channel number and operating frequency from the set's speaker, the recording option going one better by letting you record what you'd like the set to transmit for you. The latter acts as a short transmit message store, capable of storing up to 50 CW characters or three short microphone recorded speech mess-



The Front Panel Arrangement

Rear panel connections

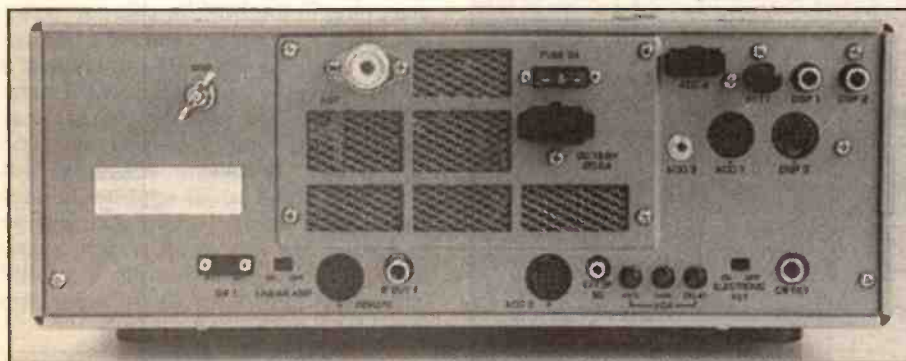

ages.

For transverter use, the set may be internally wired, following instructions given in the manual, for a low-level RF output signal on transmit in place of the existing IF socket with the main aerial connector used on receive. By suitable external wiring of a filtered DC voltage on the low-level output, the set can be remotely switched either to low level output from the rear panel or normal high power transceive operation using the main aerial socket. A possibly useful feature for permanent transverter use is that the set's main display may be pre-set to indicate selectable 50MHz, 144MHz or 430MHz frequencies for VHF/UHF operation instead of indicating the normal HF frequencies in use.

### Connectors

The rear panel of the transceiver has a large number of connectors for the many ancillaries that may be used with the set. As well as the DSP connectors, further sockets are provided for use with a linear amplifier, bandscope, and RTTY/Data terminal units including a direct FSK (Frequency Shift Keying) input. For data use, by suitable wiring of the accessory connector the front panel microphone may be disabled when AFSK is used for Packet, SSTV, Fax etc. A further computer connector allows you to use an external interface to drive the set from your computer's RS-232 port given suitable software.

### In Use

My first thoughts when switching the set on and connecting up were 'what a lovely transceiver'. It is of course often hard to put a 'feeling' across but on having an initial tune around the bands, received signals came and went very cleanly, and when trying to 'home in' on a weak one the bandwidth controls and the like just nicely fell to hand, the result often being an instant Q4 or Q5 copy of a previously Q2 or Q3 signal.

When switching on for an operating session, my normal technique is to tune across the band of interest and have an initial careful look around, entering the various possible frequencies of interest into the receiver memory for later recall, rather than 'hanging on' to just one signal at a time with the possibility of missing other stations. For this, the TS-850 provided a handy 'Quick Memory' storage mode using a button next to the main tuning knob, repeated presses of this storing up to five frequencies into memory for quick recall. Very handy, this saved me several button pushing operations!

A second-function programming mode also exists on the transceiver where many of the pre-set operating features may be 'fine tuned' to your specific requirements, such as the tuning rates for each mode, RIT/XIT range, CW auto-weight function, FSK data tone offsets and the like. One of these functions was the capability of the set's meter to pro-

vide a 'peak hold' in a similar fashion to a hi-fi level meter, the final segment remaining at the peak point for a second or two, this I found very handy to provide a more accurate indication of received strengths and the like.

The auto ATU could also be manually over-ridden using one of these modes, and although I found it would automatically match my outdoor



Easy-to-use tuning controls

verted-L aerial very quickly on the LF bands, use of this on the higher frequency bands normally needed my usual 'manual' ATU. By using the main VFO and 'VFO Ch' knobs as ATU controls, I found that using the internal ATU I could often achieve a reasonable if not perfect match when the automatic ATU had difficulty — there *are* times when a human touch scores!

On transmit, the TX switching I found was disabled at the exact band frequency edges for the UK, for example on 160m the TX started at 1.810MHz rather than 1.800MHz, a nice touch. I found the SSB speech processor gave my signal a useful 'punch' with surprisingly good audio reports, however I found I had to be a little careful when setting up and switching in the DSP function on transmit. Here, if I switched the set's processor off and the DSP-100 on, I found a degree of audio instability (not RF instability) if the mic gain on the set was turned up too much. However switching in the set's processor alleviated this problem, which could admittedly have been 'finger trouble' on my part, with an end result of a very clean, punchy signal that certainly sliced through the QRM (although I'm sure my 400W linear amp may also have helped a little!).

A switchable transmit 'monitor'

### Inside the unit

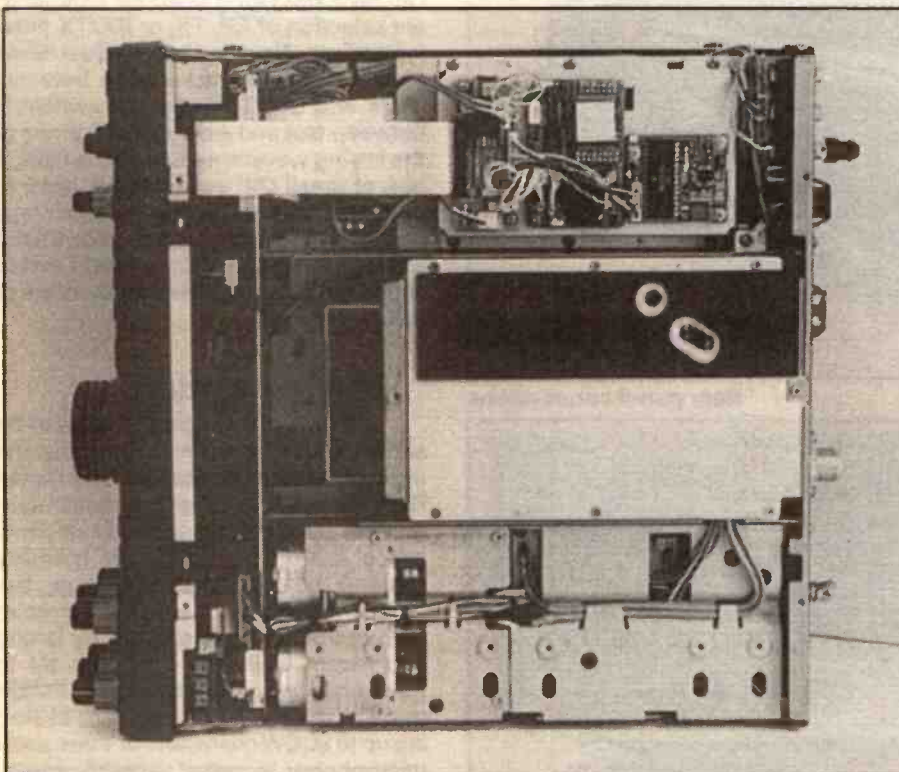

facility was provided, this was useful in letting me hear what my audio sounded like when setting up processor levels and the like, it was also useful when checking the operation of the transmitter digital recording unit when I tried using this for the odd 'CQ' call. Although this optional unit may be useful for contest operators and the like, I found in practice I rarely used it on air. I felt it was a



pity it didn't have the facility to record receive audio, as in my case this would have been a lot handier in ascertaining weak call signs and the like.

I sometimes found that if I didn't place the DSP-100 where it could have a good air circulation, it tended to get rather hot (i.e. too hot to hold) hence it ended up placed on top of the transceiver case most of the time, away from its rear heat outlet and the matching PS-51 13.8V power supply. This however provided a fairly good operating position for it, so I shouldn't complain.

You can't work stations unless you can hear them, and I couldn't fault the TS-850S receiver in this respect. Again, the low and high 'slope tune' controls were very useful in narrowing the receive bandwidth down when needed, and although I could find little difference on the HF side using the DSP-100, increasing the LF cut of this from 100Hz to 400Hz certainly cleaned much of the background 'mush' up on the LF bands. So much so that during one evening on the upper section of 80m using my inverted-L and large 'ground mat' system, stations from JA, VK, and YC0 came through, on receiving the weak YC0 and switching to my roof-mounted wide-band 'shortened' dipole the same signal was still just about there after switching

in various filters in the receiver to reduce the increased QRN level, showing the receiver was doing its utmost.

### Laboratory Tests

I have come to find that with recent HF gear, the receiver performance often stretches the test equipment used for measurements to the absolute limit, this was again the case with the TS-850S. Once I started wondering whether it is the receiver or the signal generator performance that's giving the measured result, then testing again with a further high performance signal generator as a

'check', it was time to resign myself to saying 'yes, it's OK!' and sitting down before wondering whether to bang my head against a brick wall or have a Barcardi and Coke instead. I see I'll soon have to obtain yet more crystal filters to cascade in series with the generator output, maybe combined with a pair of valve power amplifiers to provide larger and larger receive signals for testing in future.

On transmit, the SSB two-tone signal was quite clean, and as found on air, switching in the processor made little difference to the far-out products, i.e. the width of signal, apart from increasing the average speech power of course. A brief test with the DSP also showed little difference here, verifying the transmitter PA was the limiting factor. As may be seen from the results, the transmitter harmonics were well suppressed, unmeasurably so in some cases.

### LABORATORY RESULTS:

#### RECEIVER;

All measurements performed with SSB 2.7kHz bandwidth, 0dB attenuation and AIP off, unless otherwise indicated.

#### Sensitivity;

Input level required to give 12dB SINAD;

Freq. MHz	SSB/CW	FM
1.8	0.09uV pd	—
3.5	0.07uV pd	—
7.0	0.07uV pd	—
10.1	0.07uV pd	—
14.0	0.09uV pd	—
18.1	0.09uV pd	—
21.0	0.08uV pd	—
24.9	0.09uV pd	—
28.5	0.09uV pd	0.17uV pd
29.5	0.09uV pd	0.17uV pd

#### Selectivity;

	CW (500Hz)	SSB (2.7kHz)	AM (6kHz)	FM (12kHz)
-3dB	350Hz	1.39kHz	5.20kHz	7.60kHz
-6dB	440Hz	1.96kHz	6.00kHz	8.40kHz
-20dB	540Hz	2.70kHz	7.80kHz	9.80kHz
-40dB	670Hz	3.02kHz	9.40kHz	12.10kHz
-60dB	970Hz	3.18kHz	11.9kHz	14.20kHz
-80dB	1.35kHz	3.30kHz	14.2kHz	14.70kHz

#### Blocking;

Measured as increase over 12dB SINAD level of interfering signal, unmodulated carrier, causing 6dB degradation in 12dB SINAD on-channel signal, measured at 21.4MHz;

+/- 50kHz;	103.5dB
+/-100kHz;	109.0dB
+/-200kHz;	> 110dB

#### 3rd Order Intermodulation Rejection;

Increase over 12dB SINAD level of two interfering signals giving identical 12dB SINAD on-channel 3rd order intermodulation product, measured at 21.4MHz;

50/100kHz spacing;	96.5dB
100/200kHz spacing;	96.7dB

## Conclusions

Kenwood's latest 'DX machine' looks like it should again provide a high level of performance, as with many 'top range' sets it again stretched my testing capabilities to the limit. As to on-air performance, my initial thoughts of 'what a lovely radio' still stand! The TS-850S without fitted options is due to retail at around £1,300, the cost of the required 13.8V 20.5A PSU adding to this of course with the DSP-100 selling at around £400 if required.

Our thanks go to Lowe Electronics for the loan of the review equipment.

### Image Rejection;

Increase in level of signals at the first IF image frequency, and the first IF itself, over level of on-channel signal to give identical 12dB SINAD signals;

Freq. MHz	Image Rej.	IF Rej.
1.8	102.5dB	>110dB
3.5	97.0dB	>110dB
7.0	97.5dB	>110dB
10.1	101.5dB	>110dB
14.0	108.0dB	>110dB
18.1	106.5dB	>110dB
21.0	108.5dB	>110dB
24.9	>110dB	>110dB
28.5	>110dB	>110dB
29.5	>110dB	>110dB

### S-Meter Linearity

Measured at 14.25MHz;

Indication	Sig. Level	Rel. Level
S1	3.55uV pd	-25.7dB
S3	6.99uV pd	-19.8dB
S5	14.4uV pd	-13.5dB
S7	29.7uV pd	-7.2dB
S9	67.8uV pd	0dB ref
S9+20dB	673uV pd	+19.9dB
S9+40dB	6.22mV pd	+39.2dB
Full	33.1mV pd	+53.7dB

### S-Meter S9 Level;

Freq. MHz	Sig. Level
1.8	83.4uV pd
3.5	49.4uV pd
7.0	53.0uV pd
10.1	52.4uV pd
14.0	86.2uV pd
18.1	70.3uV pd
21.0	67.8uV pd
24.9	87.6uV pd
28.5	54.9uV pd
29.5	54.9uV pd

## TRANSMITTER;

### TX Power;

Freq MHz;	Power;
1.8	104W (18.2A)
3.5	107W (19.1A)
7.0	107W (19.5A)
10.1	107W (19.8A)
14.0	106W (17.8A)
18.1	106W (18.9A)
21.0	106W (17.4A)
24.9	105W (17.8A)
28.5	104W (17.2A)
29.5	103W (17.2A)

### Harmonics;

Freq. MHz	2nd	3rd	4th	5th
1.8	<-90dBc	-67dBc	<-90dBc	-82dBc
3.5	-82dBc	-75dBc	<-90dBc	-76dBc
7.0	-86dBc	-77dBc	<-90dBc	<-90dBc
10.1	<-90dBc	-66dBc	-87dBc	-83dBc
14.0	-69dBc	-80dBc	<-90dBc	<-90dBc
18.1	-78dBc	-81dBc	<-90dBc	-82dBc
21.0	-81dBc	-83dBc	<-90dBc	-82dBc
24.9	-77dBc	<-90dBc	<-90dBc	-83dBc
28.5	<-90dBc	<-90dBc	<-90dBc	-82dBc
29.5	<-90dBc	-87dBc	<-90dBc	<-90dBc

### SSB IMD Performance;

Measured with a two-tone AF signal, as dB below PEP level.

	3rd Order	5th Order	7th Order	9th Order	11th Order
Normal,	-25dB/	-44dB/	-49dB/	-52dB/	-57dB/
ALC onset	-25dB	-45dB	-49dB	-52dB	-57dB
Normal,	-25dB/	-43dB/	-49dB/	-52dB/	-57dB/
Mid ALC	-25dB	-44dB	-49dB	-52dB	-58dB
10dB	-19dB/	-31dB/	-40dB/	-48dB/	-52dB
Processing	-19dB	-31dB	-43dB	-52dB	-53dB
20dB	-18dB/	-31dB/	-38dB/	-47dB/	-52dB/
Processing	-18dB	-30dB	-42dB	-52dB	-52dB





# IF-100 Satellite Tracker

The IF-100 Interface

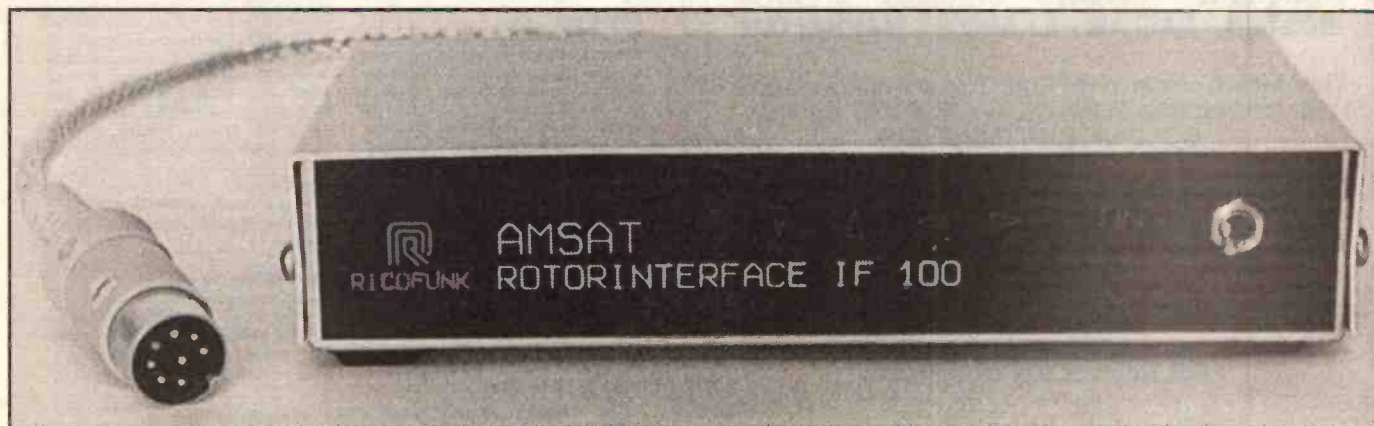

As seen from Arthur Gee G2UK's series of HRT articles on satellite operation, using high-altitude orbiting satellites involves the use of aerials which need to be positioned in elevation (i.e. up and down) as well as in azimuth (i.e. side to side). A computer is often used to determine the azi/ele angles required for a given satellite at any time, and as well as providing the times of access for individual satellites some programs also generate nice-looking maps of the world to show where the satellite is at any given instant, together with the coverage area or 'acquisition circle' given to show where you can communicate to.

## Tracking Programs

For satellite tracking, a typical program may be instructed to provide a list of azi/ele figures over a given operation period, these may of course be used with a standard azi/ele rotator unit by manual adjustment while you're listening to or communicating through the satellite. However, as some software is

## *G4HCL reviews the latest in automatic amateur satellite tracking*

also capable of generating azi/ele angles required in 'real time', a natural extension to this would be automatic control of the rotator. That's right, just tap in the satellite you want to communicate through, the program then shows you when you can do this, and when it's in range it automatically tracks your aerials for you!

## IF-100 Interface

The IF-100 reviewed here is based on the interface initially developed in 1986 for the Atari 800 computer, by Dr. J. Locke DK1HB, a member of AMSAT-DL, with the design published in the AMSAT-DL journal at that time. With the increased use of PCs, Erich DK1TB undertook to modifying the computer pro-

gram to allow the interface circuitry to operate using data from an MS-DOS PC using the Sat-PC program. AMSAT-DL have agreed with the German firm of Stabo-Ricofunk to allow use of the design and to manufacture the interface in an updated and completely solid state form (the earlier design using relays), this being supplied complete with software and ready-made leads as a 'plug-in-and-go' system. The program tested here was Sat-PC, a similar program from the same distributors also being available for the Commodore 64, this also being supplied with ready-made leads etc.

The IF-100 wired-in interface lead plugs directly into the control box of the commonly used G05400B and G-5600B rotators and their direct equivalents from Kenpro. A further supplied lead plugs between the interface and the parallel port on the rear of the PC, this being 2m long to allow convenient positioning. Because an external interface

## Rear panel presets

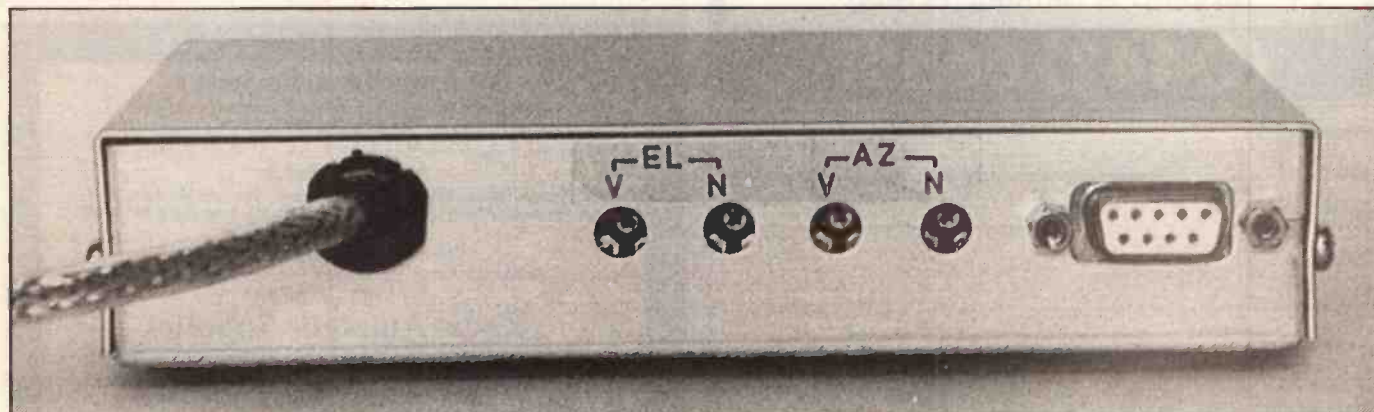

unit is used together with the parallel PC port, there is no need for the availability of empty 'slots' for a plug-in card in the computer as are often needed for hardware add-ons, indeed low-cost PCs such as the Commodore PC1 do not have any internal facility for this.

### Circuitry

In use, the Sat-PC program calculates the position of the selected satellite in 'real time' and supplies digital data from either the LPT1, LPT2 or LPT3 parallel output PC port to the interface. The IF-100 uses internal D/A (Digital to Analogue) converters to provide a pair of DC voltages which are proportional to the required azimuth and elevation. These are compared with the return voltages from the rotators, and used via a feedback and amplification network to control the Up/Down/Left/Right rotator control inputs. The resultant accuracy is specified as being better than 3 degrees.

### Sat-PC Program

The supplied software could certainly be a subject for review in its own right, such are the number of facilities offered. I've now been using it for over two months and I'm still finding new uses! Its basic task is to track the orbits of any current or future satellite, by using the relevant Keplerian data stored or subsequently fed into the computer. Using this, it also provides data for automatic rotor control through the IF-100 interface.

The program needs an XT or AT computer having at least 512k of memory, and it will work with either monochrome Hercules graphics or EGA/VGA colour display cards. The software is supplied on a 3.5 inch disk (or a pair of 5.25in disks to special order), together with an English manual. In operation, a hard disk is useful for storage although not necessary when using a 3.5in drive, a maths co-processor likewise is not necessary but it does speed up operation of the software somewhat.

### Kepler Updates

You can update Kepler information and add new satellite information to the program as required, either manually from lists of tables such as those every month in HRT, or automatically by reading in data files received off-air. In the latter case, these may be in either in the normal format or in the condensed 'two-line' format, and the program instructions state it will even ignore supplementary text as would be found in a packet message. Where data from, say, Oscar 11 is used where some parts may be corrupted, the program looks for a match in two sets of the same data before allowing confirmation of the update. The program comes ready-loaded with information for 16 satellites including AO-10 through to AO-17, Mir, RS 10/11, the Moon, and some NOAA satellites, these can of course be updated or modified as needed.

### In Use

On running the program, after the initial sign-on screen the date and time as stored in your computer is automatically retrieved, with a request for you to confirm whether each in turn of these are correct with a 'Y/N' input. The table of stored satellites then appears, and after a short processing time (when the software works things out) all of the satellites in 'view' at that time have their respective ID letters shown in a flashing format. To select any satellite, whether in view or not, you just press the required letter A-P, the software then bringing up the 'Main Menu' list of options, these being:

- 1) Graphic functions,
- 2) Output of lists,
- 3) Additional functions, or
- 4) Utility programmes.

### Graphic Functions

Selecting the first option then brings up a further menu;

- 1) Realtime autotracking,
- 2) Tracking by intervals,
- 3) Input of day & time,
- 4) Input of MA value, or
- 5) Ground Track.

The 'real time' graphic-based autotracking is the one I used most of the time, this displaying an acquisition circle for my selected satellite. At the lower right of the screen is also a small display of the ID letters of other satellites in view of my location at that specific time, and to switch between satellites I just needed to press the relevant ID letter on the keyboard.

The accompanying photos show sample screens of the large 'footprint' given by Oscar-13 in elliptic orbit, and the smaller circle of the Low-Earth-Orbiting Dove satellite. Various other details such as the Mean Anomaly value (important for seeing what mode the satellite may

Inside the unit

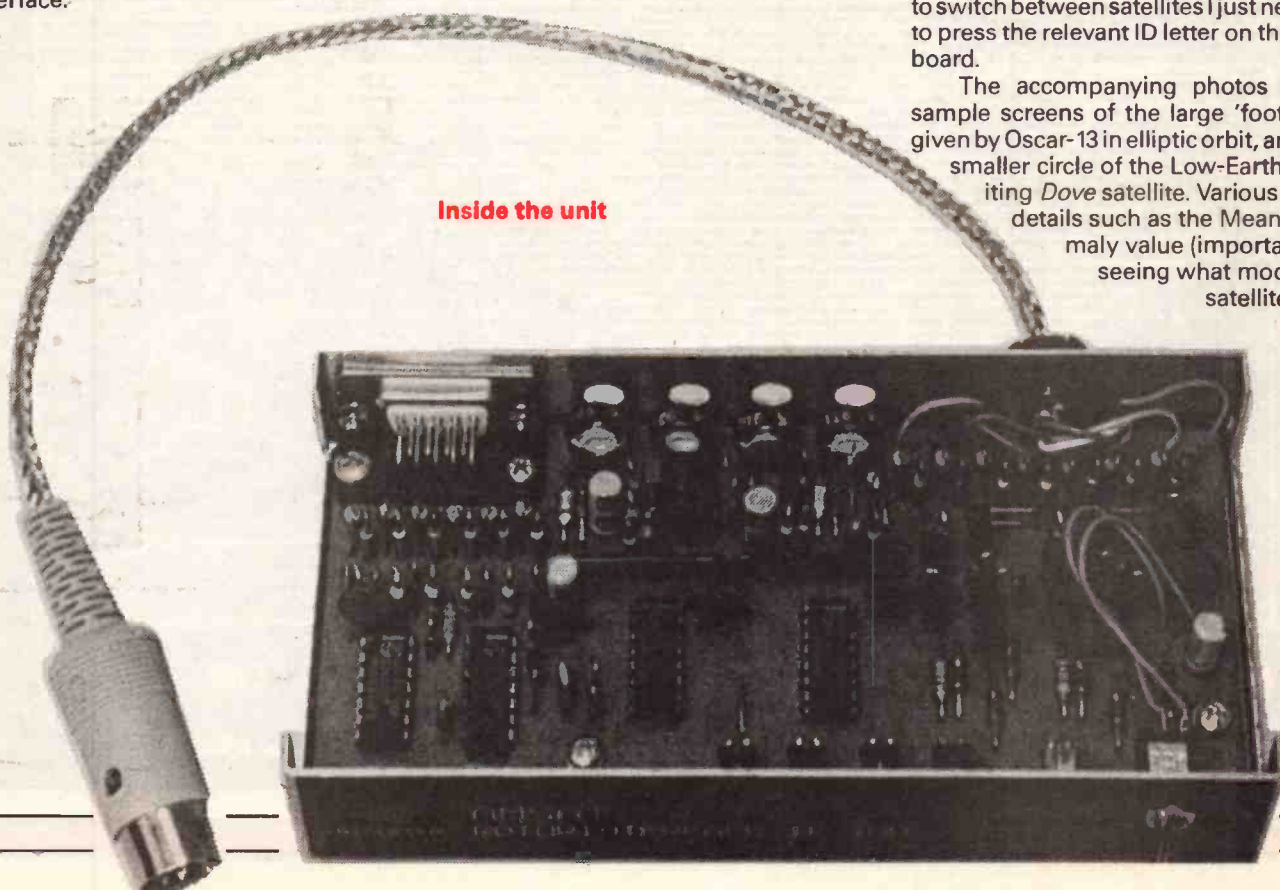

be in), satellite height, and azi/ele settings are also shown on at the bottom of the screen.

Automatic rotator control may be toggled on/off by the 'R' and 'S' keys on the computer, pressing the 'R' key for example caused my aerials to immediately shift to tracking the position of my selected satellite. After I had pre-set the small controls on the rear of the interface to accurately line up with the appropriate rotator 0 degree and 180 degree positions, watching my system which comprised a crossed 9ele for 2m, crossed 19ele for 70cm, and 28ele loop for 23cm tracking one of the lower satellites, the beams incrementing in position a degree or so at a time, was a delight to behold! Needless to say, results were perfect reception each time.

Further options in the 'Graphic Functions' menu allowed me to simulate other times and dates, and indeed to achieve a step- by-step display of a satellite's position over a given period when needed. Finally the 'ground track' option tracked a single line of the actual position of the sub-satellite point on the earth's surface.

### List Output

As well as the graphic functions, the

### Graphic Display showing AO-13

program can supply a listing either to the screen or to a printer of either all positions, positive elevation only (i.e. when the satellite is above your horizon), rising and setting times (i.e. AOS and LOS), and 'window' times and positions for use between two stations anywhere in the world. This latter feature allows you to see when you can contact another station providing you know their latitude/longitude, and is thus quite useful when planning skeds! With the Keplers already stored in the program for the Moon, this can indeed also be used for moon-bounce sked preparation.

### Additional Menus

Further menus are provided for you to enter your 'Personal Data' such as your station latitude and longitude, together with the local time offset from GMT. Other features let you vary the colours of the graphic display, change the acquisition circle 'footprint' from a hatched display to an outline, and the like, and the utility programs allow entering of Kepler data, rotator increments and so on.

### Performance

I used the software successfully on a number of computers ranging from a 4.7MHz XT with mono display, an 8MHz

XT with VGA display, and two 12MHz ATs, one with mono Hercules display and one with a VGA colour display. The software operated correctly on each model, although I did find it rather slow when running on the 4.7MHz machine when first searching for satellites in view and also when creating the graphic map, a delay of a few tens of seconds being typical. However this is really a limitation of the computer speed, the AT machines taking just a couple of seconds. The IF-100 interface gave soft LED indications of its activities whenever it was in active tracking use, and performed faultlessly over the review period.

### Conclusions

I feel the arrangement offers a very convenient method for satellite tracking, allowing the operator to be 'freed' to concentrate on actual operating rather than constantly incrementing the rotator positions when in use. Its comprehensive accompanying software also provides a useful indication of when to look for a given satellite, and then what could be simpler than just hitting a button and the computer/interface arrangement doing all the rest while the operator just sits back!

*My thanks go to South Midlands Communications Ltd., who are the UK IF-100 distributors, for the loan of the interface system.*

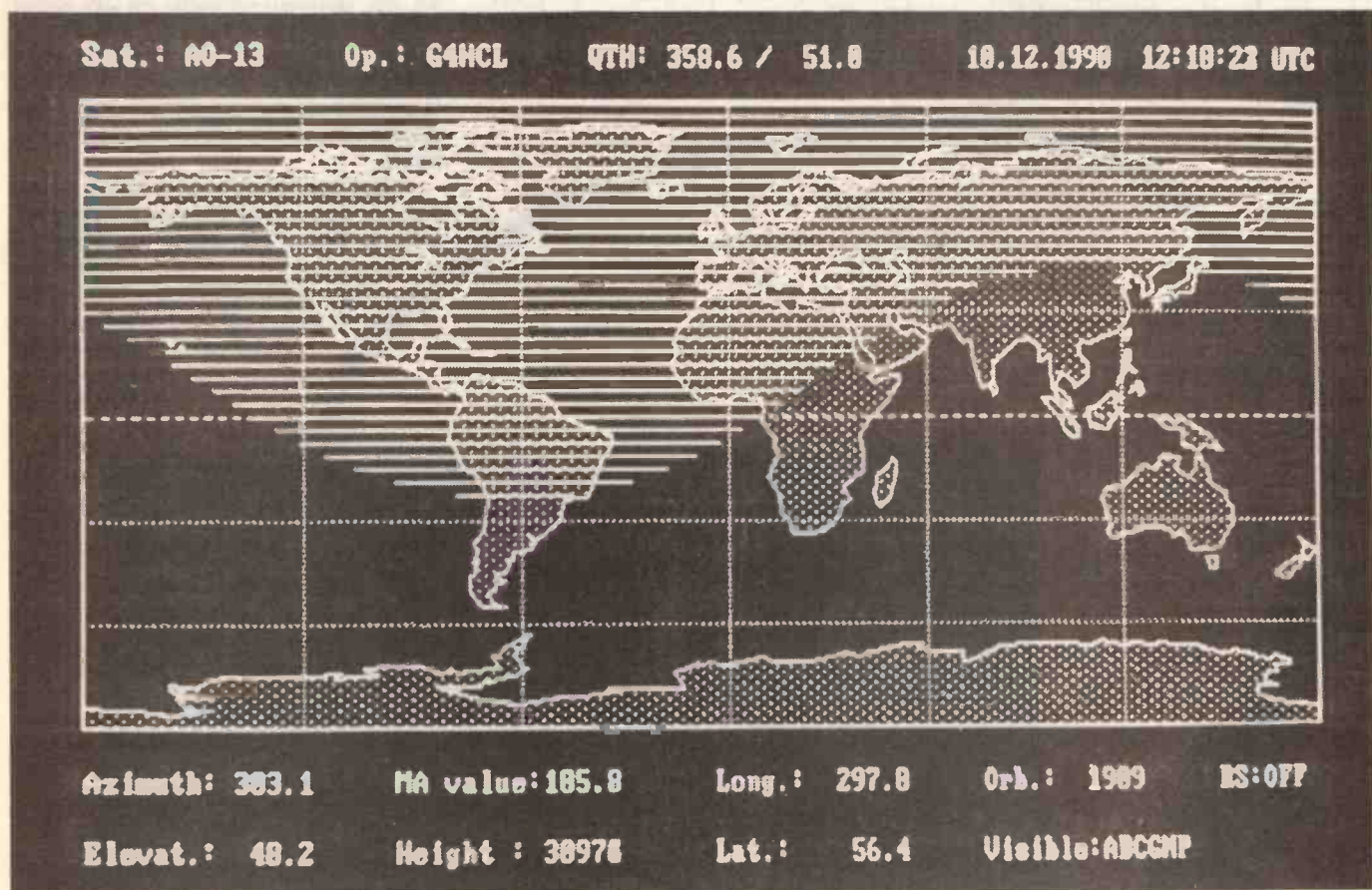

Sat.: D0-17

Op.: G4HCL

QTH: 358.6 / 51.0

10.12.1990 12:19:05 UTC

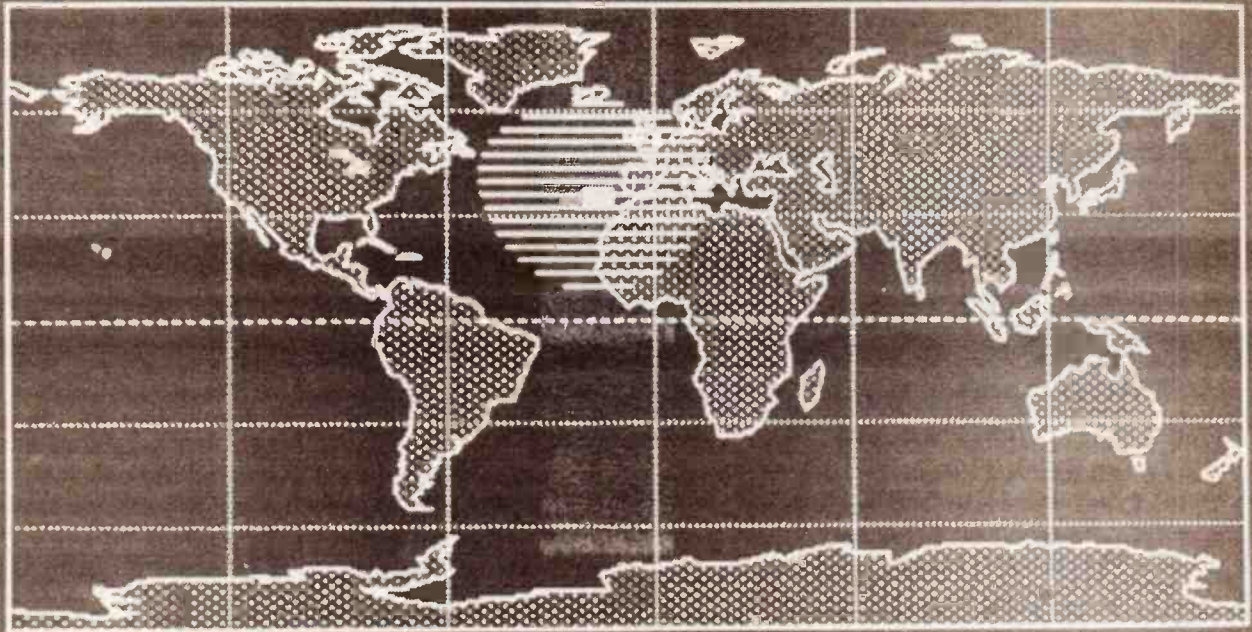

Azimuth: 221.3

MA value: 105.4

Long.: 343.1

Orb.: 4685

ES: 077

Elevat.: 9.2

Height: 799

Lat.: 35.2

Visible: ABCMP

Graphic Display showing Dove

Typical ground track display

D0-17

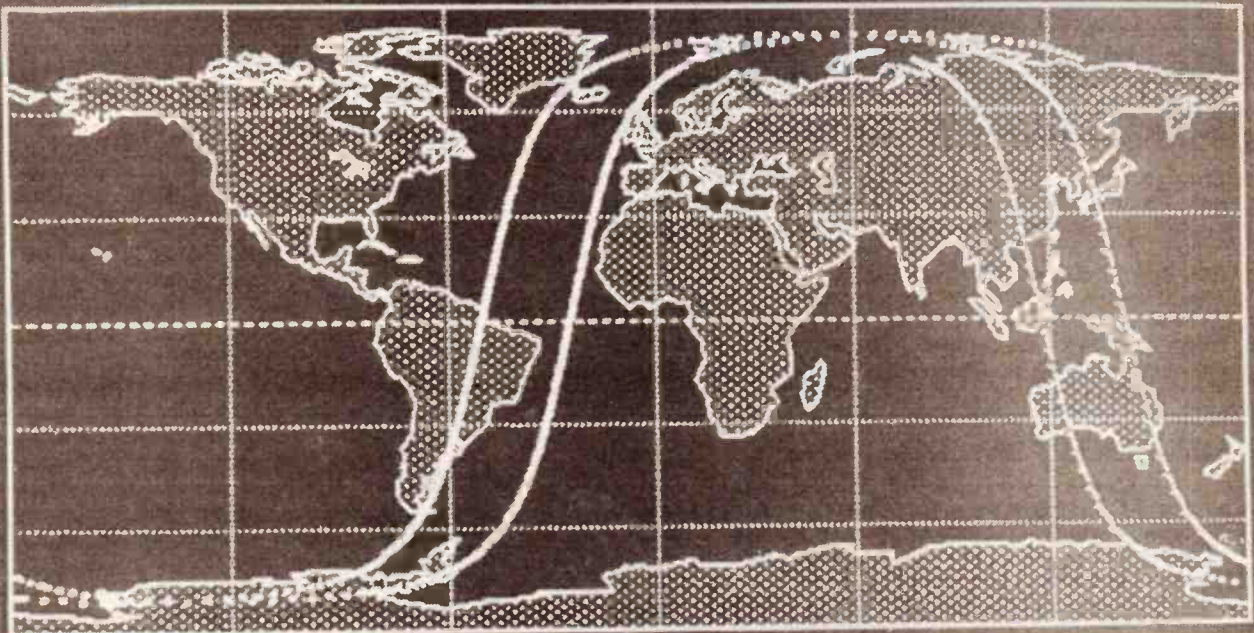

10.12.1990 15:21:45 UTC

Continue: <SPACE> Graphics: QUIT

# SMC

# South Midlands Co

SCHOOL CLOSE, CHANDLERS FORD IND. EST., EASTLEIGH, HAMPSHIRE

## NEW FROM YAESU THE FT650



The FT650 is the latest in a long line of acclaimed 6m transceivers from the Yaesu factory. Designed and built using the latest modular construction techniques and components to give great performance in a compact, easy to use package.

The transceiver covers from 24-60MHz continuous on receive and 12, 10 and 6m bands on transmit, with a full 100W output, ideal for all DX operators.

### MAIN SPECIFICATIONS/FEATURES

- ★ 24-60MHz Receive Coverage
- ★ 10, 12 and 6m Transmit Coverage
- ★ 100W PEP output (25W Carrier, AM)
- ★ LSB, USB, AM, FM, & CW Operation as standard

- ★ Optional internal 240V AC Power Supply
- ★ DVS-2 Digital message storage option
- ★ 99 memories
- ★ Programmable TX Offset

### OPTIONS

- FP-22 Internal 240V AC P.S.U.
- DVS-2 Digital Message Storage Unit
- XF455m CW Filter 600Hz

## AROUND £995

## The Best of The Best — the FT1000



Designed with no spared effort or expense for optimum performance and operability, the FT-1000 is the fruit of over 25,000 man-hours of intensive research and development by Yaesu's top design engineers. Instead of merely offering incremental improvements on existing designs or adding bells and whistles to an old model, the FT-1000 project involves a wholly new approach to the application of the latest digital and RF technologies to today's most demanding needs on the hf bands. Extensive surface-mount component technology allowed six microprocessors and five Direct Digital Synthesizers to be harmoniously integrated with a simple operator interface into a highly reliable full-featured transceiver optimized for serious hf applications.

### ADDITIONAL FEATURES

Other features include adjustable IF width, IF shift, IF notch and APF controls. AGC presentable for fast, medium and slow + defeat, on/off selectable, preamp + adjustable attenuator -6dB, -12dB, -18dB, Adjustable - mic gain, RF power o/p, processor and drive controls. Built in electronic keyer with adjustable speed control. Twin independent frequency displays with mode indication + much more.

### BRIEF SPECIFICATIONS

- ★ General Coverage Receiver 100kHz-30MHz
- ★ Ham bands TX 160-10m
- ★ Modes CW, USB, LSB, AM, FM, RTTY and Packet
- ★ VFO steps 10Hz CW, SSB, RTTY, 100Hz, AM, FM, PKT
- ★ Auto antenna impedance range 16.7 to 150 ohms
- ★ Selectable receiver band widths 2.4kHz, 2kHz, 500Hz, 250Hz
- ★ Dual band receiver tuning and monitoring with balance control
- ★ Power output up to 200 watts P.E.P. 50W AM
- ★ Sensitivity preamp on SSB/CW 0.25 micro volts 10dB S/N
- ★ D.D.S. Direct Digital Synthesiser
- ★ Dual Selectable noise blankers with adjustable threshold
- ★ 99 memories

### OPTIONS

- SP5 external L/S with audio filter
- DVS-2 Digital Voice message storage system
- BPF-1 Sub VFO filter unit
- YH-77ST Headphone for stereo or mono dual receive
- TCXO-1 High Stability oscillator unit

**LEEDS**  
**SMC (Northern)**  
 Nowell Lane  
 Industrial Estate  
 Leeds LS9 6JE  
 Leeds (0532) 350606  
 9-5.30 Mon-Sat  
 Closed Sat afternoon

**CHESTERFIELD**  
**SMC (Midlands)**  
 102 High Street  
 New Whittington  
 Chesterfield  
 Chest. (0246) 453340  
 9.30-5.30 Tues-Sat

**BIRMINGHAM**  
**SMC (Birmingham)**  
 504 Alum Rock Road  
 Alum Rock  
 Birmingham B8 3HX  
 (021-327) 1497/6313  
 9.00-5.00 Tues-Fri  
 9.00-4.00 Sat

**AXMINSTER**  
**Reg Ward & Co Ltd**  
 1 Western Parade  
 West Street  
 Axminster  
 Devon EX13 5NY  
 Axminster (0297) 34918  
 9-5.20 Tues-Sat



SOUTHAMPTON SHOWROOM open 9.00-5.00 Monday to Friday, 9.00-1.00 Saturday. Service Dept open Mon-Fri 9.00-5.00.

## TOKYO HY-POWER



### SAGRA-600

- ★ 2m Linear Amplifier
- ★ 600W Output 25W Drive (Nominal)
- ★ 2 x 4CX250B VALVES

**NOW ONLY £769.00**

AS REVIEWED IN APRIL 90 HAM RADIO TODAY

### HF LINEARS



#### HL/KGX

160-10m 2 x 4CX250B  
1KW PEP RF INPUT  
70-120W DRIVE  
**£945.00**



#### HL2K

160-10m 2 x 3-5007  
2KW PEP RF INPUT  
60-120W DRIVE  
**£1425.00**

### VHF LINEARS

HL66V	6m 10W in 50-60W out RX Preamp	£129.00
HL166V	6m 3/10W in 80-160W out RX Preamp	£249.00
HL37V	2m 3W in 32W out RX Preamp	£89.00
HL62V	2m 10W in 60W out RX Preamp	£135.00
HL110V	2m 2/10W in 100W out RX Preamp	£215.00
HL180V	2m 3-25W in 120W out RX Preamp	£295.11
HL36U	70cm 3/10W in 40-50W out RX Preamp	£135.00
HL60U	70cm 10/25W in 50W out RX Preamp	£215.00
HL130U	70cm 3-25W in 120W out RX Preamp	£389.00



The CV730-1 'V' dipole is the latest in a line of dipoles from Creative Design. The use of the 'V' shape reduces the area needed for mounting the antenna which is insensitive to changes in height above ground and surrounding metallic objects. All this for only £149 + £8 carriage (inc. VAT).

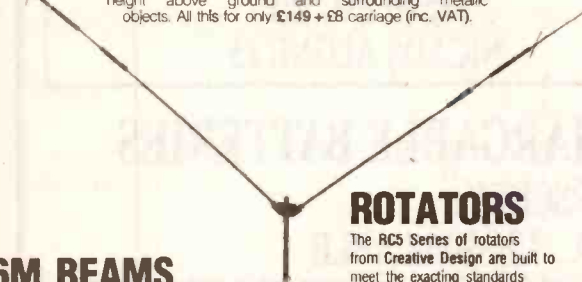

The CREATE company has, for the past twenty years, been the leading manufacturer of amateur and commercial antennas (mainly HF) in Japan.

Now available to customers in the UK through South Midlands Communications, the appointed distributor, are the popular CREATE HF beams to cover the 10/15/20 metre bands, HF baluns up to 10KW PEP and the exciting 10/15/20/40V dipole which has elements of only 19ft and is designed in such a way that it can be mounted in particularly awkward places. SMC also stock what must be one of the largest amateur antennas available, the 40 metre full sized beam, as well as 6 and 7 element and six metre yagis and professional quality log, periodic antennas for 50-1300 and 105-1300MHz. CREATE also manufacture rotators to exacting levels of precision and these have virtually no back lash, quiet gears, variable speed and large torque. All are now available from SMC stock. Please contact us NOW for full details.

### HF BEAMS

Introducing the NEW 318 series of DX Tribanders from Create which offer outstanding efficiency with High Q traps especially designed for 14, 21, & 28MHz. High grade materials are used to ensure long life, maximum reliability and light weight with no compromise in performance.

<b>All beams supplied complete with balun</b>		
CD318JR 4 ele 10-15-20M 750W PEP Gain 7:7:5:8dB F/B 18dB		Only £299 P&P £5.90
CD318 4 ele 10-15-20M 2KW PEP Gain 7:8:8:5dB F/B 18:20:20dB		Only £349 P&P £5.90
CD318B 5 ele 10-15-20M 2KW PEP Gain 7:9:9:9:5dB F/B 20:18:20dB		Only £449 P&P £7.90
CL40B-4 3 ele Yagi 40m 4KW PEP Gain 8dB F/B 22:18dB		Only £399 P&P £12.50
CL10 5 ele 10m 2KW PEP Gain 12.0dB F/B 24dB		Only £215 P&P £15.00
CL15 5 ele 15m 3KW PEP Gain 12.5dB F/B 24dB		Only £319 P&P £15.00
AFA40 2 ele 40m 2KW PEP Gain 6.0dB F/B 20dB		Only £375 P&P £17.50
714X-3 3/4 ele 15-20-40m 3KW PEP Gain 7:9:10dB F/B 20:23:20dB		Only £799 P&P £25.00
CV48 40M vertical 2KW PEP 500W PEP Radial wires included		Only £210
suitable for ground or roof mounting		Only £49 P&P £2.85
AD385 Matching network 40?80M for CV48 remote switchable		
CV730V-1 V dipole for 10-15-20-40-1KW-2KW PEP 19' ele capable of being mounted anywhere		Only £149 P&P £3.50

### 6M BEAMS

New from Creative Design are a range of 6m beams, the CL60X 6 element, CL60XX 7 element and CL6DXZ 8 element.

All these antennas are the result of long and continued research to achieve the best possible performance whilst remaining both cost effective and extremely robust.

CL6DX 6 ele 13dB*	£115.00
CL6DXX 7 ele 14.3dB*	£168.99
CL6DXZ 8 ele 14.5dB*	£225.00

\*Manufacturers figures.

### ROTATORS

The RC5 Series of rotators from Creative Design are built to meet the exacting standards required by both professional and amateur users. A range of models is available designed to cater for medium to large sized antennas. All the rotators are manufactured with high quality components allowing continued and reliable operation.

RCS-1	£219.00
RCS-3	£275.00
RC5A-3	£425.00
RCSB-3	£675.00
CK46 Rotary bearing	£34.95

### \*FREE FINANCE ON SELECTED ITEMS

On many regular priced items SMC offers Free Finance (on invoice balances over £120) 20% down and the balance over 6 months or 50% down and the balance over a year. You pay no more than the cash price! Details of eligible items available on request. \*Subject to status.

### Free interlink delivery on major equipment

Small items, Plugs, Sockets, etc by post £1.75. Antennas, cables, Wires & larger items. Lynx up to £5. Interlink delivery available, upon request for items other than radios from £7.30 depending on weight. Same day despatch whenever possible.

### YAESU DISTRIBUTOR WARRANTY

Importer warranty on Yaesu Musen products. Able staffed and equipped Service Department. Daily contact with the Yaesu, Musen-factory. Tens of thousands of spares and test equipment.

**PRICES & AVAILABILITY SUBJECT TO CHANGE WITHOUT PRIOR NOTICE**

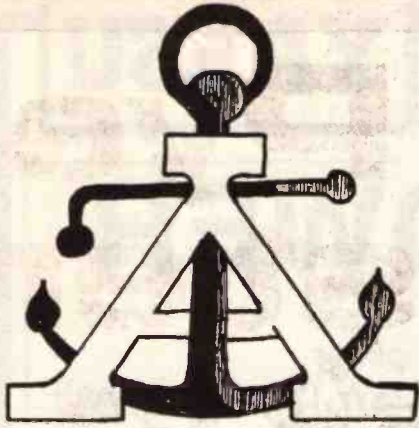

**ANCHOR SURPLUS LTD  
THE CATTLE MARKET  
NOTTINGHAM  
NG2 3GY**

**TEL: (0602) 864902 & 864041**

**FAX: (0602) 864667**

**M BAND PYE WESTMINSTERS**

**FOR THE CONVERSION ARTICLE IN THIS ISSUE.  
GET ON TO 2M FM THE CHEAP WAY... ANOTHER ANCHOR SPECIAL**

**COMPLETE SYSTEM COMPRISING... RIG... CONTROLLER... MICROPHONE...**

**ONLY £25.00 INC POST & PACKING**

**OR**

**RIG ALONE ONLY £15.00**

**INC POST & PACKING**

**ALL RIGS SUPPLIED UN-TESTED IN GOOD OVERALL CONDITION**

**COPIES OF**

**SERVICE MANUALS FOR VHF WESSIES £5.00 INCL P&P**

**ALSO HIGH BAND VHF DASH MOUNT  
WESTMINSTERS**

**SUITABLE 2 METRE FM or MARINE  
BAND**

**INC MICROPHONE £25.00 inc P/P**

**PORTABLE CARRIERS & CHARGERS IN STOCK ALSO**

**PYE PF2's — LOW BAND — FM  
70-79 MHz**

**IDEAL 4 METRE 3CH PORTABLE  
TESTED WITH NICAD**

**£25.00 INC P/P**

**NICADS ALONE £5**

**EMERGENCY or PORTABLE RE-CHARGABLE BATTERIES**

**DRYFIT A200 BY SONNERSCHNEIN**

**FULLY SEALED... GEL LEAD ACID... UN-SPILLABLE**

**IDEAL PORTABLE RADIO SUPPLY OR FOR USE WHEN THE CAR REFUSES TO START  
OR EMERGENCY 12V LIGHTS ARE REQUIRED**

**TWO SIZES AVAILABLE...**

**12V DC AT 20 AMP HOURS... £20.00 INC P/P**

**12V DC AT 36 AMP HOURS... £30.00 INC P/P**

**SUPPLIED IN EXCELLENT TESTED CONDITION**

**WATCH THIS SPACE EVERY MONTH... SPECIAL OFFERS  
EVERY ISSUE... ONLY IN HRT**



# M Band Pye Westminster Conversion



## *Chris Lorek G4HCL converts the M-Band Pye Westminster onto 2m*

The HRT series on converting ex-PMR gear has been very successful, one only needs to listen around the bands and already amateurs are finding that getting on the air needn't be expensive, with many amateurs joining in the 'conversion craze'.

Following re-arrangement of allocations in Broadcast Band II, several public utility services in the UK who previously used the upper section of this, the so called 'Mid' or 'M' band, have been given the order to move onto different frequencies. The result? You've guessed it — a huge number of obsolete two-way radio equipment comes 'up for grabs'. This of course is little use to anyone else in the UK, as the operating band can no longer be used for two-way communication, so the sets become available cheaply on the surplus market.

Some years ago, it was simply not worth the effort in trying to 'convert' sets operating on unsuitable frequencies when other sets, operating on the correct bands, were available at similar prices. However due to the forthcoming flood of these 'M' band sets we thought you'd like to know how to get them going on 2m! The calculator, soldering iron and test gear was quickly put to use in the HRT conversion department, and a well-used Mid Band Westminster soon found a new lease of life on 2m.

### **Identification**

The Mid Band Westminster operates on transmit over the range of 88-

### **Remote Mount and Dash Mount Westminsters**

108MHz, those coming out of service in the UK normally operating around 107MHz. On receive, the sets usually operated on around 140MHz, having an operational receive range of 132-156MHz. A look at the side-mounted serial number plate will show the equipment 'Cat' number as W15FM, i.e. an FM Westminster of originally around 15W transmitter output, below this the 'Code' designation will show the identification letters of typically 'SDB6', the 'S' standing for 12.5kHz channel spacing ('V' is 25kHz), 'D' signifying 'D' band of 88-108MHz (A and E bands may be used for 2m and 4m without modification — see earlier HRTs or the Argus 2-Way Radio Conversion Handbook for details, P band may be converted to 4m or 6m as per our recent HRT article), 'B' signifying boot mount, i.e. a remote mount unit ('D' is a dash mount), with the '6' signifying 6 channel capability, the sets coming in 1, 3, 6 and 10 channel variants. So make

sure you know what the set is before you buy it — you may find it operates on a different band!

The receiver can operate on 2m without any circuit modifications whatsoever, just a re-alignment job taking typically a few minutes being all that is required. The transmitter however *does* require a number of circuit modifications to operate on 2m, which I'll detail later on.

## Dash and Remote Mounts

The accompanying photographs show what a Pye Westminster looks like in the flesh, there being two versions. The first is a dash-mount, having its operating controls on the front panel together with a microphone socket and the like, the second is the more common 'remote mount' unit, where a small control box is used via a thick multi-way lead and plug/socket arrangement to control the main transceiver which is normally mounted in the car boot.

The latter version can be used to good effect if you just want an inconspicuous set in your car for local nattering, alternatively for home use with the main set placed under the table or whatever to give you a degree of extra room on your shack table. The dash-mount

version is a little on the large side for today's compact car dashboards, however it *is* more convenient for shack use. If you purchase a remote mount set, ensure you also obtain the control box **and** the connecting cable, unless of course you don't mind making your own. This could be a cheaper option also if you just want to use the set as a packet transceiver, here you don't need frequent access to volume/squelch controls and on/off switches and can be 'hard wired' into the set's case. The accompanying diagram shows the original control box circuit, the connection letters referring to those marked on the remote connector on the transceiver.

## Conversion

You have two choices here, the first and easiest is to obtain a set and use it just on receive as a monitor for your local repeater or whatever, the second is to modify it for transmit operation as well. I'll thus start with the simpler option. i.e. the receiver. For this you'll first need to obtain the required crystal for the receive frequency of your choice, the formula for this being;

$$\text{Xtal Freq} = \frac{\text{RX Freq} - 10.7\text{MHz}}{3}$$

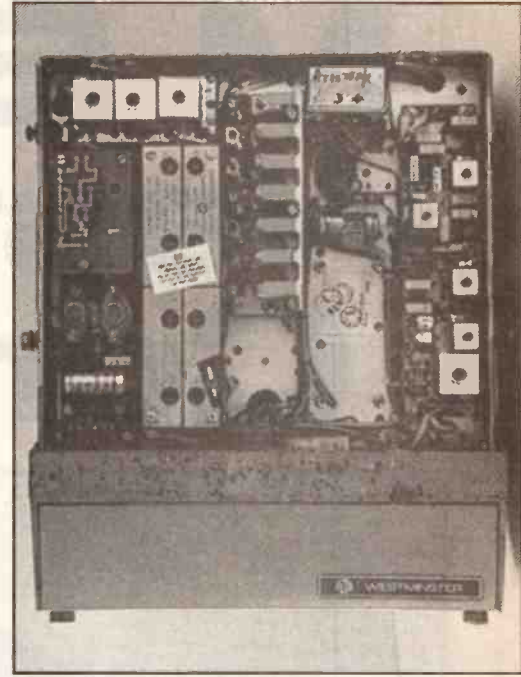

The inside top view

The crystal can size is HC6/u, and you'll find that some crystal companies may carry ex-stock crystals for popular 2m frequencies, remember to state the W15FM Pye Westminster when you order them to ensure the correct circuit loading is obtained. You'll need a DC voltmeter and a non-metallic adjustment tool for the receiver alignment, as I've said in previous conversion articles **never** be tempted to use a jeweller's screwdriver or similar metal implement for tuning — you'll break the delicate ferrite tuning cores. If you don't have a suitable adjuster, you can file down a plastic knitting needle, or even a match stick, to suit the slots in the cores. You'll also need some form of receive signal for the front end alignment, several methods of achieving this without the need for a signal generator having been well documented in the past in HRT (e.g. get a local amateur to put a signal out, or use a local repeater with changes of aerial at your end).

To start with, ensure you have a suitable power lead for the set, if one didn't come with the equipment then on the power plug you'll need to link together pins 2 to 3, and 4 to 5, then connect +ve 12V to pin 1 and -ve to pin 7, the pin numbers being marked inside the set's case. You'll also need a speaker plugged into the lead coming from the rear of the set or the control box, the original version being of 3 ohm impedance although a more common 8 ohm speaker will suffice. Plug your receive crystal in, select the appropriate channel and switch the set on, then make sure you can hear squelch noise from the speaker. If your

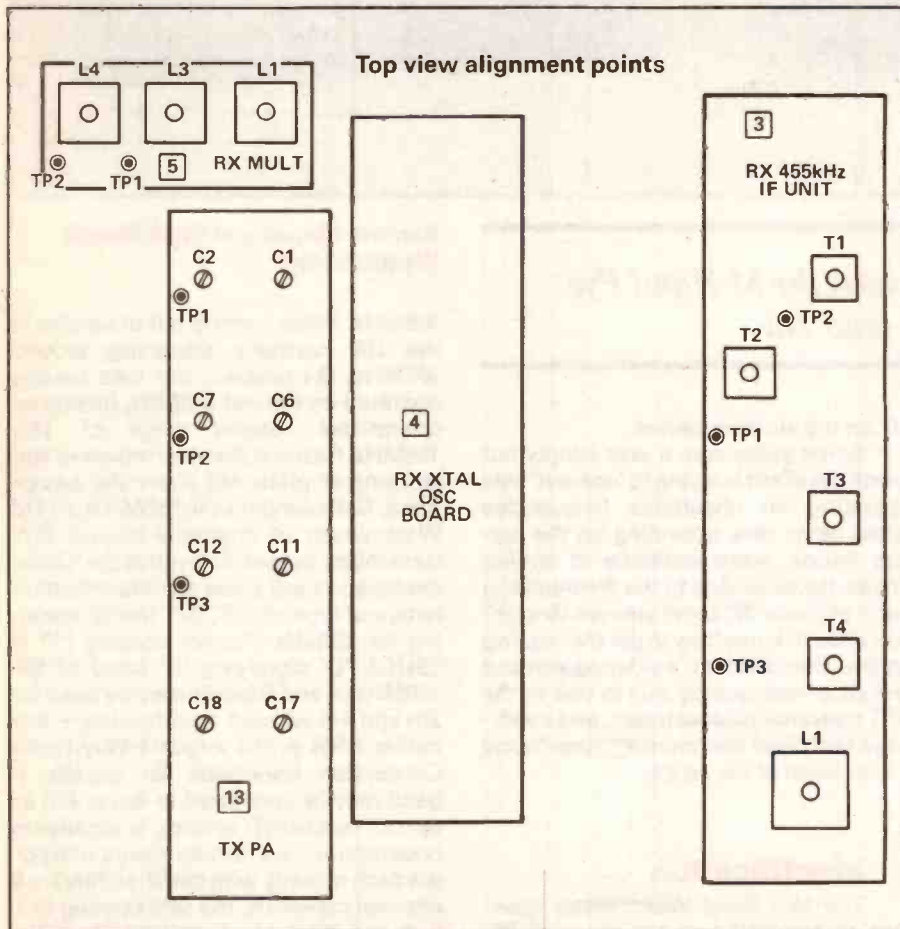

set or control box has a 15-way D-type socket mounted, you may find you'll need to link pins 8 and 9 on this to achieve a receive audio path, this socket being used for external tone signalling units.

If the set has come out of service, it will most likely be 'nearly' tuned, so don't touch the front end coil adjusters yet. Connect your DC voltmeter positive lead to TP1 on Board 5, the negative lead to the DC supply negative (not the transceiver chassis, this is not at negative volt-

The inside bottom view

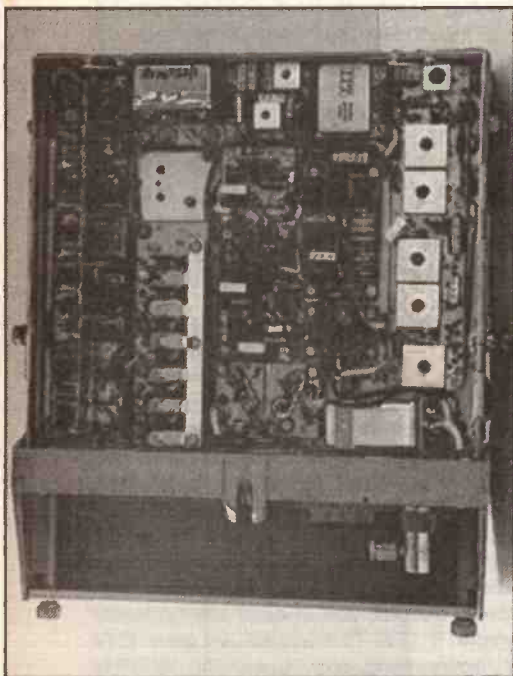

age potential), and tune the cores of L1 and L3 for maximum voltage, then transfer to TP2 and tune L4 for maximum, retuning L1, L3 and L4 again for absolute maximum. Now connect your aerial and tune the crystal adjuster core until you start hearing a clear signal, i.e. tune this for minimum distortion. For more accurate 'netting', you can connect a DC voltmeter to pin 3 on the RX IF PCB (Board 3) and tune the crystal adjuster for zero volts on a received signal, this test point providing a centre-zero discriminator output voltage. If your set is a 12.5kHz version ('S' code on the label, or +/- 3.75kHz marked on the large internal crystal filter) then you'll find well deviated signals may introduce distortion on speech peaks, however for packet use with 3-3.5kHz deviation normally used you shouldn't have too many problems receiving signals from correctly adjusted transmitters.

Once you've tuned your crystal onto frequency and can hear signals, you can concentrate on the front end. Here you simply tune the five coil adjuster cores for the best received signal, i.e. minimum noise, you shouldn't need to adjust each core more than a turn or two to bring the receiver 'spot on'. The final sensitivity will be in the order of around 0.35uV for 12dB SINAD, if you'd like to improve this you can replace the two front end transistors TR3 and TR5 (2N3819 FETs) with J310 FETs, changing the values of the resistors R6 and R14 to obtain a current of 10mA through them (this being the FET source current) for best performance.

That's it for the receiver, simple

wasn't it? Now for the transmitter modifications for the more adventurous amongst us.

## TX Driver Modifications

We'll start with the transmitter modulator/driver PCB. First of all to gain easier access, remove the screws securing this to the transceiver chassis, you'll also find it useful to unscrew the adjacent solder tag towards the rear connecting the capacitor to the transceiver chassis to prevent damaging this. Now remove capacitors C12, C15, C17 with its associated resistor, C20, C23, C25, C27 with its associated resistor, C30, C32 with its associated resistor, and C35. You may find it easier to simply cut the capacitor leads off where these are positioned next to the metal screen to avoid damaging the coil formers. Make sure you don't unsolder the coil leads from the former pins when you remove the capacitors, it won't work otherwise! Now replace the capacitors with the values shown in Table 1, but don't replace the resistors associated with C17, C27, and C32. Any normal ceramic capacitor types will suffice, but don't be tempted to use 'near' values from your junk box otherwise you may find you'll be tuning to the wrong frequency multiple when you come to the alignment stage. Where the capacitors are adjacent to the metal screen, you'll find it easier to solder these to the underside of the PCB rather than to the former pins, in either case remember to keep the capacitor lead lengths as short as possible.

The crystal frequency you'll need is given by the formula;

$$\text{Xtal Freq} = \frac{\text{TX Freq}}{36}$$

Again the can size is HC6/u, and remember to state the Pye Westminster when you order your crystals to ensure the correct crystal loading is obtained. If you didn't get a microphone with your set, you'll find the five-way 270 degree DIN socket is wired with the following;

- Pin 1 Mic Live
- Pin 2 Mic Gnd
- Pin 3 PTT
- Pin 4 RX Audio
- Pin 5 PTT Common

## TX Driver Alignment

First disconnect the thin coax lead at the rear of the board, and in its place connect a coax lead to a low power meter/dummy load, you'll need to be able to indicate around 0.25W here. Start by inserting your TX crystal, and connect your DC multimeter positive lead to TP1,

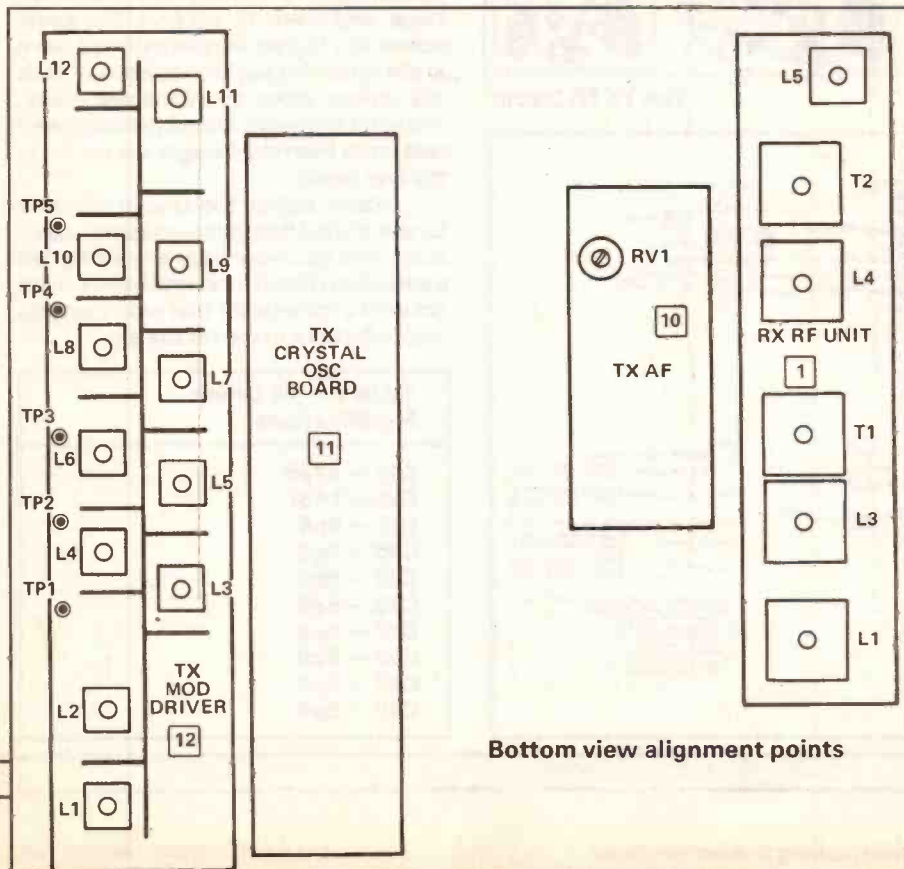

Bottom view alignment points

the negative lead to your DC supply negative connection. Key the transmitter, and tune the cores of L1 and L2 for maximum, then tune L3 for minimum, you should find just a slight 'dip' in reading is obtained when adjusting L3. In each case, you should find two tuning points, one with the core nearly flush with the top of former, the other with the core almost flush with the bottom of the former. Use the lower position in each case for best performance, this giving maximum reading, but avoid any slight peak or dip you find with the core around mid-travel.

Transfer your meter +ve lead to TP2 and tune L4 then L3 for maximum DC voltage reading, then tune L5 for a dip, again choosing the lower core position in each case. Transfer to TP3, and tune L6 then L5 for maximum, then L7 for minimum. Then on to TP4 and tune L8 then L7 for maximum, then L9 for minimum. You may by now be seeing an indication of RF power on your in-line power meter,

so tune L10, L11, L12 and L9 in that order for maximum reading, re-tuning again for absolute maximum.

You now have a low-power transmitter, you'll even be able to hear it on a nearby receiver when you talk into the microphone. If you can't hear any audio, then if your set or control box has the 15-way connector previously mentioned fitted, try linking pins 1 and 2 on this, these being the TX audio path for the external tone signalling module. The preset potentiometer RV1 on the TX AF board (Board 10) controls the peak deviation, you'll probably find you get around 3.5kHz without adjustment if the set was originally aligned for 12.5kHz channel spacing (you're now multiplying the crystal frequency by 36 instead of 24).

### PA/LPF Modifications

We now come to the 'power' side of the modifications. Re-connect the original coax on the TX driver PCB, then turn

the set over. On the Low Pass Filter PCB, you'll see three 39pF capacitors, remove these and replace them with 15pF capacitors, again any ceramic plate type should suffice but ensure you use the correct value and not 'near' value components. The transmitter PA will have a screen fitted, remove this temporarily and take a look at the air-wound coils fitted. You'll need to remove two turns from L1 and L10, the easiest way to do this is to cut off the middle section of each coil from the top, squash the remaining two turns together, then resolder these. You'll now also need to remove two turns from the link coils L6 and L9, these use enamelled wire so remove the coils and discard the resistor fitted inside the windings, shorten the coils and reconnect them in their original positions taking care to scrape a small amount of enamel from the end to ensure a good solder joint. Don't replace the associated resistor previously fitted inside the turns of each coil. Check your solder connections, then replace the screen.

Connect a power meter/dummy load to the transceiver aerial socket, you'll need to indicate a maximum of around 15W. Key the transmitter and watch carefully for a slight increase in power as you adjust C17 and C18 on the PA board, adjust these for maximum, then carefully go back and tune the capacitor pairs C1 and C2, C6 and C7, then C11 and C12, finally C17 and C18. Repeat this procedure until you can't get any more power output, you should see typically around 8-12W. The original set gave 15W at a lower frequency, but in the 145MHz Westminster a further PA transistor stage was used to achieve the same power at a higher frequency, we'll have to put up with a slightly lower level than this unless some additions are made, (the extra transistor would probably also cost more than you bought the set for in the first place).

Finally, adjust the crystal trimmer for the correct frequency, check the deviation, and you now have a working 2m transceiver! Good luck, and have fun on 2m with a transceiver that won't set you back a fortune to get on the air.

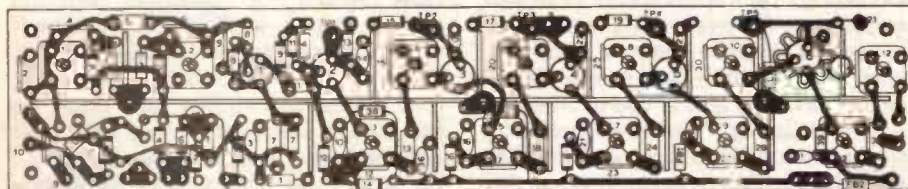

The TX Multiplier layout

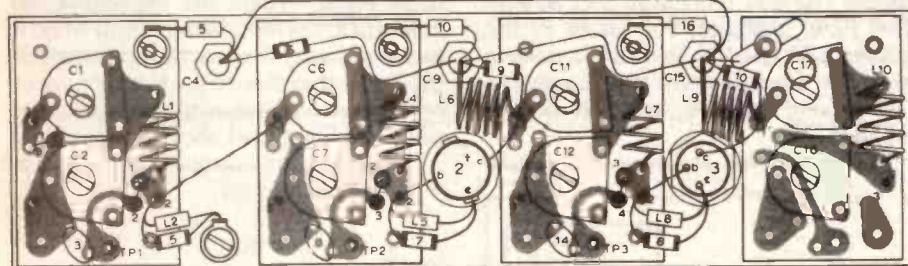

The TX PA layout

Control Unit circuitry

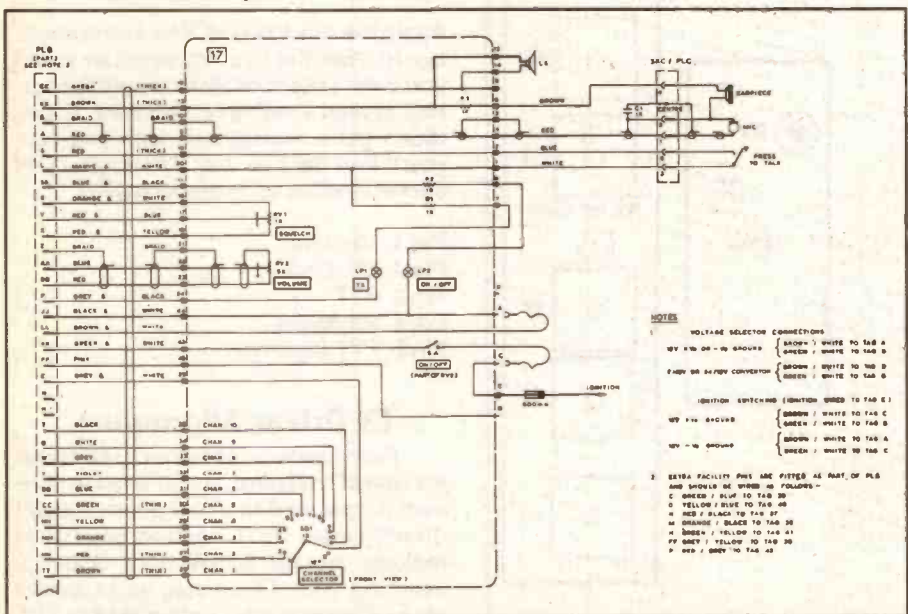

Table 1 — TX Driver Modifications

- C12 — 47pF
- C15 — 56pF
- C17 — 5p6
- C20 — 5p6
- C23 — 8p2
- C25 — 5p6
- C27 — 5p6
- C30 — 5p6
- C32 — 5p6
- C35 — 5p6



# LONDON

## AMATEUR RADIO SHOW

### NORTH HALL

All exits can be used for loading and unloading.

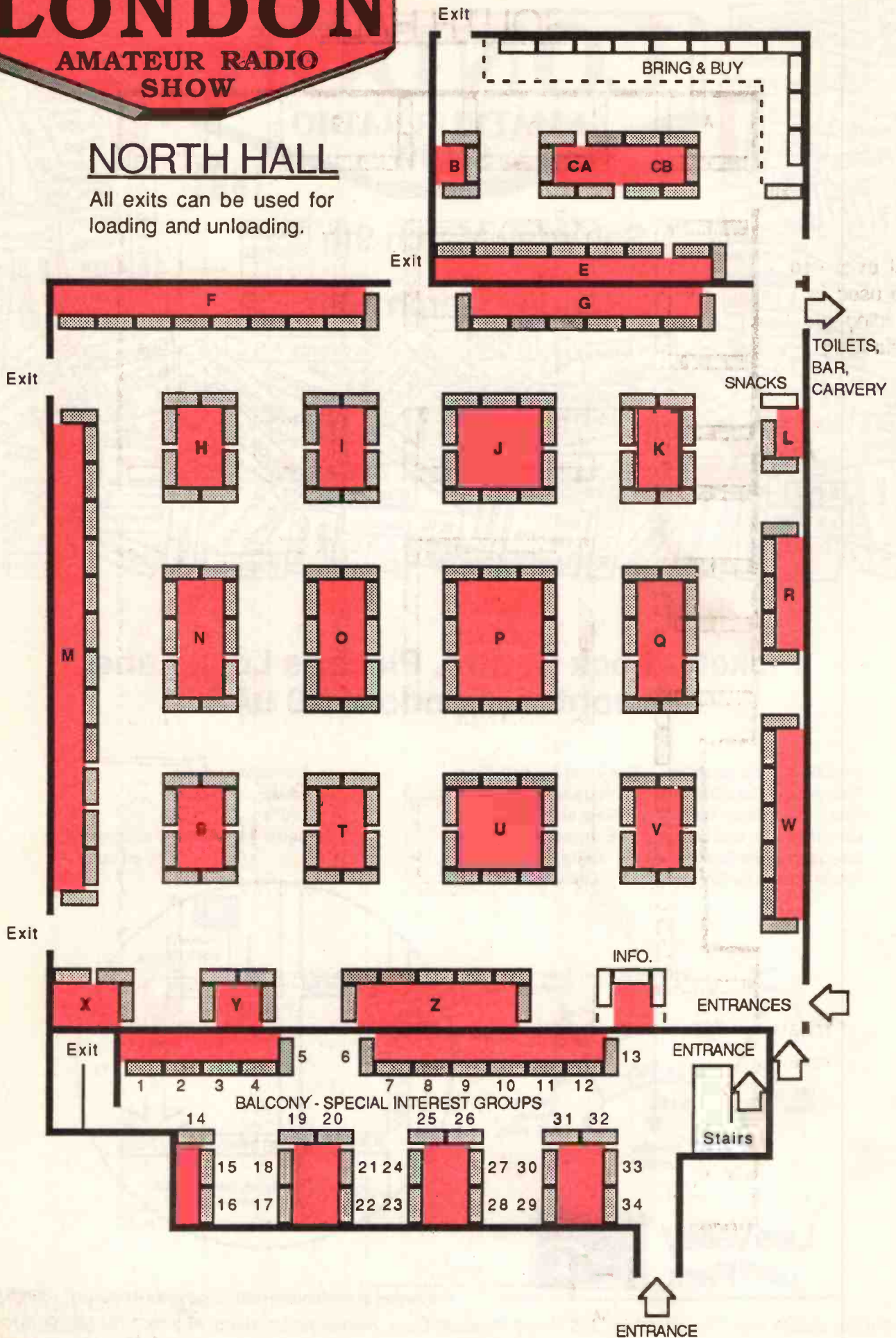

# SOUTH HALL

All exits can be used for loading and unloading.

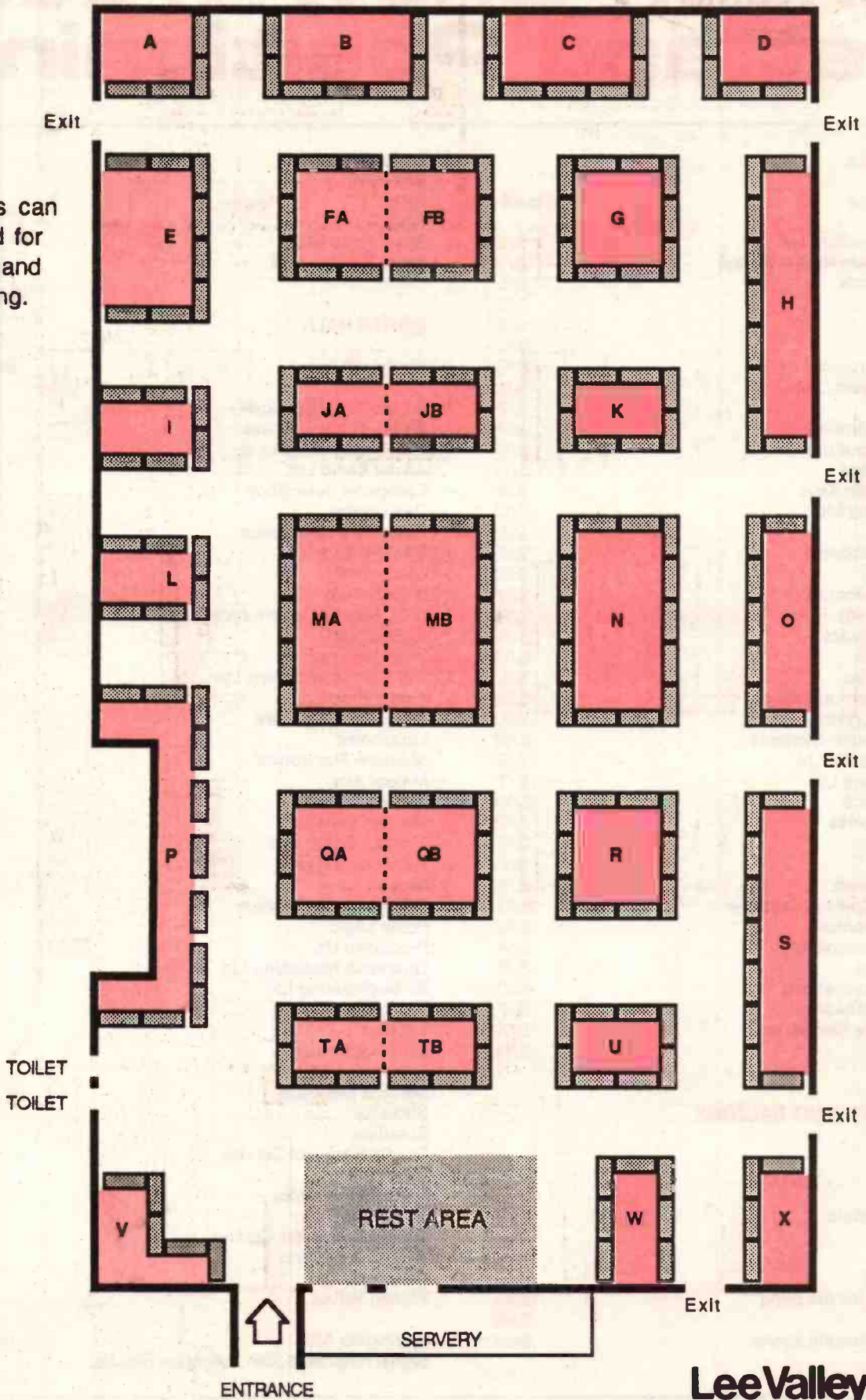

**Lee Valley**  
Leisure Park



# London Show Trader List and Positioning

## SOUTH HALL

### Trader Name

### Stand No.

ARE Communications	S/E
ASP Ltd (Ham Radio Today)	S/J
Badger Boards	S/L
Bonex Ltd	S/C
Bricomm	S/B
Browns	S/Q
Capco Electronics Ltd	S/Q
Chestnut Radio Club	S/L
Compelec	S/P
Display Electronics	S/F
Dressler Communications	S/O
G.S Electronics	S/N
G4ZPY Paddle Keys	S/P
Garex Electronics	S/D
Garibaldi	S/L
Gemini Electronics	S/F
Icom UK Ltd	S/S
ICS Electronics Ltd	S/V
Lee Electronics	S/M
Low Electronics	S/M
Martin Lynch	S/U
MFM Supplies	S/L
Nevada Communications	S/H
Newton Engraving	S/L
Oasis Computer Systems	S/M
Photo Acoustics Ltd	S/R
PW Publishing Ltd	S/T
RN Electronics	S/W
R&D Electronics	S/Q
Raycom	S/K
SEM	S/P
S&S Electronics	S/P
Sandpiper Communications	S/Q
Siskin Electronics	S/U
Surplus Electronic Ltd	S/A
Syon Trading	S/B
TAR Communications	S/G
Technical Software	S/P
WH Westlake Electronic	S/X
Wraith TW	S/N

## SPECIAL INTEREST BALCONY

### Name

Amsat UK	Balc
ATC 85th Enfield	Balc
BARTG	Balc
BYLARA	Balc
Grafton ARS	Balc
Guide dogs for the blind	Balc
ISWL	Balc
Military Communications	Balc

Radio Bygones  
RAF ARS  
RAIBC  
RAOTA  
Royal Navy ARS  
Royal Signals ARS

Balc  
Balc  
Balc  
Balc  
Balc  
Balc

## NORTH HALL

### Trader Name

### Stand No.

A1 Electrical Services	N/I
A1 Electrical Supplies	N/C
AJP Communications	N/X
Arrow Radio Ltd	N/U
Computer Junk Shop	N/Y
Dee Comm	N/F
Dewsbury Electronics	N/E
Direct Disposals	N/C
Giacomelli	N/H
G-QRP Club	N/K
C. M. Howes Communications	N/L
IC Electrical	N/K
Instrotech Ltd	N/V
KW Communications Ltd	N/Q
Kanga Products	N/K
Kent R. A. Engineers	N/V
Loutronics	N/J
Mainline Electronics	N/C
Malsor Kits	N/S
Marco Trading	N/P
Merlin Systems	N/J
Morgan Smith H. J.	N/N
New Cross Radio	N/T
Nipco	N/B
PTV Electrical Service	N/N
Poole Logic	N/S
Procomm UK	N/R
Quartslab Marketing Ltd	N/X
RF Engineering Ltd	N/K
Radio Shack Ltd	N/G
RSGB	N/O
SGS Electronics	N/P
Squire V.	N/E
Stevens Electrical	N/K
Strikalite	N/M
Suredata	N/M
Taurus Electrical Service	N/Z
Telecom	N/I
Telford Electronics	N/M
Tennamast	N/N
Trident Computer Centre	N/S
Waters & Stanton	N/W
Weirmead Ltd	N/V
Wilson Valves	N/T

Southgate ARC  
Signal Regiment 36th Volunteer Display

Info Stand



# LOWE LANDS AT HEATHROW

We have now opened our latest retail outlet just off the M4 motorway near Heathrow. As well as the full range of Kenwood amateur equipment, we are also stocking all the other well known brands so that you can compare them side by side. Add to this the AOR scanner range, marine, commercial and air band radios plus an extensive and ever changing selection of fully tested and guaranteed second hand equipment and you have the best one-stop shop for all your communications needs in the most accessible location in the South East. The shop is being set up and initially run by Barrie G3MTD, but we are looking for a permanent full time manager. So if you want to turn your hobby into your job in the first of our new Lowe Global Communications Centres, contact us at Matlock on 0629 580800.

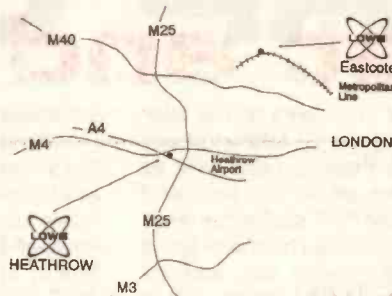

## HOW TO FIND US

The new Lowe shop at Heathrow is located just 50 feet from the main A4, 200 yards from the M4 access roundabout at junction 5.

Leave the M4 at junction 5 and take the A4 from the roundabout towards Heathrow Airport and London. After about 200 yards you will see a gap in the brick wall on the left hand side. We are directly through the gap - next door to a fish and chip shop if you are feeling hungry! You can either pull up on the grass verge and walk through the gap, or alternatively carry on another 300 yards and turn first left at the lights into Sutton Lane then first left again into Trent Road. This will bring you out right in front of the shop, where you can park for free without a yellow line in sight.



TS-950S

## LOWE ELECTRONICS LTD

6 CHERWELL CLOSE, LANGLEY, SLOUGH, BERKS SL3 8XB. Tel: 0753 45255



Don't miss the **LARGEST** single day show in the U.K.

# NORBRECK



## Radio, Electronics and Computing Exhibition

by the Northern Amateur Radio Societies Association at the

**NORBRECK CASTLE HOTEL EXHIBITION CENTRE  
QUEENS PROMENADE, NORTH SHORE, BLACKPOOL**

**on Sunday, March 17th, 1991**

**Doors open at 11 a.m.**

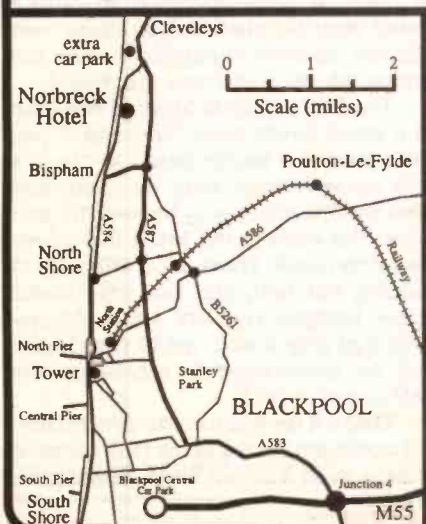

- \* Over 100 trade stands
- \* Bring & Buy stand
- \* RSGB stand and book stall
- \* Organised by over 50 clubs
- \* Find out what the new NOVICE LICENCE is all about!
- \* Free car parking (plus free bus service from extra car park)
- \* Overnight accommodation at reduced rates (contact hotel directly)
- \* Club stands
- \* Amateur Computer stands
- \* Construction competition
- \* Facilities for the disabled

## RADIO TALK-IN ON S22

Admission £1 (OAP's 50p, under 14's free) by exhibition plan

Exhibition Manager : Peter Denton, G6CGF, 051-630-5790

# QRP CORNER

March sees a lot of activity in the QRP front, members of the G-QRP club will be attending the Picketts Lock rally as there will be a club stand, do come and see us as well as the HRT staff at the large HRT stand which will also be there. Bring along your latest project too, and for those who are not yet members, this is your chance to join!

Members will also be at the NEC for the RSGB national rally during the last weekend in April, however, George G3RJV, Ian G3ROO and myself will not be there, we will be representing the club at the Dayton Hamvention in America during this time.

## QRP Field Day Results

Results of the RSGB low power field day have been announced, and it was pleasing to see a new callsign leading

are available from the author for an SAE.

Another new book on QRP has hit the scenes, at time of writing it was not available in the UK, but noises have been made about getting it over the pond. It is another from the ARRL and is a collection of 'QRP Classics' from QST and the ARRL handbook. (*Ed's note — Poole Logic always have a good selection of ARRL books even when other sources haven't!*) My copy is dog-eared already and will no doubt get even more so as time goes on. It sells for about \$12 over there so it should be well within the budget of most UK amateurs. It comes very highly recommended.

## Construction

Last month we discussed ugly construction and how easy it can make some simple projects. But for those who

in the tracks appearing where they are wanted, always ensuring that the artwork is the right way round of course. There is also available from several sources an aerosol spray which makes ordinary copper clad PCB light sensitive, this can be used in the same way.

But how do we etch the board without getting that awful ferric chloride all over the place? One simple method recently came my way involves using heavy duty 'press to seal' type bags. The ferric chloride mixture is placed in the bag, making sure that the bag is only half full, then place the PCB to be etched into the bag. Hold the lot under a tap with hot water, as hot as the hands will stand. The etching should be done quite quickly and, in theory, your hands should remain clean. The sink used should *under no circumstances* be used for food preparation, so be careful and use an enamel or glazed bathroom sink instead. When the board is etched to your satisfaction, it is merely rinsed under clean water (*don't* do this in the kitchen sink!) and the holes drilled as required.

## Dick Pascoe G0BPS shows us how to make the simple 'OXO' transmitter

the 10W section. Members of the East Barnet club used GX6KQ/P to good effect and won the Houston-Fergus trophy, and in the 3W section Tim G4ARI/P took the Southgate trophy.

Another contest will take place soon, this time from Germany, and the Activity Group Telegraphy (AGCW-DL) invite all amateurs to take part. This summer contest takes place on July 27th and 28th 1991, times are 1500 UTC on Saturday to 1500 UTC on Sunday. Full details

wish to make their own printed circuit boards, there is light at the end of the tunnel.

It is usual when making PCBs to think in the realms of etch resist pens on copper boards, and of bubbling tanks of ferric chloride. This is not always necessary. Most of the large component suppliers also stock PCB material that is directly light sensitive. Marking out your artwork on a translucent material and then placing it against the PCB will result

## Simple Transmitters

Continuing our recent piece on construction, one very popular transmitter within the G-QRP club is the OXO, from the pen of that well known Scotsman George Burt GM3OXX. This unit may be crystal or VFO controlled, and up to 2 Watts output may be obtained.

The circuit is quite simple, except for one small point. TR1 is both RF and DC coupled to TR2, so the oscillator will not work unless TR2, the 330ohm resistor and the 0.1uF capacitor are coupled as shown. The transistors shown are not critical and almost any similar type may be used. A small increase in output power may be obtained by using two 330ohm resistors in parallel, but do not reduce the value of these too much!

The RFC is just 10 turns of fine wire on a small ferrite bead. However if you don't have any ferrite beads to hand, a high value resistor may be used, just wind the fine wire along the resistor and solder the ends to the leads to achieve the same result. There is no difficulty in building this unit, just take care about solder bridges and dry joints. Happy 'OXO'ing! (*My thanks go to the G-QRP club for permission to reproduce the OXO circuit in HRT.*)

That's it for this month, information and comments to me at the HRT editorial address or to 3 Limes Road, Folkestone.

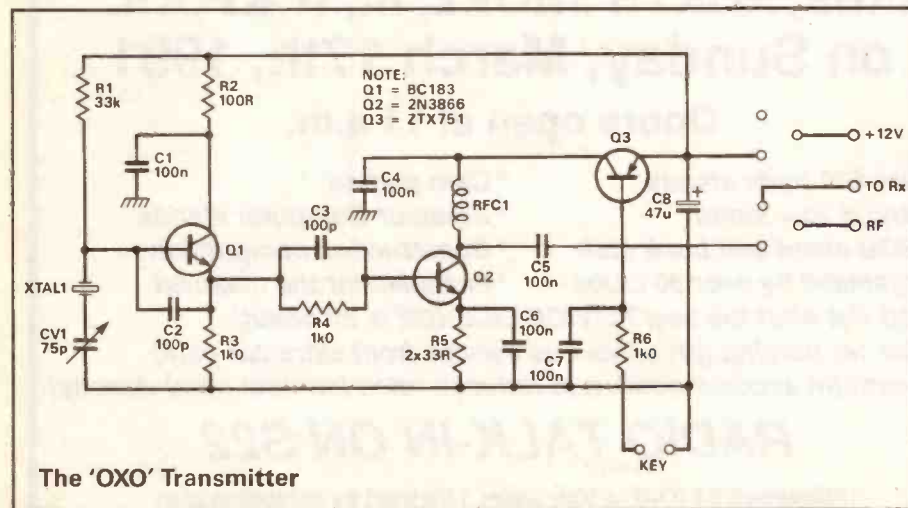

# SCANNERS

## INTERNATIONAL

**Motorwave listening**  
**- car aerial project**

**Starting out**  
**- hints and tips**  
**for beginners**

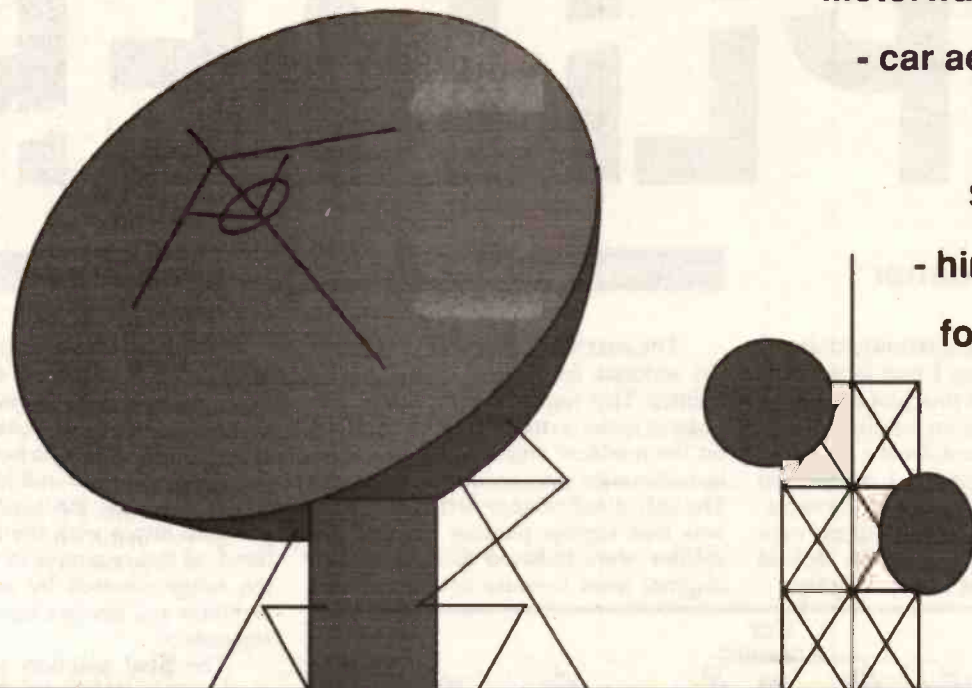

**N**ew things are happening with Scanners International! Don't let appearances be deceptive, because we've been listening to what you've been saying, and as a result, wonderful things may soon happen! To this end, we've been saving up some great articles and getting busy with plans for even more, such as reviews of the very latest scanners, details on the latest modes of two-way radio operation, and a host of our popular simple construction articles for such items as a wide-band scanner aerial for home use and the like. Already many entries have been coming in for our latest free competition, and we've got more freebies planned for the future too!

For the time being, Scanners International will as usual have a monthly presence as supplement pages in your favourite radio magazine, but the word is, Watch this Space!

In our exclusive 'Signals from Space' feature, we said to watch out for signals from the orbiting Russian MIR Space Station, with an indication that the cosmonauts up there may well be active on

the 145MHz amateur band. Well we can now confirm that since cosmonaut Musa Manarov has been back on the space station, he's been pretty active chatting to us on 145.500MHz and 145.550MHz using his callsign U2MIR, so that's where to listen to! MIR passes Western Europe each day travelling from West to East, with the passes six times a day spaced 96 minutes apart. You should hear it from early morning to early afternoon, and if you do your sums then when you hear a pass one day, the next day's pass will be 37 minutes later.

Together with this, at about the same week this appears in print there will be an Austrian radio amateur going up there also, taking with him a beacon transmitter operating on 145.805MHz. This will transmit for MIR with periods of one minute of synthesised speech (in Russian, English, and German) and two minutes of AX.25 Packet Radio Data (Bell 202 tones - you can receive this using an amateur packet 'TNC' plugged between your scanner and your computer), followed by a break of two minutes where the cosmonauts can indeed grab the microphone for a chat, the latter will probably occur later this year. The trans-

mitter will be left in the Mir space station even after the Austrian amateur has returned to Earth, so try tuning in!

As well as amateur radio activity on 145MHz, remember the MIR communication downlink operates on 143.626MHz, so if you start hearing Russian voices on that frequency every hour and a half, you'll know where they're coming from. Those of us who tuned in when the Japanese reporter was up there certainly had lots to listen to!

Some time ago, if I were tuning into a Russian space station and even chatting to the cosmonauts, my neighbours would probably have reported me to the authorities as being suspected of being a spy! Thankfully we now live in slightly more enlightened times. But I wonder what would happen if I were to start reproducing in Scanners International the USA-published frequency list I have in front of me, which I openly purchased with my credit card, giving full details of British Warship operating frequency channels and callsigns, even with accompanying photos of the ships? See you next month, if I haven't been locked up by then!



# A CAR RADIO & SCANNER ANTENNA SPLITTER

by Alan Gardener

**H**aving recently changed cars, I was faced with the problem of providing an additional antenna for the scanning receiver. I wasn't too keen on drilling more holes than necessary through the bodywork of my new pride and joy, so I decided to look at what other methods were available.

The next idea I had was to separate the antenna feed with a low-loss TV splitter. This required minor modifications in order to make it work correctly on the medium and long wave bands, but otherwise gave encouraging results. The only disadvantage of this technique was that signals passing through the splitter were reduced to half of their original level because of the splitting

It is easy enough to separate the long and medium wave broadcast stations as they operate on very much lower frequencies than those covered by a scanning receiver. A simple network consisting of separate low and high pass filter stages does the job nicely. The main problem arises with the FM broadcast band, as this is almost in the middle of the range covered by most scanning receivers and needs a bandpass filter to separate it.

The final solution was to use a combination of different filter designs in order to achieve the desired overall response. One additional advantage of this method of splitting is that it helps prevent strong broadcast signals from overloading the scanning receiver. This is sometimes a problem with continuous coverage scanners as they do not always have adequate RF stage filtering.

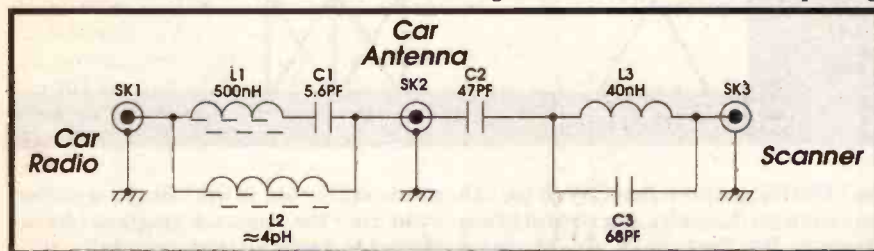

▲ Figure 1 Circuit Diagram

Over the past few years I have tried many different types of temporary antennas. These included clip-on, magnetic, boot lip and window type mounts, all of which worked well enough but tended to be slightly obtrusive, particularly when more than one antenna was attached. After considering all of the alternatives I still had a personal preference for a fixed mounting. As the car was already fitted with a roof antenna for the car radio, the idea of being able to use it with the radio and the scanner appealed to me.

My first thought was to use a relay to switch between the two receivers. The car radio had an output for use with an electrically motorised antenna so it would have been relatively easy to use this to select the feed to the car radio when it was switched on. However I soon decided against this, as I normally leave the scanner operating whilst listening to the car radio or cassette player.

action. What was really required was a filter which would separate the long, medium and FM broadcast bands from all the other frequencies.

## Construction

The construction of the splitter is very simple. I built the prototype into a small

▼ Figure 2 Layout Diagram

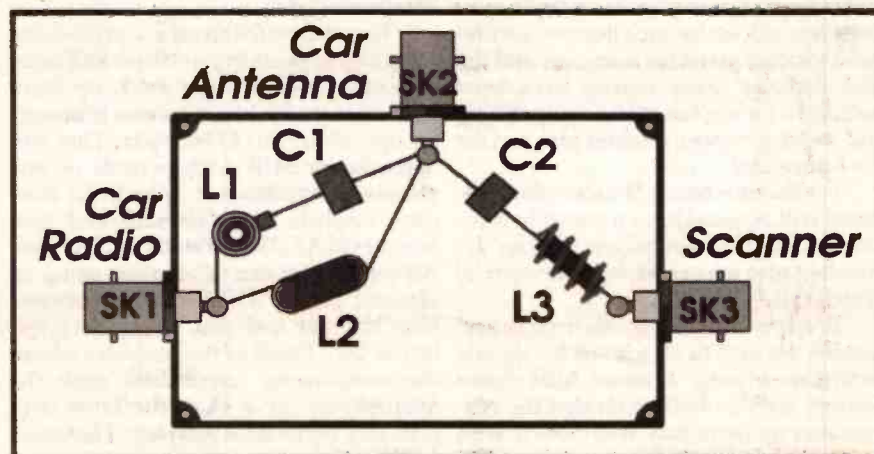

die-cast metal box, but it should be possible to use any other suitably sized metal box. I chose to use BNC type connectors on the unit but you may prefer other types. All the components are mounted in free space between the connectors, with any connecting leads kept as short as possible. This method of construction is strong enough for most purposes but if you intend to mount the unit where it is likely to experience a lot of vibration or mechanical shocks then it may be a good idea to glue the coils in place. Mount the components in the same positions as those shown in Fig 2, this is necessary in order to prevent any slight interaction between the coils affecting the performance.

L1 is fitted first with the connecting leads bent away from the body of the coil. One lead is soldered to SK1, the other lead is soldered to SK2 via the 5.6pf capacitor C1. L2 is made by feeding a short length of suitable gauge wire five times through alternate holes of a six hole ferrite bead. This forms an inductance of around 4uH, but the lossy ferrite material prevents any self resonances from occurring at unwanted frequencies. The two ends of the coil are then soldered between SK1 and SK2. SK3 is made by winding three and a half turns of 22swg tinned copper wire around the shank of a 5mm diameter drill. The wire is removed from the drill and the two ends bent at right angles to the body

of the coil and cut to a length of 5mm. The coil is then stretched so that there is about a 1mm gap between adjacent turns. C3 is passed down the inside of the coil and the leads soldered to each end. One end of L3 is soldered to SK3 and the other end to SK2 via capacitor C2.

### Alignment

Once the construction has been completed a small amount of alignment is required. You will need a scanner or FM broadcast band receiver with a signal strength meter and an external antenna. Initially connect the receiver directly to the antenna, and find a signal at around 97MHz which gives a meter reading of approximately half scale. You will need to make a note of this level before you move on to the next step.

Connect the antenna to the antenna socket of the splitter and the receiver to the car radio socket. Adjust L1 for the best signal strength reading on the meter. Use a special tool as detailed in the parts list, or an equivalent, for this purpose to avoid damaging the adjustable core. When the coil is set correctly the core should be about 2mm from the top of the former, this should give a receiver meter reading almost the same as that measured previously.

Next connect the receiver to the scanner socket, the meter reading should now be a lot lower than before. Adjust

L3 for the lowest possible meter reading by squeezing together or stretching apart adjacent turns of the coil. It may be necessary to re-tune the receiver to a slightly stronger station around 97MHz once you are near the correct tuning point, in order to find the best null. The box lid can now be replaced and the unit fitted into the car for final testing.

### Installation

The position in which the splitter is connected to the antenna is very important. Car radio antennae are fitted with a special low capacitance coaxial cable. This is designed to provide the correct input match to the car radio on the medium and long waves and should not be replaced with normal 50 ohm cable. In order to obtain the optimum results, it is best to connect the splitter unit in circuit as close to the antenna as possible. The existing cable may be cut and connectors fitted so that the unit can be bypassed with a back to back connector if required. A separate 50 ohm cable can then be used to connect the scanner to the splitter.

If the unit is working correctly, you will probably not be able to detect any difference in performance with the splitter in or out of circuit. A slight adjustment of the car radio antenna trimmer may be required in order to obtain the best reception on the long and medium wave bands, but no other adjustment should be necessary. If you want to improve reception on the scanning receiver it is possible to replace the car antenna with a wider bandwidth design. However it is a good idea to check the suitability of such antennae for broadcast band reception, as many models have an in-built DC static discharge choke and do not work too well on the lower frequency ranges. I use a commercial 5/8 over 5/8 wave UHF colinear with good results. This approximates electrically to a 1/4 wave antenna on the FM broadcast band and has the advantage of providing useful additional gain on the uhf bands where signals tend to be weaker.

### In Use

I have now tried the unit in several cars with different types of antenna. Very few problems were encountered with the operation of the unit, and in one case an actual improvement in FM reception on the car radio was noticed.

The advantage of being able to use an inconspicuous car radio antenna with your scanner should make the effort involved in constructing the unit worthwhile. When you consider the increasing number of thefts from motor vehicles in cities, it pays not to advertise your scanner with an unusual looking antenna.

### PARTS LIST

Die-Cast metal box  
BNC Connectors (3 of)  
L1 500nH  
L2 4uH

L3 40nH

C1 5.6pf  
C2 47pf  
C3 68pf  
Trimming Tool for L1

CIRKIT 21-95001  
CIRKIT 10-01000  
CIRKIT 35-10803  
3 turns on ferrite core  
CIRKIT 55-25111  
3.5 turns air spaced  
22swg tinned  
copper wire  
CIRKIT 04-56901  
CIRKIT 04-47001  
CIRKIT 04-68001  
CIRKIT 35-00001

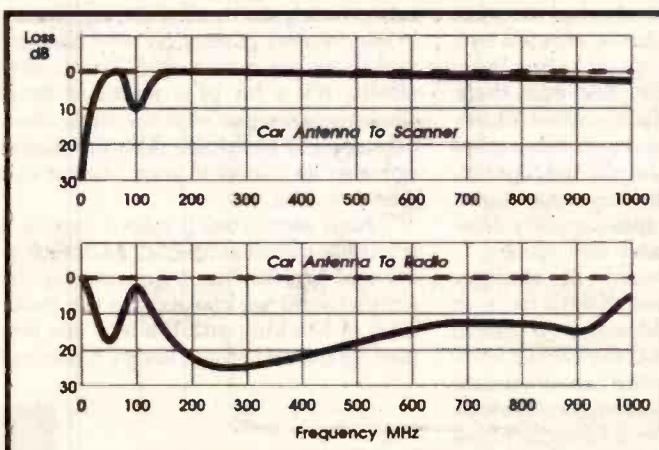

Figure 3  
Graph showing loss through Splitter Graph -3dB Points (X)  
Car Antenna to scanner 34MHz 87MHz 115 MHz  
Car Antenna to Car Radio 5MHz 88MHz 111MHz

# STARTING OUT IN Scanning

by Chris Lorek G4HCL

**W**hen we refer to 'FM' in Scanners International, we signify narrow-band FM, i.e. a few kHz of deviation, normally +/-20% of the channel spacing used, which in the case of 25kHz channel spacing gives a +/-5kHz nominal deviation. Wide Band FM on the other hand, the type used for FM Broadcasting around 100MHz, uses a deviation of around +/-75kHz and if you tune in the latter on your scanner switched to Narrow Band FM, you'll get a very distorted and barely intelligible signal. This is because the filters in the receiver are only wide enough to pass the signal required and little else. If we used a 150kHz wide filter in our receiver (i.e. that needed to just about pass a wide band FM signal with +/-75kHz deviation) for narrow-band FM reception, we'd be liable to receive several signals at once all interfering with each other with squeals and whistles in our receiver, these in fact operating on adjacent channels. For normal speech (i.e. aircraft communication) and the low-fi music that's used on Long, Medium and Short Wave, AM only requires around +/-4kHz bandwidth, although some AM ground-based transmitters for aircraft communication use a small frequency 'offset' for various reasons (our Airband series will go onto this in more detail) hence slightly confusing the matter sometimes!

But some receivers reject off-frequency signals better than others. Often in a typical receiver the choice of filtering is a compromise on FM between 12.5kHz and 25kHz spacing, with a typical receiver being capable of receiving both without distortion but subsequently offering less rejection of adjacent channel signals 12.5kHz away than 25kHz away. This means that if a strong signal came up 25kHz away from the signal you were listening to, you could have a good change of carrying on listening blissfully unaware of this. However if another off-channel signal of the same strength came up 12.5kHz away, it would stand a higher chance of interfering with

your wanted signal due to the filtering limitations in the receiver.

## Adjacent Channel Rejection

No receiver has perfect filtering, but some are better than others. It's the *difference* level of these signals that's important and the level of difference that can be reached before one signal starts interfering with the other in a given receiver. This difference level is nor-



mally expressed in dB (Decibels), with a voltage level of 20dB being a tenfold increase in signal level in the receiver (not to be confused with power, where 10dB is a tenfold increase). So an adjacent channel rejection ratio of 20dB means that the set can stand up to an adjacent channel signal of up to ten times the strength of the wanted one without totally blotting it out.

## Blocking

As well as adjacent channel interference, receivers can also be affected by a number of other signals including those several channels away, and even those several MHz away. This is called 'Blocking' of the receiver, and very often takes the form of causing the wanted signal to simply disappear while the stronger signal is being transmitted, thus typically causing the receiver to carry on scanning.

As you tune towards the stronger signal, you'll often find that the receiver squelch raises as the FM noise level reduces (or in the case of AM, the carrier level leaking through the filter increases), and hence your scanner automatically stops well before the receiver is correctly tuned

into the signal. Either of these effects can be quite annoying, causing you to start frantically hitting buttons to get your scanner operating normally again. As with adjacent channel rejection, it's the difference level of wanted/unwanted signals that's important.

You'll normally find that handheld scanners which are designed to work with small set-top aerials are built for maximum sensitivity (i.e. the capability to pull in weak signals) but not for the utmost in strong signal rejection. So when you connect an external aerial onto your handheld scanner, be prepared for blocking effects - it's not a *fault* of the set but instead more correctly described as a *limitation*.

## Review Figures

So how do you tell whether a scanner's better or worse in receiving the things you want and not being affected by the signals you don't want? In our popular *Scanners International* technical reviews (we've got another next month) we always measure the adjacent channel rejection and the blocking level of every scanner that passes through our hands, with the results being given in the dB level to cause a given degradation of a wanted signal by an unwanted off-channel signal. We measure the adjacent channel rejection at both +/-12.5kHz and +/-25kHz, and at larger offsets of 100kHz, 1MHz and 10MHz to test for blocking. Sophisticated synthesised low-noise signals generators linked to a hybrid combiner are used for this, and the same method of testing is used in every case to provide you with a comparative figure each time. This way, you can if you wish directly compare one set against the next with confidence, but without needing to be a technical wizard to interpret the results!

## Roundup

So we've seen that it is important to make sure our receiver bandwidth isn't too wide, nor too narrow. Too wide and we get unwanted interference from adjacent signals, too narrow and we get distorted reception. Also, if your receiver isn't quite up to receiving signals in the presence of stronger off-frequency signals in your area due to blocking effects, it's a bit of a waste of time! Choosing a scanner with selectable channel steps and switchable AM/FM modes can also be useful if your budget can stretch to this.

Next month we'll take a look at a few other common limitations of receivers, and possibly more importantly the simple ways we can reduce the problems of blocking and the like, see you then. In the meantime, happy scanning!

# Audio Processor Project

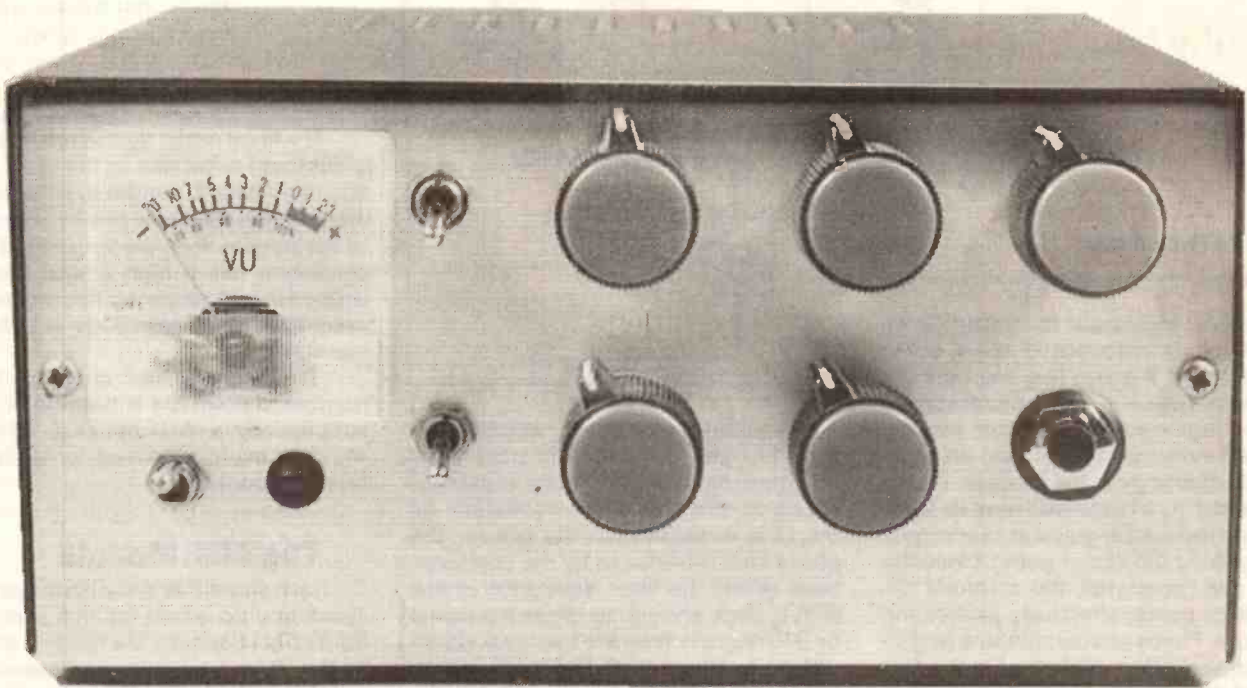

## *G. W. Goodrich describes the Audio Peak and Notch filter sections*

### The APF Module

The accompanying diagram shows the circuit diagram of the audio peak filter module. The circuit is based around two low noise op-amps available within an LM353 IC, each op-amp within the IC package is configured as a fairly conventional band pass filter. Further inspection of the circuit reveals that unlike the majority of published circuits where fixed values of R and C are used to define the centre frequency and Q (bandwidth) of the filters, the resistors are made variable. Note also that since both filters are cascaded, their pertinent resistors are ganged together via dual gang potentiometers (VR1 and VR2). In theory one could keep cascading such filters in order to achieve higher orders of rejection in the LF and HF stop bands, but unfortunately multi-gang pots are not easily available to the home constructor, and tracking tolerances would come into play, so we have to think of something else!

Since it is only practically feasible to control two band-pass filters in this fashion, we have to achieve as much

selectivity as we can from both. The easiest way of obtaining this is to ensure that the Q of the filters is relatively high.

The Q of a resonant circuit (as we might regard our bandpass filter) is defined as;

$$Q = \frac{CF}{BW}$$

Where CF is the centre frequency in Hz and BW is the 'half power' or 3db bandwidth at the filter.

If we wanted to derive a simple band

pass filter with a 100Hz bandwidth and a centre frequency of 800Hz then the Q is;

$$Q = \frac{800}{100}$$

$$Q = 8$$

Now whilst this figure might appear quite conventional for those used to designing pi-networks and suchlike, it really is a rather high figure for the simple filter we are discussing. Q can be regarded as a guide to how 'lossy' a resonant circuit is, i.e. the higher the Q the less lossy the resonant circuit. Sounds great for CF tank circuits but in an audio circuit it can be a positive menace!



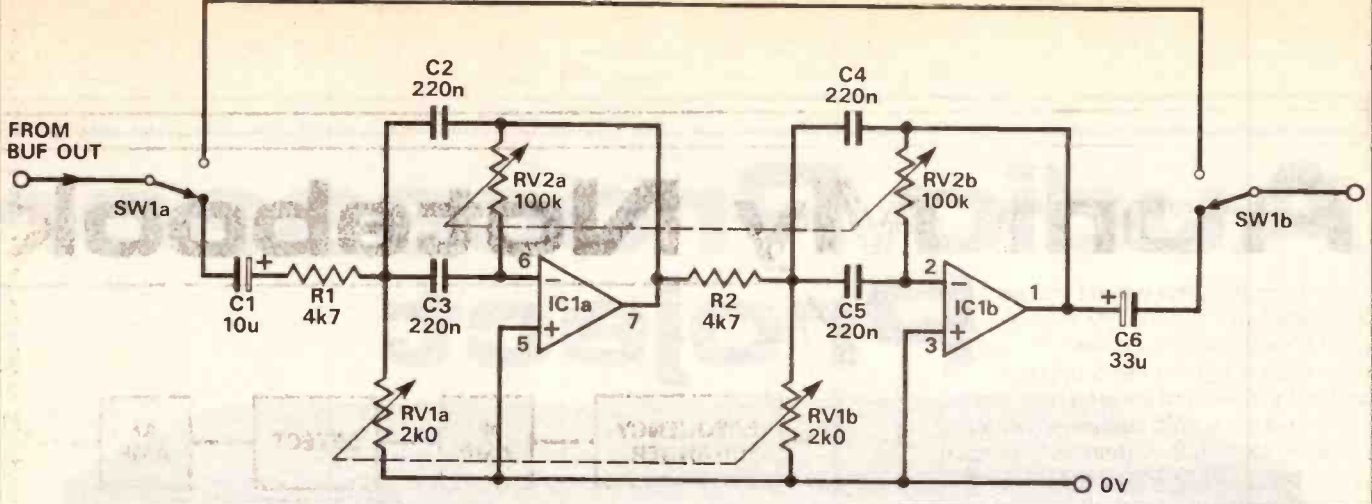

NOTE:  
IC1 = LM353N

**Audio Peak Filter**

Let me endeavour to explain. Since our circuit is resonant it takes some energy to get it going (e.g. like hitting a bell). Having got it going, the audio signal can be regarded as 'sloshing around' within the resonant circuit and only losing a bit of energy in the process. Thus a pulse entering a circuit will have its leading edge reduced in gradient as energy is used getting the circuit going. Once the pulse has completed, the resonant circuit keeps going, effectively prolonging the pulse. These effects combine to give the 'ringing' effect described in the first part of this series. That is why it is important to control the Q (and hence the bandwidth) of simple band pass filters such as these.

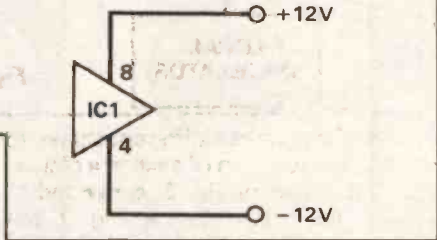

Another nasty effect, which I suppose I ought to mention in passing, is that these filters are also quite capable of acting as effective audio oscillators. As the Q is increased, so the greater the phase shift introduced by the combinations within the filter. Now if the phase shift is large enough to rotate the signal by 360 degrees then the feedback signal will be in phase with the input signal, hence the Barkhausen criterion is satisfied and you have a perfectly usable audio signal generator by default (the Barkhausen criterion — look it up!).

It will be noted by the reader at this point that I subscribe to the view that if you can't beat it, feature it, although the technique is not a new one by any stretch of the imagination. Any amplifier close to oscillation has a high Q and this was utilised in early regenerative receivers in order to achieve selectivity at radio frequencies.

The only other aspect of this module to point out is that the LF353 is supplied by a dual rail (e.g. -12V and +12V) to avoid the need for additional bias components.

**The ANF Module**

I am afraid that the author can claim absolutely no credit for this section of the design. Basically the notch is created by the Twin Tee network preceding the op-amp (a 741 in non-inverting mode). If the design is in one textbook it must be in a hundred. Basically the values of R and C are chosen such that a notch can be

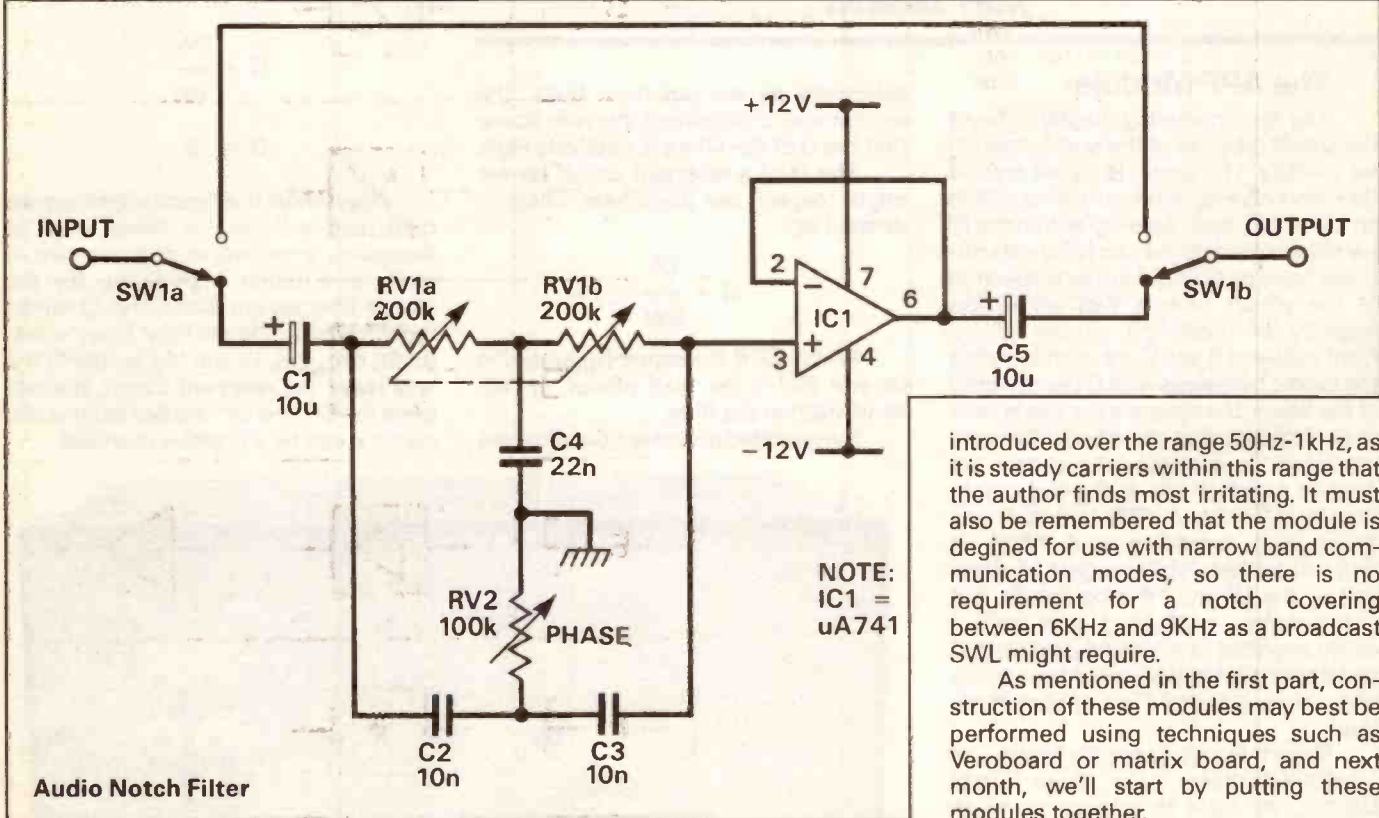

NOTE:  
IC1 = uA741

**Audio Notch Filter**

introduced over the range 50Hz-1kHz, as it is steady carriers within this range that the author finds most irritating. It must also be remembered that the module is designed for use with narrow band communication modes, so there is no requirement for a notch covering between 6KHz and 9KHz as a broadcast SWL might require.

As mentioned in the first part, construction of these modules may best be performed using techniques such as Veroboard or matrix board, and next month, we'll start by putting these modules together.



# From My Notebook

Right from the time when I first became interested in radio in my school days, then at radio college, even when I started work as a seagoing radio officer, books and magazines that insisted on showing radio and electronic equipment in block diagram form, rather than as full circuit diagrams, used to annoy me intensely. I wanted to know what was going on inside the blocks — what the components were and how they were interconnected.

As my experience increased and I understood more of how circuits worked, I began to appreciate that the block diagram had its place in giving a 'thumbnail-sketch' of a system. But it was not until some years later that I recognised how really useful block diagrams could be.

In this modern era of equipment based largely or even totally on integrated circuits, we have to learn to live with circuit diagrams that are really no more than block diagrams, and to adopt a different outlook.

**Geoff Arnold's regular 'Notebook' this month looks at block diagrams**

## What Is a Block Diagram?

A block diagram is a way of drawing an electronic circuit as a number of square or rectangular boxes or blocks (hence the name) joined together by lines which indicate signal flow, control connections and (sometimes) power supply arrangements. Taking a radio receiver as an example, the simplest block diagram we might draw is shown in Fig. 1. The block is labelled by the conventional abbreviation for a receiver 'RX' and has an input from an aerial and an output going to a loudspeaker. Otherwise the diagram tells us very little, not even whether it is a 'straight' set (TRF) or a superhet. The block diagram of Fig. 2 reveals more, and now we can see that it's a basic superhet.

The essential information about circuit functions in Fig. 2 is conveyed by the labels in the boxes, which means that we have to read those labels even to begin to interpret the circuit. For someone who doesn't speak English fluently enough to understand the abbreviations used, that means trouble, and of course exactly the same problem could arise for an English-speaker trying to read a block diagram in a foreign language. That's why a set of symbolic shapes are often added inside the boxes, or sometimes the rectangular

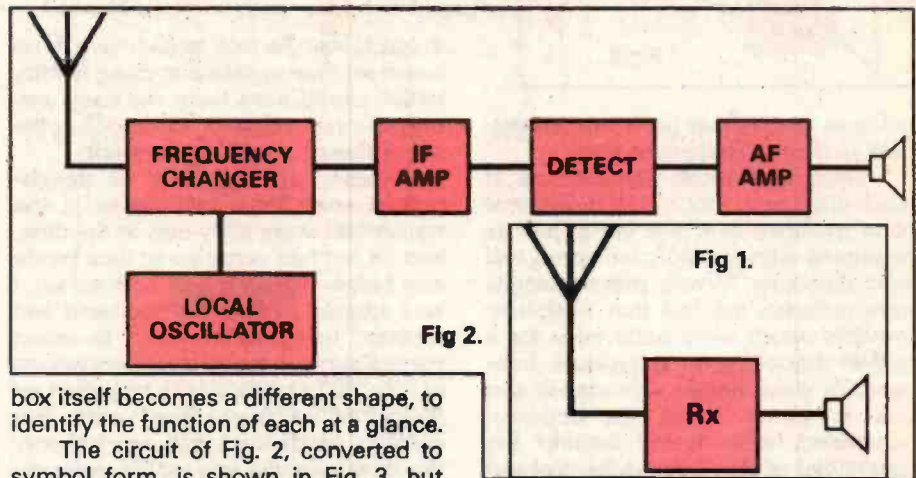

box itself becomes a different shape, to identify the function of each at a glance.

The circuit of Fig. 2, converted to symbol form, is shown in Fig. 3, but notice you still need written labels to tell you things like the frequencies of signals at various parts of the circuit, or the purpose of control connections. Also useful are sketches of signal waveforms, and notes of which active components

(valves, transistors, diodes or ICs) are contained in each functional block. The arrow-heads where connections meet the boxes are not usually included, but I prefer to add them to avoid any confusion as to which direction things are

Fig 4.	
<p><b>GENERATOR OR OSCILLATOR (WAVEFORM AND FREQUENCY INDICATED)</b></p> <p>[— A —]</p>	
<p><b>FREQUENCY CHANGER, CHANGING FROM f1 TO f2</b></p> <p>[— B —]</p>	
<p><b>FREQUENCY MULTIPLIER</b></p> <p>[— C —]</p>	
<p><b>FREQUENCY DIVIDER</b></p> <p>[— D —]</p>	
<p><b>AMPLIFIER</b></p> <p>[— E —]</p>	
<p><b>ATTENUATOR (FIXED)</b></p> <p>[— F —]</p>	
<p><b>ATTENUATOR (ADJUSTABLE)</b></p> <p>[— G —]</p>	

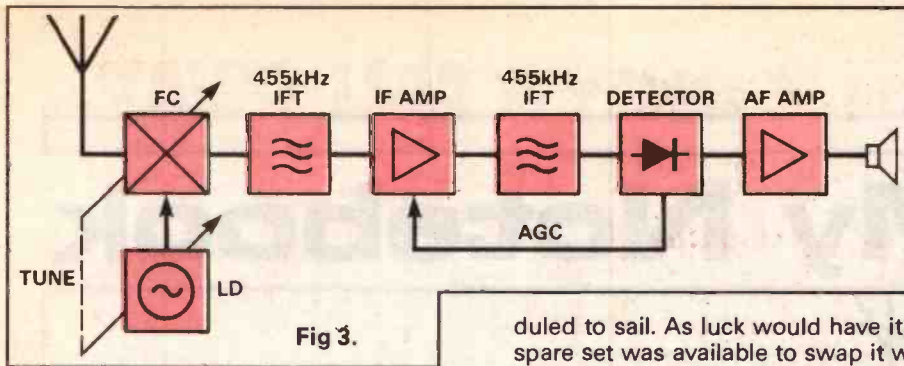

Fig 3.

going in circuits that have lots of feedback or control interconnections.

There is a British Standard set of block diagram symbols, but these have been modified over the years, just as happened with symbols for circuit and logic diagrams. Mostly, these changes have reflected the fact that traditional symbols which were quite easy for a human draughtsman to produce free-hand, or more neatly with stencil and pen or pencil when the occasion demanded, were totally beyond the capabilities of the early mechanical and computerised drafting machines. Now that computers have become much cleverer, they can cope with things like curves and zigzags, but such shapes tend to use up lots of memory and they can look pretty scruffy when output on cheaper printers. So unfortunately we're not likely to go back to earlier symbols, whether for circuit, logic or block diagrams, even though many of them were far more instantly recognisable than the modern interminable ranks of rectangular boxes. But enough of riding one of my hobby-horses!

What this means is that as you broaden your interest in radio and electronic matters, you are bound to come across block diagrams drawn to earlier standards and also some which use symbols devised by companies or individuals who 'do their own thing', inventing or modifying symbols to suit themselves. A selection of some of the frequently used symbols from the current British Standard set, and a few of the common variations, are shown in Fig. 4.

### The Light Dawns

My realisation of how useful block diagrams are, came shortly after I had encountered a really frustrating repair job. At the time, I was working in the electronics department of a major shipping company, and much of my time was spent doing overhauls and fault-finding on shipboard radio and electronic equipment. Valves were still extensively used, though transistors were becoming ever more common and the occasional integrated circuit was appearing in the very latest sets. All of this equipment had to be maintained in full working order, and much of it was subject to regular government inspections. On one of those inspections, a portable lifeboat transmitter-receiver had failed to work properly just one day before the ship was sche-

duled to sail. As luck would have it, no spare set was available to swap it with, which would have been the easy way out, so it was a case of 'fix it quick or the ship's departure will be delayed!'

These particular sets, all transistorised apart from two valves in the transmitter, were fairly new at the time, and I'd not had occasion to look inside one before. When it was opened up, I was amazed to find that the band and function turret switch used to select transmission on the distress frequencies of 500, 2182 or 8364kHz or reception on 500 or 2182, had five banks of twenty-five contacts. Inside the turret were not only the tuned circuits you would normally

expect to find, but also three quartz crystals, numerous links and level-setting resistors, and a complete 2-transistor IF amplifier!

I won't go into the dreary details, but as you can imagine, tracing the circuits back and forth via all those contacts to locate the fault was a head-spinning experience. We managed to get the set operational again in time for it to pass muster at a quick revisit by the radio surveyor first thing next morning, and the ship sailed on time, but I resolved to make sure that I was better informed before I might be presented with another fault on that type of set.

Very shortly afterwards, I was lucky enough to go on a training course to learn more about the techniques used in new radio and electronic equipment then being fitted on board ships - weather facsimile receivers, automatic

MIXER [H]	
BAND PASS FILTER [I]	
BAND STOP FILTER [J]	
LOW PASS FILTER [K]	
HIGH PASS FILTER [L]	
PHASE-SHIFTED NETWORK [M]	
DETECTOR [N]	
MODULATOR OR DEMODULATOR CARRIER INPUT AT 'c'	
[*P]	* SYMBOLS IDENTIFIED WITH AN ASTERISK ARE THOSE APPEARING IN BRITISH STANDARD BS3939

# A SUBSCRIPTION IS ONLY A CALL AWAY...

What could be a better way of keeping up to date with the latest news and developments in the world of amateur radio, than by ordering a direct subscription to H.R.T., delivered direct to your door each month.

We've now made ordering a subscription easier than ever before by calling our CREDIT CARD HOTLINE. Simply give us a call, quoting your credit card details and delivery address and we'll do the rest! Remember, a subscription delivered to any address in the UK is POST FREE, all overseas subscriptions include postage.

Subscription Rates: UK £19.20: Europe £24.00: Middle East £24.35: Far East £26.70: Rest of the World £25.75 or USA \$48.00: (Airmail Rates on Request).



Telephone 0442 876661/4  
Between usual office hours  
quoting reference: HRT/T1



telegraphy systems, data-logging equipment, computerised depth-sounders, automatic direction-finders, SSB and VHF telephony, closed-circuit TV and so on. Throughout the course, great emphasis was laid on the usefulness of block diagrams in the process of learning about complex equipment. I shall always be especially grateful, though, to one lecturer who drummed into us his view that 'the best block diagram is one that you have drawn yourself'.

How true that is. For one thing, in drawing your own block diagram of a piece of equipment, you can include just as much, or as little, information as you feel is necessary or useful. In a very simple set for example, the power supplies may be so uncomplicated that it's not worth showing them in the drawing. In another set, changing of bands and functions might be done by switching power on and off certain stages, or a supply from one voltage dropper or stabiliser may be fed to several stages. Here, by the application of a little logical thought, information on how the power supplies are arranged can be of enormous help in later fault-finding.

Also, in the process of drawing your block diagram, you are bound to learn an enormous amount about what it is that makes the circuit work. I redrew the life-boat radio that had been my nightmare

as a set of five block diagrams, one for each band and function, having devised a numbering system for the turret contacts so that each signal, power or control route on each block diagram could be related to its path on the full circuit diagram and in the set itself. By the time I had finished my set of block diagrams, I could describe in detail what every circuit did, and how each was used or modified according to the band and function in use.

It was, I suppose, an extension of Murphy's Law that I never encountered another fault on that particular model of transmitter-receiver during my remaining years in the marine industry!

## Inside Black Boxes

Nowadays, 'black-box' amateur equipment gets ever more complicated, and the circuit diagrams in the manufacturer's handbook of the average transceiver are enough to frighten anyone. The block diagrams are not much better, because they usually try to include every function on just one drawing, perhaps showing 'transmit' paths in solid lines and 'receive' paths in broken lines.

If you're keen to learn more about how your transceiver works, I can recommend no better way than drawing out

your own block diagrams, producing separate ones for transmit and receive, and maybe for different bands and modulation modes as well if the circuit arrangements change significantly. Admittedly, where lots of integrated circuits are used, this can be a tricky task, and where multi-function ICs are concerned, it can be especially difficult to sort things out. Study other block diagrams to get ideas on how things are shown, especially how certain components, such as switches, variable Rs and Cs, quartz crystals, etc., are brought outside the boxes and labelled to show their purpose more clearly. Articles on equipment conversion in recent issues of HRT use this technique, which produces a drawing that is a cross between a circuit diagram and a block diagram, and very useful too.

Don't be discouraged if your first diagram looks an absolute mess. It usually does! With a little practice and a few 're-drawings', you will generally find that you can turn it into something quite presentable and useful. And your knowledge, not only of what makes that particular rig 'tick' but also of circuit techniques in general, will have increased enormously. Another useful part of the 'self-training in wireless telegraphy and telephony' which is central to the amateur radio licence.

# Satellite Rer

## RS-14/Rudak-2

Amsat-DL officials were informed in December that the launch of RS-14/Rudak-2 would occur at the beginning of January, so hopefully by the time you read this the satellite should be in orbit. The CW telemetry beacon can be heard on a downlink frequency of 145.822 or 145.948 MHz. Leo UA3CR (who's probably also reading this) requests the help of radio amateurs worldwide to help collect telemetry, and to send it him via packet radio once the CW beacon is turned on (address it to RK3KP @ RK3KP). At the time of writing this, the exact launch window has not been announced nor have the preliminary Keplerian elements been published, hence unfortunately I can't present them here but you can listen into the Amsat-

the system also uses a Tiny-9600 modem which is added to the TNC as a daughter board. The receive antenna was a 1.5 turn helix sitting on the ground pointed more or less straight up, with a turnstile for the uplink.

On the evening of November 3 during a 60 degree pass, Jeff managed to a connect to the spacecraft BBS, obtained a directory, uploaded a message and downloaded about 16 kbytes. He then switched to the broadcast protocol, requested and received an Amsat Keplerian element file. Jeff feels that he should be able to receive 100k of data on any pass of 10 degrees maximum elevation or better.

This effort shows that, as many people have shown in the past, you don't need lots of money to get into this corner of the hobby.

ing in connected mode you will see packets from the FTLO server callsign: PAC-SAT-0 (on AO-16) or UOSAT3-12 (on UO-14). Bulletins being broadcast will have the source callsigns of UOSAT3-11 or PACSAT-11. These packets may contain some ASCII text, although each will begin with a short binary header.

Although the first version of the ground station software is not the 'all-singing-all-dancing' software that they would like it to be, it will be more than adequate to allow those with an IBM compatible computer to start using the BBS on AO-16, UO-14, and LO-19 as quickly as possible. At a later time, versions for Macintosh computers and upgraded IBM PC versions will be made available. A good place to keep an eye on for these is G8LVY's telephone BBS on 081 547 1479.

The one thing that users who start using the ground station software will immediately notice is that using AO-16's BBS will be quite different from FO-20's BBS. If you try to connect to AO-16 without the proper ground station software, after a while you will be logged off. But when the proper software is used, it will allow users to compose messages off-line and upload them very efficiently. If you fail to get the entire message uploaded during a single pass, the ground station software will remember where you were and it is from that point you can continue to upload on the next pass. The same holds for downloading a file; if it doesn't get completely downloaded during a pass, the ground station software will remember where you were and will pick the file at that particular point on the next pass. The software protocol to perform these very 'smart' file transfer operations will greatly facilitate packet traffic handling.

## *Richard G3RWL of AMSAT-UK gives an update on the amateur satellite scene*

UK nets for the latest information. The packet update interchange during and after the launch will be via RK3KP on 14.090 MHz (this is 14090.82 USB on my rig).

The Packet and CW telemetry parameters have already been announced on the packet BBS network, they aren't published here due to space restrictions but an SAE to the editorial address will get you a copy if you're interested.

## Portable Satellite Packet Operation

Researchers at the University of Surrey took their portable packet satellite station out into the field and put it on the air last week. Jeff Ward G0/K8KA, used the 9.6kB semi-automated packet station to operate UO-14 from his flat.

As Jeff describes it, apart from the aerials used the station fits in a metal carrying case about the size of a small briefcase. The RF gear uses single-channel FM receiver, and transmitter strips from Wood & Douglas with minor modifications. The transmitter generates 10W output, and no Doppler compensation is used, and the receiver has a daughter board with an AFC circuit added. The TX/RX equipment costs about £100, and

## Oscar 10

AMSAT OSCAR-10 has now come out of hibernation and appears to be receiving sufficient solar panel illumination to support Mode-B transponder operations. However if it starts FMing, users are asked to cease all transponder use immediately.

## Oscar-16 Update

The Bulletin Board software which has been on soak test on UO-14 since July has now been loaded to AO-16. Later testing uncovered a minor bug which could only be discovered while the satellite was being used by multiple stations. The problem was fixed but it caused a delay to the previously published schedule for software delivery.

Several beta testers have now had a go at the ground station software and there are still a few things that need cleaning up in it before it hits the field. To give yourself a head start, make sure your TNC cable has DCD and RTS/CTS going all the way to your computer, you need this to upload files. You also need to check that you built the PSK modem header properly for the type of TNC you have.

When someone is up or download-

## DO-17

No changes at this time, however uploading of the new software is planned shortly so things could certainly change!

## WO-18

A new version of imaging software was loaded recently. This version uses the arrays currents as well as the horizon sensors in the attitude determination algorithm. A variable timer has been added in order to allow a longer time for constraints to be met before an image capture is triggered.

# nde zvous

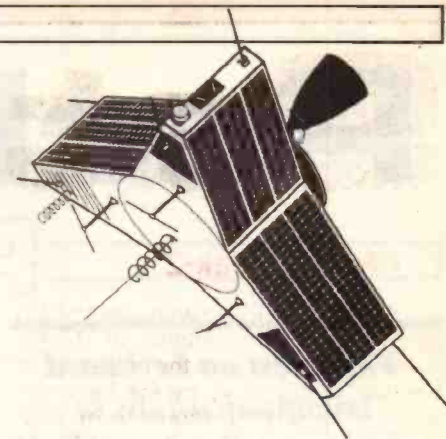

## LO-19

Again no changes, although uploading of the Pacsat file server is planned shortly so again things may change, watch this space!

## Fuji Oscar 20

Command stations have turned on both transponders (JA and JD). It has been determined that transponder operation has little effect on the internal battery temperature, and so it was decided to leave both transponders on. FO-20 has been in a non-eclipsing orbit since mid-August which means that the satellite is constantly in sunlight. The battery temperature has risen to about 40 deg. C (normal operation should have the battery temperature between 0 to 5 degrees C).

The command team are constantly monitoring the telemetry from FO-20 and may, without warning, turn off the transponders if it is deemed necessary for the satellite's well being.

NORAD still have the keplers for FO-20 and DEBUT mixed up, hence again I'm supplying both sets here.

## Satellite DX

There seems to have been a spate of DXpeditions lately operating through the satellites, and for those lucky few who made a contact with 6Y5RA, you can send your QSL to WD3Q, 338 14th

St., NE, Washington, D.C., 20002. Eric WD3Q was granted a reciprocal license for the Dominican Republic and planned to be operational through AO-13 if time during his family holiday allowed. If you were fortunate enough to work Eric, you can QSL to his home address of 338 14th Street NE, Washington, DC 20002. There was also a DXpedition to Saipan (KH0) by KH0/JR1WZI, KH0/JA0RVJ, KH0/JH1TEB, KH0/JH1OGT, QSL via. the JARL bureau. Finally, for those stations managed to work the recent DxPediton to Rhode Island, custom made QSL cards can be obtained from NG1I/1, Frank MacKensie-Lamb, P.O. Box 2058, Natick, MA 01760.

On October 27 W5UN worked VS6BI to complete the world's first two-meter DXCC. Although this DXCC is not the first 'Satellite' DXCC, what makes the accomplishment so unique, is that each of his contacts on 2m was done by bouncing his signal off the moon (i.e. OSCAR 0).

## Salyut-7

Recent atmospheric conditions have resulted in a rapidly increasing decay that threatens to bring about the re-entry of SALYUT-7 probably this month (my bet is 2nd week of February). The space station is without a crew, out of fuel, and is tumbling, so nothing can be docked to it to aid recovery or control the re-entry.

The re-entry, if above horizon and in

darkness will be a spectacular sight, and some excellent if short lived meteor scatter QSO possibilities may occur as the 60 metric tonnes of metallic debris burns up and ionises as it enters earth's atmosphere. Undoubtedly we can expect fragments weighing up to many tens of kilograms to impact, hopefully over empty marine areas.

If you're quick and it hasn't already happened, a competition is open to all who wish to follow the decay of the space station. A prize of a set of commemorative Soviet Space stamps is offered to he or she who comes nearest to predicting the exact time and date of the re-entry. Up to three entries are permitted per person, which may be given via the Amsat nets or sent to G3IOR via the mail, or sent via packet to G3IOR @ GB7VLS or GB7LDI. All entries must be received by at least one week prior to the date and time of the actual re-entry, so get your skates on!

For further information about Amsat-UK, who are the UK branch of the worldwide amateur satellite movement, you can contact them at Amsat-UK, c/o Ron Broadbent, G3AAJ, 94 Herongate Rd, London, E12 5EQ, a large SAE gets you full membership information. Licensed amateurs, SWLs, and indeed any readers having their interest sparked off by this series are most welcome.

## Keplers

SAT:	OSCAR 10	UoSat 2	AO-13	UO-14	LO-19	FO-20	RS-10/11
EPOC:	90325.45940542	90323.60787155	9031750267394	90322.73966395	90323.65401460	90325.59380162	90325.09439216
INCL:	25.9877	97.9322	56.9436	98.6895	98.6925	99.0226	82.9271
RAAN:	174.0618	10.9597	126.0467	38.3096	39.5106	342.2701	212.5923
ECCN:	0.5961398	0.0013393	0.7064813	0.0012144	0.0013586	0.0541585	0.0012955
ARGP:	194.2657	111.6941	240.2087	62.1098	63.2006	52.0494	47.7371
MA:	136.1003	248.5697	32.9306	298.1325	297.0565	312.8281	312.4869
MM:	2.05879606	14.65894846	2.09704510	14.28790482	14.29101116	12.83156346	13.72125310
DECY:	1.4E-07	1.823E-05	-2.01E-06	5.34E-06	5.21E-06	6.6E-07	1.44E-06
REVN:	2797	35873	1853	4293	4307	3693	17096
SAT:	UO-15	PACSAT	DO-17	WO-18	Mir	Salyut 7	DEBUT
EPOC:	90321.25274388	90321.45796366	90323.12914980	90323.45856257	90324.63000519	90324.13915245	90322.00270125
INCL:	98.6905	98.6939	98.6933	98.6935	51.6125	51.5979	99.0243
RAAN:	36.7800	37.2320	38.9183	39.2837	262.5174	225.2984	339.3668
ECCN:	0.0011174	0.0012540	0.0012719	0.0013221	0.0032955	0.0003738	0.0541486
ARGP:	671480	68.5913	64.4348	63.5656	276.2838	138.5517	60.0976
MA:	293.0883	291.6607	295.8146	296.6882	83.5125	221.5796	305.2814
MM:	14.28480611	14.28888085	14.28947046	14.29028895	15.61042347	15.84350908	12.83164617
DECY:	3.43E-06	5.18E-06	5.61E-06	5.05E-06	3.1994E-04	1.3497E-03	4.1E-07
REVN:	4271	4275	4299	4304	27253	48938	3647

# Packet Radio

## Roundup

### *The latest on keyboard communications in amateur radio, from Chris Lorek G4HCL*

Is packet a mode that is a means to an end? Amateurs use packet for many different reasons, some even use it as a hobby in itself. Some are constantly experimenting, finding new forms of transmission, new baud rate speeds, examining the network and writing new programs. Others use packet as a communications tool, i.e. to transfer messages to and from BBSs, satellites, and each other. Amateurs who have never even dreamed of going on packet, such as HF and VHF/UHF DX chasers, now use the rapidly growing DX PacketCluster network to alert them of both propagation changes and the appearance of DX stations.

Of course, not everyone agrees with what everyone else is doing, we're all different of course, but the fact remains that the packet network is there to serve all amateurs, and together we're pioneering the furtherance of amateur radio technology to the envy of our commercial onlookers. I've just this evening returned from attending a professional IEE lecture on the future of communications, the words 'Packet Radio' came up so often they reached an almost embarrassing level! They talked about future satellites as well. So who's already launched a network of packet satellites while others are just thinking about it?

Remember, amateur packet is a shared network, just like our frequency bands. Already there have been tales of censorship, of BBS stations closing down, of nodes threatening to be taken off air. We progress by moving forward,

by expanding, not retracting, so let's make it work. Maybe it's all because we amateurs pioneered such a good Worldwide communication system!

### New Programs

Quite a large electronic mailbag this month, and my thanks to all amateurs who have sent details of what they're doing on packet.

Ken GW3TMH tells me his BBS GB7ABC is running on his own software, which he has been writing for the last two years and only taking a break last winter when the Irish sea flooded his village! It is a multi-tasking program to handle 17 simultaneous users, and has full hierarchical forwarding which it works out itself from messages passing through. Hence once a bulletin or message has passed through with a callsign and '@ BBS' field embedded, a station wishing to send a message to a packet operator at any other BBS only needs to enter a typical command of say 'S G4HCL' and the software does the rest.

There are 21 windows on the sysop screen, all in colour, and the program runs with 2,000 active messages and hundreds of files. One interesting feature is that messages and bulletins are stored separately, both use the numbering range 1-999 and then restart again at 1, so the software never uses high message numbers.

The other thing of interest is the command set, it uses a super-set of the WORLI commands on packet, and at the same time it can also be running several AMTOR ports on the HF bands where it uses the full G3PLX AMTOR mailbox commands, these being very different to packet. Ken says it's very interesting to watch a DX station on one window accessing via AMTOR and a local coming in on packet! Ken tells me the software isn't fully completed, but we're all looking forward to the time when it may be generally available.

### Digiprom News

The plug-in cartridge based software 'Digiprom' as reviewed in HRT some time ago has now been updated to take account of the new TheNet V1.16 Node software, which the originators tell me appeared to be causing a few problems with early versions of Digiprom due to the Connect Text from the new TheNet version. The new Digiprom software, V4.06 is currently under test at the time of writing, however by now it should be available from the Digiprom User Group for free distribution. Digiprom V4.06 for the Commodore 128, operating in true 80 column mode, should also be available from Digiprom User Group at the same time.

### Starting Early

A group of 15 year old operators at the RK3KP club station in Moscow would like to hear from other packet operators, especially Scout stations, around the World. You can get in touch with Nick, Olga, Pete, Wasily, Natasha and Sweta through a message sent to RK3KPC @ RK3KP, entered on your local BBS this will automatically find its way through the packet network of course. The RK3KP club station by the way receive HRT by post every month — so why not send them a message about the work of your club or indeed what goes on in your part of the World, I'm sure they'd be pleased to hear from us.

### MSYS

The MSYS packet program is written by Mike WA8BXN, and having used it over a period Vince G1FBH tells us about its capabilities;

MSYS runs on a IBM or clone. In my case I am running it on a IBM XT with 640k of RAM. The program uses the TNC in the KISS mode and enables you to monitor every thing that is on the packet channel being monitored, including the network node broadcasts. The software contains the following items;  
**BBS with multiple BBS user access.**  
**KA-Node,**  
**Network Node,**  
**TCP\IP,**  
**SMTP,**  
**White Pages,**

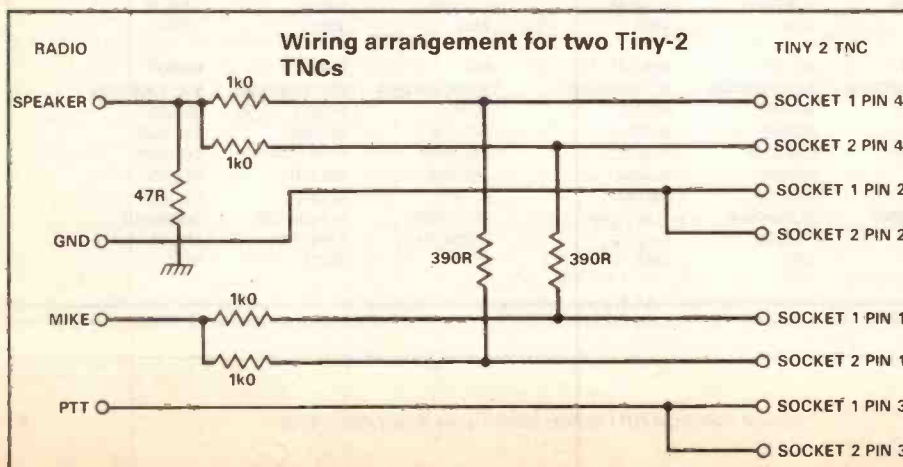

**Auto Forwarding** (Hierarchical and @ BBS),  
**Database,**  
**Remote Sysop Facilities,**  
**Help Files** for end users,  
**Different User Bit Settings,** and  
**21 MSYS Utility support programs.**

**The BBS;** On first connecting to a MSYS system, the end user will be presented with several questions such as Name, Post Code, and local BBS, they will also receive some basic help instructions on the system. Once logged onto the system, on the next connection they just receive a shorter 'log on' message followed by the 'prompt' line. The BBS will support multiple end users with also a conference facility, the maximum number of simultaneous connects is determined by the sysop and is decided on by the amount of memory the sysop wishes to allocate to the channels, each channel using about 7k of RAM.

The Command prompt line contains the following commands for the end user:-

A-ABORT  
B-BYE  
C-CONFERENCE  
D-DOWNLOAD  
G-SEARCH FILE  
H-HELP  
I-INFORMATION  
J-CALLS HEARD  
K-KILL MESSAGE  
L-LIST MESSAGES  
M-MESSAGE OF THE DAY  
N-ENTER NAME/QTH  
P-PATH TO STATION  
R-READ MESSAGES  
S-SEND MESSAGE  
T-TALK TO SYSOP  
W-WHAT FILES  
V-VERSION  
X-EXPERT MODE  
U-CURRENT USERS  
?X-INFORMATION ABOUT COM-  
MANDS  
\*-COMMENT LINE

Most of the end user commands are the same as found on other BBS systems, although with a few differences. The 'Conference' command has several other parameters such as CTRL-ZA to add a DX station heard to the spotting list, CTRL-ZB to disconnect from the system. Control ZD to display DX spotting list, CTRL-ZP channel £ to ask a station on the BBS to join the conference, CTRL-ZR to go back to the BBS and CTRL-ZU to list the current stations on the BBS or conference mode users.

The 'G' command is another interesting one, this will ask you to enter a down-loadable file name which is on the BBS. You will then be asked for a search string, and the BBS will search the name file for the occurrences of the search string and return the line or lines with

that string present.

The 'X' command is another useful command, which may be used to set or reset the 'expert' status of the user by the user, this command can also be used with a extra parameter. If for example the end user sent X 22 the during a 'Read' command the BBS would only send 22 lines of text before asking 'MORE?'. Sending a <CR> to the BBS will then send the next 22 lines of text. This can of course be a useful command for end users who employ a 'dumb' terminal to save missing any text if a good, fast packet link is present. If 'XS' is sent to the BBS then only one line of text is sent in each packet, however if 'XF' is sent then several lines of text are placed in each packet. 'XS' would thus be used when the path from the end user to the BBS is not too good, and 'XF' over a good link.

The Network Node within the system has much the same commands as the commonly encountered type, and will allow BBS access for the end user as well as a 'Talk' mode to communicate with the sysop. MSYS also has a set of commands which enable the sysop to set each end user various levels of access to the BBS. These are split up as follows;

*Expert User,*  
*BBS,*  
*Disconnect Immediately,*  
*Limited BBS,*  
*Remote Sysop Status,*  
*Prevent use of 'S' Command, i.e. user may only read messages, and Authorise use of 'File Upload Command.*

Vince tells us that MSYS is also currently being used by the Plymouth BBS GB7PLY, the sysop of this being G3KFN.

However, one of my local BBS sysops has reservations on the compatibility of MSYS if used as a 'full blown' system, although this could of course just be 'teething troubles'. Dave G4WPT tells me MSYS appears to run AX25L2V1 with L4 node traffic, and that for BBS use it does not appear to generate Extended Addresses in the @ field, which may not be acceptable for some modern BBS purposes. Dave adds that there appears to be no validity check on the destination field, as he has received messages addressed to non-existent BBSs which of course cannot be delivered. Multiple linking is restricted also, as is the format for 'WP' message generation, so the moral is be careful if you're considering it's use for more than just a personal user program!

## New Stations

Jerry G0CUO is now running a KA-Node on 29.250MHz FM, 1200 baud. It uses a Kantronics KPC-4 to allow a gateway between 10m and 144.675MHz, with

a Gateway call of G0CUO-10, and a KA-Node call of G0CUO-8. Although not at the moment operational 24hrs, it will be operation most days and nights. Jerry has applied for and is awaiting RA clearance for continuous use, in the meantime he'd appreciate reports sent to G0CUO @ GB7NCL.

A new multi-frequency node has been established in the Cotswolds, operating from Moreton in Marsh. LXS21 operates on 144.650MHz and LXS4 operates on 70.4875, with the coverage pattern of both biased to the east, south and west, and the LXS72 node on 432.675MHz is also operation with coverage biased to the South and West.

## One Radio, Two TNCs

Some time ago, John G8DZH found that he wished to use a single 2m rig and aerial with a pair of Tiny-2 TNCs, one used for his Node and the other for his personal mailbox. He came up with the solution in the accompanying diagram, which uses a simple array of resistors. The pin-outs shown are those for the Tiny-2, although I'm sure the arrangement can be adapted to several other TNCs. Thanks John, I'm sure several readers will find this useful.

## 4m Packet

Many stations are becoming operational on 4m now, through the use of modified ex-PMR gear. An important point to note though is that the 4m band is currently divided up in various sections by using 12.5kHz channel increments. This nicely matches most ex-PMR rigs, as they are fitted with crystal filters of +/- 3.75kHz bandwidth for 12.5kHz channel spacing, but many packet operators are running their transmitters at 5kHz deviation as used for 25kHz channel spacing. Now +/-5kHz into +/-3.75kHz unfortunately doesn't go! So the moral is, adjust your deviation to around 1.5kHz or 2kHz on 4m, and you'll probably find it all works a lot better.

## CTRL-Z, End of Message

That's it for this month, right now I'm getting my station ready for the new Rudak-2 Packet satellite which should be launched shortly (it'll probably be up when this appears in print), it should keep me busy for a short while! Thanks for all your messages, as always I'm pleased to publicise the activities of your packet group. I can be reached through the network by a message addressed to G4HCL @ GB7XJZ, or by post c/o the HRT editorial address. 73 until next month.

# HF HAPPENINGS

I am delighted to be taking over the reigns of this column from Steve, G4JVG, who has been a good friend of mine for many years. I hope he will be able to contribute to HRT from time to time from his new home in Papua New Guinea but, in any case, I plan to maintain regular schedules with him on the HF bands. This, of course, is one of the joys of HF amateur radio, to be able to keep in touch almost regardless of distance.

Perhaps I ought to say a little about myself at this stage. Despite having operated all bands through to 23cm my first love has always been HF, having started out with a Lafayette 9-valve receiver and a Codar AT5 transmitter (I wonder how many readers remember that excellent little rig?). My particular interest is in the LF bands, and in all aspects of competitive HF operation -

ings to Japan. By the way, if you worked GU6UW, GP6UW or GJ6UW, I am the QSL manager for all these operations.

## Band Conditions

Propagation towards the end of 1990 was rather mixed, with 10m opening up at times to the Pacific, but not consistently so. What did surprise me was LF propagation which was excellent at times. Operating from Jersey in the CQWW CW contest I was surprised, at 2300GMT, to be working stations in W6, W7, VE7 and KL7 on 40 metres, while N7DF/NH2 was very loud late in the afternoon. On Top Band (160m) there was lots of Caribbean DX to be worked, plus 9M6NA who found his way into the logs of at least two UK stations (but not mine!). Following the contest OH2BH and friends put in a sterling effort from

period. The Colvins continued their Southern Africa tour with an operation as ZS9/W6KG, AH3C put in a big effort prior to leaving the island after doing such a superb job both with this call and his previous KN0E/KH3 callsign, and there was plenty of other DX too. I was particularly interested in K9AJ's efforts as 8Q7AJ from the Maldives. He showed up every evening for a week at 2300 GMT on 3.501MHz, working both Europe and the USA. This sort of sustained and predictable behaviour from a DX station is always very welcome - too often I hear about some rare DX after the event, and the station concerned never appears again!

For my money, though, the big news to emerge in December was that Romeo of 3W3RR and 1S0XV fame is planning to activate **Afghanistan** sometime this year. Others have promised YA operations and failed, but with Romeo's track record to date we have to take this one seriously. As YA is one of only 5 countries I still need I shall be following this one very closely indeed!

**Don Field G3XTT joins HRT to bring us the latest in HF DX**

## More DXpeditions

As for other forthcoming DX, I note

**TOKELAU ISLAND**  
ZONE 31

# ZK3EKY

(PENINSULAR CALL)

CONFIRMED QSL BY	DAY	DATE	TIME	UTC	MODE	RTTY	MODE	REMARKS
G3XTT	16	Jan	90	0508	7	SSB	500	

QSL MANAGER: WASHUP  
MARY ANN CRIDER  
2485 LEWISBERRY RD.  
YORK HAVEN, PA  
17370 U.S.A.

73, OP: "ZBIG" NIEW FRANK MURDZIA  
VK2EKY, SP5EKY, ZK2EKY  
7J1AGD/6, KH8/VK2EKY  
5W1KY, A35KY

PSE QSL  TRX QSL A W/EMPTY QSL

**AMERICAN SAMOA**  
ZONE 32

# KH8/VK2EKY

CONFIRMED QSL BY	DAY	DATE	TIME	UTC	MODE	RTTY	MODE	REMARKS
G3XTT	16	Jan	90	0556	7	SSB	500	

QSL MANAGER: WASHUP  
MARY ANN CRIDER  
2485 LEWISBERRY RD.  
YORK HAVEN, PA  
17370 U.S.A.

73, OP: "ZBIG" NIEW FRANK MURDZIA  
VK2EKY, SP5EKY, ZK2EKY  
7J1AGD/6

PSE QSL  TRX QSL A W/EMPTY QSL

DXing, contesting, awards chasing, and so on. Currently I am Chairman of the Chiltern DX Club, and am busy chasing DX on the so-called WARC bands. I was also with Steve for the recent GU6UW contest operation, and returned to the Channel Islands for a single-operator effort as GJ6UW in the CQ Worldwide CW contest. I have to say, doing a 48 hour CW contest on your own, after a ferry crossing and a day putting up aerials, is no joke! Nevertheless I managed just over 3,000 contacts despite some dreadful rain static (why does it always rain on DXpeditions?) and a lack of any big open-

the Penguin Islands (off Namibia), signing ZS9Z/ZS1. ZS6BCR, a friend of mine, was one of the operators, and told me with two days still to go that they had 25,000 contacts in the log. This included some RTTY operation, as well as SSB and CW. No word yet on whether this one will count as a new one for DXCC, but the general feeling seems to be that it will.

## Maldives, S. Africa, and Afghanistan

There was plenty of other DX to be worked during the pre-Christmas

from DX News Sheet that W2BJI was due to be active as J37XC from 3rd December until 31st March, which should give everybody time to make a contact with him. From farther afield, VE3CPU and his wife are planning an operation from Rarotonga (ZK1) between 24th January and 21st February, all bands but mainly on CW. Andrew, G1SWW, is due to start a 2-3 year tour of duty about now from Haley 5 Base on the Antarctic mainland. He will sign VP8SWW as well as the base callsign VP8HAL, all SSB. QSLs should go to his home call.



## DX PacketClusters

Chris, G4HCL, wrote about PacketCluster in the December issue of HRT. This network really came into its own during the CQ Worldwide contest weekends, with over 1,000 DX alerts being put out on the weekend of the Phone contest. The network is gradually covering the country, with new Clusters recently in Sussex and Hampshire and others planned for Cambridge and Ipswich. If you are at all serious about HF DXing then one of the best investments you can make is in a packet TNC, VHF radio and PC or 'dumb terminal' in order to get access to the PacketCluster system. Not only does it provide you with lots of DX information, but it immediately puts you in direct contact with other like-minded people. Rather than have to wade through masses of irrelevant messages on the regular packet network, every message which appears on the Cluster network is likely to be of immediate interest. As you will gather, I am an enthusiast!

## DXCC News

Those of you who, like me, chase the various DXCC awards may have noticed the backlog that has been building up recently. My own application for 10m DXCC went in back in March 1990, and it was late November before the cards came back. ARRL have a team of volunteers working to clear the backlog and, in future, all records will be held on computer to save you having to re-submit the same card time and again for credit towards different awards. ARRL now make a charge for checking cards for DXCC but, to my mind, it is well worth it if this enables them to put in the level of resource which the workload requires.

While on the subject of DXCC, do remember that there is now only one Germany and one Yemen. The old East Germany has been deleted from the DXCC list, while both North and South Yemen have been deleted to make way for the new Republic of Yemen. Both the 1990 DXpeditions (7O1AA and 7O8AA) count for this new one. Cards may be submitted from 1st March for DXCC credit. There are now 322 countries on the DXCC list.

## Pacific Photos

The photograph and QSL cards I have featured this month were sent to me by Zbig, SP5EKY, who did a terrific job in the middle of last year of activating many rare Pacific islands, with particular emphasis on looking for European contacts. He is also licensed as VK2EKY and 7J6AAK, and is now resident in Japan



with his Japanese wife.

If you have tuned 20m much in recent months you will have come across the regular news broadcasts by K1MAN. These have been causing great controversy in respect of whether it is permissible to operate such a service in the amateur bands and, in particular, to start the transmissions regardless of whether the frequency is already in use. Some of the more vociferous of K1MAN's detractors have been deliberately starting QSOs on the frequency before the scheduled time of his transmissions and refusing to move, leading to some very unseemly on-the-air confrontations and the imposition of large fines by the FCC (the US licensing body). As I write this the lawyers are being brought in on either side which, knowing the US enthusiasm for litigation, means this one is set to run and run.

## Contests

A word now about forthcoming contest activity. Whether you love or loathe contests it is useful to know when they are scheduled so that you can plan your operating around them. Some of the most popular HF contests are scheduled over the next few weeks, so beware! The ARRL contests are an excellent opportunity to work US states for the WAS awards, and are a lot of fun because US contest operators are usually very efficient and disciplined. The CW leg is on 16/17th February and the SSB leg on 2/3rd March. Both run for the full 48 hours, though there may be a few hours each day when none of the bands are open to the US and you can catch some sleep!

The CQ Worldwide 160m SSB contest runs from 2200 on 22nd February

until 1600 on the 24th. The Bermuda contest, a mixed mode event, runs for the whole weekend 16/17th March. Work the US, Canada and Bermuda and win yourself a trip to Bermuda to collect your trophy — last year Ron, GW3YDX, took the honours. Will it be *you* this year? Then the CQ WPX SSB contest runs for the whole weekend 30/31st March, although single-ops are limited to 36 hours of operation. Finally, RTTY enthusiasts will want to participate in the BARTG Spring RTTY Contest on 16/17th March (0200 to 0200).

If you want fuller details of any of these contests, plus copies of log and cover sheets, I can often help out in return for an SAE. Incidentally, the RSGB HF Contests Committee has produced a handy guide to contest operating which gives advice on pre-contest planning, sorting out the RSGB paperwork, and much else.

## WARC Bandplans

Finally, a reminder about bandplans on the WARC bands. Because activity is currently relatively low, many operators are forgetting where the bands divide up! On 17m the phone segment starts at 18.110MHz, with 18.1 to 18.11 available to RTTY operators. On 12m the phone segment starts at 24.930MHz, with RTTY between 24.920 and 24.930MHz.

## See You Next Month

I hope in this first column I have covered the sort of topics you find of interest. Please feel to write and let me have your news, views and any interesting photographs for publication. My address is 105 Shiplake Bottom, Pppard, Henley on Thames, RG9 5HJ.

# VHF/UHF Message

By the time this column appears in print, the spring TEP season to South Africa and possibly South America should be under way. ZS stations are already preparing for the openings and some DXpeditions are planned to rare locations. For up to date information, listen to the UK 6m group information net each morning from around 08.00 local time on 3.718MHz and 28.885MHz. Regular UK operators exchange the latest news during the day and Rick K1JRW gives out the latest WWV solar data each evening at 1820hrs on 28.885MHz.

## History of TEP

We have to go back over 40 years to the recorded start of TEP (Trans Equatorial Propagation). During the run-up to cycle 18, from 1946 onwards, a form of long distance propagation was experienced around 50MHz between stations equidistant and at right angles to the geomagnetic equator. This could not at that time be explained. In America during 1947, XE1KE began working Argentinian stations on 50MHz, during the afternoon and early evening he had over 50 QSO's with LU and OA4. The LUs also worked TG9JW, CE1AH and PY2QK.

At this time I was operating as MD5KW in the Suez canal zone of Egypt and had the time and facilities to conduct monitoring of the 5m and 6m bands, I had been also receiving the Alexandra Palace TV on Band I. In 1946 I installed a beacon at my QTH running continuously and beaming alternatively north and south every 30 minutes, the beacon was received in the spring and autumn of 1946 in Europe and South Africa. A listening watch was kept on 28.100MHz continuously at a remote station, but no contacts were made until October and November 1947. On the 15th October there was a 15 minute opening to South Africa, and I had two way 50MHz QSOs with VQ2PL and ZS1P. On the 17th, further QSOs took place with the same stations, this was the first time that I experienced the 'flutter' type of fading which later became characteristic of one type of TEP. Flutter fading was experienced by the South African stations from around 18.00 during the remainder of November.

## All Time Firsts UK — Africa on 50MHz

On October 14th 1947, VQ2PL heard MD5KW on 50MHz and on the 15th VQ2PL and MD5KW had a crossband QSO 28/50MHz. The following day,

G5BY and ZS1P repeated a cross band QSO and ZS1P worked MD5KW two way on 50MHz. The first UK-Canal Zone two way took place at 08.55 hours on November 10th 1947 with a QSO between G6DH — MD5KW, RST 599. During the remainder of November, MD5KW had many 50MHz QSOs with UK and African stations.

During the next decade, little was heard in this country of 50MHz due to Band I TV, but some interesting experiments were being carried out by F9BG, G4LX Newcastle (who had been granted a special permit), ZC4IP, ZC4WR, ZE2JV, ZS6PW and others. These were reported in a long article by R. G. Cracknell ZE2JV (now G2AHU) in QST November 1959, Ray kindly lent me a copy and I am able to make brief extracts of some of the salient information.

"During the years since the end of WW2, increasing use of the 50MHz band by amateurs in areas adjacent to the tropics has revealed radio propagation conditions in the VHF region, up to at least 80MHz that could not be explained by conventional theories. In general the TEP path is between areas on either side of the geomagnetic equator and 1500 to 2500 miles away from it. It is effective during hours of darkness and on frequencies up to 1.5 times the observed

## Ken Ellis G5KW tells us of pioneering work on VHF

MUF for F layer propagation."

"Optimum propagation conditions occur at the same time of the spring and autumn equinox, between points on the

same longitude located about 2000 miles from the geomagnetic equator. The TE mode may be usable between locations where the direct line between the two locations cuts the geomagnetic equator at an angle as low as 45 degrees and beyond the limits mentioned above, but moving away from the most favourable spots causes both the reliability and the MUF to drop off. The quality of the modulation on a TE propagated signal is often distorted by a characteristic 'flutter fading'. A few Watts of RF into a vertical quarter wave aerial may induce a signal of 1mV or more in a similar aerial 4000 miles away in the opposite TE zone. TEP is by no means limited to the hours of darkness. At the peak of solar activity, 50MHz daytime signals were weak and infrequent at Salisbury, but in 1959, probably due to the decreased ionisation at the lower levels, signals from the Mediterranean area have been received at ZE2JV very regularly and at strength at frequencies up to 56MHz throughout the day".

I have prepared a diagram for the UK/South Africa TEP path based on the Mediterranean area/South Africa path diagram which appeared in the ARRL VHF manual 1965. These details are subject to amendment in the light of more recent observations. Examination of Fig.1 shows that the geomagnetic equator traverses Central Africa in a convex arc, approximately 500 miles north of Victoria falls, at its widest point across the continent it has a radius of approximately 2000 miles. The effect of this curvature is to give places in southern Africa lying within the TE belt, an abnormally

Fig 1. Diagram showing the geomagnetic equator

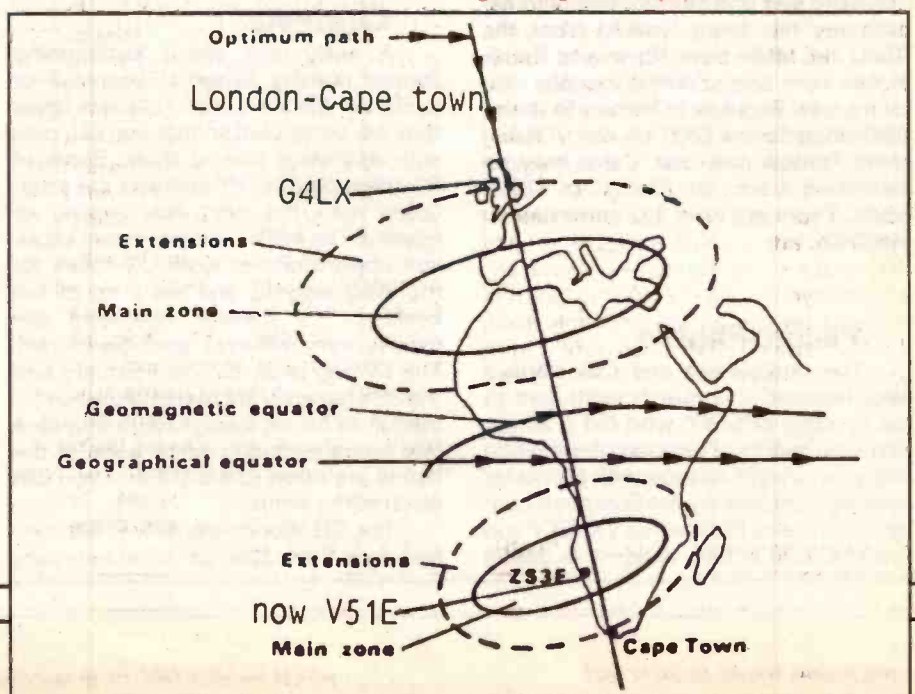

large zone into which the TE propagation is concentrated and in which interference and noise can be received.

During the RAT International Geophysical Year, Gordon Spencer G4LX (Newcastle) had a special 50MHz permit for experiments and made a valuable contribution to tests from this country. His observations showed that ZE2JV signals were received in Newcastle frequently for two brief periods; 17.00-17.15hrs usually showing a 'clean' signal and 19.00-19.30hrs showing 'flutter' which is characteristic of TE propagation (local time in Southern Rhodesia was GMT + 2hrs). It would appear that Newcastle is situated near the northern limit of TEP, but due to the few observers at that time we may have to revise this and that Cape Town is near the southern limit.

### Seasonal Effects

The position of the sun affects TEP. There tends to be more frequent and longer extensions to the south in the southern summer and to the north in the northern summer. This is most noticeable a month or so each side of the respective solstice, the spring and autumn of 1990 bore this out.

During the propagation study I made at the Isles of Scilly during the peak of cycle 21 (1979-1982), although mainly concerned with F2 propagation I made some interesting crossband QSOs during TEP openings. It has been established that during these openings the operating frequency may be up to one and a half times the actual F2 frequency at the time. Therefore, if the MUF rises above 35MHz by checking known transmissions from the south, i.e. WWV and Radio Australia's information on solar data, an indication of possible openings for TEP can be made. It is then time to look on 50MHz for South African stations. Before the days of Band I TV transmissions, the only way of checking the rise of the MUF to 50MHz was by monitoring commercial transmissions. On many occasions around the peak it was frustrating to monitor the MUF rising slowly towards 50MHz and remaining just on the fringe. 50.005MHz was a popular spot as the MUF often remained just there and no higher, I have not had that experience during this cycle but others have. Another factor to note is that for every degree south we operate from, the MUF rises 0.80MHz. Operating from the Channel Isles and Isles of Scilly bears this out.

### Comment by Geoff Brown GJ4ICD

Many operators panic on 3.718MHz

and 28.885MHz to get the latest solar figures, but what for? It must now be clear to many that 'A' index and 'K' index do not have any bearing on long distance (12,000-165,000km) communications at 50MHz (now I really have put my foot in it!), but it seems to be true. During October 1990 there were several flares plus coronal hole activity, this lifted 'A' and 'K' figures as the geomagnetic activity went high. As these figures went high, radio communication on 50MHz persisted over a 15,000km+ path, not just once but on many days during October. In fact we have had Aurora in the evening and then propagation from VK into Europe the next morning on 50MHz. Even during Auroral days the southern path has not been affected. This was seen several times before, like in 1989 when during a large auroral event CX8BE was S9 over here. It seems that something from the sun is not being monitored, something is being overlooked. So what is it all about? Low solar flux levels 28th Oct 1990 152 and still there is propagation to VK, DU, JA from Europe, but I must say for this case the 'A' and 'K' were quiet.

Where is the pattern? or is it just the seasonal changes taking place? The 'A' and 'K' give us a very good warning of an aurora when they become high and disturbed, but, many amateurs are being caught out thinking that because of high As and Ks there will be no propagation, wrong there has been, so has anyone any ideas on this one? Also the non-Great Circle path seems to be showing up quite often to 9L1, V51 and FY7, is this really 'backscatter'? And what about V51 and 9L1 both in together at S9+ (two different paths?), something that the 50MHz Reporting Club and the RSGB propagating studies committee should continue to investigate. We have much to learn on the mechanisms of 50MHz propagation just like Es on 50MHz, we have openings to the exact spot where a 28MHz beacon is, but the 28MHz beacon is sometimes never there. Es both this year and last occurred on 50MHz at the same time in the USA, JA and Europe, with this proof (and there is) how can 'Windshearing' be totally in the northern hemisphere at the same time and be one of the named causes of sporadic E?

Does anyone have any firm theories on the above? More research is needed especially on the solar flux levels and collation between the USA, JA and Europe during the next solar cycles on 50 and 144MHz. There are too many holes in the theories, suggesting something is missing. November is looking the same, I will be interested to see your reactions on these subjects, please contact GJ4ICD either directly or c/o the HRT editorial address.

### Conditions improve during December 1990

During the first few days of December there have been a welcome return of DX conditions to Africa, North, Central and South America. On December 4th many of us worked TI2HL, TI2NA, TI2KD, K4SC and W400, and on the 5th VE1YX had over 60 QSOs with G stations, the 6th saw a 5 hour opening to South Africa from Europe. On the 7th, G5KW and GJ4ICD both had a QSO with CN2JP on his last day in CN, and VE1YX had over 200 QSOs with G stations until conditions faded out at 14.30hrs. The 8th saw another major opening to North America, and G5KW had a QSO with 6W1QC for another new country. As I write this, the solar flux from 177-8-3 on the 3rd to 230-12-3 on the 8th giving a promise of continuing good conditions, even now these have shown the best conditions since last December. More to come? Hopefully this will be a repeat of propagation conditions during former cycles, when we had two years of good conditions followed by a trough of a few months of poor conditions, and then good conditions for a further two years. By the time you read this, the future pattern should be establishing itself.

### 50MHz report from Ted Collins G4UPS

The first opening across the Atlantic took place at last on the 3rd November 1990, despite the very low flux number of 140 the previous evening which appeared to be the trough for the monthly cycle. The opening was restricted to the southern part of the UK, and stations worked or reported heard were VE1YX, VE2DFO, K2QIE, K1JRW, WA1OUB and K3MLD.

**Senegal;** On 10th November, Paulo CT1LN reported that on 9th November he had worked both 6W1BL and 6W1QL on 6m, and had been told that both had received their permits the previous day. QSL details for 6W1BL are via. Box 4002, Dakar, Senegal, for 6W1QC via. JA8KJH.

**Penguin Island;** The DXpedition to Penguin Island during the CQWW CW contest at the end of November included 6m station callsign ZS9Z/ZS1 using 180W. They then went on to V51 as V51Z and then to ZS9A during December.

**DU;** The direct QSL information for KG6/DU1 is; Capt. Luis Ancaux, USNR, USCINC PACREP — LNO, US Embassy Manila, APO 96528 USA.

See you next month, until then good DX from Ken Ellis G5KW, 18 Joyes Road, Folkestone, Kent CT19 6NX. Tel. 0303 53276

# Amateur Television

In our recent introduction we provided an insight into Amateur Television, this time our intention is to take a look at what is required to receive ATV transmissions. We'll start with 70cm as it is a relatively easy band to receive.

## Using domestic equipment

Before you consider making any purchases you should check to see if any of your domestic television receiving equipment can be used to receive ATV. There are now many viewers using a portable TV or video recorder to tune to our frequency allocation on 436MHz, and it is worth noting that some early types of video recorder are more likely to cover this frequency than those curren-

## Using converters

If you do not have any of the items previously mentioned you can purchase a 70cm converter either ready built or as a kit. Using the converter is very simple, a 70cm aerial is connected to the input socket of the converter and a lead connected from the output to the normal aerial socket on a standard TV set. Apply 12V DC to the unit, tune the TV to approximately channel 36 and there you have it.

## Aerials

If you are limited to the number of aerials you can install, you can use one of the wideband TV aerials for a receive-only system, however it must be noted

The ATV allocation on this band is very wide covering over 50MHz. TV transmissions on this band are usually FM for both vision and sound, with the inter-carrier sound at 6MHz spacing, as used on broadcast TV. The quality of the pictures are outstanding, indistinguishable from your local broadcasting stations. Repeater operation is common, and repeaters are operational in Bath (AM Mode), Bristol, Cambridge, Coventry, Crawley, Durham, Dunstable, Fakenham, Glasgow, Hastings (AM Mode), High Wycombe, Leicester, Nottingham and Stoke-on-Trent. If you live near one of these locations you have no need to look further for a source of pictures! Otherwise I suggest you listen on 144.750MHz, the ATV calling and talk-back channel, for signs of local activity.

Receiving pictures on 24cm will involve down converting the signal to a lower frequency so that it can be processed with conventional techniques. Converting a domestic receiver is one option but as most transmissions are FM the result will be a compromise. Converting the 24cm signal to between 35 to 70MHz is better, then feeding into an FM board and bringing the pictures out as composite video with a separate sound channel. Satellite TV receivers can also be used as they cover the 24cm ATV band but they do need a stronger signal than a dedicated amateur receiver. One member of the East Kent group, Les G3LCW, is using his Amstrad SRX 100 satellite receiver with a 24cm masthead gasfet pre-amp and an additional sound board to receive 24cm TV. Remember though to place a capacitor in series with the centre conductor of the coax, as the outdoor LNB is powered by a DC voltage fed through the coax.

Aerials for 24cm are fairly compact, I'd suggest as a start that you construct a helical as described in the VHF/UHF handbook, it can be made from a length of coax and is easily constructed. Low loss coax is essential for the down lead as signal losses can be considerable at these frequencies.

In the next part, we'll take a look at what you can see on ATV.

## *Brian Joyner G8ZYZ details 70cm ATV reception and R. Gilham G6OKB introduces us to 24cm ATV.*

tly available. I recently discovered that my pocket TV was another method of monitoring fairly local stations, so if you have one of these little sets it is well worth trying it out with an external aerial.

## Using other equipment you already have

If you have a Yaesu FRG-9600 communications receiver you can use it to receive ATV transmissions by adding an internal video board. These units can be obtained from various sources, but beware as they were not originally designed for the PAL system. I know the board marketed by Raycom is compatible and can be obtained for a modest cost, so check with your supplier first. The board just plugs into the socket provided, you can then connect a monitor to the phono socket on the rear panel of the receiver. Most DXTV enthusiasts will also be able to tune directly to 436MHz on their TVs or via the various converters they use, without any alteration being necessary.

that these aerials do cover a very wide frequency range and therefore performance will fall off at 70cm. A better solution, and one which must be adopted before you ever transmit, is to invest in an aerial specifically intended for ATV. You could also consider tuning one of the 70cm ZL special aerials to peak at 436MHz.

In future articles we will be covering improvements to the basic receive system but that will not be before we have given you enough information to consider the basic requirements for reception and transmission on 70cm and 24cm.

Finally I do recommend that you join the British Amateur TV Club (BATC). They can supply members with PCBs, run a video tube replacement service and offer several excellent publications including their quarterly journal CQTV.

## **An Introduction to 24cm ATV by R. Gilham G6OKB**

# Club News

## Local Gatherings for Amateurs

### Bromsgrove and District

**Amateur Radio Club** meets on the 2nd

Friday of each month at the

Avoncroft Arts Centre clubroom,

Redditch Road, Stoke Heath,

Bromsgrove. Club events include;

Feb. 8th. Club night.

Feb. 23rd. Girl Guides Thinking Day special event station, Spadesbourne Suite, Bromsgrove.

Mar. 8th. Annual General Meeting.

Apr. 12th. Constructors Competition.

Further details about the club from Trevor Harper G0KIN. Tel. Bromsgrove 33173.



**South Bristol Amateur Radio Club** meets every Wednesday at the Whitchurch Folkhouse Association, Bridge Farm House, East Dundry Road, Whitechurch, Bristol, Avon. BS14 0LN. Forthcoming events include;

Feb. 6th Training for VHF field day.

Feb. 13th VHF activity evening.

Feb. 20th Computer activity evening.

Feb. 27th Microwave Workshop.

Mar. 13th HF Activity evening.

Mar. 20th Exhibition of radio controlled model boats.

Mar. 27th Computer activity evening.

Events and dates often change, so for more information Tel. Whitchurch 832222 on a Wednesday evening.

**Hastings Electronics and Radio Club** meet on the third Wednesday of each month at 7.45pm at West Hill Community Centre, Croft Road, Hastings. Also every Friday at the club room, 8.30pm at Ashdown Farm Community, Downey Close, Hastings. This active club publishes an excellent newsletter, and you can get further details from the club Chairman Ken Homewood G4UBP, Tel. Hastings 444952, or their Secretary Reg Kemp G3YYF.

**Horndean and District Amateur Radio Club** meet at the Horndean Community School at 7.30pm, Barton Cross, Horndean, Hants.

Feb. 7th Police communications control, by Dan G4BEQ.

Mar. 7th 'Something different' by Doug G4BEQ.

Apr. 4th RF health hazards.

Further details from S. W. Swain, Tel. 0705 472846

**West Kent Amateur Radio Society** meet at the school annexe, Albion Rd, Tunbridge Wells, Kent. Further details from R. J. Taylor, G3OHV, 'Eagles Rest' 9 Jefferies Way, Crowborough, E. Sussex TN6 2UH. Dates for your diary include;

Feb. 15th Talk by Nigel Peacock 'Local Radio forthcoming developments'

Apr. 19th Club AGM.

**Loughton and District Amateur Radio Society** meet at Loughton Hall, Rectory Lane, Loughton, Essex IG10 3RU, in room 14 unless stated otherwise, at 7.45pm prompt.

Feb. 9th Desk top publishing  
— how our newsletter is compiled by G1DJI and G8DZH.

Feb. 23rd At the speed of light  
— lasers explained by G8DZH.

Mar. 9th Novice licence.

Mar. 23rd Solid state amps by G0LWF.



Apr. 6th AGM.

Apr. 20th What is PEP.

Further details from the secretary Mike Pilsbury G4KCK. Tel 081 504 4581.

**Northern Heights Amateur Radio and Electronics Society** meet on the first and third Wednesdays each month at the Bradshaw Tavern, Nr. Queensbury, Bedfordshire, at 8.15pm. Events include:

Feb. 6th Constructor's clinic.

Feb. 20th Mr. Dougherty's lecture.

Mar. 6th Amateur TV with demonstrations.

Mar. 20th Bring and demonstrate your computer.

Apr. 3rd AGM.

For details contact Stan Catton G0IYR on 0274 673116



**Rhyl and District Amateur Radio Club** meets on the first and third Tuesdays each month at the Scout Hut, Vale Road, Rhyl. Their programme of events;

Feb. 4th Computers in amateur radio.

Feb. 18th Quiz. RAE multiple choice questions.

Mar. 4th Fitting coaxial connections demonstration.

Mar. 18th Planning permission.

Apr. 1st SSTV fax demonstration, specy to PC.

Apr. 15th Easter activity night, home brew construction.

For further details contact Mr. David Bevan GW4DMR (Chairman) Tel. 0745 345078, or Mr. Edward Shipton GWODSJ (Secretary) Tel. 0745 336939, or Mr George Greenhalgh GW0MOH (Treasurer) Tel. 0745 350896.

**Stourbridge & District Amateur Radio Society** meet on the first and third Monday of each month at the Robin Wood's Community Centre, Scotts Road, Stourbridge.

Programme of events;

Feb. 4th On air and natter night.

Feb. 18th Constructors competition.

Mar. 4th On air and natter night.

Mar. 18th AGM.

Their secretary is Dennis Body G0HTJ.

**Stratford upon Avon & District Radio Society** meet at the Baptist Church, Payton Street, Stratford upon Avon, at 7.30pm. Club dates include;

Feb. 11th 10GHz the easy way, Dave Ackrill G0DJA.

Feb. 25th Aligning receivers, Geoff Foster G8UKT.

Mar. 11th USA licencing, Don Field G3XTT.

Mar. 25th Discussion evening.

Apr. 8th AGM and surplus sale.

Apr. 22nd Test equipment, bring your rigs and things!

Details from A. Beasley G0CXJ. Tel. 060 882 495.



**Sunderland and District Amateur Radio Society** meet at 27a Westbourne Road, Sunderland, every Monday and Thursday at 7pm. Facilities include HF, VHF, UHF, RTTY and Packet stations. Morse tuition and assistance with RAE is provided at their meetings, agenda details yet to come. New members will be made most welcome. Details in the meantime from Arthur Everard G0ARZ, Tel. 091 548 6547.

**Todmorden and District Amateur Radio Society** meet at the Queen Hotel, Todmorden on the first and third Monday every month at 8pm.

Forthcoming events include;

Feb. 4th AGM and construction competition,

Feb. 18th Club station on air. (hopefully).

Mar. 4th Trip to brewery. (paid up members only).

Mar. 18th Test equipment, Tony G8LTC.

Apr. 15th Quiz night.

**Yeovil Amateur Radio Society** meets every Thursday 7.30pm at the Recreation centre, Chilton Grove, Yeovil. Dates for your diary are:  
Feb. 7th Simple ATV by G3MYM.  
Feb. 14th The 2 element driven beam, G3MYM.  
Feb. 21st The 2 element Yagi, G3MYM.  
Feb. 28th Natter night.  
Mar. 7th Discussion evening.  
Further details from the Chairman, Adrian G4JBH. Tel. 0935 28341 or the Secretary David Briley G0NMM.

#### National and International

**G-ORP Club** publish a quarterly magazine devoted to low power communication, and hold regular get-togethers. Their secretary is Rev. G. Dobbs, St. Aiden's Vicarage, 498 Manchester Road, Rochdale. Lancs. OL11 3HE. Tel. 0706 31812.



The **Irish Radio Transmitters Society** send out regular newsletters giving details of local activities. The contact man for this is Dave Moore EI4BZ, 12 Castle Ave, Carrigtwohill, Co Cork. Tel. (Eire) 021 883555



*To include your club in this feature, make sure you send your events details to the editorial office address, then we'll make sure our readers know exactly what you're up to each month. Note we only list active clubs who send us regular details of what they get up to! These pages are prepared two months in advance of the magazine appearing on the shelves, so please send details well in advance, i.e. dates to be included in the issue published in April should reach us at the beginning of February. If any clubs are involved in the Novice Licence training scheme, many of our readers will be most interested so please get in touch.*

# Rallies

## Gatherings for bargain hunters

#### February 3rd

**South Essex Amateur Radio Society Mobile Rally** is at the Paddocks Long Road (A130) Canvey Island. The organisers invite you to come along if you have any interest in amateur radio, short wave listening, electronics or any form of communications. This will be an all day event featuring trade stands, bring and buy, RSGB book stall, boot sale and home made refreshments. Doors open at 10.00. Extensive free parking plus parking at the main entrance for disabled visitors. 2m talk-in on S22 (G4RSE). Further information from Dave Speechley G4UVJ on 0268 697978 or 0860 847836

#### February 24th

**East Coast (Clacton) Rally** will be held at the Clacton-on-Sea Leisure Centre, Vista Road Clacton-on-Sea Essex. Doors open at 10.30, the rally continuing until 16.00. Featuring major suppliers of radio and computer equipment, large bring and but stand plus an auction, and test bench facility. Talk-in will be provide on 2m from 08.00, and the venue will be well sign posted. The centre is also five minutes walk from the main BR station, and easy access for disabled

are provided at the venue. Bar and cafe on site with hot food. Further details from ClackPak (the packet radio user group of Clacton Radio Club) on 0255 222207 or from G0NHU or G7DNS @ GB7DNS.

**Taw and Torrbridge Rally** at the BACC Halls, Biddeford, North Devon. Details from John G0GFK on 0237 476402

#### March 3rd

**Welsh Mobile Rally** is at the Barry Leisure Centre, off Holton Road, Barry. For further details, phone Ceri GW0JCB on 0446 721304

#### March 9/10th

**London Amateur Radio Show**, Picketts Lock Centre, Picketts Lock Lane, Edmonton, London. **HRT will be there!** Organised by the London Amateur Radio Show committee, in conjunction with the Southgate ARC. Further details from the London Amateur Radio Show, 126 Mount Pleasant Lane, Bricket Wood, Herts AL2 3XD.

#### March 17th

**Wythall Radio Club** will be holding their 6th annual radio rally at Wythall Park, Silver Street, Wythall, Worcestershire, on the A435 near junction 3 on M42, South West of Birmingham. Rally opens at 11.00, with an admission price of 50p. Further details from Chris Pettitt G0EYO on 021 430 7267.

#### March 24th

**Pontefract and DARS Components Fair**, at the Carleton Community Centre, Carleton, Pontefract. For further details, Tel. 0977 615549

#### March 31st

**Centre of England Easter Amateur Radio Rally**, is being held at the motorcycle museum, Brickenhill, near the NEC Birmingham. Further details from Frank Martin, G4UMF on 0952 598173

#### April 7th

**Launceston Amateur Radio Club Rally** at Launceston College. Bar, hot snacks, large bring and buy, well known traders, official Morse tests at rally, (applications through RSGB usual channels please). Doors open at 10.30, talk-in on S22. Two large halls. For more information contact Maggie on 0409 21219 or Rodney and Joy on 0566 775167

**White Rose Rally** will be held at the usual venue of Leeds University, doors open at 11.00. Further details from PO Box 73, Leeds, LS1 5AR

#### April 14th

**The Trafford Rally** is on the 14th April at the Greater Manchester Exhibition and events Centre, City Centre, Manchester. Details from Graham Oldfield G1IJK, Tel. 061 748 9804

#### April 27/28th

**RSGB National Convention** at the National Exhibition Centre, near Birmingham. A two-day event featuring trade stands and special interest groups. Details from Norman Miller G3MNV on 0227 225563.

# Free Readers Ads!

## FOR SALE

**Yaesu FT757GX** with PSU and Shure base mic, perfect condition, £565. **Yaesu FT290** with 25W amp, good condition, £250. **TAU ATU**, one of best ATUs ever made, £175. **Datong auto notch**, £50. Tel. 0603 787987 (Norwich)

**Black Jaguar BJ200 MK3** hand held scanner, easy to use, £95. Will exchange with cash adjustment for AR1000, HP100, or Jupiter scanner. Tel 0843 294446 (Thanet)

**Eddystone 990S** receiver, 250MHz, 900MHz with IF input and video output, offers WHY. Tel. 0767 680253 (Bedfordshire)

**Pro II ASA** hand held scanner, £25. **Bearcat 145XL** scanner 16 memory, £75. Tel 0903 49335 (Wakeham) evenings.

**Yaesu 101ZD**, FV901DM scanner, FT901R multiscope, FC902 ATU, SP901P phone patch speaker. Tel. 091 534 6487

**Pye Westminster** dash mount 'P' band, unmodified, ideal for conversion as per HRT Nov 90, £10. Tonna 9 element 2m beam, new type, few weeks use only, £20. Tel. 0926 498388 (Warwick)

**Burddept E** hand held with three batteries, £35. Tel Holbeach 22649 after 6pm.

**Trio TR-9130** 25W, 2m multi-mode, VGC, boxed, £300. 100W 2m amplifier, £80. £350 the pair. Tel 0444 417509 (Haywards Heath)

**Morse, RTTY and ASCII Reader**, 32 character display, mint condition, compact, £120. **Sony Air-7** scanner, Air, AM, FM, PSB with power unit, boxed, £150. May exchange for interesting equipment, WHY. Tel 0202 422273 (Bournemouth) after 6.30pm.

**Hal DS 3100ASR**, Hal ST 6000, DV 3000ASR. Tel 0932 844184 (Weybridge) evenings.

**Yaesu FT 207R** complete with speaker mic, NC2 PSU/charger, £150. **FDK Multi 700E** 2m FM mobile, 25W o/p, £85. **Pye Europa** 25W, £25. Regulated PSU 5/7amps, £15. Contact J. Massey, 25 Fleetside, East Molesey, Surrey KT8 ONF

**Amstrad CPC 464** colour monitor, DMP 2000 printer, Light pen, Joystick and software, £210 ono. Contact GM0MDB, Tel 0436 76486 (Helensburgh, Scotland) after 5pm. Buyer collects or pays postage.

**Yaesu FR50B** in very good condition, 80-10m inc 30m, complete with Heathkit HD-1424-A Active Aerial, £70, or swap for HF mini-beam or Jaybeam VR3 HF vertical. Contact Ian G0BGH, Tel. 081 668 4990 (Kenley, Surrey)

**Datong Morse Tutor**, key and tapes, £50. Navy type Morse key (Exc), £30. **Handheld FM transceiver AOR 240** with charger and handbook, VGC, £85. I will pay post and packing on all items. Contact Mr. G. Jacob GW0OET, in Cardiff. Tel. 0222 487299

**Avo 8**, with leather case, £100. **Digital Avo**, £50. **Megger**, £100. **Current clamp meter**, £16. **HV probe**, £10. **Auto probe**, £15. Tel. 081 554 2913 6-8pm. (Greater London)

**NRD-515** like new, key pad, £600. **Sony CRF320** world zone, £450. **HF225**, fitted AM detector, few months old, £300. **Racal RA17**, very good con, £150. **RA17L**, table model, fitted LF converter, RA137A, VGC, £230. Exchange for portable receiver. Tel. 081 571 5759 (Middx)

**R210** ex-army communications receiver 0-16MHz, also RCA AR88LF receiver 0-30MHz. Both in excellent condition. Offers. Tel. 0533 764582 (Leicester)

**AR1000** purchased 28th Sept, boxed, complete, £150. (Winchester) Tel. 0962 862593

**Lowe HF225** receiver, 7 months old, mint and perfect, FRT 7700 ATU to suit, £330 for both. (S. Glam) Tel. 0446 734337

**Sony Air 7** excellent condition, all extras, very little used, 2 sets of AA batts (rechargeable) and charger, £140. (Coventry) Tel. 0203 458979

**TRS88III** computer, built in console, twin 5.25in floppy drives, Superscript Profile III Plus, TRS DOS, £120 or Exchange 2m or 70cm handheld. For details Tel. 0302 531927 (Doncaster) *Sold* - Thanks to HRT, my Yaesu FRG-7000 receiver, no more phone calls please!

**Kenwood TS-530S**, 9 bands, as new, one owner, MC50 desk mic, 2 pairs 6146B and two BY7A valves, £560. **Swan Cygnet TX/RX**, needs attention, spare valves, £85. **Shure 401D** mic, £18. Buyers collect. G3LZN, Noel, (Ipswich), Tel. 0473 749139

## EXCHANGE

**Icom IC-R70** receiver, mint condition, first class performer, wish to exchange for quality receiver with direct entry and memory capability. Tel. 0202 422273 (Bournemouth) after 6pm.

**FRG7** for G4BMK packet system, for Dragon 32 or Tiny2 TNC. Tel Dave on 0229 53212 (Cumbria) after 6pm.

## WANTED

**Storno CQM5114** or **CQM5334** mobile radio. Also **Storno CQF614** 25W base station. Also **Storno CQP4114** portable or **CQP814** portable and chargers to suit. Tel. Jim on 091 2576272 (Tyne and Wear) after 6pm.

**Multiband Vertical aerial**, such as HF6V, 18AVT. **FT20 MKI** rubber duck, money manager PC complete or just instructions, also swap **Durst 601** enlarger with black and white, and colour heads for **Sinclair PC 200** computer with colour monitor. Tel. Dave on 0603

745512 (Norwich)

**Panaramic adaptor**, also interface and IBM software for Yaesu 8800. Tel 0767 680253 (Bedfordshire) evenings.

**Compact HF rig**, FT747, Icom, Trio etc. Tel. 0843 294446 (Thanet) **Pair of PF8s** in working order. Tel. 081 856 4123 (Kent)

**'Command' series equipment**, RX/TXs (BC454 etc), modulator, control boxes, racks, plugs, sockets, interconnecting leads, etc. **TBS-7 VHF RX**. **TCS-12/13 RX/TX**. **R1155**. **BC348**. All complete or incomplete for spares. **LT Rotary XFormer** for T1154/R1155. **Valves 12SR7M, 12K8M, 12SF7M**. Please contact Dave (Co. Durham) Tel. 091 410 3706

**Model DD-6C digital frequency counter** for Atlas 210X transceiver also service and operation manual. I will pay postage costs. Write to Declan Lennon EI6DUB, 45 Prarsa Plk, Sallywoggin, Co. Dublin, Eire.

**KW 160 ATU**, contact G3FVC, 1 High Bank, Watchet, Somerset TA23 0DG. Tel. 0984 34271

## ADVERTISERS' INDEX

Raycom Communications	IFC
KW Communications Ltd	4
Radio Data Systems	4
ERA Ltd	4
Lowe Electronics	4, 33
Icom	10, 11
SRW Communications Ltd	17
LE Count	17
Siskin Electronics Ltd	17
Radio Amateur Supplies	17
South Midlands Communications	22, 23, OBC
Anchor Surplus	24
London Amateur Radio	29
Northern Amateur Radio	33
Sigma Euro	IBC
Ham Radio Today Binders	17

# Free Readers Ads!

Name ..... Signature .....

Address ..... Date .....

.....  
.....

**Send this form to:**

Free Readers Ads, Ham Radio Today, PO Box 73,  
Eastleigh, Hants SO5 5WG.

**ENTER YOUR ADVERTISEMENT HERE:**

1. These advertisements are offered as a free service to readers for the sale, exchange, or wants of amateur radio equipment only. They are offered to readers who are not engaged in buying or selling the same equipment or services on a commercial basis. Commercial advertisers should contact our advertising department who will be pleased to help.
2. All that is to be reproduced in the advertisement should be entered into the space provided on the form printed periodically in the magazine. Advertisements must be no longer than 40 words, including contact information. Ensure you mark your form either 'For Sale', 'Wanted', or 'Exchange'.
3. All advertisements **must** include either a contact telephone number and location (e.g. town) or a full address, or both for readers to reply, these details must be included within the advertisement. The Editor reserves the right to add a town/county location where this has been omitted. The term QTHR will not be published as many readers cannot use this, if entered the Editor reserves the right to replace it with a recently published callbook address, however no guarantee of this nor its accuracy is given.
4. Advertisements which are suspected of including illegal equipment and/or any equipment which transmits only outside of amateur bands will not be published. The magazine reserves the right to either refuse to accept in entirety, or to delete any sections, of such advertisements.
5. Advertisers must fill in their names, addresses and (if

- available) telephone number in the space provided, these details will not be published, and advertisers must sign the form to indicate acceptance of these conditions. Forms submitted without a signature will be rejected.
6. The submitted advertisement must be either written in block capitals or typed, illegible submissions cannot be included.
7. Advertisements will be inserted as and when space becomes available, on a first come first served basis, subject to these conditions.
8. The magazine cannot be held responsible for printers' errors, however we will attempt to ensure that legible submissions are reproduced correctly. In the event of a gross error, at the request of the advertiser and at the Editor's discretion, a corrected version of the advertisement will be printed in the earliest issue in which space is available.
9. Neither the magazine nor its publishers will accept any responsibility for the contents of the advertisements, and by acceptance of these conditions the advertiser undertakes to indemnify the publisher against any legal action arising out of the contents of the advertisement.
10. Advertisements are accepted in good faith, however the publisher cannot be held responsible for any untruths or misrepresentations in the advertisement, nor for the activities of advertisers or respondents.



# MISSING ISSUES?

*Then The Ham Radio Today  
Back Issue Service  
May Be Able To Help*

*Back numbers of Ham Radio Today cost cover price plus 60p postage and packing from Ham Radio Today Back Numbers, Select Subscriptions, 5 River Park Estate, Berkhamsted, Herts HP4 1HL. Cheques should be made payable to Argus Specialist Publications.*

*Back issues are available for the previous twelve months only. As some issues are in very short supply, you should check availability on 0442 876661 so as to avoid disappointment.*

## ORDER YOUR COPY NOW - WHILE STOCKS LAST!

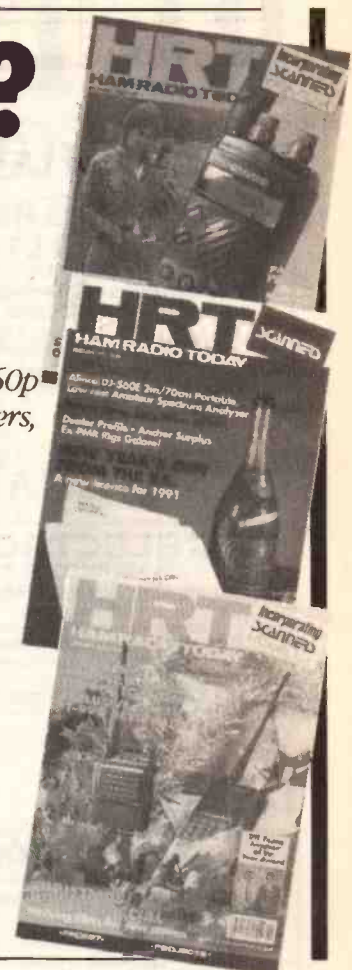

# HAM RADIO TODAY CLASSIFIED

Lineage: 55p per word + VAT (minimum 15 words) Semi Display: (minimum 2cms) £10.00 + VAT per single column centimetre. Ring for information on series bookings/discounts. All advertisements in this section must be prepaid. Advertisements are accepted subject to the terms and conditions printed on the advertisement rate card (available on request).



**0442 66551**

Send your requirements to:  
Ham Radio Today,  
Classified Department,  
Argus House, Boundary Way,  
Hemel Hempstead HP2 7ST

### COURSES

#### RADIO AMATEUR LICENCE

Start training now for the following courses. Send for our brochure — without obligation or Telephone us on 0626 779398

HRT/03/91

Name \_\_\_\_\_

- Telecomms Tech C&G 271
- Radio Amateur Licence C&G
- Micro-processor
- Introduction to Television

Radio & Telecommunications Correspondence School,  
12, Moor View Drive, Telgnmouth, Devon TQ14 9UN

#### COURSE FOR CITY & GUILDS RADIO AMATEURS EXAMINATION

Pass this important examination and obtain your licence, with an RRC Home Study Course.  
For details of this and other courses (GCSE, Career and professional examinations, etc) write or phone:  
**THE RAPID RESULTS COLLEGE**  
Dept JN101, Tullion House, London SW19 4DS  
Tel: 081-947 7272 (9am-5pm) or use our 24hr Recordcall service 081-946 1102 quoting JN101

#### ADVERTISE IN HAM RADIO TODAY

#### MISCELLANEOUS

HEATHKIT U.K. Spares and Service Centre. Cedar Electronics, 12 Isbourne Way, Broadway Road, Winchcombe, Cheltenham GL54 5NS. Tel: 0242 602402.

### FOR SALE

**FM Transmitter Kits**  
Also a Telephone Bug Detector Kit  
Ready built FM transmitter £650 including Post & Packing  
These are Commercial Kits — We also stock a selection of Scanning Receivers, so telephone for latest stock or ask for a free catalogue.

#### HOTLINE ELECTRONICS

97 LEIGH RD, ATHERTON, GT. MANCHESTER  
Telephone Atherton (0942) 891140 Mail Order Only

### NATIONAL ORGANISATIONS

**BUYING - SELLING - OR LOOKING FOR:**  
Radio • Electronic • Computers • Test Equipmt.  
**SELLING? No Commission Charges!**  
Unlimited use of Register — Annual Fee £8  
Free advertising — less than 16p a wk  
**BUYERS:- S.A.E. brings you daily updated list**  
Send S.A.E. NOW FOR APPLICATION FORM & DETAILS  
G4NKH B&SR (Dept HR)  
42 Arnott Rd, Blackpool FY4 4ED

# RETAIL NETWORK

## BIRMINGHAM

**HEWARD'S HOME STORES LTD.**  
(Est. 1963)  
822/4 Kingstanding Rd., Birmingham B44 9RT.  
Tel: 021-354 2083  
G4RJM with over 40 years in The Radio Trade  
Ham Equipment urgently wanted!  
Open: Mon-Sat 9-6

## KENT

**Icom (UK) Ltd.**  
Unit 8, Sea Street, Herne Bay, Kent CT6 8LD.  
Tel: 0227 369464 Telex: 965179 ICOM G.  
Fax: 0227 360155  
Open: Mon-Fri. 9-5.30pm.  
Lunch 1-2

## SURREY

**GUILDFORD COMMUNICATIONS**  
34 Aldershot Rd., Guildford  
Open Mon-Fri 8am-6.30pm  
Sat 8am-5.30pm  
Secondhand wanted  
0483 505756

## BIRMINGHAM

**B&C ELECTRONICS**  
51 SIR HILTONS RD  
WEST HEATH, BIRMINGHAM B31 3NH  
New and Used  
Amateur Radio and Computer Sales  
Elite antenna main dealer and commission  
sale items always required  
**BRUM'S PREMIER JUNK SHOP**  
Tel: (021) 4752426

## LANCASHIRE

**AMATEUR ELECTRONICS/HOLDINGS G3LLL.**  
YAESU, JAYBEAM, DRAE, DATONG, BLACK STAR COUNTERS,  
ETC. FT 101 EXPERTS.  
6JS6C 6KD6 12BY7A Original type approved  
valves & our own Double Balanced Mixer and  
new band WARC Kits for original FT101 MK1-E  
& S.A.E. List. Full Yaesu range. 15 mins Junction  
31 M6 Free parking. Call and consult G3LLL  
without obligation. Holidays? Phone, check we  
are open before calling.  
45 JOHNSTON STREET, BLACKBURN BB2 1EF.  
(0254) 59595. CLOSED THURSDAY.

## WEST SUSSEX

**BREDHURST ELECTRONICS LTD**  
HIGH ST., HANDCROSS,  
WEST SUSSEX.  
TEL: (0444) 400786  
Sited at the Southern end of M23. Easy access to M25  
and South London. Open Mon-Fri 9am-5pm except Wed  
9am-12.30pm. Sat 10am-4pm.  
MAIL ORDER KENWOOD RETAIL

## DEVON

**AGRIMOTORS**  
Merton CB & Radio Centre  
Merton Garage & Post Office, Merton  
Nr Oakhampton EX20 3DZ. Tel: (08053) 200  
Open 6 days 9.30-12.30 and 2.30-5.30 (Lunch 1.00-2.30)  
(Sunday by appointment)  
Specialists in 934MHz  
Supplies of all 27MHz and 934MHz equipment  
Some Amateur Radio Stocked

## LONDON

**LOWE ELECTRONICS**  
LONDON  
Sole U.K. Distributor for KENWOOD  
223/225 Field End Road  
Eastcote, Middlesex HA5 1QZ  
Tel: 081 429 3256

## SCOTLAND

**JAYCEE ELECTRONICS LTD**  
20 Woodside Way Glenrothes  
Fife KY7 5DF  
Tel: 0592 756962 (Day or Night)  
Open: Tues-Fri 9-5; Sat 9-4; Sunday by appointment  
Good range Kenwood & Yaesu etc, plus  
ICOM Quality Secondhand Equipment

## DURHAM

**BORDER** Communications Centre  
Units 8a to 8c  
Drum Industrial Estate  
Chester-le-Street  
Co. Durham DH2 1SX  
VOICE & DATA COMMUNICATIONS  
TEL: 091 4106969  
• Largest Display in the North East  
• Opens 6 days a week - Ample Parking  
• Mail Order - Large Secondhand Display

## MANCHESTER

**ST COMMUNICATION SYSTEMS LTD.** ZYCOMM  
35 CLAREMONT ROAD,  
SALFORD, MANCHESTER M4 7RS  
AT LAST! Professional repairs service to your amateur radio  
and CB equipment. Any make of radio or scanner.  
Please telephone Steve, Andy or Neil to book in your radio.  
061-736 1705 061-745 7389  
After Hours 083-627 5005

## SCOTLAND

**LOWE ELECTRONICS**  
GLASGOW  
Sole U.K. Distributor for KENWOOD  
4/5 Queen Margaret Road  
Glasgow, Scotland G20 6DP  
Tel: 041 945 2626

## DURHAM

**LOWE ELECTRONICS**  
DARLINGTON  
Sole U.K. Distributor for KENWOOD  
56 North Road, Darlington  
County Durham DL1 2EQ  
Tel: 0325 486121

## NORTHAMPTON

**VANNER'S**  
Scanner and C.B. Centre  
Sales, Service and Repairs of Scanners, C.Bs, Phones,  
Answer Machines, Radios etc.  
Agents for Garex, Revco, Bearcat, Uniden, Panasonic.  
Part Exchange. All items welcome  
34 Gloucester Avenue, Northampton  
Telephone 0604 766704

## ADVERTISERS

**FOR MORE DETAILS  
ON RATES AND COPY  
DEADLINES CALL  
0442 66551**

**SERIES DISCOUNTS  
ARE AVAILABLE ON  
REQUEST  
CALL NOW FOR DETAILS  
0442 66551**

## OXFORDSHIRE

**PROCOMM (UK)**  
Cash paid for used Amateur Equipment.  
Part exchange welcome.  
S.A.E. for stock list 9am-9pm, Mon-Sat  
Telephone: 0235 532653; 0860 593052  
Callers by appointment please:  
102 Larkhill Rd, Abingdon, Oxon  
CASH - CASH - CASH - CASH

## NORTH WALES

**T.M.P. COMMUNICATIONS**  
UNIT 27, PINFOLD INDUSTRIAL ESTATE  
PINFOLD LANE, BUCKLEY, CLWYD  
NORTH WALES 0244 549563  
ICOM YAESU  
LARGE STOCK OF SECONDHAND EQUIPMENT (Changing Daily)  
OPEN THROUGH THE WEEK 11am-7pm except Tuesdays and Sundays  
EXTENSIVE REPAIR/CALIBRATION SERVICE

# SIGMA EURO-COMM

IMPORTERS OF COMMUNICATIONS EQUIPMENT  
MANUFACTURERS OF:- ANTENNAS & ACCESSORIES

## AMATEUR — C.B. — SCANNERS ANTENNAE



**A  
R**  
1  
0  
0  
0

8-600MHz & 805-1300MHz  
1000 memory channels  
all mode operation  
**£249.00+p&p**

**Bearcat 760 XLT**

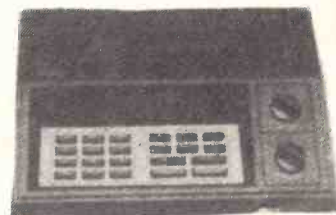

**Base  
Scanner**

100ch Memory FM, AM, Air  
Freq 29.54/118-174/406-512MHz  
**£229.00+p&p**



**R40/20** (illustrated)  
100ch Memory  
Freq 29-54/118-174/406-512MHz  
**£195.00+p&p**



**ICOM R1**  
Freq 100kHz to 1300MHz  
**£399.00+p&p**

**R40/10**  
Handheld. 10ch Memory.  
Freq 29-54/136-174/406-512MHz  
**£95.00+p&p**

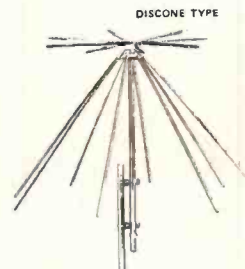

**Sigma SE 700**  
70-700MHz  
**£24.99+p&p**

**Sigma SE 1300** **£59.95+p&p**  
20-1300MHz: Receive  
Transmit: 50,144,430,900,1200MHz  
input power rating: 200 watts  
input impedance: 50 ohms

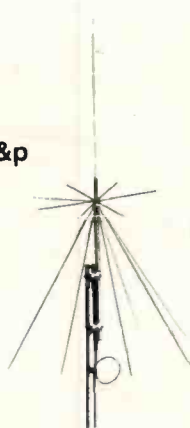

**SE 1300**

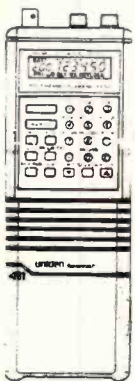

**B  
E  
A  
R  
C  
A  
T  
  
2  
0  
5  
X  
L  
T**

200ch Memory.  
Freq 29-54/118-174/406-512/806-956MHz  
**£229.00+p&p**

**HS 1300B**  
Active Hunter  
Base antenna  
**£89.00+p&p**



**BUILT IN RF AMPLIFIER**

20-1300MHz  
**HS-1300B**  
Gain 15dB ± 3dB  
(RF Amp.)  
Height: 800mm  
Weight: 440g  
w/o Accyl  
Connector: M-J  
Pole: 30-82g  
Accessory: DC-RF Mixer

**HS 1300M**  
Mobile antenna  
**£59.00+p&p**



**BUILT IN RF AMPLIFIER**

20-1300MHz  
**HS-1300M**  
Gain 15dB ± 3dB  
(RF Amp.)  
Height: 790mm  
Weight: 200g  
w/o Accyl  
Connector: M-J  
Accessory: DC-RF Mixer  
w/Cigar Plug

**\*FREE\***

With all scanners sold via Mail Order  
**DISCONE ANTENNA**



Mail Order: Cheques & PO Made Payable to Sigma Euro-Comm Trade Enquiries Welcome  
**SIGMA EURO-COMM, Unit 14, 272 Montgomery Street, Birmingham Enterprise Units,**  
**Sparkbrook, Birmingham B11 1DS**  
Tele/Fax: 021 766 8146

A high-performance HF rig . . . with a great receiver and full-power transmitter. Light in weight and low in price.

This is Yaesu's FT-747GX.

Whether you're a beginner or a veteran, it's a great way to start. And a great way to go.

**DX ready.** The 747 packs a full 100-watt RF punch on 160 to 10 meters, with continuous receive from 100 kHz to 30MHz.

And its control panel is refreshingly simple. So you can hop around the band fast to nail those DX stations.

While other guys are warming up their amplifiers, you can be working the DX!

**Multimode versatility.** The FT-747GX is ready to go on LSB, USB, CW, and AM. With provision for the FM-747 FM unit.

You get 20 memories to store frequency and mode. Dual VFOs with split frequency operation for DX-pedition work. And manual band scan

plus auto-resume memory scan via the microphone up/down buttons.

**Great receiver.** Utilizing a directly-driven mixer, the FT-747GX receiver features superb overload protection. You also get factory-installed narrow CW and AM filters. A one-touch noise blanker. All-mode squelch. RTT. And a 20-dB attenuator for local QSOs.

**Lightweight construction.** Housed in a metallized high-impact plastic case, the FT-747GX weighs in at about 7¼ pounds! With the loud-speaker mounted on the front panel for maximum audio transfer. And internal heatsinking for the transmitter, rated at full power for FM, packet, RTTY, SSTV, and AMTOR when used with a heavy-duty power supply.

**Available options.** FC-1000 or FC-757AT Automatic Antenna Tuners. FL-7000 500-watt Automatic, Solid-State Linear Amplifier. TCXO-747

Temperature-Compensated Crystal Oscillator. FAS 1 4R Remote Antenna Selector. FRB-757 Amplifier Relay Box. FP-700 Standard Power Supply. FP-757HD Heavy-Duty Power Supply. MMB-38 Mobile Mounting Bracket. MH-1B8 & MD-1B8 Microphones. New heavy duty metal case MMB42A.

**Discover the price/performance leader.** Check out Yaesu's low-cost FT-747GX at your Yaesu dealer today. Because now, Yaesu puts priceless DX into your price range.

**South Midlands Communications Ltd**  
S.M. House, School Close,  
Chandlers Ford Industrial Estate,  
Eastleigh, Hants SO5 3BY  
Tel: (0703) 255111  
UK Sole Distributor

**YAESU**

Fill your logbook.  
Without emptying your pocket.

