

HAM

AN ARGUS SPECIALIST PUBLICATION

AUGUST 1988 £1.30

RADIO

TODAY

TUNING IN TO TEN
The latest multi-mode mono-bander hits the street



EXCESS CAPACITY? Build our wide-range capacitance meter
BONZAI AERIAL FARMING 'Persuading' large aerials into small spaces
TINY-2 TNC ON TEST Low cost packet box for VHF

SCANNERS

BEARCAT BY uniden

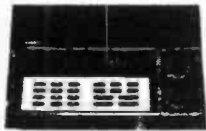

UBC 175XL



UBC 100XL

RAYCOM ARE TRADE AND RETAIL DISTRIBUTORS FOR THIS SUPERB RANGE OF QUALITY SCANNERS. THE POPULAR UBC 100XL HAND HELD HAS SOLD IN THOUSANDS, BUT IS NOW COMPLIMENTED BY THE UBC 70XCL POCKET SIZED HANDHELD. ALSO THE NEW COST EFFECTIVE UBC 50XL HANDHELD. SEE THE NEW MODELS IN OUR SHOWROOMS OR SEND A S.A.E. FOR DETAILS. FROM £95.00 + carriage

RAYCOM
COMMUNICATIONS SYSTEMS LTD

TEL: 021-544 6767

RAYCOM OPEN DAY

In conjunction with Sandwell A.R.C.
Sunday, July 3rd 11am-4.30pm
TALK IN ON 5.22, 2 MINS FROM M5 JCT 2.
MAJOR DEALER ATTENDING.
BRING AND BUY - FREE MARKET -
RADIOS - COMPONENTS - ACCESSORIES
PLENTY OF CAR PARKING, SOMETHING FOR EVERYONE.
COME AND ALONG AND HAVE A GOOD DAY.

SCANNERS

- YAESU FRG9600 from the company who specialises in fitting extra options, as supplied to Government departments and professional bodies. We also upgrade existing models, please call for more details, prices, delivery and information.
- Yaesu FRG9600 Basic Model Improved 'S' Meter + Sens £465.00
 - Yaesu FRG9600/RWC Mk2 60-950MHz 'N' Connector Fitted £495.00
 - Yaesu FRG9600/RWC Mk3 HF 100kHz-950MHz plus Mk2 Spec. £595.00
 - Yaesu FRG9600/RWC Mk5 HF 50kHz-950MHz Active Mixer £859.00
 - Icom ICR7000 25M-2GHz superb quality professional Rx £937.50
 - Icom ICR7000/AH7000 Receiver plus Matching Discone £937.50
 - Kenwood RZ 1 New 500kHz-950MHz Wide and Narrow AM/FM POA
 - Fox VHF-UHF Multi Function Mobile Scanner FM only £139.00
 - Uniden-Bearcat UBC 50XL VHF-UHF 10ch. H/held Scanner £95.00
 - Uniden-Bearcat UBC 70XL VHF-UHF 20ch. Miniature H/held £179.00
 - Uniden-Bearcat UBC 100XL VHF-UHF Airband H/held Scanner £189.00
 - Uniden-Bearcat UBC 175XL VHF-UHF Airband Desk-Top £175.00
 - BJ200 Mk2 VHF-UHF-Airband-Military Airband H/held £220.00
 - AOR 2002 25-550, 800-1300MHz Desk-Top/Mobile AM/FM £469.00
 - Sony Air 7 Top Quality VHF-Airband Handheld Scanner £245.00
- Package deal on above Mk3/5 FRG9600 c/w AH7000 discone, G5RV, PA4 AC PSU, complete receiving station HF-UHF including delivery UK mainland. Add £100.00 to above price.
PACKAGE DEAL AVAILABLE ON ALL MAKES.

A new concept in Amateur Radio . . . uniden 2830

It's here at last! A beautifully-made processor-controlled full feature 10w (20w PEP) multimode transceiver with LCD readout and all functions necessary to work DX with Sporadic E and in the forthcoming sunspot maxima and also for transverting to the VHF and UHF bands. Working out the facts . . . how much is a Two Metre Multimode? How much is the Uniden 2830 Ten Metre Multimode and a 2 metre transverter? With the Uniden 2830 you can have two bands for the price of one, with 10 watts on each band and all modes including CW.

Features

- ★ All modes, AM/FM/USB/LSB/CW
- ★ LCD readout of frequency/functions
- ★ CW with Sidetone
- ★ FM bandwidth compatible with VHF/UHF
- ★ 10Watts continuously variable o/p AM and FM
- ★ Scanning feature, up and down steps on mic.
- ★ Selectable frequency steps, 10kHz, 1kHz, 100Hz.
- ★ Ten metre band selectable in 500kHz steps
- ★ Build-in VSWR meter and protection circuit
- ★ Superb receiver sensitivity $3\mu\text{V}$ FM

Just TEN of the many reasons for choosing the UNIDEN 2830

THIS PRODUCT IS EXCLUSIVE TO RAYCOM ONLY AVAILABLE TO LICENCED RADIO AMATEURS

10 metre band amateur transceiver



£249.00
£10.00 post and packing

10/2 metre version out soon @ £399.00

HANDHELDS

* = Extended Receiver coverage available, call for details.

- YAESU FT727R/FNB4A 2.5W (5W) DUAL BANDER. C/W CHRGR £395.00
 - *YAESU FT23R/FBA10 2.5W (5W) 2MTRS £229.00
 - *YAESU FT73R/FNB10 2.5W (5W) 70CMS C/W CHARGER £259.00
 - *ICOM MICRO 2E 2.5W 2MTR HANDHELD WITH CHARGER £209.00
 - CTE1600 (SAME AS ICOM IC2E) C/W NICAD CHARGER £179.00
- Many other types of handheld stocked, please enquire.

SHORT WAVE RECEIVERS

- Yaesu FRG8800 Short Wave 100kHz-30MHz all Mode + Mem. ... £589.00
 - Yaesu FRG8800/FRV8800 as above with VHF Conv. fitted £679.00
 - Icom ICR-71 Top Grade Communications Receiver £799.00
 - Sony PRO80 HF/VHF Handheld Scanner c/w accessories £345.00
 - Sony 2001D Short Wave/Airband Receiver at £349.00
 - Sony SW1 Micro Short Wave Receiver £249.00
- Many more makes and models in stock, PLEASE CALL FOR PRICES, DELIVERY COSTS and any advise or information, or send large SAE. (Insured post and packing £10.00, Carrier £12.50).

YAESU FT 747GX

£649 inc. improved synthesisor performance

THIS SUPER NEW MACHINE FROM YAESU HAS RECEIVED EXCELLENT REVIEWS ALL AROUND, RAYCOM ARE PLEASED TO OFFER IT INCORPORATING IMPROVED SYNTHESIOR PERFORMANCE TO GIVE IT EVEN BETTER RX PERFORMANCE.
CALL OR WRITE IN FOR DETAILS.

MOBILES

- YAESU FT211RH 45W 2MTR MOBILE WITH FREE 1/4 WAVE ANT £299.00
- YAESU FT212RH NEW 45W 2MTR MOBILE DVS FEATURE OPT. £349.00
- *ICOM IC28E 2MTR 25W MOBILE WITH FREE 5/8 ANTENNA £359.00
- Ailinc Dual Band ALD-24E £445.00
- ICOM IC48E 70cm 25W £428.00
- ICOM IC3200 Dual Band 25W £499.00

Compare our prices

Many other types and makes stocked, please enquire.

PORTABLES

- FT290RMK2 2.5W MULTIMODE STANDARD ACCESSORIES £399.00
- FT290RMK2 2.5 WATT M/M AS ABOVE C/W NICADS CHRGR £425.00
- FT290RMK2/FL2025 (STD) WITH 25W LINEAR AMPLIFIER £489.00
- FT690RMK2 6MTR 2.5W MULTIMODE STANDARD ACCES. £399.00
- FT690RMK2 6MTR 2.5W M/M AS ABOVE C/W NICADS CH. £425.00
- FT790RMK2 NEW 70CM 2.5W MULTIMODE DUE OUT SOON ... £499.00

ANTENNAS & ACCESSORIES

- NOW AVAILABLE AT RAYCOM: CUSHCRAFT, BUTTERNUT, HY-GAIN ANTENNAS, JAYBEAM, TONNA, MET, HAM-M ROTATORS, Call for full details, prices, availability and delivery costs.
- ICOM AH7000 SUPER 250-1300MHz DISCONE £79.50
 - G5RV HALF SIZE HF ANTENNA ready to use £16.50
 - G5RV FULL SIZE HF ANTENNA ready to use £18.50
 - G8KW-TYPE 7.1MHz TRAP DIPOLE KIT SO239 £24.50
 - G8KW-TYPE as above for use with 75 OHM £23.50
 - G8KW-TYPE 2X 7.1 TRAPS ONLY, LESS CABLE £9.95
 - RAYCOM AIRBAND-VHF SIX ELEMENT DISCONE £12.50
 - RAYCOM DISCONE VHF 60-600MHz 8E.S0239 £29.50
 - SUN KG209 SE2M 5/8 MOBILE TILT-OVER 259 £14.50
 - RAYCOM CAST GUTTERMOUNT C/W SO239/COAX £8.50
 - GAMMA TWIN 2 METRE SLIM JIM KIT inc. Instr. £14.50
 - RAYCOM/RWC HB9CV 2 METRE 2E MINI BEAM £12.50
 - RAYCOM/RWC HB9CV 70CM 2E MINI BEAM £8.95
- The above popular products POST FREE.
(UK mainland only)

ROYAL 1300 WIDEBAND DISCON

Following the huge success and popularity of the 25-1300MHz, wideband discon antenna - Icom AH 7000 & Welz - diamond D109 with transmit facilities on VHF-UHF amateur bands, Raycom decided to persuade a UK manufacturer to make a "JAPANESE COPY!" at a very competitive price!
RAYCOM PROVIDE OUR CUSTOMERS A BETTER VALUE FOR MOENY.

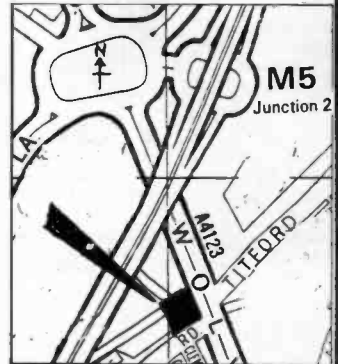
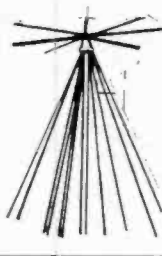

Opening hours 9am-5.30pm 6 days, late nights Thursday & Friday till 7pm.

RAYCOM COMMUNICATIONS SYSTEMS LTD.
INTERNATIONAL HOUSE, 963 WOLVERHAMPTON ROAD
OLDBURY WEST MIDLANDS B69 4RJ
Telephone 021 544 6767. Fax 544 7124. Telex 336483 Identi-G

RAYCOM gives you MORE PURCHASING POWER!



FOR FAST SERVICE PHONE IN YOUR ORDER WITH ANY MAJOR CREDIT CARD OR IN MOST CASES WE CAN OFFER YOU INSTANT CREDIT OF UP TO £1,000.00 (SUBJECT TO STATUS. RAYCOM ARE LICENSED CREDIT BROKERS. APR 29.8%, SUBJECT TO VARIATION. FREE CREDIT ON CERTAIN PRODUCTS AT LIST PRICES, 50% DEPOSIT AND SIX MONTHLY PAYMENTS. PLEASE TELEPHONE FOR MORE DETAILS AND APPLICATION FORMS.

NEW HELPLINE 0836 282228
available 5-9pm daily



ORDERING INFORMATION

ALL PRODUCTS WE ADVERTISE ARE NORMAL STOCK ITEMS OUR NEW MAIL ORDER DEPARTMENT CAN NOW DESPATCH MANY LINES SAME DAY, BUT PLEASE ALLOW UP TO 14 DAYS DELIVERY TIME IS SUBJECT TO CARRIAGE METHOD. IF ORDERING BY MAIL PLEASE INCLUDE CARRIAGE AND STATE YOUR DAYTIME TELEPHONE NUMBER. ALL PRODUCTS OVER £750.00 CARRIAGE FREE. PLEASE ALLOW TIME FOR PERSONAL CHEQUES TO CLEAR, PLEASE CALL BEFORE ORDERING AND FOR MORE DETAILS.

PLEASE TEL: 021 544 6767

THROUGH YOUR CONTINUOUS AND VALUED CUSTOM, RAY WITHERS COMMUNICATIONS LTD. HAS MOVED AND EXPANDED TO ENABLE US TO OFFER YOU EVEN BETTER SERVICE AND PRICES - STILL WITH THE RAYCOM GUARANTEE, BEST EQUIPMENT, BEST SERVICE, BEST PRICES, BEST BACK-UP, AND PLENTY OF PARKING FACILITIES AND EASIER TO GET TO! WE NOW BOAST THE BEST CENTRAL FACILITIES IN THE COUNTRY, WHY NOT POP ALONG AND SEE THE LATEST TRANSCEIVERS, SHORTWAVE/SCANNING RECEIVERS AND ACCESSORIES? MOST OTHER PRODUCTS ADVERTISED IN THIS MAGAZINE ARE AVAILABLE AT RAYCOM, AND DON'T FORGET OUR EXCLUSIVE PRODUCTS AND MODIFICATIONS!

HAM RADIO TODAY

CONTENTS

VOLUME 6 NO 8 AUGUST 1988

Editor
Dave Bobbett, G4IRQ
Technical Illustrator
Jerry Fowler
Advertisement Manager
Christopher Harris
Classified Sales Executive
Evelyn Coombes

Published by:
Argus Specialist
Publications Ltd

Distributed by
SM Distribution Ltd

Printed & bound by:
Adlard & Son Ltd
Dorking, Surrey and
Letchworth, Herts

Design by
ASP Design Studio

**Editorial and Advertising
address:**

Ham Radio Today
ASP Ltd

1 Golden Square
London W1R 3AB
Tel: 01 437 0626

*(please mark your letter for the
appropriate department)*

Subscriptions and back issues:
Ham Radio Today Subscription Dept,
Infonet Ltd, 5 River Park Estate,
Berkhamsted, Herts. HP4 1HL
Tel: (04427) 76661/4

Subscription rates:
UK £15.60, Europe £20.10,
Middle East £20.30, USA \$30,
Far East £22.00, Rest of World
£20.60. Airmail rates on request.

USA Subscription Agent:
Wise Owl Worldwide Publications,
4314 West 238th Street,
Torrance CA90505

ARGUS PRESS GROUP Member of the
Audit Bureau of Circulation



Ham Radio Today is normally published on the first Friday in the month preceding cover date. The contents of this publication including all articles, designs, plans, drawings and programs and all copyright and other intellectual property rights therein belong to Argus Specialist Publications Limited. All rights conferred by the Law of Copyright and other intellectual property rights and by virtue of international copyright conventions are specifically reserved to Argus Specialist Publications Limited and any reproduction requires the prior written consent of the Company © 1988 Argus Specialist Publications Ltd.

All reasonable care is taken in the preparation of the magazine contents, but the publishers cannot be held legally responsible for errors. Where mistakes do occur, a correction will normally be published as soon as possible afterwards. All prices and data contained in advertisements are accepted by us in good faith as correct at the time of going to press. Neither the advertisers nor the publishers can be held responsible, however, for any variations affecting price or availability which may occur after the publication has closed for press.

REGULAR COLUMNS

LETTERS	10
Goodbye to the spirit of amateur radio?	
QRZ	14
Latest update on exotic radio	
RADIO TOMORROW	43
Come and say 'Hello' to HRT at the NEC!	

FEATURES

FRINTON WIRELESS SCHOOL	12
A visit to Uncle Marconi down by the sea!	
PROPAGATION AND THE SUN PART 2	18
Solar events and their radio implications	
BONZAI AERIAL FARMING	32
The desperate operator's guide to pruning	

REVIEWS

10 METRE MONOBANDER REVIEW	26
The latest Uniden multimode on trial	
TINY-2 TNC UNIT	37
A low cost VHF packet box gets the once over	
KENWOOD TM-721	46
A two-rigs-in-one state of the art dualbander	

CONSTRUCTION

SIMPLE CRYSTAL TESTER	23
Have you got quirky quartz? Our project sorts it out!	
WIDE RANGE CAPACITANCE METER	40
A handy easy to make component tester	

HAM RADIO TODAY SUBSCRIPTION FORM	8
FREE READERS ADVERTISEMENTS	51
RETAIL NETWORK	54
CLASSIFIED ADVERTISEMENTS	55

ICOM



ICOM at the N.E.C.

At this years R.S.G.B. Exhibition the full range of ICOM Amateur Radio Equipment will be on display. ICOM (UK), the official UK importer will have their fully experienced sales team ready to discuss and recommend the ICOM products to suit you.

So come on down to NEC and see why ICOM is number 1. You will find us on stand B6 alongside R.S.G.B., B.C.N.U.

NEW! IC-32E Dual Band VHF/UHF FM handportable

Features:

- Full cross band duplex operation.
- 20 Dual band memories.
- Scanning.
- Compatible with ICOM accessories.
- 5 Watt output with IC-BP7 nicad.
- Small size.
- Power saver circuit.

When are ICOM going to produce a dual band handportable? This has been the most asked question about new ICOM products for a long time. The IC-32E is the answer.

This exciting new handportable offers full cross-band duplex operation, and with a built-in duplexer allows single antenna operation. 3 Watt output is standard but with the BP7 high power nicad pack or external 13.8v, 5 Watts can be achieved on both bands. The IC-32E comes packed with features, such as the 20 memory channels which can store both a VHF and UHF frequency in one memory and also simplex duplex condition, offset direction and frequency.

There is a choice of five scanning functions, full programmed memory, memory band and priority. The die-cast frame gives a solid construction featuring rubber gaskets for splashproof operation. The IC-32E is supplied with VHF/UHF a dual band antenna, BP3 battery pack and wall charger. OK, when are ICOM going to produce a new dual band mobile with full cross band duplex? The IC-3210E will be the answer.

Icom (UK) Ltd.

Dept HRT, Sea Street, Herne Bay, Kent CT6 8LD. Tel: 0227 363859. 24 Hour.

Count on us!

All Aboard at N.E.C.

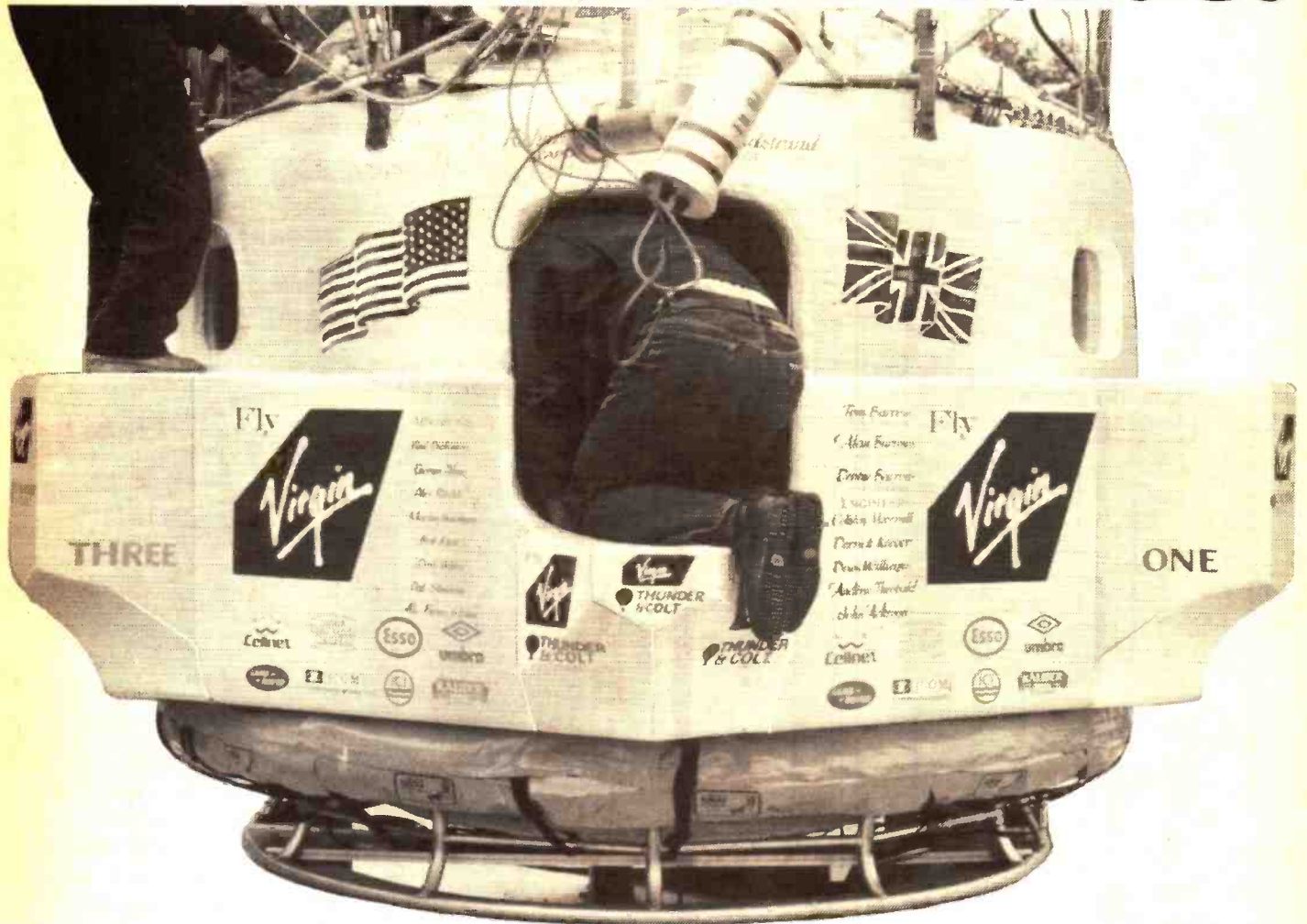

Exclusive this year to ICOM stand at N.E.C. will be the Virgin Balloon Capsule "The Flyer" which was piloted by Richard Branson and Per Lindstrand who used ICOM equipment to co-ordinate the first successful crossing of the Atlantic by Hot Air Balloon.

Climb aboard the capsule and experience the conditions encountered by the two aviators. See how ICOM equipment was utilised for aeronautical communications. Do not miss the opportunity to see the "Flyer"!

Helpline: Telephone us free-of-charge on 0800 521145, Mon-Fri 09.00-13.00 and 14.00-17.30. This service is strictly for obtaining information about or ordering Icom equipment. We regret this cannot be used by dealers or for repair enquiries and parts orders, thank you.

Datapost: Despatch on same day whenever possible.

Access & Barclaycard: Telephone orders taken by our mail order dept. instant credit & interest-free H.P.



ALTRON COMMUNICATION EQUIPMENT

ALWAYS CHOSEN BY PROFESSIONALS AND DISCERNING RADIO AMATEURS.

COMPACT LATTICE TOWERS
SLIMLINE TUBULAR MASTS

Telescopic—Tiltover, Fixed—Mobile from 3M to 60M. Over 50 Models, suitable for a wide range of civil and military applications such as:

- Radio Communications
- Amateur Radio
- CCTV and Surveillance
- Meteorological Monitoring
- Aero & Marine Nav Aids
- Flood Lighting etc.

Purpose designed using 4-5m and 3m section modules for low retracted heights and cost effective shipping. Engineered to B.S.I. standards and hot dip galvanised to BS729 for protection. Wind loads are based on BS CP3 CHAP V PT 2 1972 for wind speeds up to 100mph/160kph. (BS 8100).

ANTENNAS

AQ6-20 "SPACE SAVER", THE COMPACT 4 BANDER THAT IS DIFFERENT. 2, 3 OR 4 ELEMENTS 6, 10, 15 AND 20M.

Unique Fully Sealed Coils. Hi'Q—Close Coupled capacity hat loaded Yagi with optimized performance. Ideal for small spaces. Send for full Spec. sheet. NOW!

QUALITY
RELIABILITY
KNOW HOW

WE DESIGN—WE MAKE—WE SELL—DIRECT.
At manufacturers prices—you get best value.

SEND S.A.E. FOR FURTHER DETAILS AND PRICES OF ALTRON PRODUCTS.

H.P. TERMS



ALLWELD ENGINEERING
Factory 6, 232 Selsdon Road,
South Croydon, Surrey, CR2 6PL.
Tel: 01-680 2995 (24 hr) 01-681 6734

READ ALL ABOUT IT! IN THE SUMMER '88 Circuit CATALOGUE

TOOLS 173

PCBs & MATERIALS 95

CONNECTORS 151

KITS & MODULES 131

HARDWARE 173

BOOKS 117

SEMICONDUCTORS 109

TEST EQUIPMENT 153

Circuit
SUMMER 1988
electronic construction
EEEs worth many more
FREE!
Digital clock with
alarm over £50.00

Discount vouchers, competition, free gift and, of course, the latest new products. Available at your newsagent or direct from Circuit at the address below.

PRICE £1.30

Circuit



Circuit Distribution Ltd.

Park Lane, Broxbourne, Herts EN10 7NQ
Telephone (0992) 444111 Telex: 22478

NEVADA

THE UK'S SCANNER SPECIALISTS
Just arrived Black Jaguar MkIII

With additional features

Switchable between AM/FM.
 Base & mobile charging
 Frequency range:-
 26-30MHz, 60-88MHz,
 115-178MHz, 210-260MHz,
 410-520MHz

£235

100 XL Bearcat

Hand held scanner
 with 16 channels.
 Memory scan covering:-
 66-88 Mhz, 118-174 Mhz,
 405-512 Mhz.
 Complete with carrying case,
 earphone and charger unit.

£189⁹⁹

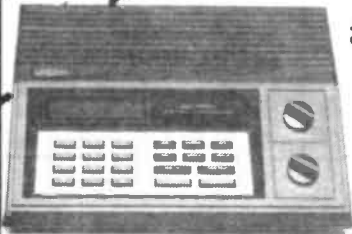

Bearcat 175 XL BASE

Base station scanning Rx
 with 16 channel memory scan
 covering: 66-88MHz,
 118-174 Mhz, 405-512 MHz.

NEW LOW PRICE

£179⁹⁹

50 XL Bearcat

A super NEW low cost
 handheld scanner with
 10 memories and covers:-
 66-88MHz, 136-174MHz
 406-512MHz

£99⁹⁹



Bearcat 800 XLT

40 Channel Base Scanner
 Covers: 29-54MHz, 118-174MHz,
 406-512MHz, 806-912MHz.
 Complete with AC adaptor

£257

NEW 580 XLT Bearcat



100 Memory channels covers:
 29-54 MHz, 118-174, 410-512 MHz

£225 Requires 12V DC supply

70 XLT Bearcat

Pocket size scanner
 with 20 memory scan
 covering 66-88 Mhz,
 118-174 MHz, 406-512 MHz
 Complete with carrying case,
 earphone and charger unit

£179⁹⁹

NEW BUMPER CATALOGUE
 Includes £2 Voucher

USE YOUR CREDIT CARD FOR IMMEDIATE DESPATCH
HOTLINE (0705) 662145

NEVADA COMMUNICATIONS
 189 London Road, North End,
 Portsmouth PO2 9AE. Telex: 869107

CAP.CO

**STAY TUNED FOREVER WITH A CAP.CO.ATU -
 ONCE BOUGHT - NEVER REPLACED**

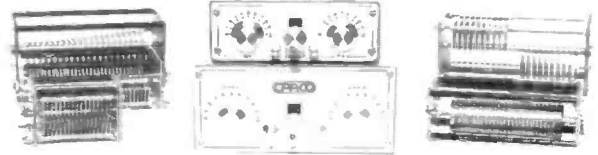

ANTENNA TUNING UNITS

SPC-300 D 1Kwp.e.p. £225.00
 SPC-3000D 1Kwp.e.p. £325.00

ADD £5.00 p&p

CAPACITORS

CAP-25S S GANG 250 pfd £15.50
 CAP-25T T GANG 250 pfd £18.95
 CAP-10S S GANG 500 pfd £21.95
 CAP-25D DIFF 500 pfd £18.95

ABOVE CAPS HAVE 2.5mm plate spacing rated at 8Kv.

ADD £2.00 p&p

CAP31S S GANG 250 pfd £17.95
 CAP31T T GANG 250 pfd £22.95
 CAP12S S GANG 1200 pfd £25.95

ABOVE CAPS HAVE 4.5mm plate spacing rated at 12Kv.

ADD £2.50 p&p

ROLLER COASTER + £2.00p&p £22.95
 BALUNS 4:1 1:1 + £2.00 p&p £16.50
 AERIAL KIT + £1.00 p&p £5.30
 TURNS COUNTER - £1.00 p&p £22.50

THE GENUINE MAGNETIC LOOP ANTENNA A RARE TECHNOLOGICAL BREAKTHROUGH

The Magnetic Loop Aerial is totally different from any other aerial. It relies solely on the magnetic portion of the electromagnetic wave to operate. It filters out all unwanted noise via 180° phase shift between the magnetic and the electrical wave, exactly what is required from 1 to 14MHz where the electrical noise is virtually unbearable.

Depending on the model used and within the bounds of the frequency designated for that model, the Control Box enables the user to operate the antenna from the lowest to the highest part of the frequency with no gaps. There are various models of loops - typically 2 antennas and 1 Control Box is required to cover the whole HF frequency range from 1 to 30 mcs. A reduction of £50.00 is allowed for two aerials. Prices range from £79.95 for the receive Loop to £456.00. Power ratings for these versions are from 100-200 watts.

The Commercial versions, power rating 500 and 1000 watts come complete with Automatic Controller which selects the frequency you require.

- It has a very high Q
- A radiation resistance of an ohm, never more than 800 mill ohms
- Has a bandwidth from 3KHz to 50KHz
- It has an SWR of 1.4 to 1 at the very least, 1.1 to 1 on most bands
- Will operate at virtually ground level
- The loop has a vertically polarised radiation pattern containing both very high and very low angle radiation (ideal as a DX antenna)
- Does not require an Antenna Tuning Unit
- Depending on the model used it only occupies from 80cm to 4m of space
- It is ultra compact, light and waterproof
- Planning permission is not necessary

PLEASE WRITE INCLUDING SAE FOR FURTHER DETAILED INFORMATION

Our equipment is guaranteed, unique and as such protected by registered designs and copyright. Our policy is one of continual research and improvement therefore current specifications are subject to change without notice.



Transceiving Loop



Receiving only Loop - ideal for S.W.L.

**63, Hallcroft, Birch Green,
 Lancs WN8 6QB.
 Telephone: 0695 27948**

K W TEN-TEC LTD ARGOSY II NOW MADE BY KW IN THE UK

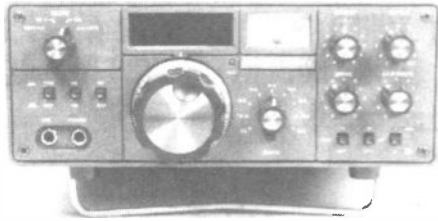

ARGOSY II - 100 WATTS SSB/CW
MOBILE, PORTABLE OR HOME STATION

CENTURY 22
NOW MADE BY KW IN THE UK
50 WATT, 6 BAND CW TRANSCEIVER COMBINING
EXCELLENT PERFORMANCE, RELIABILITY,
OPERATIONAL SIMPLICITY, AND LOW COST

ALSO FROM KW
THE PARAGON 200W SYNTHESIZED TRANSCEIVER,
THE CORSAR II 200W TRANSCEIVER
FRITZEL BALUNS. H.F. BEAMS & VERTICALS NOW
IN STOCK - FROM CUSHCRAFT, BUTTERNUTT,
HYGAIN.
MFJ PACKET RADIO UNITS AND ATU's etc.
HYGAIN ROTATORS. VHF BEAMS & VERTICALS.

K W TEN-TEC LTD
VANGUARD WORKS, JENKINS DALE, CHATHAM, KENT ME4 5RT
Tel: (Medway) 0634-815173; Telex: 965834

TINY - 2

from Pac-Comm

AX25 That won't cost you a Packet

This is the very latest in Terminal Node Controllers from the USA.

Its small Size, Weight, and low power consumption make it an ideal TNC for portable or continuous use.

Because it is 100% TNC2 Compatible it WILL run NET/ROM and TCP/IP. So offers a very inexpensive path for setting up 'GB' stations.

Additional commands enhancing BBS messages also make the TINY-2 ideal for BBS use.

Using a 3105 modem chip the TINY-2 offers superb filtering and demodulation of incoming data.

A modem disconnect header is provided for future high speed modem connection.

FEATURES

- Baud Rates 300 to 19200
- V1.1.5 Firmware
- RS232 and TTL Computer I/Face
- 32K EPROM
- 32K RAM - Battery Backed Up
- Z80 CPU (2.46/4.92 MHz)
- Modem Disconnect Header
- TCM3105 Modem IC
- 9-16V dc Operation
- 200 mA (NMOS) . <40mA (CMOS)
- Size 7.5" x 5" x 1"
- Complete with Manual, Connectors, and 1 year guarantee for £109.95 (NMOS Version) Including VAT.

Available from:

Andrews Computer Services Ltd.,
6 Ash Hill Close,
Bushey Heath,
Hertfordshire,
WD2 1BW.
Telephone: 01 950-9381 (24 Hour Ansaphone Service)
0860- 367676 (Mobile Phone)



HAM RADIO TODAY

WISH YOU WERE
BETTER INFORMED?



12 issues UK	£15.60
12 issues Europe	£20.10
12 issues Middle East	£20.30
12 issues Far East	£22.00
12 issues Rest of the World or USA	£22.00
	\$30.00

Air Mail Rates Given on Request

Send this form with your remittance to:
INFONET LTD., 5 River Park Estate,
Berkhampsted, Herts. HP4 1HL



Please begin my subscription(s) to **HAM RADIO TODAY** with the made payable to **Argus Specialist Publications Ltd.** issue.
I enclose my cheque/postal order for £..... from my Access/Barclaycard No.
or debit £..... valid from
NAME (Mr/Mrs/Miss).....
ADDRESS.....
Postcode.....
Signature.....
Date.....
Please use **BLOCK CAPITALS**
and include postcodes

SMJ ELECTRONICS

Specialists in Semiconductors

Transistors

2N3055	£0.47	2SC945	£0.08	2SC2028	£1.30	2SK30	£0.37	BD235	£0.28
2N3773	£1.55	2SC1060	£0.59	2SC2029	£1.15	2SK33	£0.40	BD241	£0.34
2N3866	£1.10	2SC1061	£0.49	2SC2078	£0.74	3N201	£1.11	BD243	£0.30
2SA473	£0.42	2SC1096	£0.71	2SC2086	£0.43	3SK40	£1.27	BD244C	£0.33
2SA564	£0.10	2SC1213	£0.12	2SC2092	£1.41	3SK48	£2.26	BD245	£0.84
2SA608	£0.11	2SC1306	£0.74	2SC2097	£21.09	3SK88	£0.59	BD246	£0.75
2SA673	£0.13	2SC1312	£0.09	2SC2099	£19.25	3SK97	£2.08	BD902	£0.51
2SA678	£0.38	2SC1318	£0.22	2SC2166	£0.95	40673	£1.50	BF244	£0.39
2SA683	£0.20	2SC1359	£0.13	2SC2236	£0.22	BC107	£0.13	BF245	£0.29
2SA684	£0.31	2SC1384	£0.27	2SC2290	£24.55	BC108	£0.07	BFY50	£0.25
2SA699	£0.66	2SC1398	£0.60	2SC2312	£3.15	BC109	£0.14	BFY51	£0.25
2SA733	£0.13	2SC1674	£0.15	2SC2314	£0.30	BC141	£0.26	MRF237	£3.39
2SA966	£0.26	2SC1675	£0.14	2SC2320	£0.10	BC142	£0.19	MRF238	£13.64
2SA999	£0.10	2SC1678	£0.80	2SC2395	£16.20	BC182	£0.06	MRF450	£13.50
2SA1012	£0.68	2SC1815	£0.10	2SC2539	£10.82	BC184	£0.10	MRF450A	£13.80
2SA1015	£0.11	2SC1909	£0.92	2SC3020	£12.90	BC212	£0.06	MRF454	£22.94
2SB525	£0.25	2SC1945	£3.41	2SC3024	£0.46	BC148L	£0.86	MRF455	£23.65
2SC380	£0.09	2SC1946	£12.37	2SC3025	£0.41	BC238	£0.06	TIP29C	£0.26
2SC495	£0.35	2SC1947	£4.29	2SD013	£0.56	BC639	£0.12	TIP30C	£0.29
2SC536	£0.10	2SC1957	£0.66	2SD025	£0.43	BC640	£0.13	TIP31C	£0.27
2SC710	£0.11	2SC1969	£1.58	2SD030	£0.48	BD131	£0.32	TIP32C	£0.33
2SC711	£0.09	2SC1970	£1.52	2SD0380	£4.26	BD132	£0.32	TIP41C	£0.35
2SC730	£0.33	2SC1971	£2.95	2SD0471	£0.29	BD135	£0.22	TIP42C	£0.36
2SC730	£0.09	2SC1972	£8.25	2SD0837	£0.71	BD139	£0.22	TIP120	£0.36
2SC828	£0.27	2SC1973	£0.51	2SD0880	£0.41	BD140	£0.25		
2SC900	£0.17	2SC2002	£0.25	2SK192	£0.23	BD201	£0.33		

BOOKS

Screwdrivers Guide to CB
PLL Data Book
Cybernet Service Manual
Uniden Service Manual

£5.00
£5.00
£3.00
£3.00

Active Filter Boards

A 10.695MHz active filter specifically designed for the HAM International and NATO 2000 type CBs. This board significantly reduces image reception and cross modulation without affecting sensitivity.

Price £6.90

Crystal Filter

This is a 10.695MHz 1kOhm 10KHz bandwidth xtal filter suitable for most FM CBs. The filter greatly reduces cross modulation (bleedover) and is extremely easy to fit

Price £2.39

Integrated Circuits

7805	£0.40	HA1377	£1.90	LC7120	£2.75	RC4558	£0.55	TDA1010	£1.15
7808	£0.38	HA1388	£3.81	LC7130	£3.26	5042	£2.50	TDA1011	£1.37
7812	£0.39	HA1392	£2.54	LC7131	£3.21	TA7061	£0.76	TDA1020	£2.28
7815	£0.37	HA1394	£2.72	LC7132	£2.89	TA7120	£0.48	TDA1510	£3.89
7818	£0.59	HA1397	£2.55	LC7137	£2.77	TA7130	£0.53	TDA1512	£3.12
AN240	£1.28	HA1398	£2.68	LM324	£0.45	TA7204	£0.98	TDA2002	£0.74
AN6551	£0.73	LA1230	£1.19	LM386	£1.15	TA7205	£0.91	TDA2004	£1.81
AN7131	£1.37	LA4102	£0.84	M51102	£1.85	TA7217	£1.22	TDA2005	£1.65
AN7140	£1.05	LA4112	£0.94	M51513	£1.86	TA7222	£1.22	TDA2020	£1.81
AN7178	£2.95	LA4140	£0.58	M51515	£1.94	TA7227	£2.06	TDA2030	£1.30
BA402	£0.59	LA4201	£1.19	M51517	£1.84	TA7240	£2.08	TDA2611	£0.79
BA521	£1.55	LA4220	£1.41	MB3712	£0.99	TA7241	£1.96	UPC1028	£0.95
BA656	£1.19	LA4250	£2.23	MB3730	£2.06	TA7270	£1.93	UPC1032	£0.73
CD4001	£0.28	LA4400	£2.59	MB3756	£1.94	TA7271	£1.93	UPC1156	£2.05
CD4008	£0.89	LA4420	£1.32	MB3719	£4.12	TA7274	£1.96	UPC1181	£0.91
CD4011	£0.11	LA4422	£1.13	MC1723	£0.48	TA7310	£0.66	UPC1182	£1.04
CD4049	£0.25	LA4440	£1.89	MC3357	£2.11	TA75902	£0.99	UPC1185	£1.81
CD4066	£0.34	LA4445	£1.90	MC3359	£2.33	TBA800	£1.38	UPC1196	£0.71
CD4069	£0.18	LA4460	£1.71	MM55108N	£3.00	TBA810T	£0.49	UPC1230	£1.80
HA13001	£2.16	LA4461	£1.71	NE567	£0.52	TC9106	£6.80	UPD585	£1.65
HA1366W	£1.33	LB1405	£0.97	PLL02	£7.59	TC9109	£4.38	UPD2816	£5.34

We have listed only a small proportion of our stock. Please feel free to contact us with your requirements. All prices are quoted as the one off price, discounts being available for quantities of ten or more of any one device. Same day despatch on all items in stock. Cheques by order with order. Please add 75p postage and packaging on all orders under £10.00. All prices are exclusive of VAT. All mail order to: 55 Slatford Road, EDINBURGH, EH11 1PB. Callers Welcome. TEL: 031 337 6950/031 337 2446.

TX-3 RTTY/CW/ASCII TRANSCIVE

Split-screen, type-ahead operation, 24 memories, clock, review store, call sign capture, RTTY auto CR/LF, CW software filtering and much more. Needs interface or TU. BBC-B/Master and CBM64 tape £20, disc £22. SPECTRUM tape £35 + 3 disc £37 inc., adapter board (needs interface/TU also). Also VIC20 RTTY/CW transceiver program, tape £20.

RX-4 RTTY/CW/AMTOR/SSTV RECEIVE

This is still a best-selling program and it's easy to see why. Superb performance on all four modes, switch modes at a keypress to catch all the action. Text and picture store with dump to screen, printer or tape/disc. The essential software for the SWL. Needs interface. BBC-B/Master, CBM64 tape £25, disc £27. VIC20 tape £25. SPECTRUM tape £40, +3 disc £42 inc. adapter board (needs interface also). The SPECTRUM software-only version is still available, tape £25, + 3 disc £27.

TIFI INTERFACE for TX-3 and RX-4. RTTY and CW filters, computer noise isolation for excellent reception. Transmit outputs for MIC, PTT and KEY. Kit £20 (assembled PCB + cables, connectors), ready-made £40 state rig. Available only with TX-3 or RX-4 software.

Also MORSE TUTOR £6, LOGBOOK £8, RAE MATHS £9 for BBC and CBM64 (disc £2 extra), SPECTRUM, ELECTRON, VIC20.

Prices include VAT and p&p, 1st class inland, airmail overseas, normally by return. Eire, C.I., BFPO deduct 13%.

technical software (HRT)

Fron, Upper Llandwrog, Caernarfon LL54 7RF.

Tel. 0286 881886



BINDERS

FOR YOUR VALUABLE COLLECTION OF HAM RADIO TODAY MAGAZINES

• SMART • EASY TO USE • TOP QUALITY
To ASP Readers Services, PO Box 35, Wolsley House, Wolsley Road, Hemel Hempstead, Herts HP2 4SS (0442-41221)

£5.95 inc. P&P

Please supply Ham Radio Today Binders @ £5.95 inc. P&P

Total £ (Please make cheques payable to ASP Ltd.)

Years Required — 198.....198.....198.....198.....

Name

Address

Please allow 21 days for delivery

R.A.S. (NOTTINGHAM)

G6XBH
G1RAS
G8UUS

Radio Amateur Supplies
Tel: 0602 280267



Visit your Local Emporium

Large selection of New/Used Equipment on Show

AGENTS FOR:

F.D.K.
AZDEN
ICOM
YAesu
ALINCO
KENPRO

ACCESSORIES:

Welz Range
Microwave Modules
Adonis Mics
Mutek Pre-Amps
Barenco Mast Supports

DRAE products
BNOS Linears and
PSUs

Agents for VODAPHONE & CELLNET

AERIALS: Tonna, Halbar, Jaybeam, New Diamond Range of Mobile Whips

Bring in your secondhand equipment for sale

JUST GIVE US A RING

Monday: CLOSED Tuesday-Saturday: 10am to 5pm

3 Farndon Green, Wollaton Park, Nottingham NG8 1DU
Off Ring Rd, between A52 (Derby Road) & A608 (Ilkeston Road)

ENTERPRISE RADIO APPLICATIONS LTD.

STANDARD MICROREADER
£119.95
WITH TUTOR
£134.95



ALL PRICES INCLUDE VAT/P&P
12 MONTHS GUARANTEE
E.R.A. Ltd., 26 CLARENDON COURT,
WINWICK QUAY, WARRINGTON WA2 8QP
Tel: (0925) 573118



GET MORE ENJOYMENT FROM YOUR H.F. LISTENING!

IF YOU THOUGHT THAT RECEPTION OF RTTY WAS COMPLICATED & REQUIRES LOTS OF EQUIPMENT THEN HERE'S THE ANSWER - THIS SMALL SELF CONTAINED UNIT IS FULLY AUTOMATIC AND SIMPLY CONNECTS TO YOUR SETS HEADPHONE OR SPEAKER SOCKET. NO INTERFACES PROGRAM TAPES OR VDU'S REQUIRED.

LEARNING MORSE?

THE BUILT IN TUTOR IS SIMPLY THE BEST THERE IS. SEE WHAT IT SENDS OR PLUG IN YOUR KEY TO SEE WHAT YOU SEND! IN FACT IT'S SO GOOD WE SELL MORE TUTORS TO CW OPERATORS THAN THOSE LEARNING FOR THE FIRST TIME.

NOW AVAILABLE WITH RS232 OR CENTRONICS INTERFACE. (RING NOW FOR DETAILS).

SEE REVIEW SEPT. '87 HRT OR RING FOR DETAILS.

LETTERS

Can we have our hobby back (please!)

Dear HRT, It's about time the RSGB stuck its head above ground and wiped the sand out of its ears. Amateur radio, particularly the 'spirit of amateur radio' is on the decline. I would argue that before the introduction of a 'novice or student' licence is issued, our use of the existing bandplan, particularly the VHF segments, may be used in accordance with current licence regulations. Secondly, more emphasis must be placed on 'the self training aspects of our hobby' as a means of being active on the bands, rather than reaching for the cheque book to buy equipment.

I live within 'end stop' signal strength of all the London repeaters, and the mis-use and abuse of these 'boxes' is legendary. The RSGB must enforce regulations which prohibit, racist, sexist language and other licence infringements by operators, who in the main appear to be black-cab, mini-cab, despatch and delivery drivers. They obviously lead very boring lives, who turn to the box for 'excitement'. Unlicensed users must be ignored, otherwise the norm would appear to be 'anything goes' and eventual chaos.

The concept of the 'super rig', the contraction of a buyers market through mergers and take-overs by the Big Three, has resulted in a 'price cartel' for new equipment. This is compounded further by the price of second-hand gear through 'members' ads', who else would dare to ask the selling price of

equipment that in some cases has given quite a few years daily service. It could be argued that a return to 'homebrew values' is desperately needed to ensure the viable future of amateur radio, companies such as Howes and others point the way. Our conduct on the airwaves attracts or detracts potential 'users' into amateur radio, and this is the key to future membership. The RSGB must talk to us about what we feel about our hobby, it is pointless to be mere negotiators of airspace with the DTI; having got Four and Six metres, who can and wants to use them.

The next phase of RSGB activity, will be the introduction of a novice licence, I welcome the idea of attracting people into our hobby, but whose interests are being served, an increased RSGB membership and increased consumption for amateur equipment, or the real needs of amateurs themselves.

Ellis Evans, G1PDA

I certainly agree that some of the behaviour which is evident on a number of repeaters is more inclined to dissuade than encourage potential recruits. Perhaps in view of the damage this does to the image of the hobby the RSGB should consider either suspending their operation entirely or require closure during peak problem periods, such as the late evening! What do other readers think? - G4IRQ

Outside View

Dear HRT, I was interested to read in your April issue a number of comments about the need to attract new blood into amateur radio. As an outsider to the hobby I should like to make a few observations from a distant perspective.

During my National Service some wireless "ops" gave me informal lessons on the Morse alphabet, and by demob date I could "send" in a lumpy fashion but was useless at receiving. It was very enjoyable rattling away on a practice circuit, especially when a "real" WOP sat in on it and made sense out of my efforts...(those lads were good!)

There ought to have been a health warning on the Morse key, *CW can affect your peace of mind*, for it always rankled that I had developed my interest too late to be able to 'read' incoming Morse. — It still rankles. Over the years there have been frequent bouts of Morse nostalgia, but the weight of the technical side of Radio has always driven the 'bug' away again.

Early this month I heard a nice steady CW transmission on our domestic set. Recognising a few letters started me off again. My modest ambition was to try to learn to receive Morse (at reasonable speeds) by recording slow texts on a cassette recorder and playing them back. I would require a key, a "gadget" to produce a tone, and a cheap recorder. It seemed vaguely feasible I could wear 'phones and have the "gadget" connected to a recorder via a DIN lead so that no audible Morse will interfere with the peace in the room. I could monitor through the 'phones and later I could play back through them. I tried talking to a few "ordinary" radio dealers who heard me out and then said I would do well to talk to a Ham enthusiast. One dealer told me I needed an oscillator, but he didn't know where I would find what I was looking for. Another said I needed a buzzer which he might be able to obtain. It sounded like a door accessory and not a thing I could record from "silently". Morse keys are no longer thick on the ground either. O for the lovely ex-WD years of the 'fifties!

Meanwhile our domestic set is

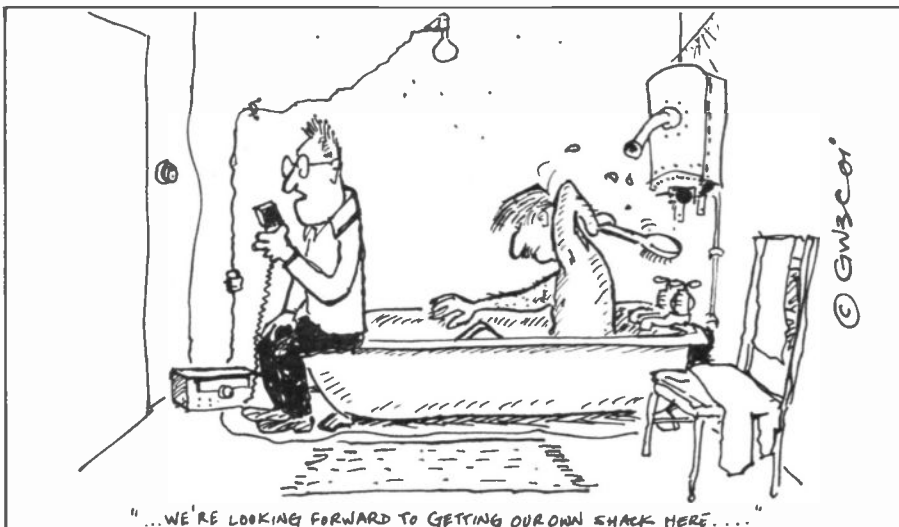

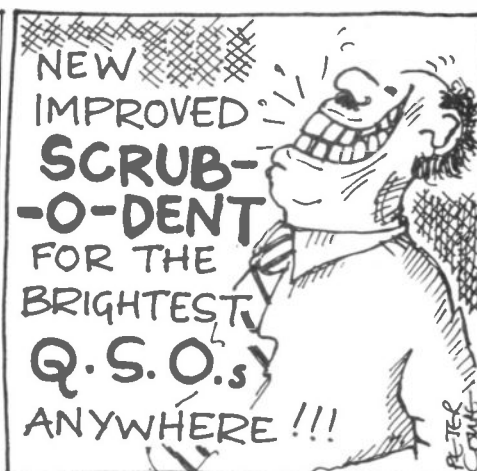

receiving precious little slow Morse to sustain my enthusiasm. Perhaps the transmission which I heard early in the month was due to unusual conditions? Reference to our local branch library's collection of radio books brought to light a chapter in fairly plain English describing suitable receivers. Ours is not a suitable receiver. I bought *HRT*, hoping I might find advertisements for oscillators, receivers and maybe books for permanent novices!

Your advertisers assume a high degree of technical knowledge, cutting their adds to the bone with lots of initials and little explanation. Prices match those of many hobbies, and it seems the would-be amateur Morse listener cannot edge gently into even so modest an ambition. I am beginning to wonder what the minimum outlay would be for an unpractical person. From such recent literature as I can understand, Ham messages would seem to be little more than establishing contact and giving mutual RST information, on average. For a listener, I could imagine this would pall after a while. So far, however, I'm hoping to get to grips with the more immediate problem of finding out if the Morse key/recorder idea will work. When and if I manage to teach myself to receive, then I'll look around, or listen out.

Still painstakingly decoding your adverts, I have come across the final irony — an ERA Microreader. I call that cheating; now if they would devise a gadget to convert jargon into plain english.

Yours, Baffled,
A.M.W. Cattle

Thank you for the timely reminder to those of us who have been licenced for quite a few years that the hobby can be totally mystifying to the newcomer. Your Morse problem can be solved by obtaining a Morse oscillator from a Tandy store, where you will also find a cheap Morse key. In its standard form, the device will not connect to a tape

recorder but at least it is a start!

A good way to 'test the water' with radio is to buy one of the cheap (£30 or so) Russian made VEGA receivers - this won't receive amateur transmissions or some Morse signals (you need a device called a BFO for that) but will introduce the world of international radio.

Finally I would strongly suggest that you contact a radio club (see our 'Contact' page for the nearest) and drop a line to the RSGB, Lambda House, Cranborne Road, Potters Bar, Herts for general information about amateur radio, evening classes and how to get a licence. - G4IRQ

UTC, GMT and BST

Dear *HRT*, I have just read your magazine and I have two questions to ask you, my first question is this: where can I get a copy of the *World Radio & Television Handbook*? I have tried all of the book shops that I know of but either they have never heard of it, or they cannot find it advertised in any of their catalogues.

In the article "Listening On" there is a part called "Far North and Far South", in which you talk about a programme in English from Radio Sweden. You say it is at 1600 UTC (GMT) on 6065kHz, but I have a schedule of programmes for Radio

Sweden from March 27 - September 24 1988.

There is no mention of such a programme, but there are two at 1700 UTC (GMT). They are on the 1179kHz (Medium Wave) 254 metre band Europe Non Dir, the second is at 1700 UTC (GMT) 6065kHz on the 49 metre band 210 degrees. You do mention two broadcasts, one at 2100 UTC (GMT) and another at 2300 UTC (GMT) on 1179kHz which is Radio Sweden's Medium Wave broadcast.

But as we have put out clocks forward one hour, 1700 becomes 1800, 2100 becomes 2800 UTC (GMT) and 2300 UTC (GMT) becomes 0000 UTC (GMT). The best reception that I get is on the 31 metre band on 9630kHz and 1100 UTC (GMT) 1200 BST, there are no more broadcasts to Europe by Radio Sweden until 1700, 2100 and 2300 UTC (GMT).

My second question is this: could you please send me the names and addresses of Radio Denmark or Danish Radio, Radio Norway or Norwegian Radio, Finnish Radio or Radio Finland, Radio Netherlands or Netherlands Radio, Radio Germany, Belgium Radio and Radio Brazil.
Martin Gosnell

The names and addresses are on their way - Ed.

£10 FOR THE LETTER OF THE MONTH

You've got a gripe about the bandplans, or you're sick of being wiped out by next door's microwave. Or maybe you've been bowled over by the excellent service from your local radio shop.

Whatever you've got to say about amateur radio say it here in the letters column and you could win yourself £10 for writing the letter of the month.

Send your epistles to: Letters Column, Ham Radio Today, ASP Ltd, 1 Golden Square, London W1R 3AB.

The Frinton Wireless SCHOOL

(Photo Courtesy Marconi Ltd.).



How things were 'way back then' in 1901, the 120ft mast towers above the two houses which were home to the wireless school.

In this day and age, with radio being so common that it merges almost unnoticed into the background, it is sometimes difficult to remember

part of every school curriculum and Universities and Colleges throughout the world teach the art, science and skills of 'wireless' com-

Even with a history of less than a century, some of the early radio landmarks have long faded from view. But there are a few, such as Marconi's Wireless School, which can still be seen by the avid radio buff as Tim Wander, G6GUX, explains

that radio is still only 90 years old. Amateur radio continually grows in popularity and local colleges and schools run numerous radio and electronics courses. Radio theory is

munication. To find out where this explosion in learning began we must first look at turn of the century England, when wireless was still in its infancy.

'Uncle Marconi'

On 25th April 1900 Guglielmo Marconi formed the Marconi International Marine Communication Company Limited. Its aim was to develop reliable two-way compact wireless systems for ship to ship, and ship to shore communication. However all wireless installations sold by the new company were to remain solely Marconi property and the equipment was to be operated only by Marconi personnel. Ship owners who required a Marconi wireless telegraphy system could therefore only lease the complete system, but would be assured that it used standard apparatus and operating methods. Maintenance, repairs and improvements would also be readily available and the system would be installed, tested and then operated by a fully trained and competent radio officer.

It was to train these operators, that the Marconi company set up the world's first wireless technical school at Frinton-on-Sea, on the Essex coast in early 1901. The school occupied the building on the left of the photographs, the other housed the school's resident students with a 120ft sectioned wooded mast standing between the two.

The Wireless School

Apparently Marconi himself actually spent little time at the Frinton School, leaving the teaching of the new art of wireless to the manager Mr Bowden Thomas, a Mr Webb, and a small team of wireless operators. The exact details of the training course are unknown but it is likely that most students would already be reasonably proficient in morse code. The course would include basis radio theory (such as it was), operating procedures and practices, care and use of batteries and some receiver theory. The instructors would also have stressed the rules concerning communications with only Marconi



The Wireless School site in 1987. Apart from a few cosmetic changes and the addition of a new estate of houses, things are still recognisable.

stations and users of Marconi equipment. Except in the case of a distress call, Marconi operators were under strict instructions not to accept any messages from wireless stations not equipped with Marconi apparatus!

However the majority of the students' time at the Frinton 'Wireless Telegraph Training College' would have been concerned with the use, maintenance and repair of the transmitting and receiving equipment. It is thought that the station's local test transmissions were usually to a small (possibly portable) station located somewhere in Pole Barn Lane some 500 yards away. However the schools large mast would have enabled the students to easily work with the main Marconi site in Hall Street, Chelmsford and with the coastal stations at Dovercourt near Harwich and North Foreland.

Why Frinton?

Just why Marconi came to Frinton is unclear, although a brief look at any map of this stretch of coast shows it to be readily accessible, with clear sea paths to North Foreland and the Kent coast. The two houses were built in 1900 and

bought by the Marconi Company, but appear to have been built as private residences along with others of a similar construction in the vicinity. They returned to this use when the station was shut down in 1904 and the training school was transferred to the Hall Street Works in Chelmsford where the students were absorbed into the general research, development and testing areas. In October 1911 the school was re-established at the Broomfield Road (North Chelmsford) research station where it continued to operate until the end of the First World War. In 1920 the Marconi company acquired the buildings and grounds of 'Chelmsford College' on Arbour Lane in North Chelmsford, which today, as Marconi College, still operates as the Marconi Company training school.

The Site Today

The Frinton mast was dismantled in 1904, but the large concrete base was not removed until the 1940s and the pieces of the extensive buried earth mat of stranded wires are still being found in the garden today, no doubt must to the irritation of contemporary

gardeners! As can be seen from the recent photograph the building has not changed much, apart from the loss of a chimney and some mock Tudor cladding. The appearance of a new housing estate both behind and in front of the buildings has reduced the site of the original somewhat, and of course a garage and television aerial are part of the new age. I am reliably told that the house may have a resident ghost; possibly some poor student who didn't make the grade?

The Frinton Wireless School surprisingly was not situated on the sea front, but some half a mile inland on Upper Third Avenue and remains to this day a quiet private residence - now called 'Marconia'. The occasional tour bus does still briefly pull up outside, but as a residence the word *private* should be emphasised. As for those of us who are interested in the history of our still-young hobby, it is perhaps comforting to know that part of it is to be found nestled away in a quiet coastal town. With those events only a few generations away, maybe some *HRT* readers can recall tales heard at their grandfathers' knee - we would love to hear them!

Q R Z



The author operating GB4CDX. Rig was a Kenwood TS940S and a TL922 linear.

put up antennas, as he lives in an old converted farm house. He has a 90 foot tower on which is mounted a KLM 3-element beam for 40 metres which, although it has linear-loaded elements and is thus not full size, is still a pretty large beast. Above that is another KLM beam, the KT-34A, which is a four-element beam for 10, 15 and 20 metres on a 16 foot boom. His most impressive antenna in my opinion, however, (from an operational viewpoint) is the 80-metre array. This consists of five half-wave sloping dipoles, with the top of each antenna at the top of the mast and each antenna sloping in a different direction. He has them firing SW, NW, N, NE and SE. The feeders are taken to a control box and any one antenna can be selected remotely from the shack. There is probably very little, if any, gain on this set-up, but there is a most impressive front-to-back and front-to-side ratio. There were several occasions during the course of the contest when it was quite easy to work north and central American stations on 80 metres on one antenna, when they were totally obliterated under European stations on another antenna.

The CQ WPX CW contest gets the once-over from Steve Telenius-Lowe - who is planning a rather unusual holiday!

This piece is being written in the middle of May, just before the time when all keen CW contest operators and DXers will be spending hours in front of their receivers or transceivers - yes, the CQ WPX CW contest. By the time this is read however you will be equally busy working on the logs, extracting the duplicate contacts and calculating the final score. To all of you who took part, I hope the contest went well for you and you achieved your targets, be it first place in Britain on a particular band, or just an improvement on last year's score.

SSB Leg

The SSB leg of the same contest took place during the last weekend of March (as always) and G30ZF, G3XTT (who has been known to write for a rival mag!) G3XVR, G3ZAY, G4DSE, G4FAM, G3LJF and myself took part in the multi-operator, single-transmitter section of the contest from G4LJF's superb

QTH in Wokingham, Berkshire. We obtained a special event callsign from the RSGB for the contest, GB4CDX (standing for Chiltern DX Club), and operated for the full 48 hours of the contest, on all bands 10-160 metres. G4LJF, Ian, is fortunate enough to have a considerable amount of space in which to



The comfortable location for the GB4CDX contest station in Wokingham.

Conditions

It is always difficult to judge how good or bad conditions are during a contest because there is so much activity that conditions may appear to a layman to be good. Stations always appear on 10 metres at unusual times, and so it was in this contest. However, in my opinion, conditions were actually rather poor. Before the contest, and now as I am writing this six weeks after, 15 metres has been open to the USA as late as midnight GMT, whereas during the contest itself, and despite the greater amount of activity then, it was actually rather difficult working US stations from mid-evening onwards. Those that did come through were the big East Coast Multi-operator contest stations, running high power and enormous antenna systems. As an aside, I was recently looking through some old QSL cards from a contest I did in 1982 and was quite surprised to see the number of cards from American stations, many in the mid-West or even on the West Coast, who were running 2 watts to a dipole - or in a few cases QRP and mobile - and all this on 10 metres!! Hopefully it will not be too long before we return to those sort of conditions.

Weird & Wonderful

The WPX contest, where the multiplier is the *prefix* of the station worked, rather than the country in which he is located, brought out its usual fair share of stations with "weird and wonderful" prefixes. TW6A, TW5E, T07TSE and TP5IA were all active from France. The VKs are allowed to use the AX prefix this year, being bi-centennial year, and many took advantage of the instant "rare prefix" possibilities given by this. Other stations worked with interesting prefixes were H22H from Cyprus, ATOT from India and TX0A from French Guyana. Other stations provided contesters with new multipliers by arranging for their own callsign to be given a special prefix: SX0GC was SV0GC from Athens, X05FX was VE5FX, ZS66A00 is usually simply ZS6 and 9X1BE is presumably usually 9X5BE. The latter station called me in the middle of a European pile-up on 80 metres and it took me quite a long time to realise that it was a 9X1

rather than 9H1! Apart from ourselves operating with a GB callsign, several other British groups took advantage of the possibility: Al Slater, G3FXB, one of Britain's top contest operators, was operating as GB2FXB; the Aston University club, G3UOA, used their usual WPX callsign of GB8AU, and GB8PX was used by a group from Dumfries and Galloway.

Expedition Activity

A contest group from Lancashire went on an expedition to the island of Colonsay in the Inner Hebrides and operated as GB5CO. Other expeditions included the very rare country of Niger, where TU4BR/5U7 was a very strong signal on 10, 15 and 20 metres and possibly may have broken some WPX contest records from Africa. Walt, DJ6QT, can usually be relied upon to turn up from somewhere interesting in WPX contests (in the 1987 contest he was operating from Sierra Leone, 9L) - this year he went to Monaco and was a good signal even on 160 metres as 3A/DJ6QT. Another big signal on 160 metres was VE1ZZ, while on 80 metres several Caribbean stations, such as FM5CL and 6Y5IC, were quite easy to work. ZL2BT and ZL3GQ were also worked on 80 metres, as well as several more on 40m.

The final tally of QSOs made by GB4CDX in the contest was a little short of 2200, after duplicates had been removed, which, with 640 prefix multipliers, gave us a final score of over 3,100,000 points. This is not particularly brilliant, though as I have said, conditions were not all that marvellous, at least in north-west Europe; but it is probably enough to give us the first place multi-single station in Britain. No doubt there will be quite a few in Europe with much higher scores. I am acting as the QSL manager for GB4CDX, so if any reader either worked or heard us, I would be pleased to reply to your QSL requests but please enclose an sae.

Simple Aerials

What about those of you that do not have the possibilities to put up a 90 foot tower with large beam antennas? Do not despair. Con-

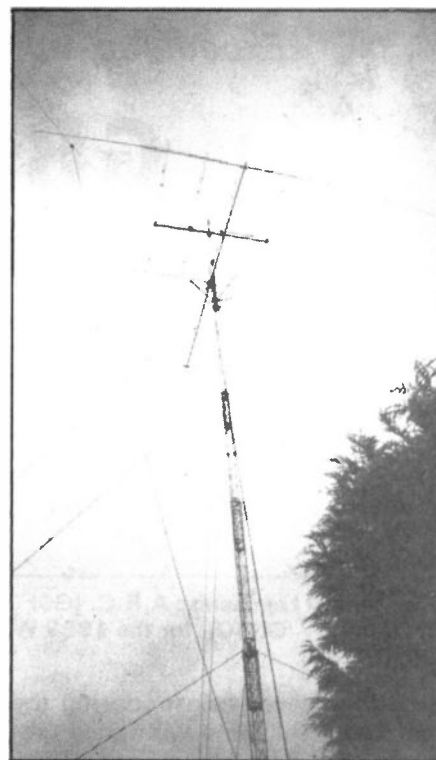

Antennas at GB4CDX: top of tower a 4-ele beam for 10-20m, below that a 3-ele for 40m. At the top left can be seen one of the five 80m sloping dipoles.

ditions have been so good during the last couple of months or so, and there have been so many DXpeditions and other operations taking place that has been enough to go round for everyone. At present, I only have two antennas at my home QTH: a 40 metre quarter-wave vertical (basically a 32 foot length of aluminium tubing held up with three guy strings) and a 20 metre half-wave dipole. The 40m vertical also works well as a three-quarter wave on 15m, with an almost perfect SWR over the whole band. I have about a dozen radials, some 30 feet long, others longer (I do not believe that the length is critical) which really makes a difference. When I mowed the lawn this week, I rolled up the radials and forgot to stretch them out again afterwards. When I next went on 15m, the band appeared to be dead, although the SWR on transmit was still 1:1. I then remembered the radials, pulled them out and almost immediately worked a couple of Indonesian stations at 59 each way. The 20 metre dipole is only some ten feet high at present and although it works very well around Europe, I will be the first to admit that it is definitely not an effective DX

LAT
56° 3' N

Expedition to Colonsay Island
CQ WPX CONTEST 1988

LONG
6° 12' W



GB5CO
SCOTLAND



IOTA EU 08 WAB NR 39 LOC IO 66 VB

TO RADIO	DATE	GMT	Mhz	RST	MODE
GB4CDX	27 Mar. 1988	1936	3.7	59	CW SSB

73 DE OP PHIL G4OBK CHRIS GOEJK

The Central Lancashire A.R.C. (G0FDX) organised a DXpedition to the island of Colonsay. GB5CO, for the 1988 WPX SSB contest. Operators were G4OBK and GOEJK.

antenna. Nevertheless, during the last few weeks and with good propagation to help, I have been able to work CE0ICD on Juan Fernandez Island in the Pacific (the one Robinson Crusoe was meant to have been stranded on), SORASD in the Western Sahara, A92BE, Don, an Englishman in Bahrain, C18CPU on Cornwallis Island in the Arctic regions of Canada, EX0QCG in the Arctic regions of the USSR, and VK9XT on Christmas Island. All these stations were worked on the 20 metre dipole about 10 feet high, so there is plenty of DX about, even for those stations who do not have massive antenna systems at their disposal.

Mauritius & W Sahara

Another station I have been lucky enough to contact recently was 3B9FR on Rodriguez Island, a dependency of Mauritius. This was interesting because for some considerable time in the Mauritian authorities had put a ban on amateur radio operations from anywhere other than the main island of Mauritius. With 3B9FR back on the air again, it may not be too long before the possibility of an operation from the very rare 3B6 or 3B7 (St Brandon Island - Cargados Carajos). These tiny islands in the Indian Ocean are another dependency of Mauritius, but are sufficiently far away from the main island to be counted separately for DXCC.

Western Sahara soon for a further operation.

Christmas & Locos Keeling Islands

Earlier I mentioned VK9XT on Christmas Island (this is the one in the Indian Ocean, not the one in the Pacific where the A-bomb tests were carried out and which is now more properly called Kiritimati). The operator, Scotty, W7SW, has been heard almost every afternoon/evening during May on 14200 working Europeans. Despite the large pile-ups (and my poor antenna on 20 metres) it was just a matter of perseverance to get through, as he was working split frequency, which helps, and very quickly. Scotty is on Christmas Island with George, a Greek-Australian with a novice callsign, VK6NKG, though whilst on Christmas Island, George has been using the call AX9NKG. The Australian novice licence gives the holder authority to operate SSB, 30 watts pep, in parts of the 10 and 15 metre bands. Prior to their arrival on Christmas Island, Scotty and George were active for three weeks from the Cocos Keeling Islands, using the calls VK9YT and VK9NKG respectively. I spoke to George a day or two before they left Cocos Keeling and he told me that between them they had made over 23000 QSOs, with George contributing 10000 in the SSB Australian novice

The Western Saharan club station, SORASD, which was established in October last year and has been mentioned in "QRZ" before, continues to be activated by the local Saharouis operators. I have worked them with ease on 20 and 40 metres. It has recently been announced that S0 will now count as a separate DXCC country too, so look out for this station. As if to celebrate the granting of separate country status, three members of the Lynx DX Club in Spain (the club which mounted the initial expedition there) will be returning to the

ZONE 29 **VK9YC**

LAT. 12° 07'

LONG. 96° 54'

SCALE km

COCOS
(KEELING)
INDIAN OCEAN

ISLANDS

OCEANIA HOUSE
HOME ISLAND
COCOS (KEELING) ISLANDS
INDIAN OCEAN

W7SW and VK6NKG made over 23000 contacts from VK7YC's QTH in the Cocos Keeling Island in April and May this year.

sub-bands of 10 and 15 metres alone. On Cocos Keeling, they stayed at the historical family home of the Clunies-Ross family, which is being let out to DXpeditioners by Cres, VK9YC, who is related to the family.

My Hols!

I met Cres at the NEC in Birmingham a couple of years ago and he invited me to stay there too, so in October this year I hope to be active from the Cocos Keeling Islands myself. I have applied for the call-sign VK9YG and so hope to be using this, or possibly also AX9YG, between 18th October and 1st November. The keen contest operators among you will notice that this period has been carefully chosen to include the big one, the CQ World Wide DX contest, the SSB leg of which this year is held over the weekend of 29th-30th October. At the operating site, apart from a transceiver and linear supplied, are two towers, one 60 feet and the other 70 feet high. These have two log-periodic beams for 10-15-20 metres, and there are wire antennas for 40-80-160 metres. Since my wife is coming along too, this will be for me primarily a holiday, with some radio thrown in. I have already had permission to operate for the whole of the contest, but before that it will be when it can be fitted in between the busy schedule of snorkling, eating, drinking and generally lazing around (there is not much else to do there!). I hope to give more details of my trip in the next "QRZ", by which time, hopefully, the callsign and other details will be more definite.

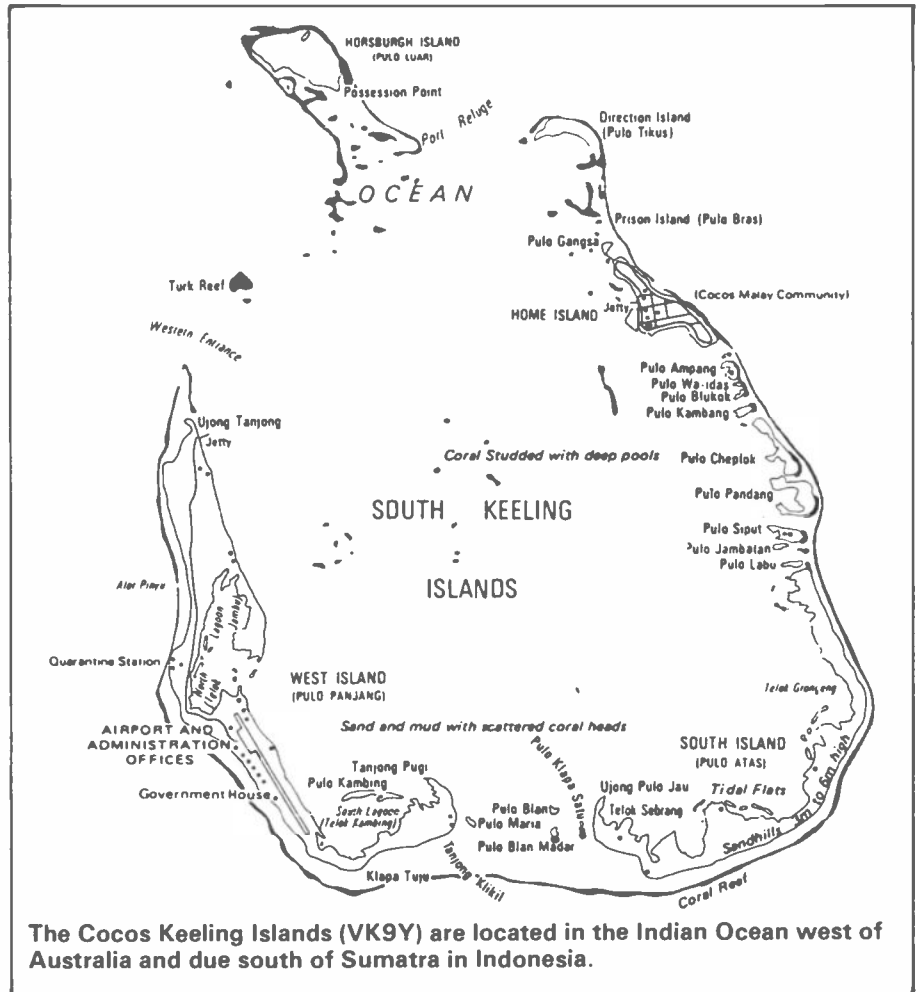

Reader Report

It was good to hear from Guy Dean in Ringwood, Hampshire again. He has been putting his Icom R71E to good use and heard JY1 (H.M. King Hussein I of Jordan) on 14224kHz at 2138 GMT one evening. Good to hear that H.M. has been active once again. Has anyone ever heard King Hassan of Morocco, who is reported to also be a radio amateur, or King Juan Carlos of Spain, EA0JC? Guy also reports some very good openings on 10m at the beginning of May, with just about every country in South America reported, as well as J2, ZS6 and 6W7 in Africa.

For those of you who cannot work the very rare DX, there have been a tremendous number of operations to various islands recently, which are always interesting to "chase". Apart from all the very rare islands I have mentioned already, FV8NDX/P has been active from Les Sept Iles, off the north coast of France, and TV60LE from Oleron, off the west coast. SVOGC/

8 has been turning up on various Greek islands: I worked him on Mykonos, but he has also been on from Khios and others. Staying in that area, SV9ANK was apparently an expedition to Crete, and a bit closer to home, GBOIOS was on from Sark in the Channel Islands. I have recently received a QSL from J56AS, who was active from a small island off the coast of Guinea-Bissau, West Africa, as well as cards from TZ6VV, TU4BR/5U7, ZD8MG and YBOWR. The latter station has a 4 element rotatable beam for 80, yes, 80 metres as well as two, yes, two separate 40 metre beams. This is not to mention what he has for the higher bands. With a set-up like that, it is not necessary to have big antennas to work him; his antennas do all the work!

As always, I would be pleased to hear from readers about what you have been working or hearing on the DX front. Photos would be especially welcomed. The address is Steve Telenius-Lowe, G4JVG, "Penworth", Tokers Green Lane, Tokers Green, Reading, RG4 9EB.

Radio Propagation and The Sun Part 2

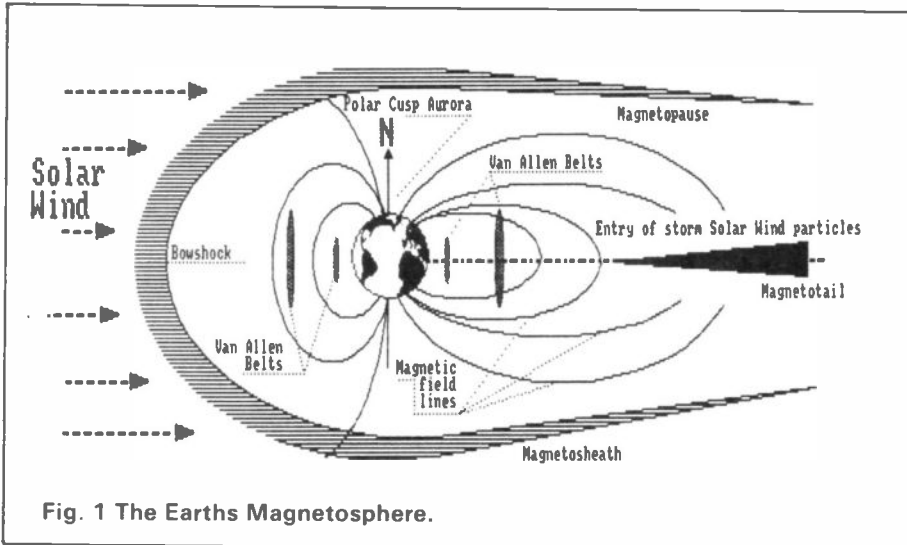

Fig. 1 The Earth's Magnetosphere.

In the last article we looked at the processes at work on and within the Sun. How the differential rotation of the Sun induced lines of magnetic force under the photosphere, and how these lines were twisted and

craft haven't travelled much beyond Neptune.

Its existence was first suspected during the early 1950's by astronomers studying the tails of comets: which always point away

were no magnetic field travelling with the solar wind, then the Earth's field would exhibit the text book structure of a bar magnet instead of the tear drop shape in Fig. 1.

To summarise then, the solar wind is a continuation of the Sun's outer atmosphere, extending beyond the orbit of Neptune. It comprises equal parts of electrons and protons (plasma) and has a magnetic field. It is continuously streaming away from the Sun, ebbing and flowing, its intensity and speed dependent on activity upon the solar surface, and the sunspot cycle.

Back to Sunspots

You will remember from part one that a sunspot can only exist whilst the cyclic exchange of material, along the magnetic field lines from penumbra to umbra, is allowed to continue. Occasionally, surges from a sunspot group will blast our solar material, which will flow along a magnetic flux tube, up into the chromosphere, and join on to another spot making a bipolar group as can be seen in Fig. 3a.

These huge arcs of glowing hydrogen gas are called Quiescent Prominences. They attain altitudes of tens of thousands of miles, persisting for weeks or even months, and are most frequent around two years after sunspot minimum. They appear in increasingly higher solar latitudes until, at sunspot maximum, they collect around the Sun's north and south polar regions.

An Active Prominence (Fig. 3b) is a more violent eruption from the area of sunspot groups, but has a much shorter life than a quiescent prominence, lasting literally only minutes. Active Prominences shoot solar material high into the corona, where it has an interesting effect. The material blasted up from the Sun's surface is of a higher density than coronal material, but at the same time has a lower temperature

This month Kevin Fox, G4MDQ, looks at flares and prominences and has a touch of solar wind. So how do these phenomena affect the radio propagating layers? Read on!

kinked by granules rising through the Convective Zone, until they burst through the surface to make a pore. The pore then developed into a sunspot. We also examined the life cycle of a sunspot.

The driving force of radio propagation is the solar wind, and this month we will be looking at this phenomenon, from its generation through to its arrival in the Earth's upper atmosphere. So what exactly is the solar wind?

The Solar Wind

The solar wind is a stream of plasma (see Fig. 1) which originates from within the corona of the Sun, and extends outwards past the orbit of Neptune. As yet we have no precise data on exactly where the solar wind ends, because space-

from the Sun (Fig. 2) due to the 'pressure' of the solar wind, rather like a solar windsock! It has since been confirmed by many spacecraft missions which have measured it directly, eg. *Mariner 2* in 1962 and the ill-fated *SkyLab* in the 1970s.

Extremely high temperatures in the solar corona (5,000,000°C) separates atoms into their component positive and negative atomic particles ie. electrons and protons. These atomic particles are carried away from the Sun in a plasma wave speeding past the Earth at an average of one million four hundred and forty thousand miles per hour!

Along with the solar wind and inseparable from it, travels a magnetic field which spirals out from the Sun, twisted by the plasma wave and the Sun's rotation. If there

which produces a local cooling in the corona, allowing the formation of a 'coronal hole'. We'll return to coronal holes later.

Flares

Finally, the most violent of solar eruptions are Flares. These are active prominences which have really gone berserk. Material is ejected with such force that it can exceed the Sun's escape velocity (Fig. 3c) punching its way through the corona and out into space. Caused by massive magnetic upheavals around a sunspot group, solar flares emit energy at radio frequencies, ranging from millimetric to kilometric wavelengths, together with extremely large amounts of ultra-violet and high energy particles, such as X-rays and even gamma rays. The radiant energy released in a typical solar flare is the equivalent of ten billion one megaton nuclear bombs!

These particles travel away from the Sun with energy levels of billions of electron volts, and at speeds of up to half the speed of light: three hundred and thirty-four million, eight hundred thousand miles per hour! As you might imagine such an environment would be lethal to organic structure which was out side the protective shell of mother Earth's atmosphere. Thirty minutes after ejection these high energy particles arrive at the Earth.

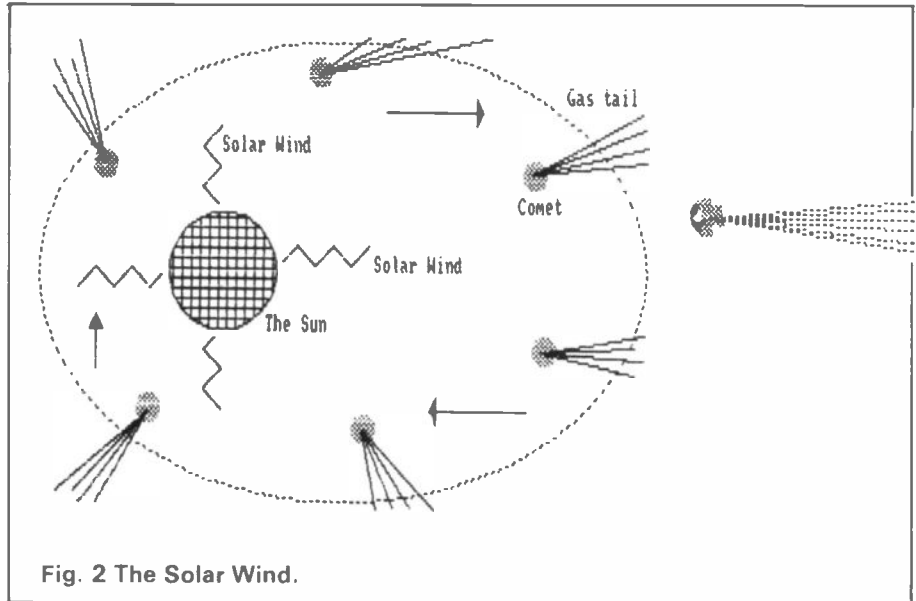

Fig. 2 The Solar Wind.

After a few hours, lower energy particles begin to arrive, slower because their energy level is down to millions of electron volts.

Then equally, one to two days after the eruption of the flare, the slowest particles arrive, bringing geomagnetic storms. These then are the generating forces of the solar wind. We've followed them from generation to arrival at the top of the Earth's atmosphere. Let's now examine the effect of the solar wind on the ionosphere.

The near-Earth environment

It's worthwhile taking time to briefly look at the near-Earth en-

vironment, as this plays a vital function in absorbing and deflecting the solar wind. If you look again at Fig. 1, the Earth's magnetosphere, you will see two belts encircling the Earth. These are the Van Allen belts, or zones, James Van Allen proposed their existence by analysing data from the *Explorer 1* space craft in 1958. They consist of two layers, (see Fig. 4) the lower being located six hundred to three thousand miles above the equator, and the upper zone nine to fifteen thousand miles above.

Each of the Van Allen belts act as sponges, soaking up charged particles contained in the solar wind and trapping them. These particles then oscillate backwards and forwards within the belts, from magnetic pole to pole. Earth's Van Allen belts make up an extremely hazardous environment, especially for Earth orbiting spacecraft which must avoid these regions if they don't want their computers to develop amnesia! To continue with our sponge analogy, the sponge is always full. Any increase in radiation from the Sun hits the Van Allen belts and causes them to leak particles out into the Earth's magnetic field were they are then guided up around the poles, causing auroral displays, and enhance/destroy radio propagation.

Aurorae

Aurorae are spectacular polar light shows which occur between fifty to one hundred and fifty miles above the surface of the Earth. Slight increases in the solar wind

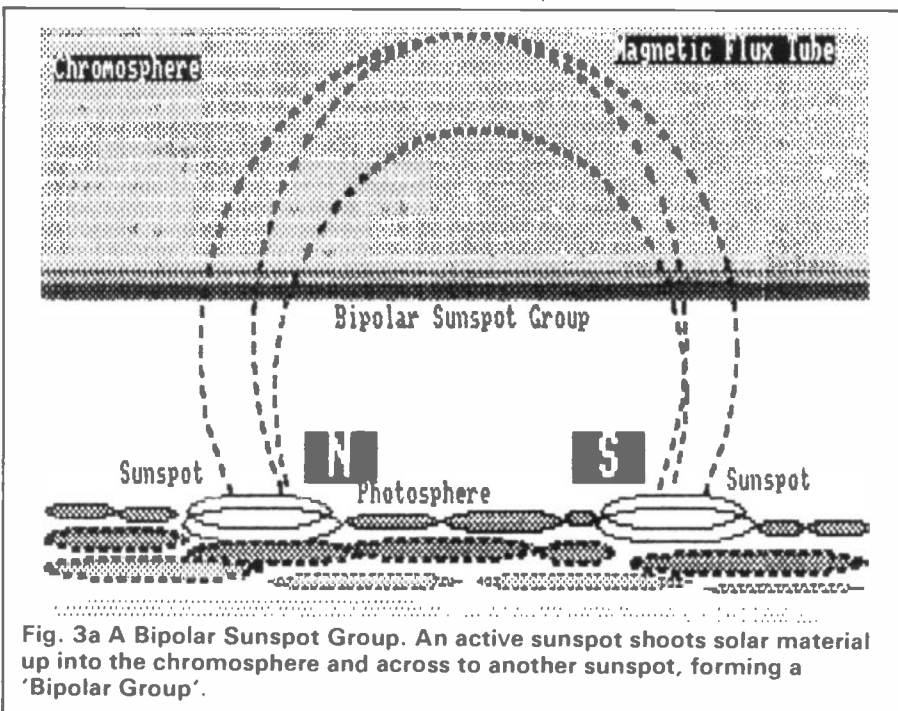

Fig. 3a A Bipolar Sunspot Group. An active sunspot shoots solar material up into the chromosphere and across to another sunspot, forming a 'Bipolar Group'.

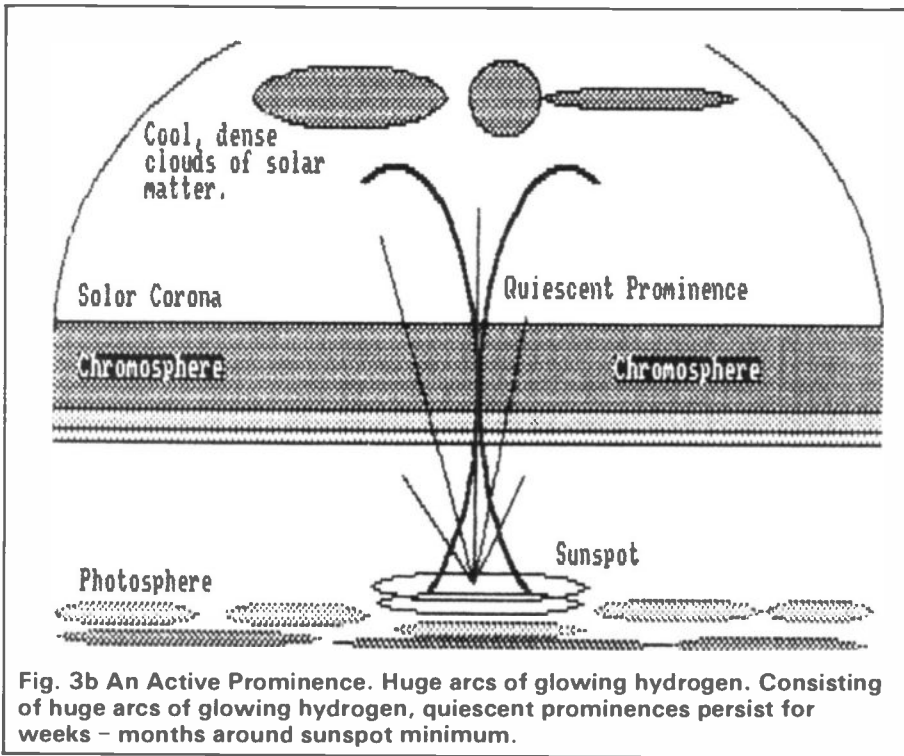

Fig. 3b An Active Prominence. Huge arcs of glowing hydrogen. Consisting of huge arcs of glowing hydrogen, quiescent prominences persist for weeks - months around sunspot minimum.

causes a steady trickle of charged particles to leak from the Van Allen belts, which are then attracted to the Earth's magnetic field lines, which cross the boundary of the magnetopause. These charged particles then follow the field lines and arrive at the polar regions. This gives rise to what is known as Polar Cusp aurorae, which is a low activity aurora not visible from temperate latitudes, eg. most of the UK, but is capable of enhancing VHF propagation.

Polar cusp aurorae form two oval haloes around the magnetic poles, extending from 20° of latitude on the sunlit side of the Earth, to 30° of latitude on the night side. The Earth rotates beneath these haloes and during really intense solar storms, aurora will be much more active,

spreading towards equatorial regions. In fact, although rare, visible aurorae have been seen in equatorial countries. Interestingly, the visible aurorae at the southern pole is a perfect mirror image of the northern aurorae.

Solar prominences, flares, etc, produces a more violent increase in the solar wind which, on arriving at Earth, is deflected by the bow shock of the magnetosphere, around to the magnetotail. The charged particles cluster around the magnetotail, building up stress until the field lines snap, releasing huge amounts of charged particles which slam into the Van Allen belts and then flood the upper atmosphere. Once these energetic charged particles meet the Earth's atmosphere they begin to ionise the

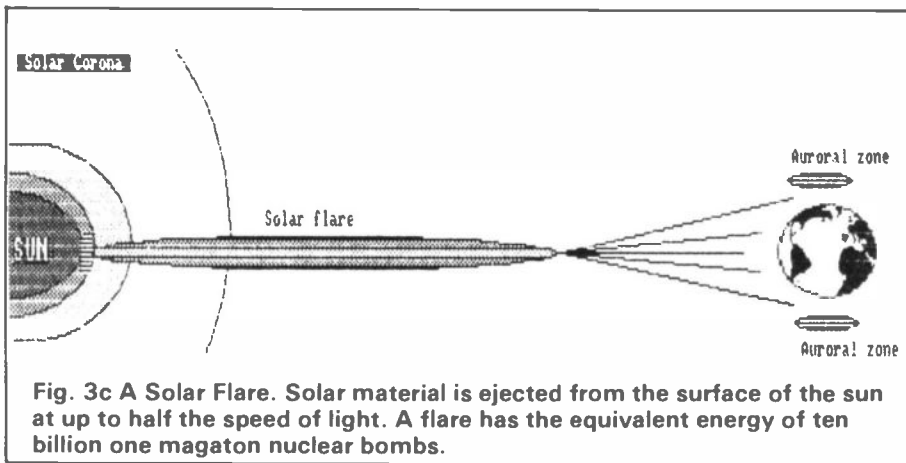

Fig. 3c A Solar Flare. Solar material is ejected from the surface of the sun at up to half the speed of light. A flare has the equivalent energy of ten billion one magaton nuclear bombs.

oxygen and nitrogen, producing the familiar ghostly glows of green and red.

Amateur Use

This ionisation process also has an interesting effect which is of use to us amateurs! A 'mirror' of ionised gas develops at the base of the auroral form, in the E layer at a height of seventy miles. This enables radio transmissions in the VHF spectrum to be greatly extended from their average, non-auroral range of approximately forty miles, to over a thousand miles.

Two amateurs living within similar geomagnetic latitudes can communicate with each other, by both pointing their beams at the aurora, eg. Scottish stations wanting to work England via aurora, point their beams north. Aurora is a field aligned phenomena, and by judicious 'sniffing' around with the aerials, you can sense the alignment, and obtain maximum use of the aurora.

However, not every aurora produces enhanced VHF coverage, neither is it easy to say that the more intense the solar disturbance, the better the radio aurora. Radio auroras have suddenly appeared with little or no sign of a visible display, and vice versa. By the way, aurorae are the kiss of death to HF operators; swings and roundabouts, I'm afraid!

Predicting aurorae is never easy. You can obviously make use of solar data predictions, but this does take time to achieve a level of acceptable competence. There are auroral early warning circuits in operation, usually run by amateurs and I make use of a friend who lives in Scotland. One simple method is to keep northern VHF beacons, such as GB3LER in your rig's memories, and monitor them for auroral qualities. If you've never heard a radio aurora, listen for a dry, rasping tone to CW transmissions, or a ghostly throaty growl, like someone with a sore throat, on SSB signals.

Remember the Sun's rotation? If you come across a radio aurora, make a careful note of the time and the date. The Sun rotates once every twenty-seven days, and on the surface of the Sun is the flare which caused the increase in the solar wind, or the coronal hole. Providing the sunspot group

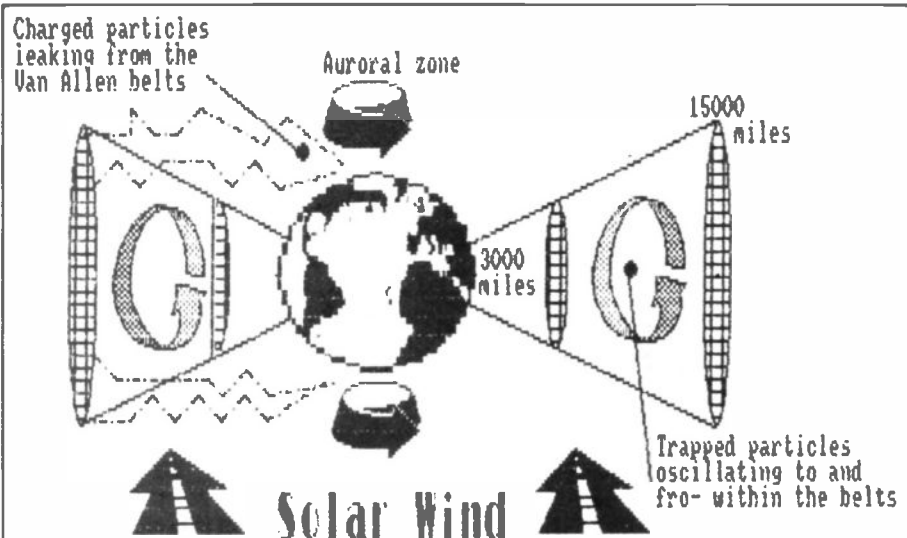

Fig. 4 The Van Allen Belts. At heights of between 600 and 3000 miles and 9 to 15000 miles the two belts trap charged particles from the solar wind. There is a steady trickle of particles from the belts, but in storm conditions this turns into a flood.

associated with the flare persists, it will survive for another solar rotation, and in approximately twenty-seven days will repeat the aurora. But the times are not exact, so be sure to listen a couple of days before and after the due date. Fig. 5 demonstrates this concept more adeptly than words!

Coronal Holes

As explained earlier, a hole in the 'skin' of the corona, which to some extent controls the flow of the solar wind, allows charged particles to escape at high speeds, and if the Earth is in line with the coronal hole, the particles will arrive in the Earth's upper atmosphere, causing an aurora. Coronal holes appear around the Sun's polar regions during sunspot minimum, but are almost unknown there during sunspot maximum. Enhanced E layer conditions are also partly attributable to coronal hole solar discharges.

Observing an Aurora

The further north you live, then the more chances you will have to observe aurorae. First, find yourself a 'dark sky' site, eg. well away from the sodium/mercury vapour street lighting which seems to be everywhere these days. Aim to be at your observing site about 2100 UTC because the 'peak viewing' time for aurorae occurs at 'geomagnetic midnight', which is 2200 UTC in the UK. After allowing your eyes to adjust to the darkness and

assuming that there actually is an aurora in progress you should see a lightening of the northern sky.

How high up in the northern skies the aurora appears will depend on the latitude of your observing site. The further north — the higher the aurora. What you seek will greatly depend on the state of excitement of the gases in the ionosphere. Low level aurora are sometimes completely overlooked although an 'average' aurora should produce some coloured lights, which can be seen glowing faintly in the northern sky.

It is during the bigger solar storms that the northern light show is at its best. Look for arcs, bands or rays of faint red green, or blue tinged light, which may be static, or slowly twisting and moving sideways. Do not expect vivid and brilliant colours zipping across the sky; you'll be very disappointed! An auroral display consists of shifting, swirling rods of ethereal light performing a ghostly celestial ballet — all in absolute silence and quite breathtaking.

Aurorae also produce effects upon the surface of the Earth, such as erratic performance of magnetic compasses. Localised weakening of the Earth's magnetic field can be detected on the surface using sensitive magnetometers. In 1982 the *Marecs B* navigation satellite was 'zapped' temporarily by one and aurorae also induce ground currents in the Earth which causes large power surges in the electricity grid systems of northern latitude countries, they have even caused erosion in the Alaskan oil pipeline!

Listen to the Wind

It's all very well to have people tell you about the solar wind, or even to read about it, but this still keeps the phenomena one step removed from your personal experience. It comes into the realm of 'that's really interesting. What's for tea?' The Sun emits a wide range of

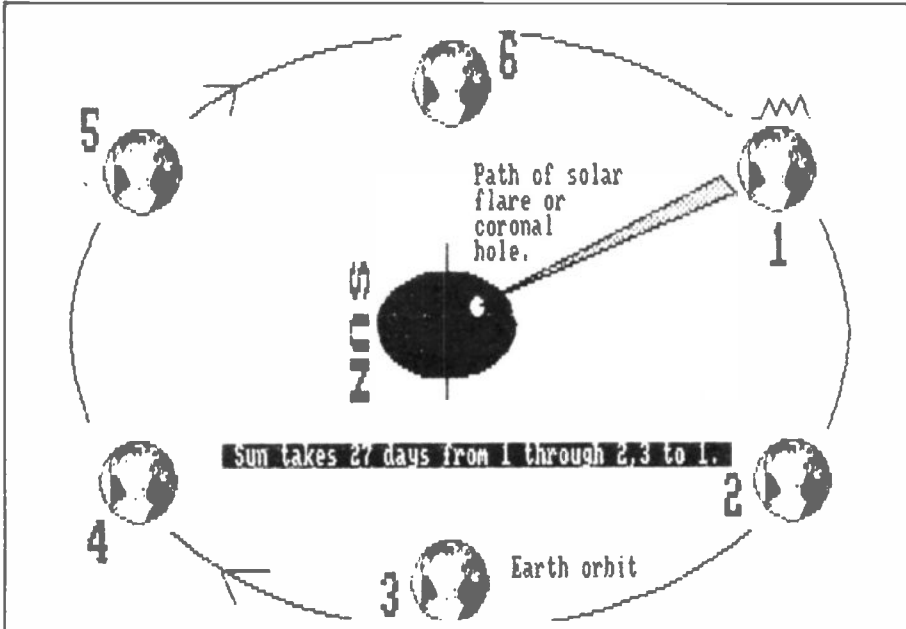

Fig. 5 Auroral Repeats. With the sun and the earth at position 1, the solar flare and the coronal hole are lined up. Due to the sun's motion this alignment will occur every 27 days.



and develop an expert ear, it's important to listen at the right times. Next time you have definite knowledge of an aurora, pop down to the HF bands and listen.

Background Noise

You will probably hear the background white noise, overlaid with various odds and end of man-made noises. But, superimposed on top of this will be the wail of the solar wind. I'll try to describe it, but once you've heard it and identified it for yourself, you'll always be able to recognise it again, and impress your family and friends with off-the-cuff remarks like. "Hmm! a nice solar storm brewing up". Or "Must get this receiver fixed!"

To me, listening on forty metres, the solar wind sounds like waves crashing on the sea shore, except that the rising and receding noises are more like tearing material, than the more melodious sound of moving water. On ten metres (28MHz) the background noises are much quieter than the LF bands. The solar wind produces an

increase in white noise, rather than overlaying a new sound. The familiar 'frying bacon' noises suddenly swell to a small crescendo, maintain the peak and then fade down to the background level. This makes identification a little more difficult, but again, once heard, always remembered.

Auroral ionisation tends to build slowly, effecting the LF bands first. Occasionally, CW and SSB signals on ten metres can exhibit auroral characteristics, giving pre-warning of enhanced VHF conditions, but the aurora can peter out before it reaches VHF. In any case, what chance have you got of hearing CW or SSB on ten in these lean years? Another aid to predicting aurora using an HF receiver is the total absence of any sound! This is usually due to an intense magnetic storm which is ionising the D layer, wiping out all LF signals.

In Part Three, next month, we'll be examining the effect of the solar wind on the ionospheric layers, enhanced propagation conditions at HF and VHF, and some info for meteor scatter buffs.

energy, and a lot of it lies in the radio frequency part of the spectrum. Sometimes to much!

It is possible to listen to these solar radio emissions. As an amateur, you'll probably already have a communications receiver of some sort. It may surprise you to know this, but you've already got everything you need to listen to the solar wind. Chances are, that you'll already have heard it many times, but never recognised it for what it is. Solar noise can be heard within most amateur bands on HF, but is particularly obvious on the LF bands and ten metres. To gain experience,



SPECTRUM COMMUNICATIONS

MANUFACTURERS OF RADIO EQUIPMENT AND KITS

4 and 6m EQUIPMENT

RECEIVE CONVERTERS 4 or 6m antenna input, 10 or 2m i.f., variable gain 0-26dB, n.f. less than 3.5dB. Buffered local oscillator output, types RC4-10, RC4-2, RC6-10 and RC6-2. PCB kit £17.25, PCB built and tested £24.50, boxed kit £29.25, boxed, built and tested £41.00.

TRANSMIT CONVERTERS 4 or 6m variable power 80mW to 2.5W, 2m or 10m drive 10mW to 100mW. Local oscillator input matches receive converters. Types TC4-10H, TC4-2H, TC6-10H, TC6-2H. PCB kit £27.50, PCB built and tested £37.75. Boxed kit £39.50, boxed, built and tested £53.00.

TRANSCEIVE CONVERTERS. Single board version of receive converter and 500mW transmit converter. 10m drive 25mW to 500mW. Types TRC4-10 and TRC6-10. PCB kit £39.00, PCB built and tested £54.00, boxed kit £54.00, boxed, built and tested £83.25.

TRANSCEIVE CONVERTERS. Separate receive converter and 2.5W transmit converter in a single boxed unit, 2m or 10m drive 10mW to 100mW only, requires r.f. sensing switch and attenuator for use with 2.5W sm rigs. Types TRX4-10H, TRX4-2H, TRX6-10H and TRX6-2H. Boxed kit £60.00, boxed and built £99.50.

TRANSCEIVE CONVERTERS As above but including an interface providing RF sensing attenuation and PTT switching. 1/2W-5W 2M drive. Types TRX4-2i and TRX6-2i. Boxed kit £68.00, boxed and built £115.00.

RECEIVE PREAMPS

2, 4, 6, or 10 metres RF switched and DC sensing, 100W transmit handling power, gain 0-20dB adjustable by panel control, NF 1dB on 2M, 2dB on 4 & 6M, 3.5dB on 10M, 13.5V negative ground operation. Excellent performance at a reasonable price. Well made attractive boxed unit 77 x 70 x 39mm, an asset to any Ham shack. Types RP2S, RP4S, RP6S, & RP10S. PCB KIT £14.75, PCB BUILT £22.25, BOXED KIT £25, BOXED BUILT & TESTED £35.50.



SEE
YOU
AT
NEC

VAT & p&p inc. prices. Delivery within 14 days subject to availability. 24 hour answering service.

FM CONVERSIONS

FOR YAESU & KENWOOD TRANSCEIVERS
FD311X & FM2000 for FT101, 101B, 101E, 101Z, 101ZD, 901, 902, 107, 107M, 77S, 77, 707, 200, 250, 7B, all £71.
FD311X & FM3000 for TS120V, 120S, 130V, 130S, 520, 520SE, 530, 830, 930, all £81.

State rig type when ordering.

CB to 10m

**CB TO 10 FM CONVERSION BOARDS - THE FIRST COMMERCIAL-
LY AVAILABLE,** suits all UK FM CB rigs to give 29.31 to 29.70MHz. Size only 63 x 40 x 13mm. Built and aligned board SC29 £18.50. Or send your rig and we'll fit it. £31.50 inc. return P&P for mobiles. £35 inc. for base rigs.

MULTIMODE CB CONVERSIONS, send your 120 channel rig and we'll convert it to give 28.01 to 29.70MHz in straight sequences without gaps. Colt 1200DX, Cobra 148, Hy Gain 5, Multimode 2, Major M360, Tristar 747 & 777, Super Star 360, Concorde, etc. £62 inc. return P&P. Jumbo or Colt Excalibur 1200, £65. 80 Channel rigs such as Stalker 9 or Major M588 are modified to give 28.31 to 29.70MHz in straight sequence without gaps, £55.00 inc. return P&P. 200 Channel in 4 bands of 50 are converted to give 28.00 to 30.00MHz or 28.00 to 29.70MHz as required. Super Hy Gain 5, Lafayette 1800, Super Star 2000, £45.00 inc. return P&P. Nato 2000 £52.50, Super Star 2000-5 x 40CH £70. Colt 1600, 4 x 40CH, £65.50.

SHOP TIMES: 9am-1pm & 2pm-5pm TUES.-FRI.
9am-1pm & 2pm-4pm SAT.
CLOSED SUNDAY & MONDAY.



UNIT B6 MARABOUT INDUSTRIAL ESTATE, DORCHESTER, DORSET. TEL: 0305 62250

Simple Crystal Tester

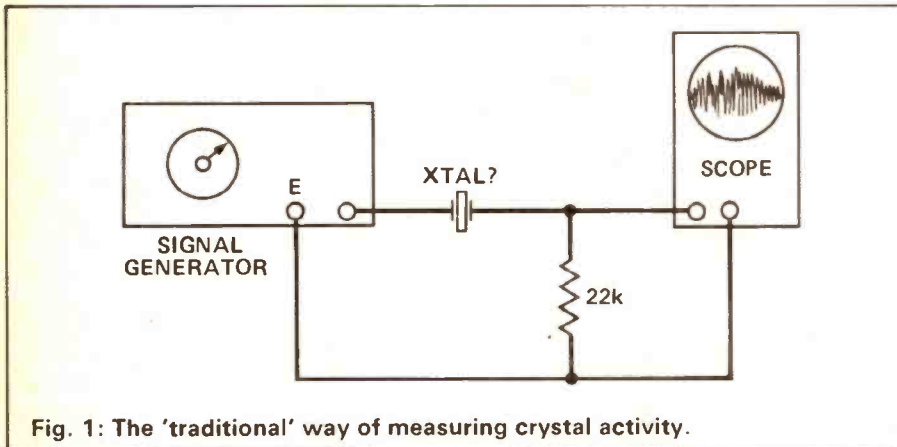

rubbed with sandpaper to remove the identity numbers. Even the crystal cases had been treated to remove any identity of the crystal frequencies. If only this information had been available then it might have been possible to discover the block schematic diagram of the set and consider if it would be feasible to convert the set for use on one of the amateur bands.

I decided that with nothing better to do that evening, I would rekindle my interest in the set. After all it had been collecting dust on the shelf for over a year now.

Mystery Crystals

The first task was to unsolder the crystals from the PCB and find some method of measuring their frequency. Various books kept were consulted to try and find a simple means of measuring the crystal frequencies and one of the books contained a circuit, Fig. 1, which required the use of a signal generator and oscilloscope. If the unknown crystal is connected between the output of the signal generator and the Y amplifier input of the oscilloscope, the amplitude of the signal displayed on the oscilloscope should give you the parallel and series resonant frequency of the crystal.

One dark and cold winter's evening I found myself sitting in the shack pondering what to do. Twenty metres was completely dead due to lack of sun spot activity. The sound

panel of an abandoned scrap transceiver. I could remember being attracted by the layout of the front panel which had coloured my judgement, and on impulse had parted

Crystal activity and operating frequency need no longer be Testing crystal activity and finding operating frequency need no longer be a problem with this pocket sized tester design from Roger Alban, GW3SPA.

of heavy rain could be heard lashing against the small shack window. The sound of some soap opera could be heard in the adjoining room where my wife could be found snug in an armchair close to the calor gas fire with one eye on her knitting, half an eye trained on the pages of a library book, the other half of the eye watching the television. What could one do to ease the boredom?

Boredom Sets In

My eyes scanned the shelves which lined three walls of the shack and contain various pieces of junk equipment which had been purchased at various rallies up and down the country. The light from the bare bulb, suspended by a thin cord from the centre of the ceiling, reflected on the plastic chrome front

with a crisp ten pound note to purchase the item.

I can also remember the disappointment on arriving home to find on removing the top cover that all the integrated circuits had been

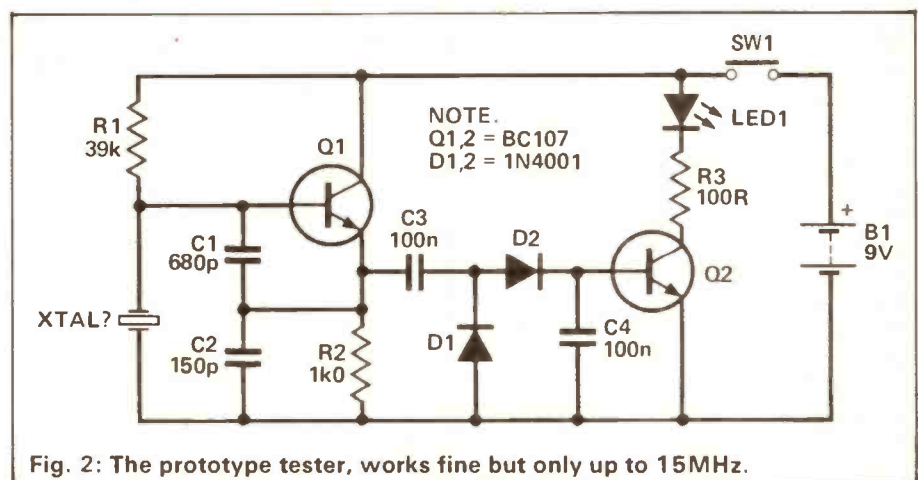

Fig. 2: The prototype tester, works fine but only up to 15MHz.

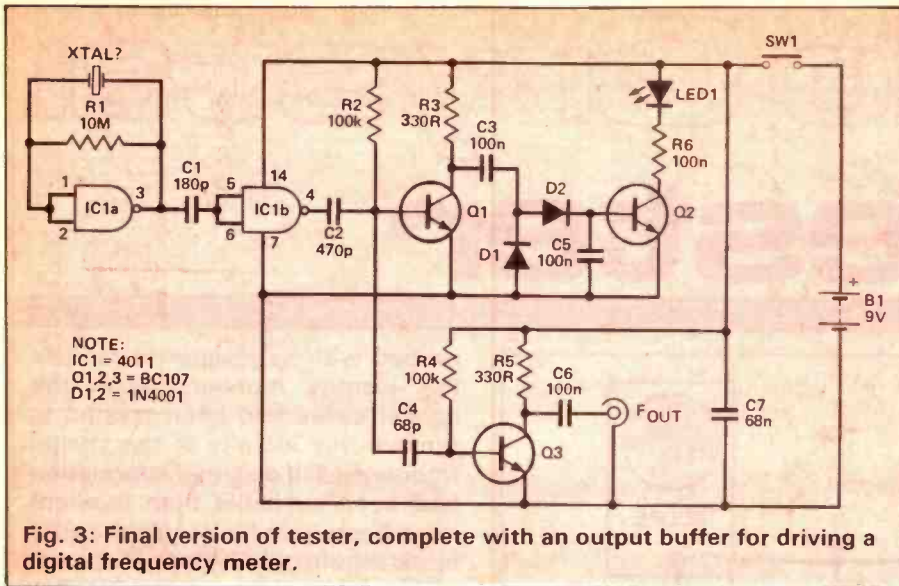

Fig. 3: Final version of tester, complete with an output buffer for driving a digital frequency meter.

The theory is that as the frequency of the signal generator is increased, the low impedance series resonance of the crystal can be observed on the oscilloscope by a rapid increase in the amplitude of the signal. This should be followed by a sharp dip in amplitude as the crystal goes into the high impedance parallel resonance. In practice however, you will find that the frequency tuning of the signal generator will not be good enough to be able to accurately observe the frequency at which parallel and series resonance occurs. Also, the change in Y amplitude may not be sufficient to be noticeable, personally I found this method of trying to accurately determine the crystal frequency rather hit and miss. What was really required was a portable self contained hand held device which could be used to determine the fundamental operating frequency of the crystal by the press of a single button. The problem is of course to find a suitable oscillator circuit which will oscillate happily from 100kHz up to 30MHz.

First Attempts

One of the circuits with which I first experimented is shown in Fig. 2, consisting of a Colpitts oscillator, feeding a voltage multiplier rectifier which in turn feeds the base of a DC amplifier with a LED in the collector lead. When an active crystal is inserted into the oscillator circuit, the oscillator will operate at the fundamental frequency of the crystal. The rectified output from the oscillator will cause the DC

amplifier to conduct which will then illuminate the LED diode. Unfortunately I discovered that the Colpitts oscillator using a fixed feedback network will only operate over a frequency range of 1MHz to 15MHz and as the frequency of the oscillator is increased, the output level will decrease to such a level that the LED will not light.

The restriction of oscillator frequency range is due to the fixed values of capacitance used in the feedback circuit. What is required to overcome this restriction, is an oscillator circuit where the crystal forms part of the feedback circuit.

Final Design

After playing around with a number of different circuit configurations, it was decided (for simplicity) to use CMOS logic in the oscillator circuitry. Fig. 3 shows the full circuit diagram. A 4011, quad 2-input NAND gate integrated circuit (IC1) is used as the heart of the oscillator. IC1a has the two input gates strapped together with the

crystal under test forming the feedback loop between the output and input. The output of IC1a is then coupled to the rest of the circuit via IC1b which acts as a buffer stage. Note that although the 4011 contains four gates, only two are used in this application. In order to protect the integrated circuit from being damaged, it is sound practice to ground the inputs of the unused gates, so pins 8, 9, 12 & 13 should be connected to the negative supply rail.

The output from IC1b is fed to the base of transistor Q1 which amplifies the signal before it is rectified by diodes D1 and D2. The resulting DC voltage is fed to the base of transistor Q2 which operates as a DC amplifier, when the DC voltage across C5 reaches approximately 0.6 volts transistor Q2 will conduct, illuminating the LED diode D3. A sample of the oscillator waveform reaching the base of transistor Q1 is taken (via C4) to the base of transistor Q3. This amplified signal is then used to drive an external frequency meter. A word of caution though. It is possible for the peak to peak voltage to approximately equal the value of the supply voltage of 9 volts, so care must be exercised when driving certain sensitive external frequency meters so as to avoid the catastrophic puff of black smoke as the delicate instrument is converted in milliseconds into a worthless lump of scrap metal! Many DFM's offer protected inputs but it is wise to be sure.

HF Crystals

In practice I found that the circuit performed well for crystals whose operating frequency varied between 1MHz up to 30MHz. This wide frequency range will cater for the majority of crystals which you

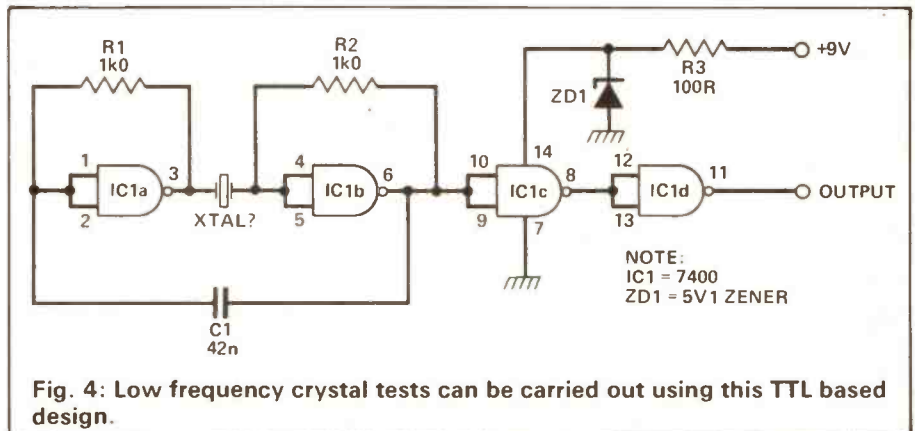

Fig. 4: Low frequency crystal tests can be carried out using this TTL based design.

are likely to encounter with amateur radio circuits but if you should need to test crystals operating below 1 MHz, then I would recommend that you construct the circuit shown in Fig. 4 which used a 7400 TTL integrated circuit. The supply voltage to the TTL logic is kept at 5 volts by the zener diode D1.

The CMOS circuit was built on Veroboard using the component layout shown in Fig. 5, the board is viewed from the component side. It is a good idea, when using CMOS chips, to use an IC holder, the 4001 should not be inserted into the holder until all the soldering has been completed and voltage checks carried out to verify that the wiring is correct.

Construction

The prototype was mounted inside an aluminium alloy die cast box measuring 114mm(L) x 64mm(W) x 30mm(H) such as Electromail stock number 509-939, but of course any suitable housing may be used. A 6.3mm diameter hole was drilled into the right hand side of the box to take the push switch and a 50 Ohm BNC socket is attached to the top side, with a 6.3mm diameter hole drilled into the bottom of the box. This takes a small grommet through which a twisted pair of wires pass, their ends being soldered to miniature crocodile clips which are connected to the crystal under test. Another 6.3mm diameter hole should be drilled into the lid of the box to take the holder for the LED diode and the box was sprayed white using a car aerosol. The lettering was completed using rub on transfers which were then protected by spraying with a clear lacquer.

The crystal checker was built some time ago and has accompanied me to many rallies. It is quite interesting to watch the expression on traders faces as you take the gadget out and begin to test their entire stock of crystals. It is surprising the number of second hand crystals that you will find which are no longer active due to a phenomenon called 'sleeping sickness'. It is also interesting to note the reaction of traders when you point out a faulty crystal, in one particular instance, the trader let me have it free of charge — the crystal that is! Later I managed to remove the case

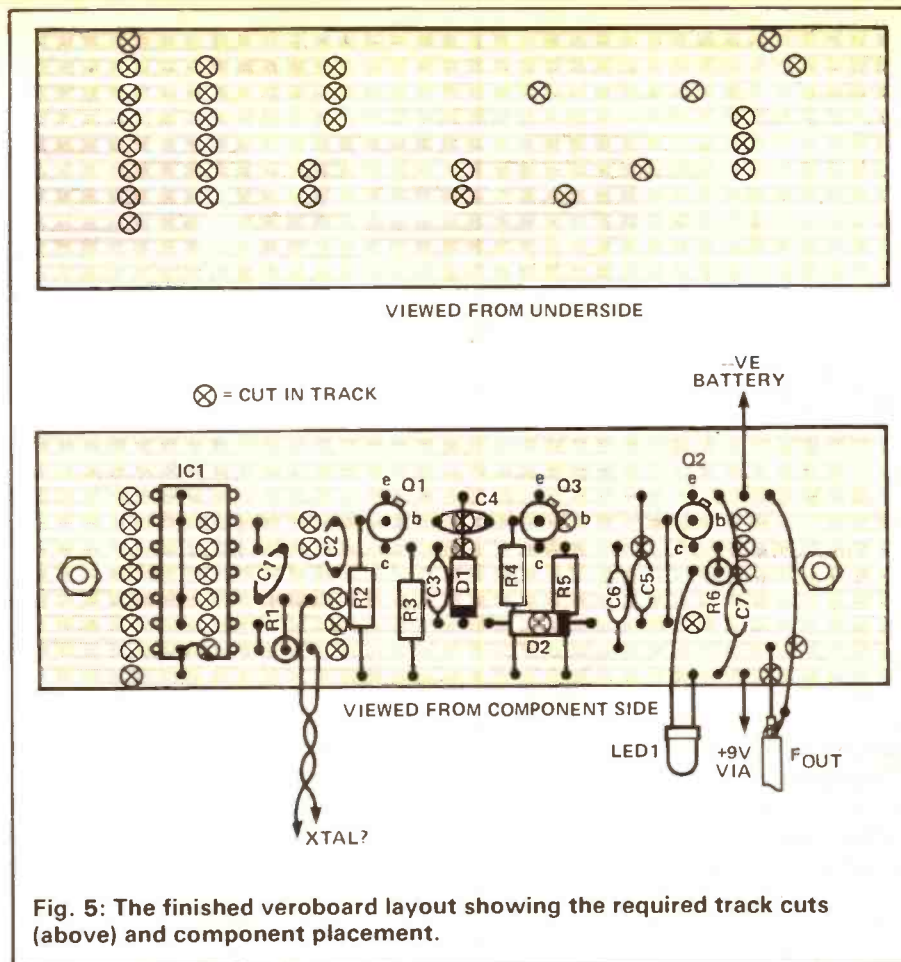

Fig. 5: The finished veroboard layout showing the required track cuts (above) and component placement.

Components List

For Fig. 2

RESISTORS

R1	39k
R2	1k
R3	100R
All resistors 1/4W, 5%	

CAPACITORS

C1	680p
C2	150p
C3, 4	100n

SEMICONDUCTORS

Q1,2	BC107
D1,2	1N4001
D3	Red LED

For Fig. 3

RESISTORS

R1	10M
R2,4	100k
R3,5	330R
R6	100R
All resistors 1/4W, 5%	

CAPACITORS

C1	180p
C2	470p
C3, 5, 6	100n
C4	68p
C7	68n

SEMICONDUCTORS

Q1, 2, 3	BC107
D1,2	1N4001
D3	Red LED
IC1	4011 CMOS

For Fig. 4

RESISTORS

R1, 2	1k
R3	100R

CAPACITORS

C1	42n
----	-----

SEMICONDUCTORS

D1	5V1 Zener
IC1	7400 TTL

to discover that the crystal wafer was shattered, probably as a result of been dropped. Another trader who was handed a faulty crystal, simply put it back in the box as soon as I walked away from the stall!

As for the project which prompted the project (!), I was able to use

the crystal checker to establish the crystal frequencies used in the transceiver, but to date the other secrets of the set await to be discovered. So if anybody has information on a CTVR-40 VHF FM transceiver....

Ten metre talkbox

REVIEW

As the sunspot cycle approaches another peak, activity on 10m is becoming more and more exciting, with world wide QSOs commonly

ing something different from their local 2m repeater on their drive into work. It certainly makes a change by talking to South African or Ameri-

Ten metres is alive and well – and getting better all the time. With this in mind we asked Chris Lorek, G4HCL, to take a look at the latest multimode monobander from Uniden.

taking place by amateurs using compact aerials and relatively low power. Mobile operation into the many USA 10m FM repeaters is possible, sometimes with cross-band links at the other end where the operator is walking down the street using a 2m portable into his local 2m-10m cross-band 'box'. 10m mobile aerials are readily available at around the same size and price as 2m whips, even fitting onto the same SO-239 socket for a quick 'band change'.

can stations on 10m FM!

Uniden have been in the radio business for some time now, they have recently become better known on the amateur market with the Uniden – Bearcat scanner receivers and the DX1000 HF receiver.

Features

The set is around the size of a 2m all-mode mobile rig, so it should fit most car dashboards. It offers LSB, USB, CW, FM and AM modes of operation and covers 28.0 – 30.0MHz in selectable 100Hz, 1kHz and 10kHz steps. The main tuning knob controls the operating frequency in the selected steps, a 'Span' button placing a cursor beneath the appropriate frequency digit corresponding to the selected step rate. The main knob allows continuous tuning across 28 – 30MHz, but to allow rapid frequency shifts this range is divided into four 'Bands' of 500kHz each,



In the past, mobile HF operation has brought up visions of large expensive sets on the passenger seat (they're normally too big to fit under a dashboard), together with conspicuous multiband whips that often need guy wires to the car's gutter to stop them swaying about. No wonder 10m with its compact aerial size is becoming more and more popular with amateurs seek-

Appearances can sometimes be deceptive, as their products are often made as 'Badge Engineered' sets to be sold under other names, even British Telecom sell their cordless telephone under the BT label! Following an invitation to visit their UK headquarters, yours truly was told that their latest offering for the amateur market was an all-mode 10m rig, to be used either as a 'stand alone' set or as a cost-effective 'driver' for 6m, 4m, 2m and 70cm transverters. Covering 28-30MHz it would be called, simply, the Uniden 2830, needless to say *HRT* were offered the first UK review sample!

being individually selected by repeated presses of the 'Band' button. Within each band range, the large fascia-mounted 'Channel' up/down buttons step the frequency up and down in 10kHz steps, this action being duplicated by microphone mounted up/down buttons. Each band range may be individually scanned for activity in 10kHz steps, the scan stopping when the all-mode squelch raises and continuing two seconds after the squelch closes.

A large backlit LCD (Liquid Crystal Display) gives a readout of the operating frequency to 100Hz together with a graduated bargraph

display of the relative level of receive signal. On transmit, this bargraph may be switched to indicate the relative RF output power, the level of transmit modulation, or the SWR (Standing Wave Ratio) present; the LCD also indicating which mode the display is in as well as giving a 'Tx' indication when in transmit mode. An RF power control allows you to continuously vary the CW/FM/AM transmit output power, and on receive an RIT (Receiver Incremental Tuning) knob is fitted to compensate for slightly off-frequency CW/SSB signals. Semi break-in CW Tx keying is provided, with a sidetone being produced from the internal speaker at a level, which can be adjusted internally.

For mobile operation, a switchable noise blanker is fitted to suppress ignition noise, and for night-time driving a 'Dim' facility allows you to reduce the brightness of the backlit LCD readout. For drivers of noisy vehicles a 'Mic. Gain' button gives a two-level mic gain control to get rid of some of the background noise whilst still allowing you to operate fixed station with a desk mic or whatever. For monster aerial users, a 'Loc/DX' button gives a two-level receive sensitivity control to help prevent blocking effects from the station down the road.

On the rear panel there are sockets for the aerial, 13.8V DC, CW key, and a multi-way accessory connector with external speaker and Tx keying lines. A large finned heatsink also on the rear panel provides for heat dissipation from the Tx PA. The set measures 185mm(W) x 63mm(H) x 250mm(D) overall, and weighs 1.85kg. It comes supplied with a fist mic and mic clip, fused DC power lead, mobile mounting bracket and mounting hardware, and user operating instructions.

On The Air

When first coupling the set up in my shack to a 13.8V DC supply and my outdoor multi-band trapped aerial I was pleased to see 10m was alive with signals from across the Atlantic. In fact my first QSO using the set came within minutes of switching it on, with an instant response from my reply to a CQ call. 10m activity comes and goes of

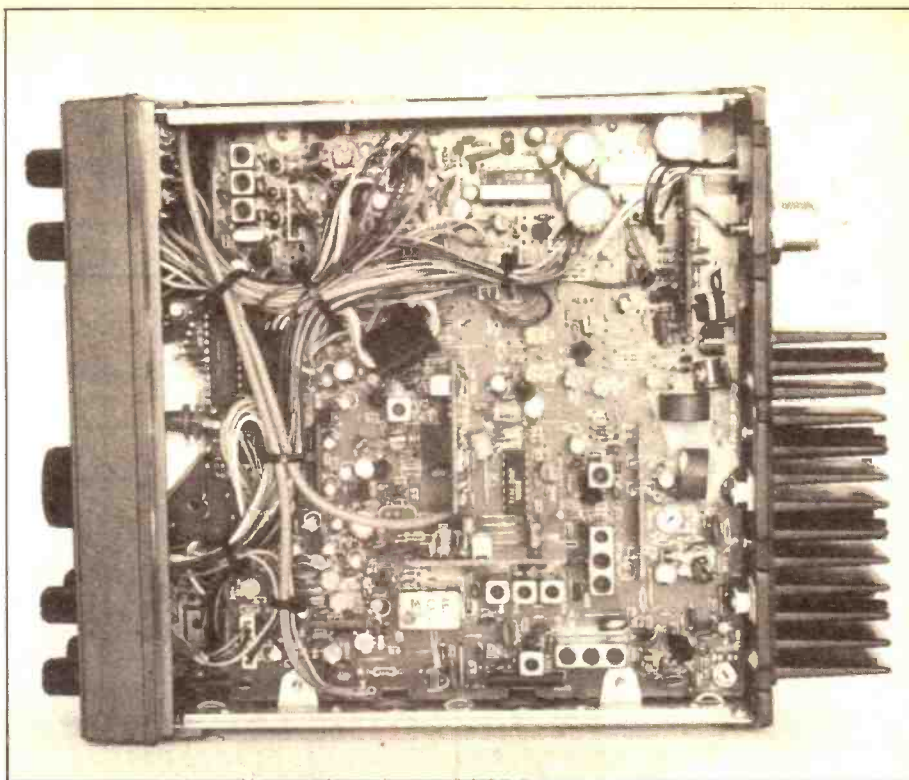

Top view of the international construction.

course as the MUF (Maximum Usable Frequency) and other propagation effects change, however as a guide over the first weekend using the set I sampled activity from Brazil, Chile, Argentina, North America, Canada, South Africa, Tenerife, Cyprus, and Israel in only a few hours of listening.

The transmitted SSB audio using only the supplied fist mic was reported as excellent, I would honestly have expected the odd slightly 'rough' report with such a set, but this was not so. No reports of 'spreading' were received after asking a local 10m operator suffering a rather strong signal from me to have a close listen either side of my transmit frequency, suggesting the set to be adequately 'clean' to drive a linear amplifier if desired.

The SSB/CW receive selectivity was wider than I have become used to from the usual (more expensive) HF multi-band sets I have used, but this set hasn't been designed for operation on highly-congested bands such as 20m and 40m of course. On CW the semi break-in time period I found to be a little short, switching back to receive between characters at around 15-18 wpm. This period is

internally set and I could find no obvious way of easily adjusting it, although the internal sidetone level adjustment is clearly marked. A 'click' was noticed at the beginning of transmitted CW characters as a result, but maybe I'm being fussy as the mic key line could always be used for manual Tx/Rx switching to overcome both limitations.

On FM transmit the audio quality was every bit as good as that on SSB, operating on FM around 29.60MHz with stations using 10kHz spacing also showed the adjacent channel filtering to be excellent, on many sets this is too wide with the result that often have to operate 20kHz away from other stations to achieve satisfactory rejection. I found the noise blanker operating very well, even when using a mobile whip in proximity to other vehicles the set brought stations who were initially drowned out in ignition noise to perfect readability. I only wish it worked as well in suppressing the noisy thermostat down the road, which unfortunately was too much for it!

Laboratory Tests

As found on the air, the adjacent channel rejection was very



good, measuring around 60dB, and likewise the blocking rejection so one shouldn't get too many problems from users of other closely-spaced bands! Careful measurement of close-in high level signals showed the set did not noticeably suffer from synthesiser reciprocal mixing noise effects which is often a letdown on modern equipment. The squelch opening sensitivity was a little disappointing, this needed a fully readable, in fact moderately strong, signal to open it, however it had a usefully wide range enabling one to squelch out most weak background electrical QRM and the like when required. The S-meter also gave a good dynamic range and the measured audio output should be ample for even the noisiest of cars when used as a mobile rig.

On transmit, the SSB two-tone IMD (showing the linearity of the transmitter and hence the amount of 'spreading') was quite reasonable. The transmit harmonics were adequately suppressed, these and the IMD products being around the same level as would be found on many of the £1000 plus HF multi-banders. The power output was accurately set at the 20W PEP level on SSB, whilst on the other modes the carrier power was similarly accurate at 10W maximum with a power reduction facility of 1.4W.

Conclusions

The 2830 presents a cost-effective method of getting onto 10m for both mobile and base station operation, allowing for instance the VHF-only operator to get a 'taste' of world-wide QSOs.

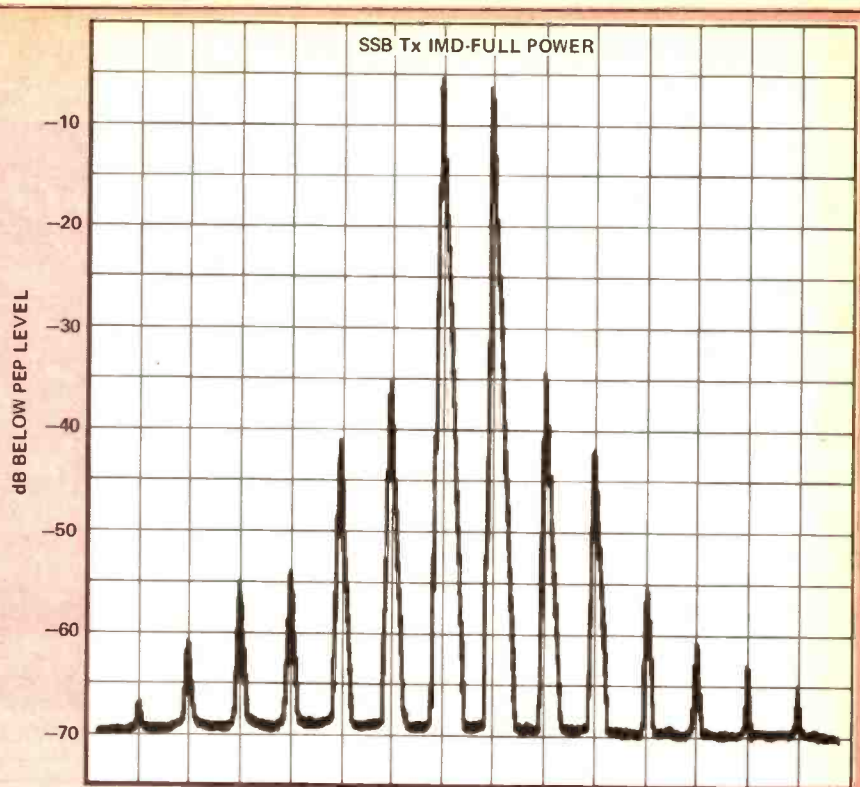

Fig. 1 IMD plot of the Uniden 2830 Tx in SSB mode.

Laboratory Results Receiver

Sensitivity Input level required to give 12dB SINAD	
Mode	Level
SSB/CW	0.132uV pd
AM	1.02uV pd
FM	0.48uV pd

Squelch Sensitivity		
Level	SSB	FM
Threshold	0.445uV pd	0.51uV pd
Maximum	1.05mV pd	1.21mV pd

FM Adjacent Channel Selectivity Measured as increase in level of interfering signal, modulated with 400Hz at 1.5kHz deviation, above 12dB SINAD ref. level to cause 6dB degradation in 12dB on-channel signal

Spacing	Level
+10kHz	59.0 dB
-10kHz	59.5 dB
+25kHz	64.0 dB
-25kHz	63.0 dB

Intermodulation Rejection Increase over 12dB SINAD level of two interfering signals giving identical 12dB SINAD on-channel 3rd order intermodulation product (measured with 200/400kHz spaced signals) 61.5 dB

Blocking Increase over 12dB SINAD level of interfering signal, of an unmodulated carrier causing 6dB degradation in 12dB SINAD on-channel signal (measured using USB)

Spacing	Level
+100kHz	80.5 dB
-100kHz	77.5 dB
+1MHz	91.0 dB
-1MHz	93.0 dB
+10MHz	110 dB
-10MHz	110 dB

Maximum Audio Output Measured at 1kHz on the onset of clipping

Load	Output RMS
3 ohm	2.97W
8 ohm	1.85W
15 ohm	1.18W

Image/IF Rejection Increase in level of signal at first IF image frequency, and at the IF frequency itself, over level of on-channel signal to give identical 12dB SINAD signals

Image Rejection (-21.39MHz)	65.5 dB
IF Rejection (10.605MHz)	64.0 dB

S-Meter Linearity		
Indication	Sig. Level	Rel. Level
S1	1.80uV pd	-37.3dB
S2	5.21uV pd	-28.1dB
S3	12.1uV pd	-20.8dB
S4	20.4uV pd	-16.2dB
S5	29.8uV pd	-12.9dB
S6	41.4uV pd	-10.1dB
S7	59.8uV pd	-6.9dB
S8	87.6uV pd	-3.6dB
S9	132uV pd	0dB ref
S9+	219uV pd	+4.4dB
S9++	378uV pd	+9.1dB

Transmitter

Max Tx Power		
Supply	SSB	FM/AM/CW
10.8V	19.6W PEP	9.6W
13.8V	20.4W PEP	10.0W
15.6V	20.7W PEP	10.2W

Harmonics/Spurii	
Harmonic	Level
2nd	-62dBc
3rd	-61dBc
4th	-63dBc
5th	-60dBc
6th	-70dBc
7th	-70dBc
Spurii	-58dBc (at +/- 8MHz)
FM Peak Deviation	3.35kHz

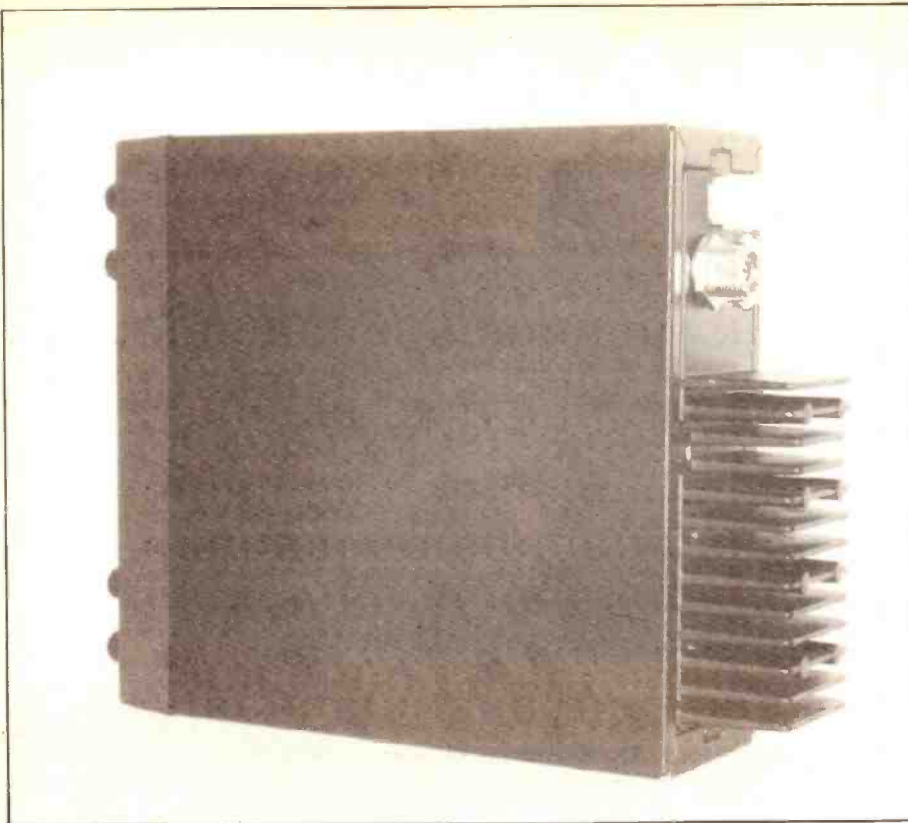

Rear panel shot of the rig showing the substantial die-cast heatsink.

Coupled with transverter use, a compact station for, say 10m and 2m, or 10m and 6m, can be put together at an economic cost. I understand the distributors will in fact shortly be offering a 'package deal' of the set with a matching 2m transverter, the set itself being optionally fitted with wider FM IF filters to provide for 25kHz channel spacing.

The set does not have the sophistication of memory channels, split frequency operation and the like, but even so it offers more facilities and modes than other 10m monobander sets that I know of which cost rather more. I have great fun with the set over the review period and an amateur colleague of mine who also tried the set out bought it for himself, coupled with two further sales after other visitors had seen the set in use. Speaks for itself, maybe I should be charging a commission . . . !

Many thanks go to Raycom Ltd, who are the Uniden 2830 Distributors, for the loan of the review set.

ICS

EVERYTHING FOR DATA COMMUNICATION BY RADIO

The Best Value Packet Radio TNC on the UK Market



- ★ Compact size
- ★ Nine front panel status indicators
- ★ NetRom compatible
- ★ Compatible with PK-87-Host Mode Control
- ★ TTL/RS232 inputs and outputs
- ★ 32K RAM buffer
- ★ Full range of high quality driver software for IBM-PC, Commodore 64 and BBC
- ★ Built in personal mailbox

Only £109.95 inc. VAT

Post and Packing: £2.50

The World Standard Multi-Mode Data Controller!



- ★ Now with seven modes: Amtor, Packet, RTTY, CW, ASCII, Facsimile and Navtex.
- ★ Superb send/receive facsimile software for IBM-PC and Commodore 64.
- ★ Unique SIAM signal acquisition and analysis capability
- ★ Firmware upgrades available for earlier PK-232s
- ★ Excellent Host Mode software support.

Still only £269.95 inc. VAT

Post and Packing: £4.00

- Applications programs for most popular personal computers.
- Complete weather facsimile demodulator/printer system only **£399.95 inc. VAT.**

Applications assistance - always. Send large SAE for further production information.
Visitors by appointment. Prices may vary according to prevailing exchange rates.
Prices include VAT at 15%.

ICS ELECTRONICS LTD.

P.O. Box 2, Arundel, West Sussex BN18 0NX
Telephone: (024 365) 655 (2 lines) Fax: (024 365) 575



The JST-135 from JRC



Japan Radio Company are big; sales turnover last year was in excess of £620 million. Not only are they big, they have been solely concerned with communications radio since 1915 and are therefore one of the world's leading companies in the field. JRC for example fit out most of the supertankers and coastal radio stations so I think there is sufficient evidence of their expertise. As a humble radio amateur, I am particularly glad that JRC find time and money to produce what must be amongst the best amateur radio equipment in the world, and as an appointed distributor in the UK, I am even more pleased to see the JST-135 arrive.

Those who know the NRD-525 receiver will recognise the family resemblance; actually the NRD-525 and JST-135 look identical, because they are clearly meant to mate together as an ultimate station. And what a transceiver the JST-135 has turned out to be. It would be impossible to list all the features which make it so outstanding, because so much of the engineering does not appear to the casual view, but take it from me, the JST-135 is destined to become a landmark in equipment design and performance.

The construction of the transceiver follows that of the NRD-525 in using individually screened and mounted plug in vertical boards; an expensive way to build, but JRC try to build to a standard of quality, not down to a price - and it looks terrific when you peek inside.

The measures taken to ensure signal quality including using the same semiconductor devices in the transmit driver stage as those in the PA; not for simplicity but to allow them to be run in Class A. The result is exceptional linearity, improved signal quality, and of course cancellation of second harmonic distortion products. The PA itself is followed by a three section Chebyshev filter, which may not interest you particularly but it all helps the reduction of harmonic radiation, and that is certainly of interest to the station trying to operate on the frequency of your third harmonic . . .

If putting frequencies into memory is your pleasure, you have 200 to go at, with each memory storing frequency, mode, agc time constant, RF attenuator setting, and IF bandwidth. Should be enough for almost anyone. All mode? Certainly, with USB, LSB, CW (full and semi break-in), AM, FSK and FM. There is even an optional ECSS unit if you want to dig out rare broadcast stations in a band full of half megawatt propaganda sources.

The receiver side (100kHz to 30MHz) has had the same dedicated attention as the transmitter, and there are some intriguing features such as the optional automatic notch system which grabs an interfering signal, throttles it at birth, and then hangs on to it whilst you tune around so that it causes no more pain and distress. (How did he do that George?)

The first brochures we received (in Japanese) mention other accessories such as (GULP) a matching linear at around £7500, but there are more affordable and useful things including the NFG-230 automatic aerial tuner. So what? There are other tuners on the market. True, but this one is fully waterproof, offers virtually instantaneous tuning of a dipole or wire aerial and is meant to be mounted where tuners ought to be - at the feedpoint of the aerial system, out there in the wind and rain.

These brief comments are only a taste of what the JST-135 can do. For more complete information, why not send off £1 for our pack containing details of all the equipment we stock, and make a particular request for the JRC range, or indeed any other equipment which takes your fancy.

All being well we should have demonstration units available for the big day at NEC (Happy Birthday RSGB), and should have some for sale. The price? Assuming no great turmoil in the money markets, we are looking at £1395 for the JST-135; about the same as you might pay for the discontinued JST-125 at the moment, so even "boring waffle" (to quote another advertiser) has its happy ending.

73
John Wilson
G3PCY/5N2AAC

JST-135 £1395 inc. VAT

Glasgow: 4/5 Queen Margaret Road.

Tel. 041-945 2626

Cardiff: c/o South Wales Carpets, Clifton Street.

Tel. 0222 464154

Darlington: 56 North Road.

Tel. 0325 486121

London: 223/225 Field End Road, Eastcote, Middlesex.

Tel. 01-429 3256

Cambridge: 162 High Street, Chesterton.

Tel. 0223 311230

Bournemouth: 27 Gillam Road, Northbourne.

Tel. 0202 577760

Note: All our shops open Tuesday to Saturday inclusive.

FREE Information is free; only the Post Office demand payment for handling it - and the Penny Black is no longer used. Send us £1 to cover Post and Packing and we will return not only the full colour Kenwood catalogue, but details of any particular rig you mention and lots of other information including latest prices.

KENWOOD TM-221E TM-421E



I really do not know how they do it. Do what? Condense so much power and performance into such incredibly tiny packages. The TM-221E and TM-421E represent the sensible and well considered use of technology by Kenwood to give the user probably the best 2 metre and 70 centimetre FM mobile transceiver that it is possible to buy.

The technology in question is the use of surface mount (sometimes called 'chip') components wherever possible. These tiny things are mounted directly on the surface of a printed circuit board, minimising space and wiring. They also have an incidental advantage in that the use of fully automatic assembly techniques gives cost savings for the customer. The surface mount components are not simply resistors and capacitors, but include integrated circuit packages and transistors, so everything is reduced in scale.

The end result in the case of the TM-221E and TM-421E is a package measuring only 140(W) x 40(H) x 179(D) mm; or if like me you are using a wooden ruler dated 1941 5.5 x 1.6 x 7 inches. In this package lurks a receiver section second to none (see the Chris Lorek review in HRT, July 87), and a transmitter which shoves out 45 watts on 2 metres, or 35 watts on 70cm in the case of the TM-421E.

The transceivers, in true Kenwood style are extremely easy to use, with all information displayed on a bright orange backlit LCD, and control operations which are delightfully simple and logical. 14 memory channels are provided, and each memory holds not only the frequency but also any repeater shift required and even whether or not you require a tone burst. If you live in the Great Wen and want to try out 12.5kHz channel spacing, it is all provided - 5, 10, 12.5, 20 and 25kHz at the touch of a button; and of course the receivers are fitted with the recommended "F" filter bandwidth to handle 12.5 and 25kHz channel spacings. Attention to detail is Kenwood's hallmark.

If you want to go the whole hog, you can mount the TM-221 and TM-421 together in a common bracket to make a terrific dual band station, and go even further by using the RC-10 remote controller (which really needs an advertisement of its own). Best of all, since it is impossible to adequately describe this equipment in a few lines, why not send off for the Kenwood catalogue, making a specific request for the brochure on the TM-221E.

TM-221E ... £317 inc. VAT. TM-421E ... £352 inc. VAT

packet radio from Kantronics



When I first heard of packet radio, I said "What?", and that is the reaction of many radio amateurs. However, I never expected it to be so much fun, and judging by the demand and the queue to get at our demonstration station here at Matlock, a lot of other people are also finding it truly fascinating.

There are several companies offering ready made packet systems, and the descriptions are usually full of terms you don't understand (including some of our own ads in the past). What for example is "enhanced generic command structure"? Sounds very much like something taught at Sandhurst or West Point.

From the equipment available, we chose to represent Kantronics, because their units are sheer delight to see, to use, and to enjoy. For full information on this most interesting aspect of our hobby, just send a couple of first class stamps and ask for "Kantronics".

Prices range from £159 to £298, and I know I haven't told you what packet radio will do - send for the info ...

Aerials for all

Every rig needs an aerial, and we try to stock as complete a range as possible. For HF, top of the popularity poll at the moment is the H5VK5, which is a trapped vertical complete with tuned radials. High performance, easy to erect, and being a vertical doesn't need a garden 132 feet long. Also, having tuned radials, it can be put on a pole, mast, or strong chimney. A real heavy duty top quality all bander 80 to 10 metres.

H5-VK5 £218 inc. VAT carr. £8

For those who do have a length of garden, we sell traps and wire for making a trap dipole, still the favourite for the lower bands. I hear that Richard, G2DYM, down in the West country makes probably the best wire aerials to be had from anywhere. Why not look him up in the callbook and drop him a line, or ring me and ask for the full address (too long to print here).

For VHF/UHF, try the Hokushin range, a few models I list below. Complete details in our price list available on demand.

GPV-5	2 metre base station colinear. 6.5dB gain	£54.92
GP-23	As GPV5 but 3 section. 7.8dB gain	£51.97
GPV-720	2m/70cm dual band base station colinear	£45.68
GPV-7	70cm base station colinear. 6.8dB gain	£45.69
HS-WX1	2m/70cm base station aerial. The most attractive slender aerial we ever saw	£59.00

Many, many more products
in our range.

Why not send off the
coupon for details.

LOWE ELECTRONICS LTD.

Chesterfield Road, Matlock, Derbyshire DE4 5LE

Telephone 0629 580800 (4 lines) Fax 0629 580020

Name
Address

Post Code

FREE INFO.
Don't forget £1
to cover postage.
H.R.T.

BONZAI

Aerial Farming

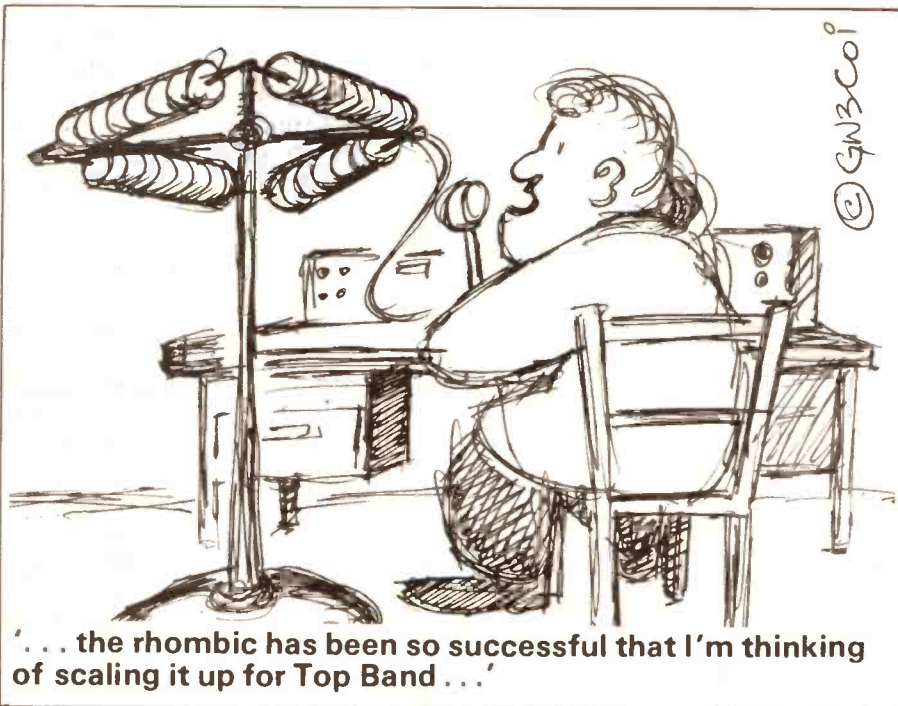

possibility of running the aerial over the roof of the house has been eliminated by the invention of open plan communal front gardens.

If that seems bad, consider the situation of a flat dweller with no access to the roof or alternatively those living where the councils have banned aerials for any purpose on their estates — and then negotiated a franchise with a cable TV company!

In each of these situations, the standard reference books on amateur transmitting aerial design are of little help, for almost all published designs are based on dimensions of at least a quarter of a wavelength which, whilst quite modest on ten metres, is much less so for the low frequency bands. A completely different approach is therefore necessary, with every situation being addressed on its own merits.

Basic Problems

It may well come as a surprise to readers steeped in the folklore of beams; colinears and multiband aerials that, provided that it is

As houses get smaller aerial problems get bigger, but Brian Kendal, G3GDU, has decided to fight back. Read his diminutive aerial tips for very small places

When *HRT* printed my article on Delta Loops a few months ago, the editor included a cartoon by the incomparable GW3COI in which a character standing in a very small back yard was saying "I'm thinking of putting up a rhombic". Intentionally or not, with that delightful drawing, GW3COI highlighted a problem which is with many amateurs today — that of the postage stamp size back gardens on modern estates.

To these, even a half size G5RV or trap dipole is an impossibility, for their rear gardens are often only twenty feet square or smaller and due to modern central heating systems, there are no chimneys for convenient aerial support. Even the

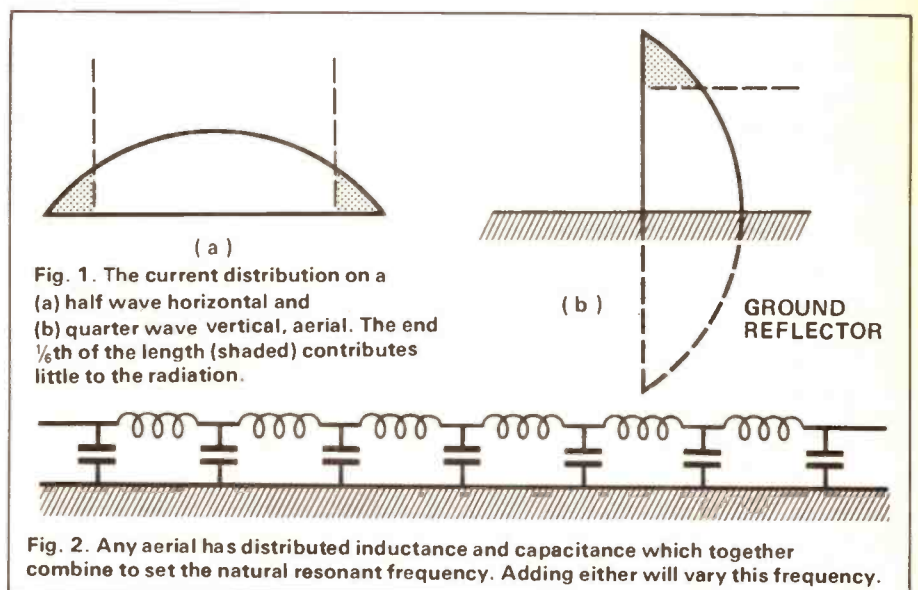

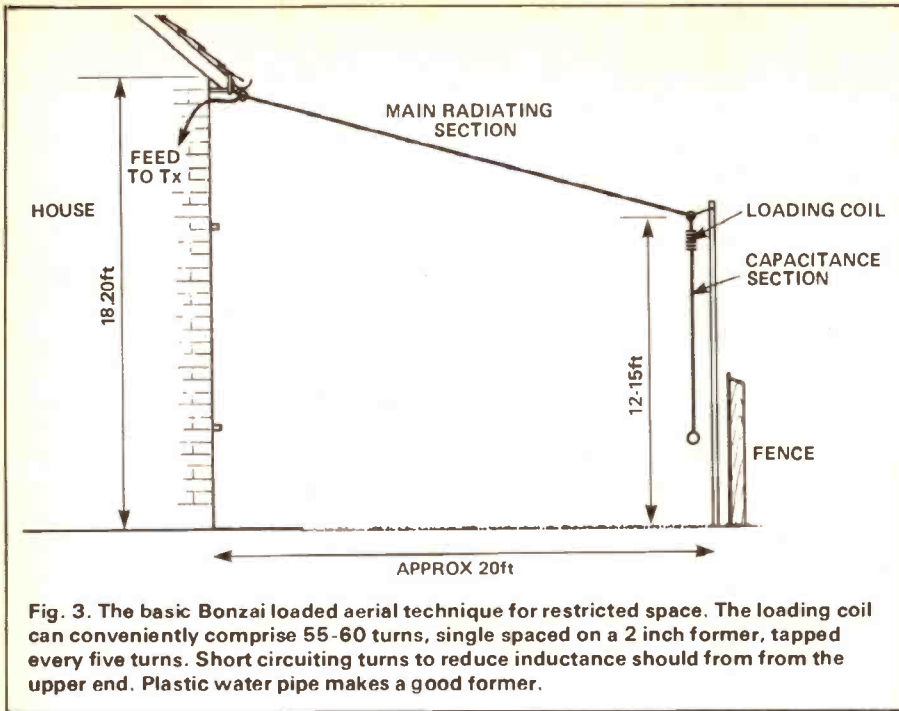

Fig. 3. The basic Bonzai loaded aerial technique for restricted space. The loading coil can conveniently comprise 55-60 turns, single spaced on a 2 inch former, tapped every five turns. Short circuiting turns to reduce inductance should be from the upper end. Plastic water pipe makes a good former.

Penalties

Such advantages are not gained without penalties however, for as an aerial is shortened, so its radiation resistance (RR) decreases. On the low frequency bands this may prove severe, for example a 66ft. wire will exhibit an RR of less than five ohms when used on 160 metres. This is because under these circumstances (with the aerial loaded against earth in a quarter wave configuration) the impedance of the earth connection will be in series with the RR. Low earth impedances are notoriously difficult to obtain and consequently, a large proportion of the output power will be wasted.

If however, the aerial can be artificially lengthened still further, although RR will not change very much, the feed impedance can be increased substantially, and as the transmitter output power is shared between the earth resistance and the aerial feed impedance, the radiating efficiency of the system will be considerably improved.

All aerials which are less than quarter of a wavelength long are capacitively reactant, thus to achieve resonance, inductance has to be added. Although the loading inductance may itself add a little to the radiation, the DC resistance of

properly matched to the transmitter, any piece of wire will radiate a signal to some degree. The art of aerial design is to take every advantage of the space available to ensure that the RF generated is radiated in the most effective way possible.

As an example of this, during World War Two, covert agents in Europe maintained regular contact with their headquarters in the United Kingdom using equipment with output powers of only a few watts, radiated from aerials which comprised twenty or thirty feet of wire thrown up into a tree or out of a window. Considering, therefore, the efficiency of present day transceivers, there would appear to be no valid reason why aerials should not be constructed which, although not as efficient as their largest brethren, are nevertheless still capable of continental, if not intercontinental working on the lower HF bands.

Every textbook on aerial theory illustrates the current distribution on a half wave dipole and that the high current part of the aerial provides maximum radiation. Fewer however, mention that the radiation off the $\frac{1}{6}$ th of the length at each end is insignificant. Here lies the first pointer towards size reduction. If an aerial is loaded against earth, the length may be reduced to a quarter of a wavelength, for the other half is mirrored in the earth plane thus

effectively reducing its length further — this is the second size reduction factor.

Thirdly, an aerial is a tuned circuit and therefore achieves resonance by a combination of distributed self capacitance and inductance. In consequence, by artificially adding either or both, a lower resonant frequency may be obtained on a relatively short aerial. This is known as loading.

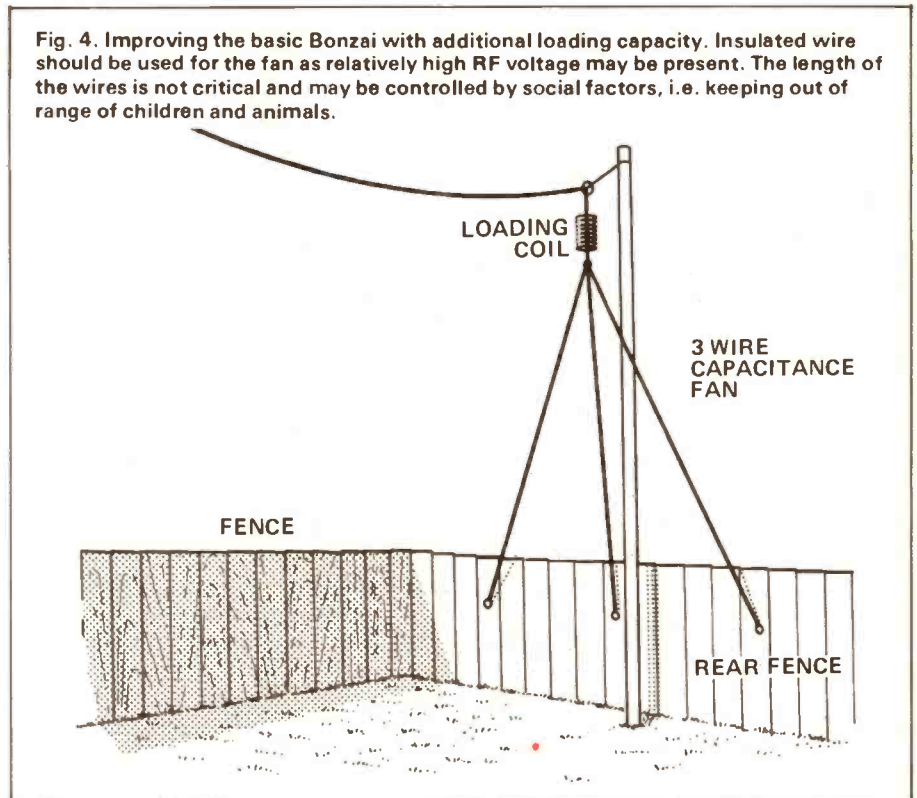

Fig. 4. Improving the basic Bonzai with additional loading capacity. Insulated wire should be used for the fan as relatively high RF voltage may be present. The length of the wires is not critical and may be controlled by social factors, i.e. keeping out of range of children and animals.

the wire used will also add to the losses. If however, the capacitance of the aerial is increased, less inductance will be necessary to achieve resonance. It is therefore desirable to add capacitive loading whenever possible.

A further advantage derived from capacitive loading stems from the fact that the Quality factor (Q) of any tuned circuit is:

$$Q = \frac{R}{r}$$

where:

R = inductive or capacitive reactance

r = DC resistance

In any tuned circuit, the higher the Q, the narrower the bandwidth. Inside equipment a narrow bandwidth for improved selectivity is obviously desirable, but in the case of aerials, high Q will mean that retuning of the aerial matching unit will be necessary for relatively small frequency excursions. A low Q is therefore to be preferred.

As for resonance, the capacitive reactance must equal the inductive reactance; by increasing the capacitive loading, less inductance will be required and the Q will be reduced with increased operating convenience. An extreme example of the disadvantages of high Q aerials is in the case of short range Non-Directional Beacons used in the aeronautical service. In some installations, the Q is so high that the bandwidth of the aerial is sufficiently narrow to limit the radiated modulation depth of the transmission!

The requirement for low Q aerials however, does not extend to the loading inductance for, as we have seen, the Q is the ratio of the inductive reactance to the resistance. For a given inductance value, a low Q would indicate a relatively high resistance (ie thin wire) which would in itself, absorb power. Loading coils should therefore be wound with the heaviest possible wire.

So to précis the foregoing discussion:

1. Design the aerial for the highest possible self capacity.
2. Make sure that the highest current part of the aerial is in the clear.
3. Wind the loading inductors

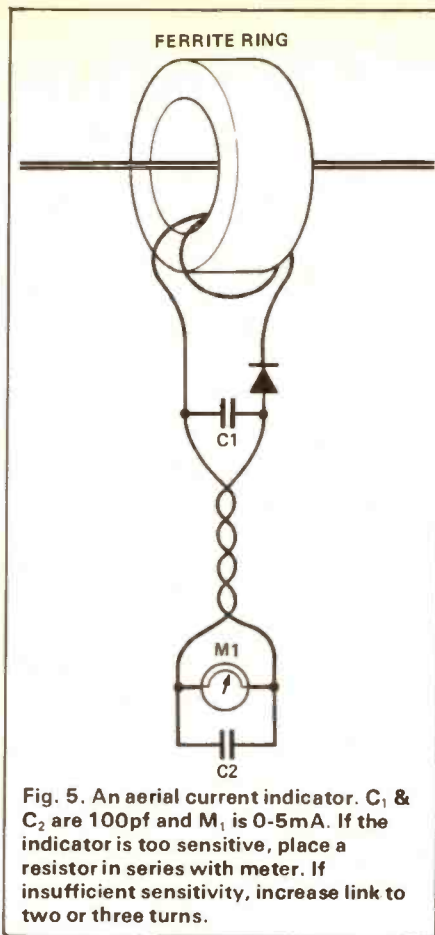

Fig. 5. An aerial current indicator. C₁ & C₂ are 100pf and M₁ is 0.5mA. If the indicator is too sensitive, place a resistor in series with meter. If insufficient sensitivity, increase link to two or three turns.

using the thickest possible wire.

4. Install the best possible earth system.

Practical Installations

The most common situations in which 'Bonzai' aerials become necessary would appear to be:

1. Very small back garden (20ft. square or less).
2. No outside aerials permitted but access to loft.
3. No outside aerials permitted, no access to loft.

Let us consider each of these situations in turn.

The Small Garden

Initially the small garden operator has to decide which bands he wishes to use. With a 20ft. garden, it is quite practical to erect a dipole for 10 metres and, with a modicum of luck, even a 15 metre dipole may be squeezed in. If a chimney is available on the house, there may even be sufficient length for a twenty metre aerial. Alternatively, a delta loop may be possible for 15 or 10.

These may be sufficient for

some operators, but to gain the maximum enjoyment from your licence, particularly at this part of the sunspot cycle, some low frequency capability is necessary. With a versatile aerial matching unit it may well be possible to short circuit the aerial feeder and load up on the LF bands but this cannot be expected to be particularly effective. Alternatively a loop aerial may be persuaded to radiate on much lower frequencies and as an example of this, the author has from time to time (inadvertently) used his 21MHz loop on 80 metres! QSOs were certainly possible, but the signal strength was at least a couple of S points down on the trap dipole. So, using the principles laid down in the earlier part of this article, how can the most effective use of the available space be made?

Taking the worst case scenario, let us assume that the house is in the middle of a terrace and has no chimney. One support of the aerial therefore has to be at the guttering level of the house — say 20ft. above ground. The other support depends largely on local planning attitudes, but a twelve or fifteen foot pole attached to the rear fence is not likely to attract too much attention. If the local authorities totally ban outside aerials, it may be found possible to provide yourself with an excellent wire clothes line which can be connected to the shack with a cliphead. Operation may have to be curtailed on washing day however, for the capacitive loading effect of wet sheets and towels is very hard to predict!

If the shack is on the first floor, the simplest aerial under such circumstances would be a single wire. The maximum length attainable, by running it from the shack to the gutter (6ft.), across to the pole (20ft.) and then vertically down to the ground (12ft.), would be in the order of 38ft.

On forty metres this would put the current maximum just about at the gutter and the aerial feed impedance would be quite low — probably in the region of 20 ohms. Unless a good earth is available, losses will be quite high and the aerial will not be particularly efficient. On 80 and 160 metres, the current maximum will be inside the aerial tuning unit and results will be disappointing to say the least.

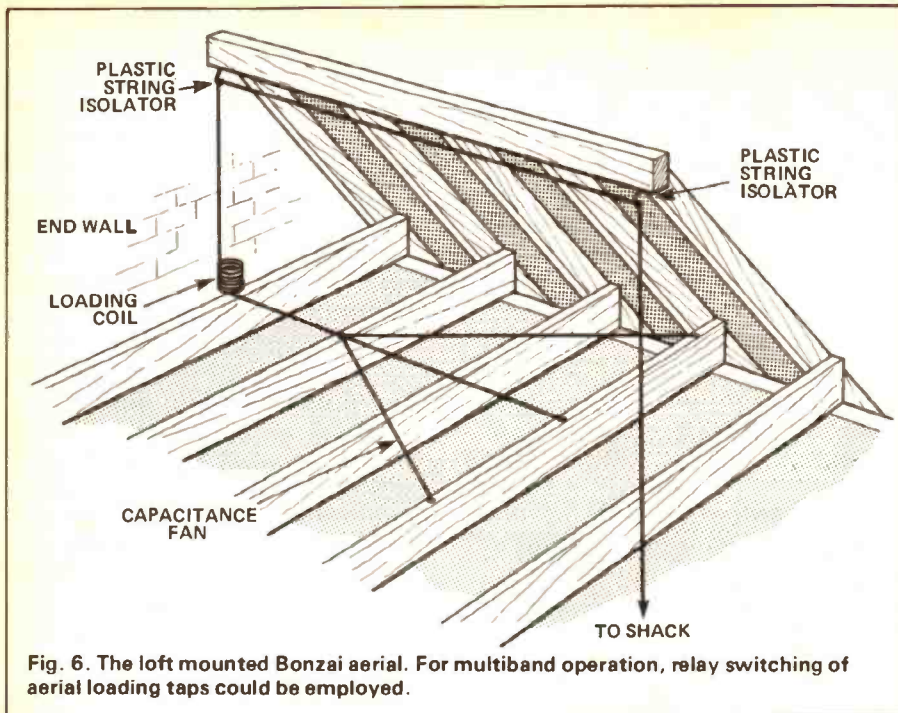

The Loft Aerial

Over the years, many planners have made efforts to ensure that housing estates remain exactly as they were originally envisaged, with the result that aerial, either for TV or amateur radio are specifically banned. Under such circumstances, an amateur may get away with a thin wire running down to the back fence but this cannot be guaranteed. The only safe solution, apart from moving house, is to move the aerial farm indoors.

If access to the loft is possible, this need not be as restrictive as may at first be thought. Provided that the number of metal objects among the domestic items stored there (ie household junk) are kept to a minimum there is no reason why several aerials for different bands should not be installed. There are, however, one or two pitfalls. The first is that there is almost certainly a quantity of metal piping feeding the water tank. This need not cause many problems provided that aerials are routed a foot or two clear.

The second is that there will certainly be housewiring for the upper floor lighting. Again, by careful selection of aerial position, problems should be avoided. It is quite possible, however, that RF will find its way into the mains and filtering of your own and neighbours' domestic appliances may be necessary.

The third, and most pernicious pitfall, which may preclude loft aerials altogether, is that some loft insulation materials have a foil backing. If such materials are applied behind the slates, the whole loft area is effectively a screened cage.

The average loft is in the order of 20 ft. square and in consequence a ten metre dipole could be run just inside the ridge. Similarly, if the last foot or two at each end is dropped down, a fifteen metre dipole could be similarly installed. Both dipoles could be fed from the same feeder. Due to proximity effects, the normal calculations for aerial length may be inappropriate and the final dimensions must be determined by empirical methods, although the standard lengths will make a good starting point.

On forty metres there is a

The performance on all three bands will be improved if the current maxima can be moved to the middle of the horizontal wire. This may be most easily achieved by adding inductive loading and the most convenient position for the loading coil is at the top of the end 12ft. section. The value of inductance necessary is entirely dependent on local circumstances and will, of course, vary from band to band. A tapped inductor is therefore necessary.

The determination of the value necessary is entirely empirical and is determined by placing a current probe in the centre of the horizontal section of the wire and adjusting the value of the inductor for each band in turn.

Current Probe

The current probe can conveniently comprise a 1 inch ferrite ring slipped over the aerial wire in the centre of the horizontal section. A second wire passed through the ring feeds a diode and from there a length of light bellwire comes down to ground level where it is connected to a meter. Sufficient RF is applied to the aerial on the highest frequency band to cause the meter to indicate and the amount of inductance in circuit is gradually increased from zero until the meter reads a maximum. Apply some marking to the appropriate tap and

repeat for each lower band in turn.

On all the low frequency bands, however, it will be found that the feed impedance is quite low — certainly less than 50 ohms — and to gain reasonable radiating efficiency a good earthing system will be necessary. It will also be found that even small frequency excursions require adjustment of the aerial matching unit, the reason for this being that the Q of the system is relatively high.

Earlier we saw how the Q could be reduced by increasing the self capacity of the aerial. In the case of the system described, this can most conveniently be achieved by replacing the single wire beyond the loading inductance by an inverted 'fan' of wires. Three or four should be sufficient, spread at angles of between thirty and forty degrees. This increase of self capacity will however, necessitate readjustment of the taps on the loading coil. The resonance of the system will also be affected by the weather and steps should be taken to weatherproof the loading coil either by applying a heavy coat of varnish or by enclosing it in a waterproof container.

It should be noted that this type of aerial system will not present an impedance of 50 ohms and, except for some older valve transmitters with PI output stages, an aerial matching unit will be found essential.

choice, for the circumference of the loft may well be sufficient to fit a king-size halo aerial similar to those used for two metre mobile SSB operation some years ago. Otherwise the Bonzai technique previously described may be used. Similarly for the lower frequency bands, the Bonzai aerial would be the only practical solution.

For loft installation the lead from the shack should be brought into the loft at one end and run just below the ridge. The capacity 'fan' may be located either adjacent to the end wall of the loft or, if not too close to household wiring, across the ceiling joists.

Adjustment of the taps on the loading coil for bandchanging would probably be inconvenient, but it should not prove difficult to install switching by relay. At this point, the switched voltage will not be high, but the current may be

several amps. One advantage of loft aerials is that, hopefully, they will remain dry at all times. Insulation may therefore be rudimentary and the author has found ordinary plastic string quite adequate. Care should be taken, however, with the elements of the capacity 'fan' for these will be at high RF voltage and should not be positioned within a couple of feet or so of house wiring.

Adjustment of the Bonzai loft aerial is exactly the same as the garden version, with the current probe being located in the middle of the section running under the ridge.

The Indoor Aerial

Installing an aerial in an apartment with no access to the loft gives much the same feeling as the traveller who, asking a local resident directions to another village is told "If I were you I wouldn't start from here". There are

a number of simple possibilities such as fixing a mobile whip to, or even hanging a wire with a weight on the end from, the window sill after dark but these are very restrictive.

Any alternatives, such as a Bonzai system, requires a very understanding partner. The main span of the aerial, in order to avoid house wiring, should be at least a foot below ceiling level and it would probably be advantageous if it ran parallel to an outside wall. For a permanent installation it may be possible to fit it behind the wallpaper or along a picture rail.

Similarly the capacitive 'fan' may be fitted behind the wallpaper, hidden by a cupboard or wardrobe or underneath the carpet. The loading coil could be on top of or inside a cupboard or hidden behind some piece of furniture.

There are as many possibilities as there are designs of apartments and the final installation will be a compromise reached in negotiation with your partner and your conscience!

Results

From the outset it must be admitted that the Bonzai aerial systems described are not as efficient as full size resonant aerials. However, they will perform far more effectively than a single wire of equivalent length, and some sort of aerial is better than none. For many years I lived in a small caravan and a full size aerial was permitted on very few sites. Nevertheless, using a Bonzai system and 25 watts it was found possible to make contacts all over Europe on 80 metres CW and phone too if QRM permitted. Likewise, most of the United Kingdom could be worked on 160m, whilst intercontinental working was possible on 40 metres and higher frequencies. The total length of the aerial was rarely more than 25ft.

Even more recently, ten watts on forty metres to a loft Bonzai gave a hundred contacts from thirty countries in a month. Use of the Bonzai technique means that no amateur need be QRT for lack of aerials. In the very worst case, local contacts will be possible and in general QSOs will be made in all but the very worst of band conditions.

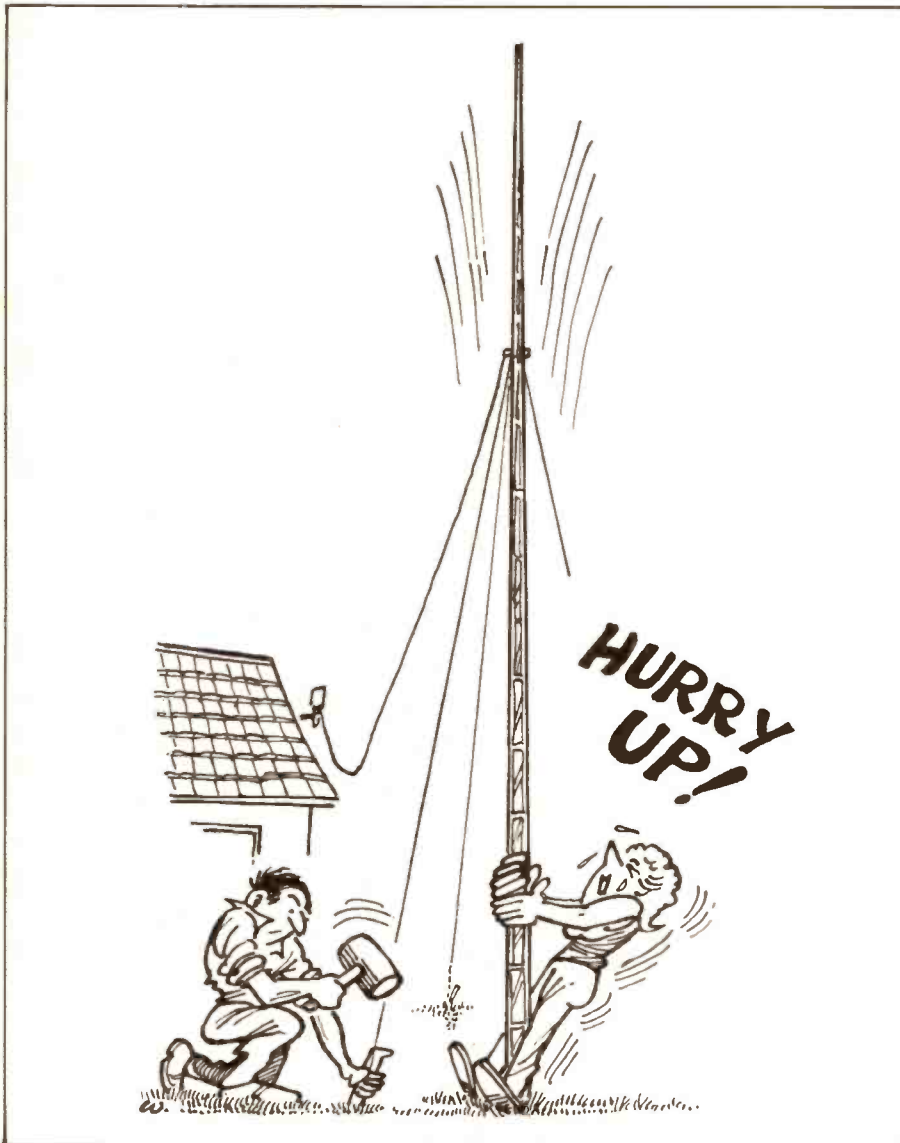

Pac-Comm Tiny-2

Review



By now, few operators of the VHF/UHF bands have not come across packet radio communication. This may have come from overhearing one of the many QSOs on the subject, or possibly by stumbling across the seemingly never-ending burst

ing less than a second each, and are timed and sent in such a way as to minimise the chance of 'collisions' with other packets of data. An error check is automatically carried out at the receiving end, with automatic re-transmission taking place

These days you can get onto packet for just over £100, so set Chris Lorek to pit his wits against this latest logic box!

of FM data on the designated packet radio channels as messages automatically travel across the country. On 20m the area around 14.1MHz also carries much traffic as international 'mailboxes' auto-forward messages to and from amateurs throughout the world. If you've ever wondered 'what goes on' there take a look at the March 1988 issue of HRT where you'll learn how to achieve worldwide one hundred per cent error free communication with other amateurs using nothing more than a complete terminal and packet radio TNC (Terminal Node Controller) connected to a 2m FM rig.

Packet radio is *the* fastest growing mode in amateur radio, maybe the doom and gloom merchants who bemoan the fact that newcomers aren't becoming interested in amateur radio ought to take a listen on 144.650MHz FM to see where they all are! Why just one frequency you may ask? Well packet radio is a 'spectrum efficient' mode, where lines of text are sent in short bursts or 'packets', sometimes tak-

ing less than perfect copy be received. This way many QSOs can all take place on the same frequency with an efficiency that would put many other modes of communication to shame!

Computer Freaks?

Many amateurs believe packet radio is all to do with computers and all-night program writing. Nothing could be further from the truth (although it is fair to say that if you're already a computer enthusiast then packet radio has much more to offer in many respects. To have QSOs on packet radio and to access the many 'mailbox' bulletin boards you don't even need to use a computer - a 'dumb terminal' consisting of a VDU and keyboard is all you need and some amateurs even use devices such as a Psion 'Organiser' as their terminal!

The 'Terminal Node Controller', TNC for short, does all the hard work, and consists of a small self-contained box fitting between your radio and the RS-232 connector of

your terminal. If you have a suitable computer sitting around, then it may certainly be put to good use for packet radio - a short 'terminal emulator' program is all you need. Alternatively many purpose-written programs are readily available to allow split-screen QSOs, file transfers, auto-storage of messages received in your absence, and the like.

The Pac-Comm Tiny-2

The Pac-Comm Tiny-2 TNC is amongst one of the lowest priced models on the market, currently selling at just over £100. HRT therefore thought it could be of interest to many readers as an 'entry' into the world of VHF packet radio. It is completely TNC-2 compatible, meaning you may plug in 'NET/ROM' EPROM-based software or run TCP/IP and so on as your future interest takes you. It does of course come supplied with 32K of on-board RAM and it's own firmware is common to most other TNC-2 'Clones'. In many respects it is identical in operation to the well-know TNC-220, apart from the fact that the Tiny-2 has only one radio port for VHF use rather than software switchable VHF/HF ports. Note that this means it *cannot* be used on HF unless you fit an external modem.

As well as the usual RS232 connection capability, TTL level input/output lines are provided to allow the TNC to be used on some computers without an RS232 facility such as the Commodore 64 and 128. Together with the built-in modem suitable for normal 1200 baud VHF use, it also has a modem disconnect header allowing future high speed modems to be connected, the TNC itself being capable of operating at speeds from 300 baud up to 19.2 kilobaud. Although not fitted to the review model, the latest news is that by the time this article appears all Tiny-2s will have

an in-built personal 'mailbox' included, using a subset of the standard WORLI commands. A 'KISS' mode will also be available to allow full computer control of operation if required.

As its name suggests, this TNC certainly is very small, measuring 125mm(W) x 34mm(H) x 188mm(D), and operating from a 9-16V DC supply drawing around 200mA. As such it is eminently suitable for portable work - yes, amateurs *do* go packet 'briefcase' portable! I saw two such amateurs walking round the Drayton Manor rally. For the battery conscious, a similar model is available with CMOS circuitry, drawing a total of 40mA, this being available at a higher price.

Connect Up

Apart from the 12V supply, the TNC needs to be connected and matched to your radio and your terminal, connectors on the rear panel being fitted for these purposes. On the radio side, you need to wire the Tx PTT line, Tx audio, Rx audio, ground, and preferably the Rx squelch line. The latter is required to let the TNC know that a carrier exists on the channel to prevent it keying your transmitter. If this is not available from your receiver than all is not lost as the TNC does have a 'Data Detect' facility to

inhibit transmission when packet data is present, this would however limit use on channels shared with other modes. For example if a strong blank carrier or voice QSO was present on the channel, then the TNC would just transmit packets in vain if your squelch line was not wired.

On the computer side, normally just three connections are required for RS232 use, these being Tx data, Rx data, and Ground, although some terminals or software programs may also require two further connections to be made; RTS (Request To Send) and CTS (Clear To Send). All the required TNC connector plugs are supplied and the suppliers of the review model can also provide ready-wired computer leads as an optional extra together with free 'intelligent modem' and full-blown Bulletin Board software for popular computers such as the BBC, Atari, PC Clones and so on.

Internal links are used to set the TNC and terminal baud rates together with preset pots (accessible through screwdriver-sized holes on the rear panel) to set the tone levels to and from your radio if required. A suitable pre-wired computer lead was furnished with the review TNC so this meant that all I needed to do was quickly wire a lead from my 2m transceiver to the TNCs rear 5 pin DIN socket,

taking me all of ten minutes. Plug in, set the computer baud rate to 1200 to match the TNC, tune to 144.650MHz, quickly adjust the volume control of my radio and hey presto, my computer screen quickly filled, decoding all the QSOs and mailbox information present. While all this was going on, out came the instruction manual to tell me what to do next!

Commands Galore

When initially faced with the TNC manual, this being over 100 pages long, I must say that I believe many newcomers would be instantly disillusioned by its sheer length and complexity the major part of it would require an experienced packet operator to understand it. However the manual *does* give a short but useful guide to getting started, explaining how to ensure the TNC is communicating properly with your terminal and following on by guiding you into your first QSO. I would still suggest that it you're trying packet for the first time, you try and read up a little on the subject to you how mailboxes work, what to do when you use a NET/ROM Node and so on. A complete description of packet radio is beyond the scope of this article but several excellent USA produced books are published, such as 'Your Gateway to Packet Radio' by WA1LOU and the Packet Radio section of 'The ARRL Operating Manual'. At the moment there is little available in the UK, but I would heartily recommend 'Digicom', a very professionally made quarterly journal produced by Maxpak, the Midlands AX-25 Packet Radio Users Group. This publication, in my opinion, currently puts offerings such as the RSGB 'Connect International' to shame. I'm told the Maxpack group are also preparing a well-needed book on packet radio at the moment.

On The Air

One of the first things which is required before going on the air with the Tiny-2 is for you to set your callsign, being pre-programmed to 'NOCALL' as a default setting. I've lost count of the number of times I've seen 'NOCALL' on the air trying to have QSOs when being a little

View of the Tiny-2 PCB, note the EPROM which can be swapped for future AX.25 protocol enhancements.

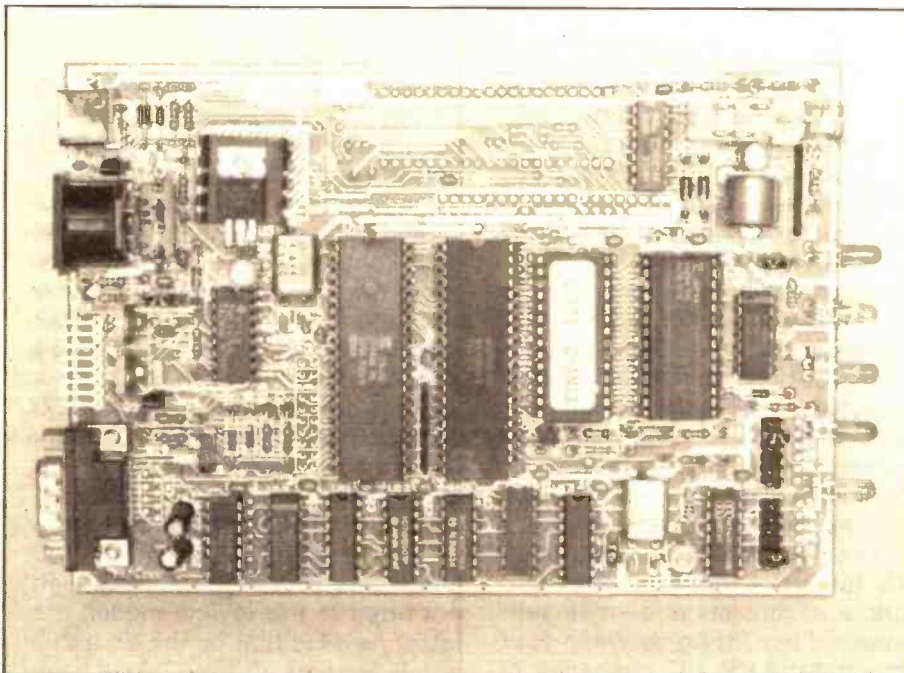

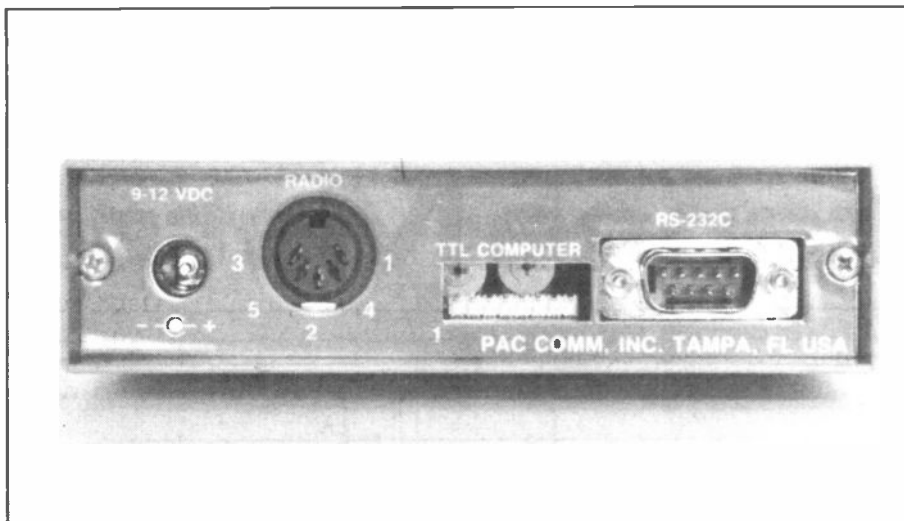

Rear connections to the TNC.

too anxious trying out the new toy! Typing 'MYCALL G4HCL' followed by a carriage return made me legal, this was followed by setting the time and date for monitoring purposes using the command 'DAYTIME' and placing this in European rather than American mode by setting 'DAYUSA' to OFF. As different transmitters vary in the time required to commence transmitting the next thing to do was to set the 'TXDELAY' of the TNC to the minimum possible for correct decoding at the other end, this being easily done by trial and error with a local station (manned or unmanned!).

A 'Calibrate' mode is available with the Tiny-2 allowing correct adjustment of the Tx output tone level, this transmitting a continuous Mark or Space tone as required. Using an adjacent monitor receiver (or an oscilloscope and deviation meter) you adjust the rear panel potentiometer to just below the level where your transmitter starts limiting, i.e. where further adjustment stops the received tone level increasing and probably starts introducing clipping distortion. This I quickly did using a dummy load; it was then time to try a first 'Connection'.

When the TNC is first switched on it is in 'Command' mode, signified by 'Cmd:' appearing on the screen following the initial self-check display. One of my local digipeaters is GB3PX (Cambridge), so I entered the magic words 'CONNECT GB3PX' and '***CONNECTED TO GB3PX' appeared on the screen, the TNC automatically switching from 'Command' into

'Converse' mode to allow me to start communicating. From then on it's pure 100% copy.

Front Panel

Five LEDs adorn the front panel, these being labelled DCD, PTT, STA, CON and PWR. The DCD is a 'Data Detect', lighting when packet bursts are received; the PTT indicates transmit keying; STA indicates unacknowledged transmit packets; CON shows that you are 'Connected' to a station, and PWR simply indicates DC power on.

Due to the extremely large number of operating commands found on all TNCs, Pac-Comm thoughtfully provide a two-page reference list of commands and their meanings to assist you. After initially setting up the CBELL (telling my computer to bleep at me when connected), USERS (number of streams available for multiple connects, i.e. simultaneous QSOs), MStamp (time and date 'stamp' of monitored packets) and so on, I found I only needed to refer to the list very occasionally, even so this did save me having to flick through the manual each time I needed my memory jogging!

Back-up

A lithium backup battery is fitted inside the unit allowing modified parameters to be stored even when the unit is switched off. However in common with many other operators I normally left the unit on 24hrs per day, with stations attempting to connect to me in my absence receiving a short one-line text inviting them to leave a mess-

age to be read on my return. Similarly the TNC/radio combination may be used as an automatic 'digipeater', a store and forward digital repeater to aid other stations not in direct range of their intended contact to establish communication using an intermediate station. This facility may be toggled on/off as required, and you may key an 'Alias' callsign into the TNC for digipeater use if you require.

Throughout the on-air tests the unit performed well and during. One evening when a tropospheric lift occurred the DCD LED never went out for several hours with all the activity present. Throughout most evenings and weekends, the band was fairly busy in my location, packets sometimes being received for around 90% of the airtime when a couple of mailboxes started going. At such times the going did get very slow when attempting communication as the TNC tried to 'squeeze in'. This of course is not a limitation of the Tiny-2 but a measure of the amount of data traffic present - as I have mentioned, packet is getting very popular!

Conclusions

At the present time the Tiny-2 must, in my opinion, represent the most cost-effective way to get started on VHF packet radio. The unit is small, light, easy to set up, and uses a command set common to others, which once learned is easy to use. The in-built personal mailbox facility to be fitted in future units will make the Tiny-2 even more desirable. Being TNC-2 compatible it is also suitable for unattended NET/ROM link use when fitted with an appropriate EPROM Repeater groups may find the Tiny-2 a viable cost effective alternative to assembling their own TNC.

Remember that for shack use you will also need an FM transceiver capable of operation on 144.650MHz, plus 144.675 if possible for QSOs away from the QRM. Many amateurs start by using their main station rig for this but be warned, in common with many other stations you could become so addicted to packet that you rig is rarely disconnected from the TNC!

My thanks go to Andrews Computer Services Ltd. for the loan of the review TNC.

Wide Range Capacitance Meter

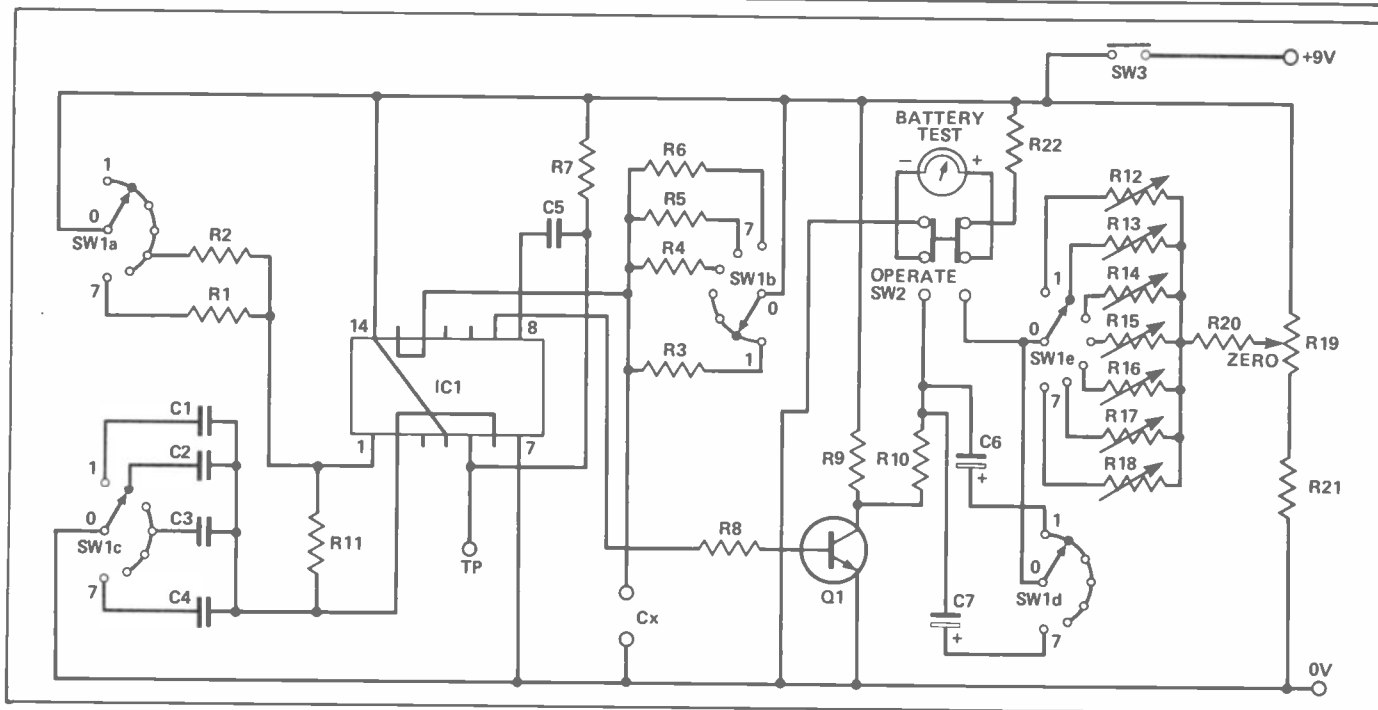

Are you tired of deciphering capacitor codes, or need to measure a mystery component? This project by S F Brown, G4LU, can cure your problems for you.

The circuit to be described Fig. 1 is not especially original but it has some individual adaptations which enable it to read from single figure pico-farads to 100 micro-farads. It uses a 556 type dual timer, one half of which is arranged as an astable oscillator to produce narrow

Traditionally the measurement of capacitance has utilised bridge methods where the unknown component is compared against standard capacitors. The accuracy of measurement obviously depends on how precisely the capacitance of the standard is known and on its quality. Obtaining a good null can be a fiddling procedure for it often involves the alternate adjustment of the main capacitance dial and a resistance/power factor control. As a result the measurement is often of greater precision than is required for practical purposes. The advent of integrated circuits has changed the situation materially and now direct reading capacitance meters are quite feasible.

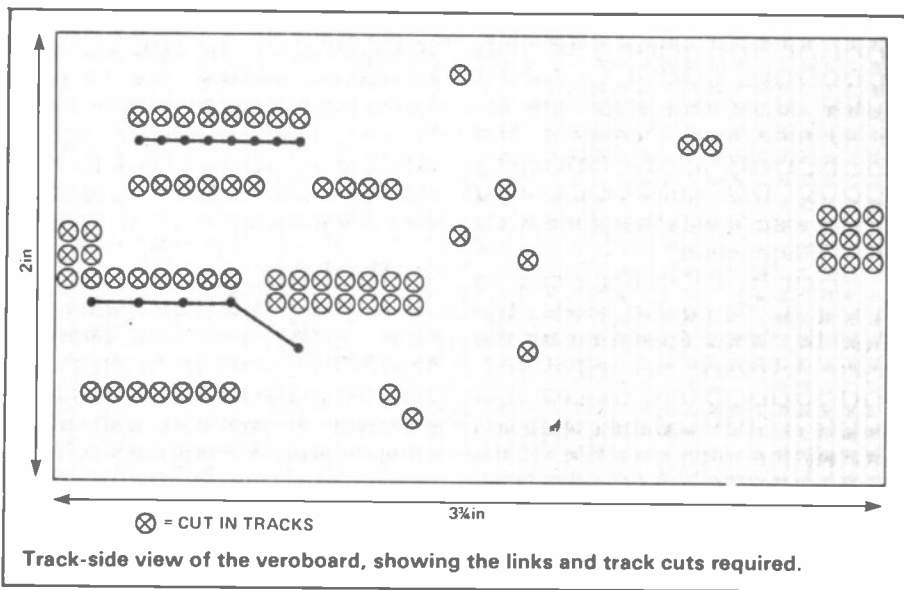

output pulses, triggering the other half which is configured as a monostable pulse generator.

The timing circuit of the latter consists of the capacitor being measured and a suitable value of resistor. These determine the width of the monostable's output pulses which are then amplitude limited in a transistor amplifier arranged to operate between cut-off and saturation. The fixed level pulses are averaged in a DC meter, the deflection of which will be proportional to the capacitance. For the meter reading to be linear over the complete scale scale on each capacitance range the monostable output pulse must terminate *before* another triggering pulse arrives from the astable oscillator and in this instrument its length at the maximum of each range is made about 75% of the trigger interval. In order to meet this criterion it follows that some or all of the timing components in the astable circuit need to be changed for each range as does (on some ranges) the resistor, which with the capacitor under test, determines the width of the monostable output pulse. The width of the astable pulse is of little consequence, provide it is not too large, since triggering occurs on its leading edge. Consequently the resistor (R11), which controls it, is kept at one value for all ranges.

Additional switching is required to change the resistors (R12-R18), which set the full scale calibration on each range and also the shunting capacitor across the meter terminals. The function of the latter is to stop the meter needle from vibrating at the pulse repetition rate and one value is sufficient for all ranges except the highest one. Here a much larger value has to be employed, but even this is not quite sufficient to steady the needle completely. However, the excursions are reasonably small and the repetition rate sufficiently low so that it is not difficult to interpolate to get the correct reading.

This is adequate for most prac-

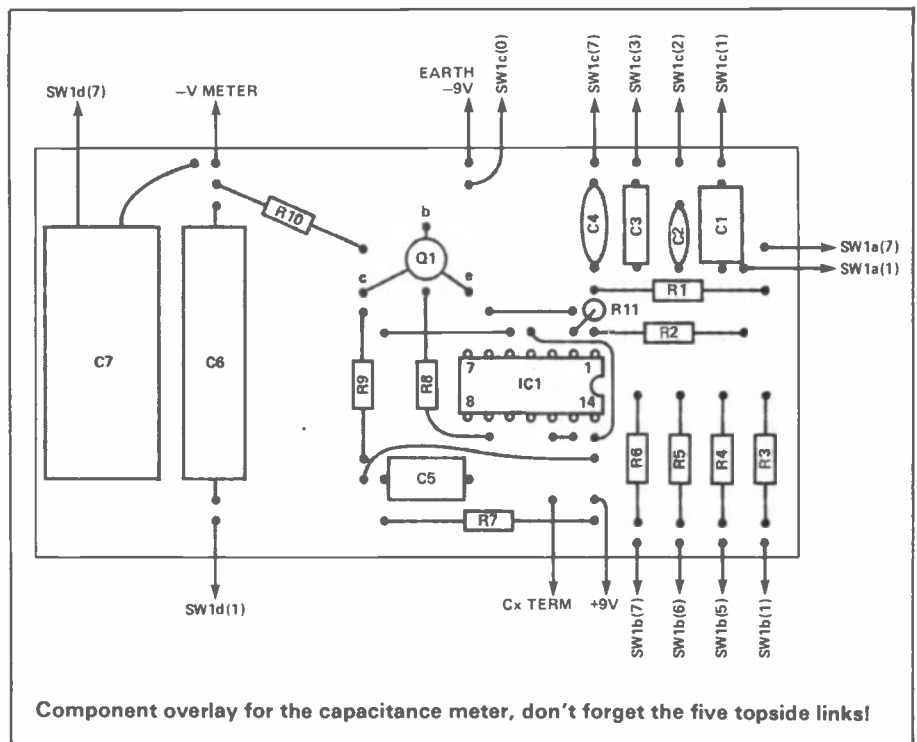

tical purposes since the capacitors measurable on the top range are usually electrolytic types and their values are not required to be known with the same degree of precision available on the lower ranges. The astable and monostable timing components for each range are listed in the table together with the other switched components.

Practical construction

Most of the details of the construction will be clear from the photograph. Any suitable box can be used, the one used originally being 8"x6"x3" deep, but this was to accommodate the large size meter which happened to be available. The components are mainly contained on a piece of 0.1" module Vero-board, 3.75"x2", which is set at a suitable height in the box on two brass pillars. The board is fastened to the pillars by means of a piece of plastic angle at each end. The copper track cut-aways are shown in the drawing (Fig. 2) of the rear side of the board and the component layout will be clear from the corresponding drawing of the front

face (Fig. 3). There is, of course, no reason why two separate 555 units should not be used instead of the dual 556 IC unit but this will necessitate changes to the track layout.

The switch will probably be the hardest and/or most expensive item to obtain and the best source will be rally stalls although, as in the writer's case, these may need to be modified or rebuilt. A suitable switch (5 bank, 1 pole, 7 way, break before make) can be built up from Maplin's Maka-switch or Electro-mail's rotary switch kits. The coupling capacitor between the astable and monostable units (C5) needs to be sufficiently large to pass the lowest pulse rate and the one specified was the only one of as conveniently small physical size to be found in the catalogues. Physically larger items will need track changes to accommodate them. The limiting transistor is a type 2N706, again from a rally job lot, but the type is not critical. Any NPN type of similar rating will be suitable since it has only to work between the extremes of its load-line. A test point is provided in the form of a protruding wire at the rear of the board from pin 5 of the IC to allow observation of the astable waveform on an oscilloscope and there are sufficient points on the face of the board where the connection can be made to observe the monostable waveform.

Range Cx	Monostable resistor SW1b	Astable capacitor SW1c	Astable resistor SW1a	Meter shunt capacitor SW1d
0-100pF	1M	1.5nF	150k	200µF
0-1nF	1M	22nF	150k	200µF
0-10nF	1M	220nF	150k	200µF
0-100nF	1M	220nF	150k	200µF
0-1µF	100k	220nF	150k	200µF
0-10µF	10k	220nF	150k	200µF
0-100µF	1k2	470nF	1M	4700µF

Meter Choice

The meter used in the instrument described is a large scale, 5"×3½", 0-1mA FSD instrument but was scaled 1-15, which meant that only two thirds of the scale was utilised for each nominal range. Obviously a 0-10 scale would be easier to read but on the other hand the calibration to 1.5 times the nominal range provides slightly more overlap at the bottom end of the scale. The linearity is sufficient to accommodate a meter scaled 0-10 but the setting resistors (R12-R18) will need to be adjusted appropriately on each range. Also R20 and/or R10 may need to be changed in order to bring the adjustment within the scope of each variable on each range. The setting resistors are mounted on a separate sub-bracket under the panel since, once set, they will require no further alteration.

The unknown capacitor is connected to the instrument by means of two bush type terminals, with integral 4mm sockets, mounted on the panel. The stray capacitance associated with them and the rest of the circuit would normally be read on the meter when nothing is connected to the terminals. This reading is brought to zero by means of the "Zero" control before the capacitor is connected for measurement. The adjustment is only of significance on the lowest range and need not be made when switching between the other ranges.

Provision is made by means of switch SW2, to check the battery voltage, which should not be allowed to fall below 8.5 volts. Since the meter is only switched on momentarily whilst a measurement is being taken battery drain is low and its life long. A suitable clamp made from brass or aluminium holds the battery in position.

Calibration

For calibration it will be necessary to obtain several capacitors each of which is equal to or near to the maximum value of the individual ranges. All that needs to be done is to connect a capacitor to the appropriate range and to adjust the range setting resistor to the proper value, having set the meter zero as necessary, beforehand. In the 0-

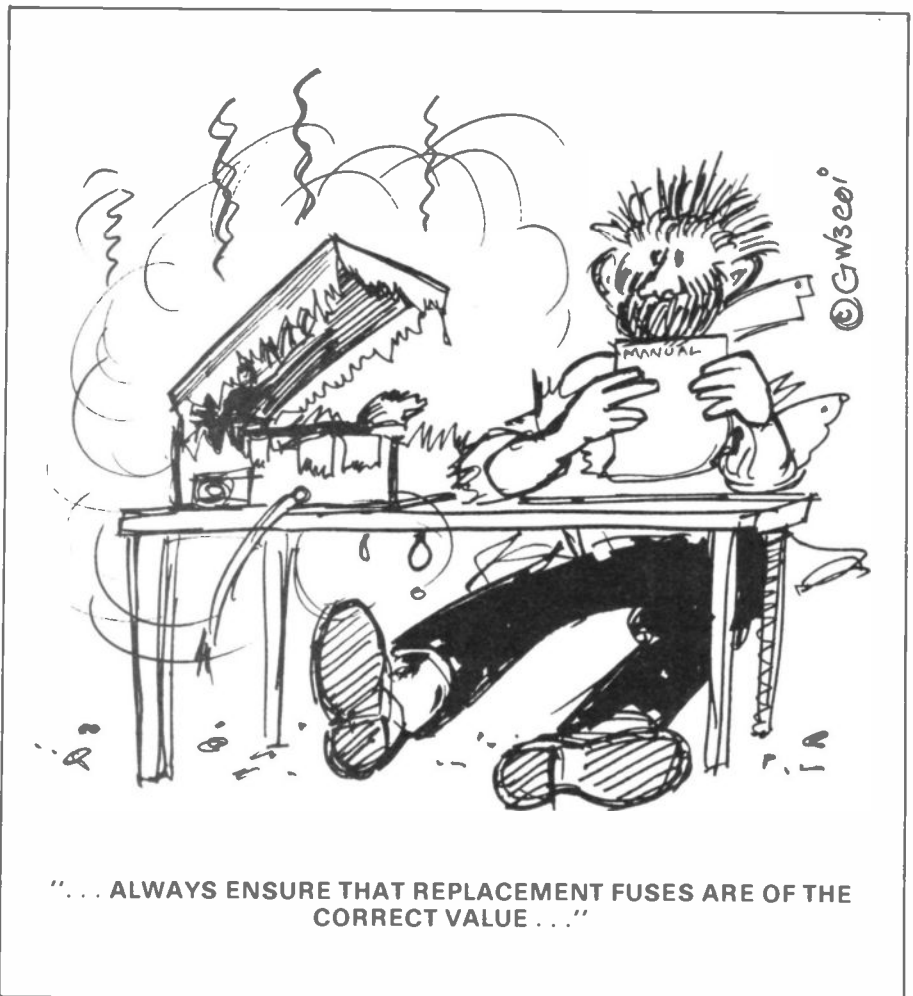

"... ALWAYS ENSURE THAT REPLACEMENT FUSES ARE OF THE CORRECT VALUE ..."

100pF range it is possible to obtain silver-mica capacitors of 1% tolerance for calibration purposes but on the other ranges SM or other types are easily available in 5%, 10% and 20% tolerances. The choice obviously will determine the ultimate accuracy of the instrument. Where units of only the widest tolerance can be obtained it is best to check with several of them and average the result to improve the accuracy. This is particularly the case on the two highest ranges where the tolerances of electrolytic

units which are likely to be used, are largely academic.

To anyone who has previously used a mains operated bridge, probably depending on thermionic valves for oscillator and detector, the convenience of a direct reading instrument will have great appeal. The instrument covers virtually the whole range of values most likely to be encountered in amateur use, with an accuracy determined in the calibration process, and which will be more than sufficient for all practical purposes.

Component List

RESISTORS

R1, 3	1M
R2	150k
R4	100k
R5, 8	10k
R6	1k2
R7, 9, 10	4k7
R11	680R
R12-19	2k2 lin pot
R22	2×33k

in parallel
All resistors ½ watt 5%

CAPACITORS

C1	1.5nF 63v Poly
----	----------------

C2	22nF 100v Mylar
C3	220nF 100v Mylar
C4	470nF 100v Mylar
C5	1µF 100v Polyester Layer
C6	220µF 16v Axial Elect
C7	4700µF 100v Radial Elect

SEMICONDUCTORS

Q1	2N706 or equiv
IC1	556 dual timer

MISCELLANEOUS

SW1 a-d 5 bank 1 pole 7 way switch SW2 Miniature 2 pole c/o, SW3 Miniature push on, 14 DIL IC socket, Terminals, M1 0-1mA FSD

RADIO Tomorrow

- 1 Jul** Loughton DARS: Rainbow & Dove Field weekend planning night. Loughton Hall, Rectory Lane, Loughton, Essex.
Blackwood & DARS: Video night. 7pm. Oakdale Community College.
Coventry ARS: Night on the air.
Maltby ARS: Project Corner.
- 2 Jul** Willenhall DARS: Special Event station GB75WS on HF to celebrate 75 years of amateur radio. Station will run throughout weekend with special QSLs being available.
- 3 Jul** Salop ARS: Fox Hunt, 3rd qualifier for club trophy.
- 4 Jul** Welwyn — Hatfield ARC: Talk 'Safety in the Shack'. Lemsford Village Hall, Brocket Rd, Lemsford.
Todmorden DARS: Treasure Hunt for G4HYY trophy. 8 pm. Queen Hotel, Todmorden.
- 5 Jul** Stevenage ARS: Fox Hunt.
Rugby ATS: 2m DF. 7.30pm. Cricket pavilion, BTI Radio Station, 'B' building entrance, A5 Trunk Rd, Hillmorton, Rugby.
Fylde ARS: DF Fox Hunt, The Kite Club, Blackpool Airport.
Delyn RC: Visit to British Aerospace.
E Lancs ARC: Fox Hunt.
S Powys ARC: Demonstration — the HRO receiver.
Wolverhampton ARS: Committee meeting.
- 6 Jul** Chestnut DARC: Natter evening, Church Room, Church Lane, Wormley, Nr. Chestnut, Herts 8pm
Stourbridge & DARS: Carnival Briefing. Robin Centre, Beauty Bank, Stourbridge.
Fareham DARC: 'When the wind blows' by SEHants Raynet Group. 7.30pm. Room 12, Portchester Community Centre, Westlands Grove, Portchester, Hampshire.
Mid-Sussex ARS: Informal meeting.
Derby DARC: Junk Sale
S Bristol ARC: Talk 'Visit to Indonesia' by Peter, G0DRX.
- 7 Jul** Yeovil ARC: Club visit to Hinkley Point.
Pontefract DARS: Talk 'Amateur Radio Awards' by G4OSY. 8pm. Carleton Community Centre, Carleton Rd, Pontefract.
Horsham ARC: Talk 'PO Box 88' by G3FXB 8pm. Guide Hall, Denne Rd, Horsham.
E. Kent RS: Car Rally (Venue to be announced).
Meirion ARS: Talk 'Wartime Clandestine Radio' by Alan, GW3INW.
- 8 Jul** Blackwood & DARS: Quiz with Newport ARC: 7pm. Oakdale Community College.
Wimbledon & DARS: Talk 'Raynet' by G4SYT & G1ADW. 7.30pm. St Andrews Church Hall, Herbert Rd, Wimbledon.
Itchen Valley RC: Talk 'PCB design using CAD' by Mike G6LMK.
- Coventry ARS: 2m DF Contest.
Grafton ARS: Special event station operating from Herstmonceux Castle, E Sussex on 70cms, 2m, 6, 10, 15, 20 and 160m. Also operating on 9th & 10th July.
Maltby ARS: Three in a Row — three short talks by members.
- 9 Jul** Stevenage ARS: Talk 'Satellite Comms' by Jay G3HEA
Stourbridge ARS: Stourbridge Carnival.
Ariel RG (BBC Club): Summer Festival. Further details from Trevor Butler, Day: 01-927-4372, Eve: 01-747-0624, Car: 0860 348113.
Willenhall DARS: Special event station GB75WS on HF to celebrate 75 years of amateur radio. Station will run throughout weekend with special QSLs being available.
- 9 Jul** Loughton DARS: Rainbow & Dove Field weekend at Hastingwood Common, Old Harlow. GB2LRS.
- 10 Jul** **Worcester DARC Rally. Droitwich High School. Details from Steve on 0905 424151.**
Sussex Mobile Rally. Brighton Race Course. details from Bob on 0798 43841.
- 11 Jul** Atherstone ARC: DF Hunt 2 7.30pm. Physics laboratory, Atherstone Upper School, Long St, Atherstone.
Felixstowe DARS: Social evening.
University of Lancaster ARS: Surplus equipment sale.
- 12 Jul** Dorking DRS: Informal meeting at 'The Plough', Coldharbour. 8pm.
Rugby ATS: Talk 'Stereo television' by Mr Robinson of BBC, 7.30pm. Cricket Pavilion, BTI Radio station, 'B' building entrance, A5 Trunk Rd, Hillmorton, Rugby.
Verulam ARC: Activity evening.
Wolverhampton ARS: Junk sale.
- 13 Jul** Chestnut DARC: Police — Security in the home. Church Room, Church Lane, Wormley, Nr. Cheshunt, Herts. 8pm.
Derby DARC: Night on the air.
S Bristol ARC: HF activity evening.
- 14 Jul** Barry College of Further Education RS: Video 'DX-Pedition to VP8 land'.
Edgware & DRS: Test equipment — talk and demonstration. Walting Community centre, 145 Orange Hill Rd, Burnt Oak, Edgware.
Pontefract DARS: Committee meeting 8pm. Carleton Community Centre, Carleton Rd, Pontefract.
Salop ARS: Talk 'Aerials for small gardens' by G3BR.
Yeovil ARC: Barbeque at Ham Hill.
- 15 Jul to 17 Jul** **RSGB National Convention at Birmingham NEC 15th, 16th and 17th July.**
Come and visit us on the Ham Radio Today stand!
- 15 Jul** Loughton DARS: Informal evening. Loughton Hall,

- Rectory Lane, Loughton, Essex.
Blackwood & DARS: Natter night. 7pm. Oakdale Community College.
Sutton & Cheam RS: First Aid for the Radio Amateur. 7.30pm. Downs lawn tennis club, Holland Ave, Cheam.
Coventry ARS: Night on the air.
Maltby ARS: Night on the air.
- 16 Jul** Barry College of Further Education RS: Coach trip to RSGB Convention, NEC, B'ham.
Wakefield & DRS: Barbeque at G4VRY.
Willenhall DARS: Special event station GB75WS on HF to celebrate 75 years of amateur radio. Station will run throughout weekend with special QSLs being available.
Coleshill (Llanelli) ARS: Special event GB4PCP. 8am - 12pm.
- 18 Jul** Stourbridge & DARS: Talk 'Test equipment use & abuse' by G8JTL & G8MCK. Robin Woods Centre, Beauty Bank, Stourbridge.
Welwyn — Hatfield ARC: Fox Hunt. Knightsfield Scout HQ, opp. Ingles, Welwyn Garden City.
Todmorden DARS: Natter night. 8pm. Queen Hotel Todmorden.
University of Lancaster ARS: Social get together at Oysterber Farm, Bentham, N Yorkshire. Special event station GB2YD operational, dance in local community centre on Saturday evening. Some caravan/camping facilities. Details from G1OHH, G1KLZ or G4DAL — All QTHR.
- 19 Jul** Wakefield & DRS: Annual Open Pitch & Putt — Holmfild Park.
Rugby ATS: Activity night. 7.30pm. Cricket pavilion, BTI Radio station, 'B' building entrance, A5 Trunk Rd Hillmorton, Rugby.
Midland ARS: Talk 'Photography' by Tim Jebbett G0GPZ.
Fylde ARS: Informal meeting. The Kite Club, Blackpool Airport.
Delyn RC: Barbeque.
S Powys ARC: Social evening.
Wolverhampton ARS: Night on the air.
- 20 Jul** Cheshunt DARC: Natter evening. Church Room, Church Lane, Wormley, Nr. Cheshunt, Herts. 8pm
Derby DARC: Talk 'Ambulance Communications' by Alan, G8SSL.
S. Bristol ARC: 2m activity evening.
- 21 Jul** E Kent RS: Operating evening at Bishopstone.
Salop ARS: Natter night.
Yeovil ARC: Talk 'Oscillators' by G3MYM.
- 22 Jul** Coventry ARS: Night on the air.
Maltby ARS: Life after amateur radio — a look at other hobbies.
Willenhall DARS: Special event station GB75WS on HF to celebrate 75 years of amateur radio. Station will run throughout weekend with special QSLs being available.
- 24 Jul** Burnham Beeches, Maidenhead & Chiltern ARC: **6th McMichael Rally. Traders, stalls, car-boot sale CAMRA beer bar & refreshments. Special event station GB7MMR. 10.30am (10.15am for disabled) at The Haymill Centre Burnham Beeches.**
Anglian Mobile Rally. High Woods Sports & Leisure Centre, Colchester. Details from G6HQI on 0206 862403.
- 25 Jul** Atherstone ARC: Informal meeting at 'The Bull', Witherley at 8pm.
Felixstowe DARS: Talk by Neville Pattinson, G8SYZ.
- 26 Jul** Dorking DRS: Portable activity 2-4-6 metres. Barbeque BYO. Assemble 7pm Devil's Dyke, Brighton.
Stevenage ARS: Committee meeting
Rugby ATS: 2m DF. 7.30pm. Cricket Pavilion, BTI Radio Station, 'B' building entrance, A5 Trunk Rd, Hillmorton, Rugby.
Verulam ARC: Talk by 'DX Eyeballs' by Basil, G4PAY.
Wolverhampton ARS: Club project.
- 27 Jul** Cheshunt DARC: Portable on Baas Hill.
Derby DARC: Talk 'Weather FAX Reception Techniques' by Reg, G8UQP.
S Bristol ARC: 70cms activity evening.
- 28 Jul** Edgware & DRS: Informal — Station on the air. Watling Community Centre, 145 Orange Hill Rd, Burnt Oak, Edgware.
Pontefract DARS: On the air night 8pm. Carleton Community Centre, Carleton Rd, Pontefract.
- 29 Jul** Loughton DARS: Night on the air. 8pm using G4ONP Loughton Hall, Rectory Lane, Loughton, Essex.
Wimbledon & DARS: Talk 'Raynet' by G4SYT & G1ADW. 7.30pm. St Andrews Church Hall, Herbert Rd, Wimbledon.
Coventry ARS: Night on the air.
Maltby ARS: Treasure Hunt — Helicopters not allowed!
Yeovil ARC: Natter night.
- 28 Jul** **Salop ARS: HF special event station on the air.**
- 30 Jul** Stevenage ARS: AMSAT Colloquim.
E Kent RS: Barbeque at Bishopstone from 6.30pm.
- 1 Aug** Welwyn-Hatfield ARC: Talk 'Fax & weather satellite images. Lemsford Village Hall, Brocket Rd, Lemsford
- 2 Aug** Fylde ARS: DF Fox Hunt The Kite Club, Blackpool Airport.
Rugby ATS: Activity night. 7.30pm. Cricket pavilion, BTI Radio Station, 'B' building entrance, A5 Trunk Rd, Hillmorton, Rugby.
Wakefield DRS: Car Treasure Hunt.
Chichester DARC: Annual summer social evening.
Delyn RC: Quiz Night.
S Powys ARC: Talk 'Telephones for home & shack'.
Wolverhampton ARS: Committee meeting.
- 3 Aug** Cheshunt DARC: Natter evening. Church Room, Church Lane, Wormley, Nr. Cheshunt, Herts. 8pm.
Derby DARC: Junk Sale.
S Bristol ARC: Discussion — Creation of Club Library.
Willenhall DARS: Talk 'Geneology' by John, G4TVA.
- 4 Aug** Pontefract DARS: On the air night 8pm. Carleton Community Centre, Carleton Rd, Pontefract.
E Kent RS: Talk 'Phase Locked Loops & Frequency Synthesisers' by Steve Reynolds, G8NVH.
Meirion ARS: Open night for visiting amateurs.
Salop ARS: Video Night — 5th in the series on circuit design.
- 5 Aug** Coventry ARS: Social evening at the Horse & Jockey.
Maltby ARS: Kite Night, with aerials in mind.
- 7 Aug** Felixstowe DARS: DF Hunt & Barbeque.
RSGB Mobile Rally. Woburn Abbey, Bedfordshire.
- 8 Aug** Todmorden DARS: Natter night. 8pm. Queen Hotel, Todmorden.
University of Lancaster ARS: Video Show.

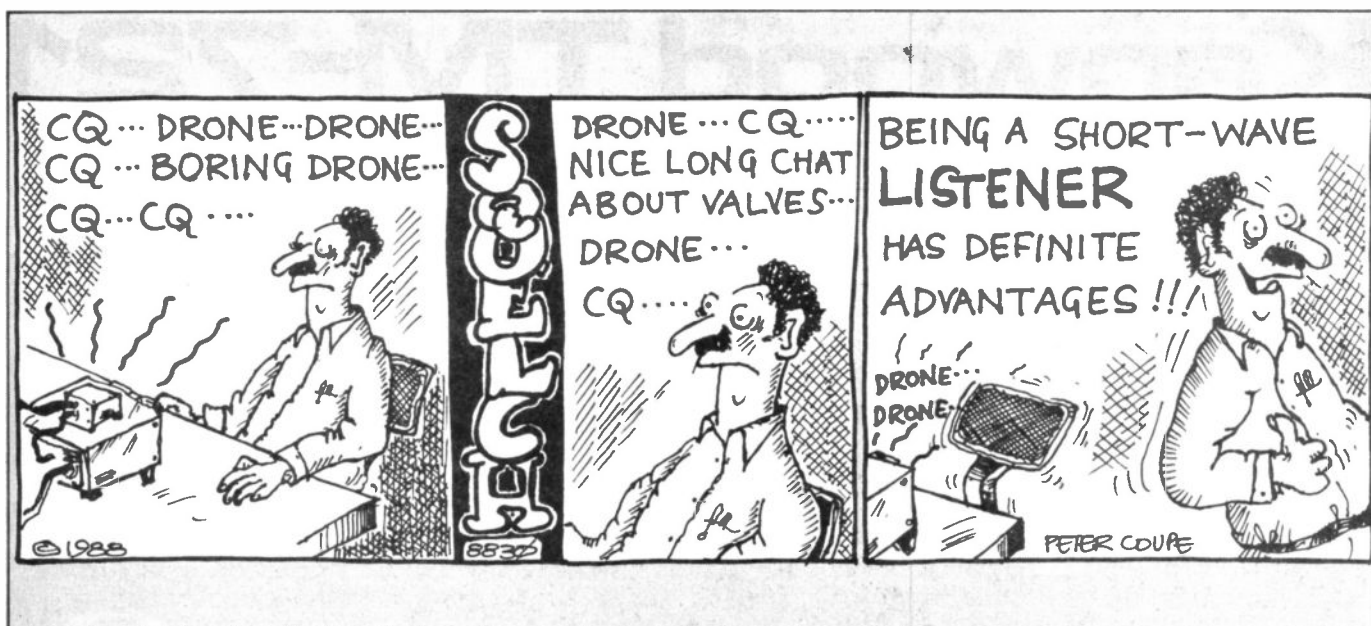

- 9 Aug** Malvern Hills RAC: Natter night. 8pm. Red Lion, St Annes Rd, Malvern, Worcs.
Rugby ATS: 10 pin bowling. Forum Bowling, Coventry
Dorking DRS: Informal meeting at 'Royal Oak', Brockham.
Wolverhampton ARS: Discussion — Home Construction.
- 10 Aug** S Bristol ARC: 6m activity evening.
Willenhall DARS: CW night on the air.
- 11 Aug** Pontefract DARS: On the air night 8pm. Carleton Community Centre, Carleton Rd, Pontefract.
Salop ARS: Natter night.
- 12 Aug** Loughton DARS: Drinks at 'Gardners Arms', Loughton
Coventry ARS: Night on the air.
Maltby ARS: VHF activity night.
- 14 Aug** Flight Refueling ARS: Hamfest '88. Stalls, Craft fair and family entertainment. Free creche available, free parking. Entrance fee 50p (children free). No charge for charities and local hobby groups — booking forms available. 10am - 5pm at The Flight Refuelling Sports & Social Club grounds, Merley, Wimborne, Dorset. Details from John Fell, 14 Rectory Ave, Wimborne, Dorset, BH21 3EZ on (0202) 691649.
Derby Rally. Lower Bemrose School, Derby. Details from Martin on 0332 556875.
- 15 Aug** Welwyn-Hatfield ARC: On air night. Knightsfield Scout HQ, opp. Ingles, Welwyn Garden City.
- 16 Aug** Fylde ARS: Informal meeting. The Kite Club, Blackpool Airport.
Rugby ATS: 2m DF. 7.30pm. Cricket pavilion, BT1 Radio station, 'B' building entrance, A5 Trunk Rd, Hillmorton, Rugby.
Delyn RC: Home made wine evening(!).
Midland ARS: Summer outing.
S Powys ARC: Social evening.
Wolverhampton ARS: Night on the air.
- 17 Aug** Cheshunt DARC: Natter evening. Church Room, Church Lane, Wormley, Nr Cheshunt, Herts. 8pm.
Chichester DARC: Club meeting.
- 18 Aug** Pontefract DARS: On the air night 8pm. Carleton Community Centre, Carleton Rd, Pontefract.
- 19 Aug** Coventry ARS: Night out operating portable.
Maltby ARS: TV & Video night with G4BVV, GOEIB & Co.
- 21 Aug** Red Rose Rally. Bolton Sports & Leisure Centre, Bolton. Details from David on 0204 24104.
- 22 Aug** RSGB City of Bristol Group: RSGB Video presentation evening. 7.30pm. Small Lecture Theatre, Queens building, University of Bristol.
Todmorden DARS: Natter night. 8pm. Queen Hotel, Todmorden.
Felixstowe DARS: Social evening.
- 23 Aug** Rugby ATS: Talk by Crime prevention officer, PC Wright. 7.30pm. Cricket pavilion, BT1 Radio station, 'B' building entrance, A5 Trunk Rd, Hillmorton, Rugby.
Wolverhampton ARS: Club project.
- 25 Aug** Pontefract DARS: On the air night 8pm. Carleton Community Centre, Carleton Rd, Pontefract.
- 26 Aug** Loughton DARS: Drinks at 'Gardners Arms', Loughton.
Coventry ARS: Canal trip.
Maltby ARS: HF activity night.
Salop ARS: HF special event station on the air.
- 28 Aug** RSGB City of Bristol Group: RSGB Video Presentation evening. 7.30pm. Small Lecture Theatre, Queens building, University of Bristol.
BARTG: 1988 BARTG Rally, Exhibitors, car boot sale, etc. Talk-in on S22, free parking, 10.30am - 5pm at Sandown Park Racecourse, Portsmouth Rd, Esher - on A307 just S. of Kingston upon Thames. Details from Peter Nicol G8VXY, 38 Mitten Avenue, Rubery, Rednal, Birmingham B45 0JB. Tel: 021-453-267 Prestel MBX 219995485.
Delyn RC: Open Night.
Torbay ARS Rally. STC Social Club, Paignton, Devon. Details from G3KZJ, QTHR.
- 30 Aug** Wolverhampton ARS: Natter night.
- 31 Aug** Cheshunt DARC: Natter evening. Church Room, Church Lane, Wormley, Nr Cheshunt, Herts. 8pm.

Kenwood TM-721

REVIEW



There are now a number of dual band mobile rigs on the market, many of which advertise 'full duplex' operation, as indeed the TM-721E does. What they often don't tell you is that you can't go

and 430-440MHz, each band being independently tunable in 5, 10, 12.5, 20 or 25kHz steps. On transmit, 45W is offered on 2m with 35W on 70cm, and a switchable low power level of 5W in each case,

frequency lock switch is provided to guard against accidental frequency shifts in use. The usual repeater and reverse repeater shifts are of course programmed and may be achieved in as required, and a 1750Hz tone button allows for repeater access.

Really two rigs in one – that is the verdict on Kenwoods latest dual bander which lets you listen and transmit at the same time.

along having a chat on one band whilst listening for a call from your friend on the other band, I know a few local amateurs who have been disappointed in this respect after having traded in their 'separates' for a single set that they believed would do it all (they obviously don't read *HRT!*). This facility sets Kenwood's latest offering aside from most of the rest, as inside the box there really does lie a pair of radios, under the common control of a single front panel. My personal preference is always that of never wanting to miss a thing that goes on around the airwaves so with this in mind the review set was immediately installed in the trusty HCL-mobile and subjected to over a thousand miles worth of nationwide full-duplex driving.

Features

The set covers 144-146MHz

and 430-440MHz, each band being independently tunable in 5, 10, 12.5, 20 or 25kHz steps. On transmit, 45W is offered on 2m with 35W on 70cm, and a switchable low power level of 5W in each case, with a GASFET receiver front end offering a sensitive receiver to match the high transmit power. Up to fourteen memory channels on each band are offered, each storing frequency, repeater offset, scan status and the frequency step size — more about this later! Two memory channels on each band may be used to store independent transmit the receive frequencies for 'odd split' use and any memory frequency may be transferred to the digital 'VFO' to allow you to tune away from it using the VFO knob of microphone mounted up/down buttons. On the set's fascia are two tuning knobs, the larger controlling the main band and the smaller one controlling the sub band for independent tuning, to quickly get from one part of the main band to another 1MHz up/down buttons are fitted beneath the main tuning knob. A fascia mounted sliding

Main & Sub Band

A 'main' and 'sub' band are controlled by the set, these may be switched between 2m and 70cm by a single button press. The set may receive both bands at the same time and a slider 'balance' control allows you to adjust the relative audio levels from each band. Individual squelch controls for each band are provided, a rotary control concentric to the main volume knob for the 'main' band and a small slider for the 'sub' band with individual 'busy' indicators and bargraph S-meters being provided on the multi-colour display. On transmit, operation takes place on the 'main' band, however an 'A.B.C.' (Auto Band Change) button switches the set's main band automatically to whichever frequency first becomes active on receive, allowing you to reply to a call on the correct band! If two bands on receive gets too much as you're driving along, then a one-touch 'mute' button quickly reduces the speaker level of the sub band by 20dB, and swithing between dual

and single band operation is possible by another single-button push.

Scanning

Several scanning modes are fitted, although these only operate on the main band. In memory mode, a press of the 'scan' button on the set's fascia commences a selective memory scan, any number of the memory channels may be inhibited from the scan whilst still allowing manual selection by the rotary knob on mic up/down buttons. In VFO mode, the range of frequencies in between the limits programmed into memory channels 'a' and 'b' are searched in the selected channel steps. In each case the scan halts when the main band receiver squelch raises, continuing five seconds later regardless of the squelch state, this may be halted by a press of the mic PTT or the fascia 'scan' button. As well as this, a 'Priority Alert' feature is available whereby Memory Channel 1 is briefly checked for activity every five seconds, a double bleep sounding if the channel becomes occupied. To allow for a degree of confirmation when operating the set's many functions by touch alone, a series of tone bleeps of differing audio frequencies are given following key depressions and the like, this function may be switched on or off as desired. The set's operating conditions are displayed on a large multi colour light-emmissive liquid crystal display panel and a dim button is provided to cut down the light intensity if required. The display shows both operating frequencies together with the main band memory channel if in use, bargraph indications of the relative receive signal strength on each band, relative power, and mode indications such as 'busy', 'low', 'scan' and so on.

Repeater Facility

I understand that with suitable internal linking, the set is capable of operating as a cross-band repeater, which can be switched in and out of operation as required from the front panel controls. This facility could be of use in controlled conditions under emergency situations and the like, where a portable 70cm user uses the car repeater as a com-

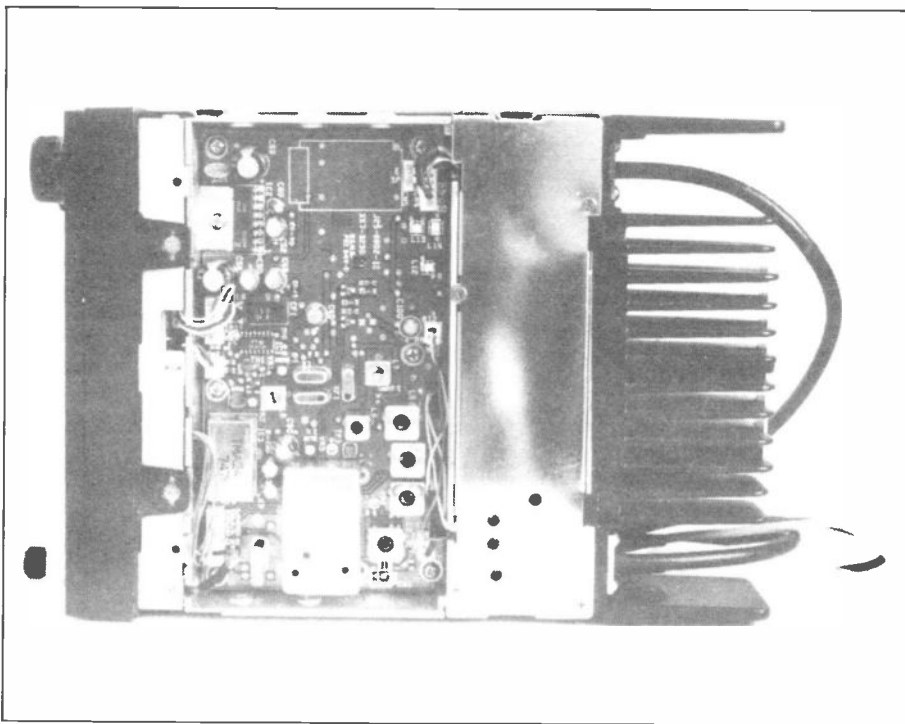

Top view of the 721 chassis.

munication link back to a distant 2m base.

The set measures 150mm(W) × 50mm(H) × 219mm(D) and weighs 1.8kg. Flying leads are provided for DC power and separate 2m and 70cm aerials, the latter coax leads being terminated with SO-239 and N-type RF connectors respectively. Supplied accessories include a mobile mounting bracket and

mounting hardware, first mic with up/down buttons, fused DC power cable, and an instruction manual containing user operating instructions together with large block and circuit diagrams.

In Use

I installed the set in my car, with the DC feed being connected straight to the battery and the aerial

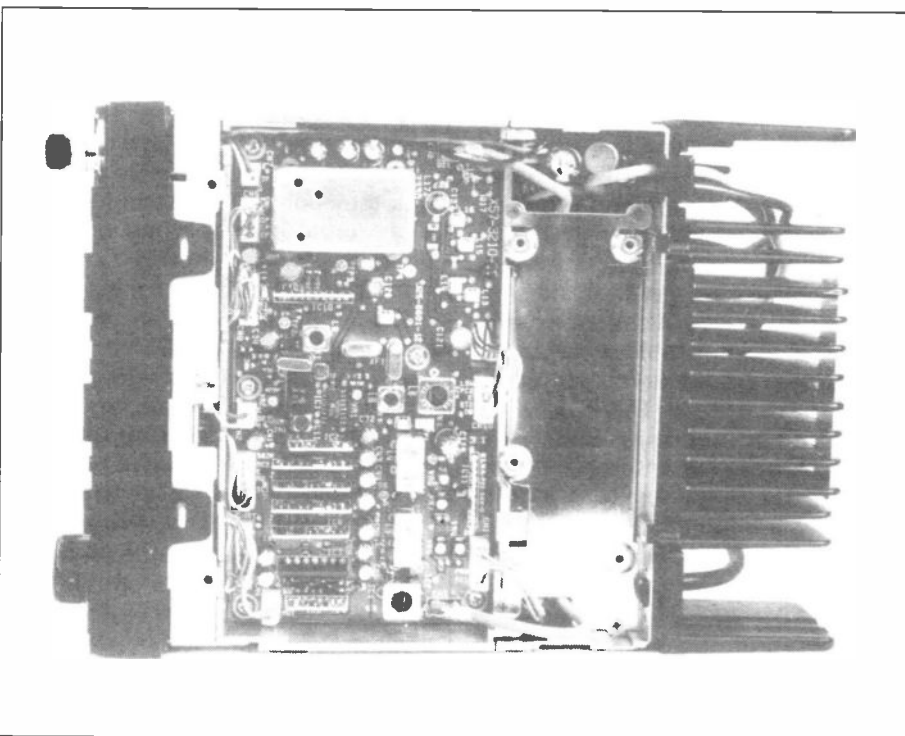

Underside view.

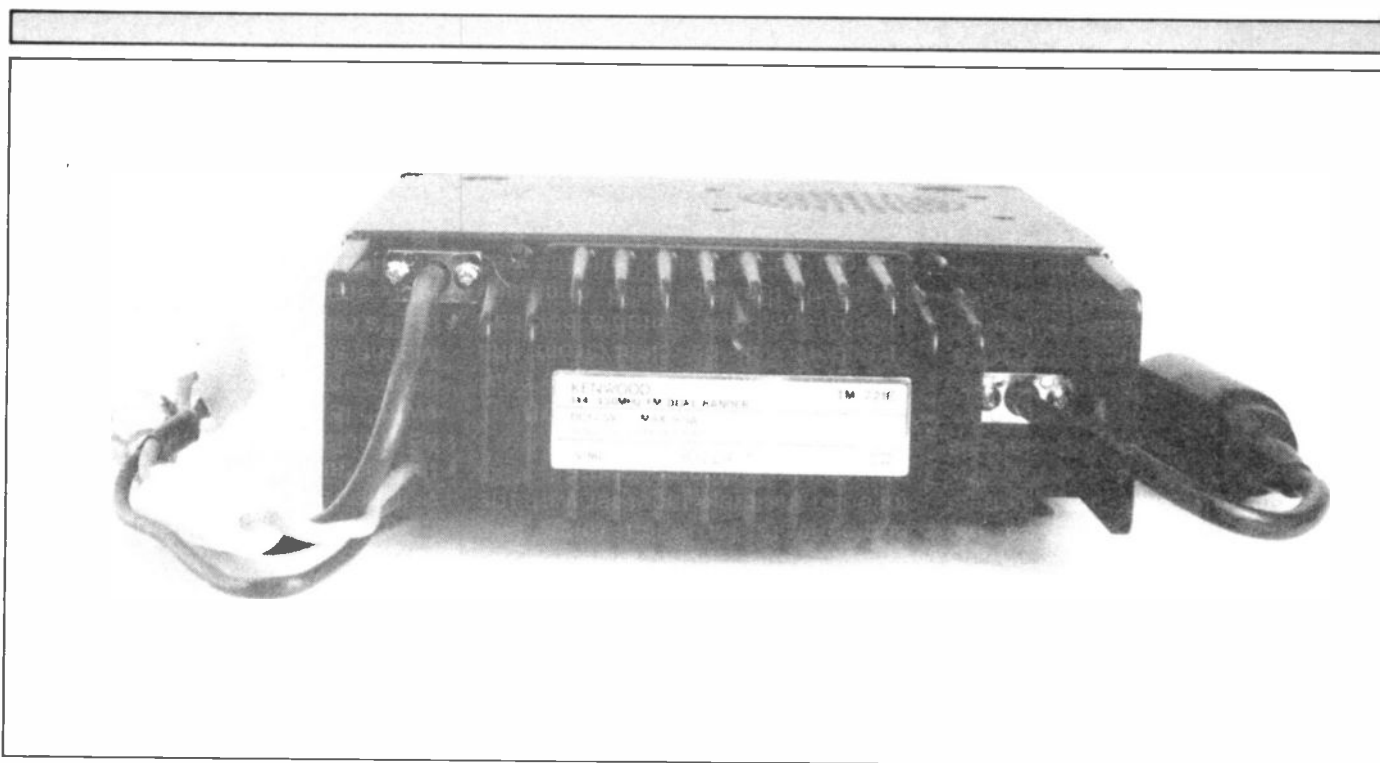

Rear view of the set.

leads via a G4HCL diplexer (*HRT* Jan 1985) to a tiny (20cm long approx.) 'Comet' dual band whip mounted on the gutter. My normal journeys to work take in a couple of semi-local 2m repeaters and a large number of 70cm repeaters. I also tested the set on long journeys across country on unfamiliar roads to see how it fared operating by touch alone whilst driving.

The first thing I noticed was the incredible sensitivity of the set, especially on UHF. 70cm repeaters that were normally rather scratchy were fully readable and one morning I surprised both myself and an amateur friend by having a ragchew through the Corby UHF repeater whilst I was driving along the A10 into Cambridge, all with a 20cm long aerial! I tested the 70cm performance over several mornings by consistently operating through another distant 'problem' repeater — but no problems at all were experienced with the TM-721E. The high transmit power certainly helped in these instances of course, and the set remained cool to the touch despite long periods of transmissions.

Memories

Operating the set in memory mode was very easy and I found that I mainly used the up/down buttons on the microphone for frequency control. A very useful feature is that

the set gives you a low frequency 'bleep' as you reach Channel 0, providing a reference point for eyes-on-the-road operation. I found the memory-to-VFO transfer easy once I had acquainted myself with the tiny button positions, these being sensibly placed next to the tuning knobs. Likewise the tone button was easy to locate, the review set was supplied with this linked as an on/off auto toneburst at the beginning of each transmission. This gave a high frequency bleep when the toneburst was switched off, a low frequency bleep when switching off, again helping operation without squinting at the display. I understand that a simple internal link may convert the toneburst to a more usual 'push for tone' button to conform to the normal requirements in this country for a tone on initial repeater access only this could be more useful depending upon your operating preferences.

I often found the display rather dim for daytime motoring use, this view was also shared by passengers when I asked them to read the display. Switching to the 'Dim' position often made the display unreadable and still a little dim for night time use, maybe a stronger backlight is called for to shine through the multi-colour LCD segments? I found the small buttons below the LCD rather difficult to operate without looking down at the

set, but these admittedly are the lesser used facilities, controlling low/high transmit power, priority channel alert and the like.

Multiple QSOs

I certainly appreciated the fact that I could put a call out on the band, or even in QSO, whilst maintaining a listening watch on the other at a lower volume, this for instance would allow you to listen out on S20 whilst scanning around 70cm. In my road tests I visited the Sandown VHF convention and the Drayton Manor Rally and I found it most useful to set the sub band to the rally talk-in frequency to warn me of any road congestion or other trouble spots while I nattered away on the other band. Similarly when driving into work I set one band to our normal natter channel to alert me when other stations became active while the other band merrily scanned away looking for signals on quiet parts of my journey. Operating the set in very close proximity to other mobile stations at the rally venues caused no receive desensitisation problems whatsoever, with some sets one can easily tell when the guy in the next car 'fires up' on transmit! I sometimes felt when driving in unfamiliar areas that I would have appreciated the ability to scan both bands at the same time, but that I suppose could be taking operating complexity a little

too far!

Received audio reports were very good, I found there was just sufficient audio from the internal speaker for high-speed motorway driving although an external speaker would be of benefit in noisy vehicles. The automatic band change was often very useful, allowing me to reply to a received call without prior button pushing operations, but I did get caught out once when a strong carrier came up on the other band a fraction of a second before I put a call out, changing the band without my realising it and resulting in a little confusion!

Inside the Box

The set is constructed on a sturdy die-cast alloy chassis, with the radio frequency boards housed in the main body of the equipment, the front panel having its own digital circuitry. Several small 'daughter' boards are mounted on the main RF 'motherboard', making repair by module replacement reasonably easy. The set uses chip components in great profusion to achieve the small size.

As technical boffins may see from the block diagram, separate receive front ends, intermediate frequency amplifiers and audio preamps are used whilst, on transmit a common mic amp feeds two totally separate transmitters. Individual synthesises are used too, each under serial control from the

common processor board. The front end transistors on each band are 3SK184 GAsFETs, preceded and followed by RF bandpass filters. The VHF filter following the front end is varicap tuned, suggesting a wide receive frequency range has been 'designed in' for use if required. Individual block type power amplifier modules are used on transmit, these being followed on each band by low pass filter networks and a directional coupler for RF power control.

Laboratory Tests

The measured receive sensitivity confirmed the excellent results obtained in practice and I was very pleased with the remarkable 70cm performance in this respect. When measuring the adjacent channel rejection both at 12.5kHz and 25kHz spacing I was initially convinced I was doing something wrong. Checking and re-checking the signal generator settings confirmed an extremely good selectivity, considerably better than I would have expected for an amateur rig, my congratulations Kenwood! The strong signal handling measurements showed the set has not been compromised by the very good sensitivity provided.

On transmit a respectable power level was noted on each band and the large rear mounted heat-sink kept the set reasonably cool throughout the measurements. Running the set on a 50% Tx:50%

Rx basis in a confined space for an hour (to simulate a typical ragchew) showed the set to cope admirably, the output power reducing little. Harmonic levels were well suppressed, and the peak deviation was nicely set as just below the recommended 5kHz maximum. The frequency accuracy was excellent.

Conclusions

The set allows a great deal of flexibility in operation, and is virtually 'two rigs in one' allowing the operator to use both hands at the same time without missing out on activity as would occur with some other 'duplex' sets. I have always emphasised this limitation when reviewing dual band sets and I'm very pleased indeed to see that Kenwood have taken note of the needs of many amateurs. The technical performance of the set is excellent—it surpasses anything in its league.

The TM-721E is small enough to fit neatly into most cars where two sets could be awkward to install, and although the current price of £699 makes it around the same cost, the TM-721 gives the advantage of common control and a single microphone and speaker. I was very pleased indeed with the set, I wonder what the opposition will come up with?

My thanks go to Lowe Electronics for the loan of the review transceiver.

Head-on shot of front panel.



Circuit diagram of the Kenwood TM-721.

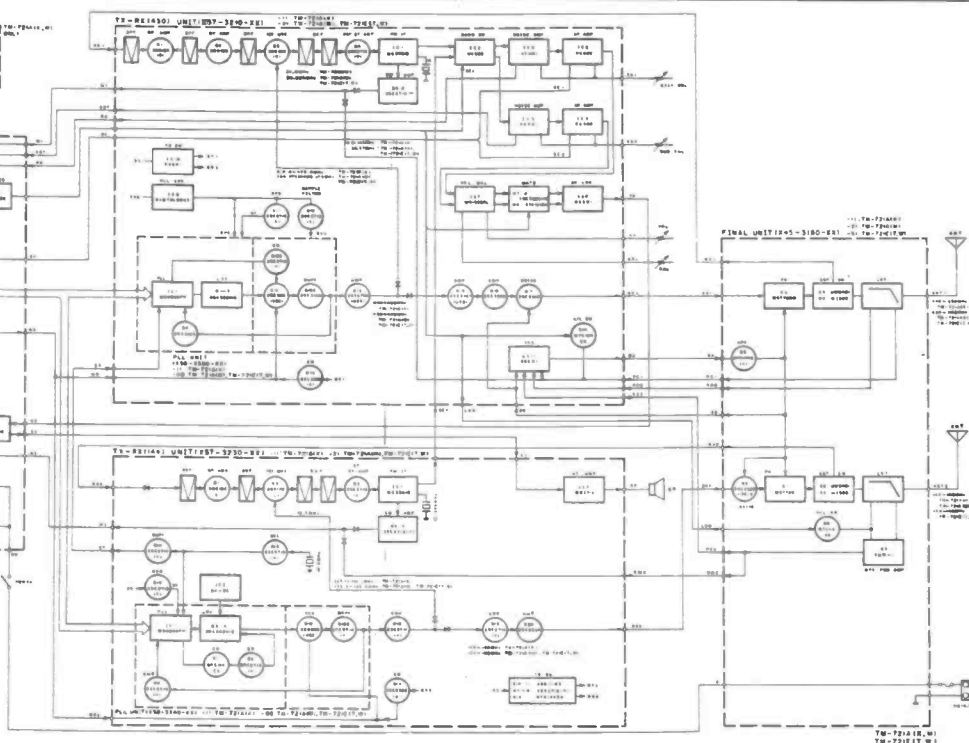

Laboratory Results:

Receiver

Sensitivity: Input level required to 12dB SINAD

Freq	Level
144MHz	0.150uV pd
145MHz	0.132uV pd
146MHz	0.131uV pd
430MHz	0.133uV pd
435MHz	0.129uV pd
440MHz	0.132uV pd

Adjacent Channel Selectivity: Measured as increase in level of interfering signal, modulated with 400Hz at 1.5kHz deviation, above 12dB SINAD ref. level to cause 6dB degradation in 12dB on-channel signal.

Spacing	145MHz	435MHz
+12.5kHz	57.0dB	50.5dB
-12.5kHz	65.0dB	67.0dB
+25kHz	79.5dB	74.0dB
-25kHz	80.5dB	74.0dB

Maximum Audio Output: Measured at 1kHz on the onset of clipping.

Load	Output RMS
3ohm	3.09W
8ohm	1.74W
15ohm	1.10W

Squelch Sensitivity

Threshold	145MHz	0.052uV pd	<2dB SINAD
	435MHz	0.046uV pd	<2dB SINAD
Maximum	145MHz	0.352uV pd	19dB SINAD
	435MHz	0.257uV pd	19dB SINAD

Blocking: Increase over 12dB SINAD level of Interfering signal modulated with 400Hz at 1.5kHz deviation to cause 6dB degradation in 12dB SINAD on-channel signal.

Spacing	145MHz	435MHz
+100kHz	90.5dB	89.0dB
-100kHz	91.0dB	88.0dB
+1MHz	99.0dB	97.0dB
-1MHz	100.0dB	97.0dB
+10MHz	101.0dB	100.0dB
-10MHz	102.0dB	101.0dB

Intermodulation Rejection: Increase over 12dB SINAD level of two interfering signals giving identical 12dB SINAD on-channel 3rd order intermodulation product.

Spacing	145MHz	435MHz
25/50kHz	74.0dB	72.5dB
50/100kHz	74.0dB	73.0dB

Image Rejection: Increase in level of signal at first IF image frequency over level of on-channel signal to give identical 12dB SINAD signals.

	145MHz	435MHz
-21.4MHz)	69.5dB	(-61.65MHz) 81.5dB

S-Meter Linearity

Indication	145MHz		435MHz	
	Sig. Level	Rel. Level	Sig. Level	Rel. Level
S1	0.320uV	-13.8dB	0.324uV	-13.5db
S3	0.650uV	-7.6dB	0.610uV	-8.0dB
S5	0.908uV	-4.7dB	0.845uV	-5.2db
S7	1.23uV	-2.1dB	1.18uV	-2.3dB
S9	1.56uV	0dB ref	1.53uV	0dB ref
S9+	2.03uV	+2.3dB	2.26uV	+3.4dB
S9++	3.02uV	+5.7dB	3.83uV	+8.0dB

Transmitter

TX Power and Current Consumption

Freq MHz	Power	10.8V Supply	13.8V Supply	15.6V Supply
144MHz	High	32.9W/6.30A	53.6W/7.85A	56.7W/7.90A
	Low	5.65W/2.75W	5.69W/2.85W	5.75W/2.85A
145MHz	High	33.0W/6.30A	53.3W/7.80A	56.0W/7.90A
	Low	5.56W/2.75A	5.62W/2.80A	5.66W/2.85A
146MHz	High	33.0W/6.3A	52.5W/7.75A	55.0W/7.90A
	Low	5.49W/2.75A	5.52W/2.75A	5.55W/2.85A
430MHz	High	21.9W/4.95A	36.8W/7.55A	39.8W/7.65A
	Low	5.66W/3.05A	5.79W/3.10A	5.82W/3.10A
435MHz	High	22.0W/6.00A	36.3W/7.45A	39.3W/7.55A
	Low	5.45W/3.00A	5.57W/3.05A	5.61W/3.05A
440MHz	High	22.1W/6.10A	36.1W/7.40A	38.8W/7.45A
	Low	5.13W/2.95A	5.23W/3.00A	5.24W/3.00A

Harmonics/Spurri

	145MHz	435MHz
2nd Harmonic	-75dBc	-73dBc
3rd Harmonic	-77dBc	-84dBc
4th Harmonic	-89dBc	<-100dBc
5th Harmonic	<-100dBc	<-100dBc
6th Harmonic	<-100dBc	<-100dBc
Other Spurri	<-75dBc	<-75dBc
Peak Deviation	4.45kHz	4.51kHz
Frequency Accuracy	<50Hz	+120Hz

Free Readers Ads!

FOR SALE

PACKET, CW, RTTY, Amtor for Commodore C64/128 A.E.A. PK64 similar to PK232 but includes driver software on Eprom £140. S.E.M. Z-Match ATU £50. G4ATZ QTHR West Yorkshire. Tel: 0937 842790.

ICOM R71E mint condition in original packing plus remote control unit superb general coverage receiver £505 o.n.o. Phone daytime 01-969 4347 N.W. London, Joseph.

AZDEN 2000 25w 2mtr scanning multimode TCVR, 9 memories, memory scan, band scan, busy or free frequency scan. RPT shift +/- up/down mic, no toneburst. Phone Peter 0538 702208 G4770 QTHR, £120 post paid.

UNUSED semiconductors, displays, LEDs, DILs (8 SPST Type) used soldering iron (good condition). A reel of 22 SIWG solder (500gls), unused analogue meter, spool of solder brade. Send S.A.E. for list or Tel: 0443 681886 after 5.30 p.m.

FT290R, Mutek board, nicads, charger, leatherette case, carry strap, 5 ELE beam, VSWR meter, heatherlite mic with scan buttons £275 or part exchange basic 2m FM rig (Trio 2300) plus cash balance or scanner W.H.Y. Tel: 01-310 4214 after mid-day, Nigel.

YAESU FRG7000 Receiver wanted, must be in mint condition. Good price paid for this receiver. Phone any evening (01) 281-2493.

934MHz Delta I plus two aerials £275 or exchange for handheld scanner must have air band and be in good condition. Chas 01-240-1277 office hours or 01-987 2296 after 7pm.

NATIONAL PANASONIC RF9000 digital world receiver as mint £995. Also have RF8000, £650. Philips D2999 as new £160 or swop for others. Tel: 0462 33690.

SCANNER Jil SX200N VHF/UHF 26-88, 108-180,

380-514MHz AM/FM various scan rates 16 mems. excellent condition. List price £325, Buyer collects £185. Chris 0634 49112.

FOR SALE FT290R, Mutek, mobile bracket £235. Linc 430 SSB/CW 70cm, £95. KW Viceroy Mark III HF Tx SSB/CW £35 2m HB9CV £3. GOEAG QTHR 04027 57606 after 6pm.

FT277ZD Sommerkamp Mark 2 never been used for 3 years only SWL CW filter fan DC converter AM and FM boards FM fitted, perfect condition £500 o.n.o. Also FC902 ATU as new. Offers. Tel: Mike (0698) 357869.

FOR SALE 2 mtr. antennas 10 element tiger £15. 16 element Tonna £20. Also 50kg rotator £25. All v.g.c. GOIXZ. Phone 0246 824061 after 6pm.

BRAND NEW FT73R 70cm H/P complete with all accessories. Case CSC26, NC28C Charger. PA6 DC-Mobile. FBA10 spare 2nd nicad. FNA10 Dry-pack. MK12AZB Sp/Mic. Belt clip. All with their boxes, papers, wrapping and two sales invoices for £409.50 total. Sell above for cash £275. Tel: 0473 85203.

YAESU FRG8800 together with VHF converter also antenna tuner FRT7700 all mint in makers boxes £350. Phone 0269-2756.

PANASONIC RF9000, RF8000 D2999 World Radios in mint condition, asking £995 - £650 - £180 or exchange for other radios or Tx/Rx. Tel: 0462 420515.

ICOM IC255E 2 metre mobile transceiver 1 watt, 25 watt output £270. Phone 0272 851501.

FOR SALE Pye UHF Westminster mobile for 70cms, c/w accessories, £40 plus carriage. Various channels available at £7.50 each. Low band AM Cambridge (no control gear) OK for 70MHz £10 o.n.o. plus carriage. G3VKM QTHR. Tel: Aldeby (0502-77) 622 (Norfolk).

FOR SALE Superstar 360FM multimode converted to 10

metre band by Spectrum. Mint condition £150. Wood and Douglas 25w 2 meter linear £20. Tel: Mark, Belfast 795783.

FOR SALE or swop for 2 mtr equipment one GR740 Heath kit scanner 30-50MHz, 118, 136MHz, 144 to 148MHz, 148 174MHz, 420 to 512MHz. 40 channel memory, very nice condition. Ring David 0282 37768.

DATONG AD270 indoor multiband active Rx aerial with PSU and instructions, hardly used £25. Telephone Cirencester 4045.

BOXED valves mullard high speed valve tester, various other testing equipment, capacitors, resistors. Quad amplifier and tuner, bomber command receiver. Few Bakelite radios plus other radios. Serious offers. Telephone Hatfield, Herts. 71585.

HAM International Concorde II multimode professionally converted to 10M 28.3-29.64MHz v.g.c. complete with service manual £90 GM0FCP QTHR 0506 880279.

MORSE Course HRT two cassettes providing tuition to the 12 WPM standard with tuition notes cost new £11.45. Yours for £6.00 including postage. Phone 0722 27413 details.

MML/100-S 144MHz 100w out 10w in all mode linear amplifier with switchable pre-amp £80. Tel: Pete, Bristol 0454 - 413433.

YAESU FV101Z remote VFO suits FT101Z, FT1012D, FT901DM, FT902DM. £65 o.n.o. Contact G3PLB QTHR. Tel: 0268 24453 after 6.00pm please.

ROBOT 400C SSTV transceiver complete with Philips V100 camera £400 Mutek TVVF 6m Transverter £150. Yaesu FT-290R11 as new £325. Ring Northampton 770718.

YOKO F-1 Portable 5-inch black and white television. UHF/VHF coverage. Ideal TVDX 240v mains or 12v DC £50 or nearest offer. Phone

Steve 01-330 0695.

MINIBEAM Altron AQ6-20/3E only 9 months old. Perfect condition £80 also AR2200 Rotator complete with control unit and additional clamps for pole mounting if required £50. Mike G3TMB Southport 0704 214012.

COMPUTER 128ZX Spectrum plus tape recorder power pack leads £75 o.n.o. Tokyo HRA-7 mast head pre-amp for 70cms £65.00. Heatherlite mobile microphone headset £15.00. Alphacom printer £15.00 FL2010 Linear 2m 10 watts, mobile £50.00. All plus postage. GOCAM, Tel: 0761-415746.

ICOM IC251E with scanning mic mobile bracket boxed v.g.c. 10in. 80w out A200 linear. Wood Douglas pre-amp all good condition £350 o.n.o. Runcorn 69882 (IC251E not used mobile). Mr. Halden, 19 Fenwick Lane, Runcorn, Cheshire WA7 5YU.

MET 50/3 unused. Buyer to collect. £28 Leamington Spa (0926) 313669.

COLLECTORS radio, very old portable receiver, valve model made by Vidor No. CN381B probably one of the earliest portables, £10. Tel: Garsington 562 near Oxford.

HANDBOOKS Dymar 880 series, AR88D, HRO, FT1012D, Racal RA17, Eddystone 840C, Pye Bantam HP1FM, FT101 Series, Heath kit RF1U, Heathkit IB1100, Pye W15FM, Ham International Concorde II. GW3YGM QTHR. Tel: 0437 2015.

WELZ CP5 80-10m vertical five band rigid loaded radial traps in base £95. 0487 823779 after 6pm.

COLLINS 75SI waters filter, thoroughly checked. No modifications, marks, excellent condition £280. Collins 75AA immaculate specimen, no mods £380 KW204 transmitter factory performance, appearance, blower, recent 6146Bs £280. This equipment is superb, prices include manuals carriage insurance 0229 89635 anytime.

FOR SALE CQDX 21 ELE double quad Yagi 17DBI six months old £25.00 o.n.o. Dave G10QG QTHR Guildford (0483) 504761.

FOR SALE Yaesu FR101RX digital deluxe model near mint condition. 500 KC filter for Drake R4C Rx, offers please. Wanted: Eddystone 940 Rx must be near mint condition also wanted Kenwood SM220 monitor scope and deluxe tuning knob for Kenwood 820 series. J. Wright, 54 Queen Mary Avenue, Basingstoke, Hants.

PYE PF1s two sets Tx's Rx's one set v.g.c. on xtalled on RB4 2nd set xtalled on SUB Tx needs re-alignment Rx ok complete with two sets of Ni-Cads and Pye Nightcall charger, mint condition £100. Tel: 0942 675445, Steve G1HAW.

TRIO TS530SP 2 hours Tx. Mint condition, boxed with manual and Lowe Passport £600. Tel: 0282 64236.

RTTY Transceiver (MM4000KB) all you need is a monochrome TV plus a 12v power pack and you can use your HF or VHF rig to send and receive RTTY £99. GW3COI Abersoch 2675.

FOR SALE Sony ICF2001D plus AN1 active antenna plus many extras. 9 months old in excellent condition. Also Swinburne DR100 Airband radio and signal R537 Airband radio. Both in excellent condition. Sony ICF2001D plus AN1 active antenna £350. Both Airband radios £60. For further details phone David (0633) 853583.

TECHNICAL Software Rx-4 receive program and RIF1 Interface for use with Spectrum computer to decode RTTY/CW/SSTV cost £65 new, accept £40. Technical Software R.A.E. maths teaching program for Spectrum, excellent program £5. Phone Ian 0359 70527 after 6pm.

SWAN 350 SSB HF Transceiver 400w PEP for mobile 12-14v £45. Separate PSU for same £20 Swan 270 transceiver built-in dual PSU £30. Passive/active CW filter £20. SEM Transmatch with Ezitune £35. Bath area. Tel: Radstock 34224 evenings.

LEGAL CB Amstrad 901 complete with magmount

aerial for mobile use and SWR meter. Excellent condition have magazine review. £40. Dave Heath. 49A Parkland Road, London N22 6SU. Tel: 01-881 0824.

FOR SALE FDK multimode 2 metre 750E transceiver two VFO's 1-10 watts very recently serviced and realigned £200. Phone 0343 820955.

EXCHANGE/SALE AR88D matching loudspeaker with lead/plug v.g.c. wanted Eddystone diecast, national, Hammulund matching speaker or W.H.Y. in early equipment. Also available mis-used EC10 for spares repair. D. Blanchard, 141 Dunes Road, Greatstone on Sea, New Romney, Kent.

FT480R (Yaesu) 2m FM/SSB/CW Transceiver 1 watt/10 watts output, with extended frequency coverage and 12½KHz channel steps. Boxed and in perfect condition, complete with mobile bracket and stand. £310. Tel: 01-989 8958 (E12).

FOR SALE AR88D receiver, good condition, spare valves, plus handbooks £40 o.n.o. Wanted PSU for BC221. Tel: Bristol 574893.

TOWER 30ft winch. WD Telescopic tilt over £300 o.n.o. Eddystone 730R needs attention. Offers Dave 02556 79742.

PSION Organiser Model XP 32K Ram, Datapak 64K, Datapak 32K, mains power unit, £160 the lot. Icom World Clock, GC5 £25. All items as new, boxed with manuals, carriage extra or buyer collects. Mr Kenwood 01-570 5603.

FOR SALE Cobra 148 GTL/DX converted to 10 metres handbook & instructions. Weltz SP15M & AC38M matching network 200w. 9 Ele Tonna 70MHz with coax £250 o.n.o. QTHR GOIMI (G6NWG) 0602/293745.

YAESU FRG7700M HF Receiver memories fitted FRV7700B converter (50-59/118-130/140-150MHz) FRA 7700 active antenna for portable or indoor reception (could also be used with long wire 12v DC socket fitted the lot for £280. Tel: 0273 (Brighton) 503958 ask for David after 6pm.

YAESU FT790R new condition, complete charger,

Nicads, case, £285. Yaesu FT 708R excellent condition, case, charger £169, many other 70cm extras. Tel: 0695 524211 John evenings.

TS430S few months old - still under guarantee, £700. Shure Desk mic to Mach £30. Yaesu FL2100Z 1kw HF linear - perfect condition £330. Amcomm 9000 HF ATU - mint condition £60. SMC VHF/HF PWR/SWR meter £10 CB PSU 5-7A £10 professional homebrew 30A PSU £50. Phone 0209 714342.

CREED 444 Teleprinter ex. BT £10. Eddystone EC10 general coverage receiver £40. 10m center load mobile antenna £8. 1987 Rand McNaly U.S.A. Road Map £2. Tel: 0709 814911.

COSSOR Table Model 397 all electric, 6 large valves walnut cabinet about 50 years old, been stored, but still working, 3 bands, original instruction leaflet, 12" mains energised speaker any offers. Phone 021 705 6324.

HQ-1 Beam for 20-15-10 metres complete with Hirschmann rotator, £110. Tel: 0443 683912.

FOR SALE: Pye W15U on 70cm C/W toneburst, £50, Crystals extra. W15FM on 144MHz, single channel, ideal for packet, £45. W15AM's, 70MHz and 144MHz, £25 o.n.o. each. HC6/U crystals 3520/35KHz, SAE list. £1.50 each. G3VKM QTHR. Tel: Aldeby (0502-77) 622.

COMPLETE Base Mobile 2 metre station FT290R c/w mobile mount, helical case, strap, charger, boom, microphone, headset, microphone chanceiver switch, base colinear, 8 element quad rotator, mobile 7/8th, mobile 1/4 wave prefer no splits £450 o.n.o. GOCCEL QTHR. 06267 79455.

QSY TO 70CMS: Standard C828 2m Mobile 10w/1w Tx/Rx 11 channels fitted £100.00. FDK "Multi 2000" 2m 10w/1w FM/SSB/CW 240v/13.5v £120.00. Icom IC/O2E 2m Handie as new £230.00. Altimeter, (Swiss) Electronic, Digital readout as new £90.00. 'Novac' computer monitor (Amber) £45.00. Telephone 01-891-

2349 evenings/weekends. Richmond area.

NIKON and other brands photo gear, S.A.E. list. Linguaphone French on 78's records plus record player £25 collected! Wanted - Keyer, Bug-Key, Datong - auto speech processor, filter F.L.3 G.W.O. essential. Retired hence secondhand. **GODET.** 479 Wordsworth Avenue, Sheffield S5 9JE. Tel: 0742 321453.

ICOM 290E 2 metre multimode 10 watts £285. Yaesu FT790 70cm Multimode £285. Matching Yaesu 7010 linear £60. 2 metre Daiwa mobile receiver £30 KDK2030 2 metre 25 watts F.M. Transceiver temperamental hence £80. Transmit Tripler 70/23cm plus filter £15 G1BWW. Doug 0462 711722 (Herts.).

ROBOT 800 Terminal Tx/Tx RTTY ASSC CW SSTV also 2 metre) 70cm MM Transverter will exchange for 2 metre large linear or WHY. Tel: 031-447-3905 after 6pm. GM4ZOA.

E.R.A. MICRO Reader for sale, four months old, perfect condition, cost £120, accept £70. Phone 0229 25836 Barrow in Furness, Cumbria.

STALKER 1X 11 metre multimode, suitable for 10 metre conversion, excellent SSB Audio £90 or WHY 2 metres? P.X. also Ham Masor Multimode, 11 metre also 80 channels, fair condition £75. Ring Taunton (0823) 45593.

S.S.T.V. System, DL2RZ, matching 5" monitor and camera £125, FT7B Tx/Rx with 160 metres added, super mobile/portable/base rig, matching 240v PSU and external speaker, mobile bracket, mike £285. Wanted: IC202S, 30w/50w 144MHz linear 3w input. Telephone 0793 771153.

MR-4099RX £82. Code Master CW/RTTY CWR-610E £92. Bearcat 200 scanner £75. Silver-Reed E.B. 50 Colour Penguash as new will work with any computer centronics interface £120. Sony AI-Active antenna £32. Trio R2000 with VC10 fitted plus non-standard steeper Kokusai filters SSB/CW £750 as new. Tel: 0272 828586 any time.

Free Readers Ads!

Buy, sell or exchange your gear through our free service to readers.

1. These advertisements are offered as a free service to readers who are not engaged in buying or selling the same equipment or services on a commercial basis. Readers who are should contact our advertising department who will be pleased to help.
2. Advertisements will be inserted as and when space becomes available.
3. The insertion of advertisements will be on a first come, first served basis, subject to condition 2. As a result, it will not be possible to guarantee the insertion of a particular advertisement into any particular magazine.
4. Readers should either write out their advertisement in BLOCK CAPITALS or type it. The first word will appear in bold.
5. The magazine cannot accept any responsibility for printers' errors in the advertisements. However, we will do our best to ensure that legibly written advertisements are reproduced correctly. In the event of a gross error, at the Editor's discretion, a corrected version of the advertisement will be printed (at the advertiser's request) in the earliest issue in which space is available.
6. The magazine or its publishers will not accept responsibility for the contents of the advertisements, and by acceptance of these

conditions, the advertiser undertakes to indemnify the publisher against any legal action arising out of the contents of the advertisement.

7. The magazine reserves the right to refuse to accept or to delete sections of advertisements where this is judged necessary. Illegal CB equipment is not acceptable unless specified as suitable for conversion to amateur or legal CB frequencies.

8. Advertisements are accepted in good faith; however, the publisher cannot be held responsible for any untruths or misrepresentations in the advertisement, nor for the activities of advertisers or respondents.

9. Advertisers must fill in their names, addresses and (if available) telephone number in the space provided, and sign the form to indicate acceptance of these conditions (forms returned without a signature will not be used).

10. All that is to be reproduced in the advertisement should be entered into the space provided on the form printed in the magazine. A photocopy is only accepted if accompanied by the corner of this page. All advertisements must give either a telephone number or address for respondents to contact or both — these must be included in the advertisement.

11. Advertisements must be 40 words or less in length including the address or phone number information. Telephone numbers normally count as two words, exchange or exchange code plus number.

Name

Address

.....

.....

I accept the conditions above.

Signature

Send this form to: Free Readers Ads, Ham Radio Today,
1 Golden Square, London, W1R 3AB

ENTER YOUR ADVERTISEMENT HERE:

RETAIL NETWORK

BEDFORDSHIRE

ELECTRO COMM
NEW CB SHOP
 2A Tennyson Road, Luton
Tel: 0582 458310
CB RADIOS ALL ACCESSORIES.
RELIABLE SPEEDY REPAIR SERVICE.
USED CB'S BOUGHT AND SOLD
(Open 9-6 Tues.-Sat.) ½ mile town centre.

KENT

ICOM (UK) LTD.
ELECTRONICS
Unit 8, Sea Street, Herne Bay, Kent
Tel: (0227) 369464
Telex: 9651791 com G
Fax: 0227 360155
Open Mon.-Sat. 9-5.30pm.
Lunch 1-2.

SUSSEX

G.W.M. RADIO LTD.
40/42 Portland Road, Worthing,
Sussex Tel: 0903 34897
Constantly changing stock of interesting items for
callers. Receivers, test equipment, components
etc. Communications receivers - Rascal RA17 £15,
Eddystone 730/4 £110, plus carriage.
NOW IN STOCK.

BIRMINGHAM

HEWARD'S HOME
STORES LTD.
(Est. 1963)
822/4 Kingstanding Rd., Birmingham B44 9RT.
Tel: 021-354 2083
G4RJM with over 40 years in the Radio Trade
Ham Equipment urgently wanted!
Open: Mon-Sat 9-6

LANCASHIRE

AMATEUR ELECTRONICS/HOLDINGS G3LLL.
YAESU JAYBEAM ORAE DATONG BLACK STAR COUNTERS
ETC FT 101 EXPERTS
6JS6C 6KD6 12BY7A Original type approved
valves & our own Double Balanced Mixer and
new band WARC Kits for original FT 101 MK1-F
S A E List Full Yaesu range 15 mins Junction
31 M6 Free parking Call and consult G3LLL,
without obligation Holidays? Phone check
we are open before calling
45 JOHNSTON STREET, BLACKBURN BB2 1EF.
(0254) 59595. CLOSED THURSDAY.

WEST SUSSEX

BREDHURST ELECTRONICS LTD
HIGH ST., HANDCROSS,
WEST SUSSEX.
TEL: (0444) 400786
Sited at the Southern end of M23 Easy
access to M25 and South London. Open Mon-
Fri 9am-5pm except Wed 9am-12.30pm
Sat 10am-4pm
MAIL ORDER RETAIL

BIRMINGHAM

RAYCOM COMMUNICATION
SYSTEMS
International House,
963 Wolverhampton Road, Oldbury,
Warley, West Midlands B69 4RT.
Tel: 021 544 6767
Opening hours 9-5.30pm Late nights Thurs.-Fri.
Send just £1 00 (refundable against purchase)
for latest catalogue + our exclusive products & used list.

LANCASHIRE

G4 DXX VIDEO ELECTRONICS
For , DRAY, WELLS, DAIWA
DATONG, Logbooks, Rotators,
Cable etc.
Open 9-5pm. Closed Wednesdays.
141 LANCASTER ROAD, MORECAMBE,
LANCASHIRE LA4 5QJ
PHONE (0524) 418873

TYNE & WEAR

ALYNTRONICS
For all amateur communications equipment and
accessories authorised dealers for
 and 
129 Chillingham Road, Heaton, Newcastle Upon
Tyne, NE6 5XL. Tel: 091 276 1002.
Open 10am-6pm Tues-Fri 10am-5pm Sat
Access & Visa accepted

CHESHIRE

FAST AND
FRIENDLY
SERVICE
PAMA HOUSE,
443 Wilmslow Rd.,
Manchester
M20 9AF
061-445 8918
061-434 5701

WHOLESALE
CB

LEICESTERSHIRE

ELLIOTT ELECTRONICS
for the Radio Enthusiast
26-28 BRAUNSTONE GATE,
LEICESTER.
TEL: 553293
Open: Mon-Sat 9.00am to 5.30pm

YORKSHIRE

ALAN HOOKER
ELECTRONICS
42 Nethernall Road,
Doncaster 
Tel - 0302 25690
Large stocks of electronic
components.

DEVON

AGRIMOTORS
Merton CB & Radio Centre
Merton Garage & Post Office, Merton,
Nr. Oakhampton EX20 3OZ. Tel: (08053) 200
Open 6 days 9-6 Lunch 1-2 15 Closed Thurs. 1pm.
(Sundays by appointment)
Specialists in 934MHz
Supplies of all 27MHz and 934MHz equipment
Amateur Radio Stocked

LONDON

ARE COMMUNICATIONS LTD.
For Yaesu Icom and Kenwood.
Phone us for the best deals on all
communication Equipment.
No. 6 Royal Parade, Hanger,
Ealing, London W5.
Tel: 01-977 4476

SCOTLAND

JAYCEE ELECTRONICS LTD
JOHN GM30PW
20 Woodside Way, Glenrothes.
Fife KY7 5DP
TEL: 0592 756962
Open Tues-Sat 9-5
Quality secondhand equipment in stock. Full
range of TRIO goodies. Jaybeam - Microwave
Modules - LAR.

HAMPSHIRE

NEVADA Communications
Ham Radio - CB Radio - Scanning Receivers.
Fast Mail Order Service.
Send £2 for our bumper catalogues
(includes £2 voucher)
HOTLINE (0705) 662145
189 London Road, North End, Portsmouth PO2 9AE

N. WALES

NORTH WALES AMATEUR
RADIO MART
AMATEUR RADIO - CB RADIO - MARINE
RADIO - P.M.R.
25 ABBEY STREET
RHYL
Open Monday-Saturday: 11am-5.30pm
All repairs and accessories available ex
stock. Mail order welcome.
Tel: 0745-51579

WALES

SMC/TMP ELECTRONICS
UNIT 27, PINFOLD WORKSHOPS,
PINFOLD LANE, BUCKLEY, CLWYD.
TEL: 0244 549563
FOR ALL YOUR AMATEUR EQUIPMENT
AND ACCESSORIES. 
OPEN TUES., WED., FRI. 10am-5pm
SATURDAY 10am-4pm. OTHER DAYS BY APPOINTMENT.

HAM RADIO TODAY

Lineage: 54p per word VAT inclusive (minimum 15 words) Semi Display: (minimum 2cms) £8.35 + VAT per single column centimetre. Ring for information on series bookings/discounts. All advertisements in this section must be prepaid. Advertisements are accepted subject to the terms and conditions printed on the advertisement rate card (available on request).

CLASSIFIED



01-437 0699 Ext 292. Send your requirements to: Ham Radio Today Classified Department, ASP Ltd., 1 Golden Square, London W1R 3AB.

ACCESSORIES



Tel: 061-445-8918 061-434-5701 061-446-2437
Fax: 061-445-0978 Tlx: 666762 PAMACO G

WHOLESALE DISTRIBUTORS OF CB

WE DELIVER NATIONWIDE - OPEN EVERY DAY, SUNDAY 10-2.
Pama House, 433 Wilmslow Road, Manchester M20 9AF

Giant range of CBs and accessories, contact us today for very fast, friendly service, competitive prices, widest range and latest CB products.

WANTED

Billington Valves

Valves Transistors I.C.'s.
Usually the lowest prices ...
Rarities our speciality.

Wholesale + Export enquiries welcome.

20lb (9kg) of resistors, capacitors, potentiometers etc. etc.
1930's-1960's £10 + V.A.T. delivered.

We wish to purchase a small quantity of valve types PX4 + PX2S (or equivalents) also types KT66 KT88, we'll also buy valve collections, transistors + shop clearance.

For quotations contact: *Martin Billington*,
39 Highland Road, Horsham, W. Sussex RH13 5LH.
Phone 0403 864086.
Fax 0403 210108. Telex 87271

FOR SALE

NEIGHBOURHOOD WATCH BURGULAR ALARM D.I.Y. KIT

will offer a professional system at a DIY price

Ham mini beam 10, 15, 20 meters. Part integrated circuits, transistors, diodes, valves, resistors, etc.

Service Manual and parts for spectrum and Amstrad
Send a 8" x 5" SAE for list.

M.J. SEAWARD (Mail Order)
St. Olafs Road, Stratton,
Nr. Bude, Cornwall.
Telephone: 0288 4892

MRZ COMMUNICATIONS LTD.

Newcastle Under Lyme

DESK DC SUPPLY AND
BASE FOR ICOM
PORTABLES

ICOM BUSINESS -
AMATEUR - MARINE - AIR
YAESU - AMATEUR
UK AND EXPORT



Telephone:
(0782) 619658
7 DAY SERVICE

TEST EQUIPMENT

CAVITY WAVEMETERS AS REVIEW IN FEB H.R.T.

144 MHz to 2500 MHz and 30 MHz
to 2500 MHz

10 GHz Wavemeter Kits
Solid Brass Based Morse Keys
S A E for more information to -
PAUL SERGENT G4 0NF
6 GURNEY CLOSE,
COSTESSEY,
NORWICH NR5 0HB
(0603) 747782
Prestel no: 603747782

01-437 0626
for advertising

GENERAL

USED AMATEUR EQUIPMENT BOUGHT, SOLD & EXCHANGED

S.A.E. for latest list, second hand price guide, updated monthly.
Useful guide for buying/selling £2.
ATU mods add top band to SEM KW etc. £650.

Call **Martyn G4SUI** Geefor Enterprises, 112 Leeds Road, Mirfield, West Yorks.

Personal callers by arrangement.
Tel: (0924) 495916

10 METER ENHANCEMENT IS HERE

ALL NEW AR-3500 ALL MODE MOBILE TRANSCEIVER - NOW AVAILABLE IN THE UK!

MANY FEATURES INCLUDE:
DIGITAL FREQUENCY READOUT - 28/30MC/S - AM, FM, USB, LSB, CW - SCANNING - SPLIT FREQUENCY OPERATION - AND MANY MORE.

S.A.E. FOR FULL DETAILS TO:
PETE JENKINS GO ECK (HR),
43 GREEN LANES,
WEST EWELL, EPSOM,
SURREY KT19 9TW.

01-437 0699

ELECTRONIC MORSE KEYER

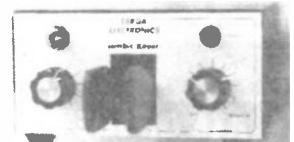

Available with internal paddle (TA2) or for use with external paddle (TA6) 12v supply or 240v P.S.U. available

* Wide range speed control.
* Adjustable sidetone vol & tone.
TA2 - with internal paddle £49.90
TA6 - requires external paddle £42.50
PU1 - A.C. mains P.S.U. £7.50
All prices fully inclusive.

NO EXTRAS
TARGA ELECTRONICS
9, Renishaw Road, Mastin Moor,
Chesterfield, Derbyshire S43 3DW

ADVERTISERS

Advertisers please note that advertising rates are subject to review from the September issue.

BE SAFE AND LEGAL WHEN MOBILE

with the "SPEAKEASY" Handsfree Microphone £15 00 inclusive
Radio Baby Listener, transmits every sound to ordinary FM Radio £7 50 inclusive
Call Box tapes your telephone conversations automatically onto standard cassette recorder £16 50 inclusive

S A E more details
Live Wireless c/o Video World
7 Wesley Street, Southport,
Merseyside
Mail Order only please

SRI PAGER XTALS S20, S22, S23 £2 00 each + 20p P+P NEW REEDS 123 136 928Hz £3 50 each + 50p P+P XTALS 4 433, 4 9152, 5 0688, 15 00MHz £1 00 each + 20p P+P
8 POLE XTAL FILTER NDK 10F 15DG 10 7MHz/15KHz BW, £9 50 + 50p P+P
SCANNER - VOX - AUTO RECORDS - ON CASSETTE £5 00/£7 00 BUILT + 50p P+P
ELECTROKITS, 15 Kings Road,
Sutton Coldfield, W. Mids. B73 5AB.
Tel: 021-354-5409

ACCESSORIES

WHOLESALE

CB radios, aerials & accessories delivered to your shop. Contact for price list.

Parma House, 433 Wilmslow Road, Manchester M20 9AF. only 3 min. from M56



OPEN EVERY DAY, SUNDAY 10-2.

NATIONWIDE DELIVERY DEALERS contact us today for very fast, Friendly Service, Competitive Prices, Widest Range & Latest CB Products.

Tel: 061-445-8918 061-434-5701 061-446-2437
Fax: 061-445-0978 Tlx: 666762 PAMACO G

PERSONALISED LEISUREWEAR

T-SHIRTS & SWEATSHIRTS
by
Interprint

MINIMUM ORDER - ONLY 12
FREE DESIGN SERVICE

Other Top Quality
Personalised Products

Sports Shirts, Ties, Hats, Lighters, Bags,
Stickers, Badges, Aprons, Tea-towels.

Write for free colour brochure to:

INTERPRINT Dept. HAM
CRAVEN ARMS,
SHROPSHIRE SY7 9NY.

TEL: (05882) 2703 & 2502



GENERAL

★ **PSSS....** ★

ALL THE SUPER
BARGAINS ARE
ON THE
INSIDE-FRONT
COVER OF THIS
MAGAZINE!!



PACKET RADIO SOFTWARE

GROSVENOR SOFTWARE

G4BMK

AX25 Packet Radio

DRAGON 32/64 and **TANDY** color A Breakthrough in Packet Radio-AX25 stand alone software in ROM cartridge plus a built VHF/HF modem for just £99! New **DRAGON 32** Computers available at £54.00 Full AX 25 implementation with up to 6 simultaneous connections optional beacon and digipeater operation Modem kits & PCB's available Send SAE for full details of this & RTYY CW SSVT & AMTOR
2 Beacon Close Seaford East Sussex BN25 2JZ Tel: (0323) 893378

AERIALS

T.A.R.

COMMUNICATIONS

For all Aerials & Lashing equipment.

We are famous for the G5 RB antenna and the 5. 7. & 12 element ZL.

For Retail or Mailorder contact:-

TAR COMMUNICATIONS

King William St., Stourbridge

W. Midlands. DY8 4EY

0384 390944

NEW GM AERIALS NOW AVAILABLE

DEADLINES

Next copy deadline for
the October issue is
21st July, 1988

WANTED

IDEAS, INVENTIONS wanted. Call I.S.C. 01-434 1272 or write: Dept (ASP) 99 Regent St. London W1.

MISCELLANEOUS

Heathkit U.K. spares and service centre. Cedar Electronics (HR), Unit 12, Station Drive, Bredon, Tewkesbury, Glos. Tel: 0684 73127.

EQUIPMENT

KITS & HOBBIES

KANGA PRODUCTS

KITS FOR THE CONSTRUCTOR

'ONER' MINIATURE V F O	£6.00
'ONER' MINIATURE RECEIVER	£8.85
R.F. SIDETONE GENERATOR	£5.95
THE V.F.O. KIT	£9.95
MARKER KIT (SEE H P T ARTICLE)	£9.95
DIGITAL DIAL/FREQUENCY COUNTER	£19.95
SINGLE BAND RECEIVER	£19.95
DUAL BAND RECEIVER (20M & 80M)	£35.95
FT77, FT707, 160M CONVERSION KIT	£27.50

(Some kits are supplied semi complete)

PLEASE ADD 85p P&P

PLUS MANY MANY MORE INTERESTING KITS
send large SAE for free catalogue

KANGA PRODUCTS

3 Limes Road, Folkestone CT19 4AU.

SURPLUS EQUIPMENT

D & D ELECTRONICS
(Kennington)

The sort of shop you used to see in
Listle St. All sorts of surplus supplies, so
come along and browse or send SAE
for info. sheets.

3a Braganza Street,

London SE17 3RD

Tel: 01-793 0054

(Open 6 days a week)



USED AMATEUR EQUIPMENT?

Buy, Sell & Exchange!

SELLING? I pay the BEST POSSIBLE
PRICES for your Clean Used Equipment!

BUYING? I have the BEST SELECTION of
top Quality Used Equipment Available!

For the Deal You've been looking for.

Phone Dave. G4TNY

On 04024 57722 or 0836 201530

9am to 7pm, Monday to Saturday.

Or send SAE for lists.

G4TNY AMATEUR RADIO

132 Albany Road, Hornchurch, Essex RM12 4AQ

SOFTWARE

STATE OF THE ART SPECTRUM SOFTWARE

G1FTV SSVT TX/RX
8 16 24 32 48 & 96 SECOND SSVT COLOUR TEXT & GRAPHICS TRANSMIT. BRIGHTNESS/CONTRAST CONTROLS. FRAME STORES & 9 TEXT MEMORIES £12 CASSETTE/£14 MICRODRIVE

G1FTV RTTY TX/RX
THE CLASSIC RTTY PROGRAMME. SPLIT SCREEN. TYPE AHEAD OPERATION. 45-110 BAUD AMATEUR/COMMERCIAL RECEPTION. REVERSE TONES. TUNING INDICATOR UNSHIFT-ON-SPACE ETC. £10 CASSETTE/£12 MICRODRIVE

G1FTV VVW TX/RX
THE ULTIMATE MORSE TRANCEIVE PROGRAM. SPLIT SCREEN. TYPE AHEAD. SOFTWARE FILTERS. QSO REVIEW, PRINT, RESEND, ETC. ETC. INCLUDES BUILT-IN IAMBIC KEYS. £10 CASSETTE/£12 MICRODRIVE

WRITE OR PHONE FOR FULL DETAILS, RETURN OF POST DESPATCH, TO:

PEARSONS COMPUTING

42 CHESTERFIELD ROAD, BARLBOROUGH, CHESTERFIELD, DERBYSHIRE.

TEL: CHESTERFIELD (0246) 810652

SERVICE MANUALS

**HAVE YOU
PLANNED YOUR
AUTUMN
ADVERTISING?**

C.B. CIRCUITS MANUAL

Giant Collection C.B. Circuits covers over 100 different makes/models.

Only £4.95 POST FREE

Plus FREE catalogue Unique

Repair and Data Guides.

MAURITRON (CB), 8 Cherry Tree Road, Chinnor, Oxon OX9 4QY.

COMPUTER SUPPLIES

Disks & Ribbons

3" CF2	£1.90
3.5" DS unbranded	£0.90
5.25" Memorex branded	
SS/DD	£0.60
5.25" 96 tpi DS, unbranded, labels etc.	£0.35
Vision 10 storage box 5.25" or 3.5"	£1.05
Imagewriter	£2.95
Citizen 120D	£3.50
Epson MX/RX/FX80	£2.75
Epson MX/RX/FX100	£3.10
Cannon PW 1080A	£2.69
Epson LX 80/86	£2.50
Kaga Taxan	£2.69

Please add 15% VAT carriage free.

T-systems Ltd.,

The Signal Cabin,

61 High Street, Orpington,

Kent BR6 0JF

Tel: 0689 22196

TERMS & CONDITIONS

CLASSIFIED ADVERTISING TERMS & CONDITIONS

Our terms for new advertisers (semi-display and lineage) are strictly pro-forma payments until satisfactory reference can be taken up (excluding recognised advertising agencies). Cheques and P.O.'s should be crossed and made payable to ARGUS SPECIALIST PUBLICATIONS LTD and sent together with the advertisements to

The Classified Dept.,

No. 1 Golden Square,

London W1R 3AB.

There are no reimbursements for cancellations. Advertisements arriving too late for a particular issue will be inserted in the following issue unless accompanied by instructions to the contrary. It is the responsibility of the advertiser to ensure that the first insertion of every series is published correctly, and corrections must be notified in time for the second insertion, otherwise the publishers will not accept liability or offer any reduction in charges.

All advertising sales are subject to Government Regulations concerning VAT. Advertisers are responsible for complying with the various legal requirements in force eg: The Trade Description Act, sex discrimination act & the business advertisements (disclosure) order 1977.

Full Terms & Conditions of Advertising available on request.

CLASSIFIED COUPON

HAM RADIO TODAY, CLASSIFIED ADVERTISEMENT
DEPT, No 1 GOLDEN SQUARE, LONDON W1R 3AB

PLEASE DEBIT MY ACCESS/BARCLAYCARD NO. EXPIRY DATE

--	--	--	--	--	--	--	--	--	--	--	--	--	--	--	--	--	--	--



FOR SALE SOFTWARE WANTED

Rates: Lineage 54p per word (VAT inclusive), minimum £8.10 semi-display
£8.35 + VAT per single column min. size 2cm x 1 column. No reimburse-
ments for cancellations. All advertisements must be pre-paid.

Name

Address

..... Daytime Tel. No:

Signature Date

EQUIPMENT AERIALS OTHERWISE STATE



AMDAT



PAC-COMM TINY-2
TAPR TNC-2 Compatible for VHF operation
£109 + £2.50 p&p

NEW COMING VERY SOON NEW
PERSONAL MAILBOX FOR THE TINY 2
RING FOR DETAILS - IT MAY BE HERE NOW!!

NEW AMFAX NEW
Customised ROM for the BBC for use with Kantronics
TNCs or MFJ 1278. Offers 40/80 column split screen
terminal. Storage/Retrieval of data. Display of Wefax
pictures and storage to disk. Printing on line or from
disk. Provide callsign with order £19.95 + 50p p&p

NEW MFJ-1278 Multi Mode Data Controller NEW
Rx and Tx on Packet, RTTY, ASCII, CW, WEFAX and
SSTV. Software switchable radio ports. Built in
Tuning Indicator. This is the affordable way to
send and receive FAX and Slow Scan pictures on HF
or VHF only £229 + £3.00 p&p

KANTRONICS KAM
Packet/AMTOR/RTTY/ASCII/CW on HF + Packet on
VHF Simultaneous HF and VHF operation including
mailbox and TCP/IP Interface. Now with FAX Rx
only £265 + £3.00 p&p

KANTRONICS KPC2
Packet on HF + VHF includes mailbox + Fax Rx.
£159 + £3.00 p&p

PAC-COMM TNC 220
Software switchable between 2 radio connections.
Comprehensive kit £139 + £2.50 p&p
Built and tested £149 + £2.50 p&p

AMDAT Crofters, Harry Stoke Road
Stoke Gifford, Bristol BS12 6QH
(0272) 699352/559398

ADVERTISERS' INDEX

Allweld Engineering	6
AMDAT	57
Andrews Computer Services	8
ARE Communications	58, IBC
Capco	7
Circuit	6
ERA	9
Icom UK	4, 5
ICS	29
KW Ten Tec	8
Lowe Electronics	30, 31, OBC
Nevada	7
RAS Nottingham	9
Raycom	IBC
SMJ	9
Spectrum Communication	22
Technical Software	9

ARE
COMMUNICATIONS

CELEBRATING 75 YEARS OF

N.E.C. N.E.C.
15th - 17th JULY 1988



TS-680S HF and SIX Metre Transceiver

Since our introduction of this remarkable transceiver last year, many of them are now in use throughout the U.K. Top-Band to Ten, including SIX Metres, plus a GENERAL COVERAGE RECEIVER thrown in!
N.E.C. Exhibition Price £899

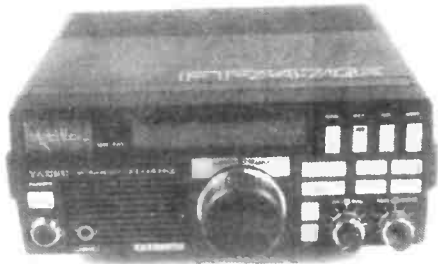

FT747GX HF "Economy" Transceiver

An HF transceiver with built in General Coverage Receiver, All Mode including FM - for less than the price of a 2M multimode?
N.E.C. Exhibition Price £659.00 + FREE FM BOARD & Microphone.



FT767GXM HF + 2M + 6M + 70CM

A complete Ham station in one package. All band, all Mode, built-in auto Aerial Tuner, 240V Power-supply, General Coverage Receiver, Digital Power/SWR meter, 100W o/p (HF). Optional 2M/6/70CM modules just plug in. Excellent part-exchange deals at N.E.C.!!
N.E.C. Exhibition Price (Ask at the show!)



Tokyo Hy-Power HT-100 Single banders

Now available from A.R.E. on an exclusive basis, the new HT-100 series of ssb/cw transceivers. Only fractionally larger than a 2m mobile, the HT-100 is the ideal transceiver for operating in the car or at home. Available on 80/40/20/15 or 10 metres, the HT-100 would make an ideal QRP station or as a prime mover for transverting or driving a linear amplifier. N.E.C. Exhibition Price £279.00



Standard C500 Dual Band Handie

You must have read our AD's by now, we've sold hundreds! 2M & 70CM, full Duplex, 138-170MHz + 420-469MHz. Many additional features. Take a look at our Exhibition price
N.E.C. Exhibition Price £339.00

THE RSGB N.E.C.

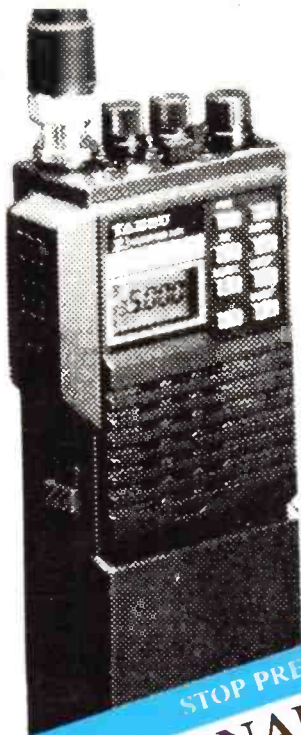

Kenwood Specials!

TS940S offered with ATU & Microphone
TL922 Magnificent HF Linear - the Favourite!
TS440S offered with ATU & Microphone
TR751E Fantastic 25W Multimode
TH-25E New 2M Handie - Huge saving!

We won't list prices here - come to N.E.C.
We guarantee due to our direct imports you cannot buy
KENWOOD cheaper!

Yaesu FT690R mkII

If you are not on SIX METRES yet, you certainly should be. What better way than to buy the new FT690R complete with a 15 watt output linear amplifier? And at the special N.E.C. Price!
N.E.C. Exhibition Price £375.00 including Linear.
(£349.00 without Linear).

Yaesu FT736R Quad-Band Multimode

The KING of VHF/UHF Base stations, the FT736R has all the facilities any discerning user may need, plus the two most important features: Uncompromised receive performance and a clean transmitted signal. Our special offer available on the first 10 sets purchased during February was so popular, we have decided to re-introduce it for the N.E.C.!
N.E.C. Exhibition Price (Ask at the Show!)

YAESU FT23R 2M HANDIE

Due to A.R.E. importing direct and cutting out the middle man, we really have slashed the price of this one!
Offered to full U.K. spec., with FBA9 battery case, helical antenna and strap.
N.E.C. Exhibition Price £195.00

STOP PRESS! Rumour has it that Brenda's special coffee will be available at the show!

NATIONAL EXHIBITION CENTRE, BIRMINGHAM. . .
. . . is here again and as usual A.R.E. Communications will be offering exceptional part-exchange deals. Bring along any clean, working, Amateur Radio equipment that we can take in part-exchange or **SELL IT FOR YOU** at the show. Remember! Bernie and Brenda are rarely beaten on price OR customer service. With H.P. facilities available at NEC, you can literally walk away with your new purchase the same day! Look forward to seeing you there. 73's Martin G4HKS.

Opening Hours London Mon/Fri 9.30 to 5.30 London Tel: 01-997 4476



A.R.E. Communications Limited, 6 Royal Parade,
Hanger Lane, Ealing, London W5A 1ET, England
Professional Tel: 01-997 4476 Fax: 01-991 2565

KENWOOD



The TS-140S from Kenwood

Every once in a while, something comes along which marks a true turning point in amateur radio equipment. Such was the case when Trio-Kenwood introduced the TS-120 series; the first of the small solid state transceivers to appear.

Following the trends of the last few years towards more "sophisticated" equipment (really meaning more and more complicated), we have seen Kenwood engineering directed more towards better performance, particularly in HF transceivers; performance which has become a standard of excellence for others to try to match.

Well, the chaps at Kenwood were not asleep, and they came up with a new transceiver which I saw as marking another turning point in HF equipment. This is the TS-140S, and I can tell you that reading the enthusiastic comments coming from happy owners, I can confidently say that the TS-140S is the "HF transceiver of the year".

The new TS-140S continues the successful "1" series, which began with the TS-120S, developed into the TS-130S and has now reached what I consider to be that new direction in amateur radio equipment. In the TS-140S, Kenwood designers have given the user a receiver section with real performance which matches today's expectations, and

remember that Kenwood have consistently set the standards for many years.

It is almost impossible for any manufacturer to give every potential customer everything that the customer wants, but there is little doubt that many people have been asking for "simplicity". However, it is also possible to carry the "simplicity" concept too far, resulting in a transceiver which is certainly low priced but lacks facilities which many users see as essential. I happen to believe that Kenwood have achieved the right balance in the TS-140S. Hundreds of happy owners obviously agree with me.

Obviously it is difficult to describe all the features and facilities of the TS-140S in a few paragraphs, but a full colour brochure is available, so why not drop us a line and ask for complete information.

In my opinion, the TS-140S in combining performance with simplicity at an attractive cost will give real satisfaction to the radio amateur who wants to enjoy his hobby of communicating, rather than counting the buttons on the front panel.

73.
G3PCY/5N2AAC

LOWE ELECTRONICS LTD.

Chesterfield Road, Matlock, Derbyshire DE4 5LE Telephone 0629 580800 (4 lines)

Sole Appointed UK Distributor for KENWOOD Amateur Radio