

# HAM RADIO HORIZONS

Owners' Report: FT-104

APRIL 1980 / \$1.50

Integrate Your Station Equipment

A Desk That Grows

Chaser for a Double-Shot of DX

"UHF = Ultra High Frustration"

US Questions and Answers

and more

MATTER RADIOS CHANGING

AND SO ARE WE

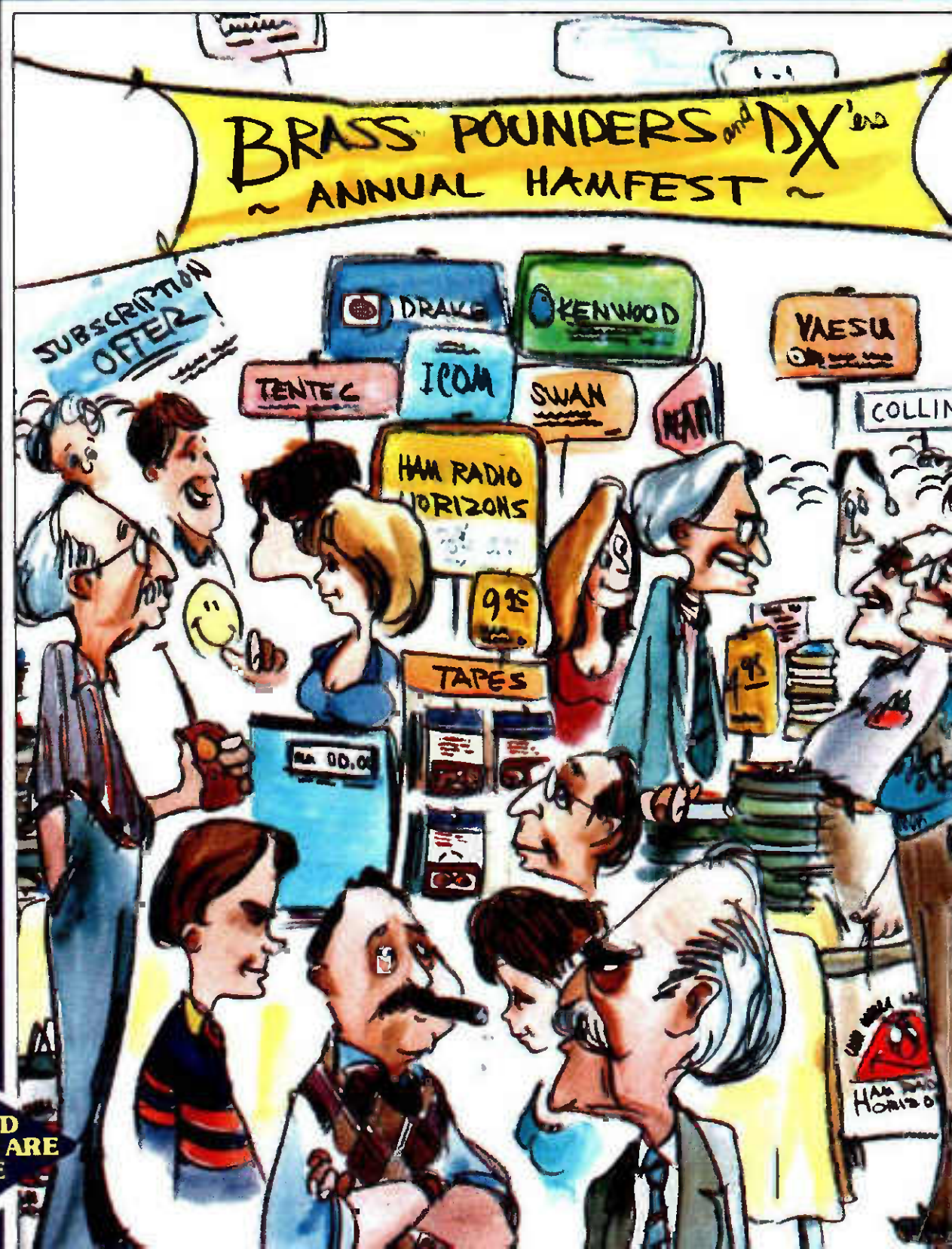



The following are excerpts from unsolicited letters and registration cards received from owners of the new TEN-TEC OMNI transceiver.

- "I sold a Yaesu to buy this and am very impressed" —WB5ULA  
 "My first QSO with OMNI-A was LAISV on CW and second was EA8SK on SSB." —N2CC  
 "Excellent rig, just as advertised." —WB5TMD  
 "Very pleased with performance. QSK feature very slick." —WB0ELM  
 "This is my 5th TEN-TEC transceiver in less than 2 years. I loved them all and still have 3." —WB0VCA  
 "Through the years I have had complete Drake and Collins stations. I tried a 544 Digital and liked it the best so decided to purchase the 546 OMNI-D Digital." —WA4NFM  
 "Your OMNI is the best rig I have had in 20 years of homing." —K4IHI  
 "As a owner of Collins rig, your OMNI-D is the best." —K9JL  
 "I already have an OMNI-A, 544 and a TRITON IV. You may ask why I own so many TEN-TEC rigs. In case there is a great RF famine, I want to be ready!" —WD4HCS  
 "You guys really know how to turn on an old timer!" —K8ELS  
 "Best operating & most conveniences of any transceiver I've ever used." —W6LZI  
 "I like CW. Compared OMNI against IC701 (rcvr) and OMNI won hands down. XYL WD6GSB really enjoys rig on SSB. Finds rig is very stable and digital readout accurate." —AC6B  
 "Have checked it out on both modes from "top bond" (160) all the way to 29 MHz. Terrific!!!!" —W4DN  
 "Works well, parts layout and design much better for any possible servicing than other ham gear. The Japanese hybrid sets can't compare to TEN-TEC for audio. Audio reports excellent without special speech processors, etc., to distort the signal." —AG8K  
 "I have been using the S-Line over 15 yrs and never thought anything could outperform it. I got the biggest surprise and THRILLED with this OMNI-D even though I have been a ham since 1936." —KV4GD

- "This must be the greatest. I've spent enough money on final tubes to almost pay for this." —KA4BIH  
 "This transceiver was recommended to me by old time hams (Xtras) whom I have known for 40 yrs. Has excellent break-in." —N6AVQ  
 "Best package job I've ever seen! First licensed 6AAV in 1926. Now in operation—a sweetheart!" —W7LUP  
 "From a 32V2/SX115 to an OMNI is a big step!" —K6YD  
 "Receiver prominent—transmitter likewise—working comfortable—pleasing design." —OE1FAA  
 "First new rig for me in 10 years but seems to be very good." —W5GBY  
 "The best transceiver I ever used or owned." —W3TS  
 "I wouldn't swap my OMNI for anything on the market, regardless of price." —WD0HTE

#### OMNI/SERIES B FEATURES

All solid-state; 160-10 meters; Broadband design; Standard 8-Pole 2.4 kHz Crystal Ladder I-F Filter + Optional 1.8 kHz SSB Filter & 0.5 kHz 8-Pole CW Filter; 3-Bandwidth Active Audio Filter; Choice of readout — OMNI-A (analog dial), OMNI-D (digital); Built-in VOX and PTT, Selectable Break-in, Dual-Range Receiver Offset Tuning, Wide Overload Capabilities, Phone Patch Interface Jacks; Adjustable ALC; Adjustable Sidetone; Exceptional Sensitivity; 200 Watts INPUT; 100% Duty Cycle, Front Panel Microphone and Key Jacks; Zero-Beat Switch; "S"/SWR Meter; Dual Speakers; Plug-In Circuit Boards; Complete Shielding; Easier-to-use size: 5 3/4" h x 14 1/4" w x 14" d; Full Options: Model 645 Keyer \$85; Model 243 Remote VFO \$139; Model 252MO matching AC power supply \$139; Model 248 Noise Blanker \$49; Model 217 500 Hz 8-Pole Crystal Ladder CW Filter \$55; Model 218 1.8 kHz 8-Pole Crystal Ladder SSB Filter \$55.

Model 545 Series B OMNI-A... \$949

Model 546 Series B OMNI-D... \$1119

To add your name to the fast-growing list of OMNI owners, see your TEN-TEC dealer, or write for full details.

**TEN-TEC**, INC.  
 SEVIERVILLE, TENNESSEE 37862  
 EXPORT 5715 LINCOLN AVE. CINCINNATI, OH 45246

# OMNI OWNERS SAY:



The engineering breakthrough by

**DRAKE**

brings an entirely new state of the art to worldwide radio communications...

solid state

**TR7**

synthesized hf transceiving system

continuous coverage

**0-30** MHz

continuous coverage reception — no gaps — no range crystals required

**160-10** Meters

Amateur Band transmission, including capability for MARS, Embassy, Government, and future band expansions



- ★ Sophisticated System Concept
- ★ Innovative Design Features
- ★ Straightforward Simplified Operation
- ★ State of the art performance now a pleasure

**7 Line Accessories**

- RV7 Remote VFO • PS7 120/240V Ac Supply • Aux7 Range Program Board
- MS7 Matching Speaker • NB7 Noise Blanker • FA7 Fan • SL300 Cw Filter, 300 Hz
- SL500 Cw Filter, 500 Hz • SL1800 Ssb/RTTY Filter, 1.8 kHz
- SL6000 A-m Filter, 6.0 kHz • MMK7 Mobile Mounting Kit • TR7 Service Kit/Extender Board Set • TR7 Service/Schematic Book.

- Broadband, 100% Solid State Design.
- Exclusive Synthesized/PTO Frequency Control — 1 kHz dial, 100 Hz digital readout. 500 kHz range pushbuttons.
- Continuous, Wide Range Frequency Coverage — 1.5 thru 30 MHz (zero thru 30 MHz with optional Aux7).
- State of the Art "Up-Conversion" Receiver Design — with high level double balanced mixer.
- True Full-Passband Tuning improves reception in heavy QRM.
- Unique Independent Receive Selectivity — Optional front panel pushbutton-selected filters.
- Effective Noise Blanker — true impulse-type performance.
- Special High Power Solid State Power Amplifier — diagonal heat sink allows internal mounting. Continuous duty on SSTV/RTTY with optional fan.
- TR7 Internal Test Facilities — "S" meter and built-in rf Wattmeter/VSWR Bridge.
- Receiver Incremental Tuning (RIT)

*Specifications and prices subject to change without notice or obligation.*

**R. L. DRAKE COMPANY**



540 Richard St., Miamisburg, Ohio 45342  
Phone: (513) 866-2421 • Telex: 288-017

For a FREE Drake Full Line Catalog contact your favorite Drake Dealer.



# THIS MONTH'S

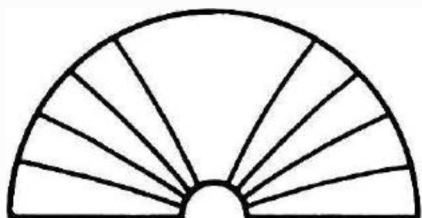

# HORIZONS

## Arranging Your Amateur Station

Here's the first of a two-part article on how to tie all your equipment together. It covers basic details on interconnecting equipment, antenna changeover, station control, and how to handle accessories such as microphones, speakers, and monitor scopes. Haywire is a thing of the past with today's modern ICs and transistors.

## Station Planning

Is your growing station spilling over into your "living" space? Does that new linear amplifier you just acquired totter precariously on the edge of a card table? Planning ahead is the secret to comfortable and efficient operating space, and if you can start in the right direction, you'll grow comfortably, instead of haphazardly. The father-and-son team of Boyd and Boyd give a short lesson in planning for growth, starting on page 18.

## Ham Radio Techniques

In this month's column, Bill offers some thoughts about WARC and how it will enter into your Amateur life, gives you a good list of reference material for your hamshack, and tantalizes the antennophile with some tall stuff from Texas and Canada.

## Unforgettable Italy

As we've pointed out before, Amateur Radio opens the doors to many lands, allowing you to meet the people on a one-to-one basis over the air. It often happens that hams arrange to travel to many of the lands they have talked to, and have found their Amateur Radio backgrounds to be the key to closer friendships and more enjoyment during their tour. When you add the bonds of Amateur Radio to the usually friendly Italian atmosphere, as WB4GKN did, the resulting adventure is sure to sparkle with outstanding memories.

## Outstanding DXpedition

Periodically, otherwise normal individuals work themselves into a lather over some untouched piece of real estate, pack up all sorts of useless, non-functional, and heavy gear, and trek off to do wonderful things for the waiting masses of hams who have not worked that particular spot on some obscure frequency. Sometimes it works, sometimes it doesn't. History is written only by the winners, about the winners. Here's the story of . . . but why spoil it for you. Look on page 33.

## Primer For DX Chasers

DXing is considered by many to be the "Big League" part of Amateur Radio, and it's important to enter this exciting hobby-within-a-hobby with the right perspective. Proper mental attitude, operating habits, and development of skills will make sure that you always enjoy working the rare ones, and, more importantly, that they will enjoy working you. This month's DX column starts on page 42.

## Yaesu Owners' Report

Word of the *Horizons* series of reports on popular ham gear seems to have spread, and the result is an increased number of questionnaires returned by our readers. This month has the Yaesu FT-101B (or later versions of it) in the spotlight. Read the comments and check the tables that reveal all, starting on page 50.

## Owners' Report No. 3

Here's another selection of rigs for all you owners to report on. This time they're all Collins. No, not the new KWM-380, but those venerable, lovable, indestructible 32S-, 75S-, and KWM-2 series of transmitters, receivers, and transceivers which have been sought after by hams for years. Recycling is nothing new to these rigs! You'll find them in current advertisements, at flea markets this summer, and, if our guess is right, they'll be there for years to come. Here's a chance for all of you who have used them to talk about your particular experiences, and a chance for you shoppers to get the inside info from several hamshacks. See page 57 for the model numbers and a report form.

**Late Arrival!**  
**FCC Study Guide — page 60.**

## The Cover

It's hamfest time again, and if the growing list of events that show up on our Activities Calendar didn't tip you off, then this original painting by Chris Walker should. He's done a great job of capturing the likeness of people you'll find at every flea market and hamfest, and if you seem to recognize some of them, it's intentional.

**HAM RADIO HORIZONS** April 1980, Volume 4, Number 4. Published monthly by Communications Technology, Inc., Greenville, New Hampshire 03048. Telephone (603) 878-1441. Second Class Postage paid at Greenville, New Hampshire and at additional mailing offices. ISSN 0147-8818.

Subscription price: Domestic, one year, \$12.00; two years, \$20.00; three years, \$27.00. Canada and Worldwide, one year, \$12.00; two years, \$22.00; three years, \$30.00, payable in United States funds.

Subscription inquiries and changes of address should be directed to *Ham Radio Horizons*, Greenville, New Hampshire 03048. Please include address label from most recent issue if possible.



NEW MFJ-410 "Professor Morse" lets you . . .

# COPY CW FASTER AND UPGRADE QUICKER

NEW MFJ Random Code Generator/Keyer sends unlimited random code in random groups for practice. Never repeats same sequence. Tailor level to your ability. Vary speed 5 to 50 WPM. Vary spacing between characters. Speed Meter. Full Feature Keyer.

*Sends unlimited random code.  
Never repeats same sequence.  
Tailor level to your ability.  
Vary speed 5-50 WPM.*



# \$149<sup>95</sup>

Copy code faster and upgrade quicker. Now you can tailor the level of code practice to your exact needs. Practice copying code anywhere and anytime you have a spare moment. Practice at home, in bed, driving to work, during lunch, etc.

The new MFJ-410 "Professor Morse" is a computer-like random code generator and keyer that sends an unlimited supply of precision Morse Code in random groups.

It never repeats the same sequence so you can't memorize it like code tapes.

Vary speed 5-50 WPM and read on speed meter.

Vary spacing between characters and character groups (for example, copy 5 WPM with 13 WPM characters) to give proper character sound at low speed.

Select alphabetic only or alphanumeric plus punctuation (period, comma, question, slash, double dash.)

Tone control. Room filling volume. Built-in speaker. Ideal for classroom teaching. Earphone jack (2.5 mm) for private listening.

Uses 110 VAC, or 9-18 VDC, or 4-C cells (for portable use). Optional cable for car cigarette lighter (\$3.00). 6x2x6 inches.

Built-in full feature keyer. Volume, speed, internal tone and weight controls. Weight control adjusts dot-dash space ratio; makes your signal distinctive to penetrate QRM. Speed meter works for keyer, too. Tune switch keys transmitter for tuning. Reliable solid-state keying: grid block, cathode, solid state rigs. OPTIONAL BENCHER IAMBIC PADDLE. Dot and dash paddles have fully adjustable ten-

tion and spacing. Heavy base with non-slip rubber feet eliminates "walking". \$39.95.

Order from MFJ and try it — no obligation. If not delighted, return it within 30 days for refund (less shipping). One year unconditional guarantee.

Order today. Call toll free 800-647-1800. Charge VISA, MC or mail check, money order for \$149.95 plus \$3.00 shipping for MFJ-410 and/or \$39.95 plus \$3.00 shipping for Bencher paddle.

**CALL TOLL FREE ... 800-647-1800**

Call 601-323-5869 for technical information, order/repair status. Also call 601-323-5869 outside continental USA and in Mississippi.

**MFJ ENTERPRISES, INC.**  
BOX 494, MISSISSIPPI STATE, MS 39762



# NEW MFJ-624 Deluxe Hybrid Phone Patch

Feature Packed: VU meter for line level and null. Has receiver gain, transmitter gain, null controls, bypass switch. Beautiful hum-free audio. RF filtered. VOX or push-to-talk. Works with any rig. Simple patch-in-patch-out installation.

*Crisp, clear hum-free audio  
is what phone patching is  
all about and MFJ has it.*



# \$59<sup>95</sup>

This new MFJ-624 Telepatch II hybrid phone patch gives you a combination of performance, features, and quality that you won't find in other phone patches.

**PERFORMANCE:** Gives you crisp clear, hum free audio which is what phone patching is all about. Use automatic VOX or push-to-talk. RF pi-filters and PC board construction eliminates RF feedback. Works with any rig.

**FEATURES:** VU meter monitors telephone line level to prevent crosstalk between telephone channels. Also lets you adjust null depth for maximum isolation between receiver and transmitter.

Separate transmitter and receiver gain controls eliminate readjusting rig's controls after patching. Null control for maximum isolation.

Function switch: OFF for normal operation. ON connects your rig to phone line for patching. NULL switches VU meter to let you adjust for maximum null.

Simple 2 cable installation (plus phone line) when rig has patch-in-patch-out jacks. Connects easily to any rig.

Phone jacks for patch-in-patch-out, speaker, microphone. Screw terminals for phone lines.

Eggshell white, walnut sides. 8x2x6 inches.

**QUALITY:** Every single unit is tested for performance and inspected for quality. Solid American construction, quality components.

**MFJ-620 TELEPATCH HYBRID PHONE PATCH.** Same as MFJ-624 but less VU meter. 6x2x6

inches. \$49.95 plus \$3.00 shipping and handling.

One year unconditional guarantee.

Order from MFJ and try it — no obligation. If not delighted, return it within 30 days for refund (less shipping).

Order today. Call toll free 800-647-1800. Charge VISA, MC or mail check, money order for \$59.95 plus \$3.00 shipping for MFJ-624 and \$49.95 plus \$3.00 shipping for MFJ-620.

**CALL TOLL FREE ... 800-647-1800**

For technical information, order/repair status, in Miss., outside continental USA, call 601-323-5869.

**MFJ ENTERPRISES, INC.**  
BOX 494, MISSISSIPPI STATE, MS 39762

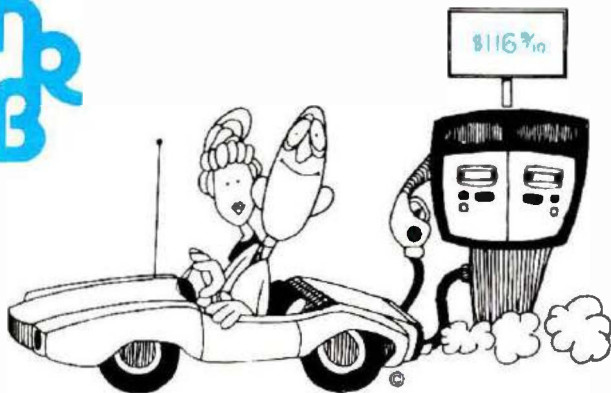

**h  
R  
B**

# SAVE TIME & MONEY!

## Shop By Mail

**NEW**

### RSGB AMATEUR RADIO OPERATING MANUAL

Edited by R. J. Eckersley

Compiled by the RSGB, this exciting new book covers just about every facet of Amateur Radio. Starting with a precise description of the Amateur Service worldwide, the Amateur Radio Operating Manual leads the Amateur through the steps to setting up a station correctly, how to operate properly, DX, contests, satellites, RTTY and Slow Scan Television. You also get 5 big appendixes jam-packed with more information: callsigns in use, maps, DXCC country list, time zones and international callsign assignments. 190 pages. ©1979.

RS-0M

Softbound \$9.95

### AMATEUR RADIO THEORY COURSE

by Martin Schwartz, W2OSH

A complete, well explained, home study course in radio theory, from elementary electronics to antennas, covering the requirements for the Novice, Technician, Conditional, and General Class Amateur License. Each of 14 lessons is followed by practice questions and "FCC Type" examination questions similar to those in the Novice and General Class exams. A complete reprint of the FCC Amateur Radio Rules and Regulations is also provided. Even if you have no prior background in electronics, you'll find this latest revised edition an excellent way to get yourself on the air. 320 pages. ©1979.

102-01

Softbound \$5.95

### REFERENCE DATA FOR RADIO ENGINEERS (6th Edition)

A must for any serious Amateur. In 45 chapters it covers not only every area of basic radio theory, but also goes into such modern areas as micro-miniature electronics and space communications. Literally hundreds of charts, nomographs and tables round out what is probably the most complete reference of this type. Sales of over 350,000 testify to its wide acceptance. 1,196 pages. ©1975

21218

Hardbound \$28.00

### RADIO HANDBOOK 20th Edition

by William I. Orr

Here's an unbeatable bargain. The Twentieth Edition of the Radio Handbook features:

- A long list of HF/VHF linear amplifier designs using popular high-power tubes.
- Many of the receiver, transmitter, antenna and accessory construction projects which have made the Radio Handbook series so popular.
- A large measure of current reference material.

Lots of usable and valuable information for an unbeatably low price. 986 pages. ©1975. Hurry. Quantities limited!

24032 was \$18.50

Hardbound \$8.95

SAVE over 50%

**NEW**

### GENERAL CLASS AMATEUR LICENSE STUDY GUIDE

by Phil Anderson, WØXI

This book was written in simple laymen's language with uncomplicated explanations and examples used to present electronic radio concepts and ideas. Throughout each chapter, questions and answers are used to strengthen your understanding of the terms and concepts presented. This book also covers several methods that can be used to improve code reception skills. The final chapter is a sample FCC exam which the author feels he would ask if he were to give the FCC exam. 160 pages. ©1979.

21617

Softbound \$6.50

**NEW**

### RADIO PUBLICATIONS SPECTRUM CHART

Here's how to tune in the world! Organized by frequency, this big, attractive, multi-colored wall poster is a must for every ham shack. Covers 10 kHz to 30 GHz listing stations or services assigned by frequency. You also get a time chart that shows each time zone and its relation to GMT. ©1978

RP-SC

\$4.95

### NEW 1980 34th EDITION WORLD RADIO & TV HANDBOOK

The world's only complete reference guide to international radio and television. This 1980 edition has complete information on each station including address, frequency and scheduling. Much additional information such as solar activity and World Time Table is included. Unquestionably the leading book of this type. 554 pages. ©1980.

WR-TV

Softbound \$14.95

### BAND-AIDS

by James Dersch, WØAJE

The author subtitled this best seller the "Radio Amateur Operators Handiest Handbook" and for good reason! Here in one easy to use package is a collection of the Ham's most often used operating aids, tables and charts. It contains such handy items as the National Traffic System's NET times and frequencies, WWV and WIAW operating schedules, international prefixes, and time zone conversions, to name only a few. In the non-operating category, Band-Aids contains useful material on Metric conversion, resistor (and other component) color coding, schematic-diagram symbols, telephone touch-tone frequencies, nomographs, and many useful formulas. All spiral-bound in a special heavy duty edition designed to withstand many years of tough station duty. 110 pages. ©1978.

CC-BA

Spiralbound \$7.95

# For Even Faster Service Call Toll Free 1 (800) 258-5353

## HAM RADIO'S BOOKSTORE • GREENVILLE, NH 03048



April, 1980  
Volume 4, Number 4

**T.H. Tenney, Jr., W1NLB**  
Publisher  
**James R. Fisk, W1HR**  
Editor-in-Chief

**Editorial Staff**  
Thomas F. McMullen, Jr., W1SL  
Managing Editor  
Martin Hanft, WB1CHQ  
Administrative Editor  
Robert Schneider, N6MR  
Joseph J. Schroeder, W9JUV  
Alfred Wilson, W6NIF  
Assistant Editors  
W.E. Scarborough, Jr., KA1DXQ  
Production Manager  
James R. Wales  
Art Director

**Publishing Staff**  
J. Craig Clark, Jr., N1ACH  
Assistant Publisher  
T.H. Tenney, Jr., W1NLB  
Advertising Manager  
James H. Gray, W1XU  
Assistant Advertising Manager  
Harold P. Kent, WA1WPP  
Dorothy A. Sargent, KA1BEB  
Advertising Sales

Susan Shorrock  
Circulation Manager  
Cassette tapes of selected articles  
from *Ham Radio Horizons* are available to  
the blind and physically handicapped  
from Recorded Periodicals  
919 Walnut Street, 8th Floor  
Philadelphia, Pennsylvania 19107

Microfilm copies  
are available from  
University Microfilms, International  
Ann Arbor, Michigan 48103

Copyright 1980 by Communications  
Technology, Inc. Title registered  
at U.S. Patent Office

Ham Radio Horizons  
is published monthly by  
Communications Technology, Inc  
Greenville, New Hampshire 03048  
Telephone 603-878-1441  
ISSN 0147-8818

# HAM RADIO HORIZONS

## CONTENTS

<b>Station Interfacing Made Easy</b>	<b>12</b>
Douglas A. Blakeslee, N1RM	
<b>Desk Ideas For Your Hamshack</b>	<b>18</b>
David S. Boyd, K9MX Max W. Boyd, N9MX	
<b>Unforgettable Visit to Italy</b>	<b>22</b>
Enrico Davoli, WB4GKN	
<b>Ham Radio Techniques</b>	<b>28</b>
William I. Orr, W6SAI	
<b>UHF Expeditions Are Fun (?)</b>	<b>33</b>
Beth Wade	
<b>Questions and Answers</b>	<b>37</b>
<b>Primer For DX Chasers</b>	<b>42</b>
Gary J. Youney, N2AGM	
<b>Yaesu FT-101 Owners' Report</b>	<b>50</b>
Thomas F. McMullen, W1SL	
<b>Ham Radio Horizons Owners' Report Form No. 3</b>	<b>57</b>
<b>FCC Study Guide</b>	<b>60</b>
<b>Activities Calendar</b>	<b>76</b>
<b>Ad Check</b>	<b>78</b>
<b>Ad Scan</b>	<b>71</b>
<b>Advertiser's Index</b>	<b>78</b>
<b>DX Column</b>	<b>42</b>
<b>DX Forecaster</b>	<b>74</b>
<b>Focus and Comment</b>	<b>8</b>
<b>Ham Radio Techniques</b>	<b>28</b>
<b>Horizons Locator</b>	<b>72</b>
<b>Newsline</b>	<b>11</b>
<b>Product Showcase</b>	<b>66</b>
<b>Propagation Chart</b>	<b>75</b>
<b>Questions and Answers</b>	<b>37</b>
<b>This Month's Horizons</b>	<b>2</b>
<b>The View From Here</b>	<b>6</b>



## THE VIEW FROM HERE

With WARC 79 now past history, the future of Amateur Radio is secure, and the large equipment manufacturers are responding with more and more sophisticated Amateur equipment for the 1980s. In fact, during the past few months, there has been at least one major new equipment announcement each and every month! And with the coming of spring, Radio Amateurs by the thousands will be flocking to their local hamfests to take a closeup look at the new equipment and to compare their first choice with the offerings of other manufacturers.

If you're among those who are considering the purchase of a new transceiver (or receiver, or linear amplifier, or whatever), be sure you ask the salesman about the factory warranty before you put your name on the dotted line; it's not well known, but the warranties and guarantees offered by various companies are not created equal! As some buyers have sadly discovered, there are some Amateur Radio equipment manufacturers who require their dealers to provide the warranty as part of their "dealer agreement;" and in some cases the manufacturer or supplier does not reimburse the dealer for his warranty repair work. Under such arrangements it's not too hard to understand why the dealers aren't particularly enthusiastic about fixing faulty equipment.

Now, most of the manufacturers support extremely good warranty programs and provide factory training for the dealers' technicians and back that up with a warehouse full of spare parts; there are those who do not, however, and their dealers are further hampered by the unavailability of up-to-date service information — dealers often have little more to work with than the manual packed with the equipment. Under these circumstances the repair of your equipment is likely to be a long drawn out affair, depending on your dealer, and how interested he is in doing the factory's warranty repair work with no reimbursement for parts and labor.

In this day and age of sophisticated equipment, the dealers and repair technicians must stock many, many different components for each item they are called on to service. Parts that are not prone to failure are probably available only from the factory, but with modern transportation, turn-around can be remarkably fast. However, if the dealer is not reimbursed for his warranty work, it's not in his best interest to tie up vast amounts of cash in spare parts — and the chances are pretty good that the manufacturer who doesn't provide a factory-backed warranty probably doesn't maintain a good stock of spare parts either! You might have to wait weeks — perhaps months — before you can get your transceiver back on the air.

Over the years most of us have chosen our new Amateur equipment primarily on the basis of performance and how it stacks up against similar equipment in the same price range — it's usually assumed that the equipment warranties offered by different companies are essentially the same; they obviously are not, although the majority of Amateur Radio manufacturers do offer a complete, factory-backed guarantee. Before you plunk down your hard-earned dollars for a new rig, be sure to ask your dealer about the warranty and what kind of turn-around you can expect if the equipment breaks down.

Jim Fisk, W1HR  
editor-in-chief



FM...SSB...CW...

# ICOM Does it All!

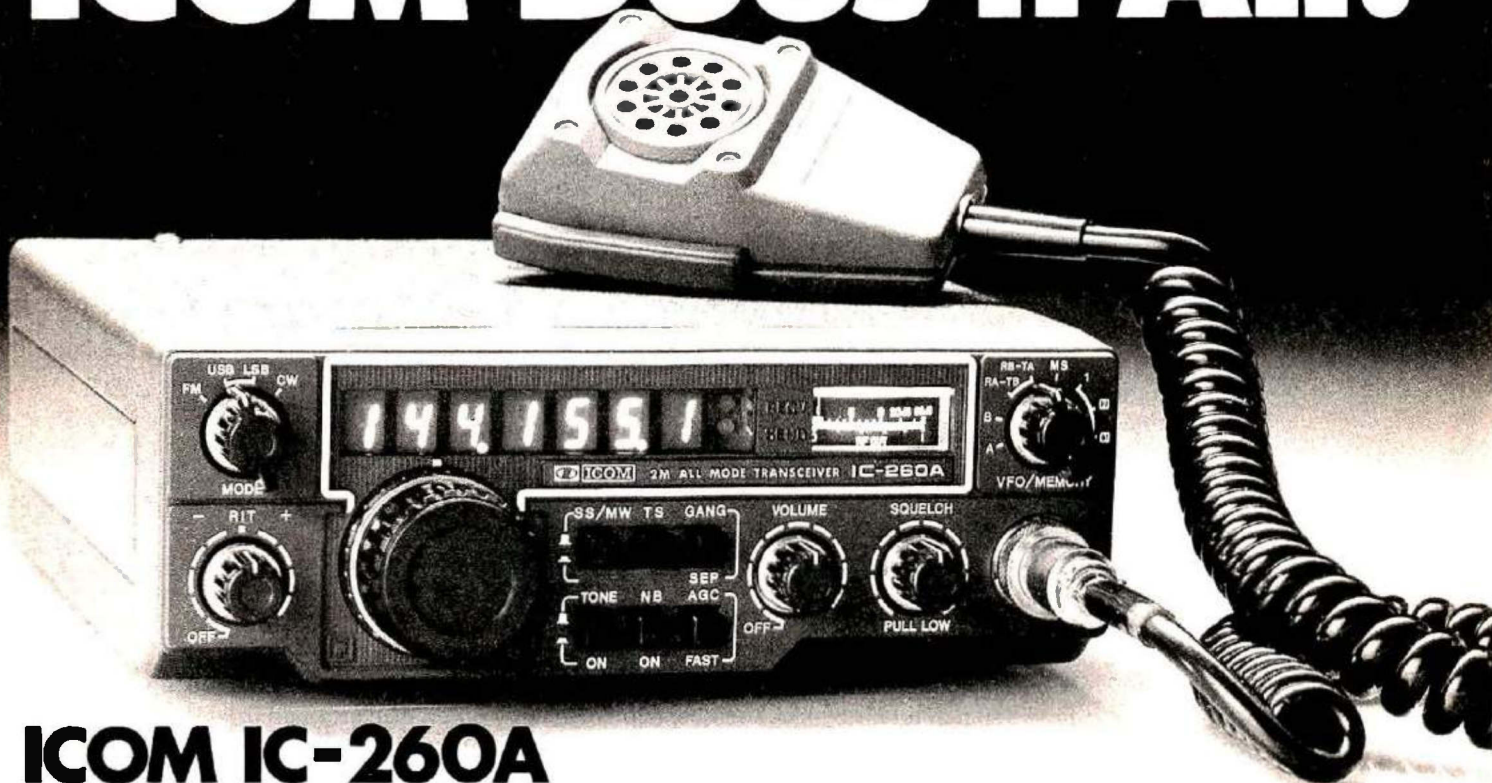

## ICOM IC-260A

Enjoy VHF mobile at its best. Sideband, FM or CW, the ICOM IC-260A does it all. The ICOM IC-260A contains all the features a mobile operator would want in a compact 2 meter mobile package with FM, SSB, CW operation. Features customers ask for most including:

- 3 memories built in (quick access to your favorite frequencies).
- Memory scan — automatically stops on an active frequency programmed in the memories.
- Programmable band scan — scan the whole band, or any portion of it you desire (adjustable scanning speed).

- Squelch on SSB. the 260A will automatically and silently scan the SSB portion of the band seeking out the SSB activity on 2.
- 600kc repeater offset built in. Easy repeater operation on the FM portion of the band.
- Variable repeater split — with the 2 built in VFOs, it's possible to work the odd splits plus accommodate future repeater band plan changes.
- Multimode operation — USB, LSB, CW, and FM. Great for getting into OSCAR, plus enjoying SSB rag chewing as well as repeater operation (including the new subband).

- With optional 117/12V supply, the 260A makes a flexible functional base for SSB/OSCAR/FM operation

The RF amplifier and first mixer circuits using FETs, and other circuits provide excellent Cross Modulation and Intermodulation characteristics. The IC-260A has excellent sensitivity demanded especially for mobile operation, high stability, and with Crystal Filters having high shape factors, exceptional selectivity.

The transmitter uses a balanced mixer in a single conversion system, a band-pass filter and a high-performance low-pass filter. This system provides distortion-free signals with a minimum spurious radiation level.

HF/VHF/UHF AMATEUR AND MARINE COMMUNICATION EQUIPMENT



# ICOM

## ICOM AMERICA, INCORPORATED

Sales Service Centers located at:

2112 116th Avenue NE  
Bellevue, WA 98004  
Phone (206) 454-8155

3331 Towerwood Dr., Suite 307  
Dallas, TX 75234  
Phone (214) 620-2780

### ICOM INFORMATION SERVICE

2112 116th Ave., N.E.  
Bellevue, WA 98004

Please send me:  IC-260A specifications sheet;  full color ICOM Product Line Catalog;  List of Authorized ICOM Dealers.

NAME \_\_\_\_\_ CALL \_\_\_\_\_

ADDRESS \_\_\_\_\_

CITY \_\_\_\_\_ STATE \_\_\_\_\_ ZIP \_\_\_\_\_

You may send a machine copy of this form

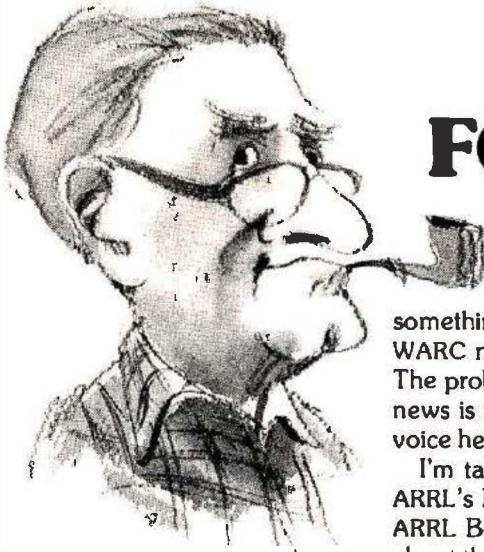

## FOCUS & COMMENT

Something very important is about to happen to your hobby, something that may have as much of an impact on you as the recent WARC meetings and the new Amateur bands that came out of them. The problem is that the results may not show up for a while. The good news is that you, every one of you, will have a chance to make your voice heard.

I'm talking about the survey of Amateur Radio to be conducted by ARRL's Long-Range Planning Committee, announced after the recent ARRL Board of Directors meeting. The interesting and attractive thing about this survey is that it will include non-members as well as members of ARRL. Previous surveys and opinion polls were limited to the

membership, and thus represented only the viewpoints of a closed, although large, group. This expansion of the data base is indeed encouraging.

The stated purpose of the survey is to "determine attitudes toward both Amateur Radio and the League." It will "concentrate on feelings and attitudes in order to develop information on where Amateur Radio and the League are now, and where they should be going." As you can see, it is not just another "What bands, what modes, do you use?" thing.

As the one organization that is consistently in touch with the FCC, ARRL should have maximum information on all aspects of the service available to it, and be able to interpret that information for the benefit of all Amateurs, regardless of their affiliation or lack of it.

While it would be nice, from ARRL's point of view, to have every licensed Amateur become a member, this will never happen, human nature and opinionated Amateurs being what they are. In the long run, this may be a good thing. A totally captive membership could lead to complacency and unresponsive management, whereas pressure from "outsiders" usually keeps any organization on its toes.

Not that I'm advocating the formation of competing organizations, mind you — this has as many dangers associated with it as does a one-party system, and the Amateur population is not large enough to withstand serious division. One large, well-informed voice can certainly command more attention than two or three weaker ones, and will certainly be less confusing to the lawmakers. But, to be effective, "outsiders" must be informed too, and there must be a way to let their voices be heard.

The survey is slated to start this spring, and be completed by fall, so the chances are you'll soon be asked some very important questions. When it comes to questions about ARRL functions, forget the old grudges, hearsay, and uninformed rhetoric, and give some straight answers.

On matters of what the Amateur Radio Service should be doing, give it some serious thought. Put yourself in the leader's position. Sure, it would be nice to have unlimited room for your favorite mode of operation, but is that really the foundation for a solid, growing, and useful Amateur Service? What would you tell Washington to do with Amateur Radio? What would your fellow Amateurs think of you then? Right!

You're going to have to educate yourself about some new modes and their uses — ASCII and computers, for example, or Narrow-Band Voice Modulation, or new satellites with greater capabilities for world-wide influence, and more. Once you've explored these new capabilities in your mind, I'll bet that you'll never again settle into your old comfortable rut of stagnation, but will find a new spark to try them in real life. You'll also feel good about having helped shaped Amateur Radio's future.

So, when that questionnaire arrives, don't just chuck it in File 13 and go back to your rag-chew or traffic net or slow-scan picture or whatever. Give 'em some answers to work on.

We have a saying here in New England that seems to fit the occasion: "If you didn't go to Town Meeting, then don't complain about the ordinances they passed!"

*Tom*

Thomas McMullen, W1SL  
Managing Editor





# INEXPENSIVELY SUPERIOR

The DS2000 KSR is the lowest priced RTTY terminal available with these advanced features:

- TX/RX operation on Baudot and ASCII RTTY plus Morse Code (Morse RX optional)
- Integrated keyboard and video generator allows editing of transmit text
- Full 24 line by 72 characters per line display
- Bright/dim display of characters differentiates between TX and RX display
- Morse receive option may be added at any time
- Separate CW identification key for RTTY operation
- Status line on top of screen shows terminal operating conditions
- Pretype transmit message into 255 character buffer; edit before transmitting
- 2 programmable "Here Is" messages
- Word-wrap-around prevents word splitting at end of display line
- Word mode allows editing of text to be transmitted
- Quick Brown Fox and RYRY test message keys
- Small size metal cabinet gives effective RFI shielding from transmitters
- Loop compatible RTTY connections and plus or minus CW key connections
- 110 and 300 baud ASCII
- 45,50,57,74,100 baud Baudot
- 1-175 wpm Morse transmit
- 1-175 wpm optional Morse receive
- 120/240 v, 50/60 Hz power
- Internal CW side-tone
- UnShift On Space for Baudot
- Keyboard Operated Switch
- SYNC idle for RTTY
- One year warranty

**HAL Communications and  
amateur radio serving  
the 1980 Winter Olympics  
through W.O.R.A.N.  
(Winter Olympics Radio  
Amateur Network)**

*Write or give us a call. We'll be glad to send you our new RTTY catalog.*



**HAL COMMUNICATIONS CORP.**  
Box 365  
Urbana, Illinois 61801  
217-367-7373

For our European customers, contact: Richter & Co. D3000  
Hannover 1 • I.E.C. Interelco. 6816 Bissone/Lugano • Radio  
Shack Ltd., London NW6 3AY • Erik Torpdahl Telecom, DK 3660  
Stenlose Denmark

DS2000 KSR.....	\$499.00
ESM-914 Video Monitor...	\$169.00
MR2000	
Morse receive option....	\$159.00



DAYTON

# HAMVENTION '80

- ★ Technical Forums
- ★ ARRL and FCC Forums
- ★ GIANT 3-Day Flea Market
- ★ New Products and Exhibits
- ★ Grand Banquet
- ★ Women's Activities
- ★ Special Group Meetings
- ★ Hundreds of Prizes
- ★ CW Proficiency Tests
- ★ Amateur of Year Award
- ★ Special Achievement Awards
- ★ Expanded Exhibits and Parking

**April 25, 26, 27, 1980**

**Hara Arena and Exhibition Center Dayton, Ohio**

Meet your amateur radio friends from all over the world at the internationally famous Dayton HAMVENTION.

Banquet speaker Saturday evening will be Senator Barry M. Goldwater, K7UGA. Seating will be limited so please make reservations early.

If you have registered within the last 3 years you will receive a brochure in late February. If not write Box 44, Dayton, OH 45401.

Nominations are requested for Radio Amateur of the Year and Special Achievement Awards. Nomination forms are available from Awards Chairman, Box 44, Dayton, OH 45401.

For special motel rates and reservations write to Hamvention Housing, 1980 Winters Tower, Dayton, OH 45423. **NO RESERVATIONS WILL BE ACCEPTED BY TELEPHONE.**

All other inquiries write Box 44, Dayton, OH 45401 or phone (513) 296-1165 - 5-10 P.M. EST.

**Rates for ALL 3 Days:**

**Admission:** \$5 in advance, \$6 at door.

**Flea Market Space:** \$11 in advance, \$13 at gate.

**Banquet:** \$12 in advance, \$14 at door.

Make checks payable to Dayton HAMVENTION, Box 333, Dayton, OH 45405.

**Bring your family and enjoy a great weekend in Dayton.**

Sponsored by the Dayton Amateur Radio Association, Inc.



# NEWSLINE

RULES PERMITTING ASCII for U.S. Amateurs were adopted at the Commission's Agenda meeting on January 30, with its use on Amateur bands likely soon. In adopting the third Report and Order on Docket 20777, the Commission specified that Amateur ASCII transmissions must conform to ANSI Standard X3.4-1968, with F1 (only) used on frequencies presently authorized for RTTY use between 3.5 and 21.25 MHz, at a maximum rate of 300 baud. On RTTY frequencies between 28 and 225 MHz, F1, F2, and A2 may be used, at a transmission rate up to 1200 baud. Above 420 MHz, F1, F2, and A2 are all permitted, with a baud rate up to 19.6 kilobaud.

Under The New Rule Section 97.69(b), ASCII will be permitted not only for conventional communications but also for such purposes as computer-to-computer communications, computer control of repeaters and other Amateur stations, and packet communications. No changes were made in present bandwidth limitations, however.

NOAA WEATHER BROADCASTS may not be transmitted via Amateur stations, the Commissioners confirmed in denying RM-3457. The Commission noted that weather information is available from many other sources, and thus the ban on the retransmission of "broadcasts" by Amateurs is still desirable.

That Ban, it should be noted, also applies to all other such "broadcasts," including WWV's time and propagation reports.

Reports On Which Of The Questions an Amateur (or commercial) license applicant got wrong cannot be provided by the FCC, the Commission also decided. In dismissing RM-2665, the Commissioners noted the cost of such a program was estimated to be about \$300,000, money that could be better spent elsewhere.

Finally, "Temporary" Amateur licenses, to be issued to a family member or friend by an Amateur whose call they'd use, were also rejected by the Commissioners. In dismissing RM-2774 and RM-3000 they noted that such a procedure would be too prone to abuse.

NOVICES AND TECHS WILL be able to operate in Canada under the new no-permit rules relaxation. However, they will be limited to the operating privileges that they enjoy with their class of license when operating in the United States.

AN ILLEGAL 40-METER STATION transmitting political broadcasts to Cuba was shut down by FCC agents and U.S. Marshalls in Miami February 7. The Spanish language operation had been the subject of complaints from both U.S. and Latin American Amateurs for the past several months. FCC long range DF stations had bracketed the operation as coming from Miami, and monitors from the Miami District Office pinpointed its location for the raiders.

THE FLIGHT COMPUTER for the AMSAT Phase III-A satellite is now running in the spacecraft, using the IPS-C flight software. The telemetry multiplexer unit, command detector, battery charge regulator, motor ignition unit, torque magnet, and umbilical interface all have been checked out.

A Reminder To Phase III Users: Before the kick motor is fired there is to be no use of the transponder passband, including the voice bulletin channels. This is because of the need for critical ranging tests prior to kick-motor firing. All satellite users are urged to refrain from putting any signal in the Phase III-A uplink passband during this period. Codestore messages on CW and RTTY will be transmitted on Phase III-A general beacon on 145.810 MHz.

NOMINATIONS FOR 1980 "Ham of the Year" will be accepted until April 11 by the Dayton Hamvention Awards Committee. All phases of a nominee's life, not just Amateur Radio, will be considered in the selection. A special achievement award for a one-time outstanding performance in Amateur Radio will also be presented. Nominations or requests for additional information should go to the Awards Committee, Box 44, Dayton, Ohio 45401.

RFI FROM AND TO PERSONAL COMPUTERS has been a problem for Amateurs who've become involved in both hobby areas, and it will be multiplied greatly when computer-to-computer communications via Amateur Radio becomes a reality shortly. The FCC has new RFI standards for computers due to go into effect July 1, but a number of computer makers are objecting strongly to that date and want it extended — some by as much as two years.

25TH ANNUAL WEST COAST VHF Conference has been set for May 9-11 at the Miramar Hotel, Santa Barbara. A special program on current superb VHF/UHF propagation is planned, plus many technical sessions, noise figure and antenna gain competitions. Early registration is \$4; N6NB has registration forms and details.

A FUND TO AID JAN GOULD, WA6YQW, who was very seriously injured on the recent Palmyra/Kingman DXpedition, has been set up to aid her through the months of hospitalization she is facing. Contributions go c/o W6ORD.

DX-80, THE BIG ANNUAL FRESNO DX Convention, has been scheduled for April 19-20 at the Fresno Holiday Inn. Expected DX notables include OH2BH, DJ9ZB, HB9MX, HB0LL, K5VT/SV5, K6LPL, the Colvins, and a contingent from the recent 824 operation.

# STATION INTERFACING

Just as the sun went down I made my way ever so quietly into my radio shack through the cellar entrance. Clutched under one arm was a new ICOM IC-701. I didn't want to meet any family members who might have questions such as, "How much did *that* thing cost?" Within minutes, I thought, I'd be on the air making great contacts with my new rig. Sad to say it wasn't to be — some problems developed.

No single manufacturer makes all the items an active Amateur will want in his station. In theory, if you purchase all your gear from a single vendor, everything should plug together, and each box in the system should be like every other box. Not so. I once spent hours trying to hook up a vhf transverter only to find the manufacturer had wired the power cable incorrectly. In another instance, I found that a transceiver was highly unstable when used with its companion amplifier, but both transceiver and amplifier worked fine when hooked to gear from other vendors.

Mr. Murphy was lying in wait for me and my new '701. Nothing worked with anything! I spent several hours with pencil and paper plus the '701 instruction book, and two evenings with a soldering iron before I could relax with a first contact.

## Advice to the beginner

My station has some commercial gear, some surplus, some home-made, and several kits. When I changed to the IC-701 the microphone, amplifier, antenna switching

BY DOUG BLAKESLEE, N1RM



scheme, second receiver, keyer and audio filter all had to be rewired or revised. As I went through this process, I wondered, "If I'm having so much trouble after twenty-five years as a ham, what happens to a newcomer?"

This article presents some advice about making various parts of a ham station work together in harmony — called interfacing in the electronics business. It's impossible, of course, to cover all problems and all types of equipment; however, I'll review some of my difficulties together with generalized solutions to various interface problems. The objective is to get the various bits and pieces of equipment in your station to work as an efficient communications station.

## Interface devices

A number of electronic components are useful when interfacing one unit to another:

**Diodes** — A diode is a semiconductor which, when a threshold voltage is reached, will conduct in one direction but will block current flow in the opposite, or reverse, direction. The

threshold voltage is typically 0.3 for germanium diodes and 0.7 for silicon diodes.

**Transistors** — Bipolar transistors are useful in switching circuits, control-voltage-level conversion, and low-impedance amplifiers of all sorts. For amplifying signals from high-impedance sources, and for sampling signals with minimum loading of the signal source, field-effect transistors (FETs) are often used.

**Op Amps** — Operational amplifiers, or op amps, are high-gain, differential-input integrated circuits that require no power from the driving source. They can work into low-impedance loads. They have two inputs and amplify only the difference signal applied between the two terminals. Op amps can be used as amplifiers, impedance transformers, level shifters, timing circuits and have many other uses.

**Transformers** — At both audio and radio frequencies, transformers are used as both coupling and impedance-matching elements. A transformer consists of two or more coils of wire, often wound on a magnetic core such as iron or ferrite.

**Relays** — These components consist of an electromagnet which activates one or more contacting mechanisms. Relays offer an inexpensive way of turning power on and off and of switching between different circuits. Relays are usually designated by their intended function such as power, control, antenna switching, and so on.



## Part one of a two-part article on how to arrange your station for maximum efficiency and operating convenience.

The relay coil is rated for a specific ac or dc operating voltage or current. The contacts are rated for a specific current. In general, dc-operated relays are preferred for Amateur applications, because ac relays develop hum sooner or later.

The types of contacts are designated by letters. A single set of contacts that are normally open is designated form A, as shown in Fig. 1A. The normal position of the contacts is with no power applied to the coil. Form B is the same as form A except that, as shown in Fig. 1B, the contacts are normally closed. Fig. 1C illustrates form C, which is an A and B set combined. Of course, one relay may contain more than one set of contacts. A power controller usually has two form As, while a control relay will have two, four, six, or eight form Cs. A coaxial antenna relay contains form C in a special housing to provide a constant impedance.

**Opto couplers** — Often it's useful to couple a signal without the need for a common ground return. Such a technique allows either the input or output circuit to float; that is, not be tied to a common point or to ground. The device used for this task is an optical isolator, usually nicknamed an "opto coupler."

The input side of the coupler is a light-emitting diode (LED), while the output side is a photosensitive diode, transistor, thyristor, or logic circuit. The transmission path through the coupler is via light, so the isolation between the input and output is typically 3000-7000 volts. Opto couplers haven't been widely used in Amateur Radio except for teletype applications. As computers and other complex digital equipment become more popular, opto couplers will have increasing applications.

**Solid-state relay** — Although still expensive, solid-state relays are most useful for remote power control. They typically contain an opto coupler, a trigger device such as a DIAC, or zero-

crossing switch, and a power-control element, usually an SCR, QUADRAC, or TRIAC. (See Table 1.) Their advantages over their mechanical cousins are a) no power required in the control signal, b) silent operation, and c) no mechanical contacts to wear or spark. They're most useful to turn on power to a teletype machine or SSTV camera, for example.

### Basic station control

Today, most Amateur transmitters and transceivers have switching circuits for receiver muting and antenna changeover. This was not always the case. My first station consisted of a Heathkit AT-1 transmitter (9 watts output on a good day) and a Hallcrafters SX-24 receiver. I changed

from receive to transmit by first throwing the mute switch on the receiver, then I used a knife switch to transfer the antenna from receiver to transmitter, then I activated the transmit switch on the transmitter. I suppose that, with my code speed and efficiency at the time, it didn't matter much.

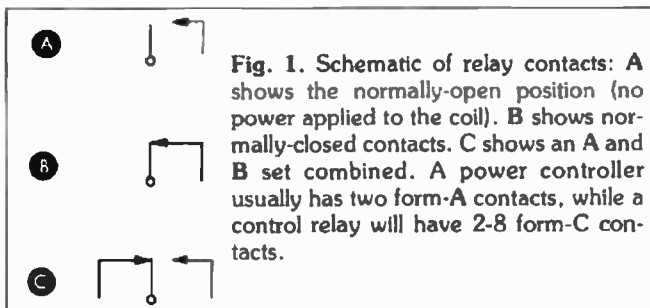

Fig. 1. Schematic of relay contacts: A shows the normally-open position (no power applied to the coil). B shows normally-closed contacts. C shows an A and B set combined. A power controller usually has two form-A contacts, while a control relay will have 2-8 form-C contacts.

But let's look at how it *should* be done, both to help those who have older or homemade rigs and to learn about the choice of relays, some timing problems, and also decoupling techniques.

Table 1. The Alphabet Soup Of Semiconductors.

DIAC	(Bidirectional Trigger Diode) — Back-to-back diodes in a single package that allow almost no current to flow until a threshold potential is reached. Above the threshold voltage, current flow is possible in either direction, limited only by external resistance. DIACs are used to set the trigger point for TRIAC control circuits.
FET	(Field-Effect Transistor) — A family of transistors that feature high input impedance and operation characteristics similar to vacuum tubes.
PUT	(Programmable Unijunction Transistor) — With a structure rather like an SCR, the PUT can perform the same functions as a UJT with control of the peak voltage point (where the negative-resistance characteristic starts).
QUADRAC	A TRIAC and DIAC built into a single package.
SCR	(Silicon Controlled Rectifier) — A rectifier diode with a gating function so that it can be turned on when desired. Current can flow only in one direction. SCRs are primarily used in power control.
TRIAC	(Bidirectional Triode Thyristors) — A gated set of rectifiers that can be turned on as needed. The TRIAC allows current flow in either direction; thus, it is most useful in ac power control.
UJT	(Unijunction Transistor) — A transistor containing a single junction that exhibits a declining current vs. increasing voltage characteristic (negative resistance), making it useful as an oscillator and pulse generator.

**Relay control:** The first task is to determine what connections are needed for relay control of transmitter and receiver. Every communications receiver I've used has provisions for an external mute circuit. Some receivers require an open circuit at the mute terminals to disable the receiver, and some need a short circuit. Determine which you have and connect to the normally open or normally closed contacts of the control relay as appropriate.

Relays

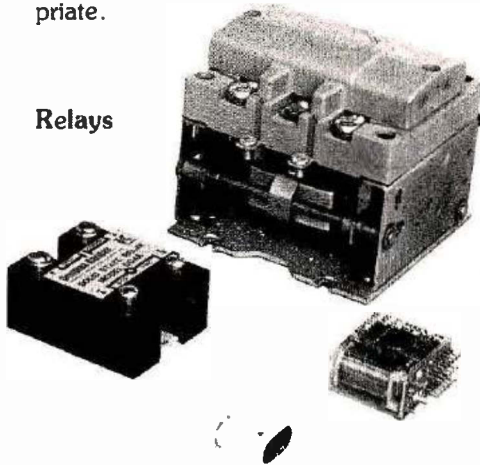

If your receiver was not intended for communications service, it may not have muting terminals. If not, you may be able to modify it. Review the schematic diagram. The best approach is to turn off the supply voltage to the audio, i-f, and rf stages and to leave the oscillators on — for best stability. Such a modification requires some cutting and chopping. A simpler method is to disable the receiver power supply by opening the ground return lead. If you don't want to cut up your receiver at all, you can use a set of relay contacts to open the receiver speaker lead and switch in a 4.7-ohm resistor in place of the speaker.

My SX-24 had muting terminals, but the AT-1 had no provision for external control. A review of the transmitter diagram indicated that it would be easy to bring out the transmit/standby function to an external relay. In the AT-1, I achieved transmit control by opening the center-tap return of the high-voltage power transformer with a front-panel-mounted switch.

Most transmitters, the AT-1 included, have a VFO or accessory socket with unused contacts which I used to connect to the transmit-standby switch as shown in Fig. 2A.

Note that an rf choke and bypass capacitor were used on the lead brought out of the transmitter. These components should be located at the VFO or accessory socket. The capacitor leads should be as short as possible. Shielded wire was used within the transmitter. Do not omit these parts. They suppress rf that may be picked up in the transmitter. If you omit them you'll find rf around your shack and — worse — interference with nearby TV sets. Manufacturers generally use extensive shielding around their transmitters. If you bring out one wire without appropriate rf decoupling, you'll destroy the effectiveness of all that shielding. Remember that rf can get in

as well as out, so use rf chokes and bypass capacitors on the accessories you build. If the transmit switch is in series with a lead, the connections shown in Fig. 2B are appropriate.

**Connections for the transmit-receive function:** The contacts of K1 mute the receiver and turn on the transmitter (Fig. 3). The leads from the gear to the control relay don't have to be shielded but it won't hurt. If you use the individual wires, twist them together into pairs. K1 typically has a 12- or 24-volt dc coil and can be an open-frame or control type. I use 24 volts dc because of the many surplus relays available at a fraction of their new cost. Most relays for military equipment operate on 24 volts dc. If you plan portable, mobile or emer-

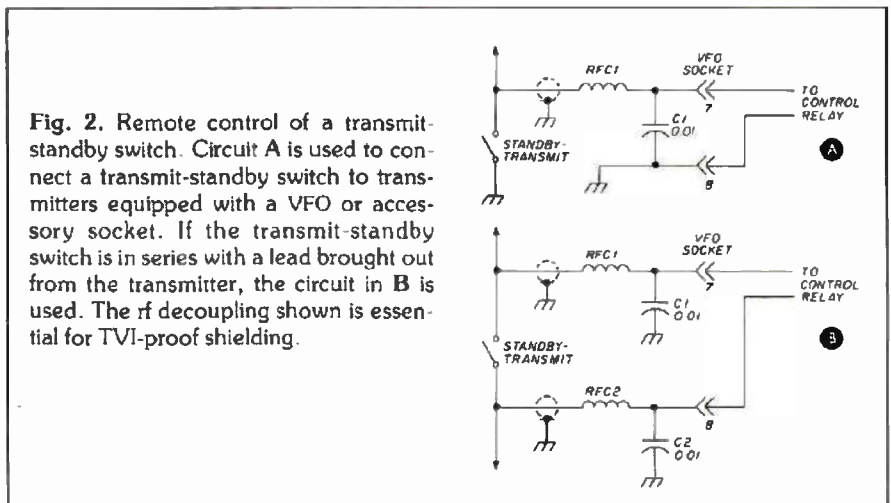

**Fig. 2.** Remote control of a transmit-standby switch. Circuit A is used to connect a transmit-standby switch to transmitters equipped with a VFO or accessory socket. If the transmit-standby switch is in series with a lead brought out from the transmitter, the circuit in B is used. The rf decoupling shown is essential for TVI-proof shielding.

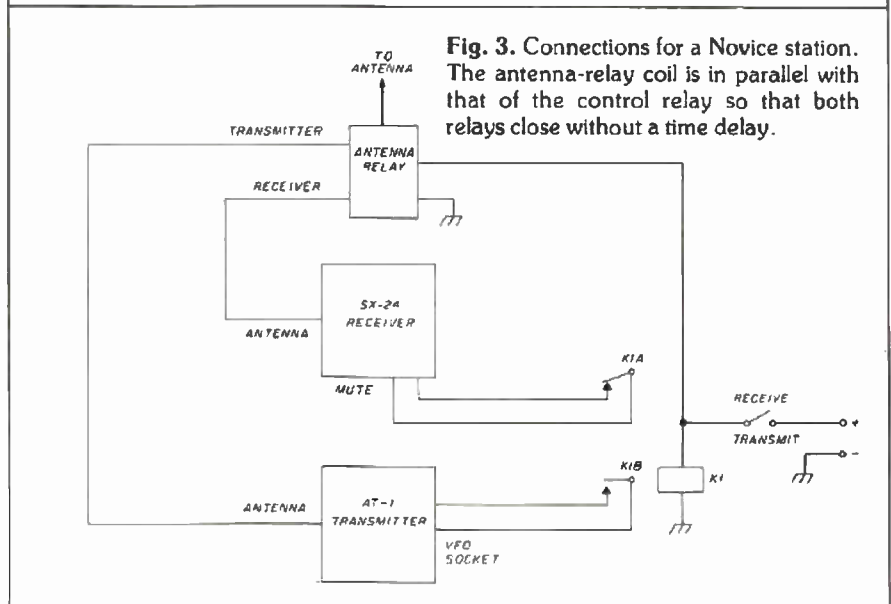

**Fig. 3.** Connections for a Novice station. The antenna-relay coil is in parallel with that of the control relay so that both relays close without a time delay.



gency operation from a battery source, 12 volts dc is a good choice. Avoid 110-Vac relays because of hum and safety considerations. A power source for relays is discussed later in this article.

Inspection of Fig. 3 shows that the antenna-relay coil is wired in parallel with the control relay coil. This is not by accident. Relays require a finite time to close. Generally the larger the relay, the longer it takes to activate. If one relay controls another, the closing times add. Such a series arrangement wouldn't be a problem with the manual switching arrangement shown in Fig. 3. But consider what would happen if the transmit switch were a voice-operated (VOX) or CW break-in circuit. The first word spoken or character sent will result in rf power from the transmitter. If a delay in operating

the antenna relay occurs, caused by a daisy-chain of relays, switching with power applied will surely cause contact arcing. Also, part of the first word or CW character will be lost. This is why so many SSB operators using VOX start every phrase with "ummm" or "ahhh." They are getting those relays closed. But this is hardly the way to carry on an intelligent conversation.

Coaxial-antenna-relay prices have increased to astronomical heights. You can build your own, following the circuit of Fig. 4. A small aluminum box encloses a relay. The open-frame relay is the best choice. The power lead for the relay coil must be decoupled for rf. A homemade antenna relay isn't suitable for vhf use but is fine for hf. The same unit can be used for remote antenna switching to

save multiple runs of expensive coaxial feeders.

### The Gadget Box

Switching relays and homemade station accessories require power. When I rebuilt my digital clock to use the 7001 integrated circuit (so that both time and date would be displayed) I built a 3-ampere power supply into the unit. From this one supply I obtained power for the clock, 12 volts for station accessories, 24 volts for relays, and 13 volts to operate a

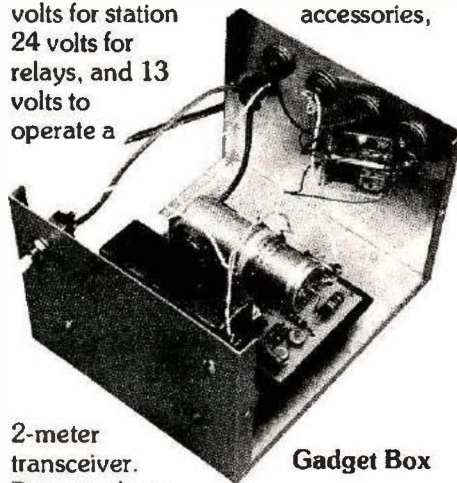

2-meter transceiver. Because there are so many gadgets connected to it I called it the "gadget box."

The circuit is shown in Fig. 5. The 24-volt output was taken from the filter capacitor. The other outputs were regulated by 7812 integrated circuits. The inner workings of these ICs were recently described in HRH.<sup>1</sup> The TR-22 likes a bit more than 12 volts, so two silicon diodes (CR5, CR6) were added to the 7812 return lead, which increase its output to 13.2 volts. Phono connectors were used for power connections on the rear panel of the power-supply/clock cabinet. The 7812s were mounted directly to the rear panel of the cabinet, which provides a heat sink. The bypass capacitors connected to the inputs and outputs of the 7812s should be located as close as possible to the ICs.

### Controlling an amplifier

Many transceivers have a set of relay contacts available for controlling an external amplifier. The ICOM 701 uses a solid-state switching system internally, with no provision for direct control of an amplifier. The instruction book contains a circuit diagram

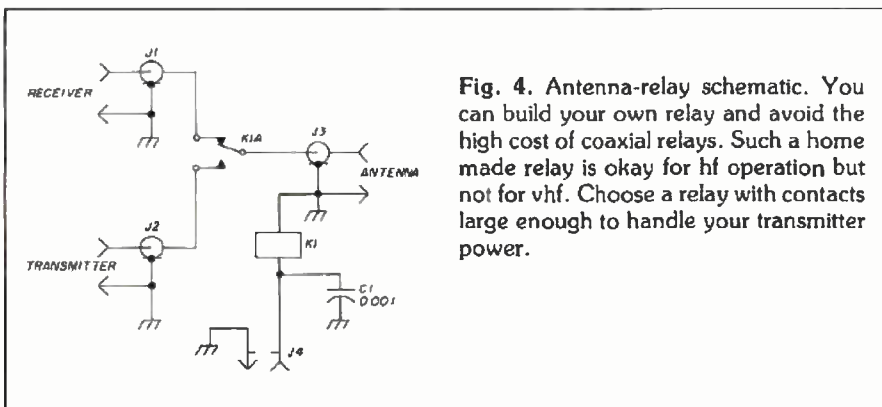

Fig. 4. Antenna-relay schematic. You can build your own relay and avoid the high cost of coaxial relays. Such a home made relay is okay for hf operation but not for vhf. Choose a relay with contacts large enough to handle your transmitter power.

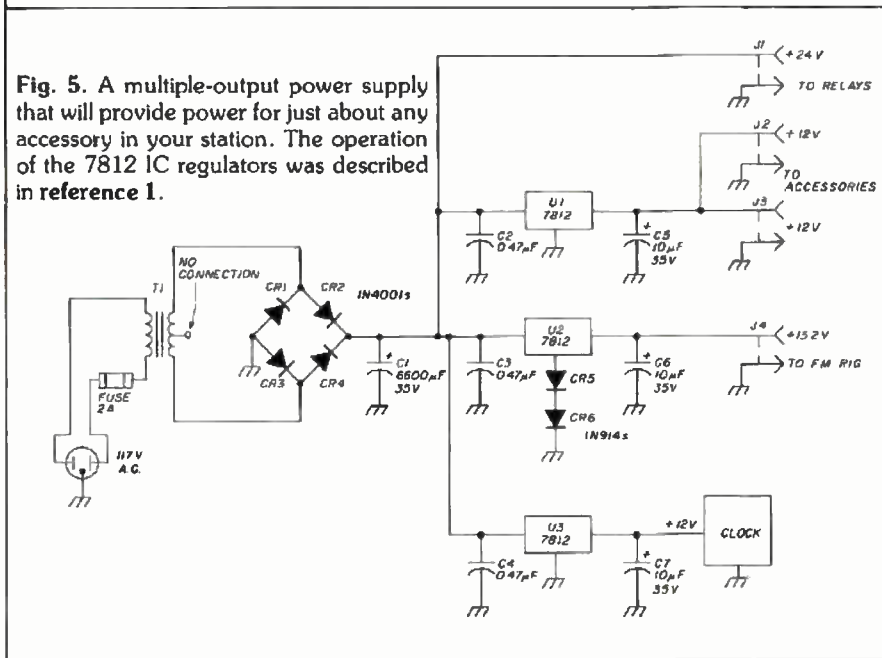

Fig. 5. A multiple-output power supply that will provide power for just about any accessory in your station. The operation of the 7812 IC regulators was described in reference 1.

for adding a control relay between a 12-volt power lead and the PTT (push-to-talk) control line. I hooked up a 2-pole control relay according to the instructions.

As mentioned above, it isn't good practice to have a chain of relays, one controlling another. To tell if you have a problem, observe the antenna changeover relay in a dark room while operating VOX or VOX-controlled CW break-in. You may have to remove a panel or cover on your amplifier to observe the relay, so be very careful when the power is on.

Coaxial relays often have a plug over the contacts to allow access for cleaning; with the plug removed, you can watch the contacts as they open and close. My test produced some impressive arcs at the contacts as the antenna relay closed in my Henry amplifier. Continued operation in this fashion would have left the contacts looking like a piece of Col. Sanders' best crispy style.

I used a 'scope and found that the control relay was taking approximately 20 milliseconds to close. Clearly, a faster switching method was needed. The choice was between a reed relay (close time typically 1-2 milliseconds) and transistor control, where switching is accomplished in microseconds. In my case a reed relay seemed to be the best choice. (The '701 has a solid-state switching circuit, which makes the design of a transistor controller rather difficult.)

**Transistor control:** For many applications transistor control is the best choice: no contacts to wear out, fast switching and lower cost than a reed relay. However, transistor circuitry is much more prone to rf interference than are relay equivalents, so extra rf decoupling is required. The circuit of Fig. 6 is typical. Bipolar transistor switches work on the principle that, when no current flows into the base, the collector draws almost no current. Inject sufficient current into the base, and the collector will draw a large current with a very small (typically a few tenths of a volt) voltage drop from the collector to emitter.

In Fig. 6, Q1 is used as an inverter. Most push-to-talk (PTT) schemes

have a voltage on the control lead that's shorted to common or ground to go from receive to transmit. When the PTT line goes to ground potential, Q1 injects current into Q2 and Q3. Q2 controls the amplifier while Q3 mutes a second receiver. (A few rigs put out a voltage when in the transmit mode. If you have one of these, omit Q1 and start at point A, in Fig. 6.)

A wide variety of transistors will work in the circuit shown. The collector-to-emitter breakdown voltage (BVCEO) should be at least twice the applied voltage. How do you know what the applied voltage will be? Inspection of the schematic diagram for the rig to be controlled may be of help. But the simple way to find out is to measure the control lead with a voltmeter.

When a dc relay has power removed from its coil, the collapsing magnetic field generates a voltage transient of opposite polarity to the current that was flowing. This voltage can be of sufficient potential to damage a switching transistor. As shown

in Fig. 6, an RC network attached at point B of Q2 will swamp voltage transients. Also, a rectifier diode can be added across the relay coil in the opposite polarity to the control current, which will prevent transient buildup. See Fig. 7.

As we mentioned earlier, some receivers require a short circuit on their control line for mute; others require the short circuit for the receive mode. If yours is the latter case, move the 2200-ohm resistor feeding the base of Q3 from point A of Q1 to point B on Q2.

In the unlikely event that you need to switch amperes of current rather than milliamperes, you can substitute a power transistor such as the 2N3055 in place of the 2N3053. Such a change will require a reduction of the resistance in series with the base lead to assure adequate turn-on current. If high voltage is to be controlled, a 2N5656 may be suitable. Or, Motorola, Delco, and others offer power Darlingtons transistors with breakdown ratings of 1200-1800 volts.

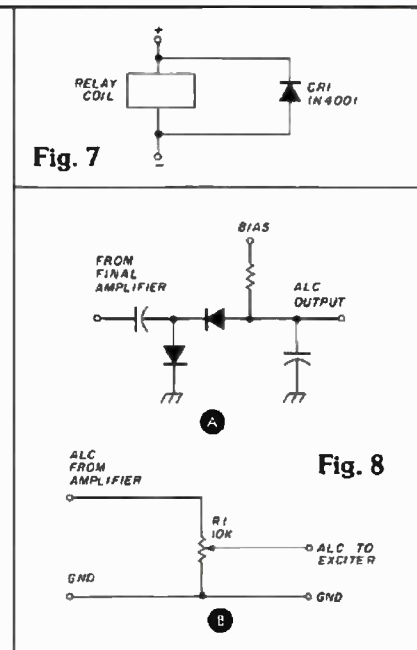
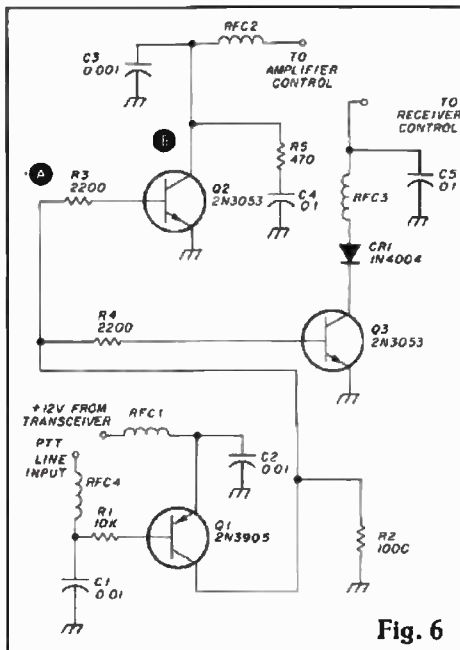

Fig. 6. Amplifier control using transistors. Advantages over relays include no contacts to wear out, fast switching, and lower cost than a reed relay. Extra rf decoupling is required, because transistor circuits are more prone to rf interference than relay-equivalent circuits. Fig. 7. A silicon diode can be used to suppress transients generated by relay operation. Fig. 8. Typical automatic-level-control (ALC) circuit used in SSB rigs. A. Circuit B may be used to reduce the ALC voltage swing, which may be a bit high for transistor rigs.



## Automatic-level control (ALC)

Most SSB transmitters and transceivers employ automatic level control (ALC). Manufacturers who sell matching amplifiers to go with their transceivers often have preadjusted ALC circuits, which require only a connecting cable. Interfacing gear from different manufacturers can pre-

quires positive voltage, then the ALC rectifier diodes in the amplifier must be unsoldered and reversed. Also, the bias polarity must be reversed, which can usually be accomplished by changing the bias-rectifier diode polarity and its associated filter capacitor. (Before taking this step make certain that the bias supply voltage is not used elsewhere in the amplifier in a

most cases they are not, so just where to set R1 is a problem. If in doubt set it for one-third of full and experiment.

ALC adjustment should be made with a general-purpose or monitor oscilloscope connected to the amplifier output. Use a two-tone generator or voice signal into the exciter and adjust its drive until mild flattening of the signal peaks is observed on the scope. Then adjust the ALC level control, R1, until the peak flattening disappears.

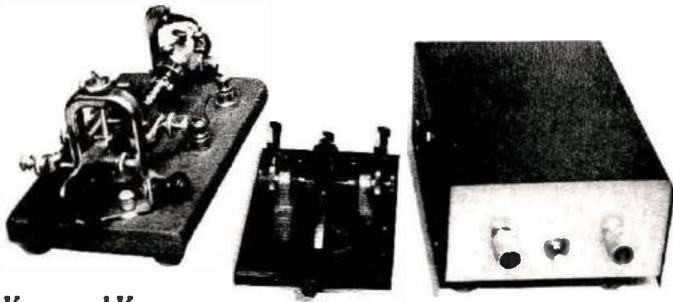

Keys and Keyers

sent problems, usually of polarity or level.

A typical ALC circuit is shown in Fig. 8A. A sample of the rf output signal is rectified by a diode. When the resulting dc voltage exceeds a preset bias voltage, ALC action starts and a negative voltage is fed to the exciter.

Most transmitters and transceivers have a negative-voltage ALC system. If you have an oddball set that re-

quires positive voltage, then the ALC rectifier diodes in the amplifier must be unsoldered and reversed. Also, the bias polarity must be reversed, which can usually be accomplished by changing the bias-rectifier diode polarity and its associated filter capacitor. (Before taking this step make certain that the bias supply voltage is not used elsewhere in the amplifier in a

way that would be damaged by polarity reversal.) Most amplifiers generate levels of ALC voltage that may be a bit high for transistor rigs. A 10,000-ohm control can be added between amplifier and exciter to reduce ALC voltage swing, as shown in Fig. 8B.

If your gear has an exceptional set of specs the ALC levels for the amplifier and exciter may be given. But, in

## Keys and keyers

Installing a hand key or a bug is usually a matter of hookup. Transmitter keying circuits use anything from a few volts to several hundred volts. In some units, it's a positive voltage; in some it's negative. The current through the keying circuit can be anything from less than a milliampere to several hundred milliamperes. Transmitter and transceiver keying circuits vary widely so I've always included a reed relay in the output of my homemade electronic keyers. Thus, the keyer can be used with any transmitter.

Of course you can make a transistor keying circuit for a particular transmitter. First, measure the voltage across the key jack. Note the voltage and the polarity. Then select a keying circuit for the appropriate polarity from Fig. 9. (These circuit ideas were used with the Curtis 8043-8044 keyer kit and are applicable with voltages below 300. For higher voltages, or currents above 100 mA, a higher power transistor will be needed.) If you find a voltage above 50 or so, remember to use appropriate safety precautions. That high voltage appears across the open terminals of your hand key.

In part 2 we'll take a look at microphones, speakers and audio filters, and monitor scopes. Also, I'll give some construction hints on how to deal with perforated and PC boards.

## Reference

1. Doug Blakeslee, W1K1K, "Power to the Projects," *Ham Radio Horizons*, December, 1977, page 30.

HRH

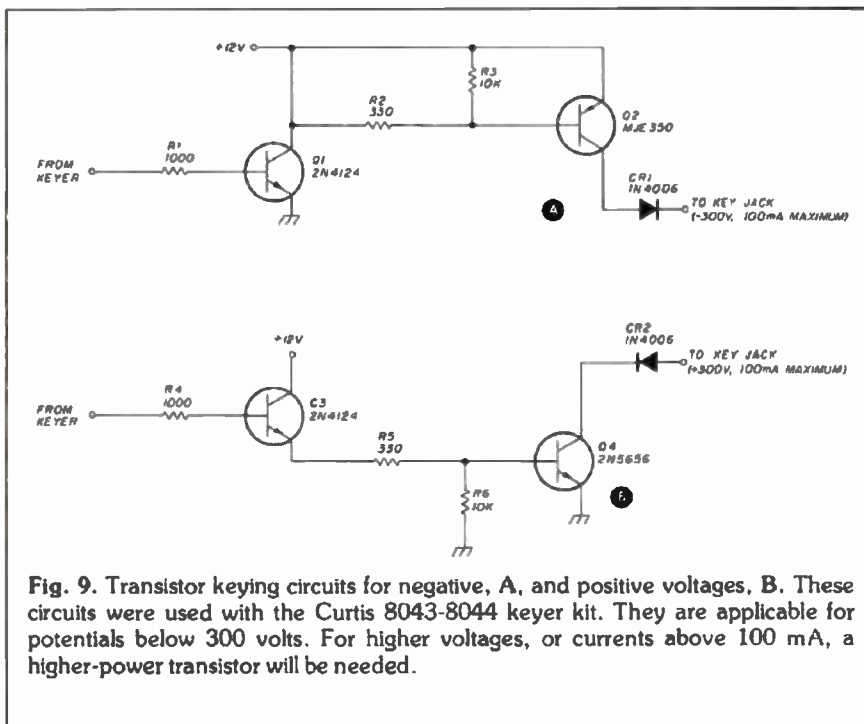
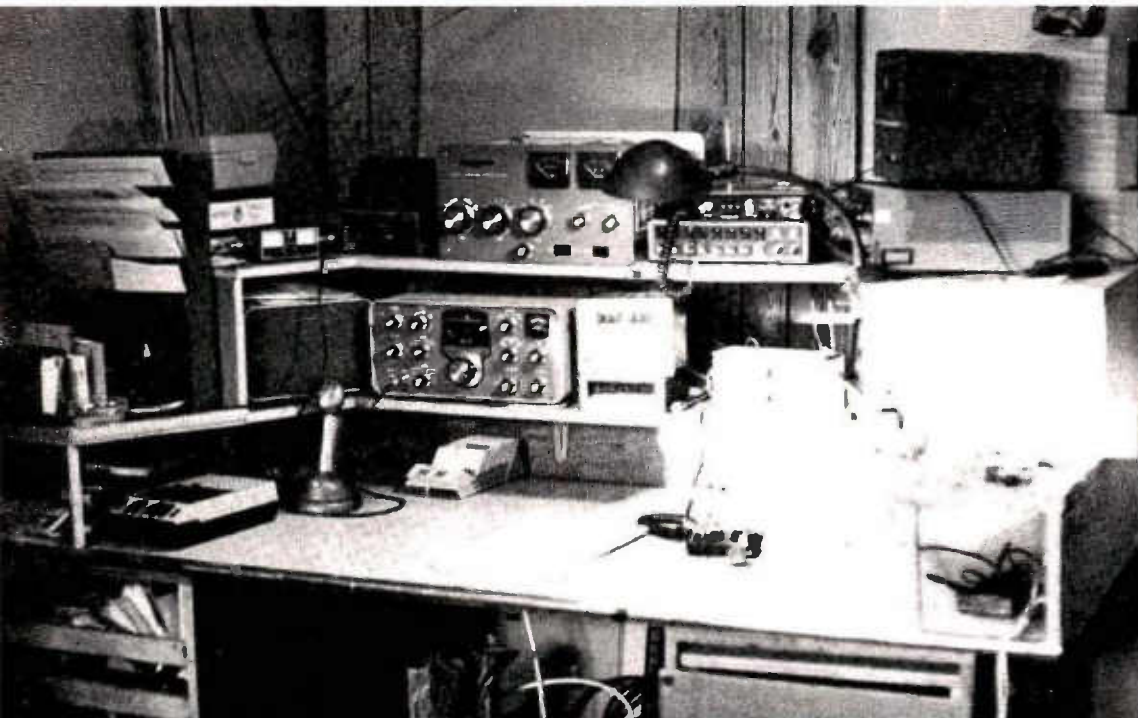

Fig. 9. Transistor keying circuits for negative, A, and positive voltages, B. These circuits were used with the Curtis 8043-8044 keyer kit. They are applicable for potentials below 300 volts. For higher voltages, or currents above 100 mA, a higher-power transistor will be needed.

# Don't Run Out Of Room

**By David Boyd, K9MX  
Max Boyd, N9MX**



**A DESK  
TO  
GROW  
WITH**



# Before You Start

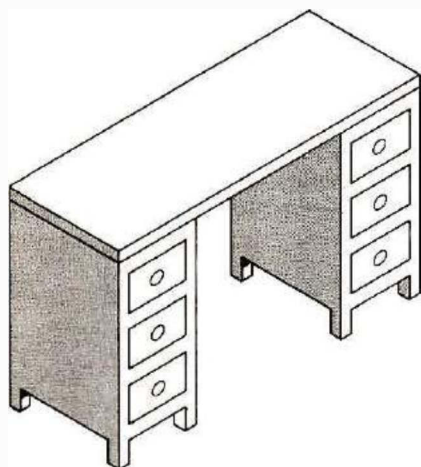

**Fig. 1.** A place to start: An old table-top, or door, or plywood top, placed across a pair of pedestals from a cast-off desk, some old furniture, or even constructed from scratch. It'll hold two or three pieces of equipment plus a key or microphone, with storage for paper, log books, and those spare parts and tools you'll find essential to maintain your station.

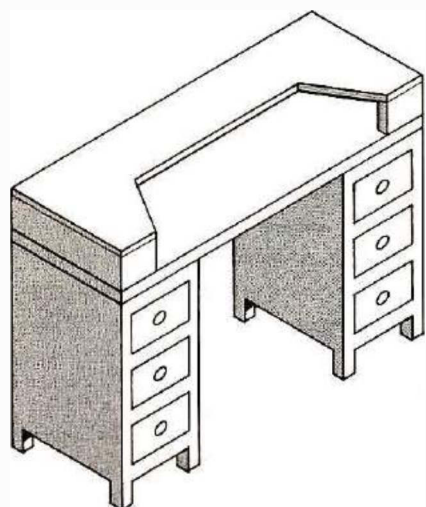

**Fig. 2.** Growing painless: A second top is added to the desk/console, providing room to stack more electronic boxes. Be sure to allow some room for ventilation above any equipment that will remain on the desk top.

After the Morse code is mastered, and the electronic theory conquered, every new ham dreams of that new station, and thumbs through catalogs to select what he wants. Even before he buys his equipment, he often is faced with the problem of deciding

where to put his gear and how to arrange it. It's not an easy task for one only vaguely familiar with Amateur Radio to plan where to put his receiver, or transmitter, or even where to locate the telegraph key. Moreover, if he is a former CBER, the problems are sometimes aggravated by his CB experience. There is a world of difference between the needs of a CW operator (most Novices) and those of a CBER. The Citizen's Band is entirely radiotelephone, so you can even lie on your bed and operate with ease. But a Novice, barely able to copy CW with pen and paper, will need — at least — a small surface on which to write and operate his telegraph key properly.

Most hams fall back on the utility of an old desk, or an old table, or even a door placed across a pair of boxes or sawhorses. But, at some point, most stations are improved to the point that a nicer operating position is required. When that happens, the old position is dismantled and the new one installed — perhaps one of the fancy, \$150 jobs you've seen advertised in the ham magazines. However, with a little planning and a lot of scrounging, you can make your first position versatile enough to expand with your needs, and you can keep it inexpensive.

The arrangements the authors use are similar but not the same. Since we each have slightly different needs, we have adapted the design accordingly. The console at N9MX is 8 feet wide because he is now retired, has the space, and has no intention of moving. At K9MX, the console is 6 feet wide, and it can be readily disassembled for shipment. Since he is in the Army and moves frequently, this smaller setup, suitable for frequent moves, is mandatory. Note too, that the position at N9MX uses the pedestals from an old desk. Since we didn't have any handy when it came time to build the one for K9MX, we built simple boxes. By following this basic design, and scaling it up or down to your needs or preference, you can have an operating position that will grow as your station does. To demon-

strate, let's follow through what is probably a typical ham career.

A Novice, strapped for funds, begins his station on a discarded kitchen table. Soon, he finds a need for drawers to hold small tools and electronic parts. Looking about, he finds two old nightstands (or desk pedestals, or file cabinets, or plywood to build two pedestals). Removing the legs of his old table, he places the table top on his new pedestals and now has a real desk, as in Fig. 1.

After a while, he decides to get into traffic handling, and discovers that the table is still a little too small. Even his limited equipment takes up a lot of space, and the cramping that results becomes tiresome during contests, long DX pursuits, and traffic nets. So, using scrap lumber, he builds a shelf about 7 inches off the table. That puts his gear at eye-level and within easy reach. The whole table top is now available for writing, operating a telegraph key, or building an electronic project, yet he has taken up no additional floor space, see Fig. 2.

Finally, our star upgrades his license class, and buys a linear. Since there is no room left on his little shelf, he builds another on top of the existing one. This new shelf is easily added, again takes no additional floor space, and still leaves the equipment within easy reach. By not permanently enclosing the fronts of any of the shelves, access to the equipment and flexibility of arrangement is enhanced. That last is important, since a ham often finds a need to rearrange things to suit his latest interests or most recent acquisition. The photograph of the K9MX station shows this stage of the growth.

Our young ham now has a really nice operating position, flexible, and as large or small as he needs, built around a basic design that can accommodate his growth as he can afford or wants to grow. All that remains are finishing touches.

Casters on the pedestals would make the desk easier to move (but they must be sturdy — this little desk can accumulate an incredible load). A little paint or veneer will hide old

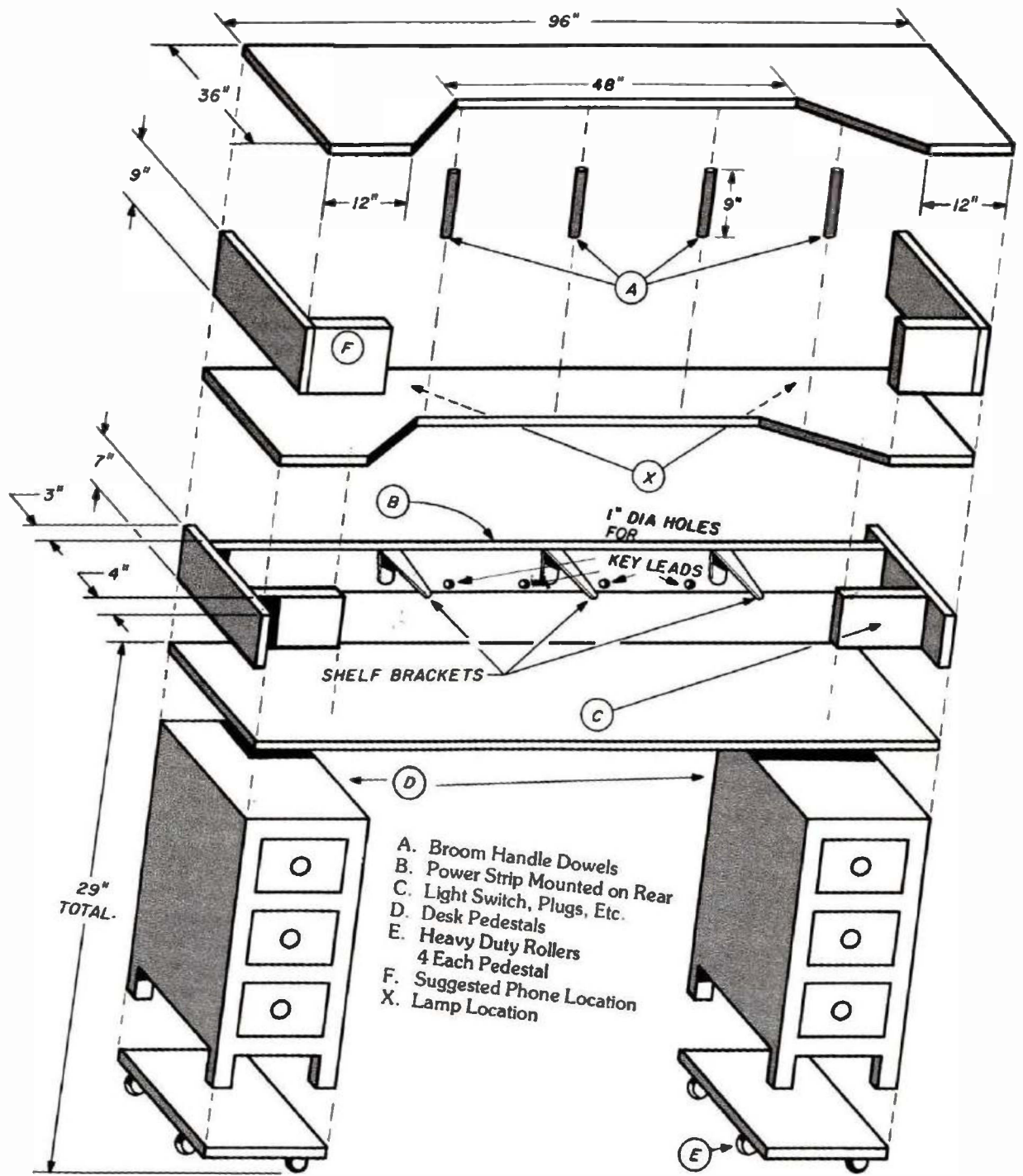

Fig. 3. Your console can evolve to this in slow, easy stages, or you can do it up right the first time. This three-decker with casters should take care of several years of growth, yet allows a degree of portability if you plan for a method of taking it apart. Note a couple of conveniences not often thought of early in the game, such as a place to put a telephone, and some lamps placed under the second deck.

wood and formica — if you used a piece of plywood or other rough material for the top — and provides a nice writing surface. A wall-mount telephone can even be hung directly on the face of the desk. If you like the built-in look, simple snap-in pieces can be cut to fit the spaces around the

cabinets of your gear. (Be cautious — well-ventilated gear performs better and lasts longer.)

Of course, our young ham could have, resources permitting, assembled the whole thing from scratch, including all the room for expansion at the very beginning, Fig. 3.

You can scale this design to meet your needs, and, as you can see, available material can be readily adapted. The major goal is to create a console flexible enough for any future needs, and keep costs within reach. This approach — certainly not a unique one — does both.

HRH



# 1 GHz For Only \$139.95

8 Digits • 1 PPM TCXO • Factory Wired 500 MHz or 1 GHz

**\$139<sup>95</sup>**  
5510 WIRED  
50 Hz to 1 GHz

**\$109<sup>95</sup>**  
5500 WIRED  
50 Hz to 512 MHz



• 1 Hz Resolution to 50 MHz.

- 1 Meg Ohm, 50 Ohm, BNC Inputs
- 15 MV Sensitivity at 250 MHz Typ.

With the introduction of the 5510 DSI has filled a long standing void in the frequency counter market place. You now have the choice of selecting a 512 MHz model 5500 for \$110 or for only \$30.00 more you can buy an 8 digit 1 GHz counter model 5510. With this 1 GHz capability, the new world of 960 MHz is immediately available to you. Both the 5500 and 5510 are available with a rechargeable battery pack which includes the AC adapter and battery charger for one low price. Whether you select the 5500 or the 5510, you will receive the best price to quality features ratio in the industry. No wonder DSI has become one of the world's largest manufacturers of freq. counters.

**1.2 GHz Only \$199<sup>95</sup>**  
5612 KIT

**512 MHz Only \$169<sup>95</sup>**  
5600 KIT

- 10 MHz Proportional Oven
- 2 PPM 10° to 40° C Time Base
- .1 Hz Resolution to 50 MHz.
- External 10 MHz Inputs outputs.
- 9 Bright .5 Inch LED Read-outs.
- 100% Factory Tested
- Kits 95% Factory Assembled.
- 50 Ohm, 1 Meg, BNC Inputs
- 10 MV Sensitivity at 250 MHz Typ.



Whether you select a 5600, 5612 Kit with 95% of the assembly completed by DSI or select a factory wired and calibrated frequency counter, you can count on DSI to solve all those difficult bench or field problems from measuring audio signals to checking a 960 MHz mobil radio (model 5612), servicing a VTR, trouble shooting a PLL signal in a TV or FM radio, etc. The 5600 or 5612 has the sensitivity and accuracy to meet any FCC landmobile, broadcast, RF, or telecommunication requirements. DSI offers a 10 HR rechargeable battery pack (BA56) option, and an audio multiplier (AM56) which will allow you to resolve a 1/1000 Hz signal in only ten seconds or 1/100 Hz signal in one second. DSI 5600 series offers just the right instrument for all your communication, RF, TV servicing and industrial testing needs.

FOR INFORMATION — DEALER LOCATION — ORDERS — OEM  
CALL 800-854-2049 CALIFORNIA RESIDENTS CALL 800-542-6253

Model	Price	Frequency Range Typ	Oven Temperature	Sensitivity Typ			Number of Readouts	Power Requirements	Size H x W x D
				10-25MHz	50-250MHz	250-450MHz			
5600A Kit	\$199.95	50Hz-550MHz	Proportional Oven 2 PPM 10° - 40°C	10-25mv	10-15mv	15-50mv	9	115 VAC or 8.2-14.5 VDC	3 1/4" x 9 1/2" x 9"
5600A-Wired	\$199.95			10-25mv	10-15mv	15-50mv			
5612 Kit	\$199.95	50Hz-1.2 GHz	Proportional Oven 2 PPM 10° - 40°C	10-25mv	10-15mv	15-50mv	9	115 VAC or 8.2-14.5 VDC	3 1/4" x 9 1/2" x 9"
5612 Wired	\$239.95			10-25mv	10-15mv	15-50mv			
5500 Wired	\$109.95	50Hz-512MHz	TCXO PPM 17° - 40°C	10-25mv	15-25mv	25-75mv	8	115 VAC or 8.2-14.5 VDC or NICAD PAK	1 1/2" x 5" x 5 1/2"
5510 Wired	\$139.95			10-25mv	15-25mv	25-75mv			

Factory wired units carry 1 year limited warranty kits carry a 90 day limited warranty  
Prices and/or specifications subject to change without notice or obligation

\*With AC-9 Adapter

Prices effective March 1, 1980

- 5510 Wired ..... 139.95
- 5500 Wired ..... 109.95
- 5510/BAC Wired ..... 164.95
- 5500/BAC Wired ..... 134.95
- T600 BNC ANT (all models) 7.95
- AC-9 AC Adapter(all models) 7.95
- LC 50.00 ..... 159.95

INTERNAL BATTERY ONLY AC-9 NOT REQUIRED

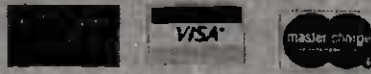

**DSI INSTRUMENTS, INC.**  
9550 Chesapeake Drive  
San Diego California 92123  
(14) 565-8402

TERMS: MC — VISA — AE — CHECK — M.O — COD  
in U.S. Funds. Please add 10% to a maximum of \$10.00  
for shipping, handling and insurance. Orders outside  
of USA & Canada please add \$20.00 additional for  
cover air shipment. California residents add 6% Sales Tax

- 5612 KIT ..... 199.95
- 5612 Wired ..... 239.95
- 5600A Kit ..... 169.95
- 5600A Wired ..... 199.95
- BA56 Rechargeable  
10 Hr. Bat. Pack ..... 29.95
- AM-56 Audio Multiplier
- 001 Hz Resolution ..... 34.95



# UNFORGETTABLE ITALY

By ENRICO DAVIOLI, WB4GKN



What scene is this? What is the occasion? An American couple in a railroad station in a strange land, far from home, in the middle of the night, yet surrounded by men and women they seem to know. First names are being used in much happy conversation and greeting. Their dress — it's not quite formal, yet above what you would expect for an afternoon shopping trip. What is the bond that ties these people together? Would you believe Amateur Radio and the opera? That's right, and here's how it happened.

Upon our arrival at the railroad station in Milan after a long day's journey from Frankfurt, Germany, my wife, Jane, and I were met by no less than six Italian Amateur Radio operators and their wives, all properly attired as though attending a semi-formal reception. The train from Frankfurt had already been one hour late, so you can well visualize the looks of relief on our friends' faces as we stepped down onto the railroad platform.

Jane and I had previously met three of the men (Carlo, I2CUK; Domenico, I2DMH; and Rino) when the internationally famous opera company, La Scala of Milan (of which these Amateurs were part), had



been in Washington, D.C., to perform at the Kennedy Center for our Bicentennial celebration in 1976. (See "La Scala Cures Some Virginia Hams," QST, February, 1978.) We had said our farewells to them in Washington, D.C., in typical Italian fashion, with much embracing and kissing.

So, it was only natural that the greeting in that railroad station in Milan at midnight continued with the same affectionate salutations! It was contagious: The other three men, Leo, I2JML; Angelo, I2PKF; and Nicola, I2XNC; as well as their wives (all of whom we had never met personally), joined in with the greetings. That's Italy, and that's the Italian way!

Thus began the most enjoyable and memorable trip Jane and I ever took, visiting a total of 56 Amateur-Radio operators, their wives and families, living with them in their homes, being wined and dined and feted like royalty. It was an experience which only served to enhance our already high regard for the hospitality and generosity of the Italian people, represented by their Amateur-Radio operators.

Our world is continually becoming smaller, and we are all becoming increasingly familiar with more and more foreign cultures, thanks not only to Amateur Radio, but to the media and the ease of international travel. I felt it would be appropriate to share the Italian Amateur Radio "scene" with you, covering the makeup of Amateur Radio as it exists in Italy today and stressing the brotherhood, courtesy, and friendship of a very congenial group of Amateur-Radio operators.

#### Licenses

There are basically two licenses available for use on the Amateur bands. The first level permits the licensee to use the 2-meter band only. The examination given is a written one only, made up of moderately difficult radio theory and regulations. Morse-code ability is not required for this first license.

Here, the prefix given the Amateur is IW. I don't imagine anyone reading

this article would ever contact an "IW" station unless he were operating 2 meters while traveling in Europe.

The second level of license allows the Amateur to use all the available Amateur frequencies, all modes. For this license, the candidate must pass another radio theory examination and be able to demonstrate his ability to send and receive code at the rate of 10 words per minute. In either case, the earliest age at which one is permitted to apply is 16. Between the ages of 16 and 18 years, the candidate must obtain signed permission from a parent. Thereafter, no parental permission is necessary.

---

## These Amateurs were part of the internationally famous opera company, La Scala, of Milan.

---

#### Organization

Amateur Radio in Italy is under the control and supervision of the Italian equivalent of our FCC, the Postal and Telecommunications division of their government. The parent organization of Amateur Radio operators in Italy is called the *Associazione Radioamatori Italiana* (ARI), comparable to our ARRL. Each little town usually has its own club and each province has representation by means of a president, much as we have our own smaller divisions and statewide chapters. The various clubs in the provinces serve as QSL bureaus for that particular province. The only manner in which an Amateur Radio operator can obtain QSL cards sent "via the bureau" is to attend the biweekly meetings (usually on Fridays).

#### Journals

There are several technical radio journals in Italy, but the official organ of their Amateur society, ARI, is called *Radio Rivista*, highly comparable to our own QST in format and content. In fact, many articles from QST are translated into Italian and reprinted in *Radio Rivista*. They also have many of their own original articles — both technical and otherwise — which are extremely well written. Foreign contributors are welcomed. I had the honor of having an article (*Dapper tutto Radioamatori*) published in *Radio Rivista*, in December, 1977, the translation of a QST article.

#### Call signs

Italy is divided into ten call areas as shown in Fig. 1. The mainland of Italy is designated by prefixes numbered IØ through I8. Sicily, a large island off the southern tip of Italy, bears the prefix IT9. Sardinia (Sardigna), a still larger island in the middle of the Mediterranean, carries the prefix ISØ.

There is a scattering of other smaller islands around Italy and surrounding the islands of Sardinia and Sicily which are very interesting to contact. These smaller islands have prefixes which bear the call numbers of the area on the mainland (or one of the two large islands) nearest which they are located. For example, IC8 is the prefix for the islands of Capri and Ischia, both of which lie off the coast of Naples, which is I8. Some of these islands are no more than volcanic peaks, and are often the sites of annual DXpeditions. Some of our readers may recall the famous 1977 DXpedition to the Tremiti Islands in the Adriatic Sea off the east-central coast of Italy. They used the call sign IL7TWI, a rare bird, indeed!

Finally, since early 1978, three autonomous regions of northern Italy have been permitted to use permanent call signs bearing the prefixes IX1, IN3, and IV3. (IX1 is for the province of Aosta; IN3 is for the provinces of Trent and Bolzano; and IV3 for the provinces of Trieste, Udine and Gorizia.)

# QSY to "I" LAND

## Ham shacks

The rigs and ham shacks in Italy are as varied as they are in any country. The major difference that I noted in Italy (and perhaps in all of Europe, for that matter) is that many Italian hams live in condominium apartments. Therefore, more often than not, their antenna systems are limited to those which can be placed on the tops of these apartment houses, many of which are ten to twenty stories high. In my travels I have seen relatively few antenna farms, as such, but several of my many Italian contacts have sent me photographs of some rather elaborately equipped shacks and antenna systems. Television interference is a chronically recurring problem and is of significant annoyance, particularly during the times of peak summer propagation between Europe and the eastern United States, mainly between 1900 and 2300 universal time.

Most Italian hams are extremely active on 2 meters. The repeater antenna systems are located on tops of tall mountains, and provide a fantastic line of coverage. Their 2-meter allocation is in the 145-MHz part of the band, and it includes a series of ten repeater systems throughout all of Italy. There is a 25-kHz spacing between channels, with no splits, and a 600-kHz offset between transmission and reception. There are relatively few 220- and 440-MHz repeaters available.

As many of you know, there are several Amateur SSTV stations and the Italians are just as versatile with their activity as we are here in the United States. There are many active contesters as well as rag-chewers. Further, the list of women Amateur-Radio operators is ever-growing in Italy, just as it is in the United States.

A great deal of electronics research is done, much as it is here. Hamfests are also very prolific endeavors; however, most of these hamfests are held so that the newer equipment can be demonstrated. Further, there is a scarcity of used equipment in Italy,

and parts for some of the rigs are extremely difficult to obtain, sometimes requiring several months or years to obtain.

The usual Italian Amateur Radio operator who speaks little or no English is somewhat shy when it comes to having a QSO with an American. However, he does make a valiant attempt at a QSO using English. You

will also hear him use terms which may sound a bit strange, particularly the use of the term "dear." This term is a Western European habit not strictly limited to the Italians. As with any one of our many foreign colleagues, some courtesy is all that is needed to effect a nice QSO — they truly appreciate our patience.

The Italians in general, and the Ital-

Domenico, I2DMH, a baritone of the famous La Scala Chorus, and his beautiful daughter Laura, trying to make contact with some DX station.



A visit to the Italian Alpine village of Sarnonico where we were hosted by Umberto, I3KUZ, standing, pouring the wine. His lovely XYL is standing next to him. Others in the group include WB4GKN; Renzo, I3RZB; Enzo, I3FSY; Jane, XYL of WB4GKN; and Freddi, I3AHO.



"The Four Bearded Ones" and Jane enjoying a dinner on the beautiful bay of Naples. From left to right, Jane, and Enrico, WB4GKN; Maurizio, I8LMY; Pietro, I8YZU, and our gracious host, Ciriaco, I8YCS, the current president of the Naples section of A.R.I.

ian Amateur Radio operators in particular, are primarily formal people when addressing strangers, yet they certainly appreciate and accept the informality afforded by Amateur Radio. There has developed a certain positive sense of good-fellowship which one can appreciate after a short QSO with an Italian operator.

Finally, if you are interested in awards, or if you are an award collector, then Italy is your country. You can obtain one award for each of the 96 provinces of Italy. Further, there are special awards, such as the Pope John XXIII award from Bergamo: a QSL in the form of a marble postcard from the area of Massa-Carrara, where the famous Carrara marble mines of Michelangelo fame are located; and QSL cards and diplomas made of cork, which are sent for contacts made with the island of Sardegna (Sardinia is known as a major center for the manufacture of cork). Then, too, there are those very special QSLs provided by some of the southern Italians in the form of bottles of wine with QSLs on the label!



### An unforgettable journey

Let us return now to the railroad platform in the Milan railroad station from which I began this story. Recall the overwhelming reception that Jane and I received at the time of our arrival. This reception was only a partial indication of what we were to expect thereafter. We were escorted to our hotel by the entire group. All over Italy, in whichever city or town we found ourselves, we always had someone with us as a constant companion and guide.

*Milan:* In this city of small skyscrapers, we were feted not just at one, but at two banquets, where we met the core of the Amateur Radio operators of Milan. The second banquet was held because all the people present at the first banquet felt that the restaurant was not very good, and thought that we, their guests, would leave Milan with a bad impression! (Jane and I were unable to determine which of the restaurants was the better, since both dinners were delicious!) At the second banquet we were formally presented with an Italian Amateur Radio pennant signed by all the Amateur Radio operators present at both dinners. Further, the two members of the La Scala chorus, Domenico, I2DMH; and Rino, spontaneously broke into some beautiful arias after dinner in that restaurant.

On our first weekend, the Milan radio operators organized a caravan of five automobiles, all equipped with 2-meter gear. Jane and I were escorted by a group of no less than fifteen to Lake Maggiore, and we visited the famous Borromean Islands, feast-

ing all the way. It was interesting to contact on 2 meters many Italian friends I had already met on 20 meters from the other side of the Atlantic.

*Bergamo:* Not to be outdone in any way by the people from Milan, at our next stop, Bergamo (home of Pope John XXIII), we were met by Mario, I2RRI; Mimmo, I2SQD; Antonio, I2BOH; and Pino, IØDUD. We were immediately escorted to a fine restaurant in the center of town, following which we had another personally conducted tour. The beautiful town of Bergamo is built in two sections, both hewn into the same mountain, with majestic views of the countryside.

*Mantua:* Our next stop would be Mantua (Mantova, in Italian), a very old town (of William Shakespeare fame) deep in north-central Italy. Our train from Milan to Mantua had already been delayed by more than three hours because of a large crowd of angry Milan citizens who were demonstrating against flash flooding conditions by standing in the middle of the railroad tracks, completely disrupting rail traffic in all of northern Italy. Almost all of the passengers, however, were unperturbed; after all, people had a perfect right to demonstrate when their homes were flooded! One irate passenger, though, upon discovering that we were Americans, blamed us and America for the train delay and for the then-current political/social/economic Italian crisis!

Our hosts in Mantua, Nullo, I2FNU, and Marcello, I2ARM, were waiting for us at the railroad station



# QSY to "I" LAND



Fig. 1. The Amateur Radio call areas of Italy. Islands take the number of the mainland district to which they are nearest.



The modern "Council of Trent" where Enrico, WB4GKN, received a plaque commemorating his visit there from the group headed by Renzo, I3RZB, sitting to the left of the author.



when we arrived more than three hours late. Jane and I were dead tired and had already planned to tell our hosts in Mantua that we really wanted to go to the hotel immediately, having been thoroughly and completely stuffed with food in Milan and Bergamo. We had *no intention whatsoever* of eating. However, Nullo and Marcello said that they had been waiting there for three hours, and sincerely hoped that everything was okay. Besides, their wives had been sitting in the best restaurant in town all this time, patiently waiting for us, and everyone was starving! Well, what else could we do? So, Jane and I were treated to yet another delicious meal consisting of eight courses and lasting until well after midnight!

would be ideal. We arrived at this idyllic location, a beautiful chateau-like restaurant nestled among the tall mountains. We were expecting a small family dinner. Instead, another banquet! Twenty-four guests! Eight full courses of the most delicious food, and several bottles of wine later, Jane was presented with hand-molded pewter long-stemmed roses, and I was formally presented with a pewter plaque commemorating our visit to the city of Trent! Unbelievable!

**Rome:** A brief stop in Roma to say hello to some old friends and meet some new relatives I never knew I had. Our friends, Paolo, IØLQP, and his lovely wife, Barbara, entertained us at their home and introduced us to some of the other hams I had already

While in Naples for a very brief time, we dined in a restaurant on the beautiful Bay of Naples, guests of Ciriaco, I8YCS, president of the Naples section of ARI.

**Potenza:** Our final stop would be Potenza in the heart of the mountains of southern Italy, hosted by Maurizio, I8LMY, a brilliant engineer, architect, mathematician, writer, and a Renaissance man if I ever met one. He also played the guitar and piano and was an avid *tifoso* (fan) of American jazz, possessing the largest jazz library I have ever seen. While there I met several other wonderful Amateur-Radio operators: Giorgio, I8ZSE, a brilliant 18-year-old engineering student, Luigi, I8TUL; and Piero, I8PQB, the local representative of the Italian equivalent of the 4-H organization.

We returned to Milan for one day, but anything said of the last day would be anticlimactic to the story of the friendships which developed during that short three-week journey through Italy in 1976.

### Conclusion

I can only close by saying that I am very proud to be an American, but an American with a heritage rich in Italian culture. I sincerely hope that many of you readers will be able to share the immense joy of Italy either through Amateur Radio, or better yet, by meeting some of those wonderful Italian Amateur Radio operators whom you hear every day on all the bands.

Jane and I plan to return soon to be amongst our friends in Italy. Of the more than 12,000 registered Amateurs in Italy, I personally have made contact and corresponded with more than 1400 since 1975.

HRH



The "caravan" which accompanied me on a trip to Lake Maggiore in northern Italy.

**Trent:** The next stop on our itinerary was Trent (or Trento, site of the famous Council of Trent in 1545-63). We were met at the railroad station by Renzo, I3RZB, a big man with an equally big heart. We were immediately escorted to Renzo's mother's house where we were unable to leave because they insisted on our staying there and nowhere else.

While in Trent, an event of great significance occurred. Jane and I were asked if we would like to go to a small chalet on the edge of an isolated lake in the sub-Alpine region of Trent, to which we agreed because we were tired and decided that a small dinner

met on 20 meters. They certainly were most gracious hosts.

**Naples:** A brief stop in Naples, where we were escorted by Pietro, I8YZU (who considers himself to be the Mario Andretti of southern Italy); Maurizio, I8LMY; and our host in Naples, Ciriaco, I8YCS. Can you imagine that we all sported beards and mustaches? All four of us were traveling with my wife in a small car in the middle of Naples, on payday, with out-of-town license tags. You can imagine what happened next! Yep! You guessed it. We were stopped by the police because we were considered to be suspicious characters!

# HAM RADIO TECHNIQUES

BY WILLIAM I. ORR, W6SAI

By now the good news is out. The World Administrative Radio Conference (WARC-79) is over and Amateur Radio has fared well, despite gloomy predictions of major frequency loss in the Amateur Radio Service. In addition to maintaining status quo, we will eventually have three new, exciting ham bands at 10, 18 and 24 MHz. More specifically, the bands will be 10.10-10.15 MHz, 18.068-18.168 MHz, and 24.890-24.990 MHz. In "ham lingo," they'll probably be known as the 30-meter, 17-meter and 12-meter bands respectively.

It has not been decided (at this time) if the bands will be subdivided for different modes of transmission, or class of license. The actual date of band occupancy is far in the future, but an exciting decade lies ahead for enthusiastic high-frequency operators!

## Antennas for the new bands

It's not too early to start thinking about antennas for the new bands, even if operation will not be possible for some time. Many frequency-sensitive antennas in use today won't work on the new bands. By "frequency sensitive" I mean Yagis, quads, certain multiband antennas, and even common dipoles. Antennas that are adjusted to the operating frequency by means of some sort of antenna tuner stand a good chance of working on the new bands: the Marconi, the end-fed wire, or the base-tuned vertical antenna, for example. A multi-band antenna for 3.5, 7, 10, 14, 18, 21, 24, and 28 MHz boggles the

mind. The log-periodic design will work, the center- or end-fed long wire will suffice, and little-used antennas such as the rhombic and V-beam will do the job relatively inexpensively. But, the majority of hams will probably put up a dipole or ground plane to try out the new bands, when they actually come into existence.

For those Amateurs who would like to cut a dipole to the new bands to hear the present activity on the frequencies, the tip-to-tip lengths are as follows:

10-MHz band: 14.1 meters (46 feet 3 inches)  
18-MHz band: 7.8 meters (25 feet 11 inches)  
24-MHz band: 5.6 meters (18 feet 9 inches)

---

**No longer will a five-band DXCC (DX Century Club award) be enough to satisfy the ardent DXer.**

---

## How about equipment?

Getting your present equipment on the new bands may pose a problem. Some of the older gear, such as Drake, Collins S-line, and KWM-2 can hit these bands with the mere purchase of a new conversion crystal. Other crystallized equipment can probably follow suit. Depending upon the conversion scheme used, some

equipment has "holes" in the operating range, in which spurious mixer products fall. If you are unlucky, your older gear may not be capable of operation in a particular band. A letter to the manufacturer will clear up this point.

Some of the newer gear, alas, also poses a problem. Depending upon the generating scheme used (often a phase-locked loop circuit), operation in the new bands may not be practical. In any event, there's plenty of time to solve this problem, and a letter to your friendly manufacturer will set you on the right track.

## A seven-band DXCC?

No longer will a five-band DXCC (DX Century Club award) be enough for the ardent DXer; a new seven- or eight-band award seems on the horizon. And how will the new bands fit into DX contests? These, and other questions, must be answered in the upcoming months. The possibilities are endless, but so are the problems.

## Information sources for the ham

Because of my writing activities over the years I have received countless letters from Amateurs asking questions about antennas, amplifiers, and other good things. A conclusion I can draw after seeing all these inquiries is that a majority of questions are about topics and techniques that are already answered in the public literature, and are readily available in many reference sources. I remember a phone call a few months ago from a ham asking questions about a linear amplifier. I referred him to the *ARRL Handbook*, which covered the subject in an excellent manner. "The *what* handbook?", was his reply. He had never heard of it! Because of this, and other equally depressing conversations, I think it's high time that I publish a partial list of reference sources recommended to all Radio Amateurs. Some of these sources are in public libraries, others are available from Ham Radio's Bookstore\* and others must be ordered individually from the sources given. All good hams should have a reference library and this list is a fine starting point.

\*The books listed are available from Ham Radio's Bookstore, Greenville, New Hampshire 03048. Write for latest prices and a catalog of other literature and Amateur material.



## The Ham's Handy Reference List

General reference handbooks that cover high-frequency transmission from A to Z:

*The Radio Amateur's Handbook*, American Radio Relay League, Newington, Connecticut 06111.

Orr, Wm. I., *Radio Handbook*, 21st edition, Editors and Engineers Division, Howard W. Sams Co., Indianapolis, Indiana 46268. (I'm partial to the "Radio Handbook" as I am the editor of it. In my opinion, a fine book!)

## Specialized publications on specific subjects:

### Antennas:

*The ARRL Antenna Book*, American Radio Relay League, Newington, Connecticut 06111.

Orr and Cowan, *The Radio Amateur Antenna Handbook*, Radio Publications, Inc., Box 149, Wilton, Connecticut 06897.

### FM:

*FM and Repeaters for the Radio Amateur*, American Radio Relay League, Newington, Connecticut 06111.

### VHF:

Orr and Cowan, *VHF Handbook for Radio Amateurs*, Radio Publications, Inc., Box 149, Wilton, Connecticut 06897.

### Transmitter Theory:

Gray and Graham, *Radio Transmitters*, McGraw-Hill Book Co., Inc., 1221 Avenue of the Americas, New York, New York 10036.

### Single-Sideband Theory:

Pappenfus, Bruene and Schoenike, *Single Sideband Principles and Circuits*, McGraw-Hill Book Co., Inc., 1221 Avenue of the Americas, New York, New York 10036.

### Amateur Newsletters:

*HR Report*, a weekly newsletter covering Amateur activities, FCC, DX, and operating news. Communications Technology, Inc., Greenville, New Hampshire 03048.

*Worldradio*, a monthly newspaper covering all Amateur activities. Worldradio, Inc., 2120 28th St., Sacramento, California 95818.

*QRZ DX*, a weekly publication about the world of DX. QRZ DX, P.O. Box 494, Howe, Texas 75059.

*Ham Trader*, a bi-monthly classified swap-and-sell newsletter. A. L. Brand, Box 356, Wheaton, Illinois 60187.

## Magazines (aside from this very fine magazine):

*QST*, the oldest Radio Amateur magazine, and jewel of the American Radio Relay League. Every Amateur should be a League member and receive this general purpose magazine, along with the other membership benefits.

*Ham Radio*, from the publishers of this magazine. Contents are on a higher technical level than *QST*. A must for the serious Amateur and technician.

*CQ*, published by CQ Publishing Co., 76 North Broadway, Hicksville, New York 11801. Under a new publisher, *CQ* is rapidly gaining enthusiastic following. A general purpose magazine with plenty of DX news and contest material.

*73 Magazine for Radio Amateurs*, published by 73, Inc., Pine St., Peterborough, New Hampshire 03458. Strongly oriented towards repeaters and solid-state technology. Amateur newcomers are warned to take the highly personalized editorials with a grain of salt. The editor lives in a world peopled with villains and hobgoblins and his writings make interesting fiction.

*Radio Communication*, published by the Radio Society of Great Britain. A first class British journal — the English equivalent of *QST*. Good technical articles and a picture of what's happening overseas. Radio Society of Great Britain, 35 Doughty Street, London WC1N 2AE. Available in the U.S. through Communications Technology, Inc., Greenville, New Hampshire 03048.

### Components Catalog:

Newark Catalog 104, a fat, 752-page publication of Newark Electronics Co., Inc. Available at any of the 81 stores in the United States. Mr. George Panos promises me that if interested readers write directly to him, he'll get a catalog off to them immediately. His address is: Newark Electronics Co., 1155A Chess Drive, Foster City, California 94404.

### Addresses and Amateur Calls:

Published since 1920, the *Radio Amateur Callbook* is an institution in itself. Two callbooks are available; U.S. listings and overseas listings. Are you in the callbook? Get one today and find out! Radio Amateur Callbook, Inc., 925 Sherwood Drive, Lake Bluff, Illinois 60044.

Other interesting Amateur publications exist and I'll mention some of the more popular ones from time to time in this column.

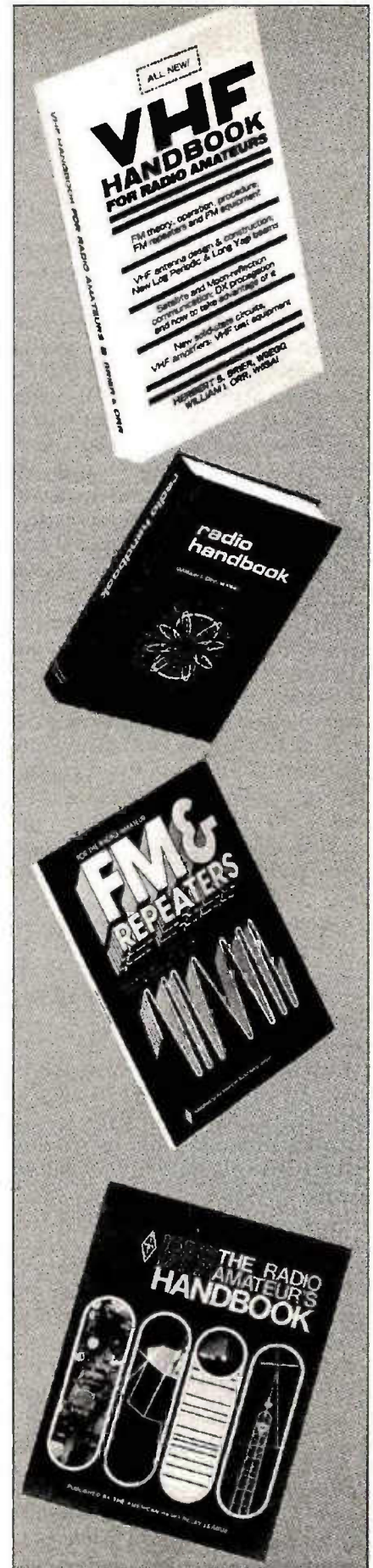



## "HAM RADIO" TECHNIQUES

### Reader feedback

In my previous column, I asked for contributions from the readers for inclusion in this work. Barely had the ink dried on the presses when I received a massive communication from Don Winfield, K5DUT, (6080 Anahuac Ave., Ft. Worth, Texas 76114). Don is an old friend whose call is very well known in DX circles because of his fantastic signal. He modestly refuses to discuss his antennas, but instead refers me to another big signal — Gary Pannell, WA5FWC, of Arlington, Texas. Gary's antenna farm is too big to get into a single photograph so Don has sent several snapshots. The "farm" consists of four, 4-element quads on 20 meters; two, 4-element quads on 15 meters, a 7-element and a 4-element quad on 10 meters, plus a 2-element quad on 40 meters. All of these antennas are mounted on two 130-foot high towers. In addition, there are two full-size quad loops on 80 meters fixed between the towers. Not shown is a 16-element quad array for 20 meters, under construction.

One photo shows the north tower with 4-over-4 on 20 meters, 4-elements on 15 and 4 on 10, plus 2-elements on 40 meters. Another photo shows K5UDT clinging to the tower. He finally made it to the top of the 130-foot tower and shot a picture along the boom. This gives a good idea of the clean shot to the horizon, plus a view of WA5FWC's airstrip and one of his planes.

The south tower at WA5FWC is another 130-foot job, which holds 4-over-4 on 20 meters, plus 4-elements on 15, 7-elements on 10, and (recently added) 7-elements on 6 meters.

Congratulations, fellows, on a bang-up antenna installation. Every ham should have one just like yours!

A second letter arrived from John Gowron, VE4ADS, (229 Kisil Bay, Winnipeg, Manitoba, Canada R2K 3E7). John sends us a photograph of a "big antenna in a small yard." The antenna is a 2-element Gem Quad,

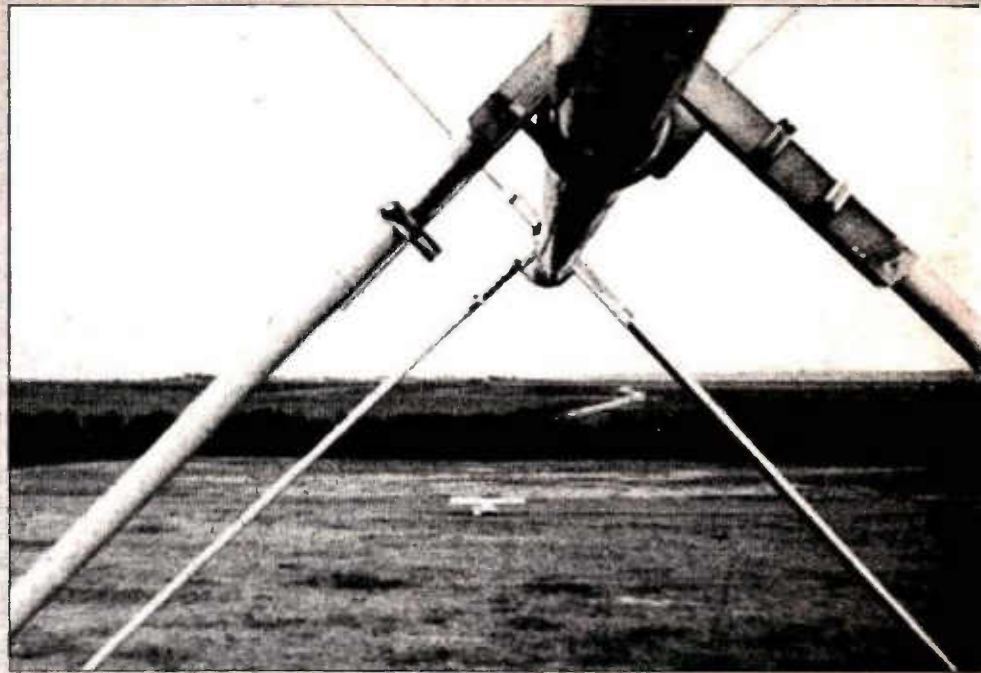

and the small yard barely takes the antenna when it is on the ground. Worst of all, the yard is surrounded on three sides by six-story apartment buildings.

In order to work on the quad, John turns it face up (or down) and jams one end of the boom into a vertical support pipe mounted in the ground. The quad elements are therefore in a horizontal plane. This makes the antenna very easy to assemble and work on.

To facilitate erection of the quad, VE4ADS designed a special gin-pole which projects from the side of the tower. It is bolted temporarily to the rotating mast atop the tower. The quad is hoisted up to the end of the gin-pole in a vertical position. The arm of the gin-pole pivots from the horizontal into a vertical position, the wires and spreaders of the Quad clearing the tower while the antenna is boosted into position and fastened to the rotating mast. Please note that the antenna crew wear hard hats and are hooked onto the tower with safety belts!

Hams interested in the unusual gin-pole should drop VE4ADS a line (including a self-addressed envelope and 17¢ for postage — or equivalent in Canadian stamps).

Before wrapping this column up, I want to bring your attention to a novel, new mobile antenna for the

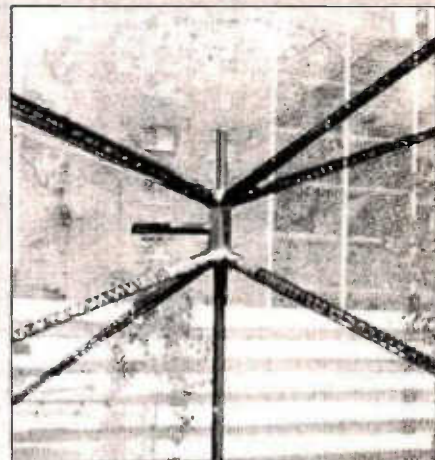
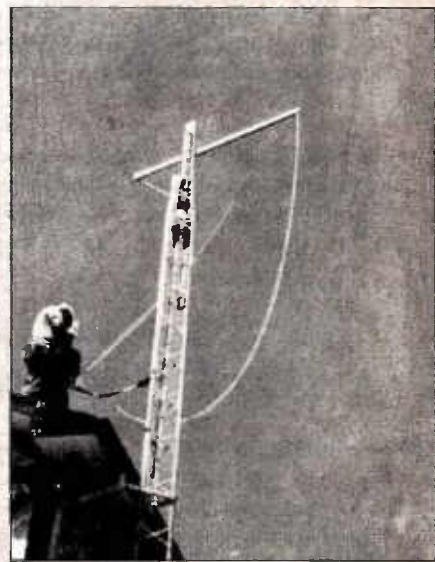



The Fort Worth, Texas, area is called the home of the monster antennas, and you can see why in these photos of part of WA5FWC's installation. The view at left is looking along the boom of the upper quad, at the 130-foot level. That's some horizon! Another view of the same tower is shown at the right, which supports quads for 10, 15, 20, and 40 meters. Below, right, is a view up one of the two 130-foot towers with Don, K5UDT, working on the bottom array. This gin pole (left center) is used by John Gowron, VE4ADS, to raise or lower his Gem Quad in quite restricted space. In the "maintenance" position, the quad boom rests on a vertical support (bottom left). This allows work to be performed on the antenna from ground level, and either set of elements can be reached by simply flipping the array over. A neat solution to the small-yard problem.

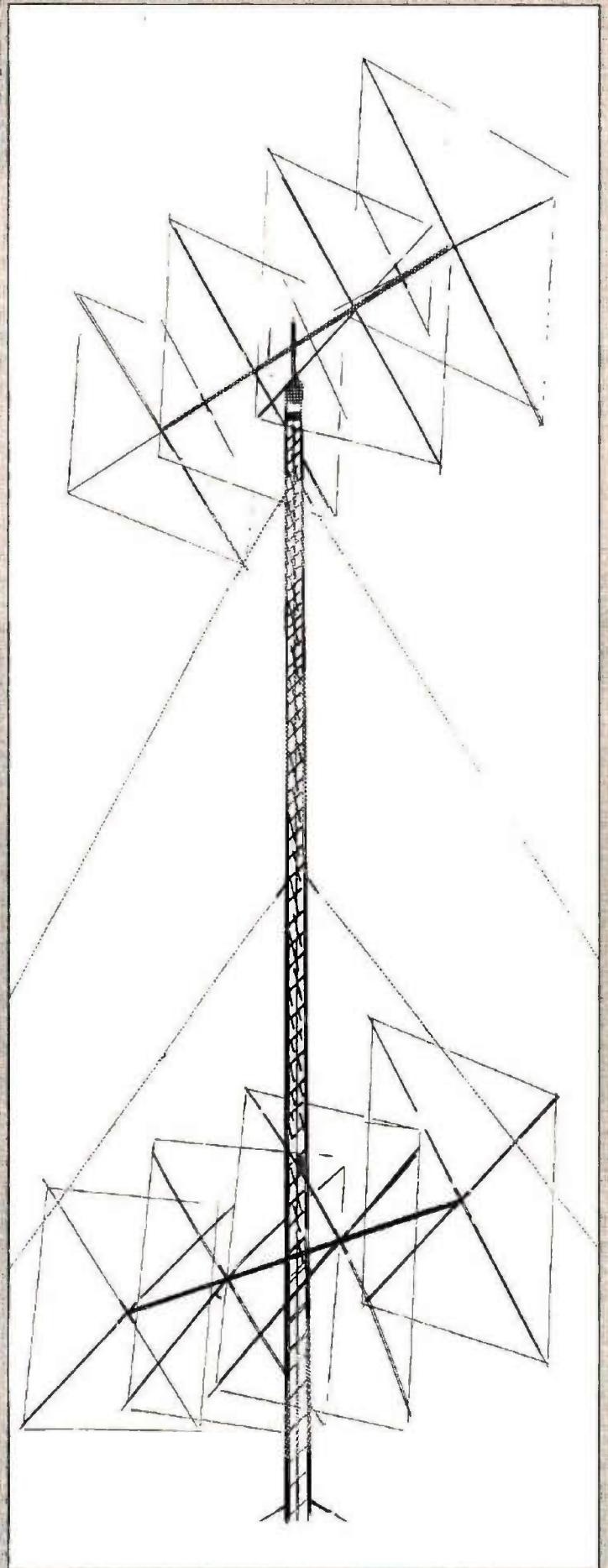
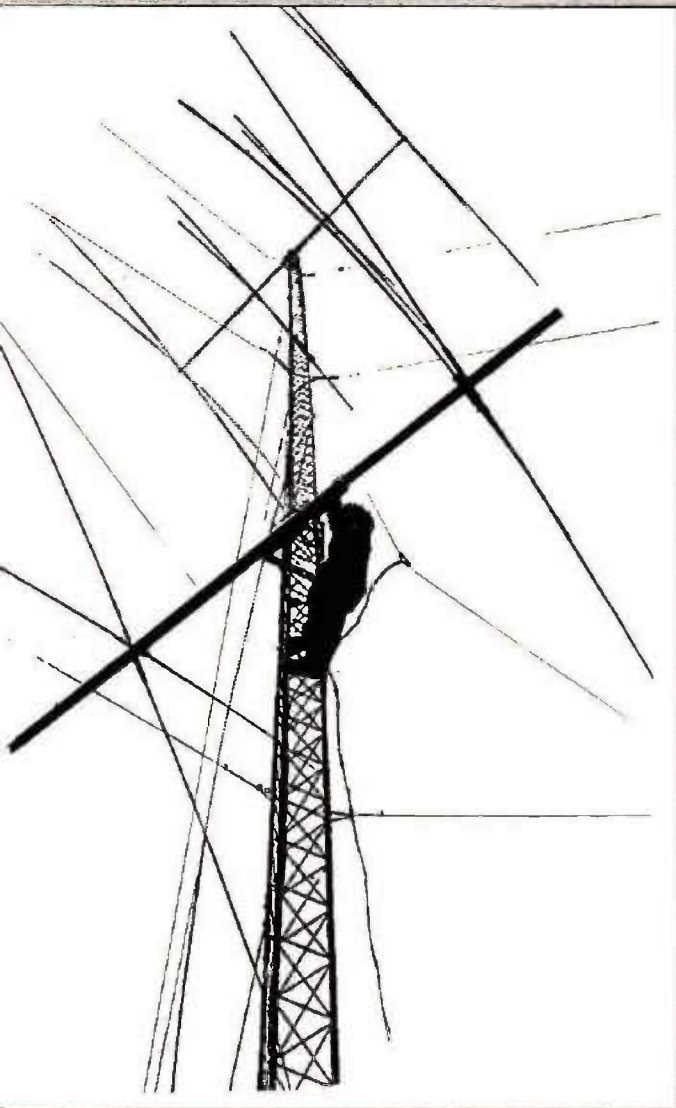



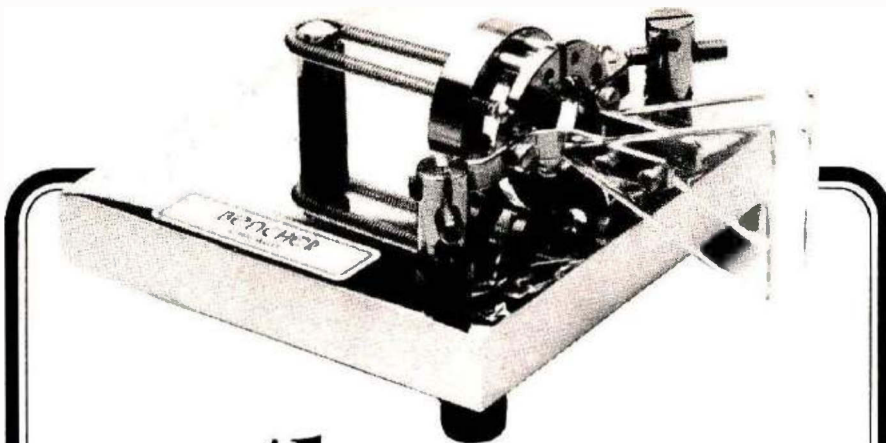

# the Ultimate IAMBIC PADDLE

- Full range of adjustment in tension and contact spacing.
- Self-adjusting nylon and steel needle bearings.
- Solid silver contact points.
- Polished lucite paddles.
- Precision-machined, chrome plated brass frames.
- Standard model has black, textured finish base; deluxe model is chrome plated.
- Heavy steel base; non-skid feet.

WRITE FOR LITERATURE

**BENCHER, INC.**

333 W. Lake Street, Dept. A  
Chicago, Illinois 60606 • (312) 263-1808

Available at selected dealers or send \$42.95 (\$52.95 for chrome model) plus \$2.00 shipping and handling. Overseas amateurs invited to request quotation for air parcel post shipment.

## "HAM RADIO" TECHNIQUES

450-MHz band. There's a lot of product similarity in the antenna business, but occasionally some manufacturer comes up with a new idea that deserves notice. Avanti Research and Development, Inc., a long-time maker of mobile antennas for military, commercial, and CB services has an interesting, new antenna (Fig. 7).

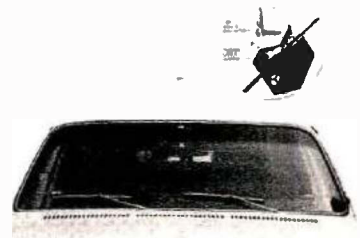

Fig. 7. The "on glass" 450-MHz mobile antenna of Avanti. No electrical connections are made to the antenna; it is coupled electrically to the transmission line through the glass. An impedance coupling unit is mounted inside the vehicle and the antenna is locked to the glass by a powerful adhesive. A similar antenna is available for 2 meters.

The antenna mounts on the vehicle windshield but has no direct connection to the radio equipment inside the vehicle. Instead, a coupling unit is mounted on the opposite side of the windshield and the signals flow through the glass to and from the antenna. The antenna is easily removed for storage, car wash, or theft protection. There are no holes to drill in the body of the vehicle, and the installation is completely waterproof. Electrically, the antenna has two in-phase elements providing substantial gain over the common 1/4-wave whip antenna.

Interest in the 3/4-meter band is rising and this looks like the right antenna at the right time.

From time to time I'll discuss interesting and *different* commercial antennas in this column — not the usual run-of-the-mill stuff — but products that provide something new for the Radio Amateur. Keep tuned in!

**HRH**

## UNADILLA

### The WA2ZOT "INTERFILTER"

2000 WATT LO-PASS

LIFETIME GUARANTEE

The only Lo-Pass you'll ever need.



### FULL-POWER, QUALITY HAM ANTENNA PARTS

AT YOUR DEALER

- BALUNS-TRAPS-INSULATORS
- QUAD PARTS-ANTENNA KITS
- BOOM/MAST MOUNTS-WIRE
- CABLE-CONNECTORS

Write or call for full Catalog

#### ASSISTANCE?

Call: **NUCW GUNNISON, WA2ZOT**  
Toll-Free 800-448-1656  
(NYS Collect 315-437-3953)

**MICROWAVE UNADILLA/REYCO DIVISION**  
**FILTER COMPANY INC.** (Dept. **HRH**)  
6743 WINNE STREET EAST SYRACUSE NEW YORK 13057

**DEALERS WANTED - OVER 300 WORLD-WIDE**

**Radio World**

CENTRAL NEW YORK'S FASTEST GROWING HAM DEALER

Featuring Yaesu, Icom, Drake, Ten-Tec, Swan, DenTron, Midland, KDK, MFJ, Microwave Module, Tempo, Astron, KLM, Hy-Gain, Mosley, Larsen, Cushcraft, Hustler, Mini Products, Bird, DSI, Mirage, Vibroplex, Bencher, Info-Tech, Universal Towers, Callbook, ARRL, Astatic, Shure. *We service everything we sell!* Write or call for quote. You Won't be Disappointed.  
We are just a few minutes off the NYS Thruway (I-90) Exit 32

**Warren**  
K2IXN  
Call Toll Free: 1-800-448-7914

**ONEIDA COUNTY AIRPORT TERMINAL BUILDING**  
**ORISKANY, NEW YORK 13424**

**Bob**  
**WA2MSH**  
New York State Residents Call: 315-337-2622 or 315-337-0203



# A DXpedition To ~~Remember~~ Forget

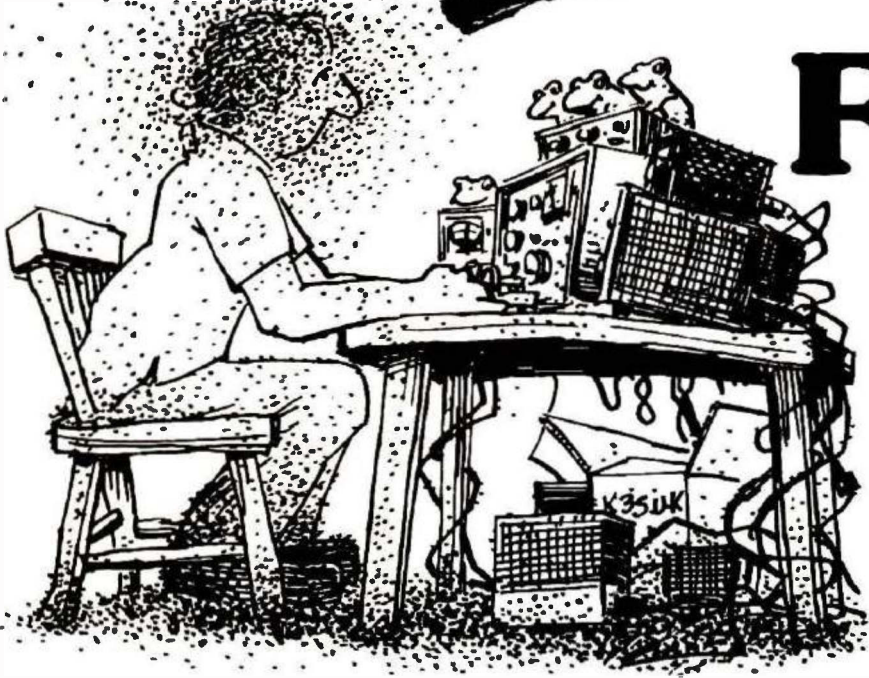

**By Beth Wade**

It's been ten years now. I can finally think about it — talk about it even, and I've decided that however painful the memory may be, the Cape Hatteras/Horseneck Beach DXpedition of 1970 deserves at least a tiny footnote in the history of ham radio.

Perhaps tiny is a poor word. So what if the distance involved was only half a thousand miles. You folks out there on the low bands who've got your QSL's from Pago Pago, you boys who've got your Seychelles, and you Novices who've worked Montana from Baltimore, you don't know what DX really is. Even you guys on 2 meters who've made it from the coast to Chicago on meteor scatter don't know what DX is all about. Ask any uhf'er; DX is working 600 miles on 1296. About the only thing that can rival *that* is working Essex County from Trenton on 3330, but that's another story.

The inspiration, the noble conception, the inking that the impossible might be achieved, entered the consciousness of several great minds of

uhf (there not being many minds in a place where alcoholic beverages were consumed. The details, the arrangements, the backbreaking procrastination spread themselves out over a period of several months. But, finally, in a feat of diplomacy equalled only by the Mideast peace negotiations, the East Coast VHF Society and the Mount Airy VHF Society of Pennsylvania (better known as the Pack Rats) put aside their well-seasoned rivalry in a united and valiant effort to break the previous 1296-MHz long-distance contact record of 500-odd miles. A late September date was set to allow time for the wounds of the June contest to heal, and for the off-season motel rates to take effect. Two sites a sloppy six-hundred miles apart were chosen. Working over water would be easier, therefore a small spur of land on Cape Hatteras, North Carolina, was chosen as the first location.

What, over water, is 600 miles from Cape Hatteras and not likely to be disturbed by a dozen strange indi-

viduals bearing ham gear, antennas, generators, and enough coax to wrap Boston? Why Horseneck Beach, Massachusetts, of course. My husband, Paul, WA2ZZF, is a member of the East Coast VHF Society. When I heard he was leaving me home with our two-year-old (who'd just learned how to drive his tricycle into the wall), I couldn't stand it. I signed on as cook and errand runner. Rumor had it that other wives would be going, too, but as September wore on and the shock of not being excluded wore off, the other ladies had time to regain their senses and think up good excuses. So it was only the boys and I who left for the place that was not on the list of major U.S. cities you memorized in the sixth grade.

After months of careful planning, Friday afternoon was spent running around scrounging equipment. When it was all stuffed, folded, spindled, and tied to the cars, the final rundown was: a carload of prized goodies from Allen, K2UYH (not including Allen, though, whose wife, Sally was threat-

ening a trip to the delivery room as her excuse). The "goodies" featured a rig with the stability of an old taxi-cab transmitter and the reliability of an amplifier made with a surplus radar cavity. There was also the aforementioned 400 miles of coax, which was, of course, a hundred miles too little; K2PPZ's standard 7-foot dish (made on the standard 7-foot concrete mold kept in his backyard); a generator — brought with rare foresight with the idea that the local power might be insufficient (which proved to be the case); and K2RTH's 2-meter equipment for liaison (including his amplifier, which could be used to heat the accommodations if the weather turned brisk). Other members of the group, if I recall, included Gerry, K2JWE; Pete, WB6NIK; Marty, WB2SZW; Dolph, WA2VTR; and Mark, WB2IRX.

By quarter-to-nine on Friday night (only four hours behind schedule) we were loaded and ready to go. The rain beat on the windshield all the way through New Jersey and New York, and really let loose in Rhode Island. When Pete and Paul and I stopped at a Dunkin Donuts near Providence at one o'clock, the counter girl looked nervously at the cash box as we climbed to our stools. We were desperate-looking characters: staring, wet, and too sober to be out that late on a Friday night. When we bought three dozen donuts she thought it was a ploy to get at the big money.

The weather cleared in Massachusetts, and by two AM we were entering Horseneck Beach, ready to tumble into a soft bed at the motel our reconnaissance team had reserved the week before. As we drove down the pot-holed road on the skinny spit of land between Buzzard's Bay and Nantucket Sound, we were sure we'd taken a lot of wrong turns; but no, there were the antenna-laden cars of the caravan parked in front of the sagging, many-gabled outline of an old

house. In front, just under the street lamp, was a hand-lettered sign that read, *Bayview Motel*.

We climbed tiredly from the car. "Watch out," somebody yelled from the suddenly blacker night. "Hold it. Don't move." We froze.

"Watch out for the toads!"

A flashlight bumped towards us, pointed sharply downward. We watched the beam part a carpet of toads on the pebbly ground.

"Don't get 'em on your shoes."

The Bayview Motel had recently been vacated by its last occupants, the owners, who had moved into their trailer for the weekend to make possible our lodging. We dumped the

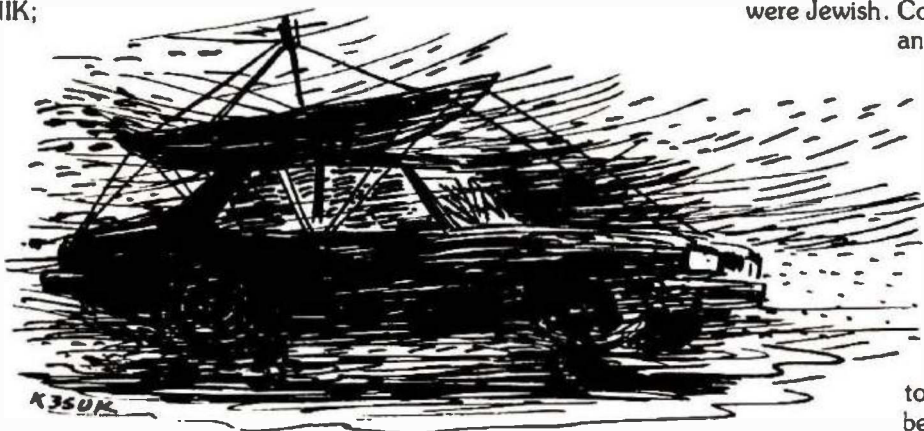

donuts, and the bacon and eggs that Pat had brought, in the kitchen (the perishables in the gas refrigerator with the condenser on top), and headed through the wainscotted hallways to our rooms. Paul and I were honored with the double bed. I rolled to the middle of it at once, while Paul went to unload the cars. I turned out the light too soon to notice that the bedspread was held together entirely by Pomeranian hair. The fellows decided it was too late to set up the gear, so they strolled down for a moonlight glimpse of one of the area's major attractions, the submarine-spotting base on nearby Toad Island — which of course wasn't an island any more than Horseneck Beach was a beach. Paul came to bed and immediately started sniffing. Pomeranian hair always does that to him.

I awoke far too early on a sunny Saturday morning, to the sounds of QRM and keying. There was a cat lying on my feet. I lay still, trying to figure out how to cook the bacon for those who wanted it without turning the stomachs of the half of our group who kept kosher. When I did get to the kitchen (after stopping on the way at the octagonal, wood-paneled bathroom with the claw-footed tub and unflushable john) I found a very unkosher looking frying pan, but I cooked the eggs first anyway, and drew water from the hand-pump for coffee. Another complication — ants in the donuts. Ants were meat. Were eggs meat or dairy? I knew eggs were meat if you were Catholic, but I was pretty sure they were dairy if you were Jewish. Could you eat ants and eggs together?

Everybody ate the ants, but nobody wanted eggs. Past experience at cooking for radio contests should have told me I wouldn't be able to sell anything that had to be eaten with two hands. I gave the eggs to the fat Pomeranian who was scratching at the back door.

It took six hours to get everything set up on 1296, following standard primitive-site procedures of setting up the high and heavy stuff (Allen's gear was totally hurricane proof; it would never blow away) before realizing that the light, low stuff that went with it was inoperable. They pressed on, sweating, shouting, swearing, and locating 400 coax adapters. And then, activity was . . . nil.

As the sun grew warmer it became apparent what supported the awesome toad population. The air was becoming thick with flies. Since the screen doors were held open by coax and extension cord, the inside of the house was no haven from the whining clouds. But the 2-meter liaison was operating.

And then, finally, W1GAN in





The town wasn't up to Bruce's amplifier.

Salem, Massachusetts, made contact on 1296, proving that the tubes in the taxi transmitter were all back in their sockets and functioning after the trip. Equipment that works is essential to the bettering of DX records. There were relieved grins.

The afternoon wore on and the flies got worse, landing with gummy feet to signal their intention of ripping off small mouthfuls of skin. Twelve ninety-six was still silent to the south. The grins began to fade. Some members of the party had begun to doubt that Pat's razor-beam antenna could be aimed with precise bearings calculated from a torn Texaco map, even with help from Gerry's sextant. I was sent to the store for Raid. When I returned, we fogged the house and I went out to sunbathe next to the generator. It had been deemed wise to spare the exposed wiring and ceramic insulators of the house current for as long as possible. The rumor that Edgar Allen Poe had spent his honeymoon in the house had been traced to Gerry, but Thomas Edison probably did install the wiring.

Inside, the flies were falling like flies. I went in to find Dolph sweeping the corpses and near corpses into disgusting three-inch-high piles. The desperate hum of dying flies was beginning to drown out the generator.

I talked Paul and Peter into taking me out to dinner — in Boston.

On our return the flies were quietly dead, but the Pack Rats hadn't heard us on 1296, and we hadn't heard them. At around eleven the generator was stilled to allow whatever inhabitants there were some sleep. The town of Horseneck Beach wasn't up to Bruce's amplifier — the street lights keyed. Bruce and Gerry, who happened to number half the clientele of the local nightspot when the change-over was made, glanced at each other, set down their bottles of Narragansett, the regional brew, and made soft-footed exits.

Through the night, the agreed-upon five-minute schedule of listening and transmitting was maintained. The coffee got stronger and stronger. Not a thing was heard — except "sssssss..."

On Sunday morning, fresh coffee didn't wipe off any scowls. The Pack Rats had a longer drive from North Carolina. By eight they announced they were shutting down, and their decision was met with understanding disgust. The 2-meter rig was unplugged. It was decided to throw a last few 1296 signals from Horseneck Beach to friends back home in New York and New Jersey, who'd never worked eastern Massachusetts. The first few contacts were as weak as cof-

fee nerves, but, by the end of an hour signals were getting stronger and stronger. Maybe North Carolina deserved another shout. What glory it would be to come from behind and pull it off after all. But, the 2-meter liaison had been shut down. Someone back in New Jersey had the phone number of the Pack Rats' motel but couldn't read his own handwriting; maybe the 7 was a 1 and maybe the 3 was an 8. We pooled our change. It was worth a try.

Wonder of wonders. The Cape Hatteras motel switchboard knew which room the radio nuts were staying in, and somebody was still inside to answer the phone.

Could the Pack Rats get back on the air? Was there still a chance for the 1296-MHz long-distance record?

Sorry, dear reader, they'd just tied their tower to the roof rack and were ready to roll.

Well, it was time to leave anyway. The ants hadn't been very filling that morning, and the flies were building up.

The 1296-MHz DXpedition of September, 1970, had failed in its mission. We had achieved nothing much except to prove that vhf societies can work together in peace and harmony.

At least until the next contest.

HRH

# the Ultimate 1:1 BALUN



- Lets your antenna radiate—not your coax
- Helps fight TVI—no ferrite core to saturate or reradiate
- Rated 5 KW peak—accepts substantial mismatch at legal limit
- DC grounded—helps protect against lightning
- Silver plated hook-up braid, Custom molded case
- Amphenol® connector; Rubber ring to stop water leakage

Model ZA-1	3.5-30 mHz	\$15.95
Model ZA-2	optimized 14-30 mHz includes hardware for 2" boom	\$17.95

Available at selected  
dealers, add \$2.00  
postage and handling  
in U.S.A.  
WRITE FOR LITERATURE

BENCHER, INC.  
333 West Lake Street, Dept A  
Chicago, Illinois 60606 (312) 263-1808

When it comes to  
**AMATEUR  
RADIO QSL's...**

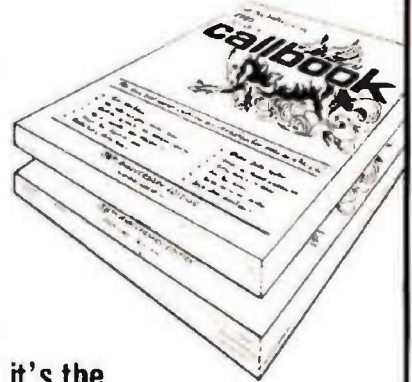

it's the  
**ONLY BOOK!**  
US or DX Listings

1980  
**callbooks**  
NOW READY!

Here they are! The latest editions. World-famous Radio Amateur Callbooks, the most respected and complete listing of radio amateurs. Lists calls, license classes, address information. Loaded with special features such as call changes, prefixes of the world, standard time charts, world-wide QSL bureaus and more. The new 1980 Radio Amateur Callbooks are available now. The U.S. Edition features over 400,000 listings, over 120,000 changes from last year. The Foreign Edition, over 315,000 listings, over 90,000 call changes. Place your order now.

	Each	Shipping	Total
<input type="checkbox"/> US Callbook	\$16.95	\$1.75	\$18.70
<input type="checkbox"/> Foreign Callbook	\$15.95	\$1.75	\$17.70

Order both books at the same time for \$34.65. Includes shipping

Order from your favorite electronics dealer or direct from the publisher. All direct orders add \$1.75 for shipping. Illinois residents add 5% Sales Tax



**SPECIAL LIMITED OFFER!**  
Amateur Radio  
Emblem Patch  
only \$2.50 postpaid

Pegasus on blue field, red lettering. 3" wide x 3" high. Great on jackets and caps. Sorry, no call letters

**ORDER TODAY!**

RADIO AMATEUR  
**callbook** INC.  
Dept. EB 2  
925 Sherwood Drive  
Lake Bluff, IL 60044



Radio equipment  
not included

Also Available ...  
Floor Space: 51" Wide by 30" Deep  
\$192.50

... at last ...

**your shack organized!**

A beautiful piece of furniture — your XYL will love it!

**\$16450 S-F RADIO DESK**  
Deluxe - Ready to Assemble

Designed with angled rear shelf for your viewing comfort and ease of operation.

FINISHES: Walnut or Teak Stain.

Floor Space: 39" Wide by 30" Deep

Additional Information on Request.

Checks, Money Orders, BankAmericard  
and Master Charge Accepted.

F.O.B. Culver City. (In Calif. Add 6% Sales Tax.)

DEALER INQUIRIES INVITED

**S-F Amateur Radio Services**

4384 KEYSTONE AVENUE • CULVER CITY, CALIF. 90230 — PHONE (213) 837-4870

## Microcraft's New Morse-A-Word

Eight character moving display.  
Built-in code practice oscillator.  
Excellent for learning Morse Code.  
Complete — no CRT or expensive  
extras needed.

Decodes audio CW signals from your  
receiver's speaker and displays letters,  
numbers, punctuation and special Morse  
characters as the code is received.



MORSE-A-WORD Kit with 4 character readout	MAWK-4	\$149.95
MORSE-A-WORD Kit with 8 character readout	MAWK-8	\$169.95
MORSE-A-WORD wired & tested with 8 character readout	MAWF	\$249.95

Send check or money order. Use your VISA or Master Charge. Add \$3.50 shipping and handling for continental U.S. Wisconsin residents add 4% State Sales Tax.

**Microcraft**

Corporation Telephone: (414) 241-8144  
P. O. Box 513HRH, Thiensville, Wisconsin 53092



# Questions & Answers

Response to our Q & A announcement and the first column in last month's Horizons has been great. We've received many good questions, and some letters commending us for the idea. Unfortunately, there were some questions that had absolutely nothing to do with Amateur Radio, so they went into the "blown-fuse" pile.

Again, the primary rule for playing the game: questions must be about some part of Amateur Radio. We'll choose those we think will be the most useful to the most readers, and provide an answer in this column, only. No answers will be sent by mail, and telephone requests will not be accepted.

You readers are all invited to take part in this too — send us a card with the call letters or name of the person submitting the question that was most useful to you, and your vote will win a prize for him, plus a grand prize for the overall best question of the year. While you're at it, put a question on the card, if you wish; get in on the fun.

And remember, your question has a better chance of being chosen if it is easy to read. Our oracle hates to admit that he needs glasses, so is wont to trample underfoot those mis-sives which he cannot read.

Now to this month's selection . . .

## The Last Bands

*Where are all the Amateur Bands? In studying for my Novice exam, only 10, 15, 20, 40, and 80 were mentioned. How about 2, 6, and 160? — KA1DXQ.*

If you mean what frequency does each band represent, you can always find the frequency in MHz by dividing the wavelength into 300, thus:

$$F(\text{MHz}) = \frac{300}{\text{Wavelength (meters)}}$$

$$F = \frac{300}{40} = 7.5 \text{ MHz}$$

and,

$$F = \frac{300}{80} = 3.75 \text{ MHz}$$

Conversely, to find the band when you know the frequency:

$$\text{Wavelength} = \frac{300}{F(\text{MHz})}$$

$$\text{Wavelength} = \frac{300}{21} = 14.2 \text{ meters}$$

These bands do not always come out where we expect them to, for various reasons. Some, like the 40-meter band, are left over from the early days when Amateurs had a larger portion of the airwaves (and less precise calibration methods). Others, such as the 21-MHz band, called 15 meters, defy a rational explanation. However, the formula will get you in the right end of the high-frequency spectrum.

However, if you are asking where these bands are in relation to other transmissions and services, you'll find 160 meters just above the standard broadcast stations. They stop around 1600 kHz, and 160 meter Amateur signals start at 1800 kHz. Six meters (50 MHz) is located just below TV channel 2, and, in fact, occupies the spot formerly planned for channel 1. Two meters (144 MHz) is between the top of the FM broadcast band (108 MHz) and TV channel 7 (174 MHz).

It is in the midst of aircraft communications, police, fire, public service, telephone service, business radio, and a lot of other services, thus can be tuned in by many of the "scanners" widely sold today.

## Recommended reading:

Bill Orr, W6SAI, "Propagation and the Ham Bands," *Ham Radio Horizons*, November, 1978, page 24. (Back issue or photocopy, \$2.)

Jay Buscemi, K2OVS, "A Guide to VHF Propagation," *Ham Radio Horizons*, February and March, 1979. (Back issues or photocopies, \$2 each issue or part.)

## Baluns and Transmatches

*Should I use my balun-equipped antenna with a Transmatch? — K1VOL.*

Much depends upon what the balun is doing, and how well it does it. First, let's be absolutely clear about the function of a balun. A balun is simply a device that is designed to transform a balanced condition into an unbalanced one. Ideally, it is a transition between two halves of a dipole antenna and the coaxial feed-line. Most baluns are 1 to 1 devices, that is, the impedance at the balanced end is the same as at the unbalanced end. If this is so, then you can hook a balanced 75-ohm impedance (the center of a half-wave dipole or 75-ohm twinlead) to one end, and it will present an unbalanced 75-ohms at the other, which will work perfectly with 75-ohm cable. Under these conditions, the SWR on the transmission line is 1:1, and no Transmatch is needed.

In more extreme cases, where the load (antenna) presents much higher impedances (say, 300 to 500 ohms) the SWR could be too high for your transmitter's output stage, and a matching network (Transmatch, etc.) will be needed. (A 300-ohm load at the end of a piece of 50-ohm cable will present an SWR of 6 to 1, which few modern transmitters will handle.) There are some step-up/step-down baluns available, and there have been some designs for them published.

You might be ahead of the game to use one of these up at the center of the antenna, rather than allow the coax to live with the high SWR, then matching to it in the shack. For example, a 4 to 1 balun, hooked to a 300-ohm antenna, will present 75 ohms to your coax, which is within the limits of your transmitter.

#### Recommended reading:

William Orr, W6SAI, *Radio Handbook*, 21st edition, Editors and Engineers Div. of Howard W. Sams & Co., Indianapolis, Indiana, 1978, Chapter 26, section 26-3. (\$21.50, hardbound, from Ham Radio's Bookstore, Greenville, New Hampshire 03048.)

#### WARC and the ham

*What is WARC, and how will it affect me? — WA1WPP.*

The letters WARC stand for the World Administrative Radio Conference. WARC-79 just concluded its deliberations this past December 4th, after the delegates took a look at the entire radio frequency spectrum, and tried to determine fair allocations for all users on a worldwide basis. Not everyone came away happy, and some services, such as International Shortwave Broadcasting, satellite frequencies and orbital positions, and parts of the microwave spectrum, will have another series of meetings, starting in 1984, to further plan for these allocations.

However, Amateur Radio came off pretty well, and you'll have three new high-frequency bands to use, starting in a couple of years with the 10.1 to 10.15 MHz band, and sometime later with 18.068 to 18.168 and 24.890 to 24.990 MHz. The effect on you and your station will be to give you more frequencies to operate on, new equipment for the new bands, and more room for the Amateur population to disperse in when the sunspot activity drops off, making the higher bands less useful for DX.

We'll have more about the aftermath of WARC in various articles in *Horizons*, and you might look at the "Newslines" column in February,

1980, *Horizons*, as well as Bill Orr's "Ham Radio Techniques" column in this issue.

#### Legal or Not?

*Is it legal for any member of a family (or a non-member) to sit down at an Amateur Radio station and call CQ (on phone) providing they do not touch the microphone? The licensee of that station will be present and controlling all emissions. — WA2TRB.*

Yes, it is legal, and they can touch the microphone if they want to, or even use the key to send Morse code.

Now, you'll get a lot of static from some old-timers on that, so you may quote the FCC to them: *Section 97.79, paragraph (d) — "The licensee of an Amateur Radio station may permit any third party to participate in Amateur Radio communication from his station, provided that a control operator is present and continuously monitors and supervises the radio communication to insure compliance with the rules."*

Let's look more closely at that. First, note that it says any third party, so you can let people who are not family members talk over your station as well.

Second, it says that a control operator (and that means you as licensee, or a licensed Amateur you delegate) should be present to monitor and supervise the communications to insure compliance with the rules. Earlier interpretation of this section had it that only a licensed Amateur could turn the carrier on and off. This interpretation kept non-Amateurs from using the key, but they could use voice as long as the station licensee turned the rig on and off for them.

Then came the day of the repeater. Obviously, this logic would not do, because no control operator was going to sit by the repeater hour after hour to turn the carrier on and off when someone wanted to use the machine. The repeater user was turning the repeater carrier on and off by remote control, and, although he was licensed, he was not necessarily the control operator or the station licensee. Therefore, a new interpretation

for the benefit of repeaters has had favorable results for all of us. Now, your daughter can use either the microphone or the key, as long as you are present and monitoring to be sure everything is legal.

A note of caution, however. There is still some unresolved controversy as to whether the person you let use your station can converse with another in a language you cannot understand. The reasoning is that if you cannot understand them, then you cannot be sure they are conducting strictly Amateur, non-business, communication.

So, relax, and let your family and friends enjoy ham radio!

#### Vertical Antenna

*Would a vertical antenna for 10, 15, 20, 40, and 80 meters, such as the Hustler 5BTV, be a good antenna for DX and local communications? — KA2DWG.*

Your question really isn't as simple as it sounds! It all depends on what you mean by "good." Different people have different definitions, based on experience. For those who are used to monoband beams at high elevations, the performance of a vertical may not be "good" but for a person who is struggling along with a dipole at twenty feet, the vertical will, indeed, provide "good" results, particularly for DX. Vertical antennas have been used for years, and on some DX paths at particular times, have produced results equivalent to those from a beam antenna. Single-band verticals may outperform multiband verticals, but most of the multiband antennas such as the 5BTV, 18AVT, WV-1, ATV-5, and other, similar, trapped verticals will have similar performance when compared with each other. You must install them according to the manufacturer's instructions, with a good ground or radial system, because verticals, such as these of the quarter-wavelength type, depend upon a good image plane for best performance.



## QUESTIONS ANSWERS

In general, properly-installed quarter-wave verticals provide good, low-angle radiation which means that they will be capable of putting a signal into far-away places. Because of their all-directional radiation pattern in the horizontal plane, they will give you good coverage in all directions, but this can be a burden, too. Sometimes, you want to hear or talk in only one direction, but the single vertical antenna will not permit this. As a result, the signal you wish to hear could be masked by stronger signals coming from unwanted directions. If you

**Yes, a vertical such as the 5BTV would be a good antenna for working DX as well as for local communications.**

have room to install several verticals near each other, appropriately connected by specific lengths of feedline, you can do a pretty good job of "beaming" your signals to desired directions, but this gets away from the single vertical you asked about.

Vertical antennas also tend to be good for working local stations and mobile stations, too, but there are always exceptions. Without going into too much detail, figure on using your vertical for DX and "local" stations. As the frequency goes higher (wavelength is shorter) the "local" distance becomes less and less, while the DX becomes farther and farther away; the reverse is also true.

To sum up this answer, yes, a vertical such as the 5BTV would be a good antenna for working DX and for local communications. Besides that, it is light, easy to erect, occupies a small space, and is relatively inexpensive. Very often these practical considerations outweigh others such as "gain" and directivity.

HRH

# Our smart machine reads sloppy copy.

**New! Includes 24-hour UTC clock, 110 and 300 baud ASCII, & tuning eye!**



Kantronics

## Field Day<sup>®</sup>

\$449.95

**If someone tells you they offer the same features we do, check them out with the list below. Kantronics offers the finest in state-of-the-art technology through over 35 dealerships in the United States, Canada and West Germany.**

- Morse copying ability
- 3 to 80 WPM Morse range
- Computer programs for improving sloppy Morse
- Radioteletype copying ability - 60, 67, 75 and 100 WPM Baudot
- ASCII radioteletype ability - 110 and 300 WPM baud
- Copies any shift of RTTY
- 24-hour UTC clock available in any mode
- Entire unit contained in one package
- Automatic code-speed tracking
- Full 10-character, large-size display
- Displays code speed
- Tuning eye for faster tuning
- Full year limited warranty
- Internal speaker
- Requires no TV set for use
- Advanced demodulator circuits
- Internal 200 Hz bandwidth filter
- All letters, numbers and punctuation plus 8 special Morse characters and 5 special RTTY characters
- 15-day trial period.

Send for our free brochure that explains the Field Day system of Morse and RTTY decoding. Or you can order from one of our dealers or our factory today. Our number is below, give us a call.

Special SWL model - \$464.95

Free

Code  
Reading  
Made  
Simple

Okay, tell me more.

Name  
Address  
City

State  
Zip

**Kantronics**

1202 E. 23rd Street (913) 842-7745  
Lawrence, Kansas 66044

# New from Long's . . . YAESU FT-107M all solid state HF SSB transceiver

**NEW!**

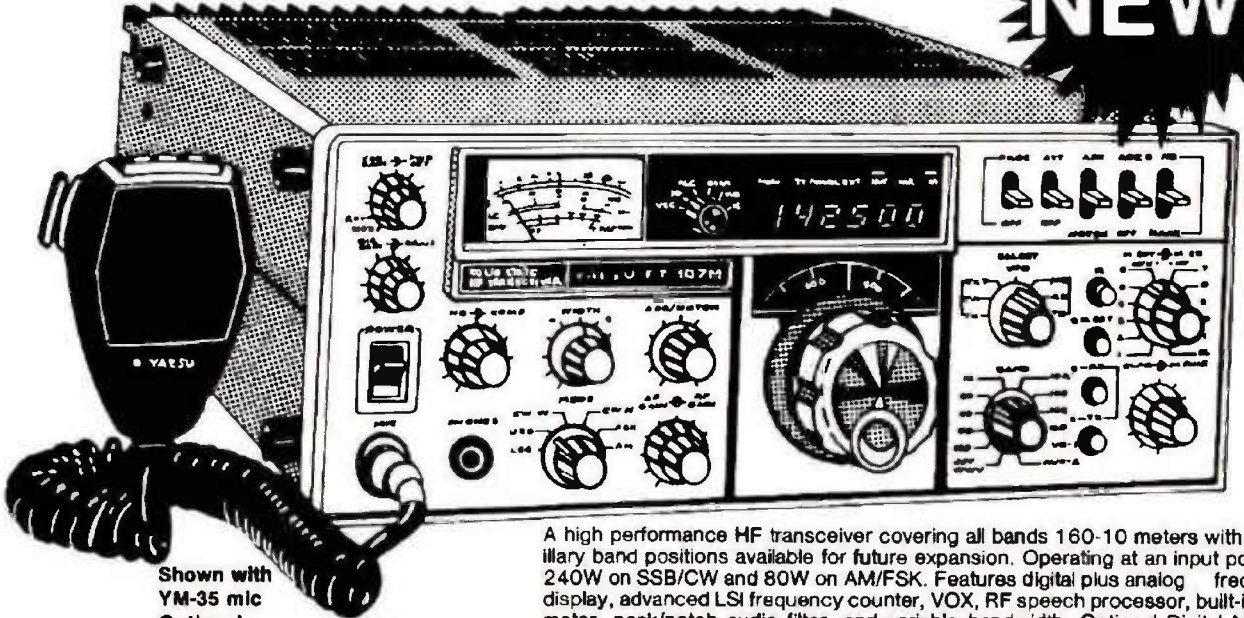

Shown with YM-35 mic Optional

A high performance HF transceiver covering all bands 160-10 meters with 2 auxiliary band positions available for future expansion. Operating at an input power of 240W on SSB/CW and 80W on AM/FSK. Features digital plus analog frequency display, advanced LSI frequency counter, VOX, RF speech processor, built-in SWR meter, peak/notch audio filter, and variable bandwidth. Optional Digital Memory Shift (DMS) has 12 discrete memories. Stores individual frequencies or use as 12 full coverage VFOs. (500 kHz each) Remote scanning possible with YM35 mic if radio is equipped with optional DMS. Sensitivity: 0.25 uV for 10dB S/N, CW/SSB, FSK, 1.0uV for 10dB S/N AM. Power required: 13.5 V DC at 20 amps.

**1045.00 List Price. Call for quote.**

FP-107E- External AC power supply/speaker console. Supplies 13.5V DC at 20 amps for proper operation of the FT 107M. 4 ohm 3W speaker built-in.

**145.00 List Price. Call for quote.**

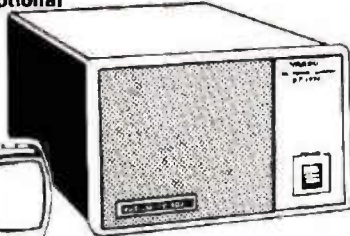

**YM-35** The hand-held scanning mic provides up/down scanning as well as scanning speed control for convenient operation. Used for scanning with a DMS memory equipped FT107M. 600 ohm impedance.

**19.00 Call Today.**

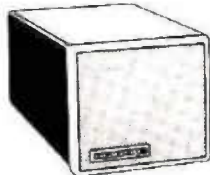

**SP-107** matching speaker for use with the FT107M. 4 ohms 5 watts.

**29.00 Call Today.**



**FV-107** Solid state external remote VFO. Operates full transceiver, receive, or transmit only. Features a  $\pm 2.5$  kHz clarifier and a precision analog dial.

**125.00 List Price. Call for quote.**

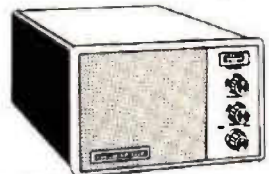

**SP-107P** Speaker/phone patch for FT107M has RX and TX gain control and VU meter. Use with high or low mic input impedance and PTT or VOX operation. 4 ohm 5W speaker built-in.

**67.00 Call Today.**

# Long's



Use your Master Charge or BankAmericard/VISA when you order.

## Ham Radio Department Store

MAIL ORDERS: P.O. BOX 11347 BIRMINGHAM, AL 35202 • STREET ADDRESS: 2808 7TH AVENUE SOUTH BIRMINGHAM, ALABAMA 35233



Call  
Toll Free

# 1-800-633-3410

IN ALABAMA CALL 1-800-292-8668 9 AM TIL 5:30 PM CST, MONDAY THRU FRIDAY

## Economically Priced Ten-Tec Century 21 CW Transceiver



The Ten-Tec logo, consisting of the letters 'T', 'E', and 'C' in a stylized, interconnected font.

The ideal transceiver for the novice or dedicated CW operator. Receives CW or SSB but transmits CW only. Features include full break-in, 70 watts input, all solid state, instant band change, overload protection, and offset receiver tuning. Also features linear crystal mixed VFO, sidetone with adjustable level, built-in regulated power supply, three positions of selectivity, separate audio and RF controls, headphone jacks, and built-in speaker. Crystals provided to cover the 80-10 meter novice bands.

**349.00 List Price**  
Call for quote.

## The Dentron Clipperton L 2KW PEP linear amplifier

The Dentron logo, featuring the word 'Dentron' in a stylized, cursive font.

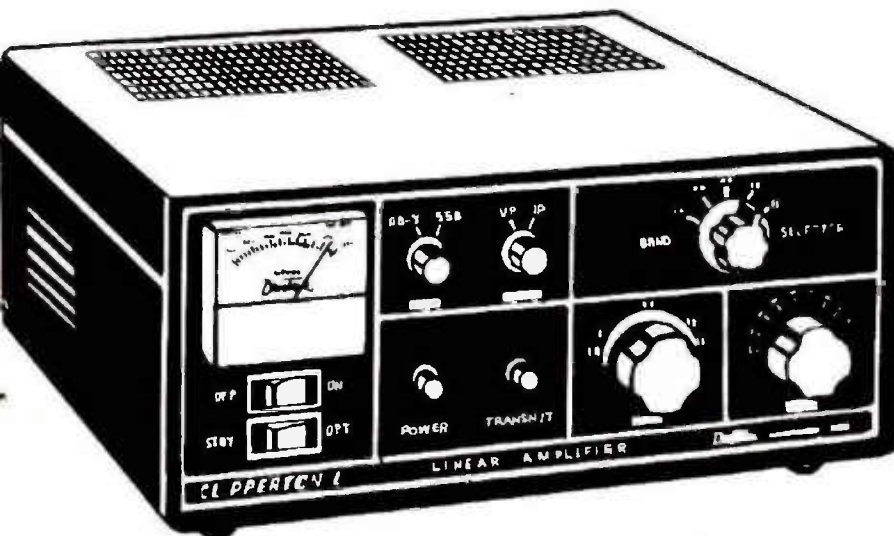

The Clipperton L covers 160-15 meters and most MARS frequencies. Delivering on continuous duty, 2000 watts PEP SSB and 1000 watts DC CW, RTTY, OR SSTV. Features include four 572B triodes operating in grounded grid, forced air cooling for longer tube life, and a built-in continuous duty power supply-2500 volt idle SSB-1800 volt idle CW approximately with rear panel section of 117 volts or 234 volts primary transformer taps and adjustable ALC. Also features standby switch, tune and load control, meter function switch, plate current and plate voltage meter, and 50 ohm output impedance.

**699.50 List Price.**  
Call for quote.

# A SHORT DX PRIMER



By Gary Youney,  
N2AGM

This second in our monthly series of DX operating tips and information features a guest appearance of DXCC member Gary Youney, N2AGM, formerly WB2ARH. Gary was first licensed in 1962, and waited many years before he succumbed to the DX fever. Once bitten, though, he surveyed the scene with a critical eye, and felt the need to pass some operating tips and encouragement along to others who may be on the verge of entering this most exciting part of Amateur Radio. Following Gary's words of wisdom, you'll find some DX station tips and late QSL information. *Editor*

Many hams become discouraged when it comes to working DX. They spin terrifying tales concerning the overwhelming difficulty involved, and the prohibitive costs. They claim the time spent in pile-ups is not worth the ultimate rewards, providing the ultimate can be achieved. After talking with many of these hams, I have discovered what I believe to be the primary reason behind their discouragement: a lack of adequate information regarding the use of DX tools.

Let's back up a moment and establish some basic definitions. For the purpose of this article, DX is taken to mean any country outside of the continental United States. We are only



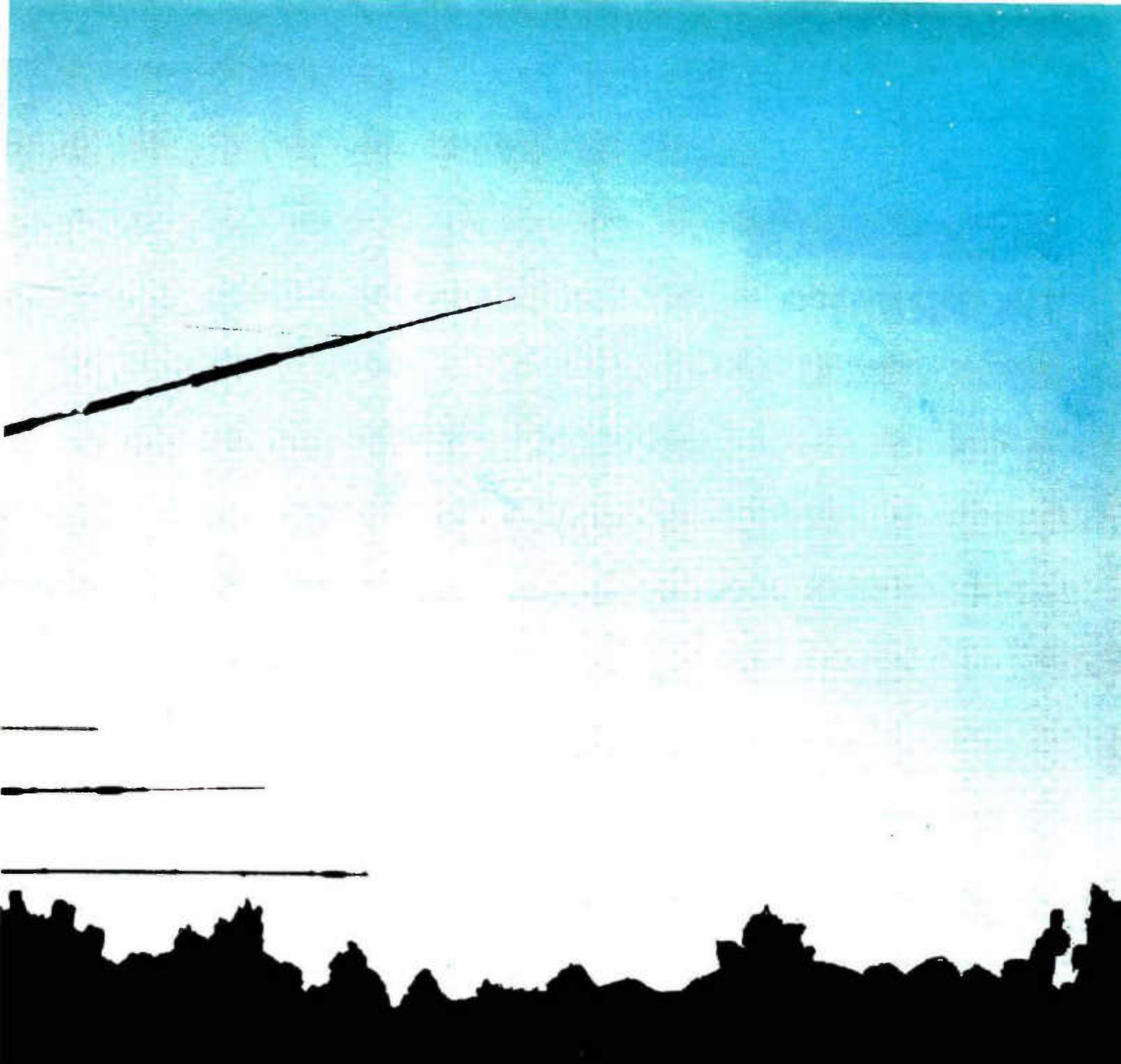

concerned here with basic DXing (DX101 in your course catalog. DX102 and DX103 are covered in other courses, but I would suggest this as a prerequisite.) The word "beginner," as used here, defines a neophyte to the DX scene. I held my General-class license for over fourteen years before I attempted to discard my "DX beginner" label.

A proper mental attitude is a must for the DXer. The DX is out there, waiting to be worked. Be bold, but not obnoxious. Be confident, but not oblivious to others. Talk to other DXers, and read everything you can about propagation and ethical operating techniques. Do not succumb to

any of the trashy methods you may hear on the bands. For every bad operator, there are one hundred excellent ones (or more). Working DX is supposed to be fun; don't spoil this aspect of the hobby by becoming a "professional" Amateur.

As in life, the formula for successful DXing is being at the right place at the right time, with the necessary credentials. Don't bite off too much at one time — start simple. For example, it is ludicrous for a newcomer to chase DX on twenty meter SSB on a Sunday afternoon, running 150 watts to a dipole. Trying to compete with the big boys too soon is a sure way to become totally discouraged and highly

frustrated. Try CW — it's great fun, much less crowded, and a wonderful equalizer. With minimal power and austere antennas, you can work and rag-chew with DX stations by way of "good old Morse." I enjoy chewing the fat on SSB, but I love chasing DX on CW.

To complete the formula for successful DXing, you must have the proper equipment, and the skills to use it. At the top of the list are the antenna and receiver. These items don't have to be the best ever made, but they should be pillars of solidarity. Choose the antenna type based upon your particular financial situation and space limitations. Feed it properly,

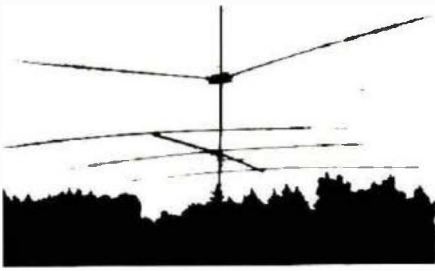

## DX PRIMER

and consider an antenna tuner. You don't need a six-element beam up thirty meters to work DX, but what you use must be a solid, efficient radiator. The receiver must be stable and sensitive; if necessary, consider such accessories as an rf preamplifier and an audio filter. Both make excellent weekend projects. Also, don't forget the most important piece of equipment of all — your ears. Train them; a good ear will compensate for many inadequacies in your other gear.

Crank up the gain in your receiver, and listen carefully for the weak ones. Don't make the mistake of thinking that, just because a distant station isn't 599, he will have a difficult time hearing you. Many DX stations will be running less power than you, with meager antennas. You'll probably find an excellent operator on the other end of the QSO who can pull you through if he can hear you at all.

Do your DXing on a band where your signal will stand a chance of getting through the QRM and QRN. Ten and fifteen meters are excellent candidates. Less power is usually needed on these bands, and modest antennas can accomplish miracles.

Keep a supply of QSL cards on hand. Send your cards out on a regular basis: the QSL card is the final courtesy of a QSO. Also, be sure to establish an account with your friendly incoming-QSL bureau. Ask a friend, or check the QSL information at the end of this column for monthly details. Don't expect DX QSLs to arrive in your mailbox one month following the QSO. These things take time, and your patience will ultimately pay off.

Put up a world map on your wall, and use pins to mark the location of each DX station worked. A wide variety of map projections is available; find one that suits your particular needs. Another purpose of the map is that it will show you that the distances

to many of the DX locations are not substantial. It is skill and patience that works DX, not brute force.

A patient attitude will help you appreciate the plight of the DX station. Chances are, he is doing you a favor of sorts; the United States is not a rare country, and QSL cards cost money.

Certain circumstances encourage long QSOs, while others necessitate "shot-gun" styles. Carefully evaluate the current band and operating conditions. The type of QSO should be determined by the DX operator, and not by you.

Choose your operating hours intelligently. Use propagation charts to establish ideal conditions between yourself and other areas of the world. With a little intelligent listening, much of this band-opening knowledge will become second nature. Many publications carry excellent columns on DX operating; they are usually loaded

---

**Remember, it is in extremely bad taste to request a QSO with "anyone" and then reject stations based upon some foolish criteria.**

---

with worthwhile information.

Try your hand at the DX contests. Even with modest equipment, many new countries and prefixes can be picked up on CW. Many ham publications carry times, dates, and required exchanges for these events. Jump in and get your feet wet!

A few brief words are in order about calling "CQ DX." This is a valid technique if you have no DX countries, or if you want to talk with just any DX operator. Remember, it is in extremely bad taste to request a QSO with "anyone," and then reject stations based upon some foolish criteria. Besides, why clutter up our already-crowded bands with this dribble, when a little intelligent listening will yield far more satisfying results?

Don't be discouraged when you don't obtain DXCC in your first few months of chasing DX. If stations

## QSL CORNER

The following QSL information is offered courtesy *DX News* (Geoff Watts), *Long Island DX Bulletin*, *QRZ DX*, *The DX Bulletin*, and gleanings from the logs of DX enthusiasts here at *Ham Radio Horizons*. If you have any information regarding QSL routes, upcoming DXpeditions, or other DX matters, by all means send it in; address all correspondence to the DX Editor.

aren't coming back to you, evaluate first your operating skills and then your equipment. Hone your ability to a fine edge, and make the most of your existing gear.

After a little operating, you will discover that the term "DX" is a relative one. What is DX to you today will probably not be next month. You will also learn that there are many levels of DX operating. As your interest and skills increase, you may find yourself moving from one DX plateau to another, deeper and deeper into this fascinating aspect of the hobby. You may even catch the terrible "DX fever," that dreaded disease that encourages the purchase of quads, Yagis, towers, and linear amplifiers.

Develop techniques and "tricks of the trade." Learn how and when to call the DX station, and how often. Don't shy away from pile-ups unless they appear totally hopeless or out of hand. Create your own incentives by keeping track of what (and who) you have worked. A well-kept station logbook is frequently your most valuable record of accomplishments.

DX chasing is but one aspect of an exciting hobby; it is not a business venture. Keeping this in mind, continually strive to make DX operating enjoyable for all involved. By your own good operating practices, you will insure the longevity of this challenging pastime.

HRH



A22DR	Box 947, Gaborone, Botswana	VY1CC	Box 4597, Whitehorse, Yukon Territory, Canada, Y1A-2R8
C5ACG	Box 596, American Embassy, Banjui, The Gambia	XT3AA	Box 375, Ouagadougou, Upper Volta, Africa
CO2JA	Box 2004, Havana, Cuba	ZS6AEC/T4	Box 506, NYLSTROOM 0510 Republic of South Africa
FH8CL	Box 37, Reunion Island (not Mayotte)	5U7BE	c/o Julius Berger, 6200 Wiesbaden, Karl Peterstraus, Federal Republic of Germany
FOØRS	Box 2891, Papeete, Tahiti	6W8EN	Box 2985, Dakar, Senegal
SVØWA	Dennis Morris, Box 2139, APO New York 09223	7P8BJ	Box 39, Maseru, Republic of Lesotho
TJ1GC	Guy, Box 1522, Douala, United Cameroon Republic		
VP2SA	AB1U Rich Casey, 85 Hacienda Cr., Plantville, Connecticut 06479		

# Reliability Service Experience



CDE T-2X  
\$197.00  
prepaid



CDE  
HAM IV  
\$145.00  
prepaid



ALLIANCE  
HD-73  
\$109.95  
prepaid

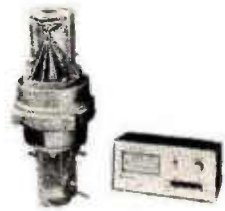

KENWOOD  
TR-2400



Check our price last!

PREPAID SHIPPING  
CONTINENTAL 48 ONLY



Quantities limited. Michigan resi-  
dents add 4% sales tax. Please in-  
clude your area code and telephone  
number with any correspondence.



# RSE HAM SHACK



1207 W. 14 MILE, CLAWSON, MI 48017  
(313) 435-5660

31155 PLYMOUTH, LIVONIA, MI 48150  
(313) 522-4232

MAIL ORDER TELEPHONE  
(313) 435-5660

Station	QSL Via	Station	QSL Via	Station	QSL Via
A4XGY	K2RU	PJ9CG	AB1U	VQ9JJ	W5RU
A7XD	WA4PYF	PR8ZPT	W7BUN	VR3AR	W7OK
AH8A	WD5EKM	PYØZAE	W1DA	VR6TC	W6HS
C21AA	P29JS	S8AYL	K9TXA	VS6SH	K4ZLZ
C21AP	F9AP	T3KA	W7OK	WA7JRL/SU	W8LZV
C31MK	EA3WZ	T3KB	W5RBO	YJ8BJ	WØPAH
C31SJ	DL1HH	T3KC	W5RBO	YS1GWD	W3HMK
C31VH	EA3AVN	T3LA	W7OK	YVØAA	YV5DFI
C5ACT	K4YT	T3PA	WB6FBN	ZD7HH	W4FRU
CT4RH	AB1U	TA1MB	K2LIO	ZD8AI	N3WM
D68AM	WB2OHD	TF3YH	WA8AAE	ZD8TC	ZD8AR
D68AP	WB2OHD	TG9CH	W4QO	ZF1MA	VE3GCO
EI9CB	WA1UVX	TG9GI	K8HV	ZF2DD	KA5Q
FK8BG	W7OK	TN8AJ	WB9TTM	ZS2MI	WA2IZN
FK8CR	W7OK	TR8DX	F6ESH	ZS6AF/T4	ZS4MG
FK8CW	K2IJL	TU4AQ	F6FPF	3B6CD	3B8CF
FP8AX	VE3AX	TZ4AQS	ON6BC	3D6AG	K9KXA
FR7BP	WØAX	U1LEN	UK2ABU	4X6AA	K2UK
FY7YE	W5JLU	UØY	UKØAAA	5B4IJ	OE8HFL
H31LR	WB3KGY	VP2KA	W7OK	5L1A	WA4DPF
HL9TO	WB6GYS	VP2KAC	N4RJ	5L2AV	N6FL
J6LOO	YASME	VP2KAD	K1PBW	5N4ROF	W4FRU
JW1SO	LA4DM	VP2KC	N4RJ	5NØDOG	W4FRU
JW5IJ	LA5NM	VP2KN	W7OK	5T5JD	W3EVW
JW7FD	LA5NM	VP2MFW	W1FB	5U7BE	DK9KE
JW8FG	LA8FG	VP2SAX	YASME	5W1AU	W6KNH
JX9WT	LA9WT	VP2SF	W7OK	5Z4YV	JA2AJA
KC6MJ	W7PHO	VP5BH	WB5OPM	5Z4YW	VE3ACY
KS6DV	WB6FBN	VP5MX	WB5OPM	7P8BQ	K9KXA
KP2A	WD2VFT	VP8AI	WD4AHZ	7X7HM	I8YCP
K9EF/H18	K1RH	VP8SO	G3KTJ	9H4EAB	WB1GVZ
OH2BP/OHØ	OH2PQ	VR1AF	W7OK	9L1CA	WA3NCP
OH3JR/OHØ	OH3JR	VR1AW	W5RBO	9Q5DH	WB4CSW
P29DP	W7OK	VR1BD	W5RBO	9Q5GB	W7KTI
P29JA	WA7OPZ	VR1PJ	WB6FBN	9Q5RM	WB2GTW
PJ2CC	K4BAI	VR1PK	W5RBO	9Y4FRC	N3RL



# WILSON SYSTEMS, INC. presents the SYSTEM 36

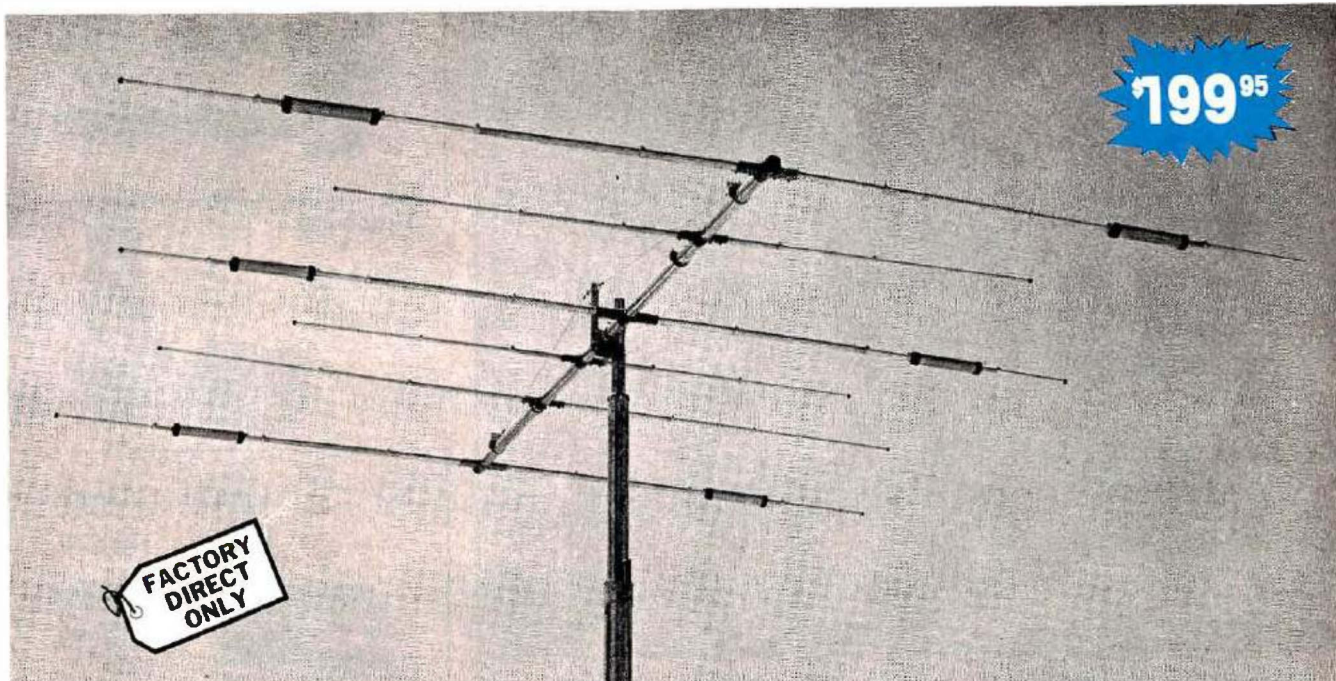

A trap loaded antenna that performs like a monobander! That's the characteristic of this six element three band beam. Through the use of wide spacing and interlacing of elements, the following is possible: three active elements on 20, three active elements on 15, and four active elements on 10 meters. No need to run separate coax feed lines for each band,

as the bandswitching is automatically made via the High-Q Wilson traps. Designed to handle the maximum legal power, the traps are capped at each end to provide a weather-proof seal against rain and dust. The special High-Q traps are the strongest available in the industry today.

## SPECIFICATIONS

Band MHz . . . . . 14-21-28  
Maximum power input, Legal limit  
Gain (dBd) . . . . . Up to 9 dB  
VSWR @ resonance . . . 1.3:1  
Impedance . . . . . 50 Ω  
F/B ratio . . . . . 20 dB or better

Boom (O.D. x Length) . . 2" x 24'2½"  
No. of elements . . . . . 6  
Longest element . . . . . 28'2½"  
Turning radius . . . . . 18'6"  
Maximum mast diameter, 2"  
Surface area . . . . . 8.6 sq. ft.

Wind loading @ 80 mph . . 215 lbs.  
Maximum wind survival . . 100 mph  
Feed method . . . . . Coaxial Balun  
Assembled weight (approx. 53 lbs.  
Shipping weight (approx.) . 62 lbs.

## Compare the SY-36 with others . . .

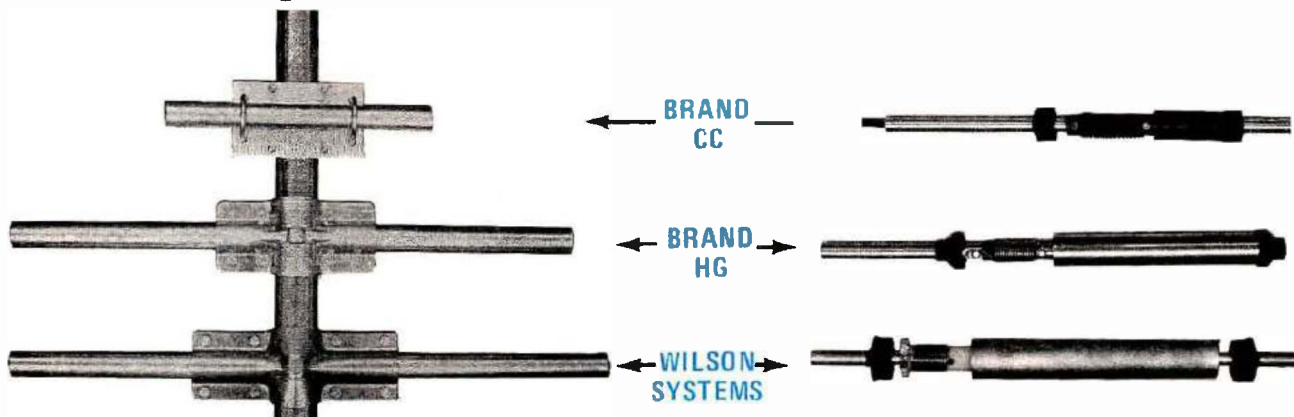

Compare the size and strength of the boom to element clamps. See who offers the largest and heaviest duty. Which would you prefer?

Wilson Systems traps offer a larger diameter trap coil and a larger outside housing, giving excellent Q and power capabilities.

**CALL  
FACTORY DIRECT  
1-800-634-6898**

**W S I WILSON  
SYSTEMS, INC.**

4286 S. Polaris Ave., Las Vegas, Nevada 89103

Prices and specifications subject to change without notice



# WILSON SYSTEMS INC. MULTI-BAND ANTENNAS

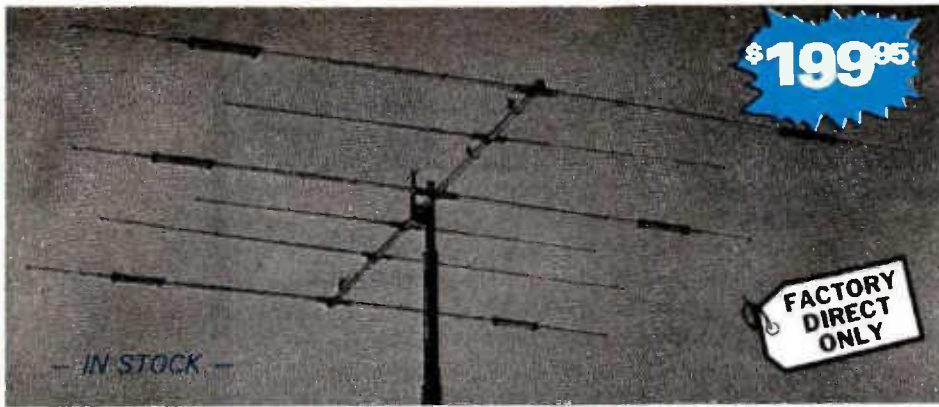

A trap loaded antenna that performs like a monobander! That's the characteristic of this six element three band beam. Through the use of wide spacing and interlacing of elements, the following is possible: three active elements on 20, three active elements on 15 and four active elements on 10 meters. No need to run separate coax feed lines for each band, as the bandswitching is automatically made via the High-Q Wilson traps. Designed to handle the maximum legal power, the traps are capped at each end to provide a weather-proof seal against rain and dust. The special High-Q traps are the strongest available in the industry today.

SPECIFICATIONS			
Band MHz	14-21-28	Boom (O.D. x Length)	2" x 24' 2 1/2"
Maximum power input	Legal Limit	No. of Elements	6
Gain (dBd)	Up to 9 dB	Longest Element	28' 2 1/2"
VSWR @ resonance	1.3:1	Turning Radius	18' 6"
Impedance	50 ohm	Maximum mast diameter	2"
F/B Ratio	20 dB or better	Surface area	8.6 sq. ft.
		Wind Loading @ 80 mph	215 lbs.
		Maximum wind survival	100 mph
		Feed method	Coaxial Balun
		Matching Method	Beta
		Assembled weight (approx)	53 lbs.
		Shipping weight (approx)	82 lbs.

**NEW!** ADD 40 METERS TO YOUR TRI-BAND WITH THE NEW 33-6 MK **\$49.95**  
 - IN STOCK -

Now you can have the capabilities of 40-meter operation on the System 36 and System 33. Using the same type high quality traps, the 40-meter addition will offer 200HKZ of bandwidth at less than 2:1 SWR. The new 33-6 MK will fit your present SY36 or SY33, and using the same single feed line.

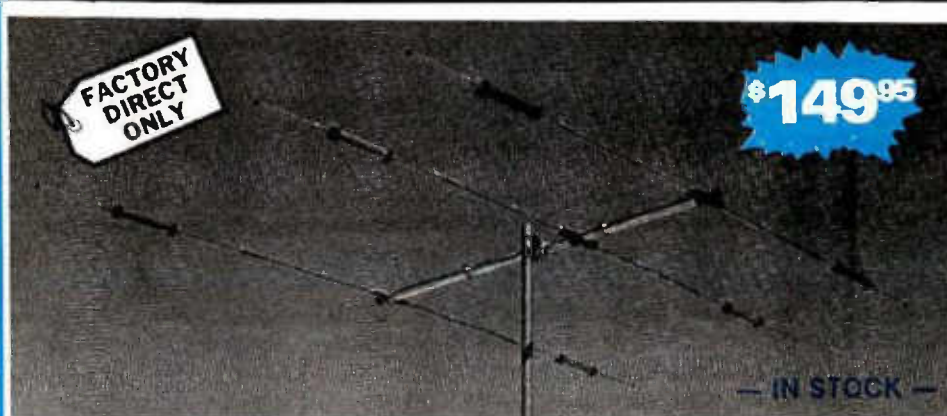

Capable of handling the Legal Limit, the "SYSTEM 33" is the finest compact tri-bander available to the amateur. Designed and produced by one of the world's largest antenna manufacturers, the traditional quality of workmanship and materials excels with the "SYSTEM 33". New boom-to-element mount consists of two 1/8" thick formed aluminum plates that will provide more clamping and holding strength to prevent element misalignment. Superior clamping power is obtained with the use of a rugged 1/4" thick aluminum plate for boom to mast mounting. The use of large diameter High-Q traps in the "SYSTEM 33" makes it a high performing tri-bander and at a very economical price. A complete step-by-step illustrated instruction manual guides you to easy assembly and the lightweight antenna makes installation of the "SYSTEM 33" quick and simple.

SPECIFICATIONS			
Band MHz	14-21-28	Boom (O.D. x length)	2" x 14' 4"
Maximum power input	Legal Limit	No. of elements	3
Gain (dbd)	Up to 8 dB	Longest element	27' 4"
VSWR at resonance	1.3:1	Turning radius	15' 9"
Impedance	50 ohms	Maximum mast diameter	2" O.D.
F/B Ratio	20 dB or better	Surface area	5.7 sq. ft.
		Wind loading at 80 mph	114 lbs.
		Assembled weight (approx)	37 lbs.
		Shipping weight (approx)	42 lbs.
		Direct 52 ohm feed - no balun required	
		Maximum wind survival	100 mph

**W S I WILSON SYSTEMS, INC.**

4286 S. Polaris Ave., Las Vegas, Nevada 89103

Prices and specifications subject to change without notice.

**ORDER FACTORY DIRECT 1-800-634-6899**

**\$49.95**  
**WV-1A**

## 4 BAND TRAP VERTICAL (10 - 40 METERS)

No bandswitching necessary with this vertical. An excellent low cost DX antenna with an electrical quarter wavelength on each band and low angle radiation. Advanced design provides low SWR and exceptionally flat response across the full width of each band.

Featured is the Wilson large diameter High-Q traps which will maintain resonant points with varying temperatures and humidity.

Easily assembled, the WV-1A is supplied with a base mount bracket to attach to vent pipe or to a mast driven in the ground.

Note:  
 Radials are required for peak operation. (See GR-1 below)

### SPECIFICATIONS

- 19' total height
- Self supporting — no guys required
- Weight — 14 lbs.
- Input impedance: 50 Ω
- Powerhandling capability: Legal Limit
- Two High-Q traps with large diameter coils
- Low angle radiation
- Omnidirectional performance
- Taper swaged aluminum tubing
- Automatic bandswitching
- Mast bracket furnished
- SWR: 1.1:1 or less on all bands

## GR-1

**\$12.95**

The GR-1 is the complete ground radial kit for the WV-1A. It consists of: 150' of 7/14 stranded copper wire and heavy duty egg insulators, instructions. The GR-1 will increase the efficiency of the GR-1 by providing the correct counterpoise.



# WILSON SYSTEMS TOWERS

— IN STOCK —



FACTORY DIRECT  
**\$949<sup>95</sup>**

## ST-77B

### Features:

Max. Height: 77'  
Min. Height: 24'  
Weight: 700 lbs.  
Winch: 1500 lbs.  
Cable: 6400 lbs.  
Requires FB-77B or RB-77B  
Totally Freestanding with Bases below

**NEW**

(Shown with FB-77B)

**IN STOCK**



FACTORY DIRECT  
**\$549<sup>95</sup>**

## MT-61B

### Features:

Max. Height: 61'  
Min. Height: 23'  
Weight: 450 lbs.  
Winch: 1200 lbs.  
Cable: 4200 lbs.  
No Guys required when mounting against house.  
For completely freestanding installation, use RB-61B or FB-61B below.

WIND LOADING			
Tower	Height	Sq. Ft.	Square Footage Based on 50 MPH Wind
ST-77B	69	18	
	77	12	
MT-61B	63	18	
	61	12	
TT-45B	37	18	
	45	12	



FACTORY DIRECT  
**\$314<sup>95</sup>**

## TT-45B

### Features:

Max Height: 45'  
Min. Height: 22'  
Weight: 250 lbs.  
Winch: 1200 lbs.  
Cable: 4200 lbs.  
No Guys required when mounting against eave of house.  
For completely freestanding installation, use RG-45B or FB-45B below.

BASE CHART		
TOWER	WIDTH	DEPTH
TT-45B	12" x 12"	30"
FB-45B	30" x 30"	4 1/2'
RB-45B	30" x 30"	4 1/2'
MT-61B	18" x 18"	4'
FB-61B	3' x 3'	5 1/2'
RB-61B	3' x 3'	5 1/2'
ST-77B	See Below	Bases
FB-77B	3 1/2' x 3 1/2'	6'
RB-77B	3 1/2' x 3 1/2'	6'

Wilson Systems uses a new high strength carbon steel tube manufactured especially for Wilson Systems. It is 25% stronger than conventional pipe or tubing. The tubing size used is: 2" & 3 1/2" .095; 4 1/2" & 6" .125, 8" .134. All tubing is hot dip galvanized. Top section is 2" O.D. for proper rotor and antenna mounting.

The TT-45B and MT-61B come complete with house bracket and hinged base plate for against-house mounting. For totally freestanding installation, use either of the tilt-over bases shown below.

The ST-77B can not be mounted against the house and must be used with the tilt-over base FB-77B or RB-77B shown below.

All three towers above are able to handle large arrays of up to 20 sq. ft. at 80 mph WHEN GUYED with one set of 4-point Guys at the top of the 3 1/2" section. Guying Kits are available at the following prices: GK-45B — \$59.95; GK-61B — \$79.95; GK-77B — \$99.95. When using the Guy System with RB Series Rotating Base, an additional thrust bearing at the top is required. The WTB-1 is available for \$49.95.

## TILT-OVER BASES FOR TOWERS

### FIXED BASE

The FB Series was designed to provide an economical method of moving the tower away from the house. It will support the tower in a completely free-standing vertical position, while also having the capabilities of tilting the tower over to provide an easy access to the antenna. The rotor mounts at the top of the tower in the conventional manner, and will not rotate the complete tower.

**FB-45B... 112 lbs... \$154.95**  
**FB-61B... 169 lbs... \$214.95**  
**FB-77B... 250 lbs... \$299.95**



### ROTATING BASE

The RB Series was designed for the Amateur who wants the added convenience of being able to work on the rotor from the ground position. This series of bases will give that ease plus rotate the complete tower and antenna system by the use of a heavy duty thrust bearing at the base of the tower mounting position, while still being able to tilt the tower over when desiring to make changes on the antenna system.

**RB-45B... 144 lbs... \$219.95**  
**RB-61B... 229 lbs... \$299.95**  
**RB-77B... 300 lbs... \$449.95**



Tilting the tower over is a one-man task with the Wilson bases. (Shown above is the RB-61B. Rotor is not included.)

ORDER  
FACTORY DIRECT  
1-800-634-6898

**W S I WILSON SYSTEMS, INC.**

4286 S. Polaris Ave., Las Vegas, Nevada 89103



# WILSON MONO-BAND BEAMS

FACTORY DIRECT ONLY

\$229<sup>95</sup>

## M520A

### THE ALL NEW 5 ELEMENT 20 METER BEAM

At last, the antennas that you have been waiting for are here! The top quality, optimum spaced, and newest designed monobanders. The Wilson System's new Monoband beams are the latest in modern design and incorporate the latest in design principles utilizing some of the strongest materials available. Through the select use of the current production of aluminum and the new boom-to-element plates, the Wilson Systems' antennas will stay up when others are falling down due to heavy ice loading or strong winds. Note the following features:

- 1. Taper Swaged Elements** — The taper swaged elements provide strength where it counts and lowers the wind loading more efficiently than the conventional method of telescoping elements of different sizes.
- 2. Mounting Plates — Element to Boom** — The new formed aluminum plates provide the strongest method of mounting the elements to the boom that is available in the entire market today. No longer will the elements tilt out of line if a bird should land on one end of the element.
- 3. Mounting Plates — Boom to Mast** — Rugged 1/4" thick aluminum plates are used in combination with sturdy U-bolts and saddles for superior clamping power.
- 4. Holes** — There are no holes drilled in the elements of the Wilson HF Monobanders. The careful attention given to the design has made it possible to eliminate this requirement as the use of holes adds an unnecessary weak point to the antenna boom.

With the Wilson Beta-match method, it is a "set it and forget it" process. You can now assemble the antenna on the ground, and using the guide-lines from the detailed instruction manual, adjust the tuning of the Beta-match so that it will remain set when raised to the top of the tower.

The Wilson Beta-match offers the ability to adjust the terminating impedance that is far superior to the other matching methods including the Gamma match and other Beta matches. As this method of matching requires a balanced line it will be necessary to use a 1:1 balun, or RF choke, for the most efficient use of the HF Monobanders.

The Wilson Monobanders are the perfect answer to the Ham who wants to stack antennas for maximum utilization of space and gain. They offer the most economical method to have more antenna for less money with better gain and maximum strength. Order yours today and see why the serious DXers are running up that impressive score in contests and number of countries worked.

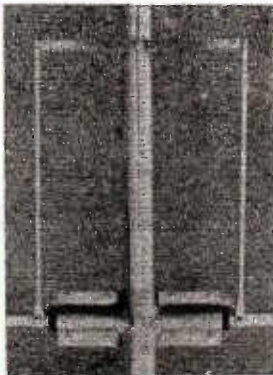

Wilson's Beta match offers maximum power transfer.

## SPECIFICATIONS

Model	Band (MHz)	Gain (dB)	F/B Ratio	Frequency (KHz)	Voltage @ Resonance	Impedance	Matching	Elements	Longest Element	Boom O.D.	Boom Length	Turning Radius	Surface Area (Sq Ft)	Wind Load @ 35 mph (Lbs)	Maximum Mast	Assembled Weight (Lbs)
M520A	20	11.5	25 dB	500 KHz	1.1:1	50 Ω	Beta	5	36'6"	2"	34'2 1/4"	25'1"	8.0	227	2"	58
M420A	20	10.0	25 dB	500 KHz	1.1:1	50 Ω	Beta	4	36'6"	2"	26'0"	22'6"	7.6	189	2"	50
M515A	15	12.0	25 dB	400 KHz	1.1:1	50 Ω	Beta	5	25'3"	2"	26'0"	17'6"	4.2	107	2"	41
M415A	15	10.0	25 dB	400 KHz	1.1:1	50 Ω	Beta	4	24'2 1/4"	2"	17'0"	14'11"	3.1	54	2"	25
M510A	10	12.0	25 dB	1.5 MHz	1.1:1	50 Ω	Beta	5	18'6"	2"	26'0"	16'0"	2.8	72	2"	36
M410A	10	10.0	25 dB	1.5 MHz	1.1:1	50 Ω	Beta	4	18'3"	2"	12'11"	11'3"	1.4	36	2"	20

WILSON SYSTEMS, INC. — 4286 S. Polaris  
Las Vegas, NV 89103 — (702) 739-7401

FACTORY DIRECT  
ORDER BLANK

Toll-Free Order Number  
1-800-634-6898

### WILSON SYSTEMS ANTENNAS

Qty	Model	Description	Shipping	Price
	SY40	10 Ele. Tribander for 10, 15, 20 Mtrs.	UPS	274.95
	SY36	6 Ele. Tribander for 10, 15, 20 Mtrs.	UPS	199.95
	SY33	3 Ele. Tribander for 10, 15, 20 Mtrs.	UPS	149.95
	33-6 MK	40 Mtr. Mod Kit for SY33 & SY36	UPS	49.95
	WV-1A	Trap Vertical for 10, 15, 20, 40 Mtrs.	UPS	49.95
	GR-1	Ground Radials for WV-1A	UPS	12.95
	M-520A	5 Elements on 20 Mtrs.	TRUCK	229.95
	M-420A	4 Elements on 20 Mtrs.	UPS	159.95
	M-515A	5 Elements on 15 Mtrs.	UPS	129.95
	M-415A	4 Elements on 15 Mtrs.	UPS	84.95
	M-510A	5 Elements on 10 Mtrs.	UPS	84.95
	M-410A	4 Elements on 10 Mtrs.	UPS	69.95
<b>ACCESSORIES</b>				
	T <sup>X</sup>	Tail Twister Rotor	UPS	199.95
	HD-73	Alliance Heavy Duty Rotor	UPS	109.95
	RC-8C	B/C Rotor Cable	UPS	12/ft.
	RG-8U	RG-8U Foam Ultra Flexible Coaxial Cable. 38 strand center conductor, 11 gauge	UPS	21/ft.

### WILSON SYSTEMS TOWERS

Qty.	Model	Description	Shipping	Price
	TT-45B	Freestanding 45' Tubular Tower	TRUCK	314.95
	RB-45B	Rotating Base for TT-45B w/tilt over feature	TRUCK	219.95
	FB-45B	Fixed Base for TT-45B w/tilt over feature	TRUCK	154.95
	MT-61B	Freestanding 61' Tubular Tower	TRUCK	549.95
	RB-61B	Rotating Base for MT-61B w/tilt over feature	TRUCK	299.95
	FB-61B	Fixed Base for MT-61B w/tilt over feature	TRUCK	214.95
	ST-77B	Freestanding 77' Tubular Tower	TRUCK	949.95
	RB-77B	Rotating Base for ST-77B w/tilt over feature	TRUCK	449.95
	FB-77B	Fixed Base for ST-77B w/tilt over feature	TRUCK	299.95
	GK-45B	Guying Kit for TT-45B	UPS	59.95
	GK-61B	Guying Kit for MT-61B	UPS	79.95
	GK-77B	Guying Kit for ST-77B	UPS	99.95
	WTB-1	Thrust Bearing for Top of Tower	UPS	49.95

Prices Effective April 1-30, 1980

Nevada Residents add Sales Tax

Ship C.O.D.  Check enclosed  Charge to VISA  MasterCard

Card No. \_\_\_\_\_ Expires \_\_\_\_\_

Bank No. \_\_\_\_\_ Signature \_\_\_\_\_

Name \_\_\_\_\_ Phone \_\_\_\_\_

Street \_\_\_\_\_

City \_\_\_\_\_ State \_\_\_\_\_ Zip \_\_\_\_\_

**NOTE:**  
On Coaxial and Rotor Cable, minimum order is 100' and 50' multiples.  
Prices and specifications subject to change without notice.  
Ninety (90) Day Limited Warranty — All Products FOB Las Vegas, Nevada

\* Prices and specifications subject to change without notice.

# FT-101 OWNERS' SURVEY

## TOM McMULLEN, W1SL

### Yaesu Owners Speak

Our questionnaire in the December, 1979, issue of *Horizons*, and in the January, 1980, issue of *ham radio*, asked for reports on the Yaesu FT-101B (or later). Well, we sure got 'em. Many owners just circled or underlined the model number at the top of the form, but a sizable number indicated which rig they had, and the list covers, in addition to the B model, the E, EE, EX, F, FE, FX, Z, and ZD. That's more models than I knew existed.

As usual, there were some great comments on all sides of the issue; some happy people, some very happy people, and some were disgruntled, to say the least (no one has yet told me they were disgruntled, though). A few of the comments were hard to interpret — "ugly," "homely," and "beautiful" I can understand, but what does a guy mean when he says his rig is "healthy"? On the other hand, I've heard many a "sick" rig on the air, so why not healthy as well. Anyway, let's look at some returns.

### Best Features

Heading the top of the list of things owners like is Ease of Operation at

27.9 per cent, followed by Good Signal Quality at 12.6 per cent. Reliability, Versatility, and Built-in ac/dc Power Supply tied for third place at 10 per cent. You'll find the whole list in Table 1. Here are some of the comments extracted from 186 reports:

"This rig is a six-band radio and very easily operated. It has many good features, such as compact size, plug-in modules, large meter, and a fairly stable VFO dial." — VE3KTU.

"A pleasure to use . . . (I like) ac/dc operation — have used it mobile on several occasions in search and rescue work." — VE7DUS.

"I honestly cannot pick a single best feature — there are so many things, such as built-in dc with dc hookup cable as standard equipment, the ease of tuning, the excellent audio quality and the quality of the speech processor." — (not signed).

"Easy tune-up and dependability, flexibility. If you're a 2 or 6 meter nut, just plug in a transverter at a very reasonable cost and you're in business." — WD6HDD.

"Modular design . . . enables you to quickly test and repair it, or add on new features. Also like Fox-Tango Club — helps solve common prob-

lems — all rig owners should be so lucky." — K1BE.

"Very good performance and features for the price. Yaesu has a very large list of matching accessories. I like the a-m mode also . . . and the ability to reach the MARS frequencies, which are outside the ham bands." — KB8FJ.

"Everything, including both 110 Vac and 12 Vdc, in one unit. I can use it at my cabin, while traveling, or at my home station." — WA7YFJ.

"Well built, everything works smoothly, not cheap looking." — WA2GVA.

"I believe the use of printed circuit board modules that are removable is one of its best features. It made installing the CW filter a breeze. This surely must be a plus if the rig needs service." — N9AFI.

"Because of the easy operation and tune-up, I am now a learning Amateur, going for my Advanced class ticket." — WB8ZUO.

"Versatility, and the options such as ac or dc and the external hookups . . . I love the Clarifier (RIT) feature." — KA6FGW.

"Speech processor works very well, and is the rig's best feature. Another



advantage is the Fox-Tango Club, which helps in many ways." — WD9CKV.

"Its selectivity . . . and its ability to withstand a high SWR. This year's Field Day would have been a disaster if I hadn't brought my rig along." — WD8AEJ.

"Excellent reports on transmitter . . . it worked so well I sold my linear amplifier." — KA2ESB.

"Transmitter is excellent — good clean, clear signals, both SSB and CW." — WB1CHY.

"Incorporates nearly all the features I wanted in one rig, and for a reasonable price — affordable versatility." — K4FKK.

"In my case, it's the room on the front panel. My hands and fingers are large, and tuning or adjusting can be more easily done on this rig. Also, score one for the audio output quality." — WD9IZA.

### Worst Features

And then there is the other side of the flounder, as they say in these parts. Leading the list is tune-up time at 23.4 per cent. Many owners noted that, although they listed this as a worst feature, they realized that it was because of the tube-type final amplifier stage in the rig. The wide SSB filter took second place with 10 per cent, with some comments about the receiver's inability to reject nearby signals. Next was the Noise Blanker at 8.1 per cent. Several other features came under fire, and they are listed in Table 1. Here are some owners' comments:

"Poor noise blanking action and severe intermod with blanker on." — VE2ASL.

"Tube finals." — WD4ATA.

"Having to tune up on band changes (but I don't really care, since I don't want a solid-state rig at this time)." — WD5BEP.

"No passband or notch filter. Would like to have 6146 tubes in final instead of 6JS6." — WD4GZB.

"Poor noise blanker and front-end overload." — VE7BS.

"Needs narrower CW filter. 600 Hz is too broad." — KA4BCM.

"Poor factory quality control; a-m is dreadful; receiver not as hot as most; microphone is still hot in CW mode." — N3DF.

"Noisy fan." — N2HP.

"There are many. It is quite difficult to tune up. The instruction manual is exceptionally deficient, especially about tuneup. The finals are sweep tubes instead of 6146s. It does not have a variable i-f width control. It has birdies on several frequencies." — (unsigned).

"After being a CBer (converted to the ham ranks), I feel the worst feature is tuning up, common to all tube rigs. No-tune-up, solid-state rigs are the wave of the future. Also, I wish the CW filter was narrower." — WB1BWR.

"Warm-up drift." — W9DLF.

"Filters too broad, and the VOX and CW sidetone adjustments are under the top cover." — WD9ABG.

"Has a hot receiver, which, unfortunately, overloads very easily." — K8JRM/5.

"Guarantee, service policy, and parts availability." — KA6EDO.

"Tube finals must be retuned for band change." — WD9CKV.

"Selectivity could be a little narrower than 2.4 kHz for better SSB reception. Also could use an i-f passband tuner." — K9INR.

**Table 1.** Best and Worst Features from 186 reports. Some owners listed more than one good or bad feature.

Best Feature	Per Cent
Ease of operation	27.9
Good signal quality	12.6
Reliability	10.0
Built-in ac/dc supply	10.0
Versatility	10.0
Compact size	9.0
Stability	8.1
Plug-in boards	7.2
Speech processor	6.3
Durability	2.8
All mode	2.7
Good portable, preselector, sensitivity, RIT, and selectivity, each	1.8
Smooth tuning, 11-meters, CW filter, SWR tolerant, each	0.9
Worst Feature	Per Cent
Tune-up time (tube finals)	23.4
SSB filter too wide	10.0
Poor noise blanker	8.1
Adjustments under top cover	6.3
Poor sensitivity	5.6
CW filter only on CW	5.5
Receiver overloads easily	5.3
Noisy fan	4.5
Drifts	3.6
Key jack in back	2.9
Poor service	2.7
Poor manual/instruction book	2.7
Poor AGC system	2.6
Too big for mobile	1.8
Too heavy	1.7
Poor RIT control, ICs soldered in, ugly, poor a-m detector, no pass-band tuning, slide switches, short VOX delay, quality control, poor speaker, each less than	1.0
None (!)	15.3



"Total lack of factory guarantee, all service has to be done by dealer. Some dealers refuse to handle the rig for this reason (so they say)." — KA0AQL.

"Noise blanker is not effective." — K0BX.

"VOX controls are under the top cover, making them difficult to reach." — WA1WRI.

"Noise blanker seems to 'broad-band' the receiver." — WD8MXP.

"That @#\*&+! power/pre-tune/S-meter!" — WB6URV.

"This rig has only one bad feature — the WWV frequency is 5 MHz. I would rather have 10 or 15 MHz." — WB5RWM.

"The worst feature is, when the rig is used in the CW mode, the VOX must be used in order to send, but with the microphone plugged in. This is not unavoidable, but after spending around \$1000, you would think that the factory would correct this minor problem." — VE3KTU.

"Use of sweep tubes. 6146s could have been used with only change of sockets, bias, and screen voltage. It would have more output on 10 and 15 meters." — W1YCM.

"Not the best mobile rig (too big)." — VE7ATG.

"Not enough rejection of adjacent signals on SSB. CW is very good." — AA8F.

"Must lift the top cover to adjust the VOX and sidetone controls." — NL7D.

"By far (worst feature is) service after sale by Yaesu. Correspondence never answered (I've written four times). Instruction manual and (\$25 rip-off) service manual conflict many times." — WD4JYH/KL7.

"CW key jack located on back of rig." — WB5MQZ.

"Mechanical relay for QSK." — W4DGX.

"Trying to set the noise blanker on late FT-101EX is almost impossible." — WD9FSE.

"Noise blanker no good. Manual good for experienced ham, but not basic enough for beginner like me. I would like simpler explanations of what happens, why, meter readings, down-to-earth stuff." — KA9CZR.

There were some comments of another type in answer to question 10, also:

"I have not as yet found a feature I dislike." — WD6BXZ.

"Haven't found it yet." — W0PZD.

"I cannot say that there is a worst feature." — N4BBK.

"None discovered." — WA7YFJ.

#### The problems I've had . . .

Then comes question number 11, "Have you had any problems?" A fast run with the calculator shows the following:

Yes = 60.6 per cent

No = 38.4 per cent

No answer = 1.0 per cent

The types of troubles reported are shown in Table 2, along with the number of times each showed up. As usual, people were glad to tell us what went wrong!

"Had an ALC problem which knocked out SSB transmission. Traced it to a blown FET." — A19X.

"Rig was struck by lightning. Repair consisted of replacing a relay, and a few resistors and capacitors." — WD8MXP.

"Had to have the ball drive assembly replaced in the main tuning dial." — N4BBK.

"Microphone connector came loose

— a very minor problem, and I fixed it myself." — W6EEG.

"When the SWR was above 1:1, I had rf feedback from linear amplifier back through the microphone. Had to bypass all leads to PTT and microphone circuit to clear up the problem. Yaesu engineer spent 30 minutes on the phone with me discussing probable causes and recommendations." — W7KHN.

"Receiver audio was inoperative when the rig arrived, though S-meter showed rf stages were working. Rig was repaired under warranty and returned free." — WB0RJJ.

"Had ac hum on receive. Easy cure by cleaning the edge connector on the audio board. No other problems in three years!" — K0BX.

"(It's a) pain to tune the transmitter — the ALC always acts up, and most of the time I have no ALC meter indication . . . transmit/receive frequency shift apart for no apparent reason and must be adjusted. Dealer cannot explain, and factory is no help . . . they haven't even answered my letters . . ." — WB2MWQ.

"The VOX has never worked. I have tried to adjust it but without success." — W9PQB.

**Table 2.** Types of problems reported, and the number of times mentioned. Some reports listed more than one problem.

Trouble	Number of instances
Final (tubes)	15
ALC doesn't work	9
VFO drift/shift	7
Power supply quit	7
VOX doesn't work	7
Noise blanker ineffective	5
Receiver overload	5
Driver tube bad	4
Audio stage dead/intermittent	4
Crystal quit oscillating	3
Dial drive slipping	3
Transmit/receive relay sticky/noisy	3
Microphone dead	3
Voltage regulator quit	3
S-meter doesn't read properly	3
Shipping damage	3
Transmit/receive frequency shift	3
Mode switch bad	3

Low sensitivity, low output, no sidetone, "birdies" in receiver, out of alignment when new, TVI, hum, rf feedback, digital display, speech compressor, headphone jack, short in wiring — all mentioned two or less times.



"Digital frequency display was erratic. Returned to dealer, but was not fixed. I found that the plastic connector was not making good contact." — (unnamed by request).

"There is a minor heat-related problem with the digital display. With dial light dimmer at full brightness, the display will lose sensitivity and display only even-numbered hertz readings (such as 14,100.2, 14,100.4, etc.). Running the dimmer on low setting will cure the problem." — WB5RWM.

"Minor initial problem with voltage regulator, which was quickly fixed the same day it was purchased." — VE7BS.

"15-meter band crystal stopped oscillating. Fixed it myself (using notes from Fox-Tango Club newsletter) by 'tweaking' trimmer." — W4PME.

"Speech compressor was intermittent. Traced the problem to a hairline crack in foil on printed-circuit board. Repaired it myself." — KB2LQ.

"Only tubes." — N4BEN.

"Unable to receive weak signals on 10 meters unless 25 or 100 kHz switch is on." — WA4APE.

"The audio became intermittent. I called (dealer) on their 800 number, and described the problem. They advised I unplug the audio section, and they mailed the replacement part which I received in 24 hours. I was back on the air the next day and didn't have to go out of my home to take advantage of the warranty." — KA1DDE.

"Tune-mode switch went bad." — WD6HDD.

"Capacitor blew up in power supply, lost the driver and final tubes as a result." — K9INR.

"The driver tube would last about four months, then short out with a flash. Turned out to be a screen dropping resistor not soldered in place." — WA4TQD.

"Headphone jack not properly wired." — AA8F.

"No ALC on ten meters, although I get plenty of power out." — WD9IRR.

"A peculiar problem with the VOX relay failing to release after a long period of operation." — K6EL/WA5ZYF/OX5AP.

"Only one in the three years I've owned the rig, and that was a regulator IC went bad and caused the VFO

to fm during reception. After finding the IC and replacing it, the rig has worked fine." — WA5WUX.

On the other hand, there were many who had no problems:

"No major problems at all." — WA6SXP.

"Only time it was back to the factory was for lightning damage, and that was my fault, not the rig's. I would like to upgrade to the FT-901, but have had such good service from this unit, I'm afraid to give it up!" — WBØYRN.

"Since I bought the rig . . . I have not had any problems with it. The local dealer took care of any set-up problems." — WD4GZB.

"Never had a rig like this one. No problems of any kind. Everything works great!" — WB1CHY.

### Service

Then, in reply to question 12, "Have you had the rig serviced?" the answers show:

No = 56.3 per cent  
Yes = 43.7 per cent

In the "Yes" category, 13.7 per cent went to the manufacturer, 51.8 per cent had the dealer fix their rig, and 34.5 per cent listed "other,"

which, naturally enough, included "myself" many times.

As to whether the service was satisfactory, 84.4 per cent said yes, 12.1 per cent said no, and 3.5 per cent said "yes and no". This last answer comes from repeated trips to the service shop, as in the example in one reply where the first two trips were unsatisfactory, but the third time the trouble was fixed, therefore satisfactory.

Time out for an observation — at hamfests and flea markets, and on the air, I've heard comments about "Yaesu's service policy," or rather, the lack of one. The numbers from our questionnaire just don't support the contention of many that the policy was all that bad. This is further reinforced by the percentages of answers given to Question 23, later in this article. There's no doubt that the person who has a defective rig and has had a problem getting it fixed is going to feel pretty upset about it, while the trouble-free rig, or one that was fixed easily and promptly, will let its owner operate happily and quietly for years. This reinforces the old adage that you should "believe only half of what you hear," especially when it comes to complaints passed along second or third hand.

Table 3. Accessories purchased for the Yaesu.

Item	Per Cent
CW filter	33.0
Phone patch	29.3
Auxiliary VFO	27.0
External speaker	25.5
Fan	28.5
Digital readout/counter	18.0
Oscilloscope/monitor	12.7
Desk microphone	12.0
Linear amplifier	12.0
Antenna tuner	9.0
G3LLL Processor	6.0
Audio filter	6.0
Keyer	5.2
Extra crystals	4.5
Low-pass filter	5.2
SWR meter, 2-meter transverter, 6-meter transverter, each	3.7
Dummy load, maintenance manual, a-m filter, each	2.2
None	6.7

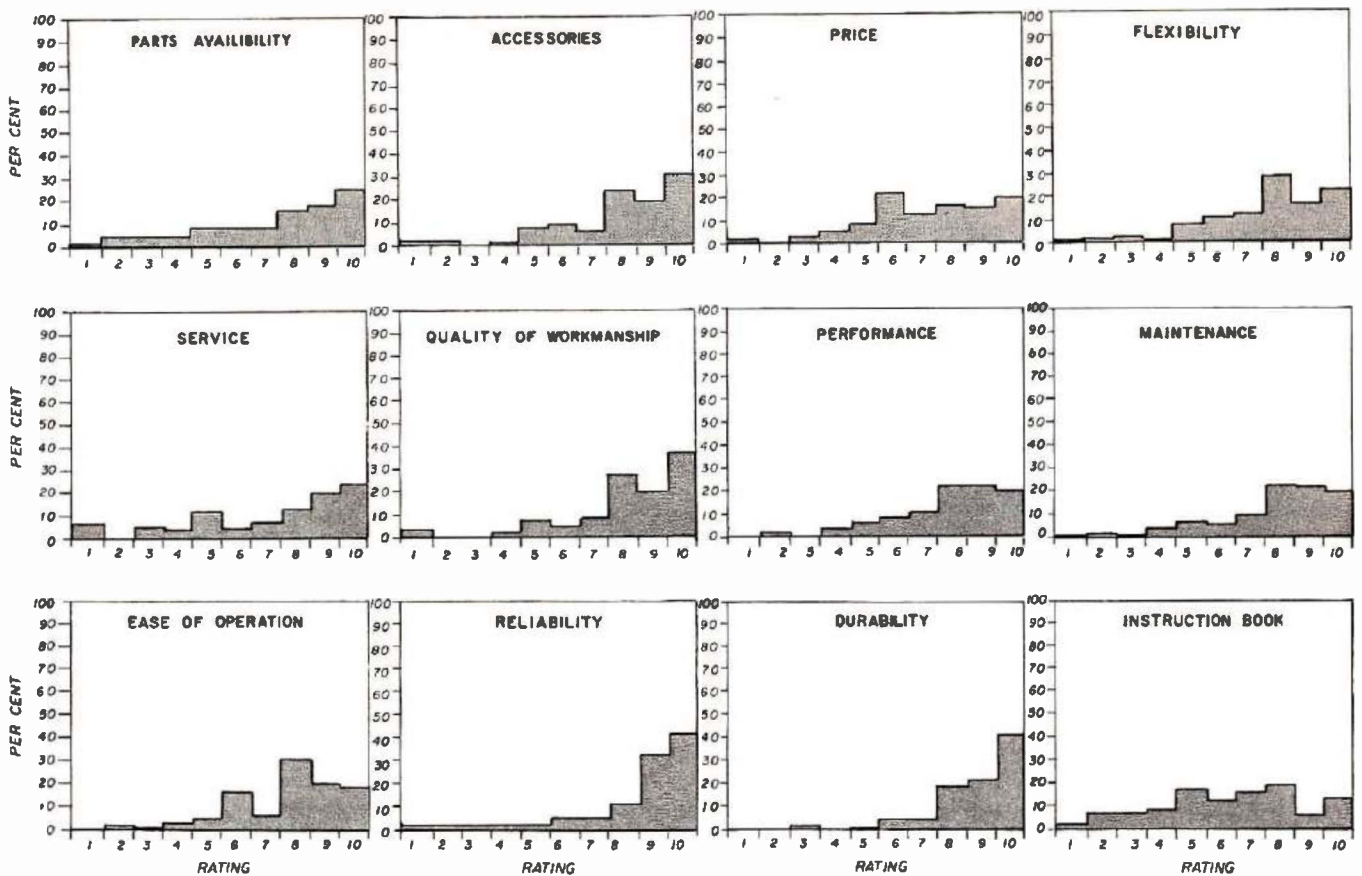

Fig. 1. The answers to Question 19 are shown in percentages of the total number of answers to each category. Reports that were left blank in any rating category were not included in the tabulation for that rating. Most users were very pleased with their Yaesu FT-101s, as shown by the "weight" on the upper end of the scale.

On the other hand, if I were producing an item with the hope of selling a lot of them, and 12 per cent of my service was unsatisfactory, I would certainly take steps to improve the product and the service policy. According to more recent comments (I've not had any official word from Yaesu that things have changed — we do not run these reports by the manufacturer before printing them), it is now easier to obtain service on Yaesu equipment than it was a couple of years ago. This is a good sign, and we'll certainly be able to note the results when we do a report on the new FT-901, after sufficient time has passed for enough of them to be in use to obtain a fair sample of owner opinion.

#### What would you like?

It would seem, based upon a look at the panel and instruction book, that a modern rig like the Yaesu would have all the features one would need. However, almost everyone came up with something additional that they

would like on theirs. One item that showed up very often in the reports was selectable/adjustable filters for SSB and CW, or some form of variable bandwidth in the i-f. Another popular "wanted" feature was passband tuning. Also, better control of AGC was listed, either in variable form or switchable. Capability for other modes was a popular request, including FSK, RTTY, and fm. Also mentioned was either a built-in speech processor, or room to add one internally if desired. Metering got some attention, with requests for separate metering, metering of the primary supply voltage, and SWR metering. Other features/accessories mentioned were: change slide switches to toggle type, dual VFO, solid-state switching/totally solid-state design, 6146s for finals, fan on/off switch, better placement of controls for VOX/sidetone, audio filter, built-in keyer, notch filter, calibrated RIT, balanced mixers, more sensitive/selective receiver, and better warranty/service policy.

#### Would you buy it again?

Question 23 is the one that summarizes all the pros and cons about the FT-101s, and is a measure of content or discontent. The answers stack up like this:

Yes = 77.1 per cent  
 No = 11.8 per cent  
 Maybe = 11.1 per cent

That's an impressive percentage indicating that they would go for the same rig again, and among those who would not, some of the comments were:

"No, because of poor factory/customer relation." — WB2MWQ.

"Technology has bypassed it." — N3DF.

"Would buy same make in solid-state." — KA2BUF.

"Probably not — not because it's bad, but because there are better rigs out now." — KQ4H.

"Probably the upgraded version." — W1HRC. There were a couple of comments couched in much stronger





The International Fox-Tango Club is an association of individuals who own or have an interest in Amateur Radio equipment manufactured by Yaesu Musen Co., Ltd. of Tokyo. Since its members are scattered throughout the world, a conventional club organization is impractical. Accordingly, the Club holds no meetings; elects no officers. Its sole purpose is to enhance the effectiveness of its members' equipment by providing a medium for the cooperative exchange of information. The Club was organized in 1971 by Milton Lowens, WA2AOQ (now N4ML); the first issue of the FT Newsletter appeared in January, 1972. Although most information published the first year related primarily to the FT-101, the Newsletter subsequently has included material of importance to those interested in other models. However, since most of the items published are obtained from members, the amount of information applying to any one model will usually be proportional to its worldwide popularity and distribution.

The FT Newsletter is the principal medium of exchange of information between members. Ten issues (excluding July and December) are published each year. Contents of each issue (usually six pages of photographically reduced typewritten copy) vary from month to month — most contain a variety of items which may include modifications, improvements, service notes from the manufacturer or his agents in various parts of the world, schematic and pictorial diagrams, suggested operating procedures, troubleshooting techniques, reviews of new and supplementary equipment, announcements, and other information not readily available (if at all) from other sources.

The Fox-Tango Net has been recently established to expedite the more timely exchange of information between Club members, as well as the Amateur fraternity generally. It is not necessary to be a club member or to own Yaesu equipment to participate in the net. The Fox-Tango Net meets each Saturday at 1700Z on 14,325 kHz to seek to answer questions, make announcements, etc. All Amateurs are welcome to participate whether Yaesu owners or Club members or not.

Membership at the close of 1979 numbered about 4100 licensed Amateurs in 43 countries. Basic dues are \$7 per year plus surcharges for non-domestic mail.

For more information, write International Fox-Tango Club, 248 Lake Dora Drive, West Palm Beach, Florida 33411.

language, but the owners didn't want their statements used! So be it.

#### Where do they come from?

A count of the answers to question 3 (Where did you buy it?), shows the following:

Dealer	= 61.9 per cent
Mail order	= 11.0 per cent
Individual	= 14.7 per cent
Flea Market	= 2.2 per cent
800 Number	= 8.7 per cent
Other	= 1.5 per cent

Looking at the next question, "Would you buy from the same source again?" reveals:

Yes	= 88.8 per cent
No	= 11.2 per cent

As noted earlier, this certainly does not indicate any widespread dissatisfaction with the rig, or with the dealers who sell and service them, in spite of criticism sometimes heard. This is reinforced when you consider that 43.7 per cent of the owners said that their rigs required service, and 61.6 per cent reported problems of one sort or another.

The next owners' report summary will be on the Ten-Tec Triton, and the stack of replies is impressive and still being analyzed at this writing. Watch for it in an early issue, and there likely will be another survey form with a new selection of rigs to report on in the same one.

Oh, yes, one last comment — we're still receiving reports from the first survey, on the Drake Twins. Sorry, but there is no way we can backtrack. Comments that arrive after the deadline listed on the bottom of the form will not change the outcome of the report in any way.

To all of you who took the time to fill out the forms and send them in on time, a sincere thank you. You are doing a great service for your fellow ham by telling him what you think of your rig, and by telling the manufacturer how well his design fares in the marketplace and on the air. These summaries may not be as scientifically precise as a lab-test type of report, but they convey the voice of the customer, which, in the long run, is more important. You can get all sorts of technical data from the specification sheets and instruction manuals, but it is the interface between the rig and you that determines whether you are happy with it or not.

HRH



Call or Write for Delivery or Quote

# KENWOOD R-1000



LEAVE A MESSAGE & WE'LL CALL YOU BACK!

MASTERCARD • VISA

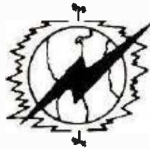

# MADISON

Electronics Supply, Inc.

1508 McKinney • Houston, Texas 77002 • (713) 658-0268

# ANTENNAS

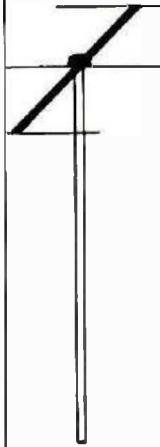

## THE RADIO AMATEUR ANTENNA HANDBOOK by William I. Orr, W6SAI and Stuart Cowan, W2LX

If you are pondering what new antennas to put up, we recommend you read this very popular book. It contains lots of well illustrated construction projects for vertical, long wire, and HF/VHF beam antennas. But, you'll also get information not usually found in antenna books. There is an honest judgment of antenna gain figures, information on the best and worst antenna locations and heights, a long look at the quad vs. the yagi antenna, information on baluns and how to use them, and some new information on the increasingly popular Sloper and Delta Loop antennas. The text is based on proven data plus practical, on-the-air experience. We don't expect you'll agree with everything Orr and Cowan have to say, but we are convinced that **The Radio Amateur Antenna Handbook** will make a valuable and often consulted addition to any Ham's library. 190 pages. ©1978.

□ RP-AH

Softbound \$6.95

## SIMPLE LOW-COST WIRE ANTENNAS

Learn how to build simple, economical wire antennas. Even if you don't know a feedline from a feed-through, W6SAI will get you on the air with an effective low-cost wire antenna. And, apartment dwellers take note! Fool your landlord and your neighbors with some of the "invisible" antennas found here. For the old-timer as well as the beginner, it's a clearly written, well diagrammed, and even humorous antenna book. 192 pages. ©1972.

□ RP-WA

Softbound \$5.95

Two exciting antenna books from Ham Radio's Bookstore. Call or write today.

Please add \$1.00 to cover shipping and handling.

## HAM RADIO'S BOOKSTORE

GREENVILLE, N. H. 03048

CALL TOLL FREE 1 (800) 258-5353

# Upgrade Your CW Easily

DATONG



### Model D70 MORSE TUTOR

- Produces random five character groups: all letters, all figures, or mixed.
- Calibrated variable speed (6½ to 37 words per minute) and variable delay (up to 3 seconds) between letters for optimum learning efficiency.
- Internal loudspeaker, plus personal ear piece for private listening. And pocket size.
- Battery operated therefore always ready for use. Current drain is very low for long battery life.
- Eleven IC, CMOS circuit for long internal battery life.
- Built-in tone oscillator for sending practice (key required).

**\$159.95** Including Pre-Paid Shipping & Full Insurance

Dealer Inquiries Invited  
Made in England • 90 Day Warranty  
Visa-Mastercharge Accepted

(Exclusive Importers of DATONG FL 1's)

**AR** Technical Products Corp. Dedicated to Excellence

Box 62  
Birmingham, Michigan 48012  
Telephone 313/644-5698

# EAVESDROPPER SWL ANTENNA!

Your ear to the world of Short Wave Listening...

RADIO ANGOLA  
RADIO MOSCOW  
VOA  
RADIO FREE EUROPE  
Deutsche Welle  
BBC  
Tokyo Calling

49, 41, 31 25 19 16 and 13 meters All the world's shortwave broadcast bands are yours with Antenna Supermarket's trap-tuned "Eavesdropper" all band antenna. Individually tuned traps make the Eavesdropper perform just as if it were seven separate antennas each tuned to a different international broadcast band.

Its 100-foot long 72-ohm balanced feedline provides an exact match to the antenna on every band assuring that the maximum signal possible gets to your receiver's antenna terminals while cancelling out noise picked up by the feedline.

The Eavesdropper comes completely assembled and ready to install with 50 feet of 450 pound test nylon rope. The Eavesdropper itself is 45' 10" long, made of tough #16 copper-clad steel wire to insure it'll survive those severe winter storms that bring down lesser antennas.

**BRING THE WORLD TO YOUR EARS...**

**ORDER YOUR EAVESDROPPER TODAY!**

Only \$54.40, plus \$2.50 UPS (U.S.A.), from your favorite dealer or direct

**ANTENNA SUPERMARKET** Box 563, Palatine, IL 60067 (312) 359-7092

call or send QSL today for our complete catalog

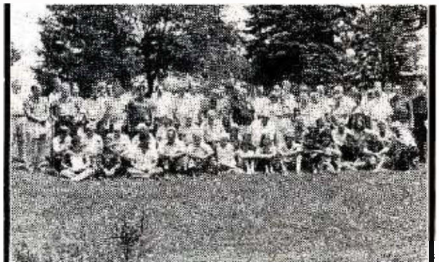

**July 26 thru August 8, 1980**

Our 21st year of successful teaching

**Boost your Ham Skills on the Blue Ridge**

**"A Vacation with a Purpose"**

Two weeks saturation learning program in Amateur Radio:

- Novice to General
- General or Technician to Advanced
- Advanced to Amateur Extra

Expert Instruction starting at your level. Code and Theory in depth along with Friendly Amateurs, Who Care About You.

C. L. PETERS, K4DNJ, Director  
Oak Hill Academy Amateur Radio Session  
Mouth of Wilson, Virginia 24363

Name \_\_\_\_\_ Call \_\_\_\_\_

Address \_\_\_\_\_

City/State/Zip \_\_\_\_\_



# Amateur Radio Equipment Survey

Here's your chance to tell the world what you think of your equipment.

BY THOMAS McMULLEN, W1SL

## It's Collins Time!

After much deliberation, and weighing the pros and cons, we've decided that the Collins 75S- series receivers, the 32S- series transmitters, as well as the KWM-2 series of transceivers, are fair game for our owners' report column.

The fact that many of these rigs have survived more than 20 years on the Amateur market is an indication of their durability and design solidarity. Also, long considered to be the "Cadillac" of Amateur gear, they still command premium prices in the bargain sheets, classified advertising sections of magazines, and at flea markets.

The later versions will still be useful



on the new bands coming out of WARC, usually with a simple addition of crystals (in the receivers), or perhaps with some modification of the transmitter tuned-circuit values. (Not that we're expecting Collins to burn the midnight oil to provide these changes — after all, they have just introduced a new rig that is designed for the era of the '80s. But, you can bet there will be several ham-designed modifications published in various journals, for the Collins rigs as well as for other makes).

So, the expectation is that these rigs will be around for some time to come. Therefore our survey will be

very useful to you who are shopping for a used rig — either to use as is, to modify, to use with converters, or as a back-up rig to supplement your other station gear. By reading these reports, you'll be able to find out what made them so popular, what the most troublesome areas were, how frequently these troubles occurred, what was done to fix them, and, in general, what many users had to say about the operation, reliability, service, and just plain fun of owning and using a Collins station.

If you'll look at the first question on the form, you'll see something different from previous ones: It's *all* Collins. In going through the list of models to be considered, it turned out that there were several variations to take into account. Rather than try to separate the early from the late, and trying to outguess the statistics on which would be the most popular (or used in the greater number of ham-shacks), we've listed the whole range. It's going to provide our bean-counters with an interesting problem in translating this into words, charts, and tables, but the results should prove very useful.

For this reason, I'd like to ask that you report on a *system*. It is conceivable that some hams have owned, at one time or another, one of each model. If you are one who has, and want to report on more than one,

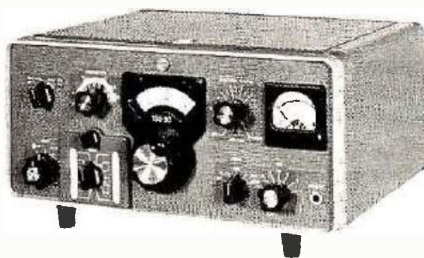

that's great — just use a separate copy of the form for each one, please.

Another way you can be helpful is if you will indicate which combination you are reporting on. If you've used (or are using) a 32S-1 transmitter with a 75S3-B receiver, or any other combination, as a system, please indicate by circling each one in Question 1. You can even draw a line linking the two together if you like.

Just remember, the more information we can extract from these reports, the better they will serve the beginner (or any other prospective buyer). If you had a 32S-1, but later upgraded to a 32S-3, for example, you should report each on a separate sheet — don't mix one rig's troubles/



good features with those of another, in other words.

Looking to the future, the number of new rigs in use, the FT901s, Omni-Ds, and the TR-7, is growing all the time, and soon there will be enough of them out there to represent a broad sample of opinion and experience. If you're interested in these, or if you are an owner, hang in there, you'll see the questionnaire for them soon.

Now, all you Collins owners, go to the top of the next page and start telling it like it is.

HRH

# Owner Report on Amateur Radio Equipment

(Fill out this form in accordance with your experience. Please type or print clearly.)

1. Make and Model (please indicate the exact unit or system you are reporting on).

32S-1  
32S-2  
32S-3  
32S-3A

75S-1  
75S-2  
75S-3  
75S-3A  
75S-3B  
75S-3C

KWM-2  
KWM-2A

2. What year did you buy it? \_\_\_\_\_ New? \_\_\_\_\_ Used? \_\_\_\_\_

3. Where did you buy it? Dealer \_\_\_\_\_ Mail Order \_\_\_\_\_ Individual \_\_\_\_\_ Flea Market \_\_\_\_\_  
800 Number \_\_\_\_\_ Other \_\_\_\_\_

4. Would you buy from the same source again? \_\_\_\_\_

5. Amount of use: Daily \_\_\_\_\_ Often \_\_\_\_\_ Occasional \_\_\_\_\_ Seldom \_\_\_\_\_

6. Is this your primary \_\_\_\_\_ or backup \_\_\_\_\_ rig?

7. What modes have you used? CW \_\_\_\_\_ SSB \_\_\_\_\_ RTTY \_\_\_\_\_ SSTV \_\_\_\_\_ AM \_\_\_\_\_ Other \_\_\_\_\_

8. What is the rig's best feature? \_\_\_\_\_

9. Worst feature? \_\_\_\_\_

10. Have you had any problems? \_\_\_\_\_ Explain \_\_\_\_\_

11. Have you had the rig serviced? \_\_\_\_\_ Where? Manufacturer \_\_\_\_\_ Dealer \_\_\_\_\_ Other \_\_\_\_\_

12. Was the service satisfactory? Yes \_\_\_\_\_ No \_\_\_\_\_

13. What accessories have you purchased for this rig? \_\_\_\_\_

14. Have you been able to obtain all the accessories and parts you need? \_\_\_\_\_

15. Have you been satisfied with these accessories? Yes \_\_\_\_\_ No \_\_\_\_\_

16. If not, why? \_\_\_\_\_



17. Additional features you would like to see built into a rig of this type \_\_\_\_\_  
\_\_\_\_\_  
\_\_\_\_\_

18. Give the equipment a score from 1 to 10 (with 1 being poorest, 4 to 6 average, and 10 perfect).

Ease of operation \_\_\_\_\_

Reliability \_\_\_\_\_

Durability  
(in continuous use) \_\_\_\_\_

Instruction Book \_\_\_\_\_

Factory/Dealer Service \_\_\_\_\_

Quality of Workmanship \_\_\_\_\_

Performance \_\_\_\_\_

Maintenance \_\_\_\_\_

Parts Availability \_\_\_\_\_

Accessories  
(ease of connection) \_\_\_\_\_

Price \_\_\_\_\_

Flexibility \_\_\_\_\_



19. How long have you been licensed? \_\_\_\_\_ Your Age \_\_\_\_\_ License Class \_\_\_\_\_

Principal activities: Contest \_\_\_\_\_ DX \_\_\_\_\_ Rag Chewing \_\_\_\_\_

Traffic Handling \_\_\_\_\_ Experimenter \_\_\_\_\_

20. What antenna do you use most? Beam \_\_\_\_\_ Wire \_\_\_\_\_ Other \_\_\_\_\_

21. What rig would you like to see reported on in the future? \_\_\_\_\_

22. Would you buy this same rig again? \_\_\_\_\_

23. (Optional: fill in the following only if you wish.)

Submitted by: Name \_\_\_\_\_ Call \_\_\_\_\_

Address \_\_\_\_\_

City \_\_\_\_\_ State \_\_\_\_\_ Zip \_\_\_\_\_

\_\_\_\_\_  
(Signature)

(Your signature authorizes Ham Radio Horizons to quote portions of your comments in our report.) May we use your name and/or call?

Yes \_\_\_\_\_ No \_\_\_\_\_

Note: If you own more than one of the rigs indicated, please use a separate form for a report on each rig.

Completed survey forms must be returned no later than May 30, 1980, to be included in our report.

Mail To: Ham Radio Horizons, User's Report No. 3, Greenville, NH 03048

# FCC STUDY GUIDE

## Study Guide for Amateur Radio License Examinations

We're very happy to present, on the following pages, the complete text of the FCC Study Guide for all classes of Amateur License. This is FCC Bulletin 1035, dated January, 1980. You should use this material to find areas of study in each subject listed under the class of license you are trying for.

Note that the FCC lists two publications available from the Government Printing Office. Previously issued license-study manuals will still be helpful, but you'll have to do considerable interpreting to be sure that the subjects mentioned in this syllabus are thoroughly covered in those books.

As this goes to press, we've just learned of an electronics textbook that has been specifically revised to include study material listed in this FCC bulletin. It is *Electronic Communication*, by Robert L. Shrader, published by McGraw-Hill Book Company. This book is one of the best all-around electronic texts we've seen, and the inclusion of new material for the Amateur licenses can only make it more useful. This new fourth edition should be available soon after you read this, so watch for advertisements or write to Ham Radio's Bookstore for availability and price.

**Special announcement:** Next month, an interview with FCC's Jay Jackson about the new syllabus and exams.

---

*This Bulletin contains syllabi for the FCC amateur radio examinations.*

### Why Are Amateur Radio Operator Examinations Required?

The examinations determine if you are qualified for the privileges conveyed by an amateur radio license. Those privileges are many and diverse. As an amateur radio operator, you will be allowed to build, repair, and modify your radio transmitters. You will be responsible for the technical quality of your station's transmissions. You will be allowed to communicate with amateur radio operators in other countries around the world and, in some cases, send messages for friends. As you upgrade to the higher operator license classes, you will be allowed to communicate using not only telegraphy and voice, but also teleprinting, facsimile, and several forms of television. For such a flexible radio service to be practical, you and every other amateur radio operator must thoroughly understand your responsibilities and develop the skills needed to operate your amateur radio station properly.

### What Subjects Do The Amateur Radio Examinations Cover?

The examinations cover the rules, practices, procedures, and technical material that you will need to know in order to operate your amateur radio station properly. Each examination element is composed of questions which will determine whether you have an adequate understanding of the topics listed in the corresponding syllabus. For example, all Element 3 examination questions are derived from the Element 3 syllabus, which appears later in this Bulletin. To properly prepare for an examination, you should become knowledgeable about all of the topics in the syllabus for the element you will be taking. Every examination covers nine general subjects:

- Rules and Regulations
- Electrical Principles
- Signals and Emissions
- Circuit Components
- Practical Circuits
- Operating Procedures
- Antennas and Feedlines
- Radio Wave Propagation
- Amateur Radio Practice

Periodically, the syllabi are updated to reflect changing technology and amateur radio practices. Comments on the study guide contents are welcome. Mail them to:

Personal Radio Branch  
Federal Communications Commission  
Washington, D.C. 20554

### Where Can Study Manuals Be Obtained?

A study manual can be helpful in preparing for an examination. Several publishers offer manuals or courses based upon the material in this Bulletin. These may be found in many public libraries and radio stores. The FCC does not offer such manuals, nor recommend any specific publisher. However, you will find two FCC publications, *Part 97 — Rules and Regulations for the Amateur Radio Service* and *How to Identify and Resolve Radio-TV Interference Problems*, useful when preparing for the amateur radio examinations. Copies are sold by the Superintendent of Documents, U.S. Government Printing office, Washington, D.C. 20402. Specify stock number 004-000-00357-8 for Part 97 and stock number 004-000-00345-4 for the Radio-TV interference booklet.



# STUDY TOPICS FOR THE NOVICE CLASS AMATEUR RADIO OPERATOR LICENSE EXAMINATION

(Element 2 Syllabus)

## A. RULES AND REGULATIONS

### Define:

- (1) Amateur radio service 97.3(a)
- (2) Amateur radio operator 97.3(c)
- (3) Amateur radio station 97.3(e)
- (4) Amateur radio communications 97.3(b)
- (5) Operator license 97.3(d)
- (6) Station license 97.3(d)
- (7) Control operator 97.3(o)
- (8) Third party traffic 97.3(v)

### Novice Class Operator Privileges:

- (9) Authorized frequency bands 97.7(e)
- (10) Authorized emission (A1) 97.7(e)

### Prohibited Practices:

- (11) Unidentified communications 97.123
- (12) Intentional interference 97.125
- (13) False signals 97.121
- (14) Communication for hire 97.112(a)

### Basis and Purpose of the Amateur Radio Service Rules and Regulations:

- (15) To recognize and enhance the value of the amateur radio service to the public as a voluntary, non-commercial communication service, particularly with respect to providing emergency communications. 97.1(a)
- (16) To continue and extend the amateur radio operators' proven ability to contribute to the advancement of the radio art. 97.1(b)
- (17) To encourage and improve the amateur radio service by providing for advancing skills in both the communication and technical phases. 97.1(c)
- (18) To expand the existing reservoir within the amateur radio service of trained operators, technicians, and electronics experts. 97.1(d)
- (19) To continue and extend the radio amateurs' unique ability to enhance international good will. 97.1(e)

### Operating Rules:

- (20) U.S. amateur radio station call signs 2.302 and FCC Public Notice
- (21) Permissible points of communications 97.89(a)(1)
- (22) Station logbook, logging requirements 97.103(a), (b); 97.105
- (23) Station identification 97.84(a)
- (24) Novice band transmitter power limitation 97.67(b), (d)
- (25) Necessary procedure in response to an official notice of violation 97.137
- (26) Control operator requirements 97.79(a), (b)

## B. OPERATING PROCEDURES

- (1) R-S-T signal reporting system
- (2) Choice of telegraphy speed
- (3) Zero-beating received signal
- (4) Transmitter tune-up procedure
- (5) Use of common and internationally recognized telegraphy abbreviations, including: CQ, DE, K, SK, R, AR, 73, QRS, QRZ, QTH, QSL, QRM, QRN

## C. RADIO WAVE PROPAGATION

- (1) Sky wave; "skip"
- (2) Ground wave

## D. AMATEUR RADIO PRACTICE

- (1) Measures to prevent use of amateur radio station equipment by unauthorized persons

### Safety Precautions:

- (2) Lightning protection for antenna system
- (3) Ground system
- (4) Antenna installation safety procedures

### Electromagnetic compatibility — identify and suggest cure:

- (5) Overload of consumer electronic products by strong radio frequency fields
- (6) Interference to consumer electronic products caused by radiated harmonics

### Interpretation of S.W.R. readings as related to faults in antenna system:

- (7) Acceptable readings
- (8) Possible causes of unacceptable readings

## E. ELECTRICAL PRINCIPLES

### Concepts:

- (1) Voltage
- (2) Alternating current, direct current
- (3) Conductor, insulator
- (4) Open circuit, short circuit
- (5) Energy, power
- (6) Frequency, wavelength
- (7) Radio frequency
- (8) Audio frequency

### Electrical Units:

- (9) Volt
- (10) Ampere
- (11) Watt
- (12) Hertz
- (13) Metric prefixes, mega, kilo, centi, milli, micro, pico

## F. CIRCUIT COMPONENTS

### Physical appearance, applications, and schematic symbols of:

- (1) Quartz crystals
- (2) Meters (D'Arsonval movement)

- (3) Vacuum tubes
- (4) Fuses

## G. PRACTICAL CIRCUITS

### Block Diagrams:

- (1) The stages in a simple telegraphy (A1) transmitter
- (2) The stages in a simple receiver capable of telegraphy (A1) reception
- (3) The functional layout of novice station equipment, including transmitter, receiver, antenna switching, antenna feedline, antenna, and telegraph key

## H. SIGNALS AND EMISSIONS

- (1) Emission type A1

### Cause and cure:

- (2) Backwave
- (3) Key clicks
- (4) Chirp
- (5) Superimposed hum
- (6) Undesirable harmonic emissions
- (7) Spurious emissions

## I. ANTENNAS AND FEEDLINES

Necessary physical dimensions of these popular high frequency antennas for resonance on amateur radio frequencies:

- (1) A half-wave dipole
- (2) A quarter-wave vertical

Common types of feedlines used at amateur radio stations

- (3) Coaxial cable
- (4) Parallel conductor line

## STUDY TOPICS FOR THE TECHNICIAN/GENERAL CLASS AMATEUR RADIO OPERATOR LICENSE EXAMINATION

(Element 3 Syllabus)

### A. RULES AND REGULATIONS

- (1) Control point 97.3(p)
- (2) Emergency communications 97.3(w); 97.107
- (3) Amateur radio transmitter power limitations 97.67
- (4) Station identification requirements 97.84(b), (f), (g); 97.79(c)
- (5) Third party participation in amateur radio communications 97.79(d)
- (6) Domestic and international third party traffic 97.114; Appendix 2, Art. 41, Sec. 2
- (7) Permissible one-way transmissions 97.91
- (8) Frequency bands available to the technician class 97.7(d)
- (9) Frequency bands available to the general class 97.7(b)
- (10) Limitations on use of amateur radio frequencies 97.61

- (11) Selection and use of frequencies 97.63
- (12) Radio controlled model crafts and vehicles 97.65(a); 97.99
- (13) Radioteleprinter emissions 97.69

### Prohibited practices:

- (14) Broadcasting 97.113
- (15) Music 97.115
- (16) Codes and ciphers 97.117
- (17) Obscenity, indecency, profanity 97.119

## B. OPERATING PROCEDURES

- (1) Radiotelephony
- (2) Radio teleprinting
- (3) Use of repeaters
- (4) Vox transmitter control
- (5) Full break-in telegraphy
- (6) Operating courtesies
- (7) Antenna orientation
- (8) International communication
- (9) Emergency preparedness drills

## C. RADIO WAVE PROPAGATION

- (1) Ionospheric layers; D, E, F1, F2
- (2) Absorption
- (3) Maximum usable frequency
- (4) Regular daily variations
- (5) Sudden ionospheric disturbance
- (6) Scatter
- (7) Sunspot cycle
- (8) Line-of-sight
- (9) Ducting, tropospheric bending

## D. AMATEUR RADIO PRACTICE

### Safety precautions:

- (1) Household ac supply and electrical wiring safety
- (2) Dangerous voltages in equipment made inaccessible to accidental contact

### Transmitter performance:

- (3) Two tone test
- (4) Neutralizing final amplifier
- (5) Power measurement

### Use of test equipment:

- (6) Oscilloscope
- (7) Multimeter
- (8) Signal generators
- (9) Signal tracer

### Electromagnetic compatibility; identify and suggest cure:

- (10) Disturbance in consumer electronic products caused by audio rectification

### Proper use of the following station components and accessories:

- (11) Reflectometer (VSWR meter)
- (12) Speech processor — RF and AF
- (13) Electronic T-R switch
- (14) Antenna tuning unit; matching network
- (15) Monitoring oscilloscope



- (16) Non-radiating load; "dummy antenna"
- (17) Field strength meter; S-meter
- (18) Wattmeter

### E. ELECTRICAL PRINCIPLES

#### Concepts:

- (1) Impedance
- (2) Resistance
- (3) Reactance
- (4) Inductance
- (5) Capacitance
- (6) Impedance matching

#### Electrical units:

- (7) Ohm
- (8) Microfarad, picofarad
- (9) Henry, millihenry, microhenry
- (10) Decibel

#### Mathematical relationships:

- (11) Ohm's law
- (12) Current and voltage dividers
- (13) Electrical power calculations
- (14) Series and parallel combinations; of resistors, of capacitors, of inductors
- (15) Turns ratio; voltage, current, and impedance transformation
- (16) Root mean square value of a sine wave alternating current

### F. CIRCUIT COMPONENTS

#### Physical appearance, types, characteristics, applications, and schematic symbols for:

- (1) Resistors
- (2) Capacitors
- (3) Inductors
- (4) Transformers
- (5) Power supply type diode rectifiers

### G. PRACTICAL CIRCUITS

- (1) Power supplies
- (2) High-pass, low-pass, and band-pass filters
- (3) Block diagrams showing the stages in complete am, ssb, and fm transmitters and receivers

### H. SIGNALS AND EMISSIONS

- (1) Emission types A0, A3, F1, F2, F3
- (2) Signal; information
- (3) Amplitude modulation
- (4) Double sideband
- (5) Single sideband
- (6) Frequency modulation
- (7) Phase modulation
- (8) Carrier
- (9) Sidebands.
- (10) Bandwidth
- (11) Envelope
- (12) Deviation
- (13) Overmodulation
- (14) Splatter

- (15) Frequency translation; mixing, multiplication
- (16) Radioteleprinting; audio frequency shift keying, mark, space, shift

### I. ANTENNAS AND FEEDLINES

#### Popular amateur radio antennas and their characteristics:

- (1) Yagi antenna
- (2) Quad antenna
- (3) Physical dimensions
- (4) Vertical and horizontal polarization
- (5) Feedpoint impedance of half-wave dipole, quarter wave vertical
- (6) Radiation patterns; directivity, major lobes

#### Characteristics of popular amateur radio antenna feedlines; related concepts:

- (7) Characteristic impedance
- (8) Standing waves
- (9) Standing wave ratio; significance of
- (10) Balanced, unbalanced
- (11) Attenuation
- (12) Antenna-feedline mismatch

## STUDY TOPICS FOR THE ADVANCED CLASS AMATEUR RADIO OPERATOR LICENSE EXAMINATION

(Element 4A Syllabus)

### A. RULES AND REGULATIONS

- (1) Frequency bands available to the advanced class amateur radio operator and limitations on use 97.7(a); 97.61
- (2) Automatic retransmission of amateur radio signals and signals from other radio services 97.3(x); 97.113; 97.126
- (3) Amateur radio stations in repeater operation 97.3(1); 97.85; 97.61(c)
- (4) Amateur radio stations in auxiliary operation 97.3(1); 97.86; 97.61(d)
- (5) Remote control of amateur radio stations 97.3(m)(2); 97.88
- (6) Automatic control of amateur radio stations 97.3(m)(3)
- (7) Control link 97.3(n)
- (8) System network diagram 97.3(u)
- (9) Station identification 97.84(c), (d), (e)
- (10) Station log requirements 97.103(c), (d), (e), (f), (g)
- (11) Height limitations for amateur radio station antenna structures, including FAA notification criteria, and calculation of height above average terrain 97.45; 97.67(c); Appendix 5

### B. OPERATING PROCEDURES

- (1) Facsimile transmission
- (2) Slow-scan television transmission

## C. RADIO WAVE PROPAGATION

- (1) Sporadic-E
- (2) Selective fading
- (3) Auroral propagation
- (4) Radio-path horizon

## D. AMATEUR RADIO PRACTICE

### Use of test equipment:

- (1) Frequency measurement devices
- (2) Grid-dip meter; solid state dip meter
- (3) Performance limitations of oscilloscopes, meters, frequency counters; accuracy, frequency response, stability

### Electromagnetic compatibility:

- (4) Intermodulation interference
- (5) Receiver desensitizing
- (6) Cross modulation interference
- (7) Capture effect

## E. ELECTRICAL PRINCIPLES

### Concepts:

- (1) Reactive power
- (2) Series and parallel resonance
- (3) Skin effect
- (4) Fields, energy storage, electrostatic, electromagnetic

### Mathematical relationships:

- (5) Resonant frequency, bandwidth, and "Q" of R-L-C circuits, given component values
- (6) Phase angle between voltage and current, given resistance and reactance
- (7) Power factor, given phase angle
- (8) Effective radiated power, given system gains and losses
- (9) Replacement of voltage source and resistive voltage divider with equivalent circuit consisting of a voltage source and one resistor (an application of Thevenin's theorem, used to predict the current supplied by a voltage divider to a known load)

## F. CIRCUIT COMPONENTS

### Physical appearance, types, characteristics, applications, and schematic symbols for the following:

- (1) Diodes; zener, tunnel, varactor, hot-carrier, junction, point contact, pin
- (2) Transistors; NPN, PNP, junction, unijunction, power, germanium, silicon
- (3) Silicon controlled rectifier, triac
- (4) Light emitting diode, neon lamp
- (5) Crystal lattice ssb filters

## G. PRACTICAL CIRCUITS

- (1) Voltage regulator circuits; discrete and integrated
- (2) Amplifiers; Class A, AB, B, C; characteristics of each type
- (3) Impedance matching networks; PI, L, PI-L
- (4) Filters; constant K, M-derived, band-stop, notch,

modern-network-theory, pi-section, T-section, L-section (not necessary to memorize design equations; know general description, characteristics, responses, and applications of these filters)

- (5) Oscillators; various types and their applications; stability

### Transmitter and receiver circuits — know purpose of each, and how, basically, each functions:

- (6) Modulators; am, fm, balanced
- (7) Transmitter final amplifiers
- (8) Detectors, mixer stages
- (9) RF and IF amplifier stages

### Calculation of voltages, currents, and power in common amateur radio oriented circuits:

- (10) Common emitter class A transistor amplifier; bias network, signal gain, input and output impedances
- (11) Common collector class A transistor amplifier; bias network, signal gain, input and output impedances

### Circuit design; selection of circuit component values:

- (12) Voltage regulator with pass transistor and zener diode to produce given output voltage
- (13) Select coil and capacitor to resonate at given frequency

## H. SIGNALS AND EMISSIONS

- (1) Emission types A4, A5, F4, F5
- (2) Modulation methods
- (3) Deviation ratio
- (4) Modulation index
- (5) Electromagnetic radiation
- (6) Wave polarization
- (7) Sine, square, sawtooth waveforms
- (8) Root mean square value
- (9) Peak envelope power relative to average
- (10) Signal to noise ratio

## I. ANTENNAS AND FEEDLINES

- (1) Antenna gain, beamwidth
- (2) Trap antennas
- (3) Parasitic elements
- (4) Radiation resistance
- (5) Driven elements
- (6) Efficiency of antenna
- (7) Folded, multiple wire dipoles
- (8) Velocity factor
- (9) Electrical length of a feedline
- (10) Voltage and current nodes
- (11) Mobile antennas
- (12) Loading coil; base, center, top

## STUDY TOPICS FOR THE AMATEUR EXTRA CLASS AMATEUR RADIO OPERATOR LICENSE EXAMINATION

(Element 4B Syllabus)

## A. RULES AND REGULATIONS



- (1) Frequency bands available to the U.S. amateur radio operator and limitations on their use including variations for regions 1 and 3 97.61; 97.95
- (2) Space amateur radio stations 97.3(i)
- (3) Purity of emissions 97.73
- (4) Mobile operation aboard ships or aircraft 97.101
- (5) Races operation Part 97, Subpart F
- (6) Points of communications 97.89

### B. OPERATING PROCEDURES

- (1) Use of amateur radio satellite
- (2) Amateur fast-scan television

### C. RADIO WAVE PROPAGATION

- (1) EME; "moonbounce"
- (2) Meteor burst
- (3) Trans-equatorial

### D. AMATEUR RADIO PRACTICE

#### Use of test equipment:

- (1) Spectrum analyzer; interpret display; display of transmitter output spectrum, such as commonly found in new product review articles in amateur radio magazines
- (2) Logic probe; indication of high or low state, pulsing state

#### Electromagnetic compatibility:

- (3) Vehicle noise suppression; ignition noise, alternator whine, static
- (4) Direction finding techniques; methods for location of source of radio signals

### E. ELECTRICAL PRINCIPLES

#### Concepts:

- (1) Photoconductive effect
- (2) Exponential charge/discharge

#### Mathematical relationships; calculations:

- (3) Time constant for R-C and R-L circuits (including circuits with more than one resistor, capacitor or inductor)
- (4) Impedance diagrams; basic principles of Smith chart
- (5) Impedance of R-L-C networks at a specified frequency
- (6) Algebraic operations using complex numbers; real, imaginary, magnitude, angle

### F. CIRCUIT COMPONENTS

#### Physical appearance, types, characteristics, applications, and schematic symbols for:

- (1) Field effect transistors; enhancement, depletion, MOS, CMOS, N-channel, P-channel
- (2) Operational amplifier and phase-locked loop integrated circuits
- (3) 7400 series TTL digital integrated circuits
- (4) 4000 series CMOS digital integrated circuits
- (5) Vidicon; cathode ray tube

### G. PRACTICAL CIRCUITS

- (1) Digital logic circuits; flip-flop, multivibrator, and/or/nand/nor/gates
- (2) Digital frequency divider circuits; crystal marker, counters
- (3) Active audio filters using integrated operational amplifiers

#### High performance receiver characteristics

- (4) Noise figure, sensitivity
- (5) Selectivity
- (6) Dynamic range

#### Calculation of voltages, currents, and power in common amateur radio oriented circuits:

- (7) Integrated operational amplifier; voltage gain, frequency response
- (8) F.E.T. common source amplifier; input impedance

#### Circuit design; selection of circuit component values:

- (9) L-C preselector with fixed and variable capacitors to tune a given frequency range
- (10) Single stage amplifier to have desired frequency response by proper selection of bypass and coupling capacitors

### H. SIGNALS AND EMISSIONS

- (1) Pulse modulation; position, width
- (2) Digital signals
- (3) Narrow band voice modulation
- (4) Information rate vs. bandwidth
- (5) Peak amplitude of a signal
- (6) Peak-to-peak values of a signal

### I. ANTENNAS AND FEEDLINES

- (1) Antennas for space radio communications; gain, beamwidth, tracking
- (2) Isotropic radiator; use as a standard of comparison
- (3) Phased vertical antennas; resultant patterns, spacing in wavelengths
- (4) Rhombic antennas; advantages, disadvantages
- (5) Matching antenna to feedline; delta, gamma, stub
- (6) Properties of 1/8, 1/4, 3/8, and 1/2 wavelength sections of feedlines; shorted, open



—STUDY! STUDY! STUDY!

# PRODUCT SHOWCASE

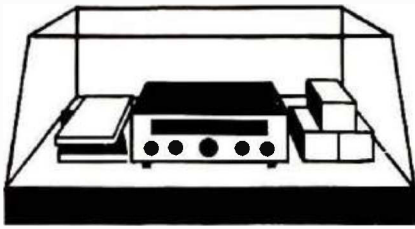

For literature on any of the Product Showcase items use our *ad-check* service on page 78.

## DenTron GLA-1000B Linear Amplifier

DenTron Radio Company has introduced an improved model of its popular GLA-1000 linear amplifier, the GLA-1000B. Featuring a tuned input circuit for consistent 50-ohm input impedance, the new unit is the smallest and most economical 1200-watt SSB (800-watt CW) linear amplifier ever offered to Amateurs.

DenTron has also added an innovation in Amateur linear amplifiers, namely a front-panel mounted antenna switch, designed to allow user selection of either a dummy load (such as a DenTron Big Dummy) or an alternate antenna system.

Additional improvements include the use of LED status indicators for standby and transmit, thus ending the need for replacement of incandescent light bulbs, and greatly enhanced tube life through design refinements.

Retained in the new GLA are the basic features of the original unit; compact size, complete metering of essential voltages, currents, and relative power output with a large back-lighted meter, easy conversion to 10



meters by a licensed Amateur, economical D-50A finals that cost less than \$40.00 to replace the full complement, a built-in power supply that is user selectable for 117 Vac or 234 Vac primary voltages, and FCC type acceptance.

The most exciting news, however, is the price, with DenTron offering the new GLA-1000B for under \$300 at suggested retail. That makes the GLA-1000B the most economical linear amplifier of the decade! The new GLA-1000B is available now from DenTron dealers worldwide. DenTron Radio Company, 1605 Commerce Drive, Stow, Ohio 44224.

## J.W. Miller Brochure

A new four-page brochure describing accessory equipment for Amateur Radio operators is now available from J.W. Miller Division Bell Industries. Included in the brochure are descriptions and technical details of SWR and power meters, rf speech processors, precision coaxial switches, and various interference filters.

Direct reading SWR, forward power, and reflected power are provided by models CN-720 and CN-620 over the 1.8-150 MHz range; model CN-630 covers 140-450 MHz.

Rf clipping that assures low distortion is provided by models RF-440 and RF-660 speech processors.

Adjacent channel isolation of better than 50 dB at 300 MHz and 45 dB at 450 MHz is provided by 2-position model CS-201 and 4-position model CS-401 coaxial switches. The broad-line of interference filters includes high pass, lowpass, audio, and ac power line filters.

For additional information, contact Jerry Hall, Operations Manager, J.W. Miller Division, Bell Industries, 19070 Reyes Avenue, Compton, California 90221.

## Fox-Tango Crystal Filters

Fox-Tango Corporation, sponsor of the 4000-member, eight-year-old International Fox-Tango Club for owners of Yaesu Amateur Radio equipment, announces the expansion of its quality line of eight-pole crystal filters and related accessories to

include not only popular models produced by Yaesu but also those of Kenwood, Heath, Drake, and Collins.

Noting that most manufacturers of Amateur Radio equipment were content to supply relatively few filters to supplement the SSB unit supplied as standard equipment, and these as extra cost options of six poles or even less, Fox-Tango decided it was time to offer the worldwide Amateur fraternity true "freedom of choice" by making available a variety of filter types and bandwidths never previously obtainable or adaptable to their rigs. For example, for its popular FT-101 line, Yaesu offered only a single 600-Hz bandwidth CW filter for direct installation, and, while a 600-Hz a-m filter could be bought, it could be used only by sacrificing the CW filter whose spot it pre-empted. Both optional Yaesu filters were of six-pole construction.



By contrast, for the same set, Fox-Tango now offers 250, 500, 600, 1800, 2400, and 6000 Hz bandwidths — all carefully designed and manufactured eight-pole units made up of specially treated Hi-Q, high-quality quartz crystals. Moreover, to compensate for the lack of space in the original design for more than one optional filter, Fox-Tango offers inexpensive diode-switching boards (both single and dual types) for most Yaesu and Kenwood models, which permit the addition of up to three filters more than those for which the manufacturer provided room. Thus owners of older models can "up-date" their sets either by the "drop-in" installation of superior filters to supplant original units, or they can supplement them by adding selectable-bandwidth filtering, often using switches already existing on front panels. All filters are



custom-made to perfectly match the sets for which they are designed, both physically and electronically, so installation is a simple matter of tightening two nuts and soldering two connections. Fox-Tango filters are guaranteed on a money-back or replacement basis, as preferred, for one year.

The following filters are currently available for the brands indicated (prices include airmail for U.S. and Canada. Elsewhere add \$3 per unit):

**Yaesu:** FT-101 (to F), FR-101, FT-301, FT-7/8, FT-901/101Z, FT-200, FT-401. Bandwidths: 250, 500, 600 (6P \$45), 1800, 2400, 6000 Hz — \$55 each.

**Kenwood:** TS520/R599, TS820/R820. Bandwidths: 250, 400, 1800, 2100 ((R820 only, \$125).

**Heath:** All but SB104. Bandwidths: 250, 400, 1800, 2100 Hz — \$55 each.

**Drake:** R-4B/C only. Broad first i-f (6 or 8 kHz BW) — \$65 each. Narrow first i-f (600 or 800 Hz BW) with relays for switching from broad to narrow i-f, for CW only — \$99 each. Very sharp second i-f (plugs in) 125 Hz — \$90 each. Product Detector Kit: converts existing units to superior double-balanced type — \$30.

**Collins:** 75S-3/B/C. For superior CW. 250 Hz bandwidth — \$125 each.

Since not every bandwidth is available for every listed model, write for detailed specifications to: Fox-Tango Corporation, Box 15944, West Palm Beach, Florida 33406; phone (305) 683-9587.

## Keyer Add-On Provides Practice and Memory

An add-on accessory provides both random code practice and message storage for the Curtis Electro Devices EK-480 series keyers. Called the IM-480, this device will automatically send Morse code in random groups, at speeds from 6 to 50 WPM. It allows variable extra spacing between letters and groups to allow slow-speed copy with letters being formed at higher speed. This feature enhances learning in the 6 to 10 WPM range. A meter display of code speed allows accurate setting.

The IM-480 also includes a message-memory function, storing four messages of approximately 32 characters each, with an automatic repeat function. The messages are programmable from the paddle key.

The IM-480 is the same size as the EK-480 — 18 × 11 × 6 cm (7 × 4½ × 2½ inches), and the two units connect via a short length of ribbon cable and plug. Use of the Curtis 8046 and 8047 LSI ICs allows the

compact packaging. The IM-480 is priced at \$179.95.

A code-practice-function-only model, called the I-480 (Instructo-Mate) is available at \$124.95. Similarly, the M-480 (Message-Mate) containing only the message storage function, is available at \$124.95.

For further information, contact Curtis Electro Devices, Inc., Box 4090, Mountain View, California 94040.

# KLAUS QUALITY AMATEUR RADIO EQUIPMENT & ACCESSORIES

## KENWOOD



TS 520 S  
HF TRANSCEIVER

TS 600  
MULTIMODE 6-M  
TRANSCEIVER

TS 820 S  
HF TRANSCEIVER

... call or write for the KLAUS price ...

## YAESU



FT-901 D  
HF TRANSCEIVER

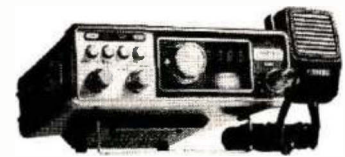

FT-227 R  
2-METER FM TRANSCEIVER

... call or write for the KLAUS price ...

## CUSHCRAFT

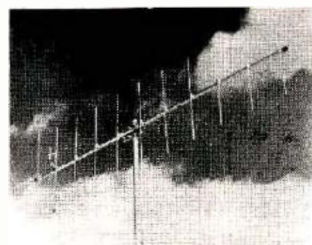

We have a complete stock of Cushcraft antennas — too many to mention in detail, so ask about our 2-meter line of verticals and beams for special low, low prices.

# KLAUS RADIO Inc.

8400 N. Pioneer Parkway, Peoria, IL 61614

Phone 309-691-4840

Tim Daily, Amateur Equipment Sales Manager

## Chemtronics Electrical-Contact Cleaner



Contact Clean® and Contact Restorer® permit rapid and effective spray servicing of switches, relays, connectors, potentiometers — virtually everything around the ham shack.

"Hams can now throw away their burnishing tools," stated Chemtronics' General Manager Louis Friedman, as he announced his company's new combination of products for contact maintenance, Contact Clean and Contact Restorer.

"Some ham gear requires contact cleaning with a solution that leaves no residue, while other contacts require a cleaner that also lubricates and prevents corrosion. Still others require both," stated Mr. Friedman, "so we have developed this unique one-two punch for contacts, to cover all situations around the ham shack."

Contact Clean, an instant, non-residue cleaner for all types of contacts, switches, and controls, is a chemically pure cleaning agent which restores electrical and mechanical continuity. It quickly penetrates surface pores, removing grease, dirt, oil, and oxidation. It is safe for painted and plated surfaces, and may even be applied while equipment is in operation, leaving contacts and mechanisms absolutely clean. It is available in a 6 ounce can which retails for a suggested \$1.39, and a 16 ounce economy size with a \$2.30 suggested retail.

Contact Restorer also cleans all types of contacts by penetrating surface pores and dissolving grease, dirt, and oxidation, and then protects sprayed surfaces against wear and corrosion by leaving a long-lasting film of high-grade lubricant. As a preventive maintenance aid, Contact Restorer will help eliminate potential failures before they occur if sprayed regularly on contacts and switches.

Both aerosols come with extension tubes for pinpoint application, and are completely safe for precious metal contacts. They are available exclusively through Chemtronics distributors. Details may be obtained by contacting Chemtronics Inc., 681 Old Willets Path, Hauppauge, New York 11787; telephone (516) 582-3322.

## AEA MorseMatic Keyer

A computerized electronic keyer is now available that combines virtually all the features of all the other keyers in the marketplace, at a price that is affordable for any true CW enthusiast.

The AEA MorseMatic uses two custom, state-of-the-art micro-computer chips to perform functions that were previously only a CW operator's fantasy.

The MorseMatic can be tailored to the user's needs. Features considered to be great by some users (such as dot and dash memory) are disliked by others. For the first time, the MorseMatic makes a keyer available that will appeal to all users because it can be tailored exactly to each operator's desires with a 16-button keypad.

For serious contest enthusiasts, the MorseMatic offers the most flexible automatic serial-number generator on the market.

For serious vhf DXers, the MorseMatic offers the exclusive automatic-beacon mode for precise moon-bounce, scatter, or tropospheric DX scheduling. To use the beacon mode, instruct the MorseMatic how long to transmit any selected message and how long to pause before the message is automatically transmitted again. The computers will automatically set the message code speed to fit the desired transmit window. The beacon mode can also be used for contest operating and for vhf beacon transmissions.

The finest message keyer available. The MorseMatic is the first to offer "soft-partitioning" of the memory, unlike the "hard partitioning" in all other keyers. Soft-partitioning means no wasted memory space. All of the memory can be allotted to one message location, or it can be divided up into as many as ten locations. The memory can be loaded in automatic mode for perfect message formatting, or it can be loaded in the real-time mode for individualizing a message. Memory can also be loaded in automatic-keyer mode (any dot and dash ratio) or in semi-auto (bug) mode. Any message can be played back with any selected dot and dash ratio. Hence, the user can send a sloppily loaded bug-mode message back with perfect 3 to 1 dash to dot ratio. Conversely, a perfectly loaded 3 to 1 dash to dot ratio message can be replayed later with as much as an 8 to 1 dash to dot ratio (sounding like a bug).

Automatic transmit-tune mode. The MorseMatic can be used to key the transmitter for tuning purposes. The operator need only hit any keypad button or the key paddle to defeat the tune mode.

Editing a memory loading mistake is a snap with the MorseMatic. If you are near the end of loading a message into memory and a mistake is made, it only takes seconds to erase the mistake and then continue with an error-free message.

All this, plus the world's best Morse trainer, is included in the basic price of the MorseMatic. It is the only trainer that will automatically increase the speed of the practice characters so that your brain is "fooled" into thinking it is still copying the starting speed. No more need to keep buying practice tapes as you start memorizing old ones, or as you progress in speed.





The MorseMatic will take you from 2 to 99 WPM. MorseMatic and Soft-Partitioning are trademarks of AEA.

Introductory Amateur net price is \$199.95. Write Advanced Electronics Applications, P.O. Box 2160, Lynnwood, Washington 98036.

## Azden PCS-2000 FM Transceiver

Amateur-Wholesale Electronics is proud to announce its superior new Azden PCS-2000 2-meter fm transceiver. The PCS-2000 covers 144-148 MHz in 5-kHz steps (800 channels). It features six memory channels, and scanning of memory or the full band in "free," "busy," and "vacant" modes. All frequency-control functions are performed by a microcomputer.

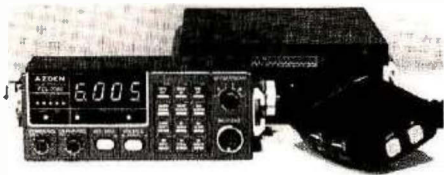

Upon inspection, the most striking feature is the absence of a large knob for frequency control. In place of a knob, there is a 12-button microcomputer control keyboard. The desired frequency is programmed into the radio digit-by-digit. Simplex, -600 kHz, or +600 kHz operation is selected by pushing a keyboard button. Using a front-panel rotary switch, three additional offsets become available: +400 kHz, +1 MHz and +1.6 MHz.

It won't take an observer long to notice that the unit comes apart into two pieces; the control head separates from the main unit. With an optional connecting cable, the two units can be located as much as 15 feet apart. This allows great flexibility for mobile and portable operation.

The microphone contains a volume and squelch control, two frequency-control buttons, and a button for instant recall of memory channel 1. By using these controls, the necessity of reaching down to the control panel while driving is greatly minimized.

The PCS-2000 has a huge 1/2-inch

# SPRING THINGS

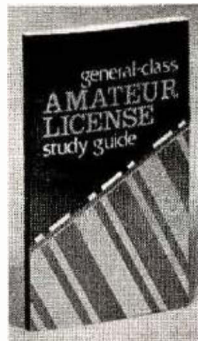
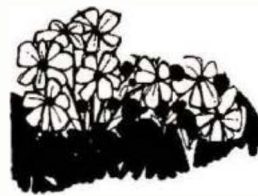

## GENERAL CLASS AMATEUR LICENSE STUDY GUIDE

by Phil Anderson, WBXI

This book was written in simple laymen's language with uncomplicated explanations and examples used to present electronic radio concepts and ideas. Throughout each chapter, questions and answers are used to strengthen your understanding of the terms and concepts presented. This book also covers several methods that can be used to improve code reception skills. The final chapter is a sample FCC exam which the author feels he would ask if he were to give the FCC exam. 160 pages. ©1979.

☐ 21617

Softbound \$6.50

## RSGB AMATEUR RADIO OPERATING MANUAL

Edited by R. J. Eckersley

Compiled by the RSGB, this exciting new book covers just about every facet of Amateur Radio. Starting with a precise description of the Amateur Service worldwide, the Amateur Radio Operating Manual leads the Amateur through the steps to setting up a station correctly, how to operate properly, DX, contests, satellites, RTTY and Slow Scan Television. You also get 5 big appendixes jam-packed with more information; call signs in use, maps, DXCC country list, time zones and international call sign assignments. 190 pages. ©1979.

☐ RS-0M

Softbound \$9.95



## RADIO PUBLICATIONS SPECTRUM CHART

Here's how to tune in the world! Organized by frequency, this big, attractive, multi-colored wall poster is a must for every ham shack. Covers 10 kHz to 30 GHz listing stations or services assigned by frequency. You also get a time chart that shows each time zone and its relation to GMT.

©1978.

☐ RP-SC

\$4.95

## ARRL WEEKEND PROJECTS VOL. 1

Edited by Marion Anderson, WB1FSB

Nobody's building much these days. For many of us, there just isn't enough time to do all the things we would like to do. Cost is another reason why we don't build that much anymore. There is a simple answer however — weekend projects. Simple and relatively inexpensive to build, these short term projects are the answer to meeting one's desire to build at least one small part of the station. *Weekend Projects* is a carefully selected anthology from the pages of QST. If you're looking for some simple, low cost fun, you'll find it in *Weekend Projects*. 64 pages. ©1979.

☐ AR-WP1

Softbound \$3.00



**No matter what the season, no matter  
what the interest, Ham Radio's Bookstore  
has something for you!**

**For Fast Service  
Call Toll Free 1 (800) 258-5353**

HAM RADIO'S BOOKSTORE • GREENVILLE, NH 03048

# Loop Antenna



Here is an exciting new device to improve your reception on 160, 80, the broadcast band, and on VLF.

It is well known that loops pick up far less noise than most other antennas. And they can null out interference. Now Palomar Engineers brings you these features and more in a compact, carefully engineered, attractive desktop package.

Unlike ordinary direction-finder loops, it tilts to match the incoming wave front. The result: Deep nulls up to 70 db. You have to listen to believe it!

Does the Loran on 160 give you a headache? The loop practically eliminates it. Broadcast station 2nd harmonic ruining your DX? Turn and tilt the loop and it's gone. Does your friend in the next block with his kilowatt block those weak ones? Use the loop and hear him fade out.

Loop nulls are very sharp on local and ground wave signals but usually are broad or nonexistent on distant skywave signals. This allows local interference to be eliminated while DX stations can still be heard from all directions.

The loops are Litz-wire wound on RF ferrite rods. They plug into the Loop Amplifier which boosts the loop signal 20 db and isolates and preserves the high Q of the loop. The tuning control peaks the loop and gives extra preselection to your receiver.

Plug-in loops are available for these bands:

- 150-550 KHz (VLF)
- 540-1600 KHz (Broadcast)
- 1600-5000 KHz (160 & 80 meters)
- 10-40 KHz (Omega)
- 40-150 KHz (WWVB, Loran)



Send for free descriptive brochure.

Loop Amplifier \$67.50; Plug-in Loop Antennas \$47.50 each [specify frequency band]. To order add \$3 packing/shipping. Calif. residents add sales tax.

LED display that makes frequency determination easy. The S/Rf meter is digital, using LEDs instead of the usual, often-troublesome mechanical movement. There are two selectable power output levels: 5 watts and 25 watts. Low power is internally adjustable from 3 to 7 watts. Frequency deviation is  $\pm 5$  kHz maximum. Azden units are significantly better than FCC specifications limiting spurious emissions.

An external speaker jack is provided on both the control head and the main unit. Optional accessories include external speaker, remote cable, desk microphone, and tone-pad microphone kit. Both the desk microphone and the tone-pad kit provide the same remote-control functions as the standard microphone. The Azden PCS-2000 is priced at \$369.00 and carries a 90-day warranty. For additional details contact Amateur-Wholesale Electronics, 8817 S.W. 129 Terrace, Miami, Florida 33176.

## Chroma Turret Systems



Chroma system turrets can be used with Hammond's Chroma rack cabinets or desks to create inclined panel surfaces. The turret components are designed so that hundreds of console configurations are possible. Rack cabinets and turrets may be ganged together to provide longer console arrangements. Full details and design assistance information are provided in Hammond's new 9R-8 catalogue. All Chroma products are now available through Hammond distributors, or write to Hammond Manufacturing Company, Limited, 394 Edinburgh Road, Guelph, Ontario, Canada N1H 1E1.

# Palomar Engineers

Box 455, Escondido, CA. 92025 • Phone: [714] 747-3343





**RATES** Regular classified is available at 50¢ per word. Display classified (1 inch deep x 2 1/4 inches wide) is \$65, or at the 12x rate is \$50. All Ad Scan payable in advance. No cash discounts or agency commissions allowed.

**HAMFESTS** Sponsored by non-profit organizations receive one free regular classified ad (subject to our editing). Repeat insertions of hamfest ads pay the standard rate.

**COPY** No special layout or arrangements available. Material should be typewritten or clearly printed (not all capitals) and must include full name and address. We reserve the right to reject unsuitable copy. *HORIZONS* cannot check each advertiser and thus cannot be held responsible for claims made. Liability for correctness of material limited to corrected ad in next available issue.

**DEADLINE** 15th of third preceding month.

**SEND MATERIAL TO:** Ad Scan, Ham Radio Horizons, Greenville, N. H. 03048.

**WANTED** — Military radios and equipment beginning with letters "SS" (example — SSTR-1); also RS-6 radio. Melton, Box 2037, Ogden, Utah 84404; (801) 394-3290.

**DISTINCTIVE QSL's** — Largest selection, lowest prices, top quality photo and completely customized cards. Make your QSL's truly unique at the same cost as a standard card, and get a better return rate! Free samples, catalogue. Stamps appreciated. Stu, K2RPZ, Box 412, Rocky Point, NY 11778, (516) 744-6260.

**CB CONVERSIONS TO 10 METERS** by the pros. Guaranteed, reasonable. Your rig or ours. AM/SSB/or CW. Certified Communications, 4138 South Ferris, Fremont, Michigan 49412. (616) 924-4561.

**VERTICAL USERS:** Which installation is best — ground, roof, or pole mount? Our non-technical, detailed, and copyrighted report explains. We've compared them on five bands. \$5. Allow three weeks. Danrick Enterprises, 213 Dayton Avenue, Clifton, New Jersey 07011.

**MAKE CODE EASY!** Supplement your code program with a self-improvement hypnosis cassette. Tape #3, Learning the Code; Tape #4, Breaking the Speed Barrier. Send \$10.95 each to The John Wolf Self Hypnosis Center, P.O. Box 497, Hayden Lake, Idaho 83835.

**NOVICES:** Improve your skill with eight important operating aids on one 11" x 17" sheet; CW abbreviations, Q-signals, punctuation, U.T.C. conversion and more. \$2. postpaid. WDSKFN, Box 1296, Albany, TX 76430.

**HAM STATIONERY.** Your name/call/QTH, typeset and printed on bond paper. 100-\$12.00, 200-\$15.00, 500-\$20.00. Joseph Francis, Box 1521-H, Staten Island, NY 10314.

**CUSTOM EMBROIDERED EMBLEMS** — Your design, low minimum. Informational booklet. Emblems, Dept 65, Littleton, New Hampshire 03561.

**THE MOR-GAIN HD DIPOLES** are the most advanced, highest performance multi-band HF dipole antennas available. Patented design provides length one-half of conventional dipoles. 50 ohm feed on all bands, no tuner or balun required. Can be installed as inverted VEE. Thousands in use worldwide. 22 models available including two models engineered for optimum performance for the novice bands. The Mor-Gain HD dipoles N/T series are the only commercial antennas specifically designed to meet the operational requirements of the novice license. Our 1-year warranty is backed by nearly 20 years of HD dipole production experience. Write or call today for our 5-page brochure. (813) 682-3142. Mor-Gain, P.O. Box 329N, Leavenworth, KS 66048.

**WANT TO START QRP (Low Power) Ham magazine.** Anyone interested in subscriptions and/or contributing articles, write Lynn Woods, 1435 W. 25th, #6, Anchorage, Alaska 99503.

**SHORTWAVE RADIOS!** We carry the best equipment for BCB or SW listening! Special modifications, and antenna systems! Free Catalog and Advice! Radio West, 3417 Purer Road, Escondido, CA 92025; (714) 741-2891. VISA/MC.

**MOBILE HF ANTENNA 3.2** — 30 MHz inclusive, 750 watts PEP, center loaded, tuned from the base, eliminating coil changing or removing from mount. Less than 1.5 to 1 VSWR thru entire coverage. 129.95 ea. plus shipping. Contact your local dealer, if none in your area order direct. Antack, Inc., Route One, Hansen, Idaho 83334. (208) 423-4100. Master Chg. and VISA accepted. Dealer and factory rep. inquiries invited.

**WISCONSIN: 3-F A.R.C. SWAPFEST, 8 A.M. to 3 P.M. Saturday, May 3, 1980,** at the Neenah Labor Temple, 157 South Green Bay Road (just off Highway 41 at the Highway 114 or 150 exits) in Neenah, Wisconsin. Large parking area, indoor/outdoor swap area, free suction, food & beverage, and much more! Advance admission \$1.50 for tickets and \$1.50 for tables. At door, \$2.00 for tickets and \$2.00 for tables. Talk-in on 146.52 simplex. Contact Mark Michel, W9OP, 339 Naymut Street, Menasha, Wisconsin 54952. Call (414) 772-4034.

**HAM RADIO REPAIR, alignment.** Hassle-free from anywhere via UPS. Expert, prompt, reasonable. Modern lab. "Grid" Gridley, W4GJO, Route 2, Box 138B, Rising Fawn, GA 30738.

**QSLs SECOND TO NONE.** Same day service. Samples 50 cents. Include your call for free decal. Ray, K7HLR, Box 331, Clearfield, UT 84015.

**KENWOOD INTERNATIONAL USER'S CLUB** is now operational. SASE for details. N8RT, Pohorence, 9600 Kickapoo Pass, Streetsboro, OH 44240.

**CODE FLASH CARDS!** Visualize code — don't try to pronounce it! Based on age-old principle for teaching math, language. Learn code easily, painlessly, in less time! Code Deck \$3.95. Gulf Press, 12 Bigelow Ctr., Ft. Myers Beach, FL 33931.

**CODE CASSETTES. EASYREAD** code instruction is more than computer generated code. Time is important in code practice. Use your time to practice quality material. Easyread 90 minute cassettes were formulated by an experienced code instructor using proven techniques. Each contains balanced content of qso, text, groups, numbers and punctuation. All have computer controlled character to word speed ratio. Specify beginners, 5, 7 1/2, 10, 12 1/2, 15, 17 1/2, 20, 22 1/2, etc. to 35 wpm. Speeds overlap. \$5.95 each, any 5 \$27.50, any 10 \$49.90, any 25 \$99.75. Marshall K. Kingery, K4ER, Box 268H, Manchester, TN 37355.

**QSL ECONOMY:** \$12 per 1000 UPS paid. S.A.S.E. for samples. W4TG, Drawer F, Gray, GA 31032.

**MAGAZINE SAMPLES!** For a free list of over 135 magazines offering a sample copy, send a stamped, addressed envelope to: Publishers Exchange, P.O. Box 1368, Dept. 26A, Plainfield, NJ 07061.

**MOBILE IGNITION SHIELDING** provides more range with no noise. Bonding strap sale less than 50¢ each. Literature. Estes Engineering, 930 Marine Drive, Port Angeles, Wash. 98362.

**QSL INSURANCE.** No more QRL DX operators, managers, or bureaus. New product called "Confirmation Mailer" is your best guarantee in Amateur Radio of receiving a fast direct reply. \$5.50 brings you 30 Polices! Bob Zittnan, K9UJA, P.O. Box 94973, Schaumburg, IL 60193.

**QSLs with class!** Unbeatable quality, reasonable price. Samples: 50¢ refundable. QSLs Unlimited, 1472 SW 13th Street, Boca Raton, FL 33432.

**DX — YOU BET!** The DX Bulletin — Best weekly DX info in the world — send for FREE sample copy. The DX Bulletin, 306 Vernon Avenue, Vernon, Connecticut 06086.

**QSLs & RUBBER STAMPS** — Top Quality! QSLs: Glossy Inks and Cardstock. Rubber Stamps: Report forms, Call Letter, Address, State outlines — More! Stamp Catalog and Card Samples 50¢. Ebbert Graphics 5H, Box 70, Westerville, Ohio 43081.

**STOP LOOKING** for a good deal on amateur radio equipment — you've found it here — at your amateur radio headquarters in the heart of the Midwest. Now more than ever where you buy is as important as what you buy! We are factory-authorized dealers for Kenwood, Drake, Yaesu, Collins, Wilson, Ten-Tec, Atlas, ICOM, DenTron, MFJ, Tempo, Regency, Hy-Gain, Mosley, Alpha, Cushcraft, Swan and many more. Write or call us today for our low quote and try our personal and friendly Hoosier service. HOOSIER ELECTRONICS, P.O. Box 2001, Terre Haute, Indiana 47802. (812) 238-1456.

**ELECTRONIC BARGAINS, CLOSEOUTS, SURPLUS!** Parts, equipment, stereo, industrial, educational. Amazing values! Fascinating items unavailable in stores or catalogs anywhere. Unusual FREE catalog. ETCO-059, Box 782, Plattsburgh, N.Y. 12901.

**NEW REGENCY M100** touch scanners, 10-channel with priority and search feature. Compact size. Frequency range 30-50, 144-174, and 440-512 MHz. AC/DC. \$229.95 check or money order to Merrimack Communications and Safety Equipment Company, P.O. Box 267, Merrimack, N.H. 03054.

# HRH LOCATOR

TO HELP YOU FIND YOUR LOCAL AMATEUR RADIO DEALER

## Arizona

**POWER COMMUNICATIONS**  
6012 N. 27 AVENUE  
PHOENIX, AZ 85017  
602-242-6030  
Arizona's #1 "Ham" Store,  
Kenwood, Yaesu, Drake, ICOM,  
& more.

## California

**JUN'S ELECTRONICS**  
11656 W. PICO BLVD.  
LOS ANGELES, CA 90064  
213-477-1824 Trades  
714-463-1886 San Diego  
The Home of the One Year Warranty  
— Parts at Cost — Full Service.

**SHAVER RADIO, INC.**  
1378 S. BASCOM AVE.  
SAN JOSE, CA 95128  
408-998-1103  
Atlas, Kenwood, Yaesu, KDK, Icom,  
Tempo, Wilson, Ten-Tec, VHF  
Engineering.

**TELE-COM**  
15460 UNION AVENUE  
SAN JOSE, CA 95124  
408-377-4479

## Connecticut

**THOMAS COMMUNICATIONS**  
95 KITTS LANE  
NEWINGTON, CT 06111  
203-667-0811  
Authorized dealer for Kenwood,  
Yaesu, Drake, Icom, etc. - CALL US.

## Delaware

**DELAWARE AMATEUR SUPPLY**  
71 MEADOW ROAD  
NEW CASTLE, DE 19720  
302-328-7728  
Icom, Ten-Tec, Swan, DenTron,  
Wilson, Tempo, KDK, and more.  
One mile off I-95, no sales tax.

## Florida

**AGL ELECTRONICS, INC.**  
1898 DREW STREET  
CLEARWATER, FL 33515  
813-461-HAMS  
West Coast's Only Full Service  
Amateur Radio Store

**AMATEUR RADIO CENTER, INC.**  
2805 N.E. 2ND AVENUE  
MIAMI, FL 33137  
305-573-8383  
The Place For Great Dependable  
Names in Ham Radio

**RAY'S AMATEUR RADIO**  
1590 US HWY. 19 SOUTH  
CLEARWATER, FL 33516  
813-535-1416  
Atlas, B&W, Bird, Cushcraft,  
DenTron, Drake, Hustler, Hy-Gain,  
Icom, K.D.K., Kenwood, MFJ,  
Rohn, Swan, Ten-Tec, Wilson.

**SUNRISE AMATEUR RADIO**  
1351 STATE RD. 84  
FT. LAUDERDALE, FL 33315  
(305) 761-7676  
"Best Prices in Country.  
Try Us — We'll prove it."

## Illinois

**AUREUS ELECTRONICS INC.**  
1415 N. EAGLE STREET  
NAPERVILLE, IL 60540  
312-420-8629  
"Amateur Excellence"

**ERICKSON COMMUNICATIONS, INC.**  
5456 NORTH MILWAUKEE AVE.  
CHICAGO, IL 60630  
312-631-5181  
Outside Illinois 800-621-5802  
Hours 9:30-5:30 Mon., Tues., Wed.,  
Fri.; 9:30-9:00 Thurs.; 9:00-3:00 Sat.

**KLAUS RADIO, INC.**  
8400 NO. PIONEER PARKWAY  
PEORIA, IL 61614  
309-691-4840  
Let Us Quote Your Amateur Needs.

## Iowa

**BOB SMITH ELECTRONICS**  
RFD #3, HIGHWAY 169 & 7  
FORT DODGE, IA 50501  
515-576-3886  
For an EZ deal  
800-247-2476/1793  
Iowa: 800-362-2371

## Kansas

**ASSOCIATED RADIO COMM**  
8012 CONSER  
OVERLAND PARK, KS 66204  
913-381-5900  
America's No. 1 Real Amateur Radio  
Store. Trade - Sell - Buy.

## Maryland

**THE COMM CENTER, INC.**  
LAUREL PLAZA RT. 198  
LAUREL, MD 20810  
800-638-4486  
Kenwood, Drake, Icom, Ten-Tec,  
Tempo, DenTron, Swan  
& Apple Computers.

## Massachusetts

**TEL-COM, INC.**  
675 GREAT RD., RT. 119  
LITTLETON, MA 01460  
617-486-3040  
The Ham Store of New England  
You Can Rely On.

## Minnesota

**PAL ELECTRONICS INC.**  
3452 FREMONT AVE. NO.  
MINNEAPOLIS, MN 55412  
612-521-4662  
Midwest's Fastest Growing Ham  
Store. Where Service Counts.

## Nebraska

**COMMUNICATIONS CENTER, INC.**  
443 N. 48 STREET  
LINCOLN, NE 68504  
800-228-4097  
Kenwood, Yaesu, Drake and More  
at Discount Prices.



Continued

## New Hampshire

**EVANS RADIO, INC.**  
 BOX 893, RT. 3A BOW JUNCTION  
 CONCORD, NH 03301  
 603-224-9961  
 Icom, DenTron, Yaesu, Drake.  
 We service what we sell.

## New Jersey

**ATKINSON & SMITH, INC.**  
 17 LEWIS STREET  
 EATONTOWN, NJ 07724  
 201-542-2447  
 Ham supplies since "55".

### BARGAIN BROTHERS ELECTRONICS

216 SCOTCH ROAD  
 GLEN ROC SHOPPING CTR.  
 WEST TRENTON, NJ 06828  
 609-883-2050  
 A million parts — Lowest prices  
 anywhere. Call us!

### BARGAIN BROTHERS II ELECTRONICS

181 HADDON AVENUE  
 WEST BERLIN, NJ 08091  
 609-767-5252  
 Surplus Parts and Equipment  
 Bought — Sold — Traded.

### METUCHEN RADIO

216 MAIN STREET  
 METUCHEN, NJ 08840  
 201-494-8350  
 New and Used Ham Equipment.  
 WA2AET "T" Bruno

### RADIOS UNLIMITED

P. O. BOX 347  
 1760 EASTON AVENUE  
 SOMERSET, NJ 08873  
 201-469-4599  
 New Jersey's Fastest  
 Growing Ham Store.

### ROUTE ELECTRONICS 46

225 ROUTE 46 WEST  
 TOTOWA, NJ 07512  
 201-256-8555  
 Drake, Swan, DenTron, Cushcraft,  
 Hy-Gain, Hustler, Larsen and more.

### WITTIE ELECTRONICS

384 LAKEVIEW AVE.  
 CLIFTON, NJ 07011  
 201-772-2222  
 Same location for 62 years.  
 Full-line authorized Drake dealer.

## New York

### HAM-BONE RADIO

(Div. Stereo Repair Shop)  
 3206 ERIE BOULEVARD EAST,  
 SYRACUSE, NY 13214  
 315-446-2266  
 We Deal, We Trade,  
 We Discount, We Please!  
 2-Way Service Shop on Premises!

### HARRISON RADIO CORP.

20 SMITH STREET  
 FARMINGDALE, NY 11735  
 516-293-7990  
 "Ham Headquarters USA®"  
 since 1925.  
 Call toll free 800-645-9187.

### RADIO WORLD

ONEIDA COUNTY AIRPORT  
 TERMINAL BLDG.  
 ORISKANY, NY 13424  
 800-448-7914  
 315-337-2622 } NY  
 315-337-0203 } Res.  
 New & Used Ham Equipment. See  
 Warren K2IXN or Bob WA2MSH

## Ohio

### UNIVERSAL AMATEUR RADIO, INC.

1280 AIDA DRIVE  
 COLUMBUS (REYNOLDSBURG)  
 OH 43068  
 614-866-4267  
 Complete Amateur Radio Sales and  
 Service. All major brands · spacious  
 store · near I-270.

## Pennsylvania

### HAMTRONICS, DIV. OF

TREVOSE ELECT.  
 4033 BROWNSVILLE RD.  
 TREVOSE, PA 19047  
 215-357-1400  
 Same Location for  
 More Than 30 Years.

### LaRUE ELECTRONICS

1112 GRANDVIEW STREET  
 SCRANTON, PENNSYLVANIA 18509  
 717-343-2124  
 ICOM, Bird, Cushcraft, CDE,  
 Ham-Keys, VHF Engineering,  
 Antenna Specialists.

# HELP!

Anytime you have a question about your Ham Radio HORIZONS subscription, please include a mailing label to insure prompt service on your inquiry.

AFFIX  
 LABEL  
 HERE

### CHANGE OF ADDRESS

Moving? Please let us know 4-6 weeks beforehand. Or, if anything is wrong with your current mailing label, please carefully print the updated information below and affix your present label above.

PLEASE HELP US TO SERVE YOU BETTER

**HAM RADIO HORIZONS** Greenville, NH 03048

Call \_\_\_\_\_

Name \_\_\_\_\_

Address \_\_\_\_\_

City \_\_\_\_\_

State \_\_\_\_\_ Zip \_\_\_\_\_

## ADVERTISERS

Two of our advertisers recently told me about the surprising response they have received from their ads in Ham Radio HORIZONS.\* One advertiser said that the sales from his HORIZONS ad are *greater* than from his ad in QST! Another advertiser told us that his sales, based upon warranty-card return — and in spite of *less* advertising in HORIZONS — have equaled sales from any of the other magazines *except* QST, where he advertises the most!

**MORAL:** If you really want to sell a product, don't take our word for it, run an ad with us and let your results prove it. Try Ham Radio HORIZONS. We think you'll be pleasantly (and profitably) surprised, unless of course you are already an advertiser; and, then, you know!

Call (800) 258-5353  
 ask for Jim Gray, Harold Kent,  
 or Dot Sargent

\*Names upon request

# CALL TOLL FREE

For the best deal on

- AEA ● Ameco ● Apple ● ASP
- Belden ● Bencher ● Bird
- CDE ● CES ● Cushcraft
- Daiwa ● DenTron ● Drake
- Hy-Gain ● Icom ● KLM
- Kenwood ● Larsen ● MFJ
- Midland ● Mosley ● NPC
- Newtronics ● Nye ● Palomar
- Regency ● Shure ● Swan
- Standard ● Tempo ● Ten-Tec
- Tonna ● Transcom ● Wilson
- Yaesu

## NEW for 1980! Apple Computers..

get Erickson's price!

RTTY interface available  
Larsen Mag Mounts...  
CLOSEOUT! 20 % off on  
any Larsen mag mount  
antenna in stock!

### SUPER SPECIAL...

A few sets of Kenwood  
Twins...while they last.\$799!



CALL TOLL FREE  
(outside Illinois only)

(800) 621-5802



Hours:

9:30-5:30 Mon., Tues., Wed. & Fri.

9:30-9:00 Thursday

9:00-3:00 Saturday



**ERICKSON**

COMMUNICATIONS, INC.

5456 N MILWAUKEE AVE

CHICAGO IL 60630 (312) 631-5181

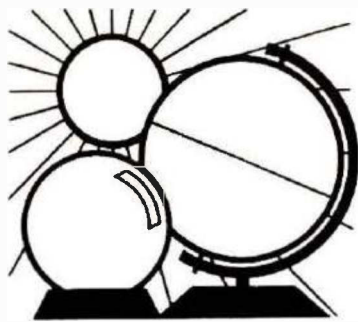

# DX FORECASTER

### Last-minute predictions

The period between April 5th and 11th is likely to be very disturbed, with possible solar flare activity, geomagnetic field upsets, and atmospheric storms. The most probable days are the 6th, 7th, and 8th. Minor upsets are possible again between the 15th and 20th, and between the 24th and 29th. Perigee occurs on the 14th, new moon on the 15th, and full moon on the 30th.

### Band-by-band forecast

Excellent skip propagation — both long and short — is forecast for the month of April on all bands between 6 and 160 meters! A seasonal increase in noise levels will make the lower frequency bands, particularly 80 and 160, a bit difficult at times, but there will still be plenty of DX after dark — providing it can be heard through the thunderstorm static crashes. The higher-frequency bands will be a treasure-trove of DX opportunities, and trans-equatorial skip will be the rule rather than the exception.

Six meters will provide frequent band openings, peaking during the early afternoon hours on many days. North-south DX paths will be favored, and your best guide to possible activity will be strong openings on 10 meters. Always look on the next higher frequency band whenever possible, because it could be "hot."

Ten, fifteen, and twenty meters will be jumping with signals from morning to night almost every day, with the exception of those days when upsets occur. During daylight hours, short skip will be mixed with DX signals, and three-way QSOs between several U.S. and/or foreign stations will be commonplace. As you move higher in frequency, you will discover the bands peaking earlier into a particular area, so prepare to take advantage of this fact by starting at the highest

usable band and move down as the day progresses. Twenty will be open long after dark, while fifteen and ten will close shortly after sunset.

Forty and Eighty meters will have lots of short skip during daylight hours and DX after dark. Forty must inevitably displace eighty as your favorite nighttime DX band because the QRN will make signals on the lower frequencies almost impossible to hear at times. On those nights when conditions are favorable, however, DX will be nearly as good as it was in mid-winter, and Pacific areas will come through strongly during the hour or two surrounding dawn.

One-sixty meters will revert to the summertime doldrums on many days of the month, but don't give up just yet. There is still much DX to be worked, and many stateside stations as well, when QRN is not severe.

### Position is everything

In winter, the earth is closest to the sun, in spite of the fact that the northern hemisphere is colder — a condition produced by the earth's axial tilt. In winter the sun's rays do not impinge so directly on the atmosphere above the northern hemisphere, meaning less ionization and fewer DX operating hours. In spring and fall, however, the earth's tilt is neither toward nor away from the sun, but "sideways," meaning that both hemispheres receive about equal sunshine and have about equal hours of daylight and darkness. Ionization is nearly constant over both hemispheres on the sunny side of the globe and, since DX path lengths are greatest across the equator, your opportunities to work South Africa, Australia, Argentina and even Antarctica, will be greatest at this time of year — and again in the fall when similar conditions exist. Use the accompanying chart as your guide to "DXland."



**WESTERN USA**

**MID USA**

**EASTERN USA**

GMT	WESTERN USA										MID USA										EASTERN USA													
	ASIA FAR EAST	EUROPE	S. AFRICA	S. AMERICA	ANTARCTICA	AUSTRALIA	OCEANIA NEW ZEALAND	JAPAN	ASIA FAR EAST	EUROPE	S. AFRICA	S. AMERICA	ANTARCTICA	AUSTRALIA	OCEANIA NEW ZEALAND	JAPAN	ASIA FAR EAST	EUROPE	S. AFRICA	S. AMERICA	CARIBBEAN S. AMERICA	ANTARCTICA	AUSTRALIA	OCEANIA NEW ZEALAND	JAPAN									
PST	N	NE	E	SE	S	SW	W	NW	N	NE	E	SE	S	SW	W	NW	EST	N	NE	E	SE	S	SW	W	NW	EST	N	NE	E	SE	S	SW	W	NW
0000	10	20	20	10	10	10	10	10	15	20	20	10	10	10	15	10	7:00	15	20	20	15	10	10	10	10	15	7:00	15	20	20	15	10	10	10
0100	10	20	20	10	10	10	10	10	15	20	20	15	15	10	15	10	7:00	15	20	20	15	15	10	10	10	15	8:00	15	20	20	15	10	10	15
0200	10	20	20	15	10	10	10	10	15	40	20	15	15	10	15	15	8:00	15	40	20	15	15	10	15	15	15	9:00	15	20	20	15	15	20	20
0300	10	20	20	15	15	10	15	10	15	40	20	15	15	15	15	15	10:00	15	40	20	15	15	15	15	15	15	10:00	15	20	20	15	15	20	20
0400	10	20	20	15	15	10	15	15	20	40*	20	15	15	15	15	20	11:00	20	40*	20	15	15	15	15	20	20	11:00	20	40	20	15	15	20	20
0500	10	20	20	15	15	15	15	20	20	40*	20	20	20	15	15	20	12:00	20	40*	20	20	20	15	15	20	20	12:00	20	40	20	20	20	20	20
0600	10	20	20	15	15	15	15	20	20	40*	20	20	20	15	15	20	1:00	20	40	20	20	20	15	15	20	20	1:00	20	40	20	20	20	20	20
0700	10	20	20	15	15	15	15	20	20	40*	20	20	20	15	15	20	2:00	20	40	20	20	20	15	15	20	20	2:00	20	40	20	20	20	20	20
0800	10	20	20	15	15	15	15	20	20	40*	20	20	20	15	15	20	3:00	20	40	20	20	20	15	15	20	20	3:00	20	40	20	20	20	20	20
0900	10	20	20	15	15	15	15	20	20	40*	20	20	20	15	15	20	4:00	20	40	20	20	20	15	15	20	20	4:00	20	40	20	20	20	20	20
1000	10	20	20	15	15	15	15	20	20	40*	20	20	20	15	15	20	5:00	20	40	20	20	20	15	15	20	20	5:00	20	40	20	20	20	20	20
1100	10	20	20	15	15	15	15	20	20	40*	20	20	20	15	15	20	6:00	20	40	20	20	20	15	15	20	20	6:00	20	40	20	20	20	20	20
1200	10	20	20	15	15	15	15	20	20	40*	20	20	20	15	15	20	7:00	20	40	20	20	20	15	15	20	20	7:00	20	40	20	20	20	20	20
1300	10	20	20	15	15	15	15	20	20	40*	20	20	20	15	15	20	8:00	20	40	20	20	20	15	15	20	20	8:00	20	40	20	20	20	20	20
1400	10	20	20	15	15	15	15	20	20	40*	20	20	20	15	15	20	9:00	20	40	20	20	20	15	15	20	20	9:00	20	40	20	20	20	20	20
1500	10	20	20	15	15	15	15	20	20	40*	20	20	20	15	15	20	10:00	20	40	20	20	20	15	15	20	20	10:00	20	40	20	20	20	20	20
1600	10	20	20	15	15	15	15	20	20	40*	20	20	20	15	15	20	11:00	20	40	20	20	20	15	15	20	20	11:00	20	40	20	20	20	20	20
1700	10	20	20	15	15	15	15	20	20	40*	20	20	20	15	15	20	12:00	20	40	20	20	20	15	15	20	20	12:00	20	40	20	20	20	20	20
1800	10	20	20	15	15	15	15	20	20	40*	20	20	20	15	15	20	1:00	20	40	20	20	20	15	15	20	20	1:00	20	40	20	20	20	20	20
1900	10	20	20	15	15	15	15	20	20	40*	20	20	20	15	15	20	2:00	20	40	20	20	20	15	15	20	20	2:00	20	40	20	20	20	20	20
2000	10	20	20	15	15	15	15	20	20	40*	20	20	20	15	15	20	3:00	20	40	20	20	20	15	15	20	20	3:00	20	40	20	20	20	20	20
2100	10	20	20	15	15	15	15	20	20	40*	20	20	20	15	15	20	4:00	20	40	20	20	20	15	15	20	20	4:00	20	40	20	20	20	20	20
2200	10	20	20	15	15	15	15	20	20	40*	20	20	20	15	15	20	5:00	20	40	20	20	20	15	15	20	20	5:00	20	40	20	20	20	20	20
2300	10	20	20	15	15	15	15	20	20	40*	20	20	20	15	15	20	6:00	20	40	20	20	20	15	15	20	20	6:00	20	40	20	20	20	20	20

# April 1980

# HAM CALENDAR

Sunday	Monday	Tuesday	Wednesday	Thursday	Friday	Saturday
<p><b>Missouri Valley Amateur Radio Club</b> — Second Annual Pony Express Days — 1500Z to 0100Z — Luncheon with W8NH on (Phone) 10 meters — 28.575, 15, 20, 40, 75 meters — 10 kHz from bottom of General phone band (ICW) 10 meters — 28.15K MHz, 15 meters — 21.150 MHz, and 40 meters — 7.125 MHz — 6 &amp; 7</p>	<p><b>Florida Ham News</b> — Swap Net By the Broward ARC 146.31-91 at 7:30 PM <b>Glenhurst Radio Society Transmits Amateur Radio News</b> — 222.66/224.26 MHz via WR2APG and 21.400 MHz USB</p>	<p><b>AMSAT Eastcoast Net</b> 3850 kHz 9:00 PM EDT 10100Z Wednesday Morning! <b>AMSAT Mid-Continent Net</b> 3850 kHz 9:00 PM CDT 10200Z Wednesday Morning! <b>AMSAT Westcoast Net</b> 3850 kHz 8:00 PM PDT 10300Z Wednesday Morning!</p>	2	3	4	5
<p><b>South Eastern Michigan Amateur Radio Association</b> — Twenty-Second Annual Hamfest — South Lake High School, St. Clair Shores, Michigan — 8:00AM EST to 3:00PM EST — W0BPCQ 13 <b>Black River Radio Club</b> — Fourteenth Annual Hamfest — Lee C. Clark Amphitheater, Millville, NJ <b>Madison Area Responder Association</b> — Eighth Area Madison Swapfest — Dana County Expo Center Forum Building, Madison, Wisconsin — 9AM CST — W09GRI — 13 <b>Penn. Wireless Association, Inc.</b> — Tradefest '80 — National Guard Armory, Southampton Rd., Langhorne, Pennsylvania — W0BKRIV — 13</p>	<p><b>Florida Ham News</b> — Swap Net By the Broward ARC 146.31-91 at 7:30 PM <b>Glenhurst Radio Society Transmits Amateur Radio News</b> — 222.66/224.26 MHz via WR2APG and 21.400 MHz USB <b>West Coast Bulletin Editor &amp; Transmitter</b> by W6ZF 8:00 PM PST 3540 kHz, A-1, 22 WPM</p>	<p><b>AMSAT Eastcoast Net</b> 3850 kHz 9:00 PM EDT 10100Z Wednesday Morning! <b>AMSAT Mid-Continent Net</b> 3850 kHz 9:00 PM CDT 10200Z Wednesday Morning! <b>AMSAT Westcoast Net</b> 3850 kHz 8:00 PM PDT 10300Z Wednesday Morning!</p>	9	10	11	12
<p><b>Invigitation Radio Amateur Club</b> — Annual Hamites — P.A.I. Building, Irvington, New Jersey — 9AM EST — W0BZRGV — 20 <b>Delaware Valley Radio Association and the Lawrenceville Amateur Group</b> — Annual Flax Meats — New Jersey National Center, KESWIK — 20 <b>Stateside Annual Penn. Central Hamfest</b> — Woodward Township, Pennsylvania, Fire Hall — 11AM to 5PM EST — W0BKRIN — 20</p>	<p><b>Florida Ham News</b> — Swap Net By the Broward ARC 146.31-91 at 7:30 PM <b>Glenhurst Radio Society Transmits Amateur Radio News</b> — 222.66/224.26 MHz via WR2APG and 21.400 MHz USB</p>	<p><b>AMSAT Eastcoast Net</b> 3850 kHz 9:00 PM EDT 10100Z Wednesday Morning! <b>AMSAT Mid-Continent Net</b> 3850 kHz 9:00 PM CDT 10200Z Wednesday Morning! <b>AMSAT Westcoast Net</b> 3850 kHz 8:00 PM PDT 10300Z Wednesday Morning!</p>	16	17	18	19
<p><b>Freshingham Amateur Radio Association</b> — Annual Spring Flea Market — Fresh Pond, Millis, Massachusetts — 10AM to 3PM EST — K1VYIM — 27 <b>PVRA Third Annual Flea Market</b> — Newington High School, Newington, Connecticut — 10AM to 5PM EST — K1NFE — 27</p>	<p><b>Florida Ham News</b> — Swap Net By the Broward ARC 146.31-91 at 7:30 PM <b>Glenhurst Radio Society Transmits Amateur Radio News</b> — 222.66/224.26 MHz via WR2APG and 21.400 MHz USB <b>West Coast Bulletin Editor &amp; Transmitter</b> by W6ZF 8:00 PM PST 3540 kHz, A-1, 22 WPM</p>	<p><b>AMSAT Eastcoast Net</b> 3850 kHz 9:00 PM EDT 10100Z Wednesday Morning! <b>AMSAT Mid-Continent Net</b> 3850 kHz 9:00 PM CDT 10200Z Wednesday Morning! <b>AMSAT Westcoast Net</b> 3850 kHz 8:00 PM PDT 10300Z Wednesday Morning!</p>	23	24	25	26
<p><b>Dayton Amateur Radio Association, Inc.</b> — Hamvention '80 — Dayton Area Aero and Exhibition Center, Dayton, Ohio — W0BQZC — 25, 26 &amp; 27 <b>Puerto Rico Amateur Radio Club</b> — Convention and Hamfest — Montemar Inn, Aguadilla, Puerto Rico — 26 &amp; 27 <b>Trophy H.M. The King of Spain</b> — (EA) — Helena Contest (IHS) — 26-27</p>	<p><b>Florida Ham News</b> — Swap Net By the Broward ARC 146.31-91 at 7:30 PM <b>Glenhurst Radio Society Transmits Amateur Radio News</b> — 222.66/224.26 MHz via WR2APG and 21.400 MHz USB</p>	<p><b>AMSAT Eastcoast Net</b> 3850 kHz 9:00 PM EDT 10100Z Wednesday Morning! <b>AMSAT Mid-Continent Net</b> 3850 kHz 9:00 PM CDT 10200Z Wednesday Morning! <b>AMSAT Westcoast Net</b> 3850 kHz 8:00 PM PDT 10300Z Wednesday Morning!</p>	30			



First family  
of power...

# ALPHA

See all the ALPHAS  
at **DAYTON 1980**  
A GREAT CHANCE TO STUDY ALL THE  
SUPERB ALPHAS INSIDE AND OUT...  
TALK WITH ETO FACTORY EXPERTS...



Glen Eyrie, Garden of the Gods in ETO's backyard  
Photo By RIC HELSTROM

... THEN TAKE IMMEDIATE DELIVERY OF YOUR NEW ALPHA LINEAR from one of these outstanding dealers who'll be stocked and exhibiting at the 1980 DAYTON HAMVENTION, April 25 thru 27:

- AMATEUR ELECTRONIC SUPPLY
- HAM RADIO OUTLET
- PAYNE RADIO
- COMMUNICATIONS CENTER
- HAMTRONICS
- ROSS DISTRIBUTING
- G.I.S.M.O.
- MADISON ELECTRONICS
- UNIVERSAL AMATEUR RADIO



EHRHORN TECHNOLOGICAL OPERATIONS, INC.  
BOX 708, CAÑON CITY, CO. 81212 (303) 275-1613

# AD CHECK

... for literature, in a hurry — we'll rush your name to the companies whose names you check.

Place your check mark in the space between name and number. Example: HRH  150.

AR Tech. ___ 687	Icom *
A. E. A. ___ 677	Kantronics *
Aluma ___ 589	Kenwood *
Amateur Wholesale Elec. ___ 003	Klaus ___ 430 Long's ___ 468
Antenna Supermarket *	MFJ ___ 082
Bencher ___ 629	Madison ___ 431
Chemtronics ___ 706	Microcraft ___ 774
Curtis Electro ___ 034	Microwave Filter ___ 837
DSI ___ 656	J.W. Miller ___ 745
Dayton Hamvention ___ 223	NCG ___ 829
DenTron ___ 259	Oak Hill Academy A. R. S. *
Digitrex ___ 823	Palomar Eng. *
Drake *	RSE Ham Shack ___ 607
E. T. O. *	Callbook ___ 100
Erickson *	Constructor *
Fox-Tango ___ 657	Radio World *
Hal *	S-F A. R. S. ___ 640
Ham Gear Mart *	Tedco ___ 791
HRB ___ 150	Ten-Tec *
Hammond Mfg. Ltd. ___ 830	Van Gorden ___ 737 Wilson Sys. ___ 787

\* Please contact this advertiser directly.

Limit 15 inquiries per request.

APRIL 1980

Please use before May 31, 1980

Tear off and mail to  
**HAM RADIO HORIZONS — "Ad Check"**  
Greenville, N. H. 03048

NAME \_\_\_\_\_  
CALL \_\_\_\_\_  
STREET \_\_\_\_\_  
CITY \_\_\_\_\_  
STATE \_\_\_\_\_ ZIP \_\_\_\_\_

# EASTER EGGS

ALPHA 76, 374, 78 In Stock	Call
Cushcraft "boomer"	69.95
OMNI-J 2 Meter Antenna	39.95
Bird 43 and slugs, UPS paid in USA.	stock
Microwave Modules, Less 10% off list.	stock
Telrex TB5EM, in stock	415.00
TB6EM	520.00
Monobanders in stock	
New Telrex TB5ES, 2KW Pep version.	315.00
New Palomar Transceiver Preamp	89.50
Bencher Paddles	39.95
	chrome 49.95
Vibroplex Paddles in stock, & bugs	call
Lunar 6M-2M-220 In-line Preamps	stock
Janel QSA-5	41.95
HAM-X Tailtwister Rotor	189.00
HAM-4 Rotor	139.00
Celtron or GE 572B	32.00/ea
GE AMPGREGX, Raytheon G146B	9.95
Motorola HEP170	0.29
Mallory 2.5A/1000 PIV Epoxy diode	0.19
Sprague 100MFD/450VDC Cap.	2.00
Aerovox 1000PF/500V Feedthru Cap.	1.95
Adel Nibbling Tool	8.45
Technical books: Ameco, ARRL, Sams, TAB, Rider, Radio Pub., Callbook, Cowan, WRTVH, etc. Call	
New Belden 9405 (2#16x6#18) 8 wire Rotor cable, heavy duty for long runs	0.32/ft
8448 8 wire Rotor Cable	0.20/ft
9888 Double Shield RG8 Foam	0.46/ft
8214 RG8 Foam	0.26/ft
8237 RG8 Regular	0.23/ft
8267 RG213	0.30/ft
9251 RG8 A/U	0.35/ft
Belden #8000 14GA Stranded Antenna wire	0.06/ft
Amphenol Silverplate PL259 (8315P)	0.69
Berklex RG8X 52ohm, KW	0.16/ft
Robot "Slow Scan" 400	499.00

Telrex antennas?  
In Stock!

Monobanders?  
You bet!

Looking for antique parts?  
Write specific need to W5GJ

## THIS MONTH'S SPECIALS:

New IC701, AC MIC	\$1195.00.
New ICOM IC251A — 2M	\$599.00.
IC551D -6M-100W	\$599.00.
IC551	\$399.00.

Dentron GLA1000B	295.00
Dentron Clipperton L	499.00
Bearcat 250, 220	299.00
300	399.00

## MASTERCHARGE • VISA

All prices fob Houston except where indicated.  
Prices subject to change without notice, all items guaranteed. Some items subject prior sale. Send letterhead for Dealer price list. Texas residents add 6% tax. Please add postage estimate \$1.00 minimum.



1506 McKinney • Houston, Texas 77002 • (713) 858-0288

# AD INDEX

AR Technical Products, Inc.	56
Aluma Tower Co.	80
Antenna Supermarket	56
Bencher, Inc.	32, 36
DSI Instruments	21
Dayton Hamvention	10, 79
Digitrex Electronics	79
Drake Co., R.L.	1
Ehrhorn Technological Operations	77
Epsilon	79
Erickson Communications	74
Hal Communications	9, Cover IV
Ham Gear Mart	80
Ham Radio's Bookstore	4, 56, 69, 80
Ham Radio Horizons	73
Icom	7
Kantronics	39
Trio-Kenwood Communications, Inc.	Cover III
Klaus Radio, Inc.	67
Long's Electronics	40, 41,
MFJ Enterprises	3
Madison Electronic Supply	56, 78, 80
Microcraft Corporation	36
Microwave Filter, Inc.	32
NCG Companies	79
Oak Hill Academy Amateur Radio Session	56
Palomar Engineers	70
RSE Ham Shack	45
Radio Amateur Callbook	36
Radio & Electronics Constructor	80
Radio World	32
S-F Amateur Radio Services	36
Tedco	79
Ten-Tec	Cover II
Van Gorden Engineering	79
Wilson Systems, Inc.	46, 47, 48, 49

## Foreign Subscription Agents for Ham Radio HORIZONS

Ham Radio Austria F. Beier Hauptplatz 5 A-2700 Wiener Neustadt Austria	Ham Radio Holland MRL Electronics Postbus 88 NL 2204 Delft Holland
Ham Radio Belgium Stevenshouse Brusselsesteenweg 418 B-8218 Gent Belgium	Ham Radio Italy G. Vulpari P.O. Box 37 I-22083 Cantù Italy
Ham Radio Canada Box 400, Goderich Ontario, Canada N7A 4C7	Ham Radio Switzerland Karin Ueber Postfach 2454 D-7850 Loerrach West Germany
Ham Radio Europe Box 444 S-194 04 Upplana Vasby Sweden	Ham Radio UK P.O. Box 63, Harrow Middlesex HA3 81S England
Ham Radio France SM Electronic 20 bis, Ave des Clartons F-95000 Aulnay France	Ham Radio Germany Karin Ueber Postfach 2454 D-7850 Loerrach West Germany
	Holland Radio 143 Greenway Greenvalde, Johannesburg Republic of South Africa





# "HAM OF THE YEAR"

To be honored at the Dayton Hamvention April 26, 1980

You probably know someone who deserves this award — a friend, neighbor — perhaps your husband or wife. Send in your nomination, fully detailed, by April 11, 1980 to:

**AWARDS CHAIRMAN  
DAYTON HAMVENTION  
PO Box 44  
Dayton, OH 45401**

## CODE got you stumped?

RELAX and worry not! Learn international Morse Code the EASY, Rus Farnsworth way. No books, no gimmicks, just listen & learn. Using the word method, based on modern psychological techniques, you can zoom past 13 w.p.m. in less than half the time! Available in cassettes @ \$10.95 and LP records at \$9.95 — you get over two hours of instruction!

**EPSILON RECORDS  
P.O. Box 626  
San Jacinto, CA 92383**

## COMING EVENTS

**THE 11TH ANNUAL FM B\*A\*S\*H** will be held on the Friday night of the Dayton Hamvention, April 25, 1980 at the convention center, Main and Fifth Streets. Parking in adjacent City garage. Admission is free to all. Sandwiches, snacks and C.O.D. bar available. Live entertainment provided for a super social evening. Don't miss it. Awards include a new synthesized HT. For further information contact the Miami Valley FM Assn., P.O. Box 283, Dayton, Ohio 45401.

**RADIO EXPO '80** — Lake County Fair Grounds, Rt. 45 & 120, September 6 and 7. Advance tickets \$2.00, \$3.00 at gate. Write Radio Expo Tickets, P.O. Box 1532, Evanston, IL 60204. Exhibitor information call (312) BST-EXPO.

**NEW YORK:** 21st Annual Southern Tier A.R.C. Hamfest; Saturday, May 3, 1980, at the Owego Treadway Inn, Route 17, Exit 35, Owego, N.Y. Buffet and general admission: \$8.00; gate \$2. Reservations received after April 20th will be held at the door. Flea Market, Vendors, Tech Talks. Fun for all. For Hotel Room accommodations, call Owego Treadway Inn (607) 687-4500, ask for Debbie Chambers. STARC, P.O. Box 11, Endicott, N.Y. 13760.

**PENNSYLVANIA:** Tradefest '80 sponsored by the Penn Wireless Association, Sunday, April 13, 1980, at the National Guard Armory, Southampton Road and Roosevelt Boulevard (Route 1) 1/2 mile south of Turnpike Exit 28, Langhorne, Pa. Seller's space 6 x 8 foot — \$5. Bring tables. Limited power connections — \$3. General admission — \$3. Prizes, refreshments, rest area, displays and surprises. Talk-in on 146.715 and 146.52. Contact Robert L. Daut, Jr., WB3KRV, P.O. Box 734, Langhorne, Pennsylvania 19047.

## 21 MHz SSB-CW PLL DIGITAL TRANSCEIVER

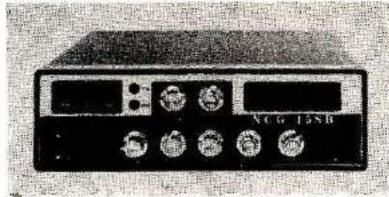

NCG-15-SB

### SPECIFICATIONS:

- Frequency Range: 21.000-21.495 MHz ± VXO adj.
- VXO Range: Approx ± 5 kHz from display
- Sweep Scan Range: Same as VXO
- Power Output: 15W (PEP) nominal max.
- Spurious Radiation: Down 60 dB or more
- Carrier Suppression: 40 dB or more, CW or SSB
- RX Sensitivity: 0.5 uV or better for 10 dB S/N
- RX Selectivity: 2.2 kHz at 6 dB; 4.6 kHz, 50 dB
- Image Rejection: 60 dB or more
- RX Spurious Response: Down 50 dB or more
- Power Required: 13.8 VDC, 2.5 A (peak)
- XMIT. & positive or negative ground
- Modulation: USB (Suppressed Carrier) or CW

### FEATURES:

- Active noise blanker
- Squelch
- RX RF gain control
- 5 digit frequency display
- CW sidetone
- Transmit ALC & HI/LO power switch

A fine Novice/Tech Base & General/Adv/Extra Mobile

Call or write for price

Dealer Inquiries Invited

## NCG COMPANIES

1275 NORTH GROVE ST., ANAHEIM, CA 92806  
(714) 630-4541

## 80 & 84-METER TRANSCEIVERS

**QRP!**

**ONLY \$79.95 EACH**

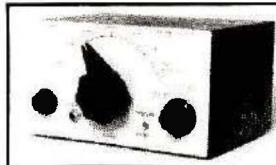

PPD U.S.A. LESS BATTERIES

### 30-DAY MONEY-BACK GUARANTEE

- 84-meter transceiver which covers 3500 to 3600 kHz is for the old timer.
- NOVICES should order the 80-meter unit which covers 3685 to 3755 kHz.
- CW operation with VFO control.
- Output power approximately 1/2 watt.
- Expect up to 1000 mile range when used with a half-wave dipole.
- Adjustable RF output impedance.
- Low distortion sidetone oscillator doubles as a code practice oscillator.
- Direct conversion receiver.
- RF amplifier and sharp audio filter.
- Receiver independent tuning.
- Long life operation from 9 self-contained 1.5 volt carbon-zinc D cells.
- Size 9" wide by 5" high by 8" deep.
- Instruction manual included.

Accessories required but not included, are 8-ohm stereo phones, telegraph key, a good antenna such as a half-wave dipole, and a dc volt-meter.

MANUAL AVAILABLE SEP. \$2.00  
SEND S.A.S.E. FOR SPEC SHEET  
R.I. RESIDENTS ADD 6% SALES TAX

## TEDCO

9 Canonicus Avenue  
Newport, Rhode Island  
02840

## Digitrex Electronics

### PA-19 Wideband Preamp

- 2 to 200 MHz Bandwidth (3dB Points)
- 19 dB Gain
- 50 Ohms Input & Output Impedance
- Tiny PC Board Size (7/8" x 1-5/8")
- Absolutely No Tuning Required
- Extremely Stable
- Draws only 20mA @ 12VDC
- Great Way to Increase Sensitivity of Receivers, Counters, etc
- Fully Assembled and Tested
- Instructions Provided, Full Warranty

only **\$8.95**

• 50 Shipping/Handling



• 75 mV Sensitivity

### Portable 600 MHz Frequency Counter

- 1-600 MHz Range
- 1 KHz or 100 Hz Resolution
- Assembled and Tested
- Full Lifetime Warranty
- Size 5 1/2 x 2 1/2 x 1 1/2"
- BNC Whip Antenna Opt. \$8.95

**\$59.95** post. (less gov.)

C.O.D. Orders Welcome

**Digitrex Electronics**  
4412 Fernlee, Royal Oak  
Michigan 48073 313 661-9247

## HI-Q BALUN

- For dipoles, yagis, inverted vees & doublets
- Replaces center insulator
- Puts power in antenna
- Broadbanded 3-40 MHz
- Small, lightweight and weatherproof
- 1:1 Impedance ratio
- For full legal power and more
- Helps eliminate TVI
- With SO 239 connector



**\$10.95**

## HI-Q ANTENNA CENTER INSULATOR



- Small, rugged, lightweight weatherproof
- Replaces center insulator
- Handles full legal power and more

**\$5.95** With SO 239 connector

## HI-Q ANTENNA END INSULATORS



Rugged lightweight weather proof made of top quality material with high dielectric qualities and excellent weatherability. End insulators are constructed in a spring-urdering fashion to permit winding of loading coils or current winding for tuned traps.

- May be used for Guy wire strain insulators
- End or center insulators for antennas

**\$4.95** • Construction of antenna loading coils or multiband traps

## DIPOLES

MODEL	BANDS	LENGTH	PRICE WITH HI-Q BALUN	WITH HI-Q CENTER INSULATOR
<b>Dipoles</b>				
D 80	80-75	130	\$29.95	\$24.95
D 40	40-15	66	25.95	21.95
D 20	20	33	14.95	20.95
D 15	15	22	23.95	19.95
D 10	10	16	22.95	18.95
<b>Shortened dipoles</b>				
SD 80	80-75	93	31.95	27.95
SD 40	40	43	28.95	24.95
<b>Parallel dipoles</b>				
PD 8010	80-40-20-10-15	130	39.95	35.95
PD 4010	40-20-10-15	66	33.95	29.95
PD 8040	80-40-15	130	34.95	31.95
PD 4020	40-20-15	66	29.95	25.95
<b>Dipole shorteners - only, same as included in SD models</b>				
S 80	80-75		\$34.95	\$31.95
S 40	40		\$31.95	\$28.95

All antennas will come into with HI-Q Balun or HI-Q Antenna Center Insulator. All 14 antennas are weather resistant. 100 MHz antenna support rope (SD models only) is made of high legal power. Antennas may be used as an inverted U and may also be used by MARS or SWLs.

**Antenna accessories** - available with antenna orders  
Nylon guy rope 40' length 10' length \$7.49  
Ceramic (Dogone) Type antenna insulators \$7.00 or \$5  
SO 239 size connector bars \$5

All prices are postpaid USA 48. Available at job layover. Dealer orders direct from us.

**Van Gorden Engineering**  
BOX 2198, S. RUCHE, OHIO 43121 Dealer Inquiries Invited

Call or Write for Delivery or Quote

# KENWOOD TR-9000



LEAVE A MESSAGE & WE'LL CALL YOU BACK!

MASTERCARD • VISA

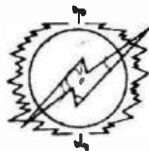

## MADISON

Electronics Supply, Inc.

1508 McKinney • Houston, Texas 77002 • (713) 658-0268

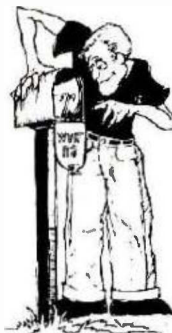

**Feel like you're  
missing something?**

You could be if you don't have a subscription to the "NEW" Ham Radio HORIZONS.

Here are some exciting features from the upcoming May issue:

- Easy to assemble and inexpensive to build keyer
- FCC Interview
- Bill Orr on a basic 813 amplifier
- Q & A column
- And much, much more!

More than ever HORIZONS is your kind of magazine, written with your interests in mind. Try a subscription today. Just use the handy bind-in card found between pages 68 and 69 or send \$12 for a year's subscription to:



Greenville, NH 03048

AMATEUR  
RADIO'S  
CHANGING  
AND SO ARE  
WE

# TOWERS by ALUMA

HIGHEST QUALITY  
ALUMINUM & STEEL

60 Ft. Aluminum,  
Crank-Up  
Model T-60 H

40' Steel  
Crank-Up  
Model SHG-40

★ TELESCOPING  
(CRANK UP)

★ GUYED (STACK-UP)

★ TILT-OVER MODELS

Easy to install. Low Prices.  
Crank-ups to 100 ft.

EXCELLENT FOR  
HAM COMMUNICATIONS

SPECIAL  
Four Section 50 Ft.  
Van Mounted Crank-Up  
Aluma Tower

Over 36 types aluminum  
and steel towers made—  
specials designed and  
made—write for details

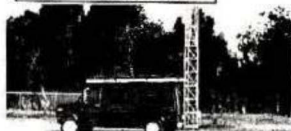

**ALUMA TOWER CO.**  
Box 2806 HH  
VERO BEACH, FLA. 32960  
PHONE (305) 567-3423  
TELEX 80-3405



**A FLEA GROWS IN HAMERICA!**  
YES, A NATIONAL MARKET PLACE  
FOR DEALINGS IN USED GEAR.

1879 POST RD. P.O. BOX 66, SOUTHPORT, CT 06490

HGM matches Buyers with Owners of used equipment. Perfectly! Register gear you want to sell or buy, nationally, for only \$3.75. At least once a week, HGM compares Buyer specifications to all available equipment registered by Owners. For each perfect match, HGM writes Buyers the particulars about the gear. Buyers contact Owners directly, and all negotiations are strictly between Owners and Buyers.

HGM GUARANTEE. Just \$3.75 per registration to "sell" or a "buy", and your Registration remains active for 17 unique matchings or 17 months. No HGM commissions! We cannot warrant or guarantee any equipment found through HGM since everything is between Owners and Buyers. But we do guarantee unique matchings and 17 matchings or months. A fabulous service for the amateur service!

REGISTER NOW. Use this form or facsimile and enclose the \$3.75 fee for each Registration. OWNERS: Describe unit by Type, Brand, and Model. Indicate exact Sell Price and purchase date. BUYERS have two choices: Choice #1: Type of Gear, Indicate Type and one Price Range. Example Transceiver, \$700-\$800. Choice #2: Specific Unit, regardless of price. Indicate specific Brand and Model you want. Example: Transceiver, Ten-Tec, Century 21.

YES, hamgearmart, I need your help! I understand your Guarantee, and I'm enclosing \$3.75 with this Registration. Enter my Registration immediately.

Please register me as a

**OWNER**  **BUYER**

SELL PRICE	TYPE OF GEAR	PRICE RANGES
GEAR YEAR	BRAND NAME	A 40 - 99 B 100 - 199 C 200 - 299 D 300 - 399 E 400 - 524 F 525 - 699 G 700 - 899 H 900 - 1099 I 1100 - 1399 J 1400 AND UP
PURCHASED	MODEL NUMBER	
NEW/USED		

NAME \_\_\_\_\_ CALL \_\_\_\_\_ CLASS \_\_\_\_\_

ADDRESS \_\_\_\_\_ TELEPHONE \_\_\_\_\_

CITY \_\_\_\_\_ STATE \_\_\_\_\_ ZIP \_\_\_\_\_

hamgearmart 1879 Post Road, P.O. Box 66  
Southport, Connecticut 06490

**Hobbyists:**

Here is an interesting general electronics hobby magazine. It's loaded with lots of interesting simple circuits and ideas, not only about radio, but in all phases of electronics including test gear, audio, remote control and security systems. We are sure that you will find a number of worthwhile projects in this British magazine. For a sample copy, please send \$1 to cover postage and handling costs. Your dollar is applied to the cost of the subscription when ordered.

**1 Year (12 issues) \$20.00**  
**Radio & Electronics Constructor**  
Greenville, NH 03048



# New 2-meter direction.



## A compact transceiver with FM/SSB/CW plus...

### TR-9000

Kenwood's done it again! Now, it's the exciting TR-9000 2-meter all-mode transceiver... complete with a host of new features. Combining the convenience of FM with long-distance SSB and CW in a very compact, very affordable package, the TR-9000 is the answer for any serious Amateur Operator! Versatile? You bet! Because of its compactness, the TR-9000 is ideal for mobile installation. Add on its fixed-station accessories and it becomes the obvious choice for your ham shack!

#### TR-9000 FEATURES:

- FM, USB, LSB, and CW... all popular modes
- Compact size... only 6 11/16 inches wide X 2 21/32 inches high X 9 7/32 inches deep
- Digital dual VFOs...with selectable tuning steps of 100 Hz, 5 kHz, and 10 kHz, convenient for each mode of operation
- Digital frequency display... five, four or three digits, depending on selected tuning step

- Extended frequency coverage 143 9000 – 148 9999 MHz
- Five memories:
  - M1 – M4... for simplex or  $\pm$  600 kHz repeater offset
  - M5... for nonstandard offset (memorizes transmit and receive frequency independently)
- Scan of entire band... automatic busy stop and free scan
- SSB/CW search... sweeps over selectable 9.9-kHz bandwidth segments, for easy monitoring
- UP/DOWN microphone (standard) "beep" sounds with each frequency step
- Noise blanker... eliminates pulse-type noise on SSB and CW
- Low-noise, dual-gate MOSFET and two-stage monolithic crystal filter for improved receiver front-end characteristics
- RIT (receiver incremental tuning) for SSB and CW... effective even on memory channels
- RF gain control
- CW sidetone
- Automatic selection of AGC time constant with MODE switch (slow for SSB and fast for CW)
- Improved power module for reliable and stable linear RF output
- Selectable power outputs 10 W (HI)/1 W (LOW)
- Mobile mounting bracket... easy to mount, with quick-release levers
- LED indicators... ON AIR, BUSY, and VFO
- Accessory terminals on rear panel... KEY, BACKUP DC, STBY, EXT SP, DC, TONE INPUT, and ANT

See your Authorized Kenwood Dealer now for details on the TR-9000... the new direction in 2-meter all-mode transceivers!

NOTE: Price, specifications subject to change without notice and obligation

#### MATCHING ACCESSORIES FOR FIXED-STATION OPERATION:

- PS-20 power supply
- SP-120 external speaker
- BO-9 System Base... with power switch, SEND/RECEIVE switch for CW operation, backup power supply for memory retention (BC-1 backup power adaptor may also be used for this application), and headphone jack



# WHEN OUR CUSTOMERS TALK...WE LISTEN.

DS3100 ASR

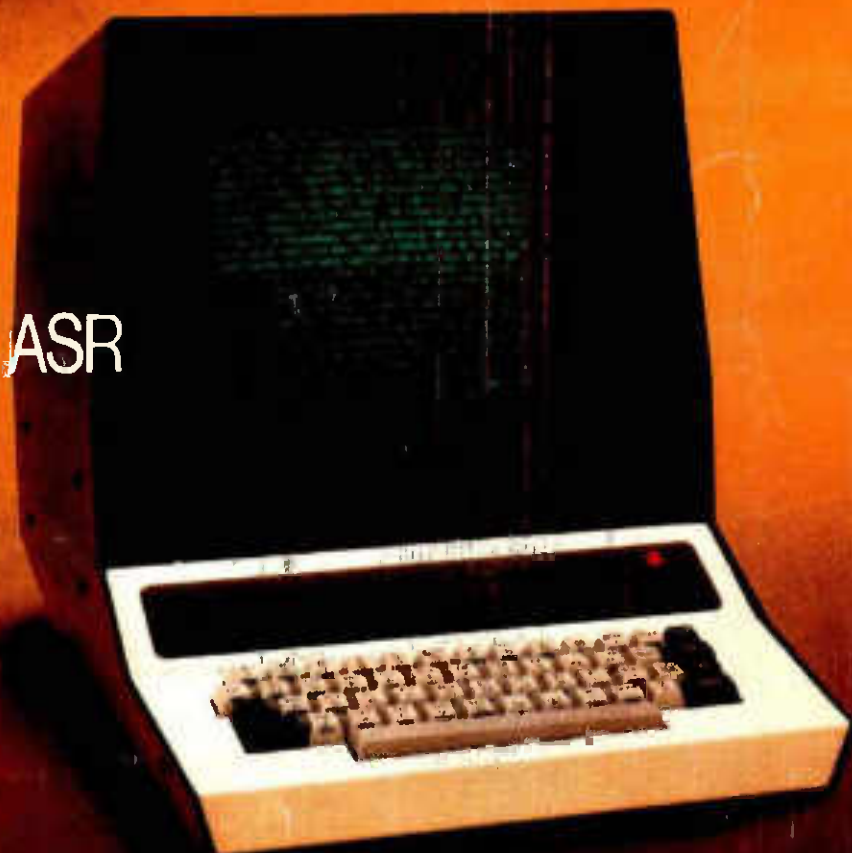

## We've Been Taking Notes.

Combining your ideas with some of our own, we've come up with what has to be the most advanced and convenient terminal available. These are some of the conveniences you can now enjoy by putting the DS3100 ASR in your RTTY and CW station:

### ASR Operation (Compose your transmission *WHILE* receiving)

- 150-line Receiver Buffer
- 50-line Transmit Buffer
- Split Screen to Show Buffers
- Internal Real-Time Clock
- 10 Programmable Messages
- Automatic Answer-Back (WRU)
- Morse, Baudot, or ASCII Operation
- RTTY and CW Identification
- Full 128-Character ASCII
- 110-9600 baud ASCII
- 60-130 WPM Baudot
- 1-175 WPM Morse

Write or call for the DS3100 ASR specifications and see how **YOU** have helped design the new standard in amateur radio terminals.



**HAL COMMUNICATIONS CORP.**

Box 365  
Urbana, Illinois 61801  
217-367-7373

For our European Customers Contact:  
Richter & Co., Hannover  
I E C Interelco, Bissone