

**Focus
on antennas**

HAM RADIO HORIZONS

JUNE 1978 / \$1.25

How to cure your high SWR
HRH Interview: an SSB pioneer



Sam Broscious, W4ZRN



DRAKE TR-7

solid state continuous coverage synthesized hf system

Introducing a remarkable engineering breakthrough...



Designed and
manufactured
in U.S.A.

Models shown
are Drake
TR-7/DR-7
with RV-7
and MS-7

0-30 MHz

continuous coverage reception capability

160-10 Meters

Amateur Band transmission, including capability for
MARS, Embassy, Government, and future band expansions*

**The Drake TR-7 System significantly
advances the technology of worldwide
radio communications and unfolds
an entirely new state of the art.**

KENWOOD SUPER BUYS

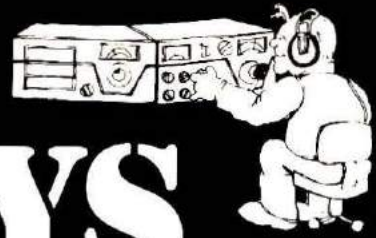

CALL TOLL FREE! 1-800-633-3410

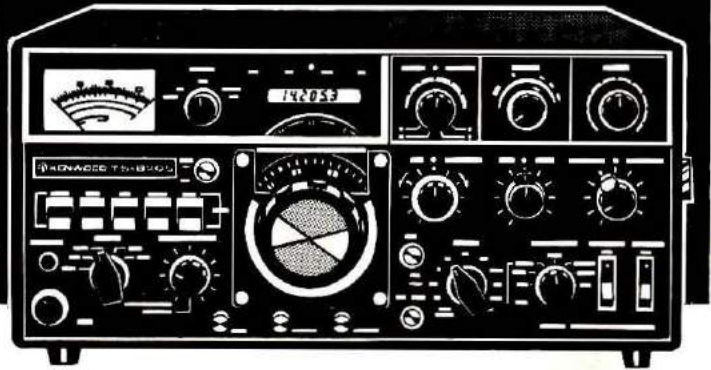
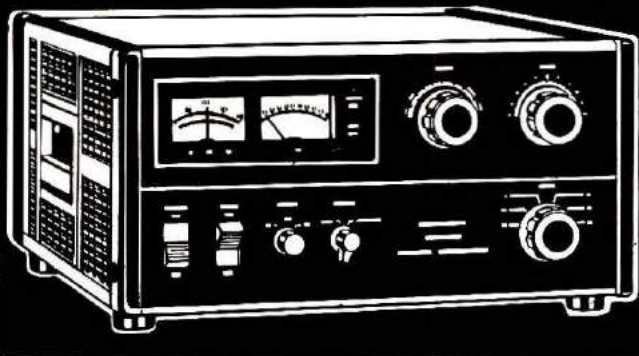

KENWOOD TL-922 linear amplifier

The TL-922 features: • 160 thru 10 meter coverage • Uses two EIMAC 3-500Z tubes • Grounded-grid AB2 • Time delay fan circuit • Drive requirements: 80W or more for full output • RF input power: 2000W PEP on SSB, 1000W DC on CW, RTTY • Power requirements: 120/220/240 VAC, 50/60 Hz • Thermal protected transformer.

1100.00 list price. Call Toll-Free for quote.

KENWOOD TS-820S transceiver

The NEW Kenwood TS-820S features a factory installed digital frequency readout. • 160 thru 10 meter coverage • Integral IF shift • RF speech processor • VOX • Noise blanker • PLL • Built-in 25 KHz calibrator • CW side tone & semi-break-in • IF OUT, RTTY, & XVTR • Phone patch IN and OUT terminals.

1098.00 list price. Call Toll-Free for quote.



KENWOOD TR-7400A 2m FM transceiver

Features: • CTCSS provisions, encode and decode • 25 watt output RF • Solid-state final stage • LED readout • PLL gives 800 discrete channels • Repeater offset circuit • PLL unlock protection circuit • MOS FET.

399.00 list price. Call for quote.



KENWOOD TS-520S SSB transceiver

TS-520S features: • 160 thru 10 meter coverage • Optional DG-5 frequency display (on top of unit) • New speech processor with audio compression amplifier • Built-in AC power supply (DC-DC converter, optional) • RF attenuator • Provision for separate receive antenna & phone-patch.

739.00 list price. Call for quote.



KENWOOD TR-2200A 2m FM transceiver

A high performance, portable 2 meter FM transceiver. Features: • 146 to 148 MHz coverage • 12 channels (6 supplied) • 2 watts HI output or 0.4 watts LOW output • ¼ wave telescoping antenna • Also included: NiCad battery pack, charger, carrying case and microphone.

229.00 list price. Call for quote.

Remember, you can call TOLL FREE: 1-800-633-3410 in U.S.A. or call 1-800-292-8668 in Alabama for our low price quote. Store hours: 9:00 AM til 5:30 PM, Monday thru Friday.



Long's Electronics



MAIL ORDERS: P.O. BOX 11347 BIRMINGHAM, AL 35202 • STREET ADDRESS: 2808 7TH AVENUE SOUTH BIRMINGHAM, ALABAMA 35233

THIS MONTHS

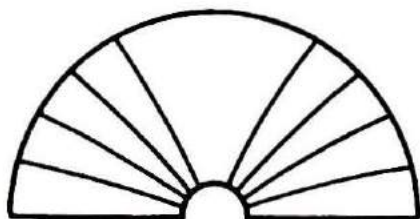

HORIZONS

High-Frequency Antennas

When you're putting your amateur station together, one of the first things you have to think about is an antenna. With so many types to choose from, it's a difficult choice. In this article W1HR talks about some simple antennas for the high-frequency amateur bands which will give you the most bang for your buck.

High Standing-Wave Ratio?

Sometimes amateurs worry too much about their SWR, but there are times when something is definitely wrong — your transmitter doesn't like the feedline any more; you have RF all over the shack instead of out yonder; for the first time in years you have TVI! What's going on? K4IPV relates some of his troubles, and what he did to cure them, in the hope that you'll avoid the same pitfalls.

Amateur Radio at School

Did you ever wonder how amateur radio clubs at schools got there? Establishing one is a little more complicated than simply plunking a transceiver down in a corner of a classroom and hooking it to an antenna, but it's not an impossible task if approached with planning and tact. Authors Kates and Smith, of Michigan State University, let you in on some of the secrets to

getting a school radio club established. Study them well — you'll have successfully completed the course when your club station makes its first contact on the air.

Stalking the Ionosphere

Here is the second part of N1RM's interview with Dr. Mike Villard. The questions touch on some intriguing subjects as they turn to such things as the study of meteoritic particles in space, long-delayed echoes, creating an artificial ionosphere, and on a more down-to-earth mode, selective audio filters with a dual purpose.

Questions? And Answers!

This is the last section of the Question and Answer series of license study aids, and one in which several of the components discussed previously are put together in some practical circuits. You'll see why an oscillator works, and how you keep an amplifier from being an oscillator. There's also a basic transmitter circuit, and a discussion of receivers — from a simple detector to a complex superheterodyne. Just in case you've forgotten what they look like, there's a sample FCC-type question to wind things up.

Five-Meter Days

Ask any old-timer in the vhf game if the present six-meter band compares to the five-meter spot of yesterday, and he'll regale you with stories of why it doesn't. He cannot give you technical data to back up his assertions, but he "knows" it is so. Perhaps he is right; maybe it's not the frequency difference, but rather the people difference that he feels. No matter, author Orr tells you a bit about the rigs and the operators of that now-submerged island, once inhabited by a special race — the vhf people.

Waiting Room Hamfest

Doctor's waiting rooms can be the most boring places on earth and, if you'll look around, most of the people there are just as bored as you are. However, a hand-held portable transceiver is bound to attract some curious glances, if not some outright questions. It won't cure what ails you, but it might take your mind off it for a while, as N9YL points out.

Delta-Loop Gain Antenna

Although the antenna described by G3LLL is designed for the 20-meter band, it can be easily scaled for the Novice portion of 15 meters. It uses material readily available in the amateur "junkbox" — some wire, a few insulators, some nylon fishing line, some TV masting, and clamps. Author G3LLL claims superior performance of this delta loop array over a multiband inverted V dipole mounted at the same point above his roof.

The Cover

Antennas are a vital part of an amateur's station, and they come in an endless variety of shapes and sizes. Now, at the beginning of the outdoor season, is time to start planning and constructing. Look at some of the ideas presented in this issue, then get outside and start measuring the distances and heights involved in putting up a new and better skywire. Original cover painting by Tom Broscius, WA2RWA.

HAM RADIO HORIZONS June, 1978, Volume 2, No. 6. Published monthly by Communications Technology, Inc., Greenville, New Hampshire 03048. One-year subscription rate, \$10.00; three-year subscription rate, \$24.00. Second-class postage paid at Greenville, New Hampshire 03048 and additional offices.

This NEW MFJ Versa Tuner II . . .

has SWR and dual range wattmeter, antenna switch, efficient airwound inductor, built in balun. Up to 300 watts RF output. Matches everything from 160 thru 10 Meters: dipoles, inverted vees, random wires, verticals, mobile whips, beams, balance lines, coax lines.

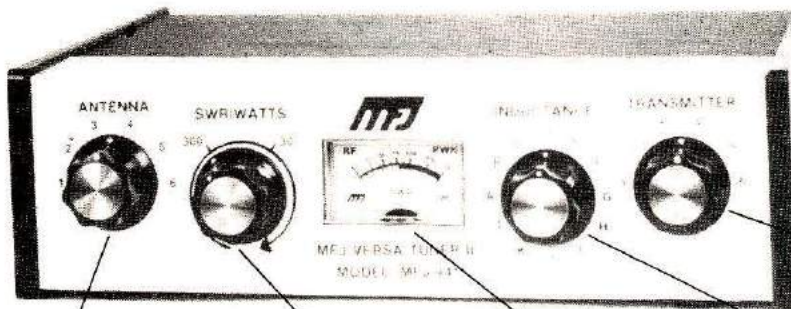

BRAND NEW

\$79⁹⁵

Antenna matching capacitor. 208 pf. 1000 volt spacing.

Sets power range, 300 and 30 watts. Pull for SWR.

Meter reads SWR and RF watts in 2 ranges.

Efficient airwound inductor gives more watts out and less losses.

Transmitter matching capacitor. 208 pf. 1000 volt spacing.

Only MFJ gives you this MFJ-941 Versa Tuner II with all these features at this price:

A SWR and dual range wattmeter (300 and 30 watts full scale) lets you measure RF power output for simplified tuning.

An antenna switch lets you select 2 coax fed antennas, random wire or balance line, and tuner bypass.

A new efficient airwound inductor (12 positions) gives you less losses than a tapped toroid for more watts out.

A 1:4 balun for balance lines. 1000 volt capacitor spacing. Mounting brackets for mobile installations (not shown).

With the NEW MFJ Versa Tuner II you can run your full transceiver power output — up to 300 watts RF power output — and match your

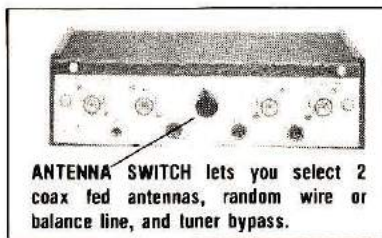

ANTENNA SWITCH lets you select 2 coax fed antennas, random wire or balance line, and tuner bypass.

transmitter to **any** feedline from 160 thru 10 Meters whether you have coax cable, balance line, or random wire.

You can tune out the SWR on your dipole, inverted vee, random wire, vertical, mobile whip, beam, quad, or whatever you have.

You can even operate all bands with just

one existing antenna. No need to put up separate antennas for each band.

Increase the usable bandwidth of your mobile whip by tuning out the SWR from inside your car. Works great with all solid state rigs (like the Atlas) and with all tube type rigs.

It travels well, too. Its ultra compact size 5x2x6 inches fits easily in a small corner of your suitcase.

This beautiful little tuner is housed in a deluxe eggshell white Ten-Tec enclosure with walnut grain sides.

SO-239 coax connectors are provided for transmitter input and coax fed antennas. Quality five way binding posts are used for the balance line inputs (2), random wire input (1), and ground (1).

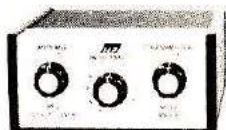

\$59⁹⁵

BRAND NEW

MFJ-901 VERSA TUNER

New efficient air wound coil for more watts out.

Only MFJ uses an efficient air wound inductor (12 positions) in this class of tuners to give you more watts out and less losses than a tapped toroid. Matches everything from 160 thru 10 Meters: dipoles, inverted vees, random wires, verticals, mobile whips, beams, balance lines, coax lines. Up to 200 watts RF output. 1:4 balun for balance lines. Tune out the SWR of your mobile whip from inside your car. Works with all rigs. Ultra compact 5x2x6 inches. SO-239 connectors. 5 way binding posts. Ten Tec enclosure.

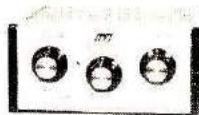

\$49⁹⁵

BRAND NEW

MFJ-900 ECONO TUNER

Same as MFJ-901 Versa Tuner, but does not have built-in balun for balance lines. Tunes coax lines and random lines.



\$39⁹⁵

MFJ-16010 RANDOM WIRE TUNER

Operate 160 thru 10 Meters. Up to 200 watts RF output. Matches high and low impedances. 12 position inductor. SO-239 connectors. 2x3x4 inches. Matches 25 to 200 ohms at 1.8 MHz.



\$49⁹⁵

BRAND NEW

MFJ-202 RF NOISE BRIDGE

This MFJ RF Noise Bridge lets you adjust your antenna quickly for maximum performance. Measure resonant frequency, radiation resistance and reactance. **Exclusive** range extender and expanded capacitance range (± 150 pf) gives you much extended measuring range.

Tells resonant frequency and whether to shorten or lengthen your antenna for minimum SWR. Adjust your single or multi-band dipole, inverted vee, beam, vertical, mobile whip or random system for maximum performance. 1 to 100 MHz. SO-239 connectors. 2x3x4 inches. 9 volt battery.

For Orders

Call toll-free 800-647-8660

For technical information, order and repair status, and in Mississippi, please call 601-323-5869.

Order any product from MFJ and try it. If not delighted, return within 30 days for a prompt refund (less shipping).

Order today. Money back if not delighted. One year unconditional guarantee. Add \$2.00 shipping/handling.

Order By Mail or Call TOLL FREE 800-647-8660 and Charge It On



MFJ ENTERPRISES

P. O. BOX 494
MISSISSIPPI STATE, MISSISSIPPI 39762

ATB-34

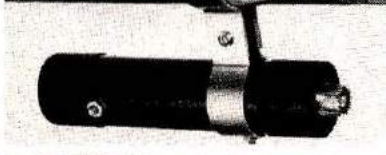
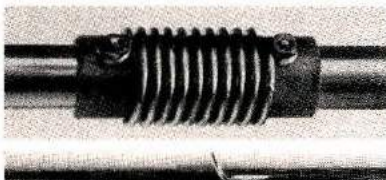
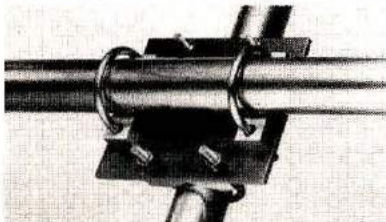
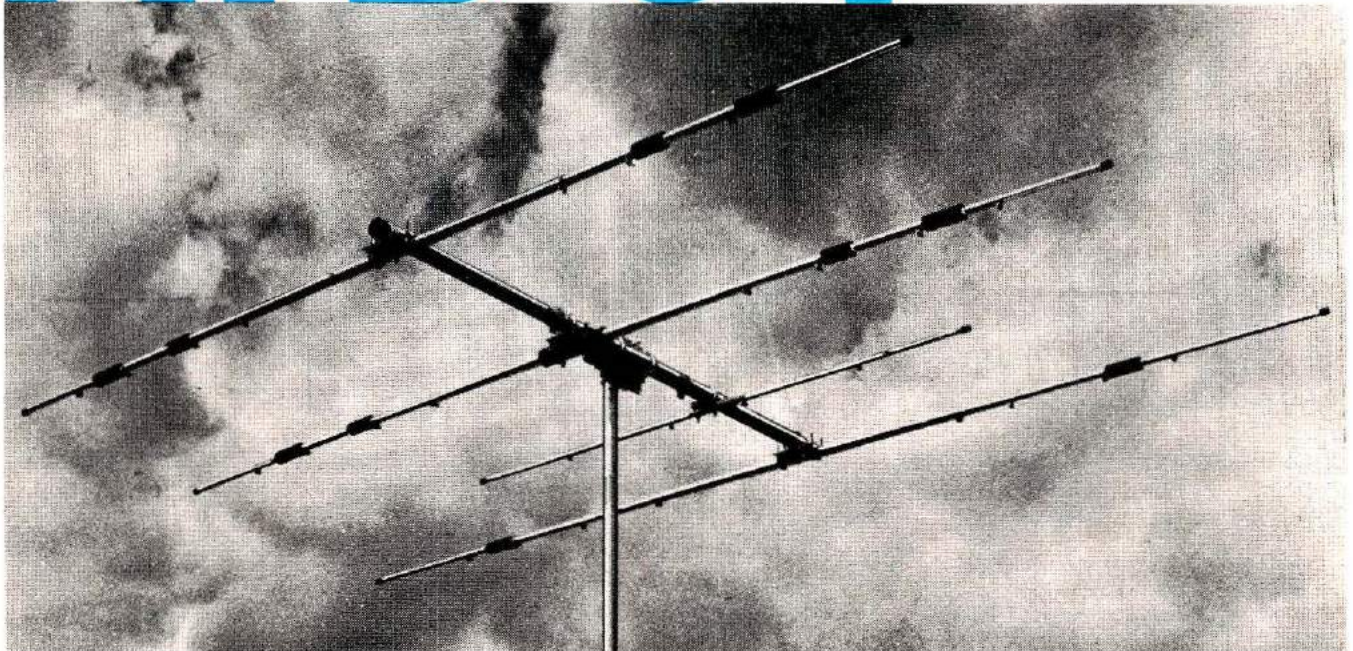

4 ELEMENT-3 BAND 10-15-20 METER BEAM

Cushcraft engineers have incorporated more than 30 years of design experience into the best 3 band HF beam available today. **ATB-34** has superb performance with three active elements on each band, the convenience of easy assembly and modest dimensions. Value through heavy duty all aluminum construction and a price complete with 1-1 balun.

Enjoy a new world of DX communications with ATB-34!

SPECIFICATIONS

FORWARD GAIN -	7.5 dBd	WIND SFC -	5.4 Sq.Ft.
F/B RATIO -	30 dB	WEIGHT -	42 Lbs.
VSWR -	1.5-1	WIND SURVIVAL -	90 MPH.
POWER HANDLING -	2000 WATTS PEP		
BOOM LENGTH/DIA. -	18' x 2 1/8"		
LONGEST ELEMENT -	32'8"		
TURNING RADIUS -	18'9"		

UPS SHIPPABLE

**COMPLETE
NO EXTRAS TO BUY**

IN STOCK WITH DISTRIBUTORS WORLDWIDE



cushcraft

CORPORATION

BOX 4680, MANCHESTER, N.H. 03108

June, 1978
Volume 2, Number 6

HAM RADIO HORIZONS

T.H. Tenney, Jr., W1NLB
Publisher
James R. Fisk, W1HR
Editor-in-Chief

Editorial Staff

Thomas F. McMullen, Jr., W1SL
Managing Editor
Patricia A. Hawes, WA1WPM
Executive Editor
Martin Hanft, WB1CHQ
Administrative Editor
Charles J. Carroll, K1XX
Alfred Wilson, W6NIF
Assistant Editors

Publishing Staff

C. Edward Buffington, WB1AMU
Assistant Publisher
Fred D. Moller, Jr., WA1USO
Advertising Manager
James H. Gray, W1XU
Assistant Advertising Manager
Therese R. Bourgault
Circulation Manager

Copyright 1978 by Communications
Technology, Inc. Title registered
at U.S. Patent Office

Subscription rates are
\$10.00 per year, worldwide

Microfilm copies
are available from
University Microfilms, International
Ann Arbor, Michigan 48103

Cassette tapes of selected articles
from *Ham Radio Horizons* are available to
the blind and physically handicapped
from Recorded Periodicals
919 Walnut Street, 8th Floor
Philadelphia, Pennsylvania 19107

Ham Radio Horizons
is published monthly by
Communications Technology, Inc
Greenville, New Hampshire 03048
Telephone 603-878-1441

CONTENTS

High-Frequency Antennas	12	
James R. Fisk, W1HR		
Some Cures for High SWR	20	
Joseph J. Carr, K4IPV		
Start An Amateur Club at School	24	
James R. Kates, WB8TCC Norman P. Smith, WA6ABD		
HRH Interviews Dr. O. G. Villard, W6QYT	30	
Douglas A. Blakeslee, N1RM		
Questions? And Answers!	36	
Thomas F. McMullen, W1SL		
Five-Meter Days	44	
William I. Orr, W6SAI		
A Funny Thing Happened Today	50	
Janice D. Shillington, N9YL		
Inverted V Delta Loop	54	
Harry Leeming, G3LLL		
Activities Calendar	92	Horizons Locator 83
Ad Check	94	Newsline 11
Ad Scan	89	Postbox 60
Advertiser's Index	94	Product Showcase 68
Benchmarks	64	Propagation Chart 91
DX Forecaster	90	The View From Here 6
Focus and Comment	8	This Month's Horizons 2

THE VIEW FROM HERE

Let's say you have an extra, advanced, or general class license and are bored with working DX, handling traffic, or trying out new SSTV circuits. What next? Why not shift gears and put your station and expertise to work helping out the Novice operators?

The other day I was tuning across the 40-meter Novice band and heard a cool, crisp, CW signal sending CQ. The band was full of shortwave-broadcast signals, and the CQ signal wasn't very strong. But it sounded like a tape recording — slow, steady, and with good spacing between characters. I listened. Nothing much but foreign-broadcast QRM and a few weak CW stations working each other. Then, down in the noise, I heard a fellow calling and answering the CQ. He was a WB9, sending very slowly with many errors, pauses, and lots of stops and starts. The station calling CQ answered the WB9, slowly and patiently. What ensued was one of the more beautiful things that happen in amateur radio. The station calling CQ was an old timer, who decided to put his rig on the Novice 40-meter band. The Novice who answered his call, obviously brand new and unsure of himself, was glad to hear *any* station. I listened to the QSO. What happened renewed my faith in ham radio. The old timer was obviously ready to use his high-speed keyer — you could tell at the end of his transmission. But the OT kept his cool and pounded away on his straight key, slow and steady.

It all ended with the usual amenities. The Novice op wanted another QSO, but above all, he wanted a QSL card to confirm the QSO. No problem. Addresses and names were exchanged. Hopefully, both exchanged QSL cards and both followed up to build a lasting friendship.

If you're an experienced ham operator and are interested in expanding your horizons, why not consider putting your rig on the Novice bands? The 40-meter Novice band is a good place to start. Many new hams obtain gear that is band limited. And most Novices start out on the low-frequency ham bands — 40 and 80 meters. Equipment is easy to get working on these bands, as most old timers will realize. Whatever Novice band you choose, bear in mind the following facts.

Most Novices have dipole antennas and rather unsophisticated transmit-receive facilities. Many use knife switches to transfer between receive and transmit. So if you decide to put your rig on the Novice bands, with all the new features, remember that the Novice is unaware of most modern developments. He's interested in receiving your transmission, simply and without flair.

Patience is the watchword when working Novices. Patience requires a certain discipline that pays off in genuine self satisfaction when you've completed a good QSO.

If you're an overseas amateur, your signal is more than welcome in the U.S. Novice bands. You'll find Novices that can handle Morse pretty well — they're almost ready for the next step — the exam for the General-Class license. But don't overlook the vast majority of U.S. Novices. All would like a QSO with a DX station. Slow down from time-to-time and give the new fellows a chance.

Some additional tips if you're an old timer and want to work Novices: If you call a Novice station and a reply is not immediately forthcoming, listen for at least two minutes. Perhaps it's his first QSO. The new amateur who puts his rig on the air for the first time is usually nervous, anxious, and maybe somewhat confused. If you can remember your first QSO, I'm sure you know the feeling (the first time I attempted to answer another station I forgot to turn on the B+ supply to the transmitter, but that's another story). So if the Novice you call doesn't come back right away, tune around and wait. Chances are he'll answer after a few minutes. If not, call him again. He's probably overwhelmed that someone answered his call.

It's a great feeling to be able to help a newcomer. All you need is a little patience and perseverance. If you do it right, you'll be surprised. You'll have a pile-up of Novices trying to work you — it's almost like being a rare DX. Try it, you'll like it . . . but be patient.

Jim Fisk, W1HR
editor-in-chief

ICOM wants you to

Begin with the Best

As you develop your skills, increase your participation in Ham Radio activities, and add hardware for ever-increasing flexibility of operations, you'll come to know ICOM. Just ask any old Ham. ICOM is the quality name in VHF/UHF Amateur Radio equipment because it is simply the best. ICOM is the line you'll want to move up to for unequaled quality and features.

But you needn't wait until you can trade in a truck load of equipment to reach up to ICOM. You can begin building your Amateur Radio operations with reasonably priced ICOM units that have flexible add-on features when you purchase your very first voice transceiver. And when you are installing ICOM's top-of-the-line fixed station unit, the ICOM equipment you began with will probably still be an important integral part of your active hardware.

Don't delay in moving up to ICOM: begin with the best.



Clockwise from lower left: IC-211 4MHz, 2 meter, All Mode Transceiver; IC-245 Mobile 2 meter Transceiver; IC-229 Mobile VHF FM Transceiver; IC-502 Portable 50 MHz SSB Transceiver; IC-215 Portable 2 meter FM Transceiver; IC-30A Mobile UHF FM Transceiver.

Ask your dealer for ICOM's complete product line catalog, or mail your request to an address below.

VHF/UHF AMATEUR AND MARINE COMMUNICATION EQUIPMENT

Distributed by:



ICOM

ICOM WEST, INC.
Suite 3
13256 Northrup Way
Bellevue, Wash. 98005
(206) 747-9020

ICOM EAST, INC.
Suite 307
3331 Towerwood Drive
Dallas, Texas 75234
(214) 620-2780

ICOM CANADA
7087 Victoria Drive
Vancouver B.C. V5P 3Y9
Canada
(604) 321-1833

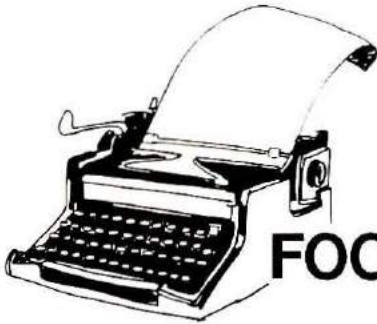

FOCUS & COMMENT

Have you practiced having an emergency lately? You really should try one on for size, you know. This emergency preparedness stuff is more than just something that the police and fire departments take care of on a plotting board down in the basement of the town hall. It should reach into your home, right into your shack, on a very personal level. When you get right down to it, that is what emergencies do — they involve individuals. The fact that often there are several individuals doesn't lessen the severity for any one of them. So, the sensible thing to do is to get ready to meet emergency situations on your own personal level.

To be realistic about it, carry your preparedness further than just counting the cans of soup on the emergency shelf, and looking at the supply of flashlight batteries and spare blankets. Check your rig and shack for preparedness, and then, when you think you are all set, pull the fuses to the ac mains and try making a few contacts. (Don't shut down your freezer or refrigerator unless you have an auxiliary power source; there's no point in making the drill wasteful of food supplies.) How did you make out? Did you actually work someone during your personal "power blackout?"

Now, for the next step: assume that whatever it was that took out the power to your house also removed your antenna. How long would it take you to rig up a substitute? Try it — you might as well make sure. After all, the real thing will not wait while you pore over the theory books and grope around in the basement (remember it has no lights) for that roll of wire and the components for a ground system.

You have a two-meter (or other vhf-band) fm rig? Fine! By all means try it out. Where is the adapter cord that converts it from the ac supply to battery operation? While you are thinking about fm, let me ask about your local repeater. Can it operate when the power lines are out? How often do they (the repeater technical committee, of course) operate it under emergency power? That's part of *your* preparedness too. The list of things to try goes on and on, but I'm sure you'll get more ideas when you actually try your own "personal" emergency drill.

There's no particular season of the year that is better or worse for disasters and emergencies, but I must admit that what got me started thinking about this theme was a small item in a newspaper — something to the effect that all of the excess moisture that the country has received this past winter makes things ripe for a tornado season of high activity. There are plenty of other "demons of destruction" that plague the country; floods, forest fires, earthquakes, industrial explosions, power blackouts, and, as we have seen this past winter, unusual snowstorms. It's a matter of considerable pride to read that amateurs did so much great work in helping out during the floods and snowfalls, but stop and ask yourself if those news items could have said the same thing of you.

Don't wait for a nationally declared simulated emergency test — start your own. When you have your own station functioning smoothly while the lights are out, look around the neighborhood and see if there is a club or group that you can join or offer your services to. If there isn't perhaps it's time to start one. Remember, intentions don't handle messages, preparedness does; and it makes good headlines for Amateur Radio too!

Thomas McMullen, W1SL
Managing Editor

TRIPLE BONUS DEAL

on KENWOOD TS-820S

**SERVING
HAMS
BETTER!**

*North ... south ...
east ... west*

All leading brands ...
in-depth stocks ...
new/used gear.



Bob Ferrero, W6RJ/K6AHV,
Jim Rafferty, N6RJ other well known
hams give you courteous, personalized service.



The deal:

- 1)—Send us **1098.00*** (in the form of check, M/O, BankAmericard, VISA, Master Charge)
- 2)—We'll ship you immediately, a beautiful brand-spanking-new, peerless performing **KENWOOD TS-820S TRANSCEIVER!**

- 3)—PLUS a BIRD Model 43 wattmeter

(a 120.00 retail value). **OR . . .**
De luxe Remote VFO
(for TS-820S) Reg. 149.00



**PLUS prepaid
shipment of
both items**
(UPS Brown)



Kenwood TS-520S Transceiver

PLUS 1)-Hustler 4BTV antenna (Reg. 99.95) or
your 2)-Hy-Gain 18AVT antenna (Reg. 97.00) or
choice of: 3)-Dentron Jr. Tuner (Reg. 79.00).

Special **739.00** Prepaid, U.P.S. Brown.

**HAM X
TAILTWISTER™**
Reg. 349.95
249.00



**SHURE
444 MIC.**
33.95



HAM III 129.95



**Kenwood TR-7400 Transceiver PLUS
Astron 12A, 12VDC/115VAC supply (Reg. 59.95)
399.00** prepaid (UPS Brown)

BIRD ELEMENTS
(Not supplied with
BIRD wattmeter)
2-30MHz **42.00**
25-1000MHz **36.00**

OVER THE COUNTER (Mon. thru Sat. 10AM to 5:30PM) MAIL ORDER, phone, write

ANAHEIM, CA. 92801
2620 W. La Palma
(714) 761-3033, (213) 860-2040
1 mile east Knotts Berry Farm

SAN DIEGO, CA. 92123
5375 Kearny Villa Road
(714) 560-4900

BURLINGAME, CA. 94010
999 Howard Avenue
(415) 342-5757
5 miles south on 101 from S.F. Airport.

VAN NUYS, CA. 91401
13754 Victory Blvd.
(213) 988-2212

**HAM
RADIO
OUTLET®**



• ATLAS • BIRD • CDE • COLLINS • CUSHCRAFT • CURTIS • DENTRON • DRAKE
• EIMAC • HUSTLER • HY-GAIN • ICOM • KENWOOD • KLM • MOSLEY • SWAN • TEMPO
• TEN-TEC • TRI-EX • YAESU • more

Prices/specs subject to change without notice. Calif. residents add sales tax.

THE SYSTEM TWO™

Top Performance for 20 - 15 - 10 Meters!

TRIBANDER ANTENNA . . .

Wilson

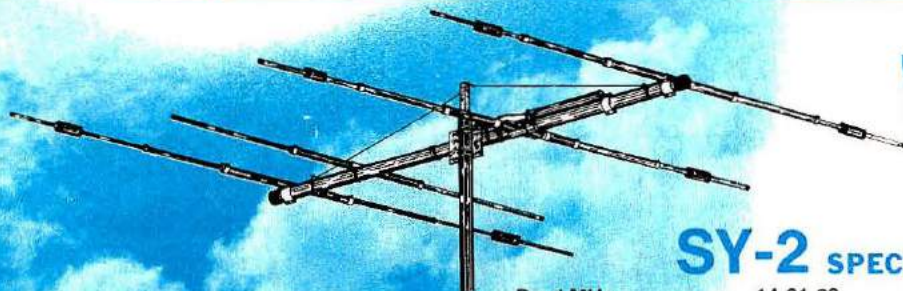

SY-2 SPECIFICATIONS

Band MHz	14-21-28
Maximum Power Input	4 Kw
VSWR (at Resonance)	1.5:1
Impedance	50 Ohms
F/B Ratio (dB)	20-25
Boom (O.D. x Length)	2" x 18'6"
No. Elements	4
Longest Element (Ft.)	26'7"
Turning Radius (Ft.)	16'4"
Mast Diameter	2" O.D.
Boom Diameter	2" O.D.

Surface Area (Sq. Ft.)	6.15
Wind Loading at 80 mph	153
Assembled Weight (Lbs. - Approx.)	47
Shipping Weight (Lbs. - Approx.)	50
Matching Method	Beta
Only One Feed Line Required	

Delivers outstanding performance on 20, 15 and 10 meters. Features Wilson's large diameter High-Q Traps, feeds with 52 ohms coax, a beta match method presents tapered impedance which provides most efficient 3 band matching and DC ground to eliminate precipitation static. The result is SWR less than 1.5 to 1 at resonance on all bands and maximum front-to-back. An added feature is the separate 10 meter reflector for correct monoband spacing. Add to this the rugged boom to element mounting, heavy duty taper swaged elements, and you have

SYSTEM TWO™

. . . a space efficient, high performing, cost effective new tribander . . . value priced at \$199.95!

DEALERSHIPS AVAILABLE!!!
 We are looking for new Dealers for certain areas of the country. If you are interested, contact us for details.

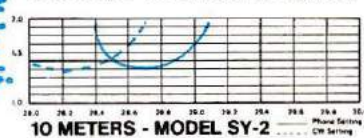
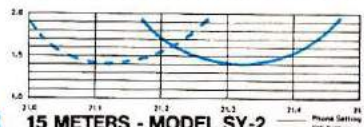
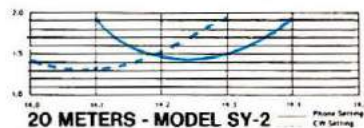

40 THRU 10 METERS VERTICAL TRAP

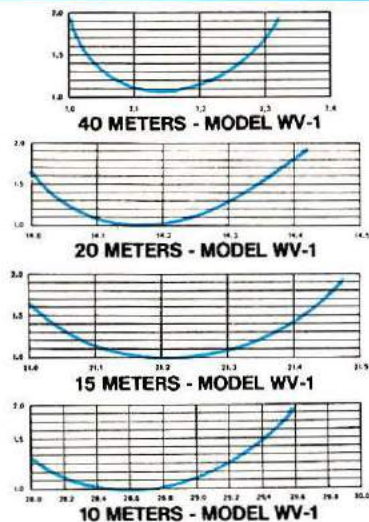

WV-1 WILSON VERTICAL TRAP ANTENNA

No bandswitching necessary with this vertical. An excellent low cost DX antenna with an electrical quarter wavelength on each band and low angle radiation. Advanced design provides low SWR and exceptionally flat response across full width of each band. Featured is the Wilson large diameter High-Q traps which will maintain resonant points with varying temperatures and humidity. Easily assembled, the WV-1 is supplied with base mount bracket to attach to vent pipe or to mast driven in the ground. The new WV-1 Antenna is priced at \$65.00 . . . and ships via UPS!

SPECIFICATIONS

Input Impedance: 50 Ohms • Powerhandling capability: Legal Limit • Two High-Q Traps with large diameter coils • Low Angle Radiation Omnidirectional performance • Taper Swaged Aluminum Tubing • Automatic Bandswitching • Mast Bracket furnished • SWR: 1.5:1 on all Bands • 1½" O.D. Heavy wall aluminum tubing • Does not require guying • Overall length: 25' 1½"

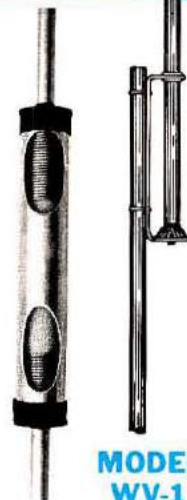

MODEL WV-1

Wilson Electronics Corp.
 4288 SO. POLARIS AVENUE • P. O. Box 19000 • LAS VEGAS, NEVADA 89119
 TELEPHONE (702) 739-1931 • TELEX 684-522

NEWSLINE

NOVICE LICENSES NOW have five-year terms and may be renewed just like any other Amateur license as a result of the Commission's action on Docket 20282. At the same time they also extended Technician's privileges to all Amateur frequencies above 50 MHz, giving Techs all of 6 as well as 2 meters. The effective date for these changes is May 15.

Though No New WR callsigns will be issued, present repeater licenses will remain in effect until their expiration dates. Repeaters not using WR callsigns will be able to use their owner's call with either "R" or "RPT" on CW, the word "Repeater" on phone.

144.5-145.5 MHz Will Be the new 2-meter repeater sub-band. However, repeaters will not be permitted the use of 220.0-220.5, 431-433, or 435-438 MHz to allow weak signal and satellite communications on those bands.

144.2 Has Been Suggested as the new 2-meter calling frequency for SSB to replace 145.1 when Techs get the rest of that band May 15. Rag chewers could then move up from 144.2, and DX chasers down, to leave the frequency open for later callers while still avoiding existing 144.1 operation.

INTERNATIONAL THIRD PARTY traffic is legal with only 28 countries, FCC noted in an April 5 release, and of those only four — Ghana, Israel, Jordan, and Liberia — are not in the Americas. A few special arrangements do exist, however; 4U1ITU in Geneva has a special agreement with the U.S. for such traffic.

A "Banned" List — three countries with whom U.S. Amateurs are not permitted contacts — was also included with the release but was apparently not current. As of now, the only country with which U.S. Amateurs are not permitted contact is mainland China, and even that prohibition may be lifted soon.

NEW CHIEF OF THE FCC'S Safety and Special Services Bureau is Carlos Roberts, replacing Charley Higginbotham whose retirement became official April 7. Roberts comes to Safety and Special Services from the FCC's Office of Plans and Policy, where he's been Chief since July, 1975. He's been with the FCC since graduating from college in 1970, starting with the Field Operations Bureau. In 1973 he supervised a Special Enforcement Facility for CB rules, so he's no stranger to either CB or Amateur Radio.

AMSAT NEEDS A FULL TIME ENGINEER and a technician to work on the Phase III satellite development and construction. Work will be in the Washington area, probably at AMSAT's planned new facility at Goddard, and will last through at least 1979. Contact AMSAT, Box 27, Washington, D.C. 20044 if interested.

OSCAR 8's Launch and insertion into orbit got international publicity from a taped rebroadcast over Voice of America that was beamed to Africa and Europe. KØBJ has also made a one-hour tape of the highlights of OSCAR 8's birth and has copies available for \$2.75 postpaid to Ham Data Systems, PO Drawer DX, Colby, Kansas 67701.

NEW PREFIXES FOR U.S. Pacific and Caribbean islands are: KH1, Canton; KH2, Guam; KH3, Johnston; KH4, Midway; KH5K, Kingman; KH5, Palmyra; KH6, Hawaii; KH7, Kure; KH8, Samoa; and KH9, Wake. Also KP1, Navassa; KP2, Virgin Islands; KP3, Serrana Bank, and KP4, Puerto Rico. Other spots such as the Marshall Islands and Guantanamo Bay are not FCC administered so remain unchanged.

VERY HIGH SUNSPOT ACTIVITY is predicted for solar-cycle 21 by a new prediction technique developed by Soviet Scientist A.I. Ohl and refined by Space Environment Services Center researcher H.H. Sargent. In a paper delivered March 24 at the IEEE Vehicular Technology Group Conference in Denver, Mr. Sargent explained the technique and showed how it predicts that smoothed monthly sunspot numbers will reach 100 this fall and go to over 150 as this cycle peaks in early 1980.

CBERS WON'T BE TALKING to Amateurs, despite reports to that effect appearing in news items concerning the new simplified CB rules. FCC did drop the specific prohibition against CB-to-Amateur communication in the new rules, but only as a move to ease future emergency-communications possibilities.

NEW ZEALAND AMATEURS now have operating privileges for the entire 40-meter band, 7.0-7.3 MHz.

HEATH MICODER USERS who've been troubled by frequency-stability problems can update their encoders with the crystal-controlled oscillator used in the Micoder II. Price of modification kit is \$9 plus 90¢ shipping from Heath.

"GOING SAILING WITH Amateur Radio" is a new book featuring recent W6QKI and K3RXX articles from Ham Radio Horizons plus a good deal of related (potential Amateur) Horizons material. It also includes pertinent FCC marine Amateur Radio Rules. Price is \$3.95 postpaid from the Ham Radio Bookstore, Greenville, New Hampshire 03048.

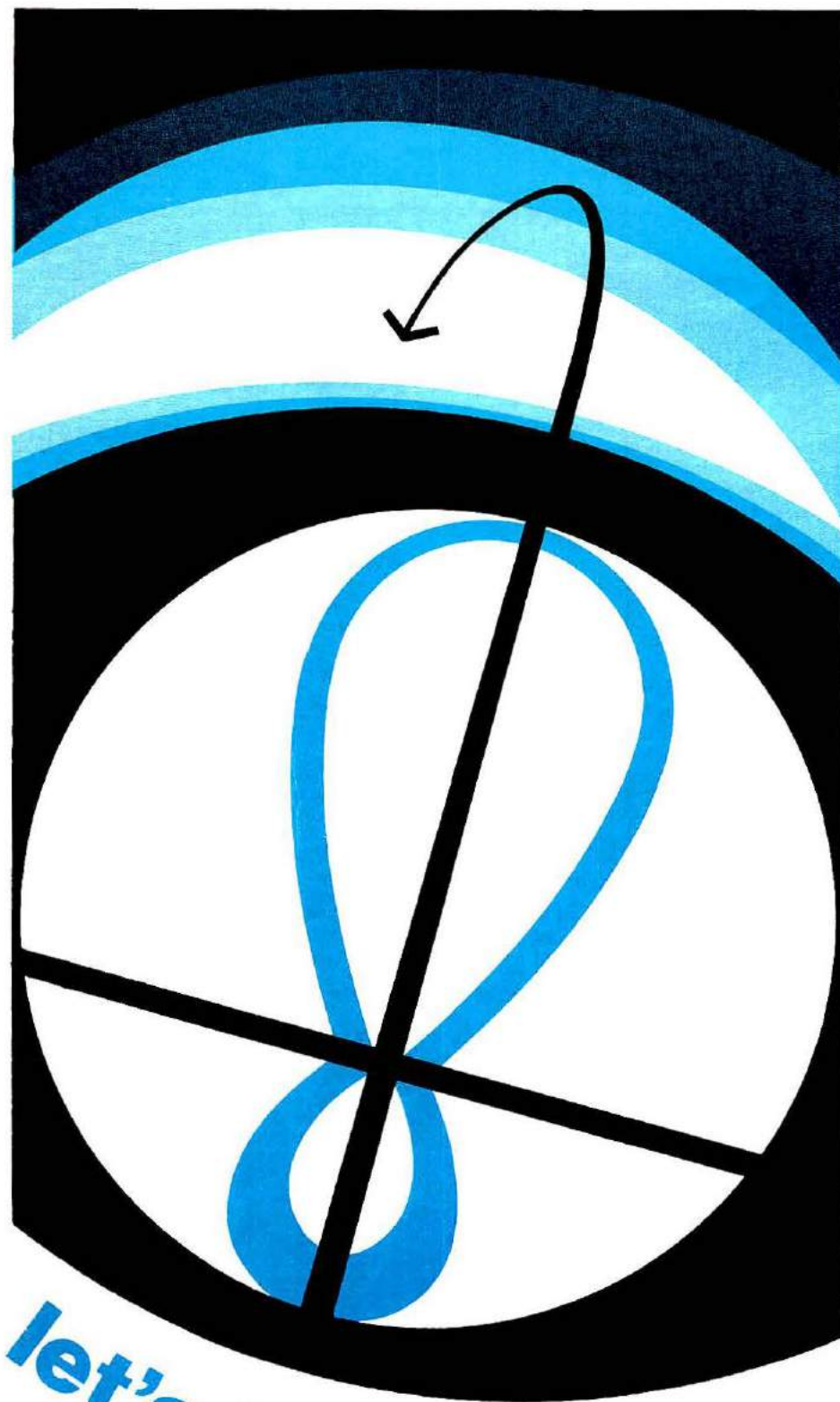

let's talk about

HF ANTENNAS

BY JAMES R. FISK, W1HR

If you tune across the amateur bands, listening in on the conversations, you'll probably find that the topic discussed most is antennas. This should not be surprising since most amateurs use commercial equipment, so the station antenna is one of the few items left open for experimentation. And all hams, by nature, are experimenters.

If a station seems to be getting out especially well, the first thing other amateurs want to know is what it has for an antenna. If a stateside station has a particularly potent signal into Europe, for example, you can bet that all the Europeans want to know what the American ham is using for an antenna. I've seen the same scenario time and again during late-night DX ragchews on 80 meters, on the 20-meter County Hunter's Net, and on various 40-meter traffic nets.

I've known amateurs who have spent all summer building and testing antennas, trying to come up with the best possible combination; others are convinced that a particular design has the most potential and will spend days fine tuning it for maximum performance. Amateurs who've been on the air for a few years have a pretty good idea of which antennas work best (and which fit within their budget), but there are so many antenna types the newcomer simply doesn't know where to begin. Where antennas are concerned, simplest isn't necessarily the best in terms of performance, but simplest is almost always the least expensive and certainly the best place to start.

Simple amateur antennas

The one antenna that offers simplicity, low cost, and dependability is the simple doublet or half-wavelength dipole shown in Fig. 1. Of all its characteristics, dependability is probably the most

important — if it's cut to the right length, you can be sure it will be an effective radiator. It can be placed at practically any height above ground, it provides a good match to coaxial transmission line, and it

network in your transmitter compensates for non-resonance, within limits. In general, if you use a factory-made transmitter, it will properly load a dipole if you stay within about ± 2 per cent

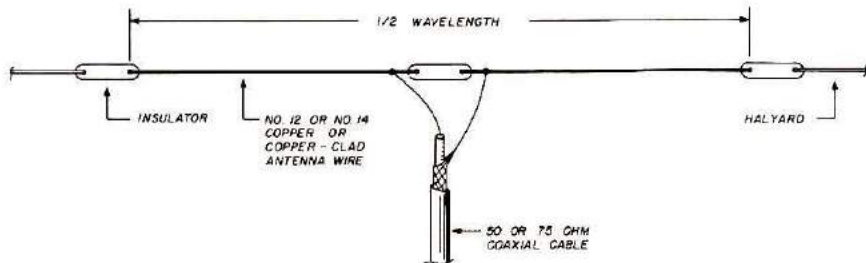

Fig. 1. Half-wave doublet or dipole antenna provides a good match to 50- or 75-ohm coaxial transmission lines. Correct dimensions for various high-frequency amateur bands are listed in Table 1. The lengths of rope which support the end of the dipole are called halyards.

is not dependent on a good ground system. Furthermore, you can assemble a dipole in a couple of hours for less than ten dollars. The correct length for the various amateur bands is shown in Table 1.

Although any antenna is naturally resonant at only one frequency, it can be used effectively both below and above resonance. This is because the output matching

of the dipole's resonant frequency. This means that a dipole which is cut to the center of most of the high-frequency amateur bands will provide good performance from one end of the band to the other. Unfortunately, the 80-meter band is an exception; on this band a dipole has a bandwidth of only about 150 kHz. This is sufficient bandwidth for the CW end of the band, or the

phone end, but not both.

One of the problems with a half-wavelength dipole on 80 meters is its great length. If you live on an average city lot, there's simply not enough space in your backyard for a horizontal 3.5-MHz dipole. One solution which is very popular is the inverted-V arrangement shown in Fig. 2. The inverted-V requires only one tall support instead of two, and gives nearly equal performance to the typical horizontal dipole which is only 40 or 50 feet (12 to 15 meters) high. (A dipole that is as high above ground as it is long is best for DX work, but few amateurs are able to install their 80-meter dipoles 125 feet [38 meters] above the ground.)

Sloping the halves of the dipole down toward ground in the inverted-V arrangement tends to lower the resonant frequency of the antenna, so the length of the inverted-V must be shortened somewhat to resonate at the same frequency as a horizontal dipole. Since both resonance and feedpoint impedance are a function of the apex angle (which should not be less than 90 degrees), there's no fixed formula for figuring out the correct length. The best bet is to cut the inverted-V to the length shown in Table 1 and equally shorten the length of each half until the antenna provides a good match to your coaxial transmission line at the desired operating frequency.

The operating bandwidth of an inverted-V is slightly less than a horizontal dipole, but bandwidth is still great enough to provide band-edge to band-edge operation on all bands but 80 meters. You can solve the limited bandwidth problem on 80 meters by using extra lengths of wire at the ends of the antenna, which are attached by clip leads, as shown in Fig. 3. If you cut the center section of the inverted-V for 3900 kHz, for example, and resonate the antenna at 3650 kHz with the added end sec-

Table 1. Length of half-wavelength dipole antennas for various frequencies in the high-frequency amateur bands.

Band	Frequency (MHz)	Use	Half Wavelength	
			(feet, inches)	(meters)
160	1.875	General	249' 7 1/4"	76.1
80	3.600	CW	130' 0"	39.6
80	3.725	Novice	125' 7 1/2"	38.3
80	3.750	General	124' 9 1/2"	38.0
75	3.800	Phone	123' 2"	37.5
40	7.100	CW	65' 11"	20.1
40	7.150	General	65' 5 1/2"	19.9
40	7.175	Novice	65' 3"	19.8
40	7.250	Phone	64' 6 1/2"	19.7
20	14.050	CW	33' 3 3/4"	10.15
20	14.150	General	33' 1"	10.08
20	14.200	Phone	32' 11 1/2"	10.05
20	14.275	Phone	32' 9 1/2"	10.00
15	21.100	CW	22' 2"	6.76
15	21.175	Novice	22' 1 1/4"	6.72
15	21.225	General	22' 1/2"	6.72
15	21.350	Phone	21' 11"	6.68
10	28.050	CW	16' 8 1/4"	5.09
10	28.150	Novice	16' 7 1/2"	5.07
10	28.510	Phone	16' 5"	5.00
10	29.475	Oscar	15' 10 1/2"	4.84



The SST T-1 Random Wire Antenna Tuner provides all-band operation (160 through 10 meters) with any random length of wire and will handle up to 200 watts. The same company also makes the T-2 Ultra Tuner which is designed for both coaxial fed antennas and random wires (photo courtesy SST Electronics).

tions, you should be able to cover all of 80 meters except the Extra-class CW segment at the low end, and the Extra-class phone band from 3750 to 3800 kHz. (You will be able to receive these frequencies perfectly well, but the output matching circuits in your transmitter won't be able to compensate for the off-resonance effects).

If you want to use your 80-meter dipole on any of the other amateur bands, you'll have to use an antenna tuner in the line to your transmitter. There are a number of antenna tuners or antenna matchers on the market which are designed to be used with coaxial transmission line; others are designed for end-fed wires (Fig. 4), so be sure you buy the right type.

For correct adjustment of the antenna tuner you must have an indication of swr, so it's a good idea to buy a tuner which incorporates an swr meter. The other consideration when purchasing an antenna tuner is the unit's power rating; obviously you don't want to use a 75-watt antenna tuner if you

have a 250-watt transmitter.

Another way to obtain multiband operation with a single simple antenna is to install another dipole under the first, as shown in Fig. 5. On the lower frequency band the longer pair of wires acts as a conventional half-wavelength dipole — the shorter dipole has

practically no effect on operation. On the higher band the shorter dipole radiates. There is some interaction on the higher band if the resonant frequencies are not harmonically related (3600 and 7200 kHz, for example), but this can be compensated for by slightly increasing the length of the higher frequency dipole (lowering its resonant frequency). It's nearly impossible to predict exactly how much the shorter, higher-frequency dipole must be lengthened, but if you plot the antenna's swr vs frequency on graph paper, you will immediately see where the antenna is resonant (the point of minimum swr).

Assuming the minimum swr occurs out of the amateur band at 7375 kHz, and you want minimum swr in the center of the band at 7150 kHz, the shorter dipole should be lengthened about 22 inches or 56 cm (11 inches or 28 cm on each end). This is based on the fact that the resonant frequency of a 40-meter dipole changes approximately 9 kHz per inch (4 kHz per cm). On the other high-frequency amateur bands the approximate change of

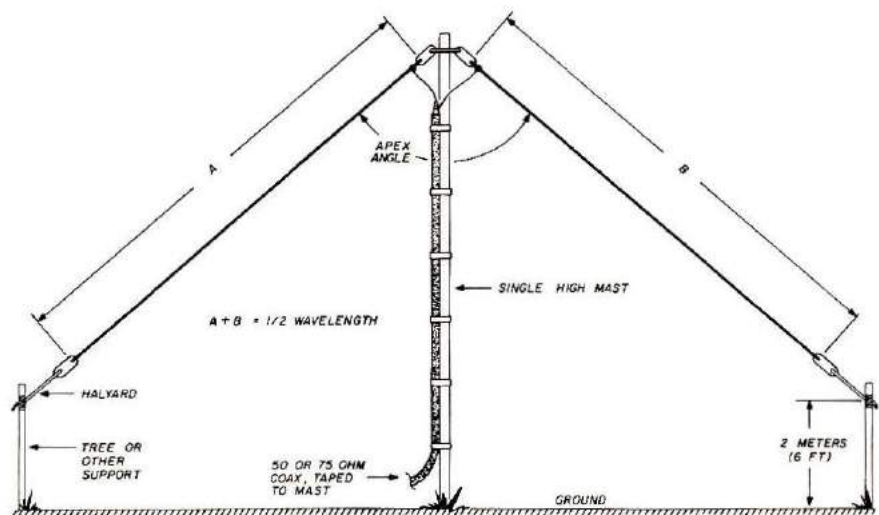

Fig. 2. The inverted-V dipole is simply a half-wavelength dipole with the ends sloping down toward the ground; the tie points for the halyards on each end of the antenna should be a minimum of 6 feet (2 meters) above ground so people don't walk into them. The resonant frequency of the inverted-V depends upon the apex angle and height above ground, so the length of the antenna must be pruned for low SWR as discussed in the text.

resonance with length is as follows:

80 meters	1.5 kHz/inch	1 kHz/cm
40 meters	9 kHz/inch	4 kHz/cm
20 meters	36 kHz/inch	14 kHz/cm
15 meters	80 kHz/inch	31 kHz/cm
10 meters	142 kHz/inch	56 kHz/cm

One special case of two-band operation with a single dipole is the use of a 40-meter dipole on 15 meters. Since a half-wavelength 40-meter dipole is three half-wavelengths long at 15 meters, it provides a good match to coaxial transmission line. However, you must be careful to cut the 40-meter dipole to resonant low in the band. If your 40-meter dipole resonates at 7075 kHz, for example, it will be resonant near the center of the 15-meter band. If the antenna is a half-wavelength long at 7200 kHz, however, its third-harmonic resonant point will be at 21.6 MHz, 150 kHz above the top 15-meter band edge!

If you want to operate on more than two bands with a simple horizontal antenna, you may want to try a trapped dipole as discussed in the January, 1978, issue of *Horizons*.^{*} There are also commercial multiband dipoles on the market which have been designed to give maximum

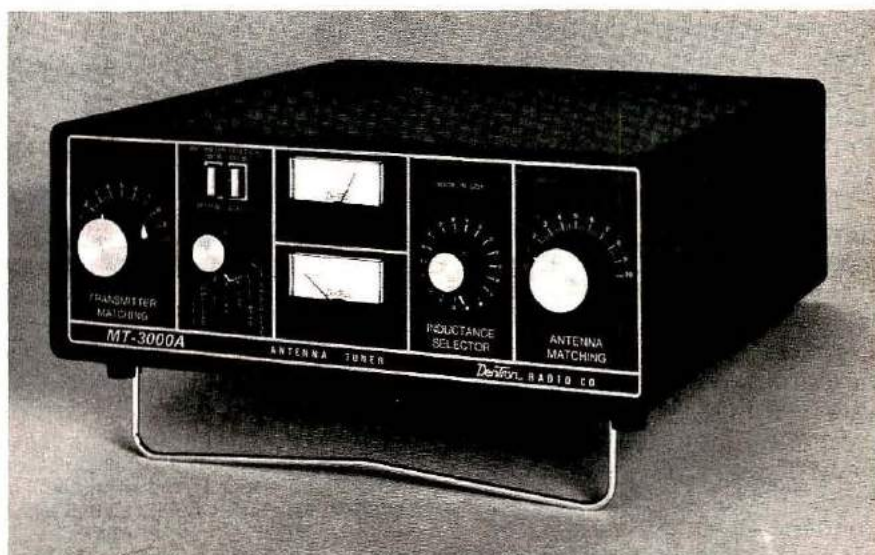

DenTron offers a versatile piece of equipment that provides matching capabilities to several types of antennas, as well as power and vswr monitoring circuits. A switch allows the operator to select one of several feed lines, or a dummy load for tune-up purposes. The built-in wattmeter has two ranges: 200 watts, or 2000 watts. The MT-3000A tuner covers the frequency range of 1.8 through 30 MHz, and will handle the maximum legal amateur power (photo courtesy DenTron Radio Company).

performance on several bands with a single antenna.

Dipole construction

When building a dipole, there are two things to keep in mind; the wire you use must be a good conductor and it must be strong enough to support the weight of the coaxial transmission line. Any good electrical conductor can be used for an antenna, including silver,

gold, copper, and aluminum. The precious metals are usually ruled out because of cost, but that hasn't always been the case. In the 1920s one amateur station in the Chicago area, in an effort to obtain maximum radiation efficiency, used gold-plated wire for his antenna — much to his surprise, it made absolutely no difference in performance! Gold plating is used on some military antennas, and those for spacecraft, but it's used because gold doesn't corrode or combine with other elements, not because of any magical electrical property. Silver plating is sometimes used at microwave frequencies for improved electrical performance, but it offers no measurable advantage below 1000 MHz or so.

From the standpoints of availability, cost, strength, and ease of soldering, copper is perhaps closest to the ideal antenna material. Aluminum is next best, and for antennas where weight is important, is

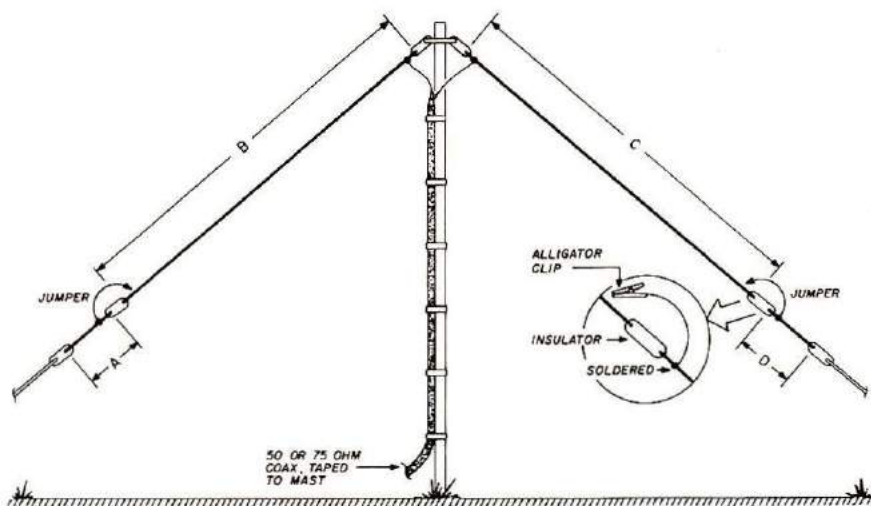

Fig. 3. How to build a single inverted-V for 75-meter phone and 80-meter CW. For operation on the phone end of the band antenna legs **B** and **C** are resonated at approximately 3900 kHz. For CW operation the antenna lengthening wires, **A** and **D**, are attached to the main antenna with alligator clips and adjusted for overall antenna resonance at about 3650 kHz.

^{*}J. Fisk, W1HR, "Simple Dipole Antennas," *Ham Radio Horizons*, January, 1978, pages 18-26.

often a better choice. Phosphor-bronze, a copper-based alloy, also works well and is often used in military antennas; sometimes you can find phosphor-bronze wire on the surplus market.

At radio frequencies the current flow tends to be concentrated near the surface of the conductor; this is called "skin effect" and is due to internal effects. Since rf current flow is confined to an area near the surface of the conductor, the rf resistance is many times the dc resistance and increases at the higher frequencies. On 80 meters, for example, most of the rf current flow in a copper wire is in an

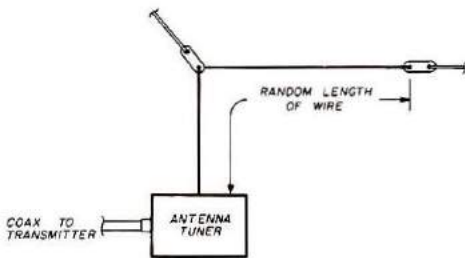

Fig. 4. In locations where there's insufficient room for a full-length dipole, an end-fed wire can be used with good results. Wire length is not critical, but the longer, the better. This type of antenna requires the use of an antenna tuner which is designed for "random wire" antennas.

area less than two thousandths of an inch (1.4 mils or 36 microns) below the surface of the conductor; this dimension decreases to 0.5 mil or 13 microns at 10 meters.

Because of skin effect, a length of copper tubing has exactly the same rf resistance as a solid copper conductor of the same diameter; this means that you don't have to use solid-copper conductors at high frequencies for good performance. *Copperweld** antenna wire, which consists of a steel core with a thin copper coating, is often used for antennas because it is much stronger

* *Copperweld* is the registered trademark of the Copperweld Corporation of Glassport, Pennsylvania.



The MFJ Versa Tuner II covers the frequency range from 1.8 to 30 MHz and will match antennas fed with coaxial cable, open-wire line or twinlead, or a random wire. The tuner features a built-in SWR meter and dual-range wattmeter (30 to 300 watts full scale), as well as an antenna selection switch (photo courtesy MFJ Electronics).

and stretches less than solid copper wire. Above about 1 MHz its rf resistance is the same as solid copper wire of the same size.

If you can't locate a source of *Copperweld*, select copper wire which has been designated as "antenna wire." Ordinary soft-drawn copper wire, such as that used in house wiring, is unsuitable for antennas because it has a tendency to stretch. If you build an 80-meter antenna with this material and cut it for the center of the band, eventually the wire will stretch so much the resonant point will move below the lower band edge!

When choosing antenna wire, don't select a size that is too small. For wire antennas where the maximum span length is less than 150 feet (45 meters),

the National Electrical Code specifies a minimum wire size of number 14 (1.6 mm); for lengths greater than 150 feet (45 meters), number 10 (2.6 mm) wire is required if you use hard-drawn copper — number 12 (2.1 mm) is recommended for high-strength materials such as copper-clad steel (*Copperweld*) or phosphor bronze. Note that the maximum span length is the distance between the supporting points, so includes both the antenna and any halyards or supporting ropes.

Don't be concerned if the antenna wire is insulated — the insulation will have absolutely no effect on the radiation properties of the antenna. Thick plastic insulation may slightly affect the electrical length of the antenna and cause it to resonate at a

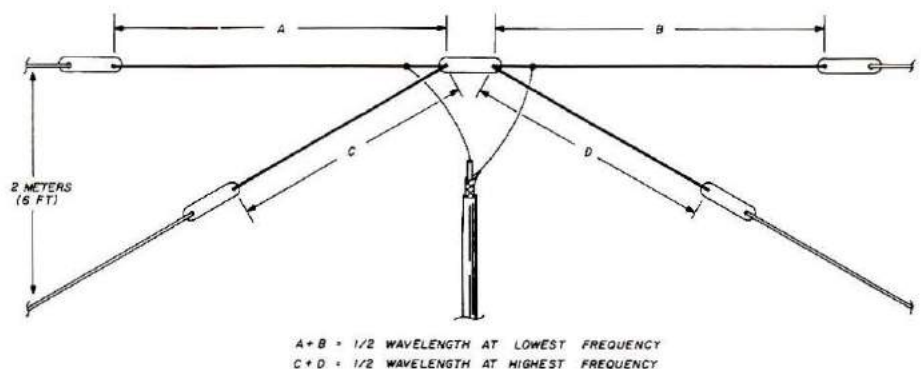
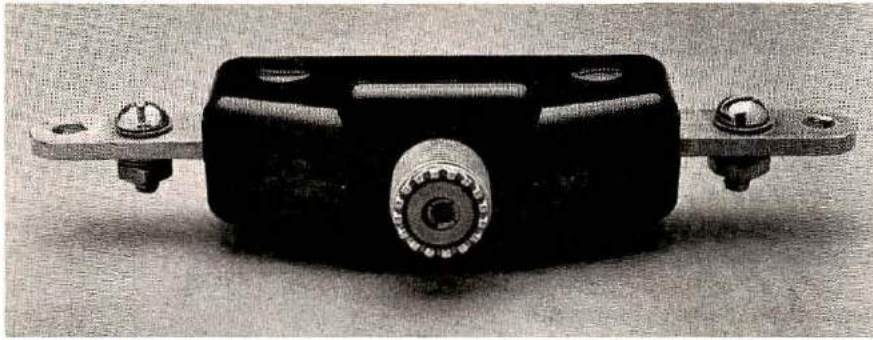

Fig. 5. Multiple dipole antennas can be used for operation on two amateur bands with a single feedline, but if the center frequencies of the two antennas are not harmonically related, for low SWR the shorter, higher frequency antenna must be made slightly longer than 1/2-wavelength as discussed in the text.



Hy-Gain's new antenna center insulator is molded from high-strength plastic and is designed for easy hookup to a coaxial feedline with a PL-259 connector. All internal connections are fully weatherproofed and insulated with silicone for complete reliability under all weather conditions (photo courtesy Hy-Gain Electronics).

lower frequency, but you probably won't notice the difference unless you have test equipment to make very careful measurements. Obviously, you must remove the insulation where you connect the transmission line, but the rest of the insulation may be left intact.

When buying insulators for your dipole, be sure the ones you choose are strong enough for the job. In general, there are two types available, straight antenna insulators and strain insulators, as shown in Fig. 6. In addition to these two basic types, there are also insulators which provide an attachment point for the coaxial feedline and are designed especially for use in the center of wire dipoles. The strain or "egg" insulator is the strongest because the insulating material is under compression; to a certain extent it is also fail-safe because the antenna wires are still interconnected if the insulator fails. If a straight antenna insulator fails, your antenna is going to collapse!

You can also make your own antenna insulators from thick plastic rod or strip, but I would recommend that you use home-made insulators only on half-wavelength antennas for 40 meters and above. If you've ever hoisted a full-length 80-meter dipole into the air, you know it takes considerable pull on the halyards to install the dipole with minimum droop. This is essentially the same tension that the insulators must withstand without failing, and leaves no safety margin for extra loading by wind or ice. For 80-meter dipoles I recommend the use of insulators with a breaking strength of about 400 pounds; most 5/8-inch diameter ceramic insulators meet this requirement.

Vertical antennas

Although horizontal dipoles are very popular, many amateurs prefer to use quarter-wavelength vertical antennas which are operated against a good ground system as shown in Fig. 7. If backyard space for

an antenna is at a premium, the vertical is a good choice because it can be installed in a very small area. However, because of its great height on 80 meters (approximately 65 feet or 20 meters), the vertical is most suitable for the amateur bands above 7 MHz.

For best performance the vertical should be operated against a good ground system, but many amateurs get good

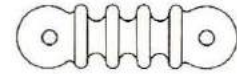

A GLASS ANTENNA INSULATOR

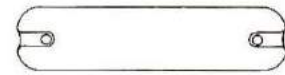

B CERAMIC ANTENNA INSULATOR

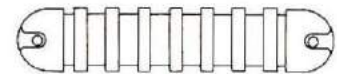

C PLASTIC ANTENNA INSULATOR

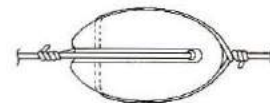

D CERAMIC STRAIN AMPLIFIER

Fig. 6. Various types of antenna insulators which are available on the market. Antenna insulators for 80-meter dipoles should be about 5/8-inch (16 mm) in diameter; insulators for higher frequency dipoles may be 1/2-inch (13 mm) or smaller. Ceramic strain insulators, D, are usually found in guy wires but can also be used in wire antennas; this type of insulator is fail-safe because the wires are interlocked if the insulator breaks.

results with a ground system which consists of a single 8-foot (2 1/2-meter) ground rod driven into the ground. With a ground rod system, the DX performance of the antenna will depend almost entirely on the characteristics of the soil in your back yard. If the antenna is installed in an area where the soil is very dry or sandy, for example, it won't work as well as if it were installed in an area where the soil has low electrical resistance.

Interestingly enough, if you

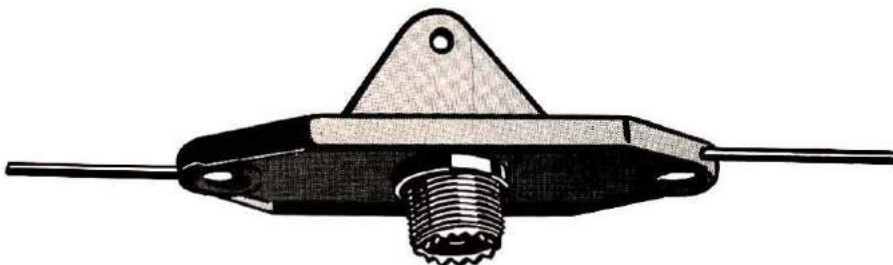

The Budwig Hye-Que HQ-1 center insulator is molded from a special glass-filled plastic which offers exceptional tensile strength. The insulator is completely weatherproof. The same company manufactures antenna end insulators made from the same material (photo courtesy Budwig Manufacturing).

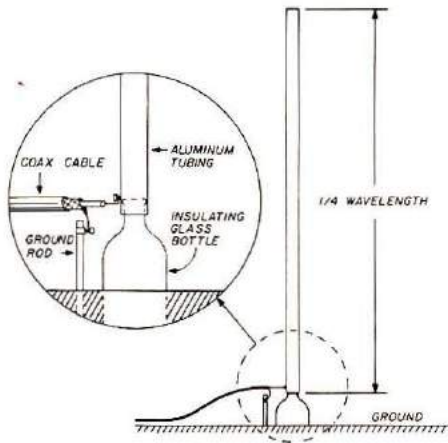

Fig. 7. The quarter-wavelength vertical is often used where backyard space is limited. The ground rod provides adequate performance in some locations, but a system of radials (**Fig. 8**) is better. Amateurs who build their own verticals often use large, thick-walled soft-drink bottles for the base insulator.

plot the swr vs frequency for a vertical with a ground rod, and a vertical with a good ground system, and compare the two, you'll probably find that the antenna with the poorer ground can be operated over a wider frequency range with low swr. This is caused by resistive losses in the poor ground system which mask variations in antenna feedpoint impedance.

This brings up one very important point: don't be

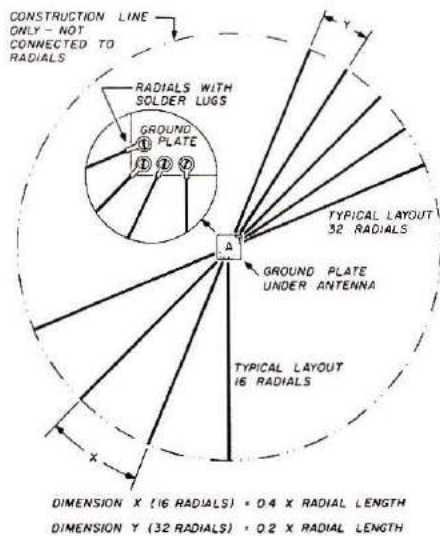

Fig. 8. Layout of a radial ground system. Nearly perfect ground can be obtained with 120 radials, but 16 or 32 is a good compromise (see **Fig. 9**). Each of the radials should be a minimum of 1/4-wavelength long at the lowest operating frequency.

misled by the fact that your antenna has very low swr over a wide bandwidth. If you plot the SWR vs frequency and find it is less than 2:1 more than 2 per cent from resonance, you probably have unwanted losses somewhere in the antenna system which will degrade the antenna's performance.

The best way to improve the ground system around your vertical is to install radial wires which are spaced equally around the base of the antenna as shown in **Fig. 8**. In theory, 120 ground radials, each 1/2-wavelength long, will provide a nearly perfect ground. However, when you consider that would require almost 3 miles (5 km) of wire on 80 meters, you can see why few amateurs have a ground system which even comes close to being perfect!

Fortunately, you can build a very good ground system with considerably less than 120 radials, and they don't have to be a full half-wavelength long. If you look at a graph of signal strength versus the number of ground radials (**Fig. 9**), you'll find that there's only a slight improvement after about 32 radials have been installed. There's a dramatic increase in signal strength with the first 16 radials, and a noticeable improvement at double that number, but then the curve levels out. I think the optimum number of radials for an amateur antenna system falls somewhere between 16 and 32, but as few as four will provide improved performance as compared to a single ground rod.

When choosing wire for a radial system the main consideration is the size of the wire. Since there are chemicals in the soil which will eat away at the wire, the larger wire you use, the longer it will last. Stay away from very fine wire or stranded wire — both will completely disintegrate in a few years. The minimum size you should use is number 14, but the wire doesn't have to be copper. Many amateurs use

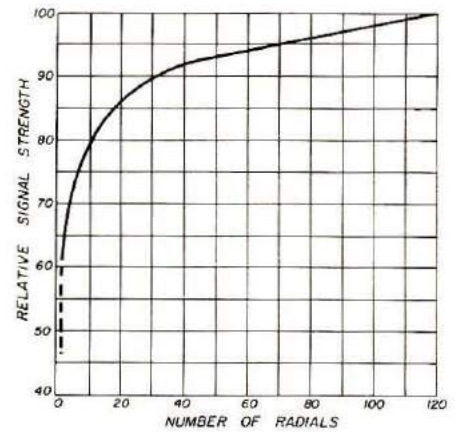

Fig. 9. Relative radiated field strength from a 1/4-wave vertical as a function of the number of ground radials. Since there is limited performance improvement after more than 32 radials are installed, this represents a good compromise and is recommended for permanent amateur antenna installations.

aluminum or galvanized electric fence wire which is available in quarter-mile spools (1320 feet or 400 meters) from Sears at a reasonable price. If there are any new homes being built in your area, or if you have a friend who's an electrician, you may be able to pick up enough scrap copper wire to build a radial system, but you'll have to strip off the insulation. If the scrap pieces are too short, you can splice them together using the technique shown in **Fig. 10**.

At the base of the vertical all the radials should be connected together at a single point; then a heavy wire or strap should be run to the grounding point on the antenna (or to the shield of the coaxial transmission line). Aluminum wire presents a bit of a problem because it can't be soldered, but you can form small closed

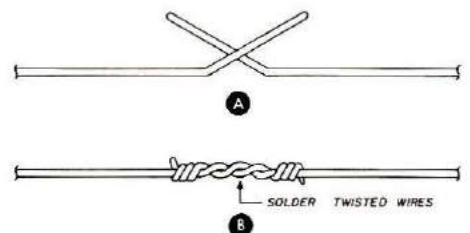

Fig. 10. Correct method for splicing wires in a ground system. This splice, which is known as the Western Union splice, is very strong and can also be used in antenna construction.

loops in the end of each wire and clamp the loops together with a bolt and nut. After the nut has been tightened, slather bath-tub calking or other waterproof material over the joint to keep the water out.

Ground-plane antennas

Another type of vertical antenna which is used by many amateurs is the ground-plane antenna shown in **Fig. 11**. This antenna is much like the ground-mounted vertical with a system of radials, but in this case only four 1/4-wavelength radials are used and the whole antenna system is elevated well above ground. For best results the antenna should be installed away from trees and other objects which might distort the radiation pattern. Ground-plane antennas are usually built with aluminum tubing and are often used to provide omnidirectional coverage (all directions) on vhf.

Since ground-plane antennas have a low angle of radiation, they also provide good DX performance on 10, 15, and 20 meters. On 80 and 40 meters the length of the vertical radiator is so long it's difficult to build a structure that will hold up in strong winds, but some amateurs have had

success with a ground plane made entirely of wire and hung from a tree.

Multiband verticals

If you want to operate on more than one band with a vertical antenna, your best bet is a commercial trapped vertical. There are a number of types available that will cover three, four, or five high-frequency amateur bands with low swr. These antennas may be used with a simple ground rod, but a system of ground radials (1/4-wavelength long at the lowest operating frequency) will provide better results. During the past winter I used a four-band trapped vertical with sixteen 33-foot (9-meter) radials for DX contacts all over the world on 40, 20, 15, and 10 meters.

Another type of multiband vertical which is available commercially uses a loading inductor at the base of the radiator (**Fig. 12**). This type of antenna is somewhat less expensive than a trapped vertical, but you have to adjust the tap on the inductor every time you want to change bands. If you don't mind running outside occasionally to move the tap, or if most of your operating is confined to a

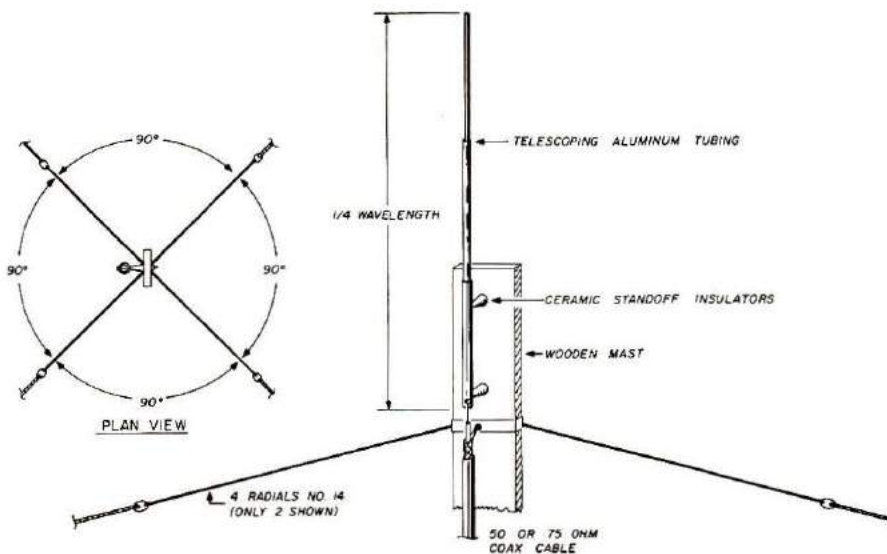

Fig. 11. Construction of a single-band ground plane antenna for the higher-frequency amateur bands (40, 20, 15, or 10 meters). Because of the great height of the vertical radiator on 80 meters, this type of construction is not suitable for that band. The ground radials are also used as guy wires.

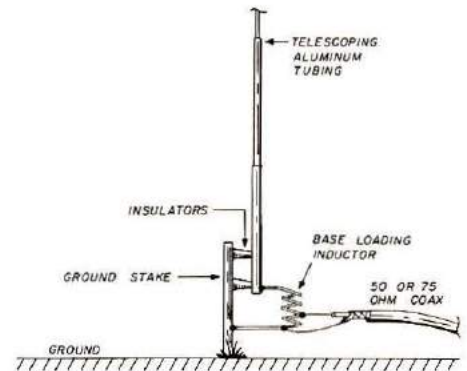

Fig. 12. Base-loaded verticals can be tuned to any of the high-frequency amateur bands, but don't provide automatic band switching. If you normally operate on only one band, this type of antenna is a good choice, but if you move around from band to band you should consider a commercial multiband vertical which requires no adjustments.

single amateur band, the multiband base-loaded vertical is a good choice. If you often move around from band to band, however, you'll be a lot happier with the automatic band-switching characteristics of the trapped vertical.

Vertical or horizontal?

There's little practical difference between a half-wavelength dipole and a quarter-wavelength vertical with a good ground system, but most amateurs find it much easier (and less expensive) to install a dipole. If you don't have any trees the right distance apart to support a dipole, a vertical is your best bet; I recommend a minimum of four ground radials, but a ground rod may be used if you're on a very tight budget — you can always add radials later.

There are many, many different types of antennas being used by amateurs, but the simple dipoles and verticals discussed in this article will get you on the air with a good signal. If you thumb through any of the amateur antenna books you'll find many other antennas which give more gain, or better DX operation, but they cost more and require careful adjustments for proper operation.

HRH

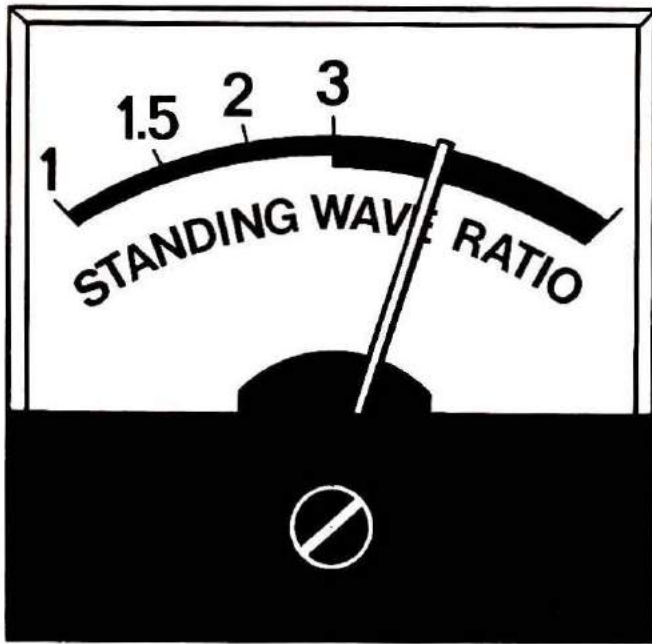

What do you do for high swr?

Caught with your swr up? Don't overlook the obvious causes

BY JOSEPH J. CARR, K4IPV

Most amateurs operating on the high-frequency bands will, at one time or another, use either a simple dipole or vertical antenna. These two basic forms, shown in Fig. 1, have a perennial popularity because they seem to work well with little or no fussing or problems, yet are reasonably low in cost. Many books and magazine articles will murmur contentedly about how to erect these antennas, and what is the proper length for any given center frequency. Most, for example, will give an equation for half-wave antenna dimensions as:

$$\text{Length}_{(\text{feet})} = 468 / F_{\text{MHz}} \quad (1)$$

$$\text{Length}_{(\text{meters})} = 150 / F_{\text{MHz}}$$

or, for a quarterwave antenna:

$$\text{Length}_{(\text{feet})} = 234 / F_{\text{MHz}} \quad (2)$$

$$\text{Length}_{(\text{meters})} = 75 / F_{\text{MHz}}$$

So what happens? You run out and buy some materials and a tape measure, and then spend Saturday afternoon erecting your prize antenna. Most of the time, the antenna

works and that is the end of it, but occasionally the swr is found to be excessively high. Now what?

Or alternatively, you have been operating with an antenna for about a year only to find

*High swr is of major concern chiefly because many transmitters will not operate properly when feeding a system that is not matched within certain limits. Most modern equipment will function when facing an swr of 3:1, or even 5:1 in some cases; most solid-state rigs have protection circuits that simply reduce the power output under mismatch conditions to prevent damage to the transistors. The additional losses in a transmission line with a high swr are small and of little consequence for amateur operation on the high-frequency bands. A matching device between the transmitter and the feedline will keep the rig happy, leaving the problem of reflected rf in unwanted places as your major concern. However, an swr that changes with the weather, or for no apparent reason, is a nuisance at best, and should be dealt with as the author points out. Readers who would like to delve more thoroughly into swr and its effects should read the excellent series of articles "Another Look at Reflections," by M. Walter Maxwell, W2DU, starting in the April, 1973 issue of *QST*. You can obtain the back issues, or Xerox copies of the articles, for a nominal fee by writing to ARRL, 225 Main Street, Newington, Connecticut 06111.

Editor

one day that the transmitter tuning is a little touchy. When you measure the swr it is found to be something like 5:1, or more.* Now what?

These are different situations, so you might expect to find that different causes and solutions apply. In the case of the antenna that now reads and performs poorly, you have at least one important advantage: it worked at one time, which puts you ahead of the game.

Finding the cause

One possible cause of a change in the swr of a previously working antenna is foliage growth. If the antenna was erected during the winter, when the trees were bare, then it sometimes happens that spring growth comes close to, or even touches, the antenna. The result is a greatly increased swr, and the solution is to move either the foliage or the antenna.

Another possibility is deterioration of exposed solder joints. I erected the antenna shown in Fig. 2 several years ago for use on the 20-meter band. The initial swr was 1.5:1,

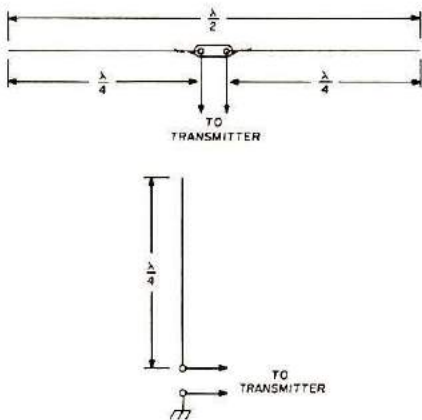

Fig. 1. Half-wavelength dipoles and quarter-wave verticals are among the most common high-frequency amateur antennas.

which is certainly an acceptable figure. A year later, however, the swr was found to be 4:1 and the transmitter tuning was extremely touchy. What happened in the interim? One of the solder joints had been poorly made and the year's wear and tear took its toll. The result — a high swr!

The best way to handle this type of situation is to *prevent* it. Good craftsmanship in the first place may well have kept that antenna up for as long as its predecessor served! Two errors were made here: the solder joint between the coaxial cable and the antenna wire should not have been exposed, and I should have done a proper soldering job.

Exposure of the soldered connection could have been prevented by using an enclosed center insulator such as the B&W or Hy-Gain models, or a 1:1 Balun transformer such as the one sold by W2AU. In this case, either would have been in order, although I must admit to a certain bias in favor of using the balun.

The exact cause of the defect was a corroded, poorly soldered joint between the coaxial cable and the antenna wire. I suspect that the original problem was the use of an insufficient soldering iron. Unfortunately, not all soldering jobs can be done with the same iron! Copper wire is a

rather good heat sink, making a cold-solder joint hard to avoid. Lightweight pencil irons, or low-wattage soldering guns, simply will not do the trick. I recommend the use of a soldering iron of not less than 200-watt rating, or a small propane torch, when working on antennas. Good, well-made, solder joints help produce long-lived antennas.

Troubleshooting new antennas

Certain pieces of test equipment are needed to *properly* troubleshoot any antenna problem. This is not to say that you will not be able to find the trouble without an armload of equipment, but it is true that you will not have to spend so much time cutting and trying. I recommend that you buy or borrow a dip oscillator, and obtain either of two types of antenna bridge: the noise bridge or the antenna-impedance bridge.

Several of these instruments are available either as ready-

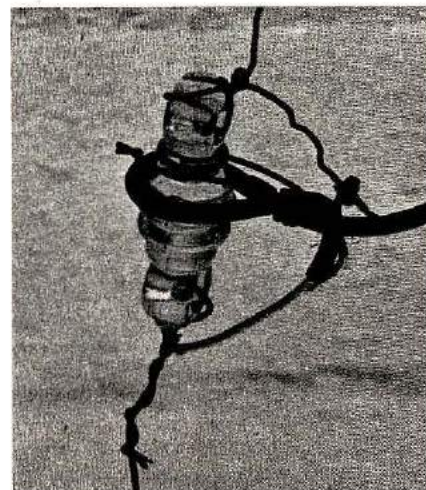

Fig. 2. Corroded solder joints spoiled this 20-meter dipole.

built instruments or as kits. The Heath Company, for example, makes a dip oscillator (shown in Fig. 3). Also available are the Palomar Engineers R-X noise bridge and the Omega-T noise bridge. Leader Electronics manufactures both an antenna-impedance bridge and the

Fig. 3. Antenna test equipment: (left to right) Palomar Engineers R-X noise bridge, Omega-T noise bridge, Heath dip oscillator, and a Leader impedance bridge.



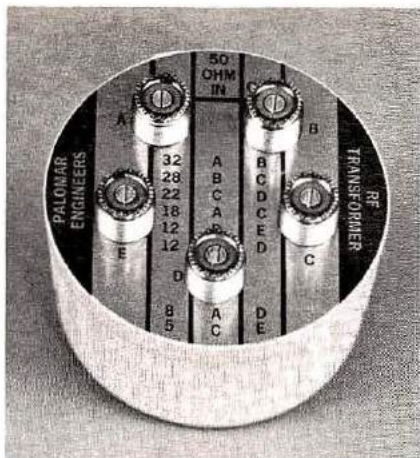

Fig. 4. Palomar Engineers RF transformer (photo courtesy Palomar Engineers).

matching dip oscillator that is used as a driving source for the bridge. These instruments are not particularly expensive and will serve well for amateur applications.

You must also be aware of the factors that could cause a poor swr on a new antenna. First, there is the poor craftsmanship of the sort that fouls up all antennas. Look at your work practices and soldering skills to see where improvements can be made. For example, when you install the PL-259 connector at the end of the coaxial cable, do you leave little frizzy edges from the shield inside of the connector, where a little flexing will allow them to short out to the connector's center conductor pin? Or is your specialty the use of too much heat for too long a time when soldering the shield to the barrel of the connector? That second problem usually conspires to melt the center insulation and short out the coax.

Secondly, what type of feedline is in use? Is it appropriate to the type of antenna being built? Most verticals and dipoles are fed with coaxial cable of either 52-ohm or 75-ohm impedance. Surprisingly enough, it often doesn't make too great a difference which impedance is used because many antennas

have an impedance that is different from the value given in the book. A frequent error is to use flea-market-special cable of doubtful quality, ancient lineage, or of an unmarked breed, which may have an impedance far from the normal ranges.

Third, is the antenna the correct length for the intended operating frequency?

Fourth, are there nearby objects that tend to interfere with the proper operation of the antenna?

Fifth, are your measurements really valid? The type of simple measuring equipment that is used to measure impedance and swr of amateur antennas is often sensitive to feedline length. Note that swr is *not* a function of the line length, but simple instruments that really measure something akin to swr will deliver a valid reading only at the antenna feedpoint or at multiples of a halfwave along the feedline. In order to make measurements you must be sure that the feedline length is an *electrical* halfwave, or an integer (*i.e.*, 1, 2, 3, . . . *n*) multiple of a half wavelength. An *electrical* halfwave can be found by multiplying the result obtained from Eq. 1 by the coaxial cable's velocity factor, or:

$$\text{Length}_{(\text{feet})} = (468 \times V) / F_{\text{MHz}} \quad (3)$$

$$\text{Length}_{(\text{meters})} = (150 \times V) / F_{\text{MHz}}$$

Where *V* is the coaxial cable velocity factor. *V* has approximate values of 0.8 in foam dielectric cable, and 0.66 in polyethylene (regular) coaxial cable.

There is an unusually persistent myth, particularly prevalent amongst CBers, that the swr can be changed by trimming the length of the feedline. *This is definitely not true*, but the nature of the instrumentation makes it appear to *happen* that way. This situation points out the necessity for *understanding* antenna theory, and not

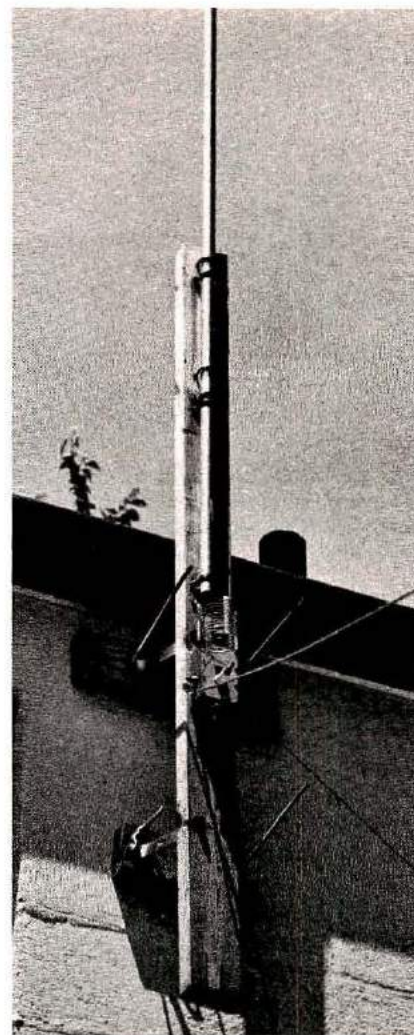

Fig. 5. Anatomy of a 20-meter disaster.

relying on simple, empirical observations . . . they are not always gospel truth! So make swr measurements through a feedline that is an integer multiple of an electrical half wavelength.

It is also necessary to realize that the lengths found when using the formulas (Eqs. 1 and 2) are not absolutes, but are merely generalizations that *usually* work. Various factors that are a function of how and where the antenna is erected can alter the situation a little bit. A good noise bridge will help you determine if the antenna is the correct length.

Short antennas, most of which are verticals, present another problem. They are intentionally short for one reason or another, so must be treated a little differently. An

inductor in series with the radiator will allow the antenna to *resonate* at or near the correct frequency, a condition that can be found either with a dip oscillator or swr bridge. You will still find a mismatch-caused swr, however, because the antenna impedance is composed of both reactance and resistance — the radiation resistance of the antenna, plus some capacitive or inductive reactance because of the antenna's non-resonant length.

Matching of the actual radiation resistance can be done with a suitable transformer at the feedpoint. Palomar Engineers manufactures a suitable rf transformer that is designed for use with high-frequency antennas (see Fig. 4). The Palomar transformer will match 50-ohm coaxial cable to antenna radiation resistances of 5, 8, 12, 18, 22, 28, or 32-ohms.

A case history

Consider the 20-meter vertical antenna shown in Fig. 5. This antenna was constructed from aluminum tubing purchased from a local supplier. Interestingly enough, adjacent-diameter-size tubing will allow the smaller tube to fit inside of the larger tube tightly enough that the antenna can be made from two ten-foot (3-meter) lengths.

According to all that is right with antenna theory (as embodied in Eq. 2) this antenna should have worked. The radiation resistance of vertical antennas with drooped radials is usually on the order of 25 to 40 ohms, so the swr with 50-ohm coaxial cable should have been not worse than:

$$Z_o/R_r = 50/25 = 2/1 = 2:1 \quad (4)$$

Why was it 5:1 instead (sigh)? Look closely at the mounting. The base of the antenna is almost touching the gutter at the roof line! Then there is that untreated wooden support which would further foul things up on rainy days.

Also, the 40-meter loading coil, added as an afterthought, was exposed to the elements. Three steps were taken to cure the 20-meter problems, and one additional step to fix it on 40-meters. Specifically:

1. A new 2x4 support was made so that the antenna would be several feet above the gutter.
2. Ceramic *beehive* insulators were mounted on the new 2x4 to support the radiator, and insulate it from the wood.
3. A Palomar rf transformer was installed.

The 40-meter problem would become apparent on rainy days, and was due to the exposed loading coil. The coil was then installed in a large chassis box (so that the coil would not be close to the metal walls) and the edges of the box were sealed with RTV silicone compound.

One further bit of advice that I believe in very strongly is the use of a matching network between the transmitter and the feedline. I personally use a Drake MN-4 coupler between my DX-60 transmitter and the coax, but any of the others will work nicely, I am sure. The reason for this suggestion is that it will help minimize any mismatch problems, and has the added advantage of reducing harmonics even further.

HRH



"... and here's a card from the Ace Antenna Company offering to finish the job for \$50."

HI-Q Communications

Proudly Presents

the



Model HQ-6

STATION ORGANIZER

The only completely organized station console, featuring:

- 24 hour digital clock with WWV setting
- 6 amp, 12V dc power supply
- High quality speaker
- Three 110V ac convenience outlets
- Headphone jacks - located in front

Manufactured completely in United States, FHBH*

Retail Price \$119.95

*For Hams By Hams

DEALER INQUIRIES INVITED

HI-Q Communications
P.O. Box 1533 Stow, Ohio 44224
Tel. 216-688-5918

Please send me more information on this terrific console!

Name _____

Address _____

HI-Q STANDS FOR QUALITY!

radio clubs

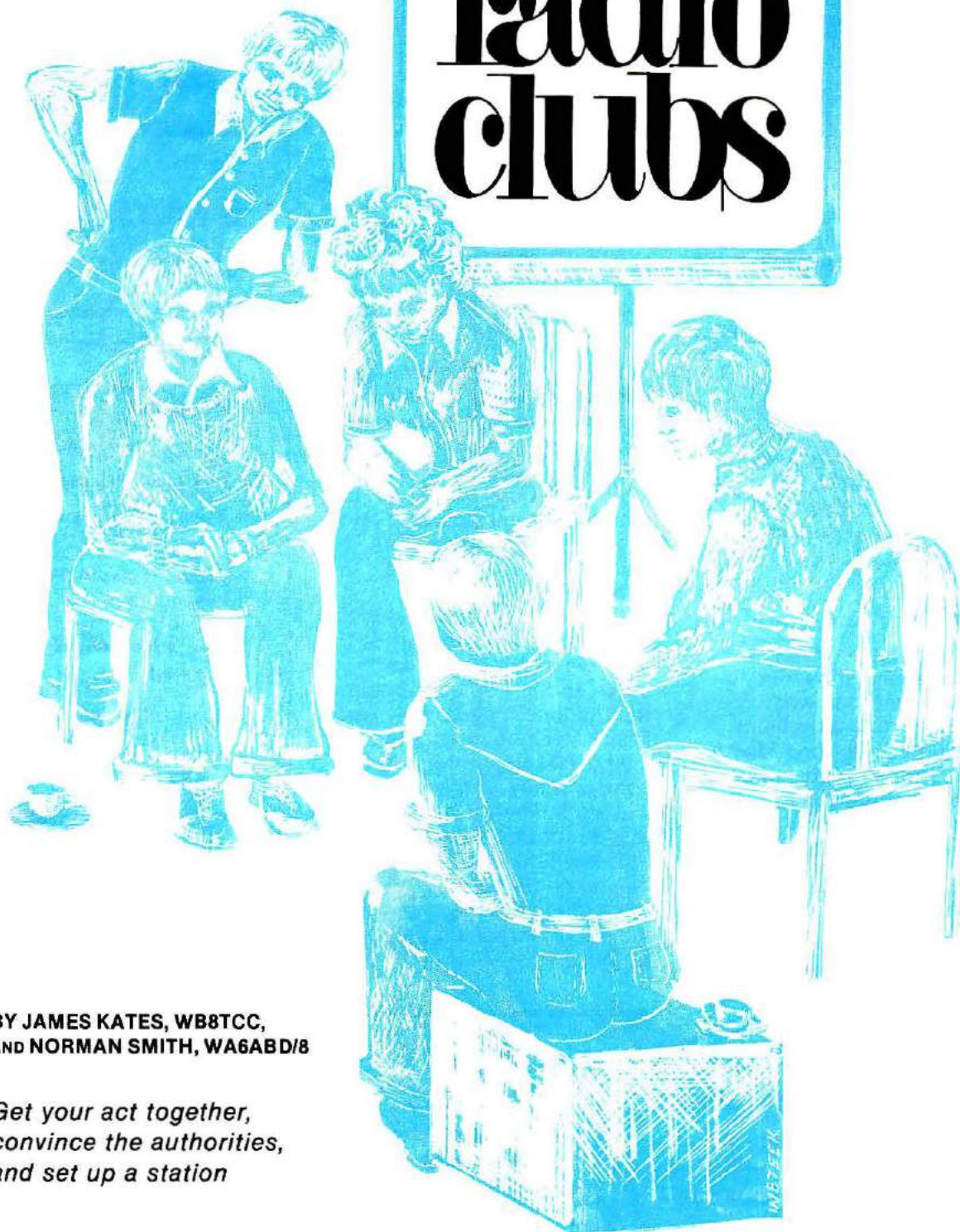

**BY JAMES KATES, WB8TCC,
AND NORMAN SMITH, WA6ABD/8**

*Get your act together,
convince the authorities,
and set up a station*

There are many different types of amateur radio clubs — DX hunting clubs, traffic-net clubs, social clubs that started from a common interest in amateur radio, contest-operating clubs, field-day clubs, and a surprising number of clubs at schools of all levels. Many amateurs and would-be amateurs take the existence of these school clubs for granted; they seem to have always been there. There is no way of determining how many didn't come into existence because of a faulty start, or how many foundered in the launching process because of improper planning or a lack of recognized and acceptable objectives.

There are still many institutions of learning, from the high-school level to technical or trade schools, colleges, and universities, that do not have an amateur radio club. There are some that had a club at one time, but the memory of it is dim, or perhaps no one remembers it at all. Perhaps the discussion that follows will help some of you to start a club at your school, or to revive the faint vestige of what was a going thing — a source of education, service, and enjoyment to fellow students and the community.

Definition

As a starting point, let's define an amateur radio club: it is a group of individuals, licensed or not, who share a common interest in amateur radio. A club station is an extension of the club and is operated, and oftentimes owned, by the members. The existence of a club and station at school, especially at a college, university, or trade school, where students in dormitories are unable to put up antennas, is priceless to the would-be operator. In addition, the club station serves as a means of getting on the air for those who can't afford the necessary equipment, or don't have the space for it.

The cornerstone in the foundation of a club is its charter membership. Each member must have more than a normal allotment of dedication so the club will not falter in its first steps; this holds true whether the charter members number 3 or 103. Initially, a chairman, and perhaps a small executive committee, should be elected to coordinate the activities of the infant club, to see that the talents of each member are used to the fullest. The members of the committee will later act as the spokesmen for the club, and should have adequate speaking and writing abilities so they will be able to effectively represent the club before the prospective

trustee(s), the school administration, and the public.

What is a trustee?

A trustee is a licensed amateur who takes a personal interest in the club and its activities by becoming an advisor as well as being legally responsible for the proper use of the club station. He can be a faculty member or an outside citizen, but it must be kept in mind that the best trustees are sometimes hard to find, and some special qualities are necessary in such an advisor to keep him from hindering the club. These qualities might include: being the holder of a general- or higher-class amateur ticket to give the club station reasonable operating privileges, having the dedication required to see the birth of a new club, and the possession of the skill and patience to work with the charter members as well as the school administration.

The manner in which the potential trustee is approached will be the key factor in whether or not his services are obtained. As with salesmanship, the pitch itself is the moment of truth, and a

haphazard approach might convince the potential trustee that the club is not a wise undertaking. A letter of intent, along with a well-rehearsed sales pitch, will make an effective presentation. Such a letter should cover all aspects of the proposed club, perhaps answering some questions in a format similar to the outline presented below:

- A. Why do you want a club? What will be the value of the club to its members?
- B. What will be the activities of your club? Will you be involved in DXing, contests, public service, and the like?
- C. Of what benefit will the club be to the school? Will you help coordinate school activities, sponsor demonstrations and/or classes on the subject of amateur radio, or handle traffic for the student body?
- D. Of what benefit will the club be to the general public? Will you sponsor such events as listed above for the citizens of your community, or perhaps help in the coordination of such civic events as bike-a-thons,

The W8SH equipment. Collins S-Line with speaker console and linear amplifier, keyer, antenna-rotor control, and another important feature — a comfortable operating chair (photo by WB8TCC).

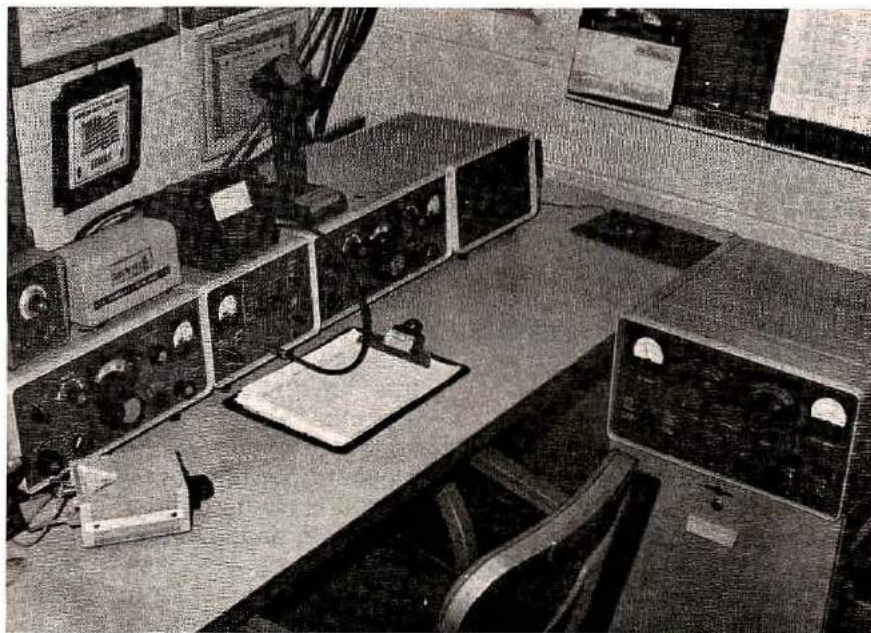

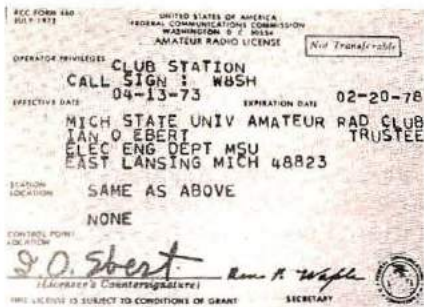

The W8SH club station license, as issued to trustee Ian O. Ebert, W8SM. Yes, the license has been renewed! (Photo by WB8TCC.)

parades, cancer drives, and the like?

- E. How will the club be financed? Will the gear be donated by the club members or outside citizens, or will it have to be purchased or built? Will a grant from the administration be necessary to get started?

The completed letter should be as detailed as possible and include some long-term projections of club activities. Once the services of a trustee have been obtained, and group activities and plans are well defined, the next step is approaching the administration.

Convincing the administration

In approaching the school officials, it is wise to first decide which level of administration, or particular administrator, to see before blindly heading into the office. With the help of the trustee, this can usually be correctly determined the first time out. For junior and senior high schools, the principal is the person most likely to be of help, and for colleges or trade schools, heads of engineering departments will usually have justification for the support of the club. But before the administration on any level is actually approached, a brief outline must be prepared so the group will be able to answer some specific questions the administration might ask. These would likely include: Where do you want to

locate your station? What about antenna installations? And, inevitably, how much money do you need? The administration, as the club's potential benefactor, *does* have a right to ask these questions, however, so courtesy is of prime importance. You must always remember that the club station being asked for is a *privilege*, not a right.

Being turned down by the administration on the first try is not necessarily the kiss of death for the club and its station. If the trustee's support is still solid, the group may reorganize, eradicate the flaws in its presentation, and perhaps check into other sources of money if this seems to be the major problem from the administration's point of view. Equipment for an amateur radio club, if need be, can consist of no more than a borrowed transceiver in a corner of the electronics shop, coupled to a random length of wire. Such a club station, even though its resources are few, may help convince the administration of its value, and may well be the key to obtaining more elaborate facilities in the future.

There are several variables to consider in the selection of a station location. Experienced amateurs may have their individual preferences, but most will agree that there are a few qualities universal to any good amateur "shack." Most will agree that an amateur station should be as spacious as possible, because being cramped into too small a room (i.e., a broom closet) greatly reduces the enjoyment of operation. The room must have adequate security to prevent theft of the equipment, be relatively moisture- and dust-free, have plenty of grounded electrical outlets, and have adequate soundproofing to prevent operating activities from disturbing nearby academic endeavors and vice-versa. For easy access to the roof and antennas, a top-floor room with a convenient cold-air

duct or window to pass the coaxial cable is ideal. The room should also have plenty of wall space for those soon-to-be-accumulated maps, QSL cards, and awards.

The ideal club antenna system would be something on the order of beams for each band with separate tall towers and heavy-duty rotors, but, for obvious reasons, sights will have to be set somewhat lower than that (at least at first!). The initial antennas can consist of dipoles, inverted-V dipoles, verticals where space is at a premium, or even matched long wires. Installation of such antennas as high as possible above the roof of the building (atop masts or towers if practical) can be easily accomplished if all the members are willing to pitch in. Such a beginning setup will yield many hours of pleasant operation, and sights can be set on successive improvements as money or roof space warrant.

Equipment

Station equipment is again another matter based highly on personal preference. There are a few considerations that any club should bear in mind, though, and a discussion among group members will usually reveal that they have similar objectives in the field of equipment acquisition. As the principal station unit, most groups will want a transceiver or transmitter-receiver pair with SSB and CW capability on 80 through 10 meters. Essential accessories would probably include a microphone, straight key, speaker, power supply for the rig if needed, a coax switch for multi-antenna installations, an swr/power meter, and a station clock. Some of the considerations to bear in mind when purchasing this gear would be:

1. How rugged is the gear in question? Will it stand up to years of heavy use and abuse by many operators?
2. How dependable is the

gear? Will it spend more time in the shack or the repair shop?

3. What is the cost of the gear? Can it be obtained in good used condition or at a discount from a ham supplier?

At this point the club may want to contact local amateurs on the merits of the equipment in question, both to gain personal opinions on particular radios and to find out how they have performed in the hands of other amateurs. If the preliminary judgments are favorable for a certain radio, the next step is placing of the radio on the air, if at all possible, for an all-bands, all-modes performance test. If, after these tests, the gear meets the expectations of the club members, an appointed "acquisition committee" can purchase it for the club station.

A few of the accessories that are not essential but nice to have might include: a linear amplifier, an automatic keyer, a "bug", vhf-uhf gear and antennas, an emergency power generator, 160-meter gear, phone-patch equipment, and equipment for specialized communication such as ATV or RTTY. In this case, placement of specialized communication equipment in the club shack on

a voluntary basis will do much to help spur interest and build club membership.

It is fully possible to run a club at a school for a few dollars a year to cover basic expenses such as postage, QSL bureaus, QSL card printing, and the like. If the members have decided to purchase gear, as opposed to using donated or borrowed equipment, it will be necessary for the club to document its financial plans in order to obtain a grant. Most clubs will find some additional funding in the form of dues, which may range anywhere from one to ten dollars a year, unless the sponsor stipulates for any reason that dues not be collected. When you prepare the budget, keep in mind that the purchase of used gear will usually help lower the amount of money needed, and such gear, when bought from reliable sources and maintained in good condition, can yield years of trouble-free service.

If the gear is thoroughly checked before purchase, the club can avoid buying someone else's problem. After shopping around, and the preparation of lists quoting the price on a possible rig from as many different sources as possible, several budgets for equipment

can be drawn up — that is, a \$300 budget, a \$500 budget, etc. In this way, one of the budgets can be presented when asking for a grant, and alternative proposals will be available if the administration is not willing to part with as much money as you originally hoped for. The club spokesman should be prepared, when submitting a request for a grant, to explain the basic differences between types of gear to an administration that may not be technically oriented. When a grant is obtained, the prepared budget for that particular amount can be used to help the group get the most for its money.

Some alternative sources of club finances include local businessmen, and ideally, amateur-equipment dealers. While gear from these dealers most likely couldn't be obtained free of cost, many would be willing to allow a discount to the club station. Some local businesses may be willing to supplement the club's buying power.

Often, local amateurs will be happy to donate or lend amateur equipment to the club, and the community amateur radio club may be able to provide both operating and test equipment to the club on a temporary basis. Another source of equipment is through the "junkbox" engineer, as long as some of the club members are skilled enough to keep the home brew equipment on the air while it is still in the developmental stage. Ideally, the first alternative saves the club money on equipment purchases, and the second gives club members valuable experience in building and maintaining electronic apparatus.

Structure and license

In organizing the official structure of the club, the basic rules, objectives, and procedures can be formulated in a constitution and a set of by-laws, copies of which were

W8SH in operation, with author WB8TCC at the mike (photo by WA6ABD/8).



required at one time by the FCC for the acquisition of a club license. Starting with the original objectives as stated in the letter of intent, the constitution can be expanded into a format similar to the one below:

1. Name
2. Purpose
3. Membership
4. Officers
5. Financial
6. Removal of Officers
7. Policies, procedures, rules
8. Meetings
9. Rules of Order
10. Quorum (number of members necessary to conduct business at any meeting)
11. Amendments

This format can be used as is, or modified as needed, to conform to the club's purposes. Club officers usually include a President, a Chief Operator, and a Secretary-Treasurer. The President presides over meetings and is the principal representative of the club when dealing with the administration, the student body, and the public. The Chief Operator serves as the Vice President, filling in for the President during absence, and provides for the maintenance of the equipment. The Secretary-Treasurer keeps the minutes of the meetings, handles correspondence concerning club activities, and keeps the financial ledger.

Meetings need not be cut-and-dried business all the time. By inviting club members or outside guests to give talks on equipment or communications techniques, the meetings can be kept fun and informative. Local experts in the fields of RTTY, SSTV, ATV, or OSCAR, just to name a few of the new fields opening up, can be invited to speak at the club. And, of course, club social

meetings and events will help members maintain their interest.

With the establishment of a constitution and a workable set of by-laws, the club is ready to apply for a station license. Until the station license arrives, licensed club members may use their individual calls when operating. The license is issued to the trustee and holds the same privileges as the trustee's own license, in accordance with parts 97.39 and 97.41 of the FCC rules and regulations. With the increasing work load at the FCC, however, the issuance of special club calls may not continue much longer.

The task of club record keeping, which falls upon the Secretary-Treasurer, is vital to the club's administration process. Logs must contain the required information as prescribed by law, and can also include incidental notes as members may wish. Most clubs will want to design a customized log sheet for this purpose. It should also be noted that each person who operates the station is required to sign the log. Although the legal requirements are not as strict as they used to be, club logs are best kept filed away for as long as possible. DX and stateside QSLs can be filed by callsign, with separate files for desired awards such as DXCC and WAS. After a lot of cards are obtained, the club may decide to let members keep cards from stations they have worked, to decrease the storage problem.

Public image

As soon as the club is established, some thought should be given to the building of a favorable image of the organization in the eye of the public. By doing some good

*Write for "I want to become a ham" package, Ham Radio Horizons, Greenville, New Hampshire 03048.

public-relations work, much favorable attention can be drawn to the club. This can attract many people who might be interested in becoming amateur radio operators.

Reaching the public is largely done through the mass media — giving news releases to the local papers, television, and radio stations. Posters are also useful; when distributed around the school, they can bring interested persons into the club and the amateur hobby, and when distributed around town, they can draw attention to a club's public-service activity. A code and theory class is one of the finest ways to bring new hams into the fraternity, and is easily taught with material available from Ham Radio's Communications Bookstore.* Above all, club members should never be too busy to explain amateur radio to anyone who is interested.

The opportunities for public service at a club station are many. At universities there may be foreign students who could benefit from international phone patches if third-party agreements so allow. A radiogram table, where students can send messages, will be invaluable to both them and the club image. Traffic nets also provide a vast opportunity for service, and many groups participate in emergency-preparedness planning and tests. Most communities will have many events where coordination via two-meter fm would be helpful.

All things considered, there are many benefits to be had from a school club station, for the members, the student body, and the public in general. Add to this the fun and excitement of rag chewing, contest operation, DXing, and a myriad of other activities, and the task of setting up a club station seems minimal indeed when compared to what it has to offer.

HRH

Yesterday you could admire LED digital tuning in short wave.* Today you can afford it.



Introducing Panasonic's Command Series™ top-of-the-line RF-4800. Everything you want in short wave. Except the price. Like a five-digit LED frequency display. It's so accurate (within 1 kHz, to be exact), you can tune in a station, even before it's broadcasting. And with the RF-4800's eight short wave bands, you can choose any broadcast between 1.6 and 31 MHz. That's the full frequency range. That's Panasonic.

And what you see on the outside is just a small part of what Panasonic gives you inside. There's a double superheterodyne system for enhanced reception stability and selectivity as well as image rejection. An input-tuned RF amplifier with a 3-ganged variable tuning capacitor for exceptional sensitivity and frequency linearity. Ladder-type ceramic filters to reduce frequency interference. And even an antenna trimmer that changes the front-end capacitance for maximum reception from minimal broadcast signals.

To help you control all that sophisticated

circuitry, Panasonic's RF-4800 gives you all these sophisticated controls. Like an all-gear-drive tuning control to prevent "backlash." Separate wide/narrow bandwidth selectors for optimum reception even in crowded conditions. Adjustable calibration for easy tuning to exact frequencies. A BFO pitch control. RF-gain control for increased selectivity in busy signal areas. An ANL switch. Even separate bass and treble controls.

And if all that short wave isn't enough. There's more. Like SSB (single sideband) amateur radio. All 40 CB channels. Ship to shore.

Even Morse communications. AC/DC operation. And with Panasonic's 4" full-range speaker, the big sound of AM and FM will really sound big.

The RF-4800. If you had a short wave receiver as good. You wouldn't still be reading. You'd be listening.

*The ability to receive short wave broadcasts will vary with antenna size, time of day, operator's geographic location and other factors. You may need an optional outside antenna to receive distant short wave broadcasts.



Panasonic
just slightly ahead of our time.



STALKING THE WILD IONOSPHERE

Part 2

BY DOUGLAS BLAKESLEE, N1RM

In the first part of our *Ham Radio Horizons* interview with Dr. Mike Villard, W6QYT, some of his early studies and amateur radio activities were covered, and he told us about a radar-like display once used to detect band openings. This second part of the interview continues to probe some of the electronic experiments that Mike has been involved in, starting with a question about an array of antennas that would make a DX hound turn green with envy:

HRH: Up at the Stanford University antenna farm there is a long line of telephone poles, each of which holds a 4-element Yagi antenna. The array is enough to make any ham drool with envy. What experiment requires such a huge antenna?

Mike: This huge array is the business end of a 23-MHz "radar" used to study the distribution of very small meteoric particles in space. The beam pattern is a narrow fan, only a degree or so in width; the earth's rotation scanned this fan through space. Small dust particles burn out at comparatively great heights; relatively low radio frequencies must be used to detect their trails. To obtain the desired

beamwidth and resolution at 23 MHz, an array nearly 1000 feet (300 meters) in length was needed.

HRH: At the same antenna site there's a 150-foot (45-meter) dish. A group of hams have worked via moon reflection on 432 MHz using the Stanford dish under the call sign WA6LET. What other experiments involve this dish?

Mike: The dish, built some years ago, is not a precision instrument by modern standards. But its cost (roughly \$250,000) was so low that three others just like it were built elsewhere by other organizations. The original was deliberately located on the Stanford campus so that students could have easy access to it. If low-noise reception had been the

The Stanford dish, used for communication to interplanetary probes and for 432-MHz moonbounce communication by a group of local hams and students, using the call WA6LET.

principal goal, a location several hours drive away would have been necessary.

Since Stanford is located in a suburban area, noise levels are inevitably high. Hence, the emphasis has always been on

“One of the fascinating propagation mysteries . . . is that of long-delayed echoes (LDE).”

transmitting experiments, such as a study of radio reflections from mid-latitude aurora. At the moment, the dish is used mainly for transmitting signals to space probes, in order to measure planetary atmospheres during occultations as the spacecraft flies by a planet. Variations in interplanetary electron density, caused by solar activity, have also been measured.

HRH: What, if anything, can be done about the rf pollution problem?

Mike: Not much, of course. But the interference goes down as radio frequency increases. By using the highest possible frequencies, and looking through “windows” in the spectrum, it is surprising how much good work can still be done. For example, in chasing meteors, we have successfully used the “window” between the carrier and the first adjacent 60-Hz side-frequency component of a TV broadcast transmission!

HRH: One of the fascinating propagation mysteries — yet unsolved — is that of long delayed echos (LDE). What got you started as the echo sleuth?

Mike: I first became aware of LDEs through publication of the results of a year-long search conducted in England at the Cavendish Laboratory, just after WW II. Although the results of this search were negative, it seemed to me that if the effect were truly rare it could easily have been missed because of the sampling nature of the search; and that radio hams because of their numbers, geographical distribution, operating hours, and widespread use of transceivers, are in a unique position to observe LDEs. That was what motivated me to start collecting reports from amateurs.

HRH: Several individuals have suggested that the long delay of the echo can be explained because the signal has traveled far out into space and either bounced off something or was retransmitted by an alien relay station. What other — shall we say, down to earth — theories are being advanced to explain long delayed echos?

Mike: The first question to be answered, of course, is whether

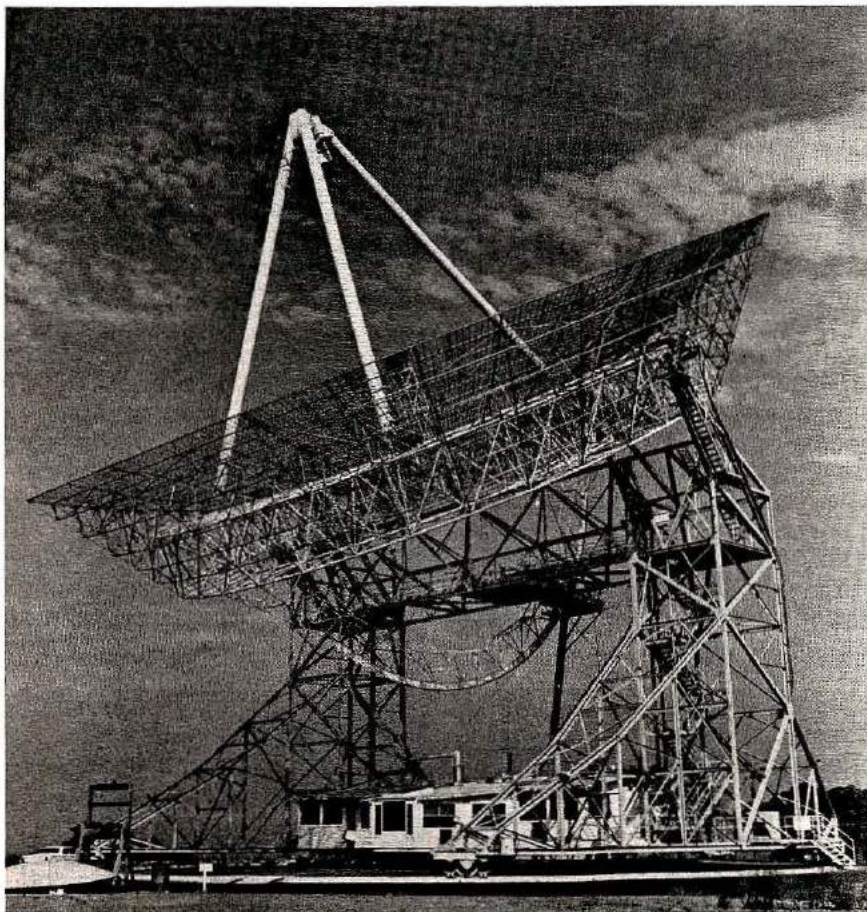

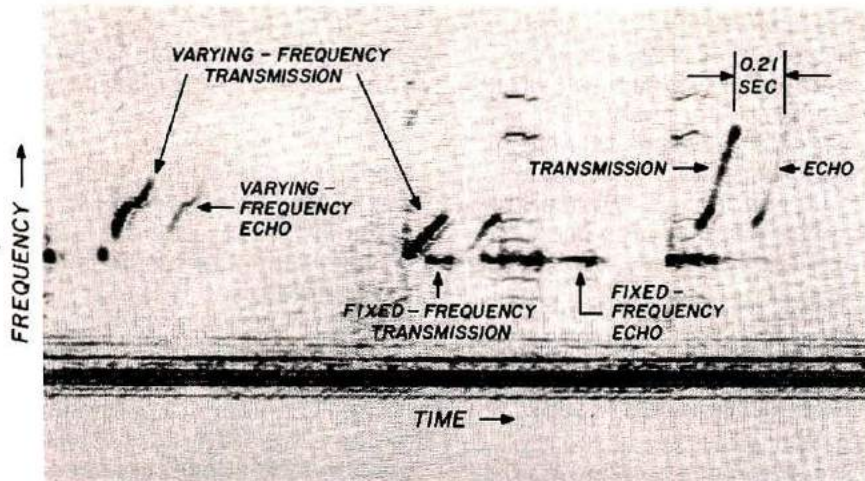

Example of an echo of baffling delay. This is a frequency-amplitude-time plot, or "Sonagram," of the recording made by K7DS of other stations in a 75-meter phone round-table in the spring of 1977. The variable-frequency transmissions were made by turning the knob of the VFO. These "chirps" permit exceptionally accurate measurement of a delay which turns out to be too long for around-the-world transmission. The effect lasted for more than half an hour and was heard by many stations. There is no readily obvious explanation. Only a handful of recordings like this are known to exist; this is probably the best of the lot.

we are dealing with a problem in physics or in psychology. Assuming that the first possibility is correct, one of my colleagues at Stanford University, Professor F. W. Crawford, along with several graduate students, has been working on a theory. The reported several-second delay in itself is not so surprising, because under the right conditions the speed of travel of radio waves within the

"A few recordings have turned up which might be considered to be in the true LDE category."

ionosphere can slow down to a crawl. But what *is* hard to explain, is why such signals would still be audibly strong after spending all that time in travel, so to speak. Dr. Crawford believes that the losses might be overcome by energy provided by electrons (part of the *solar wind*) that are known to occasionally bombard the ionosphere. The action would be roughly similar to what happens in a traveling-wave tube. I feel the matter is far from fully settled, however, because many amateur

reports do not satisfy the special geometry required by Dr. Crawford's theory.

HRH: Has anyone recorded a long delayed echo?

Mike: The answer is a qualified yes. In the early days when LDEs were first noted, there were no recorders. More recently, a few recordings have turned up which might be considered to be in the "true LDE" category. One showed a delay of 15 minutes, which might have been some prankster recording a signal and later playing it back. The typical LDE is very hard to record because it happens so infrequently that it catches people unprepared.

There are many recordings which turn out to be round-the-world propagation. A few other recordings are of related effects which produce delays of a few tenths of a second by a mechanism which is still not well understood. There was an instance recently, on the West Coast, where a whole network of stations heard this effect on each other and experimented with it. The particular echo effect can last several minutes before disappearing.

This shorter delay might be

caused by propagation of energy which gets into field-aligned ducts, or ionization columns, that extend between the hemispheres. One would then be hearing a signal which presumably (a) starts out in the Northern Hemisphere, (b) travels out into space along the field lines, (c) is reflected by the ionosphere or the ground in the Southern Hemisphere, and (d) is returned over essentially the same path. In this situation the predicted delays would be comparable to those actually observed. Similar ducts are known to give hemisphere-to-hemisphere propagation at vlf (very low frequencies). It is very unexpected to get an analogous effect on the high frequencies, but Professor H. G. Booker of UCSD has shown that it is possible.

HRH: What is the average person's chances of hearing an LDE?

Mike: Very small. Very few people have heard more than one, and many more have never heard an LDE. In my own amateur experience I only once may have heard an LDE, and even today I'm not sure. I was monitoring WWV on 15 MHz as the station went into a silent period. To my amazement, instead of cutting off cleanly the signal died slowly into the noise. I can't be sure that the WWV transmitter didn't malfunction, and I can't be sure that I didn't hear a burst of signal from another standard-frequency station on the same frequency elsewhere in the world. That's why LDEs are so tantalizing.

I don't think it would pay the average ham to search deliberately for LDEs. Scientific searches at Stanford, and also in England, extending over several years, have produced only a very few instances which might be explained as LDEs. And there is still no completely convincing proof that the echoes are truly associated with the outgoing transmissions.

HRH: Are you still looking for reports of long delayed echoes?

Mike: Yes indeed, reports of really long delays would very much be welcomed. By "really long" I mean two or three seconds or more. The words "one thousand and one," spoken slowly represent roughly one second. Round-the-world echoes, which involve delays of a couple of tenths of a second, are of no

"The technique for creating artificial layers . . . calls for heating the region with high-frequency, high-power radio waves."

interest to me, although when conditions are right they can be very startling to the listener.

HRH: You've been active in research about creating an artificial ionosphere. What do you do to produce ionospheric reflection on demand?

Mike: It turns out that at ionospheric heights what remains of the atmospheric gas is incredibly rarefied — it's about like the vacuum of an ordinary Thermos bottle. Therefore, it doesn't take much energy to create an "artificial" layer, if one does it right. An exceptionally intense meteor shower — such as might be encountered every 20 years or so — in effect generates an artificial layer. Easily ionizable chemicals such as cesium, when ejected from a rocket, spread out to form what could be called large "clouds" or small layers. Atomic explosions at the right altitudes can also create spectacular layers.

On the other hand, plain old water released within an ionospheric layer tends to make the electrons disappear. Since water is a major ingredient of rocket exhaust plumes, some concern has been expressed that operation of space-shuttle engines might

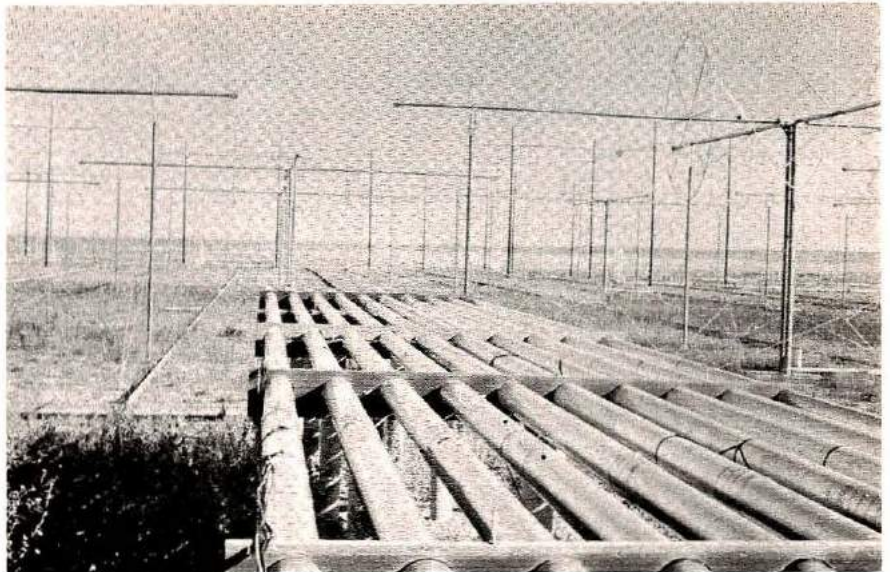

An antenna field for ionospheric heating. Irrigation-pipe coaxial feeders in the foreground convey power from ten 100-kW transmitters to as many broad-band cage-type dipoles, which collectively beam a circularly-polarized signal straight up. Located at Platteville, Colorado, the installation belongs to the Institute for Telecommunication Sciences of the Department of Commerce (*photo courtesy of K6FV*).

cause appreciable interruptions to high-frequency transmissions reflected by the ionosphere. Fortunately, water is a natural ingredient of our atmosphere and the effect only lasts half an hour or so.

But the technique for creating artificial layers that intrigues me the most is entirely reversible and non-polluting. It calls for heating the region with earth-based high-frequency, high-power, radio waves. This rather unexpectedly rearranges the electrons in such a way as to make possible the oblique reflection of signals at frequencies up to the uhf band, under the right geometrical conditions.

HRH: What is the background of the ionospheric modification tests?

Mike: The possibility of ionospheric modification by heating was predicted in Russia about 1962. We at Stanford became interested in testing for such an effect in 1965, did so, and came within a whisker of finding it. But, we didn't succeed. Later on, when the National Bureau of Standards built a much bigger

heating transmitter, the effect was discovered right away.

My own contributions to the heating work — if you could call them that — had to do with the oblique transmission possibility. They really stem from my previous experience in communicating via auroral reflections. These, in turn, were a fallout of my backscatter and meteor-detection work. So, it all ties together.

HRH: What kind of equipment is needed for the "heater" ground station?

Mike: Nothing more than a powerful CW transmitter and an antenna directed upward. The frequency to use depends on the time of day. With an antenna of "modest" size some 10 megawatts of power is required. On the other hand, a 100-kilowatt transmitter suffices at the 1000-foot-diameter spherical reflector at Arecibo, Puerto Rico.

HRH: What work have you done on radio hardware in addition to ssb transmitters?

Mike: Well, one item was the *Selectoject*. It's funny how

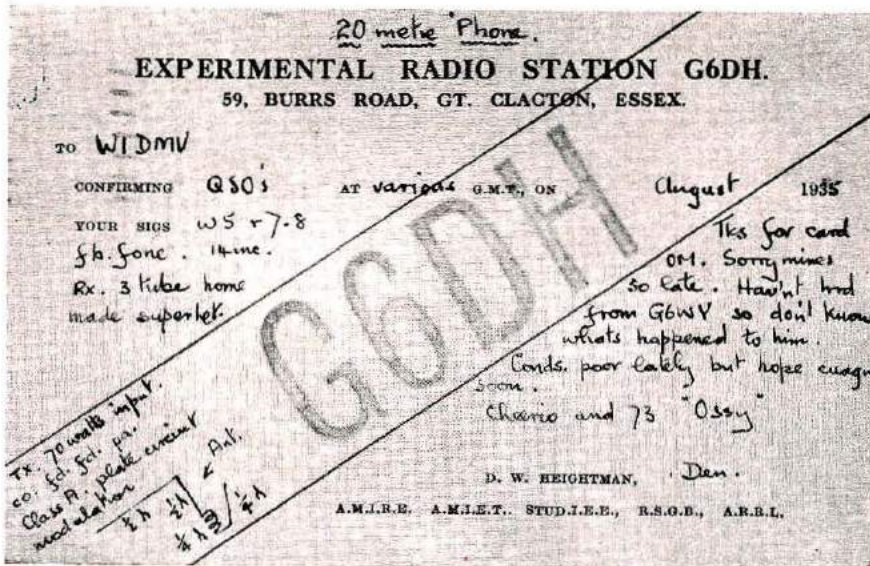

W1DMV regularly worked into Europe using his rhombic antenna. Here is a 1936 QSL from G6DH, who Villard QSOed often and subsequently visited during a trip to England in 1937.

things grow out of other things. As a result of work on phase-difference audio circuits for ssb, in which phase is shifted while keeping amplitude constant, it occurred to me that it would be possible to build a simple resistance-tuned oscillator, or a selective filter, using this principle. At this time the National Radio Company happened to have a large number of plastic cases left over from a product that didn't sell well. After my first article on the devpzh appeared in *Electronics*, they contacted me about producing the filter, which fortunately would fit their box very nicely. They thought up the name Selectoject, and it was a natural. It was used for many years.

HRH: Did you develop any other filters?

Mike: The Selectoject was designed to be used in series with a receiver's audio circuit. Of course, it is always better to accomplish selectivity in the i-f stages if possible. I developed a unit which could be attached to an existing receiver's i-f amplifier by lifting one tube slightly, thus exposing a prong

and connecting a small capacitance probe to it. No other modification was necessary. Improved selectivity was accomplished by positive feedback, and the scheme

This ad for the Select-O-Ject (forerunner of the Q multiplier) appeared in the December 1949 issue of *QST*.

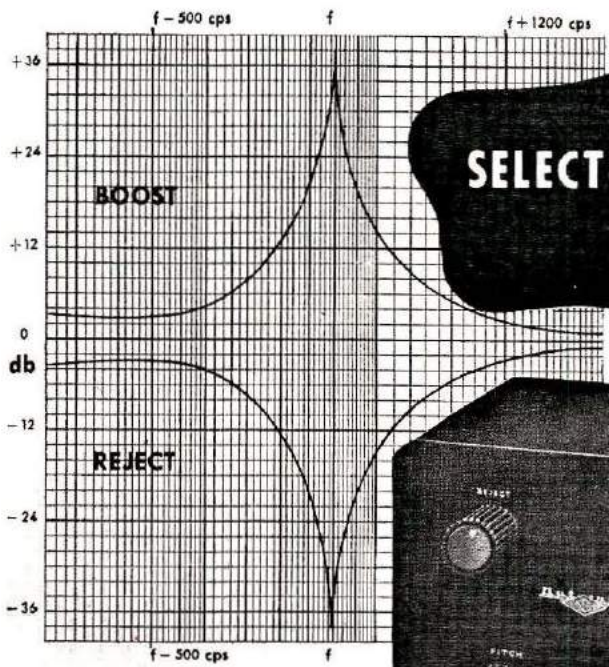

**amazingly
versatile
new audio filter**

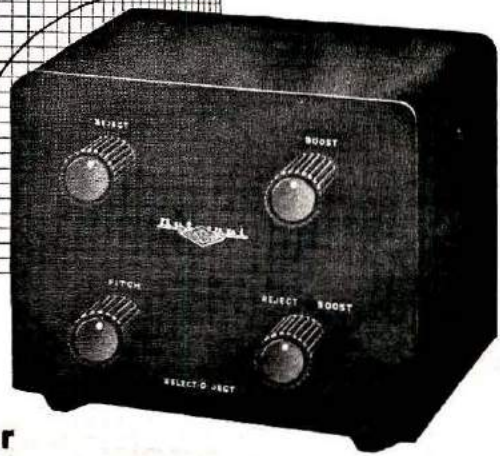

BOOSTS 38db! REJECTS 38db! ANY SELECTED FREQUENCY!

became known as a *Q-Multiplier*. Drake and Hammarlund marketed receivers with built-in Q-multipliers. Heath sold a copy of my circuit as a kit. I cannot lay claim to the name; a chap at MIT wrote an article for *Electronics* about a clever circuit, to stabilize positive rf feedback, which he called the "Q Multiplier." Although my device didn't use his circuit, the name was so appropriate that it soon was used for what might otherwise have been called the "I-F Selectoject."

HRH: Can amateur radio still make a contribution to science?

Mike: We are entering a period where determining the practicality — or suitability for public use — of any invention or discovery is becoming increasingly important. Amateurs, with their love of

innovation, practical technical skills, and wide geographic distribution, represent — in my view — an invaluable test bed for trying out new communication schemes and techniques.

It's too bad that more use is not made of radio amateurs as a resource. The situation is different in astronomy. Comets need to be studied and their occurrence is completely unpredictable. It is impractical for scientists to keep a continuous watch on all parts of the sky in an effort to catch a comet when it first appears. But amateur astronomers, with minimal training and very simple equipment, have regularly spotted new comets as they first become visible. The astronomical community recognizes the value of this contribution by using the discoverer's name to identify the comet.

HRH: Are there new areas to be explored by radio amateurs?

Mike: It's a funny thing that during certain periods in history, such as the end of the 19th Century, many people tended to believe that all the laws of physics had been discovered; the record shows otherwise. Today, we live in an age where many of the discoveries are not as spectacular, perhaps, as the electric light, but nonetheless, they are enormously interesting and potentially valuable. The age of discovery is by no means over.

HRH: Are there new areas of technology that amateurs should be experimenting with?

Mike: It seems to me that communicating by fiber optics has fascinating possibilities. The equipment is becoming cheap and readily available, and no FCC license is required. It would be feasible to string optical cables around a neighborhood very inconspicuously on telephone poles, in storm drains or



W6YX today. Dr. Villard, the trustee, is at the rear, enjoying a ham radio contact with two of the club's student officers.

sewers. When will the first all-amateur fiber-optic two-way TV "network" be established? Also the possibilities of personal computers have only just begun to be explored. The interconnection of computers, displays, and data banks, by radio techniques is an exciting new field of great practical importance.

HRH: You have been a part of what seems to be a remarkable string of discoveries. In closing, do you have any additional thoughts for our readers?

Mike: What tickles me is that most of the things I have been involved with are really direct outgrowths of my interest in ham radio. I certainly can't deny that I've been uncommonly lucky. But it's perfectly clear to me that anyone with a real interest in how things work can derive tremendous benefit from ham radio as a hobby. There's no better way to learn than by exploring on one's own, and nature has endless secrets just waiting to be unlocked. It's hard to be complacent about the present state of knowledge

when we don't know exactly why and how the ionosphere causes satellite signals to fade or "scintillate," any more than we understand LDE's, or know how to predict droughts. Can anyone tell us, for example, — with certainty — what the sunspot number at the peak of the next cycle will be?

The mysteries of the ionosphere have always excited me, just as others (like Jacques Cousteau) are endlessly intrigued and excited by the earth's oceans. One can say that the world is surrounded by an eighth sea — a blanket of air extending a hundred or more miles high. That ocean also has tides and currents, and calms and storms, just like its watery counterpart. Although much of the atmospheric sea is invisible, there is a portion — the ionosphere — which we can make visible by means of radio waves, so that we can study its moods and tantrums in detail. This same ionosphere serves as an invaluable buffer between the dangerous radiation fields and energetic particles of outer space, and the thin layer of breathable air within which human life has evolved. **HRH**



QUESTIONS & ANSWERS

Oscillators and Amplifiers; Transmitters and Receivers

BY THOMAS McMULLEN, W1SL

In the two issues previous to this, I told you about some of the components that go into making up electrical equipment, and explained how some of them work. Now is the time to put some of the parts together to make something useful. I've picked a few oscillator circuits to tell you about, and then combined some circuits to form a basic transmitter. You'll need to know about receivers too, and I'll show you the bare bones of what they are made of.

So, let's start things off by taking a look at some oscillators. All radio communications start off with an oscillator of some type, otherwise there would be nothing to send through the atmosphere to be picked up by your antenna. The most effective receivers use an oscillator too, and I'll get around to that later.

Oscillators

There's one thing that you can remember about oscillator circuits that will help you to recognize them, and to figure out how they work: an oscillator is essentially an amplifier circuit that has a path for part of its output energy to be returned to its input. This path is called a *feedback* circuit, and it can be put there

by design or it can occur by accident. A circuit that is *designed* to be an oscillator has the feedback path precisely arranged and controlled so the oscillations will be stable and dependable. An accidental feedback path can occur when a component becomes defective, which will allow an

amplifier to become an oscillator. A common example of an accidental feedback path is the audio howl heard through a public-address system when someone turns the amplifier gain up too high, or moves the microphone or speakers; part of the output signal gets back to the input, is amplified, and presto! — you have an oscillator. Another accidental path could be in a circuit that feeds the dc voltage and current to several different stages. If the power supply circuit is not well filtered, some of the output signal can appear on the dc supply line, and this signal will be passed along to a previous stage, to be amplified again, causing oscillations. The principle works the same for either audio or radio frequencies.

Fig. 1 shows an oscillator circuit in which the feedback path is not too apparent unless you know what to look for. The circuit is called a tuned-plate, tuned-grid (TPTG) oscillator, and the feedback path is through the internal elements of the tube. Remember that a capacitor is two conductors separated by a non-conductor. The inside of a vacuum tube fits that category — the grid elements and the plate (anode) structure are both metal, separated by vacuum, so the tube has a built-in capacitor.

This capacitor behaves in just the same way any other one would — it couples energy between the two circuits. This means that part of the signal that appears on the plate also appears at the grid, where it is amplified by the tube, causing a bigger signal on the plate, which is connected back to the grid, and so on. The only thing that prevents the process from generating an even larger signal is the limitation of the tube itself; it will only withstand so much signal on the grid and then it saturates (cannot amplify any more).

How does the first signal get started, to be amplified into an

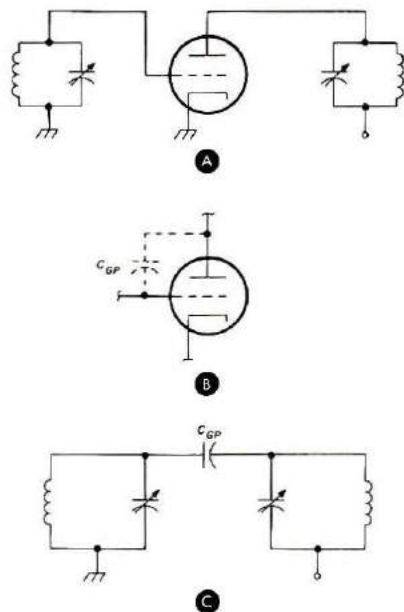

Fig. 1. A very basic oscillator circuit consists of a vacuum tube with the input circuit and the output circuit tuned to the same frequency. The two circuits are connected to each other by the internal capacitance between the grid and the plate, C_{gp} , as shown in B and C. This grid-to-plate capacitance can be a help, as in the oscillator above, or it can cause problems in amplifiers.

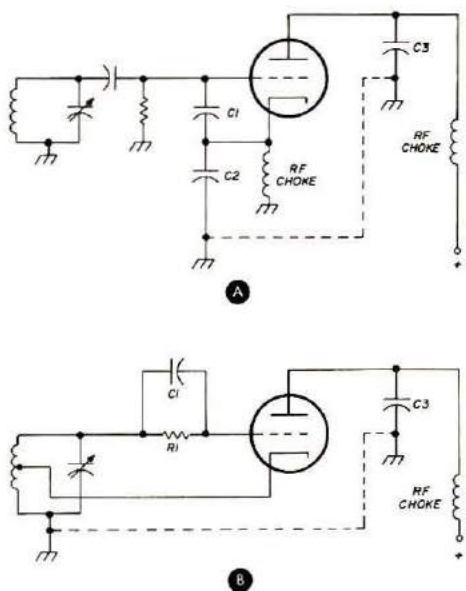

Fig. 2. The oscillator at **A** is called a Colpitts, after its inventor. Part of the rf energy on the cathode is coupled to the grid by the voltage divider, C1 and C2. The tuned circuit determines the frequency of oscillation. C3 is used to bypass rf from the plate circuit to ground, and the dotted line from C3 to C2 shows that the rf path is complete. One thing to remember about rf — you must provide a place for it to go, or it will find its own way and cause trouble as it does so. The Hartley oscillator, **B**, was also named after its inventor. A characteristic of this type is the tapped coil. Again, the dotted line shows the completed rf path.

oscillation? It's usually triggered by the current rushing in when the circuit is first turned on. The current flow through the tuned circuit and tube elements causes a change in electrostatic charge and magnetic field, which causes a further change, etc., building up to a full oscillation. It doesn't take long — usually microseconds.

Other oscillators

Fig. 2 shows some oscillators with a different type of feedback path. Note that the cathode circuit of **Fig. 2A** is not bypassed to ground with any large capacitance, but rather has a voltage divider consisting of C1 and C2. This allows part of the signal voltage on the cathode to be coupled (connected) to the grid. This is called a Colpitts oscillator, after its inventor. Again, the grid-plate action of

the tube amplifies the signal. Because the current through the plate circuit must also pass through the cathode, this amplified signal appears on the grid again, and so on. Some circuits with this type of feedback are designed to be very stable — they use very high quality components, and some of the components are made to compensate for temperature changes. These well-designed circuits will stay on their intended frequency for long periods of time, which is often very important in radio work. Transistorized versions of these circuits are shown in **Fig. 3**.

Note, in **Fig. 2A** and **B**, the dotted line from the plate bypass capacitor (C3) back to the "grounded" end of the input circuit. This line shows that the rf circuit is complete — this is very important. The rf energy must have a clear path to travel, just as the dc flow must come from the power

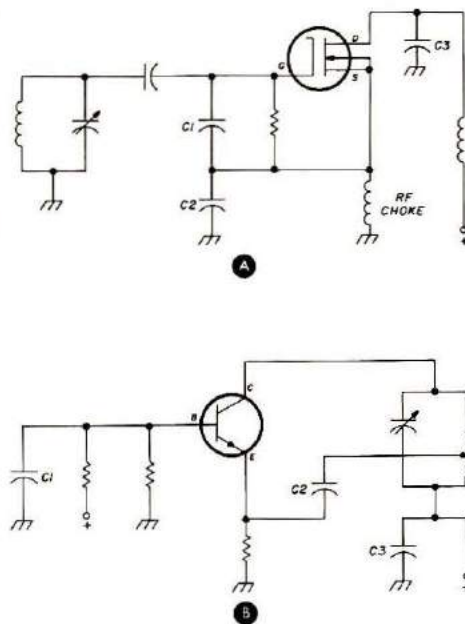

Fig. 3. Here are transistorized versions of the Colpitts, **A**, and the Hartley, **B**, oscillators. Note that the emitter in **B** is tapped on the collector tuned-circuit. This couples some of the energy in the tuned circuit back to the emitter, which allows it to be amplified again, sustaining oscillations. The circuit at **A** uses a Junction FET, which behaves very much like a vacuum tube.

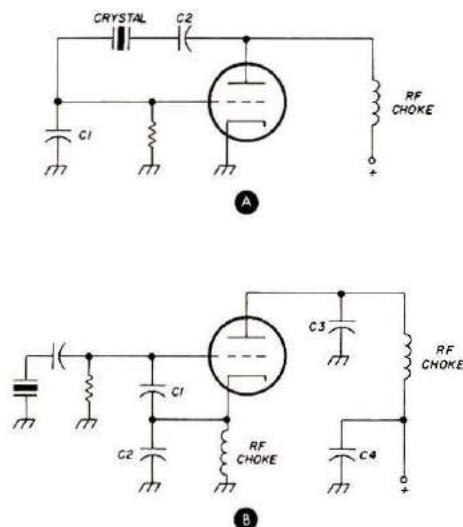

Fig. 4. A quartz crystal can be substituted for a tuned circuit, which will create a very stable oscillator. In **A** the crystal is in the feedback path between the plate and the grid. C2 is there to keep high-voltage dc away from the fragile crystal. This is called the Pierce oscillator. The circuit at **B** is a modification of the Colpitts oscillator, with the familiar voltage divider between the cathode and the grid.

supply and return to it.

Another very stable circuit is the crystal controlled one, **Fig. 4**. (Here's where I tell you about a crystal, as I promised last month.) A crystal that is used in frequency-control circuits is made of quartz, a mineral form of silicon, which is found in natural formations, or can be grown in specially designed ovens. The crystal is sliced and ground into precisely shaped wafers and mounted in a convenient holder for ease of handling and protection from moisture and corrosive elements.

A unique property of these processed crystal wafers is that when you apply a voltage to them, they vibrate. The vibrations are at a rate determined by how the crystal was cut, how well it has been polished, and its dimensions. If the crystal were large enough, you could hear the vibrations just as you can hear a tuning fork. However, radio-frequency crystals are usually very thin (about as thick as 4 or 5 sheets of paper). A crystal that

vibrated one million times per second would be oscillating at 1 MHz — right in the middle of the a-m broadcast band on your transistor radio. Manufacturers can process special crystals to work at over 100 MHz. Because they are very stable, crystals are often used to control the operating frequency of equipment in aircraft, boats, commercial stations, or anywhere that accuracy and stability are important.

Amplifiers

An amplifier is a circuit that accepts a small signal and increases its power to some significant degree, in order to make the signal useful. A public-address amplifier in a large room builds the small voice of a person up to the point where it fills the whole room. An amplifier for an electric guitar picks up the small signal from the vibrating strings and sends it out to thousands in the audience. A radio-frequency amplifier in a transmitter accepts the fraction of a watt from the oscillator and builds it up to hundreds of watts so it will span the world, and the amplifiers in your receiver pick up an incoming signal that is only a few millionths of a watt and build it up to enough power to drive a speaker or earphones.

A basic amplifier circuit is shown in Fig. 5. The small input signal is applied to the grid, and is amplified by the electron flow in the tube and through the external circuits. (It works the same way with transistors — as shown in Fig. 5B). A tube or transistor amplifier that is directly connected between the power supply voltages as in Figs. 5A and B, would allow too much current to flow through it, and therefore overheat. The amount of current that flows through a tube or transistor can be controlled by applying an inhibiting voltage called *bias*. There are two common ways of applying protective bias in vacuum

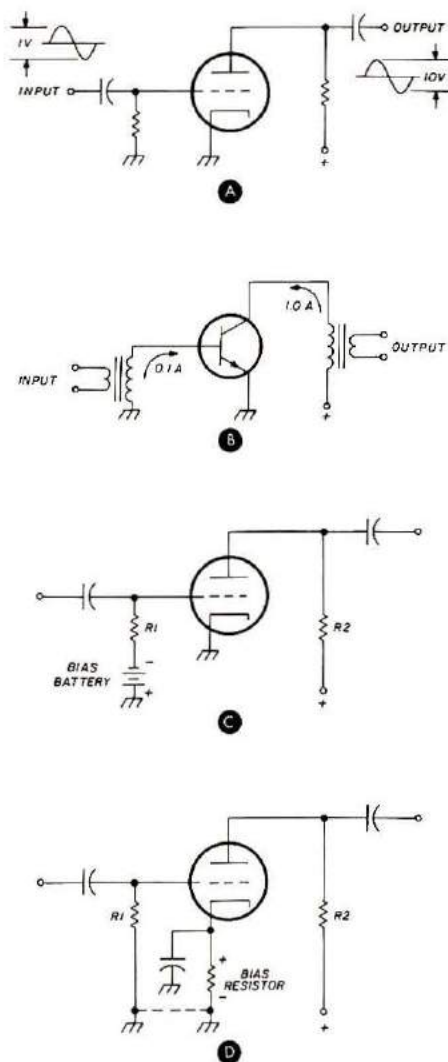

Fig. 5. A very basic amplifier is shown at **A**. It is simply a triode vacuum tube with an input signal coupled to the grid by means of a capacitor. The changing flow of electrons through the plate resistor, R_p , creates a varying voltage across it, which is simply an amplified version of the input signal. A transistorized amplifier is shown at **B**. This version uses transformers to couple the signal in and out, but resistors and capacitors can do the job as well. Since the transistor is a current-amplifying device, I have shown the increase of current flow in the collector, as a result of the flow in the base. Amplifier devices connected across a power source in this simple manner would allow too much current to flow, and overheat. They must have *bias* to restrict the flow. This is done by means of a bias battery or supply, as shown in **C**. The grid is more negative than the cathode, thereby decreasing the flow of electrons from cathode to plate. A resistor can be used in series with the cathode, **D**, to do the job. The dotted line shows how the grid circuit is made more negative than the cathode, just the same as when you had a bias battery in the circuit.

tubes; direct grid bias from an external source, usually a small supply or battery, Fig. 5C, or by cathode bias, Fig. 5D.

In either type of bias arrangement, the idea is to make the grid circuit slightly negative with respect to the cathode. This will reduce the number of electrons that leave the cathode to get to the anode, and thus protect the tube. When you study for higher classes of license you'll learn how changing the amount of bias causes the amplifier to work in what we call different "classes" of operation, each of which has its own characteristics and advantages. The important thing at the moment is to recognize a bias circuit when you see it. If there is not a direct connection from the grid circuit to a bias source of some kind, then look for some resistance in the cathode circuit that performs the biasing function. It is sometimes confusing unless you know what to expect, because there are often capacitors and rf chokes there too, to keep radio-frequency energy from going to the wrong places.

Radio frequency amplifiers

The illustrations in Fig. 5 were generally for audio amplifiers, but amplifiers are needed at radio frequencies, too, and Fig. 6 shows some of them. They differ mainly in that some parts of the circuit are designed to be efficient at radio frequencies — they pass only a small band of rf, or they do not inhibit rf from flowing in the circuit. An example of the selective circuit is the resonant **L** and **C** combination in the plate of the tube, Fig. 6A. The dc for the cathode/anode circuit flows through the inductor, and the resonance of the L2/C3 pair allows radio-frequency energy to build up on the plate.

The grid circuit is connected to a bias supply through the rf choke, which passes dc, but does not allow the rf to get back to the bias supply. The

capacitors, C2 and C4, are there to make sure that no stray rf gets past the rf chokes into the bias supply or the B+ circuit (if it did, this would be an accidental or unwanted feedback path, causing oscillations, just as I mentioned in the section about oscillators).

Speaking of unwanted feedback paths and oscillations — what can you do about the capacitance between the grid and the plate, inside the tube? It's always there, and constitutes a real and fixed path to connect the grid and plate circuits together, as I explained earlier in the case of a TPTG oscillator. Well, the term used for what we do about it is called *neutralization*. This is done by taking advantage of the phase characteristics of certain parts of the amplifier circuit. A simple version is shown in Fig. 6B. The radio frequency energy at the plate end of the inductor is of a given phase, let's call it "in phase," just for reference. At the other end of the tuned circuit, the energy is "out of phase." This is a characteristic of this type of tuned circuit. Now, if we take a small portion of the energy that is out of phase, and couple it back to the grid, it will cancel the energy that the internal grid-to-plate capacitance tends to couple to the grid. Let's go over that again: the grid-to-plate capacitance, C_{gp} , couples a

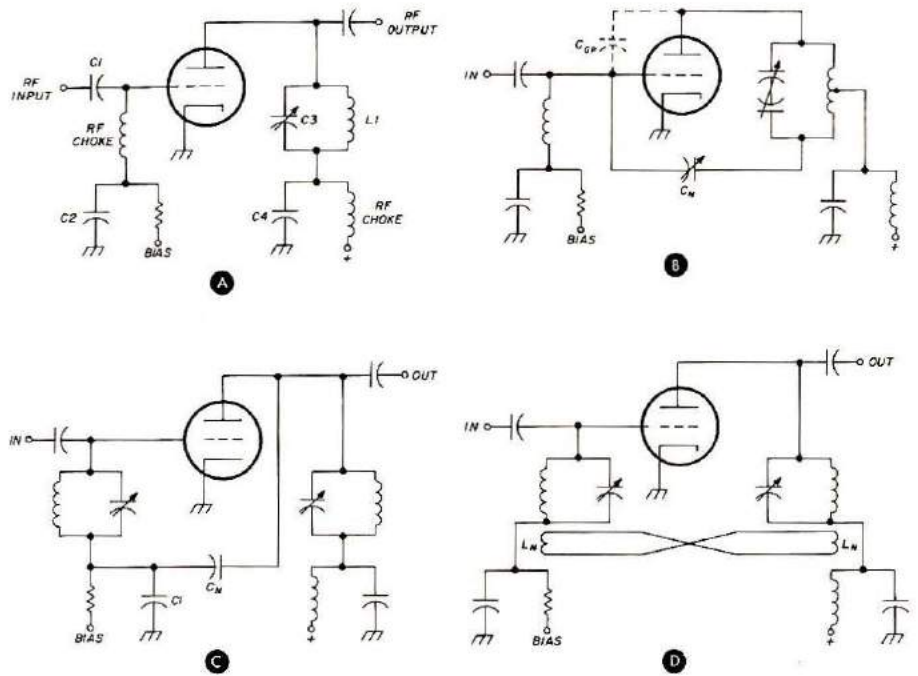

Fig. 6. A basic radio-frequency amplifier differs little from an audio amplifier, except for the input and output circuits, which are made to work at radio frequencies. In A, L1/C3 is resonant at the desired frequency of operation. Actually, the circuit at A would oscillate because of the grid-to-plate capacitance, which I talked about earlier. This must be neutralized out, as shown in B. If C_n is equal to C_{gp} in value, the coupling effect of C_{gp} is canceled, and the circuit will not oscillate. Other methods of neutralizing an amplifier are shown in C and D. In C, a voltage divider consisting of C_n and C1 couple part of the energy back to the grid circuit to neutralize the amplifier. Inductive neutralization, D, is not often found in modern transmitters, but it follows the same principle of coupling out-of-phase energy from the output back to the input.

fixed amount of energy from the plate to the grid, Fig. 6B. If the neutralizing capacitor C_n , is of exactly the same value as C_{gp} then it will couple exactly the same amount of energy, but this energy will be 180 degrees out of phase and will cancel (neutralize) the energy that C_{gp} passes. Neat, huh?

Another neutralizing scheme

takes advantage of the phase shift between the grid circuit and the plate, and couples some neutralizing energy back to the grid through a capacitive voltage divider, C1 and C_n , as shown in Fig. 6C. It works the same way, but is a little bit harder to follow because of the extra capacitor involved.

Some old-time circuits used inductive neutralization, Fig. 6D, where one or two turns of wire (L_n) are coupled to the plate circuit, and connected to another turn or two coupled to the grid circuit. A 180-degree twist is given to the connecting wires to make sure that the energy is out of phase. This type of neutralization is seldom used today, but it is well to know about it just in case you find the circuit in an old book or transmitter, or get it on an exam some time.

Just in case you're wondering if there isn't a way to build a tube that doesn't need to be

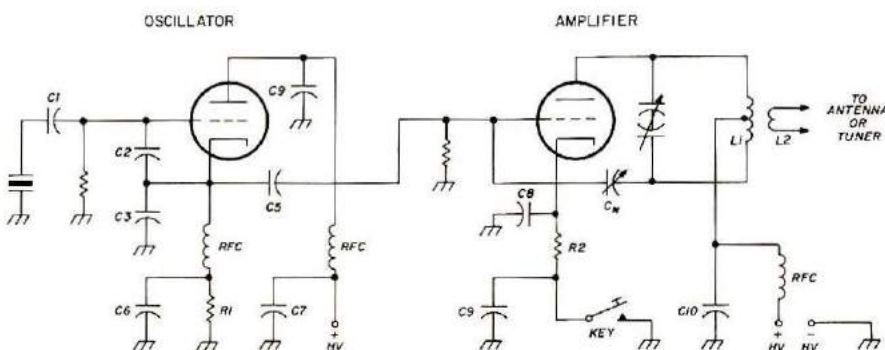

Fig. 7. By combining an oscillator circuit with an amplifier, you have a basic transmitter. Energy from the cathode of the oscillator is coupled to the amplifier grid by C5. Fixed bias is provided by a resistor in the cathode circuit of each tube (R1 and R2). The amplifier stage is neutralized, and uses a link to couple energy from the output circuit to the transmission line or antenna circuit.

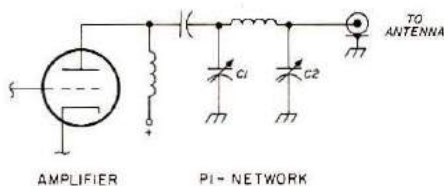

Fig. 8. The pi network is a type of matching circuit that is often used in the output circuit of transmitters. C1 and C2 can be varied to match a wide range of impedances at either the input or output end of the circuit. This type of matching circuit can be used between stages in a transmitter, especially those with transistorized amplifiers.

neutralized, let me say yes, there is. That is really what the screen grid that I talked about in last month's session was intended to do — it was supposed to provide a shield, or screen, between the grid and the plate to reduce the capacitance between the two elements. It works, to a great degree, but is not completely effective in all cases. Some tubes require a small amount of neutralization even though they have a screen grid. This is usually because of stray resonances or capacitances within the tube structure itself. These "strays" might not bother a circuit operating at some frequencies, but would at others. Usually, the manufacturer's data for the tube will indicate whether neutralizing is needed — and circuits that have been proven by use in the field are good ones to follow in this respect. The point is, just because a tube has a screen grid, don't assume that it will need no neutralizing.

Basic transmitter

Now, let's tie a couple of pieces together and make a transmitter. I've taken an oscillator from **Fig. 4** and connected it to an amplifier, which gives us a two-stage transmitter, **Fig. 7**. An amplifier not only increases the power of the signal, but its presence between the oscillator and the antenna provides some isolation so that the antenna circuit will not "pull" the oscillator

frequency away from where you want it. Notice that the oscillator has a crystal in the feedback path from plate to grid, which controls the frequency. The oscillator is turned on and off by the key in the cathode circuit, which interrupts the electron flow. The radio-frequency energy on the cathode of the oscillator tube is coupled to the grid of the amplifier by the capacitor, C5. The relatively small signal on the grid of the amplifier is increased to a larger one on the plate by the amplification factor of the tube. A link made of a few turns of wire couples this energy to the antenna circuit.

Remember, when I told you about inductors and transformers, I said that some were impedance-changing devices? Well, this is a good example. The impedance at the plate end of the tuned circuit is very high, several thousand ohms. Coaxial transmission line used to conduct energy from your transmitter to the antenna is usually 50 to 75 ohms. The tuned (resonant) circuit and coupling link of **Fig. 7** transform the high plate-impedance to the low line-impedance.

Another impedance transforming circuit, which is more properly termed an impedance matching circuit is the pi-network as shown in **Fig. 8**. This circuit gets its name from resemblance to the symbol for a mathematical term, π . The input capacitor (C1) can be varied to have a reactance equal to the impedance of the tube anode, and the output capacitor (C2) can be varied to match the transmission line or other load that is connected to the output of the circuit.

There's another thing I should mention about amplifier circuits here, and that is a neat trick you can do with them to increase the frequency of the energy you get out of them. If the plate circuit (output circuit) is tuned to a multiple of the input signal, you then have a

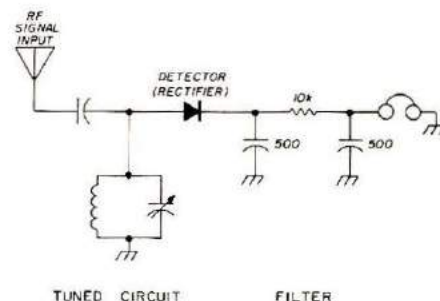

Fig. 9. A simple detector consists of a tuned circuit to select a particular frequency, and a diode to detect (rectify) the rf energy. The resistor and two capacitors make up a filter circuit which shunts the rf to ground, but allows the audio modulation to pass on to the earphones.

frequency multiplier. Many older transmitters use this type of circuit to enable an amateur to operate on several bands with just one set of crystals or with a VFO that is made for just one band.

For example, suppose you had a crystal oscillator that was designed to operate between 3.5 and 3.8 MHz. By placing a frequency *doubler* in the circuit after the oscillator, you can obtain output in the 7.0 to 7.3 MHz band (but be sure to pick the right crystal; $3.8 \times 2 = 7.6$ MHz, which is out of the band!). You can make frequency triplers, and even quadruplers, simply by tuning the output circuit to the right multiple of the oscillator frequency. One word of caution though — the higher the order of multiplication, the lower the efficiency. Except for very low-power stages in receiver circuits, multipliers of an order higher than X4 are seldom used. Improved crystal-manufacturing techniques, and the ease of heterodyning two frequencies to produce a third, have made it relatively simple to work directly at frequencies anywhere in the amateur bands, without the need for multipliers.

Receivers

Receivers have only one function, and that is to transform the radio-frequency

energy picked up on your antenna into a form you can hear. This function can be performed by a very simple circuit, as in a crystal detector, or by an immensely complex piece of equipment with dozens of stages and hundreds of dollars worth of parts. If all you want to hear is the broadcast station down the block, the crystal detector will suffice. When you want to receive extremely weak signals from distant stations and separate one particular signal from a multitude (as in the midst of a DX pile-up), then you need the complicated, multi-stage receiver.

A very simple receiver is shown in Fig. 9. It is nothing more than a rectifier, just as you would use to make a power supply. The difference is in the frequency of energy applied to the diode, and in the filtering on the output side of the rectifier. Remember that amplitude modulation is an rf carrier with audio superimposed upon it. All you need to do to detect this type of signal is to filter out the radio frequency and leave the audio intact, and you have a receiver. Note that the filter capacitors are very small in value. They are almost non-existent as far as the audio is concerned, but they shunt the radio frequency to ground, thus keeping it out of the earphones or audio amplifier.

Other receivers are usually an improvement built upon that basic idea of a rectifier-type detector. There is no need to go into exact schematic

diagrams of each type here, but I have shown some block diagrams in Fig. 10. Note that the first logical step is to add an amplifier to increase the audio so you can hear it on a loudspeaker, **A**. The next step, **B**, is to add a radio-frequency amplifier so you can pick up weaker signals.

Now you have a basic, sensitive receiver that is fine for amplitude modulated signals, such as your local broadcast stations, but if you want to copy Morse code or ssb voice, then you have to add a beat-frequency oscillator (BFO), **C**. This does just what its name implies — it beats against, or heterodynes with, the incoming signal. A receiver such as this has one flaw when you try to use it on a crowded amateur band — it tends to pick up several signals at once. The cure for that is to place some selectivity, in the form of a filter, in the circuit. However, the filter has losses, so an amplifier must be added to regain the signal strength that was lost. This creates problems, too, because there is a limit to the number of amplifiers you can hook in series before the overall gain causes them to become one huge oscillator. This led designers to try an approach called the superheterodyne receiver, or *superhet* for short, see Fig. 11.

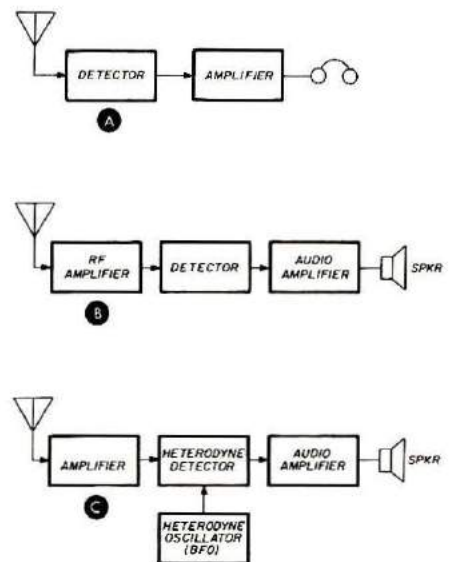

Fig. 10. To create more sensitive receivers, you can add an audio amplifier, **A**, and then add an rf amplifier, **B**. This type of receiver will work for local a-m broadcast stations, but not much else. To receive Morse code and single-sideband signals, you must add a heterodyne oscillator, **C**. The signal from the BFO beats against the incoming signal, and you can hear the audio beat-note between the two.

In the superhet receiver, a signal is amplified in one stage, then heterodyned with a local oscillator that is operating at a frequency near the signal, but not close enough to cause an audio beat note. The difference between the two frequencies (signal and oscillator) is called the intermediate frequency (i-f). The i-f signal can be amplified by another stage. This amplifier will not cause problems because it is tuned to a frequency that is different from the input amplifier. The twice-amplified signal can now be fed to a detector which will convert it to audio for you to listen to. The detector following the i-f amplifier can be either a simple rectifier-and-filter type or a heterodyne type, the same as you would use for the basic receiver I mentioned earlier, Fig. 10.

Note that in Fig. 11 I have indicated that the local oscillator can be made variable, and you'll often hear the term VFO,

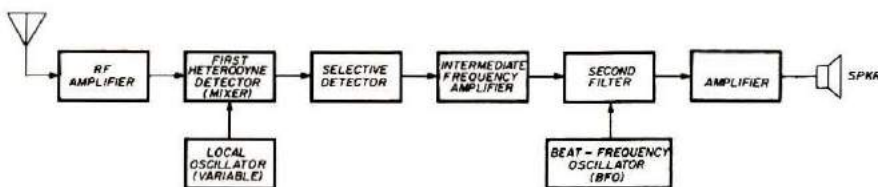

Fig. 11. A more complex receiver has an rf amplifier to boost weak signals, and a local oscillator to mix with the incoming signal in the first detector or mixer. Filters, and an intermediate-frequency amplifier, follow the mixer to further improve the signal. The second detector creates something that you can hear by either rectifying the signal or by using a beat-frequency oscillator. An audio amplifier puts the finishing touches on boosting the signal up to a comfortable listening level.

Larsen...

the coolest antenna in town gives you the hottest performance!

Since the first Larsen Antenna was introduced some 15 years ago, this basic fact has not changed: **Larsen Mobile Antennas are designed and built to outperform.**

With the introduction of the Larsen exclusive Kūlrod whip, this superior performance is a fact more than ever.

We're not going to confuse you with details on metallurgy, radiation resistance, plating systems and all that. Instead we suggest that you make this simple test:

Take any antenna other than a Larsen . . . one with a regular unplated 17-7 PH stainless steel (.100/.050) tapered whip. Apply a good husky signal to it . . . 100 watts, for, say, a full minute. Then, power off, feel the antenna. Careful! Burn blisters aren't pleasant.

Next . . . try a Larsen Kūlrod Antenna. Put it to the same test.

Amazing, isn't it!

That's our story. Heat means power . . . power that isn't radiated . . . power you shouldn't throw away. With the Larsen Kūlrod, power goes into communicating instead of heating the antenna. That's why **you can HEAR the difference.**

Larsen Antennas are available to fit all styles of mounts and to cover Amateur frequencies from 6 meters through 450 MHz. Write for complete catalog and list of dealers nearest you.



Larsen Antennas

11611 N.E. 50th Ave.
P.O. Box 1686
Vancouver, WA 98663
Phone: 206/573-2722

In Canada write to:
Canadian Larsen
Electronics, Ltd.
1340 Clark Drive
Vancouver, B.C. V5L 3K9
Phone: 604/254-4936

© Kūlrod is a Registered Trademark of
Larsen Electronics, Inc.



meaning variable-frequency oscillator. A VFO can be used in either a transmitter or a receiver. In the receiver, you would use a VFO to heterodyne with different incoming signals to produce an i-f signal. This is exactly what happens when you move the dial of your superheterodyne — the difference frequency, between the VFO and the signal, changes until it is no longer in the "window" that the i-f filter has, so you no longer hear it. In the meantime, you are getting closer to a second signal, and when the difference between it and your VFO is just right, then the second signal appears in the window, is amplified and detected, and you hear it.

Conclusion

That's the finish of the circuits section, and incidently, the end of this *Question? And Answers!* series. Obviously, there is an endless variety of electronics and communications subjects to talk about, but I've tried to keep the information presented here confined to what you'll need when you try for your Novice class license. As a parting shot, I'll give you a final sample question, direct from the FCC study guide:

A basic radio transmitter for use at a Novice station would not include

- (a) an oscillator stage
- (b) a frequency multiplier stage
- (c) a detector stage
- (d) tuning and loading controls
- (e) a final amplifier stage

The correct answer is **c**, of course. A detector is used in receivers, and the question concerns a transmitter. Note that a transmitter *might* have a frequency multiplier stage, but it doesn't *have* to have one. Therefore, the only item that is definitely *not* needed in a transmitter is a detector. Good luck with your exam! **HRH**

King of the Road

ATLAS 210x/215x

5 BAND—200 WATT—ALL SOLID STATE
HF SSB/CW TRANSCEIVER

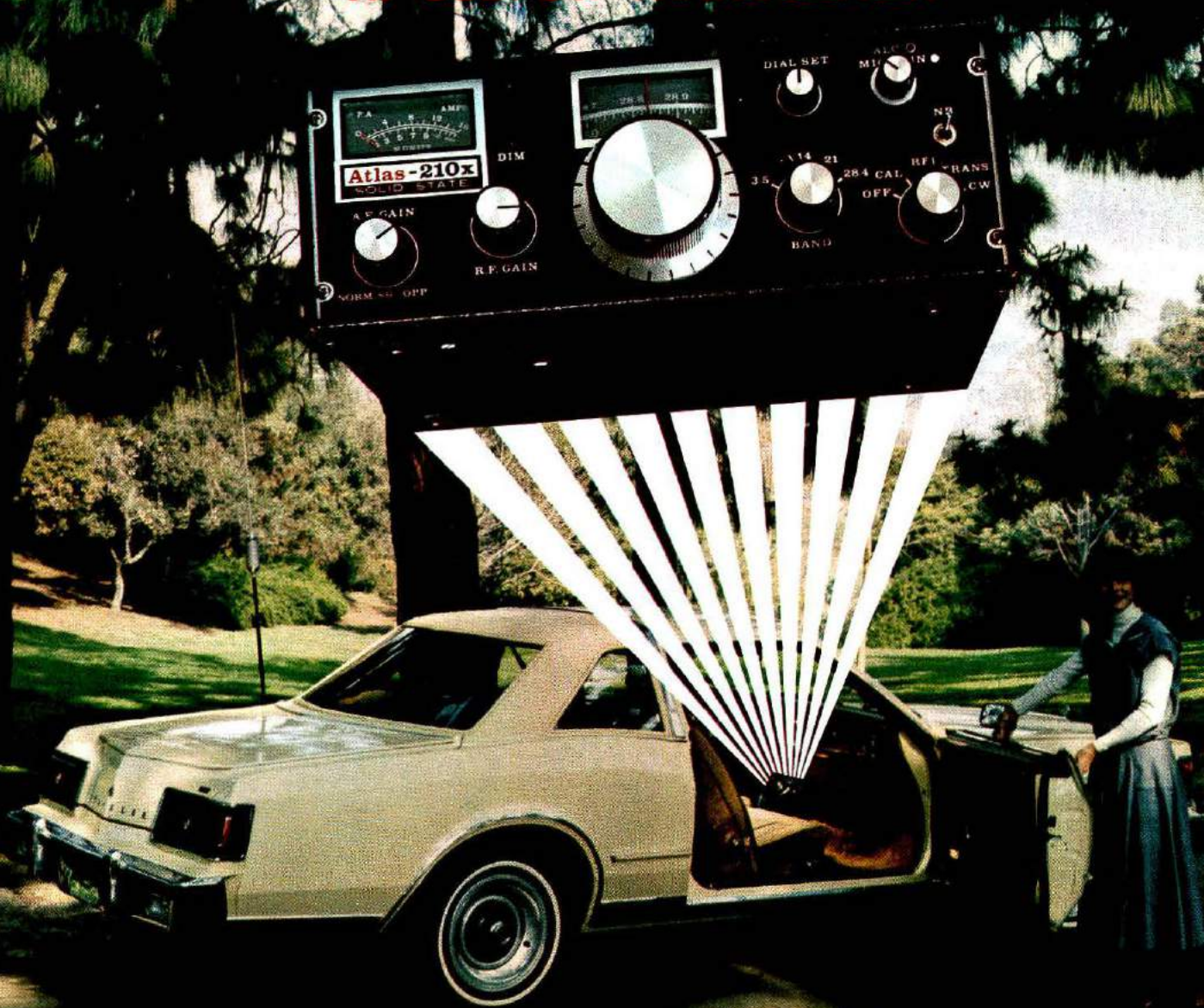

The Perfect Mobile Rig

With its exclusive PLUG-IN-AND-GO MOBILE MOUNT, its light weight (7 pounds), and compact size (3½" high X 9½" wide X 9½" deep) the Atlas 210x/215x is the perfect mobile rig.

To go mobile just slip the 210x into its mobile mount and all connections are made automatically.

In just 10 seconds you're on the air mobile!

(ATLAS 210x or 215x \$765)
with noise blanker \$810

 **ATLAS**
RADIO INC.

417 Via Del Monte, Oceanside, CA 92054

Phone (714) 433-1983

Special Customer Service Direct Line

(714) 433-9591

MADE IN AMERICA

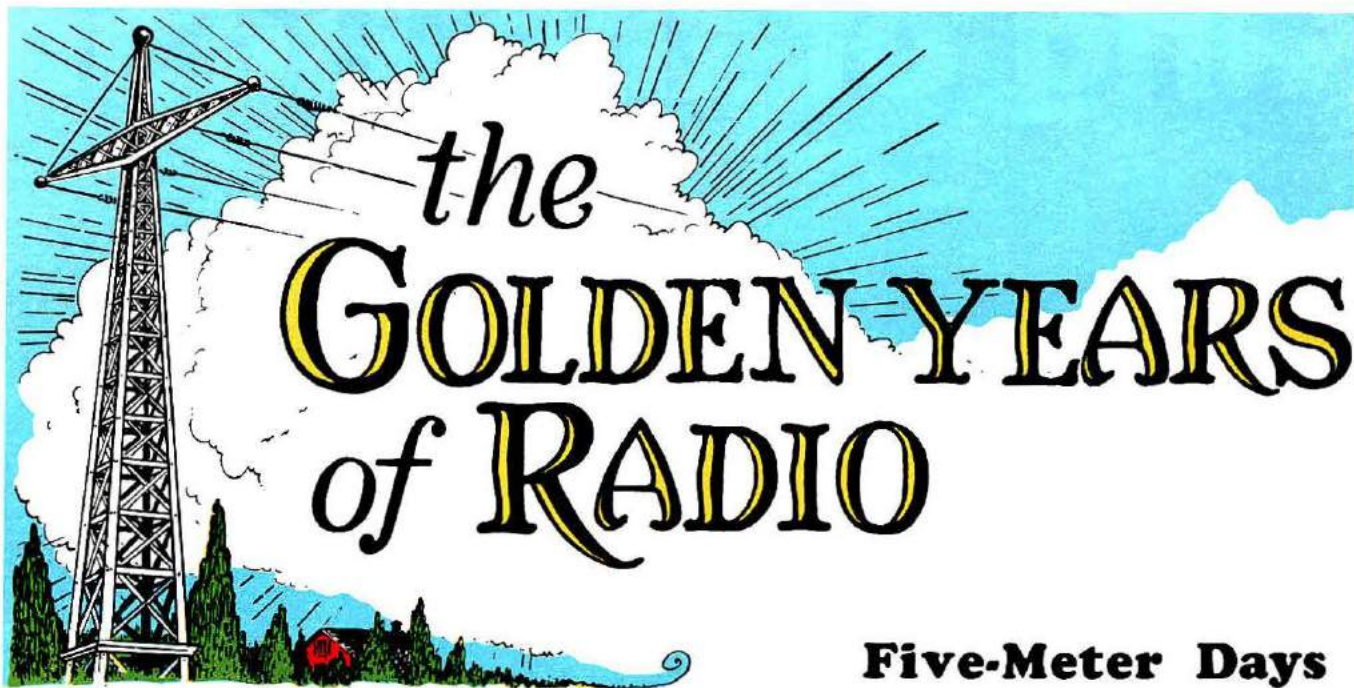

Five-Meter Days

BY WILLIAM ORR, W6SAI

Buried and sleeping beneath the bombast of soap opera, violence, talk shows, and noisome commercials on television channel 2 lies the old 5-meter amateur band.

Removed from the Amateur Service in 1947 by the learned decision of those who should have known better, the 5-meter band was replaced by the almost useless 6-meter band, which was to serve as a *guard band* for the splash-over from the powerful channel-2 TV transmitters.

Yes! Looking back to the Golden Years of amateur radio, the 5-meter band combined the tantalizing prospect of inter-continental DX with the comfortable and friendly local contacts of a wide group of "ultra-high frequency" operators who used equipment unknown to the majority of today's amateurs. An ideal band for the beginner in 1936, the 5-meter band was chock-full of inexpensive, home-built station equipment that afforded untold pleasure to those lucky amateurs who were fortunate enough to have experienced the beginning of vhf operation typified by today's sophisticated solid-state gear, multi-

element beam antennas, and mountain-top repeaters.

The way it was

Interested in getting on the air, young fellow? You have your Class B (General class) license? (Of course, no Novice or Technician class licenses

existed in those days.) Well, then, for about fifty dollars — or less if you have a good junk box — you can be on the air on the 5-meter band with a radio-telephone station!

Of course, in 1936 not all enthusiastic, would-be

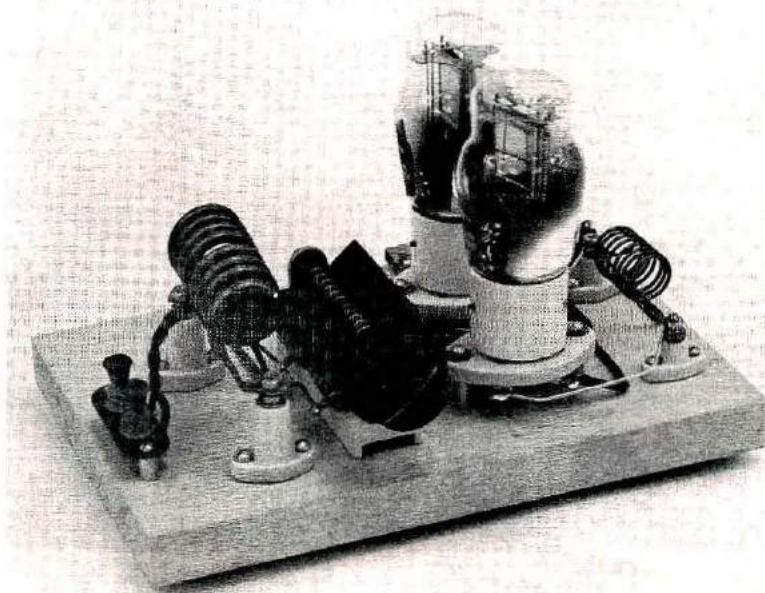

The Beginner's "ultra-high frequency" Transmitter of 1936. The modulated oscillator reigned supreme on the old five-meter band in pre-war years. This 1977 duplicate of the author's original transmitter uses isolantite-based 112As in a push-pull TNT (tuned-not-tuned) circuit. Grid modulation was used for phone. The little oscillator was built in a few hours from authentic parts, and provided a 5-watt carrier — right in the middle of today's TV channel two! The isolantite based 112As? I ran across a friend who had a whole box full of them in his attic — undisturbed for over thirty years!

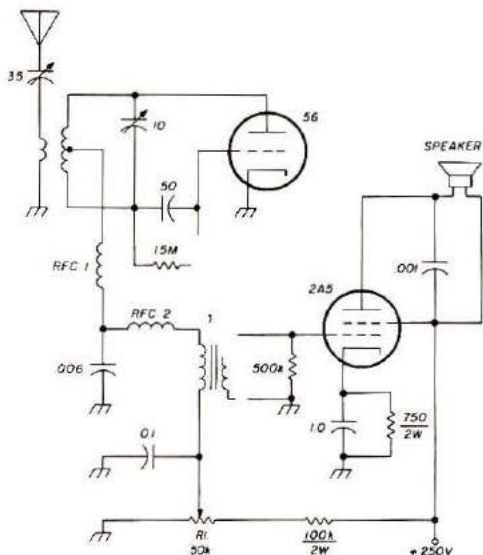

Fig. 1. The "rush-box" receiver. The simple two-tube set is full of tricks, as the author learned when he built his 1977 replica of the 1936 receiver. Placement of parts in the detector circuit is critical and hand-capacitance effects are disturbing. The rf chokes have to be tried experimentally until two are found that eliminate audio howling caused by the quench frequency passing through the audio transformer into the audio amplifier. The resistor across the secondary of the audio transformer is also required to prevent fringe howl, a peculiar form of audio distortion noticed when the detector is just on the verge of oscillation. The capacitor from plate to screen of the audio tube prevents the speaker leads from picking up the detector radiation and coupling it into the audio stage. The plate bypass capacitor (0.006 μ F) in the detector stage is chosen for smoothest superregeneration. The series capacitor in the antenna lead is adjusted so that antenna resonance does not pull the detector stage out of oscillation. Otherwise, there's nothing critical about the receiver.

amateurs went to the bother of getting an FCC license. Untold numbers of bootleggers flourished in the metropolitan areas, aided by the number of cheap, easily purchased "UHF" transceivers sold by numerous radio dealers. Unlike today, however, when the majority of unlicensed radio operation comes from hyper-active CBers who move into unauthorized bands, the bootlegger of the 1930s clung to the ham bands. He was usually a young fellow, studying for his ham ticket, who let his enthusiasm run away with him. In general, most of the bootleggers eventually settled down and became

amateurs, but the fact remains that a great deal of unlicensed operation took place on the old 5-meter band. The combination of cheap, easily built (or bought) equipment and the lure of talking across town seemed too great for many. Most amateurs accepted the brash upstarts with an easy tolerance. Indeed, in some areas there was no one to talk to except a bootlegger, so sparsely occupied were these ultra-high frequency bands.

Around the big cities, however, 5-meters was jumping with signals in 1936. Modulated oscillators and super-regenerative receivers were universally used, and rare indeed was the crystal-controlled transmitter and superheterodyne receiver. The state-of-the-art just hadn't moved that fast in those early days.

Interested in 5-meter work? Okay, let's go! The receiver will be a two-tube superregen and the transmitter a modulated oscillator. We'll tackle the receiver first (**Fig. 1**). Unknown today to most amateurs, the "rush box" was a widely used 5-meter receiver in the 1930s. The superregen is essentially a regenerative detector with a means provided to rapidly switch the circuit in and out of oscillation. The frequency at which the detector is switched (quenched) varies with the frequency being received, but is generally between 50 and 150 kHz. This action considerably increases the sensitivity of the oscillating detector so that the usual background noise is greatly amplified when no signal is being received.

The simplest superregen (shown here) is arranged so as to produce its own interruption-frequency oscillation without the aid of a separate quench stage. The detector tube quenches itself out of oscillation at a rapid rate by virtue of the high value of grid resistor (15 megohms) and the proper size

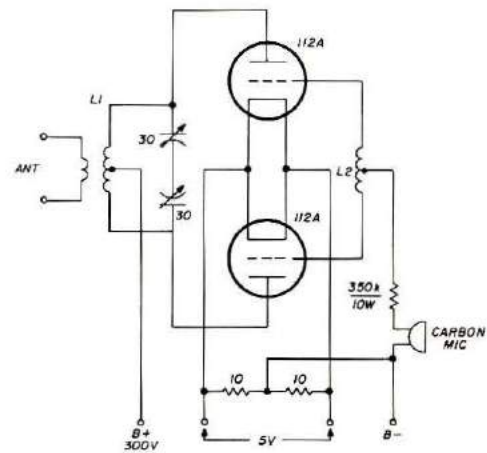

Fig. 2. The 5-meter modulated oscillator circuit. This simple circuit was very popular in the late 1930s for local ragchewing. The oscillator was grid modulated by a carbon microphone, which provided a combination of amplitude modulation and lop-sided frequency modulation. When the operator grabbed the microphone, the frequency of the transmitter shifted 20 or 30 kHz. But since the super-regenerative receiver had a selectivity on the order of several hundred kilohertz, this effect went unnoticed. The phone signal from this little oscillator sounded surprisingly good in a rush box receiver. Using a dipole antenna, the operating range of the little transmitter was about 30 miles. Plate modulation provided a much more intelligible signal and eventually most users switched to that form of modulation. A pair of push-pull 45s would do the job at low cost.

plate-blocking capacitor.

Considering that only one tube is used, this simple circuit provides good weak-signal detection, good agc (automatic-gain-control) action, and is remarkably free from overload. Unfortunately, the superregen detector has poor selectivity and radiates a broad, rough signal at the same time it is receiving. Operating was pretty miserable in areas of high ham activity when a number of rush boxes were being used. On the other hand, it was always possible to determine if there was any activity on the band; you could always hear the nearby receivers tuning back and forth!

The receiver shown, one of the popular early circuits, uses a 56 triode as a superregen detector and a 2A5 pentode audio stage. A small magnetic speaker is directly driven by the 2A5. Sensitivity and



The National 1-10 vhf/uhf receiver, first introduced in 1936, tuned from 30 to 300 MHz and covered the 5-meter, 2-1/2-meter, and 1-1/4-meter bands then available to amateurs. This popular receiver featured an rf amplifier stage followed by a superregenerative detector and two stages of audio.

superregeneration are controlled by the potentiometer in the plate circuit and by the degree of antenna coupling.

The five-meter transmitter

Like the receiver, the transmitter is built on a breadboard chassis. The circuit is simplicity in itself (Fig. 2). Two receiving-type triodes are used. Some amateurs used 45s or 171As, but the best tube seemed to be the 112A. This tube could grind out several watts at 5 meters when run from a 300-volt plate supply. If the builder were lucky, he could buy a pair of matched, isolantite-based 112As suitable for "ultra high frequency" oscillator service. The pair shown in the photograph was made by Raytheon. The less-affluent ham had to use ordinary bakelite-based tubes. In reality, there was little difference in performance, especially if the bakelite base was slit by a hacksaw between the grid and plate prongs!

The push-pull oscillator could be plate modulated in the

normal fashion, or could be grid modulated with surprisingly good results. Grid modulation was accomplished by simply putting a single-button carbon microphone in series with the grid resistor. This provided a combination of grid modulation and frequency modulation that sounded quite good on the rush-box receiver. The amateur with a few extra dollars built up a plate-modulation system with a pair of 45 tubes in push-pull, providing nearly 5 watts of audio power.

When run at 12-watts input (300 volts at 40 mA) the little oscillator provided a carrier power of about 5 watts, with everything running cool.

Unfortunately, the combination of amplitude and frequency modulation, plus the inherent instability of the oscillator, produced a signal that took up about 100 kHz of spectrum space! In addition, as the oscillator warmed up, the frequency would drift lower as the various components expanded; no matter. The five-meter band was 4-MHz wide (56 to 60 MHz) and no one really seemed to know where the band edges were!

The QRM situation

In a large metropolitan area the five-meter band was jammed, even though occupancy was relatively light, compared to today's operating standards. The wobbly, broad signals combined with the poor selectivity of the rush-box receiver meant that five or six loud signals completely filled the band. And, sandwiched among the signals, the weaker signals of other rush-box receivers filled the in-between spaces on the dial.

A case in point: I was on 5 meters in New York City in 1936. Some of the advanced stations had crystal-controlled transmitters and sensitive superheterodyne receivers, but they were far outnumbered by the modulated oscillators and rush boxes. One night a local station heard a W4 in the Washington, D.C., area on 5

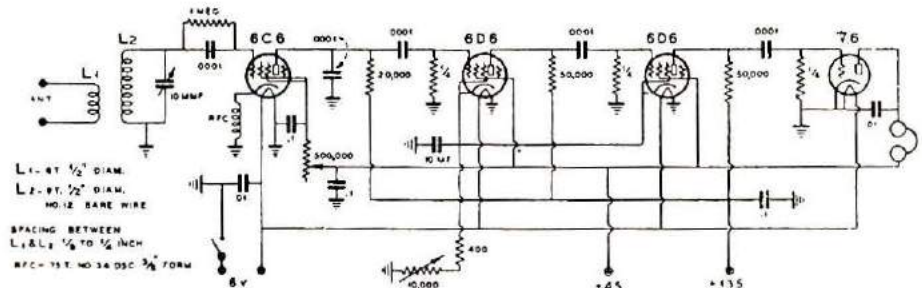

Fig. 3. The Frank Jones resistance-coupled superhet receiver for 5 meters. This simple receiver solved most of the problems inherent in the superregenerative receiver. An oscillating mixer stage (6C6) feeds two stages of resistance-capacitance coupled i-f amplification. Circuit values are chosen so the i-f response peaks at about 50 kHz. Detector is a 76 triode (circuit from first edition of the *Radio Handbook*.)

meters, which was outstanding DX in those times. Eager to hear the W4 myself, I tuned around with my rush box. When I inadvertently hit the frequency of the W4 and could hear him weakly, the rough emission from my rush box wiped out the signal of the W4 all over the New York City area! Believe me, I certainly heard about that indiscretion the next day when the big DXers deduced who the upstart was who ruined their DX contact!

However primitive, the modulated oscillator and rush-box receiver remained supreme until the amateur bands were

closed by war in 1941. But by 1940 most amateurs realized that the days of the broad signal were past. Indeed, many of the new receivers could not pass the signals of the unsteady, wobbly oscillators.

The R-C superheterodyne

The immediate problem of a good, inexpensive non-radiating receiver was solved almost single-handedly by one of the most famous vhf operators of all time: Frank Jones, W6AJF. Going back to the 1920s, Frank resurrected the autodyne detector circuit and used it in a simple superheterodyne

receiver (Fig. 3). This amazing set had no i-f transformers and a single tube served as mixer and local oscillator. In this particular circuit, the 6C6 tube was the mixer/oscillator, the oscillation taking place about 50 kHz from the received signal. The difference signal of 50 kHz was then passed through the i-f amplifier which employed resistance coupling instead of transformers. The value of resistors and capacitors was chosen to provide an i-f passband from about 20 kHz to 100 kHz, with maximum gain peaked at 50 kHz. The passband, then, was 80 kHz or thereabouts; ample for all but the most badly overmodulated oscillators.

Since the intermediate frequency was so low, the image signal was as loud as the primary signal, and all signals appeared at two closely spaced spots on the dial. In this case, the receiver was mistuned about half a dial degree, to the point where the audio was the loudest. And that's all there was to it!

While this interesting design was developed and published in March, 1935 (*Radio* magazine), the idea did not really take fire for a year or so. But by late 1936 or early 1937, simple R-C superhets were in common use on 5 meters, and the day of the modulated oscillator was drawing to a close. Oscillator-amplifier transmitters with their relative freedom from modulation instability were becoming popular, and many of the more advanced amateurs were already using crystal control for the highest degree of stability. Acorn tubes were on the market, and high-frequency superheterodyne receivers were on the horizon. In a few short years the simple and unassuming "ultra-high-frequency" modulated oscillator and rush-box receiver were to be relegated to that special Valhalla of the mind where such cherished objects linger only in memory.

PRACTICAL AMATEUR RADIO SERIES

5-METER

RADIOTELEPHONY

by **FRANK JONES**
DESIGNER OF FIVE METER EQUIPMENT
FOR THE SAN FRANCISCO BAY BRIDGE

25¢

**DESIGN
CONSTRUCTION
OPERATION**

Published by "RADIO," The National Magazine for Amateurs and Short-Wave Experimenters

One of the first amateur vhf handbooks was Frank Jones' *5-Meter Radiotelephony* which was published by *Radio* magazine in 1934. If an amateur was active on 5 meters in the 1930s, you can bet he had a copy of this book on the shelf!

HRH

REFLECTIONS of FREEDOM

DenTron antenna tuners give you the freedom to experiment with antennas. Whether you're using a beam or a vertical, a piece of wire or the gutters on your motel room; our tuners provide continuous tuning 1.8 - 30 MHz.

Let DenTron amplifiers give you the power to stand out in a crowd and be heard around the world. The MLA-1200 and MLA-2500 are an exceptional source of power, offering understated luxury exemplifying pride in design and workmanship.

B

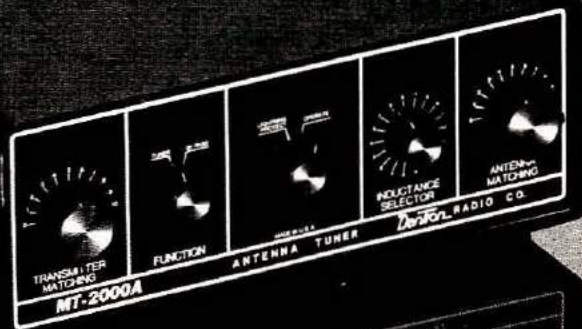

A

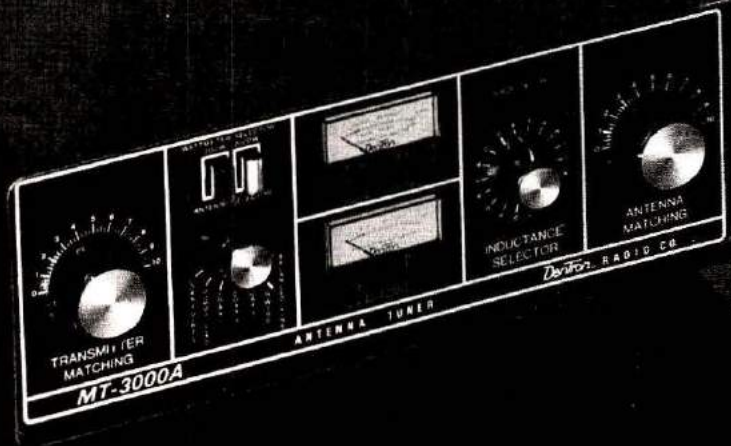

A The MT-3000A \$349.50. The MT-3000A is the perfect choice for the amateur professionalizing his station. It is a 3KW PEP antenna tuner. It has built-in dual watt meters, and (a) enables you to by-pass the tuner systems.

B NEW! The MT-2000A 3KW PEP \$199.50. The MT-2000A is a new addition to the amateur market. It includes features such as a protection grounding switch, and the ability to by-pass the feedline.

C NEW! MLA-1200 \$399.50, external antenna amplifier. The MLA-1200 shares many fine features with its family. It has many distinctive features of its own. It employs a 1KW DC. It incorporates the same built-in protection as the 1200 watt linear amplifier on the market.

D MLA-2500 \$899.50. The MLA-2500 is the most powerful amateur amplifier. It was designed to provide precision plus power. Coast to coast. It has 1KW watts DC input on CW, RTTY, or SSB. It has a built-in contained power supply, and it features

FREEDOM and POWER

Dentron

Radio Co., Inc.
2100 Enterprise Parkway
Twinsburg, Ohio 44087
Phone (216) 425-3173



00A was designed for the serious ham interested in rugged antenna tuner that easily handles 3KW PEP, a built-in dummy load. The antenna selector switch, direct; (b) select the dummy load or 5 other antenna

50. The MT-2000A is the most versatile, basic tuner with front panel coax bypass switching, front panel lightning protection ability to match coax, random wire, and balanced

supply, \$159.50, DC supply \$199.50. The MLA-1200 is the smaller brother, the MLA-2500, but also has a few toys a single Eimac 8875, running 1200 watts PEP or built-in ALC as the 2500. The MLA-1200 is the smallest in the line, great for your mobile home, boat or car!

one of the world's finest high performance military grade tubes for the discriminating buyer who knows and appreciates quality. The heart of the MLA-2500 is a heavy duty, self-heating 2 Eimac 8875's.

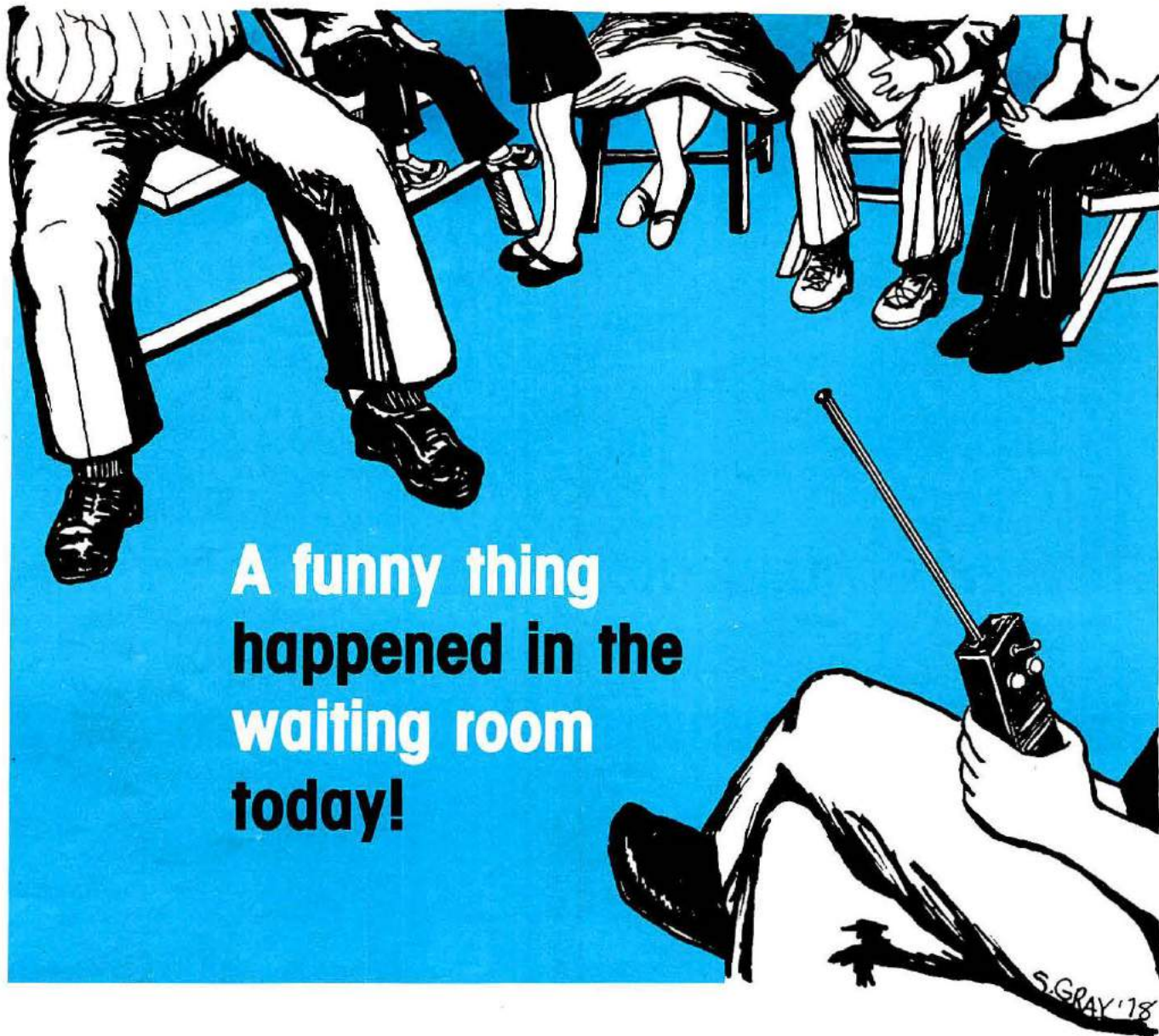

A funny thing happened in the waiting room today!

BY JANICE SHILLINGTON, N9YL

Waiting in the doctor's office can seem like a very long time, but the hand-held transceiver I carry is always good for conversation openers.

"I see you have a walkie-talkie. What's your handle?" asked the man in the next chair.

"No, this is called a handi-talkie. It's an amateur radio set, not a Citizens Band radio. We really don't have "handles," we just use our own name and call," I reply.

"My brother just got his call too. He sent in his application a few months ago. He calls himself Red Rover. He drives a red landrover you see," responds the gentleman.

"Your brother must have a Citizens Band license. In amateur radio you must pass a written test on radio theory and also pass a code test before you are issued a license."

"You mean the International Morse code? Come on now, how many people really use the Morse code anymore? Didn't that go out with the bustle?"

"Well, it is an international regulation that the operator must have knowledge of the International Morse code to be licensed to use the airwaves. Morse code is really another language, a distinct form of communication. You can actually get to the point where you hear complete words rather

than individual letters."

"Really? It seems like one big blurp to me."

"Me too — at first. The code can make you want to pull your hair out."

"Not me," responds the gentleman.

"Oops, sorry." I say, as I notice that he is completely bald! "It's a skill — sharpens your mind and makes you think."

"Hmm. It is a medical fact that you must use your brain power or you will lose it."

"That's true. The code is really neat. It can cut right through the static and interference much better than a voice. I made a friend in

Venezuela just through code. We had great conversations; we discussed everything from families to the philosophy of life. It's not just radio, you know. The rhythmic pattern of long and short taps can be related to any sound. Tap it out with a spoon — a loud bang for the dash and short tap for the dot. It works! You can use your foot, anything. Prisoners-of-war used to tap out code messages on the pipes."

"Come to think of it, in one episode of *Hawaii Five-O*, Steve McGarrett tapped out code on a hidden microphone — saved his life. Lucy, you remember *I Love Lucy*, tapped out code when she locked herself in the bank vault."

"Yes, the code certainly can come in handy. Code is a regular form of communication with ships at sea. The Navy also uses light blinkers to form the dots and dashes."

"The blinker lights! I've seen those John Wayne movies too."

"There are even deaf, dumb, and blind hams who operate amateur stations. They listen to the code by feeling, with their fingertips, the vibrations on the cone of the speaker. Can you imagine how their whole world expanded, from dark and lonely to communicating literally with the whole world on an equal basis, through amateur radio."

"Wow, human beings are truly amazing! It must take a lot of power to reach the world."

"Not necessarily. You learn about the skip phenomenon when you study for your license. Your radio signal bounces off the ionosphere and is reflected back to earth. Anyone who can hear you can transmit back to you via the same route. The time of day, sunspots, frequency, things like that, affect the skip distance. Some amateurs use only low power, and can reach long distances on a few watts. Amateurs are allowed to use 1000 watts; Citizens Band is allowed only five watts. CB and ham radio are two different services with different pur-

poses. CB is for short-range personal radio communication while ham radio is international, and also is there for experimenting — advancing the radio art so to speak — and providing trained operators, radio experts, and emergency communications."

"My brother has QSL cards from contacts in Colorado; he gets California a lot too," said the gentleman.



"Well . . . actually, that's illegal. CB is limited to 150 mile radius."

"How do you talk with all these other countries anyway. Do they all speak English?" he asked, showing some interest.

"A lot of people do speak English, but the Q signals are international. You can talk any language with them."

"The *what?*"

"The Q signals. It's Morse-code shorthand. Instead of asking the person where he is located you send "QTH?"

"QRM?" means "are you being interfered with?" "QRU" means I have nothing further for you; "QSL" means confirmation. The QSL card is a written confirmation of your radio contact. Understand?"

"Hmm, live and learn, I guess. But you can't beat getting all that traffic information and the smokey reports."

"Hams have several different frequency bands for local communication," I countered. "Two-meter fm is very popular; the 220-MHz and 450-MHz bands are being operated quite a bit too. The fm mode is very

quiet. You don't hear all the noise and hash."

"Yes, sometimes the static on the CB set can give you a headache," he conceded.

"It's possible to use a one-watt transceiver to talk into a repeater station and communicate with hams within a 60 mile radius, depending on the repeater itself and band conditions. I think that CB operations are limited to a few miles. In fact, some repeaters have a system whereby a ham operator can dial direct from his radio to make phone calls. That way you can dial the police direct."

"Interesting, but you must admit those truck drivers can be very funny."

"Yes, that's true. What city has the largest Easter bunny population?"

"What?" He thought a moment. "Oh, I don't know."

"Albany (all bunny). I heard that on two meters; hams can be funny too! Seriously, people are people, both funny and profound at times. Amateur radio does police itself pretty well. If the rules are broken, someone will usually inform the party. There are observers who send out notices of rule violations, just as friendly reminders."

"You mentioned experimenting. What kind do hams do?"

"Gee, there are so many different fields. I have a lot of fun with antennas. There is Teletype and television . . ."

"You mean you go on TV?"

"Yes, on the amateur frequencies."

"I would look great on TV, don't you think?" he asked, as he sat up straight and adjusted his tie.

"Definitely, just be sure to powder your head," I said as I have him a friendly wink, and got an energetic laugh in response. "You can operate your own slow-scan or fast-scan TV station. There's even a satellite to use."

"A space satellite. Come on now, you're pulling my leg."

"No, NASA allows amateurs

... at last ...
your shack organized!
 A beautiful piece of furniture — your XYL will love it!



\$13995 S-F RADIO DESK
Deluxe - Ready to Assemble

Designed with **angled rear shelf** for your viewing comfort and ease of operation.

FINISHES: Walnut or Teak Stain.
 Also available in Unfinished Birch, \$124.95.

Additional Information on Request.
 Checks, Money Orders, BankAmericard and Master Charge Accepted.

F.O.B. Culver City. (In Calif. Add 6% Sales Tax.)
S-F AMATEUR RADIO SERVICES
 4384 KEYSTONE AVENUE • CULVER CITY, CALIF. 90230 — PHONE (213) 837-4870

Radio equipment not included
 Floor Space: 39" Wide 30" Deep

Attention HAMS LOOKING for a great tower?

Do not attempt to raise antenna or antenna support near power lines—YOU CAN BE KILLED!

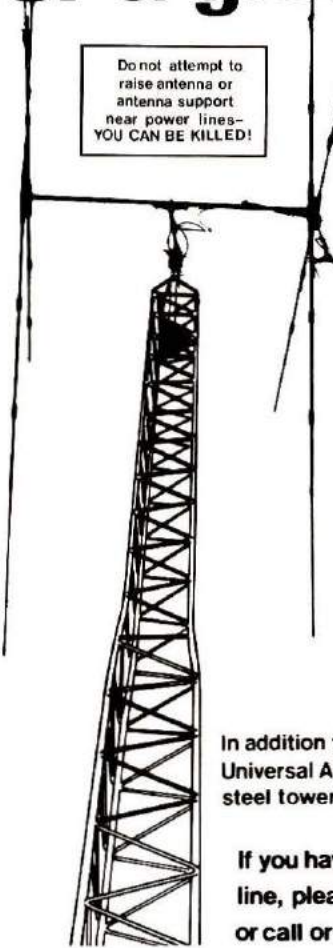

Three good reasons to use Universal Towers

- 1. LIGHT WEIGHT**— In addition to its weight advantages, aluminum offers maintenance-free lifetime beauty. Eliminates painting and ugly rust inherent in steel towers.
- 2. EASY ASSEMBLY**— Child's play to assemble. You can easily put together a tower on the ground and walk it up, or assemble it erect section by section.
- 3. STRENGTH**— Important to your choice of a tower. Universal Towers are tested to withstand the force of 80 m.p.h. winds and are designed to resist winds exceeding that velocity.

In addition to all of these advantages, the total cost of a Universal Aluminum Tower is less than that of similar steel towers extended over the life of the tower.

If you have any questions regarding our product line, please contact your local distributor or call or write for information.

UNIVERSAL TOWERS

Universal Manufacturing Co. 12357 E. 8 Mile Rd. Warren, Mich. 48089 [313] 774-4140
FREE STANDING ALUMINUM TOWER

to use their weather rockets and such to launch the amateur satellites in order to further public education in space science. These satellites are very popular with hams."

"Boy, you sure can do a lot of things with an amateur license!"

"Right! The FCC has what they call incentive licensing in the amateur service. The more you study and learn, the more frequencies you are allowed to use. The Novice license test isn't too bad. In fact many young kids have their very own amateur license. There is no age limit as there is in Citizen Band radio."

"I think my brother does have the highest CB license."

"That's nice, but it's different in ham radio. The privilege to use the airwaves must be earned."

"I guess it's just human nature to value what you must work hard to get."

"Exactly. There's a hamfest coming up next week. Why don't you take your brother? Maybe you both could find out more about amateur radio." As I scribbled down the information on a piece of paper, the lady on the other side of the room, (the one with the screaming kids) comes over and asks, "Did you say hamfest? You know, the last ham I bought for dinner last week had an awful lot of fat and gristle. I would like to go to that ham festival too."

"This is a ham-radio get together. A flea market type of thing with . . ."

"Oh, you mean the radio stuff. My neighbor has a CB too and he is always getting into my TV during the best parts of the movie."

"No, this is amateur radio; it's different from Citizens Band."

As my headache is turning into a definite migraine, the nurse finally calls my name. Just in time!

The gentleman smiles and says, "10-4 good buddy."

"Roger. It's been fun. 73."

HRH



The parameters of the Palomar PTR-130k are the outer perimeters of logic technology.

Never before has any transceiver approached the capabilities of the Palomar PTR 130k!

It's the first, completely multi-functional transceiver ever made available to the public!

The Palomar PTR 130k is a miniaturized mobile transceiver

capable of operating in 100 cycle resolution from 100 KHz to 30 Mhz in all modes of transmission and reception. Instant frequency selection is available with the touch of a finger.

The Palomar PTR 130k.

technology is pure space age . . . the price is strictly down-to-earth.

Send for our full color brochure to:

Palomar Electronics Corporation
665 Opper Street
Escondido, CA 92025
Telephone: (714) 746-2666



TECHNOLOGY AT THE SPEED OF SOUND

Inverted V 2-Element

Delta-Loop Antenna

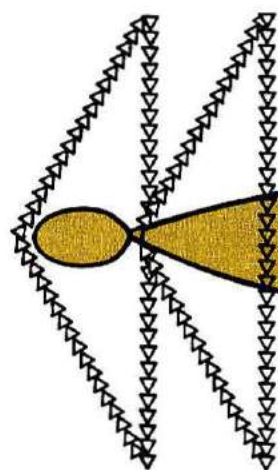

Twenty-meter beams usually require a lot in cash, mechanical ability, or both. This inverted V delta loop antenna demands very little of either and seems to be just about as effective as the two-element quad from which it's derived. The antenna has only one snag: you can't rotate it. But if you have an interest in a particular direction (I like to work the USA from England, some of you fellows speak quite good English!), it can be recommended.

Description

Dimensions aren't critical (Fig. 1). No guy wires or tower are required, and the configuration can be adjusted to suit your house and direction of fire. I bolted together two aluminum television masts and mounted them to the side of the house with wall brackets. On the top of the mast I had a 2-meter ground-plane antenna, and just below that an fm broadcast antenna. The fm broadcast antenna boom is used as support A. About 4.6 meters (15 ft) below this is mounted a pole 2.7 meters (9 ft) long. This pole holds the center of the delta loops and provides a slight inverted V configuration to the bottom of the elements.

The delta loops are 22 AWG (0.6 mm) wire; the ends are held by nylon fishing line.

Setting it up

The antenna is designed for individual locations, so exact dimensions aren't given. Truly, I don't know the dimensions of my own antenna! For 20 meters, start by making the reflector 30 meters (76 ft) long. Make the driven element 22.5 meters (72 ft) long. Complete the circuit for both elements, but leave at convenient points small, one-turn coupling loops.

Next, check the resonant frequencies of the two elements with a grid-dip meter. Make sure that the meter is

BY HARRY LEEMING, G3LLL

calibrated accurately against a receiver and is loosely coupled to give accurate readings.

Ideally the reflector should resonate between 13.8-13.9 MHz and the driven element at about 14.250 MHz.

Almost certainly, with the dimensions given, the resonant frequencies will be too low; hence the elements must be shortened until the resonant frequencies are correct. Note that considerable interaction will occur between the elements, so mechanically shortening one will electrically shorten both.

Work carefully, cutting a small amount off each element until the resonant frequencies

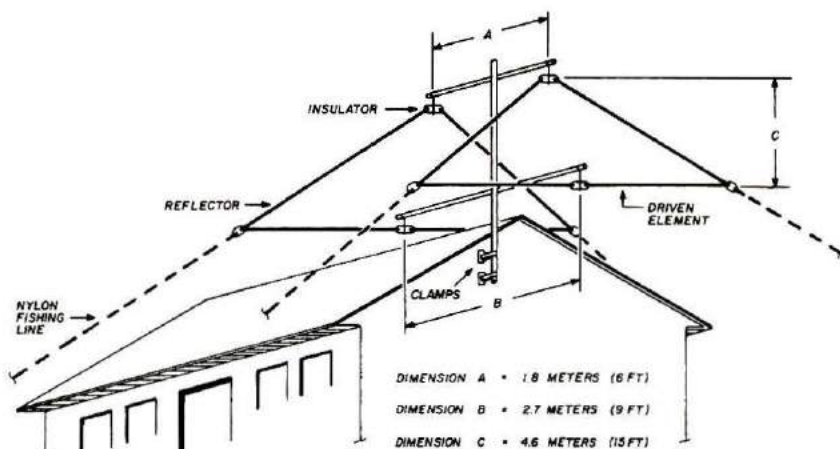

Fig. 1. Inverted-V delta loop antenna beam for 20 meters. The author used an fm antenna for the top support to separate the two elements. The mast consists of two pieces of aluminum TV masting held together with clamps. The structure is only 4.6 meters (about 15 feet) above roof level. The antenna elements are secured with nylon fishing line.

Uncompromising performance. Incredible price. A professional 3½ digit DMM Kit for less than \$70.



Incredible? True! Professionals and hobbyists alike are believers in this Sabtronics 2000, the only portable/bench DMM which offers such uncompromising performance at the astonishingly low price of \$69.95.

Uncompromising performance you'd expect only from a specialist in digital technology such as Sabtronics: Basic DCV accuracy of 0.1% ± 1 digit; 5 functions giving 28 ranges; readings to ±1999 with 100% overrange; overrange indication; input overload protection; automatic polarity; and automatic zeroing.

The low price of \$69.95? Simple: The Model 2000 is all solid-state, incorporating a single LSI circuit and high-quality components. You assemble it yourself, using our clear, easy-to-follow, step-by-step assembly manual. Kit is complete, including a high-impact case.

Now you too can have it! A professional-quality, 3½ digit Sabtronics Model 2000 DMM kit for only \$69.95. If you don't have one in your lab, use the coupon below to order NOW.

BRIEF SPECIFICATIONS:

DC volts in 5 ranges: 100 µV to 1 kV · AC volts in 5 ranges: 100 µV to 1 kV · DC current in 6 ranges: 100 nA to 2 A · AC current in 6 ranges: 100 nA to 2 A · Resistance: 0.1 Ω to 20 MΩ in 6 ranges · AC frequency response: 40 Hz to 50 kHz · Display: 0.36" (9.1 mm) 7-segment LED · Input impedance: 10 MΩ · Size: 8" W x 6.5" D x 3" H (203 x 165 x 76 mm) · Power requirement: 4 "C" cells (not included).

GUARANTEE:

Examine the 2000 DMM kit for 10 days. If not completely satisfied, return unassembled for full refund of purchase price. (Less shipping and handling)

Use your Master Charge or Visa.
To order by phone call: (214) 783-0994



Made in U.S.A.

sabtronics 
INTERNATIONAL INC.

13426 Floyd Circle • Dallas, Texas 75243

To: Sabtronics International, Inc.		HRH
13426 Floyd Circle, Dallas, TX 75243		
Please send me _____ Sabtronics Model 2000 DMM kit(s)		
at \$69.95 each.....	\$ _____	
Shipping and handling, \$5.00 per unit*	\$ _____	
Texas Residents Add Sales Tax	\$ _____	
TOTAL enclosed	\$ _____	
Name _____		
Street _____		
City _____		
State _____	Zip _____	
*USA only. Canada \$6.50. All other countries, \$10.00 (surface mail)		



*our little boxes
replace a lot of cable!*

- select any of five antennas at the turn of a knob, with just one feedline and a control cable to the remote switching unit •
- saves coax, simplifies station layout •
- handles 4 kw p.e.p. •
- other models to nine positions •
- full one-year warranty •

model sw-5 heavy duty —
REMOTE CONTROLLED ANTENNA SWITCH — \$135⁰⁰ plus \$3 shipping
 • order direct or write for brochure •



ANTENNA MART

515-292-7114

box 1010, i.s.u. station, ames, iowa 50010

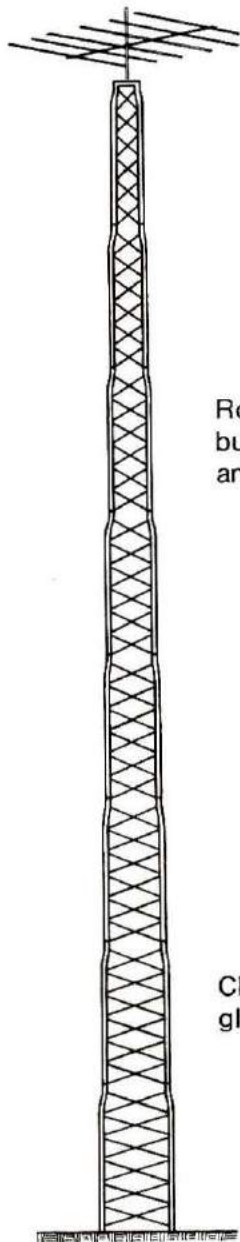

Rohn is the TOWER FORCE when it comes to building towers — look at the BX Towers and you'll see why . . .

- HDBX Towers will hold up to 18 sq. ft. antenna capacity.
- Due to design, BX Towers hold greater antenna loads than competitive models.
- Can be assembled on the ground and hinged up or built vertically, section upon section.
- Shipped nested
- Fabricated in U.S.A.

Check out the ROHN TOWER FORCE, you'll be glad you did!

Unarco-Rohn

Division of Unarco Industries, Inc.
 6718 West Plank Road, P.O. Box 2000
 Peoria, Illinois 61656

are correct. Be extra careful to couple the dip meter as *loosely as possible*. Make sure to keep your hand well away from the wire.

Feed point

Once these adjustments have been made, break the center of the driven element at the point shown in Fig. 1. Connect either a 70-ohm twin feeder or 50-ohm coaxial cable. Ideally, with 50-ohm coaxial cable, a balun transformer should be used but I manage quite well without one.

On my antenna, which is resonated with an antenna tuner, the swr is below 1.5 across the phone section of the 20-meter band, increasing to 2.5 at 14 MHz.

Results

I don't have the equipment for exact measurements and can only make comparisons with a multiband inverted V dipole, which was hung from the same mast as the delta loop beam. The new antenna boosts stateside stations by 1.5-2.0 S units and attenuates the rest of Europe, which is to the rear, by about 2-3 S units. From a transmitting point of view, I now get solid transatlantic QSOs instead of "Sorry, old man, see you again when conditions are better."

HRH

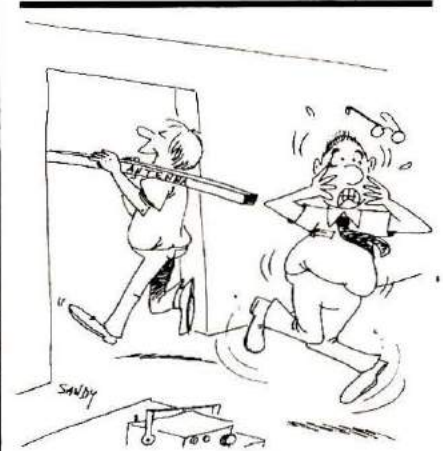

"Thanks, buddy. I know I'll get good reception with this baby . . . I'm agonna mount'er on the tippy-top of that big old electric pole . . ."

9:30 CST
TO
5:00 CST
MON. thru SAT.

YAESU
The radio.



Is Our Number **1** Line At

Cohoon Amateur Supply

1. Full Repair Service
2. Sub-Dealers Welcome
3. Good Prices
4. Ship UPS The Same Day
5. All Used Gear Listed Below Has A 90 Day Warranty.

USED BUYS

YAESU

FT-101E	\$599
FT-101EE	\$539
FT-101EX	\$489
FL-21000	\$359
SP-101B	\$15
FT-301SD	\$459
FT-301S	\$330

TEN-TEC

540	\$499
544	\$539
2626	\$99
509	\$290

DRAKE

T4XB	\$299
R4B	\$299
MN-4	\$89
DC-3	\$45
TR-4CW/w RIT	\$625
DC-4	\$79
MS-4	\$15

HEATH

SB-104 w/p.s.	\$659
HW101 w/p.s.	\$369
SB-301	\$180

ALSO STOCKING

KENWOOD

TEN-TEC

TEMPO

WILSON

INFO-TECH

KANTRONICS

ATLAS

DENTRON

CUSHCRAFT

KLM

SWAN

TO SERVE YOU BETTER
2 LOCATIONS

Cohoon Amateur Supply

SOUTH

Hwy. 475 Trenton, Kentucky 42286

502-886-4534

Cohoon Amateur Supply

NORTH

Box 4073 Austintown, Ohio 44515

216-538-3424



YAESU
DEALER

New!
QSO tape for the new exams.



Code kit
\$19.95
Tape only
\$4.95

Kantronics Speed-Building Kit

Get prepared!

To pass the new FCC code exams, you'll need to identify unusual names, places, antenna heights, rig types and a variety of other items garnered from simulated QSOs.

Now you can really study for the new exams with the **Kantronics QSO Tape!** Our C-60 cassette sends simulated "on-the-air" transmissions at **7½, 10, 13, and 15 WPM.**

The QSO Tape generates sharp, crisp code to **exact Morse specifications, just as the FCC does.** Order your QSO Tape with Speed-Building Kit, or separately, today! Our other fine tapes are also available at 5, 7½, 10, 13, 16 and 20 WPM speeds.

KANTRONICS
The Lightweight Champs.

Telephone 913-842-7745
Lawrence, Kansas 66044

1202 East 23rd St

NEW VISUAL CODE READER AND ELECTRONIC KEYS



Works with any keyer, including squeeze keyer in speeds from 7 WPM to 40 WPM. Both in a single unit.
Model CR101E
\$249

from **ATRONICS**

- Display letters, numbers, and commonly used punctuation visually as Morse Code signal is received.
- Operating speed 5 to 50 WPM at selected speeds.
- All Solid State.
- Makes code learning faster and easier.
- A single connection to your receiver or transceiver speaker puts it into operation.
- Hard copy read-out of CW available with TU-102 TTY interface Module accessory.

Our popular, lowest priced CODE READER KIT
Model KCR101 \$149
Ready made CODE READER... Model CR101 \$225

BUY FACTORY DIRECT & SAVE! SEND FOR FREE LITERATURE.
USE YOUR BANKAMERICAN OR MASTER CHARGE

BOX 2946

LAGUNA HILLS, CA 92653

(714) 830-6428

Atronic



SAVE

to the
tune of

\$100

*THESE OFFERS STRICTLY "CASH"
NO TRADES OR BANK CARDS

DENTRON MLA-2500

160 thru 10 Meter Amplifier



REG.
\$899⁵⁰

While they last . . . Only \$799^{50*}

TOWER POWER

by **TRISTAO**

Superior Quality and
Construction at a price
you can afford.

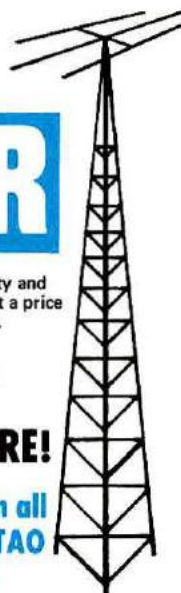

Save to the tune of
10 PER CENT AND MORE!

SUPER "PACKAGE" DEALS on all
new **ROHN, TRI-EX and TRISTAO**
TOWERS are our **SPECIALTY!**

Whether you need "JUST THE TOWER" or the **WHOLE BALL OF WAX** — beam, rotor, wire, etc. we can put together the **RIGHT PACKAGE** for YOU!

CALL or WRITE TODAY for **FULL/FREE INFORMATION** and our everyday "down-to-earth" **PACKAGE QUOTE!**

Ask for **ERV(KØ0TZ)** — our tower "EXPERT" — who is always **MORE THAN HAPPY** to answer your questions, make recommendations and offer whatever **FIRST-HAND, practical advice** YOU NEED in ordering **AND ERECTING** your antenna system . . .

. . . **AND, as always, THERE IS NO EXTRA CHARGE** for this type of "S-E-R-V-I-C-E" at

Burghardt INC.
AMATEUR CENTER

Spring Cheer is Here!

A CHORUS OF
VALUE FROM . . .

featuring **KENWOOD**

Pacesetter in Amateur Radio

Burghardt

INC.

AMATEUR CENTER

We provide FULL SALES
AND "S-E-R-V-I-C-E" back-
up on the COMPLETE LINE
of QUALITY KENWOOD
PRODUCTS!



TS-820S
NOW IN STOCK!

**ORDER
YOURS
TODAY**



TS-520S

CALL or WRITE TODAY FOR FREE SPEC SHEETS
and PRICE QUOTE! "GOOD 'n CLEAN" USED
EQUIPMENT ALWAYS "WELCOMED" on TRADE!!

CDE HAM-III ROTORS

New/Improved Heavy Duty Rotor
with Control (LESS CABLE)

**NOW ONLY
... \$129.95**

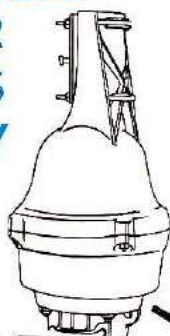

hy-gain

cushcraft

Wilson

Mosley

MAIL AND
TELEPHONE
ORDERS
"WELCOMED"
... They're our
business!!

SERVICE??
NO PROBLEM!
It's OUR Policy.

"When it comes to
FAST DELIVERY, HONEST
DEALING + PROMPT/DEPENDABLE
S-E-R-V-I-C-E,
we don't just advertise it —
WE GIVE IT!

**SPECIAL
TRI-BAND
BEAM OFFER**
SAVE 10%
PLUS

SWING INTO SPRING with a
NEW 10-15-20-METER BEAM!
10% "CASH" SAVINGS NOW IN EFFECT on
these popular TRI-BAND BEAMS! AND . . .
with "PACKAGE" PURCHASE of selected
TRI-BANDERS . . . you can BUY A NEW CDE
HAM-III ROTOR for LESS THAN ONE
HUNDRED DOLLARS! LIMITED — ORDER
NOW & SAVE! CALL or WRITE TODAY . . .

MAKE/MODEL

CUSHCRAFT ATB-34
HY-GAIN TH3-JR.
HY-GAIN TH3-MK3
HY-GAIN TH6-DXX
MOSLEY TA-33-JR
MOSLEY TA-33
MOSLEY TA-36
MOSLEY CL-33
MOSLEY CL-36
WILSON SYSTEM I
WILSON SYSTEM II

SPECIFICATIONS

4-Element 2-KW
3-Element/300W
3-Element/1KW
6-Element/2KW
3-Element/1KW
3-Element/2KW
6-Element/2KW
3-Element/2KW
6-Element/2KW
4-Element/2KW
3-Element/2KW

REGULAR
PRICE

\$259.95
\$144.50
\$199.95
\$249.95
\$151.85
\$206.50
\$335.25
\$232.50
\$310.65
\$274.95
\$219.95

SPECIAL "CASH" PRICES*

BEAM ONLY BEAM & ROTOR

\$233.95 \$335.25
\$129.95 \$242.50
\$179.95 \$289.95
\$224.95 \$329.95
\$136.50 \$247.50
\$185.00 \$294.50
\$299.95 \$399.95
\$209.00 \$317.25
\$279.50 \$384.50
\$247.50 \$353.50
\$197.95 \$307.00

FREIGHT: ALL SHIPPING CHARGES "COLLECT" — F.O.B. WATERTOWN!

PHONE NO. (605)-886-7314 P.O. BOX 73 WATERTOWN, SOUTH DAKOTA 57201



Dear Horizons:

For those of us who do not work professionally in electronics, *Ham Radio Horizons* is an excellent magazine with technical articles at just the right level. I have found the antenna issues particularly useful.

Let me relate an "interference" problem with a happy ending: when I operate on 40-meters CW the lighted button for our doorbell flashes brilliantly in exact sequence with the code transmission. There is no difficulty with adjacent TV sets or stereo equipment — it seems to be strictly DBI (Door Bell Interference).

The happy ending? The ten year old directly across the street is copying at about three words per minute!

**John P. Murphy, WB0DJG
Grand Junction, Colorado**

Dear Horizons:

Three cheers for your Focus & Comment editorial in the February issue, regarding "users and builders." If ham radio is to inspire new blood, all of us who are hams should inspire beginners, not with fancy, high-powered equipment, but rather with the desire to understand and experiment with simple and workable rigs that don't cost \$500 plus!

The article "Why CW," by WA1KWJ is a masterpiece, and expresses my feelings better than I could . . . It is with a great deal of pride that I am among the 1/10 of 1 per cent who, as Doug mentions, "can make sense out of utterly unintelligible noise."

Please always remember that there are thousands like me, who

are not, and never will be electrical engineers, but rather are just plain folks, from every vocation and profession, drawn together by the desire to communicate. We are HAMS, and darn proud of it!

**Byron P. Liles, W9LOH
Kane, Illinois**

Dear Horizons:

May I suggest that you write an article on QRP (low-power) operation covering the technique involved, its joys, and the great improvement in such mundane things as RFI and TVI. A lot of your readers, such as I, probably are living in apartments, and if we are to co-exist in peace with our many neighbors we must make do with a minimum of power and unobtrusive antennas. I have had a ball since going QRP and feel that most hams are missing a lot of fun.

Your magazine is truly great and like a breath of fresh air to many of us who may not have been too active for more years than we would like to remember.

**Bill Robinson, W5QAR
Rockport, Texas**

There's a lot to what you say, Bill, and low-power operation has many adherents and advocates. Horizons has not recommended QRP for beginners, however, because they have enough problems just getting acquainted with life on the ham bands, without the handicap of weak signals. To understand what I mean — if you were a new ham and had a chance to answer either of two signals, one really strong, and the other just a bit above the noise level, which would you prefer to work? For the older hands, and the apartment dwellers, QRP does fit right in, and one of our authors is doing a story about it. I'm sure he will present the QRP story in its true light. **Editor.**

Dear Horizons:

I have included in this letter the address label I reluctantly cut off my November issue (I bind the back issues and a cut up cover is tacky) as an aid to you in checking my subscription records.

Despite my 20+ years as a ham, I find your magazine refreshing and have really missed it. Please

don't cut me off! In time, I think I could become a *Ham Radio Horizons* junkie!

Incidentally, I spotted your February issue at my local ham radio shop last Saturday and was so intrigued with the article on QSL card design that I bought a copy, even though I expect I will receive another when my subscription mix-up is corrected. Kudos to Jim Fisk for an excellent article. I can see why the graphics used in *Horizons* are so outstanding.

**Kent Voigt, K8JWG
Troy, Mississippi**

Dear Horizons:

Thanks for your article by W1HR in the January issue, "Simple Dipole Antennas." It was very informative and in plain language that we can all understand. Please continue to give us non-engineers such information. I will keep that issue handy for ready reference.

**Pete Flowers, WD4FKB
Mobile, Alabama**

Dear Horizons:

I enjoy the Bob Locher, W9KNI, stories about DX (on 20-meters), but how about something about CW DX on the Novice part of 15 meters. After all, if your magazine is in large part for new hams, he should have something on this also.

**Stan Horowitz, WB2MJQ
Monroe, New York**

Dear Horizons:

My amateur radio activities for some time have centered around amateur radio promotion and training, and I have seen what I believe to be a void in literature available for the beginner. *Ham Radio Horizons* is helping to fill this void. It is absolutely refreshing to pick up the magazine, read common English, see the old ham radio enthusiasm, and find digestible information to work with. I am recommending the magazine to all my students as the first priority periodical. Now that you have found this important theme, I sincerely hope you will continue and expand it. That's ham radio!

**Donald G. Wiseman, K5CA
Dickinson, Texas**

CALL TOLL FREE

1-800-228-4097

Antenna Sale!



CUSHCRAFT
ATB-34

MOSLEY		Regular	Special
Classic 33	3 ele. 10, 15, 20 Mtr. beam	\$232.50	\$189.95
Classic 36	6 ele. 10, 15, 20 Mtr. beam	310.65	249.95
TA-33	3 ele. 10, 15, 20 Mtr. beam	206.50	169.95
TA-36	6 ele. 10, 15, 20 Mtr. beam	335.25	279.95
TA-33 Jr.	3 ele. 10, 15, 20 Mtr. beam	151.85	129.95
TA-40KR	40 Mtr. add on	92.25	74.95

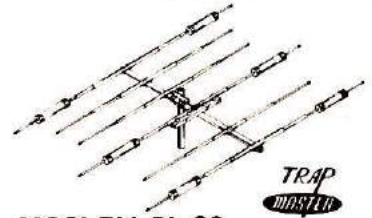

MOSLEY CL-36

CUSHCRAFT		Regular	Special
ATB-34	4 ele. 10, 15, 20 Mtr. beam	239.95	199.95
ARX-2	2 Mtr. Ringo Ranger	32.95	29.95
A147-20T	2 Mtr. Twist	54.95	47.95
A144-10T	10 ele. Twist 2 Mtr.	34.95	31.95
A144-20T	20 ele. Twist 2 Mtr.	54.95	47.95
A14T-MB	Mounting Boom	15.95	14.95

HUSTLER		Regular	Special
4BTV	10-40 Mtr. Trap Vertical	99.95	82.95
RM-75	75 Meter Resonator	15.50	13.50
RM-75s	75 Meter Super Resonator	30.00	26.50
G6-144-A	6 db. 2 Mtr. Base Colinear	67.55	57.95

HY-GAIN		Regular	Special
TH6-DXX	Super Thunderbird	249.95	209.95
TH3-MK3	3 ele. 10, 15, 20 Mtr. beam	199.95	169.95
Hy-Quad	2 ele. Quad 10, 15, 20 Mtr.	219.95	189.95
TH3-Jr.	3 ele. 10, 15, 20 Mtr. beam	144.50	129.95
18 HT	Hy-Tower 10-80 Mtr. Vertical	279.95	239.95
14AVQ/WB	10-40 Mtr. Trap Vertical	67.00	57.00
18AVT/WB	10-80 Mtr. Trap Vertical	97.00	84.95
203	3 ele. 2 Mtr. beam	12.95	
205	5 ele. 2 Mtr. beam	16.95	
208	8 ele. 2 Mtr. beam	19.95	
214	14 ele. 2 Mtr. beam	26.95	

WILSON		Regular	Special
System One	5 ele. 10, 15, 20 Mtr. beam	259.95	239.95
System Two	4 ele. 10, 15, 20 Mtr. beam	199.95	185.00

CDE ROTORS	
Ham III	\$125.00
T2X Tail Twister	\$249.00
CD-44	\$105.00

Call for SUPER price on Consolidated Tower and Berk-Tec Coax Cable



18HT

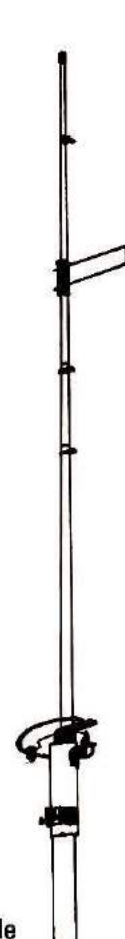

RINGO
RANGER



4BTV



Open seven days a week

Communications Center

The Radio Store

443 N. 48th, Lincoln, Nebraska 68504

In Nebraska Call (402) 466-8402





New NYE "Matchmaker" VIKING MB II

Antenna impedance-matching network for maximum power, perfectly matched to your antenna.

Model MB II \$285
(with Balun) \$315

MB II FEATURES

* 1/4" silver-plated copper ribbon variable inductor. * 7000 volt variable capacitor. * 10000 volt fixed capacitors. * 100 micro-ampere SWR meter. *.080" aluminum cabinet. * Large, easy-to-read dials. * 3000 watt Balun (optional) for twin lead antennas.



By the manufacturer of NYE VIKING Speed-X and Super Squeeze Keys, Iambic Keyers, Low Pass Filters and Phone Patches. Available at leading dealers throughout the U.S.A.

WM. M. NYE COMPANY, INC.

1614 - 130th Avenue N.E., Bellevue, WA 98005 • (206) 454-4524

MB II PROVIDES

* Constant SWR monitoring. * Precision tuning of final amp. * Harmonic suppression. * Receiver input impedance-matching. * Maximum power transfer to antenna. * Continuous frequency coverage - 1.6 to 30 MHz. * Precision tuning of any wire 1/8 wavelength or longer, with SWR of 1:1.

Limited Quantities THE DIGITAL 101 MANUFACTURERS' CLOSE OUT

**10 Meter Synthesized
Transceiver \$249.95
F.O.B. ESCONDIDO**

- 140 Selectable USB Channels in the 28.500 to 29.040MHz band. Other (10Mtr Band) 540KHz segments available on special order.
- PLL with 2.5KHz Reference.
- 28.500MHz to 28.770MHz and 28.770MHz to 29.040MHz with front panel selector.
- Vxo control offers ± 1.5 KHz frequency variation.
- Transmit Power output: 12 watts PEP.
- Receive Sensitivity: exceeds .5uv/10db S+N/N.
- All Harmonics better than -40db.
- Receive audio output: 3 watts into 4 ohm speaker.
- Power requirement: 13.8 volts D.C. @ 5 amps.
- Dimension: 14 1/2" x 10 3/8" x 2 5/8"
- Weight: 9 1/4 lbs.

Also available in limited quantities, R & T/Synthesizer Boards, Components & Chassis. Call or write Palomar Electronics Corp • 665 Opper Street Calif 92025
Telephone: 746-2666.

universal amateur radio inc

1280 AIDA DRIVE
COLUMBUS, OHIO
Reynoldsburg, 43068



STORE HOURS

MON 9 AM to 9 PM
TUE 9 AM to 6 PM
WED 9 AM to 6 PM
THU 9 AM to 9 PM
FRI 9 AM to 6 PM
SAT 9 AM to 5 PM

- all major brands
- full factory service
- antennas and towers
- competitive prices
- large inventory
- all amateur needs

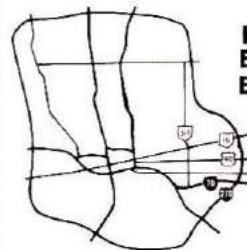

I-270 EXIT NO.41
EAST 1.8 MILES ON
EAST MAIN STREET (RT 40)

Northeast Corner
of Reynoldsburg
Shopping Center

614-866-4267

Put TEN-TEC At The Top Of Your Accessory List

It figures that the leader in solid-state HF technology would be the leader in solid-state HF accessories. So, when it's time to add to your operating equipment, look to the leader — TEN-TEC.

A. NEW TEN-TEC Model 247 Antenna Tuner — \$69

So unique there is a patent pending, the 247 features a 47-tap toroid with silver plated 18 gauge wire, silver plated tap selector and 1kV variable capacitors in a universal Transmatch circuit. Matches 50-75 ohm outputs to a variety of load impedances, balanced and unbalanced (built-in balun). Antennas such as dipoles, inverted "V"s, long random wires, Windoms, beams, rhombics, mobile whips, Zepp, Hertz and similar types can be matched from 1.8 to 30 MHz. Power rating: 200 watts, rf, continuous duty. Attractive aluminum case with black end panels.

B. NEW TEN-TEC Model 277 Antenna Tuner/SWR Bridge — \$85

Same unique features of model 247 above plus built-in SWR bridge and meter that shows ratios up to 5:1. Handsome black and gray styling. Matches Century 21.

C. TEN-TEC KR50 Ultramatic Keyer — \$110

The keyer you control. Dual memories, individually defeatable, for operation as full iambic (squeeze) keyer, with single memory, or as conventional keyer. Self-completing characters. Adjustable automatic weighting (50 to 150%) determined by speed setting, paddle force (5-50 gms), speed (6-50 wpm), and 500 Hz side-tone level (to 1 v.) 117 VAC, 50-60 Hz or 6-14 VDC.

D. TEN-TEC KR20-A Electronic Keyer — \$69.50

Speed 6-50 wpm. Factory adjusted paddle return force and weighting. Self-completing characters. Adjustable side-tone level. 117 VAC, 50-60 Hz or 6-14 VDC.

E. TEN-TEC KR5-A Electronic Keyer — \$39.50

Same as KR20-A less side-tone and power supply. 6-14 VDC.

F. TEN-TEC KR1-A Deluxe Dual Paddle — \$35

Same paddle as KR50; for iambic or conventional keyers.

G. TEN-TEC KR2-A Single Lever Paddle — \$17

Same paddle as KR20-A; for "TO" or discrete character keyers.

H. TEN-TEC 206-A 25/100 kHz Crystal Calibrator — \$29

Pulsed output for easy identification. 9-12 VDC.

I. TEN-TEC 208 CW Filter — \$29

Four stage audio active filter provides 150 Hz bandwidth centered at 750 Hz. Two selectivity switch positions. 9-12 VDC.

J. TEN-TEC 244 Digital Readout/Frequency Counter — \$197

Six digits show transmitted and received frequencies to hundreds of Hertz. LSI circuitry. 9 MHz preset information. Mode Switch selects freq. band or counter operation. 12-14 VDC.

K. NEW TEN-TEC 262M AC Power Supply with VOX — \$145

Solid-state; built-in ammeter. Output 13 VDC $\pm 0.5V$, to 18 A. Regulation better than 1%. Electronic circuit breaker. Mic. input: 2 megohms. VOX gain and delay control. Adjustable delay, 0.1 to 1 sec.

L. NEW TEN-TEC 252M AC Power Supply — \$119

Same as 262M except less VOX.

M. TEN-TEC 215P Ceramic Microphone — \$29.50

Use hand-held or at desk with matching stand included. Optimum articulation, smooth response free of power limiting peaks, impervious to temp. or humidity extremes. PTT switch, cable and 3-circuit plug. Black and gray.

N. TEN-TEC 210 AC Power Supply — \$34

Solid-state. Output: 13 VDC, $\pm 0.5 V$, to 1.2 A. Regulation better than 1%.

O. TEN-TEC Blank Enclosures — from \$7

Five sizes, finished to match 540/544.

See your TEN-TEC dealer or write for full details.



THE BEST THING NEXT TO A TEN-TEC TRANSCEIVER (or any other) IS A TEN-TEC ACCESSORY

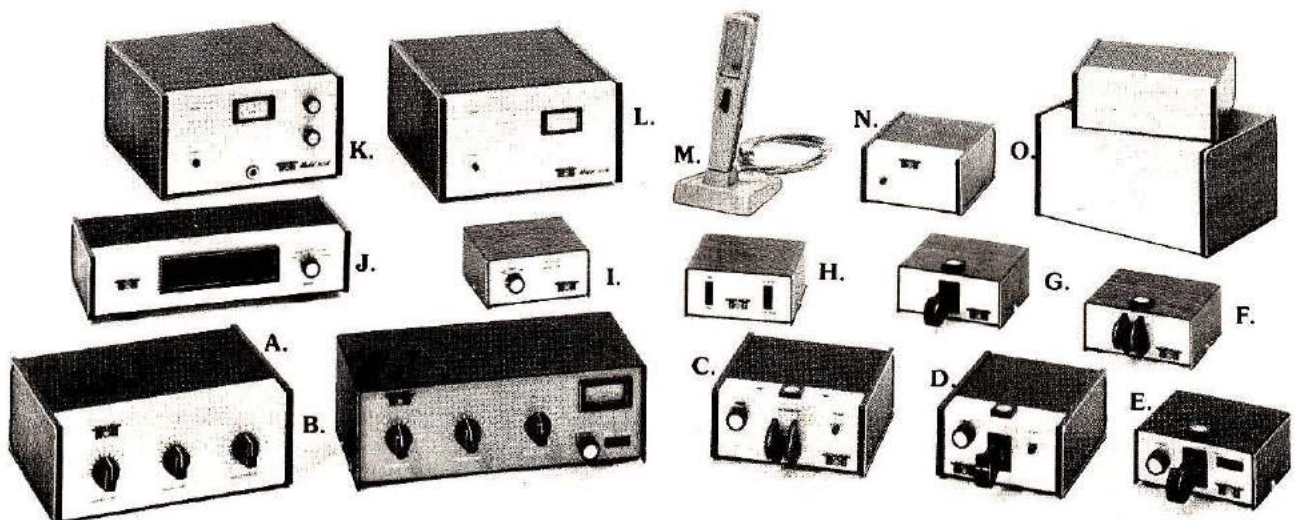

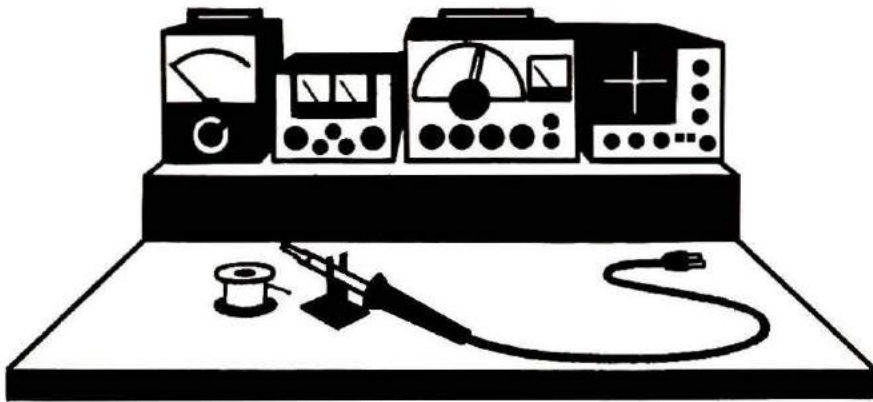

BENCHMARKS

The Digiteye Logic Probe

Here is a project that will impress your friends, become an asset to your workbench, and deplete your wallet less than seven dollars if you buy all new parts. You can build it in an evening and all the parts are readily available.

Lately there has been a profusion of circuits and kits for digital logic probes. Simply, the probes allow the user to see what voltages are present in a particular circuit. Typical features are: voltage-presence indicator, ground indicator, and a pulse stretcher. Most units take power from the circuit

being tested and are rather compact.

The *Digiteye* is unique in that it requires one IC to perform all these functions, has an input impedance of more than 500 thousand ohms, and costs so little; mine cost less than two dollars.

The active device in the unit is the versatile LM3900, a quad Norton amplifier. This high-gain op amp requires only a single voltage supply, can safely source 10 mA and is readily available.

The circuit is straightforward in design. Amplifier A operates as a non-inverting current amplifier. The LED will light when more than 1.4 volts is

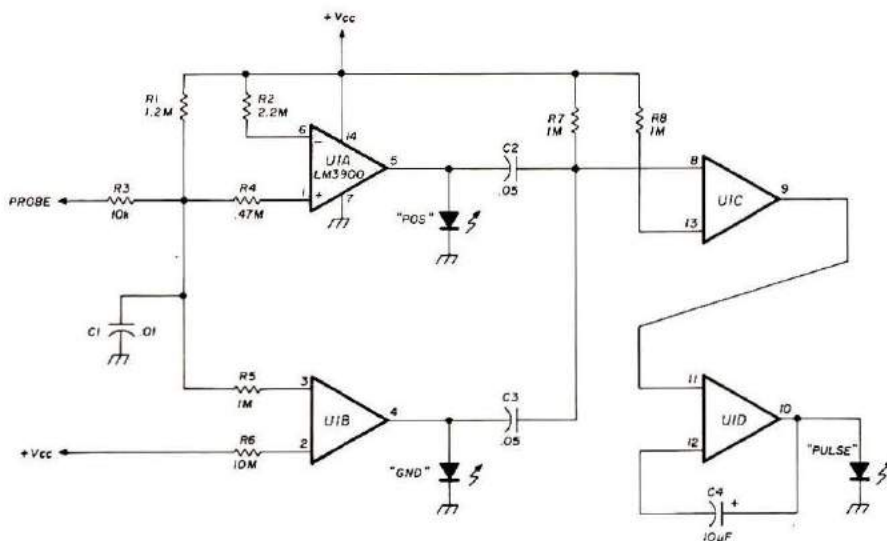

Fig. 1. The schematic diagram of the Digiteye. All resistors are 1/4-watt, 10 per cent. Capacitors are 20-volt units.

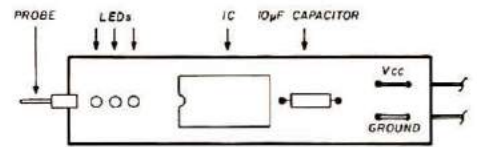

Fig. 2. A suggested parts placement for the perf board assembly, top view. Only the major components are shown. Point-to-point wiring will be adequate.

present at the probe tip. No current limiting resistor is required at the LED due to the 8000-ohm output impedance of the op amp.

The B amplifier is connected as an inverting amplifier. The LED comes on with less than 1.0 volt at the probe tip.

Amplifier C operates as a current amplifier, inverting the pulse from C2 or C3, and increasing its amplitude. The pulse stretcher, amplifier D, is interesting. When the negative-going pulse appears at pin 11 it turns the amplifier on and turns on the LED. C4 discharges into pin 12, keeping the amplifier on well after the pulse at pin 11 is gone. The time constant is about one second.

Care is called for in building the device. Don't even think of using your soldering gun! The case is a cigar can (take the cigar out). I used a can from a Robert Burns Black Watch. The circuit board is ordinary 0.1 x 0.1 perf board. Cut the board about 127 mm (5 in.) long by 15 mm (5/8 in.) wide. Use your imagination for layout but here are some pointers: concentrate the tallest components near the center (from side to side) so they will not hit the can; mount the LEDs near the front and the IC near the center, and use the rear of the board for strain relief of the Vcc and ground leads.

A good probe tip can be made of a pin plug with the plastic sleeve removed and the threaded end soldered to the board. The tip sticks through a grommet in the end of the can.

The project is not hard, but patience and care will pay off with a good piece of test equipment for your bench.

Charles W. Kelly, Jr., WD0CGT

FOR THE

EXPERIMENTER

INTERNATIONAL CRYSTALS & KITS
 OSCILLATORS • RF MIXERS • RF AMPLIFIER • POWER AMPLIFIER

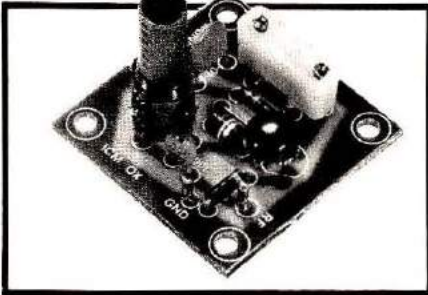

OX OSCILLATOR

Crystal controlled transistor type. 3 to 20 MHz, OX-Lo, Cat. No. 035100. 20 to 60 MHz, OX-Hi, Cat. No. 035101.
Specify when ordering.

\$4.95 ea.

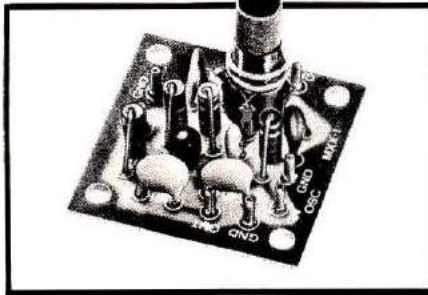

MXX-1 TRANSISTOR RF MIXER

A single tuned circuit intended for signal conversion in the 30 to 170 MHz range. Harmonics of the OX or OF-1 oscillator are used for injection in the 60 to 179 MHz range. 3 to 20 MHz, Lo Kit, Cat. No. 035105. 20 to 170 MHz, Hi Kit, Cat. No. 035106.
Specify when ordering.

\$5.50 ea.

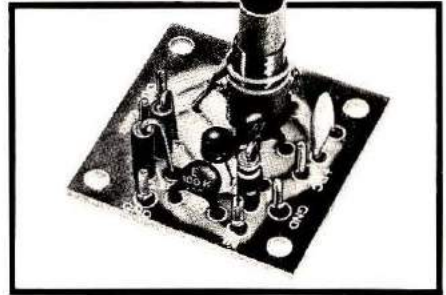

PAX-1 TRANSISTOR RF POWER AMP

A single tuned output amplifier designed to follow the OX or OF-1 oscillator. Outputs up to 200 mw, depending on frequency and voltage. Amplifier can be amplitude modulated 3 to 30 MHz, Cat. No. 035104.
Specify when ordering.

\$5.75 ea.

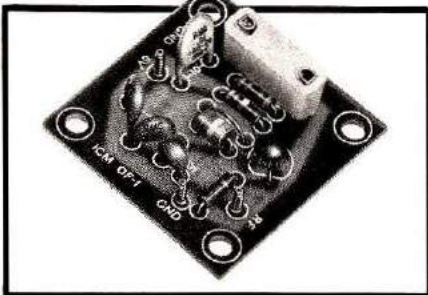

OF-1 OSCILLATOR

Resistor/capacitor circuit provides osc over a range of freq with the desired crystal. 2 to 22 MHz, OF-1 LO, Cat. No. 035108. 18 to 60 MHz, OF-1 HI, Cat. No. 035109.
Specify when ordering.

\$4.25 ea.

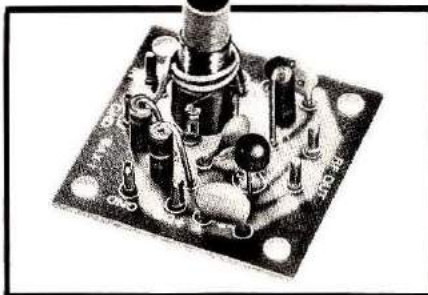

SAX-1 TRANSISTOR RF AMP

A small signal amplifier to drive the MXX-1 Mixer. Single tuned input and link output. 3 to 20 MHz, Lo Kit, Cat. No. 035102. 20 to 170 MHz, Hi Kit, Cat. No. 035103.
Specify when ordering.

\$5.50 ea.

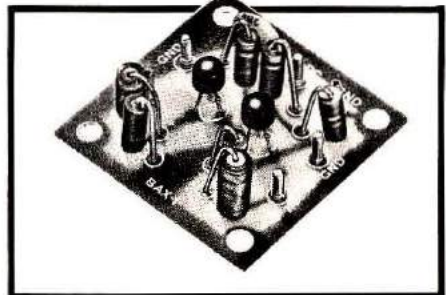

BAX-1 BROADBAND AMP

General purpose amplifier which may be used as a tuned or untuned unit in RF and audio applications. 20 Hz to 150 MHz with 6 to 30 db gain. Cat. No. 035107.
Specify when ordering.

\$5.75 ea.

.02% Calibration Tolerance
EXPERIMENTER CRYSTALS
 (HC 6/U Holder)



Cat. No.	Specifications	
031080	3 to 20 MHz — for use in OX OSC Lo	\$5.95 ea.
	<i>Specify when ordering</i>	
031081	20 to 60 MHz — For use in OX OSC Hi	\$5.95 ea.
	<i>Specify when ordering</i>	
031300	3 to 20 MHz — For use in OF-1L OSC	\$4.75 ea.
	<i>Specify when ordering</i>	
031310	20 to 60 MHz — For use in OF-1H OSC	\$4.75 ea.
	<i>Specify when ordering</i>	

Shipping and postage (inside U.S., Canada and Mexico only) will be prepaid by International. Prices quoted for U.S., Canada and Mexico orders only. Orders for shipment to other countries will be quoted on request. Address orders to:
 M/S Dept., P.O. Box 32497,
 Oklahoma City, Oklahoma 73132.

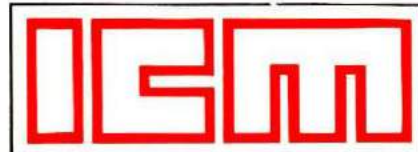

International Crystal Mfg. Co., Inc.
 10 North Lee
 Oklahoma City, Oklahoma 73102

The "ULTIMATE" in CW Reception!



ACTUAL SIZE
3-1/2" WIDE
2-3/8" HIGH
4-3/8" DEEP

COPY ONE® \$99.95

COPY ONE IS NOT A FILTER! This station accessory is a must for the discriminating amateur who operates CW, whether he is an avid CW op or one who engages in CW for proficiency. The CW signal is **processed** (not filtered) in a manner which allows true **ULTIMATE STATION REJECTION**, a mode which has been previously unavailable. The circuitry is **totally unique** (patent pending), a must for emergency CW operations. If you haven't had the opportunity to operate a COPY ONE, ORDER YOURS TODAY!

COPY ONE CW PROCESSOR SPECIFICATIONS & FEATURES:

- **Ultimate station rejection** (almost unbelievable but true!)
- **Pitch & volume independent** of receiver or transceiver
- **Full quieting** (i.e., no background noise) without squelch
- **COPY ONE is not a filter**, there is absolutely no ringing or background noise
- **Plugs into transceiver or receiver/transmitter combo** without modification
- **Discriminates signals** in 80 to 100 cycle increments
- **Full break-in CW operation**
- **Includes 115 volt AC power supply** or may be battery operated
- **Built in code practice oscillator**
- **LED lock-up controls** front panel mounted

ORDER YOURS TODAY!
send \$99.95 by check or money order to:

LOGITRONICS, INC.®
3135 N. COLE RD. BOISE, IDAHO 83704

The 1978 Atlanta HamFestival and Georgia State ARRL Convention June 3-4, 1978

Downtown Atlanta Marriott Hotel

- **GIANT covered Fleamarket/Swapshop!**
- **More than 50 Forums/Meetings!**
- **FCC Exams!**
- **Parking for thousands of cars!**
- **140 Major Exhibits!**
- **Special MICROPROCESSOR Section!**
- **Programs for Ladies & Children!**
- **Activities Galore!**

Registration: \$3 per person **IN ADVANCE**, \$4 at the door
Ladies & Children **FREE!**

If you do not receive a Preregistration Packet by May 1st, write:

Atlanta HamFestival 1978
100 Woodlawn Drive
Marietta, Georgia 30067

or call Area 404/971-HAMS anytime day or night (PLEASE DO NOT CALL BEFORE MAY 1st)

Hotel Rate: \$26 per day single OR double!

Write for Hotel Reservations to:

Marriott Hotel • Courtland at International Blvd. • Atlanta, GA 30303
or phone: Area 404/659-6500 and hurry, hurry, hurry!

THE BEST HAMFEST IN THE WORLD!

BUILT FOR ACTION FROM THE GROUND UP

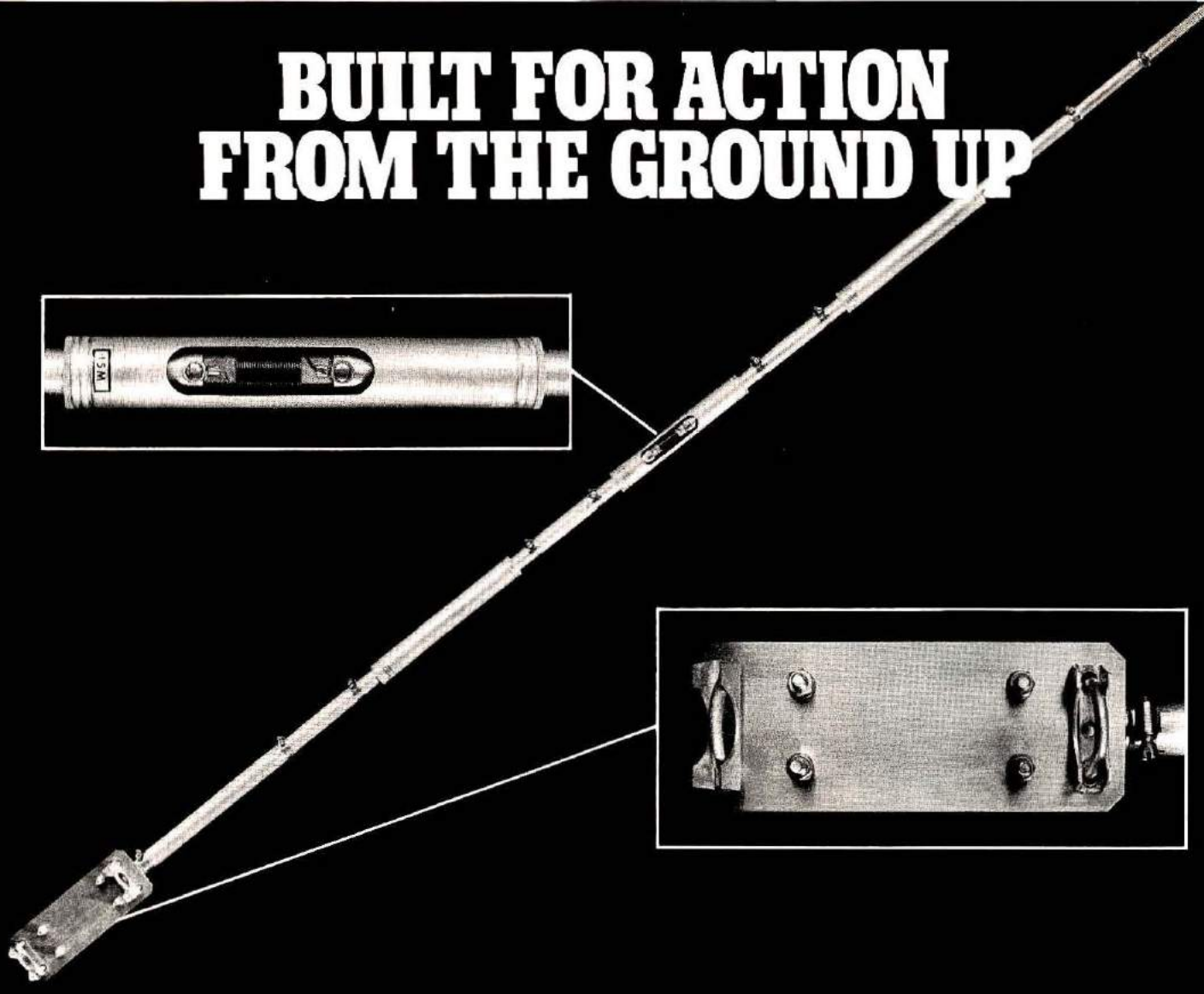

If you've got a calling for far-reaching action, have we got a number for you!

Swan's 4010V: precision engineered for 40-20-15-10 meters.

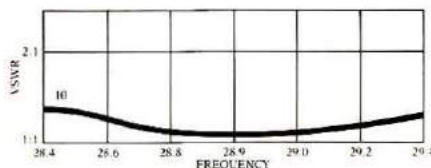
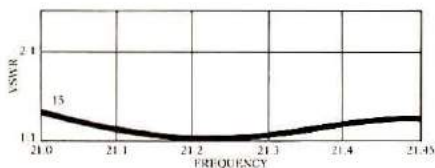
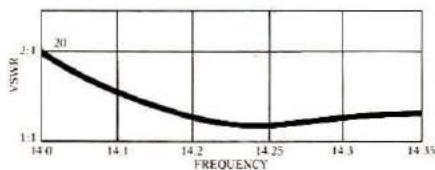
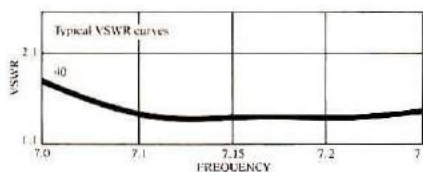

With slim-line traps, this 4-band vertical offers advanced light-weight construction *with* heavy weight performance.

4010V's fine-tuned to handle 2000 PEP. With a typical VSWR of 1.5:1 at resonance.

Powerfully designed — yet powerfully simple to set up.

No-hassle installation. The 21' vertical comes in short, easy to assemble lengths. Complete with mounting hardware. You're up and running in record time.

Expandable too. No trick at all to stretch your reach into 75 meters, with the optional Swan 75 AK Kit.

Just \$74.95 for an outstanding 4-band trap vertical, the 4010V

(and \$39.95 for the 75-meter add-on kit), at your Swan dealer. And by all means, use your Swan Credit Card.

Please rush full specs for Swan's

- 4010V 4-band trap vertical antenna
- 75 AK 75-meter Kit

Name _____

Address _____

City _____

State _____ Zip _____

FREE! Personalized call-letter plaque

2 1/2" x 4" with stand, no charge

- Please send my plaque imprinted with my station call



SWAN
ELECTRONICS
a subsidiary of Cubic Corporation

305 Airport Road, Oceanside, CA 92054

Swan's continuing commitment to product improvement may affect specifications and prices without notice.

PRODUCT SHOWCASE

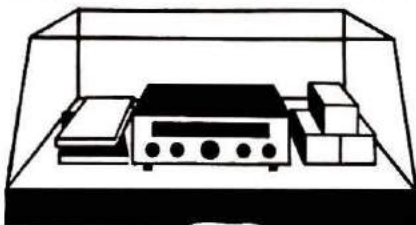

New CDE Rotor for Super Antennas



Cornell-Dubilier Electric Company has introduced a new heavy-duty rotor, the *Tail Twister*, to handle antennas with up to 2.6 square meters (28 ft²) of wind load area. A new control box was designed for the rotor to complete the system.

The rotor incorporates the highly successful HAM II design with a new, thicker, cast-aluminum bell housing. Wider reinforced webs of the housing permit easy support of large antennas. On this model the upper mast-support is predrilled to have a bolt-through installation for positive locking. Also new is a three-ring ball-bearing assembly to provide increased side thrust control and vertical load-carrying capacities. The motor is a new design with an automatic coast-down prebrake action and a metal pinion gear to guard against stripping.

The control box features a full metered indication of the antenna direction with front panel

control for calibration and brake. A separate on/off switch is provided for instant antenna location and brake operation. LEDs provide a positive signal for rotational power and brake operation. The unit is attractively housed in a black satin case. Low voltage control assures safe operation for the user and installer.

The *Tail Twister* system is designed for tower mounting as required for most "super" communications antennas. Weighing slightly over 8 kg (18 pounds), with a height of 36 cm (14-1/16 in), and a diameter of 23 cm (9-5/16 in), the unit is secured with six bolts provided. The mast diameter is a hefty 5 cm (2 in). For further information, please contact Mr. W. Carlson, Cornell-Dubilier Electric Co., 150 Avenue L, Newark, New Jersey 07101, or call (201) 589-7500; or use *ad check* on page 94.

SST Ultra Tuner

SST Electronics has introduced the SST T-2 ultra tuner to tune out the swr on any coax-fed or random-wire antenna. The T-2 will work on 160 through 10



meters and is capable of handling 200 watts. It uses a toroid inductor and specially made capacitors for small size. Its compact, rugged, attractively finished, bronze enclosure is 134 x 57.5 x 63.5 cm (5-1/4 x 2-1/4 x 2-1/2 inches). SO-239 type connectors are used for the transmitter input and coax-fed antennas, while convenient binding posts are used for the random wire and ground connections.

The SST T-3 impedance transformer matches 52-ohm coax to the low impedance of a mobile whip or vertical. Using a 12-

position switch, with taps between 3 and 52 ohms, this impedance transformer provides broadband matching between 1 and 30 MHz. The SST T-3 is also housed in an attractive, bronze-finished cabinet, 70 x 51 x 57.5 cm (2-3/4 x 2 x 2-1/4 inches), with a toroid inductor accounting for its small size.

All SST products are guaranteed for one year. In addition, they may be returned for a full refund within 10 days. The SST T-2 costs \$49.95, while the T-3 is priced at \$19.95. For additional information, contact SST Electronics, P.O. Box 1, Lawndale, California 90260; or use *ad check* on page 94.

MFJ Antenna Tuners

MFJ Enterprises has introduced a series of three new antenna tuners, using efficient, air wound coils, producing less loss than a tapped toroid.

The versatile, top-of-the-line MFJ-941 Versa Tuner II features built-in swr and dual-range wattmeter (300 and 30 watts full scale), antenna switch for selecting two coax-fed antennas, random wire or balanced line, or tuner bypass, and a 1:4 balun. It handles up to 300 watts of rf power and matches dipoles, inverted Vees, random wire, verticals, mobile whips, beams, balanced lines, and coax lines, from 1.8 through 30 MHz.

This beautiful little tuner is housed in a deluxe, eggshell white Ten-Tec enclosure with walnut grain sides and is a compact 20 x 5 x 15 cm (8 x 2 x 6 inches). SO-239 coax connec-



tors are provided for the transmitter input and all coax fed antennas, while quality five-way binding posts are used for balanced line, random wire, and ground connections.

The MFJ-941 Versa Tuner II sells for \$79.95 and comes complete with mobile mounting brackets.

The MFJ-901 Versa Tuner also uses an efficient airwound coil, handles up to 200 watts, and has a built-in 1:4 balun for balanced lines. It matches all types of transmission lines (coax, balanced lines, random wire) and virtually all types of antennas from 1.8 through 30 MHz. It is an ultra compact 12.7 x 5 x 15 cm (5 x 2 x 6 inches) and uses SO-239 coax connectors and quality five-way binding posts. The MFJ-901 Versa Tuner sells for \$59.95.



The MFJ-900 Econo Tuner is the same as the MFJ-901 Versa Tuner except that it does not have the built-in 1:4 balun for balanced lines. Price is \$49.95.

The MFJ-941 Versa Tuner II, MFJ-901 Versa Tuner, and the MFJ-900 Econo Tuner are all available from MFJ Enterprises, and each has a 30-day money back trial period. MFJ also provides a one year, unconditional warranty.

To order, call toll free 800-647-8660 or write to MFJ Enterprises, Box 494, Mississippi State, Mississippi 39762; or use *ad check* on page 94.

High-Power VHF Mobile Antennas

A line of mobile antennas with high power ratings, covering the six and two-meter frequency ranges, has been introduced by Antenna Incorporated. The six-meter antennas feature 200-watt loading coils; the two-meter antennas are available with either 150 or 200-watt loading coils. They are available with 3/4-inch toggle mounts, cowl mounts, and no-hole trunk-lip

Loop Antenna

All Palomar Engineers products are made in U.S.A. Since 1965, manufacturers of Amateur Radio equipment only.

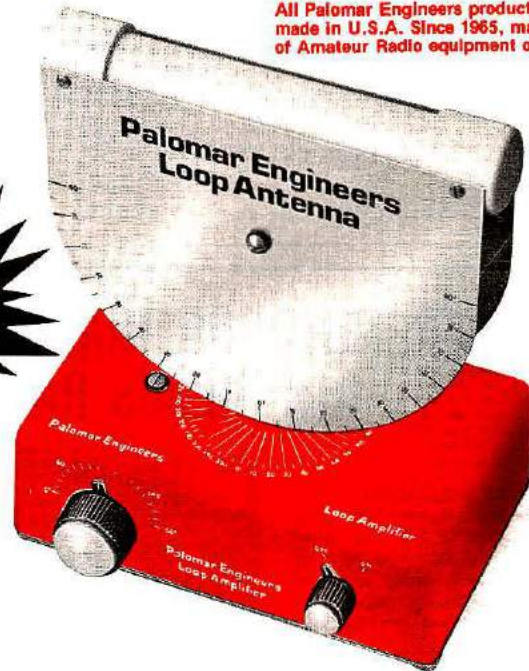

Here is an exciting new device to improve your reception on 160, 80, the broadcast band, and on VLF.

It is well known that loops pick up far less noise than most other antennas. And they can null out interference. Now Palomar Engineers brings you these features and more in a compact, carefully engineered, attractive desktop package.

Unlike ordinary direction-finder loops, it tilts to match the incoming wave front. The result: Deep nulls up to 70 db. You have to listen to believe it!

Does the Loran on 160 give you a headache? The loop practically eliminates it. Broadcast station 2nd harmonic ruining your DX? Turn and tilt the loop and it's gone. Does your friend in the next block with his kilowatt block those weak ones? Use the loop and hear him fade out.

Loop nulls are very sharp on local and ground wave signals but usually are broad or nonexistent on distant skywave signals. This allows local interference to be eliminated while DX stations can still be heard from all directions.

The loops are Litz-wire wound on RF ferrite rods. They plug into the Loop Amplifier which boosts the loop signal 20 db and isolates and preserves the high Q of the loop. The tuning control peaks the loop and gives extra preselection to your receiver.

Plug-in loops are available for these bands:

- 150-550 KHz (VLF)
- 540-1600 KHz (Broadcast)
- 1600-5000 KHz (160 & 80 meters)

Send for free descriptive brochure.

Order direct. Loop Amplifier \$67.50; Plug-in Loop Antennas \$47.50 each [specify frequency band]. Add \$2 packing/shipping. Calif. residents add sales tax.

Palomar Engineers

Box 455, Escondido, CA. 92025 • Phone: [714] 747-3343

mounts. Also available are 100-watt models with either the same mounts, or with 3/8-inch snap-in, spring-clip gutter, and magnet mounts. Loading coils are tuned at the factory to achieve a standing wave ratio of 1.5:1 or less, and each antenna includes a cutting chart so the whips can be field trimmed to exact frequencies.

Each antenna features a

plated stainless steel whip for low resistivity to combat skin effect, stainless steel impact spring, shock-resistant and weatherproofed PVC-wrapped loading coil, and 17 feet of coaxial cable with a soldered PL-259-type connector.

The 200 watt two-meter antennas also feature Antenna Incorporated's new high-power coaxial cable. While the 150 watt

high-band and 200 watt low-band antennas include RG/58-U cable, this cable cannot safely handle 200 watts of power on two meters. Antenna Incorporated's high-power cable has performance characteristics similar to RG-8/U, but in a smaller size, thus eliminating the problems of using the larger cable in mobile applications.

"These antennas also are part of Antenna Incorporated's professional land mobile line and have been designed to meet the needs of high power communications users," sales manager Randall Friedberg said. "They offer the amateur the best in antenna quality and dependability."

For further information on the company's complete line of communications antennas and accessories, contact Randall J. Friedberg, Antenna Incorporated, 23850 Commerce Park Road, Cleveland, Ohio 44122. Phone (216) 464-7075, or use *ad check* on page 94.

QUALITY KENWOOD TRANSCEIVERS ... from KLAUS RADIO

The TS-820S is the rig that is the talk of the Ham Bands. Too many built-in features to list here. What a rig and only \$1098.00 ppd. in U.S.A. Many accessories are also available to increase your operating pleasure and station versatility.



**TS-820S
160-10M TRANSCEIVER**

Super 2-meter operating capability is yours with this ultimate design. Operates all modes: SSB (upper & lower), FM, AM and CW. 4 MHz coverage (144 to 148 MHz). The combination of this unit's many exciting features with the quality & reliability that is inherent in Kenwood equipment is yours for only \$729.00 ppd. in U.S.A.

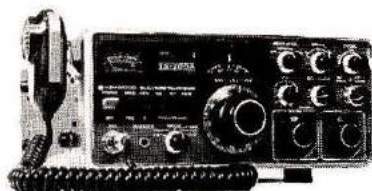

**TS-700S
2M TRANSCEIVER**

Guess which transceiver has made the Kenwood name near and dear to Amateur operators, probably more than any other piece of equipment? That's right, the TS-520S. Reliability is the name of this rig in capital letters. 80 thru 10 meters with many, many built-in features for only \$739.00 ppd. in U.S.A.



**TS-520S
80-10M TRANSCEIVER**

This brand new mobile transceiver (TR-7400A) with the astonishing price tag is causing quite a commotion. Two meters with 25W or 10W output (selectable), digital read-out, 144 through 148 MHz and 800 channels are some of the features that make this such a great buy at \$399.00 ppd. in U.S.A.



**TR-7400A
2M MOBILE TRANSCEIVER**

Send SASE NOW for detailed info on these systems as well as on many other fine lines. Or, better still, visit our store Monday thru Friday from 8:00 a.m. thru 5:00 p.m. The Amateurs at Klaus Radio are here to assist you in the selection of the optimum unit to fulfill your needs.

KLAUS RADIO Inc.

8400 N. Pioneer Parkway, Peoria, IL 61614
Jim Plack W9NWE — Phone 309-691-4840

73 Dipole and Long-Wire Antennas

An amateur radio axiom maintains that for one with limited time and finances, effort expended in improving one's antenna will give greater rewards than an equal effort in improving any other area of one's station. Obviously a better antenna system helps both on receiving and transmitting. Since the hobby's earliest years, antenna experimentation has been a popular pursuit, and amateurs have developed dozens of simple, efficient, and ingenious wire antennas to fit different situations.

Readers of *Ham Radio Magazine* will recognize the name Edward Noll as the author of the ever-popular "Circuits and Techniques" column. In this book Ed, who is W3FQJ, describes a treasure-trove of antenna ideas ranging from the most basic, single-band, Novice-type dipole to huge, sophisticated, multi-band directional arrays for the

serious DXer. In between are dipoles, inverted vees, long-wires, vee-beams, and the legendary rhombics. Yet all of W3FQJ's antennas require a minimum of materials — generally just a few insulators, some wire, and whatever supports are available.

In his clear and straightforward style, the author gives full practical construction details along with enough theory and formulas to help you in your own further experimentation. He also includes handy appendices on antenna and transmission line theory, use of antenna tuners, and the best procedures for tuning any antenna for peak performance.

After reading the book, it will be hard to settle for the traditional dipole when the range of other simple wire antennas is so broad. For the amateur with more space than money, in particular, this book could be the key to both a better signal and many fascinating and rewarding hours of antenna experimentation.

Soft cover, 160 pages, \$4.50 plus 35¢ shipping and handling, from Ham Radio's Communications Bookstore, Greenville, New Hampshire 03048. Catalog number 24006.

Listener 7 Active Antenna

The resurgence in short-wave listening has brought along with it a need for more antennas to pick up the signals from far-off lands. Unfortunately, many of those people most interested in short-wave reception are living in crowded areas, where their proximity to noise-creating electrical devices makes listening difficult, if not impossible. A good antenna will help, but those same crowded conditions that put the listener close to the noise preclude the installation of a good antenna. What to do?

Active antennas seem to be the answer, and many SWLers agree. A newcomer to the active antenna field is the *RAK Listen-*

er 7. What is an active antenna? It's an antenna that is physically small, so it can be mounted high or in the clear away from noise sources, with a high-gain preamplifier built into the base or supporting structure. The overall effect is to obtain performance equal to, or better than, a full-sized antenna, but in much less space. It is also easier to mount, since in most

cases only a single support is needed.

The *Listener 7* is a vertical whip, with a preamplifier built into the base/mounting bracket. The whole assembly can be mounted on a rooftop, railing, post, tv mast, or whatever. The low-voltage dc (a single 9-volt battery can supply it) is fed up the coaxial cable to the amplifier, and the amplified radio-

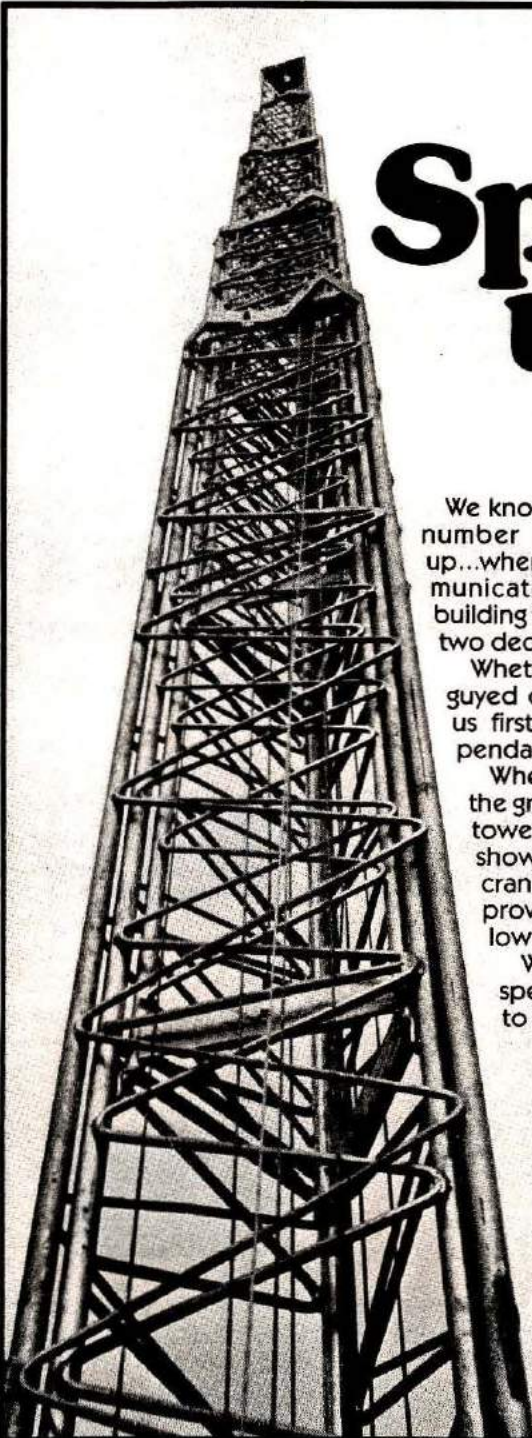

Speak up.

We know all about up. In fact, we're number one from the ground up...when it comes to amateur communications towers. We've been building them for HAMS for more than two decades.

Whether you're thinking crank-up, guyed or free-standing, check with us first. We're Tri-Ex. Reliable, dependable.

When we say number one from the ground up, we're talking about towers like Tri-Ex's new "Big W" shown here. It's a free-standing crank-up with a height of 80-ft, providing good DX capability at low cost. Ideal for serious HAMS.

Write today. We'll help you speak up. As high as you want to go. Act now.



Tri-Ex
TOWER CORPORATION
7182 Rasmussen Ave.
Visalia, Calif. 93277

TOWER PACKAGE SPECIALISTS

in
Steel and Aluminum

CRANK-UP CRANK-OVER SELF-SUPPORTING

Call or Write for Your Custom Tower Package.

TOWERS BY

ALUMA
E-Z WAY
HEIGHTS
ROHN
TRI-EX
TRISTAO
UNIVERSAL

ROTORS BY

CDE ●
CHANNELMASTER
HY-GAIN
KLM
TELREX
WILSON

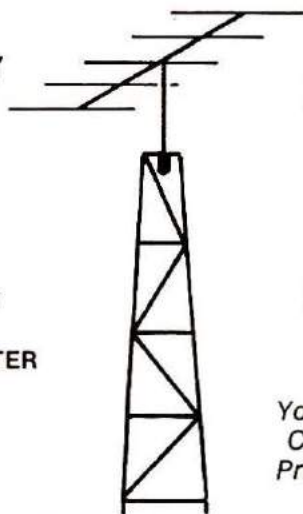

ANTENNAS BY

A-S
CUSHCRAFT
HY-GAIN
KLM
LARSEN
MOSLEY
NEWTONICS
SWAN
TELREX
WILSON

Your Antenna Dream
Comes True — at a
Price You Can Afford

Communications Specialists Serving Hams
— Since 1939 —

ELECTRONIC DISTRIBUTORS, INC.

1960 PECK STREET
TELEPHONE (616) 726-3196

MUSKEGON, MICHIGAN 49441
TELEX 22-8411

STEP UP TO TELREX

Professionally Engineered Antenna Systems

Single transmission line "TRI-BAND® ARRAY"

MONARCH
TB5EM/4KWP

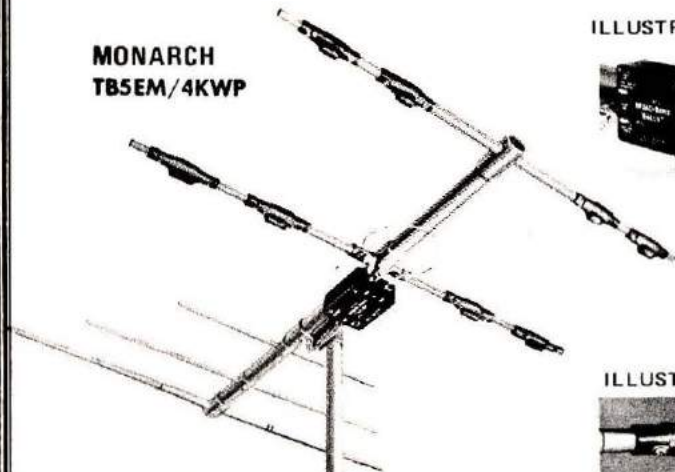

ILLUSTRATION BALUN

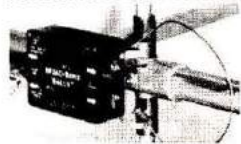

ILLUSTRATION TRAP



By the only test that means anything... on the air comparison... this array continues to outperform all competition... and has for two decades. Here's why... Telrex uses a unique trap design employing 20 HiQ 7500V ceramic condensers per antenna. Telrex uses 3 optimum-spaced, optimum-tuned reflectors to provide maximum gain and true F/B Tri-band performance.

For technical data and prices on complete Telrex line, write for Catalog PL 7

COMMUNICATION SYSTEMS SINCE 1921 **telrex** Laboratories
ASBURY PARK, NEW JERSEY 07712, U.S.A.

frequency signals are returned down the same cable to be fed into your receiver in the normal manner. An ac-to-dc converter is available for those who do not want to use batteries. An LED indicator shows when the unit is on, and tells you about battery condition.

The *RAK Listener 7* active antenna is available from Gilfer Associates, Inc., Post Office Box 239, 52 Park Avenue, Park Ridge, New Jersey 07656. The cost is \$67, delivered. For more information on Gilfer Associates products, use *ad check* on page 94.

Three-Band Vertical Antenna

The Omega-t HV-3 is a 30-foot (9.1 meter), self-supporting, top-loaded, vertical monopole antenna for the 80, 40, and 20 meter bands. Matching to the feedline is accomplished by a unique plug-in base-matching unit. The full height of the antenna is used on each band, resulting in good gain and bandwidth and a low angle of radiation. The HV-3 can handle full legal amateur power for ssb or CW. A model HP-2 matching unit is available for 160 meter operation. The matching units feature continuously variable tuning and matching adjustments; tuning within a band or changing of matching units can be accomplished in seconds.

Antenna construction is of heavy-wall extruded 6061T-6 aluminum pipe; hardware and top-loading rods are stainless steel. A tilt-up base can be mounted to a pipe or post for easy one-man installation. For more information write to D. E. Aetzman, Electrospace Systems, Inc., P.O. Box 1359, Richardson, Texas 75080, or call (214) 231-9303, or use *ad check* on page 94.

Mobile Antenna Matcher

Barker & Williamson offers their new model **AT-200** antenna

matcher for matching two-meter amateur mobile transceivers to automobile a-m/fm broadcast receiver antennas. The model AT-200 is intended to provide the theft-foiling benefits of disguised and "hideaway" antennas at lower cost, and to eliminate the nuisance of constantly putting up and taking down a second antenna.

The new unit consists of a tunable matching network, an output indicator, and a selector switch, in a compact case. It is furnished with two coaxial cables for connections to the entertainment radio and the two-meter rig. The connecting cables have a Motorola-type connector for the entertainment radio and a PL-259 connector for the two-meter rig. The front panel contains a tuning knob, a two-position (a-m/fm or two-meter) selector switch, and an output indicator light. The unit is supplied with a mounting bracket and installation instructions and will handle 100 watts from the transceiver.

The model AT-200 antenna matcher is available through Barker & Williamson distributors and dealers at an introductory price of \$22.50. For additional information, call or write Barker & Williamson, Inc., 10 Canal Street, Bristol, Pennsylvania 19007; or use *ad check* on page 94.

Kenwood Power Supply

Trio-Kenwood has recently introduced the Model PS-8 dc power supply. The PS-8 is designed for use with the Kenwood TR-7400A 2-meter transceiver and matches it both in color and styling. The PS-8 supplies 12 volts dc and is rated at 5 amps (continuous) and 8 amps (intermittent). It lists at \$129.00 and is available from authorized Trio-Kenwood dealers throughout the United States. For a list of authorized dealers and more information on the PS-8, write to Trio-Kenwood Communications, Inc., 1111 West Walnut Street, Compton, California 90220; or use *ad check* on page 94.

Let's Make Yours DRAKE!

It's time to get on the Bandwagon and join the large number of Discriminating Hams "who know" and who choose **DRAKE** gear for their serious operating. Find out just why they will not consider anything else. Let yourself enjoy the Total, Reliable and Convenient operation of the equipment with the famous name. If you ever have a problem, the R.L. **DRAKE CO.** provides the best Factory Warranty and Service Back-up there is. Just ask any **DRAKE** owner.

AMATEUR ELECTRONIC SUPPLY - Just ask around! We're the Ham House with the Solid Reputation. We have nearly 20 years in the business and have built a large organization with a Mail Order Headquarters and two fine Branch Stores employing 30 licensed Hams to serve you. Large Stocks, Fast Service and Top Trades. Write or Call Today for information. If you have Clean, Late Model SSB Gear to trade, Get our Deal! Otherwise, just Get our Price.

R-4C 160-10m receiver	5699.00
MS-4 Speaker	33.00
4-NB Noise blanker	74.00
FL-250 250 Hz filter	52.00
FL-500 500 Hz filter	52.00
FL-1500 1.5 KHz filter	52.00
FL-4000 4 KHz filter	52.00
FL-6000 6 KHz filter	52.00
T-4XC 160-10m transmitter	699.00
AC-4 AC supply	150.00
TR-4CW 80-10m transceiver w/RIT	799.00
34PNB Noise blanker	100.00
RV-4C Remote VFO/speaker	170.00
DC-4 DC supply	160.00
MMK-3 Mobile mounting kit	10.95
Optional Crystals	5.25
L-4B 2 KW PEP linear	995.00
FS-4 Frequency Synthesizer	300.00
Split Frequency adaptor (C-Line)	10.00
Interface kit for SPR-4	10.00
MN-4C 160-10m Matching Network	165.00
B-1000 4 1 Balun	24.95
MN-2000 Matching Network	250.00
W-4 Wattmeter	79.00
WV-4 VHF Wattmeter	89.00
RCS-4 Remote antenna switch	120.00
RP-500 Receiver protector	90.00
TV-42-LP 100w low-pass filter	14.60
TV-3300-LP 1000w low-pass	26.60
TV-5200-LP 1000w 200w 6m	26.60
TV-75-HP High-pass filter	13.25
TV-300-HP High-pass filter	10.60
SSR-1 General coverage rcvr	350.00
PC-PC DC power cord	5.00
SPR-4 Programmable rcvr	699.00
5NB Noise blanker	80.00
SCC-4 Crystal calibrator	22.00
DC-PC DC cig. lighter cord	5.00
Plain crystal selector dial	3.00
Amateur bands xtal kit	31.20
MARS bands xtal kit	26.00
Time and frequency standard kit	26.00
Commercial teletype xtal kit	20.80
Aeronautical overseas xtal kit	36.40
Marine bands xtal kit	57.2
Tropical broadcast kit	15.60
CB band xtal kit	5.25
DSR-2 Digital receiver	3200.00
TR-33C Portable 2m FM Xcvr	229.95
1525EM Encoder microphone	49.95
7079 Vinyl case for TR-33C	9.95
MMK-33 Mobile mount	12.95
Crystals for TR-33C	6.30
1340 UV-3 2m FM Xcvr	595.00
1343 UV-3 2m/220 MHz FM Xcvr	695.00
1344 UV-3 2m/440 MHz FM Xcvr	695.00
1346 UV-3 2m/220 MHz/440 Mhz	795.00
1359 UV-3E 144/430, European	695.00
PS-3 AC power supply	89.95
UMK-3 Remote trunk kit	69.95
220 or 440Mhz add-on (factory)	175.00
World Radio/TV Handbook	10.95

AMATEUR ELECTRONIC SUPPLY®

4828 W. Fond du Lac Avenue
Milwaukee, Wisconsin 53216
Phone (414) 442-4200

Branch Stores in:
Cleveland, Ohio & Orlando, Fla.
Send Orders and Inquiries to Milw. Hq.



Here's **Ray Grenier, K9KHW** operating and enjoying his latest **DRAKE** equipment. Watch for him on your favorite band. Ray is National Sales Manager at **AES** - Write or Call him today.



Meet **Miles Cundy, K9HMQ** our Service Manager. His job is making sure the quality of our repair work does not deviate from the standards we have become famous for over the years.



To: **AMATEUR ELECTRONIC SUPPLY**
4828 W. Fond du Lac Ave, Milwaukee, Wis. 53216

I am interested in the following new equipment:

I have the following to trade: (what's your deal?)

Ship me:

I Enclose \$ _____; I will pay balance (if any):

COD (20% Deposit) American Express
 Master Charge* BankAmericard

Account Number: _____

Expiration DATE _____ *Master Charge Interbank number _____ (4 digits)

Name: _____

Address: _____

City & State: _____

Send latest new and used gear lists

MARCH 1977
**HAM RADIO
HORIZONS**

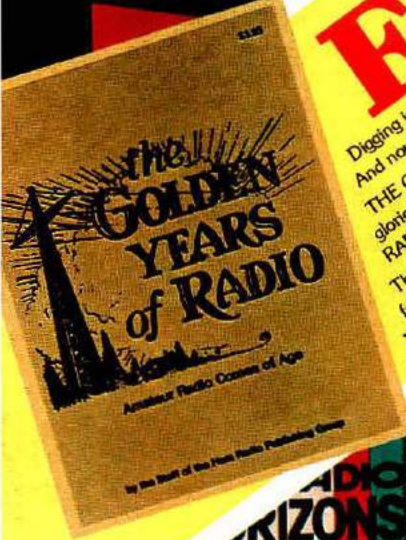

FREE!

Digging into radio's past is a truly fascinating adventure no one should miss. And now you can experience this trip absolutely FREE!
THE GOLDEN YEARS OF RADIO captures the excitement (and the frustrations) of these glorious bygone days... the discoveries, the people and the events. **THE GOLDEN DAYS OF RADIO** is a collection of articles skillfully compiled by the editors of Ham Radio **HORIZONS**. But hurry! To get this fascinating 64-page booklet, you must act within the next 14 days. A Special Limited Offer. Now, how about **HORIZONS**.

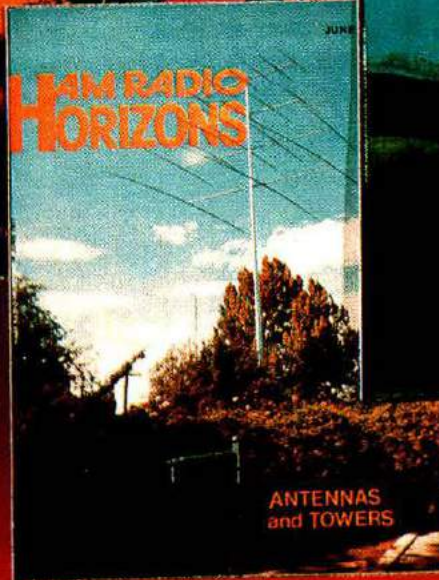
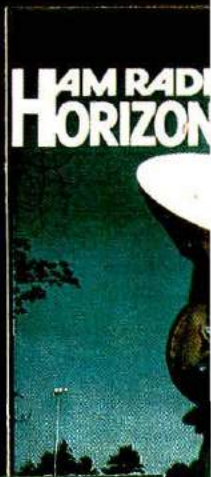
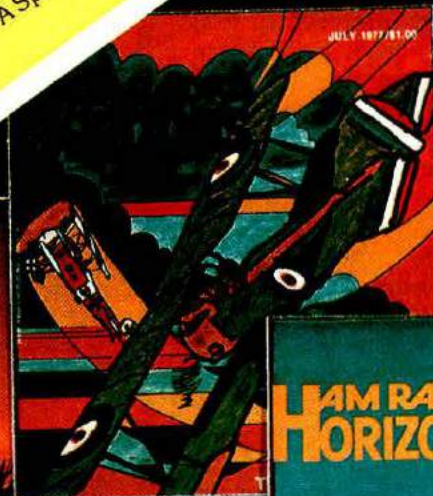
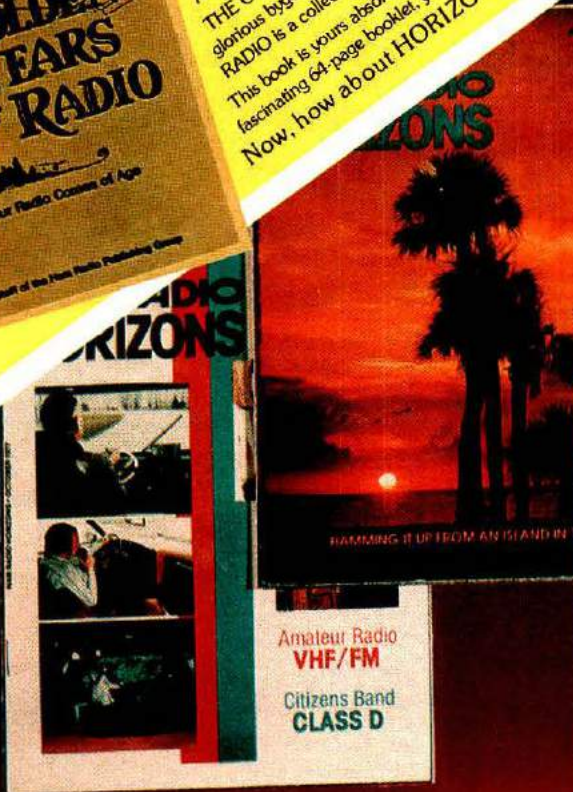

Now's your chance.

If you want to know all about Amateur Radio, and we mean to really understand its many aspects—DXing, propagation, antennas, license upgrading, basic construction and just downright fun—now is the time to subscribe to **HORIZONS** and get as a great bonus your FREE copy of **THE GOLDEN YEARS OF RADIO**. Hurry though—this offer is only good for 14 days. Send us your subscription right away! We'll send you **THE GOLDEN YEARS OF RADIO** and immediately start your subscription to Amateur Radio's most enjoyable magazine—Ham Radio **HORIZONS**.

**HAM RADIO
HORIZONS**

READERS' COMMENTS:

Dear **HORIZONS**:
Thank you for assembling one terrific Ham Radio magazine. Your staff certainly deserves some nice bouquets on a job very well done.
Please keep up the good work.
WB9VUD Park Forest, Illinois

Dear **HORIZONS**:
As a writer, I appreciate clarity of thought, excellence of content, effectiveness of presentation, and vivid writing. The articles in **HRH** have aided me immensely in sorting out some of the mysteries of electronics. Keep up the good work.
WB3BDV Washington Bureau News

Dear **HORIZONS**:
I think your magazine is just great. I would probably subscribe even if the price were \$20.00. I like the way it's written, and I especially like the "Questions and Answers" series. Keep up the good work.
WB2JWY Flushing, New York

Dear **HORIZONS**:
A hearty well-done to you and your staff for providing the Amateur community with this excellent publication. As most Amateurs are not of the electronic engineer caliber, it's refreshing to read a magazine that we can totally comprehend. Keep up the good work and you have my subscription for life!
F.C.B. Okinawa, JAPAN

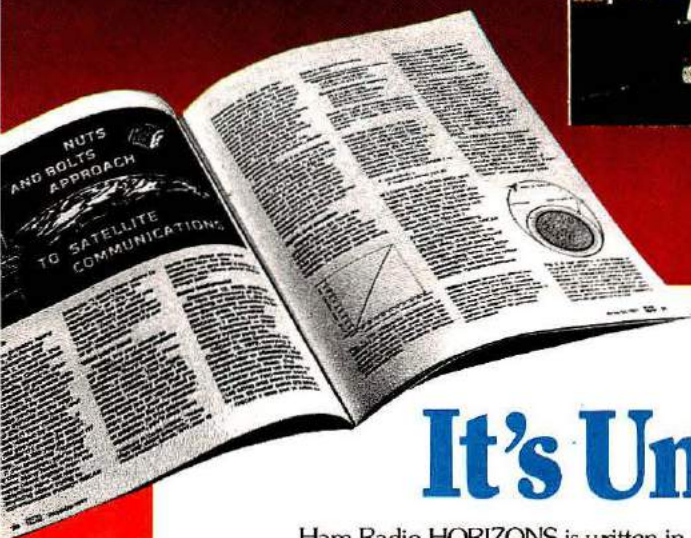
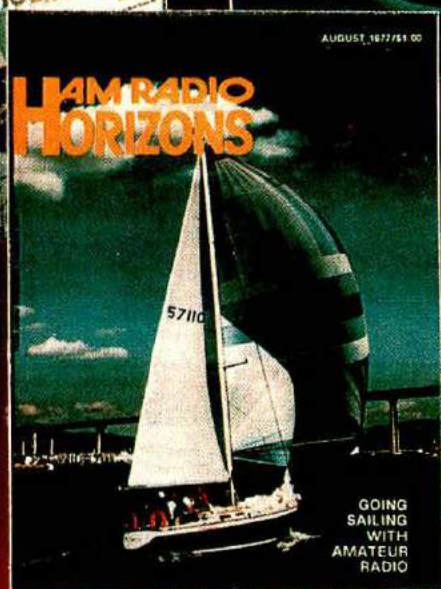
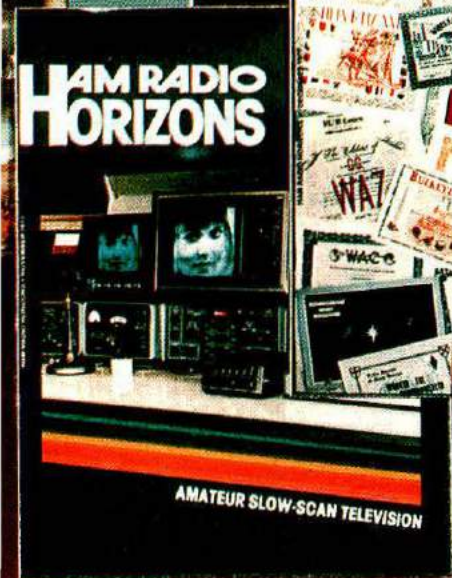
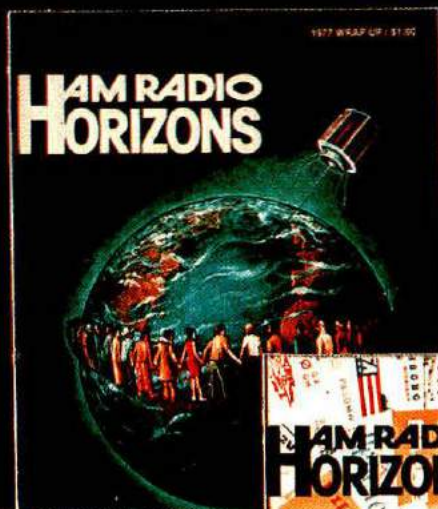
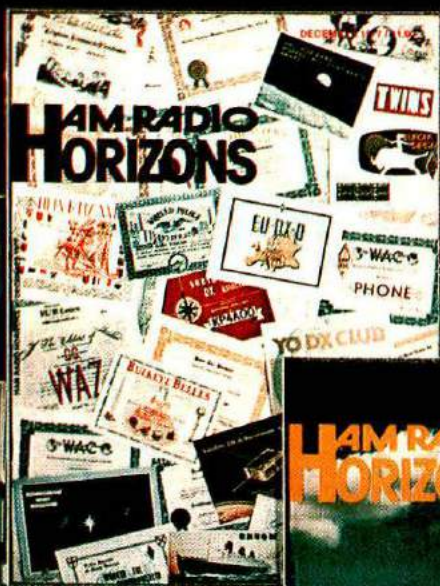

It's Understandable.

Ham Radio HORIZONS is written in a language just for you. Easy to understand, easy to enjoy. If you really want a thorough, well-rounded knowledge of Amateur Radio and not just a hazy idea of what it is all about, then you need Ham Radio HORIZONS.

HORIZONS is the only popular monthly Amateur Radio magazine which doesn't bombard you with deep technical material. It is devoted to the operator, old-timer and beginner alike, but not the technical genius (although he'll enjoy its fresh entertaining look, too). It's devoted

to you — the person who enjoys getting on the air and wants to get the most from this great pastime.

Rather than keep you guessing, HORIZONS spells it out so you know exactly what's happening in Amateur Radio. Great authors like Bill Orr, W6SAI; Bob Locher, W9KNI; Charlene Knadle, WB2HJD plus our own super-staff of Jim Fisk, W1HR; Tom McMullen, W1SL; and Jim Gray, W1XU, bring you the excellent, down-to-earth writing that Radio Amateurs at *all* levels are talking about.

SPECIAL GUARANTEE

Ham Radio HORIZONS positively guarantees your satisfaction with every issue. If at any time you are not satisfied with an issue of HORIZONS, just enclose this guarantee coupon along with the front cover of the issue in question and we will extend your subscription by one month—Absolutely FREE!

And of course our regular money-back guarantee also applies to your HORIZONS subscription. You must be satisfied or we will refund any unused portion of your subscription.

Ham Radio HORIZONS, Greenville, NH 03048



It's Understandable.

Subscribe Now!

FREE! THE GOLDEN YEARS OF RADIO

YES, I want to subscribe to HORIZONS and receive FREE the exciting, new *GOLDEN YEARS OF RADIO*.

- 1 year 12 issues \$9.97 (Save 33% OFF Newsstand Price) NEW
 3 years 36 issues \$23.97 (Save 50% OFF Newsstand Price) RENEWAL
 Check or Money Order enclosed Master Charge VISA Bill Me

Acct. # _____ Exp. date _____ MCBank # _____

Name _____

Address _____

City _____ State _____ Zip _____

Ham Radio HORIZONS, Greenville, NH 03048

NEW 1978 EDITION



The most complete directory of Amateur Radio Equipment ever published. The all new 1978 Edition includes specifications, pictures, and prices of transceivers, transmitters, receivers, amplifiers, power supplies, transverters, antennas, tuners, towers, meters, microphones, keyers, VFO's, preamps, test gear, etc. etc. No ham library will be complete without a copy of the 1978 Amateur Radio Equipment Directory.

\$4.00 Postpaid (U.S.)
 Canada \$5.00, Foreign (Air) \$7.00
KENGORE CORP. Dept. HR
 9 James Avenue
 Kendall Park, N. J. 08824

SEND FOR YOUR COPY TODAY

RADIO & ELECTRONICS CONSTRUCTOR

Here is an interesting general electronics hobby magazine. It's loaded with lots of interesting simple circuits and ideas, not only about radio, but in all phases of electronics including test gear, audio, remote control and security electronics.

We are sure that you will find a number of worthwhile projects in this British magazine.

1 Year (12 issues) \$12.00

**Radio & Electronics
 Constructor**
 Greenville, NH 03048

GOTHAM QUADS

A classic case . . .

of simplicity in design providing reliability and high performance at rock bottom prices.

These are two element quads with full wavelength driven element and reflector. Gain is equal to that of a three element beam and directivity is exceptional! ALL METAL construction (except the insulators.) Complete with boom, aluminium alloy spreaders, sturdy universal type boom mount, wire and all hardware. Uses 52 ohm coaxial feed. This is a foolproof quad that always works with great results.

Now check this super price: 10/15/20 quad, complete, ready for simple assembly . . . **JUST \$59.95.** Also available 10/15/20 Quad "S", shipped UPS freight prepaid. \$15.00 additional. Assembled weight 25 lbs.

GOTHAM, INC.

(305) 573-2080

2051 N.W. 2nd Ave., Miami, FL 33127

"Getting out for 30 years!"

Please send the following:

Quantity	Description	Amount

(Florida residents add 6% sales tax)

Send self addressed, stamped envelope for literature.

NAME _____

ADDRESS _____

CITY _____ STATE _____ ZIP _____

How to order: Remit total amount with order. All quads except quad "S" option sent freight collect cheapest way, due to size of package. Check your local truck lines for estimated freight rates.

HRH

FIELD DAY — AT RSE

YAESU



**FT-301D TRANSCEIVER
 ALL SOLID STATE**

Buy your TS-301D from us for \$935 and we will include the AC power supply and CW filter (installed) FREE.

KENWOOD

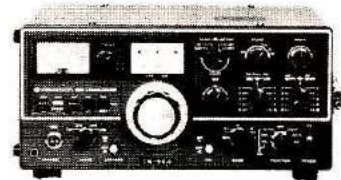

**TS-520S
 160-10M TRANSCEIVER**

Buy your TS-520S from us for \$739 and we will include an MC-50 microphone and CW-520 filter FREE.

ICOM

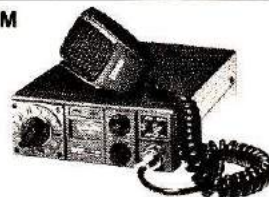

**IC-22S PROGRAMMABLE
 TWO-METER TRANSCEIVER**

Purchase your IC-22S for \$299 from RSE and take \$25 credit toward the purchase of any other merchandise!



**TS-600 SIX-METER
 ALL-MODE TRANSCEIVER**

Purchase your TS-600 from RSE for \$699 and take \$100 credit toward the purchase of any other merchandise.

Please include your area code and telephone number with any correspondence.

RSE HAM SHACK



1207 W. 14 MILE, CLAWSON, MICHIGAN 48017
 313-435-5660



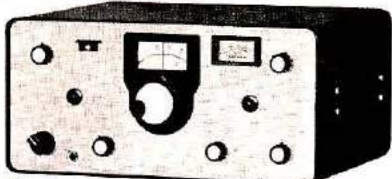

TEN-TEC 570 Century 21 70w CW Transceiver.
 Full coverage on 3.5, 7, 14, 21MHz bands, 1 MHz on 28MHz. Totally solid-state. Instant band change. No tune-up. Full Break-in. (Hear between transmitted characters) Clean, click free keying. Overload protection. Built-in low-pass filters. Offset tuning. Selectivity: .5, 1.0 or 2.5KHz. Adjustable sidetone level. Built-in AC power supply. Dim. 6 1/2" h x 12 1/2" w x 12" d \$289.00
574 Century 21w/Digital readout..... 399.00
670 Keyer..... 29.00
276 Callibrator..... 29.00
277 Ant. tuner/SWR bridge..... 89.00



AMATEUR ELECTRONIC SUPPLY®
4828 West Fond du Lac Avenue
Milwaukee, Wisconsin 53216
Phone (414) 442-4200

BRANCH STORES:
28940 Euclid Avenue; Wickliffe, Ohio 44092
Phone: (216) 585-7388
621 Commonwealth Ave.; Orlando, Fla. 32803
Phone: (305) 894-3238

Note: Branch Stores are set-up to handle Walk-in business or telephone orders only. They do not have facilities to respond to written inquiries.

INSTRUCTOGRAPH MORSE CODE

Since 1924 Instructograph has serviced the world with the most complete equipment ever devised for learning Continental code. You have complete control of sending & receiving **AT ANY SPEED YOU DESIRE** while machine is running, without changing tapes (not cassettes). A complete course for beginners incl. machine, 10 double sided tapes, key, manual, built-in speaker. Nothing else to buy. \$98.50 plus UPS 12 lb. del. chg. Add 6% S.T. for Calif. del. For catalog on 45 advanced tapes or complete information write: Instructograph Co., Box 5032, Dept. 4, Glendale, CA 91201. (213) 246-3902 or 245-2250.

NOTICE: Closed for vacation July 10 to August 10, 1978.

MORSE CODE INSTRUCTOGRAPH

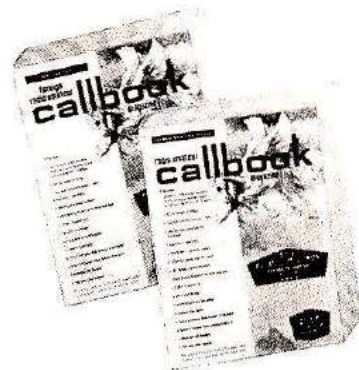

There's nothing like it !

RADIO AMATEUR callbook

Respected worldwide as the only complete authority for radio amateur QSL and QTH information.

The **U. S. Callbook** has over 300,000 W & K listings. It lists calls, license classes, names and addresses plus the many valuable back-up charts and references you come to expect from the **Callbook**.

Specialize in DX? Then you're looking for the **Foreign Callbook** with almost 300,000 calls, names and addresses of amateurs outside of the USA.

U.S. Callbook \$14.95

Foreign Callbook \$13.95

Order from your favorite electronics dealer or direct from the publisher. All direct orders add \$1.50 for shipping. Illinois residents add 5% Sales Tax.

RADIO AMATEUR callbook INC.
 Dept. E 925 Sherwood Drive
 Lake Bluff, Ill. 60044

More details? Ad Check page 94.

PROUD OF YOUR CALL? . . . WORRIED ABOUT THEFT?

Identify your FM transceiver with automatic code on each transmission.

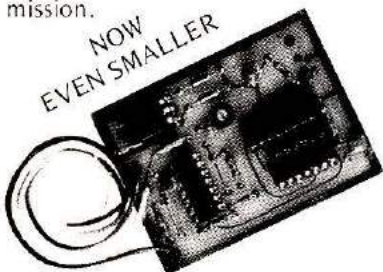

SIZE: 1 3/4" X 2 1/4" X 5/16"
Installation: Only THREE wires

WARRANTY

Returnable for full refund within ten day trial period. One year for repair or replacement.

PRICE \$39.95 Ppd
+\$2.40 for CA address

Your call sign programmed at factory, please be sure to state call sign when ordering.

AUTOCODE
8116 Glider Ave, Dept H
Los Angeles, Ca. 90045
(213) 645-1892



Oak Hill Academy Amateur Radio Session

19th Year - July 29 thru August 11, 1978

We have moved our location just 15 miles from our previous site to the Oak Hill Academy, Mouth of Wilson, Virginia.

Our accommodations are now the finest one could hope for, suites in a beautiful Dorm with bath for each four students. Lovely spacious lobby and fine recreation room in the lower level of the dorm.

Oak Hill Academy in the Appalachian Mountains of Virginia offers an intensive two week Radio Session in code and theory starting at your level.

Expert instructors, some of whom have been on the staff for the past 18 years are the same. Only the location has been changed. Close association with fellow amateurs offers an opportunity for Saturation Learning that has been very successful since its conception.

Novices upgrade to General, Techs to General & Advanced, and Advanced become Extras. Golf privileges, canoeing on the New River & many other recreation activities are offered. Make your vacation a "Vacation with a Purpose" and upgrade your license at a beautiful school in the cool mountains of Virginia.

Formerly Glade Valley School Radio Session

C. L. PETERS, K4DNJ, Director
 Oak Hill Academy Amateur Radio Session
 Mouth of Wilson, Virginia 24363

Name _____ Call _____
 Address _____
 City/State/Zip _____

YOU'VE GOT THE WORLD AT YOUR FINGERTIPS

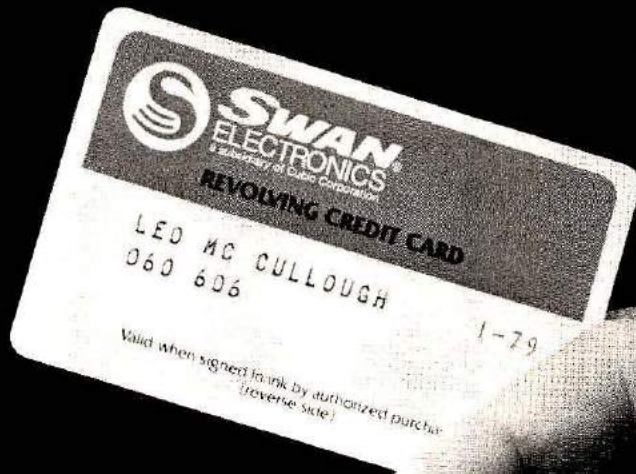

...WITH A SWAN CREDIT CARD.

Why put off until tomorrow the gear you're itching for today? A Swan Credit Card puts the world in the palm of your hand. Gets you up and running sooner: no more "saving-up" delays...no more loading up your bank charge cards.

Use Swan Revolving Credit to finance any kind of equipment from Swan's broad line of amateur radio products: from big-ticket transceivers to meters...

from antennas to accessories.

Use the Swan Credit Card by phone, by mail, or in person. At any Swan dealer, or for any factory-direct order. Once you're approved for Swan revolving credit service, just follow our easy charge procedures...and you're in business!

You can pick up full details and application forms from a Swan dealer, or send us the coupon today.

Please rush me (_____) Swan Revolving Credit Service Application forms.

Name _____

Address _____

City _____ State _____ Zip _____

 **SWAN**
ELECTRONICS
a subsidiary of Cubic Corporation

305 Airport Road, Oceanside, Calif. 92054

the famous
HAM·KEY™

TM Trade-Mark

The keys that are easy
to put your fingers on!



JUST DIAL
1-800-325-3636
TOLL FREE

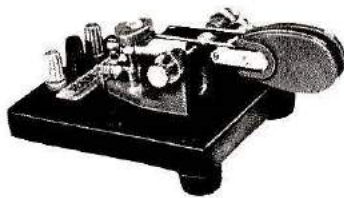

Model HK-1

- Dual-lever squeeze paddle
- Use with HK-5 or any electronic keyer
- Heavy base with non-slip rubber feet
- Paddles reversible for wide- or close-finger spacing

\$29⁹⁵

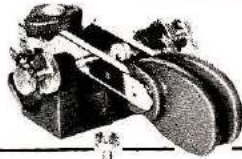

Model HK-2

- Same as HK-1 less base for incorporation in own keyer

\$19⁹⁵

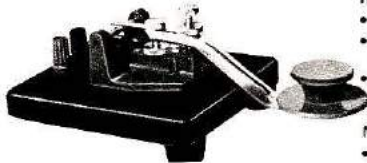

Model HK-3

- Deluxe straight key
- Heavy base — no need to attach to desk
- Velvet smooth action

\$16⁹⁵

Model HK-3A

- Same as above less base \$9.95

Navy type knob, only \$2.75

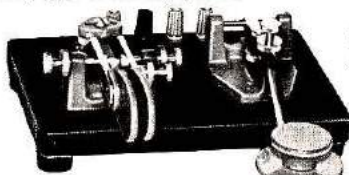

Model HK-4

- Combination of HK-1 and HK-3 on same base

\$44⁹⁵

- Base only with rubber feet \$12.00

Terminals, red or black, \$.75 each



NEW AND IMPROVED

Model HK-5A Electronic Keyer

- New Cabinet Colored-Keyed to Match most modern radio equipment
- Iambic Circuit for squeeze keying
- Self-completing dots and dashes
- Dot memory
- Battery operated with provision for external power
- Built-in side-tone monitor
- Grid block or direct keying

\$69⁹⁵

Same day shipment... PREPAID



We welcome the use of your



HAM RADIO CENTER

8340-42 Olive Blvd • P.O. Box 28271 • St. Louis, MO 63132

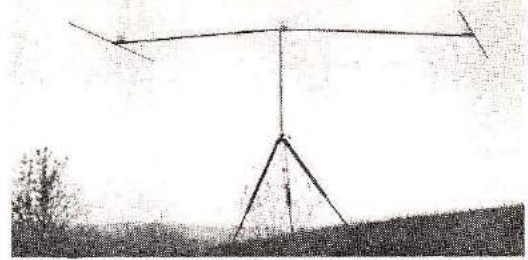

!! JUST IN TIME FOR FIELD-DAY !!

The **HF BANTAM DIPOLE** is a truly portable all-band miniature dipole complete with its own carrying case and mast/hardware to mount on a camera tripod (3/8" x 24 adaptor available). High performance is obtained on 80-10 meters at its normal 13 foot length or the same antenna may be shortened to 7 feet for 75-10 meter coverage. Polarization is quickly interchangeable from horizontal to vertical. No ground system necessary. The **BANTAM DIPOLE** is ideal for camping, traveling, mountain-topping, apartment living, or if you're stuck with building code restrictions. Construction is of high quality 6061-T6 aluminum and stainless steel hardware. 30-day money back guarantee.



\$59⁹⁵

plus U.P.S. shipping

LAUREL PLAZA — RTE. 198
LAUREL, MD 20810
301-792-0600

Send S.A.E. for spec sheet
U.S. patent pending
Dealer inquiries invited

DRAKE • ICOM • TEN-TEC • TEMPO • WILSON

The Lightweight Champ.

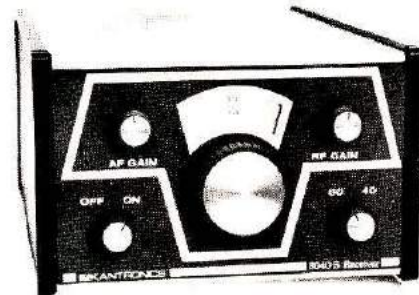

only
\$79.95

Kantronics 8040-B Receiver

The **8040-B** is a versatile CW receiver at a modest price! This **battery-powered** unit makes a great camping and vacationing rig.

Prospective hams can **copy real QSOs** with a reasonable investment. Watch for our **companion transmitter**, available soon!

Coverage runs from 3.650 to 3.760 MHz, and 7.050 to 7.150 MHz. **Write us for more details!**

KANTRONICS
The Lightweight Champs.

Telephone 913-842-7745
Lawrence, Kansas 66044

1202 East 23rd St

ANTENNA PANIC

NOT IF YOU SHOP AT WHITEHOUSE FOR CUSHCRAFT

VERTICALS

- EASY TO INSTALL
- INEXPENSIVE
- SIMPLE TO TUNE
- PLEASING TO LOOK AT
- NO CLIMBING NECESSARY
- WORK DX QUICKLY

80-10 Meter ATV5
Regularly \$109.95
Now \$99.95

40-10 Meter ATV-4
Regularly \$89.95
Now \$79.95

20-10 Meter ATV3
Regularly \$49.95
Now \$44.95

WORLD'S MOST POPULAR ANTENNA

Ringo Rangers

Save Reg. \$36.95

NOW
\$32.95
Delivered.



OMNIDIRECTIONAL
GAIN
FIXED STATION
ANTENNAS
FOR
MAXIMUM
PERFORMANCE
AND
VALUE

ARX2
137-160 MHz
ARX220
220-225 MHz
ARX450
435-450 MHz



- ✓ Delivery to your door
- ✓ We pay UPS shipping
- ✓ No sales tax
- ✓ No parking or driving hassle
- ✓ Immediate shipment
- ✓ Pay next month with VISA or MasterCharge
- ✓ Call for fastest service

603-673-6290
WHITEHOUSE

OSCAR ANTENNAS

A144-10T	145 MHz 10 El. Twist	\$59.95
A432-20T	430-436 MHz 20 El. Twist	\$54.95
A14T-MB	Twist Boom & Bracket	\$17.95

Total List Price \$132.85

OUR PRICE \$119.50

HR Horizons Special ATB-34

4 Elements • 3 Bands • Superb Performance • Plus coax switch — B&W 595 — 6 Antennas • Automatic Grounding • Top Quality

Regularly \$279 value

Now \$219

2 METER FUN

GET MORE ENJOYMENT FROM YOUR RIG
SSB — CW — DX

	List	Our Price
20 El. DX Array DX120	\$47.95	\$42.95
A147-4 146-148 MHz 4 El. Yagi	\$22.95	\$20.65
A147-11 146-148 MHz 11 El. Yagi	\$34.95	\$31.45
A147-22 146-148 MHz 22 El. Yagi	\$99.95	\$89.95
AFM-4D 144-148 MHz Four Pole	\$64.95	\$58.45
A144-10T 145 MHz 10 El. Twist	\$59.95	\$53.95
A144-20T 145 MHz 20 El. Twist	\$59.95	\$53.95
A147-20T 146 & 147 MHz 20 El. Twist	\$59.95	\$53.95

For Parts or Antennas

G.R.  WHITEHOUSE & CO.
15 Newbury Drive, Amherst, N. H. 03031

Send for NEW 28-page Catalog

HRH LOCATOR

TO HELP YOU FIND YOUR LOCAL AMATEUR RADIO DEALER

Alabama

LONG'S ELECTRONICS
2808 7TH AVENUE SOUTH
BIRMINGHAM, AL 35202
800-633-3410
Call Us Toll-Free
To Place Your Order.

Arizona

POWER COMMUNICATIONS
6012 N. 27 AVENUE
PHOENIX, AZ 85017
602-242-6030
Arizona's #1 "Ham" Store,
Kenwood, Drake, Icom & more.

California

C & A ELECTRONIC ENTERPRISES
2529 EAST CARSON STREET
P. O. BOX 5232
CARSON, CA 90745
213-834-5868
Not the biggest, but the best —
since 1962.

TOWER ELECTRONICS CORP.
24001 ALICIA PARKWAY
MISSION VIEJO, CA 92675
714-768-8900
Authorized Yaesu Sales & Service.
Mail Orders A Specialty.

Connecticut

ARCOMM ELECTRONICS
2865 MAIN STREET
BRIDGEPORT, CT 06606
203-335-9850
Featuring Ten-Tec and DenTron.

AUDIOTRONICS, INC.
18 ISAAC STREET
NORWALK, CT 06850
203-838-4877
The northeast's fastest growing ham
department. Dedicated to service.
Kenwood dealer.

Delaware

**AMATEUR AND ADVANCED
COMMUNICATIONS**
3208 CONCORD PIKE (RT. 202)
WILMINGTON, DE 19803
302-478-2757
Delaware's Fastest Growing
Ham Dealer.

Florida

LAFAYETTE RADIO ELECTRONICS
(Assoc. Store)
1811 N. HIGHWAY 17-92
MAITLAND, FL 32751
305-831-2271
The Electronics Emporium

RAY'S AMATEUR RADIO
1590 US HWY. 90 SOUTH
CLEARWATER, FL 33516
813-535-1416
West Coast's only dealer: Drake,
ICOM, Cushcraft, Hustler.

Illinois

ERICKSON COMMUNICATIONS, INC.
5935 NORTH MILWAUKEE AVE.
CHICAGO, IL 60646
312-631-5181
Hours 9:30-5:30 Mon., Tues., Wed.,
Fri.; 9:30-9:00 Thurs.; 9:00-3:00 Sat.

SPECTRONICS, INC.
1009 GARFIELD STREET
OAK PARK, IL 60304
312-848-6777
Chicagoland's Amateur Radio
leader.

Indiana

HOOSIER ELECTRONICS, INC.
P. O. BOX 2001
(43B Meadows Shopping Center)
TERRE HAUTE, IN 47802
812-238-1456
Communications Headquarters
of the U.S.A.

Iowa

BOB SMITH ELECTRONICS
RFD #3, HIGHWAY 169 & 7
FORT DODGE, IA 50501
515-576-3886
For an EZ Deal on New
or Used Equipment.

Kansas

ASSOCIATED RADIO
8012 CONSER, P. O. B. 4327
OVERLAND PARK, KS 66204
913-381-5901
Amateur Radio's top dealer.
Buy — Sell — Trade.

Maryland

THE COMM CENTER, INC.
LAUREL PLAZA - RTE. 198
LAUREL, MD 20810
301-792-0600
Drake, Hy-Gain, Mosley, Tempo,
Ten-Tec, Wilson.

Massachusetts

TUFTS ELECTRONICS
209 MYSTIC AVENUE
MEDFORD, MA 02155
617-395-8280
New England's Friendliest
Ham Store.

Michigan

RSE HAM SHACK
1207 W. 14 MILE
CLAWSON, MI 48017
313-435-5660
Complete Amateur Supplies.

Minnesota

PAL ELECTRONICS INC.
3452 FREMONT AVE. NO.
MINNEAPOLIS, MN 55412
612-521-4662
The Midwest's fastest growing
ham dealer.

Nebraska

COMMUNICATIONS CENTER, INC.
443 N. 48 STREET
LINCOLN, NE 68504
800-228-4097
Kenwood, Yaesu, Drake and More
at Discount Prices.

New Hampshire

EVANS RADIO, INC.
BOX 893, RT. 3A BOW JUNCTION
CONCORD, NH 03301
603-224-9961
Icom, DenTron & Yaesu dealer.
We service what we sell.

HRH LOCATOR

Continued

New Jersey

ATKINSON & SMITH, INC.
17 LEWIS STREET
EATONTOWN, NJ 07724
201-542-2447
Ham supplies since "55".

RADIOS UNLIMITED
1760 EASTON AVENUE
SOMERSET, NJ 08873
201-469-4599
New Jersey's newest, complete,
Amateur Radio center.

New York

ADIRONDACK RADIO SUPPLY, INC.
185 WEST MAIN STREET
AMSTERDAM, NY 12010
518-842-8350
Yaesu and Kenwood dealer
for the Northeast.

HAM-BONE RADIO
(Div. Stereo Repair Shop)
3206 ERIE BOULEVARD, EAST
SYRACUSE, NY 13214
315-446-2266
We Deal, We Trade,
We Discount, We Please!

HARRISON RADIO CORP.
20 SMITH STREET
FARMINGDALE, NY 11735
516-293-7990
"Ham Headquarters USA®"
since 1925.
Call toll free 800-645-9187.

RADIO WORLD
ONEIDA COUNTY AIRPORT
TERMINAL BLDG.
ORISKANY, NY 13424
315-337-2622
New & Used Ham Equipment. See
Warren K2IXN or Bob WA2MSH

Ohio

AMATEUR RADIO
SALES & SERVICE INC.
2187 E. LIVINGSTON AVE.
COLUMBUS, OH 43209
614-236-1625
Antennas for all services.

UNIVERSAL AMATEUR RADIO
1280 AIDA DRIVE
REYNOLDSBURG (Columbus)
OH 43068
614-866-HAMS
Drake, Yaesu, Ten-Tec, KDK, Wilson.
All Lines In Stock.

Pennsylvania

ARTCO ELECTRONICS
302 WYOMING AVENUE
KINGSTON, PA 18704
717-288-8585
The largest variety of semiconduc-
tors in Northeastern Pennsylvania

ELECTRONIC EXCHANGE
136 N. MAIN STREET
SOUDERTON, PA 18964
215-723-1200
Personal attention to Newcomer
and Oldtimer.

HAMTRONICS, DIV. OF
TREVOSE ELECT.
4033 BROWNSVILLE RD.
TREVOSE, PA 19047
215-357-1400
Same Location for 25 years.

Texas

HARDIN ELECTRONICS
5635 EAST ROSEDALE
FORT WORTH, TX 76112
817-461-9761
You Bet Fort Worth
Has A Ham Store!

Dealers-

You should be here too!
Contact HORIZONS today
for complete details.

(TOLL FREE)

800-258-5353

CHICAGO

Area Amateurs

Know

ERICKSON

Can Provide
All Their
Amateur Radio
needs!

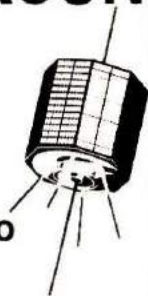

**WB9JKT, WB9ZRA
and WN9ANF**
serving you with...

- Ameco • ASP • Atlas
- Belden • Bird • CDE • CIR
- CES • Collins • Cushcraft
- Dentron • Drake • HAL
- Hy-Gain • Icom • KLM
- Kenwood • Larsen • MFJ
- Midland • Mosley • NPC
- Newtronics • Nye
- Regency • Shure • Swan
- Standard • TPL • Tempo
- Ten-Tec • Wilson • Yaesu



Hours: 9:30-5:30 Mon., Tues., Wed. & Fri.
9:30-9:00 Thurs.
9:00-3:00 Sat.



ERICKSON
COMMUNICATIONS
5935 N. Milwaukee Ave.
Chicago, IL 60646
(312) 631-5181

Just The Best.

Larsen Kūlrod Antennas



NMO 150 · 220 · 440 · K	\$35.45
ANTENNA ONLY	\$25.55
NLA 150 · 220 · 440 · K	\$35.45
ANTENNA ONLY	\$25.55
LM 150 · 220 · 440 · K	\$35.45
ANTENNA ONLY	\$25.55
JM 150 · 220 · 440 · K	\$35.45
ANTENNA ONLY	\$25.55

ORDER BY MOUNT, FREQ. ADD K FOR COMPLETE ANTENNA.

CW ELECTRONIC SALES CO.
 1401 BLAKE ST. DENVER, CO. 80202
 (303)-893-5525

Keep your rigs newer, longer with Cover Craft Dust Covers



- Protects your equipment and your investment.
- Handsome appearance precise fit.
- Made of durable vinyl — machine stitched.

Cover Craft Dust Covers are custom designed for hundreds of different models.

If you've invested hard earned cash in ham gear, you want it to last long and bring a good trade-in price. Our covers can help. They reduce dust build-up on surfaces and vital components which can degrade performance and destroy value. Repairs are reduced, useful life is extended. You save!

See your dealer or send S.A.S.E. for list of over 100 covers and complete order information.

COVER CRAFT
 P.O. BOX 555, AMHERST, NH 03031
 Telephone (603) 673-8592

New! Better than a pet rock!



only
\$69.95

Kantronics Freedom VFO

With almost 350,000 licensed amateurs on the air, variable frequency operation isn't a luxury, it's a necessity.

If you've tried to operate a rock-bound transmitter on the HF bands today, you know there must be a better way. There is.

The **Kantronics Freedom VFO** will drive the high impedance oscillator tubes of transmitters like the HW-16, DX-60, DX-35 and other "oldie-but-goodies."

The **Freedom VFO** sets you free to roam from 3.650 to 3.750 MHz and 7.000 to 7.200 MHz.

Give your pet rocks to a trusted friend and order a **Freedom VFO** today. Or write us for information and a list of authorized **Kantronics** dealers.

Order now!

KANTRONICS
The Lightweight Champs.

1202 East 23rd St
Lawrence Kansas 66044

Telephone 913 842 7745

DSI

DSI INSTRUMENTS INC.

Be the one who's on FREQUENCY!!

With your *DSI Counter*. . . save the shop cost of tweaking xtals. . . know your frequency. . . from 160 meters through 450 MHz. Now *DSI* offers *the most* counter for your dollar. Latest state-of-the-art technology. . . *DSI* advanced LSI design far exceeds outdated TTL. Go with the leader . . . buy a *DSI FREQUENCY* counter and **SAVE TIME & MONEY!!**



MODEL 3500 \$139.95
Includes TCXO ± 1 PPM



MODEL 3600A \$189.95
Includes oven timebase $\pm .5$ PPM

- **MADE IN USA**—Factory assembled—2 Hr. Burn-in Test & Calibration
- Built in 600MHz Prescaler with RF Preamp—Not an add-on
- 7 Large Bright— $\frac{1}{2}$ inch LED Readouts
- Resolution—10Hz Non-Prescaled 100Hz Prescaled, .1 sec Gate
- **ACCURACY** ± 1 PPM \pm one count ± 1 PPM per six months from 65°F to 85°F
- **SENSITIVITY**—50 mVrms 150 to 250MHz 100mV @ 450MHz
- Gate Time Light—Automatic Decimal Point Placement
- Automatic Leading Zero Blanking When No Input Signal is Present
- No RF Connection Required with Supplied Antenna
- **S0239** Connectors Supplied for Direct Probe Input
- AC or DC Operation—115 VAC 50/60 Hz 8.5V to 13.5 VDC @ 300ma
- Comprehensive **Owners Manual** with Complete Schematics
- Size 2 7/8" H x 8" W x 5" Deep

- **MADE IN USA**—Factory Assembled—8 Hr. Burn-in Test & Calibration
- Built in 600MHz Prescaler & RF Preamp—Not and add-on
- 8 Large Bright— $\frac{1}{2}$ inch LED Readouts
- Two Selectable Gate Times—.1 sec. & .1 sec. 100Hz to 600MHz
- **Accuracy** $\pm .5$ PPM \pm one count ± 1 PPM per six months from 50°F to 100°F
- **Sensitivity**—10mVrms 150 to 250MHz 50mV @ 450MHz
- Gate-time & Oven Light—Automatic Decimal Point Placement
- Automatic Leading Zero Blanking—When No Input Signal is present
- No Direct RF Connection Required—With Supplied Antenna
- **S0239** Hz input 50Hz to 75MHz—**S0239** Low ± 10 MHz to 600MHz
- AC or DC Operation 115 VAC 50/60 Hz, 8.5V to 13.5VDC @ 400ma
- 50Hz to 600MHz Sine or Square Wave Input
- **FCC Certifiable**—Designed for the Professional Service Technician
- Resolution 1 Hz Non-Prescaled 10Hz Prescaled @ .1 sec. Gate

PERFORMANCE YOU CAN COUNT ON

1. **PPM OVER TEMPERATURE RANGE** With a spec. of ± 1 PPM over 50°F to 100°F, your worst error over temperature would be ± 145 Hz, when measuring 145 MHz. This is the most important specification for any frequency counter because temperature variation of only a few degrees could have a drastic effect on the accuracy of your counter.
2. **PPM LONG TERM** With a spec. of ± 1 PPM per six months, your additional error would only be 145Hz when measuring 145MHz, six months after calibration.
3. **LAST DIGIT ERROR** All counters have an error in the last digit, if the last digit should read a 5 it could be a 4, 5 or 6. When you have 10 Hz resolution (last digit represents tens of Hz) your additional error will be ± 10 Hz.
4. **TOTAL ERROR** The overall error of a counter is the sum of the error due to temperature variation, last digit error and long term error. A simple ± 1 PPM spec. with no mention of temperature or ageing could conceal a much larger overall inaccuracy. Example: ± 1 PPM at 75°F is ± 145 Hz at 145MHz, but the same counter might be in error 1 KHz or more at only 85°F.

VISIT US AT YOUR NEXT HAMVENTION

Dayton, Ohio 28, 29, 30 April • Baton Rouge, LA 5, 6, 7 May • Birmingham, ALA 13, 14 May • L.E.R.C., L.A., CA 20, 21 May

See Your Local Dealer

OR

Call Toll Free (800) 854-2049 *DSI Instruments Inc.*

• NO EXTRA COSTS •

FREE Shipping anywhere in U.S.A.

Name _____

Address _____

City _____ State _____ Zip Code _____

Please send more information on your full line of instruments

Check Enclosed C.O.D.

Please charge my: Bank Americard Visa Master Charge AE

Card # _____ Exp. Date _____

Signature _____

.....
 : Strongest warranty in the counter field. :
 : **ONE YEAR** Parts and Labor :
 : Satisfaction Guaranteed. :
 :

Dennis Romack WA60Y1
VP Marketing, DSI

California Residents add 6% State Sales Tax and Call Collect (714) 565-8402

7914 Ronson Road No. G, San Diego, CA 92111

This is easy- anyone can solder- WITH KESTER SOLDER

**KESTER
SOLDER**

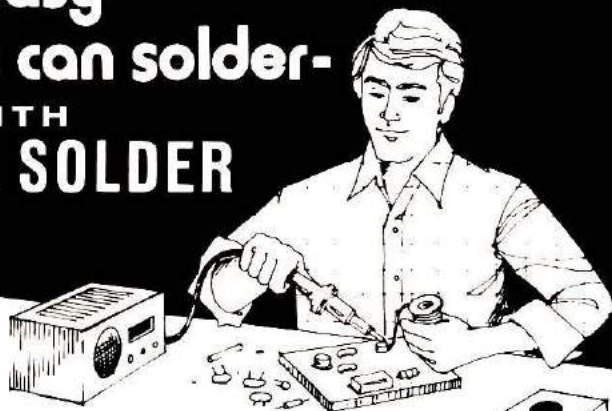

Handymen! Hobbyists! DO-IT-YOURSELFERS!

Let Kester Solder aid you in your home repairs or hobbies. For that household item that needs repairing — a radio, TV, model train, jewelry, appliances, minor electrical repairs, plumbing, etc. — Save money — repair it yourself. Soldering with Kester is a simple, inexpensive way to permanently join two metals.

When you Solder go "First Class" — use Kester Solder.

For valuable soldering information send self-addressed stamped envelope to Kester for a FREE Copy of "Soldering Simplified".



KESTER SOLDER

Litton 4201 WRIGHTWOOD AVENUE/CHICAGO, ILLINOIS 60639

The only REALLY NEW 80-10 meter vertical design in 20 years!

Completely automatic bandswitching 80 through 10m
[160-10m with optional TBR-160 add-on unit.]

Low V.S.W.R. over entire 40, 20, 15, & 10m bands plus ANY 60-
100 KHZ segment of 80/75m. NO ANTENNA TUNER NEEDED!
ENTIRE 26 ft. length active on 80, 40, 20, & 10m with full 1/4
wave resonance on 15m for greater bandwidth & superior DX
performance. Ground, roof, or tower mount—no guys needed.

HIGHEST QUALITY CONSTRUCTION & WORKMANSHIP THROUGH-
OUT. HIGH STRENGTH ALUMINUM ALLOY AND FIBERGLASS DE-
SIGN. Complete with 1-1/8 in. O.D. tubular mounting post, RG-
11/U matching line, and connector for PL-259. Use any length
of 50-52Ω coax.

V.S.W.R. at resonance: 1.5:1 or less; all bands.

Power rating: Legal limit SSB/CW 40-10m; 1200 W.
P.E.P./500W. CW on 80/75m.

AT YOUR DEALER OR DIRECTLY FROM



**BUTTERNUT
ELECTRONICS CO.**

ROUTE ONE DEPT. 3
LAKE CRYSTAL, MN. 56055
PHONE 507-947-3126

OTHER MODELS, TOO! FREE INFORMATION.



15m trap

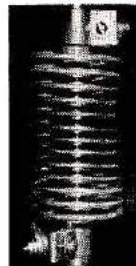

80m coil



Base

Model HF5V-II \$74.50 PPD. IN CONT. USA (BY UPS).
MN. RESIDENTS ADD TAX.

For VHF MONTH and FIELD DAY

Try "HAM"BUERGER with
RELISH!



These Super June Specials are
Going Fast — So Call or Write NOW!
REMEMBER: We pay shipping charges on
all prepaid orders!

**"HAM"BUERGER
INC.**

ELECTRONIC EQUIPMENT DISTRIBUTOR
2 mi. south of PA Turnpike Exit 27 on Route 611
Serving You Continuously Since 1956

WA3ZID-Bob WB3GXP-Dave
WB3BPJ-Bob WB3HOF-Jeff

68 NORTH YORK ROAD
WILLOW GROVE, PA 19090
(215) 659-5900

Store Hours —
Mon., Wed., Fri. — 9:30-9:00
Tues., Thur., Sat. — 9:30-5:30



ALL BAND TRAP ANTENNAS!



ALL 5 BAND OPERATION - ONLY ONE NEAT SMALL ANTENNA. FOR CONGESTED HOUSING AND APARTMENT DWELLERS! LIGHT, NEAT - ALMOST INVISIBLE!

FOR ALL MAKES AMATEUR HF TRANSMITTERS - TRANSRECEIVERS - GUARANTEED FOR 2,000 WATTS PEP POWER. FOR NOVICE AND ALL CLASS AMATEURS!

COMPLETE Ready to put up with 30 ft. Dacron end support cords! Wt. 3 lbs., 1"X5" MOLDED RESONANT TRAPS - just switch your transmitter to desired band for EXCELLENT PERFORMANCE! NO TUNERS OR BALUNS NEEDED! CAN BE USED IN ATTICS, TOPS OF BUILDINGS, INVERTED Vs IN MINIMUM SPACE. NO CENTER SUPPORT NEEDED, NO HAYWIRE HOUSE APPEARANCE COMPLETELY ASSEMBLED. No tuning - cutting - soldering - measuring - JUST HANG IT, AND USE IT! SWR IS 1.2 AT RESONANCE THOUSANDS IN USE - EASIEST INSTALLATION!

80-40-20-15-10 meter bands---102ft. with 90 ft. RG58U coax - connector -Model 998BU... \$49.95
40-20-15-10 meter bands---54 ft. with 90 ft. RG58U coax - connector -Model 1001BU... \$48.95
20-15-10 meter bands---26ft. with 90 ft. RG58U coax - connector -Model 1007BU... \$47.95

Send only \$5.00 (cash, ck., mo.) and pay postman balance plus COD postage OR SEND FULL PRICE FOR POST PAID DEL. IN USA (Canada is \$5.00 extra) or order by MAIL OR PHONE with BankAmericard VISA - MASTER CHARGE - OR AM EXP. Give number and ex. date. Ph 1-308-236-5333 week days. We ship in 2-3 days. INFLATION? PRICES MAY INCREASE - SAVE - ORDER NOW! INFO. AVAILABLE FROM. WESTERN ELECTRONICS Dept. AR-6 Kearney, Nebraska, 68847

TROUBLE FREE TOUCH - TONE ENCODER

Pat. Pend.

POSITIVE TOUCH (KEYS DEPRESS) • MOBILE • HANDHELD
POSITIVE MOUNT • NO POTTED PARTS (SERVICEABLE)
MIL. SPEC. COMPONENTS • NO RFI • SELF CONTAINED
XTAL CONTROLLED • LEVEL ADJUSTMENT FROM FRONT

Supplied with: Instructions, schematic, template, hardware. Operating Voltage: 4.5 - 80V. PP-1A, designed for Standard Communications Handhelds.
(California residents add 6% sales tax.)
PP-1=\$55.00, PP-2=\$58.00, PP-1A=\$58.00
PP-1M=\$55.00, PP-2M=\$58.00, M series-Mobile
PP-1K=\$66.00, PP-2K=\$69.00.
K-series = Self Contained Delay Relay
LETTERING OF UNITS OPTIONAL

Available at: Ham Radio Center (800) 325-3636
Denver Colo., CW Electronics (303) 893-5525
Medford, MA, Tufts (617) 395-8280
Los Angeles, Henry Radio (213) 272-0861
New York City, Harrison (800) 645-9187

Pipo Communications

P.O. Box 3435, Dept. B1
Hollywood, California 90028
213/852 1515

DON'T KEEP A GOOD ANTENNA DOWN

...put it up instead. Install the World-Record Breaking antenna that won W6TYP the QRP ARC 1,000,000 miles/watt award.

THE JOYSTICK VFA

(Variable freq. ant) gives low angle, omnidirectional, harmonic free radiation on all bands 160 thru 10 (+MARS and receive on all BC & SW).

1000's of glowing reports in our files of the VFA in use, often in poor QTH and/or under QRP, contests, etc.,

SYSTEM 'A' \$84.00

250W P.E.P. &/or Receiving only

SYSTEM 'J' \$110.00

500W P.E.P. &/or Improved Q Factor Receive

Air mail cost included (Each system 3 sections easily assembled to make unit 7' 6" long. Matching ATU). Not only will you save space but you get better value per \$ if buying direct UK manuf. Rush your order -Mastercharge, Visa, BankAmericard, or check, or ask for brochure:-

PARTRIDGE (HH) ELECTRONICS LTD.

Broadstairs, Kent, England
Tel: 0843 62535

G3CED

G3VFA

TERMALINE OR THRULINE ...

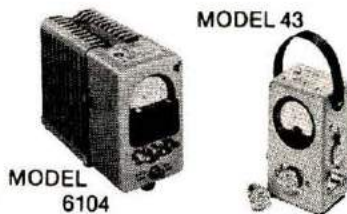

... MADISON'S BIRD IS ...

TOP OF THE LINE

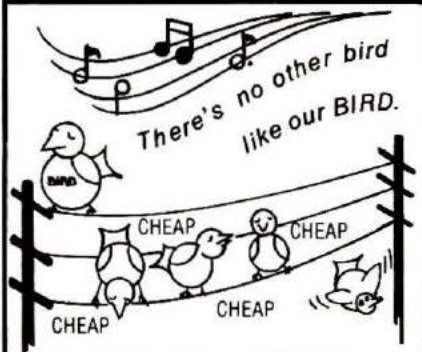

MADISON ELECTRONICS SUPPLY, INC.

1508 MCKINNEY HOUSTON, TEXAS 77002
713/658-0268 Nites 713/497-5683

Taylor 2 Meter Antennas Perform

Taylor Radio's two famous high performers - 2M64MM Magnet Mount and 2M64GP-64 Wave Length Base Station Antennas-they both really Get Out for maximum performance.

2M64MM - magnet mounted for quick setup from vehicle to vehicle. Super Grip with a 80# ceramic magnet will stay with you up to 100 miles per hour. Permanent magnet will never lose its grip. Comes completely pretuned and assembled with 17 feet of R58A/U coax and connector 100 watt rating.

2M64GP-.64 wave length ground plane - optimum performance at a low cost; 3.8 gain over a ¼ wave. Vertically polarized low angle radiation perfect for getting into that far away repeater. General purpose application mounts on any pipe up to 1¼". (1½ O. D.) Phasing and match coil sealed against moisture and operates at DC ground for low noise and protection against lightning.

Look to Taylor for high performance in 2 meter antennas. Get yours today and Really Get Out.

For additional information, see your nearest dealer or write to us.



2M64MM Magnet Mount



2M64GP .64 wave length

TAYLOR RADIO COMPANY, INC.
3305 Commerce Drive-North Leg Industrial Park
Augusta, Georgia 30909-Phone 404-736-3336

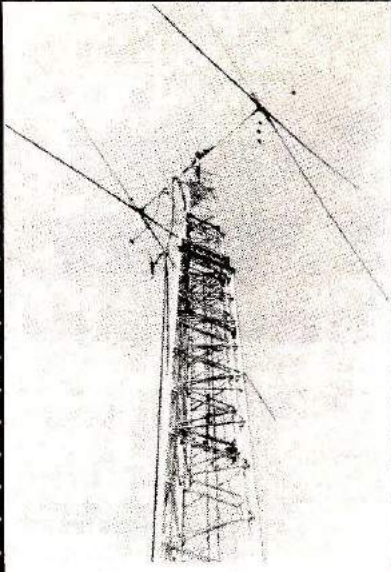

**The popular
CUA 64-12
by Heights**

Light,
permanently
beautiful
ALUMINUM
towers

**THE MOST IMPORTANT
FEATURE OF
YOUR ANTENNA
IS PUTTING
IT UP WHERE
IT CAN DO
WHAT YOU EXPECT.
RELIABLE DX —
SIGNALS EARLIEST IN
AND LAST OUT.**

ALUMINUM
Complete Telescoping
and Fold-Over
Series available
Self-Supporting
Easy to Assemble
and Erect
All towers mounted
on hinged bases

And now, with motorized options, you can crank it up or down, or fold it over, from the operating position in the house.

Write for 12 page brochure giving dozens of combinations of height, weight and wind load.

ALSO TOWERS FOR WINDMILLS
HEIGHTS
MANUFACTURING CO.
In Almont Heights Industrial Park
Almont, Michigan 48003

**The Ultimate
IAMBIC
PADDLE...**

- Full range of adjustment in tension and contact spacing
- Self-adjusting nylon and brass needle bearings
- Solid silver contact points
- Precision-machined, chrome plated brass frames
- Heavy steel base has black, textured finish (chrome plated base optional)
- Non-skid feet



Write for literature

Available at selected dealers or send \$39.95 (\$49.95 for chrome model) plus \$2.00 shipping and handling. Money-back guarantee.

BENCHER, INC.
Dept. A, 333 W. Lake St., Chicago, IL 60606
(312) 263-1808

Rush
ELECTRONICS, INC.

- MAJOR BRANDS
YAESU
TEMPO
KDK
DENTRON
CUSHCRAFT
LARSEN
- OTHERS -

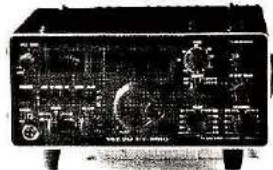

YAESU
FT 301-D
\$935.00
Retail

ELECTRONIC DEPT. STORE
LAFAYETTE RADIO ELECTRONICS ASSOCIATE STORE
COMPLETE QUALITY ELECTRONIC EQUIPMENT

WRITE FOR SPECIAL QUOTE
1315 BLUFF CITY HWY.
BRISTOL, TN. 37620

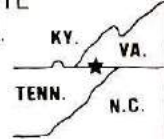

**CALL BOB BROWN
WA4HAA
FOR YOUR
SPECIAL PRICE**
615-764-0831
615-968-5343

VISIT OUR BOOTH JUNE 3-4 ATLANTA, GA. HAMFEST

EEB STOCKS



All Models & elements

- We pay AIR FREIGHT on all prepaid or credit card orders.
- Call our order desk collect: 703-938-3511.
- We stock in depth: Bird 43 Thru-line, All Table 1 elements, CC-1 & EC-1 cases.

MODEL 43 \$120.00

AUTHORIZED BIRD DISTRIBUTOR
DEALER INQUIRIES INVITED.



IN STOCK

IC-245/SSB	\$599
IC-211	\$749
IC-701	Write
plus others	



IN STOCK

WE-800	\$459
MARK II HANDHELD	\$219
MARK IV HANDHELD	\$249

and much, much more

All Prepaid & Charge Orders
Shipped NO CHARGE in U.S.
Sales tax 4% to Virginia residents only.

ELECTRONIC EQUIPMENT BANK, INC.
516H Mill St., Vienna, VA 22180
Call COLLECT 703-938-3511



Anytime you have a question about your Ham Radio HORIZONS subscription, please include a mailing label to insure prompt service on your inquiry.

CHANGE OF ADDRESS

If you're going to move, please let us know four to six weeks before doing so. Or, if there is anything wrong with your current mailing label, please let us know on this form also. Simply affix your present label here, and carefully print the updated information below.

PLEASE HELP US TO SERVE YOU BETTER



Greenville, NH 03048

Name _____ Call _____
Address _____
City _____
State _____ Zip _____

AFFIX
LABEL
HERE



RATES Regular classified is available at 50¢ per word. Display classified (1 inch deep x 2 1/4 inches wide) is \$50, or at the 12x rate is \$35. All Ad Scan payable in advance. No cash discounts or agency commissions allowed.

HAMFESTS Sponsored by non-profit organizations receive one free regular classified ad (subject to our editing). Repeat insertions of hamfest ads pay the standard rate.

COPY No special layout or arrangements available. Material should be typewritten or clearly printed (not all capitals) and must include full name and address. We reserve the right to reject unsuitable copy. *HORIZONS* cannot check each advertiser and thus cannot be held responsible for claims made. Liability for correctness of material limited to corrected ad in next available issue.

DEADLINE 15th of third preceding month.

SEND MATERIAL TO: Ad Scan, Ham Radio Horizons, Greenville, N. H. 03048.

21ST ANNUAL ABC HAMFEST Sponsored by the Six Meter Club of Chicago, Sunday, June 11, 1978, at Santa Fe Park, Willow Springs, Illinois, 91st and Wolf Road, Southwest of Chicago. Advance registration \$1.50; \$2. at gate. Large swap row, picnic grounds, plenty of parking, refreshments, AFMARS meeting. Talk in on 146.94 FM or 37/97 WR9ABC (PL2A). Contact K9ZWV, 3420 So. 60th Court, Cicero, IL 60650.

TOROIDS 88 or 44 mH. Same day shipment. 5 for \$3.50 postpaid. Gull Electronics, 12690 Rt. 30, N. Huntingdon, PA 15642.

MOBILE IGNITION SHIELDING provides more range with no noise. Bonding strap sale less than 50¢ each. Literature. Estes Engineering, 930 Marine Drive, Port Angeles, Wash. 98362.

QSL's with class! Unbeatable quality, reasonable price. Samples, 50¢. QSL's Unlimited, Box 27553H, Atlanta, GA 30327.

DIRECTORY OF STATESIDE QSL MANAGERS. Computerized cross-reference listing. Updated weekly. Most accurate and comprehensive source available. \$1.00 with 24-cent business-size s.a.s.e. Gary Yarus, WB0MSZ, 921 N. Clay, St. Louis, Missouri 63122.

QSL CARDS 500/\$10. 400 illustrations, sample. Bowman Printing, Dept. HRH, 743 Harvard, St. Louis, MO 63130.

JUNE 4, 1978, STARVED ROCK RADIO CLUB HAMFEST, Bureau County Fairgrounds, Princeton, Illinois. Advance registrations \$1.50 if postmarked before May 25, after that \$2.00. Large S.A.S.E. please for registrations, map, information, etc. W9MKS/WR9AFG/SRRC, RFD #1 Box 171, Oglesby, Illinois 61348. (815) 667-4614.

OHIO: SANDUSKY COUNTY HAMFEST — Fleamarket June 11, 1978 — Held at Sandusky County Fairgrounds Fremont, Ohio. Free Tables, good food, Talk-in 31/91, 52/52 simplex. Donation \$1.00 at the gate. Further info contact Ken KuKay WD8NVF.

EASTERN CONNECTICUT/A.R.A. FOURTH ANNUAL GIANT FLEAMARKET, June 4th, Point Breeze Restaurant, Webster, Massachusetts. For more information call (203) 928-5930 or write K1VSC.

CODE PRACTICE OSCILLATOR! Your gateway to the exciting world of ham radio. Complete with key, speaker and assembled circuit board. All you need is a 9v battery to start developing your "fist." By K5YEF. At only \$8.99 you can't afford to put off ham radio any longer. Send today! Harding Electronics, P.O. Box 1627, Plano, TX 75074.

AWARD CERTIFICATES

Award for Public Service or Emergency Communications Award. Send 2.00 each, event, name and address. FREE Information. 49'er RADIO CLUB, Box 1400-HH, Downey, Calif. 90240.

ANNUAL TEXAS VHF-FM SOCIETY SUMMER CONVENTION, hosted by the Houston Echo Society, August 4, 5, 6, 1978 at the Galleria Plaza Hotel off Interstate Loop 610 at Westheimer Road. Microprocessors/Microcomputers, hidden transmitter hunt, OSCAR communications, VHF-FM activities. ARRL & FCC forums, open hospitality suite, ladies' activities, Astrodome-Astroworld tours for the kids, Exhibitors, and prizes. Saturday night banquet featuring Bill Tynan, W3XO, editor of QST's "World Above 50 MHz", as guest speaker. For information and reservations write FM Society Summer Convention, P.O. Box 717, Tomball, Texas 77375.

CALIFORNIA: THE SATELLITE AMATEUR RADIO CLUB will hold its annual Swap/Fun Fest and Santa Maria BBQ on Sunday, June 18. Join us for the best steak and biggest hamfest in the west. Fantastic prizes! Swap tables available. All you can eat dinner — \$6.00 adults; \$3.00 children under 12. Contact W2KVA/6 at (805) 925-0398, or write SWAPFEST, P.O. Box 2531, Orcutt, California 93454.

CODE PRACTICE OSCILLATORS, hand keys, electronics keyers, other products. Free catalog. Globalman Products, Box 246, El Toro, CA 92630. 714-533-4400.

"THE CADILLAC" of QSL's! — New! Samples: \$1.00 (Refundable) — MAC'S SHACK, Box #1171-G, Garland, Texas 75040.

SAVE \$\$\$. Build your own: LINEAR AMPLIFIERS, 50-100 watt solid state. FREQUENCY COUNTER, 300 MHz, 7 digit, crystal accuracy, portable/mobile, memory! BASE ANTENNA, omnidirectional! Omnidirectional! VOX-COMPRESSOR AND MORE! Construction plans \$3.00 each, 3 up/\$2.50 each. Specify desired band. PANAXIS, Box 5516-AS5, Walnut Creek, CA 94596.

QSLs — Top Quality — Samples 25¢. Includes rubber stamp info. Ebbert Graphics, Dept. 5H, Box 70, Westerville; Ohio 43081.

ENGRAVED NAMETAGS 1 1/2" x 2 1/2" — \$3.00. QTH added \$0.50. Door plates, key tags available. Black, blue, red, walnut with white letters. Other colors available. Tag-it Co., Box 2062, Indianapolis, IN 46206.

ROME HAM FAMILY DAY will be held on June 4, 1978. For information write Rome Radio Club, P.O. Box 721, Rome, NY 13440. (Dealer inquiries invited.)

NEW CONCEPT — Novice instructional package, theory tape & study material. Complete license study package, \$17.95. General study package, \$19.95. MARI, 1320 Canary Drive, West Columbia, SC 29169.

REPAIRS BY N2MB, NEW YORK AREA. First Class Commercial license, Amateur extra, in business 20 years — Radio Clinic, N2MB (formerly WA2BIT). 212-327-4952.

WASHINGTON STATE: FIRST ANNUAL 7-LAND QSO PARTY sponsored by NAS Whidbey Island A.R.C. from 1200Z July 1st to 2400Z July 2nd 1978 for single- and multi-operator, single transmitter stations. Object to work as many 7-land WVE stations as possible in 30 out of 36 hours. For more information, write Bill Gosney, WB7BFK, 4471 40th N.E. Street, Oak Harbor, Washington 98277.

VIRGINIA: "OLE VIRGINIA HAMS" A.R.C. Annual Manassas Hamfest, June 4th, at the Prince William County Fairgrounds on Route 234 one-half mile south of Manassas. Open 7 A.M. for tailgating, 8 A.M. for general admission. Admission \$3 (under 12 free). Tailgating \$2. Refreshments, YL program, Children's entertainment, FM Clinic, CW Proficiency, fantastic prizes. Indoor exhibit space for dealers. Camping & accommodations nearby. Contact Sam Lebowich, 9512 Sudley Manor Dr., Manassas, Virginia 22110. Talk-in on 37/97 or 84/24 and CB CH. 1.

Amateur TV Converter

Use your TV to see hams on TV
Varactor tuned 420-450 MHz Com-
plete with regulated AC supply. Guaranteed 2 years —
\$49.95 postpaid. Semi-kit — \$39.95

Spectrum Analyzer Kit (key parts, instructions) . . . \$23.95
Color, Dot/Bar Generator Kits from \$39.95

SEND FOR FREE CATALOG Dept. HH 1 BOX 393
science workshop BETHPAGE, N.Y. 11714

CODE PRACTICE CASSETTES. Proven method, best price. 0-5 wpm, 5-13 wpm, 13-15 wpm, 20-22 wpm, 25-30 wpm, 30-35 wpm. \$3. ea., 4/\$10.00. Amateur Radio Station belt buckles, Call engraved, \$10.00 each. Royal, Dept B, P.O. Box 2174, Sandusky, Ohio 44870.

ATTENTION CERTIFICATE HUNTERS. Free information on beautiful operating awards. SASE to HAROAA, P.O. Box 341, Hinckley, Ohio 44233.

NEW! IC KEYER

The World's Greatest
Sending Device

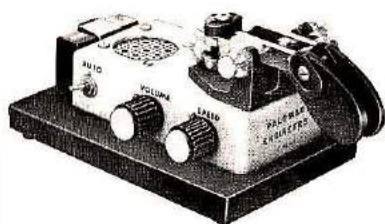

Adjustable to Any
Desired Speed

Now available from Palomar Engineers — the new Electronic IC KEYER. Highly prized by professional operators because it is **EASIER, QUICKER, and MORE ACCURATE.**

It transmits with amazing ease **CLEAR, CLEAN-CUT** signals at any desired speed. Saves the arm. Prevents cramp, and enables anyone to send with the skill of an expert.

▶ SPECIAL
RADIO MODEL ◀

Equipped with large specially constructed contact points. Keys any amateur transmitter with ease. Sends Manual, Semi-Automatic, Full Automatic, Dot Memory, Squeeze, and Iambic — **MORE FEATURES** than any other keyer. Has built-in sidetone, speaker, speed and volume controls, **BATTERY OPERATED**, heavy shielded die-cast metal case. **FULLY ADJUSTABLE** contact spacing and paddle tension. The perfect paddle touch will **AMAZE** you.

Every amateur and licensed operator should know how to send with the IC KEYER. **EASY TO LEARN.** Sent anywhere on receipt of price. Free brochure sent on request.

Send check or money order. IC KEYER \$97.50 in U.S. and Canada. IC KEYER LESS PADDLE and non-skid base \$67.50. Add \$3.00 shipping/handling. Add sales tax in California.

Fully guaranteed by the world's oldest manufacturer of electronic keys. **ORDER YOURS NOW!**

PALOMAR ENGINEERS

BOX 455, ESCONDIDO, CA 92025
Phone: (714) 747-3343

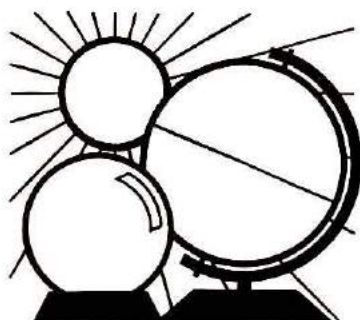

DX FORECASTER

Last-minute predictions

It appears that the first week of the month may be somewhat disturbed, particularly between the 2nd and 5th, but these disturbances are likely to be minor. A larger disturbance is forecast for the period of June 14th to June 21st, with the possibility that the entire period may show signs of unusual ionospheric and atmospheric activity. For moonbouncers, perigee occurs June 21st at the 12th hour (UTC). The summer solstice begins on June 21st at the 18th hour (UTC).

Band-by-band prediction

Twenty meters will be open most of the day and evening to one part of the world or another, with an early-morning burst of activity, followed by prolonged afternoon and evening activity. Short skip out to 1600 kilometers (1000 miles) will occur around noontime on most days of the month.

Fifteen meters will vie with twenty for DX performance. Some morning activity, followed by a great amount of afternoon and evening activity will be the rule rather than the exception. A much-improved sunspot situation will provide the necessary ionization to hold the band open to many areas of the world during most of the day. Short skip of about 1900 kilometers (1200 miles) will take place most days.

Ten meters this year will be far better than it was just a year ago, but not as good as it was this spring. Look for DX on many days of the month, following the chart predictions. Excellent short skip conditions will prevail throughout most days, except for disturbed periods, with skip to about 2000 kilometers (1300 miles) common during daylight hours.

Eighty and forty meters will provide some DX during the hours of darkness, but the signals will often be buried under thunderstorm QRN. Short skip of 500 kilometers (300 miles) during the day and 1200 kilometers (800 miles) at night will keep you busy on 80. Forty-meter short skip will be 1100 kilometers (700 miles) maximum during the day and 1600 kilometers (1000 miles) or more after dark.

One hundred sixty meters is gone for the summer with few exceptions. Occasional evening signals at good strength will override the QRN, but don't rely on the band for regular communications.

Tips on using the chart:

The asterisks (*) mean to look at the next *higher* band, because it, too, may be open on the path and at the time indicated. The arrows indicate general beam-pointing directions, with north at the top.

HRH

WESTERN USA



MID USA

EASTERN USA

GMT	WESTERN USA							MID USA							EASTERN USA																		
	PDT	N	NE	E	SE	S	SW	W	NW	FAR EAST	CENTRAL ASIA	EUROPE	S. AFRICA	S. AMERICA	ANTARCTICA	NEW ZEALAND	W. AUSTRALIA	OCEANIA	S. AMERICA	CENTRAL AFRICA	EUROPE	FAR EAST	EDT	N	NE	E	SE	S	SW	W	NW		
0000	5:00	20	20	—	20	15	15	15	15	15	20	20	—	20	—	15	15	15	15	15	20	20	15	8:00	15	20	—	—	15	20	20	15	
0100	6:00	20	20	—	20	15	15	15	15	15	20	20	—	20	—	15	15	15	15	15	20	20	15	9:00	15	20	—	—	20	20	20	15	
0200	7:00	20	20	—	20	—	15	15	15	15	20*	20	—	20	—	15	15	15	15	15	20	20	15	10:00	20	20	—	—	20	20	20	15	
0300	8:00	20	20	—	20	—	15	15	15	15	20*	20	—	20	—	15	15	15	15	15	20	20	15	11:00	20	40	40*	40	20	20	20	15	
0400	9:00	15	—	—	20	20	15	15*	15	15	20	—	20	—	20	15	15	15	15	15	20	20	20	12:00	20	40	40	40*	20	20	20	20	
0500	10:00	20	20	40*	20	20	15	15	15	15	20	—	20	—	20	15	15	15	15	15	20	20	20	1:00	—	40	40	40*	20	—	—	20	
0600	11:00	20	20*	40*	20	20	15	15	15	15	40	20	—	20	—	20	20	20	20	20	20	20	20	2:00	—	40	40	—	40	20	—	20	
0700	12:00	40	40	40*	40	20	20	15	15	15	40	40	—	20	—	20	20	20	20	20	20	20	20	3:00	—	—	40	—	40	—	—	—	
0800	1:00	40	40	40*	40	—	20	20	15	15	40	40	—	20	—	20	20	20	20	20	20	20	20	4:00	—	—	20	—	40	—	40	40	
0900	2:00	40	40	—	40	—	20	20	15	15	40	40	—	20	—	20	20	20	20	20	20	20	20	5:00	40	—	20	—	40	40	40	40	
1000	3:00	—	—	—	—	—	20	20	20	20	—	—	—	40	40	40	40	40	40	40	40	40	40	6:00	40	—	20	—	40	40	40	40	
1100	4:00	—	—	—	—	40	40	40	20	20	—	—	—	40	40	40	40	40	40	40	40	40	40	7:00	40	—	20	—	40	40	40	40	
1200	5:00	—	—	20*	—	40	40	40	—	20	20	—	—	40	40	40	40	40	40	40	40	40	40	8:00	20*	20	20	20	20	20	20	—	—
1300	6:00	—	—	20*	—	40	40	40	—	20	20	—	—	40	40	40	40	40	40	40	40	40	40	9:00	15	20	20	20	20*	20	20	—	—
1400	7:00	—	15	20*	15	—	40	—	15	15	20	15	20	20	40	—	20	20*	20*	20*	20*	20*	20*	10:00	15	15*	15	15	20*	20	20	—	—
1500	8:00	20	15	20*	15	—	20	—	15	15	20	15	20	20	—	—	20	20	20	20	20	20	20	11:00	15	15*	15*	15	15	20	20	—	—
1600	9:00	20	15	20	10	—	20	—	15	15	20	15	20	20	—	—	20	20	20	20	20	20	20	12:00	20	15	15*	20	15	15	15	—	—
1700	10:00	20	15	20	10	—	20	—	15	15	20	15	20	20	—	—	20	20	20	20	20	20	20	1:00	—	15	15	20	15	15*	15*	—	—
1800	11:00	20	15	20	10	—	20	—	15	15	20	15	20	20	—	—	20	20	20	20	20	20	20	2:00	—	20	20	—	15	15*	15*	—	—
1900	12:00	15	20	20	10	—	20	—	15	15	20	15	20	20	—	—	20	20	20	20	20	20	20	3:00	—	20	20	—	15	15*	15*	—	—
2000	1:00	20	20	20	10	—	20	—	15	15	20	15	20	20	—	—	20	20	20	20	20	20	20	4:00	—	20	20	—	15	15	15	20	20
2100	2:00	20	20	20	15	—	20	—	15	15	20	15	20	20	—	—	20	20	20	20	20	20	20	5:00	15	20	20	—	15	15	15	20	15
2200	3:00	20	20	—	15	—	15	15	15	15	20	20	—	15	—	15	15	15	15	15	15	15	15	6:00	15	20	—	—	15	20*	15	15	15
2300	4:00	20	20	—	15	—	15	15	15	15	20	20	—	15	—	15	15	15	15	15	15	15	15	7:00	15	20	—	—	15	20*	15	15	15

HAM CALENDAR

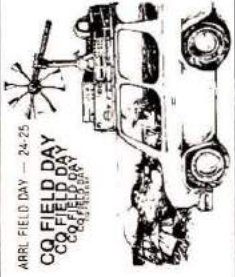
June 1978

SUNDAY	MONDAY	TUESDAY	WEDNESDAY	THURSDAY	FRIDAY	SATURDAY
<p>All international events such as contests are shown on the GAT days on which they take place even though they may actually begin on the evening of the preceding day in North America.</p> <p>4</p> <p>Dexter ARC West Washington Swap 'N' Shop — Chelsea Fairgrounds — Dexter, MI — W0SJFG</p> <p>Goodyear ARC Hamfest/Family Picnic — Wingfoot Lake Park — Akron, OH — WA8SJJ</p> <p>Eastern Connecticut ARA Fleamarket — Point Breeze Restaurant — Webster, MA — Inq. (203) 928-5930</p> <p>Long Island Mobile ARC Hamfest — Islip Speedway — Islip, NY — W0ZALW or W0ZBYC</p> <p>Milton ARC Hamfest — Allanwood Freshmen's Fairground — Allenwood, PA — W4USXG</p> <p>**Continued below</p>	<p>5</p> <p>FLORIDA HAM NEWS — SWAP NET by the Broward ARC</p> <p>GLENHURST RADIO SOCIETY Transmits Amateur Radio News — 222.66/224.26 MHz via WR2APG and 21.400 MHz USB</p> <p>WEST COAST BULLETIN Edited & Transmitted by WR2F 9PM PDST 3540 KHz, A-1, 22 WPM</p>	<p>6</p> <p>AMSAT Eastcoast Net 3850 KHz 9PM EDT (0100Z Wednesday Morning)</p> <p>AMSAT Midcontinent Net 3850 KHz 9PM CDT (0200Z Wednesday Morning)</p> <p>AMSAT Westcoast Net 3850 KHz 8PM PDST (0300Z Wednesday Morning)</p>	<p>7</p> <p>W1YAN Qualifying Run</p>	<p>8</p> <p>West Coast Qualifying Run</p>	<p>9</p> <p>ARRL VHF QSO Party — 10:11</p> <p>Portland Amateur Wireless Assoc. Fleamarket — Red Coach Grill — Portland, ME</p>	<p>10</p> <p>Advanced Microcomputer Interfacing & Programming Workshop Caribbean Cruise aboard the USS Carmvale — sponsored by VPI & SU Extension Div. and course directors — 17-24</p> <p>All-Asian Contest — Phone — 17-18</p> <p>Utah Council of Amateur Radio Clubs is holding a statewide/regional ARRL Hamfest — Inq. Utah ARRL Hamfest, P.O. Box 18562, Salt Lake City, Utah 84118</p> <p>West Virginia QSO Party — 17-19</p>
<p>11</p> <p>Egyptian RC, Inc. — Hamfest — Club Grounds — Granite City, IL</p> <p>Goodyear ARC Hamfest/Family Picnic — Wingfoot Lake Park — Akron, OH — WA8SJJ</p> <p>Marionette ARC Hamfest — Monroe County Community College — Monroe, MI</p> <p>Sandusky County Hamfest/Fleamarket — Sandusky County Fairgrounds — Fremont, OH — W0B3NV</p> <p>Six Meter Club of Chicago, Inc., Hamfest — Santa Fe Park, 91st Street and Wolf Road — Willow Springs, IL</p>	<p>12</p> <p>FLORIDA HAM NEWS — SWAP NET by the Broward ARC</p> <p>GLENHURST RADIO SOCIETY Transmits Amateur Radio News — 222.66/224.26 MHz via WR2APG and 21.400 MHz USB</p>	<p>13</p> <p>AMSAT Eastcoast Net 3850 KHz 9PM EDT (0100Z Wednesday Morning)</p> <p>AMSAT Midcontinent Net 3850 KHz 9PM CDT (0200Z Wednesday Morning)</p> <p>AMSAT Westcoast Net 3850 KHz 8PM PDST (0300Z Wednesday Morning)</p>	<p>14</p> <p>W1AW Qualifying Run</p>	<p>15</p>	<p>16</p>	<p>17</p> <p>ARRL FIELD DAY — 24-25</p> <p>CO FIELD DAY COFIELDAY COFIELDAY</p> 
<p>18</p> <p>Frederick ARC Hamfest — Frederick Fairgrounds — E. Patrick St. — Frederick, MD</p> <p>Ham Bathers Net Picnic — on Highway 75, 60 miles south of Topoka, or 15 miles south of US- — Burlington, KS</p> <p>Lakeside ARC Picnic — Tazak Nation League Picnic Grounds — Portage, WI</p> <p>Schryer ARC Hamfest — Lakeswood Park — Barnesville, PA — W3EKK</p>	<p>19</p> <p>FLORIDA HAM NEWS — SWAP NET by the Broward ARC</p> <p>GLENHURST RADIO SOCIETY Transmits Amateur Radio News — 222.66/224.26 MHz via WR2APG and 21.400 MHz USB</p> <p>WEST COAST BULLETIN Edited & Transmitted by W6ZF 9PM PDST 3540 KHz, A-1, 22 WPM</p>	<p>20</p> <p>AMSAT Eastcoast Net 3850 KHz 9PM EDT (0100Z Wednesday Morning)</p> <p>AMSAT Midcontinent Net 3850 KHz 9PM CDT (0200Z Wednesday Morning)</p> <p>AMSAT Westcoast Net 3850 KHz 8PM PDST (0300Z Wednesday Morning)</p>	<p>21</p> <p>W1AW Qualifying Run</p>	<p>22</p>	<p>23</p>	<p>24</p> <p>**The Virginia Arms ARC Inc. Hamfest — Prince William County Fairgrounds — 1 1/2 miles south of Manassas, VA on Route 234</p> <p>Rome RC Ham Family Day — Rome, NY — W4ZHR8</p> <p>Starved Rock RC Hamfest — Bureau County Fairgrounds — Princeton, IL</p> <p>Ti-State ABA Hamfest — Camden Park, Route 60 — W. Huntington, WV</p>
<p>25</p> <p>See June 2, 3, 4, 8, 14, 15, 17, 21, 24</p> 	<p>26</p> <p>FLORIDA HAM NEWS — SWAP NET by the Broward ARC</p> <p>GLENHURST RADIO SOCIETY Transmits Amateur Radio News — 222.66/224.26 MHz via WR2APG and 21.400 MHz USB</p>	<p>27</p> <p>AMSAT Eastcoast Net 3850 KHz 9PM EDT (0100Z Wednesday Morning)</p> <p>AMSAT Midcontinent Net 3850 KHz 9PM CDT (0200Z Wednesday Morning)</p> <p>AMSAT Westcoast Net 3850 KHz 8PM PDST (0300Z Wednesday Morning)</p>	<p>28</p>	<p>29</p>	<p>30</p> <p>The Superior Peninsula Amateur Radio Klub (SPARK) welcomes all radio amateurs, exhibitors, CBers and CUWA members for a weekend of renewed acquaintance from the U.P. to lower Michigan and neighboring areas. Activities commence Saturday, the 10th with the Tonserville Trolley and River Trip, followed by a fish fry at Peninsula Township Hall, Annual Swap 'N' Shop on Sunday the 11th at Peninsula Township Hall, Inq. W00BH, W06SU, W8SSU</p>	
<p>31</p> <p>JEFFERSON DAVIS MONUMENT AWARD — The Pennington ARC will be operating portable from the Jefferson Davis Monument at the Jefferson Davis Memorial Park — 1400Z 6/3 — 0500Z 6/4 — Frequencies 3.740, 21.140, 28.140 — Novices — 3.970, 7.270, 14.310, 21.370, 28.610 — General</p>	<p>1</p>	<p>2</p> <p>IARS-CHC/PHC/WH-OSO Party 2200Z 6/2 — 0000Z 6/5</p>	<p>3</p>			

either way... you can save from \$50 to \$500 with a Henry Radio antenna package

A

Special packages with special savings...

Package No. 1

Swan TB-2A
Tristao MM-40 or Triex SM-40
CDR CD-44
RG-58 100'
Control Cable 100'

Retail Price: approximately \$620
Package Price: \$525

Package No. 2

Swan TB-3HA
Tristao MM-40 or Triex SM-40
CDR Ham-II
RG-8 100'
Control Cable 100'

Retail Price: approximately \$750
Package Price: \$640

Package No. 3

Swan TB-3HA
Tristao CZ-454 FS or Triex W-51
5' mast
CDR Ham-II
RG-8 100'
Control Cable 100'

Retail Price: approximately \$1300
Package Price: \$1095

Package No. 4

Swan TB-4HA or Cushcraft ATB-34
Tristao CZ-454 FS or Triex W-51
5' mast
CDR Ham-11
RG-8 100'
Control Cable 100'

Retail Price: approximately \$1360
Package Price: \$1140

B

or design-it-yourself...and you'll still save

For many years Henry Radio has been providing a beam-antenna package program for amateurs who wanted an efficient but economical package. Thousands have benefited from this offer in the past. In recent years we have offered the customer the versatility of designing their own system with the components that they want. Our only requirement is the purchase of at least:

1 Antenna
1 Rotator
1 Tower
100' Rotator Cable
100' Coax Cable

We sell merchandise from the following manufacturers and our packages can include their products.

Swan Antennas
Cushcraft Antennas
HyGain Antennas (when available)
Mosley Antennas (when available)
Wilson Antennas
KLM Antennas
Mini Products Antennas
CDR Rotators
Tristao Towers
Triex Towers
Rohn Towers
Accessories of All Kinds

Send us a note telling us what your choice is and we'll send you our low package price.

Why buy from Henry Radio?

Over 50 years experience. No finance charges if paid within 90 days. Low interest contracts - 8%/yr add on (14% annual rate) - as long as 24 months. 10% down or trade-in down payments. Good used equipment. Most makes and models. Used equipment carries a 15 day trial, 90 day warranty and may be traded back within 90 days for full credit towards the purchase of NEW equipment. Write for literature.

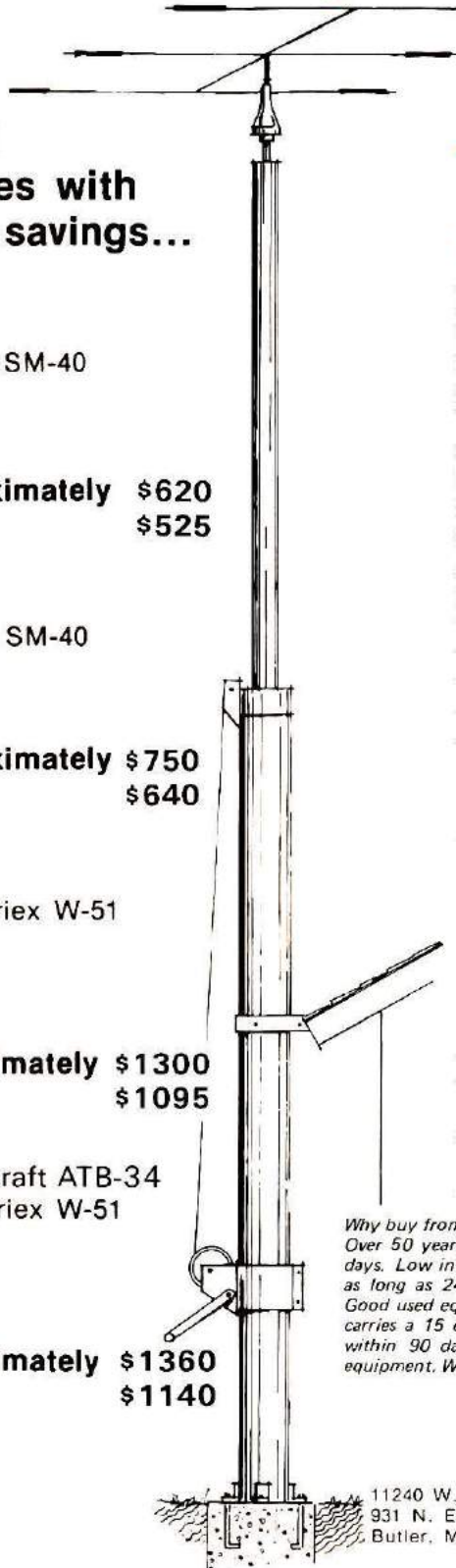

Henry Radio

11240 W. Olympic Blvd., Los Angeles, Calif. 90064 213/477-6701
931 N. Euclid, Anaheim, Calif. 92801 714/772-9200
Butler, Missouri 64730 816/679-3127

AD CHECK

... for literature, in a hurry — we'll rush your name to the companies whose names you check.

Place your check mark in the space between name and number. Example: HRH 150.

- | | |
|--|--|
| Amateur Elect. Supply <input type="checkbox"/> 659 | Int. Crystal <input type="checkbox"/> 066 |
| Antenna, Inc. <input type="checkbox"/> 686 | Kantronics <input type="checkbox"/> 605 |
| Antenna Mart <input type="checkbox"/> 009 | Kengore <input type="checkbox"/> 538 |
| Atlanta Hamfest * <input type="checkbox"/> 198 | Kenwood * <input type="checkbox"/> 430 |
| Atlas <input type="checkbox"/> 382 | Kester * <input type="checkbox"/> 430 |
| Atrionics <input type="checkbox"/> 382 | Klaus <input type="checkbox"/> 430 |
| Autocode <input type="checkbox"/> 665 | Larsen <input type="checkbox"/> 078 |
| Barker & Will. <input type="checkbox"/> 015 | Logitronics <input type="checkbox"/> 651 |
| Bencher <input type="checkbox"/> 629 | Long's <input type="checkbox"/> 468 |
| Burghardt <input type="checkbox"/> 530 | MFJ <input type="checkbox"/> 082 |
| Butternut <input type="checkbox"/> 603 | Madison * <input type="checkbox"/> 214 |
| CW Elect. <input type="checkbox"/> 533 | Nye <input type="checkbox"/> 214 |
| Cohoon <input type="checkbox"/> 559 | Oak Hill Acad. A. R. S. <input type="checkbox"/> 213 |
| Comm. Center <input type="checkbox"/> 634 | Palomar Elect. <input type="checkbox"/> 673 |
| Commun. Center <input type="checkbox"/> 534 | Palomar <input type="checkbox"/> 093 |
| Cover Craft <input type="checkbox"/> 685 | Panasonic <input type="checkbox"/> 683 |
| Cushcraft <input type="checkbox"/> 035 | Partridge <input type="checkbox"/> 439 |
| DSI <input type="checkbox"/> 656 | Pipo <input type="checkbox"/> 481 |
| DenTron <input type="checkbox"/> 259 | RSE Ham Shack <input type="checkbox"/> 607 |
| Drake <input type="checkbox"/> 039 | Callbook <input type="checkbox"/> 100 |
| E. T. O. * <input type="checkbox"/> 044 | Constructor <input type="checkbox"/> 586 |
| Elect. Equip. Bank <input type="checkbox"/> 288 | Rohn <input type="checkbox"/> 410 |
| Electro-space <input type="checkbox"/> 407 | Rush <input type="checkbox"/> 867 |
| Erickson <input type="checkbox"/> 047 | S-F A. R. S. <input type="checkbox"/> 640 |
| Gilfer <input type="checkbox"/> 207 | Sabtronics * <input type="checkbox"/> 375 |
| Gotham * <input type="checkbox"/> 491 | Science Workshop * <input type="checkbox"/> 375 |
| "Ham" Buerger * <input type="checkbox"/> 150 | SST <input type="checkbox"/> 375 |
| Ham Center <input type="checkbox"/> 595 | Swan <input type="checkbox"/> 111 |
| Ham Outlet <input type="checkbox"/> 060 | Taylor <input type="checkbox"/> 674 |
| Heath <input type="checkbox"/> 061 | Telrex <input type="checkbox"/> 377 |
| Heights <input type="checkbox"/> 062 | Ten-Tec * <input type="checkbox"/> 116 |
| Hi-Q * <input type="checkbox"/> 065 | Tri-Ex <input type="checkbox"/> 116 |
| ICOM <input type="checkbox"/> 666 | Universal A. R. S. <input type="checkbox"/> 653 |
| Instructo-graph <input type="checkbox"/> 666 | Universal Mfg. <input type="checkbox"/> 684 |
| | Western * <input type="checkbox"/> 378 |
| | Whitehouse <input type="checkbox"/> 378 |
| | Wilson <input type="checkbox"/> 123 |

*Please contact this advertiser directly. Limit 15 inquiries per request.

JUNE, 1978

Please use before July 31, 1978

Tear off and mail to
HAM RADIO HORIZONS — "Ad Check"
 Greenville, N. H. 03048

NAME _____

CALL _____

STREET _____

CITY _____

STATE _____ ZIP _____

MADISON SUPER SUMMER BUYS

NEW OMNI-J 2-meter mobile or portable antenna. 3/8" thread, 5-dB gain (1.5-dB gain over conventional 5/8-wave mobile whip antenna). \$29.95. 220-MHz \$27.95. 450 MHz \$27.95. Guaranteed results.

KLM: Antennas, Linears, Accessories All In Stock. FREE balun w/2 meter base antenna.

BIRD 43 Wattmeter plus slugs, in stock, prepaid freight.

BENCHER keyer paddles in stock \$39.95. chrome \$49.95

MIDLAND 23-136 dual meter, reads SWR and relative POWER handles 1 kW from 3-150 MHz \$21.95

YAESU FT-901D series Call for Quote

TELE-TOWER 40' w/breakover \$299

55' w/breakover \$399

MICROWAVE MODULES in stock

F9FT TONNA antennas: 144/16 el. \$55.95

9/19 OSCAR \$53.00

JANEL Preamps in stock

TECHNICAL BOOKS: ARRL, Sams, TAB, TI, Rider, Radio Pub., Callbook, Cowan, TEPABCO, many others call

HAM X ROTOR (New Model) Turns 28 sq. ft. of antenna. List \$325. In stock. Your Price \$249

CDE HAM-III \$129.00

SWAN METERS: WM 6200 VHF Wattmeter \$49.95

SWR 3 Mobile \$9.95

TELEX HEADSETS in stock

CETRON 572B \$27.95 ea.

ADEL nibbling tool \$6.45. punch \$3.50

CABLE 5/32" 6-strand, soft-drawn guy cable. For mast or light tower. 3c foot.

BELDEN COAX CABLE: 9888 double shield RG8 foam coax. 100% braid, suitable for direct bury 39c ft.

8237 RG8 21c ft. 8214 RG8 foam 26c ft. 8448 8-wire rotor cable 16c ft. 8210 72 ohm kw twinlead \$19/100 ft. 8235 300 ohm kw twinlead \$12/100 ft. Amphenol PL-259, silverplated 59c. UG175 adapter 19c. PL-258 dbl female \$1.00. BNC female chassis mount 59c ea. MICRO RG-8/U same size as RG-59. 2 KW PEP @ 30 MHz 16c ft.

BELDEN 14 gauge cop stranded antenna wire \$5/100 ft.

TIMES 1/2" foam hardline 60c/ft. connectors \$15 ea.

KESTER SOLDER 1 lb 60/40, 062 \$6.50

LEADER — Amateur Test Equip — 10% off list.

2.5A/1000 PIV epoxy diode 19c ea.

.001 MFD 20KV CAP. \$1.95

GE receiving tubes. 50% off list

GE6146B, 8950 \$7.95 ea.

SAY

Electronic Power Supplies

Completely Regulated 13.8 to 20 volts dc, variable. Separate volt and amp meters. Dual protection against over voltage and over current.

4 amp \$59.95

8 amp \$109.95

20 amp \$159.95

CALL FOR QUOTES ON: YAESU FT-301D, FT301, FT-227R, KENWOOD TS520S, TS820S, FT-901DM, FT-101E, ALDA, AMCOMM, VHF-ONE PLUS & ETO-ALPHA. ALL IN SEALED CARTONS. CALL FOR QUOTES ON ITEMS NOT LISTED. THIS MONTH'S SPECIAL: BEARCAT 210 SCANNER \$249.

CALL FOR FAST QUOTES SPECIAL ORDERS WELCOME

TERMS: All prices FOB Houston. Prices subject to change without notice. All Items Guaranteed. Some items subject to prior sale. Send letterhead for Amateur dealers price list. Texas residents add 5% tax. Please add postage estimate.

MADISON ELECTRONICS SUPPLY, INC.

1508 McKinney HOUSTON, TEXAS 77002
 713/658-0268 Nites 713/497-5683

AD INDEX

- | | |
|--|----------------|
| Amateur Electronic Supply | 73, 78 |
| Antenna Mart | 56 |
| Atlanta Hamfest | 66 |
| Atlas Radio Company | 43 |
| Atrionics | 58 |
| Autocode | 78 |
| Bencher, Inc. | 88 |
| Burghardt Amateur Center | 58, 59 |
| Butternut Electronics | 86 |
| CW Electronic Sales Company | 84 |
| Cohoon Amateur Supply | 57 |
| The Comm Center | 61 |
| Communications Center | 63 |
| Cover Craft | 84 |
| Cushcraft | 4, 96 |
| DSI Instruments | 85 |
| DenTron Radio Company | 48, 49 |
| Drake Co., R.L. Cover II | |
| Ehrhorn Technological Operations | 95 |
| Electronic Distributors, Inc. | 72 |
| Electronic Equipment Bank | 88 |
| Erickson Communications | 83 |
| Gotham | 77 |
| "Ham" Buerger | 86 |
| Ham Radio Center | 80 |
| Ham Radio's | |
| Communications Bookstore | 74, 75, 76, 88 |
| Ham Radio Outlet | 9 |
| Heath Company | Cover IV |
| Heights Manufacturing Co. | 88 |
| Henry Radio Stores | 93 |
| Hi-Q Communications | 23 |
| ICOM | 7 |
| Instructograph Co. | 78 |
| International Crystal | 65 |
| Kantronics | 58, 80, 84 |
| Kengore Corp. | 77 |
| Trio-Kenwood Communications, Inc. | Cover III |
| Kester Solder | 86 |
| Klaus Radio Inc. | 70 |
| Larsen Antennas | 42 |
| Logitronics | 66 |
| Long's Electronics | 1 |
| MFJ Enterprises | 3 |
| Madison Electronic Supply | 87, 94 |
| William Nye Co. | 62 |
| Oak Hill Academy Amateur Radio Session | 78 |
| Palomar Electronics Corp. | 53, 62 |
| Palomar Engineers | 69, 90 |
| Panasonic | 29 |
| Partridge Electronics Ltd. | 87 |
| Pipo Communications | 87 |
| RSE Ham Shack | 77 |
| Radio Amateur Callbook | 78 |
| Radio & Electronics Constructor | 77 |
| Unarco-Rohn | 56 |
| Rush Electronics | 88 |
| S-F Amateur Radio Services | 52 |
| Sabtronics International Inc. | 55 |
| Science Workshop | 89 |
| Swan Electronics | 67, 79 |
| Taylor Radio Company, Inc. | 87 |
| Telrex Laboratories | 72 |
| Ten-Tec | 63 |
| Tri-Ex Tower Corp. | 71 |
| Universal Amateur Radio Service | 62 |
| Universal Manufacturing Corp. | 52 |
| Western Electronics | 87 |
| G. R. Whitehouse & Co. | 81 |
| Wilson Electronics | 10 |

Foreign Subscription Agents for Ham Radio HORIZONS

- | | |
|---|---|
| Ham Radio Austria
Karin Lieber
Postfach 2454
D-7850 Loerrach
West Germany | Ham Radio Holland
MRL Electronics
Postbus 88
NL-2204 Deift
Holland |
| Ham Radio Belgium
Sterrehouse
Brusselsesteenweg 416
B-9218 Gent
Belgium | Ham Radio Italy
S.T.E. Via Maniago 15
I-20134 Milano
Italy |
| Ham Radio Canada
Box 114, Goderich
Ontario, Canada N7A 3Y5 | Ham Radio Switzerland
Karin Lieber
Postfach 2454
D-7850 Loerrach
West Germany |
| Ham Radio Europe
Box 444
S-194 04 Upplands Vasby
Sweden | Ham Radio UK
P.O. Box 63, Harrow
Middlesex HA3 6HS,
England |
| Ham Radio France
Christiane Michel
F-89117 Parly
France | Ham Radio
Holland Radio
143 Greenway
Greenside, Johannesburg
Republic of South Africa |
| Ham Radio Germany
Karin Lieber
Postfach 2454
D-7850 Loerrach
West Germany | |

ALPHA 76A



A RUGGED NEW BEAUTY IN A CLASS BY ITSELF

There are lots of so-called "Maximum Legal Power" linear amplifiers on the market. Why is it that so many knowledgeable amateurs, after checking out (and often owning) the others, ultimately choose an ALPHA?

For one thing, "maximum legal power" doesn't begin to tell the whole story. Nearly all manufacturers' ratings implicitly assume an amateur service duty cycle much less than 100%. Even the terms "continuous" and "100%" duty have been so debased in recent years as to be meaningless unless explicitly defined. The consequence, too often, is a power transformer or tube going up in smoke during a long operating period.

Every ALPHA amplifier is unequivocally rated to run a full 1000 watts of continuous, average d-c power input, in any mode, with No Time Limit (NTL). You could leave your ALPHA (ANY ALPHA) all day with a brick on the key, at a kilowatt input (or at 2 KW PEP input, two-tone SSB) without hurting it. In fact, you could leave it for weeks: last year we ran a standard ALPHA 76 key-down at a kilowatt for 18 days without ill effect. That's ALPHA POWER. To top it off, your new ALPHA is protected by ETO's exclusive 18 MONTH factory warranty—SIX TIMES AS LONG as the industry-standard 90 days! Now that DOES pretty much tell the whole story.

What's new with the ALPHA 76A? We haven't tampered with success. Behind that sleek new exterior is the same robust, reliable, easy-to-use powerhouse that January QST described with such phrases as, "Typically excellent ETO construction . . .," ". . . excellent efficiency . . .," ". . . tunes smoothly . . .," and ". . . runs cool and quiet . . ."

The basic ALPHA 76 components and circuit remain unchanged for very good reason: hundreds of 76's in service over the past two years have suffered NOT ONE SINGLE INSTANCE of transformer burn-out, and virtually no tube failures—less than 0.1%! That record is particularly remarkable when you consider the extent to which owners take their ALPHA's for granted.

We think the new ALPHA 76A sets a standard for style. And ETO engineers have added a separate Plate Current meter and a new push-button power control system, making it even more convenient to use. But the real beauty of every ALPHA linear amplifier is INSIDE the cabinet . . . where engineering and craftsmanship tell the whole story of ALPHA superiority.

A few ALPHA's may still be available with factory-installed 10 meter coverage. Contact ETO or your dealer today for detailed information and fast delivery. Six meter ALPHA 76/6 available about June 1: \$1095. Order now.

ALPHA: Sure you can buy a cheaper linear . . . But is that REALLY what you want?

ETO Ehrhorn Technological Operations, Inc.

P.O. Box 708 · Canon City, Colorado 81212 · (303) 275-1613

VHF DX

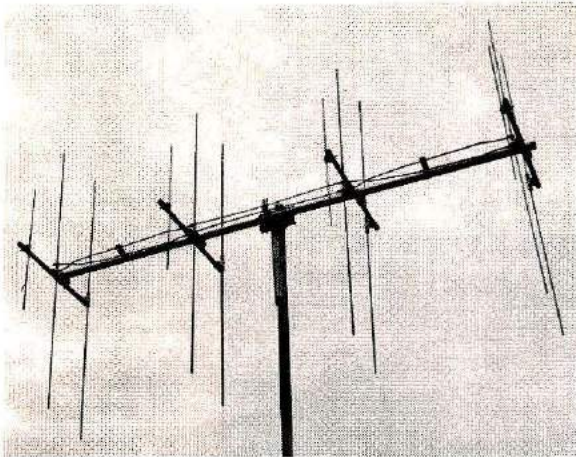

FM —

Enjoy the thrill of dependable long distance contacts on simplex or thru remote repeaters. The 20 element co-linear DX-Array offers a precise pattern with large capture area. This vertically polarized, horizontally stacked array provides a narrow beamwidth for the discriminating FM user. Wide impedance and gain bandwidths make the DX-Array a natural choice for the serious FM'er. A vertical polarization bracket, model DX-VPB, is required (support boom and mast not supplied). Seek out new horizons with DX-Array!

SSB/CW —

Discover reliability in long-haul communications with VHF SSB and CW. The Cush Craft DX-Array also gives low angle, high gain performance for many exotic propagation modes — tropo, aurora, sporadic-E, and meteor scatter. Horizontally polarized DX-Arrays may be used singly or combined in pairs (twice Effective Radiated Power) or quads (4 x ERP). Each DXK stacking kit is complete with stacking frame and phasing harness (vertical mast not supplied). This year has seen some spectacular VHF band openings — Don't miss the next one!

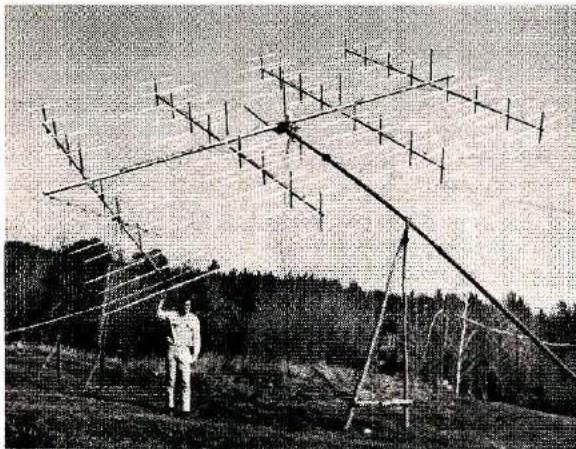
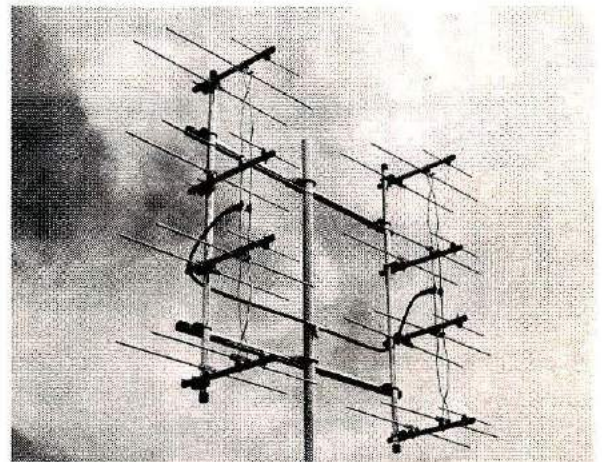

Dave Olean, K1WHS, with his 160 Element DX-Array and Polar Mount EME System

EME —

Many VHF experimenters have found excitement in conquering the formidable Earth-Moon-Earth (EME) path. 2-meter moonbouncers have achieved outstanding success using eight stacked DX-Arrays. Impedance and gain characteristics of this antenna permit stacking without the critical detuning problems inherent in large arrays of Yagis. Enlarging system size will yield a more uniform gain increase with DX-Arrays than with many other large antennas. The physical configuration alleviates mounting and phasing/tuning problems. EME enthusiasts are setting new records — So can you!

DX-ARRAY LEADS THE WAY!

Description:	144 MHz.		220 MHz.		432 MHz.	
	Model:	Price:	Model:	Price:	Model:	Price:
20 Element DX-Array	DX-120	\$42.95	DX-220	\$37.95	DX-420	\$32.95
Frame & Harness (40 E.)	DXK-140	\$59.95	DXK-240	\$54.95	DXK-440	\$39.95
Frame & Harness (80 E.)	DXK-180	\$109.95	DXK-280	\$89.95	DXK-480	\$79.95
1-152-ohm Balun	DX-1BN	\$12.95	DX-2BN	\$12.95	DX-4BN	\$12.95
Vert. Pol. Bracket (20 E.)	DX-VPB	\$9.95	DX-VPB	\$9.95	DX-VPB	\$9.95

IN STOCK WITH
DISTRIBUTORS WORLDWIDE

cushcraft
THE ANTENNA COMPANY
P.O. BOX 4680, MANCHESTER, N.H. 03108

STILL THE SAME FINE, TIME PROVEN RIG. BUT NOW WITH THE SIMPLE ADDITION OF A PLUG-IN CRYSTAL, THE TS-700SP WILL BE ABLE TO UTILIZE THE NEW REPEATER SUB-BAND (144.5 to 145.5 MHz) STILL FEATURES ALL OF THE FINE ATTRIBUTES OF THE TS-700S: A DIGITAL FREQUENCY DISPLAY, RECEIVER PRE-AMP, VOX, SEMI-BREAK IN, AND CW SIDETONE. OF COURSE, IT'S ALL MODE, 144-148 MHz, VFO CONTROLLED... AND KENWOOD QUALITY THROUGHOUT.

Features: 4 MHz band coverage (144 to 148 MHz)
 • Automatic repeater offset capability on all FCC authorized repeater subbands including 144.5-145.5 MHz • Simply dial receive frequency and radio does the rest... simplex, repeater, or reverse. Same features on any of 11 crystal positions • Transmit/Receive capability on 44 channels with 11 crystals • Operates all modes: SSB (upper and lower), FM, AM and CW • Digital readout with "Kenwood Blue" digits • Receiver pre-amp • Built-in VOX • Semi break-in on CW • CW sidetone • All solid-state • AC and DC capability: 10 watts RF output on SSB, FM, CW • 3 watts on AM • 1 watt FM low-power switch • 0.25 μ V for 10 dB (S+N)/N SSB/CW sensitivity • 0.4 μ V for 20 dB quieting FM sensitivity.
 10 watts RF output on SSB, FM, CW • 3 watts on AM • 1 watt FM low-power switch • 0.25 μ V for 10 dB (S+N)/N SSB/CW sensitivity • 0.4 μ V for 20 dB quieting FM sensitivity.

TS-700SP



The TS-700SP shown with the matching VFO-700S and SP-70. Also shown is Kenwood's new MC-30 noise cancelling hand held microphone, HS-4 headphone set and the MC-50 dynamic microphone.



The **HEATHKIT** SB-104A

The Head of the Class

Our top-of-the-line Heathkit SB-104A is the culmination of Heath's engineering excellence and expertise in Amateur Radio design. It's the transceiver the serious Radio Amateur aspires to - totally broadbanded, fully solid-state, true digital readout and much more - a truly superior performer that should be the "heart" of any first-class operating station.

That same engineering excellence goes into every piece of Heathkit Amateur Radio equipment - it's part of the reason Heath has been the start, and standby, of Amateur Radio hobbyists the world over. Heathkit equipment

gives you superior performance, day-in, day-out reliability and more VALUE for your money. And because Heathkit Amateur equipment comes to you in easy-to-build kit form, you learn more about your hobby as you put the kits together, you SAVE money over comparable assembled units, and you can service the equipment and keep it in top operating condition.

So whether you intend to work the world on a couple of watts CW, or "go-the-limit" with state-of-the-art SSB, you'll find Heath is the place with quality good enough to measure up... to you!

For complete information on our entire line of quality Amateur Radio products use the postcard, found elsewhere in this magazine, and send for your FREE Heathkit Catalog, or write: Heath Company, Dept. 348-420 Benton Harbor, Michigan 49022.