

APRIL 1978 / \$1.25

I AM RADIO HORIZONS



**THE SUN . . .
energy
for the Hamshack?**

The Drake MN-2000 Antenna Matching Network



A study in operator convenience

*(or—how not to hang upside down behind your
operating desk in order to disconnect your tuner from the line.)*

FRONT PANEL SELECTION of key operating functions. No need to manually connect and disconnect the unit from the line for bypass applications.

FRONT PANEL SELECTION of up to three different antennas, or two antennas and a dummy load. The two may be selected in the matched or bypassed mode in each circuit with the flip of a switch.

FRONT PANEL SELECTION of forward or reflected rf power with a built-in precision wattmeter — not just a relative indicator.

This coax to coax 2kW tuner will tame VSWR up to 5:1 at any phase angle. If your 75 meter antenna is flat on ssb, but has high VSWR on cw, this could be just the answer.

Excellent for beams that exhibit a high VSWR on the opposite end of the band from where you set the elements.

The MN-2000 provides an additional 25 to 35 dB second harmonic attenuation which can help reduce TVI.

Covers 80-10 meter ham bands. Considering the built-in coax antenna switch, by-pass switch and rf wattmeter/VSWR bridge, the MN-2000 is a real value at \$250.00.

To receive a **FREE**
Drake Full Line Catalog,
please send name
and date of this
publication to:

*The unique design
lets it work like
a tunable low pass
TVI filter. Helps keep
your neighbors happy!*



R. L. DRAKE COMPANY



DRAKE

540 Richard St., Miamisburg, Ohio 45342
Phone: (513) 866-2421 • Telex: 288-017

Western Service Center, 2020 Western Street, Las Vegas, Nevada 89102 • 702/382-9470

DRAKE SUPER BUYS

CALL TOLL FREE! 1-800-633-3410

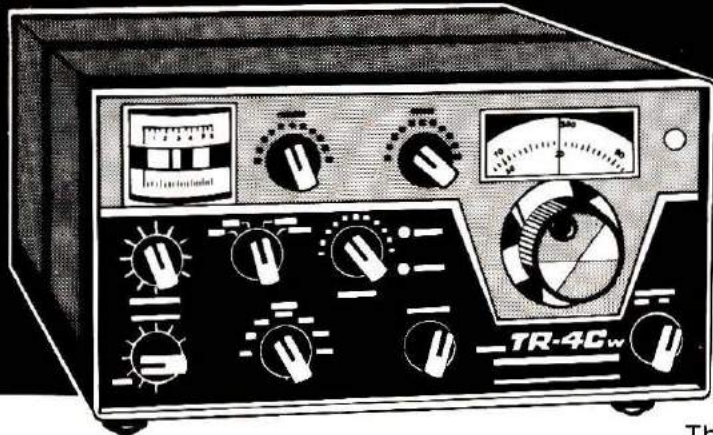
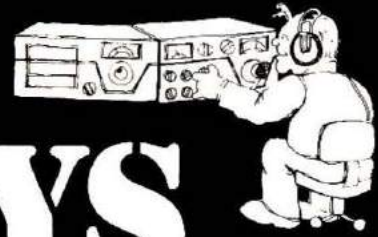

DRAKE TR-4CW transceiver

799.00 List price. Call for quote.

DRAKE AC-4 power supply

The AC-4 works with all Drake 4-line transceivers and transmitters. Fits inside the MS-4 speaker cabinet • Input: 120 or 240 VAC • Output: 650 VDC at 300 mA average, 500 mA peak, also: 12.6 VAC at 5.5 amps.

150.00 List price. Call for quote.

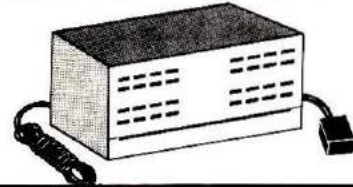

The TR-4CW covers 80 thru 10 meters. Modes SSB, AM, CW • 300 watts PEP input on SSB, 260 watts on CW, AM • 500 Hz CW filter included • Transceive or separate PTO • Wide range receiving AGC • Constant calibration mode to mode • Solid-state VFO • Shifted-carrier CW • VOX or PTT • Output impedance is adjustable • CW semi-break-in • Audio output: 3 watts • Receiver Incremental Tuning.



DRAKE R-4C receiver

R-4C has same coverage as the T-4XC, plus any 500 KHz range between 1.5 and 30 MHz • Also use for MARS, WWV, CB, Marine & Shortwave reception • Linear permeability-tuned VFO • 3 AGC release times • Crystal lattice filter in first IF prevents cross-modulation.

699.00 List price. Call for quote.

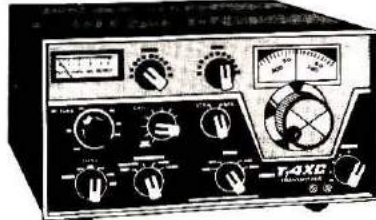

DRAKE T-4XC transmitter

• Coverage: 80, 40, 20, 15 m & 28.5 to 29.0 MHz of 10 meters • Covers 160 meter w/accessory crystal • Two 8-pole crystal lattice filters for SSB selection • Controlled carrier modulation for AM • Built-in VOX or PTT on SSB or AM • TX AGC prevents flat-topping • RTTY easy adaption, AFSK or FSK.

699.00 List price. Call for quote.

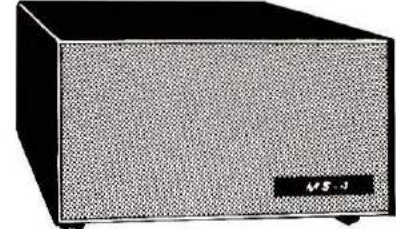

DRAKE MS-4 matching speaker

The MS-4 is designed for use with the Drake R-4C, R-4B, R-4A, & R-4 receivers. It has space inside for the Drake AC-4 power supply • The 8-ohm speaker will always come through loud and clear.

33.00 Call for yours today.

Remember, you can call TOLL-FREE: 1-800-633-3410 in U.S.A. or call 1-800-292-8668 in Alabama for our low price quote. Store hours: 9:00 AM til 5:30 PM, Monday thru Friday



Long's Electronics



MAIL ORDERS: P.O. BOX 11347 BIRMINGHAM, AL 35202 • STREET ADDRESS: 2808 7TH AVENUE SOUTH BIRMINGHAM, ALABAMA 35233

THIS MONTHS

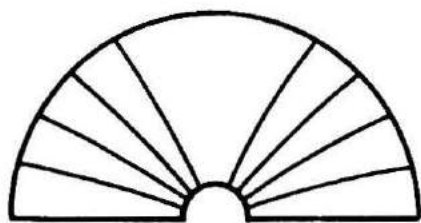

HORIZONS

Solar Electric Power

We've all seen the solar panels depicted in artists' renditions of satellites in space — even amateursatellites, and an occasional news item about some imaginative application of solar power for the land-bound. W1SL looks at the status of this "free" energy technique, and talks about its uses in a hamshack, and other hobby applications.

Fire Protection In The Ham Shack

Every year, fire causes billions of dollars of property damage and leaves thousands homeless; a large percentage of these fires have electrical origins: overloaded electrical circuits, poor connections, faulty wiring, lightning — practically all could have been prevented. In this article W1HR discusses fire prevention in your ham shack and outlines some of the steps you should take to protect yourself, your family, and your home.

A Night to Remember

Those words have been used as the title for many circumstances and stories, but the one we are concerned with has to do with the *Titanic*. Certainly those who were closely associated with the disaster have reason to remember the night, but is there a tie between that night and the life of amateur radio? Author Orr brings to light a theory by an amateur who feels that there is

a definite cause and effect to be seen here. An important part of the message is that the foes of amateur radio are still listening, 66 years after the ship went down!

Sorcerer's Apprentice

A beginner looks at a schematic diagram, a collection of parts, and reads the instructions — but the thought persists, "How will I ever get that stuff together to make a rig out of it?" Enter the helping hand of an old timer who has been there many times. The knowledge he applies with such abandon must truly seem to be black magic, but out of it all comes a rig, or two, or more — and an apprentice who carries on the tradition.

One-Transistor Rig For 40 Meters

History repeats itself, almost! Single-tube transmitters were the mainstay of amateur stations when the switch from spark to CW became necessary. The tubes were large, had impressive bright filaments, and often glowed red with excess dissipation; their efficiency was horrible. It's a good thing that power-measuring devices were scarce, because most of the rigs put out 5 watts or less. But then, bands were not as crowded, and the amateurs were having so much fun they couldn't worry about a lack of kilowatt amplifiers. Here's a little five-watter of more recent vintage that will provide many pleasant hours of operating, at a minimal cost.

Terlingua Creek Incident

A couple of weekend campers encounter a dangerous smuggler who threatens to turn their pleasure hike into disaster. A portable rig that survives rough treatment, plus a sharp operator, turns the situation around and leads to new understanding of amateur radio's capabilities.

WA5SNZ offers this thriller for you to read after the band goes dead.

Improved Two-Meter Whip

For a few pennies and about an hour's time, you can increase the efficiency of the popular two-meter magnet-mount whip with this portable ground plane. It can also serve as a handy home-station antenna when not in use on your vehicle.

Questions? And Answers!

This part of the Question and Answer series describes several of the most common components that are used in the radio world. The theory of Ohm's law can be carried just so far, and then you have to know what a resistor looks like. The same is true of inductors, capacitors, tubes, and transistors — even if you have a thousand words of theory, a photograph is still valuable. W1SL deals with the passive components in this issue, saving the active ones for later.

The Cover

This color spectacular is one of the results of photography done by the SKYLAB 3 astronauts. The solar corona is shown after electronic processing of the original photograph. Because the picture was made from outside the earth's atmosphere, it shows details far into the ultraviolet spectrum which would never be seen by terrestrial observers (*courtesy NASA*).

HAM RADIO HORIZONS April, 1978, Volume 2, No. 4. Published monthly by Communications Technology, Inc., Greenville, New Hampshire 03048. One-year subscription rate, \$10.00; three-year subscription rate, \$24.00. Second-class postage paid at Greenville, New Hampshire 03048 and additional offices.

This NEW MFJ Versa Tuner II . . .

has SWR and dual range wattmeter, antenna switch, efficient airwound inductor, built in balun. Up to 300 watts RF output. Matches everything from 160 thru 10 Meters: dipoles, inverted vees, random wires, verticals, mobile whips, beams, balance lines, coax lines.



BRAND NEW

\$79⁹⁵

Antenna matching capacitor. 208 pf. 1000 volt spacing.

Sets power range, 300 and 30 watts. Pull for SWR.

Meter reads SWR and RF watts in 2 ranges.

Efficient airwound inductor gives more watts out and less losses.

Transmitter matching capacitor. 208 pf. 1000 volt spacing.

Only MFJ gives you this MFJ-941 Versa Tuner II with all these features at this price:

A SWR and dual range wattmeter (300 and 30 watts full scale) lets you measure RF power output for simplified tuning.

An antenna switch lets you select 2 coax fed antennas, random wire or balance line, and tuner bypass.

A new efficient airwound inductor (12 positions) gives you less losses than a tapped toroid for more watts out.

A 1:4 balun for balance lines. 1000 volt capacitor spacing. Mounting brackets for mobile installations (not shown).

With the NEW MFJ Versa Tuner II you can run your full transceiver power output — up to 300 watts RF power output — and match your

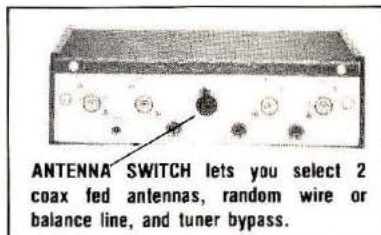

ANTENNA SWITCH lets you select 2 coax fed antennas, random wire or balance line, and tuner bypass.

transmitter to any feedline from 160 thru 10 Meters whether you have coax cable, balance line, or random wire.

You can tune out the SWR on your dipole, inverted vee, random wire, vertical, mobile whip, beam, quad, or whatever you have.

You can even operate all bands with just

one existing antenna. No need to put up separate antennas for each band.

Increase the usable bandwidth of your mobile whip by tuning out the SWR from inside your car. Works great with all solid state rigs (like the Atlas) and with all tube type rigs.

It travels well, too. Its ultra compact size 5x2x6 inches fits easily in a small corner of your suitcase.

This beautiful little tuner is housed in a deluxe eggshell white Ten-Tec enclosure with walnut grain sides.

SO-239 coax connectors are provided for transmitter input and coax fed antennas. Quality five way binding posts are used for the balance line inputs (2), random wire input (1), and ground (1).

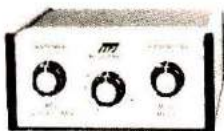

\$59⁹⁵

BRAND NEW

MFJ-901 VERSA TUNER

New efficient air wound coil for more watts out.

Only MFJ uses an efficient air wound inductor (12 positions) in this class of tuners to give you more watts out and less losses than a tapped toroid. Matches everything from 160 thru 10 Meters: dipoles, inverted vees, random wires, verticals, mobile whips, beams, balance lines, coax lines. Up to 200 watts RF output. 1:4 balun for balance lines. Tune out the SWR of your mobile whip from inside your car. Works with all rigs. Ultra compact 5x2x6 inches. SO-239 connectors. 5 way binding posts. Ten Tec enclosure.



\$49⁹⁵

BRAND NEW

MFJ-900 ECONO TUNER

Same as MFJ-901 Versa Tuner, but does not have built-in balun for balance lines. Tunes coax lines and random lines.



\$39⁹⁵

MFJ-16010 RANDOM WIRE TUNER

Operate 160 thru 10 Meters. Up to 200 watts RF output. Matches high and low impedances. 12 position inductor. SO-239 connectors. 2x3x4 inches. Matches 25 to 200 ohms at 1.8 MHz.



\$49⁹⁵

BRAND NEW

MFJ-202 RF NOISE BRIDGE

This MFJ RF Noise Bridge lets you adjust your antenna quickly for maximum performance. Measure resonant frequency, radiation resistance and reactance. Exclusive range extender and expanded capacitance range (± 150 pf) gives you much extended measuring range.

Tells resonant frequency and whether to shorten or lengthen your antenna for minimum SWR. Adjust your single or multi-band dipole, inverted vee, beam, vertical, mobile whip or random system for maximum performance. 1 to 100 MHz. SO-239 connectors. 2x3x4 inches. 9 volt battery.

For Orders

Call toll-free 800-647-8660

For technical information, order and repair status, and in Mississippi, please call 601-323-5869.

Order any product from MFJ and try it. If not delighted, return within 30 days for a prompt refund (less shipping).

Order today. Money back if not delighted. One year unconditional guarantee. Add \$2.00 shipping/handling.

Order By Mail or Call TOLL FREE 800-647-8660 and Charge It On



MFJ ENTERPRISES

P. O. BOX 494
MISSISSIPPI STATE, MISSISSIPPI 39762

ATB-34

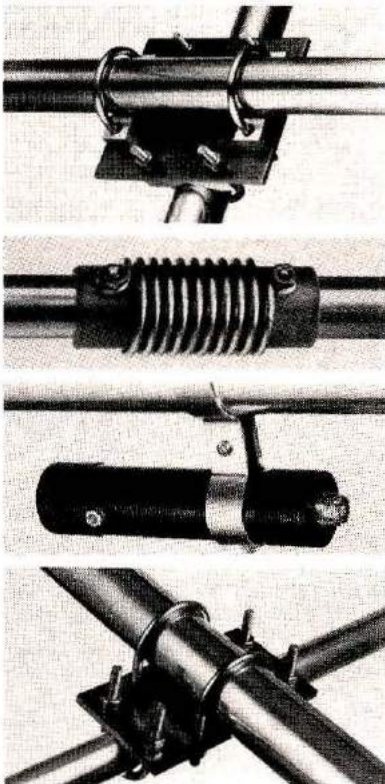
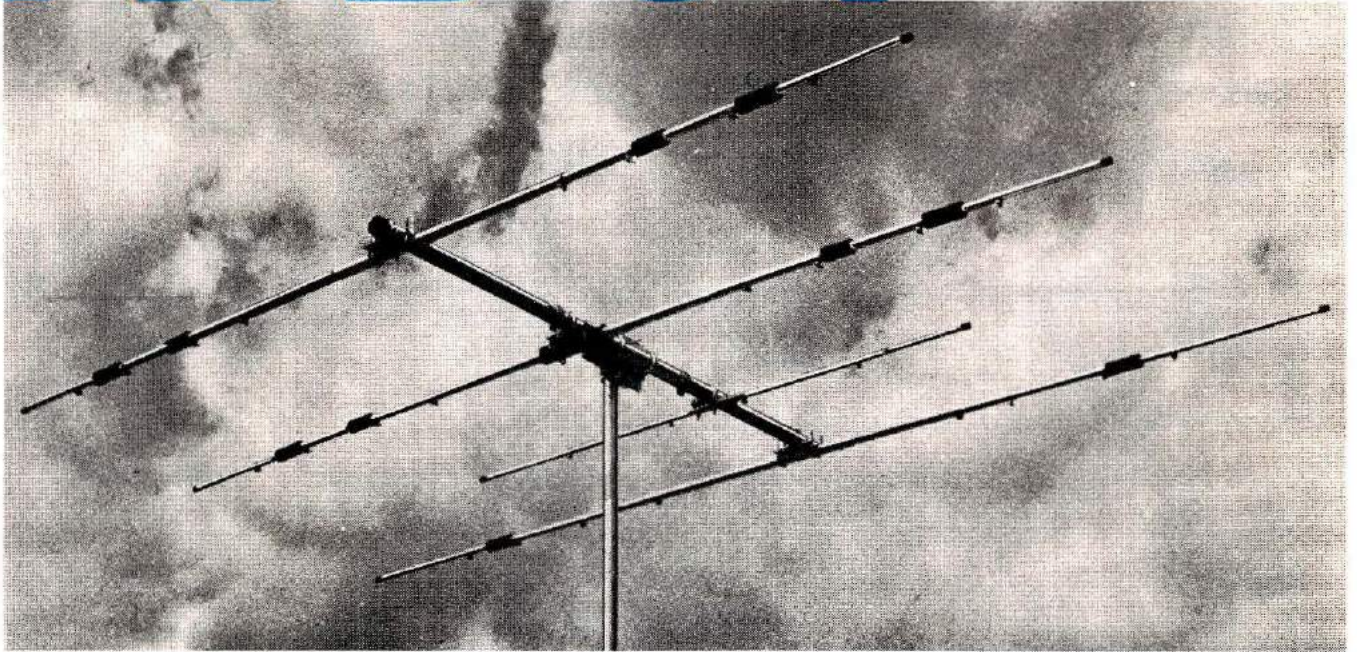

4 ELEMENT-3 BAND 10-15-20 METER BEAM

Cushcraft engineers have incorporated more than 30 years of design experience into the best 3 band HF beam available today. **ATB-34** has superb performance with three active elements on each band, the convenience of easy assembly and modest dimensions. Value through heavy duty all aluminum construction and a price complete with 1-1 balun.

Enjoy a new world of DX communications with ATB-34!

SPECIFICATIONS

FORWARD GAIN -	7.5 dBd	WIND SFC -	5.4 Sq.Ft.
F/B RATIO -	30 dB	WEIGHT -	42 Lbs.
VSWR -	1.5-1	WIND SURVIVAL -	90 MPH.
POWER HANDLING -	2000 WATTS PEP		
BOOM LENGTH/ DIA. -	18' x 2 1/8"		
LONGEST ELEMENT -	32'8"		
TURNING RADIUS -	18'9"		

UPS SHIPPABLE **COMPLETE**
NO EXTRAS TO BUY
IN STOCK WITH DISTRIBUTORS WORLDWIDE



cushcraft

CORPORATION

BOX 4680, MANCHESTER, N.H. 03108

April, 1978
Volume 2, Number 4

HAM RADIO HORIZONS

T.H. Tenney, Jr., W1NLB
Publisher
James R. Fisk, W1HR
Editor-in-Chief

Editorial Staff

Thomas F. McMullen, Jr., W1SL
Managing Editor
Patricia A. Hawes, WA1WPM
Executive Editor
Charles J. Carroll, K1XX
Alfred Wilson, W6NIF
Assistant Editors

Publishing Staff

C. Edward Buffington, WB1AMU
Assistant Publisher
Fred D. Moller, Jr., WA1USO
Advertising Manager
James H. Gray, W1XU
Assistant Advertising Manager
Therese R. Bourgault
Circulation Manager

Copyright 1978 by Communications
Technology, Inc. Title registered
at U.S. Patent Office

Subscription rates are
\$10.00 per year, worldwide

Microfilm copies
are available from
University Microfilms, International
Ann Arbor, Michigan 48103

Cassette tapes of selected articles
from *Ham Radio Horizons* are available to
the blind and physically handicapped
from Recorded Periodicals
919 Walnut Street, 8th Floor
Philadelphia, Pennsylvania 19107

Ham Radio Horizons
is published monthly by
Communications Technology, Inc
Greenville, New Hampshire 03048
Telephone 603-878-1441

CONTENTS

Solar Energy for Radio Communications	12	
Thomas F. McMullen, W1SL		
Fire Prevention in Your Ham Shack	24	
James R. Fisk, W1HR		
The Night the Titanic Went Down	34	
William I. Orr, W6SAI		
The (Radio) Sorcerer's Apprentice	38	
Douglas Stivison, WA1KWJ		
One-Transistor 40-Meter Rig	42	
Edward Marriner, W6BLZ John Merideth, K5GXR		
Incident at Terlingua Creek	46	
Courtney Hall, WA5SNZ		
Improved Two-Meter Quarter-Wave Antenna	54	
Alfred Wilson, W6NIF		
Questions? And Answers! Part 9	58	
Thomas F. McMullen, W1SL		
Activities Calendar	84	Newsline 11
Ad Check	86	Postbox 66
Ad Scan	81	Product Showcase 70
Advertiser's Index	86	Propagation Chart 83
DX Forecaster	82	The View From Here 6
Focus and Comment	8	This Month's Horizons 2
Horizons Locator	78	

THE VIEW FROM HERE

This month I thought you'd like a viewpoint on ham radio and ham-radio operators from a non-ham. The non-ham is the wife of a dedicated DXer and CW operator, who has been around for a while. She has some things to say about ham radio from the other side of the coin — living with a ham, but not really partaking of his hobby interests. Herewith is a guest editorial by a devoted (but tolerant) XYL non-ham.

Ham radio is a fascinating hobby, as I've learned over the years. A ham shack has been a part of our home for over 25 years. I've read several articles in *Ham Radio Horizons* about a wife getting involved with her husband's hobby and key-clicking through life together. I say: "Do your own thing, but just let the OM alone."

There are four antennas on our roof (excluding the TV antenna). Our garage, which was designed for two ordinary cars, contains a multitude of strange-looking boxes and cabinets with dials, knobs, switches, and blinking lights. In the middle of my garden in the backyard a huge metal structure extends into the air. On top is a spidery looking object that's called a beam antenna. The tower is a landmark hereabouts. Other hams see it and drop by for what are known as eyeball QSOs. Sometimes the local DX club decides to have a meeting at our house. Thirty or forty hams converge on our front lawn and mumble amongst themselves about the long path. Then they troop inside and hold their "DX meeting." Most of the meeting is about who worked what and when, with a lot of whooping and outrageous tales of pileups. What's a pileup? As far as I'm concerned, a pileup occurs around the coffee and doughnuts (which yours truly provides) after the meeting. I'm not complaining, you understand.

Yep, there's a ham in our house all right, but it isn't me. My ham and I live together 24 hours a day. He's semi-retired and self employed. We feel it's necessary to have separate interests and maintain our individuality. He does his thing and I do mine. But it works fine, because we don't try to force each other into our individual hobby interests. I don't want to become a ham, but I certainly respect my husband's interests and activity in ham radio.

We share enough common interests without living in each other's pockets, so to speak. For example, the two-meter rig is with us in our car on mini vacations. I drive while the OM talks on the radio. Maybe some wives feel left out when, after checking into a motel, the husband ham sits in the car in the parking lot talking to the locals. I say, "Let him be!" While he's doing that I work on sewing projects I've brought along. I'm a quilt maker.

In our area there's a ham swap meet every month. The OM wouldn't miss it. Local hams take turns driving to the meet. They round up card tables to display their ham stuff for likely buyers one month. The next month they sell stuff they've bought the previous month (generally at a loss). My husband tells me that more tall tales are swapped than radio parts. I wouldn't go to such a swap meet any more than I'd drag the OM through a fabric shop while I look at material. So he and I have developed an amused but loving tolerance for each other's interests. It's nice. He doesn't want me to be a ham any more than I want him to be a quilt maker.

I'm not putting down ham radio for any wife who's sincerely interested and wants to become a ham. That's great! It's just that, in our case, we've found after many years together, it's still *vive la difference*. I guess my message is, if you like it, do it.

One aspect I enjoy about hamming is the spirit of camaraderie. Even though it appears to be a competitive hobby (especially in a DX pileup), if a guy is off the air for some reason or other, ham friends seem to come out of the woodwork to help. They supply a necessary part or help raise a fallen antenna or install a tower. They just *do it*.

My husband has given several Novice license tests to potential hams. They all passed and they remember him as he remembers the friend who got him interested in ham radio and gave him his first ham equipment many years ago. It reminds me, in a way, of old-time barn raisings when all the men got together and helped a neighbor build a barn, while the ladies had a quilting party.

Last year our son, Paul, went away to college in Oregon. For four months we didn't hear a word from him. We had a bunch of cancelled checks with his scrawled endorsement on the back. Paul didn't have a phone, and since I'm the eternal earth mother, I worried myself into a full-blown snit. "Where is my little boy?" (He's 19 years old and big as a bear). When I decided to call the Oregon police, my OM called "CQ Oregon." Within minutes a ham in Portland answered. While I stood by nervously, a ham in Ashland broke in and said he was two blocks from Paul's house and that he would go over and tell Paul to call home.

The phone rang, and there he was. "Hi, Mom, what'samatter? I was playing my guitar and this guy came over and told me to call you. Sorry I haven't written. I've been really busy (ha!). The cookies you sent were just great." The call, of course, was collect.

Yes, ham radio is great. When all the little buttons are pushed and knobs are dialed to the right numbers, it's a joy for this sometime listener. It's my husband's hobby, though, and I don't want any part of operating the mysterious black cabinets in his shack.

I'm going to San Francisco to take in a three-day quilt show with another non-ham wife; a trip financed by quilts I've sold in a local shop. I'll phone my dear ham husband after 6 AM when the long path is closed, or maybe I'll look for one of those funny looking antennas in someone's backyard . . .

Jim Fisk, W1HR
editor-in-chief

ICOM wants you to

Begin with the Best

As you develop your skills, increase your participation in Ham Radio activities, and add hardware for ever-increasing flexibility of operations, you'll come to know ICOM. Just ask any old Ham. ICOM is the quality name in VHF/UHF Amateur Radio equipment because it is simply the best. ICOM is the line you'll want to move up to for unequalled quality and features.

But you needn't wait until you can trade in a truck load of equipment to reach up to ICOM. You can begin building your Amateur Radio operations with reasonably priced ICOM units that have flexible add-on features when you purchase your very first voice transceiver. And when you are installing ICOM's top-of-the-line fixed station unit, the ICOM equipment you began with will probably still be an important integral part of your active hardware.

Don't delay in moving up to ICOM: begin with the best.



Clockwise from lower left: **IC-211** 4MHz, 2 meter, All Mode Transceiver; **IC-245** Mobile 2 meter Transceiver; **IC-225** Mobile VHF FM Transceiver; **IC-502** Portable 50 MHz SSB Transceiver; **IC-215** Portable 2 meter FM Transceiver; **IC-30A** Mobile UHF FM Transceiver.

Ask your dealer for ICOM's complete product line catalog, or mail your request to an address below.

VHF/UHF AMATEUR AND MARINE COMMUNICATION EQUIPMENT

Distributed by:



ICOM

ICOM WEST, INC.
Suite 3
13256 Northrup Way
Bellevue, Wash. 98005
(206) 747-9020

ICOM EAST, INC.
Suite 307
3331 Towerwood Drive
Dallas, Texas 75234
(214) 620-2780

ICOM CANADA
7087 Victoria Drive
Vancouver B.C. V5P 3Y9
Canada
(604) 321-1833



FOCUS & COMMENT

There's a story on page 34 of this issue that I urgently call to your attention. It's about the *Titanic* disaster, and the changes that it possibly brought about in the amateur radio world. My original thought was to emphasize the point of the story, to remind you of where our improper operation can lead to in these days before the World Administrative Radio Conference (WARC) in 1979. However, in reading "A Night To Remember" one more time, I do not see how I can improve the impact by building upon it. The point of the story is quite clear, and I'm sure you'll get it.

In the meantime, another bit of amateur operating technique has come to my attention, and it has made me wonder if we really listen to what we say on the air.

I'm sure that many of you heard about the operation of the Marconi Anniversary Station, KM1CC, from Cape Cod during the middle of January. The station obtained permission to tone-modulate its CW signal to simulate the sound of the 240-Hz buzz of the original Marconi spark transmitter. It was a distinct, unique, and captivating sound, and I'm glad that I was able to work the station, tape-record the sound, and listen for hours to that melodious note as the operator piled up the contacts in contest fashion. I've never heard a real spark-transmitter signal over the air, but I can sense the romanticism that old timers attach to the "roar of spark."

The thing that surprised me was that a very high percentage of the hams who worked KM1CC gave him a report indicating the signal had a pure-dc tone! Reports of 599, 589, 579 were commonplace. A few operators, realizing their error after sending the report, backtracked, sent a string of dits as an error signal, then sent another report indicating a less-than-dc note, usually with an appended "HI HI." Some operators gave a correct report the first time, but they were in the minority, at least during the period when I was listening.

The RST system was set up so that one amateur could tell the other something about the quality of his signal. The first number is supposed to indicate the *relative readability* of the signal, the second number is supposed to indicate the *relative strength*, and the last number is supposed to indicate the *purity of tone*, ranging from a raw, unfiltered, ac roar with no tonal quality, up to a pure dc supply (no hum at all).

Have we become so out of touch with what we are saying that the reports we are giving are meaningless? Certainly I would be more than happy to have someone tell me that my signal was T7, T8, or worse — I'd go looking for the trouble before I got a more emphatic statement from the FCC!

Aside from the KM1CC operation, have you noticed how the rarity of a DX station causes his signal report to improve in direct proportion? Could it be that we hope to flatter him into a hasty response with the QSL card by inflating his signal report? How can he gain a true indication of propagation conditions and antenna performance if the signal-strength reports are so unreliable? On the other hand, most DX stations are run by pretty sharp individuals, and they probably see through the inflated-report tactic with ease.

Contests come under a different category, and I can see a bit of the reasoning behind the standard "RST 579" report that is heard most often. The operators are under pressure, and the miniscule amount of time that is required to evaluate the true signal strength and translate that into dots and dashes does slow things down. However, if the reports are nothing more than some numbers sent to meet the requirement that information be exchanged, perhaps it is time for contest promoters to take another look at what should be exchanged. Perhaps zip codes, birthdates, years licensed, or latitude and longitude will be sufficient — and more meaningful.

Anyway, the time spent listening to KM1CC and those worked provided some laughs, some interesting observations (yes, embarrassment does come through on CW), and a resolve to look more closely at what kind of report I send. I hope you read me 599.

Thomas McMullen, W1SL
Managing Editor

TRIPLE BONUS DEAL on KENWOOD TS-820S

**SERVING
HAMS
BETTER!**

*North ... south ...
east ... west*

All leading brands ...
in-depth stocks ...
new/used gear.



The deal:

- 1)—Send us **1098.00*** (in the form of check, M/O, BankAmericard, VISA, Master Charge)
- 2)—We'll ship you immediately, a beautiful brand-spanking-new, peerless performing **KENWOOD TS-820S TRANSCEIVER!**

- 3)—**PLUS a BIRD Model 43 wattmeter** (a 120.00 retail value). **OR . . . De luxe Remote VFO** (for TS-820S) Reg. 149.00

PLUS prepaid shipment of both items (UPS Brown)



Prices subject to change without notice. Calif. residents add 6% sales tax

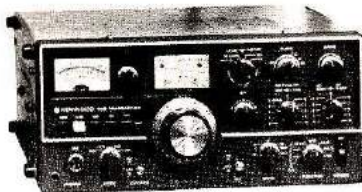

PLUS your choice of: **Kenwood TS-520S Transceiver**
 1)-Hustler 4BTV antenna (Reg. 99.00) or
 2)-Hy-Gain 18AVT antenna (Reg. 97.00) or
 3)-Dentron Jr. Tuner (Reg. 79.00).
Special 739.00 Prepaid, U.P.S. Brown.

**HAM X
TAILTWISTER™**
Reg. 349.95
249.00

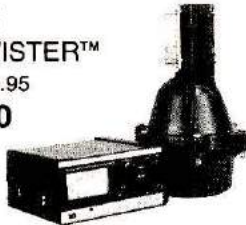

**SHURE
444 MIC.**
33.95



**HAM III
129.95**



← shipped prepaid (UPS Brown) →



**Kenwood TR-7400 Transceiver PLUS
Astron 12A, 12VDC/115VAC supply (Reg. 59.95)
399.00**

BIRD ELEMENTS
(Not supplied with BIRD wattmeter)

2-30MHz **42.00**
25-1000MHz **36.00**

OVER THE COUNTER (Mon. thru Sat. 10AM to 5:30PM). PHONE. WRITE. SAME DAY SHIPMENT MOST ITEMS.

HAM RADIO OUTLET

SOUTH

Anaheim, Calif. 92801
2620 W. La Palma, (714) 761-3033
1 mile east Knott's Berry Farm (213) 860-2040

NORTH

Burlingame, Calif. 94010
999 Howard Ave., (415) 342-5757
5 miles south on 101 from S.F. Airport.

SOUTH

Van Nuys, Calif. 91401
13754 Victory Blvd., (213) 988-2212
Dealer inquiries invited.



**Bob Ferrero,
K6AHV/W6RJ,
Jim Rafferty, N6RJ,**
other well known hams,
give you courteous,
personalized service.



• ATLAS • BIRD • CDE • COLLINS • CUSHCRAFT • CURTIS • DENTRON • DRAKE • EIMAC • HUSTLER
• HY-GAIN • ICOM • KENWOOD • KLM • MOSLEY • SWAN • TEMPO • TEN TEC • TRI-EX • YAESU • more.

THE SYSTEM TWO™

Top Performance for 20 - 15 - 10 Meters!

TRIBANDER ANTENNA ...

Wilson

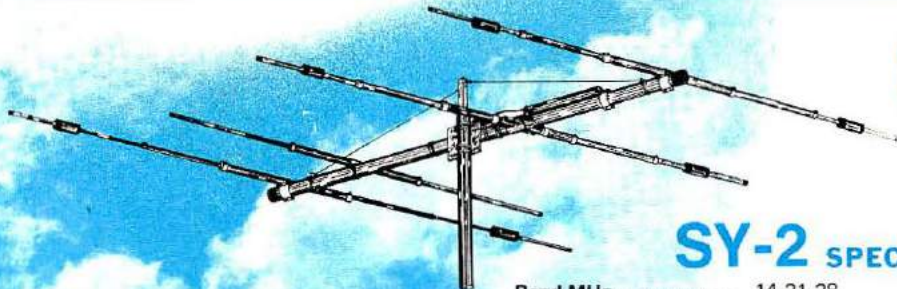

SY-2 SPECIFICATIONS

Band MHz	14-21-28	Surface Area (Sq. Ft.)	6.15
Maximum Power Input	4 Kw	Wind Loading at 80 mph	153
VSWR (at Resonance)	1.5:1	Assembled Weight (Lbs. - Approx.)	47
Impedance	50 Ohms	Shipping Weight (Lbs. - Approx.)	50
F/B Ratio (dB)	20-25	Matching Method	Beta
Boom (O.D. x Length)	2" x 18'6"	Only One Feed Line Required	
No. Elements	4		
Longest Element (Ft.)	26'7"		
Turning Radius (Ft.)	16'4"		
Mast Diameter	2" O.D.		
Boom Diameter	2" O.D.		

SHIPS BY U.P.S.!!!

Delivers outstanding performance on 20, 15 and 10 meters. Features Wilson's large diameter High-Q Traps, feeds with 52 ohms coax, a beta match method presents tapered impedance which provides most efficient 3 band matching and DC ground to eliminate precipitation static. The result is SWR less than 1.5 to 1 at resonance on all bands and maximum front-to-back. An added feature is the separate 10 meter reflector for correct monoband spacing. Add to this the rugged boom to element mounting, heavy duty taper swaged elements, and you have

SYSTEM TWO™

... a space efficient, high performing, cost effective new tribander ... value priced at \$199.95!

DEALERSHIPS AVAILABLE!!!

We are looking for new Dealers for certain areas of the country. If you are interested, contact us for details.

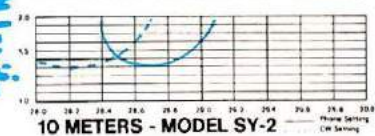
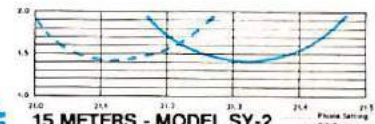
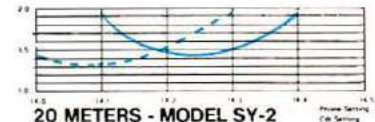

40 THRU 10 METERS VERTICAL TRAP

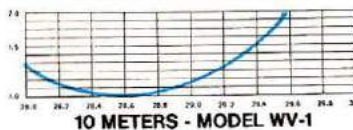
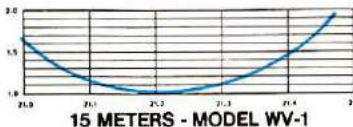
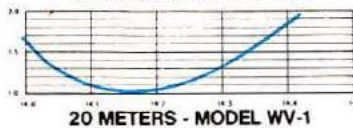
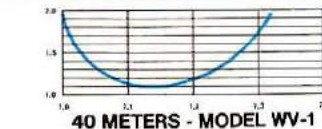

WV-1 WILSON VERTICAL TRAP ANTENNA

No bandswitching necessary with this vertical. An excellent low cost DX antenna with an electrical quarter wavelength on each band and low angle radiation. Advanced design provides low SWR and exceptionally flat response across full width of each band. Featured is the Wilson large diameter High-Q traps which will maintain resonant points with varying temperatures and humidity. Easily assembled, the WV-1 is supplied with base mount bracket to attach to vent pipe or to mast driven in the ground. The new WV-1 Antenna is priced at \$65.00 ... and ships via UPS!

SPECIFICATIONS

Input Impedance: 50 Ohms • Powerhandling capability: Legal Limit • Two High-Q Traps with large diameter coils • Low Angle Radiation Omnidirectional performance • Taper Swaged Aluminum Tubing • Automatic Bandswitching • Mast Bracket furnished • SWR: 1.5:1 on all Bands • 1½" O.D. Heavy wall aluminum tubing • Does not require guying • Overall length: 25' 1½".

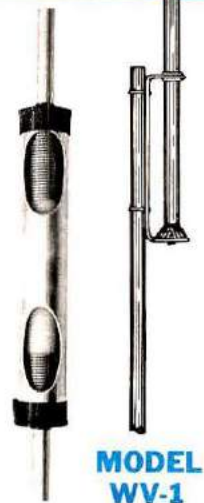

MODEL WV-1

Wilson Electronics Corp.

4288 SO. POLARIS AVENUE • P. O. Box 19000 • LAS VEGAS, NEVADA 89119
TELEPHONE (702) 739-1931 • TELEX 684-522

NEWSLINE

AMATEUR SECONDARY STATION licenses for individuals will be phased out as their present terms expire as a result of the first Report and Order on Docket 21135, adopted by the FCC on February 8th. Special events stations and callsigns were also eliminated as the Commissioners attempted to reduce the Amateur Radio workload at Gettysburg to within budgetary limitations. For Amateurs who presently hold more than one station license the effect will be a decision on their part as to which callsign to keep when it is time to renew; the freeze on issuance of new secondary licenses, in effect for almost a year, is now permanent.

Extra Class Requests for specific 1x2 or 2x2 callsigns will no longer be honored under the newly adopted rules, though they will still be able to request an unspecified 2-letter-suffixed callsign.

Club, RACES And Military Amateur station licenses are to be further considered under a new Notice of Proposed Rule Making on Docket 21135. Distinctive prefixes for club stations (WK) and military stations (WM) are also proposed in that NPRM. It's also proposed that the criteria for a club station license be tightened considerably.

FCC License Fees will probably be reinstated in the not too distant future, while at the same time many licensees will be in line for a refund on previously paid fees. The reason for this seeming paradox is that the Commission is supposed to develop and institute an appropriate fee schedule, but will then have to refund the difference between what previous applicants actually paid and what "appropriate" fees should have been when fees were in effect during the 1970-1976 period.

FCC'S Ban On Marketing 23-channel CB sets also extends to quite a bit of Amateur equipment, at least some of which was not intended. In a January 30 release explaining the ban, the FCC describes one category of equipment whose sale is strictly forbidden as "Any receiver or transceiver which has a separate band to receive CB signals and which has not been approved by the Commission..." This definition includes not only some of the frequently misused types of recent Amateur multiband transceivers, but (for example) the Collins 75A receiver series from the 1950s, when 11 meters was an Amateur band!

THE SEVERE WINTER STORMS that plagued much of the eastern United States saw Amateur Radio doing an outstanding job of providing emergency communications. Amateurs with portable equipment rode snowmobiles and four-wheel-drive vehicles to keep rescuers in touch with operations centers. Two-meter repeaters carried much of the load, with 75-meter nets providing inter-area coverage as well as some phone-patch activity. During the early part of the storms in New England several repeater operators were heard keeping in touch with mobile users who were trying to get home, and finding nearby shelter for those who could not make it. In Connecticut, radio and television stations were giving out telephone numbers for the public to use for amateur assistance in relaying emergency traffic. In the Ohio, Indiana, and Michigan storms the amateurs rode with National Guard personnel to maintain communications, often through repeaters. Throughout the area, this volunteer communications service is credited by many officials with preventing the death toll from being considerably higher.

THE AMATEUR'S RIGHT to a tower will reach the U.S. Supreme Court for the first time as a result of a long-standing battle by a West Coast Amateur with the City of Cerritos, California. An appeal challenging the Constitutionality of a municipal zoning ordinance regulating antenna height was filed with the Court in February.

OSCAR 7 WILL BE OPERATING ONLY on Mode B until further notice due to a battery over-temperature problem. Over charging is the problem, and since Mode B draws more current, the satellite will be kept in that mode until it leaves the period of maximum sunlight. Expectations are that the condition will last for about a month, and though it may switch itself back into Mode A for brief periods the command stations will return it to Mode B as quickly as possible.

Enough Solar Cell (2522) and battery cell (36) donations have been received to take care of the first Phase III satellite.

ARRL HAS PETITIONED the FCC to extend the 80-meter Novice band to 3675-3750, and to open all of 6 and 2 meters to Technicians.

A NEW ZEALAND NOVICE license with only 80-meter privileges is now available. Licensees are limited to 10 watts input, crystal controlled, on 3525-3575 kHz but may use AM or SSB as well as CW. The non-renewable license costs about \$6.00 and requires a 6-WPM code test plus a written exam on basic theory and regulations. Callsigns are ZL1-4 with an "N" suffix, as "ZL2NAA."

ZAMBIA NOW HAS a 10-meter beacon on 28202.5, operating daily from 0400-0500 and 1500-1600Z.

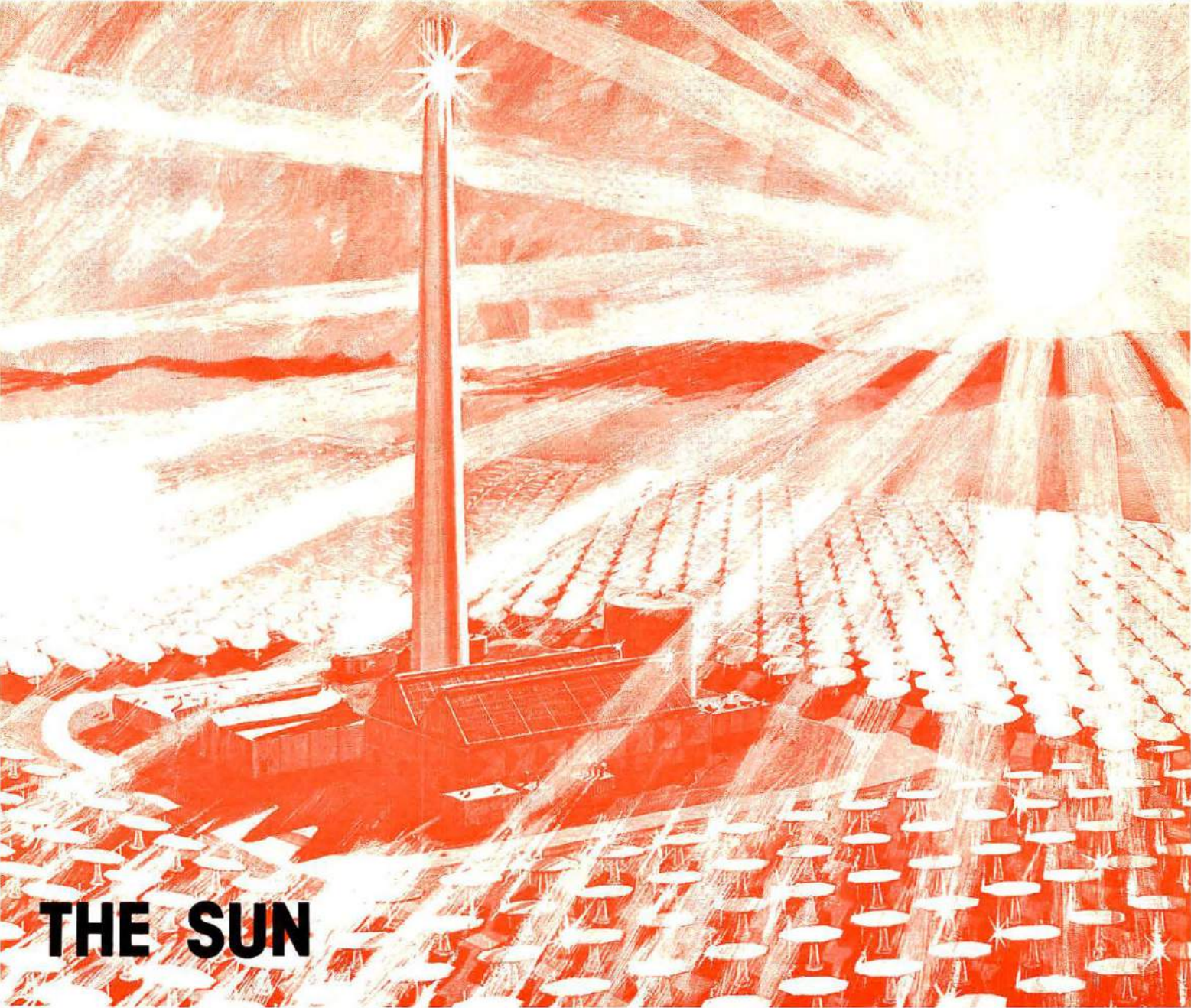

THE SUN

energy for the Ham Shack?

A source of power that is continuous — as long as the sun shines

BY THOMAS McMULLEN, W1SL

A weary hiker moves carefully along a mountain trail until he comes to a convenient boulder near a large pine. His pack stays on his shoulders as he eases down against the natural back rest with a sigh of relief.

He glances at the late afternoon sun as it hovers just above the treetops. After a quick look at his watch and a bit of mental probing of the trail ahead, he reaches to his belt and unsnaps a small radio transceiver. It's not very large — but the plastic case and clean lines speak of a well-engineered handful. A quick check to see if the frequency is busy, then . . . "WB5---this is WA5---, over." Twice again he tries the call before the

welcome response comes back to him from many miles away. "WA5---from WB5---, yeah, Clay, I'm here. What's up and where are you?"

Communications — it's great stuff, and no one appreciates it more than this hiker, who has been on the trail since sunrise. He has hiked over a pretty rugged slice of mountain wilderness this day, and his wife promised to meet him where the hiking trail crosses the main highway. There

should have been plenty of time to make the hike, but something had gone wrong with the new boots he was breaking in for a later, longer jaunt. A crippling blister had put him hours behind.

Without a means of communication with him, Clay's worried wife might have called for help to search the trail — and she would have been right to do so, even though it would have been embarrassing to him when the search party caught up. Now, thanks to a hand-held transceiver and a mountain-top repeater, he could assure her that he was okay, but would be somewhat late. It will be well after dark before he can see the lights of the cars as he approaches the highway. Good thing that there is going to be an early moon tonight.

But, wait a minute! What's this about a repeater in the mountain wilderness area? There are no power lines up there, no streams dammed up to provide hydroelectric energy, and surely no one is going to run a gasoline or diesel engine to generate watts for a repeater are they? The hand-held unit? It's only a 2-watt vhf unit, incapable of reaching across the rugged terrain the hiker has yet to cover. You're putting me on!

Nope, it's not an unlikely tale at all. There *is* such a repeater, in such a wilderness area, and it can be (and has been) used by hikers (and other radio amateurs) with just such a small, portable unit. The repeater is powered by batteries that are kept in a fully charged state by a bank of solar cells. Sun powered? Well,

The lead photograph for this article is an artist's conception of a proposed 10-million watt solar electric power plant. The mirrors track the sun, focusing the rays on a boiler at the top of the tower. The steam thus generated drives turbines and generators (courtesy ERDA).

yes, in a way. A more accurate term might be solar-electric powered, because the energy from the sun can be put to use in many forms. It is this solar-electric power that is of most interest to radio amateurs and electronic hobbyists, so I'll dwell on that type of solar energy, and let someone else talk about solar-thermal heating and what it can do for you.

There is a lot of energy available from the sun, but you need to find a way to convert it into a useful form. The satellites that relay television and radio signals across oceans, and pass thousands of telephone conversations between continents, use up many, many watts of solar-electric power. They, too, have a battery system that is kept charged by solar panels. In fact, it was this need for power sources for spacecraft that gave the impetus to an industry that had been on the back burner for a long time.

The principles of photovoltaic conversion of light

into electricity have been known since the late 1800s. Early cells were horribly inefficient, and used selenium — an element that is not particularly pleasant or safe to work with. This inefficiency, plus the readily available and cheap sources of power from coal, oil, and water, kept photovoltaic converters in the class of laboratory instruments or novelties.

As to the amount of power that reaches the earth's surface, it is the equivalent of approximately 250 watts per square meter (23 W/ft²). That means that if you take an average newspaper, open it out, and place it flat on the ground, the equivalent of nearly 150 watts of energy will fall on it on a clear day. The earth's atmosphere absorbs a lot of the sun's energy — beyond the atmosphere the power is equivalent to 1400 watts per square meter. Just think what you could do with that much free electricity, all day, every day! Hold it! Who said it was

Most arrays are mounted on a frame that can be tilted for optimum performance at any given location, like this panel from Solar Power Corporation (see address in Bibliography). If you are seriously planning an installation, they have a computer program that will determine the correct angle as well as the number of panels required to power your installation.

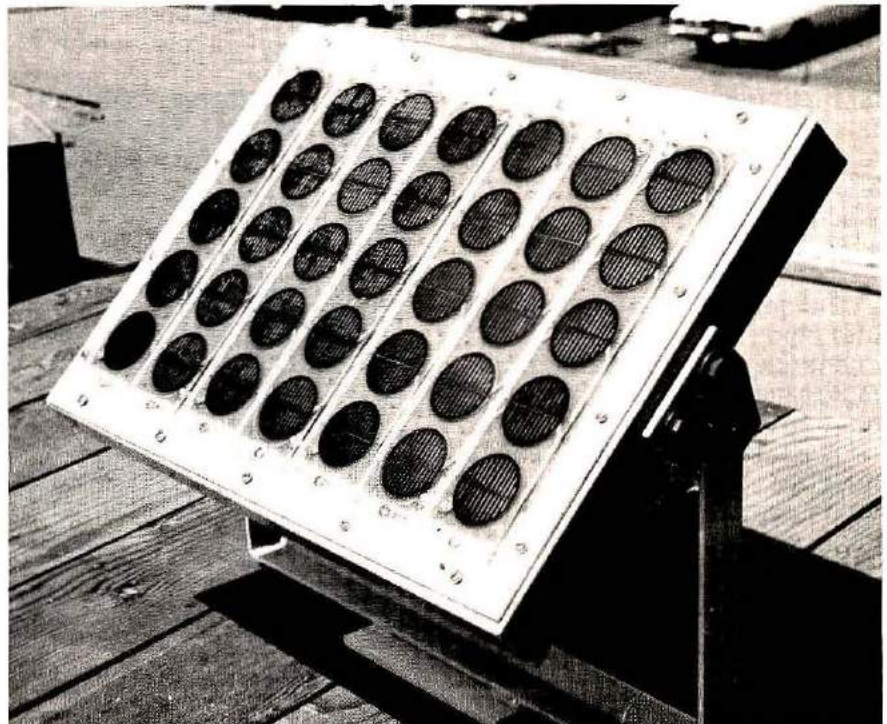

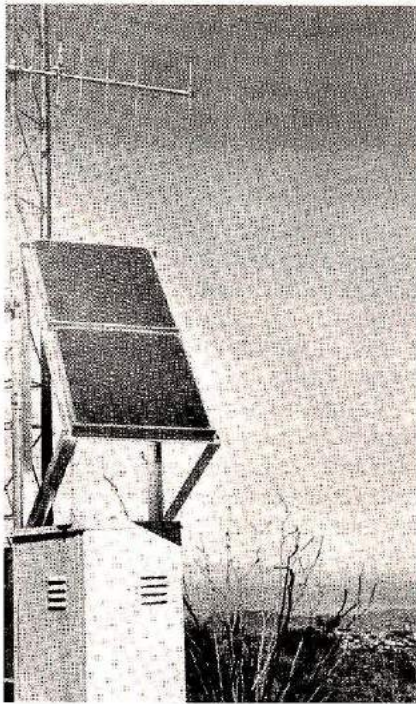

Mountain-top repeaters in locations far from commercial power lines are finding it economical to use solar-electric systems for their power. The solar-cell array is tilted to obtain maximum energy from the winter-time sun. Commercial communications services, microwave relay systems, community television (cable tv) and radio amateur repeaters are all taking advantage of this type of "sun-power" (photo courtesy Motorola Semiconductor).

free? Remember, TANSTAFU (There Ain't No Such Thing As Free Lunch). Somewhere, somehow, someone is going to have to pay something to get all that "free" energy. Before I talk about money, though, let's take a look at how you go about converting sunlight into electrical energy.

How solar cells work

The conversion of sunlight into electrical energy in quantities that are useful to the radio amateur and hobbyist is done by *photovoltaic* conversion. Silicon is the basic material that most of the technology of today is based upon, although many other materials are being investigated in a search for better efficiency or lower cost, or both.

The basic solar cell consists of two layers of material. One

layer is of silicon with an impurity (dopant) added that causes it to have a tendency toward a shortage of electrons, which means, in the terms of semiconductor theory, that it has an excess of "holes" where electrons could be. This is the "P" type material. The second layer is treated with a dopant that causes it to have a slight surplus of electrons, which gives it a tendency toward a negative charge. This is called the "N" material.

The two materials are placed next to each other, and put through a diffusion (heating) process, which causes the two layers to become inseparable along the boundary between the two types. This boundary is called the "PN" junction. Now, you might think that the two materials, one with a need for electrons, the other with a few extra ones, would just swap electrons and "holes" until both were back to normal again. Fortunately, that is not what happens. The PN junction is also a barrier that prevents migration of the electrons unless they have acquired a certain amount of energy. Here's where sunlight gets into the act. Scientists have determined that light is made up of what could be termed "particles of energy," which

they have named *photons*. These photons penetrate the layer of P material, and give up part of their energy as heat, and part of it in knocking electrons out of place. These electrons now have enough energy to cross the barrier at the PN junction — energy that was transferred to them from the photon.

The continuous flow of sunlight (photons) into the P layer creates a supply of electrons with enough energy to cross the barrier, which in turn causes the N layer to have a great surplus of electrons — great enough that they can flow through the external circuitry to return to the "holes" in the P layer, where the process starts all over again, see Fig. 1. On the way from the N to the P layer, the electrons do some useful work for us, such as charging batteries, powering motors, providing energy for electronic equipment in spacecraft (satellites), and so on.

The basic efficiency of a solar cell is determined by how much of the sun's energy it can convert to electron flow, instead of just letting the sunlight heat up the material. Today's manufacturing techniques allow efficiencies of approximately 15 per cent

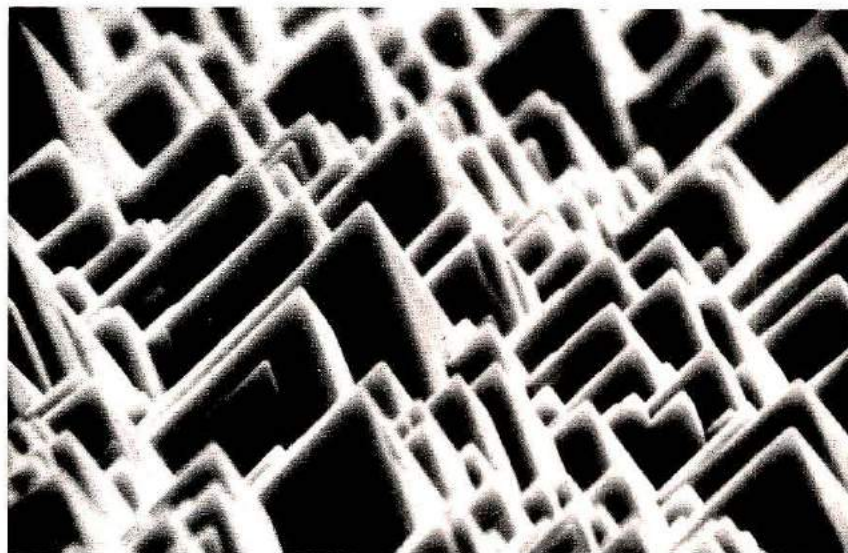

Energy that is reflected from the surface of a solar cell is lost, so Motorola Semiconductor has developed a textured surface for their product. The thousands of tiny pyramids trap the light for less reflection and more effective use.

with silicon material. Other semiconductor materials, such as cadmium sulphide, are being investigated in a search for lower-cost cells, but to date CdS solar cells have an efficiency of only 6 to 8 per cent.

What are the problems?

At the moment, the biggest hang-up in the search for more efficiency and lower cost seems to be in techniques of handling the silicon. However, the situation is more complex than that simple statement would indicate. Silicon, as an element, is abundant — the rub comes in when you try to get *pure* silicon. The process of making semiconductor material requires that you refine or treat silicon until it is virtually free of contaminants (which can be one or several of the other common elements), and then add a precise amount of a specific impurity to obtain just the right function. As I mentioned before, you need an excess of “holes” for P type material and an abundance of electrons for N type material. If you add boron to silicon you get P-type material; adding phosphorus to silicon will produce N-type semiconductor material. The impurities must be added in just the right amount for best performance, which means that the process must be very closely

controlled. This might be relatively easy to do in a laboratory, but is a different matter when you try it in production quantities.

Silicon material has heretofore been “grown,” or pulled, in crystalline form, out of a pool of molten stock. The resulting crystal is usually between five and seven centimeters (two to three inches) in diameter and ten or more centimeters in length. This ingot must be cut into thin wafers, which is done by sawing it with special diamond-tipped tools, much in the same way you would saw disks of wood from a log. The process is time-consuming, and requires considerable energy and much manpower for the several operations that take place. Additionally, it must all be done in an environment that is cleaner than most hospital operating rooms.

New techniques

It is somewhat obvious that if you can reduce the number of operations needed, or the amount of energy required, to produce the silicon base-material, then the cost of solar cells will decrease accordingly. This is an area in which a tremendous amount of research is being conducted. Present investigations include a method of “growing” silicon in a ribbon or flat sheet, which



A photovoltaic demonstration kit is being marketed by Solarex Corporation, 1335 Piccard Drive, Rockville, Maryland 20850. It is intended for educators and demonstration purposes. The kit contains 19 component parts. The cells are mounted in modules that plug together; meters, buzzers, motors, and other components are similarly mounted for ease in assembling a system. An 8-page demonstration booklet describes some circuits and characteristics of solar cells. The kit price is \$299.95 in single-lot quantities.

can be easily scribed and broken into wafers of the required size. Another scheme is to use capillary action to induce molten silicon to travel through a narrow slit, moving upward in a continuous flow which is cooled, and the resulting ribbon guided to a scribing and separating machine. The object, in addition to lower processing costs, is to obtain a larger surface area, which increases the current-producing ability of the wafer.

However, all of these developments take time — first to prove the theory that a given process will work, then to implement the changes in machinery that are necessary for production to begin. Manufacturers are rightfully cautious, because they know that research is far from complete; a breakthrough in any one of several areas could make today's methods as obsolete as a horse and buggy almost overnight. You're not likely to see production lines grinding out low-cost solar cells by the millions in the immediate future. Today's production is bolstered by the needs of various space programs; research into new

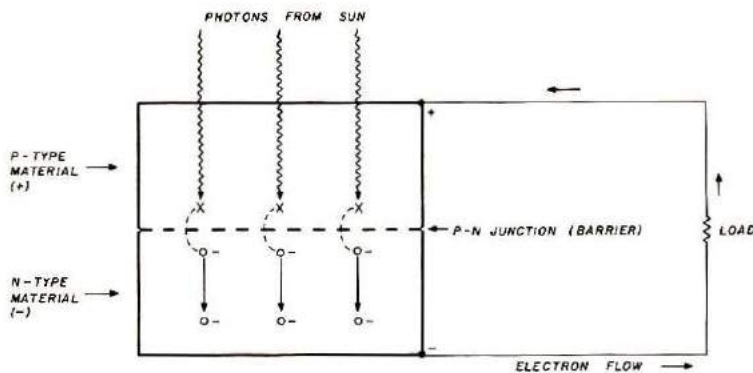

Fig. 1. A silicon solar cell is made up of two layers of semiconductor material, which have had impurities added in controlled amounts to produce either P or N type material. Energy from sunlight (photons) penetrates the material, and creates free (unattached) electrons, which then have enough energy to cross the PN junction, or barrier, between the two sections. The electrons can then travel through external circuitry to perform work in the form of electricity.

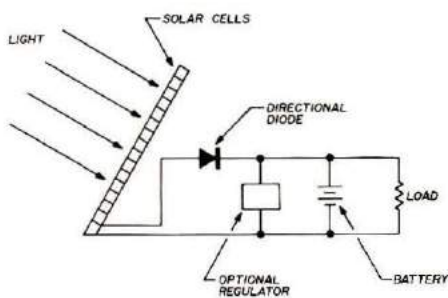

Fig. 2. A system to use solar-electric power on a continuing basis requires a battery for storage, a regulator to prevent overcharging and damaging the battery, and a diode that prevents the battery from discharging back through the solar array when the light-level is too low. Most systems use a shunt regulator because it does not introduce any loss in series with the power from the array.

materials and techniques is largely funded by grants from the Energy Research and Development Agency (ERDA), and, to some extent by private corporations such as Exxon and Mobil.

Is solar power economical?

If you ask the question, "Is solar-electric power cheap?" the answer is "No!" This can be seen from the fact that an array which will produce one ampere at 12 to 14 volts costs between \$200 and \$400, depending upon who manufactured it and what type of mounting, enclosure, or protection is used. However, solar-electric power can be *economical*, depending upon what you want to do with it. For instance, to run a power line to a remote mountain-top site to power a repeater station could cost from \$6000 to \$10 000 per mile. However, a well-engineered, solid-state repeater could use a solar-electric system that costs only a small fraction of those figures — even if you include the cost of energy-storage (batteries). Indeed, such repeater installations do exist, both in the world of commercial radio and television services and in amateur radio. I'll tell you more about amateur repeaters shortly.

There are several schemes being tried in an effort to increase the efficiency, thereby lowering the cost, of producing solar-electric power. One of the more obvious ones is to concentrate the sunlight so that a cell receives more than the amount of energy that would directly fall upon it. This has advantages and disadvantages, as you might expect. The advantage is that it does work — concentrated sunlight increases the current flow from a solar cell, in direct relationship to the degree of concentration. However, too much of a good thing will melt the cell! It doesn't take a very large surface, highly polished for good reflectivity, to generate enough heat to melt silicon at 1410°C (2570°F). Even before the melting point is reached, the heat begins to take its toll by way of reduced output from the cell; present semiconductor materials are temperature sensitive. This heat must be conducted away from the cell, which adds cost and complexity to the system.

Some enterprising experimenters have used this excess of heat to good advantage — the plumbing that carries the coolant away from the solar collector can go to a heat exchanger to provide hot water or space heating. They found that for every 1-kW of electrical energy received, they also got 5 to 6 kW equivalent of thermal energy. Don't rush out to cover your house with cells and heat exchangers, however.

Bright, direct, sunlight, combined with a proper tilt angle, allows the solar array to charge a weak battery at the 2-ampere rating of the array.

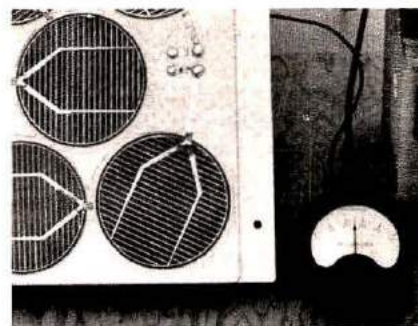
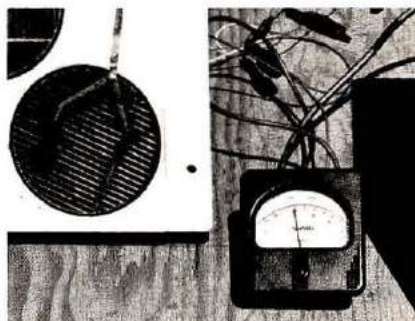

Even the diffuse light from a heavy over-cast sky provides a small amount of charging current from the solar-cell array. Moments after this photograph was taken a downpour forced the author to grab the camera and retreat to shelter. The cells continued to charge the battery at a 250-milliampere rate even though it rained hard for a couple of hours.

With the price per peak watt at \$15 to \$20, you'll spend better than \$1500 for the cells alone — to which must be added the installation and wiring and storage costs. Current estimates of using solar-thermal energy for home heating start at \$5000 and go upward, so the combined cost for a dual system could start at \$6500 or more. Like many ideas, the system looks great in the laboratory, but the scheme falls apart when you and I have to pay for it.

Another bugaboo in the concentrated-sunlight system is that you must track the sun for best efficiency. That involves a mounting scheme with bearings and drives for motion in the east-west plane, to follow the daily movement of the sun, and a provision for adjusting the tilt for seasonal movement.

On a large scale, however, a concentrated-energy system does hold promise for obtaining power at competitive prices. The lead photograph accompanying this article shows an artist's conception of a proposed solar concentrator that is to provide 10 megawatts of power. This is hardly the kind of thing that you could install in your average backyard; no information is given on the size of the field, but the tower is supposed to

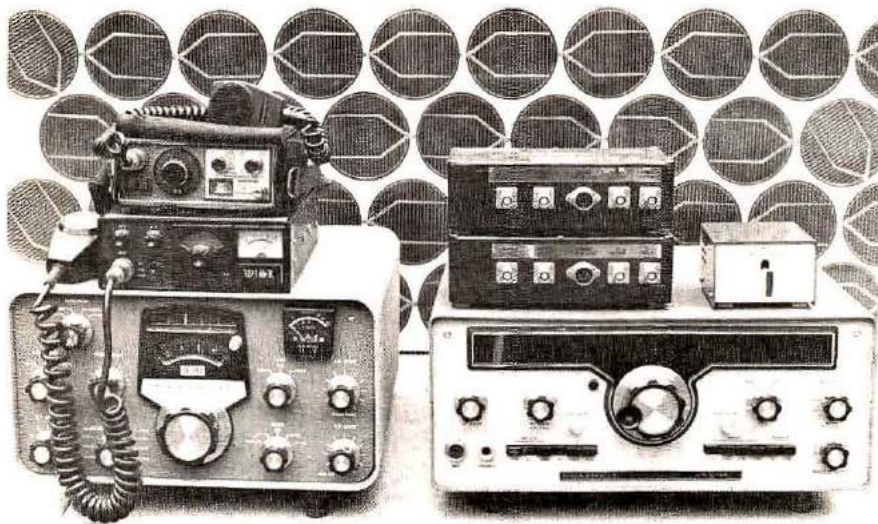

An assortment of equipment from the author's station that can be operated by the panel in the background (a Solar Power Corporation M12-4010). The equipment includes a Heath SB-303 receiver, Heath HW-104 transceiver, Midland 220-MHz mobile fm transceiver, Kenwood 146-MHz fm portable transceiver, Microwave Modules transmitting and receiving converters (one for 144 MHz, one for 432 MHz), and an MFJ Enterprises electronic keyer. If the HW-104 transceiver is to be used at full 100-watts output, a power or time budget will have to be followed to prevent depleting the storage battery, as explained in the text.

be 86 meters (282 feet) high. Even if you use a conservative scale to judge the size of the field, that's a lot of mirrors!

A bounty for Pitcairn

Solar-electric power is reaching out to such a remote place as Pitcairn Island, in the Pacific ocean between South America and New Zealand. Since the island is an isolated spot with no fuel resources of its own, electricity has been an expensive luxury — available only at specified hours and in limited amounts. Many radio amateurs around the world have waited in line to talk to VR6TC, Tom Christian, a direct descendant of the Christian of *Mutiny On The Bounty* fame. Tom is an active ham, and loves to talk with people everywhere, but all too often his chats must be cut short because of the limited power available on the island.

Things may be looking better, thanks to some California students and their counselors. A 5-kW solar-electric generating system is destined to be sent to Pitcairn as part of a project started by a high-school physics class.

The generator is named Sunfire I. It started in 1974 when Howard Broyles got Jim Akers and his physics class at Crescenta Valley High School interested in research and construction of a solar-electric generator. The project was almost lost when the site the class had planned to use became unavailable. Another site was found, thanks to the Jet Propulsion Laboratory and its Space Explorer Post. There it was named the Solar Energy Experimentation Project (SEEP), and the experiment continued, eventually to be renamed Sunfire I.

In operation, Sunfire's parabolic mirror will direct rays from the sun to a boiler located at the focal point. The energy creates steam in the boiler, which is used to drive a turbine to create electric power. A double-turbine set of alternators is used to extract the most power from the steam. After the steam has passed through the turbine blades, it is converted back to water in a condenser, and injected into the boiler for reuse.

The mirror and boiler must

track the sun, of course, and this is done by means of a winch to allow for seasonal position changes, and by an electric motor to drive it in the east-west direction.

In addition to providing a better supply of electricity for Pitcairn Island people, the project proved that enthusiastic high-school and college students can acquire the skills and knowledge necessary to build a complex power plant that takes advantage of modern technology.

Today's uses

There are a number of unique applications of solar-electric energy that are noteworthy in spite of the high cost of materials and cells. For instance, helping corn to grow in Nebraska. At first glance, something doesn't seem right about that — Nebraska has plenty of sunshine and a warm climate, and does pretty well with its corn crop. However, researchers at the University of Nebraska test site at Mead found that the corn yield per acre was 150 to 180 bushels; the state-wide average is 135 bushels. They obtained the increase, in part, by irrigation techniques which used solar-electric power to drive the pumps that brought water to the field from a holding pond.

The array of cells consists of two rows, each 99 meters (325 feet) long. They can be tilted for maximum conversion efficiency, and the peak output is 25 kW. There are 97 000 individual cells in the array, supplied by Sensor Technology, Inc. of Chatsworth, California, and Solarex Corporation of Rockville, Maryland. The contractor was Lincoln Lab, of Lexington, Massachusetts, who worked with the University of Nebraska's agricultural engineering department on the contract from the Department of Energy. This corn-growing experiment is all part of the exploration to see what can be done with solar electricity.

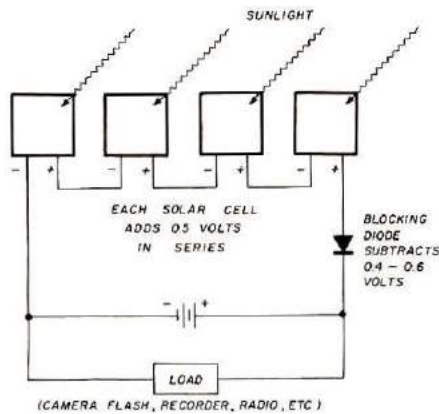

Fig. 3. A solar system for light hobby uses can be made from several low-cost cells. To figure out what you need, obtain the battery voltage of your device and then calculate the number of cells needed at 0.5 volts each. For example, for 8 Nickel-Cadmium cells at 1.2 V each, you have a total voltage of 9.6. You'll need more than the total voltage to provide charging current, so figure about 10.5 volts, plus an extra 0.5 volt for the loss in the series blocking diode, for a total of 11 volts. At 0.5 volts per solar cell, you'll need 22 cells.

A predictable use of solar cells that is beyond the experimental stage is to power electronic equipment in remote areas, where it would be just too expensive to bring in electric power from commercial mains. This is being done in many parts of the country — a remote marker beacon for airline guidance in Alaska, microwave relay stations in the Rocky Mountains, a low-powered television relay that provides services for several families in an isolated Colorado valley, and warning lights at a railroad crossing in Georgia.

Amateur repeaters

The hiker at the beginning of this article was hypothetical, but the repeater is not. There is such a repeater, in the midst of a wilderness-recreation area in New Mexico. It puts approximately 4.5 watts into the antenna and is located at an elevation of 3430 meters (11,250 ft). Because of the trees at the site, the solar panel is located at the top of the tower to get the maximum sunlight available. The batteries (jelled-

electrolyte types) and the entire receiver/transmitter/control circuitry are placed in a sealed, locked, metal drum and buried! This keeps the temperature constantly above freezing during the long periods when the wind and snow would make it miserable at such an elevated location.

While it was not designed as a DX repeater — it provides excellent coverage in north-central New Mexico — there have been some instances where stations 400 km (250 miles) apart maintained solid communications through it. This repeater, WR5ARO, is on the amateur repeater frequency pair of 146.19 (input) and 146.79 (output) MHz.

I have heard of two other amateur repeaters that use solar-electric power: one on Capitan Peak, in New Mexico, "buys" its power from a commercial solar-electric installation which also provides power for other electronic equipment. Another repeater is in southern California. It was tested during the past summer at a convenient location to check the reliability of both the equipment and the solar panels. As this is being written, the amateur crew is moving it to a remote location for

permanent service.

It's almost a sure bet that there will be more amateur repeaters with solar-electric power sources as the cost of solar cells drops. Sometimes modest output power from a superior location is a good tradeoff against the availability of commercial ac service.

Solar-powered contacts

Radio amateurs were right in the forefront in investigating this use of "free" power for transmitters and receivers. The cover of the September, 1955, issue of *QST* shows a Field-Day setup that was operated by Laird Campbell, W1CUT.¹ The transmitter was a crystal-controlled, transistorized, oscillator on the amateur 1.8-MHz band. It was powered by six International Rectifier B2M solar cells, which provided almost 3 volts at 2 milliamperes. This was the first amateur use of solar-electric power for transmitting and receiving that I am aware of, and certainly it was the only one to gain publicity for many years afterward. Ed Noll, W3FQJ, has been working with solar-electric power for amateur-radio use, and he reported on some of the possibilities and experiments

Fig. 4. This map shows the daily peak-sun hours for North America, averaged over a 1-year period (chart courtesy Solarex Corporation).

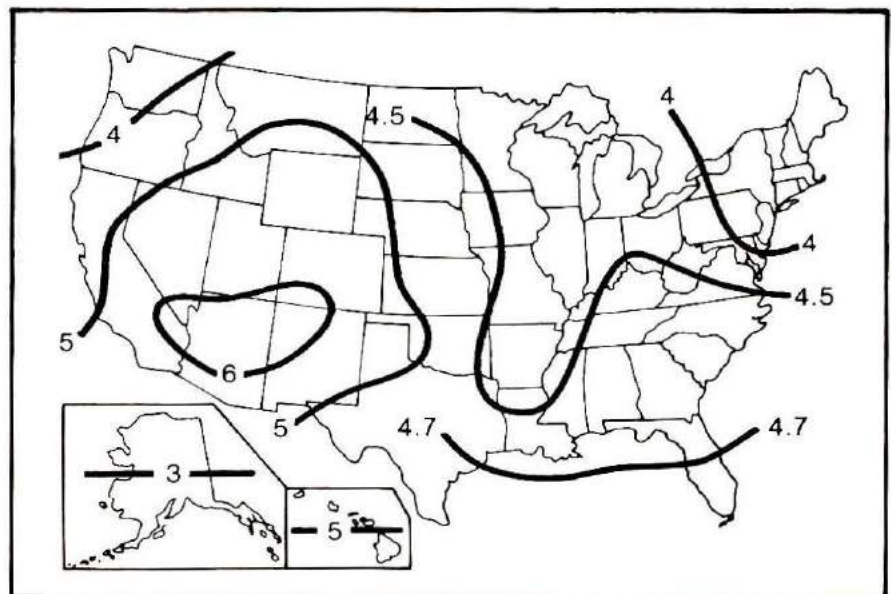

in his "Circuits and Techniques" column in the July, 1974 issue of *ham radio*. He has also written a book that includes a discussion and photographs of solar-powered amateur station equipment (see Bibliography). A more recent example of the capabilities of a solar-electric system for amateur use was detailed by W1FB in a review and description in *QST*.²

It is the nature of amateurs that many have been experimenting with such cells

through OSCAR, you have used solar power.

You can do some experiments, and even find some useful applications, with solar energy without spending a bundle on hardware. The first use that I made of solar cells was to charge up the AA-size cells in the flash attachment for my camera. I picked up several cells in "blister-packs" at a local hobby shop and mounted them on a piece of stiff cardboard with strips of transparent tape. By propping

charge your batteries while you await your turn at flying, racing, or whatever.

Pocket calculators? Sure, there's nothing to it. As long as you have a source of sunlight for a part of the day you can use it to keep the batteries in peak condition. Just find out what the voltage should be to charge them at a safe current, and wire up enough solar cells in an array to do the job (Fig. 3). Don't forget the isolating diode between the array and the batteries — it's there to

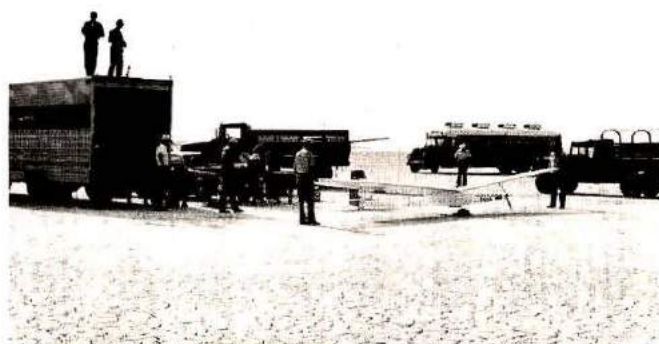
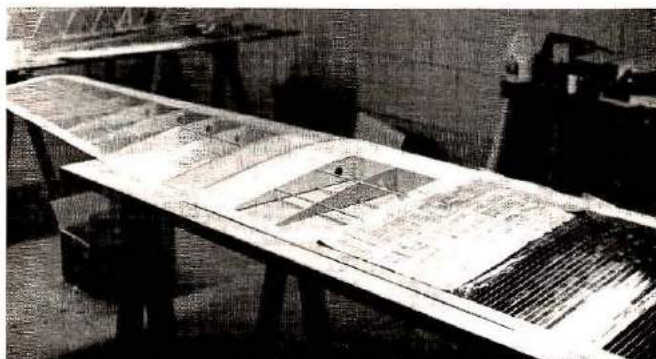

The first solar-powered flight took place on November 4, 1974, with the Astro-Flight Model 7404, shown above being prepared for takeoff at a Nellis (California) test range. Model 7402 made a longer flight on September 27, 1975, which lasted 3 hours and 25 minutes and took it to an altitude of 5.24 km (17000 feet). The photograph at right shows some of the thin solar cells installed on a wing section where they can receive full sunlight. The flight was under full radio control and had a sun-position navigation system to augment visual tracking. The planes, named *Sunrise*, have a wingspan of 9.7 meters (32 ft), a length of 4.3 meters (14.3 ft), and a gross weight of 10.3 kg (22.8 lbs). The radio equipment on board included a telemetry system (photos courtesy Astro Flight, Venice, California).

as are available to them from laboratories, business connections, or surplus markets. Who will be the first to report an entire year's operation powered exclusively by the sun?

Then, too, we cannot forget OSCAR — the amateur transponder satellites that have provided thousands of contacts between amateurs all over the world. Oscar 6 was in operation for 56 months before its internal batteries developed problems that shut it down in June, 1977. Oscar 7 is still going strong, recharging its batteries from solar panels on the outside of the spacecraft. New amateur satellites are being built which will, of course, rely upon large solar panels for their continued functioning. If you've worked

the array up in a window for a few hours each day, I kept the Nickel-Cadmium cells charged and ready to go. At one time, flash photographs that I took in a Colorado conference room were illuminated by New England sunshine!

Economical? Of course not, but it was fun!

There are similar things you can do with solar cells: how about keeping that emergency flashlight in your car or home charged up by sunlight. Just replace the normal cells with Nickel-Cadmium cells, and wire up an inexpensive solar array to charge them. Are you a radio-controlled model enthusiast? Chances are that the batteries in your transmitter and in the model are already rechargeable, so all you need to do is add the solar array. Then you can

prevent the batteries from trying to discharge back through the array when there is not enough light to charge the batteries.

Would you like to join in (or listen to) an amateur get-together that has to do with solar energy (in part)? Fine! Tune in on the Alternate Sources of Energy Net. It meets every Sunday at 2:30 pm, Eastern time, on 14344 kHz. The exact frequency may vary a few kHz because of interference, but you'll find net control station W4VPD, of Miami, Florida, conducting sessions that have to do with all sorts of energy sources from windpower to water and sunlight.

Solar cells fly high

Speaking of unusual appli-

cations of solar-electric power, here's one that really is — a solar-powered plane! Yep, they really did it, twice! Two special sailplanes (sometimes called gliders) were built by Astro-Flight of Venice, California, and then electric motors were installed, along with an array of solar cells to drive them.^{3,4} The planes were approximately 4.4 meters (14½ feet) long, with a wingspan of 9.7 meters (32 feet). The upper surface of the wing held an array of solar cells that could provide over 500 watts. The electric motor was a 0.6 horsepower, permanent-magnet type.

The first plane flew well, with radio control of its movements, to an altitude of 900 meters (3000 feet), where it encountered extreme turbulence which destroyed it. A second one had better luck. It flew for 3 hours, 25 minutes, and climbed to an altitude of 5.2 km (17,200 feet)! Calculations indicate that it could have tripled that altitude and stayed airborne for more than 18 hours!

Down to earth

Land-bound vehicles are trying the solar-cell routine too. Mr. Wallace Moore in the Los Angeles, California, area is testing a solar-electric powered Honda CVCC car. At the moment it is not completely reliant upon solar energy, (the original engine and drive train can be used, too), but Mr. Moore is driving it in everyday use to see what the problems are and how they can be worked out. He has an array of 9 modules mounted on the roof. Each module contains 44 cells, and the total charging current in full sunlight is 3 amperes. In addition to the high cost of the solar cell array (\$2700), the weight and inefficiency of the batteries that power the car are a problem. Better batteries and less expensive solar cells are in the works, however, so he



Old vehicle meets new power source — a 1912 Baker Electric horseless carriage was fitted out with a solar panel by International Rectifier as part of their research and demonstration program. The 10640 individual cells provide a combined power output of approximately 200 watts to recharge the vehicle's batteries. The 12 batteries and 3-horsepower motor give the Baker a range of approximately 80 km (50 miles) and a top speed of 32 km/hr (20 mph) (photo courtesy International Rectifier Corporation).

has hopes for the future of his project.

The Moore experiment is not the first, however. In 1960 International Rectifier Corporation fitted out a 1912 Baker Electric automobile with an array of 10,640 solar cells, which provide 200 watts to charge the batteries. The auto is still used from time to time as a demonstrator. Eighteen years in the solar-electric age? Most modern cars don't last that long!

Who's who

Of course, you are curious about who is manufacturing solar cells, and what is available to you as an experimenter or user.

The Department of Energy (Energy Research and Development Administration) is sponsoring many projects through contracts to manufacturers. Some of the projects are to test the uses of solar cells, and others are to find new or better means of manufacturing them. The goal is to bring the cost down to 50

cents per peak watt of output power by the year 1980. (It is now approximately \$15 per peak watt, which is half what it was two years ago.)

A list of those active in the solar-electric field reads like a who's who of industry — a lot of familiar names, but with plenty of new ones, too. Some of the more prominent ones include Solar Power Corporation, in Massachusetts; Sensor Technology, Inc., in California; Solarex Corporation, in Maryland; Spectrolab, in California; M7 International, in Illinois; Mobil Tycho Solar Energy Corp., in Massachusetts; Motorola Semiconductor Products, Inc., of Arizona; Westinghouse Research Labs in Pennsylvania; and Texas Instruments in Texas. It is interesting to note that several of the firms long associated with other forms of energy also have divisions or subsidiaries at work on Solar energy: Shell Oil (Solar Energy Systems, Inc.), Mobil Oil (Mobil Tycho Solar Energy Corp.), and Exxon (Solar Power Corp.).

Most of these firms are investigating or manufacturing the end product — the completed cell or array. There are dozens of others working with the process of producing the raw material of which solar cells are made. The technique of growing pure silicon is under investigation by several firms, and the search for new materials is being pressed forward in many university and commercial laboratories.

There are, fortunately, some items of solar-electric hardware available to you now. As a starter, I would recommend that you write to Poly Paks, Box 942, South Lynnfield, Massachusetts 01440; or Edmund Scientific, Edscorp Building, Barrington, New Jersey 08007, and ask for their latest catalog. They have several sizes of solar cells listed, at prices that are not beyond reach. You can figure out what you would like to do

and obtain the cells needed. Admittedly these are "fall-outs" from space programs or manufacturing runs, and some may be slightly flawed, but they work, and can provide hours of experiment or useful energy for you. A word of caution: unless you are experienced at soldering to very-thin-film material, buy only cells that have wire leads attached. If you use the wrong heat or solder, the metallization that is your only connection to the cell will pull away, leaving you with an interesting but useless piece of silicon.

You can obtain an educator's demonstration kit from Solarex Corporation, which is designed to acquaint people with the principles of photovoltaic conversion. It contains 19 component parts, including meters, cells, buzzers, motors, and an instruction booklet (see photograph).

There are several surplus houses that advertise solar cells in the various electronic and amateur magazines from time to time. Many of these are good buys for experimental purposes or for use where access is not a problem. I would not, however, use a surplus panel as part of a system that was in a remote location with no ready access; the reliability of a tested and guaranteed unit brings greater peace of mind than the money you would save by going the surplus route.

You'll find solar cells advertised in popular magazines for science, mechanics, and hobby fields, too. It is wise to shop around for price, however. Some of the surplus houses will charge all that the trade will bear, and others may be able to offer a better bargain because they made the right deal on a volume or bulk purchase of leftover units.

The first thing you should do when you obtain some cells is check them for output in sunlight. The voltage, with no

load, will usually be close to 0.5, sometimes as low as 0.45, from each cell. The current through a short circuit will depend upon the surface area of the cell, so you'll have to go by the seller's figures in testing for current capability. Don't worry, a momentary short circuit will not injure an individual cell, but don't check a large array in this manner. If a cell fails to meet advertised specifications, send it back immediately. Unmounted cells are very thin and brittle, so handle them as if they were glass (which they are, in a way).

M-7 International, of Arlington Heights, Illinois, has a low-cost power package that includes the solar cells and a battery pack. Called the *Sun-tap 1*, it is designed to power small radios, calculators, tape recorders, and the like.

There are plenty of sources of solar cells available to both the experimenter and the serious user. At the present rate of development, you should see more of the lower cost arrays appearing on the market, and this, coupled with the rising cost of conventional energy, should make solar-electric power more attractive for amateur and electronic hobby uses.

Power for an amateur station

About this time you're probably asking "what will I need to run my station from solar power?" If you do some careful figuring, you'll know just what size and capacity solar panel you'll need to run the equipment you have. For example, the photograph shows an assortment of equipment from my shack, all of which can be operated from a solar-panel/battery-storage system. The heaviest user is the HW-104, of course. It's a 100-watt (output) transceiver, which uses 20 amperes at approximately 13.8 volts, when the key is closed, on CW. The drain is not much different when I use ssb; the ratio of

time between peak drain and minimum drain may vary slightly. That means that the rig will use approximately 275 watts from the battery when I am transmitting. The period of time during which that amount of power will be used will vary, of course, but for the sake of discussion I'll say that I operate approximately 2 hours an evening. Presumably I'll be listening as much as I transmit, so, in effect, I'll be using 275 watt-hours of electric power from my storage system. The receiver uses approximately 20 watt-hours during the same evening. If I am monitoring one of the local vhf channels with some of the fm equipment, that can easily add another 5 watt hours, which makes the total drain for the evening a convenient (and surprising) 300 watt-hours. (Add up the energy use for your own shack, or home, sometime; it'll surprise you.)

The solar panel in the photograph with the equipment is capable of charging a 12-volt battery at approximately 2 amperes, in full sunlight. However, the peak-sun-hours chart (Fig. 4) for this part of New England shows that I'll receive an average of only 4 peak sun hours per day. That means I'll receive 4 x 24, or 96 watt-hours of energy into my storage, while I am taking 300 out! A bank account cannot last long with an overdraft like that! Obviously, I will need 3 panels of 96 watt-hours capacity to maintain that level of activity, and power output.

Another approach would be to figure the energy supply and requirements on a weekly basis, and readjust my operating hours to stay within that budget. At 4 peak sun hours per day, I'll have a weekly input of 28 peak hours, at 24 watts per hour, giving me 672 watt-hours per week. Since I know that my station is using 300 watts at full output, this tells me that I'll have just a bit more than four hours operating

time (50 per cent transmitting, 50 per cent receiving) before I exceed the budget. (Except for vhf contests, that's more than I should be at the rig anyway!

Of course, I could stretch a point and figure that I'll get more power than that, and in the summertime I probably will; the daylight hours start earlier and end later. However, the information from the chart (Fig. 4), is used by engineers to calculate the needs of a solar-electric system for reliability on a worst-case basis, so I'll be smart to follow their lead. Otherwise, I might suddenly find my station incapable of operating after a week of cloudy weather.

You can see that operating a station from solar power involves knowing how much power you need, and how much is available, and then sticking to your power budget. It is also somewhat obvious that if you want to run the legal amateur power limit, your cost for solar panels is going to be tremendous. The use of electronic equipment that is not designed for 12 Vdc is also a problem. There are converters that will transform the 12 Vdc into 115 Vac, but that will add to the expense, and their inefficiency will require more storage and make-up facility for the same amount of rf power out of your rig. I can increase the reliability of my system by providing an additional source of energy to recharge the batteries, such as a wind-powered generator, and I most likely will do so. However, that is part of another story.

So far, I have talked about the cost of solar-powered stations, and shown some of the problems in maintaining an operating system. If you are wondering why I would bother, I'll go over some of the reasons in favor of such a system.

Independence plays a large part in my leaning toward solar-electric power; I know that no matter what happens to the wires from the power company

to my house, I'll have the ability to use my amateur equipment for either personal or public-service communications. As solar equipment becomes lower-priced, the system can be expanded to provide other needs, such as higher power capability and minimal lighting.

Then, too, there is that indefinable satisfaction that comes from being in on something as new as the space age. Here is a technology that has been developed within the lifetime of most of us, and is

available for my use. Also, using such a system, and telling people about it in print and over the air, will make more people energy-conscious. Oh, sure, there will always be someone who will demand a 2-kW ego trip, just as there'll always be some who will insist on driving a Cadillac when the price of filling the tank has increased to \$5 per gallon. I guess you could say that obtaining energy for my hobby from the sun and wind is *my* kind of ego trip. Care to join me?

References

1. E. Laird Campbell, W1CUT, "Solarized QSO," *QST*, September, 1955, page 11.
2. Doug DeMaw, W1FB, "Solar Electric Power for the Amateur," *QST*, August, 1977, page 24; also "Product Review," page 45, same issue.
3. Larry Fogel, "Soaring" column, *R/C Sportsman*, October, 1976, page 10.
4. Robert Boucher, "Project Sunrise," *R/C Modeler*, January, 1977, page 98. Reprints available for \$1 from R/C Modeler, Sierra Madre Boulevard, Sierra Madre, California 91024.

Bibliography

1. Baer, Steve, *Sunspots*; a discussion of various forms of solar energy use, including some solar-electric; not highly technical, but useful in considering problems and advantages. 115 pages, soft cover; \$4 from TEA, Church Hill, Harrisville, New Hampshire 03450.
2. Noll, Edward M., W3FQJ, *Wind/Solar Energy*; theory and practical information about wind and solar energy. Soft cover, 208 pages; \$7.95 from Ham Radio's Communications Bookstore, Greenville, New Hampshire 03048. Order 21305.
3. *Building Blocks for Solar Electricity*; description and design information for systems using Solarex panels. Solarex Corporation, 1335 Piccard Drive, Rockville, Maryland 20850.
4. *Solar Age* magazine; a trade-journal type of publication, covering many aspects of using solar energy. United States subscription rates, 1-year, \$20; 2-years, \$32; 3-years, \$40. Solar Age, Church Hill, Harrisville, New Hampshire 03450.
5. *Solar Building and Off Peak Electricity*; booklet done by Total Environmental Associates (TEA) in conjunction with ERDA. TEA, Church Hill, Harrisville, New Hampshire 03450. Upon request, TEA will also provide a catalog of publications dealing with alternative energy forms.
6. *Solar Electric Generator Systems*; principles of operation and design concepts. Solar Power Corporation, 5 Executive Park Drive, North Billerica, Massachusetts 01862.
7. *Solar UPS*; components and uses of Solar Uninterruptible Power Systems. Spectrolab, Division of Textron, Inc., 12484 Gladstone Avenue, Sylmar, California 91342.
8. *Usable Electricity from the Sun*; five-page booklet from the Solar Energy Division of the Energy Research and Development Administration. Available from Superintendent of Documents, U.S. Government Printing Office, Washington, D.C. Stock No. 060-000-00039-5, price 35 cents. (There is a minimum order charge of \$1; for economy, order 3 and give the extra ones to a friend.)

HRH

A Component System for RTTY



ST-5000

RVD-1005

DKB-2010

Active amateur, short wave listener, beginner, or old-timer—you'll enjoy RTTY with the HAL component system. Shown above are our ST-5000 Demodulator, RVD-1005 Visual Display Unit, and DKB-2010 Dual-mode Keyboard. The RVD-1005 is a time-proven display generator that converts BAUDOT coded RTTY pulses into a video display. It receives the 4 standard RTTY speeds (60,66,75, and 100 words per minute) and generates a 25 line, 40 characters per line display. The low-bandwidth video output can drive either a TV monitor or a modified TV Set (power transformer and video connection required). The DKB-2010 will transmit these same four RTTY speeds as well as MORSE code at 8 to 60 wpm. The DKB also features N-key rollover, adjustable CW weight, HERE IS message, and internal CW side-tone oscillator. The 3-key standard buffer can be extended to 128 keys with the EMO-128 buffer option. The ST-5000 is the newest of HAL's line of RTTY equipment, offering 2-shift operation with high-performance active filter circuitry. It also has built-in AFSK oscillator and loop supply and can be factory tuned for either the "High" or "Low" frequency tone pairs. Autostart and printer control circuitry make the ST-5000 ideal for both electronic and mechanical RTTY terminals. For a high-performance and cost-effective RTTY station, the RVD-1005/DKB-2010/ST-5000 combination is hard to beat!

ST-5000

- 170 and 850 Hz Shift
- Low or High Tones
- Integral Tone Keyer
- Active Filters
- Autostart
- Meter Tuning Indicator
- Internal Loop Supply
- Attractive, Small Cabinet
- High-gain, Wide-bandwidth Limiter
- For either HF or VHF operation
- 120/240V, 50/60 Hz Power

ST-5000 \$275.00
(Specify High or Low Tones)

RVD-1005

- 4 RTTY Speeds
(60, 66, 75, 100 wpm)
- Crystal Controlled
- Baudot RTTY Code
- Unshift-on-Space
(Switch Selectable)
- Loop or RS-232 Input
- 40 Character Lines
25 Line Display
- Table or Rack Cabinet
- Use with modified TV Set
- 120/240V, 50/60 Hz Power

RVD-1005 \$395.00
(Specify Table or Rack Cabinet)

RVD-2110 Quasar TV \$150.00
(Shown above)

DKB-2010

- Baudot RTTY & Morse Codes
- 4 RTTY Speeds (60, 66, 75, 100 wpm)
- Crystal Controlled
- 8 to 60 wpm Morse Code
- Programmable HERE IS message
- N-Key Rollover
- 3-Key Buffer Standard
(128 Key with 128 EMO option)
- Quick Brown Fox test message
- Automatic FIGS/LTRS for RTTY
- Internal CW Sidetone Oscillator
- 120/240V, 50/60 Hz Power

DKB-2010 \$395.00
(Specify HERE IS message)

EMO-128 Buffer Option \$ 85.00

Write for our new catalog and RTTY guide.



HAL COMMUNICATIONS CORP.

Box 365
Urbana, Illinois 61801
217-367-7373



For our European customers
see HAL equipment at:

Richter & Co.; Hannover
I.E.C. Interlco; Bissone
Primetek Systems; Handen, Sweden
Radio Shack of London



*"Fire is the
most useful
of all
servants,
the most
fearful
of all
masters"*

THOMAS CARLYLE, 1843

FIRE PREVENTION IN THE HAM SHACK

BY

JAMES R. FISK,

W1HR

FIRE! Sirens wailing through the cool night air, the staccato of unmuffled engines punctuating the urgency as trucks dash to the scene; the victims huddling in their night clothes as the flames dance against the blue-black sky. By dawn all that remains is a smoking hulk. What yesterday was a home full of laughter and warmth is today a ruin of ashes and debris. Fire, that most fiendish of all nightmares, has struck again.

Every year fire causes billions of dollars of property damage and leaves thousands homeless, and of the many house fires reported daily in the newspapers, a large percentage have electrical origins: overloaded electrical circuits, poor connections, faulty wiring, lightning — practically all could have been prevented, but the precautions are so simple they are often overlooked.

As a matter of fact, when was the last time you made a fire-safety check? If you're like most amateurs, it probably never occurred to you that you should even make such a check, yet wherever there is electrical or electronic equipment, there's the chance of fire, and if your ham shack is like most, it's probably full of radio and electronic gear.

A fire in your ham shack is always likely to be or to become an electrical fire, and there are always other fire-prone materials around a busy shack to fuel the flames once they get started. Let's look at some of the most common hazards, and work up a fire-safety check list for the future.

Electrical fires

First, exactly what is an "electrical fire?" Well, it almost always begins with an arc. When insulation breaks down or the applied voltage is too high for the insulation, an arc occurs. And the temperature of an arc, even a tiny one, can be a thousand degrees or more. The heat can melt ordinary

insulating materials, crack ceramic insulators, char printed-circuit boards, and raise havoc in general.

Continued arcing can carbonize insulators, turning them into good conductors; carbon encourages the arc, which gets hotter, carbonizing more of the insulator, and on and on. The heat melts insulation on nearby wiring which eventually breaks down, causing even more arcing. If there's any flammable material nearby, you're going to end up with a real conflagration; at the very least you're going to have a mess on your hands. If you can stop the arc as soon as it gets started, however, the equipment will easily keep its own cool. Fuses are designed to do exactly that.

Fuses

The best way to stop any fire is to keep it from getting started. What that boils down to in electrical fires is to provide fuse protection for all the electrical equipment in your ham shack. Some hams seem to have the idea that, "What the heck, it's only 110 volts," but what they have forgotten is



The Heinemann Electric *Re-Cirk-It* (top) protects electronic circuitry like a fuse (bottom), but can be reset. It is designed to be installed in the same panel space as a conventional fuseholder. The *Re-Cirk-It* is available with current ratings from 0.25 through 10 amperes (photo courtesy Heinemann Electric Company).

that 110 volts has all the current it needs to burn your shack to the ground — and it's the current that makes an arc so hot and destructive. Remember that an arc welder uses relatively low voltage but the 100 amps or more that flow through its electrodes can melt steel!

Fuses are affected primarily by current; the voltage rating printed on the fuse is put there so you won't use it in a circuit where the voltage is so high that an arc could form across the fuse after it has blown. When electronic equipment is properly fused, the fuse will carry the normal load but will open up instantly when there is a serious current overload (such as that caused by an arc).

Fast-acting fuses which will blow in a few seconds with as little as 150 per cent of the rated current are commonly used to protect radios and electronic instruments; slower acting "slow blow" types are used in equipment which has heavy starting currents such as electric motors and capacitive input power supplies. Both types, however, open up almost instantly when there is an overload of 200 per cent or more (see Fig. 1).

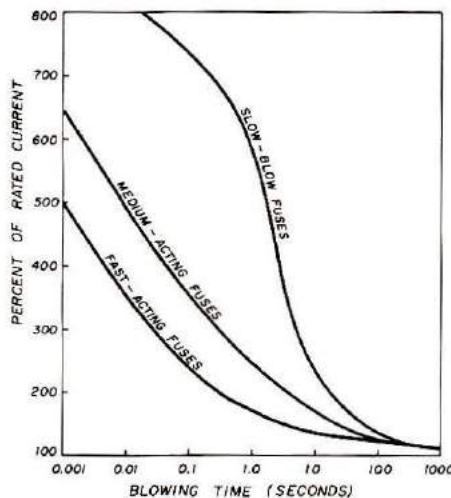

Fig. 1. Graph showing relationship between fuse flowing time and per cent of rated current for three types of fuses. Fast-acting fuses are normally used to protect sensitive instruments; medium-acting fuses are used in most electronic equipment; slow-blow types are used in equipment which has high starting currents such as electric motors and heavy-duty power supplies.

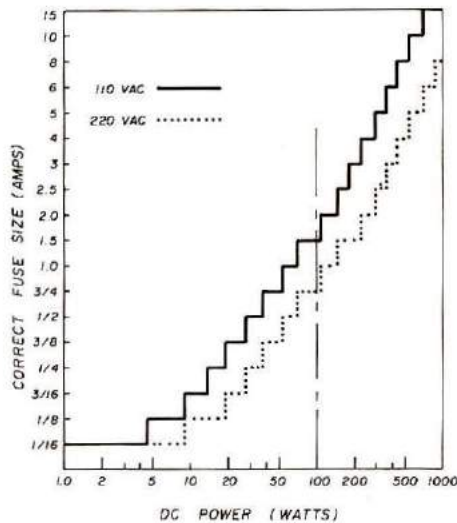

Fig. 3. Chart for choosing the correct fuse for 110 and 220 Vac power, based on the dc power in watts. Electronic equipment which has a total power dissipation of 100 watts, for example, requires a 1.5 ampere fuse if powered by 110 Vac; the same equipment would require a 3/4 ampere fuse if powered by 220 Vac.

If you have any doubt as to the correct type of fuse you should be using in your equipment, check the instruction manual. Don't depend on the fact that the fuse in the equipment is the right one — a previous owner may have substituted a larger fuse simply because he didn't have the correct one on hand.

A few years ago, when I was checking out a high-voltage power supply I picked up at a local flea market, I discovered the ham I bought it from had soldered a wire directly across the fuse holder! When I removed the jumper and installed the correct fuse, it blew instantly when I turned on the power. Some troubleshooting revealed a minor problem with the surge protection circuit, which in itself would not likely cause a problem, but the bypassed fuse holder was a serious safety hazard if it had gone undetected. The previous owner could have found the source of the problem if he had only looked for it, but it was

apparently more expedient to simply bypass the protective fuse!

Some electronics equipment, particularly that designed for commercial and military applications, uses circuit breakers instead of fuses. There are many types available, including small chassis-mount circuit breakers with ratings from 500 mA up to 20 amps. Although the initial cost of circuit breakers is higher than that for fuses, breakers have the advantage that you don't have to keep a supply of spare fuses on hand. Also, some circuit breakers are designed to serve double duty as the equipment's ON/OFF switch.

Here, then, is the first item for your fire-prevention check list: Make sure every piece of equipment in your ham shack, right down to the soldering iron, is protected by a fuse or circuit breaker of the right size. When you build a piece of equipment, even a kit, make sure it has a protective fuse. All too many pieces of homebrew radio gear have no protection at all, or not enough.

Fig. 2 shows several ways to fuse electronics equipment. For equipment that is powered

by 110 Vac, you need a fuse only in one leg of the primary, **F1** in **Fig. 2A**; the secondary fuse at the center-tap of the transformer (**F2**) is sometimes included but it's not required if the primary fuse is properly chosen. If the fuse at the center-tap is the only one in the unit, another fuse should be installed in the primary circuit — the secondary fuse doesn't provide protection against a shorted winding in the transformer, and it's foolish to rely on the house fuses.

If the equipment is powered from 220 Vac, there should be a fuse in each of the primary legs as shown in **Fig. 2B** (don't put a fuse in the neutral). You may also want to place a fuse in the B+ line (**F3** in **Fig. 2B**) to protect the rectifiers from a shorted filter capacitor, but make sure the voltage rating of the fuse is adequate.

To properly fuse a piece of equipment you only have to know one thing: how much current the equipment requires for normal operation. Most amateurs don't have instruments to directly measure ac current or power, but if you have a multimeter you can measure dc voltage and

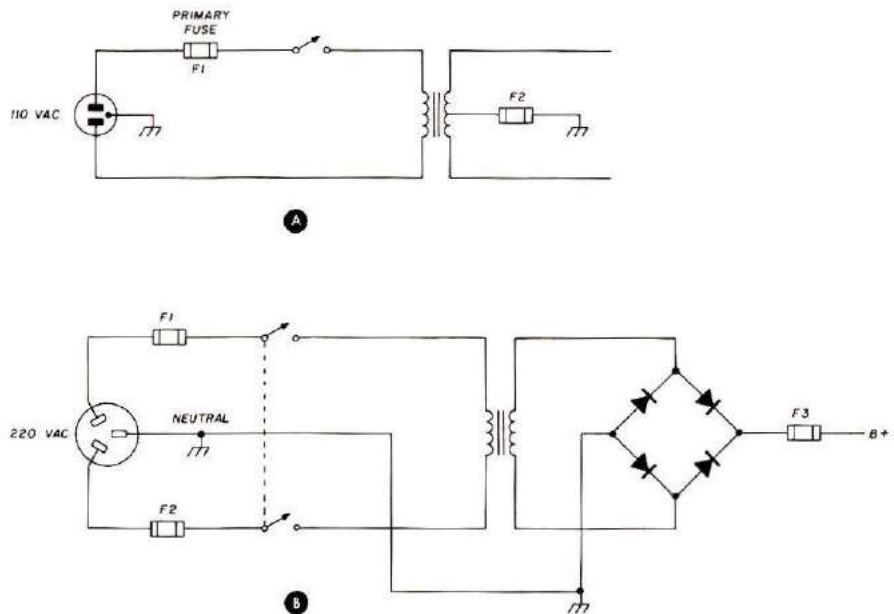

Fig. 2. Correct methods of fusing power supplies. If the supply is powered from 110 Vac, it's necessary to fuse only one leg (**F1** at **A**). The fuse at **F2** is not required if **F1** is properly chosen. If the supply is powered from 220 Vac, a fuse should be placed in each leg as in **B** (no fuse should be placed in the neutral). Fuse **F3** is used to protect the rectifiers against a shorted filter capacitor but is not required for safety purposes.

current, and that will give you all the information you need.

For example, if your two-meter fm rig requires 3 amps at 12 volts during transmit, that represents 36 watts (3 amps times 12 volts = 36 watts). To determine how much ac current is required when using an ac power supply, simply divide 36 watts by 110 volts (or 220 in the unlikely case you're using a 220 Vac transformer). The answer is about 0.33 amp. Add about 50 per cent safety factor and select the nearest value fuse; for this application you need a 0.5 amp fuse.

If you're unsure of your math, you may wish to use the simple graph in Fig. 3. Once you have calculated the dc power in watts, this graph will tell you what size fuse you need in the primary leads for either 110 or 220 Vac.

If you have some radio equipment that needs a fuse, but the chassis is so crowded there's no place to install a fuse holder, you can use a fuse plug which is installed on the line cord. These plugs have built-in clips for a pair of glass cartridge fuses. To replace a blown fuse you have only to push it out with a toothpick and install the new fuse.

House wiring

Another important factor in fire safety is the ac wiring in

your house. If you live in a house that was built more than 25 years ago, take a few minutes to look over the ac wiring. The fixtures, outlets, and switches used then weren't as good as those used in modern construction and, besides, they're 25 years old. Wall outlets and receptacles used to be rated at about 600 watts, which isn't very much by today's standards; plug in a big transmitter, a receiver, and a soldering iron, and you're asking for trouble . . . the contacts, which were designed for 5 amps if they're bright and clean (which they're not), get hot; this makes them tarnish, which makes them hotter, which increases the resistance, which makes them hotter, and so on and on . . .

Modern electrical outlets have a minimum rating of 15 amps or about 1600 watts and you can get 20-amp types for practically the same price. But don't install 20-amp receptacles unless your house is wired with no. 12 (2.1 mm) wire. Many older homes were wired with no. 14 (1.6 mm) which will safely handle only 15 amps, maximum.

If you have a big rig, say 1000 watts, plus a good-sized tube-type receiver, they're going to draw a fair amount of current from the ac line. The transmitter alone may use 2000

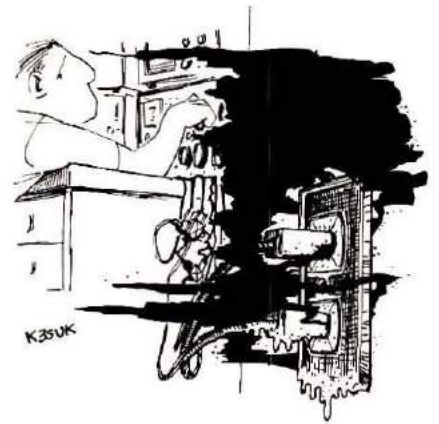

Plug in a big transmitter, a receiver, and a soldering iron, and you're asking for trouble . . .

watts of power or more; the receiver takes another 150 to 200 watts. To that you must add the power required for any accessories you may be using — an electronic keyer, monitor scope, external vfo, or vhf fm transmitter. For a well equipped amateur station the total power requirements can easily exceed the capability of the no. 14 (1.6 mm) power line.

If you have only one electrical outlet in your shack, you may want to add another, but don't start your new wiring at an existing outlet box. That's worse than foolish — it's dangerous. If you tap into a wall outlet that happens to be at the end of about 50 feet (15 meters) of no. 14 (1.6 mm) wire, you can heat up the wire with the overload and cause a serious fire hazard.

If you want to add electrical outlets to your ham shack, go all the way back to the main circuit breaker or load center and start your wiring from there. But don't even consider doing it yourself unless you know exactly what you're doing. An electrical contractor will do the work for a nominal fee and he has the equipment to "snake" new wiring through existing partitions with a minimum of fuss.

You should also keep in mind that many communities have building codes which require that all electrical wiring must be done by a licensed

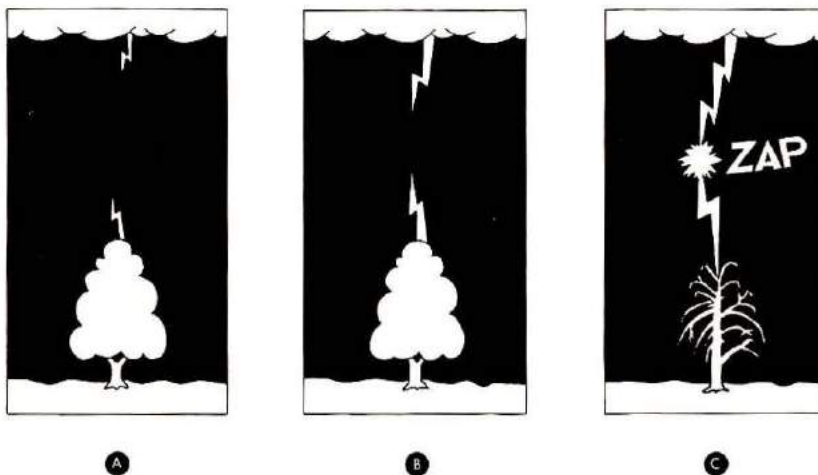

Fig. 4. Lightning strike begins to form with charge filaments extending both from an object on ground and a thundercloud, A. As the charge builds, the filaments lengthen and become more pronounced, B. When the two charge filaments meet, C, thousands of amperes are discharged in a blinding flash.



Cushcraft Blitzbug® can be inserted in coaxial feedline to antenna. The shell is grounded to a good earth ground. Inside the "bug" is a gap that conducts high-voltage surges to ground without in any way interfering with transmission or reception.

electrician. Furthermore, if you have a fire which is caused by electrical wiring which doesn't conform to the code, you may have trouble collecting from your insurance company!

If your transmitter runs more than about 500 watts input, I recommend that it be powered from 220 Vac. Most modern high-power equipment can be wired for either 110 or 220 Vac — the instruction manual will show you how to change the taps on the power transformer to make the change. If you don't have a 220-volt line coming into your shack, you can have the electrician install one at the same time he's putting in your additional outlets.

Lightning hazards

Lightning is one fire danger you can't always do a whole lot about. That tower outside your shack is a good lightning rod, so you're apt to get a shot once in a while. Nevertheless, there are several precautions you can take to keep the hazard to a minimum. As an added bonus, a tower or antenna system that is properly protected actually acts as a "shield" against direct lightning strikes to your house.

The basis of all lightning protection is to keep the hot stuff outside the building and shuttling it to ground as

quickly as possible. Number 1 on the list is a good lightning arrester. You can't actually "arrest" lightning, but you can steer it to ground so it won't set your house on fire. An arrester carries the energy off to ground by providing an easy path for it; therefore, the connection from arrester to ground must be short, heavy, and direct — a ground wire that is too small will simply vaporize if it gets a direct hit. The minimum recommended size is no. 6 (4.1 mm) stranded copper, which can be purchased in short lengths from electrical supply stores.

Don't depend on the cold-water pipes in your house for a good ground. For one thing, the object is to keep the effects of a lightning strike *outside* your house; grounding to the house's plumbing system is an engraved invitation for it to come inside.

If you're one of the few amateurs who has an extensive system of ground radials for a vertical antenna, you can use that for your lightning arrester ground. If not, buy an 8-foot (2.5 meter) ground rod from your local electrical supply house and drive it all the way into the ground.

If you use coaxial transmission line, one of the

best lightning arresters on the market is the Cushcraft *Blitzbug* shown in the photograph. This little gadget has a small spark gap inside which bleeds off static charges before they become large enough to cause damage to your rig (or start a fire).

Although it's not too well known, a lightning bolt doesn't originate only in a thundercloud. Studies with high-speed photography have shown that a lightning strike actually consists of two charge filaments; one originating at ground level, the other at the thunder cloud as shown in Fig. 4. If the static charge at ground level is dissipated before it becomes large enough to extend a filament into the sky, the lightning will seek some other spot to strike. The best arresters are those that dissipate the static charge before it's big enough to cause serious damage.

If you use open-wire transmission lines, you can build a simple but effective lightning arrester as shown in Fig. 5. Don't skim on the material you use for the gap conductors — it should be a minimum of 1/8 inch (3 mm) thick and a good conductor such as copper or aluminum. An easy way to get the copper

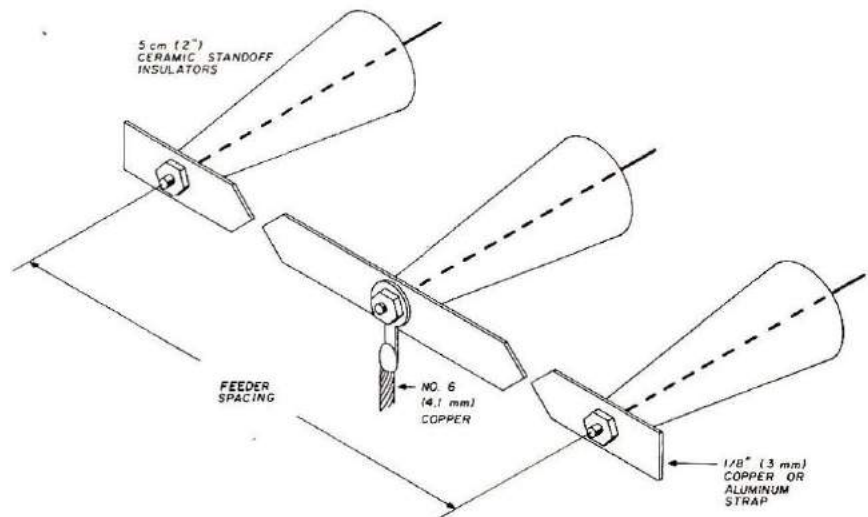

Fig. 5. Simple lightning arrester for open-wire feedline. The slots in the two outside electrodes allow for gap adjustment (adjust for minimum gap spacing which permits maximum transmitter power without arcing). The no. 6 (4.1mm) copper cable is run directly to ground. Large ceramic standoff insulators are available from Fair Radio.*

*Fair Radio Sales Company, Post Office Box 1105, Lima, Ohio 45802. Ask for a copy of their latest catalog.



As a minimum, use an 8-foot ground, driven all the way in.

is to ask your friendly plumber for a scrap piece of copper water pipe (you need a piece no longer than 30 cm or 12 inches); pound it flat with a hammer or mash it in a vise. Adjust the gap spacing to the minimum that will prevent arcing when you're running full power.

It's also a good idea to install a grounding switch to disconnect your transmitter and receiver and ground the antenna when you're not around. If you use coax cable, Barker & Williamson manufactures *Protax* antenna switches which function as regular antenna selector switches but have one position which automatically grounds the entire antenna system when the rig is not in use.* For open-wire transmission lines a wide-spaced knife switch can be used.

Even with all these precautions, a direct hit can wander all over your incoming wires. To minimize the chances of a fire's starting, run all transmission lines well away from wooden walls, drapes, and other flammable materials. Even coaxial cable can get very hot if it's carrying a lightning surge; the intense heat can actually bring the center insulating material to a boil — the cable bursts under the resulting pressure. I've also

seen cases where the coaxial line welded itself to the side of a tower during a direct lightning strike.

Many people don't realize it, but there's an amazing amount of energy floating around on the ac power lines during electrical storms. There have even been cases where damage has been reported a mile or more from a strike to a power pole. Since the high-voltage surges enter the service entrance and seek the least resistance path to ground, all too often that path is through your carefully grounded amateur equipment. Television sets, electric stoves, hot-water heaters, and house wiring also fall prey to service entrance lightning and many bad fires have been caused by it.

In most cases, if the surge is large enough to cause damage, the circuit breakers in the junction box will pop open. Unfortunately, they don't open up instantaneously so the lightning surge is already on its way to ground (through your precious ham gear) by the time the breakers let go. There's an inexpensive solution to this

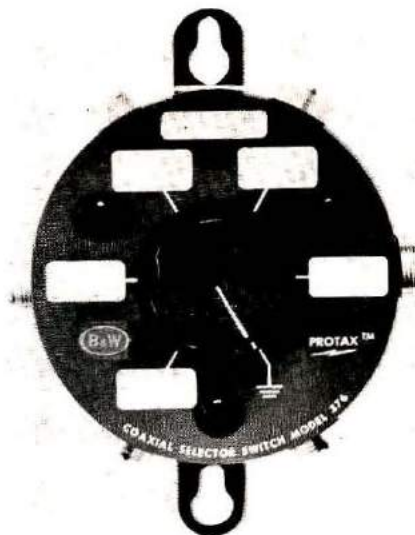

The *Protax* rotary coaxial selector switch manufactured by B&W provides one switch position which automatically grounds all incoming transmission lines. Two models are available; the model 376 shown here with the connectors on the side, and the model 375, which has the coaxial connectors at the rear.

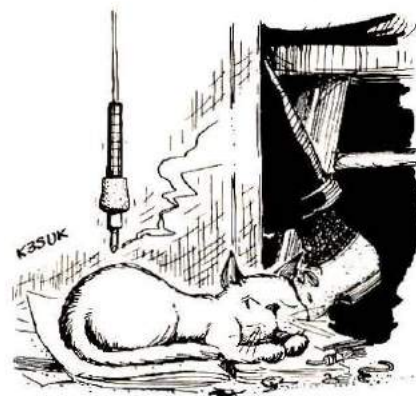

Don't forget your soldering iron . . . it gets plenty hot.

problem in the form of a small, low-cost lightning arrester which is similar to the large units used at electrical substations. Both General Electric and Westinghouse manufacture these devices. The General Electric 9L15CCB007 home lightning protector, for example, costs about \$12.00, can be installed at the service entrance or inside the main breaker panel, and is guaranteed for a minimum of ten years.

Diverse fire dangers

Watch the common things you're apt to forget — such as your soldering iron. It gets plenty hot, so put in on a heavy stand that can't tip over. A holder which has a screen or mesh cover is best. Keep cleaning rags, scratch paper, and other flammable materials away from the iron — I'm sure you've had an experience where you charred a schematic or a page in the *Handbook* with a carelessly placed soldering iron. If you're a good housekeeper, you'll be much more fire safe.

Now and then you have to use chemical cleaners around the ham shack; switch contacts and potentiometers get dirty and require periodic maintenance to keep them working to perfection. Be sure the cleaner you use is fireproof.

*Available from G. R. Whitehouse & Company, 15 Newbury Drive, Amherst, New Hampshire 03031.

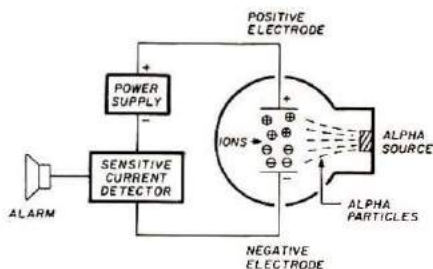

Fig. 6. Ion chamber smoke detector. Alpha particles ionize the air in the chamber, causing an electrical current flow between the electrodes. Combustion particles reduce current flow, which is sensed by the detector, triggering the alarm.

Nobody in his right mind would use gasoline for this task, but lighter fluid can be nearly as dangerous. Carbon tetrachloride, once popular for cleaning electrical parts, is fireproof, but the vapor can make you pretty sick. The safe stuff is available in spray cans — and it does a better job as well!

If prevention fails

I've mentioned the most likely causes of fire in your ham shack, and how to keep them from starting a blaze, but what do you do if you're suddenly faced with a fire anyway? Easy, grab your fire extinguisher and pour it on — but be sure you grab the right kind of extinguisher; the wrong one can get you killed!

Note that fire extinguishers are rated for three classes of fires, so be sure you choose the correct type of extinguisher. Fires are classified as follows:

Class A fires. Include burning wood, paper, etc., where dousing with water or insulating with multipurpose dry chemical will extinguish the blaze.

Class B fires. Consist of burning flammable liquids such as gasoline, paints, or cooking fats where smothering action is required to put out the fire.

Class C fires. Occur in electrical equipment such as

radios, appliances, or motors where the extinguishing agent must be a non-conductor of electricity.

If there is any electrical hot stuff in or near the fire, and there probably will be, DON'T use soda-acid, foam, carbon tetrachloride, or freon fire extinguishers. The soda-acid types are those brass-colored extinguishers you see hanging on the walls with a hose on top; you turn them upside down to spray the fire. The solution in them is mostly plain water so you can figure out what happens when a stream of conductive water hits high voltage and you're hanging onto the metal case . . .

The foam extinguishers also contain water mixed with special chemicals; don't use them on electrical fires. Carbon tetrachloride is a very good fire-extinguishing fluid but when it strikes a hot fire, it turns into phosgene gas, which is a deadly poison; Freon, a popular ingredient in small home extinguishers, has the same problem as carbon tet — while non-toxic at room temperature, it breaks down into phosgene gas when it strikes a hot fire. If used on a fire in a small room,

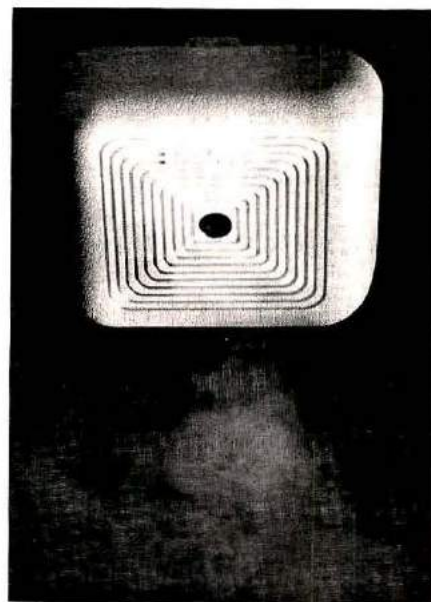

GE's Home Sentry smoke alarm sounds the alarm before appreciable smoke is present — at the earliest stages of a home fire — while there's still time to escape. Test button allows testing of the entire system (not just the alarm). This reliable alarm system is available in ac wired-in, corded, and dc battery-operated models (photo courtesy General Electric).

both carbon tet and Freon can put you off the air, permanently!

There are two types of extinguishers recommended for electrical fires: CO₂ and dry chemical types. The best known of these is the CO₂ "fog

The Siliconix L911 detector IC is at the heart of many modern alarm systems. It is the latest addition to a line of solid-state devices which includes the Siliconix SM110 smoke detector IC.

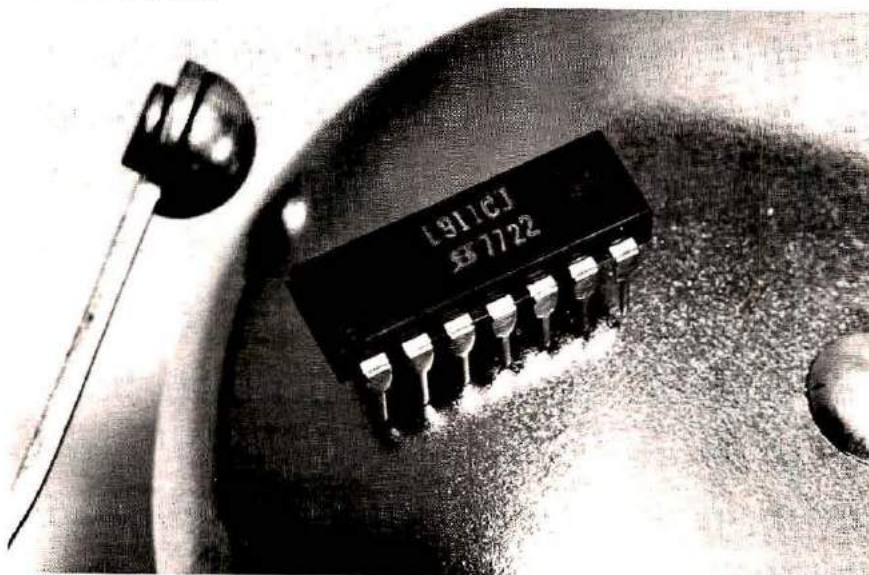

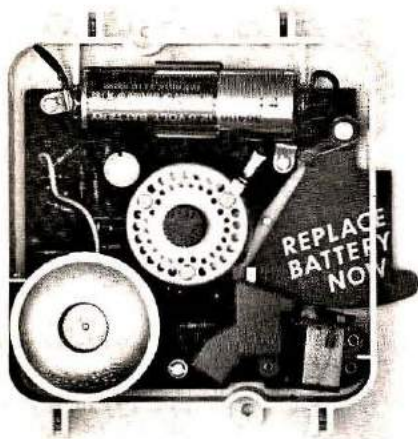

Interior view of GE's Home Sentry smoke alarm showing the ionization chamber, center, alarm bell, lower left, and battery, top. When the battery ages and is no longer able to provide reliable operation, a spring-loaded REPLACE BATTERY flag is released from the side of the cover (photo courtesy General Electric).

bottle" which smothers a fire by keeping it from getting enough oxygen to burn. It is harmless to humans and doesn't leave any residue — some types of extinguishers leave a mess that's more damaging than a small fire (assuming, of course, that the small fire doesn't grow into a complete conflagration).

The second type of extinguisher recommended for electrical fires is the dry-powder type. The better ones are pressurized and will spray several pounds of powder 3 meters (10 feet) or more. In lower cost extinguishers the powder is packaged in long paper tubes; you tear off the powder cap and dump the powder on the fire. This is fine for small fires, but the pressurized extinguishers are more effective.

Dry chemical extinguishers which are recommended for Class B and Class C fires (burning liquids and electrical fires) use plain bicarbonate of soda as the fire snuffer; however, this type of extinguisher isn't very effective in putting out fires involving wood, paper, or plastics (Class A fires). Extinguishers which

are recommended for all types of fires are charged with a monammonium phosphate based dry chemical; this type of extinguisher is slightly more expensive but gives better all around protection.

You can buy these extinguishers in 1- and 2-pound capacities at department stores, but they're not recommended — the very minimum size you should purchase for home use is 2 3/4 pounds. If you ask your local fire chief, he'll tell you the best sizes are the 5 and 10 pounders; these will completely put out most fires, even if they get a good start.

Note, when you're comparing fire extinguishers, that they are rated for the three classes of fire. The larger the rating number, the more effective it is on the class of fire indicated. Following are typical ratings for 5- and 10-pound dry-chemical types:

Type	Rating	Approximate Range
5 pound (2.3kg)	1-A 5-B:C	13 feet (4 meters) for 10 seconds
10 pound (4.6kg)	(2-A 40-B:C)	18 feet (5.5 meters) for 10 seconds

Fire alarms

If you're in the shack when a fire starts, you can combat it right away, but if something heats up while you're away, it's a whole different story. Daily, there are newspaper accounts of people who died while asleep because they had no warning that a fire had started. Because of the great number of such incidents, smoke and heat detectors are becoming mandatory in many new and remodeled homes; all new homes insured by the FHA or VA are required to have them. Although many people apparently consider these devices an unnecessary expense, they can reduce the

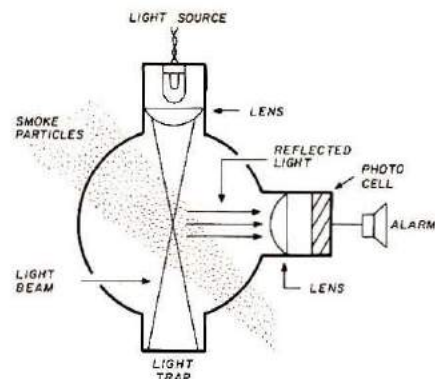

Fig. 7. Photo-electric smoke detector. Smoke particles reflect the light onto the sensitive photo cell, which sets off the alarm.

many deaths caused by smoke asphyxiation or toxic gases from home fires.

The National Fire Protection Association (NFPA) has observed that in nearly all fires detectable quantities of smoke precede detectable heat. In addition, slowly developing fires such as those caused by overloaded electrical circuits seldom increase room temperature, but they nearly always release toxic gases such as carbon monoxide. Many of the new synthetic materials found in homes (such as plastic insulation on wiring and PVC plumbing) produce deadly gases as they burn. For this reason the NFPA recommends that a home should include at least one smoke detector in the fire protection system.

There are three types of smoke detectors presently available: ion chamber, photo-electric, and semiconductor. In the ion chamber detector, Fig. 6, a source of alpha particles ionizes the air within a sensing chamber. When combustion particles enter the chamber the ions attach themselves to the particles and the current flow is reduced. The alarm is activated when the current flow falls below a predetermined value.

In the photo-electric smoke detector, Fig. 7, a light beam shines across the sensing chamber into a light trap on the

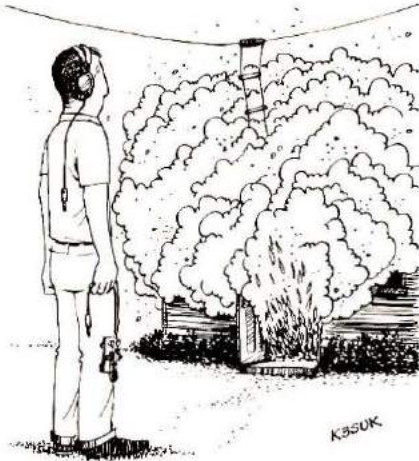

Some ham shacks are disasters waiting to happen . . .

opposite side. When smoke enters the chamber, light reflected by the smoke particles is detected by a photo cell. When the voltage output from the photo cell reaches a preset value, an alarm is sounded.

The semiconductor gas detector uses a crystal with a metallic oxide coating. Combustible gases near the crystal reduce its electrical resistance and trigger an alarm. Unfortunately, any flammable gas in the home — alcohol, perfume, cooking smoke — can also set off the alarm. Tests have also shown that semiconductor smoke detectors do not respond to fires which are burning with little smoke. For these reasons, the semiconductor gas detector is not as good for home use as the ion chamber or photo-electric types.

In general, if the fire is a slow and smoldering one, without flame, the photo-electric sensor will respond faster than the ion chamber; if flaming is present the ion chamber detector is faster. Either detector can be used for early fire warning detection, however.

Practically all of the smoke detectors on the market can be operated from battery power; some types can also be operated with 120 Vac. Ac

powered units are very convenient, and since the power almost never fails before the detector would sound an alarm, ac types are very popular. Almost no maintenance is required on any of the units, but don't forget to replace the batteries every year. You may also have to replace the lamp in the photo-electric sensor after 4 or 5 years.

The basic level of protection recognized by the NFPA (called Level 4 protection) requires a smoke detector in each sleeping area and at the top of each stairway leading to an occupied area. Only one smoke detector would be required in small single-story homes with clustered bedrooms and no basement. More complete protection (called Level 1 protection by the NFPA) requires smoke detectors in or near each sleeping area, and at the top of the basement stairs;

in addition, every room must be covered by a smoke or heat detector.

Summary

There are a surprising number of potential fire hazards around the average ham shack: unfused equipment, poor grounding, ineffectual lightning protection (or none at all), overloaded electrical circuits, papers scattered over the operating desk, no fire extinguisher in sight — each is a disaster waiting to happen.

Take a minute to go over the fire check list on this page, then take it into your ham shack and check each of the listed items. When you find something that doesn't measure up, add the needed protection. It won't take long, it won't cost much, and your peace of mind will more than make up for it. **HRH**

FIRE PROTECTION CHECK LIST

Electrical

- | | |
|--|--|
| 1. Is all your equipment properly fused? | 6. Do you have a grounding switch in your transmission line? |
| 2. Is all the wiring heavy enough to carry its normal load without overheating? | 7. Is all your equipment properly grounded? |
| 3. Are all the electrical outlets and switches in good shape — not dirty or loose? | 8. Are your fire extinguishers the correct type for use on electrical fires? |
| 4. Is your radio gear fully protected by a suitable lightning arrester? | 9. Are smoke detectors installed and checked? |
| 5. Do you have a good grounding system? | |

Housekeeping

- | | |
|--|---|
| 1. Is your ham shack neat and clean? | 5. Is the wastebasket made of fire-proof metal or of meltable plastic? |
| 2. Are papers, old magazines, and other flammable items stacked around in corners? | 6. Is the wastebasket full, running over, or kept nearly empty? |
| 3. Even worse, are they stacked on top of hot electrical equipment? | 7. If you smoke, how are the ash trays? Full? Clean? Big enough for a long rag-chewing session? |
| 4. Is your soldering iron protected against paper or rags falling on the hot tip? | |

★ BUY THE BEST ★

BUY

★ AMERICAN ★



ATLAS 350-XL

The ultimate radio.

For SSB and CW... 10, 15, 20, 40, 80, and 160 meters, full coverage... Plus WWV, 5, 10, 15 MHz... Up to 10 additional 500 kHz ranges by adding crystals... 350 watts P.E.P. and CW input power... Broadband design,

preselector tuning only... Digital frequency readout (optional), and standard analog dial... High receiver sensitivity... Super selectivity... Exceptional Dynamic Range... CW Filter... QSK Full Break-In CW... Sidetone... RIT... AF Notcher... Noise Blanker... ANL... VOX... Operates directly from a 12 to 14 volt DC supply, ideal for mobile and portable work... Optional mobile mount provides quick plug-in for going mobile.

MADE IN U.S.A. Every Atlas transceiver is designed and manufactured in the U.S.A. BUY THE BEST... BUY AMERICAN.

CUSTOMER SERVICE... SECOND TO NONE... That is our motto. When you buy an Atlas product... you inherit the best service policy there is. Ask the ham who owns one!



Model 350-XL (less options) . \$995.
Model DD6-XL Digital Dial . . . \$229.
Model 305 Auxilliary VFO . . . \$155.
Model 305PS AC Power Supply \$229.



ATLAS
RADIO INC.

417 Via Del Monte, Oceanside, CA 92054
(714) 433-1983
Special Customer Service Direct Line (714) 433-9591
TWX 910-322-1397

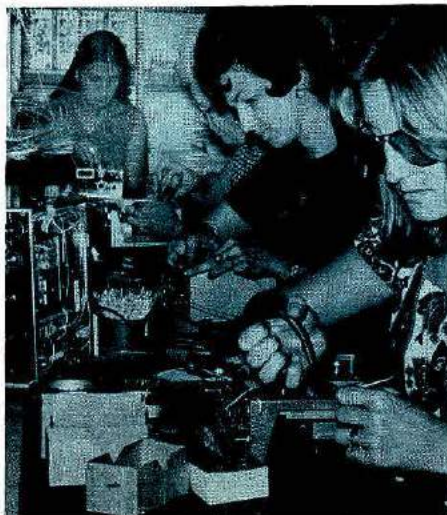

A Night To Remember

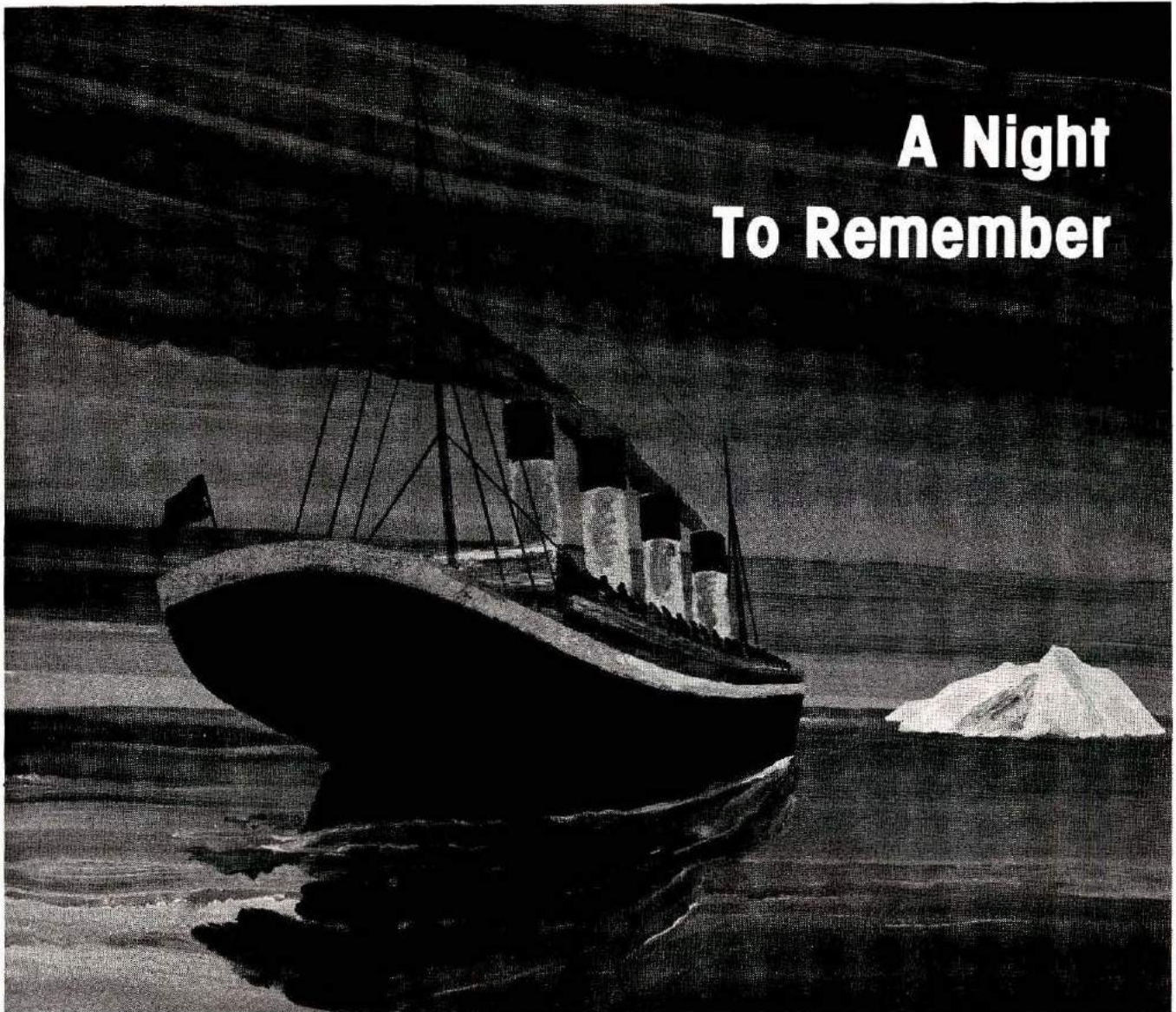

BY WILLIAM I. ORR, W6SAI

It is said that when a leaf falls the future of the world changes. Perhaps so. And if this is true, then did the sinking of the vessel *Titanic* indirectly influence the fate of amateur radio? At least one amateur thought it did, and this is his story.

The story starts way back in 1912. On the night of Sunday, April 14, to be exact. That was the night the Titanic sank. This great new White Star liner was on her maiden voyage from Southampton, England, to New York City. She was 883 feet long, the biggest ship ever launched, and said to be

*unsinkable because of her double bottom and water-tight bulkheads; although how anything heavier than water could be "unsinkable" is not apparent. At any rate, she was widely advertised to the travelling public as unsinkable. She carried, on this occasion, 1348 passengers and a crew of 860**

At 11:45 that night, off the Newfoundland Banks, she hit

*In the various literature about the *Titanic*, there is a disagreement in the number of passengers and crew; one source indicates a passenger list of 1316 and a crew of 892. **Editor**

†Here, too, figures differ; one report has 705 total survivors. **Editor**

an iceberg and within two and one-half hours had gone to the bottom. Of the passengers 533 were saved and of the crew 172.† The Cunard liner, Carpathia, outward bound from New York, that made the rescue turned about and conveyed the survivors to New York.

When the Carpathia proceeded from the scene of the wreck at 8:30 in the morning after the disaster, message blanks were handed to the survivors and they were told they could "wireless" free of charge. Nearly all availed themselves of the privilege so that the operator was ordered to disregard all calls to the ship

except such as had to do with instructions to the operator and to the captain.

The range of the Carpathia's spark transmitter was only about 100 miles in daylight. As one shore station along the American coast found it increasingly hard to receive the ship's signals, the next station down the coast took up the burden of copying the avalanche of shoreward-bound messages. The work on the ship was so heavy that operator Cottam, worn out with continuous duty since Sunday morning, collapsed at the key on Tuesday night. It was then that Bride, the operator rescued out of the water after the Titanic went down, had recovered enough from his injuries to take over the task of moving the tremendous backlog of messages.

The Fessenden reception station

The Carpathia's set was a Fessenden. At that time Fessenden's main factory was in Pittsburgh, Pennsylvania. He also had a small plant in one of the huge manufacturing buildings of the Bush Terminal — advantageous to him because it was near the Brooklyn (New York) Navy Yard, where he was equipping some of the ships of the Navy. I was interested in what was going on at the Brooklyn plant. As an operating Vice-President of the Bush Terminal Company I had been able to accommodate the Fessenden Company in various small ways. Among other favors, they had been permitted to use without charge the roof of the 600-foot building in which their plant was established. At each end of the roof they had erected steel towers for their antenna. And I had built a fireproof shack for them in the middle of the roof. So, while visitors were generally barred, I had the run of the premises.

The Fessenden Company wished to copy as much of the Carpathia's traffic as possible,

by request, I understood, of authorities in Washington where the Carpathia could not be heard. In the emergency I hustled about and helped the Fessenden men to get the new shack in commission. The operator invited me to sit in with him, and we listened hour after hour to the Carpathia.

I hope I never again see such a stack of messages. An amateur occasionally handles one that gives the sympathies a wrench, but those from the Carpathia — reading both the



The Chief Marconi (wireless) operator aboard the Titanic was J. G. Phillips, who stayed at his key until water flooded the radio room.

text and between the lines — were just a stream of shocks. "Mother is with us but James and Father are gone." "Mary and I saved. We know nothing of the rest." "Have Father meet me at the dock. I am all that is left but do not tell him." And on and on, broken now and then by messages about the movements of the ship.

All ship and shore stations had strict orders to keep off the air and leave the air free for the Carpathia's messages. Only once did we hear a commercial station disregard that order. A heavy spark banged in, as if from a strong station nearby. It was a ship, leaving New York and calling the Carpathia. She must have had a dumb operator

as the Carpathia set was working at that time. Immediately another strong station crashed in with "QRT." It was the Marconi chief in New York.

Amateur interference

Here is where the conduct of the amateurs comes in for uncompromising criticism. The air was clear of commercial stations. All amateurs were in a position to know that it was of vital importance that they keep off the air. But, no doubt, in those days, too, the amateur ranks had their full complement of dumb specimens. There was never a time when the air wasn't full of ham signals, blathering away about the Titanic and the Carpathia, or just chewing the rag about nothing at all. It was only the distinctiveness of the Carpathia's 500-cycle whine that made copying at all possible.

Many of the messages were broken or garbled because of the ham QRM. This accounted, no doubt, for the non-delivery of many urgent survivor messages.

It was this inexcusable misconduct of the New England hams — largely those in the New York area — that had the most to do with driving the whole amateur fraternity down to 200 meters. They would have been moved from the ship's wavelengths in any event, for they didn't belong there; but they would have stood much higher in public esteem if the amateur

A White Star Lines advertisement for the voyages of the Titanic and the Olympic.

White Star Line

TRIPLE-SCREW ROYAL MAIL STEAMERS

"OLYMPIC," 45,324 tons, and "TITANIC" 45,000 tons, are the Largest Vessels in the World.

(Fitted with Marconi Wireless Apparatus.)

"OLYMPIC" sails from Southampton and Cherbourg to New York regularly.

"TITANIC" sails from Southampton and Cherbourg on first voyage to New York April 10, 1912

White Star Line

LIVERPOOL, LONDON, SOUTHAMPTON, NEW YORK



News of the disaster was relayed over electric news tape systems through centers like this one.

*organization had taken the initiative and moved out voluntarily instead of waiting to be kicked out. Or, to put it in accord with the facts of the case, the amateurs could have moved down enough to keep off the ships' wavelength instead of waiting to be kicked wholly off the air. For this was the deliberate intention of the commercial people and their adherents in Washington, who believed then that 200 meters was useless for communication.**

This story was told by Colonel Clair Foster, W6HM, in the October, 1933, issue of *Radio* magazine. It was a portion of editorial comment dealing with the interaction between the Amateur Radio Service and the recently completed Madrid Treaty of the International Telecommunications Union (1927), which placed restrictive measures on amateur radio. The point of the story, which is equally important today, is that all radio amateurs operate openly

The wireless room on the *Olympic*, sister ship to the *Titanic*. A crystal/tube receiver and a multiple tuner occupy the bench top. A spark transmitter and induction coil are on the wall. The backwards word "efficiency" on the coil was installed that way for some unknown reason (courtesy *Titanic Historical Society*).

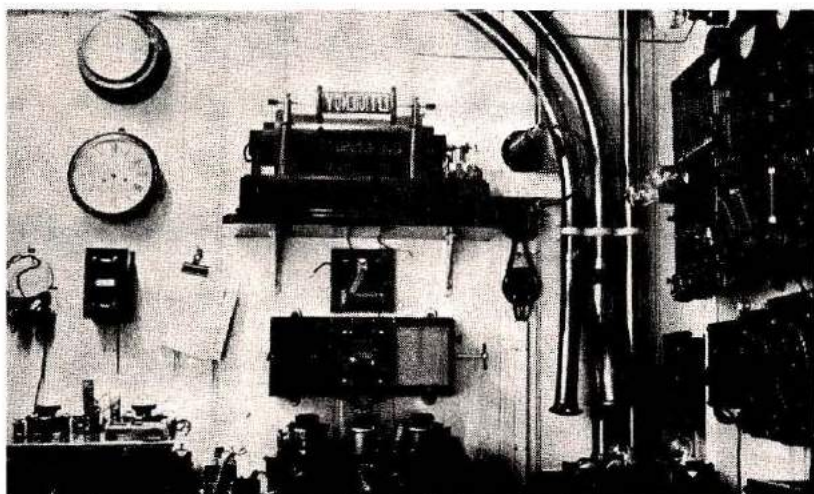

before the eyes of the world and their actions are observed by many who exert a life or death influence at the international conventions of the ITU. While perhaps not as blatant as in the case of the *Carpathia*, those amateurs who create intentional interference, or otherwise violate accepted laws of behavior — or the regulations of the FCC — are (by the very nature of radio) creating a public nuisance readily observed by both friends and enemies.

On the international DX bands the voice of the radio amateur is heard world wide. Even on the local bands, those unfriendly to amateur radio have ears.

A few years ago a delegate of the United States to an important ITU conference told me that a delegate of another country wished a portion of the 80-meter amateur band to be turned over to the Broadcasting Service. To emphasize his point that the 80-meter ham band was a waste of spectrum space, he had recorded a drunken party of loud-mouthed hams operating on 80-meters, making fools of themselves on the air. He was prepared to play the tape at a forthcoming conference meeting that would decide the fate of the 80-meter band! It took the United States delegate many hours of discussion and urging to get the other delegate to reluctantly agree not to play the recording at the meeting.

A word to the wise should be sufficient. Don't place amateur radio in jeopardy by unbecoming conduct on the air. Reassess your operating in terms of the unseen listener! Are *you* a credit to amateur radio?

HRH

*The timing of subsequent events lends much support to Colonel Foster's theory. The Radio Act of 1912 was passed and signed into law on August 9, 1912, by President Taft. In this act, amateurs were relegated to "below 200 meters," with ships working at 300 and 600 meters. The government reserved 600 to 1200 meters for its own needs.

Editor

YOU'VE GOT THE WORLD AT YOUR FINGERTIPS



...WITH A SWAN CREDIT CARD.

Why put off until tomorrow the gear you're itching for today? A Swan Credit Card puts the world in the palm of your hand. Gets you up and running sooner: no more "saving-up" delays... no more loading up your bank charge cards.

Use Swan Revolving Credit to finance any kind of equipment from Swan's broad line of amateur radio products: from big-ticket transceivers to meters...

from antennas to accessories.

Use the Swan Credit Card by phone, by mail, or in person. At any Swan dealer, or for any factory-direct order. Once you're approved for Swan revolving credit service, just follow our easy charge procedures... and you're in business!

You can pick up full details and application forms from a Swan dealer, or send us the coupon today.

Please rush me (____) Swan Revolving Credit Service Application forms.

Name _____

Address _____

City _____ State _____ Zip _____



305 Airport Road, Oceanside, Calif. 92054



the Sorcerer's Apprentice Ham-Radio Style

BY DOUGLAS STIVISON, WA1KWJ

*There is a time-honored way to
create a radio amateur. All you need
is one curious boy and one old-timer*



Not unlike old-world apprenticeships, amateur radio has always relied heavily on old-time, experienced hams helping and teaching newcomers. It is so much a part of the hobby, in fact, that these helpful older hams have a special name — they are “Elmers.”

Certainly some hams have built stations entirely from books, without any outside help. But these fellows are rare birds, indeed. For most of us, luckily, our curiosity and enthusiastic desire to join the amateur ranks have been the basis for a very special relationship with a helpful old-timer.

Recently, I have been serving as an Elmer to a 12-year-old future Novice. I find myself recalling the old-timer who had helped me out during some of the frustrating periods while learning the code, putting up my first antenna, and building my first rig. Webb was my Elmer; a character who not only knew everything that anyone could possibly know about amateur radio, but also all about hundreds of other things including airplanes and fixing cars.

I meet my Elmer

I first met Webb in the radio parts store one rainy Saturday morning. I was thumbing through the magazine rack when this tall, thin, gray-haired fellow came up next to me. Ignoring the books for CBers, experimenters, and hi-fi fans, he went straight for the stack of *QST* magazines. Here, obviously, was a real live ham-radio operator. Because he looked friendly I went right ahead and asked him the obvious question — if he was a ham. With that simple question, I met my Elmer.

In the ten-minute conversation which followed, I told him about my progress toward my Novice license and my naive plans to build a simple transmitter from my spanking new copy of the

ARRL Handbook. Eventually Webb invited me over to visit his shack and see if we couldn't gather together “some old junkbox parts” and maybe save me a few dollars in building the rig. So Webb gave me his address and we agreed to get together later that afternoon.

Webb's wife answered the door and directed me towards the basement steps. I got the feeling that I was not the first starry-eyed young visitor to ever come by Webb's place. Rushing down the basement steps, I saw Webb's shack as an island of light in one corner of a dark and cluttered basement. Ever since that moment, I have been disappointed by Cape Kennedy and the Houston Space Center. Those places look so sterile with their banks of white-shirted computer technicians ministering to anonymous Formica consoles — every bit as exciting and romantic as a group of bank tellers.

The real thing

Webb's shack, on the other hand, was the real thing. Here was the greatest collection of knob-studded boxes, meters, wires, glowing panel lights, HIGH VOLTAGE signs, and mysterious black-painted homemade boxes. The walls were covered with QSL cards and pin-studded maps, and on his operating table was the single most awe-inspiring device ever devised by mortal man: there was a chrome-plated Vibroplex bug — the absolutely indisputable badge of the chosen few who have not just learned, but truly mastered, THE CODE.

I pause in writing this to look at my prized ZB2 and VQ9 QSL cards and the business-like panels of my Collins S-line equipment. I know that, though my gear is better and my DX is rarer, Webb's shack will always remain a hundred times more of a *real* ham shack than mine could ever be.

It is odd what we remember

and what we forget. I can't remember a thing about the sample QSO Webb made while showing off his gear. But I do remember that overwhelming feeling that this was not a mere picture in *How To Become A Radio Amateur*, but the thing that I wanted more than anything else in the whole world.

I meet the junkbox

Eventually Webb said it was time to see about putting a rig together for me. I produced my *Handbook* and while Webb proceeded to light his pipe, he scrutinized the schematic diagram. Once his pipe was drawing well, he got up and started scrounging through his junkbox. I was so naive that I thought a junkbox was just what the name implied. That day was my introduction to the mystique of the ham junkbox — the builder's lifeblood. Here were the raw materials which, when combined with a ham's traditional skill and boundless ingenuity, would yield a cornucopia of rigs, gadgets, and intriguing black boxes.

Outside of the circle of light which was the shack, Webb's basement was lighted by two bare 30-watt bulbs. The air was heavy with the universal junkbox smell detested by wives and mothers, but soporific to hams. How can I describe that particular smell? It combined dust, burned rosin-core solder, fungicide residue from military surplus gear, the hot smell from overheated transformers and charred insulation, and everything carried on a base of pipe tobacco. This is the same smell you could cut with a knife in the old surplus houses and Radio Row emporiums. Webb's basement was my first, hopelessly habit-forming, fix of junkbox smell.

I learned that a junkbox actually meant dozens of cigar boxes tucked into dusty corners. It meant rows of tobacco and coffee cans with yellowed labels attached with

brittle pieces of old Scotch tape. Under benches and behind chairs were anonymous dark hulks — later revealed to be old chassis and surplus military units undergoing slow cannibalization.

A wizard in action

With pliers and dikes (diagonal cutters) Webb dived into one of the half-stripped chassis. In a minute he threw onto the bench a heavy metal box with two dozen protruding wires.

"There's your power transformer," he said.

I looked dubious. The schematic clearly called for a very particular Stancor catalog number — not a dirty, unmarked black box. Observing the look on my face, Webb laughed, explaining that while power transformers were generally the most expensive single component in most rigs, they were seldom critical components. As long as my transmitter used tv-type rectifier and amplifier tubes, why not use a tv power transformer?

"But Webb," I queried, "how do you know what wire is what?" In a flash Webb produced two devices: his ever-handy Heathkit VTVM (vacuum-tube voltmeter) and a "suicide cord." Webb handled this last device, a power cord terminated in two alligator clips, with the utmost respect. In about two minutes Webb had masking-tape labels attached to the protruding wires, clearly telling me which wires were primary, filaments, and high-voltage. After that demonstration, Webb's unquestioned authority as an amateur-radio wizard was assured.

The parts gathering proceeded quickly. Webb hoisted another gray box onto the bench — this one with only two protruding wires. He looked at the schematic and hefted the unmarked hunk of metal. It felt right. All he said

was, "That's your power supply choke." To this day I have never met anyone else who could determine the usefulness of a choke by weight alone.

I left Webb's home that afternoon with a short shopping list, promising to return the next Saturday with

bench, seemingly unnoticed by the chief op.

After an amazing demonstration of Webb's bag of layout tricks, we ended up with a neat chassis bristling with components and ready for soldering.

Now a generation of builders



the few remaining parts and, in deference to appearances, a fresh metal chassis and enclosure.

The initiation

I returned the next week to be initiated into the fine art of amateur homebrewing. First, perhaps a few words describing Webb's workbench are in order. It was a familiar enough sight to all OTs, but few "young squirts" in this day of miniatures and circuit boards have ever seen such a staggering pile of general debris: breadboards, bent pieces of sheet metal, tools, tubes, coffee cups, and books. When it was time to lay out my chassis, Webb cleared a space simply by shoving everything aside with a terrifying crunching sound. Debris cascaded off both ends of the

who have never used anything larger than a 25-watt soldering pencil cannot imagine the presence of Webb's 200-watt American Beauty soldering iron. It weighed five pounds and had a tip the size of a fountain pen. When it was hot enough, Webb tinned the iron by applying solder to the iron and smearing the molten metal with a deft twist of his right thumb. This, incidentally, is a procedure which I still follow today. I also must confess to an exhibitionist's pride when I flaunt my callused thumb at hamfests. Next to pipe smoking and the overuse of "by-golly," a callused thumb is the surest mark of an old-timer . . . or a would-be old-timer.

With Webb's patient instruction during the following weeks, I learned the traditions of ham construction, including

filament-lead twisting, bus-bar bending, and such flourishes as making all resistor color codes read in the same direction. Eventually Webb approved my wiring after the humiliating correction of two dull-gray cold-solder joints.

Will it work?

Before firing up the rig, however, we had to make sure our scrounged and improvised tank circuits would actually resonate as the designers had intended. Webb brought out a varnished mahogany box from its protected niche in his operating desk drawer. Out of the box came a stack of brightly-colored coils and a strange device called a grid-dipper. Webb plugged one of the coils into the grid-dipper and proceeded to poke the dipper into my rig. He fiddled with the rig's loading and tuning condensers (capacitors). After a bit of muttering and pushing and pulling on the turns of the tank coil, Webb withdrew the dipper with the comment, "Smack in the middle of the Novice band, Doug."

Doubtlessly this was black magic. Without even turning the rig on, Webb had pronounced this rag-tag collection of junk parts as actually capable of not only generating a signal, but putting it out right where we wanted it!

The same old story

The rest of the story has been repeated countless times. The antenna went up, the license arrived, and the rig did a fine job of pumping its 35 watts into the air on 3725 and 7175 kHz (the only two crystals I owned at the time). In the crucible of the Novice bands, I became a ham.

The trips to Webb's basement continued for many years with his junkbox providing the parts for dozens of rigs and gadgets. I spent hundreds of hours listening to Webb's stories of early radio and his youthful adventures as

a barnstorming pilot. Of course I tried to emulate Webb in every possible way. Even his prejudices — against lids, CBers, and single-sidebanders — became my own.

It's been many years now. That old transmitter kicked around for a long time, passing through two other Novice's stations before being cannibalized for parts. Sadly, Webb has become a silent key. Thanks to him, though, there are at least a dozen men who grew up in my town who are still radio amateurs, still strung-out on junkbox smell, and still inveterate parts scroungers.

I told a young friend to come on over this afternoon. I said that we would try to scrape together some of the parts and maybe save him a few dollars in building that IC project that appeared in *Ham Radio Horizons* a few months back. Now, let me just light my pipe and take a look at that schematic . . .

HRH



"Your signal is plenty strong, but your audio sounds a little watery..."

NEW! IC KEYER

The World's Greatest
Sending Device

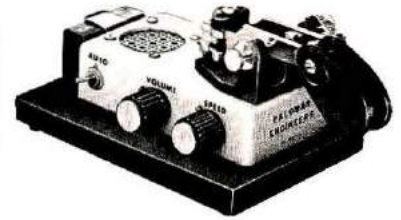

Adjustable to Any
Desired Speed

Now available from Palomar Engineers — the new Electronic IC KEYER. Highly prized by professional operators because it is **EASIER, QUICKER, and MORE ACCURATE.**

It transmits with amazing ease **CLEAR, CLEAN-CUT** signals at any desired speed. Saves the arm. Prevents cramp, and enables anyone to send with the skill of an expert.

▶ SPECIAL RADIO MODEL ◀

Equipped with large specially constructed contact points. Keys any amateur transmitter with ease. Sends Manual, Semi-Automatic, Full Automatic, Dot Memory, Squeeze, and Iambic — **MORE FEATURES** than any other keyer. Has built-in sidetone, speaker, speed and volume controls, **BATTERY OPERATED**, heavy shielded die-cast metal case. **FULLY ADJUSTABLE** contact spacing and paddle tension. The perfect paddle touch will **AMAZE** you.

Every amateur and licensed operator should know how to send with the IC KEYER. **EASY TO LEARN.** Sent anywhere on receipt of price. Free brochure sent on request.

Send check or money order. IC KEYER \$97.50 postpaid in U.S. and Canada. IC KEYER **LESS PADDLE** and non-skid base \$67.50. Add 6% sales tax in California.

Italy write i2VTT, P.O. Box 37, 22063 Cantu.

Fully guaranteed by the world's oldest manufacturer of electronic keys. **ORDER YOURS NOW!**

PALOMAR ENGINEERS

BOX 455, ESCONDIDO, CA 92025
Phone: (714) 747-3343

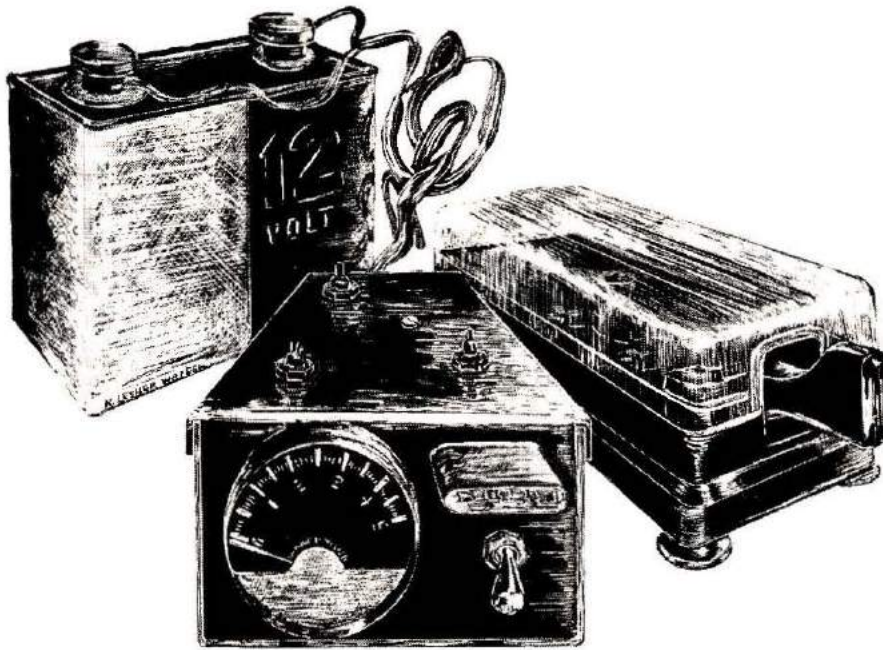

One-Transistor Rig For 40 Meters

BY ED MARRINER, W6BLZ, and JOHN MERIDETH, K5GXR

If you want to go solid-state, here is a crystal-controlled 40-meter transmitter that has an output of two-and-one-half watts. It was built more or less as a curiosity, but it worked far better than expected. It's simple to build, uses one transistor, and is powered by a standard 12-volt lantern battery. The battery should last for several months of normal CW operation.

We often forget that in the early days of wireless, a five-watt transmitter was the average power most amateurs had on the air. Although there weren't as many layers of QRM then as there are now, an awful lot of contacts were made. Even today, a low-power transmitter can give some surprises; one evening I worked a station near Sacramento, 500 miles (800km) away, with a 599X report. It was impressive. A whole new world opened up.

The similarity between the "old" days and the "new" becomes apparent when you start to buy parts for a transistor transmitter. The transistor costs about the same as a "bootleg" 210 did in the early 1930s. Let's face it, some

transistors and associated tiny parts are expensive.

This transmitter costs about \$10.00 to build, but it depends somewhat on the parts you use. There are all grades, and prices vary considerably. Basically, the RCA 2N3553 power transistor costs \$4.75. You need that! A 50-microamp meter can run anywhere from \$2.95, for an inexpensive imported tuning type without a scale, up to \$15 or so. The inexpensive one does just as good a job here because it only functions as an rf-output indicator.

You also need a power source. A lantern battery is the most convenient, and costs about \$3.00. An old 12-volt car battery and a trickle charger will do a nice job; or you can build a power supply with a

filament transformer — for more money.

Circuit

This circuit is a Pierce-type crystal oscillator using a single 2N3553 transistor. The toroidal tank coil is used because the field is contained in a small space and miniature construction is possible. Capacitor C3 tunes the tank circuit to resonance on 40 meters, and C4 couples the load to the transmitter. Capacitor C1 is the feedback capacitor and is adjusted for proper keying and good circuit efficiency.

The antenna is inductively coupled to the collector of the 2N3553 through the final tank circuit and its link. Capacitor C4 controls antenna loading. The load impedance should be between 40 and 100 ohms resistive for proper operation. A relative-power meter is used for rf output indication.

Keying is done in the emitter of the 2N3553. Capacitor C2 does a fine job as a key-click suppressor. The emitter current with a 12-volt collector supply is from 200 to 300 mA, depending on internal battery resistance as it increases with use. This represents 3 to 4 watts dc input. Collector-circuit efficiency runs about 70 per cent at this level.

Construction

The transmitter shown in the photographs is built in an LMB 138 chassis, 3 x 2-1/2 x 2 inches (7.5x6.3x5cm), although a larger chassis may be used for easy wiring. Placement of components and leads is not

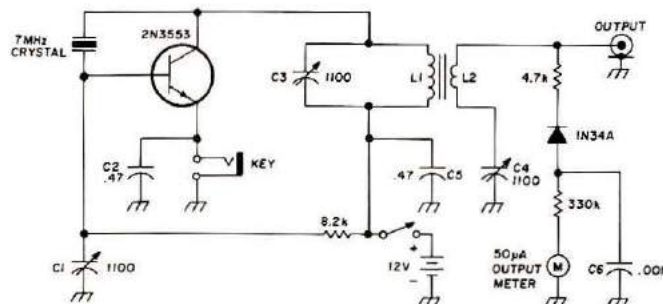

Fig. 1. Schematic diagram of the one-transistor rig for 7 MHz. A power output of 2-1/2 watts was measured. See Fig. 2 for construction of L1 and L2.

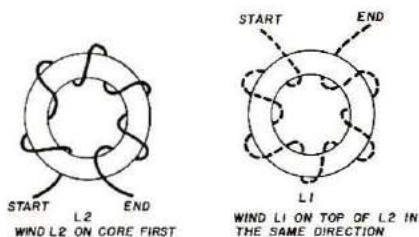

Fig. 2. Each winding on the output circuit consists of 11 turns of No. 18 (1mm) enameled wire on a T-94-2 ferrite core.

critical. The various holes in the chassis should be punched or drilled before starting assembly.

Construction of the toroidal tank coil, L1 and L2, is shown in Fig. 2. L2 should be wound first, using about ten inches (25cm) of number 18 (1mm) enameled wire. Leave about one-and-one-half inches (4cm) of lead, and count each turn as it goes through the center of the core. Space the turns so that the last turn is about one-eighth inch (3mm) from the starting turn. Clip the excess wire so you have about one-and-a-half inches (4cm) of lead left on L2. L1 is wound in a similar manner — starting 90 degrees clockwise from the starting point of L2 and winding counter-clockwise from that point. Leave one-and-one-half inches (4cm) of lead on each end.

The trimmer capacitors, tie lugs, crystal socket, key jack, antenna jack, power-lead grommet, switch, and meter

A bottom view of the chassis shows the transistor in its heatsink just above the center, immediately below the toroidal output transformer.

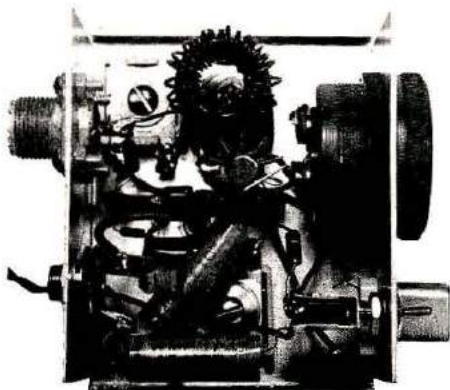

are mounted in that order. The transistor should be provided with a heatsink and soldered into the circuit last. Be careful not to heat the transistor leads; use a heatsink, such as long-nose pliers, between the solder joint and transistor.

Tuning

After checking the circuit over carefully for wiring errors, connect the power supply. Take extra precaution, and check the polarity of the battery leads — this may save you a burned out 2N3553. Next, plug in a 40-meter crystal and connect the transmitter to a dummy load. You can make one from three

maximum power output consistent with good keying characteristics.

An antenna can now be substituted for the dummy load, and C3 and C4 tuned for maximum output indication on the meter. If the antenna does not provide a resistive load between 40 and 100 ohms, use an antenna tuner.

To check power output, you can use an rf probe and a vtvm. You should measure 3 volts on the hot side of the 50-ohm dummy load.

This transmitter has been tested by several amateurs. WB6OGA had excellent results throughout Southern California.

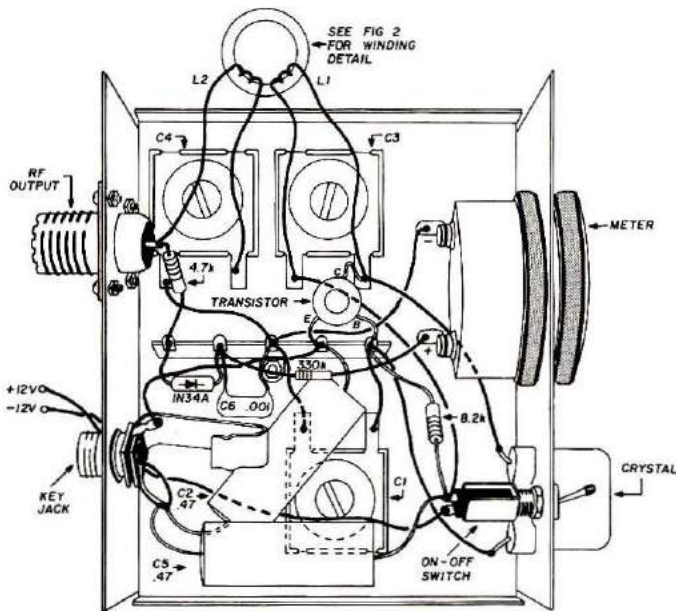

Fig. 3. This drawing of the parts placement will help in proper construction of the transmitter. Fasten the tie-strip in place first, then the variable capacitors. Modern dipped-plastic capacitors are a suitable substitute for the paper ones shown here (two 0.47 μ F and one 0.001 μ F).

parallel-connected, 150-ohm, 1-watt resistors.

Tighten C1 to full compression, and then back it off two turns. Key the transmitter, and tune C3 until the output meter kicks. Tune C4 and C3 for maximum indication on the meter. If you don't get any output, try changing C1 while simultaneously tuning C3. Once you get output, tune C4 and C3 for maximum indication on the meter. Peak the output with C1 while listening to the keyed note on a receiver; set C1 for

K6WC made a critical check and found the keying clean, with no trace of chirps or clicks at a distance of 13 miles (21km). The ground signal was a constant S7 at this distance, indicating good possibilities of 40-meter skip for long-distance work. The overall dc to rf output-conversion efficiency of 70 per cent is ideal for portable battery operation or as a driver for a higher power amplifier; I'll build one as soon as I can save the money to buy a high-power transistor. **HRH**

REFLECTIONS of FREEDOM

DenTron antenna tuners give you the freedom to experiment with antennas. Whether you're using a beam or a vertical, a piece of wire or the gutters on your motel room; our tuners provide continuous tuning 1.8 - 30 MHz.

Let DenTron amplifiers give you the power to stand out in a crowd and be heard around the world. The MLA-1200 and MLA-2500 are an exceptional source of power, offering understated luxury exemplifying pride in design and workmanship.

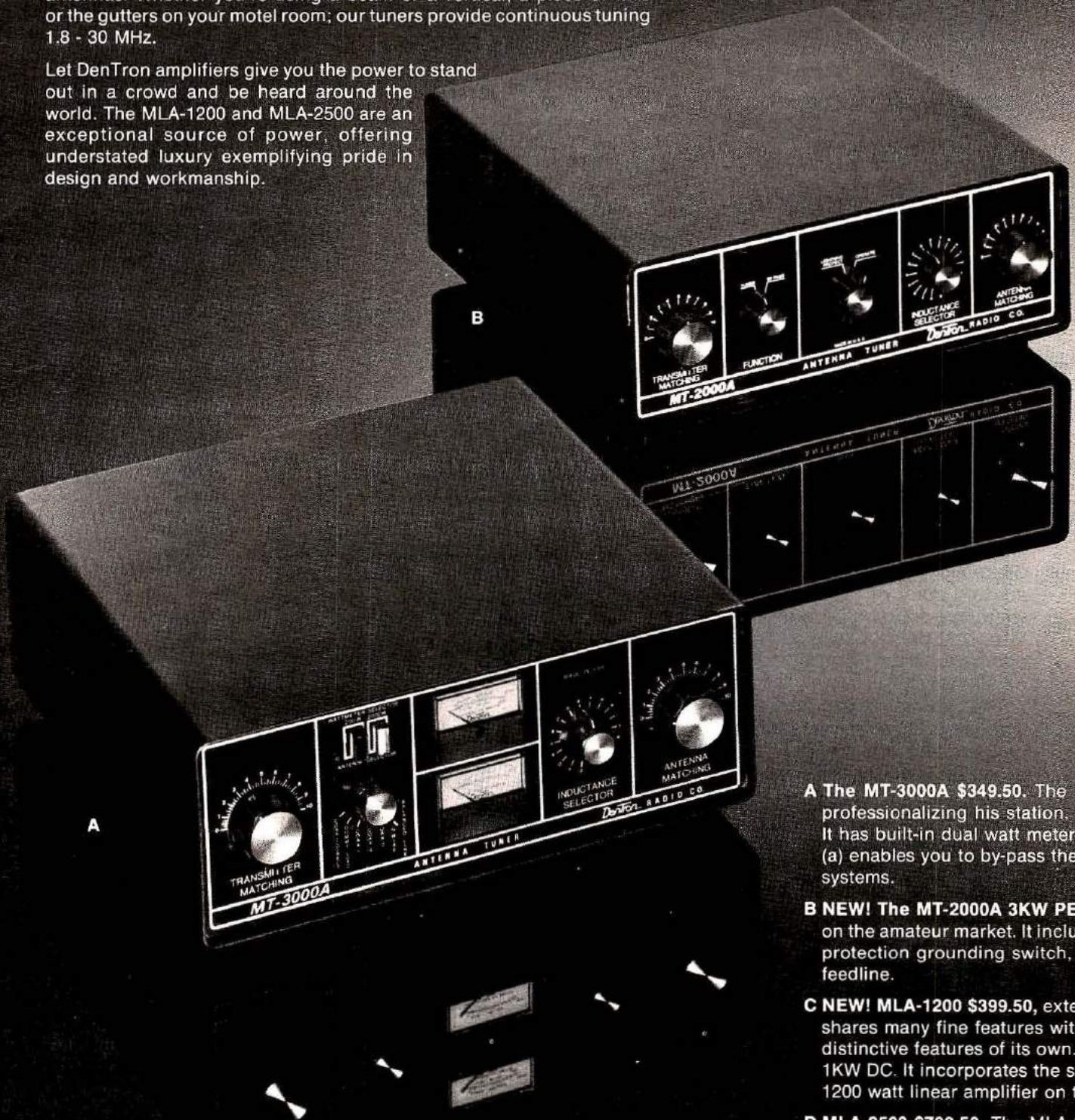

A The MT-3000A \$349.50. The MT-3000A is designed for the professionalizing his station. It is a rugged unit with built-in dual watt meters, and a bypass switch (a) enables you to by-pass the tuner in emergency situations.

B NEW! The MT-2000A 3KW PEP \$199.50. This unit is designed for the amateur market. It includes features such as a built-in protection grounding switch, and the ability to bypass the feedline.

C NEW! MLA-1200 \$399.50, external AC power. It shares many fine features with its family of amplifiers. It has distinctive features of its own. It employs a 1KW DC. It incorporates the same built-in protection as the 1200 watt linear amplifier on the market.

D MLA-2500 \$799.50. The MLA-2500 is designed for the amateur amplifiers. It was designed for precision plus power. Coast to coast, it handles 1KW DC input on CW, RTTY, or SSB. It has a built-in power supply, and it features

FREEDOM and POWER

Dentron

Radio Co., Inc.
2100 Enterprise Parkway
Twinsburg, Ohio 44087
Phone (216) 425-3173



DA was designed for the serious ham interested in rugged antenna tuner that easily handles 3KW PEP. It has a built-in dummy load. The antenna selector switch: (a) select direct; (b) select the dummy load or 5 other antenna

50. The MT-2000A is the most versatile, basic tuner with front panel coax bypass switching, front panel lightning protection, and the ability to match coax, random wire, and balanced

supply, \$159.50, DC supply \$199.50. The MLA-1200 is the smallest and most big brother, the MLA-2500, but also has a few features: a single Eimac 8875, running 1200 watts PEP or 1000 watts ALC as the 2500. The MLA-1200 is the smallest and most compact, great for your mobile home, boat or car!

one of the world's finest high performance military grade vacuum tubes. For the discriminating buyer who knows and appreciates quality, the MLA-2500 is a real bargain. It's built with a full 2000 watts PEP input on SSB, 1000 watts on CW. The heart of the MLA-2500 is a heavy duty, self-heating 2 Eimac 8875's.

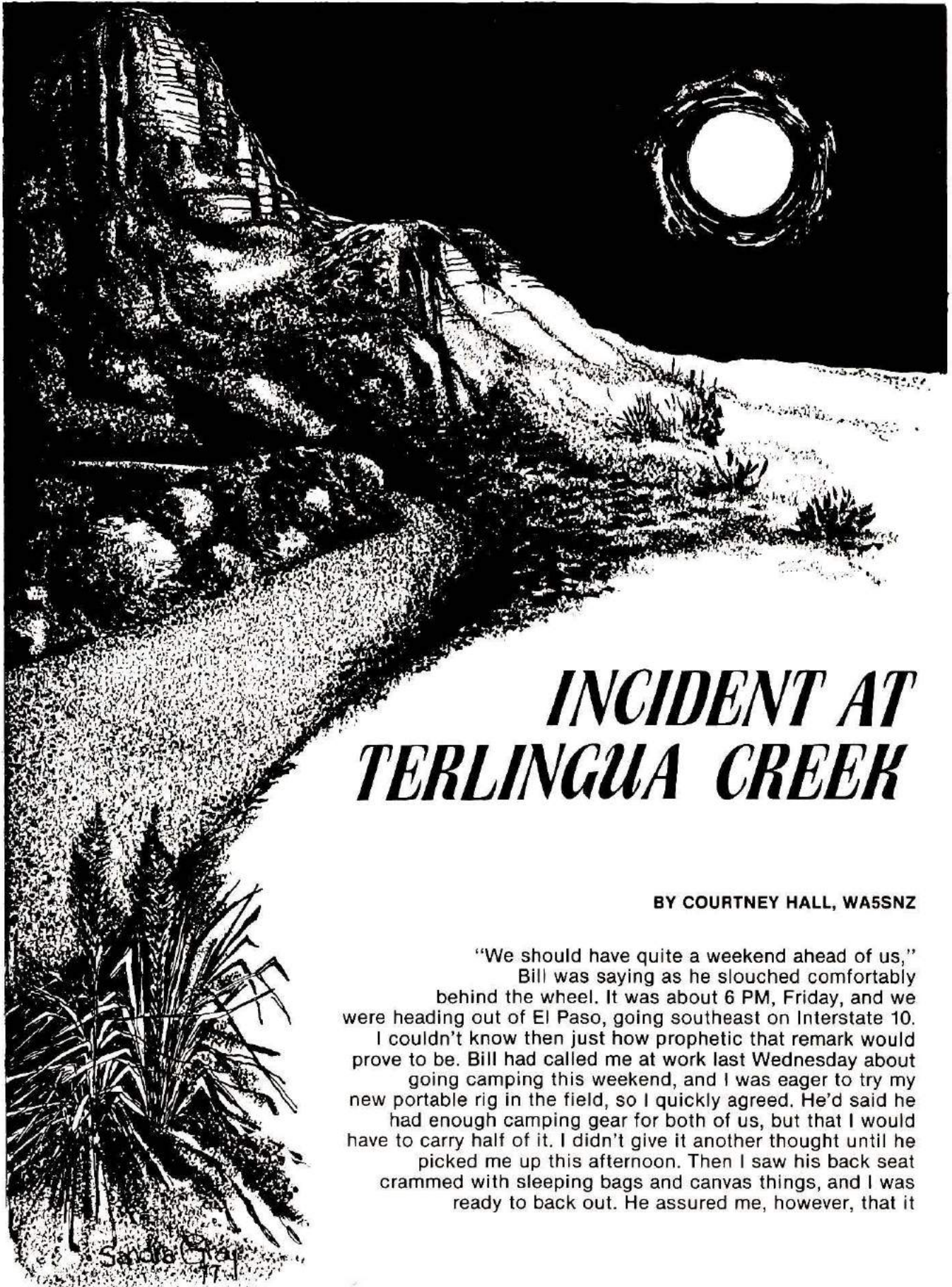

INCIDENT AT TERLINGUA CREEK

BY COURTNEY HALL, WASSNZ

"We should have quite a weekend ahead of us,"

Bill was saying as he slouched comfortably behind the wheel. It was about 6 PM, Friday, and we were heading out of El Paso, going southeast on Interstate 10.

I couldn't know then just how prophetic that remark would prove to be. Bill had called me at work last Wednesday about going camping this weekend, and I was eager to try my new portable rig in the field, so I quickly agreed. He'd said he had enough camping gear for both of us, but that I would have to carry half of it. I didn't give it another thought until he picked me up this afternoon. Then I saw his back seat crammed with sleeping bags and canvas things, and I was ready to back out. He assured me, however, that it

Sandra Gray
1978

wasn't as heavy as it looked.

"How'd you get to be such a weekend camping enthusiast?" I asked.

"My dad and I used to go mountain climbing and backpacking a lot on weekends, Wally. I guess I just got to liking the outdoors and sleeping under the stars."

"Well, this is my first time," I warned, "and the idea of roughing it has never appealed to me very much. Since I've gotten interested in portable ham rigs and battery-powered operation in the field, though, maybe I'll learn to like it."

"I used to be interested in short-wave listening when I was a kid," said Bill, "and lately I've been thinking of trying to get a Novice license, so maybe I can learn something from watching you in action."

"I didn't know you had any inclination toward amateur radio, Bill."

"Well, yeah. It sounds like fun, and hamming, like you're going to do this weekend, might be interesting on camping trips. By the way, what kind of rig did you bring?"

"Oh, it's just a little homebrew thing I've been working on," I said. "The receiver is what's called a direct conversion type; only has four transistors. And the transmitter is very low power — about one watt. That doesn't sound like much, but I've already talked to the Canal Zone with it."

"Really?" said Bill. "I had no idea you could work with such low power."

"Sure. I've worked 40 meters CW for years with eight watts and a rather low-slung dipole antenna. Worked all over the United States, Canada, and Central America. This portable rig is built for 20 meters, though; sort of a compromise between reliable night-time operation and antenna size. My antenna is two 16-foot wires going up from the rig in the form of a V. I brought some nylon string for tying the wires up to tree limbs or whatever."

"Sounds like you did a good job on it. I'm anxious to see it."

"It's wrapped in a towel in the bottom of my pack," I said. "I brought a couple of six-volt lantern batteries to power it, and they're larger than the whole rig." Heavier, too, I thought, as I envisioned myself struggling up a mountain side with all that camping gear.

A little after 8 o'clock we reached Van Horn and turned south on route 90. We were off the divided highway now, and the quality of the roads would continue to decline as we approached our destination, Big Bend National Park, where the Rio Grande River curves northward before its final turn to the southeast and the Gulf of Mexico. Around ten o'clock we stopped for hamburgers and coffee in Alpine, then headed due south on highway 118, straight for the Big Bend country. We were getting well into the mountains, and they seemed to take on an ominous look in the cold light of the full moon.

I must have dozed for nearly an hour, because the next thing I knew, Bill was shaking me excitedly. "Look out there, Wally!" he shouted, pointing to the sky ahead of us and a little off to the right. At first, all I could make out was a small source of light, moving toward us. It was not far above the ground and seemed to be flickering. As it approached, I could see that it was a small twin-engine plane, and its right engine was on fire.

"I think it's going to crash," I said.

"Yeah," said Bill softly. "He must be over Terlingua Creek; that's about a mile west of the road." The plane was almost directly to the right of us by now and had descended to a point where it would touch the ground in a few seconds. Bill stopped the car as the flaming aircraft disappeared from sight. "We passed a dirt road about a half-mile back," he said. "I think it probably goes over to the creek bed." He turned the car around and sped north.

"Maybe we should just report this to the authorities when we get to the park lodge," I said, a lump growing in my throat. I was thinking about recent newspaper accounts of marijuana being smuggled into the United States from Mexico by small aircraft.

"It would take us nearly an hour to get to the lodge — they could all be dead by then," said Bill. We came to the dirt road and turned off.

"But, what if they're . . ."

"I don't know," said Bill, cutting me off.

"Did you happen to bring a gun, Bill?" I asked.

"No." There was a note of finality in his voice. The dirt road was pretty rough, but Bill drove as fast as he could, without wrecking the car. We came to a rise in the road and could see Terlingua Creek down the slope about two hundred yards ahead. Bill stopped the car. The plane was downstream to the left, on our side of the creek, and a man seemed to be trying to fight the engine fire with a fire extinguisher. I'd never seen a plane flat on its belly before, with no landing gear showing.

"There's no point in both of us sticking our necks out," said Bill hurriedly. "You stay here with the car. I'll go down there and check it out; if I wave you off, you get out of here fast and go get the police."

"No way, Bill. I'm not leaving you here!"

"Please, Wally. There's no time to argue. Anyway, it might be just a rancher." With that Bill was out of the car and running toward the plane. It was all happening too fast. What he said made sense, but I felt like a guilty dog as I slid over to the driver's seat and watched him jog down the slope toward the burning aircraft.

By the time Bill got to the plane, the man had the engine fire almost out, and that made it harder to see what was going on. They seemed to talk for a moment, then Bill and the man went to the plane and took

something large and heavy out and laid it on the ground. They knelt over it for a few seconds, then Bill jumped up, pointing one arm toward the highway, and waved me away. I swallowed hard, unable to move. Then I saw a little flash of light in front of the man and, a half-second later, the crack of a gunshot. He was shooting at me! I put the car in gear and tried to turn around, but, unnoticed until now, I found there was a three-foot dropoff on the left side of the narrow road, and heavy underbrush on the right; there was no turning around here. For a moment I considered backing out, but the road was so rough I hesitated to do that. The sound of a second shot drove me into decisive action. I could see a large flat area near the creek straight ahead and raced the car toward it as fast as possible. I could get there, turn around, and get away before the man could intercept me. He was running toward me now, but it wasn't going to be any contest, I thought. As I came into the flat area by the creek, I made a large circular turn to keep moving as fast as I could. When my path took me by the edge of the creek, the headlights lit up a glistening patch of mud directly in front of me. I tried to stop short, but it was too late; from the way the car slid when I locked the brakes, I knew there wasn't much chance I would get out of it. Frantically, I spun the wheels and tried to rock the car back and forth, but it was no use.

I watched the man run the final yards to the car, holding a pistol at arm's length, pointing it at me. "All right," he yelled, "get out!" I turned off the engine, opened the car door slowly, and got out, never taking my eyes off him. He was medium height, slender, about 30, and had dark hair, neatly trimmed. There was a cut on his cheek. "Hey, you!" he shouted at Bill, "Get over here!" When Bill got to us, the

man told us to take everything out of the car, then we had to open up everything for his inspection; I left my rig wrapped in the towel, and he evidently thought it was just a towel. "What are these batteries for?" he asked. "I don't see any lantern."

chopping down brush and small trees, then dragging them to the plane where we were directed how to place them. By dawn nothing of the plane could have been visible from the air or the ground, although we had arranged sort of a tunnel so we could enter the



The plane was down stream to the left, on our side of the creek, and a man seemed to be trying to fight the engine fire with a fire extinguisher.

"Uh, we left in such a hurry that I accidentally left it behind." I said.

He picked up the hand axe Bill had brought. "Okay, we're going to cut some brush and cover the plane," he announced. "And we're going to stay together all the time. If you don't want to get hurt, do exactly as I say." We turned and started walking toward the plane, Bill and I a few paces in front of the man.

"The pilot's dead," said Bill very quietly. "And there're a lot of white sacks in the plane. Probably . . ."

"Shut up!" the man ordered. "No talking."

When we got to the plane I saw the pilot lying motionless on the ground. He had a large gash in his forehead. Bill and I spent the rest of the night

man-made thicket and reach the aircraft. We'd hardly sat down to rest when the man said it was time to get the car out of the mud. I had a sick feeling that as soon as the car was unstuck, this man would no longer feel it necessary for Bill and me to go on living.

"Is it okay if we have something to eat first?" I asked.

"Yeah," he said slowly, "I am kind of hungry."

"I'll go back to the car and get the food," I volunteered. I was afraid he would want us all to go, but apparently he preferred to stay out of sight as much as possible, now that it was daylight.

He nodded and motioned Bill to the opening in the brush. "We'll stay with the plane, but don't get any smart ideas. I don't want to have to come

after you. And while you're there, put all the stuff back in the car." I started for the car as they entered the thicket, and got there as quickly as I could. Not wasting any time, I grabbed the towel-wrapped rig in which I had also packed headphones, key, antenna wire, and the string. Then I picked up the batteries and slogged through the mud on up the creek. He wouldn't have any trouble tracking me, I thought.

There was a knoll some distance up the creek from the car, and I made for it as fast as I could. On the other side were some small trees to which I could string my antenna. About half-way there, I reached the edge of the muddy area and ran the rest of the way to the knoll. Once in the trees on the other side, I knelt and nervously unwrapped the radio, connected batteries, phones, key, antenna wires, and tied the wires to the tree limbs. I lay down to keep a low profile, put on the phones, and turned on the battery switch. Holding my breath, I tuned across the CW portion of the 20-meter band. My heart sank. I could hear only a couple of signals which were too weak to copy. This might be my only chance, so I set my transmitter frequency half-way between the two signals, turned the transmit-receive switch to transmit, and started sending:

SOS SOS SOS TERLINGUA
TERLINGUA CREEK CREEK 30 30 MI MI
NORTH NORTH RIO RIO GRANDE
GRANDE SEND SEND POLICE POLICE

I fought off the temptation to send rapidly; my impulse was to blurt it all out as fast as I could, but I wanted anyone who might hear it to be able to copy. Sending each word twice and keeping my speed down to about ten words-per-minute tested my will power to the limit. Again:

SOS SOS SOS TERLINGUA
TERLINGUA CREEK CREEK 30 30 MI MI
NORTH NORTH RIO RIO GRANDE
GRANDE SEND SEND POLICE POLICE

I flipped the switch back to receive and reached for the receiver dial to tune around my frequency for a reply. Before I could move the dial, though, the sound came loud and clear in the headphones: **DIDAHDIT DIDAHDIT**. The cadence gave a distinct emphasis to the dah sound in the letter R, the way one hears it when the person on the other end has copied you solid all the way. A chill went over me and my throat seemed to swell shut with a mixture of relief and exultation. No sound was ever sweeter than on that morning when I heard the letter R.

R R R SOLID COPY OM
WHATS UR CALL? DE W4J.

"Hold it right there!" The menacing tone of the loud voice sent quivers up the back of my neck. I looked up and saw Bill and the man standing over me. Somehow I felt it was imperative that I respond in some way to the request for my call letters by the W4. As fast as I could, I flipped the switch back to transmit and started to send my call, but I only got off the letter W before he kicked the rig away, giving my head a glancing blow with his shin at the same time. I rolled over on my back, feigning to be hurt more than I was, hoping this might appease him enough so he wouldn't start shooting.

"I ought to finish you right now!" he said, pointing the muzzle of the pistol at my face. My throat was so tight I could hardly breathe. His jaw was set hard and his eyes blazed anger at me. I thought if I could say something, anything, it might buy me a few more seconds, but all I could manage was a sort of moan. Bill came to my rescue.

"You're going to need him to help get the car out of the mud." Good old Bill, always cool in a tight situation.

"Did you get through to anybody on that thing?" the man asked harshly, as though not hearing Bill. I didn't know

what to say. If I said yes, he might shoot me out of anger, or, fearing he was in jeopardy of imminent capture, he might back off. If I said no, he might feel more secure and still shoot me in anger, or he might figure he needed me to help with the car.

"No," I said, trying to look dejected. He looked at me for a long moment, evidently trying to decide on the validity of my answer.

"Okay," he said finally, "let's get the car out." I let out a long sigh and slowly got to my feet. As we trudged back to the car, I kept turning over in my mind what the W4 I had contacted might do. Would he think I was some bootleg operator sending a false distress signal? Would he discount the whole thing because I didn't send him my call letters? No, if he was any kind of operator at all, he'd report it. But how long would it take for help to arrive? Maybe he'd call his local police and they'd relay it to the Texas police. Or maybe he'd try to call the Texas police directly. How long would that take? Would they believe him?

We stopped at the edge of the mud where the car was stalled. The man looked at the car, then at the surrounding terrain, then at Bill and me. I guess he knew what we were thinking, and we probably knew his plans. It wasn't to our advantage to help him get the car out, because he'd probably do us in and leave in the car. Yet he had the option to shoot us and take his chances on foot. He must have decided to negotiate.

"Are you going to help me get the car out or not?" he asked flatly.

"What's in it for us?" replied Bill, rather matter-of-factly.

"I'll tie you up and leave you here," he said.

"How do we know you won't shoot us when we get the car out?" countered Bill.

"You don't. But if you won't help with the car, then that's it." He raised his gun

until it was leveled at us.

"Okay," I said, "we'll get it out. What choice do we have?"

"If I catch you stalling," he warned, "then I'll have to leave the car . . . and you." Bill and I looked at each other. We'd have to play it straight. I wished that I could let him know I had gotten through to the W4.

At the man's direction, we took all our gear and put it under some trees by the creek, then started cutting brush and small trees to make sort of a wooden road for the car to back out of the mud. The man knew what he was doing and made us build it right; when we'd finished, there wasn't any doubt in my mind that the car could back out of the mud like it was on solid road. I glanced at my watch; it had been nearly two hours since I'd sent the distress call. What if they didn't get here in time? What if nobody was even coming!

"Get in front and push," the man ordered. He got in and started the engine; the back wheels caught quickly, and the car was on dry ground in no time. He got out, leaving the motor running. "Okay, let's take a little walk down to the creek," he said. His voice was relaxed now, but it seemed more threatening than ever. Bill and I waded through the mud to the creek, and the man angled from the car to meet us there.

"Wh-What are you going to do?" I stammered when he stopped in front of us.

"Well," he said slowly, a cruel smile forming on his face, "I'd like to leave you tied up here, but I don't have any rope." He knew we had rope in our gear, so there was no doubt now as to his intentions. I was so fearful of what was about to happen that I almost failed to notice the faint put-put-put sound in the distance. In a moment I was sure; it was a helicopter! And headed this way. I could see it coming in from the east. The man heard

it too; he backed off from us and turned so he could see it. He stared at it a moment, then turned back to us. "All right, get back to the car. Move!" We jogged toward the car. He's going to use us as hostages, I thought, but we're as good as dead when he's through with

silver-colored one with black letters on the side: USAF. A door opened and maybe half-a-dozen men in steel helmets and green fatigues jumped out; each carried a carbine. An exhilarating surge of joy and relief flowed through me; I felt like the Marines had



"Hold it right there!" The menacing tone of the loud voice sent quivers up the back of my neck. I looked up and saw Bill and the man standing over me.

us. At the car, he got in the back seat, Bill behind the wheel, and I in the front passenger seat. "Get moving," the man ordered, and Bill headed for the dirt road. We were still a hundred yards from the top of the rise when a car came into view, headed toward us on the road. It stopped and two uniformed men got out.

"Stop the car!" came the order from the back seat, and Bill complied. The sound of the helicopter was very loud behind us now, and I looked back to see it landing perhaps 50 yards away. It was a large

landed! Then I thought I heard the man whimper as he crouched in the back of the car.

"Well, what are you going to do now, Hot Shot?" I yelled. I nudged Bill, opened my door, and rolled out on the ground. Bill did the same on his side. I just lay there flat, as the troops were within a few yards of the car. "He's in the back seat! He's got a gun!" I yelled to them.

"Throw out your weapon and come out slowly!" the trooper nearest me shouted. He and the others formed a ring

around the car, each with his carbine aimed at the car. The man peeped out the window, threw out his gun, and crawled out as the two Border Patrol officers arrived from the car on the dirt road.

After we had given our statements, we were told that an amateur radio operator in Florida had heard my distress call and notified the FBI, who, in turn, had called the Border Patrol. In addition, a helicopter had been dispatched from Laughlin Air Force Base at Del Rio, and several Air Force MARS stations took bearings on my signal to verify our location.

"My signal?" I said, "How can that be? I was only on the air for a few minutes."

"Your signal's still on the air," one of the Air Force men said. We walked up the creek to where I had set up the radio. I had thought that when the radio had been kicked, some of the battery or antenna wires had come loose, but not so. Instead, the rig had come to rest partly on top of the key, holding it closed. I guess my head had slowed the man's leg when he kicked the radio, and everything had held together.

When the helicopter had gone, and the officers had called for assistance to remove the plane and its pilot, Bill and I were released. We gathered up our gear and drove on to the park lodge where we ate, rested, and got a good night's sleep. We felt much better Sunday as we drove back to El Paso.

"Well, we didn't get any mountain climbing done," I reflected, "but I did manage to get in just a little hamming. I'm going to write that ham in Florida to tell him what happened and thank him for saving our lives."

"Amen!" said Bill. "And the next time we go camping, you be sure to bring that rig of yours along — and something I can study for my license."

"Amen!" I said.

HRH

Larsen...

the coolest antenna in town gives you the hottest performance!

Since the first Larsen Antenna was introduced some 15 years ago, this basic fact has not changed: **Larsen Mobile Antennas are designed and built to outperform.**

With the introduction of the Larsen exclusive Kūlrod whip, this superior performance is a fact more than ever.

We're not going to confuse you with details on metallurgy, radiation resistance, plating systems and all that. Instead we suggest that you make this simple test:

Take any antenna other than a Larsen . . . one with a regular unplated 17-7 PH stainless steel (.100/.050) tapered whip. Apply a good husky signal to it . . . 100 watts, for, say, a full minute. Then, power off, feel the antenna. Careful! Burn blisters aren't pleasant.

Next . . . try a Larsen Kūlrod Antenna. Put it to the same test.

Amazing, isn't it!

That's our story. Heat means power . . . power that isn't radiated . . . power you shouldn't throw away. With the Larsen Kūlrod, power goes into communicating instead of heating the antenna. That's why **you can HEAR the difference.**

Larsen Antennas are available to fit all styles of mounts and to cover Amateur frequencies from 6 meters through 450 MHz. Write for complete catalog and list of dealers nearest you.



Larsen Antennas

11611 N.E. 50th Ave.
P.O. Box 1686
Vancouver, WA 98663
Phone: 206/573-2722

In Canada write to:
Canadian Larsen
Electronics, Ltd.
1340 Clark Drive
Vancouver, B.C. V5L 3K9
Phone: 604/254-4936

© Kūlrod is a Registered Trademark of
Larsen Electronics, Inc.



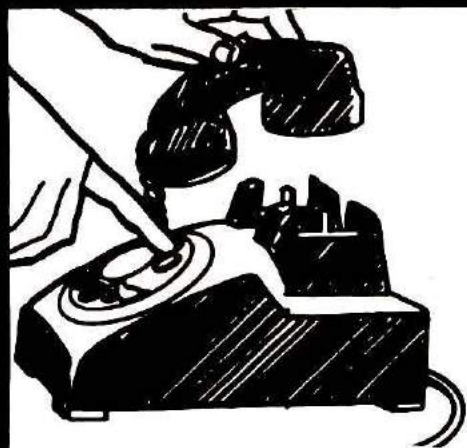

**CALL TOLL FREE
1-800-535-9598**

LA. RESIDENTS CALL COLLECT

AUTHORIZED DEALER FOR...

 **KENWOOD**



DRAKE



ICOM

YAESU!



**ROHN FOLD OVER TOWERS
ATLAS • BIRD • CDE • DENTRON
ETO • HUSTLER • HY-GAIN
KLM • LARSEN • MOSLEY
SWAN • TEMPO • TEN-TEC
TRI-EX • WILSON • CUSHCRAFT**

- Prompt phone and mail service
- Large inventory
- Same day shipment if ordered before noon
- Visa and Master Charge accepted

DIGITAL ELECTRONICS INC.

1201 ANNUNCIATION ST.
P.O. BOX 30566
NEW ORLEANS, LA. 70190
PHONE 504-568-9879

TEN-TEC CENTURY 21 GOES DIGITAL!

Century 21, the exciting 70-watt, 5-band CW transceiver that surprised everyone with its super performance and low cost, has another surprise for you. A second model with digital readout (and a mod kit for those who would like to convert their dial model). Both Models 570 and 574 have the same unique circuitry that has won raves from everyone — both have the same fine features:

- Direct Frequency Readout (Model 574: 5 red LED digits, 0.3" high, accurate to nearest 1 kHz. Model 570: marked in 5 kHz increments from 0-500 kHz, MHz markings for each band displayed, tuning rate typically 17 kHz per tuning knob turn.
- Full Break-In • Full Band Coverage on 3, 5, 7, 14, 21 MHz Bands, 1 MHz on 28 MHz Band • 70 Watts Input • Total Solid-State • Receives SSB and CW • Receiver Sensitivity 1 μ V • Instant Band Change, No Tune-up • Offset Receiver Tuning • 3-Position Selectivity • Adjustable Sidetone Level • Linear Crystal-Mixed VFO • Overload Protection • Built-In AC Power Supply • Black & Gray Styling • HWD: 6 $\frac{1}{8}$ " x 12 $\frac{1}{2}$ " x 12", 15 $\frac{1}{2}$ lbs. • Matching Accessories

THE RECEIVER. Double-Direct-Conversion. Easy tuning. Just select the frequency and set the audio level. Excellent cross-modulation characteristics. Offset tuning so you can tune either side of zero beat to reduce QRM. Front panel control selects one of 3 selectivity curves: 2.5 kHz for SSB reception, 1 kHz for normal CW, and 500 Hz for when the QRM gets rough. Plus separate AF and RF controls, headphone jack, and built-in speaker.

THE TRANSMITTER. Total solid-state. Push-pull Class C final amplifier. Individual low-pass filters are switched into the antenna line to reduce unwanted radiations, minimize TVI. No tune-up needed when changing frequencies or bands. And *full break-in* allows incoming signals to be heard between transmitted characters. Now CW is real conversation!

THE VFO. Common to receiver and transmitter. Permeability tuned. Linear scale on model 570. 5-5.5 MHz basic frequency is crystal-mixed to the desired frequency so bandwidth and stability are the same on all bands (crystals included for 3.5, 7, 14, 21, and 28-28.5 MHz segment of the 10 meter band).

THE POWER SUPPLY. Built-in, AC operated, and regulated. Monitors current demand, shuts down automatically when necessary for protection. Lighted input current meter shows proper Drive setting.

MATCHING ACCESSORIES. Model 277 Antenna Tuner/SWR Meter. Model 670 Electronic Keyer, 6-50 wpm, self-completing characters. Model 276 Calibrator for markers at every 25 and 100 kHz. Model 273 Crystal for 28.5-29 MHz. Model 1170 12 VDC Circuit Breaker for mobile operation of models 574 and 570.

574 Century 21 Digital Transceiver	\$399.00
570 Century 21 Non-Digital Transceiver	\$299.00
277 Antenna Tuner/SWR Meter	\$ 85.00
670 Century 21 Keyer	\$ 29.00
276 Century 21 Calibrator	\$ 29.00
273 Crystal for 28.5-29 MHz	\$ 5.00
274 Digital Mod. Kit for Model 570	\$ 90.00
1170 DC Circuit Breaker	\$ 8.75

See both Century 21 surprises at your TEN-TEC dealer — or write for full details.

TEN-TEC, INC.
SEVIERVILLE, TENNESSEE 37862
EXPORT 5715 LINCOLN AVE., CHICAGO, ILL. 60646

THE SECOND SURPRISE OF THE CENTURY: DIGITAL



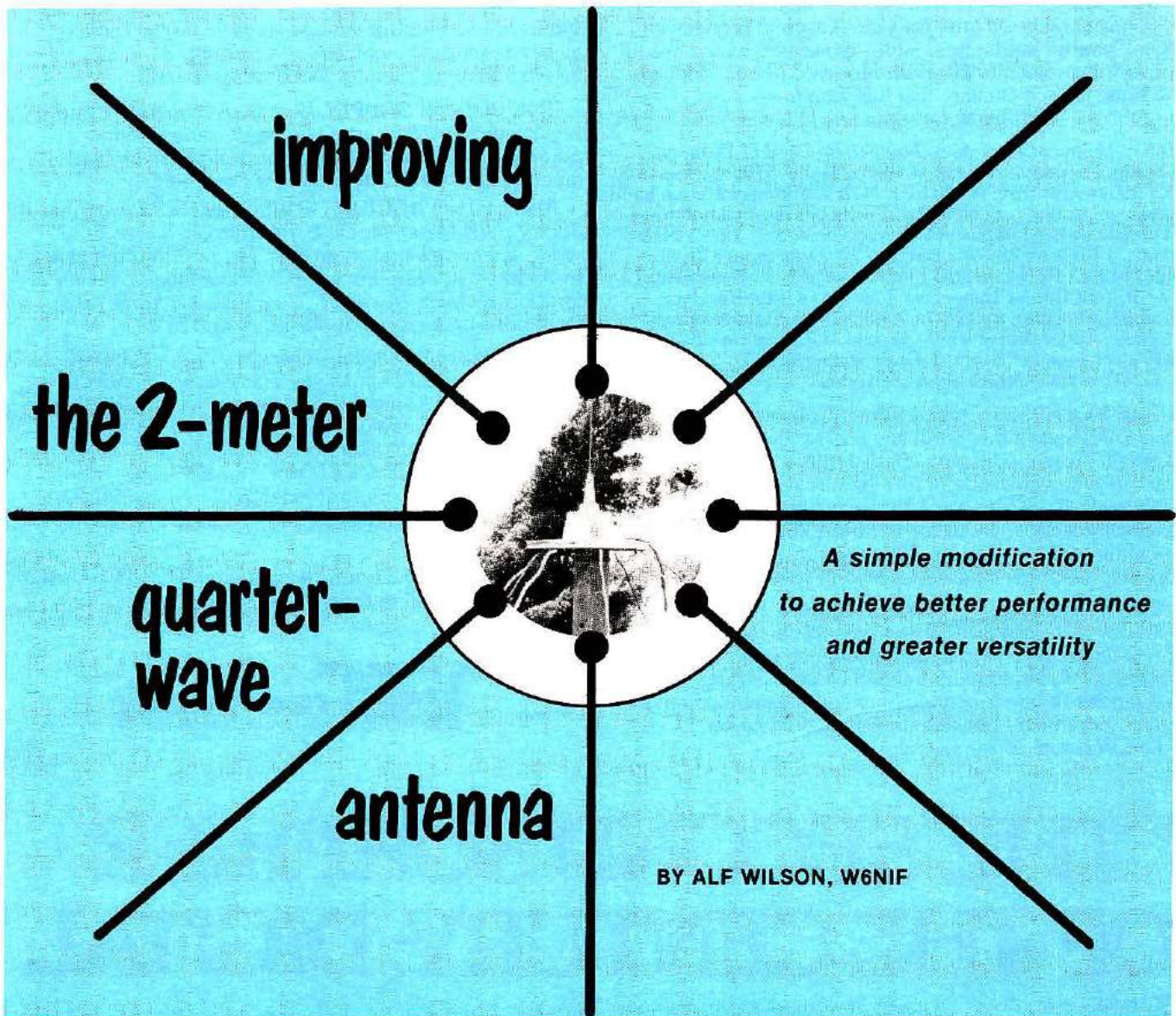

If you are into the mobile two-meter scene you've no doubt heard of the magnetic-mount 1/4-wavelength whip antenna. These little antennas are great, especially if you're only interested in casual mobile work. No holes are needed to mount them because a built-in magnet in the antenna base allows you to place the antenna on top of your car roof. Then all you do is bring the coax transmission line through the car window and connect it to your transceiver. After mobiling, just lift off the mag-mount antenna and attached coax. You can then use it with your home station, if you wish, as explained later.

The 1/4-wave ground plane

Probably the most popular mag-mount two-meter antenna is the 1/4-wavelength vertical whip. A 5/8-wavelength vertical whip is also available, which is more expensive. The 5/8-wavelength antenna provides about 3-dB gain over the 1/4-wavelength vertical, but of course it costs more. A 1/4-wavelength antenna, oriented vertically, and operating at *maximum efficiency* will put your signal into most two-meter repeaters across the country.

The main problem with most commercially available mag-mount vertical whips for 144-MHz is that they do not operate

at maximum efficiency. These antennas are mounted on the car roof, which is supposed to act as a ground plane. The problem is that, because of the paint on the car, which causes poor coupling to the metal surface, a true ground plane does not exist in the typical mag-mount installation.

A ground plane is an artificial ground (sometimes called a "counterpoise") that is elevated above the true earth ground. For a vertical antenna system to operate at maximum efficiency, the ratio of antenna radiation resistance to the system ohmic resistance (including ground resistance) must be as high as possible.

That's why broadcast stations, for example, use as many as 120 radial wires at the base of a vertical antenna. The idea is to decrease the ohmic resistance of the antenna system as much as possible, so that the *efficiency* will be as high as possible. The radial wires constitute a ground plane when the antenna is elevated above earth.

Making the ground plane

All you need to improve the 1/4-wavelength mag-mount vertical is listed below.

1. 152 inches (386 cm) of number 12 AWG (2.1 mm) copper wire
2. A lid from a 1-gallon (3.8 liter) paint can
3. A 200-watt soldering iron
4. About 1 ounce (28gm) of rosin-core solder
5. Wire cutters
6. Sharp knife
7. Some rust-resistant paint (such as *Rustoleum*)

The ground plane is illustrated in **Fig. 1**. Pretty simple, right? Just make sure that the wire radials are *really* soldered to the paint-can lid. It will be helpful to have an assistant hold the radial wires while you apply the solder, or you can use a weight to keep the wires from wandering while you make the solder

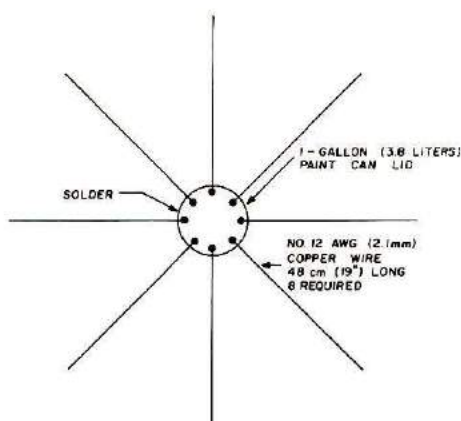

Fig. 1. Construction details for the two-meter ground plane for use with mag-mount vertical antennas.

connection. It's extremely important that *good* solder connections are made. Cold-solder joints can blow the entire project, so take your time and make certain that good electrical contact exists between the radial wires and the paint-can lid.

The next step is to make sure that a good electrical contact exists between the paint-can lid (the ground plane) and the mag-mount whip antenna, which mounts on the ground plane. I used self-tapping screws to mount my whip to the ground plane; however, this isn't necessary if you scrape the paint-can lid with a knife. It's imperative that the mag-mount antenna make good electrical contact with the ground plane (remember, you're trying to decrease the ohmic resistance of the system).

It's also a good idea to give the ground plane a coat of rust-resistant paint. But of course you must not paint the area in the center of the ground plane on which the mag-mount antenna rests.

If you bend each radial from the horizontal to about 45 degrees (see photo) you'll find that the system will offer a better impedance match to your 50-ohm transmission line.

Operation

The photo shows my mag-mount whip, mounted on its ground plane, which is in turn mounted on a piece of TV mast about 20 feet (6 meters) above ground. It's easy to transfer the entire antenna and ground plane assembly to the top of my pickup truck when I want to go mobile.

Performance? Well, before I built this simple ground plane to augment my 1/4-wave whip I couldn't raise the two-meter repeater on Catalina Island (about 90 miles, or 144km) from my home location. Now, with the little paint-can lid and its radials I can access Catalina every time.

HRH

CHICAGO

Area Amateurs
Know

ERICKSON

Can Provide
All Their
Amateur Radio
needs!

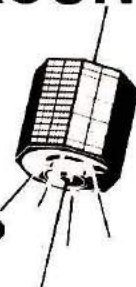

**WB9JKT, WB9ZRA
and WN9ANF
serving you with...**

- Ameco • ASP • Atlas
- Belden • Bird • CDE • CIR
- CES • Collins • Cushcraft
- Dentron • Drake • HAL
- Hy-Gain • Icom • KLM
- Kenwood • Larsen • MFJ
- Midland • Mosley • NPC
- Newtronics • Nye
- Regency • Shure • Swan
- Standard • TPL • Tempo
- Ten-Tec • Wilson • Yaesu



Hours: 9:30-5:30 Mon., Tues., Wed. & Fri.
9:30-9:00 Thurs.
9:00-3:00 Sat.



**ERICKSON
COMMUNICATIONS**
5935 N. Milwaukee Ave.
Chicago, IL 60646
(312) 631-5181

GET IN ON THE SWAN

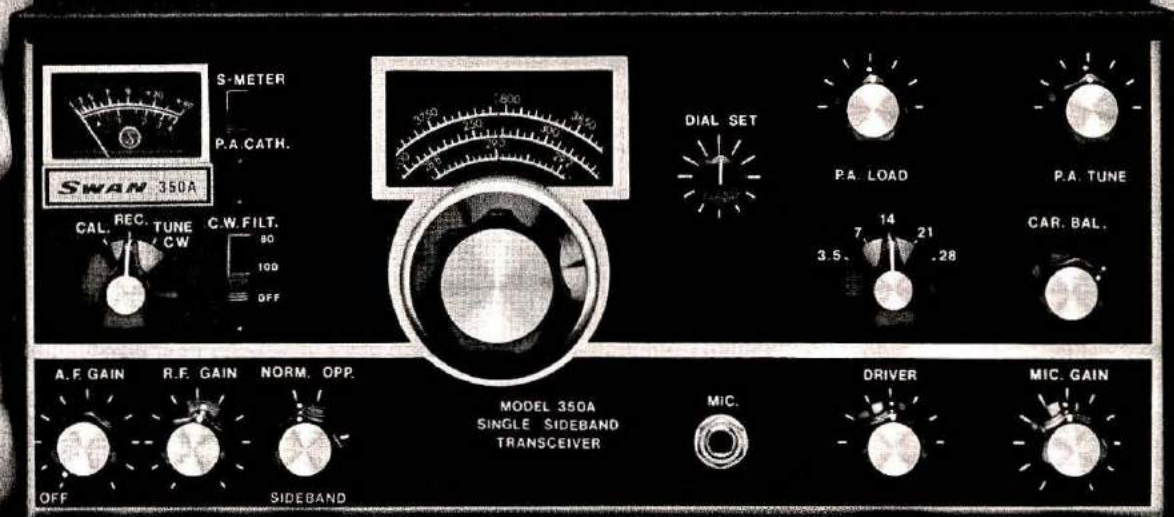

Swan puts top-line transceivers into your grasp. At down-to-earth prices — even a novice can afford to become a world power. You start with more watts per buck; boost your rig's performance anytime. Swan makes it easy to add on capabilities.

Swan 350A. \$599.95 with built-in AC power supply

- 300 watts P.E.P. Input SSB
- 200 watts DC Input on CW
- 80 through 10 meters, USB, LSB, CW
- 5.5 Mhz, 2.7 KHz bandwidth crystal filter
- Oscillators are solid state and IC regulated for stability
- CW sidetone monitor with adjustable pitch and volume
- CW audio filter 80 and 100 Hz selectable
- Crystal Calibrator (350A only)
- Built-in 117 VAC power supply and speaker. (220 VAC power supply available on special request)

Accessories:

- VX-2 Vox
- 14A DC Converter
- 1200X linear amplifier

Swan 350D. \$699.95 with built-in AC power supply

Same basic features as 350A except added feature of:

- 6 digit LED frequency display with readout to 100 Hz



WORLDWIDE POWER GRAB!



Swan transceivers are compatible with an extensive line of proven accessories, available at your Swan dealer or factory direct. Including linear amplifiers that can stretch your power grab, to the legal limits around the globe.

Swan 750CW. \$679.95 (PSU-3 AC Power Supply \$173.95)

- 700 watts P.E.P. Input on SSB
- 400 watts DC Input on CW
- CW audio filter selectable 80 or 100 Hz
- CW sidetone monitor with adjustable pitch and volume control
- 80 through 10 meters, USB, LSB, CW
- Selectable 25 or 100 KHz crystal calibrator
- Standard 5.5 Mhz, 2.7 Hz bandwidth crystal filter or optional accessory 16 pole filter available with 140 dB ultimate rejection

Accessories:

- VX-2 Vox
- MK-II Linear amplifier
- DD-76 Digital Dial
- SS-16B 16 pole filter

Please rush full specs for Swan Transceiver:

____ 350A
____ 350D
____ 750CW

Send application forms for Swan Revolving Credit Card, useful for financing Swan equipment purchases through dealers or factory.

Name _____

Address _____

City _____ State _____ Zip _____

 **SWAN**
ELECTRONICS
a subsidiary of Cubic Corporation

305 Airport Road, Oceanside, CA 92054

Swan's continuing commitment to product improvement may affect specifications and prices without notice.



QUESTIONS & ANSWERS

BY THOMAS McMULLEN, W1SL

Last month I finished up the Electrical Principles segment of the FCC Study Guide and, according to that guide, the next section should be Practical Circuits. However, it seems to me that before I can tell you about an oscillator that uses a vacuum tube, an inductor, capacitor, and some resistors, you'll have to know what they look like and what a vacuum tube is. Therefore, I'll jump over that section for the moment, and get into section G, Circuit Components.

Did you know that there are three ways to tune in a signal on your radio, even the broadcast-band radio that you listen to music on? There are, and I'll tell you about them, also. However, let's first take a look at some of the passive components; capacitors, inductors, resistors, and transformers.

Capacitors

Capacitors are as good to start off with as anything. If you recall, a basic capacitor is made of two metal electrodes separated by something called a dielectric. The dielectric helps to concentrate the *electrostatic* lines of force between the two electrodes. (Electrostatic lines of force are the ones that make a piece of paper cling to a comb after you

have brushed it on a cloth, or run it through your dry hair.) The most common dielectric available is air, which has a dielectric constant of 1.0005 (which is very close to 1, and is usually considered to be 1 except for very exact measurements). The only thing with a constant less than air is a vacuum, which is rated at 1.000; see **Table 1**. Other materials have higher dielectric constants, which is very convenient, because it allows us to make capacitors very small. Just in case you didn't follow that reasoning — it works this way: suppose a given set of plates, with air dielectric, measures 10 square centimeters (1.55 in²) and has a capacitance of 3.5 pF. If you replace the air with a dielectric that has twice the value, then the capacitance doubles, or,

Table 1. Dielectric constants of some materials used in capacitors.

Vacuum	1.0
Air	1.0005
Rubber	2.8
Paper	2.7
Ceramics	3.5-6.5
Glass	3.8-6.8
Quartz	3.9
Mica	5.5-6.5
Porcelain	6.5
Water	75-80
Barium titanate	7000+

conversely, you can obtain the same capacitance with plates with half the area.

The photograph shows several types of capacitors that are used in radio and electronic equipment and **Fig. 1** shows the schematic symbols for them. There are some variable capacitors shown, which are used to adjust the frequency to which circuits are tuned. When you turn the dial of your radio, you actually turn the shaft of a variable capacitor, which "tunes" the circuit to a station (there, that's one way to tune in a signal, I'll tell you about the other two later).

Other types of capacitors shown are the oil-filled, used in power supplies, the disk ceramic or tubular ceramic (sometimes called dogbone) used in radio-frequency stages, the paper-dielectric type, used in audio circuits, and the molded—mica types, which are used in both radio- and audio-frequency circuits. The capacitors with a metal can, with the + and - signs, or with a band at one end marked *negative*, are electrolytics. That means that the dielectric between the metal electrodes is impregnated with a chemical that increases its dielectric constant. It also makes the capacitors sensitive to the polarity of the voltage applied to them, so they must be hooked in the circuit correctly or they will get hot, and perhaps explode. Incidentally, the chemical electrolyte is very corrosive, so always be careful around these capacitors — if one should burst open, don't let the electrolyte get into your eyes, and immediately wash it off your hands.

The ceramic disk capacitors are not polarity sensitive, but they are voltage sensitive — they will withstand only a certain amount of applied voltage before they short out internally. The same is true of the paper, oil-filled, mica, and air-dielectric types. The air-dielectric variable capacitors will simply arc over until the

voltage is removed, and then continue to function normally. However, the other types will be permanently damaged by too much voltage and will have to be replaced. Voltage ratings are sometimes marked on the fixed capacitors, or sometimes indicated by color dots or number codes that are discernible to the experienced electronics expert. The voltage rating of the variable capacitors can be determined by calculations involving the spacing between the plates, but you seldom have to go through that exercise nowadays — only a few different voltage ratings are available in standard capacitors that you can buy, and you simply use one that the manufacturer rates as high enough to handle the combination of rf and dc voltage in your circuit.

Inductors

Just as capacitors can be

made of different sizes by using different materials, so too can inductors be made smaller or larger. One thing that determines the size of an inductor is the type of core material. Most of the large inductors, such as those used in a power supply, have an iron core. It is made of several thin sheets of an iron or steel alloy, placed side-by-side, with the copper coil wound around this core. The iron core (called laminations) concentrates the *magnetic* lines of force so they can be used more effectively. In the photograph, I have taken the end laminations off one of the chokes so you can see the construction. (Many transformers are made the same way — more about them later.)

Another factor that determines the size of an inductor is the wire size. If your inductor must pass a large amount of current, then you must use wire of a size that

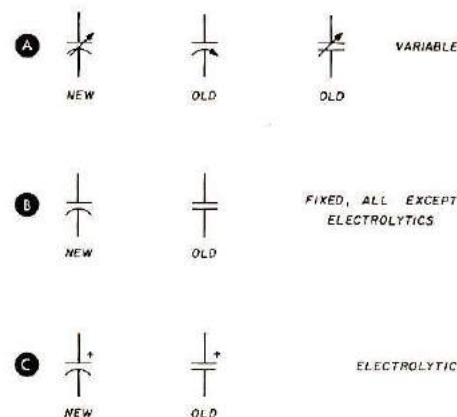

Fig. 1. Symbols for variable capacitors, A, fixed capacitors, B, and electrolytic types, C. I have included the older symbols because you'll still find many schematic diagrams done in the old style. Electrolytic types are voltage sensitive, and will be damaged if connected to voltage of the wrong polarity.

will not overheat at that rating. There must be enough space for the wire, plus the insulation between turns, therefore high-current inductors tend to be quite large.

The inductance required will also have a lot to do with the size of the device — a very small inductance that is to be used at vhf can be made of perhaps a dozen turns of wire the size of a hair, wound on a form about as large as a toothpick. Obviously this cannot handle much current before it overheats, and with so few turns of wire the inductance will be very small.

The pie-wound inductors (chokes) in the photograph are used to isolate the rf energy in high-frequency circuits — to keep it out of the dc or audio parts of the radio where it would cause problems. The windings are in segments, or pies, like that in order to reduce the capacitance between the turns of wire, which would spoil the effectiveness of the choke at radio frequencies. Some rf chokes are wound with air at the center of the winding (air core), and others have a form of powdered metal called ferrite as their core. The ferrite can be varied as to its composition

An assortment of variable capacitors is shown on the left; fixed units on the right. The two small variables at the bottom left are ceramic types, and the two immediately above them are a glass-piston and a mica-insulated type. The rest are air-dielectric variables. The large fixed capacitor at the top is an oil-filled unit; the black unit with leads and the metal upright are electrolytics, as are the four immediately in front of them. The next row of four have paper or plastic dielectric. The bottom right row contains three disk ceramic capacitors and one ceramic (threaded) feedthrough. The row of three just above them are all mica-dielectric types.

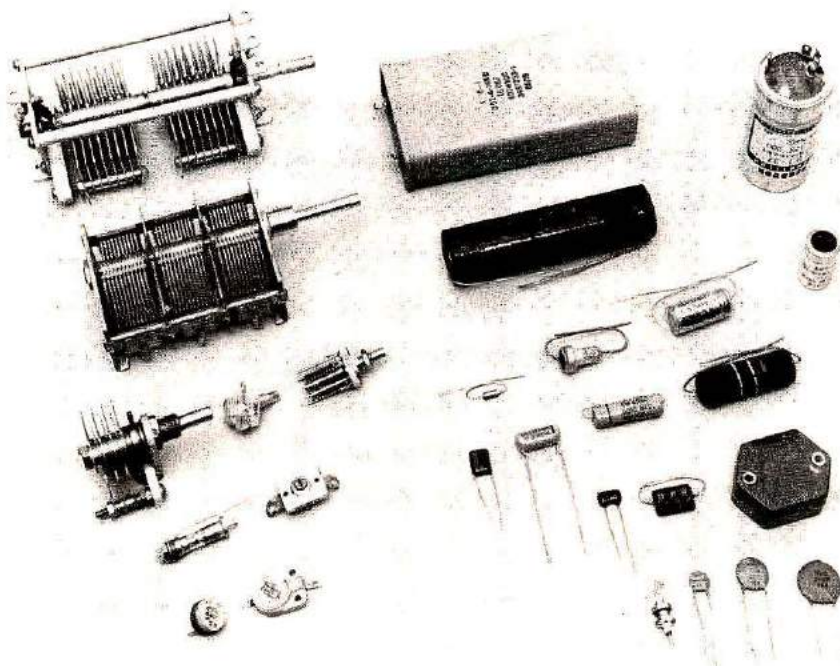

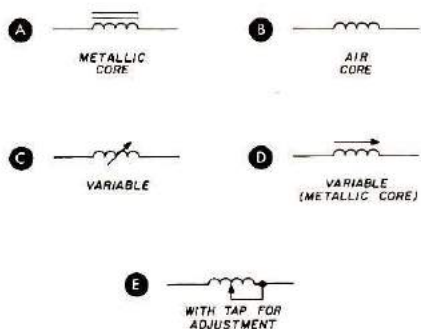

Fig. 2. Inductors of both the fixed and variable types. A metallic-core symbol can mean either a laminated iron core or a powdered core.

and fineness of grain, thereby allowing some control over the effect it has on the inductor that is wound around it.

You can also make a variable inductor, which allows you to change the value over a small range. This is most often done at radio frequencies, or very high audio frequencies — like the horizontal-hold on your television set, for example. It is usually a coil of several hundred turns of fine wire, wound on a hollow phenolic form. A slug of powdered iron is mounted so that it can be moved in or out of the form, thus changing the inductance of the coil of wire. A few amateur and short-wave receivers use this variable inductance principle to tune in signals (this is the second method; one more to go).

Tuned circuit

Let's take a moment to look at a tuned circuit here, so you'll know what causes it to "tune" a signal, or a transmitter stage. A tuned circuit consists of two elements: a capacitor and an inductor, Fig. 3. Both are energy storage devices, if you will recall from last month's discussion. At that time I told you how they worked at low frequencies, as found in power supplies. They perform much the same way at radio frequencies, too, but of course at a faster rate. Because of the time involved, they do not have to be so large (the interval between energy pulses and

storage-release times is not very long).

Suppose that you charged up a capacitor and then connected an inductor across it, as in Fig. 3. Naturally, the electrons in the capacitor see the path through the inductor as a means of getting from one plate to the other, so they start flowing in that direction. The inductor, doing its thing, opposes this flow as long as it can, and eventually the electron flow decreases and stops, as the charge on the two plates becomes equal. However, the inductor has all that energy hanging out there around the windings in the form of a magnetic field, which begins to collapse. The collapsing field, remember, causes the electron flow to continue in the same direction as before, which pushes the electrons toward the capacitor plate. Now the capacitor has an excess of electrons on one

plate again, but this time it is the plate opposite from the one that had the - and + charge in the first place!

The whole process starts all over, and continues again and again, until the resistance of the wire dissipates the energy and the whole thing reaches a state of calm (equilibrium). This cycling back and forth of the electron charge is called a *flywheel effect*, and it is most perfect when the time of discharge of the capacitor and the time of release of the energy from the inductor's magnetic field are exactly matched (tuned). The proper technical explanation for this condition is: *the circuit is resonant when the capacitive reactance is equal to the inductive reactance*. You can vary either the inductance or the capacitance to change the resonant frequency of the combination, but if you go too far from the ideal condition, the

The three inductors at the left are plug-in units designed for transmitter use. They actually are radio-frequency transformers, each with a secondary winding of a few turns of wire. The long coil of wire at the top of the next row is a stock coil which you can trim to the size you need. Below that coil are five rf chokes; three pie-wound, one single-layer (solenoid) wound, and one encapsulated in plastic. The third row contains three radio frequency transformers with metal shield cans over them, a ferrite-core loopstick (antenna), and three inductors with a variable ferrite (iron) core. In the right row, the top and bottom units are power transformers with heavy laminated cores. The center unit is a power-supply choke (inductor) with some laminations removed so you can see the construction. The three donut-shaped units at the bottom are toroidal inductors (the center one is a core only, you can wind your own wire on it for the needed inductance).

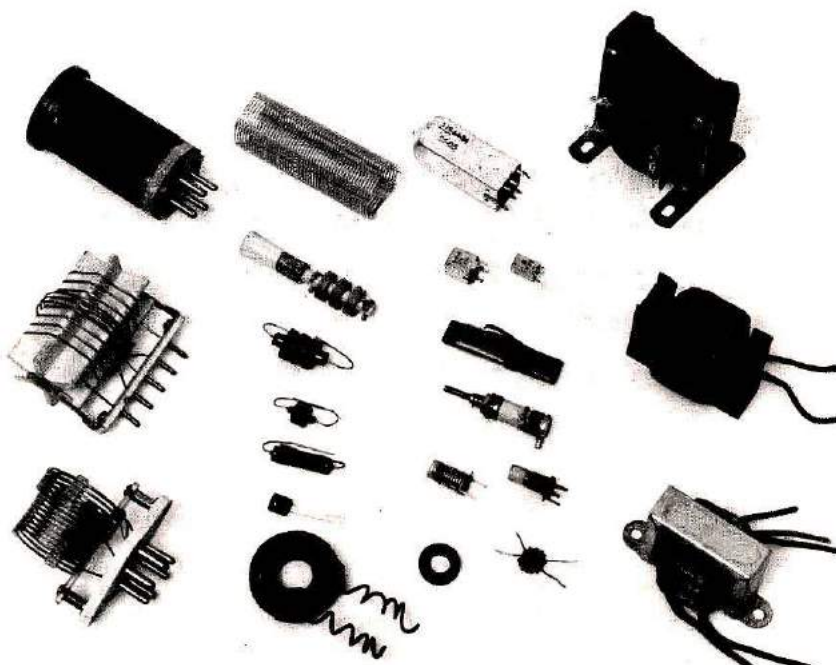

efficiency begins to suffer because one will run out of stored energy before the other, or one will have more stored energy than the other can handle within its natural charge/discharge time.

This whole process, of course, is happening very, very fast — in a circuit that is tuned to the middle of the broadcast band, say 1000 kHz, it is happening 1 million times per second! It all works the same way, even up through the uhf television channels (over 800 million times per second) and beyond; the capacitors just

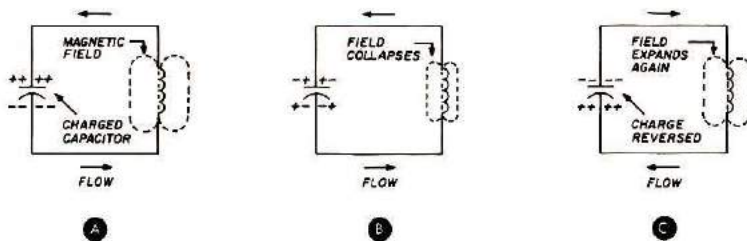

Fig. 3. A tuned circuit consists of an inductance and capacitance, connected in parallel. If a charge is placed on the capacitor plates, it immediately tries to discharge through the inductor. The inductor first tries to stop the discharge, then forces it to continue, eventually reversing the charge on the capacitor. The process then starts over again, until the charge is back to its original place on the capacitor. The number of times that the cycle takes place in a second is called the frequency of resonance of a tuned circuit. A circuit that charges and discharges 1 million times per second is resonant at 1 MHz.

become smaller in value, and the inductors are no longer made of wire, but rather are of heavy tubing or in the form of specially shaped cavities.

Resistors

I gave you a brief description of a resistor and what it does in an earlier segment of this series, but the photograph and Fig. 4 show several types that are commonly used in radio work. The fixed resistors come in various sizes, depending upon the amount of heat (watts) they must be able to handle. When you get into the large wire-wound types, they are rated at power levels up into the hundreds of watts and must be mounted so that they can radiate the excess heat without damaging other components.

Variable resistors are used to

change the resistance in a circuit from time to time. One term for a variable resistor with just two terminals is *rheostat*.

A three-terminal variable resistor can be connected to do the same job, Fig. 4F. A light-dimmer control for automobile dashboard lighting is an example of a rheostat. A potentiometer is usually a three-terminal variable resistor, with the fixed-resistance part connected across a voltage (potential), and the arm connected to the circuit that needs a variable voltage.

The most common form of

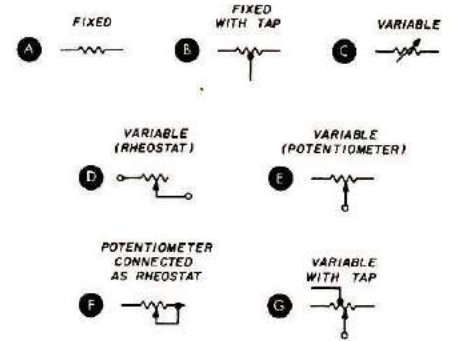

Fig. 4. Symbols for fixed and variable resistors and rheostats. Note that the same symbol is used for either wire-wound or carbon composition types.

important in many circuits, but if you are working at radio frequencies, you need the carbon types. The wire-wound resistors can become resonant, just like inductors, and make your radio circuit do strange things.

Some resistors are made by depositing a carbon or metal film on a small glass or ceramic tube, and then cutting away some of the deposited material by means of an abrasive wheel, or by a laser beam. Some of these precision resistors are then encapsulated in glass or a hard plastic so that moisture or chemicals will not change their value. These resistors are quite expensive, of course, and not often used in amateur radio equipment. They are sometimes found in surplus computer or space-system assemblies.

Transformers

Here is a new subject — transformers — which I've not

fixed resistor is made of a film, or small-diameter rod, of carbon composition. There are some resistors that have fine resistance wire as the element, and they can fool you because they often look just like the carbon-composition ones, with the same body style, size, and coloring. The difference is not

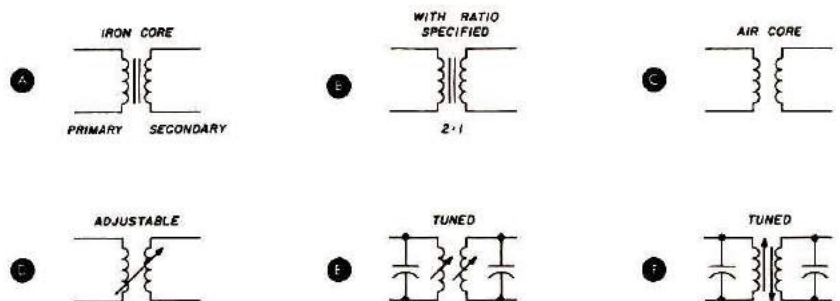
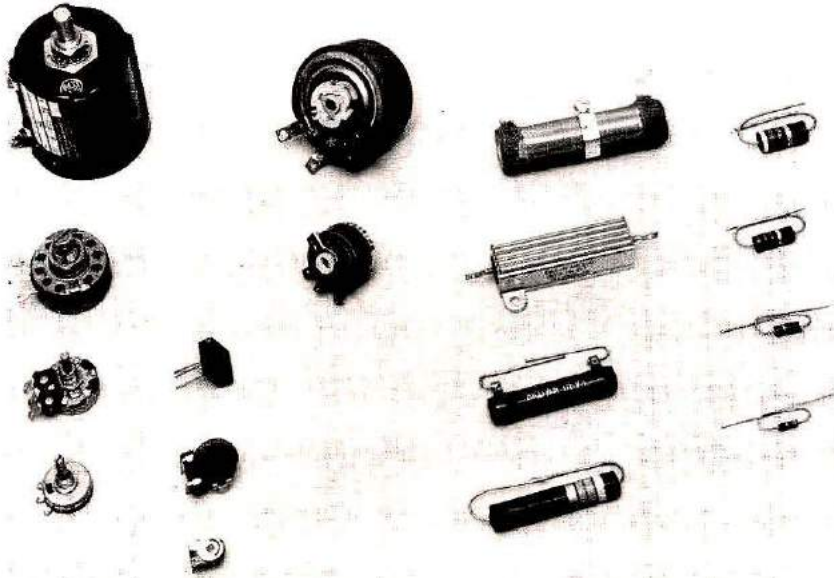

Fig. 5. As noted in the text, a transformer is simply two or more inductors that share the same magnetic field. The field can be intensified by means of an iron core, as found in power transformers. Air-core transformers are used mainly at radio frequencies. The double-tuned types are seen most often in the intermediate stages of receivers or transmitters.



Some variable and fixed resistors. Shown here are a ten-turn precision unit at the top left, a heavy wire-wound rheostat just to the right of that one, and other wire-wound or carbon-composition types down to the tiny unit at the bottom for transistor radios. The fixed resistors in the row at the right are carbon composition (but some wire-wound types look just the same), from 2-watt (top) to 1/4-watt ratings. The row next to them has a wire-wound fixed unit with a sliding tap, a fixed unit with heat-radiating enclosure, and a 10-watt and 2-watt wire-wound resistor.

talked about before (except for a brief mention in the section where I told you how power got from the generating station to your house). The photograph and Fig. 5 show several transformers, from audio and power types to small, open windings that work at radio frequencies.

A transformer is simply two inductors that share the same magnetic field. Or, to put it another way, the two windings are so close that when a magnetic field is built up around one of them, it cuts across the second one. Now, if you'll remember that a magnetic field, when it cuts across a wire, induces a current flow in that wire, then you can see that passing a current through the first winding (primary) will cause a current to flow in the second winding (secondary). The amount of electron flow which can be produced in the secondary depends upon the ratio between the two

windings. Sometimes this ratio is expressed as a turns ratio; it can be an impedance ratio as well.

For example, if you have a transformer with a ratio of 1:1, you know that for every volt that you apply to the primary, you will get one volt out. A common audio-circuit transformer has a ratio of 3:1. This means that the output is one-third of the input, if the transformer is used as a step-down device. If you turn it around, it then becomes a step-up transformer, and for every volt that you apply to the primary, you'll get three volts out of the secondary. However, remember that you don't get something for nothing — the power in and out of the transformer must be the same and is limited by the current that the wire can handle and the size of the iron core. If you have 1 ampere flowing in the primary of a transformer with a ratio of 1:2, then your output current can only be 0.5 ampere,

but at twice the voltage.

Many amateur transmitters use transformers that have both a step-up and a step-down feature. The primary is designed for 115 Vac (sometimes 230 Vac) and the secondary has several windings. One winding may step the voltage up to 600 or so, for the plate circuit of the output tube. Another winding will step the voltage down to provide the 6.3 volts to light the filaments in the tubes, the dial lights, and so on.

Transformers that are used at radio frequencies work the same way, but are usually thought of as impedance-matching transformers, rather than voltage-changing devices. In vacuum-tube circuitry, an i-f (intermediate frequency) transformer would match the 10 000-ohm plate circuit to the 2-megohm (*meg = mega*, short for million) grid circuit of the next stage. It accomplishes this, by having the correct turns ratio, as a step-up transformer. An output circuit for a transmitter would be a similar device, matching a 4000-ohm plate circuit to a 75-ohm coaxial feedline, but the windings would be in open air.

Next month

That just about covers the passive components that are the most important to you at this stage of the game. In next month's session I can tell you about the active devices (tubes and semiconductors).

Oh, yes, the third method of tuning a circuit — well, it involves an active device, which will be included next month. I'll give you a hint: it's a form of semiconductor — a type of diode to be exact. You'll like the way it behaves.

In the meantime, look the component symbols over carefully so that you can recognize them when I get to the Practical Circuits section in the FCC Study Guide.

HRH

The Lightweight Champ.

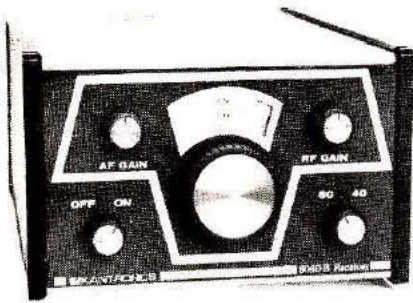

only
\$79.95

Kantronics 8040-B Receiver

The **8040-B** is a versatile CW receiver at a modest price! This **battery-powered** unit makes a great camping and vacationing rig.

Prospective hams can **copy real QSOs** with a reasonable investment. Watch for our **companion transmitter**, available soon!

Coverage runs from 3.650 to 3.760 MHz, and 7.050 to 7.150 MHz. **Write us for more details!**

KANTRONICS
The Lightweight Champs.

Telephone 913-842-7745
Lawrence, Kansas 66044

1202 East 23rd St

Beams, Quads, All Band Vertical Antennas **30 YEARS...**

of experience in supplying top quality antennas to Ham Radio operators at *rock bottom prices* guarantees high quality and low prices to novice and experienced operator alike. Gotham antennas are a classic case of simplicity in design providing reliability and contest winning performance, at *rock bottom prices*.

Gotham offers a broad line of quads, full size beams and all band vertical antennas to satisfy the needs of all Ham Radio operators. For literature and full information on our complete line, please send self-addressed stamped envelope.

GOTHAM

2051 N.W. 2nd Avenue
Miami, Florida 33127

For fast action, call
(305) 573-2080

Beams, Quads, All Band Vertical Antennas

the famous HAM-KEY™

TM Trade-Mark

The keys that are easy
to put your fingers on!



JUST DIAL
1-800-325-3636
TOLL FREE



Model HK-1

- Dual-lever squeeze paddle
- Use with HK-5 or any electronic keyer
- Heavy base with non-slip rubber feet
- Paddles reversible for wide- or close-finger spacing

\$29⁹⁵

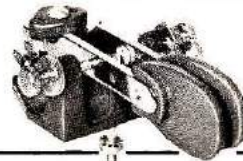

Model HK-2

- Same as HK-1, less base for incorporation in own keyer

\$19⁹⁵

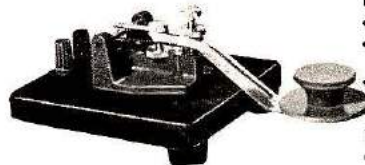

Model HK-3

- Deluxe straight key
- Heavy base - no need to attach to desk
- Velvet smooth action

\$16⁹⁵

Model HK-3A

- Same as above less base \$9.95

Navy type knob, only \$2.75

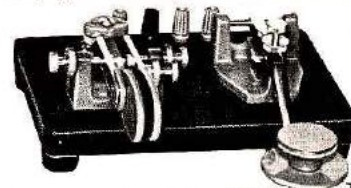

Model HK-4

- Combination of HK-1 and HK-3 on same base

\$44⁹⁵

- Base only with rubber feet \$12.00

Terminals, red or black, \$.75 each



NEW AND IMPROVED

Model HK-5A Electronic Keyer

- New Cabinet Colored-Keyed to Match most modern radio equipment
- Iambic Circuit for squeeze keying
- Self-completing dots and dashes
- Dot memory
- Battery operated with provision for external power
- Built-in side-tone monitor
- Grid block or direct keying

\$69⁹⁵

Same day shipment . . . PREPAID

We welcome the use of your



HAM RADIO CENTER

8340-42 Olive Blvd. • P.O. Box 28271 • St. Louis, MO 63132

DSI**Be the one who's on FREQUENCY!!**

With your *DSI Counter*. . . save the shop cost of tweaking xtals. . . know your frequency. . . from 160 meters through 450 MHz. Now *DSI* offers *the most* counter for your dollar. Latest state-of-the-art technology. . . *DSI* advanced LSI design far exceeds outdated TTL. Go with the leader . . . buy a *DSI FREQUENCY* counter and **SAVE TIME & MONEY!!**

NOT A KIT**MODEL 3500 \$139.95****500 MHz Frequency Counter**

- Includes 500 MHz Prescaler — Not an addon
- 7 Large bright — ½ inch LED Readouts
- Temperature compensated crystal timebase
- Accuracy 1 PPM Typ
- Sensitivity 50 mVrms 150 & 250 MHz 150 mVrms 450 MHz
- Gate time light
- No direct RF connection Required
- AC or DC operation
- 50 Hz to 500 MHz typ
- Comprehensive owners manual with complete accurate schematics
- Factory assembled & tested

**MODEL 3600A \$189.95**

Includes oven timebase

600 MHz Frequency Counter

- Includes oven compensated crystal timebase
- Includes built-in 600MHz Prescaler-Not and addon
- 8 Large bright — ½ inch LED Readouts
- Two timebases 0.1 sec & 1. sec
- Resolution 1 Hz Direct 10 Hz Prescaled
- Sensitivity 20 mVrms @ 150 & 220 MHz 100 mVrms 450 MHz
- Accuracy .5 PPM over temperature
- Oven light & Gate time light
- Automatic Decimal point placement
- NO DIRECT RF CONNECTION Required.
- Comprehensive owners manual with complete accurate schematics
- AC or DC operation
- 50 Hz to 600 MHz Typ.
- Factory assembled & tested

Use it in the car or on the bench. . . take it to the repeater site. . . high-impact case. . . light weight—but rugged. . . Designed with the latest readily available LSI, CMOS, Schottky, Mecl-integrated circuits.

NEW PRODUCTS

- 250 MHz 7 Digit Battery operated hand held counter \$109.95
- 3½ Digit Bench Digital Multi-meter AC or Battery operated \$99.95

Visit us at **DAYTON HAMVENTION** — April 28, 29, 30

Strongest Warranty in the Counter Field. ONE Year Parts and Labor we pay the return shipping plus . . . satisfaction guaranteed . . . Dennis Romack, WA6OYI.
VP-Marketing, DSI

TO ORDER CALL COLLECT (714) 565-8402

Name _____ Call _____

Address _____

City _____ State _____ Zip _____

Phone: _____

Order: _____

 Check enclosed Please send more information on your full line of Instruments and Accessories. BankAmericard MasterCard VISA R.E.

Credit card # _____ Card expiration date _____ Signature _____

DSI INSTRUMENTS INC.
Div. Diversified Security Ind, Inc.

We pay shipping charges anywhere in the U.S.A. UPS Brown or P.P. — CA Residents please add 6% state sales tax.

- American Express
- Bank of America
- MasterCard
- VISA

7914 Ronson Road No. G, San Diego, CA 92111

DSI

DSI INSTRUMENTS INC.

250MHZ FREQUENCY COUNTER BATTERY OPERATED HAND-HELD

ALL NEW! Unparalleled DSI quality hand-held counter at a price that is affordable for any budget. Remember the 3240 is factory assembled and ready to use. GO with the leader and order your counter today.

MODEL 3240HH

\$109.95

**Made in USA
Not A Kit**

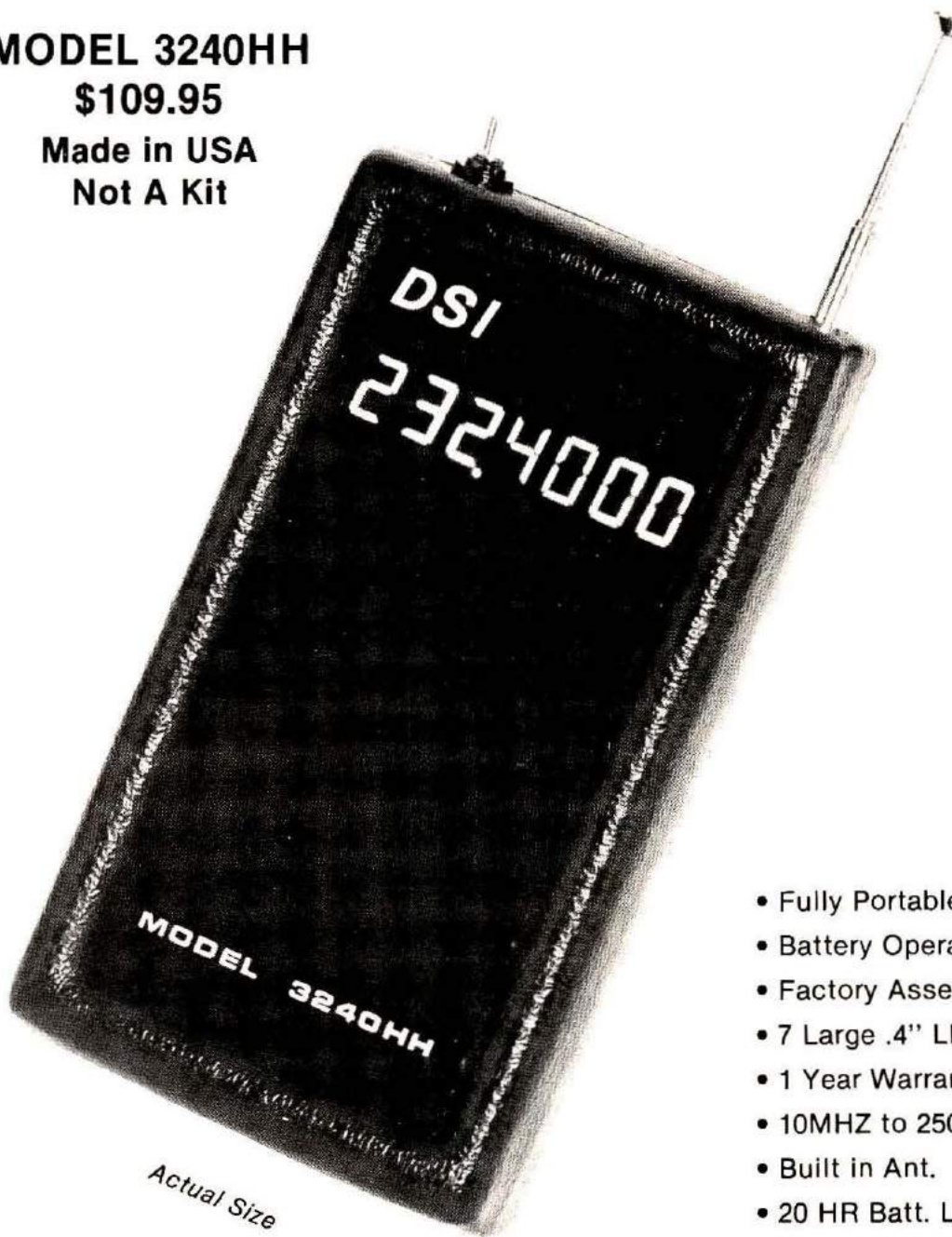

Actual Size

- Fully Portable.
- Battery Operated.
- Factory Assembled.
- 7 Large .4" LED Readouts.
- 1 Year Warranty.
- 10MHZ to 250MHZ.
- Built in Ant.
- 20 HR Batt. Life.
- Uses H AA Batteries.

7914 Ronson Road No. G, San Diego, CA 92111



Dear Horizons:

I want you to know that I have definitely found a truly excellent magazine. I not only enjoy reading it for pleasure, but I have found valuable information in *Ham Radio Horizons* regarding the ham radio club at school. Due to the fine stories and "aids" regarding a novice license, my club at school has increased tremendously. Whenever I get a new issue I take the magazine to school. It's hard for me to get it back because everybody is so interested. I must say that my success as president of the ham radio club this year owes much to *Ham Radio Horizons*. I hope I can get as much interest from the members of the club in the future as I receive now.

Glenn A. Hoffner, WB2GKM
Kew Gardens, New York

Dear Horizons:

I think your magazine is just great. I would probably subscribe even if the price were \$20. I like the way it's written, and I especially liked the "Questions and Answers" series. Keep up the good work!

Jonathan Burstein, WB2JWY
Flushing, New York

Dear Horizons:

I am very pleased with your magazine, and I have already received a year's worth of copies. I began my subscription with very little knowledge about amateur communications, but after a year of *Ham Radio Horizons* my knowledge has increased ten fold. I now own a short wave receiver and I listen very often. I have

recommended your magazine to all my interested friends too; many are now subscribers.

Please try to write a story on RTTY equipment and operation. I am very interested in it and other subscribers may be too.

Chris Miller
Greenville, New Hampshire

We're working on a RTTY story for our interested (or curious) readers, Chris. Thanks for your good words.

Editor

Dear Horizons:

I enjoyed your December issue. The article "Tri-Band Wire Yagi Antenna" was very interesting. I think this antenna will help me make that W-JA contact.

Please keep up the good work.

Keiji Tabata JF1BNU
Japan

Dear Horizons:

I would have subscribed on the basis of "Zero Bandwidth SSB" alone.

Humor is too valuable to be so flagrantly neglected.

Frank C. Sneed, W5FIF
Lawton, Oklahoma

Dear Horizons:

I can't praise you folks enough on *Ham Radio Horizons*. Every issue is so interesting, readable, and understandable. I've been trying to get that ham ticket off and on for 20 years and *Horizons* is going to make that possible.

Every month another understandable magazine keeps me fired up. Keep them coming!

Bob Bates
Brunswick, Ohio

Dear Horizons:

Thank you and Joe Fincutter for the fine article on special event station NN3SI. On my recent vacation I had the privilege of viewing the Nation of Nations exhibit and of guest operating NN3SI under Joe's supervision. This working display of amateur radio is, in my opinion, the finest public representation of our hobby we could ask for. I am only sorry that more amateurs aren't aware of

the station. In all but one of the contacts I made from the station I received questions about the "strange" call sign (is that one of those new extra calls?). Up till now I have seen only one other article on the station and it was nowhere nearly as informative as yours. I am certain now that when other amateurs work NN3SI they will realize that not only are they a part of amateur radio's finest public exhibit but also an active part of an exhibit of America's pride and tradition in "A Nation of Nations."

Mark E. Barrineau, WA4YVC
Norfolk, Virginia

Dear Horizons:

I wish I could have had your fine magazine when I began as a Novice. Other magazines do not offer enough help to beginners. *Ham Radio Horizons* is my favorite.

Eugene E. Brandenburg, WB4CWV
Lake Park, Florida

Dear Horizons:

I have enclosed my check to renew my subscription to your very wonderful magazine. This is the first magazine I have seen in almost twenty years as a ham that has been written for the non-professional electronic man or ham.

I am looking forward to the next three years . . .

Richard H. Dowst, WB4HZK
Leisure City, Florida

Dear Horizons:

I wish to congratulate your fine publication! The interesting articles found in *Ham Radio Horizons* increase my joy and understanding of ham radio very much.

The article, "All Is Not Gold That Glistens," in the December issue was very informative and stimulating to a newcomer and motivated wallpaper chaser such as I am.

Due to its personal and simple approach, I like to think of *Ham Radio Horizons* as my second "Elmer."

Uwe Glup, WD6AUM/0
Central University of Iowa

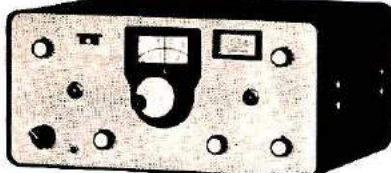

TEN-TEC 570 Century 21 70w CW Transceiver.
 Full coverage on 3.5, 7, 14, 21MHz bands, 1 MHz on 28MHz. Totally solid-state. Instant band change. No tune-up. Full Break-in. (Hear between transmitted characters) Clean, click free keying. Overload protection. Built-in low-pass filters. Offset tuning. Selectivity: .5, 1.0 or 2.5KHz. Adjustable sidetone level. Built-in AC power supply. Dim. 6 1/2" h x 12 1/2" w x 12" d. \$289.00
574 Century 21w/Digital readout. 399.00
670 Keyer. 29.00
276 Calibrator 29.00
277 Ant. tuner/SWR bridge. 89.00



AMATEUR ELECTRONIC SUPPLY®
 4828 West Fond du Lac Avenue
 Milwaukee, Wisconsin 53216
 Phone (414) 442-4200
BRANCH STORES:
 28940 Euclid Avenue; Wickliffe, Ohio 44092
 Phone: (216) 585-7388
 621 Commonwealth Ave.; Orlando, Fla. 32803
 Phone: (305) 894-3238
 Note: Branch Stores are set-up to handle Walk-in business or telephone orders only. They do not have facilities to respond to written inquiries.

The Ultimate IAMBIC PADDLE...

- Full range of adjustment in tension and contact spacing
- Self-adjusting nylon and brass needle bearings
- Solid silver contact points
- Precision-machined, chrome plated brass frames
- Heavy steel base has black, textured finish (chrome plated base optional)
- Non-skid feet

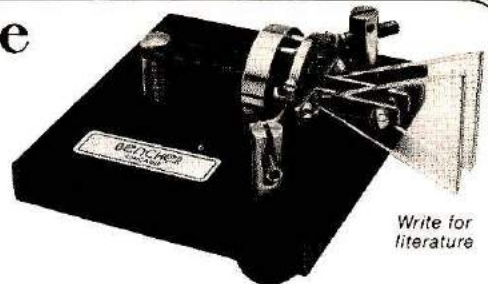

Write for literature

Available at selected dealers or send \$39.95 (\$49.95 for chrome model) plus \$2.00 shipping and handling. Money-back guarantee.

BENCHNER, INC.
 Dept. A, 333 W. Lake St., Chicago, IL 60606
 (312) 263-1808

We Don't Claim That Your ALPHA Linear Will Run A Kilowatt Key-Down FOREVER . . .



. . . But We Don't Put A Time Limit On It, Either.

YOU'LL PROBABLY NEVER SET A BRICK ON YOUR KEY FOR 26,000 MINUTES. BUT WE DID IT TO ILLUSTRATE WHAT ETO'S NO TIME LIMIT [NTL] CONTINUOUS DUTY RATINGS REALLY MEAN TO EVERY ALPHA AMPLIFIER OWNER.

April 7th: A standard **ALPHA 76** was taken from production, loaded up to a full 1000 watts key-down dc input, and left operating with a brick on the key.

April 25th: The '76 was still operating completely normally, delivering about 675 watts of continuous rf carrier output into a very hot dummy load — after 18 days — 435 hours — some 26,000 consecutive minutes key-down at a full kilowatt. You may have seen the same unit running key-down all day long the following week-end at the Dayton Hamvention. It's still as good as new — a fact which will surprise no one who knows how all **ALPHA's** are built. You'd expect no less.

The point is, every **ALPHA** linear amplifier — including the power- and value-packed **ALPHA 76** and the exclusive NO-TUNE-UP **ALPHA 374** — is meticulously engineered and built to handle continuous operation IN ANY MODE AT MAXIMUM LEGAL POWER [NTL] . . . No Time Limit. And ETO's warranty on every **ALPHA** amplifier protects you FOR EIGHTEEN MONTHS — FIVE TIMES LONGER than most amateur equipment warranties!

ALPHA: SURE YOU CAN BUY A CHEAPER LINEAR . . . BUT IS THAT REALLY WHAT YOU WANT?

A LINEAR AMPLIFIER IS A BIG INVESTMENT . . . MAKE IT WISELY. For an enlightening glimpse at what goes into the design of every **ALPHA** by ETO's power professionals, or to aid you in comparing one linear with another, call or write for our brief guide entitled, "EVERYTHING YOU ALWAYS WANTED TO KNOW ABOUT (COMPARING) LINEARS. . . BUT DIDN'T KNOW WHOM TO ASK." We'll also send you fully detailed and illustrated literature describing the entire ETO line of superb **ALPHA** power amplifiers and **ALPHA/VOMAX** — the new split-band speech processor that's your key to rf clipper type "talk power" combined with easy mike-line installation and low-distortion, practically foolproof operation.



EHRHORN TECHNOLOGICAL OPERATIONS, INC.
 P.O. BOX 708 — INDUSTRIAL PARK
 CANON CITY, CO. 81212 PHONE (303) 275-1613

ENERGY CRISIS SOLVED!

Personal energy crisis? Get precious RF on DX target with World Record Breaking antenna that won W6TYP the QRP ARC 1,000,000 miles/watt award.

THE JOYSTICK VFA

(Variable freq. ant) gives low angle, omnidirectional, harmonic free radiation on all bands 160 thru 10 (- MARS and receive on all BC & SW).

1000's of glowing reports in our files of the VFA in use, often in poor QTH and/or under QRP, contests, etc.

SYSTEM 'A' \$75.00

250W P.E.P. &/or Receiving Only
SYSTEM 'J' \$99.00

500WP, E.P. &/or Improved Q Factor Receive
 Air Mail cost included. (Each system 3 sections easily assembled to make unit 7' 6" long. Matching ATU). Not only will you save space but you will save \$\$\$ at present low exch. rate and by buying direct UK manuf. Rush your order — Mastercharge or check, or ask for brochure.

PARTRIDGE (HH) ELECTRONICS LTD.
 Broadstairs, Kent, England
 Tel. Thanet 62535

G3CED

G3VFA

The "ULTIMATE" in CW Reception!

COPY ONE®

\$89.95

[Introductory Offer]



ACTUAL SIZE
3 1/2" WIDE
2 3/8" HIGH
4 3/8" DEEP

COPY ONE IS NOT A FILTER! This station accessory is a must for the discriminating amateur who operates CW, whether he is an avid CW op or one who engages in CW for proficiency. The CW signal is **processed** (not filtered) in a manner which allows true **ULTIMATE STATION REJECTION**, a mode which has been previously unavailable. The circuitry* is **totally unique** (patent pending), a must for emergency CW operations. If you haven't had the opportunity to operate a **COPY ONE**, ORDER YOURS TODAY!

COPY ONE CW PROCESSOR SPECIFICATIONS & FEATURES:

- **Ultimate station rejection** (almost unbelievable but true!)
- **Pitch & volume independent** of receiver or transceiver
- **Full quieting** (i.e., no background noise) without squelch
- **COPY ONE is not a filter**, there is absolutely no ringing or background noise
- **Plugs into transceiver or receiver/transmitter combo** without modification
- **Discriminates signals** in 80 to 100 cycle increments
- **Full break-in** CW operation
- **Includes** 115 volt AC power supply or may be battery operated
- **Built in** code practice oscillator
- **LED lock-up controls** front panel mounted

ORDER YOURS TODAY!

send \$89.95 by check
or money order to:

COPY ONE®

3135 North Cole Road Boise, Idaho 83704 [208] 377-1562

* **COPY ONE** is a registered trademark - all design, research and development, patent rights and trademarks were developed by and for the laboratories of Logitronics, 3135 N. Cole Rd., Boise, Idaho, 83704.

THE BIG STEAL

"PART 2"
Featuring the
**Bearcat
210**

Frequency Reception Range	
Low Band	32-50 MHz
"Ham" Band	146-148 MHz
High Band	148-174 MHz
UHF Band	450-470 MHz
"F" Band	470-512 MHz

*Also receives UHF from 416-450 MHz

REG. \$349.95

NOW
\$269

Offer good to licensed hams only.
Include call with order.

Freight prepaid in continental U.S.

No COD's

The **Bearcat 210** is a sophisticated scanning instrument with the ease of operation and frequency versatility you've dreamed of. Imagine, selecting from any of the public service bands and from all local frequencies by simply pushing a few buttons. No longer are you limited by crystals to a given band and set of frequencies. It's all made possible by **Bearcat** space-age solid state circuitry. You can forget crystals forever.

Automatic search lets you scan any given range of frequencies of your choice within a band. Push button lockout permits you to selectively skip frequencies not of current interest. The decimal display with its exclusive "rolling zeros" tells you which channels you're monitoring. When the **Bearcat 210** locks in on an active frequency the decimal display shows the channel and frequency being monitored.



**1401 Blake Street
Denver, Co. 80202**



electronics
303-893-5525



FOR THE

EXPERIMENTER

INTERNATIONAL CRYSTALS & KITS
 OSCILLATORS • RF MIXERS • RF AMPLIFIER • POWER AMPLIFIER

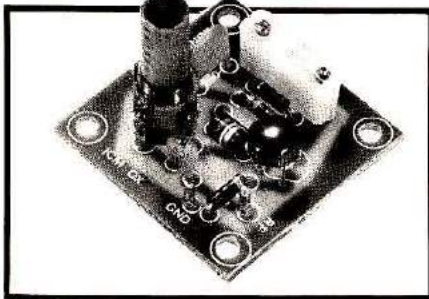

OX OSCILLATOR

Crystal controlled transistor type. 3 to 20 MHz, OX-Lo, Cat. No. 035100. 20 to 60 MHz, OX-Hi, Cat. No. 035101.
Specify when ordering.

\$4.95 ea.

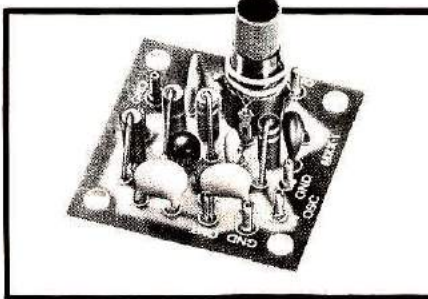

MXX-1 TRANSISTOR RF MIXER

A single tuned circuit intended for signal conversion in the 30 to 170 MHz range. Harmonics of the OX or OF-1 oscillator are used for injection in the 60 to 179 MHz range. 3 to 20 MHz, Lo Kit, Cat. No. 035105. 20 to 170 MHz, Hi Kit, Cat. No. 035106.
Specify when ordering.

\$5.50 ea.

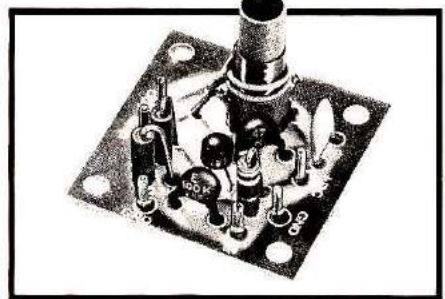

PAX-1 TRANSISTOR RF POWER AMP

A single tuned output amplifier designed to follow the OX or OF-1 oscillator. Outputs up to 200 mw, depending on frequency and voltage. Amplifier can be amplitude modulated 3 to 30 MHz, Cat. No. 035104.
Specify when ordering.

\$5.75 ea.

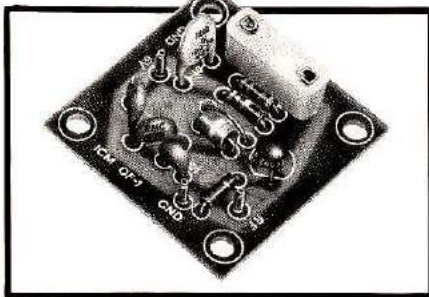

OF-1 OSCILLATOR

Resistor/capacitor circuit provides osc over a range of freq with the desired crystal. 2 to 22 MHz, OF-1 LO, Cat. No. 035108. 18 to 60 MHz, OF-1 HI, Cat. No. 035109.
Specify when ordering.

\$4.25 ea.

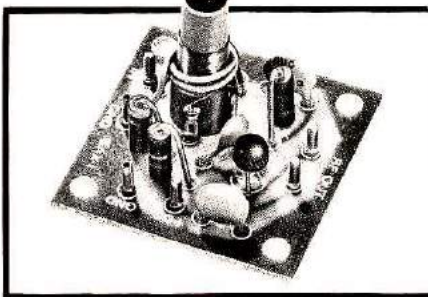

SAX-1 TRANSISTOR RF AMP

A small signal amplifier to drive the MXX-1 Mixer. Single tuned input and link output. 3 to 20 MHz, Lo Kit, Cat. No. 035102. 20 to 170 MHz, Hi Kit, Cat. No. 035103.
Specify when ordering.

\$5.50 ea.

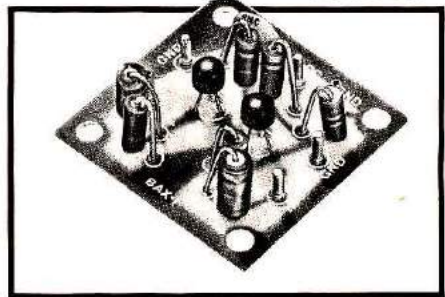

BAX-1 BROADBAND AMP

General purpose amplifier which may be used as a tuned or untuned unit in RF and audio applications. 20 Hz to 150 MHz with 6 to 30 db gain. Cat. No. 035107.
Specify when ordering.

\$5.75 ea.

.02% Calibration Tolerance
EXPERIMENTER CRYSTALS
 (HC 6/U Holder)

Cat. No.	Specifications	
031080	3 to 20 MHz — for use in OX OSC Lo	\$5.95 ea.
	<i>Specify when ordering</i>	
031081	20 to 60 MHz — For use in OX OSC Hi	\$5.95 ea.
	<i>Specify when ordering</i>	
031300	3 to 20 MHz — For use in OF-1L OSC	\$4.75 ea.
	<i>Specify when ordering</i>	
031310	20 to 60 MHz — For use in OF-1H OSC	\$4.75 ea.
	<i>Specify when ordering</i>	

Shipping and postage (inside U.S., Canada and Mexico only) will be prepaid by International. Prices quoted for U.S., Canada and Mexico orders only. Orders for shipment to other countries will be quoted on request. Address orders to:
 M/S Dept., P.O. Box 32497,
 Oklahoma City, Oklahoma 73132.

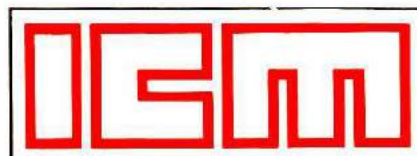

International Crystal Mfg. Co., Inc.
 10 North Lee
 Oklahoma City, Oklahoma 73102

PRODUCT SHOWCASE

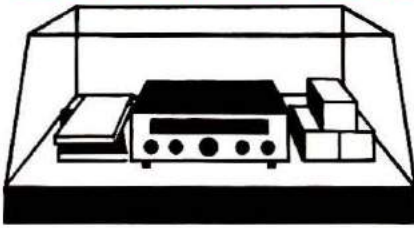

Solarex Blister-Packed Solar Cells

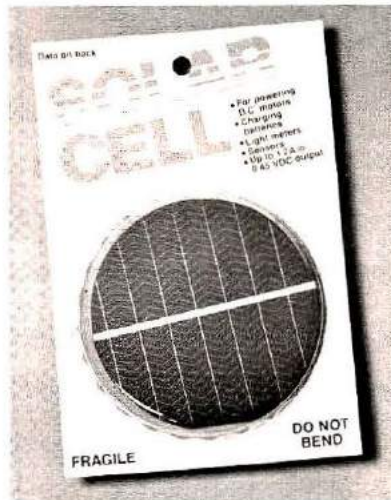

Seven of the most popular *Solarex* solar cells and *Microgenerators* are now available in attractive, easily displayed blister packs. Ideal as photosensors and for sun-powering small motors, electronic circuits, and thousands of other applications, the cells range in output from 22 mA to 1200 mA at 0.45 volt. Circular cells are available in 57 and 76 mm (2¼ and 3 inch) diameters, and rectangular cells range from 10 to 20 mm (0.4 to 0.8 inch) square. The *Microgenerators* provide up to 40 mA at 1.5 volts, and are particularly useful in applications requiring higher output voltage in a compact unit, such as charging small batteries. *Solarex* and *Microgenerators* are registered trade name and trade mark of Solarex Corporation.

Solarex Corporation's solar cells are virtually unaffected by climatic extremes and are in daily use in such demanding en-

vironments as the Mojave Desert, an Alaskan mountaintop, and the corrosive air of smog-laden cities. Originally developed for use in the space program, advanced-technology photo-voltaics are now available from Solarex at down-to-earth prices: the blister-packed units retail as low as \$2.95. Dealer/distributor inquiries are welcome; contact Bob Edgerton, Solarex Marketing Manager, at Solarex Corporation, 1335 Piccard Drive, Rockville, Maryland, 20850. For more information use *ad check* on page 86.

Ham-Band Low-Pass Filter

The Unadilla/Reyco Division is offering a ham-band lowpass filter with good rejection characteristics and long-life performance. Named the "WA2ZOT Low-Pass Filter," it will pass frequencies below 40 MHz with an insertion loss of only 0.3 dB, and a maximum SWR of 1.2:1. Rejection of signals above 54 MHz is 70 dB.

The filter comes in a sealed case to prevent entry of dust and moisture. The connectors are type UHF (SO-239). Each unit has a serial number, and carries a *no-time-limit* guarantee. The retail price is \$39.95. Contact Unadilla/Reyco Division of Microwave Filter Company, Inc., 6743 Kinne Street, East Syracuse, New York 13057; or use *ad check* on page 86.

Heath Company "Starter" Instrument Package

Heath Company, world's largest manufacturer of electronic kits, has announced the introduction of five new test instrument kits which comprise a "starter" test bench oriented primarily toward the electronics newcomer. The **IT-5283 Signal Tracer** provides audio and radio frequency signal tracing, audible volt/ohm indication, and

substitute-speaker functions for general radio and hi-fi servicing. The **IM-5284 Multimeter** measures ac and dc voltage to 1000 volts, dc current flow to 1000 mA, and has four ranges for resistance measurements to 100 megohms. Output from 310 kHz to 100 MHz, divided into five bands, and usable to 220 MHz with harmonics, is the feature of the **IG-5280 RF Oscillator**. The **IG-5282 Audio Generator** features sine- and square-wave functions and switchable ranges from 10 Hz to 100 kHz. Separate resistance, inductance and capacitance ranges are all features of the **IB-5281 RCL Bridge**.

Power requirements for each of the five units are met by an internal battery supply (two nine-volt batteries are required, plus one C cell for the IM-5284), or by the **IPA-5280-1** power supply. This power supply operates from an ac outlet and has five separate outputs to allow simultaneous operation of all five in-

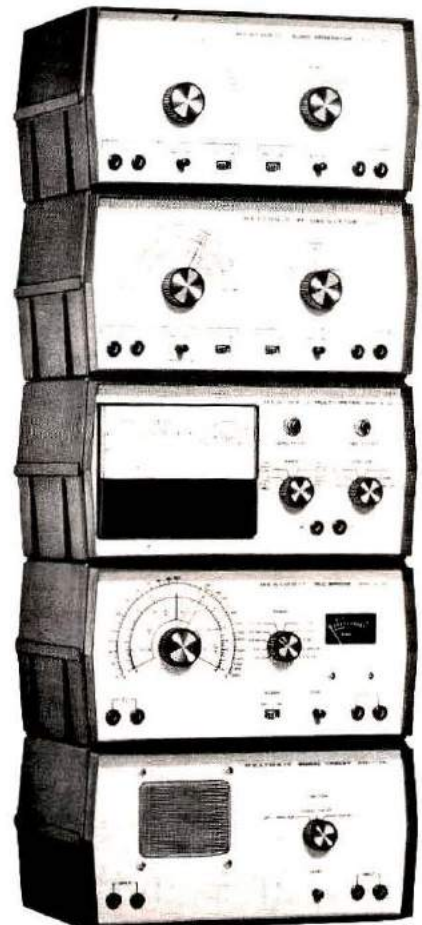

struments. For further information on these units, mail-order priced at \$37.95 each (IPA-5280-1 power supply is \$24.95), write for a free catalog to Heath Company, Dept. 350-500, Benton Harbor, Michigan 49022; or use *ad check* on page 86.

Quartz Technology Manual

A new Quartz Technology Manual has just been released by Sentry Manufacturing Company, a leader in quartz-crystal frequency control for quality communications and time-base standards. The 150-page manual takes the mystery out of understanding and using quartz crystals. It also includes the most complete military-specification summary ever published, to simplify military-equipment design.

This handy Sentry reference helps you specify what you need for your commercial two-way, Marine, aircraft, public service, ham-radio, and monitor equipment. For those CB enthusiasts who want a 40-channel set, the manual includes a comprehensive compilation of frequency charts for 23-channel rigs so you can tell what crystals you need to convert it to 40-channel use. Also, the manual includes a section on how to understand and use quartz digital clocks.

The first printing is only 20,000 copies. Send a check or money order today for \$2.95 (includes postage and handling) to be sure of receiving a first-edition copy. Write to Sentry Manufacturing Company, Jim Bennett, Sales Manager, Crystal Park, Chickasha, Oklahoma 73018 or use *ad check* on page 86.

New Hump-Mount Console

Equipment installation problems in a vehicle are minimized with the new *Kriket* (a registered trade name) hump-mount console, according to Stephen R.

R-X Noise Bridge



- Learn the truth about your antenna.
- Find its resonant frequency.
- Adjust it to your operating frequency quickly and easily.

If there is one place in your station where you cannot risk uncertain results it is in your antenna.

The Palomar Engineers R-X Noise Bridge tells you if your antenna is resonant or not and, if it is not, whether it is too long or too short. All this in one measurement reading. And it works just as well with ham-band-only receivers as with general coverage equipment because it gives perfect null readings even when the antenna is not resonant. It gives resistance and reactance readings on dipoles, inverted Vees, quads, beams multiband trap dipoles and verticals. No station is complete without this up-to-date instrument.

Why work in the dark? Your SWR meter or your resistance noise bridge tells you only half the story. Get the instrument that really works, the Palomar Engineers R-X Noise Bridge. Use it to check your antennas from 1 to 100 MHz. And use it in your shack to adjust resonant frequencies of both series and parallel tuned circuits. Works better than a dip meter and costs a lot less. Send for our free brochure.

The price is \$49.95 and we deliver postpaid anywhere in the U.S. and Canada. California residents add sales tax.

Italy write i2VTT, P.O. Box 37, 22063 Cantu. Elsewhere send \$52.00 (U.S.) for air parcel post delivery worldwide.

Fully guaranteed by the originator of the R-X Noise Bridge. ORDER YOURS NOW!

Palomar Engineers

Box 455, Escondido, CA. 92025 • Phone: [714] 747-3343

YOUR TEN-TEC HEADQUARTERS

CENTURY 21

A 70-watt, 5-band CW transceiver that combines excellent performance, reliability, simplicity of operation and low cost.

PRICE \$299

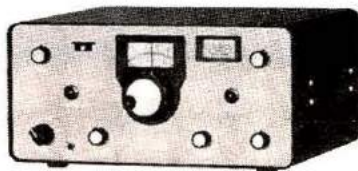

ELECTRONIC DISTRIBUTORS, INC.

Communications Specialists for over 39 Years

1960 PECK STREET MUSKEGON, MICHIGAN 49441

TELEPHONE (616) 726-3196

TELEX 22-8411

Davis, president of Acoustic Fiber Sound Systems, Inc.

The new Model 1020 console features a slot-pattern design on the back panel, which permits mounting of any mobile transceiver bracket made. With the rig mounted, just set the entire unit in place, connect antenna and power leads, and you are ready to communicate.



"Because there are no bolts to unbolt or screws to unscrew," Davis said, "the unit is most convenient for removal and placement in the trunk, when the user must leave his vehicle. By the same token, it reinstalls by simply placing it back on the transmission hump and connecting antenna and power leads."

It is this easy removal feature that makes the *Kriket* console unit the best answer to theft, Davis pointed out. It can be removed in just seconds, and people are willing to do it. No tell-tale bracket is left in place.

Designed for stability, special "teeth" in the base of the unit hold it snugly in place while driving; no rattles, no slipping out and falling to the floor.

Because it is subject to extreme temperature exposure and rough driving conditions, the new *Kriket* hump-mount console is made of specially designed plastic. Yet sturdy construction has not robbed the unit of its attractive console look.

Another convenience factor rests in the storage compartment facing the vehicle driver. It is ideal for stowing all those

Stay up.

Do it late at night if you want to patch to the other side of the world—stay up. We'll help. We know all about up. In fact, we're number one from the ground up...when it comes to amateur communications towers. We've been building them for HAMS for more than two decades.

Whether you're thinking crank-up, guyed or free-standing, check with us first. We're Tri-Ex. Reliable, dependable.

When we say number one from the ground up, we're talking about towers like Tri-Ex's superb Sky Needle TM series. You can stay up all night anywhere from 40-feet to 100-feet. Comes complete with hinged concrete base mount. Will meet all EIA and UBC codes. Designed for large amateur beams—and it's free-standing.

Write today. Tri-Ex's Sky Needle will stay up as long as you want it to, day and night. Send for more information now.



TOWER CORPORATION

7182 Rasmussen Ave.
Visalia, Calif. 93277

ALL BAND TRAP ANTENNAS!



ALL 5 BAND OPERATION - ONLY ONE NEAT SMALL ANTENNA. FOR CONGESTED HOUSING AND APARTMENT DWELLERS! LIGHT, NEAT - ALMOST INVISIBLE!

FOR ALL MAKES AMATEUR HF TRANSMITTERS - TRANSCEIVERS - GUARANTEED FOR 2,000 WATTS PEP. POWER. FOR NOVICE AND ALL CLASS AMATEURS!

COMPLETE RESONANT TRAPS - just switch your transmitter to desired band for EXCELLENT PERFORMANCE!

NO TUNERS OR BALUNS NEEDED! CAN BE USED IN ATTICS, TOPS OF BUILDINGS, INVERTED V_s IN MINIMUM SPACE. NO CENTER SUPPORT NEEDED. NO HAYWIRE HOUSE APPEARANCE COMPLETELY ASSEMBLED. No tuning - cutting - soldering - measuring - JUST HANG IT, AND USE IT! SWR IS 1.2 AT RESONANCE THOUSANDS IN USE - EASIEST INSTALLATION!

80-40-20-15-10 meter bands---102 ft. with 90 ft. RG58U coax - connector - Model 998BU...\$49.95
40-20-15-10 meter bands---54 ft. with 90 ft. RG58U coax - connector - Model 1001BU...\$48.95
20-15-10 meter bands---26 ft. with 90 ft. RG58U coax - connector - Model 1007BU...\$47.95

Send only \$5.00 (cash, ck., mo.) and pay postman balance plus COD postage OR SEND FULL PRICE FOR POST PAID DEL. IN USA (Canada is \$5.00 extra) or order by MAIL OR PHONE with BankAmericard VISA - MASTER CHARGE - OR AM. EXP. Give number and ex. date. Ph 1-308-236-5333 week days. We ship in 2-3 days. NOTE: ALL PRICES WILL INCREASE SEPT. 1/78 FREE INFO. AVAILABLE FROM. WESTERN ELECTRONICS Dept. AR-4 Kearney, Nebraska, 68847

things usually carried that are forever falling on the floor and rolling under the seat.

A key safety element is provided by the 45-degree angle at which the transceiver rests, making dials easily visible to the driver, and making operation of the set easier and safer.

Suggested retail price of the new hump-mount is \$14.95 each. For more information, call (317) 842-0620, or write to Acoustic Fiber Sound Systems, Inc., P. O. Box 50829, Indianapolis, Indiana 46250; or use *ad check* on page 86.

Continental Specialties Corporation Hobbyist Catalog

Continental Specialties, manufacturers of breadboarding and test equipment, has announced that their spring catalog is now available for hobbyists and engineers. This 24-page catalog features the complete line of Continental Specialties' products, including the new EXPERIMENTOR sockets. The Experimentor 600 is ideal for microprocessor and clock chips, RAMs, ROMs, PROMs, and other large ICs; Experimentor 300 is perfect for small DIPs. Both are excellent breadboarding aids for the hobbyist or the engineer.

CSC's latest catalog now makes it easier than ever to convert designs to hardware by providing a three-page listing of electronic components that includes integrated circuits, low power Schottky and CMOS ICs, LEDs, trim pots, seven-segment displays, diodes, transformers and more, all available from CSC, all in stock, and all backed by CSC's reputation for fast and efficient service. Catalogs are available from Continental Specialties Corporation, 44 Kendall Street, PO Box 1942, New Haven, Connecticut 06509; or use *ad check* on page 86.

QUALITY KENWOOD TRANSCEIVERS ... from KLAUS RADIO

The TS-820S is the rig that is the talk of the Ham Bands. Too many built-in features to list here. What a rig and only \$1098.00 ppd. in U.S.A. Many accessories are also available to increase your operating pleasure and station versatility.

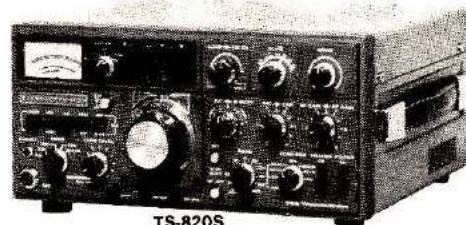

TS-820S
160-10M TRANSCEIVER

Super 2-meter operating capability is yours with this ultimate design. Operates all modes: SSB (upper & lower), FM, AM and CW. 4 MHz coverage (144 to 148 MHz). The combination of this unit's many exciting features with the quality & reliability that is inherent in Kenwood equipment is yours for only \$729.00 ppd. in U.S.A.



TS-700S
2M TRANSCEIVER

Guess which transceiver has made the Kenwood name near and dear to Amateur operators, probably more than any other piece of equipment? That's right, the TS-520S. Reliability is the name of this rig in capital letters. 80 thru 10 meters with many, many built-in features for only \$739.00 ppd. in U.S.A.

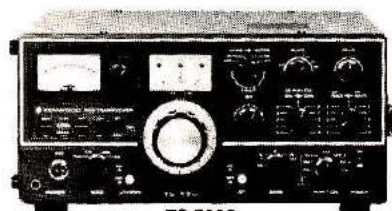

TS-520S
80-10M TRANSCEIVER



TR-7400A
2M MOBILE TRANSCEIVER

This brand new mobile transceiver (TR-7400A) with the astonishing price tag is causing quite a commotion. Two meters with 25W or 10W output (selectable), digital read-out, 144 through 148 MHz and 800 channels are some of the features that make this such a great buy at \$399.00 ppd. in U.S.A.

Send SASE NOW for detailed info on these systems as well as on many other fine lines. Or, better still, visit our store Monday thru Friday from 8:00 a.m. thru 5:00 p.m. The Amateurs at Klaus Radio are here to assist you in the selection of the optimum unit to fulfill your needs.

KLAUS RADIO Inc.

8400 N. Pioneer Parkway, Peoria, IL 61614
Jim Plack W9NWE — Phone 309-691-4840

AMATEUR PRODUCTS GALORE!

YAESU

FT-301D all solid-state transceiver; 160-10 meters; AM, CW, SSB, FSK; 200 watts PEP input on SSB, 200 watts DC input on CW, and 50 watts DC input on AM or FSK; features 100-Hz frequency stability, 6-digit LED frequency display; tailored audio response, 0.25 μ sensitivity, variable selectivity from 0.6 to 12 kHz, requires only 13.5-volts DC power source; matching AC supply and speaker available.*



FT-301D TRANSCEIVER
ALL SOLID STATE

Famous YAESU quality, reliability, and versatility, and now all solid state!
Conserves energy too.

*We will include FREE AC power supply with every purchase of a new FT-301D. You can't beat this offer, so order now.

Call or visit with us today for assistance in selecting the Amateur product that is the most likely to meet your operating requirements.



RSE HAM SHACK

1207 W. 14 MILE, CLAWSON, MICHIGAN 48017
313-435-5660



KENWOOD



TS-520S
160-10M TRANSCEIVER

Ask around about Kenwood's TS-520. It's in constant use around the globe and has a record of reliability that is universally admired. USB, LSB, CW, operates AC, WWV receiver, RIT, VOX and noise blanker are some features that make the TS-520 a very welcome companion in your shack.

Also, come in and ask about the NEW Kenwood TS-820 that has all of the great features found in the TS-520 plus so many truly unique operating advantages that it is the Pacesetter of the industry.

KENWOOD

TR-7400A two-meter FM transceiver covers 144-148 MHz in 5-kHz steps, selectable simplex and 600-kHz offset; PLL circuitry with unlock protection; LED digital frequency display; CTCSS encode-decode, plus tone-burst; MOSFET with helical resonators, plus 2-pole 10.7-kHz crystal IF filter for superior sensitivity and selectivity, and much more. Write today for details and price.



There's nothing like it!

RADIO AMATEUR **callbook**

Respected worldwide as the only complete authority for radio amateur QSL and QTH information.

The U. S. Callbook has over 300,000 W & K listings. It lists calls, license classes, names and addresses plus the many valuable back-up charts and references you come to expect from the Callbook.

Specialize in DX? Then you're looking for the Foreign Callbook with almost 300,000 calls, names and addresses of amateurs outside of the USA.

U.S. Callbook \$14.95

Foreign Callbook \$13.95



Order from your favorite electronics dealer or direct from the publisher. All direct orders add \$1.50 for shipping. Illinois residents add 5% Sales Tax.

RADIO AMATEUR **callbook** INC.
Dept. E 925 Sherwood Drive
Lake Bluff, Ill. 60044



our little boxes replace a lot of cable!

- select any of five antennas at the turn of a knob, with just one feedline and a control cable to the remote switching unit •
- saves coax, simplifies station layout •
- handles 4 kw p.e.p. •
- other models to nine positions •
- full one-year warranty •

model sw-5 heavy duty —
REMOTE CONTROLLED ANTENNA SWITCH — \$135⁰⁰ plus \$3 shipping  
• order direct or write for brochure •



ANTENNA MART

515-292-7114

box 1010, i.s.u. station, ames, iowa 50010

All You Want to Know About...

OSCAR

by Stratis Caramanolis

Comprehensive look at satellite communications, specifically the OSCAR series, from basic principles through locating and working the bird. The only book providing the thorough understanding you'll want to really get involved. Send for your copy today.



Order RS-0

Only \$8.50



Greenville, NH 03048

INSTRUCTOGRAPH MORSE CODE

Since 1924 Instructograph has serviced the world with the most complete equipment ever devised for learning Continental code. You have complete control of sending & receiving AT ANY SPEED YOU DESIRE while machine is running, without changing tapes (not cassettes). A complete course for beginners incl. machine, 10 double sided tapes, key, manual, built-in speaker. Nothing else to buy. \$98.50 plus UPS 12 lb. del. chg. Add 6% S.T. for Calif. del. For catalog on 45 advanced tapes or complete information write: Instructograph Co., Box 5032, Dept. 4, Glendale, CA 91201. (213) 246-3902 or 245-2250.

NOTICE: Closed for vacation July 10 to August 10, 1978.

MORSE CODE INSTRUCTOGRAPH

MARCONI PERSONALIZED QSL CARDS

*New Three-color Cards
... from Rusprint*

- Call Letters — Black
- Marconi Spark Coil and Spark Gap - Gold and Brown
- Size - 3½x5½
- Coated Stock
- Standard Report Form on Reverse Side
- 100 cards \$10.00
- Additional 100 - \$5.00
- QSL Catalog - .25

Order style # 407

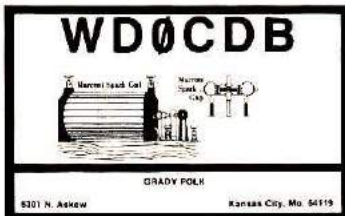

Mail Check or Money Order To:

RUSPRINT —

P. O. Box 7575 - Dept. Y-478 -
North Kansas City, Mo. 64116

Look what's new from Whitehouse:

Complete Cushcraft product line.
Below is a partial listing.

DX-120

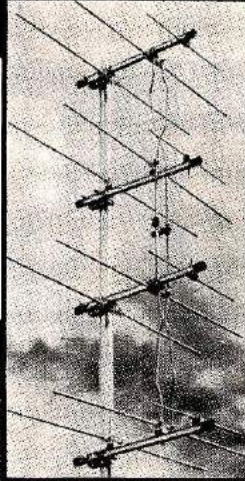

ARX-2

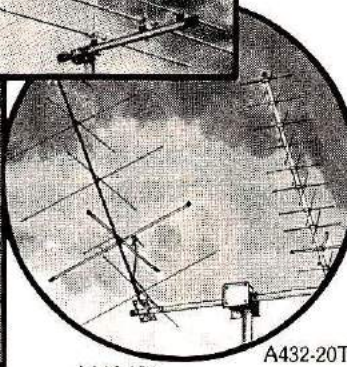

DX-ARRAYS 20 ELEMENTS 144, 220 or 430 MHz

DX-Arrays have already established new records in DX-ing and moonbounce programs. Whatever your interest may be, ragchewing, contests, DX or moonbounce. Get in on the excitement of VHF hamming, today.

	List	OUR PRICE
DX-120 144 MHz	\$42.95	\$39.95
DX-220 220 MHz	\$37.95	\$34.95
DX-420 432 MHz	\$32.95	\$30.95

SPRING SPECIAL

OSCAR ANTENNAS

Antenna systems for working through OSCAR satellites. For 144 MHz a ten element twist antenna. For 432 MHz a 20 element twist antenna. Includes phasing harness for selectable horizontal, vertical and circular polarization.

A144-10T 145 MHz 10 El. Twist	\$34.95
A432-20T 430-436 MHz 20 El. Twist	\$49.95
A14T-MB Twist Boom & Bracket	\$15.95

Total List Price \$108.85
OUR PRICE \$94.95

RINGO RANG **SPRING SPECIAL**

Work full quieting into more repeaters and extend the radius of your direct contacts with the Ringo Ranger.

Model	Frequency	YOUR CHOICE
ARX 2	135-170 MHz	\$30.00 Delivered in USA Reg. List \$32.95
ARX 220	220-225 MHz	
ARX 450	435-450 MHz	

SPRING SPECIAL

Move those 220 and 430 MHz signals in and out with the quality you deserve. A Cushcraft antenna from G.R. Whitehouse & Co.

A220-7	220-225 MHz 7 El.	\$21.95
A220-11	220-225 MHz 11 El.	\$27.95
A220-20	220-225 MHz 22 El.	\$74.95
AFM-24D	220-225 MHz Four Pole ..	\$57.95
AFM-44D	440-450 MHz Four Pole ..	\$54.95
A432-20T	430-436 MHz 20 El.	\$49.95

CUSHCRAFT HF ANTENNAS

ATB-34	Tri-band 4 El.	\$224.95
A14-3	14 MHz 3 El Monoband ..	\$125.95
A21-4	21 MHz 4 El Monoband ..	\$107.95
A28-4	28 MHz 4 El Monoband ..	\$ 71.95

We also carry rotors, towers, coax, etc. and a wide selection of hard-to-find radio parts.

Make 2 Meters all the fun you had hoped for... put more signal into the other guy's receiver with a new Cushcraft 2 meter antenna.

A147-4	146-148 MHz 4 El. Yagi	\$19.95
A147-11	146-148 MHz 11 El. Yagi	\$29.95
A147-22	146-148 MHz 22 El. Yagi	\$84.95
AFM-4D	144-148 MHz Four Pole (9dB over ½ wave dipole)	\$59.95
A144-10T	145 MHz 10 El. Twist ..	\$34.95
A144-20T	145 MHz 20 El. Twist ..	\$54.95
A147-20T	146 & 147 MHz 20 El. Twist ..	\$54.95
A14-Sk	Stacking Kit for two A147-4's	\$15.95
A14-VPK	Vertical Pole for two A147-4's	\$23.95
DXK-140	Stacking Kit for two DX-120's	\$59.95
DXK-180	Stacking Kit for four DX-120's	\$109.95

UPS Shipping included on orders up to 50 lbs.

(603) 673-6290

Prices subject to change without notice.

G.R. WHITEHOUSE & CO.
11 Newbury Drive, Amherst, NH 03031



HAMVENTION®

April 28, 29, 30.
At Hara Arena,
Dayton, Ohio

This year's Dayton Hamvention promises to be the biggest and best yet!

Start with more exhibit and flea market space than before. Then: • informative programs • new products • technical sessions • ARRL and FCC forums • special and group meetings • ladies' programs • transmitter hunts • total value of prizes exceeds \$15,000.

Top it all off with the Grand Banquet, Saturday evening April 29.

'78

If you have registered within the last 3 years you will receive a program and information brochure in March.

Admission \$3 in advance, \$4 at the door. Saturday night banquet \$8 per person. Flea Market space \$5 to \$8 per space depending on number of spaces. At door only. Make check payable to: Dayton Hamvention, P.O. Box 44, Dayton, Ohio 45401.

For special hotel/motel rates and reservations information write to above address. Inquiries: call 513-854-4126.

See you at the world's largest Ham Convention!

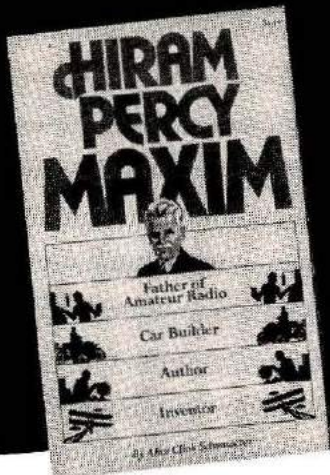

"Hiram Percy Maxim" will be a featured book among the several hundred book titles awaiting you at Ham Radio's exciting exhibit at the Dayton Hamvention.

Inventor, author, technological pioneer — the life story of the "Father of Amateur Radio" details this outstanding American's unique contributions. You can use this special show savings coupon or purchase the book directly from HRPG for just \$4.50.

Visit Ham Radio — and "Hiram Percy Maxim" at the Dayton Hamvention.

See you there!
HAM RADIO PUBLISHING GROUP
GREENVILLE, NH 03048

HIRAM PERCY MAXIM goes to DAYTON

with the
HAM RADIO
PUBLISHING GROUP

save 10%

**SPECIAL
SAVINGS COUPON**

save 10%

Visit the Ham Radio Publishing Group's exhibition at the Dayton Hamvention and present this coupon for a 10% discount on the cover price of **Hiram Percy Maxim**.

This coupon is good only at the Dayton Hamvention on April 28th, 29th, and 30th, 1978.

save 10%

save 10%

**PROUD OF YOUR CALL? . .
WORRIED ABOUT THEFT?**

Identify your FM transceiver with automatic code on each transmission.

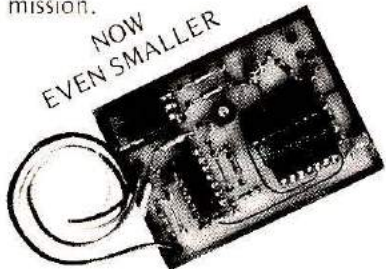

SIZE: 1 3/4" X 2 1/4" X 5/16"
Installation: Only THREE wires

WARRANTY

Returnable for full refund within ten day trial period. One year for repair or replacement.

PRICE \$39.95 Ppd
+\$2.40 for CA address

Your call sign programmed at factory, please be sure to state call sign when ordering.

AUTOCODE

8116 Glider Ave, Dept H
Los Angeles, Ca. 90045
(213) 645-1892

ICOM SPRING has SPRUNG? ICOM

Well, not quite, but NOW'S the time to be thinking about hilltopping and portable operation. Take ICOM . . . your compatible companion . . . for

SSB vhf FM



IC-502
6 METER SSB & CW
PORTABLE



IC-215
2 METER FM
PORTABLE



IC-202
2 METER SSB
PORTABLE

Call or write TODAY for our very best deal on:

AMP, Ameco, Amphenol, Antenna Specialists, ARRL publications, Astatic, Astron, B&W, Bearcat, CDE, CES, Callbook, Covercraft, Crystek/Bowmar, Cushcraft, Drake, HEP, Ham Key, Hustler, Hy-Gain, Icom, LMB, MFJ, Microwave Filter, Mosley, NPC, Nye, Regency, Rohn, SEI, SST, Sams, Standard, Swan, TAB, TPL, TRW, Telex, TenTec, Vibroplex, Weller, Wilson.

CALL for special deals for HAMS on the Bearcat 210!

REMEMBER: We pay shipping charges on all prepaid orders!

"HAM" BUERGER, INC.

ELECTRONIC EQUIPMENT DISTRIBUTOR
2 mi. south of PA Turnpike Exit 27 on Route 611
Serving You Continuously Since 1956

*We support the
ARRL Code
of Ethics*

WA3ZID-Bob
WB3BPJ-Bob
WB3GXP-Dave
WB3HOF-Jeff

68 NORTH YORK RD.
WILLOW GROVE, PA
19090
(215) 659-5900

Store Hours —
Mon., Wed., Fri. — 9:30-9:00
Tues., Thur., Sat. — 9:30-5:30



BIRD LOVERS

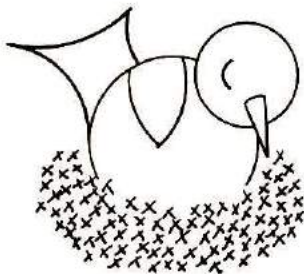

**FEATHER YOUR
OWN NEST . . .**

with a
MODEL
43



\$120

ALL ITEMS AND ELEMENTS
ORDINARILY IN STOCK
Prepaid Shipment in Continental USA Only
FROM

**MADISON
ELECTRONICS SUPPLY, INC.**

1508 MCKINNEY HOUSTON, TEXAS 77002
713/658-0268 Nites 713/497-5683



Radio equipment
not included

Floor Space: 39" Wide 30" Deep

**... at last ...
your shack organized!**

A beautiful piece of furniture — your XYL will love it!

\$13995 S-F RADIO DESK
Deluxe - Ready to Assemble

Designed with angled rear shelf for your viewing comfort and ease of operation.

FINISHES: Walnut or Teak Stain.
Also available in Unfinished Birch, \$124.95.

Additional Information on Request.

Checks, Money Orders, BankAmericard
and Master Charge Accepted.

F.O.B. Culver City. (In Calif. Add 6% Sales Tax.)

S-F AMATEUR RADIO SERVICES

4384 KEYSTONE AVENUE • CULVER CITY, CALIF. 90230 — PHONE (213) 837-4870

Rush ELECTRONIC DEPT. STORE
LAFAYETTE RADIO ELECTRONICS ASSOCIATE STORE
COMPLETE QUALITY ELECTRONIC EQUIPMENT

ELECTRONICS, INC.

MAJOR BRANDS

YAESU
TEMPO
KDK
DENTRON
CUSHCRAFT
LARSEN
- OTHERS -

WRITE FOR SPECIAL QUOTE

1315 BLUFF CITY HWY.
BRISTOL, TN. 37620

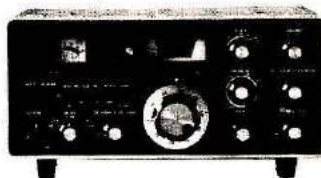

YAESU
FT 101-E
\$799.00
Retail

**CALL BOB BROWN
WA4HAA
FOR YOUR
SPECIAL PRICE**

VISIT OUR BOOTH APRIL 1-2 CHARLOTTE, N.C. HAMFEST

615-764-0831
615-968-5343

HRH LOCATOR

TO HELP YOU FIND YOUR LOCAL AMATEUR RADIO DEALER

Alabama

LONG'S ELECTRONICS
2808 7TH AVENUE SOUTH
BIRMINGHAM, AL 35202
800-633-3410
Call Us Toll-Free
To Place Your Order.

Arizona

POWER COMMUNICATIONS
6012 N. 27 AVENUE
PHOENIX, AZ 85017
602-242-6030
Arizona's #1 "Ham" Store,
Kenwood, Drake, Icom & more.

California

C & A ELECTRONIC ENTERPRISES
2529 EAST CARSON STREET
P. O. BOX 5232
CARSON, CA 90745
213-834-5868
Not the biggest, but the best —
since 1962.

TOWER ELECTRONICS CORP.
24001 ALICIA PARKWAY
MISSION VIEJO, CA 92675
714-768-8900
Authorized Yaesu Sales & Service.
Mail Orders A Specialty.

Connecticut

ARCOMM ELECTRONICS
2865 MAIN STREET
BRIDGEPORT, CT 06606
203-335-9850
Featuring Ten-Tec and DenTron.

AUDIOTRONICS, INC.
18 ISAAC STREET
NORWALK, CT 06850
203-838-4877
The northeast's fastest growing ham
department. Dedicated to service.
Kenwood dealer.

Florida

LAFAYETTE RADIO ELECTRONICS
(Assoc. Store)
1811 N. HIGHWAY 17-92
MAITLAND, FL 32751
305-831-2271
The Electronics Emporium

Illinois

ERICKSON COMMUNICATIONS, INC.
5935 NORTH MILWAUKEE AVE.
CHICAGO, IL 60646
312-631-5181
Hours 9:30-9 Mon & Th. 9:30-5 Tu,
Wed, Fri. 9-3 Sat.

SPECTRONICS, INC.
1009 GARFIELD STREET
OAK PARK, IL 60304
312-848-6777
Chicagoland's Amateur Radio
leader.

Indiana

HOOSIER ELECTRONICS, INC.
P. O. BOX 2001
(43B Meadows Shopping Center)
TERRE HAUTE, IN 47802
812-238-1456
Communications Headquarters
of the U.S.A.

Iowa

BOB SMITH ELECTRONICS
RFD #3, HIGHWAY 169 & 7
FORT DODGE, IA 50501
515-576-3886
For an EZ Deal on New
or Used Equipment.

Kansas

ASSOCIATED RADIO
8012 CONSER, P. O. B. 4327
OVERLAND PARK, KS 66204
913-381-5901
Amateur Radio's top dealer.
Buy — Sell — Trade.

Maryland

THE COMM CENTER, INC.
LAUREL PLAZA - RTE. 198
LAUREL, MD 20810
301-792-0600
Drake, Hy-Gain, Mosley, Tempo,
Ten-Tec, Willson.

Massachusetts

TUFTS ELECTRONICS
209 MYSTIC AVENUE
MEDFORD, MA 02155
617-395-8280
New England's Friendliest
Ham Store.

Michigan

RSE HAM SHACK
1207 W. 14 MILE
CLAWSON, MI 48017
313-435-5660
Complete Amateur Supplies.

Minnesota

PAL ELECTRONICS INC.
3452 FREMONT AVE. NO.
MINNEAPOLIS, MN 55412
612-521-4662
The Midwest's fastest growing
ham dealer.

Nebraska

COMMUNICATIONS CENTER, INC.
443 N. 48 STREET
LINCOLN, NE 68503
402-466-8402
Call Toll Free for Low
Prices! 800-228-4097

New Hampshire

EVANS RADIO, INC.
BOX 893, RT. 3A BOW JUNCTION
CONCORD, NH 03301
603-224-9961
Icom, DenTron & Yaesu dealer.
We service what we sell.

New Jersey

ATKINSON & SMITH, INC.
17 LEWIS STREET
EATONTOWN, NJ 07724
201-542-2447
Ham supplies since "55".

RADIOS UNLIMITED
1760 EASTON AVENUE
SOMERSET, NJ 08873
201-469-4599
New Jersey's newest, complete,
Amateur Radio center.

New York

ADIRONDACK RADIO SUPPLY, INC.
185 WEST MAIN STREET
AMSTERDAM, NY 12010
518-842-8350
Yaesu and Kenwood dealer
for the Northeast.

HRH LOCATOR

Continued

HAM-BONE RADIO

(Div. Stereo Repair Shop)
3206 ERIE BOULEVARD, EAST
SYRACUSE, NY 13214
315-446-2266
We Deal, We Trade,
We Discount, We Please!

HARRISON RADIO CORP.

20 SMITH STREET
FARMINGDALE, NY 11735
516-293-7990
"Ham Headquarters USA®"
since 1925.
Call toll free 800-645-9187.

Ohio

AMATEUR RADIO

SALES & SERVICE INC.
2187 E. LIVINGSTON AVE.
COLUMBUS, OH 43209
614-236-1625
Antennas for all services.

UNIVERSAL AMATEUR RADIO

1280 AIDA DRIVE
REYNOLDSBURG (Columbus)
OH 43068
614-866-HAMS
Drake, Yaesu, Ten-Tec, KDK, Wilson.
All Lines In Stock.

Pennsylvania

ARTCO ELECTRONICS

302 WYOMING AVENUE
KINGSTON, PA 18704
717-288-8585
The largest variety of semiconduc-
tors in Northeastern Pennsylvania

ELECTRONIC EXCHANGE

136 N. MAIN STREET
SOUDERTON, PA 18964
215-723-1200
Personal attention to Newcomer
and Oldtimer.

Texas

HARDIN ELECTRONICS

5635 EAST ROSEDALE
FORT WORTH, TX 76112
817-461-9761
You Bet Fort Worth
Has A Ham Store!



502-886-4534



YAESU — TEN-TEC — TEMPO — DENTRON

- WE HAVE FULL SERVICE ON WARRANTY AND NON-WARRANTY RADIOS.
- ALL NEW DIGITAL MODELS ARE NOW IN STOCK.
- CALL US SOON FOR PERSONAL SERVICE.

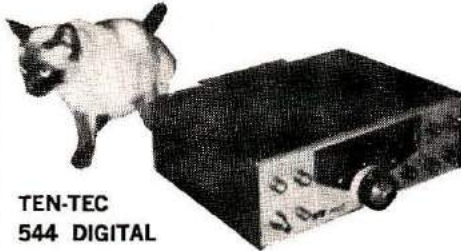

TEN-TEC
544 DIGITAL

TRENTON, KY. 42286

COHOON

AMATEUR SUPPLY



Oak Hill Academy Amateur Radio Session

19th Year — July 29 thru August 11, 1978

We have moved our location just 15 miles from our previous site to the Oak Hill Academy, Mouth of Wilson, Virginia. Our accommodations are now the finest one could hope for, suites in a beautiful Dorm with bath for each four students. Lovely spacious lobby and fine recreation room in the lower level of the dorm.

Oak Hill Academy in the Appalachian Mountains of Virginia offers an intensive two week Radio Session in code and theory starting at your level.

Expert instructors, some of whom have been on the staff for the past 18 years are the same. Only the location has been changed. Close association with fellow amateurs offers an opportunity for Saturation Learning that has been very successful since its conception. Novices upgrade to General, Techs to General & Advanced, and Advanced become Extras. Golf privileges, canoeing on the New River & many other recreation activities are offered. Make your vacation a "Vacation with a Purpose" and upgrade your license at a beautiful school in the cool mountains of Virginia. Formerly Glade Valley School Radio Session

C. L. PETERS, K4DNJ, Director
Oak Hill Academy Amateur Radio Session
Mouth of Wilson, Virginia 24363

Name _____ Call _____
Address _____
City/State/Zip _____

GILFER

"NORTH
AMERICA'S
SHORTWAVE
MAIL ORDER
PLACE"

One-Stop
Armchair Shopping
For All SWL Needs



- *Receivers — Drake, Yaesu — special mods for better performance
- *Frequency Readouts
- *Receiving Antennas
- *Antenna Tuners
- *Frequency Calibrators
- *Log Books
- *FM or TV Guides
- *QSL Albums
- *AM Pattern Maps
- *ITU Publications
- *QSL Address Books
- *Confidential Frequency List
- *Clocks
- *All SWL Books

The New 1978
32nd Edition
WORLD RADIO TV
HANDBOOK
Is Ready!



Listen to the world with this comprehensive directory of stations at your side. Best there is! Only \$11.95 ppd.

FREE SWL MINI-CATALOG
GILFER SHORTWAVE
Dept. HRH-4, Box 239, Park Ridge, NJ 07656

This is easy- anyone can solder- WITH KESTER SOLDER

**KESTER
SOLDER**

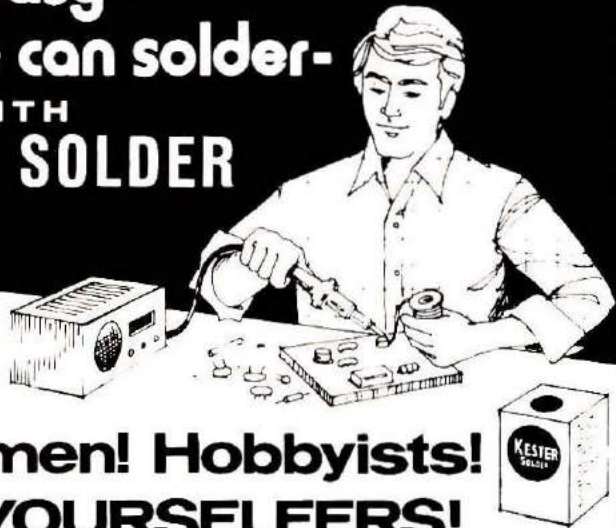

Handymen! Hobbyists! DO-IT-YOURSELFERS!

Let Kester Solder aid you in your home repairs or hobbies. For that household item that needs repairing — a radio, TV, model train, jewelry, appliances, minor electrical repairs, plumbing, etc. — Save money — repair it yourself. Soldering with Kester is a simple, inexpensive way to permanently join two metals.

When you Solder go "First Class" — use Kester Solder.

For valuable soldering information send self-addressed stamped envelope to Kester for a FREE Copy of "Soldering Simplified".



KESTER SOLDER

Litton 4201 WRIGHTWOOD AVENUE/CHICAGO, ILLINOIS 60639

RADIO & ELECTRONICS CONSTRUCTOR

Here is an interesting general electronics hobby magazine. It's loaded with lots of interesting simple circuits and ideas, not only about radio, but in all phases of electronics including test gear, audio, remote control and security electronics.

We are sure that you will find a number of worthwhile projects in this British magazine.

1 Year (12 issues) \$12.00

**Radio & Electronics
Constructor**
Greenville, NH 03048

WE STOCK

ICOM & WILSON

WILSON WE800
IN STOCK . . . \$459

WILSON MARK II
ON THEIR WAY . . . \$199

WILSON MARK IV
ON THEIR WAY . . . \$239

ORONS

DAVIS COUNTER

NEW TO 600 MHZ!
MODEL 7208

We have it! . . . \$199.95

Guess who's got your **BIRD**



EEB DOES, and here's why . . .

- We pay the AIR FREIGHT on all prepaid or credit card orders.
- Call our order desk collect: 703-938-3511.
- We stock in depth: Bird 43 Thruline, All Table 1 elements, GC-1 & EC-1 cases.

\$120.00

AUTHORIZED BIRD DISTRIBUTOR

All Prepaid & Charge Orders
Shipped NO CHARGE To You.

Sales tax 4% to Virginia residents only.

ELECTRONIC EQUIPMENT BANK, INC.

516H Mill St., Vienna, VA 22180
Call COLLECT 703-938-3511

NEW 1978 EDITION



The most complete directory of Amateur Radio Equipment ever published. The all new 1978 Edition includes specifications, pictures, and prices of transceivers, transmitters, receivers, amplifiers, power supplies, transverters, antennas, tuners, towers, meters, microphones, keyers, VFO's, preamps, test gear, etc. etc. No ham library will be complete without a copy of the 1978 Amateur Radio Equipment Directory.

\$4.00 Postpaid (U.S.)

Canada \$5.00, Foreign (Air) \$7.00

KENGORE CORP. Dept. HR
9 James Avenue

Kendall Park, N. J. 08824

SEND FOR YOUR COPY TODAY

* MAGIC BACK ISSUES

They are disappearing before our eyes (April, 1977 is already gone!), so now is the time to buy the Ham Radio HORIZONS back issues you need. Send for your FREE back issue index, — or — Order the HORIZONS past issues you need for \$2.00 each or 3 for \$4.95. Find that special article, complete your series, replace lost issues and discover new ones.

Send to

HAM RADIO HORIZONS

GREENVILLE, NH 03048

HORIZONS ad-scan

RATES Regular classified is available at 50¢ per word. Display classified (1 inch deep x 2 1/4 inches wide) is \$50, or at the 12x rate is \$35. All Ad Scan payable in advance. No cash discounts or agency commissions allowed.

HAMFESTS Sponsored by non-profit organizations receive one free regular classified ad (subject to our editing). Repeat insertions of hamfest ads pay the standard rate.

COPY No special layout or arrangements available. Material should be typewritten or clearly printed (not all capitals) and must include full name and address. We reserve the right to reject unsuitable copy. *HORIZONS* cannot check each advertiser and thus cannot be held responsible for claims made. Liability for correctness of material limited to corrected ad in next available issue.

DEADLINE 15th of third preceding month.

SEND MATERIAL TO: Ad Scan, Ham Radio Horizons, Greenville, N. H. 03048.

27th DAYTON HAMVENTION at Hara Arena April 28, 29, 30, 1978. More room this year! Technical forums, exhibits and huge flea market. Program brochure mailed March 6th to those registered within past three years. For accommodations or advance flyer, write Hamvention, P.O. Box 44, Dayton, OH 45401 or call 513-854-4126.

MOULTRIE AMATEUR RADIO CLUB'S 17th Annual Hamfest April 23, 1978 at Wyman Park in Sullivan, Ill. Heated Indoor and Large Outdoor fleamarket. No charge to vendors. Talk-in 146.94. For more info write MARK, Box 327, Mattoon, ILL. 61938.

SPOKANE SWAP-FEST '78 Saturday, April 29 at the Interstate Fairgrounds. All day flea market and mini-auctions, contests, family picnic, valuable prizes, and some most unusual radio exhibits. Sponsored by the Inland Empire area amateur clubs. Talk-in any area repeater. Write: RAY KRESEK (WA7YFM) Swap-Fest Chairman, P.O. Box 3606, Spokane, WA 99220

DIRECTORY OF STATESIDE QSL MANAGERS. Computerized cross-reference listing. Updated weekly. Most accurate and comprehensive source available. \$1.00 with 24-cent business-size s.a.s.e. Gary Yarus, WS0MSZ, 921 N. Clay, St. Louis, Missouri 63122.

CODE got you stumped?

RELAX and worry not! Learn International Morse Code the EASY Rus Farnsworth way. No books, no gimmicks, just listen & learn. Using the word method based on modern psychological techniques, you can learn past 13 w.p.m. in less than half the time! Available in cassettes @ \$10.95 and LP records at \$9.95 — you get over two hours of instruction!

EPSILON RECORDS
P.O. Box 626, San Jacinto, CA 92383

ALABAMA FORESTRY FESTIVAL — April 22, 1978. The Twin Base Amateur Radio Club station WA4PRY will be operating on site in conjunction with the Alabama Forestry Festival at the State Fair Grounds, Montgomery, Alabama. Any ARS completing a two way contact will receive a special certificate in exchange for a QSL card and SASE. Operations will be conducted from 1600 hours to 2300 hours UTC on frequencies 14.300 MHz and 3.950 MHz normal SSB; slow C.W. (5 to 10 WPM) on 7.125 MHz during even hours UTC and 21.150 MHz during odd hours UTC. QRM frequency adjustments will be up band.

SAVE \$\$\$. Build your own: LINEAR AMPLIFIERS, 50-100 watt solid state. FREQUENCY COUNTER, 300 MHz, 7 digit, crystal accuracy, portable/mobile, memory! BASE ANTENNA, omnidirectional! Omnidirectional! VOX-COMPRESSOR AND MORE! Construction plans \$3.00 each, 3 up/\$2.50 each. Specify desired band. PANAXIS, Box 5516-AS4, Walnut Creek, CA 94596.

CODE PRACTICE OSCILLATOR! Your gateway to the exciting world of ham radio. Complete with key, speaker and assembled circuit board. All you need is a 9v battery to start developing your "fist." By K5YEF. At only \$8.99 you can't afford to put off ham radio any longer. Send today! Harding Electronics, P.O. Box 1627, Plano, TX 75074.

WARMINSTER AMATEUR RADIO Club's Fourth Annual "HAMMART", Flea Market and Auction Sunday, May 14, 9 to 4, at William Tennent Senior High School, Street Road (Route 132) 2 miles East of York Road (Route 263), Warminster, Bucks County, Pa. Registration \$1.00, Tailgating \$2.00 additional. No indoor selling, bring your own tables. Talk-in on 146.16-76 and 146.52. For further information write Horace Carter, K3KT, 38 Hickory Lane, Doylestown, PA 18901 or call 215-345-6816.

TOROIDS 88 or 44 mH. Same day shipment. 5 for \$3.50 postpaid. Gull Electronics, 12690 Rt. 30, N. Huntington, PA 15642.

UPGRADE NOW — to Ham Radio Magazine, the technical journal for all radio amateurs that brings you the latest ideas, construction projects, new circuits, and state-of-the-art advances in electronic communication. You can't afford to miss it at only \$12 per year. Ham Radio, Greenville, New Hampshire 03048.

MASSACHUSETTS: The Wellesley Amateur Radio Society is conducting its annual auction on Saturday, April 15, 1978, beginning at 11:00 a.m. at the Wellesley High School Cafeteria on Rice Street, Wellesley, Massachusetts. Talk in on — 96.36, 04-64 and 52. Doors open at 10:00 a.m. Contact Kevin P. Kelly, WA1YHV, 7 Lawnwood Place, Charlestown, Massachusetts 02129.

CODE PRACTICE OSCILLATORS, hand keys, electronics keyers, other products. Free catalog. Globalman Products, Box 246, El Toro, CA 92630. 714-533-4400.

MOBILE IGNITION SHIELDING provides more range with no noise. Bonding strap sale less than 50¢ each. Literature. Estes Engineering, 930 Marine Drive, Port Angeles, Wash. 98362.

HAMFEST APRIL 1-2 by Mecklenburg Amateur Radio Society, Inc., W4BFB at new Civic Center in Charlotte, N.C. Plenty of parking, fun, and excitement. Come and enjoy with us!

LAKE SHORE RADIO FEST sponsored by the Sheboygan County Amateur Radio Club, Inc., Sheboygan, Wisconsin, April 8th, 9 to 5 at the Sheboygan Town Hall. Ham, CB, Marine gear on display; auction, sales of new and used gear; food, prizes; FUN. Special family entertainment. Adults \$2, children FREE. Talk in on 66/06 or 40-meter 'fone. For more information, call (414) 452-7570.

QSL's with class! Unbeatable quality, reasonable price. Samples, 25¢. QSL's Unlimited, Box 27553H, Atlanta, GA 30327.

ATLANTIC CITY AREA HAMFEST Sunday, April 16, 1978 Rain or Shine. 200 Indoor — 400 Outdoor table spaces, Stockton State College Campus, Pomona, N.J., lots of dealers. \$1 advance; \$1.50 gate. Door prizes, more info — SPARC, P.O. Box 142, Absecon, N.J. 08201.

AWARD CERTIFICATES

Award for Public Service or Emergency Communications Award. Send 2.00 each, event, name and address. FREE Information. 49'er RADIO CLUB, Box 1400-HH, Downey, Calif. 90240.

ENGRAVED NAMETAGS 1 1/2" x 2 1/2" — \$3.00. QTH added \$0.50. Door plates, key tags available. Black, blue, red, walnut with white letters. Other colors available. Tag-it Co., Box 2062, Indianapolis, IN 46206.

"THE CADILLAC" of QSL's! — New! Samples: \$1.00 (Refundable) — MAC'S SHACK, Box #1171-G, Garland, Texas 75040.

KENTUCKY HAM-O-RAMA — Sunday, May 28 (Memorial Day Weekend). 7 minutes south of Cincinnati. Erlanger Lions Park, Erlanger, Kentucky. Donaldson Road exit, I-75 South. Prizes, exhibits, flea market. NKARC, Box 31, Ft. Mitchell, Kentucky 41017.

THE 4TH ANNUAL NORTHWESTERN PENNSYLVANIA Hamfest, May 6th, Crawford County Fairgrounds, Meadville, PA. Gates open at 8:00. \$2 prize ticket required for admission — \$1 to display. Children FREE. Hourly door prizes, refreshments, commercial displays welcome. Indoors if rain. Talk-in 04/64 and 52. Details CARS, P.O. Box 653, Meadville, PA. 16335.

33RD ANNUAL LAWTON-FORT SILL HAMFEST April 8 and 9. Montego Bay Complex, Lawton, Oklahoma. No charge for dealers and swap tables. For registration info, write W5KS, Box 892, Lawton, Oklahoma 73502.

UR TRIPOLE MULTI-BAND



All-band antenna. 80 to 6 Meters plus 160' 5 SWL M Bands Built-in balun 2 KW PEP rating. No returning, tap or trap changes. 80 to 120 ft. inverted-V or horizontal. Available in kit form or assembled.
Kit 160-K \$54.95 cash PPD in USA

Team residents add 5% sales tax. Send postal card for information on 78 other antennas and accessories.

Universal Radio Co. Dept. H3
Box 20044 El Paso, TX 79926
Telephone (915) 292-1910



**30 years
of serving
the mid-west
with
all major brand
names of
amateur
radio
equipment
and supplies**

• KDK • B&W • YAESU • DRAKE
• HEIGHTS • ICOM • MFJ • NYE
• SWAN • TELREX • TEN-TEC
• VHF ENG • WILSON • MOSLEY
• KLM • CUSHCRAFT • LARSEN
• REGENCY • HUSTLER • CDE
• ANT. SPEC. • DENTRON
... and many more.

• full factory
authorized service
• immediate delivery
• competitive prices



• large inventory

**universal
amateur
radio inc**

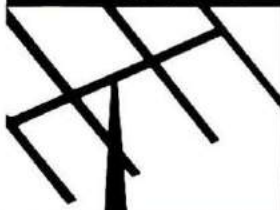

1280 AIDA DRIVE
COLUMBUS, OHIO
(Reynoldsburg) 43068

(614)-866-HAMS

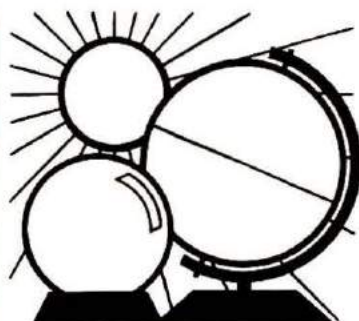

DX FORECASTER

April propagation conditions are likely to be disturbed during the period between April 4th and 11th. A geomagnetic storm is possible on the 8th. Be alert for vhf opportunities during this seven-day period. It is possible that the low bands may be very poor for a day or two, returning to normal slowly. Severe weather could accompany or shortly follow the geomagnetic upset, with the 9th and 10th being particularly susceptible. Minor ionospheric disturbances may also occur between the 16th and 20th, and again between the 23rd and 27th. A partial solar eclipse will occur on April 7th, but will be visible only from the lower tip of South America, South Africa, and parts of Antarctica. Moon perigee occurs April 26th. April is also the month for the Lyrid meteor shower (meaning that the apparent point source in the sky from which the meteors originate is the constellation Lyra) and you should look for vhf meteor-scatter communication on April 22nd and 23rd, when the Lyrids enter the earth's atmosphere at the rate of about 15 per hour.

Band-by-band propagation

Ten Meters will be quite active this month at selected times and over certain paths (see the chart for details) but *Fifteen Meters* will be the stellar performer. This band will be open to virtually all areas of the world at some time or other during the month. You can expect good signal strength and longer periods of daylight helping to keep the band open longer into the evening hours.

Twenty Meters is still the choice of DXers for *reliable* world-wide communications, but don't expect the going to be easy. The goodies are there if you're willing to work. Picking the right time from the chart will help you in your effort.

Forty Meters is still a worthwhile DX band, but the absorption levels are increasing rapidly, enhanced by greater sunspot activity and longer hours of daylight, meaning that the DX signals will not be as strong or present as often as they were last winter. Then, too, spring thunderstorms raise QRN to levels that blot out DX.

Eighty Meters is a repeat of forty, only more so. Use this band for morning and evening rag chewing, and forget DX until next fall.

One-sixty Meters is about gone for the season, except on clear cool evenings for a few hours of local communication. It will open again for DX later this coming fall and winter — just be patient.

Vhfs will like the meteor-bursts, the ionospheric upsets, and storm-front propagation opportunities. Be alert for excellent openings on 50, 144, 220, and even 432. April will be an outstanding month for you!

Tips on using the chart:

The asterisks (*) mean to look at the next *higher* band, because it, too, may be open on the path and at the time indicated. The arrows indicate general beam-pointing directions, with north at the top.

SUNDAY	MONDAY	TUESDAY	WEDNESDAY	THURSDAY	FRIDAY	SATURDAY
<p>*All international events such as contests are shown on the GMT days on which they take place even though they may actually begin on the evening of the preceding day in North America.</p> <p>University of Pittsburgh ABA Hamfest — Student Union Building across from the Cathedral of Learning — Pittsburgh, PA.</p>	<p>See April 1, 3, 6, 8, 11, 14, 17, 22, 30</p>  <p>FLORIDA HAM NEWS — SWAP NET By the Broward ARC — Ft. Lauderdale, FL — 146-31-91 at 7:30PM WEST COAST BULLETIN Edited & Transmitted by W6ZT, DR1, PST — 3540 kHz, A-1, 22 WPM</p>	<p>AMSAT Eastcoast Net 3850 kHz BPM EST (0100Z Wednesday Morning) AMSAT Mid-Continent Net 3850 kHz — 8PM CST (0200Z Wednesday Morning) AMSAT Westcoast Net 3850 kHz — 7PM PST (0300Z Wednesday Morning)</p> <p>AMSAT Eastcoast Net 3850 kHz BPM EST (0100Z Wednesday Morning) AMSAT Mid-Continent Net 3850 kHz — 8PM CST (0200Z Wednesday Morning) AMSAT Westcoast Net 3850 kHz — 7PM PST (0300Z Wednesday Morning)</p> <p>AMSAT Eastcoast Net 3850 kHz BPM EST (0100Z Wednesday Morning) AMSAT Mid-Continent Net 3850 kHz — 8PM CST (0200Z Wednesday Morning) AMSAT Westcoast Net 3850 kHz — 7PM PST (0300Z Wednesday Morning)</p>	<p>Twin Base ARC station WA4PXY will be operating on site in conjunction with the Alabama Forestry Festival at the State Fair Grounds — Montgomery, Alabama — Operations will be conducted from 1800Z - 2300Z on frequencies 14 300 MHz and 3 550 MHz SSB — slow CW (5-10 WPM) 7 125 MHz during even hours — 21 150 MHz during odd hours — GRM frequency adjustments will be up odd — 472Z</p>	<p>West Coast Qualifying Run</p>	<p>WIAW Qualifying Run</p>	<p>ARRL Repeater Council Meeting — Delaware County Historical Society Building — Delaware, OH SPC OSD Party — CW — 1-3 SPC DX Contest — CW — 1-2 Tennessee QSO Party — 2100Z 4/1 - 0500Z 4/2 — 1400Z 2000Z 4/2</p>
<p>Madison Area Repeater Assoc. Swapfest — Dane County Expo Center Youth Building — Madison, WI Plover Valley Repeater Assoc. Fleamarket/Auction — Newington High School — Willard St. — Newington, CT — K1NFE South Eastern Michigan ABA Hamfest — South Lake High School — 21900 E. Nine Mile Road at Mack Ave. — St. Clair Shores, MI — W0BBYE</p>	<p>FLORIDA HAM NEWS — SWAP NET By the Broward ARC — Ft. Lauderdale, FL — 146-31-91 at 7:30PM WEST COAST BULLETIN Edited & Transmitted by W6ZT, DR1, PST — 3540 kHz, A-1, 22 WPM</p>	<p>AMSAT Eastcoast Net 3850 kHz BPM EST (0100Z Wednesday Morning) AMSAT Mid-Continent Net 3850 kHz — 8PM CST (0200Z Wednesday Morning) AMSAT Westcoast Net 3850 kHz — 7PM PST (0300Z Wednesday Morning)</p>	<p>AMSAT Eastcoast Net 3850 kHz BPM EST (0100Z Wednesday Morning) AMSAT Mid-Continent Net 3850 kHz — 8PM CST (0200Z Wednesday Morning) AMSAT Westcoast Net 3850 kHz — 7PM PST (0300Z Wednesday Morning)</p>	<p>AMSAT Eastcoast Net 3850 kHz BPM EST (0100Z Wednesday Morning) AMSAT Mid-Continent Net 3850 kHz — 8PM CST (0200Z Wednesday Morning) AMSAT Westcoast Net 3850 kHz — 7PM PST (0300Z Wednesday Morning)</p>	<p>Holidays-Dive Festival QSO Party — By the Amateur Radio Club of Shreveport, LA — 1800Z 4/21 - 2400Z 4/30</p>	<p>ARRL Great Lakes Division Convention — Muskegon Community College Muskegon, MI Columbus ARC Hamfest — Columbus Municipal Auditorium at the Fairgrounds — Columbus, GA — K5JNL — 8-9 Open — CD Party — Phone — 15-16 Rochester Repeater Society Hamfest — Center St. — Rochester, MN — K8TS or W0BAMA SP DX Contest — Phone — 15-16 Walkley ARS Auction — Walkley High School, California — Rice St. — Wellesley, MA — WA1HYH</p>
<p>Shore Points ARC Hamfest — Stockton State College Campus — Pomona, NJ</p>	<p>FLORIDA HAM NEWS — SWAP NET By the Broward ARC — Ft. Lauderdale, FL — 146-31-91 at 7:30PM WEST COAST BULLETIN Edited & Transmitted by W6ZT, DR1, PST — 3540 kHz, A-1, 22 WPM</p>	<p>AMSAT Eastcoast Net 3850 kHz BPM EST (0100Z Wednesday Morning) AMSAT Mid-Continent Net 3850 kHz — 8PM CST (0200Z Wednesday Morning) AMSAT Westcoast Net 3850 kHz — 7PM PST (0300Z Wednesday Morning)</p>	<p>AMSAT Eastcoast Net 3850 kHz BPM EST (0100Z Wednesday Morning) AMSAT Mid-Continent Net 3850 kHz — 8PM CST (0200Z Wednesday Morning) AMSAT Westcoast Net 3850 kHz — 7PM PST (0300Z Wednesday Morning)</p>	<p>AMSAT Eastcoast Net 3850 kHz BPM EST (0100Z Wednesday Morning) AMSAT Mid-Continent Net 3850 kHz — 8PM CST (0200Z Wednesday Morning) AMSAT Westcoast Net 3850 kHz — 7PM PST (0300Z Wednesday Morning)</p>	<p>Holidays-Dive Festival QSO Party — By the Amateur Radio Club of Shreveport, LA — 1800Z 4/21 - 2400Z 4/30</p>	<p>EME Contest — (Net part) — 15-16 Mobile ARC Hamfest/Contest — University of South Alabama — Mobile, AL — WA4VPI — 15-16 Open — CD Party — Phone — 15-16 Rochester Repeater Society Hamfest — Center St. — Rochester, MN — K8TS or W0BAMA SP DX Contest — Phone — 15-16 Walkley ARS Auction — Walkley High School, California — Rice St. — Wellesley, MA — WA1HYH</p>
<p>Dayton Hamvention Delaware Valley RA Fleamarket/Auction — W Trouton, NJ WIAW Qualifying Run</p>	<p>FLORIDA HAM NEWS — SWAP NET By the Broward ARC — Ft. Lauderdale, FL — 146-31-91 at 7:30PM</p>	<p>AMSAT Eastcoast Net 3850 kHz BPM EST (0100Z Wednesday Morning) AMSAT Mid-Continent Net 3850 kHz — 8PM CST (0200Z Wednesday Morning) AMSAT Westcoast Net 3850 kHz — 7PM PST (0300Z Wednesday Morning)</p>	<p>AMSAT Eastcoast Net 3850 kHz BPM EST (0100Z Wednesday Morning) AMSAT Mid-Continent Net 3850 kHz — 8PM CST (0200Z Wednesday Morning) AMSAT Westcoast Net 3850 kHz — 7PM PST (0300Z Wednesday Morning)</p>	<p>AMSAT Eastcoast Net 3850 kHz BPM EST (0100Z Wednesday Morning) AMSAT Mid-Continent Net 3850 kHz — 8PM CST (0200Z Wednesday Morning) AMSAT Westcoast Net 3850 kHz — 7PM PST (0300Z Wednesday Morning)</p>	<p>DAYTON HAMVENTION FM Bash — By the Miami Valley FM Assoc. — Friday night at the Dayton Hamvention — Dayton Blimont Towers Hotel Main & First Streets — BPM in mid-night Radio Club de Puerto Rico Hamfest (Radio El Encuentro) — Pajaro, PR — 78-35</p>	<p>ARRL Repeater Council Meeting — Delaware County Historical Society Building — Delaware, OH SPC OSD Party — CW — 1-3 SPC DX Contest — CW — 1-2 Tennessee QSO Party — 2100Z 4/1 - 0500Z 4/2 — 1400Z 2000Z 4/2</p>
<p>Dayton Hamvention Delaware Valley RA Fleamarket/Auction — W Trouton, NJ WIAW Qualifying Run</p>	<p>FLORIDA HAM NEWS — SWAP NET By the Broward ARC — Ft. Lauderdale, FL — 146-31-91 at 7:30PM</p>	<p>AMSAT Eastcoast Net 3850 kHz BPM EST (0100Z Wednesday Morning) AMSAT Mid-Continent Net 3850 kHz — 8PM CST (0200Z Wednesday Morning) AMSAT Westcoast Net 3850 kHz — 7PM PST (0300Z Wednesday Morning)</p>	<p>AMSAT Eastcoast Net 3850 kHz BPM EST (0100Z Wednesday Morning) AMSAT Mid-Continent Net 3850 kHz — 8PM CST (0200Z Wednesday Morning) AMSAT Westcoast Net 3850 kHz — 7PM PST (0300Z Wednesday Morning)</p>	<p>AMSAT Eastcoast Net 3850 kHz BPM EST (0100Z Wednesday Morning) AMSAT Mid-Continent Net 3850 kHz — 8PM CST (0200Z Wednesday Morning) AMSAT Westcoast Net 3850 kHz — 7PM PST (0300Z Wednesday Morning)</p>	<p>DAYTON HAMVENTION FM Bash — By the Miami Valley FM Assoc. — Friday night at the Dayton Hamvention — Dayton Blimont Towers Hotel Main & First Streets — BPM in mid-night Radio Club de Puerto Rico Hamfest (Radio El Encuentro) — Pajaro, PR — 78-35</p>	<p>ARRL Repeater Council Meeting — Delaware County Historical Society Building — Delaware, OH SPC OSD Party — CW — 1-3 SPC DX Contest — CW — 1-2 Tennessee QSO Party — 2100Z 4/1 - 0500Z 4/2 — 1400Z 2000Z 4/2</p>

An advanced microcomputer interfacing and programming workshop to be presented by the Extension Division of York College. The workshop is scheduled to be presented about the TSS Campus from June 17 through 24. It will consist of an introductory session followed by five daily sessions, six hours of lecture and laboratory work. The course content is designed for scientists, engineers and specialists who have prior knowledge of basic digital electronics and micro-computer interfacing and programming techniques.



Norris Bell, Director of VPI's Continuing Education Center, said that the course is the result of a search for new and interesting ways of providing continuing education. Additional information on the course and the travel agency handling the arrangements are available from the Registrar, CEC, VPI & SU, Blacksburg, VA 24061, phone (703) 951-9182.

DEADLINE FOR CRUISE RESERVATIONS — All cruise payments must be made by April 15, 1978.

CALL TOLL FREE

1-800-228-4097

for Quality Ham Radio Products at Discount Prices

YAESU SUPER DEALS - limited supply

DEAL #1

Buy a Yaesu FT-301 (dial) for only \$769.00 and you get a FP-301 AC Power Supply and a CW Filter absolutely FREE. Total Value \$966.00
SAVE \$197.00

DEAL #2

Buy a Yaesu FT-301d (digital) for only \$935.00 and you get a FP-301 AC Power Supply and a CW Filter absolutely FREE. Total Value \$1132.00
SAVE \$197.00

Kenwood
Yaesu
Drake
Hy-Gain
ICOM
Ten-Tec
Dentron
Swan
Tempo
Wilson
Midland
Bearcat
CDE Rotors
ETO Alpha

Call for similar savings on all these excellent lines



Communications Center

The Radio Store



443 N. 48th, Lincoln, Nebraska 68504

In Nebraska Call (402) 466-8402

NEW VISUAL CODE READER AND ELECTRONIC KEYS



Works with any keyer, including squeeze keyer in speeds from 7 WPM to 40 WPM. Both in a single unit.
Model CR101EK
\$249

from **ATRONICS**

- Display letters, numbers, and commonly used punctuation visually as Morse Code signal is received.
- Operating speed 5 to 50 WPM at selected speeds.
- All Solid State.
- Makes code learning faster and easier.
- A single connection to your receiver or transceiver speaker puts it into operation.
- Hard copy read-out of CW available with TU-102 TTY interface Module accessory.

Our popular, lowest priced CODE READER KIT
Model KCR101 \$149
Ready made CODE READER, Model CR101 \$225

BUY FACTORY DIRECT & SAVE! SEND FOR FREE LITERATURE.
USE YOUR BANKAMERICARD OR MASTER CHARGE

BOX 2946

LAGUNA HILLS, CA 92653

(714) 830-6428

Atronic

New! QSO tape for the new exams.



Code kit
\$19.95

Tape only
\$4.95

Kantronics Speed-Building Kit

Get prepared!

To pass the new FCC code exams, you'll need to identify unusual names, places, antenna heights, rig types and a variety of other items garnered from simulated QSOs.

Now you can really study for the new exams with the **Kantronics QSO Tape!** Our C-60 cassette sends simulated "on-the-air" transmissions at 7½, 10, 13, and 15 WPM.

The QSO Tape generates sharp, crisp code to exact Morse specifications, just as the FCC does. Order your QSO Tape with Speed-Building Kit, or separately, today! Our other fine tapes are also available at 5, 7½, 10, 13, 16 and 20 WPM speeds.

KANTRONICS
The Lightweight Champs.

Telephone 913-842-7745
Lawrence, Kansas 66044

1202 East 23rd St.

AD CHECK

... for literature, in a hurry — we'll rush your name to the companies whose names you check.

Place your check mark in the space between name and number. Example: HRH 150.

- | | |
|----------------------------------|------------------------------------|
| Acoustic
Fiber ___ 462 | Henry ___ 062 |
| Amateur Elect.
Supply ___ 659 | ICOM ___ 065 |
| Antenna
Mart ___ 009 | Instructo-
graph ___ 666 |
| Atlas ___ 198 | Int. Crystal ___ 066 |
| Atronics ___ 382 | Kantronics ___ 605 |
| Autocode ___ 665 | Kengore ___ 538 |
| Bencher ___ 629 | Kenwood * |
| CW Elect. ___ 533 | Kester * |
| Cohoon ___ 559 | Klaus ___ 430 |
| Comm.
Center ___ 534 | Larsen ___ 078 |
| Cont. Specialties
___ 348 | Long's ___ 468 |
| Copy One ___ 651 | MFJ ___ 082 |
| Cushcraft ___ 035 | Madison * |
| DSI ___ 656 | Microwave
Filter * |
| Dayton
Hamvention * | Oak Hill Acad.
A. R. S. ___ 213 |
| DenTron ___ 259 | Palomar ___ 093 |
| Digital ___ 631 | Partridge ___ 439 |
| Drake ___ 039 | RSE Ham
Shack ___ 607 |
| E. T. O. * | Callbook ___ 100 |
| Elect. Dist. ___ 044 | Constructor ___ 586 |
| Elect. Equip.
Bank ___ 288 | Rush ___ 667 |
| Erickson ___ 047 | Rusprint ___ 662 |
| Gilfer ___ 207 | S-F Am. Radio
Serv. ___ 640 |
| Gotham * | Sentry ___ 600 |
| HAL ___ 057 | Solorex ___ 668 |
| "Ham" Buerger * | Swan ___ 111 |
| Ham Center ___ 491 | Ten-Tec * |
| H. R. C. B. ___ 150 | Tri-Ex ___ 116 |
| H. R. Magazine
___ 150 | Universal
A. R. S. ___ 653 |
| Ham Outlet ___ 595 | Western * |
| Heath ___ 060 | Whitehouse ___ 378 |
| | Wilson ___ 123 |

*Please contact this advertiser directly.
Limit 15 inquiries per request.

APRIL, 1978

Please use before May 31, 1978

Tear off and mail to
HAM RADIO HORIZONS — "Ad Check"
Greenville, N. H. 03048

NAME _____

CALL _____

STREET _____

CITY _____

STATE _____ ZIP _____

MADISON BIG SIGNAL BUYS NEW

OMNI-J 2-meter mobile or portable antenna, 3/8" thread, 5-dB gain (1.5-dB gain over conventional 3/4-wave mobile whip antenna). \$29.95; 220 MHz \$27.95, 450 MHz \$27.95. Guaranteed results.

KLM: Antennas, Linears, Accessories All In Stock
FREE balun w/2 meter base antenna.

BIRD 43 Wattmeter plus slugs, in stock, prepaid freight.

PREMAX 4-foot ground rod plus clamps \$4.50

YAESU FT-301D plus FREE FP-301 AC \$935.00

YAESU FT-301 plus FREE FP-301 AC \$750.00

HY GAIN 18AVT/WB + 100 feet RG8 coax \$100.00

HY GAIN 18V vertical \$19.95

Model 214 2m Yagi \$21.50

Hy-Gain 208 2M Yagi \$15.95

VHF SPECIAL: Kenwood TS700S List . . . \$679

Call for quote

JANEL PREAMPS: In Stock. Technical Books (ARRL, Sams, Tab, RCA, T.I., etc.)

HAM X ROTOR (New Model) Turns 28 sq. ft. of antenna. List \$325. In Stock. Your Price \$249

CDE HAM-III \$129.00

BIRD 43 WATTMETERS plus slugs in stock.

SWAN METERS: WM 6200 VHF Wattmeter \$49.95; SWR 3 Mobile \$9.95.

TELEX HEADSETS: In Stock \$24.95 ea.

CETRON 572B

ADEL nibbling tool, \$6.45; punch \$3.50

CABLE 5/32", 6-strand, soft-drawn guy cable. For mast or light tower, 3c foot.

BELDEN COAX CABLE: 9888 double shield RG8 foam coax, 100% braid, suitable for direct bury 39c ft., 8237 RG8 21c ft.

8214 RG8 foam 25c ft., 8448 8-wire rotor cable 16c ft., 8210 72 ohm kw twinlead \$19/100 ft., 8235 300 ohm kw twinlead \$12/100 ft., Amphenol PL-259, silver-plated 59c, UG175 adapter 19c, PL-258 dbf female \$1.00. BNC female chassis mount 59c ea; MICRO RG-8/U same size as RG-59, 2 KW PEP @ 30 MHz 16c/ft.

BELDEN 14 gauge copper stranded antenna wire. \$5.00/100 ft.

22 gauge plastic covered ant. wire for long wire, radials. \$3.50/1000 ft.

KESTER SOLDER 1 lb. 60/40, .062 \$6.50

Leader — Amateur Test Equip. — 10% off list.

Mallory 2.5A/1000PIV epoxy diode 19c ea. .001 MFD 20KV CAP. \$1.95

Raytheon 811A, sealed cartons. \$16.00 pr. GE receiving tubes. 50% off list

GE6146B, 8950 \$7.95 ea.

**CALL FOR QUOTES ON:
YAESU FT301D, FT301,
FT-227R, KENWOOD TS520S,
TS820S, TS600A, TR7400A,
TR7500A & ETO-ALPHA. ALL IN
SEALED CARTONS. CALL FOR
QUOTES ON ITEMS NOT LIST-
ED. THIS MONTH'S SPECIAL:
BEARCAT 210 SCANNER \$249.**

CALL FOR FAST QUOTE, OR WRITE AND INCLUDE TELEPHONE NUMBER. IF WE HAVE YOUR BARGAIN, WE'LL CALL YOU PREPAID.

TERMS: All prices FOB Houston. Prices subject to change without notice. All Items Guaranteed. Some items subject to prior sale. Send letterhead for Amateur dealers price list. Texas residents add 5% tax. Please add postage estimate.

MADISON ELECTRONICS SUPPLY, INC.

1508 MCKINNEY HOUSTON, TEXAS 77002
713/658-0268 Nites 713/497-5683

AD INDEX

- | | |
|---|------------|
| Acoustic Fiber Sound Systems, Inc | 71 |
| Amateur Electronic Supply | 67 |
| Antenna Mart | 74 |
| Atlas Radio Company | 33 |
| Atronics | 85 |
| Autocode | 77 |
| Bencher, Inc. | 67 |
| CW Electronic Sales Co. | 68 |
| Cohoon Amateur Supply | 79 |
| Communications Center | 85 |
| Continental Specialties | 73 |
| Copy One | 68 |
| Cushcraft | 4, 86 |
| DSI Instruments | 64, 65 |
| Dayton Hamvention | 76 |
| DenTron Radio Company | 44, 45 |
| Digital Electronics, Inc. | 52 |
| Drake Co., R.L. Cover II | |
| Ehrhorn Technological Operations | 67 |
| Electronic Distributors, Inc. | 72 |
| Electronic Equipment Bank | 80 |
| Erickson Communications | 55 |
| Gilfer Associates | 79 |
| Gotham | 63 |
| HAL Communications Corp. | 23 |
| "Ham" Buerger | 77 |
| Ham Radio Center | 63 |
| Ham Radio's
Communications Bookstore | 76 |
| Ham Radio Magazine | 74, 80 |
| Ham Radio Outlet | 9 |
| Heath Company Cover IV, 70 | |
| Henry Radio Stores | 87 |
| ICOM | 7 |
| Instructograph Co. | 75 |
| International Crystal | 69 |
| Kantronics | 63, 85 |
| Kengore Corporation | 80 |
| Trio-Kenwood Communications Inc.
Cover III | |
| Kester Solder | 80 |
| Klaus Radio, Inc. | 73 |
| Larsen Antennas | 51 |
| Long's Electronics | 1 |
| MFJ Enterprises | 3 |
| Madison Electronic Supply | 77, 86 |
| Microwave Filter, Inc. | 70 |
| Oak Hill Academy Amateur
Radio Session | 79 |
| Palomar Engineers | 41, 71 |
| Partridge Electronics Ltd. | 67 |
| RSE Hamshack | 74 |
| Radio Amateur Callbook | 74 |
| Radio & Electronics Constructor | 80 |
| Rush Electronics | 77 |
| Rusprint | 75 |
| S-F Amateur Radio Services | 77 |
| Sentry Manufacturing | 71 |
| Solorex Corp | 70 |
| Swan Electronics | 37, 56, 57 |
| Ten-Tec | 53 |
| Tri-Ex Tower Corporation | 72 |
| Universal Amateur Radio Service, Inc. | 82 |
| Western Electronics | 73 |
| G. R. Whitehouse & Co. | 75 |
| Wilson Electronics | 10 |

Foreign Subscription Agents for Ham Radio HORIZONS

- | | |
|--|--|
| Ham Radio Austria
Karin Ueber
Postfach 2454
D-7850 Loerrach
West Germany | Ham Radio Holland
MPL Electronics
Postbus 89
NL-2204 Delft
Holland |
| Ham Radio Belgium
Sterehouse
Brusselsesteenweg 416
B-9218 Gent
Belgium | Ham Radio Italy
S.T.E. Via Maniago 15
I-20134 Milano
Italy |
| Ham Radio Canada
Box 114, Goderich
Ontario, Canada N7A 3Y5 | Ham Radio Switzerland
Karin Ueber
Postfach 2454
D-7850 Loerrach
West Germany |
| Ham Radio Europe
Box 444
S-194 04 Upplands Vasby
Sweden | Ham Radio UK
P.O. Box 63, Harrow
Middlesex HA3 6HS,
England |
| Ham Radio France
Christiane Michel
F-89117 Parly
France | Ham Radio Germany
Karin Ueber
Postfach 2454
D-7850 Loerrach
West Germany |
| | Holland Radio
143 Greenway
Greenside, Johannesburg
Republic of South Africa |

HALF A CENTURY OF SERVICE

Fifty years ago in 1928, Henry Radio first offered to help amateur radio operators solve their communications problems. Today Amateurs, not only in the United States but throughout the free world, still look to Henry Radio as their pre-eminent supplier of fine communications equipment. Fifty years is a long time in the life of an individual. It is a long time in the history of amateur radio. So we are proud to be celebrating our fiftieth anniversary of service to Amateur Radio. We believe it says something important about Henry Radio and about the pioneering contributions we have made to our industry.

From the beginning, we offered personalized service. Service that recognized that every person's needs were as individual as each person is unique. We were the first to offer low cost time sales of Amateur equipment. We were among the first to trade for used equipment.

Even then we had an expert service department to assure that each piece of equipment operated the way it should. We pioneered "satisfaction guaranteed" and the ten day free trial policy. Then as now we recognized our obligation to provide amateurs everywhere with fine equipment and good service.

At Henry Radio we don't know any other way of doing business. Since we have been active amateurs for all these years, we know the correct answers when we ask ourselves, "Is this the way I would want to be served if I were a customer of Henry Radio?"

Looking back, 50 years seems a long time. Looking ahead we feel like eager youngsters impatient to know the exciting new experiences that the next 50 years will bring. Eager to help our amateur friends all over the world share the unique communication thrills that only amateur radio can provide. May we help you?

Looking back, 50 years seems a long time. Looking ahead we feel like eager youngsters impatient to know the exciting new experiences that the next 50 years will bring. Eager to help our amateur friends all over the world share the unique communication thrills that only amateur radio can provide. May we help you?

Looking back, 50 years seems a long time. Looking ahead we feel like eager youngsters impatient to know the exciting new experiences that the next 50 years will bring. Eager to help our amateur friends all over the world share the unique communication thrills that only amateur radio can provide. May we help you?

May we help you?



11240 W. Olympic Blvd., Los Angeles, Calif. 90064 213/477-6701
 931 N. Euclid, Anaheim, Calif. 92801 714/772-9200
 Butler, Missouri 64730 816/679-3127

Henry Radio

2 METERS...

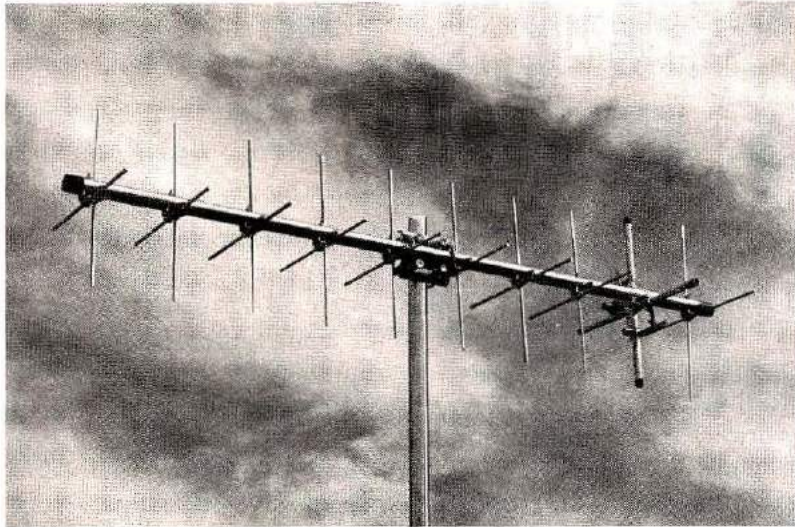

... *Alive* with activity at *both* ends of the band! Be a part of the total 2 Meter picture with the Cush Craft Twist Antenna. Actually two, easily assembled, 10 element yagis in one — the vertical elements are cut for the high end, the horizontal elements for the low end, and separate feed lines are used. The A147-20T is tailored to meet the demands of the operator who enjoys the best of both worlds

— FM and SSB/CW.

A147-20T

\$54.95

CQ OSCAR ...

... *Extend your horizon* — Explore the exciting new world of amateur satellite communications using low power with our multi-polarized Twist Antennas. All models include phasing harness for selectable linear or right/left circular polarization. Two of these Twists may be mounted on the A14T-MB mounting boom which is complete with a pre-drilled plate for a readily available mast-through rotator. *Face this challenging frontier — Become a Specialist!*

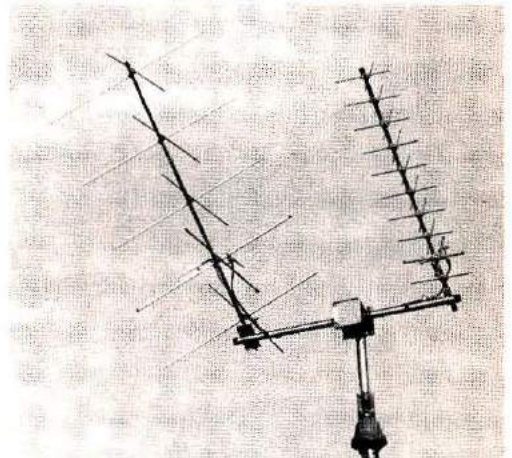

A144-10T \$34.95 A432-20T \$49.95
A144-20T \$54.95 A14T-MB \$15.95

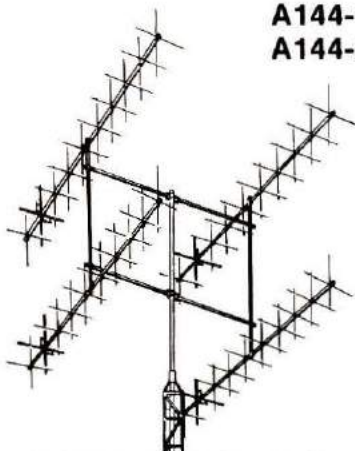

PERFORMANCE ARRAYS . . .

Enjoy fade-free contacts on VHF/UHF with Twist Antennas and Arrays. Excellent for scatter and other long-haul techniques. Double your effective radiated power by stacking two Twists, or quadruple ERP by stacking four Twists. Arrays are easily assembled for your special communications requirement. Write for stacking and phasing harness details concerning amateur and commercial frequencies.

Dependable communications — *Now Yours!*

	SPECIFICATIONS			
Model	A147-20T	A144-10T	A144-20T	A432-20T
Center Freq. (MHz)	144.5/146.5	145.9	145.9	432
No. Elements	10/10	10	20	20
Weight (lbs.)	6	3.5	6	3.5
Wind Surf. Area (ft. ²)	1.42	.74	1.42	.37
Mounting	Center	Rear	Center	Rear
Dimensions (Inches)	40x40x140	40x40x70	40x40x140	14x14x57

IN STOCK WITH
 DISTRIBUTORS WORLDWIDE

cushcraft
 THE ANTENNA COMPANY
 P.O. BOX 4680, MANCHESTER, N.H. 03108

KENWOOD
...pacesetter in amateur radio

The TS-520S ... still the most popular transceiver in the world, is a solid foundation for an expanding series designed to please any ham ... from Novice to Extra.

TS-520S

The TS-520S provides full coverage on all amateur bands from 1.8 to 29.7 MHz. It provides 160 meter capability, WWV on 15.0 MHz and an auxiliary band position for maximum flexibility. With the addition of the DG-5, you have an easy to read, accurate readout of your operating frequency while transmitting and receiving. The TS-520S is solid state except for the driver and the two final tubes. It also incorporates a 3SK35 dual gate MOSFET for outstanding cross modulation and spurious response characteristics.

The TS-520S is completely self-contained with a rugged AC power supply built in. The addition of the DS-1A DC-DC converter (option) allows for mobile operation. Additional features of the TS-520S include: A new improved speech processor • An extremely effective noise blanker • A built in 20 dB attenuator • Convenient jacks for PHONE PATCH IN and PHONE PATCH OUT • Amplified type AGC circuit RIT control • 8-pole crystal filter • Built-in 25 KHz calibrator • Front panel carrier level control • Semi-break-in CW with sidetone • VOX/PTT/MOX • TUNE position for low power tune up • Built in speaker • Built in cooling fan • Provision for 4 fixed frequency channels • Heater switch.

The man to see ... your local Authorized Kenwood Dealer. He can give you all the information you need and the best deal.



A great station ... at an affordable price! The TS-520S with its companion accessories ... including two new units. The AT-200 antenna tuner provides a versatile tool in any station. The other is the TV-520S, Kenwood's 2 meter transverter for SSB and CW operation from 146 to 148 MHz.

TRIO-KENWOOD COMMUNICATIONS INC.
 1111 WEST WALNUT/COMPTON, CA 90220



Pictured with optional HD-1984 Micoder.[™]

The **HEATHKIT** HW-2036A

...just that much better!

We'll give it to you straight!

The HW-2036 was a great 2-meter transceiver — but the HW-2036A is just that much better!

It boasts a conservative $0.5\mu\text{v}$ sensitivity figure, completely synthesized operation, a minimum 10 watts out, and now... a full 4 MHz of coverage over any portion of its 143.5 to 148.5 MHz operating range.

But most startling of all is the price tag. At \$269.95* the HW-2036A is the **lowest priced**, synthesized, 2-meter transceiver anywhere!

Heath Amateur Radio Gear...
....the quality that measures up!

At Heath we're holding down the soaring cost of Amateur Radio. Look over our entire line — then join the thousands of Amateurs who've taken the sensible alternative and turned to our easy-to-build Heathkit Amateur Radio kits for economy, quality and value.

Catalogs are also available at the 50 Heathkit Electronic Centers coast-to-coast (Units of Schlumberger Products Corporation) where Heathkit products are displayed, serviced and sold. Retail prices on some products may be slightly higher. See your phone directory white pages.

*Price is mail-order F.O.B., Benton Harbor, Michigan.
 Price and specifications subject to change without notice.

For a FREE catalog, mail card found elsewhere in this magazine. Or write: Heath Company, Dept. 348-400, Benton Harbor, MI 49022.