

MAY 1990 / \$2.95

HAM RADIO



PAOCX

annual ANTENNA issue

The IC-781 Is Just Too Much Transceiver To Squeeze On One Page

It is almost impossible to fit the prestigious IC-781 on a single page. Its futuristic design and superior features defy boundaries.

Never before has a transceiver captivated radio enthusiasts so intensely. The IC-781 inspires countless hours and loyal attention to your hobby...whether it is DX'ing, contesting, exploring new interests or simply enjoying legendary performance.

From the Multi-Function 5-Inch CRT and Spectrum Scope to Twin Passband Tuning, Dual Watch, ICOM's exclusive DDS System and continuous coverage of all amateur bands, the IC-781 is a total communications package designed to exceed your every expectation. The IC-781...Today's Standard of Excellence. See it at an ICOM Dealer near you.

AUTOMATIC ANTENNA TUNER



TWIN PASSBAND TUNING

DUAL WATCH

INDEPENDENT FILTER SELECTION

AUDIO PEAKING FILTER FOR SUPERB CW RECEPTION

MULTI-FUNCTIONAL CRT DISPLAY
Can be used as a terminal to display DX packet cluster information!

SEPARATE RIT & TX FOR EACH VFO

SPECTRUM SCOPE

CORPORATE HEADQUARTERS
ICOM America, Inc. 2380-116th Ave. N.E., Bellevue, WA 98004
Customer Service Hotline (206) 454-7619
CUSTOMER SERVICE CENTERS
3150 Premier Drive, Suite 126, Irving, TX 75063
1777 Phoenix Parkway, Suite 201, Atlanta, GA 30349
3071 - #5 Road, Unit 9, Richmond, B.C. V6X 2T4 Canada
All stated specifications are subject to change without notice or obligation. All ICOM radios significantly exceed FCC regulations limiting spurious emissions. 781390.

For a brochure on this or any other ICOM product, call our Toll-Free Literature Request Hotline 1-800-999-9877.



ICOM

First in Communications

DUAL WIDTH NOISE BLANKER

FULL CW BREAK-IN



FM & or PACKET

Looking for a way to work your local FM repeater . . .
to occasionally check in to your club net . . .
to get on packet . . .
or to work faster packet without the expense and complexity?
If so, then you've found it.

The DVR 2-2 is ideal as a dedicated 2-meter transceiver for voice (FM) and/or packet. It features fast switching, fast squelch and DCD, with separate voice and data connectors, small size, and low-cost. And it's designed with data in mind.

For packet, the DVR 2-2 has discriminator output available on the rear panel. This makes the radio high speed packet ready without modification, when used with a higher rate modem. And the data connector is plug compatible with the Kantronics' KAM and TNCs.

For FM, it's an excellent low-cost alternative for FM communication via your local amateur repeater. Great for control links too. And it's compatible with the RFC VHF 30-watt amplifier if you wish to out-reach your local repeater.

The specs:

- 2 meters, 144-148 MHz range
- Dual conversion superhet - 10.7 MHz IF, 455 KHz 2nd IF
- PIN diode switching, less than 5ms
- 2-watts or greater output, crystal controlled, mic & speaker jacks provided
- DB-9 data connector with direct-buffered connections to varicap and detector
- Optional-mic, speaker, extra channel crystals, antenna & technical reference manual

For more information contact the factory. To purchase, contact your favorite Kantronics dealer.

Price \$239.00
Made in the U.S.A.

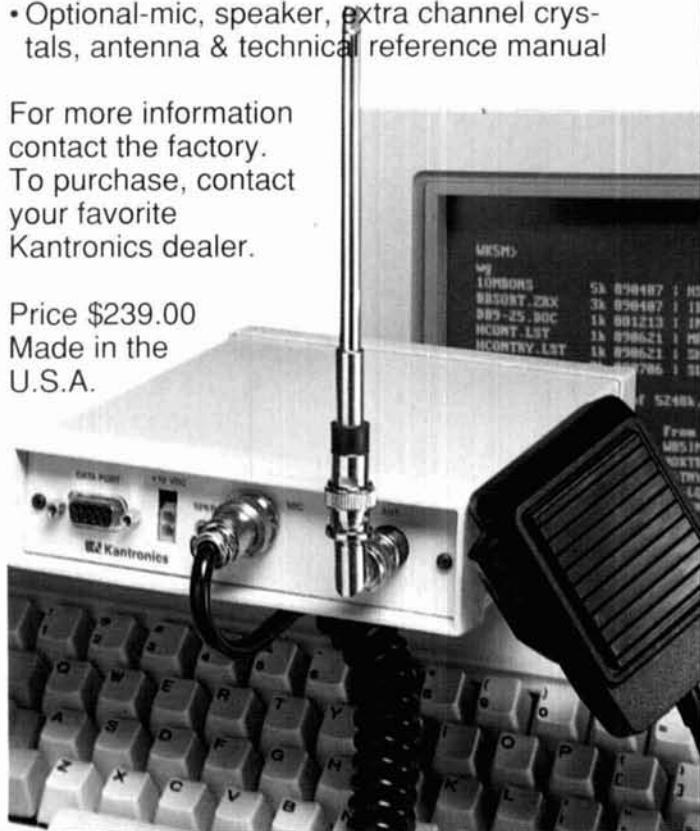

KENWOOD



TS-950SD

"DX-clusive" HF Transceiver

The new TS-950SD is the first Amateur Radio transceiver to utilize Digital Signal Processing (DSP), a high voltage final amplifier, dual fluorescent tube digital display and digital meter with a peak-hold function.

- Dual Frequency Receive Function. The TS-950SD can receive two frequencies simultaneously.
- New! Digital AF filter. Synchronized with SSB IF slope tuning, the digital AF filter provides sharp characteristics for optimum filter response.
- New high voltage final amplifier. 50 V power transistors in the 150-watt final section, resulting in minimum distortion and higher efficiency. Full-power key-down time exceeds one hour.
- New! Built-in microprocessor controlled automatic antenna tuner.
- Outstanding general coverage receiver performance and sensitivity. Kenwood's Dyna-Mix™ high sensitivity direct mixing system provides incredible performance from 100 kHz to 30 MHz. The Intermodulation dynamic range is 105 dB.
- Famous Kenwood interference reduction circuits. SSB Slope Tuning, CW VBT (Variable Bandwidth Tuning), CW AF tune, IF notch filter, dual-mode noise blander with level control, 4-step RF attenuator (10, 20, or 30 dB), switchable AGC circuit, and all-mode squelch.

Complete service manuals are available for all Kenwood transceivers and most accessories. Specifications, features and prices subject to change without notice or obligation.

The Ultimate Signal.

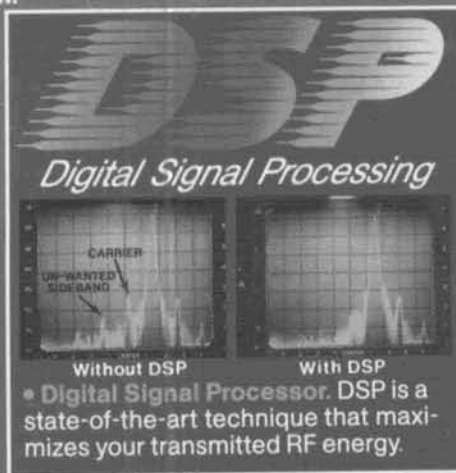

- Digital Signal Processor. DSP is a state-of-the-art technique that maximizes your transmitted RF energy.
- High performance IF filters built-in† Select various filter combinations from the front panel. For CW, 250 and 500 Hz, 2.4 kHz for SSB, and 6 kHz for AM. Filter selections can be stored in memory!
- Multi-Drive Band Pass Filter (BPF) circuitry. Fifteen band pass filters are available in the front end to enhance performance.

- Built-in TCXO for the highest stability.†
- Built-in electronic keyer circuit.
- 100 memory channels. Store independent transmit and receive frequencies, mode, filter data, auto-tuner data and CTCSS frequency.
- Digital bar meter.

Additional Features: • Built-in interface for computer control • Programmable tone encoder • Built-in heavy duty AC power supply and speaker • Adjustable VFO tuning torque • Multiple scanning functions • MC-43S hand microphone supplied

Optional Accessories

- DSP-10 Digital Signal Processor*
- SO-2 TCXO* • VS-2 Voice synthesizer
- YK-88C-1 500 Hz CW filter for 8.83 MHz IF*
- YG-455C-1 500 Hz CW filter for 455 kHz IF*
- YK-88CN-1 270 Hz CW filter for 8.83 MHz IF*
- YG-455CN-1 250 Hz CW filter for 455 kHz IF*
- YK-88SN-1 1.8 kHz SSB filter for 8.83 MHz IF*
- YG-455S-1 2.4 kHz SSB filter for 455 kHz IF*
- SP-950 External speaker w/AF filter
- SM-230 Station monitor w/pan display
- SW-2100 SWR/power meter
- TL-922A Linear amplifier (not for QSK)

* Built-in for the TS-950SD
† Optional for the TS-950S

KENWOOD U.S.A. CORPORATION
COMMUNICATIONS & TEST EQUIPMENT GROUP
P.O. BOX 22745, 2201 E. Dominguez Street
Long Beach, CA 90801-5745

KENWOOD ELECTRONICS CANADA INC.
P.O. BOX 1075, 959 Gana Court
Mississauga, Ontario, Canada L4T 4C2

KENWOOD

...pacesetter in Amateur Radio



HAM RADIO



K3OQF, page 11

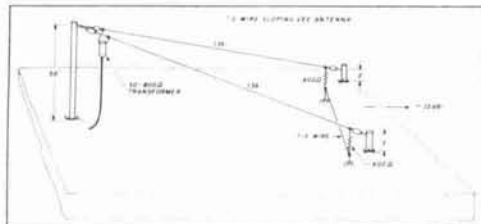

KL7ISA, page 49

MAY 1990
Volume 23, Number 5

Publisher & Editor-in-Chief:
T.H. TENNEY, JR., W1NLB

EDITORIAL STAFF

Editor:
TERRY NORTHUP, KA1STC

Consulting Technical Editors:
Marty Durham, NB1H
David McLanahan, WA1FHB
Alfred Wilson, W6NIF
Robert D. Wilson, WA1TKH

Associate Editors:
Peter Bertini, K1ZJH
Tom McMullen, W1SL
Joseph J. Schroeder, W9JUV

Production Editor: Susan Shorrock
Copy Editor: Peggy Tenney, KA1QDG
Editorial Assistant: Beth McCormack

Editorial Review Board:

Forrest Gehrke, K2BT
Michael Gruchalla, P.E.
Hunter Harris, W1SI
Bob Lewis, W2EBS
Mason Logan, K4MT
Vern Riportella, WA2LQQ
Ed Wetherhold, W3NQN

PUBLISHING STAFF

Assistant Publisher:
J. CRAIG CLARK, JR., NX1G

Advertising Manager:
Marty Durham, NB1H

Advertising Production Manager:
Dorothy Sargent, KA1ZK

Circulation Manager: Susan Shorrock
Circulation: Marion Tuttle
Traffic Manager: Phil Alix, N1FPX
Book Store: Priscilla Gauvin

Cover illustration: Hans Evers, PA0CX.

FEATURES

THE GÖTTINGEN HEART ANTENNA	11
<i>Walter J. Schulz, K3OQF</i>	
Microwaves: FEEDBACK	18
<i>Bob Atkins, KA1GT</i>	
ROTATABLE TRAP DIPOLE FOR 12 AND 17 METERS	22
<i>Gary Nichols, KD9SV</i>	
The Weekender: THE HELICAL WHIP FOR RV AND MOBILE USE	24
<i>J.T. McCullough, W0BHG</i>	
SKYWAVE COMMUNICATIONS, PART 3	34
<i>Cornell Drentea, WB3JZO</i>	
THE BI-SQUARE ARRAY	42
<i>C. Drayton Cooper, N4LBJ</i>	
NONRESONANT DELTA AND V BEAM ANTENNAS	49
<i>Robert Wilson, KL7ISA</i>	
Ham Radio Techniques: MAY PERAMBULATION	56
<i>Bill Orr, W6SAI</i>	
The Weekender: INEXPENSIVE TRIBAND MOBILE ANTENNA	62
<i>Phil Salas, AD5X</i>	
Elmer's Notebook: ELEMENTARY ELECTRONICS: ALTERNATING CURRENT AND CAPACITORS	67
<i>Tom McMullen, W1SL</i>	
Practically Speaking: POTPOURRI	71
<i>Joseph J. Carr, K4IPV</i>	

DEPARTMENTS

BACKSCATTER	4	SHORT CIRCUITS	78
EDITOR'S NOTES	4	DX FORECASTER	82
COMMENTS	6	NEW PRODUCTS	86,87
HAM RADIO		FLEA MARKET	88,89
BULLETIN BOARD	9	ADVERTISERS INDEX	90
HAM NOTEBOOK	30	READER SERVICE	90

HAM RADIO Magazine (ISSN 0148-5989) is published monthly by Communications Technology, Inc. Main Street, Greenville, New Hampshire 03048-0498 Telephone: 603-878-1441 FAX: 603-878-1951. **Subscription Rates:** United States: one year, \$22.95; two years, \$38.95; three years, \$49.95; Canada and Mexico: one year, \$31.00; two years, \$55.00; three years, \$74.00. All other countries: one year, \$35.00 via surface mail only. All subscription orders payable in U.S. funds, via international postal money order or check drawn on U.S. bank. **International Subscription Agents:** page 76.

Microfilm copies are available from Buckmaster Publishing Mineral, Virginia 23117. Cassette tapes of selected articles from HAM RADIO are available to the blind and physically handicapped from Recorded Periodicals, 919 Walnut Street, Philadelphia, Pennsylvania 19107.

Copyright 1990 by Communications Technology, Inc. Title registered at U.S. Patent Office.

Second-class postage paid at Greenville, New Hampshire 03048-0498 and at additional mailing offices. Send change of address to HAM RADIO, Greenville, New Hampshire 03048-0498.

Backscatter



FOR SALE: THE 20-METER AMATEUR BAND. BIDS START AT \$2,000,000,000. GET YOUR AUCTION NUMBER NOW!

How's that for a headline! Think I'm kidding? Read on and learn the exciting details of this fascinating opportunity.

The National Telecommunications and Information Administration (NTIA) and the FCC are responsible for the management and allocation of the radio spectrum for the federal government. On December 8, 1989, the NTIA filed a long and involved Notice of Inquiry (NOI) which was published in the Federal Register. It dealt with a number of important subjects.

This NOI covered the following areas: economic impact of spectrum management, accommodation of new technologies, block allocations, separate processes for government versus private sector allocations, sharing between government and private services, private use of government frequencies, international conference preparation, unmet spectrum demands, definitions and standards, usage measurement of allocated bands, and unlicensed device interference. While this is a very broad list, it covers a number of very important areas of concern to Radio Amateurs.

Of special interest are the NTIA's thoughts on auctioning off radio spectrum to generate revenue for the federal government. Huh???? Who's kidding who! That's one of the best jokes I've heard in years. Ostensibly, revenues raised by auction would go to reduce the federal deficit. However, we all know that the reduction would be a drop in the bucket compared with the real value of the spectrum that they're proposing to sell. And what about future value? Would this be a one-time auction, or would we be bidding for a yearly lease on the frequencies?

On February 23rd the ARRL filed a rather lengthy reply to the NTIA's NOI petition. They did a very complete job of addressing the concerns of Amateur Radio operators. Stating that the League has been involved in spectrum management for 76 years, they commented: "Just as public policy requires that there be public parks and other open space for the nourishment of the human spirit, so must there be 'open spaces' in the radio spectrum where the public can pursue personal, noncommercial ends. This is the essence of the Amateur Radio Service."¹

There are certain parts of our American culture that the government holds in trust for its citizens. National parks, monuments, and the treasures of the Smithsonian Institution are all kept and preserved for us by the government. Imagine the outcry if the Smithsonian were to auction off the Hope Diamond. It would generate millions — maybe even billions. But at what cost? A number of groups are now fighting the Parks and Forest Services' attempts to auction off mineral and timber rights in our national forests and parks. Sure, this will raise huge sums of money — but at the irrevocable loss of a national treasure.

A similar parallel can be made to selling frequencies — once they're gone, well, it's all over, they're gone!

Over the years, in times of disaster, the Amateur Radio community has provided continuity of communications for government and non-government relief agents and the public, when normal communications links have been disrupted or completely severed. To quote the ARRL once again, "The Amateur Radio Service, through participation by thousands of dedicated volunteers, provides a resource that could never be matched by commercial services... A pure marketplace approach to spectrum management would work to the serious detriment of Radio Amateurs, and thus to the public interest."

What the League doesn't say in its statement, because it's "playing" politics and can't, is that this is a simply ridiculous proposal. Sooner or later our government has to come to grips with the deficit and implement a fair and equitable plan to bring it under control. Auctioning off spectrum is *not* the way to do it. At best it is a stop-gap measure that creates as many problems as it resolves. In the end, we all end up as losers!

Even if there were to be an exclusion for Amateur Radio which said we wouldn't have to bid competitively for "our bands," this would still be an ill-conceived and poorly thought out proposal. However, if we don't assert ourselves and let the NTIA, FCC, and our elected representatives know that we feel this is a stupid proposal, we may have to live with the consequences of our inaction.

We urge you to stay current with this issue. It could result in major changes in Amateur Radio as we know it.

de NX1G

¹ "ARRL comments in NTIA Spectrum Management Inquiry," *The ARRL Letter*, Volume 9, No. 5, March 16, 1990, page 1.

Editor's Notes

Well, the April Fool's joke was on me! As many of you noticed, the article "Trap Dipole for 12 and 17 Meters" listed on the cover of our April 1990 issue was nowhere to be found inside the magazine. I'd like to be able to say I was just checking to see if anyone reads the cover, but I must confess that I simply forgot to include it. For those who have been eagerly awaiting its arrival, the piece (by Gary Nichols, KD9SV) appears on page 22 of this issue. My apologies to Gary and to all who've had to wait an extra month to read about this interesting antenna.

Terry Northup, KA1STC

KENWOOD

...pacesetter in Amateur Radio

220 MHz
TH-315A
Here Now!

This HT Has it All!

TH-215A/315A/415A

Full-featured Hand-held Transceivers

Kenwood brings you the greatest hand-held transceiver ever! More than just "big rig performance," the new TH-215A for 2 m, TH-315A for 220 MHz, and TH-415A for 70 cm pack the most features and the best performance in a handy size. And our full line of accessories will let you go from hamshack to portable to mobile with the greatest of ease!

- Wide receiver frequency range. Receives from 141-163 MHz. Includes the weather channels! Transmit from 144-148 MHz. Modifiable to cover 141-151 MHz (MARS or CAP permit required).
- TH-315A covers 220-225 MHz, TH-415A covers 440-449.995 MHz.
- 5, 2.5, or 1.5 W output, depending on the power source. Supplied battery pack (PB-2) provides 2.5 W output. Optional NiCd packs for extended operation or higher RF output available.
- CTCSS encoder built-in. TSU-4 CTCSS decoder optional.
- 10 memory channels store any offset, in 100-KHz steps.
- Odd split, any frequency TX or RX, in memory channel "0".
- Nine types of scanning! Including new "seek scan" and priority alert. Also memory channel lock-out.
- Intelligent 2-way battery saver circuit extends battery life. Two battery-saver modes to choose, with power saver ratio selection.
- Easy memory recall. Simply press the channel number!
- 12 VDC input terminal for direct mobile or base station supply operation. When 12 volts applied, RF output is 5 W! (Cable supplied!)
- New Twist-Lok Positive-Connect™ locking battery case.
- Priority alert function.
- Monitor switch to defeat squelch. Used to check the frequency when CTCSS encode/decode is used or when squelch is on.



- Large, easy-to-read multi-function LCD display with night light.
- Audible beeper to confirm keypad operation. The beeper has a unique tone for each key. DTMF monitor also included.
- Supplied accessories: Belt hook, rubber flex antenna, PB-2 standard NiCd battery pack (for 2.5 W operation), wall charger, DC cable, dust caps.



Optional Accessories:

- PB-1: 12 V, 800 mAh NiCd pack for 5 W output
- PB-2: 8.4 V, 500 mAh NiCd pack (2.5 W output)
- PB-3: 7.2 V, 800 mAh NiCd pack (1.5 W output)
- PB-4: 7.2 V, 1600 mAh NiCd pack (1.5 W output)
- BT-5 AA cell manganese/alkaline battery case
- BC-7 rapid charger for PB-1, 2, 3, or 4
- BC-8 compact battery charger
- SMC-30 speaker microphone
- SC-12, 13 soft cases
- RA-3, 5 telescoping antennas
- RA-8B StubbyDuk antenna
- TSU-4 CTCSS decode unit
- VB-2530: 2m, 25 W amplifier (1-4 W input)
- LH-4, 5 leather cases
- MB-4 mobile bracket
- BH-5 swivel mount
- PG-2V extra DC cable
- PG-3D cigarette lighter cord with filter



KENWOOD

KENWOOD U.S.A. CORPORATION
2201E Dominguez St. Long Beach, CA 90810
P.O. Box 22745, Long Beach, CA 90801-5745

Comments

Repeater etiquette

Dear HR

In the January 1990 issue, K6BAZ laments the fact that only 1 percent of the 440 repeaters in southern California are open to the licensed public. While I'm not sure that the other 99 percent are truly closed, I think your readers will gain some insight when they ask themselves the following questions.

1. Do you feel you have a right to use any repeater you choose, anytime you choose?

2. Do I have a right to come into your shack and operate your equipment any time I like?

3. Do you financially, or in other ways, support the repeater(s) you use?

4. Do you and your friends talk to the other users, or do you consider the repeater your own private intercom?

5. Do you complain on the air (or otherwise) when the repeater is down or sick?

6. Is tone squelch on a repeater receiver only to deny access, or could it be used for legitimate technical reasons?

I ask you to consider your answers to these questions carefully. Then, try to envision yourself as a repeater owner and how you would want others to use *your* repeater. I think you'll soon understand why some repeaters are closed, some are run with an iron fist, and why some go off the air.

Closed repeaters are a result of a lack of understanding and common sense operating. Please take the time to think about your own behavior, and perhaps your favorite repeater won't be closed.

**Paul M. Alberghini, WA1KAH
Cumberland Center, Maine**

Nice to hear...

Dear HR

I wanted you to know how much I enjoy *Ham Radio*. Each issue seems to get better. It doesn't surprise me that your number of subscribers is growing.

**Richard Steck, W9RS,
Lake Forest, Illinois**

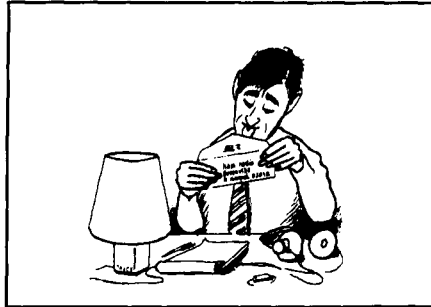

Kudos from a pro

Dear HR

This is my first year's subscription to your fine magazine and I'm impressed not only with the content and articles, but with the quality of the printing.

I've been a pressman for some 45 years and currently run a five-unit web press. My congrats to the press crew for the excellent color and "in register" production.

Ham Radio rates a number one spot in a collage of publications for the Amateur. 73.

**Dick Burnham, KA1ILR,
No. Abington, Massachusetts**

No guarantees with your license

Dear HR

I wish to take exception to remarks made by N6SWA in the February 1990 "Comments" column. These comments pertained to use of the 10-meter Novice phone band by holders of General and above licenses.

I think that Mr. Gleeson is not considering the fact that those of us who hold these licenses worked to earn them, and by doing so gained the ability to operate in larger portions of the spectrum. With our incentive licensing system, it would be neither reasonable nor logical to make portions of the

spectrum available exclusively to those holding the classes of license that require the least amount of study and experience. This would, in essence, penalize people for upgrading.

Mr. Gleeson should also realize that the 28.3 to 28.5 MHz band was not available to Novices until 1987. Those with General class and above licenses have always had the privilege of running higher power in that part of the band. Revoking that privilege most likely would have caused resentment among these operators, and might have been a hindrance towards having Novice enhancement accepted by the ham community.

There's no guarantee of interference-free operation with an Amateur license of any class. Interference happens to all of us equally. It is absolutely ludicrous to say that it is "rude, inconsiderate, and not in the ham spirit" for Generals, Advanced, and Extras to operate legally in the Novice bands. It is, however, illegal to use more power than necessary to communicate with other stations. It is also illegal to splatter across 10 kHz of spectrum. Operators who do these illegal things, however, come in all classes of license, but are in a class of their own — that of LID.

Anyone with the Novice or Technician license who is not happy with the privileges may do one of the following three things: (1) Upgrade your license class. (2) Learn to live with it. (3) Take up a different hobby.

**Stephen M. Murphy, WD8O,
East Detroit, Michigan**

Correction

In a letter by Carlton D. Trotman, W3BRX, which appeared in the "Comments" section of our March issue, we inadvertently called General Curtis LeMay the *late* General LeMay. According to friends, General LeMay is living in California, where he continues to be involved in Amateur Radio. Our sincere apologies to General LeMay. Ed.

BOOMER ANTENNAS



cushcraft

ANTENNAS

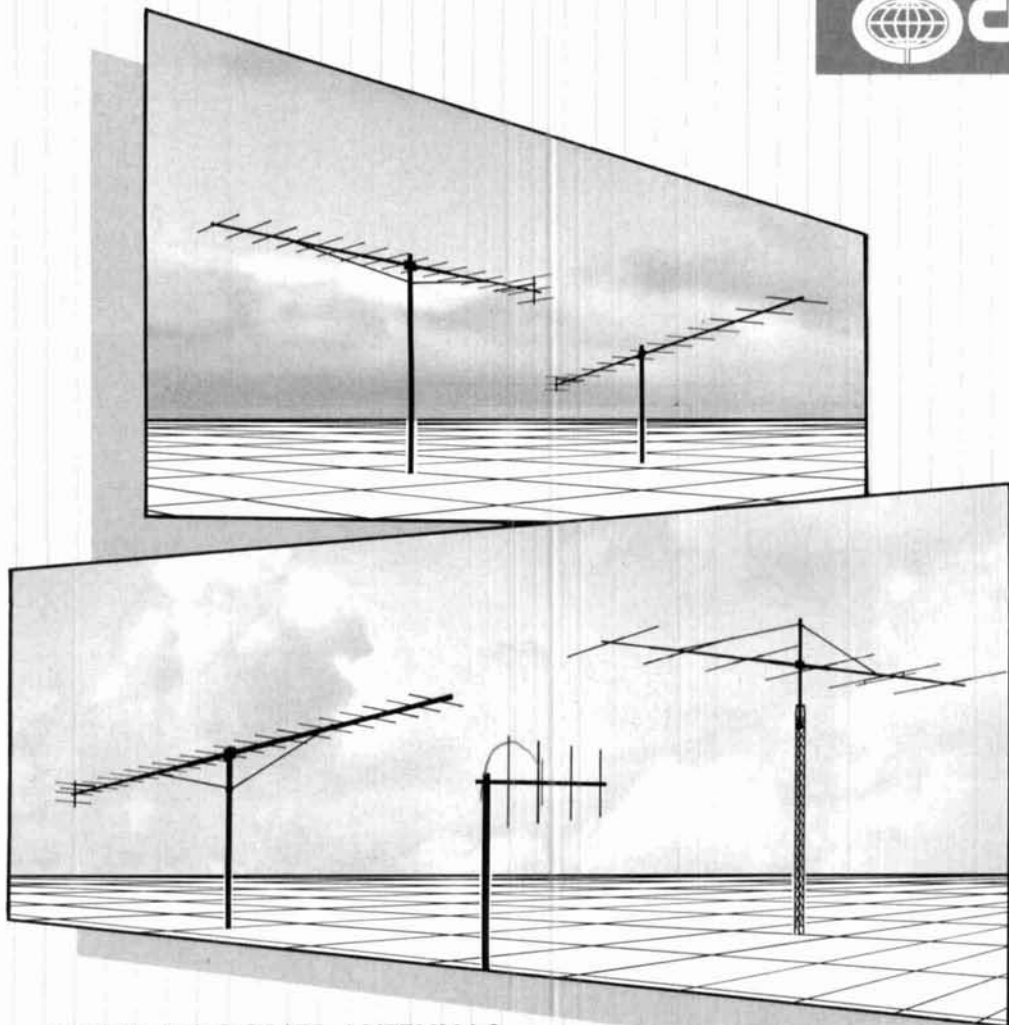

EME - CW - SSB

FM - PACKET

VHF/UHF BOOMER ANTENNAS

Antennas so efficient, powerful and successful that they defy comparison. They have established new VHF/UHF distance records. Boomers' computer based design has become the standard of comparison.

All Cushcraft Boomers are built with stainless steel hardware, ultraviolet stabilized element insulators, coaxial balun and heavy wall boom material with stainless steel locking pins. They are consistent winners in every antenna gain measuring contest and they are the choice of VHF and UHF antennas for hams around the world. **Built to perform and built to last. The best your money can buy.**

SIDEBAND CW BOOMERS

The antennas VHF/UHF operators choose for EME Meteor scatter and contesting. They all have balanced T-Match feed systems and trigon reflectors for precise patterns and maximum performance.

4218XL	144-145 MHz	18 Element	28' BOOMER
32-19	144-146 MHz	19 Element	22' BOOMER
215WB	144-148 MHz	15 Element	15' BOOMER
220B	220-223 MHz	17 Element	19' BOOMER
424B	424-435 MHz	24 Element	17' BOOMER

6 METER BOOMER

Our 617-6B has more gain than any antenna in its class! Serious operators appreciate the design durability of this long boom 6 meter antenna. The excellent gain and front to back ratio are combined with a new clean pattern to focus your signal where you want it. The 617-6B is designed to survive the toughest conditions.

617-6B 50-51 MHz 6 Element 34' BOOMER

FM BOOMERS

Our FM Boomers feature the latest wideband technology to give the high performance required for FM and Packet or sideband and CW. There are three high performance models for two meters and two models for the new 220MHz novice phone band. All are designed for quick, easy assembly and horizontal or vertical mounting.

124WB	144-148 MHz	4 Element	4' BOOMER
215WB	144-148 MHz	15 Element	15' BOOMER
230WB	144-148 MHz	2x15 Element	BOOMER
224WB	220-225 MHz	4 Element	3' BOOMER
225WB	220-225 MHz	15 Element	10' BOOMER



48 Perimeter Road, P.O. Box 4680, Manchester, NH 03108 USA
Telephone: 603-627-7877 • Telex: 4949472 • FAX: 603-627-1764
AVAILABLE THROUGH DEALERS WORLDWIDE

MFJ's Deluxe 300 Watt Tuner

... gives you **full** 1.8-30 MHz coverage, a **peak reading** (and average) Cross-Needle meter, built-in **dummy load**, antenna switch and balun ... all covered by a **full one year unconditional guarantee** ... for only \$149.95

MFJ-949D

\$149⁹⁵

Made in U.S.A.

- Peak reading meter
- Built-in dummy load
- Covers 1.8 to 30 MHz
- 1 full year guarantee



You won't find all these useful features in any other 300 watt tuner -- not even at twice the price.

New peak reading meter

The new **peak** and average reading Cross-Needle meter in the MFJ-949D shows you SWR, forward and reflected power -- all in a single glance.

Without a **peak-reading** wattmeter you just won't be able to tell if your rig is putting out all the peak SSB power it's designed for. Don't be without one if you want top performance.

Built-in dummy load

A built-in 300 watt 50 ohm dummy load makes tuning up your rig sooooo easy. How do you tune up your rig without one?

An external dummy load will cost you about \$30 more -- plus it takes up valuable space at your operating position and requires another cable.

Full 1.8 to 30 MHz coverage

The MFJ-949D gives you **full** 1.8-30 MHz coverage.

Make sure the tuner you're considering covers **all** the HF bands.

Don't get a tuner that keeps you from operating all the frequencies you've worked for -- now or in the future.

Plus more . . .

You get a versatile 6-position antenna switch and a 4:1 balun for balanced lines.

You can run up to 300 watts PEP and tune out SWR on coax, balanced lines or random wires.

Unconditional Guarantee

You get a **full one year unconditional guarantee**. That means we will repair or replace your MFJ tuner (at our option) **no matter what** for a full year.

Others give you a 90 day **limited** warranty. What do you do **after** 90 days? Or **before** 90 days when they say, "Sorry, it's your fault"?

What's really important? precise control for minimum SWR

What's really important is your tuner's ability to get your SWR down to a minimum -- and the MFJ-949D gives you more precise control over SWR than any tuner that uses two tapped inductors.

Why? Because the two **continuously** variable capacitors in the MFJ-949D give you **infinitely** more positions than the **limited** number on two switched coils.

This gives you the precise control you need to get minimum SWR and maximum

power into your antenna.

After all, isn't that why you need a tuner?

High efficiency and a compact size: performance is most important

The MFJ-949D uses a **single** airwound coil. Using only one inductor takes up a minimum of space and there's no mutual coupling problems.

The excellent form factor of the short fat coil gives you highest Q. Plus you get plenty of inductance that gives you a much wider matching range than other designs.

This results in a highly efficient tuner that puts maximum power into your antenna **and** a compact 10 x 3 x 7 inch size that complements your rig and fits right into your station.

Competing tuners using **two** tapped coils require a large cabinet -- not just to house the coils but also to help reduce detrimental coupling between the inductors. The result? A tuner that's **bigger** than your radio.

Your very best value

The MFJ-949D gives you your very best value, first-rate performance, proven reliability and the best guarantee in ham radio . . . all from the **most trusted** name in antenna tuners. Don't settle for less. Get yours today!

MFJ's 1500 Watt Tuner

MFJ-962C
\$229⁹⁵



For a few extra dollars the MFJ-962C lets you use your barefoot rig now and have the capacity to add a 1.5 KW PEP linear amplifier later. It covers 1.8 to 30 MHz.

You get MFJ's **new peak** and average reading Cross-Needle SWR/Wattmeter.

You also get a 6-position antenna switch and a teflon wound balun with ceramic feed-thru insulators for balanced lines. Measures just 10³/₄ x 4¹/₂ x 14 7/8 inches.

How can an American manufacturer like MFJ give you more tuner for your money than clearing houses for foreign competition?

MFJ tuners are made in America. **Here's** how MFJ gives you more tuner for your money than any clearing house for foreign competition.

MFJ builds every tuner cabinet from scratch using the latest high-speed

computer controlled punch presses.

MFJ manufactures, assembles and tests every PC board that goes into MFJ tuners.

Instruction manuals and other materials are printed in MFJ's print shop.

MFJ tuners go directly from our factory to your dealer. We're not just an importer adding profits, tariffs and import charges.

With MFJ's efficient in-house manufacturing and straight to your dealer distribution you get the most tuner for your money.

WHY CHOOSE AN MFJ TUNER?

Hard-earned Reputation: There's just no shortcut. **MFJ is a name you can trust** -- more hams trust MFJ tuners throughout the world than all other tuners combined.

Proven Reliability: MFJ has made more tuners for more years than anyone else -- with MFJ tuners you get a highly-developed product with proven reliability.

First-rate Performance: MFJ tuners have earned their reputation for being able to match just about anything -- anywhere.

One full year unconditional guarantee: That means we will repair or replace your tuner (at our option) **no matter what** for a full year.

Continuing Service: MFJ Customer Service Technicians are available to help you keep your MFJ tuner performing flawlessly -- no matter how long you have it -- just call 601-323-5869.

Your very best value: MFJ tuners give you the most for your money. Not only do you get a **proven** tuner at the lowest cost -- you also get a one year **unconditional** guarantee and **continuing** service. That's how MFJ became the world's leading tuner manufacturer -- by giving you your very best value.

Choose your MFJ tuner with confidence! You're getting proven performance and reliability from the most trusted name in antenna tuners. Don't settle for less.

Call or write for a **free** full-line MFJ catalog with all 10 of our tuners and tons of ham radio accessories!

Copyright © 1989 by MFJ Enterprises, Inc.

MFJ

MFJ ENTERPRISES, INC.
P.O. Box 494, Mississippi State, MS 39762
601-323-5869, TELEX: 534590 MFJSTKY
Nearest Dealer/Orders: 800-647-1800
Include shipping and handling

MFJ ... making quality affordable

Ham Radio Bulletin Board

Setting The Record Straight

I would like to call your attention to an error in NU1N's article "Understanding Over-The-Horizon Radar" in the February issue of HR. The facility in Caribou, Maine which I had the privilege of commanding prior to my retirement, is not an OTH radar but a LORAN C transmitting station operated by the U.S. Coast Guard. This mistake, apparently started by Mr. Helms (Reference 9 of the article), has been perpetuated ever since. This may be due to the unique antenna in use at Caribou.

The normal LORAN C antenna is a 625-foot top-loaded monopole. This is a high Q antenna, and when used with the older vacuum tube transmitters requires frequent and tedious "pulse building" to maintain the proper pulse shape as the tubes age. Often, expensive PA tubes have to be replaced because of their inability to maintain this critical pulse shape. In the mid 1960s, the Coast Guard Electronics Engineering Center in Wildwood, New Jersey set out to design a better antenna. Results of modeling suggested that some type of conical antenna would provide the desired results. Because of lack of space at Wildwood for a full size antenna, land was purchased and an experimental station was constructed at Caribou. Development there resulted in an antenna which is an inverted wire pyramid suspended from four 700-foot towers arranged in a square 1400 feet on a side. This antenna has about double the bandwidth of the monopole and made "pulse building" a relatively infrequent and non-critical affair. When viewed from ground level, with the tower guy wires running in all directions, this antenna is hard to visualize and could be mistaken for some sort of HF directional array. Due to the expense of erecting four towers, the enormous amount of real estate involved, and the advent of new solid-state transmitters that maintain pulse shape automatically under micropro-

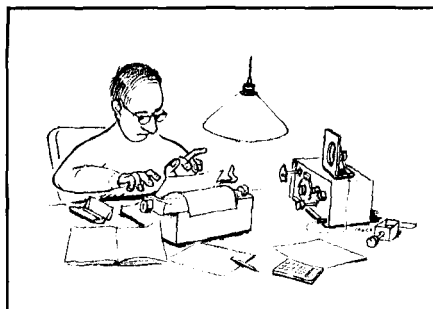

cessor control, this will probably be the last of these antennas constructed for LORAN C use.

The Caribou station has since been absorbed into the LORAN network and presently transmits on rate 9960 as a secondary station in the Northeast U.S. chain and on 5930 as a master station for the Canadian East Coast chain.

There is an OTH system in Maine operated by General Electric for the Air Force. The transmitter site is at Moscow, receivers are at Colombia Falls, and the control center is at the Air National Guard facility in Bangor.

**Roger D. Johnson,
AD1G, CWO4, USCG (retired)**

Attention antennex Subscribers

I would like to let *Ham Radio* readers know that *antenneX*, the magazine for antenna experimenters, is no longer being published.

Unfortunately, the phone has been disconnected and the offices closed. I'm at a loss about where to direct people with questions regarding subscriptions or other items they may have ordered.

I am disappointed at this turn of events, as *antenneX* had filled a void in the market. For those of you who enjoyed the articles I wrote while I was editor of the magazine, please know that I intend to continue writing pieces on whatever comes to mind. Look for me in the pages of other Amateur Radio publications.

**Richard Morrow, K5CNF,
Former Editor, *antenneX***

HF Packet

HF digital communications are becoming very popular because of the availability of computers and economical all-mode modems like the PK232. The most positive thing about this is the increased use of low error rate modes like AMTOR. But there should be more concern about packet operation. As an experiment with few users, HF packet has been technically interesting and fun. As it proliferates, we need to question its fundamental design.

VHF/UHF packet operates under the assumption that almost everyone hears each other. This means that, with moderate traffic, little time is lost through retransmission to correct errors. Communication is at a high bit rate so the message bursts are short. This reduces the probability of message collision. Spectrum space at VHF/UHF is ample so there is room for several users, especially since their numbers are horizon limited.

At HF, all the above assumptions are invalid. There is no horizon limit. Ionospheric propagation favors some and ignores others. A marginal link can chew up enormous time. A trivial 3-minute QSO for RTTY or AMTOR becomes a 30-minute ordeal. The 300-baud rate is at least four times slower than VHF/UHF. Even at these rates, packet is still error prone compared with RTTY and AMTOR. This creates multiple message repeats that frustrate the link user and adjacent RTTY/AMTOR links. Yes, "gentlemen's agreement" sub-band infringement is very common on weekends.

Beyond the fun experiment, the motivation for HF packet may have been to create a nationwide emergency communications net connected to local VHF/UHF nets. There are better solutions with efficient long haul links that don't broadcast endlessly. Communications should match the medium. The rules for line-of-sight communications are not appropriate for ionospheric skip.

**Hunter Harris, W1SI,
Ham Radio Editorial Review Board**

HAM-COM '90



June 8-10, 1990
Arlington Convention Center
D/FW Metroplex, Texas
"The Big One In Texas"
Over 8,000 expected!

Programs & Forums

Friday, June 8th:

- 1 PM Gordon West's Novice/Tech License Course, WB6NOA
- 6 PM Learn To Teach Code
- 8 PM Slow/Fast Code Techniques

Saturday, June 9th:

- 9 AM 10-10 International Forum Contest Forum, K1AR Scanning & SWL, N5AUX Packet for Beginners Training to Teach Youth Hands On Packet
- 10 AM Packet, Using DX Clusters VHF/UHF Technology Forum Traffic Handling, N5TC AMSAT - Microsats, N8IWJ VLF Radio Worldwide, N5SU
- 12 Noon Packet Performance Monitor
- 12:30 PM Packet, Designing Networks
- 1 PM ARRL Forum MARS Forum Soc. for Preservation of AM Microwave UHF Forum YL's In Amateur Radio
- 3 PM Packet Shuttle EXperiment Kids Only - Getting Started DX "Bonanza" Programs Wayne Green's Forum Amateur TV Forum, N5PIU
- 3:30 PM TAPR Packet Radio, TexNet

Sunday, June 10th:

- 9AM 10-10 International Forum Contest Forum Gordon West's 2Mtr DX Protecting from Surges Packet for Beginners
- 10:00 AM Packet, HARPS NET/ROM
- 11 AM Young People in Ham Radio Rohn 25 Rotating Tower Hazardous Materials Forum AMSAT, Getting Started Satellite Uplinks/Downlinks
- 11:30 AM Packet for RACES & ARES
- 2 PM Skywarn School

ARRL Affiliation

Ham-Com '90 is a fully recognized ARRL approved Hamfest. There will be a giant ARRL booth, an ARRL Forum and ARRL VIP's on hand.



Giant DX Lunch - Bonanza DX Program

New for Ham-Com '90 will be a giant 450 seat DX Luncheon featuring Bob Winn, W5KNE, Editor of "QRZ-DX". Tickets are \$10.00 each. After lunch, we will have the DX Program with DX personalities flown in from the four corners: Dave Schmocker, KJ9I, on Mellish Reef & Willis Island, Bob Winn, W5KNE, on Sable Island, Chuck Coleman, K5LZO, on Desecheo Island, and Don Greenbaum, WB2DND, on United Arab Emirates.

American Is Official Ham-Com Airline

American Airlines is the official airline for Ham-Com '90 affording you 40% off the full day coach fare or lowest possible rate for your travel circumstances. Call 800-433-1790, 7 AM - 12 Midnight, Central Time, 7 days a week, and refer to Star File Number S02604H.

Ham-Com '90 Hospitality

Ham-Com '90 Hospitality will be open at Noon on Friday at the "Waters Edge" Lobby bar of the Sheraton CenterPark Hotel, adjacent to the Convention Center. At 7 PM Ham-Com will provide a giant round of roast beef and we'll draw the Preregistration Prize at 7:30. The "Lower Side Band", including our own K5VOU, will provide the genuine Texas country music. Be sure to come early enough to join in this great party.

Get Your Ticket Upgrade!

There will be testing for all levels from Novice to Extra Class. On Saturday there are sessions at 9 AM, 1 PM and 6 PM. The Sunday session begins at 9 AM. Tests are on a first-come basis. Bring your original license, a copy of your license which we may keep, and photo ID. The testing fee is \$4.95.

Giant Indoor Flea Market

The giant indoor, air-conditioned flea market boasts 444 6-ft. tables with electricity available if desired. Tables are \$15 each for the first three, \$25.00 each for all over three. You will find everything you ever wanted from ham gear to computers, and much more. Don't wait to get your table, it's always a sellout!

Commercial Exhibits

You will find 100 commercial exhibit booths at Ham-Com. A virtual who's who of amateur radio manufacturers. In addition you will find many national and regional dealers stocked and ready to sell you whatever you want. Bring money!

Ham-Com '90 Convention Banquet

Plan to attend the Ham-Com '90 Convention banquet at 7 PM on Saturday, June 9th. It's great food, a good time and a very interesting AMSAT program by Rich Ensign, N8IWJ, AMSAT Science Education Advisor. In addition, we will present the North Texas Section's Amateur Of The Year Award. Tickets are \$16.00 each.

QCWA Continental Breakfast

Sunday morning, June 10th, at 7:30 AM, the Dallas and Fort Worth Chapters of the QCWA will host the QCWA Breakfast and Hospitality gather-

ing at the Sheraton Hotel. Breakfast tickets are \$3.50 each, but you need not purchase breakfast to attend the gathering.

Convention Schedule

Friday, June 8th, 1990:

- 12 Noon Exhibit Set-Up, Ham-Com '90 Hospitality Open at Sheraton
- 2 PM Ham-Com Registration Open Flea Market Open for Set-Up
- 7 PM Hospitality & Entertainment at Sheraton.
- 9 PM Set-Ups Closed

Saturday, June 9th, 1990:

- 6 AM Ham-Com Registration Open Flea Market Open for Set-Up
- 7 AM Flea Market Open
- 9 AM Commercial Exhibits Open
- 11 AM DX Lunch & Forum
- 2 PM Xmtr Hunt
- 5 PM Exhibits & Flea Market Closed
- 7 PM Banquet at Sheraton

Sunday, June 10th, 1990:

- 7 AM Flea Mkt./Registration Open
- 7:30 AM QCWA Breakfast
- 9 AM Commercial Exhibits Open
- 2 PM Exhibits & Flea Market Closed Skywarn School

Hotel Accommodations

Ham-Com offers a wide range of hotels for you to choose from, including the Sheraton Center-Park Hotel, headquarters hotel for Ham-Com. Please make your reservations direct with the hotel of your choice. Be sure to tell them you will be attending Ham-Com '90 so you will get the special Convention room rate.

Radisson Suite	\$79	(817) 640-0440
Sheraton Hotel	\$72	(817) 261-8200
Best Western	\$55	(817) 461-1122
Rodeway Inn	\$54	(817) 640-7080
Marriott Courtyard	\$52	(817) 277-2774

For Further Information Call: (214) 521-9430

Ham-Com '90
June 8-10, 1990
Pre-Registration Deadline: June 1st.

Name _____

Address _____

City _____ State _____ Zip _____

Phone Number _____

_____ Single Preregistration, \$7.00 ea

_____ Family Preregistration, \$10.00 ea

_____ Flea Market Table, first 3, \$15.00 ea

_____ Additional Tables, over 3, \$25.00 ea

_____ Flea Mkt Electrical Outlet, \$32.00 ea

_____ DX Lunch & Program, \$10.00 ea

_____ Convention Banquet, \$16.00 ea

_____ QCWA Breakfast, \$3.50 ea

_____ Tour #1, Shopping, \$12.00 ea

_____ Tour #2, Museum, \$12.00 ea

Total Amount of Order _____

Send To: Ham-Com Inc.
P.O. Box 861829
Plano, Texas 75086-1829

THE GÖTTINGEN HEART ANTENNA

Uniquely shaped antenna gives good performance

By Walter J. Schulz, K3OQF, 15225 Wayside Road, Philadelphia, Pennsylvania 19116

One of the most interesting places in Germany is the valley where the Leine river wanders between the Harz mountains and the university city of Göttingen. To academicians, Göttingen is renowned as the city where 30 Nobel Prize winners have resided. It's also famous for the Max Planck Institutes located in the city and the countryside nearby. These 52 institutes are descendants of the Kaiser Wilhelm Institute organization which was devoted to the study of interesting scientific problems.

Gerd E.A. Meier, DJ7FY, and Rudolf J. Dvorak, DK4AP, of the Max Planck-Institut for Flow Research in Göttingen recently developed a new antenna. It is known throughout Germany as the Göttingen Heart (Herz) antenna, named for the city where it was developed and its heart shape.*

The antenna is unique. It is broadbanded over a more than 10:1 frequency range, and at the same time gives directive gain that increases with frequency. The antenna handles large amounts of RF power without corona discharge.

The Heart antenna doesn't need a large area to be broadbanded, as does the rhombic antenna, nor does it need the active dipoles that form a radiating cell of a log periodic array. The whole antenna is active on all excited frequencies and is small enough to be rotated on a single mast (see **Photo A**).

Dr. Meier was intrigued with professor Heinrich Hertz's original spark gap apparatus. Meier discovered through experimentation that two similar plates, when excited with RF energy, displayed not only directivity but some broadband behavior as well (see **Figure 1**). This led to the birth of the Heart antenna. Additional experiments by Dr. Meier and Mr. Dvorak showed that directivity was enhanced by

FIGURE 1

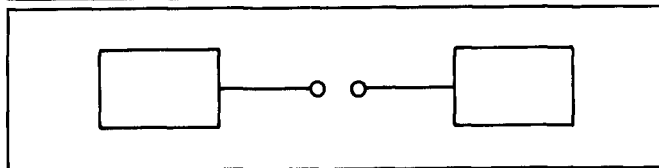

Spark gap with capacitance plates.

FIGURE 2

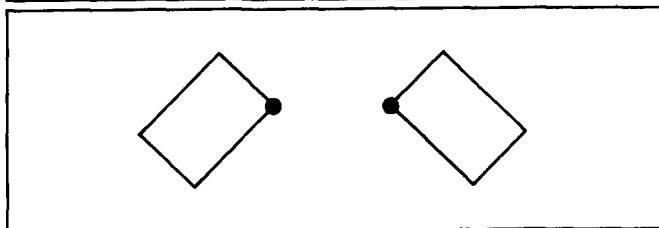

V configuration.

FIGURE 3

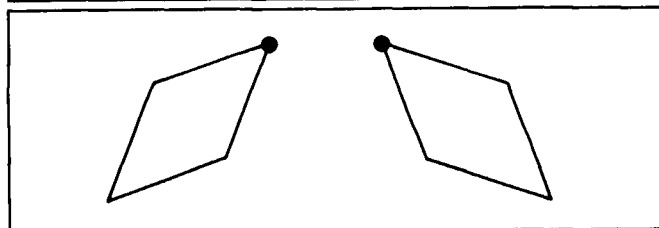

Rhombus plates in V configuration.

* The antenna is protected by EPO Patent number 0124559. An meldetag 15.11.83. Priority 15 Nov 82. Granted 4.03.87 Patent Blatt 87/10.

optimizing the V configuration of the plates, as shown in Figure 2. They also found that by changing from rectangular-shaped plates to rhombus-shaped ones (Figure 3), the antenna became broadband as the input impedance flattened out.

It was at this point that Mr. Dvorak found it necessary to "cut and try" many profiles. He noticed that as the curves of the antenna shape became smoother, there were less variations in the feedpoint impedance, and the VSWR ratio remained below 2:1. Moreover, as the frequency increased, so did the forward gain. At the same time, the antenna had approximately 16-dB loss off the back. The antenna's SWR was flat over the 10:1 frequency range and directive.

PHOTO A

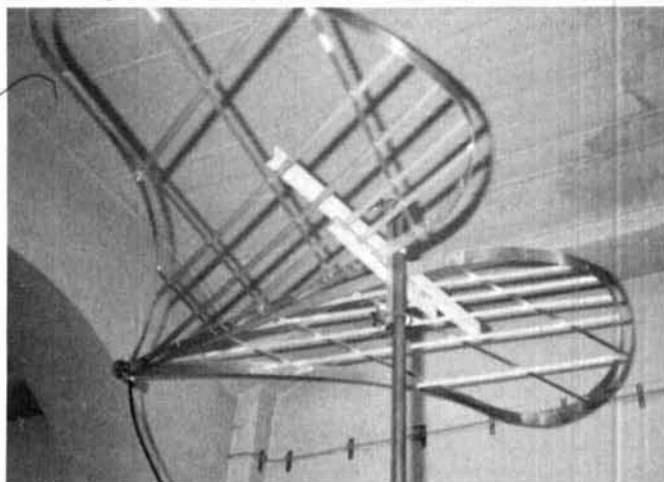

Active on all excited frequencies, the antenna is small enough to be rotated on a single mast.

The antenna wing profile

Figures 4A and B give the physical dimensions of the Heart antenna. Because this antenna is symmetrical, only one profile, or Heart wing, is shown in Figure 4B — a grid pattern.

FIGURE 4A

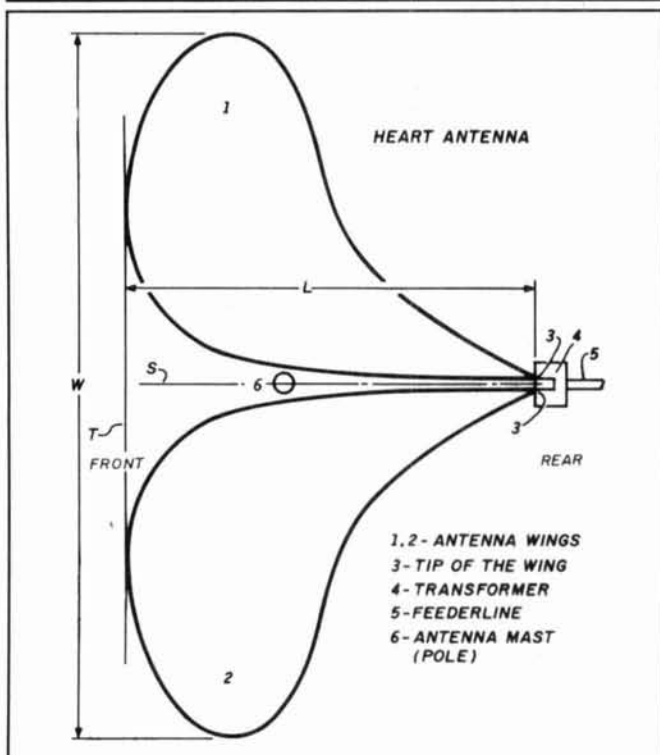

Symmetrical Heart antenna (showing both wing profiles).

FIGURE 4B

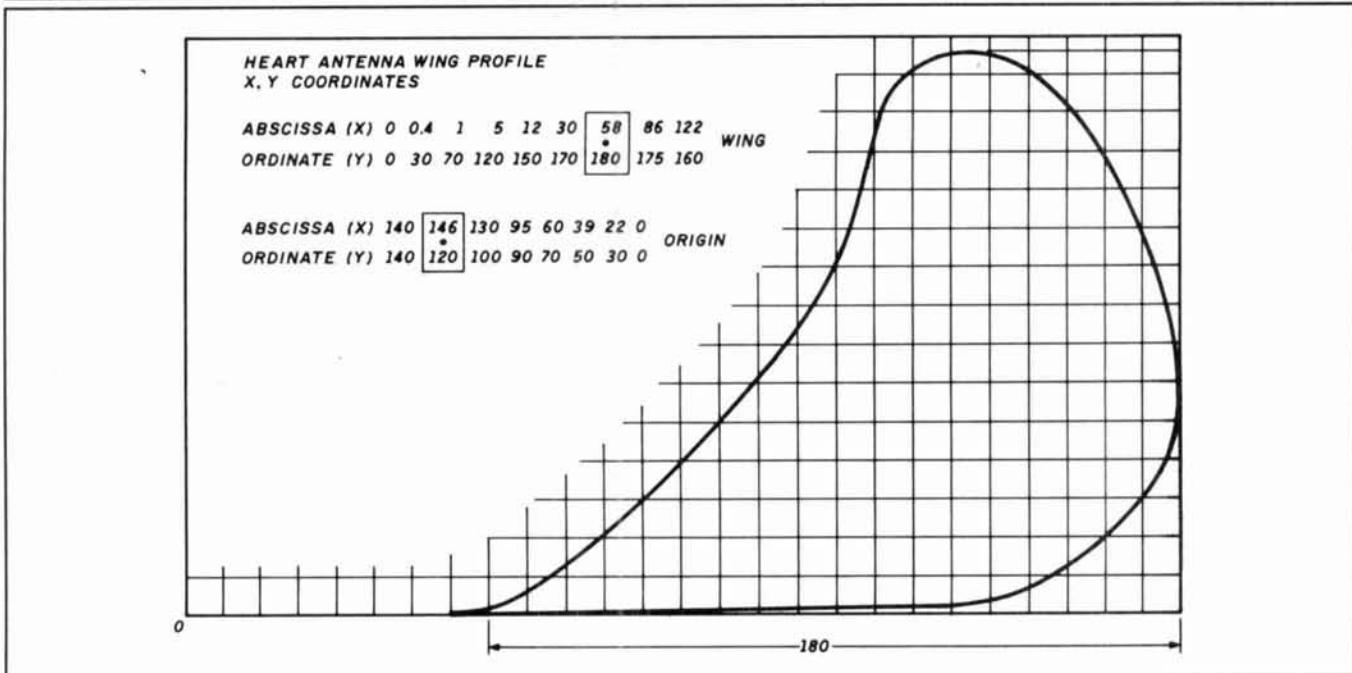

Heart antenna profile with X, Y coordinates.

INTRODUCING AEA'S NEW ATV SYSTEM

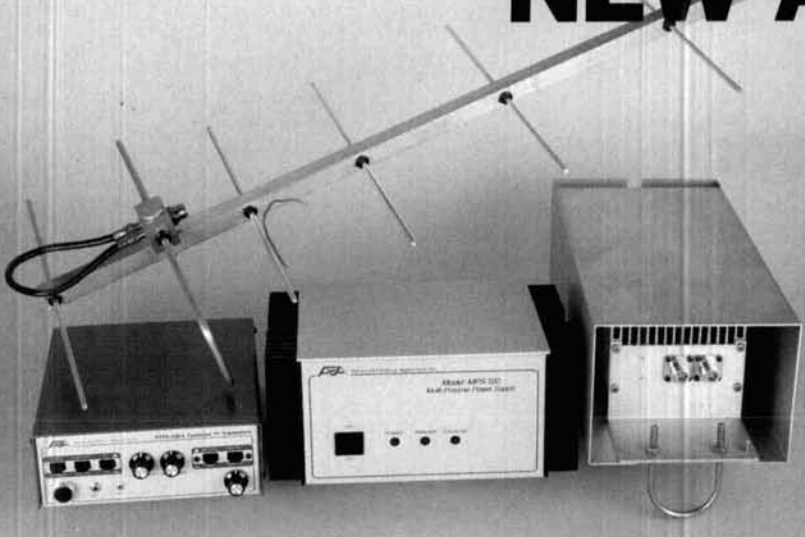

Add a new dimension to your amateur radio communications with AEA's Amateur Television (ATV) system. If you hold at least a technician-class license, you can transmit and receive live or taped audio and video Fast-Scan TV (FSTV) information that rivals broadcast quality. Now you can share more than conversation over the air with this new mode of "personal communications."

It's Easy and Inexpensive. If you have a video camera or camcorder and a standard TV set, you may already own the most expensive components of an ATV system. AEA's ATV system includes a transceiver and antenna. Simply connect the camera, TV and the antenna to the transceiver, and you're on the air LIVE with one watt P.E.P.! Your TV set will monitor your transmitted and received pictures. If you want to broadcast with more power, AEA also offers a 50 watt mast-mounted linear amplifier with power supply.

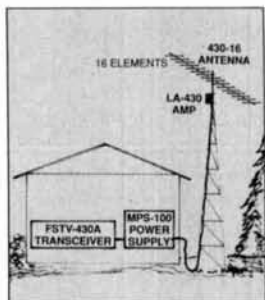

The FSTV-430A Transceiver features a low-noise UHF GaAsFET preamp with a typical noise figure of less than 1.5dB and a crystal-controlled or variable tuning down converter. Output is available on channel 3 or 4 for signal reception AND monitoring transmissions. Two frequencies can be selected from the front panel for transmission (one crystal is included). The AEA design is also optimized for superior video and audio quality without sync buzz even with weak signals. The FSTV-430A is the only transceiver you need to work ATV and it also allows you to use the same TV set to monitor your transmitted and received pictures.

The LA-430/50 Amplifier with Power Supply gives a boost to your ATV signal. It includes a 50W P.E.P. mast-mounted Linear Amplifier (patent pending) covering 420 to 450 MHz and a GaAsFET preamp which utilize the antenna feedline for DC power. The mast-mount eliminates the line loss between the amplifier/preamplifier and the antenna to improve both transmission and reception, and is the equivalent of a 100W amplifier in the shack with a 3dB line loss. The amplifier is housed in a weather-resistant anodized aluminum case. The MPS-100 power supply also provides a 13.6 volt output for the FSTV-430A.

The 430-16 Antenna is a high-performance, computer-optimized yagi specifically designed for ATV operation. It features broadband frequency coverage from 420 to 440 MHz, 14.3dB gain, O-ring sealed connectors, 28 degree E plane and 32 degree H plane beam widths and 16 elements on a 10-foot boom.

See AEA's FSTV System at your local authorized AEA dealer. Put yourself in the ATV picture and join the fun!



What is the advantage of Vestigial Sideband (VSB)?

AEA's FSTV-430A Vestigial Sideband operation drastically reduces adjacent-channel interference. VSB requires much less bandwidth than existing double-sideband designs; it's the standard method of modulation required by the FCC for all U.S. broadcast TV stations. Similar in principle to SSB, VSB puts all of the audio energy and most of the video in ONE sideband instead of two. Using about half the spectrum space of competitive units, the FSTV-430A is the ONLY ATV unit that conserves spectrum space by using VSB. Even with AEA's LA-430/50 amplifier, one sideband is reduced more than 30dB. VSB presents an obvious advantage to the bandwidth-conscious ATV operator.

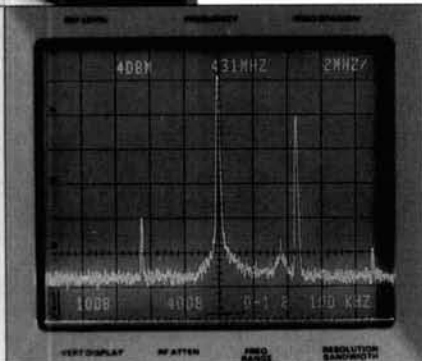

Advanced Electronic Applications, Inc.

2006-196th St. SW/P.O. Box 2160 Lynnwood, WA 98036 206-775-7373

Prices and specifications subject to change without notice or obligation.
Dealer inquiries invited. Copyright 1989.

**AEA Brings You
A Better Experience.**

You'll find that it's simplest to lay out a profile using graph paper. The grids on the paper make it easy to draw the curve shown in **Figure 4B**. Once you've made your sketch, you can transfer the profile to your building material.

Always cut the profile to the lowest frequency of operation. The length (L) shown in **Figure 4B** is one-third of the longest

desired operating wavelength, so you'll find the following relationship useful:

$$L = 1/3 \text{ maximum } \lambda$$

Construction materials

You can use common materials for antenna construction; they aren't critical electrically. This antenna has been built from aluminum foil, potato chip bag foil, chicken wire, wire mesh, foil-backed insulating foam sheathing, and aluminum angle stock (see **Photos B** and **C**). It is important to note that different material thicknesses and apertures will place certain restrictions on antenna performance, depending on the

PHOTO B



Common materials can be used to build the antenna. Here you see the Heart antenna made of aluminum sheet stock.

PHOTO C

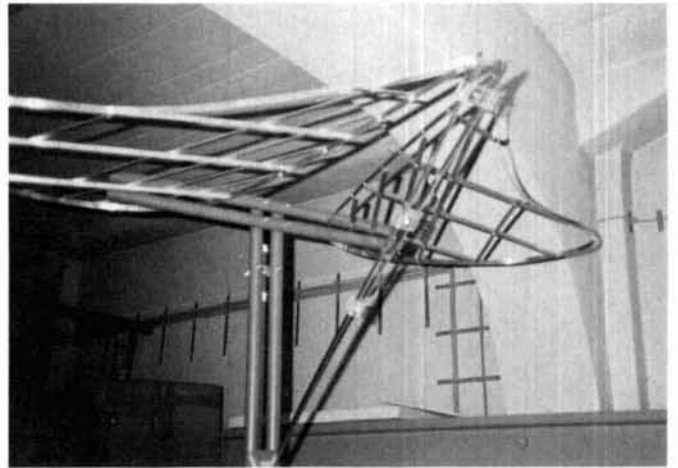

Another version of the Heart antenna constructed from aluminum strips.

FIGURE 5

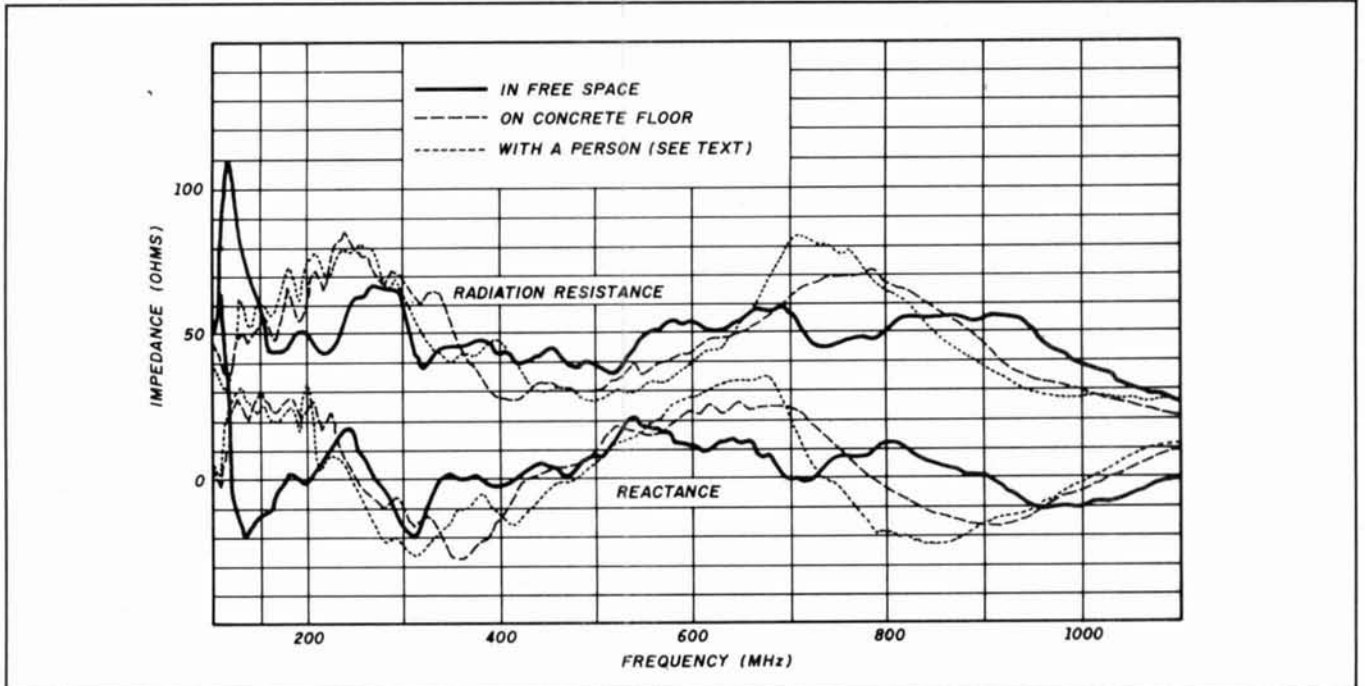

Impedance versus frequency of a symmetrical Heart antenna. (Antenna is made from sheet aluminum 1.5 mm thick.)

INTRODUCING OUR NEW COMPUTER-CONTROLLED REP-200 REPEATER

If you always thought a computer-controlled repeater had to be expensive, LOOK AGAIN! You could easily spend this much just for a controller.

As always, Hamtronics strives to give superb performance at modest cost! In this case, a premium repeater with versatile computer control, autopatch, and many dtmf control features at less than many charge for a bare-bones repeater!

We don't skimp on rf modules, either! Check the features on R144 Receiver, for instance. GaAs FET front-end, helical resonators, sharp crystal filters, hysteresis squelch.

We completely re-thought the whole idea of what a repeater should be, to give the best features at the lowest cost.

ONLY \$1295!

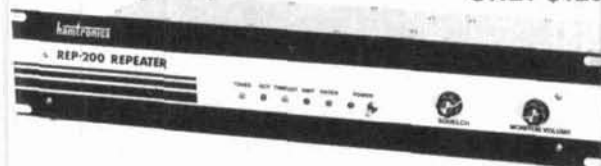

- Available for the 10M, 6M, 2M, 220MHz, 440MHz, 902MHz ham bands. FCC type accepted models also available for vhf and uhf commercial bands.
- Rugged exciter and PA, designed for continuous duty.
- Power output 15-18W (25W option) on 2M or hi-band; 15W on 220MHz; 10W on uhf or 902MHz.
- Accessory add-on PA's available with power levels up to 100W.
- Five courtesy beep types, including a pleasant multi-tone sequence.
- AUTOPATCH: either open or closed access, toll-call restrict, auto-disconnect.
- Reverse Autopatch, two types; auto-answer or ring tone on the air.
- DTMF CONTROL: over 45 functions can be controlled by touch-tone. Separate 4-digit control code for each function, plus extra 4-digit owner password.
- Owner can inhibit autopatch or repeater, enable either open- or closed-access for repeater or autopatch, and enable toll calls, reverse patch, kerchunk filter, site alarm, aux rcvr, and other options, including two auxiliary external circuits.
- The cwid message, dtmf command codes, and owner-specified default parameters for cor and cwid timers and tones are burned into the eeprom at the factory.
- Cw speed and tone, courtesy beep and tail timers, and courtesy beep type can all be changed at any time by owner-password-protected dtmf commands.
- Many built-in diagnostic & testing functions using microprocessor.
- Color coded led's indicate status of all major functions.
- Welded partitions for exciter, pa, receiver, and controller. PEM nuts for covers.
- 3-1/2 inch aluminum rack panel, finished in eggshell white and black.
- Auxiliary receiver input for independent control or cross linking repeaters.

There are many other features, too numerous to mention. Request catalog for full details.

HIGH PERFORMANCE XMTRS & RCVRs FOR REPEATERS, AF & DIGITAL LINKS, TELEMETRY, ETC.

FM EXCITERS: kits \$99, w/t \$169. 2W continuous duty. TCXO & xtal oven options available. FCC type accepted for com'l uhf & hi bands.

- TA51 for 10M, 6M, 2M, 150-174, 220MHz.
- TA451 for uhf.
- TA901 for 902-928MHz. 0.5W out (w/t only, \$169).
- VHF & UHF AMPLIFIERS. For fm, ssb, atv. Output from 10W to 100W. Several models, kits starting at \$79.

FM RECEIVERS: kits \$139, w/t \$189.

- R144/R220 FM RECEIVERS for 2M, 150-174, or 220MHz. GaAs FET front end, 0.15uV sensitivity! Both crystal & ceramic if filters plus helical resonator front end for exceptional selectivity: >100dB at ±12kHz (best available anywhere!) Flutter-proof hysteresis squelch; afc tracks drift.
- R451 UHF FM RCVR, similar to above
- R901 902-928MHz FM RCVR. Triple-conversion, GaAs FET front end.
- R76 ECONOMY FM RCVR for 10M, 6M, 2M, 220MHz, w/o helical res. or afc. Kits \$129.
- Weather satellite & AM aircraft rcvrs also available.

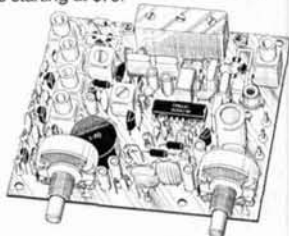
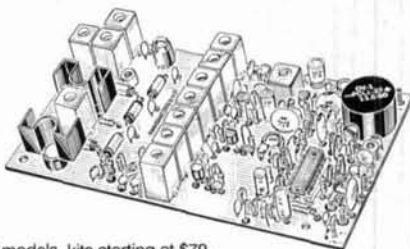

If you prefer a plain-vanilla or kit repeater, you couldn't find a better value than our original REP-100 REPEATER

Same fine rf modules as REP-200 but with COR-4 Controller. Can add autopatch, dtmf decoder, CTCSS, either now or later. Kit only \$675, w/t \$975.

ACCESSORIES

COR-3 REPEATER CONTROLLER kit. Features adjustable tail & time-out timers, solid-state relay, courtesy beep, and local speaker amplifier\$49

CWID kit. Diode programmed any time in the field, adjustable tone, speed, and timer, to go with COR-3\$59

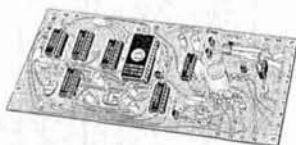

NEW COR-4 kit. Complete COR and CWID all on one board for easy construction. CMOS logic for low power consumption. Many new features. EPROM programmed; specify call ..\$99



NEW TD-3 SUBAUDIBLE TONE DECODER/ENCODER kit. Adjustable for any tone. Designed especially for repeaters, with remote control activate/deactivate provisions\$24

TD-2 TOUCH-TONE DECODER/CONTROLLER kit. Full 16 digits, with toll-call restrictor, programmable. Can turn 5 functions on/off. Great for selective calling, tool\$79

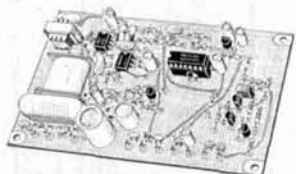

AP-3 AUTOPATCH kit. Use with above for repeater autopatch. Reverse patch & phone line remote control are std.\$79

AP-2 SIMPLE AUTOPATCH Timing Board kit. Use with above for simplex operation using a transceiver\$39

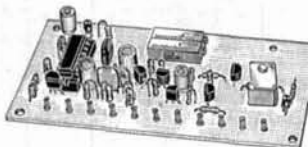

MO-202 FSK DATA MODULATOR kit. Run up to 1200 baud digital signals through any fm transmitter with full handshakes. Radio link computers, telemetry gear, etc.\$39

DE-202 FSK DEMODULATOR kit. For receive end of link.\$39

9600 BAUD DIGITAL RF LINKS. Low-cost packet networking system, consisting of new MO-96 Modem and special versions of our 220 or 450 mhz FM Transmitters and Receivers. Interface directly with most TNC's. Fast, diode-switched PA's output 15 or 50W. Call for more info on the right system for your application!

GaAs FET PREAMPS

at a fraction of the cost of comparable units!

LNG-(*)

ONLY \$59
wired/tested



FEATURES:

- Very low noise: 0.7dB vhf, 0.8dB uhf
 - High gain: 13-20dB, depends on freq.
 - Wide dynamic range - resist overload
 - Stable: low-feedback dual-gate FET
- *Specify tuning range: 26-30, 46-56, 137-150, 150-172, 210-230, 400-470, or 800-960 MHz.

LNW-(*) MINIATURE GaAs FET PREAMP

ONLY \$24/klt, \$39 wired/tested

- GaAs FET Preamp similar to LNG, except designed for low cost & small size. Only 5/8"W x 1-5/8"L x 3/4"H. Easily mounts in many radios.
- *Specify tuning range: 26-35, 35-55, 55-90, 90-120, 120-150, 150-200, 200-270, or 400-500 MHz.

LNS-(*) IN-LINE PREAMP

ONLY \$79/klt, \$99 wired/tested

- GaAs FET Preamp with features similar to LNG series, except automatically switches out of line during transmit. Use with base or mobile transceivers up to 25W. Tower mounting brackets incl.
- *Specify tuning range: 120-175, 200-240, or 400-500 MHz.

HELICAL RESONATOR PREAMPS

Preamps with 3 or 4 section helical resonators reduce intermod & cross-band interference in critical applications. MODEL HRA-(*) \$49 vhf, \$94 uhf. *Specify tuning range: 142-150, 150-162, 162-174, 213-233, 420-450, 450-470.



RECEIVING CONVERTERS

Low noise converters to receive vhf and uhf bands on a 10M receiver. Choice of kit with case & BNC jacks, kit with pcb only, or w/t unit in a case. Other models available for other in/out ranges & atv. Request catalog for complete listings.

VHF input ranges avail: 136-138, 144-146, 145-147, 146-148, 220-222, 222-224; kit less case \$39, kit w/case \$59, w/t in case \$89.

UHF input ranges avail: 432-434, 435-437; kit less case \$49, kit w/case \$69, w/t in case \$99.

902-928 MHz converts down to 422-448 or 430-450 range. Same price as uhf.

TRANSMITTING CONVERTERS

XV2 for vhf and xv4 for uhf. Models to convert 10M ssb, cw, fm, etc. to 6M, 2M, 220, 432, 435, and for atv. 1W output. Kit only \$79. PA's up to 45W available. Request catalog for complete listings.

OUR 27TH YEAR!

hamtronics, inc.

65 MOUL RD. - HILTON NY 14468-9535
Phone: 716-392-9430 -- FAX: 716-392-9420

Hamtronics is a registered trademark. Copyright 1989, Hamtronics, Inc. All rights reserved.

- For complete info, call or write for FREE 40-page catalog.

Send \$2 for overseas air mail. For casual interest, check reader service; allow 3-4 weeks.

- Order by mail, fax, or phone (answering machine off hrs).

- Min. \$3 S&H charge for first pound plus add'l weight & ins.

- Use VISA, Mastercard, check, or UPS C.O.D. (\$3 fee).



WOW! SO MANY FEATURES!

DJ-160T DJ-460T

Engineered with the most advanced electronic technology, the new DJ-160T and DJ-460T, VHF and UHF FM hand-held transceiver from Alinco are now available. Standard features include simple operation, easy to read LCD, 3 methods of frequency selection, 5W when operated on 12V DC, and a unique DTMF Decode/display features.

- **Ultra Compact Body:**
5-1/2"(H) x 2- 1/2"(W) x 1-1/4"(D)
- **Power Output**
DJ-160T 3 Watts
DJ-460T 2.5 Watts
with standard 700mAH Battery
- **Extended Frequency Coverage**
DJ-160T
144.0 Mhz - 147.995 Mhz (TX)
137.0 Mhz - 173.995 Mhz (RX)
DJ-460T
440.0Mhz - 450.0Mhz (TX)
410.0Mhz - 470.0Mhz (RX)
Specification guaranteed on amateur band only (Modifiable for mars / Cap-permits required)
- **Easy to Enter Frequency Selection**
Direct Frequency entry from keyboard, UP/DOWN Buttons or Dial
- **20 Memory Channels plus 1 Call Channel**
Tone Frequency, Tone Encode, + or - Shift, DSQ Setting and Offset Frequency can be stored in memory
- **3 Scan Modes**
Memory Scan, Band Scan or Program Scan
- **2 Selectable Scan Types**
Busy Scan - Resume Scan after the signal drops



- **Time Scan - Resume Scan after a 5 second pause on a busy frequency**
- **DSQ (DTMF Squelch) Function**
3 Types of paging Function, Group Paging, Private Paging in a group or Private Paging to a specific person (This Function is compatible with other manufacturers units) The DTMF decode Function and optional tone squelch (DJ-160) will give you additional flexibility in your communication needs
- **Encode: 38 Programmable Sub-Audible Tones, Displayed in Hz.**
- **Priority Function: VFO Priority, Memory Priority or Call Priority**
- **Simultaneous Scanning and Priority Operation with Several Variations**
- **Dual Watch:** The unit will scan between Call Frequency and VFO frequency, or Call Frequency and Memory Frequency, pausing 3 seconds on each frequency alternately
- **Auto Power Off Function**
This function will turn the power off automatically after 30 minutes of non - use
- **Auto Dialer:** There are two, 16 digit memories for frequently used numbers
- **DTMF Decode/Display Function:**
The unit displays DTMF Codes, as received, on LCD
- **Reverse Function, LCD Light, Battery Save and More - Much More!**
- **Limited 2 Year Factory Warranty**

ALINCO ELECTRONICS, INC.

20705 S. WESTERN AVE., SUITE 104
TORRANCE, CALIFORNIA 90501
TEL: (213) 618-8616 / FAX: (213) 618-8758

FIGURE 6

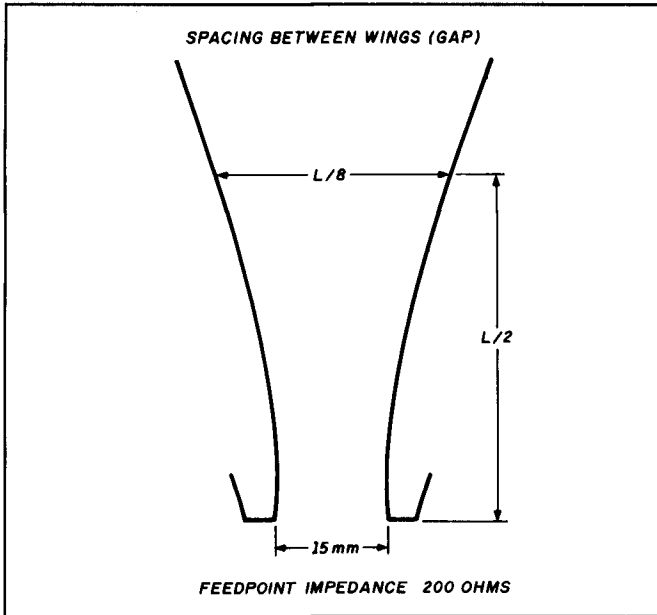

Profile wing spacing for 200-ohm feedpoint impedance.

FIGURE 7

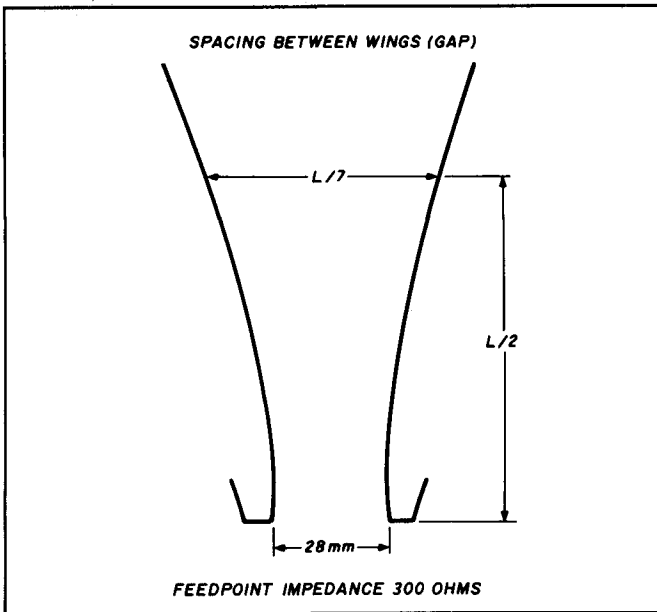

Profile wing spacing for 300-ohm feedpoint impedance.

frequency and desired impedance at the feedpoint.

It's best to match the antenna with a step-down balun or an exponential line. An impedance transformation from 300 to 75 ohms, or 200 to 50 ohms, usually gives the best results and yields the highest efficiency. Figure 5 shows feedpoint impedance versus frequency.

The spacing (gap) between the wings and the wing thickness determines the feedpoint impedance. A feedpoint impedance of 200 to 300 ohms is best. You can obtain a 75-ohm impedance by using close gap spacing between the wings, but this becomes very critical. The small distances

involved are also affected by the wing thickness. Figures 6 and 7 give the wing spacing for 200 and 300-ohm feedpoint impedances. These spacings are most efficient when the wings are made of thin materials — like foils less than 0.3 mm thick.

The gap must be larger for thicker materials or mesh wire with reinforced rims. Larger gap spacing — especially at half wavelengths — gives better gain at lower frequencies, but spoils impedance matching. The antenna impedance doesn't change when in close proximity to other objects. To prove this to yourself, you can place a foil Heart antenna on the floor, have someone stand on the antenna wings, and note the results.

Verification of results

Dvorak verified gain and impedance measurements with computer-controlled measuring equipment. He and Dr. Meier also submitted the antenna system to Gunter Schwarzbeck, DL1BU, the technical referent for the German Amateur Radio Club (DARC). Schwarzbeck, famous for his many critiques on radio antennas and measurements among European radio Amateurs, performed an impartial review, measurements, and a critical analysis. The Heart was tested thoroughly on a commercial antenna range. I have used the antenna here in the States and find it to be one of those antennas that wants to work and gives good results due to its simple construction.

In closing, I wish to thank Dr. Meier and Mr. Dvorak for making information about the Heart antenna available. You can address inquiries about the Heart antenna system to: Meier Messtechnik, Am Menzelberg 6, D-3400 Göttingen, Federal Republic of Germany. 

BIBLIOGRAPHY

1. Gerd E. A. Meier and Rudolf J. Dvorak, *The Heart Antenna — A New Broadband Directional Antenna*, December 1982.
2. Gunter Schwarzbeck, "Herz-Antenne," *CQ-DL Magazine*, February 1988, DARC.
3. "Herz ist Trumpf," *Funk Magazine*, February 1985, pages 40-42.
4. Personal interview and correspondence with the inventors.

NEW BOOKS

1990 EDITIONS

1990 RADIO AMATEUR CALLBOOKS

NORTH AMERICAN EDITION

Fully updated and edited to include all the latest FCC and foreign government call signs and addresses for Hams in North America. Includes plenty of handy operating aids such as time charts, QSL bureau addresses, census information and much more. Calls from snowy Canada to tropical Panama. Now is the time to buy a new Callbook when you'll get the most use out of your investment. ©1989.

CB-US90

Softbound \$27.95

INTERNATIONAL EDITION

QSLs are a very important part of our hobby. All sorts of awards, including the coveted DXCC, require confirmation of contact before the award can be issued. Of special interest, addresses are being added daily for Hams in the USSR and other countries. While in no means complete, it's a start and will be of tremendous help in getting QSLs. Handy operating aids round out this super book value. ©1989

CB-F90

Softbound \$29.95

BUY 'EM BOTH SPECIAL

Reg. \$57.90 Only \$52.95 SAVE \$4.95

Please enclose \$3.75 shipping & handling

HAM RADIO'S BOOKSTORE

Greenville, NH 03048

603-878-1441 FAX (603) 878-1951



Microwaves

By Bob Atkins, KA1GT

Feedback

Although you're reading this column in late April or early May 1990, I'm writing it during the first week of February. Your letters are just starting to arrive and I am pleasantly surprised by their numbers and their overall message of support for the column. Some letters simply voiced their approval of a new column, while others contained pages of suggestions for topics. Please be assured that I read all the mail you send and will take your comments into account when planning the subjects to be presented in future columns.

Some readers (I know of at least one!) will be glad to learn that this is the last column devoted to optical communication. Though optical systems aren't strictly "microwave" frequencies, I decided to cover them for a couple of reasons. First, contacts at optical frequencies do qualify for points in a number of ARRL-sponsored contests and therefore have some legitimacy in Amateur Radio. Second, there are quite a few Amateurs experimenting with optical communication (indeed a ham radio talkback link is almost essential in setting up a DX optical link). Third, I felt there was a need to make available information which I haven't seen presented in the literature generally available to radio Amateurs. I may come back to the subject from time to time, but next month the column will move down in frequency by several orders of magnitude and return to the traditional microwave bands!

One concern expressed in a number of letters is the problem of finding local help for those trying to get started on the microwave bands. I might be able to be of service if the secretaries of VHF/UHF/Microwave clubs and organizations send me copies of their membership lists (paper copies or MS-DOS readable disks — any size, any capacity, ASCII, dBASE, most word processing formats). I could then try to direct inquiries to the closest active microwave station in the area.

Thanks to the organizations who sent along copies of their newsletters. A lot of information appears in these newsletters which is seen only by a small number of hams. I'll try to extract



short items (with full credit given, of course) for this column, or in the case of longer technical items, I'll print short abstracts and direct readers to the original articles. If you send in a newsletter, please include instructions on subscribing so I can pass the information along.

A few items of interest from this month's newsletters include:

The 24th Annual Central States VHF Conference will be held in Wichita, Kansas at the Marriott Hotel, July 26 through 29, 1990. In addition to the technical program, there will be antenna and noise figure measurement sessions. KF0M is organizing the technical program and any contributions to the proceedings (to be published by the ARRL) should be submitted to him by May 15th (as ASCII files on IBM compatible 5-1/4" diskettes). KD5RO/2 is collecting prizes for the conference. (MWVHFR)

After a successful meeting in the Dallas/Fort Worth area in 1989, the 1990 Microwave Update meeting moves back to Colorado and will take place somewhere in the Denver area under the care of W0PW. I'll have more on dates and location when they are announced. (MWVHFR, NTMS)

OE9PMJ published details of a 76-GHz station in DUBUS, April 1989. The rig starts with an 81-MHz crystal oscillator, multiplied and amplified to give 1 watt at 978 MHz. This is then multiplied by 16 in a diode multiplier (BXY 21) and amplified (MGF1302) to give 10 mW at 15.6 GHz. This is fed to a waveguide 5x multiplier/mixer/ filter. Output power is a few microwatts and noise figure is around 40 dB. FM modulation of the crystal oscillator is used and operation is in the Gunnplexer mode (two stations use offset frequencies equal to the receive IF). With 35-cm dishes, DX is about 3 km so far. (NTMS)

AA5C reports using a 45-foot run of 3/4-inch copper tubing as circular waveguide at 10 GHz with a loss of only 1 dB. WR-75 transitions to rectangular guide were used at the ends. By flattening the ends of the tube, it was possible to insert the WR-75 rectangular guide and solder the two together. Total cost was around \$32. (NTMS)

N3CX has designed a 903-MHz DL6WU-type Yagi. Construction details are given. (PACKRATS via NTMS)

Credits:

NTMS — North Texas Microwave Society "Feedpoint" (January/February 1990). NTMS membership is \$12 per year. Contact Wes Atchison, WA5TKU, Rt. 4, Box 565, Sanger, Texas 76266.

MWVHFR — Midwest VHF Report (November 1989). Subscription rate is \$7.50/6 months, \$15/year. Contact Roger Cox, WB0DGF, 3451 Dudley Street, Lincon, Nebraska 68503-2034.

PACKRATS — Mt. Airy VHF Radio Club "Cheese Bits" (September 1989). Subscription rate is \$5 per year. Contact Doc Cutler, K3GAS, 7815 New Second Street, Elkins Park, Pennsylvania 19117.

Other news

The RSGB seems to have beaten the ARRL to the punch with the publication of the first part of their *Microwave Handbook*. I haven't seen a copy yet (I have my order placed!), but I'll review it in this column as soon as I receive it. By the time you read this it should be available from the HAM RADIO Bookstore.* As of early February 1990, the first part of the long-awaited ARRL *Microwave Handbook* is still in the preparation stages, but rumor has it that it's almost ready and "it won't be long now" before it's in print.

Atmospheric optical propagation

In this, the final part of a series of columns on laser communication, I'll take a look at the atmospheric propagation of light. While there are many propagation modes for RF energy — like E skip, meteor scatter, line of sight, troposcatter, and ducting — there's

*Available from the HAM RADIO Bookstore for \$35 plus \$3.75 shipping and handling

only one mode of propagation for light that's of practical importance in optical communication. This mode is line of sight. While propagation via tropospheric scattering is possible, the equipment needed (several watts of laser power and lenses or mirrors many feet in diameter) is beyond the reach of Amateurs. The only non line-of-sight mode of optical propagation which could be within the reach of Amateurs is a form of ducting known as a mirage. It occurs when layers of air of very different refractive indexes cause light to bend around the curvature of the earth. If you can recall the number of mirages you have seen, you'll get some idea of the low probability of using this propagation mode for laser communication!

Restricting the discussion to line-of-sight propagation, you must first ask what effects the atmosphere has on a laser beam. For example, does the atmosphere absorb light? At visible wavelengths, there's no significant absorption of light. This isn't true in the ultraviolet and infrared regions, but we're only concerned here with visible light. Another effect of the atmosphere on light propagation is due to turbulence. Stars "twinkle" not because they vary intrinsically in brightness, but because their light undergoes rapid intensity and positional changes as it passes through the unhomogeneous atmosphere. Similar effects may be observed on a laser beam passing through the atmosphere. However, for the simple communications system described here, they will not affect the received signal as long as they aren't so severe as to result in a laser beam deflection great enough to cause it to miss the receiver for a significant fraction of time. This is very unlikely to occur and can be disregarded for all practical purposes.

Scattering is the only atmospheric effect on light propagation of significant importance to a simple optical communications system. Light which is scattered by the atmosphere is prevented from reaching the receiver and results in received signal attenuation. There are two causes of atmospheric scattering. First, there's scattering by the molecules of the air itself. This is fairly constant and can be described by the process of Rayleigh scattering (scattering by elements much smaller than the wavelength of the radiation being scattered). Second,

there's scattering by particulates in the atmosphere — water droplets and dust particles, for example. This type of scattering is highly variable and is the cause of smog and haze, with which we are all familiar. It can be described by the process of Mie scattering (scattering by elements similar in size to the wavelength of the radiation being scattered). Both types of scattering result in higher losses for shorter wavelengths; that is, blue light is scattered more than red light. This is why the sun (and often the moon) appears very red when rising or setting. The red light penetrates the atmosphere with less scattering losses than the blue light. Similarly, the sky is blue because we are seeing the preferential scattering by the atmosphere of blue light.

In addition to scattering, the other significant process which gives rise to signal loss on a line-of-sight path is due to the geometric spreading of the laser beam. If you know the path length, the divergence of the beam, and the size of the receiving optics, you can calculate how much of the original laser power will be collected by the receiver using simple geometry that I'll describe later. If a beam expander is used, then the transmissivity of the optics involved must be taken into account, but this is usually just a small correction.

If you're interested in the details of the calculations involved, read the appendix to this month's column. The math is simple geometry and algebra, but I won't inflict it on those it might scare away!

The most important variable in transmission is the clarity of the atmosphere. In my area, New Jersey, visibility of 20 miles (as noted in local weather reports) is not uncommon. I have heard reports of 50+ mile visibility while in Maine, and on a recent trip to California I heard a weather report claiming 100-mile visibility in the Sacramento Valley.

Using the formulas given in the appendix or the graphs derived from them to calculate the range of a typical system, you should come up with the following:

Given: Laser power = 1 mW
 Laser beam divergence = 1 mR
 Laser wavelength = 632.8 nm (He-Ne)
 Diameter of receiving optics = 8 inches
 Transmissivity of receiving optics = 0.9

Detector sensitivity = 1×10^{-10} watts

Visual range = 32 km (20 miles)

The DX range at a 0-dB signal to noise ratio is 49 km. This reduces to 45 km for a 3-dB ratio and to 40 km for a 6-dB ratio. Doubling either the laser power, receiving optics area, or detector sensitivity will only increase the 0-dB S/N range to about 54 km. Multiplying any one of these same factors by 5 yields an increase in range to 61 km. However, an improvement of only 25 percent in visual range (to 40 km) yields a DX range of 58 km with the original equipment parameters. Waiting for a slightly clearer day can result in the same difference in potential range as will a large change in equipment, and small increases in distance can make a big change in signal strength. Note that using blue light (440 nm) in place of red indicates a reduction in range of around 40 percent under these conditions.

I hope that this analysis gives you some idea of the capabilities of modest laser communications systems and the factors important to performance. The numbers calculated should be used only as a guide, because the calculation of scattering losses on the basis of "visual range" is only an approximation.

Appendix

To calculate the strength of a laser signal over a given path, you need to know the following:

- 1—The laser power
- 2—The beam divergence
- 3—The transmissivity of any beam expander
- 4—The path length
- 5—The transmissivity of the atmosphere
- 6—The area of the receiving optics
- 7—The transmissivity of the receiving optics

All of these factors are known (or can be reasonably estimated) with the exception of the atmospheric transmissivity loss factor. This factor can be calculated using the formula:

$$\text{atmospheric transmissivity} = e^{-(M+R)D}$$

where M is the Mie scattering coefficient (km^{-1}),
 R is the Rayleigh scattering coefficient (km^{-1}),
 D is the path length (km), and
 (M+R) is the atmospheric attenuation coefficient.

You can estimate the scattering

coefficients using empirically derived relationships. The Rayleigh scattering coefficient is given by the expression:

$$R = 0.00833 * (\lambda / 600)^{-4.08}$$

where λ is the wavelength of the laser light (nm).

The Mie scattering coefficient is given by the expression:

$$M = (3.91 / V) * (\lambda / 550)^{-0.585} * (V^{0.3})$$

where V = the visual range (km).

Visual range is a measure of how far you can see, based on the apparent contrast observed in a standard target at a given distance. It's often given in weather reports and aviation weather forecasts. It may be estimated on the basis of the following qualitative descriptions.

Conditions	Visual range (km)	Atmospheric attenuation coefficient (km ⁻¹ at 632 nm)
Extremely clear	100	0.03
Very clear	40	0.08
Clear	20	0.16
Light haze	7	0.49
Haze	2.5	1.40

This information is also depicted graphically in Figure 1.

Referring to Figure 2, you have a laser of power P watts and beam divergence θ radians illuminating an area of radius r km at a distance of D km.

For small angles,

$$\tan[\theta(\text{degrees})] = \theta(\text{radians})$$

The radius, r, of the illuminated circle at a distance, D, is given by the relationships:

$$r = D \tan(\theta/2) \text{ [}\theta \text{ in degrees]}$$

$$r = D \theta/2 \text{ [}\theta \text{ in radians]}$$

The area illuminated will therefore be given by the relationship:

$$\text{area} = \pi r^2 = (\pi D^2 \theta^2) / 4$$

The power density at the target is given by power/area and is therefore (assuming uniform illumination):

$$\text{power density} = 4P / \pi D^2 \theta^2$$

(In fact the power density will be somewhat higher if the laser is aimed accurately, because the illumination isn't uniform across the beam but peaks in the center. Thus, this is a conservative estimate.)

For a detector capturing light from A (area of lens or mirror), the power received will be given by:

FIGURE 1

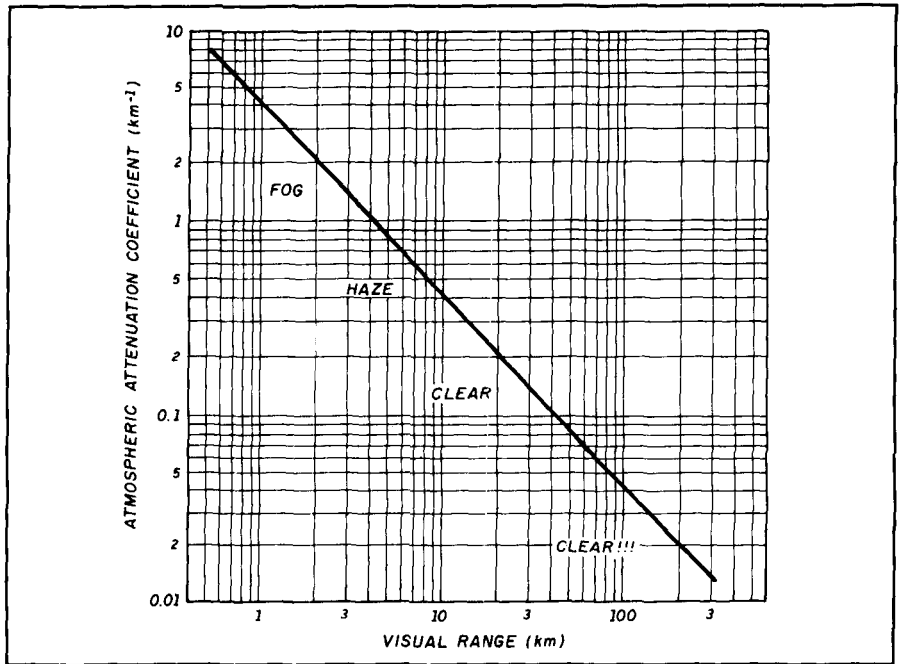

Relationship between visual range and atmospheric attenuation coefficient. Values are approximate. They will be about 10 percent lower at the red end of the spectrum and about 20 percent higher at the blue end.

$$\text{power received} = 4PA / \pi D^2 \theta^2$$

And, if T_o is the transmissivity of the optics and T_a is the transmissivity of the atmosphere, then the power incident on the detector will be given by:

$$\text{power at detector} = 4PAT_oT_a / \pi D^2 \theta^2$$

If the detector can detect a minimum signal power D_p , then at the maximum communication distance D:

$$D_p = (4PAT_oT_a) / (\pi D^2 \theta^2)$$

Rearranging this, you have:

$$D^2 = (4PAT_oT_a) / (\pi D_p \theta^2)$$

The only unknowns in this equation are D, the maximum communications distance, and T_a , the transmissivity of the atmosphere. T_a can be determined as described above, and so D can be calculated.

T_a is given by the expression:

$$T_a = e^{-(M+R)D}$$

where $e = 2.71828$, M is the Mie coefficient, R is the Rayleigh coefficient, and (M+R) is the combined atmospheric attenuation coefficient.

Thus, the final expression for calculating maximum distance is:

$$\frac{D^2}{e^{-(M+R)D}} = \frac{4PAT_o}{\pi D_p \theta^2}$$

This isn't a trivial equation to solve.

FIGURE 2

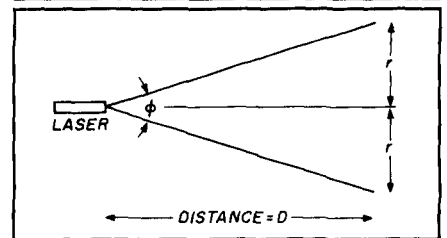

A graphic depiction of the laser beam divergence illuminating an area.

It can be solved graphically using Figure 3, where the right-hand side of the equation is plotted against DX potential for a number of different scattering conditions. Note that units must be consistent. Here's an example: for distance in km, the area of the receiving optics (A) must be expressed in square km, the atmospheric attenuation factor (M+R) must be in units of km⁻¹, and all power and sensitivity factors must be expressed in the same units (watts). Perhaps the easiest solution for those with access to a computer is to use a trial and error method. Because all quantities except D are known, substitute increasing values of D into the equation until both sides are equal. A TURBO BASIC listing* is available

*Send an SASE with \$25 postage to Ham Radio Magazine for program listing

FIGURE 3

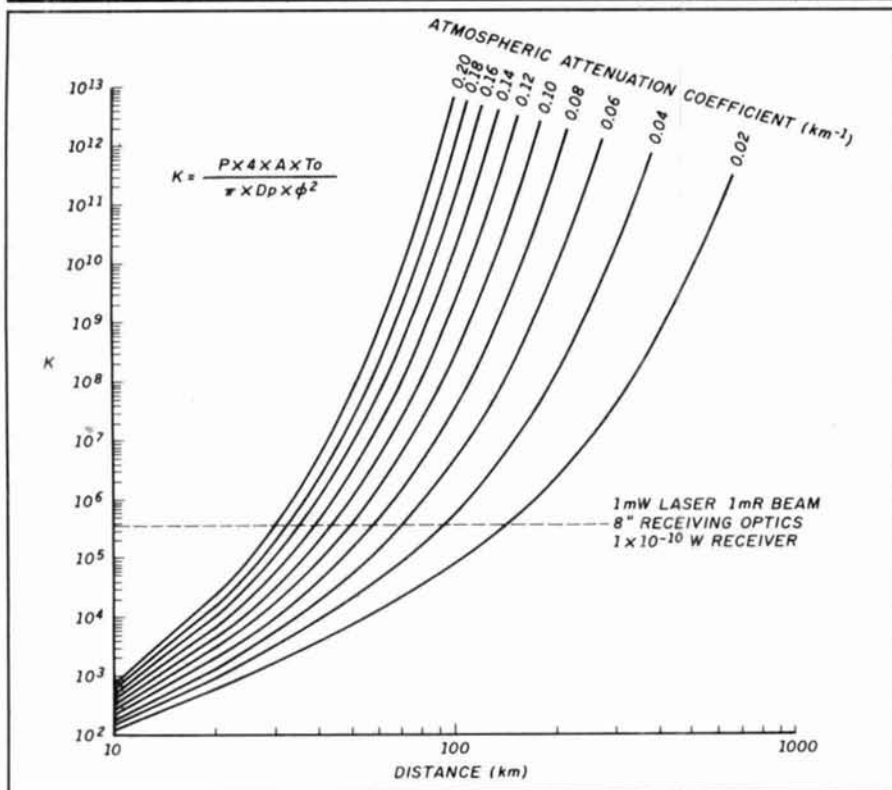

Relationship between K (as defined above) and maximum communication range for an optical communications system for a number of different atmospheric conditions (as given in Figure 1).

which uses this formula to calculate DX range (at 0-dB signal to noise ratio) for a given atmospheric communication system. The program should also run under QuickBASIC, but to run under more traditional versions of BASIC (like GW-BASIC) some modifications, like the addition of line numbers, the

replacement of labels with line numbers in the GOTO statements, and the REM keyword before the remarks, will be required. A compiled version of this program which will run on any IBM PC compatible machine is available from the author for \$5 to cover materials and shipping.

B & W PRESENTS A WINNING COMBINATION



MODEL PT2500A LINEAR AMPLIFIER

The Barker & Williamson PT2500A Linear Amplifier is a completely self-contained table-top unit designed for continuous SSB, CW, RTTY, AM or ATV operation, intended for coverage of all amateur bands between 1.8 MHz and 21 MHz. Two type 3-500z glass envelope triodes provide reliability and rapid turn-on time.

FEATURES INCLUDE:

- Full 1500 watt output
- Pi-network input for maximum drive
- Pressurized plenum cooling system
- DC antenna relay for hum-free operation
- Illuminated SWR and power meters
- Vernier tuning for accurate settings
- Pi-L output for greater harmonic attenuation

Ruggedly constructed of proven design, this amplifier reflects the manufacturer's critical attention to details—such as the silver-plated tank coil for maximum efficiency. Cathode zener fuse and internal/external cooling are among the protective and safety devices employed. Input and output impedances are 50 ohms.

Dimensions: 17" wide x 19" deep x 8 1/2" high
Weight: 80 lbs. (shipped in 3 cartons to meet UPS requirements)

Price: **\$2175.00** FOB factory. Price includes one year limited warranty.

Call or write factory for complete specifications.



MODEL VS1500A ANTENNA COUPLER

The Barker & Williamson VS1500A antenna coupler is designed to match virtually any receiver, transmitter or transceiver in the 160 to 10 meter range (1.8 to 30 MHz) with up to 1500 watts RF power to almost any antenna, including dipoles, inverted vees, verticals, mobile whips, beams, random wire and others, fed by coax cable, balanced lines or a single wire. A 1:4 balun is built in for connection to balanced lines.

FEATURES INCLUDE:

- Series parallel capacitor connection for greater harmonic attenuation.
- In-circuit wattmeter for continuous monitoring.
- Vernier tuning for easy adjustment.

Front panel switching allows rapid selection of antennas, or to an external dummy load, or permits bypassing the tuner.

Dimension (Approx.): 11" wide x 13" deep x 6" high

Weight: 6 1/2 lbs.

Price: **\$499.00** FOB Factory. Fully warranted for one year.

ALL OUR PRODUCTS MADE IN USA
BW BARKER & WILLIAMSON
Quality Communication Products Since 1932
At your Distributor. Write or Call
10 Canal Street, Bristol, PA 19007
(215) 788-5581

"ONLINE" U.S. CALL DIRECTORY

Hamcall service gives you all hams via your computer & modem. Updated each month! Only \$29.95 per year. Unlimited use - you pay for phone call.

BUCKMASTER PUBLISHING

Route 3, Box 56
Mineral, Virginia 23117
703/894-5777 visa/mc 800/282-5628

110



1923-H EDWARD LN
MERRICK, NY 11566

Custom Call Sign

AMATEUR RADIO

W1AW

- Adheres to glass (interior) or metal
- Instant transfer car to car
- 2 1/4" x 8" flexible plastic sign for cars, trucks or RVs. "Amateur Radio" + your call in white lettering. Order Magnetic or Suction mounted version. Choose black, blue or red background. \$8.50 ea.; 2/\$15 ppd. Quick delivery.

111

ROTATABLE TRAP DIPOLE FOR 12 AND 17 METERS

By Gary Nichols, KD9SV, 4100 Fahlsing Road,
Woodburn, Indiana 46797

Like many Amateurs, I tried loading every antenna I had on 12 and 17 meters with an antenna tuner when we were given operating privileges for the new WARC bands. I had limited success. My small (33 foot) off-center loaded dipole for 40 meters was about the best I had. However, I've never been fond of hiding a mismatch with an antenna tuner.

I decided to redo my antenna system and convert the 40-meter rotatable dipole into a trap antenna for 12 and 17 meters. I also decided to shunt feed the tower as a 5/8-wavelength vertical on 40 meters; this worked out better than the dipole.

Trap description

Design guidelines suggested that 100 to 300 ohms reactance is recommended for trap design. The capacitance of the tubular traps is about 37 pF, which is very near 200 ohms at 24.95 MHz. Fourteen turns of no. 12 solid housewire will resonate with the tubular capacitor on 12 meters (see Figure 1).

The trap is built with two telescoping sections of aluminum. A piece of polybutylene water pipe is placed between them for the capacitor dielectric. This makes a self-supporting, adjustable, easily constructed trap. It's similar to the gamma capacitors used on some beam antennas. The coil is wound over part of the plastic pipe.

Assembly

Cut all aluminum pieces in half. Use a hacksaw to cut two lengthwise slits, about 1 inch long, in one end only of the 1-inch and 7/8-inch tubing. These are for the hose clamps. Make four slits in the 3/4 and 1/2-inch tubing on one end only.

Cut two 8-3/4 inch pieces of the plastic tubing and "hammer" them onto each piece of 1/2-inch aluminum. Leave 1 inch of aluminum exposed at the slit end. You'll

have to stand the tubing on end on top of something hard and pound the plastic on, because it fits very snugly.

Take a 3-foot length of no. 12 solid wire with black insulation and wind about 17 turns over a 1/2 or 9/16-inch diameter tube. Then screw the coil over the plastic and assemble as shown in Figure 2. Use 14 turns for the coil, and terminate the coil ends with a strip of tin-plated brass. Wrap the tin plate around the aluminum tubes and secure with a hose clamp. With the 1/2-inch aluminum tube engaged approximately 4-3/4 inches into the 3/4-inch tube, the trap should resonate near 25 MHz. Tune the trap by sliding it in or out slightly; set resonance at 24.9 MHz using a grid dip meter. Be sure to check your dipper with the station receiver for accuracy.

PARTS LIST

1-inch OD 0.058-wall aluminum, 6 feet
7/8-inch OD 0.058-wall aluminum, 8 feet
3/4-inch OD 0.049-wall aluminum, 8 feet
1/2-inch OD 0.058-wall aluminum, 17 inches
3/8-inch OD 0.058-wall aluminum, 6 feet

5/8 x 1/2-inch plastic water pipe, polybutylene, 2 pieces approximately 9 inches each

8 hose clamps: 4 each 1 inch, 2 each 3/4 inch, and 2 each 1/2 inch (all stainless preferred)

12 inches of PVC pipe approximately 1-inch ID, schedule 40 pipe

4 U bolts to fit over the PVC pipe

Angle or bar stock for antenna-to-mast mounting plate (I used 1/4 x 3-inch x 12-inch aluminum.)

0.015-inch thick tin-plated brass stock (4 pieces 1/2 x 2 inches) for terminating coil ends

6 feet of no. 12 solid wire with TW or TWH insulation (black)

FIGURE 1

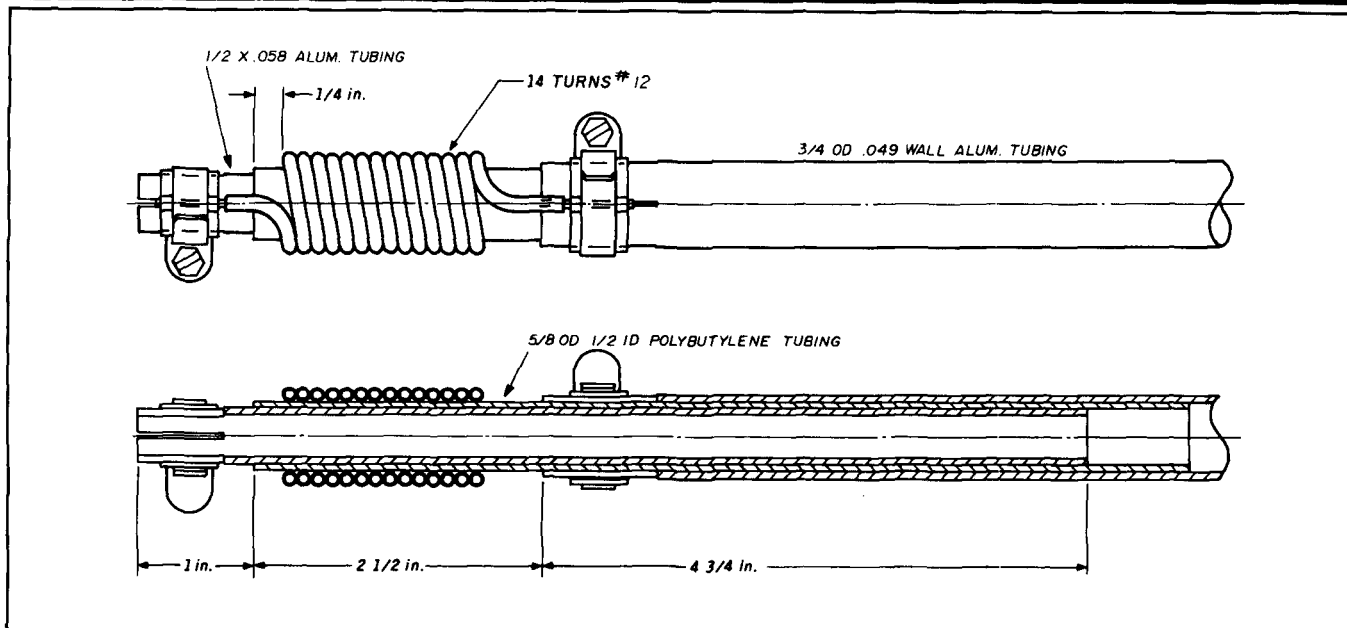

The 12-meter trap.

FIGURE 2

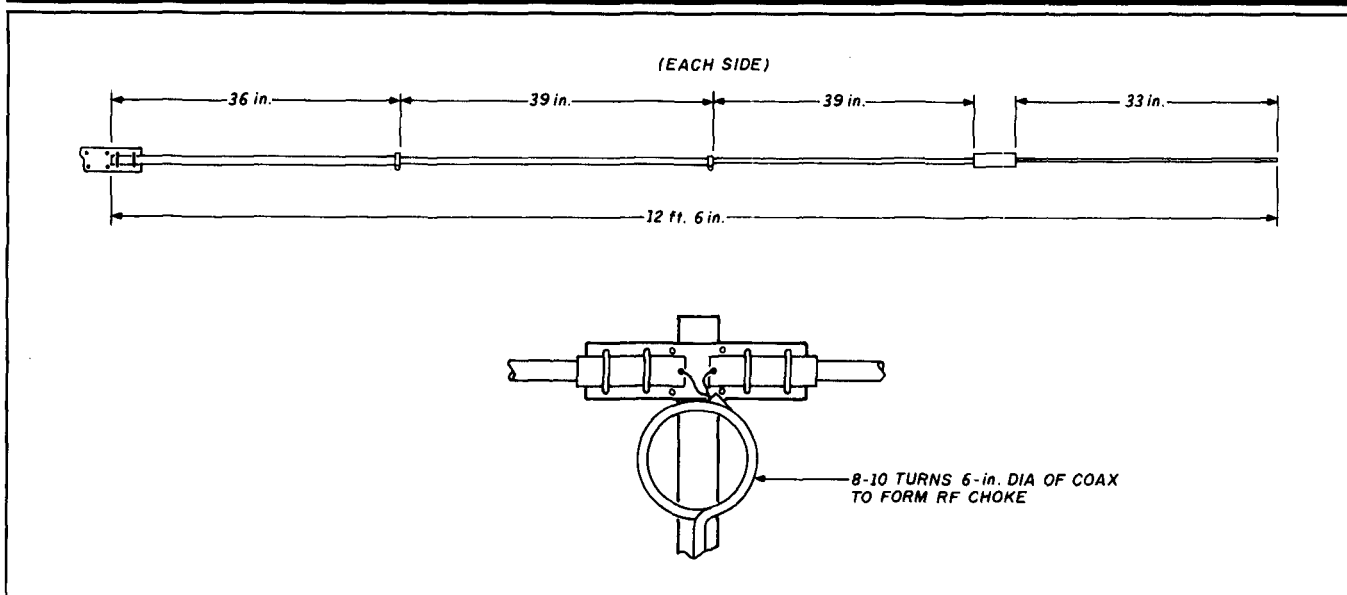

Assembly of 12/17-meter rotatable dipole.

Don't use white insulated wire; it's not very ultraviolet resistant. Be sure to use the tin-plated brass to terminate the coil ends. This will give you a lot of contact area and it won't corrode with the aluminum, as copper will. If you follow the drawing dimensions closely, almost no further adjustment will be necessary. I placed the trap and 4-foot section of 3/4-inch tubing on the top of a plastic wastebasket while checking with the grid dip meter.

Finish assembling the antenna as shown in **Figure 2** and test it with the antenna up about 20 feet or so, if possible. Input impedance on a properly tuned antenna should be

approximately 60 ohms on 12 meters and about 65 ohms on 17 meters for a VSWR of about 1.3:1.

For best results feed the dipole with a good piece of coax, and use either a 1:1 balun or RF coax choke. Eight turns 6 inches in diameter are adequate.

This antenna has taken a kilowatt keydown with ease, and the trap capacitor has been hi-pot tested to 25 kV. Full legal power shouldn't be a problem.

I have completed antennas available, should you not wish to build your own. Write to me at the address at the beginning of this article for details. 

THE HELICAL WHIP FOR RV AND MOBILE USE

By J.T. McCullough, W0BHG, 1401 North Jesse James Road, Excelsior Springs, Missouri 64024

When I retired I found I needed to reduce the complexity of my antennas for several bands, and simplify their mounting and connections. I needed to cut down on the time I spent setting up and disassembling antennas for recreational vehicle (RV) and motor home use.

Advantages

The antennas presented here will also work well for ordinary mobile operations. They can be adapted easily for home use in tight space situations in an attic, on a porch roof, or on a small lot. While it's quite likely that the helical vertical will never perform any better than a full quarter-wave vertical in the same situation, the difference can be rather negligible. Helicals can also be used back to back for a one-half wave vertical or horizontal dipole. They will work as radials for a ground plane antenna too.

For temporary or permanent use on one WARC band, attach the helical vertically to the framework of a metal beam assembly near the feedpoint. Then connect the base directly to the coax feed. The framework and elements of the beam provide the ground plane. By mounting the helicals at a slight angle from each other, you could use two or three new bands in the same way.

It appears that at certain times of day, especially in the early evening, stronger DX signals may be obtained from 10, 15, and 20-meter helicals atop a metal-covered RV than from much more sophisticated antennas in the same location. This may be because the metal covering of an RV makes an almost perfect ground plane.

Development

I started using helical whips with a large magnet mount about two years ago. My first was a CB antenna, modified

FIGURE 1

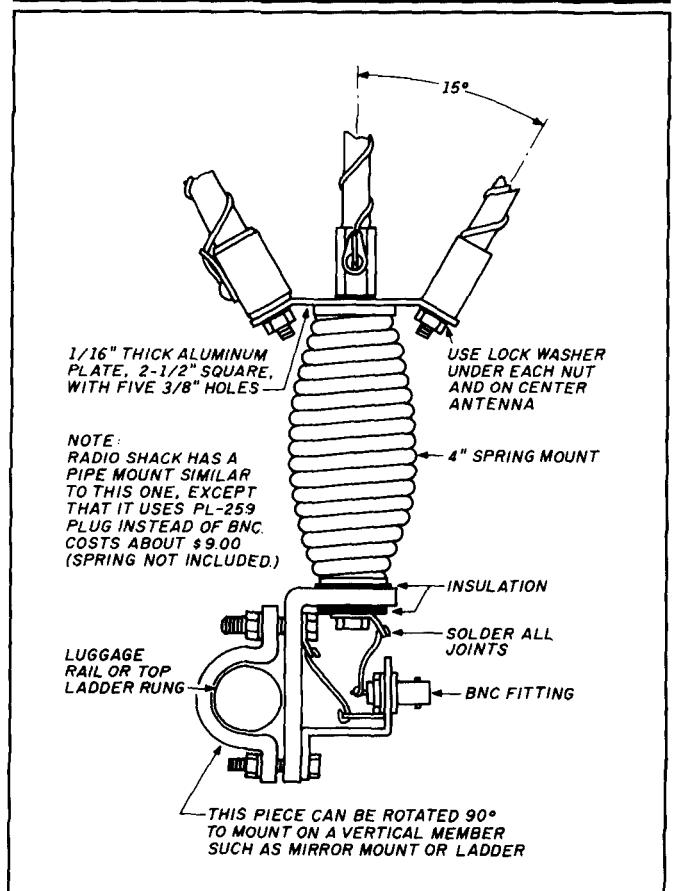

Motor home antenna mount.

PHOTO A

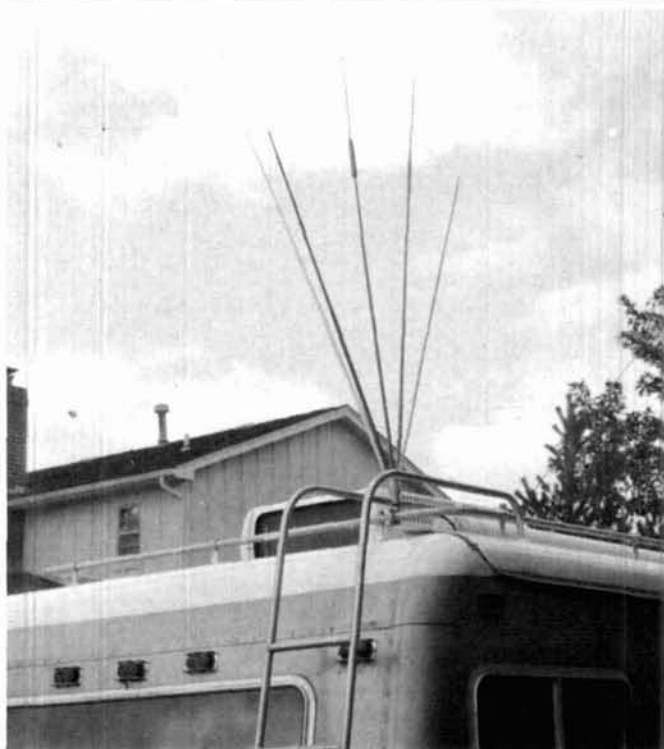

Five-band helical antenna on single spring mount.

for 20 meters. It was fantastic! I used it atop my pickup truck while traveling, and on my trailer or motor home at campsites. I worked a lot of DX, including all continents. (More about modifying the CB antenna later.)

I wanted to work five bands: 10, 12, 15, 17, and 20 meters. To do this I tied all five helicals together near the feedpoint. I started with a heavy 4-inch spring mount. Then I made a 2-1/4 inch square plate out of 1/16 inch thick aluminum and drilled five 3/8-inch holes — one in the middle and one in each corner. I bent each corner down about 15 degrees. I installed one antenna in the center hole to hold the plate in place on top of a spring mount. Next I put one antenna in each of the other four holes, using lock washers and 3/8-24 nuts. See Photo A and Figure 1 for details.

Performance comments

There appears to be no significant interaction between the five antennas, with the possible exception of the center unit. Each was developed individually using a method I'll describe later, so that VSWR was lowest in the center of the desired band. When attached to the common spring mount on top of the motor home, four of the antennas had low VSWR (less than 1.5:1) without retuning.

The center unit (20 meters) was affected slightly, and I needed to shorten the tip 1/2 inch to obtain the best VSWR for the phone band. The 20-meter antenna also had narrow bandwidth, although it still covered the phone band. For this reason, it might be better to put one of the narrowband antennas (11 or 17 meters) in the center.

While traveling, tilting the assembly about 45 degrees or more to the rear should help you avoid losing some of it to an underpass or bridge. You'll encounter another hazard

in residential areas, where large trees often overhang the streets. Mobile operation is still quite feasible, even at a 45-degree tilt, if you mount the assembly on a rear luggage rail or ladder.

Testing procedure

I used the test setup in Figure 2 to check all the antennas during construction. If you don't plan to go into heavy production, the steel top of a car or pickup truck should work quite well as a base for the magnet mount. Take precautions to protect the top of the vehicle. A thin sheet of plastic should work, as capacitance between the magnet mount and car top will serve as an effective RF ground connection.

I consider a grid-dip meter a must for checking antenna resonant frequency, but an RX noise bridge may work if you are proficient in its use. Checking VSWR is useless for initial testing unless the resonant frequency happens to be in or very near the band in question. If you have a BNC fitting on the magnet mount, you can easily attach a small loop for grid-dip meter readings, exchanging it for coax for testing VSWR or on-the-air use.

After you adjust an antenna roughly to the correct frequency with the grid-dip meter, make fine adjustments by connecting the antenna to a transceiver and finding the frequency of lowest VSWR with a VSWR meter. An adjustment of as little as 1/4 inch to the tip of the antenna may

FIGURE 2

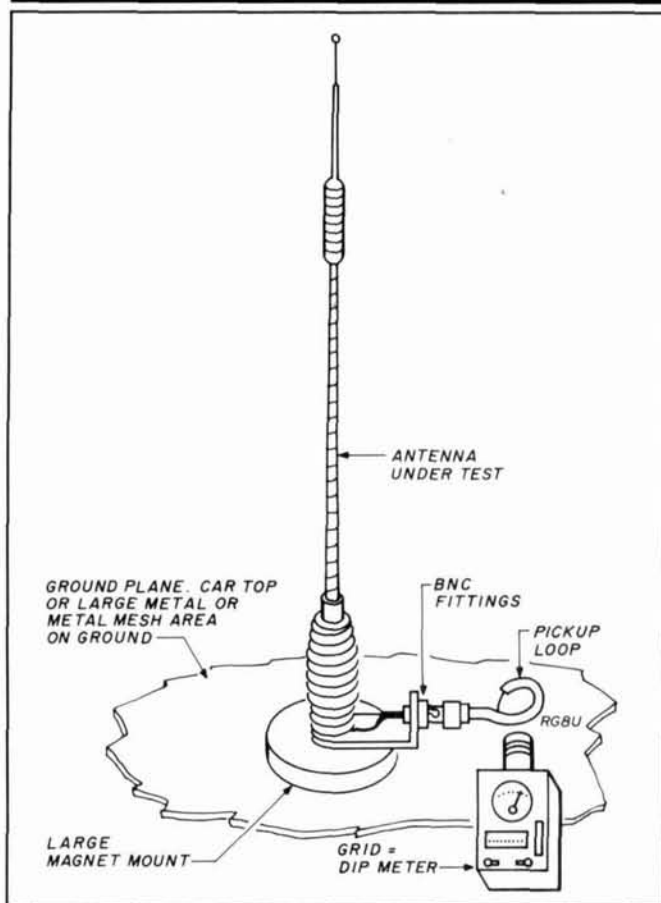

Test setup.

FIGURE 3

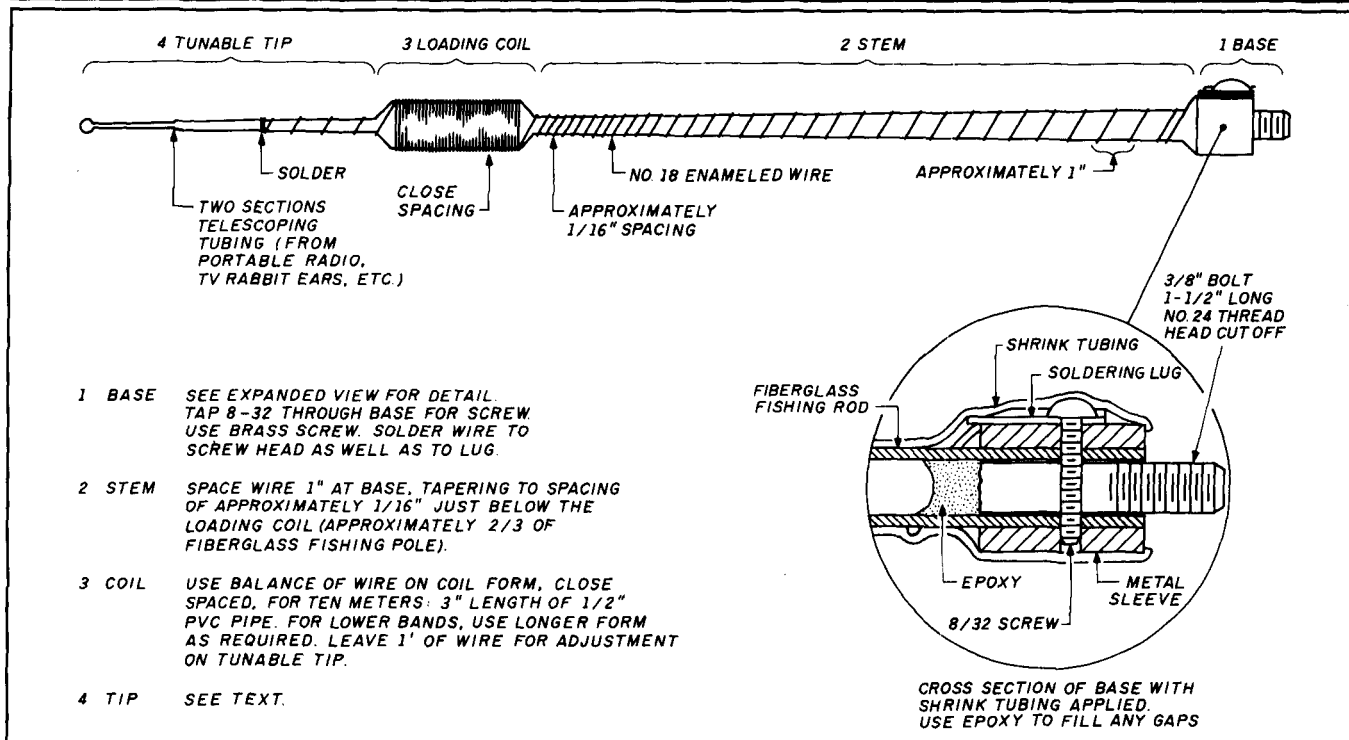

Fiber glass helical antenna.

be necessary to bring the lowest VSWR point to the center of the desired band. It's usually sufficient to check the VSWR every 100 kHz to find the low point. A dual needle VSWR meter is a real time saver here.

It's better to start with an antenna that's too long; you can find the correct length with careful pruning. If you haven't found a low VSWR point after your first check with a grid-dip meter, recheck the meter's frequency. Don't be concerned with other higher frequency dips. Some may be harmonic dips and some may not. Depending on the length of the wire up to that point, the loading coil may act as a trap or a choke, creating a much higher frequency dip.

Construction of the modified CB antenna

The modified CB antenna requires the least work and is very efficient. I recommend using a top-loaded type with short tuning stubs at the very top, just above the loading coil. The one I used had about 3 feet of helical winding spaced evenly on constant diameter fiber glass rod, followed by a close-spaced loading coil several inches long, and topped by a metal tuning tip with a set screw and 2 or 3 inches of 1/8-inch steel rod. I replaced this rod with one of the same diameter about 24 inches long, and cut and adjusted it until it resonated at the proper point in the 20-meter band.

It's important not to extend this rod into the loading coil, as it will cause frequency change. If it is steel, it will likely heat up if much power is applied. Your local hardware store is a good source of brass brazing rod. While I didn't try this antenna on other bands, it should work well on 12, 15, or 17 meters if you use different lengths of preadjusted rod. For 10 meters, it will probably be necessary to remove a few turns from the loading coil.

Neighborhood garage sales and flea markets are good, inexpensive sources for CB antennas. Because most late model, top-loaded CB antennas don't have the tuning tip, you may need to improvise one (details on how to do this later).

Building fiber glass rod helicals

The light weight of fiber glass fishing rods makes them useful in helical antenna construction. Weight can be important when four or five antennas are placed on one spring mount.

Choosing a fiber glass rod

You can find fiber glass rods at garage sales and flea markets. Poles with broken or missing guides and handles can often be bought for almost nothing. Look for hollow rods at least 4 or 5 feet long with a 3/8 to 1/2-inch diameter near the handle. You can use smaller, solid rods, but they require heavier, larger loading coils. Use one-piece rods with no metal ferrules or joints. It's possible to use larger rods with metal ferrules if you cut them out and rejoin the rod pieces with epoxy. One way to do this is to slide one end into the other, or use a tight-fitting piece from a solid rod as an internal splint. Refer to Figure 3 for construction details.

Base

Remove all windings, wire, and thread, along with the tip, guides, and any foil or metal bands. Remove the entire handle, unless it appears that an inch or two would make a good base mount. There are so many different types of handle attachments that it's difficult to prescribe a standard of construction. Keep in mind the cross-section drawing of

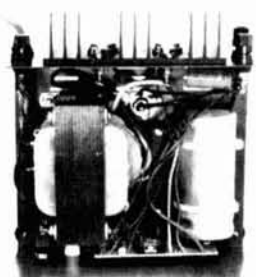

INSIDE VIEW — RS-12A

ASTRON POWER SUPPLIES

• HEAVY DUTY • HIGH QUALITY • RUGGED • RELIABLE •

SPECIAL FEATURES

- SOLID STATE ELECTRONICALLY REGULATED
- FOLD-BACK CURRENT LIMITING Protects Power Supply from excessive current & continuous shorted output
- CROWBAR OVER VOLTAGE PROTECTION on all Models except RS-3A, RS-4A, RS-5A.
- MAINTAIN REGULATION & LOW RIPPLE at low line input Voltage
- HEAVY DUTY HEAT SINK • CHASSIS MOUNT FUSE
- THREE CONDUCTOR POWER CORD
- ONE YEAR WARRANTY • MADE IN U.S.A.

PERFORMANCE SPECIFICATIONS

- INPUT VOLTAGE: 105-125 VAC
- OUTPUT VOLTAGE: 13.8 VDC ± 0.05 volts (Internally Adjustable: 11-15 VDC)
- RIPPLE Less than 5mv peak to peak (full load & low line)
- Also available with 220 VAC input voltage



MODEL RS-50A



MODEL RS-50M



MODEL VS-50M

RM SERIES



MODEL RM-35M

19" × 5 1/4" RACK MOUNT POWER SUPPLIES

MODEL	Continuous Duty (Amps)	ICS* (Amps)	Size (IN) H × W × D	Shipping Wt. (lbs.)
RM-12A	9	12	5 1/4 × 19 × 8 1/4	16
RM-35A	25	35	5 1/4 × 19 × 12 1/2	38
RM-50A	37	50	5 1/4 × 19 × 12 1/2	50
• Separate Volt and Amp Meters				
RM-12M	9	12	5 1/4 × 19 × 8 1/4	16
RM-35M	25	35	5 1/4 × 19 × 12 1/2	38
RM-50M	37	50	5 1/4 × 19 × 12 1/2	50

RS-A SERIES



MODEL RS-7A

MODEL	Continuous Duty (Amps)	ICS* (Amps)	Size (IN) H × W × D	Shipping Wt. (lbs.)
RS-3A	2.5	3	3 × 4 3/4 × 5 3/4	4
RS-4A	3	4	3 3/4 × 6 1/2 × 9	5
RS-5A	4	5	3 1/2 × 6 1/4 × 7 1/4	7
RS-7A	5	7	3 3/4 × 6 1/2 × 9	9
RS-7B	5	7	4 × 7 1/2 × 10 3/4	10
RS-10A	7.5	10	4 × 7 1/2 × 10 3/4	11
RS-12A	9	12	4 1/2 × 8 × 9	13
RS-12B	9	12	4 × 7 1/2 × 10 3/4	13
RS-20A	16	20	5 × 9 × 10 1/2	18
RS-35A	25	35	5 × 11 × 11	27
RS-50A	37	50	6 × 13 3/4 × 11	46

RS-M SERIES



MODEL RS-35M

MODEL	Continuous Duty (Amps)	ICS* (Amps)	Size (IN) H × W × D	Shipping Wt. (lbs.)
• Switchable volt and Amp meter				
RS-12M	9	12	4 1/2 × 8 × 9	13
• Separate volt and Amp meters				
RS-20M	16	20	5 × 9 × 10 1/2	18
RS-35M	25	35	5 × 11 × 11	27
RS-50M	37	50	6 × 13 3/4 × 11	46

VS-M AND VRM-M SERIES



MODEL VS-35M

MODEL	Continuous Duty (Amps)			ICS* (Amps) @13.8V	Size (IN) H × W × D	Shipping Wt. (lbs.)
	@13.8VDC	@10VDC	@5VDC			
VS-12M	9	5	2	12	4 1/2 × 8 × 9	13
VS-20M	16	9	4	20	5 × 9 × 10 1/2	20
VS-35M	25	15	7	35	5 × 11 × 11	29
VS-50M	37	22	10	50	6 × 13 3/4 × 11	46
• Variable rack mount power supplies						
VRM-35M	25	15	7	35	5 1/4 × 19 × 12 1/2	38
VRM-50M	37	22	10	50	5 1/4 × 19 × 12 1/2	50

RS-S SERIES



MODEL RS-12S

MODEL	Continuous Duty (Amps)	ICS* Amps	Size (IN) H × W × D	Shipping Wt. (lbs.)
• Built in speaker				
RS-7S	5	7	4 × 7 1/2 × 10 3/4	10
RS-10S	7.5	10	4 × 7 1/2 × 10 3/4	12
RS-12S	9	12	4 1/2 × 8 × 9	13
RS-20S	16	20	5 × 9 × 10 1/2	18

FIGURE 4

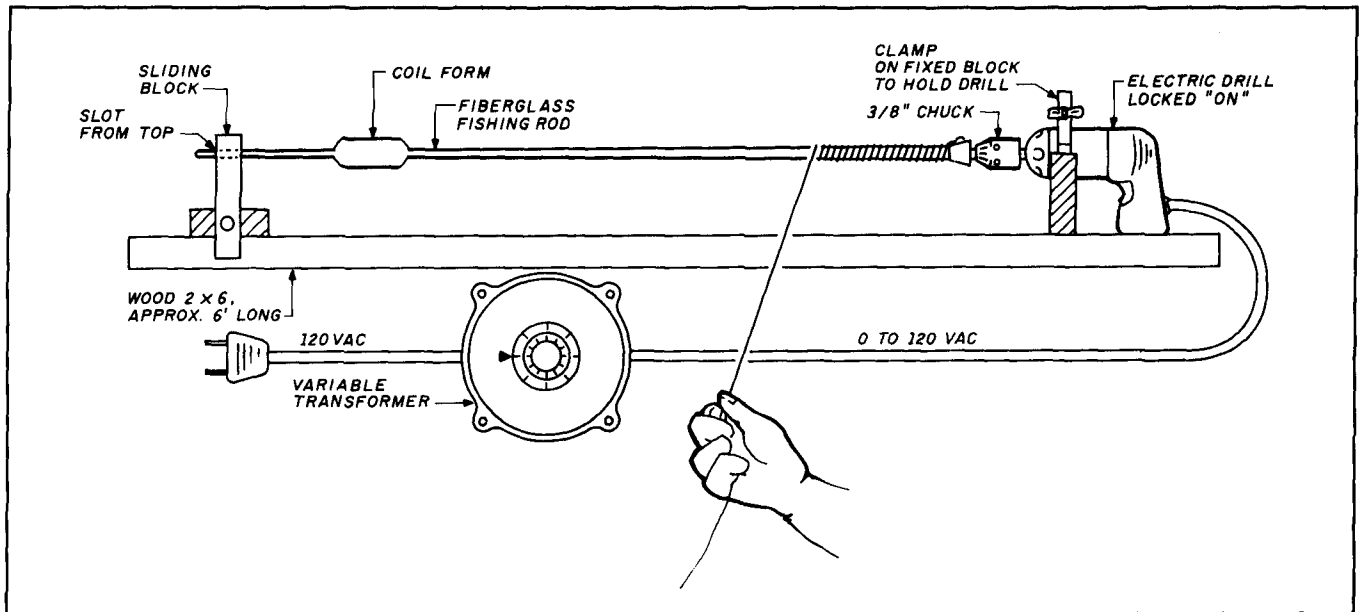

Winding setup using an electric drill and Variac.

Figure 3. You'll need to mount a 3/8-inch diameter steel or brass bolt with no. 24 thread 1-1/2 to 2 inches long in the base after cutting off the head of the bolt. Use two-part epoxy to hold this bolt in place. The 5-minute kind will save construction time.

Now drill and tap through the bolt and handle to provide an electrical connection. Brass bolts (8-32) are ideal. Use a solder lug to attach the antenna wire, soldering to both the lug and the screw head. You should cover the complete base with shrink tubing or several coats of good enamel, or both.

Stem

Cut a length of wire, preferably no. 18 copper enameled (no. 20 or 16 will do), for the frequency desired. The length should be one-half wavelength plus approximately 12 inches. To find the length for one-half wavelength in feet, divide 468 by the desired frequency in MHz. You can do the winding by hand, with the help of another person, or by improvising a jig like that in **Figure 4**. If you have access to a 0 to 120-volt Variac, you can use a 3/8-inch or larger electric drill (see **Figure 4**). If necessary, use a handle with 3/8-inch or larger drill chuck mounted on it, instead of the electric drill setup shown.

With the shaft turning slowly, wind on about one-half or a little more of the wire allotted, starting with spacings of about 1 inch. As you reach the loading coil position, gradually reduce the spacing until the turns are barely separated. The bottom of the loading coil should be roughly 12 inches from the top of the pole.

Loading coil

The loading coil offers several variations. You are, of course, dealing with low power here — in the area of 100 watts or less. This is definitely not a high powered linear amplifier.

If you're using a "fat" pole (5/16 inch or larger diameter

at the loading coil position), you can wind the loading coil directly on the pole — especially for a 10 or 12-meter antenna. However, VSWR usually seems to be better with a larger diameter. A loading coil of 1/2-inch PVC pipe works well, but if fiber glass poles with larger ends are available (say 1/2 inch or slightly larger) a short section cut from the larger end would be lighter and better.

You'll have to improvise when mounting the coil form. Corks with a hole in the center and some epoxy will do the trick. Cut or grind off the excess part. The small mushroom-shaped wooden buttons used for covering screw holes in furniture work nicely for 1/2-inch PVC by enlarging the hole in the end of the pipe. These buttons usually cost a dime or less at most hardware stores.

If the loading coil is approximately 1/2 inch in diameter, it should be about 3 inches long for 10 and 12 meters, 4 inches for 15 and 17 meters, and about 5 inches for 20 meters. Wind all the remaining wire, except for the last 12 or 14 inches, close spaced on the loading coil form. The remaining 12 inches or so of wire can be loosely spiraled up the pole to hold the wire steady for testing. You can use tape or epoxy to hold turns in place where needed, like the beginning and end of the loading coil.

Now you're ready to screw the assembly onto the spring magnet mount. Place the antenna on the ground plane in the yard or on top of the vehicle. Use a grid-dip meter and VSWR test equipment as described in the section on testing.

It may be necessary to cut off half or more of the last 12 inches of wire. If, after cutting it all off, the resonant frequency is too low, remove a few turns from the top of the loading coil and extend the last 12 inches as before. Then recheck for resonance with a grid-dip meter. This may all sound like a lot of guesswork, but it seems that if you've used the prescribed amount of wire, the antenna will almost always work out when you vary the last 12 inches. All the bands can have nearly the same pole length of about 5 feet, if you desire. The big variable is the loading coil. Remov-

ing 1 inch from the tip will make a rather large difference in resonant frequency, but you'd need to remove several inches from the loading coil to make a similar difference.

Tunable tip

You can make the tip adjustable if you wish by using telescoping sections from TV rabbit ears, old auto or portable radio antennas, and so forth. Use only two sections; choose those that will fit the rod above the loading coil after cutting off any excess fiber glass rod. Epoxy the tip onto the rod after sanding off a spot of chrome to allow for easy soldering of the wire end. The total midadjustment length of the telescoping section will be a little shorter than the length of wire it replaces because of the greater capacitance of the tubing. Recheck the VSWR, and if the midrange setting hits the desired VSWR at the frequency selected, the section is ready for completion — after you plug the hole in the end of the tip.

With the exception of the sliding tip, you can use heatshrink tubing over the length of the antenna. This can be a bit difficult because of the larger diameter of the loading coil, and possibly the base. It may be expedient to shrink tubing over the stem area before sliding on the loading coil form. Have two or three sizes of heatshrink tubing on hand. If places remain where the tubing doesn't fit closely, fill the gap with epoxy and sand smooth.

To shrink the tubing on long items like this antenna, try a toaster oven. This is another easy-to-find garage sale item; you can often find one for \$3 to \$5. You can dedicate your oven to this type of service by cutting a 3 or 4-inch diameter hole in the back. Finally, spray the antenna with two or three coats of good enamel.

If you're not particular about its bulky appearance, 1/2-inch PVC pipe makes quite satisfactory antennas. Using PVC eliminates the need for a form for loading coils. Otherwise, follow the procedure for coil winding and use the same amount of wire. The tunable tip will require some kind of cap or plug with a hole in it. Seal the tip well to keep water out.

Conclusion

Anyone who likes to experiment will surely enjoy using some combination of the antennas described. On a recent trip to southern Missouri, I made contacts on all five bands using the antennas in **Photo A** and a Yaesu FT-101E modified for the WARC bands. I also worked 17 stations in Europe and Asia in 2 hours operating time. I made contacts on 40 meters by attaching a 33-foot wire to a common feedpoint and throwing the other end up into a tree. Attaching the 40-meter wire didn't affect the operation of the five helicals on the spring mount. Your results can be equal to those obtained with expensive commercial products.

The features I've tried to stress here are:

- Top loading has an advantage over middle or bottom loading.
- Top-of-vehicle mounting is superior to bumper mounting.
- Multiband operation is possible with one lead.
- Good efficiency occurs at low power.

But in the final analysis, great economy and the fun of building one's own equipment are probably the best features of all. **hr**

AMATEUR TELEVISION

SMILE! YOU'RE ON TV



See you in Dayton!

Only
\$329



Designed and built in the USA
Value + Quality
from over 25 years
in ATV...W6ORG

With our all in one box TC70-1, 70cm ATV Transceiver, you can easily transmit and receive live action color and sound video just like broadcast TV. Use any home TV camera or VCR by plugging the composite video and audio into the front VHS 10 pin or rear phono jacks. Add 70cm antenna, coax, 13.8 Vdc and TV set and you are on the air...it's that easy! TC70-1 has >1 watt p.e.p. with one xtal on 439.25, 434.0 or 426.25 MHz & properly matches Mirage D15, D24, D100 amps for 15, 50, or 70 watts. Hot GaAsfet downconverter varicap tunes whole 420-450 MHz band to your TV ch3. Shielded cabinet 7x7x2.5". Req. 13.8 VDC @ .5A. Transmitters sold only to licensed amateurs, for legal purposes, verified in the latest Callbook or send copy of new license. Call or write now for our complete ATV catalog including downconverters, transmitters, linear amps, and antennas for the 70, 33, & 23cm bands.

(818) 447-4565 m-f 8am-5:30pm pst.

Visa, MC, COD

P.C. ELECTRONICS

Tom (W6ORG)

2522 Paxson Ln Arcadia CA 91006

Maryann (WB6YSS)

✓ 113

NOW HEAR THIS

FINALLY!
High-Powered
Sound from
your HT.

- 10 DB of Audio Gain
- 3.5 inch Oval Speaker
- Automatic Shut-OFF
- Internal NiCad Charger
- External Power 5-15 VDC



Model HTS-1

Naval ELECTRONICS INC.

5417 Jet View Circle, Tampa, Florida 33634

Phone: (813) 885-6091 Telex: 289-237 (NAVL UR) Fax: (813) 885-3789

✓ 114

Design Curves For Loudness-compensated Volume Controls

Hams deal with AF problems on occasion. Once one of my ham friends complained about the trouble he had adjusting the loudness-compensated volume control in his homemade FM receiver. I decided to analyze and test a popular loudness-compensated volume control circuit and make a set of experimental curves demonstrating how and to what extent different components' values affect its performance.

This work, though tedious, is worthwhile as one can easily determine the proper values of circuit components in minutes.

It's known that the human ear is not equally responsive across the audio range. It's more sensitive to mid-frequencies than to the lower and

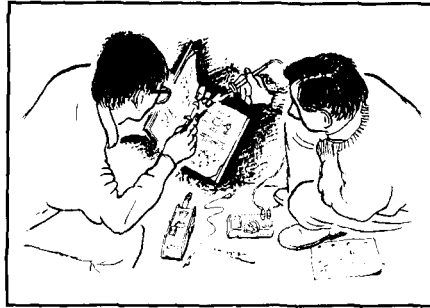

higher frequencies. This situation becomes more pronounced at low volume levels.

The equal loudness curves given in Figure 1 show the nonlinear frequency response of the ear. We see that for equal loudness the amplifier output at bass and treble frequencies should be greater than at mid-frequencies. So, for best reception of music or other signals with a wide frequency range, it's desirable to use a volume control with properly designed loudness-compensated characteristics. This means at low volume settings the amplifier output should be greater as frequency goes lower or higher from the mid-frequencies.

FIGURE 1

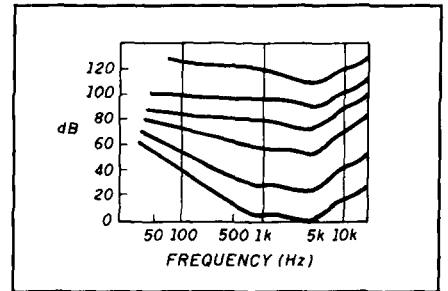

Equal loudness curves to human ear at different power levels.

FIGURE 2

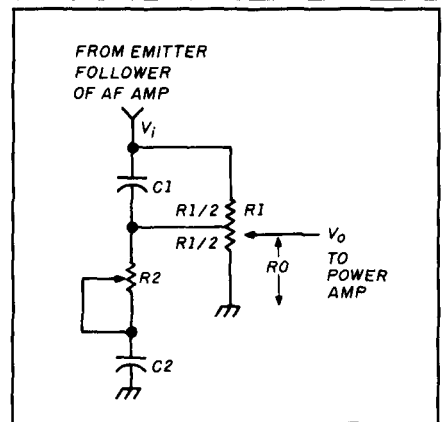

Loudness-compensated volume control circuit.

Circuit and working principle

The loudness-compensated volume control which I analyzed and tested is shown in Figure 2.

R_1 is a center-tapped pot. The combined impedance of C_1 in parallel with $R_1/2$, or R , decreases as frequency increases from the mid-frequencies, so the treble range is boosted. The combined impedance of C_2 in series with R_2 increases as frequency decreases from mid-frequencies, so bass frequencies are boosted.

Voltage transfer function of the loudness-compensated volume control

The voltage transfer function in dB of the loudness-compensated volume control through circuit analysis can be expressed as

A Digital Field Strength Meter

Here's an adapter that turns a digital voltmeter (DVM) into a field strength meter (see Figure 1). The DVM is well suited to the purpose because it's sensitive (down to 1 mV) and can detect slight changes in signal level (e.g., 0.1-percent change at 1 volt).

I built the adapter in a plastic film can. Banana plugs are epoxied into holes in the can so that the device plugs directly into the DVM. In operation the meter is set to the 2-volt DC range. The antenna is a short wire whip.

Parts aren't critical. The capacitor (0.1 μ F) is larger than usually used. Unlike a conventional meter, the DVM has no inherent damping action; if its input has an AC component, it refuses to settle on a definite reading. The larger value capacitor reduces this problem.

Michael A. Covington, N4TMI

FIGURE 1

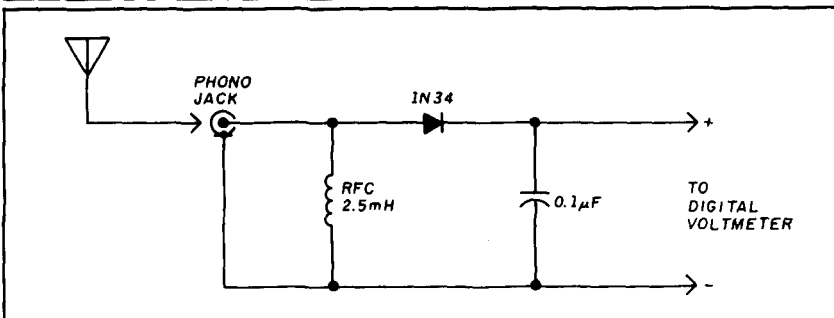

Schematic for a digital field strength meter.

ICOM

IC-24AT
IC-32AT

WE CHALLENGE YOU TO A DUAL.

ICOM'S DUAL BAND HANDHELDS

ICOM's IC-24AT and IC-32AT call you to action with the most feature packed, power packed dual band handhelds available. Whether you prefer the convenience of a mini-handheld or the grasp of a full-size handheld, ICOM has the dual-bander fit for you.

The IC-24AT mini-handheld and the IC-32AT give you full operation on the 2-meter and 440MHz amateur bands. Outstanding Performance!

POWER PACKED HANDHELDS.

The IC-24AT provides up to 5 watts on 2-meters and 440MHz with a 12V battery while the IC-32AT is 5 1/2 watts on 2-meters and 5 watts on 440MHz.

PLENTY OF MEMORIES. Store any frequency, Tx offset and subaudible tone in any memory. Total flexibility to meet your needs.

PROGRAMMABLE SCANNING. Both units scan band and memories plus offer easy memory lockout and instant memory recall.

PRIORITY WATCH. Monitor the call channel, a memory channel or all memory channels every five seconds while operating!

ADDITIONAL FEATURES INCLUDE: Battery saver, multi-function LCD readout, dial selectability and



DTMF pad for memory channel auto-patching. The compact light-weight IC-24AT also features a 24 hour clock with timer, and an autodialer. Access to multi-digit phone numbers at the touch of a button.

ACCESSORIES: The IC-24AT uses accessories from the "S" Series handhelds while the IC-32AT is compatible with all IC-2AT/02AT accessories. An optional UT-50 provides all subaudible tones while the optional UT-40 beeper silently monitors a busy channel for your calls. When the preprogrammed subaudible tone is received, the unit beeps and the LCD flashes. The dual is over, ICOM's IC-24AT mini-dual bander and IC-32AT full-size dual bander give you maximum performance in the package best suited for your needs. Check your local ICOM dealer for the finest dual banders available today. The ICOM IC-24AT and IC-32AT.

ICOM
First in Communications.

**KENWOOD
★SPECIAL★**

TS-140S
Price \$789
cash price

MA. ★

TEL-COM★

Electronic Communications

NEW ENGLAND'S FACTORY-
AUTHORIZED SALES & SERVICE
FOR

KENWOOD  **ICOM**

Also displaying the popular accessories needed to complete a HAM STATION . . .

- ARRL PUBLICATIONS • AEA PRODUCTS • AMPHENOL
- ALPHA DELTA • ASTRON • AUSTIN ANTENNAS • AVANTI
- BELDEN • BENCHER • B & W • DAIWA • ALINCO
- HUSTLER • KLM • LARSEN • MIRAGE • ROHN
- TELEX/HY-GAIN • TOKYO HY-POWER LABS
- TRAC KEYERS • VIBROPLEX • WELZ • ETC.

DIAMOND

- Power Meters
- Dry Loads
- Antennas
- Duplexers

OPEN SIX DAYS A WEEK   WELCOMED

Telephone 508/486-3400, 3040

675 Great Rd., (Rte. 119) Littleton, MA 01460

1 1/4 miles from Rte. 495 (Exit 31) toward Groton, Mass.

✓ 116

Improve Your World Image



PC HF FACSIMILE 4.0 \$99

A complete facsimile reception system for the IBM PC or Compatible. Receives up to 16 intensity levels.

Includes:

- | | |
|----------------|----------------------|
| Demodulator | 80 Page Manual |
| Software | Tutorial Cassette |
| Frequency List | Interpretation Guide |

Features:

- Print on Epson, or HP Laser Jet
- Disk Save, Zooming, Image processing
- Unattended Image Capture and much more

PC GOES/WEFAX \$250

Designed to receive images directly from U.S. and Soviet meteorological satellites. Includes all of the above feature plus a complete orbital tracking system and resolution of up to 256 gray levels.

Software Systems Consulting
150 Avenida Cabrillo, "C", San Clemente, CA 92672
(714)-498-5784

✓ 117

"GUARANTEED TO OUTPERFORM"
THEOR YOUR MONEY BACK!

HAM 10™

TEN METER HAM ANTENNA

The "Ham 10" ten meter antenna is designed and manufactured by American Antenna, makers of the world famous K40 Antenna. With a power handling capacity of 1500 watts and a band width of 1.5 mhz between 2:1 SWR points the "HAM 10" is the perfect compliment to all single-band ten meter rigs. The stainless steel base of the "HAM 10" is supplied with an adjustable trunk lip mount. Also available is an optional adaptable heavy duty magnamount.

EXCLUSIVE FEATURES:

- ① HANDLES UP TO 1500 WATTS!
- ② METALPLAS CONSTRUCTION.
- ③ 30° ROTATION OF BASE.
- ④ STAINLESS STEEL WHIP AND BASE.
- ⑤ MOUNTS ANYWHERE ON ANY VEHICLE!
- ⑥ FULLY ASSEMBLED WITH 18' OF RG-58 COAX.
- ⑦ COMPUTER DESIGNED ISOLATION CHAMBER.

For A Free Brochure, Call:

1-800-323-5608

IN IL. 1 800-942-8175

....(Or Write) AMERICAN ANTENNA 1500 EXECUTIVE DR. ELGIN, IL 60123

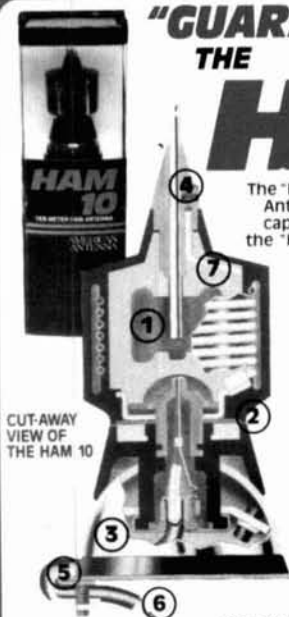

CUT-AWAY VIEW OF THE HAM 10

FIGURE 3

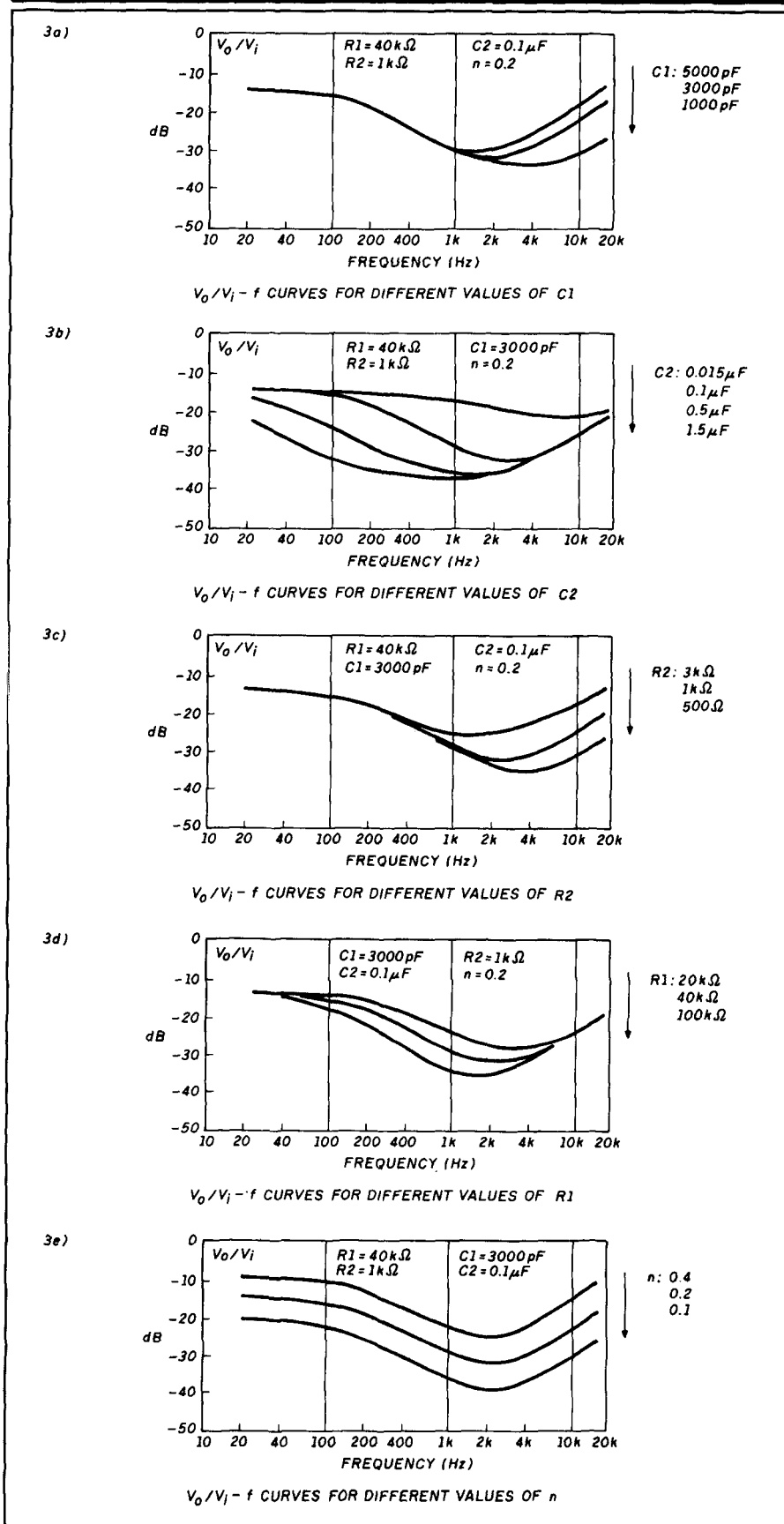

Voltage transfer function characteristics of the loudness-compensated volume control in Figure 2.

$$V_0/V_i =$$

$$20 \log \left[2n \sqrt{\frac{A^2 + B^2}{C^2 + D^2}} \right] \quad (1)$$

where

$$A = RR_2 - \frac{1}{4\pi^2 f^2 C_1 C_2}$$

$$B = R/2\pi f C_2 + R_2/2\pi f C_1$$

$$C = RR_2 - 1/2\pi^2 f^2 C_1 C_2$$

$$D = R(C_1 + C_2)/2\pi f C_1 C_2 + R_2/\pi f C_1$$

$$n = R_0/R_1, R = R_1/2$$

since we are only interested in the low volume case, for $n = 1/2$.

Experimental curves and conclusions

The loudness-compensated volume control was tested for its voltage transfer function as a function of frequency under various circuit conditions. The experimental curves are shown in Figures 3A through 3E.

All the experimental curves shown are in agreement with the computer data of the analytical expression, and give useful information about the effects of components values on the circuit performance.

These curves indicate that decreasing the value of C_1 will shift the minimum-output frequency (MOF) to the high frequency side and lower the output power in the high frequency range. The transfer function characteristics remain unaltered below mid-frequencies. Increasing the value of C_2 will mainly shift the MOF towards the low frequency side and lower the power output in the low frequency range. The transfer function characteristics remain basically the same above mid-frequencies if the value of C_2 is not too small.

Decreasing the value of R_2 shows somewhat the same effects as decreasing the value of C_1 . Increasing the value of R_1 shows somewhat the same effects as increasing the value of C_2 .

The following is a design example. With the component values shown in Figure 3E, the MOF is near 3 kHz. As the volume control is turned down, decreasing the value of n , both bass and treble are boosted.

Tseng C. Liao

SKYWAVE COMMUNICATIONS

PART 3

Predicting skywave propagation

By Cornell Drentea, WB3JZO

Casual short term propagation predictions for HF communications can be made through simple observations of sunspot activity. Do-it-yourself types can make visual inspections of the sun's surface, using amateur telescopes equipped with dark glass to count the number of spots. The data can be input to the smoothed solar flux formula:

$$SF = 63.7 + 0.73 R + 0.0009 R^2$$

where R is the relative number of spots and can be obtained from:

$$R = k (10g + f)$$

where g is the number of sunspot groups, f is total number of observed spots, and k is the observer difference factor.

The smoothed sunspot number is then obtained by calculating the monthly mean relative sunspot number, R_m , which is the monthly average of all daily numbers. Additional smoothing is obtained by averaging all monthly numbers into a 12-month average called R_s (relative sunspot) expressed by the following formula:

$$R_s = \frac{\frac{1}{2} R_{m1} + R_{m2} + R_{m3} + \dots + R_{m12} + \frac{1}{2} R_{m13}}{12}$$

When plotted, the smoothed solar flux value is an almost linear function of the smoothed number of sunspots as shown in Figure 1.

Sunspot observations started with Galileo in 1611. Recorded observations and the discovery of the 11-year cycle have been attributed to Hendrik Schwabe, a German pharmacist in the mid-1800s. Solar flux has been measured since 1947 by a Canadian observatory in Ottawa (readings are taken daily at 1700 UTC). Most of today's methods of measuring the sun flux use radio flux readings. In 1942 radar defense stations in Great Britain found that the relative

RF noise amplitude coming from the sun was representative of the sunspot activity. It was later decided that the radio noise received at 2,800 MHz (10.7 cm) correlates almost linearly with the number of sunspots present on the sun (as was discussed earlier). This is the preferred method of observation today. Although it's possible to build simple amateur radiometer receivers at this frequency, the information can also be obtained from the WWV* broadcasts at 18 minutes after the hour as part of the geophysical alerts (gealerts). WWV can be heard on 2.5, 5, 10, 15, and 20 MHz. Additional information in the bulletins deals with the estimated A-index, a measure of the earth's geomagnetic activity as impacted by the slowly arriving low energy protons

FIGURE 1

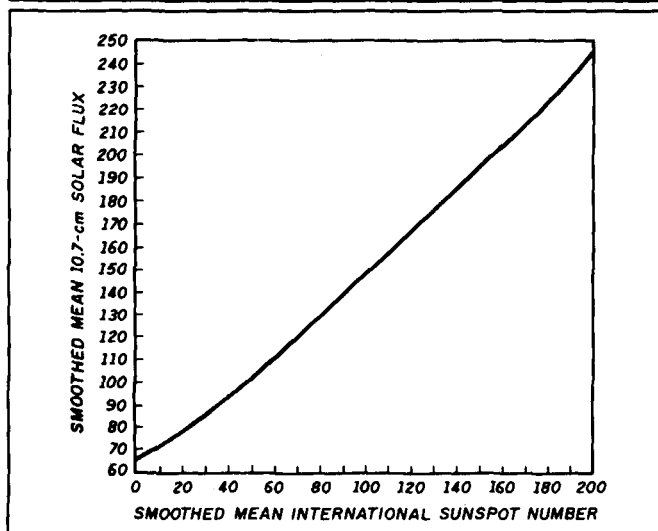

The solar flux is almost a linear function of the number of sunspots. In general, the higher the number of sunspots, the higher the probability of propagation through reflections and refractions in the F layer.

*WWV is operated by the Department of Commerce, National Oceanic and Atmospheric Administration, Environmental Research Laboratories in Boulder, Colorado. The stations are maintained at Ft. Collins, Colorado, and Kuaui, Hawaii.

and electrons. This data is collected daily at a midaltitude site, like Fredericksburg, Virginia. The K-index gives additional data. This is the value of geomagnetic activity taken at 3-hour intervals, given for Boulder, Colorado. The K-index correlates closely with the A-index, as shown in **Table 1**. **Table 2** shows the relationship of all elements in a WWV geoalert. The short term probability of propagation has been graded from 0 to 5, with 5 being the best.

Here are some real life examples. A typical geoalert announcement may sound something like this:

"The solar flux is 235
The A-index is 10
The K-index is 2"

What does this mean? From the information in **Table 2**, you'll see that with a solar index of 235, skywave propagation should be very good at the F layer level. However, with an A-index of 10 and a K-index of 2, **Table 2** indicates that the geomagnetic field is *unsettled*. This makes for a grade 4 short term probability (good to fair) of propagation.

Another example may sound like this:

"The solar flux is 221
The A-index is 4
The K-index is 1"

Looking at **Table 2**, you can see that the solar flux is high enough to allow for good to excellent conditions. With an A-index of 4 and a K-index of 1, a period of quiet geomagnetic activity is expected along with grade 5 (excellent) conditions. I chose the preceding two examples as actual real life situations and have verified them with expected results on the air. **Table 2** should be a useful tool to give you a good feel for short term propagation. A very simple program

TABLE 1

Correlation between the A-index and the K-index

A index	K index
0	0
3	1
7	2
15	3
27	4
48	5
80	6
140	7
240	8
400	9

could be devised for a programmable calculator or a computer using the algorithms shown.

In addition to these tools, the relative signal strength of WWV can also be a good indicator of immediate propagation conditions. A scan of these frequencies can reveal with some certainty what the MUF is at a given time.

Electromagnetic storm prediction

How can a geomagnetic storm be forecast? Immediately following a sun disturbance, a number of spots and consequent flares result. The number of flares varies from about 60 during the low part of the 11-year cycle to about 380 during the peak years. The flares produce a certain amount of ultraviolet and x-ray radiation which interacts with the ionosphere within 10 minutes of the outburst. This energy, together with the higher energy protons and alpha particles, plays an immediate role in ionizing all layers and providing

TABLE 2

Determining propagation from WWV. The propagation depends on the close relationship between the solar flux, the A-index, and the K-index, as shown. The probability of propagation is graded from 0 to 5 as follows:

- 0 = BLACKOUT
- 1 = VERY POOR
- 2 = POOR
- 3 = FAIR
- 4 = GOOD
- 5 = EXCELLENT

1. If solar flux ≤ 150 , probability of skip is poor to good.
2. If solar flux > 150 , probability of skip is good to excellent.
3. If the solar flux index is as in notes 1 and 2, and the A and K-indices are as below, propagation probability is:

If A-index is:	And K-index is:	Geomagnetic activity is:	Propagation probability grade is:
≤ 7	≤ 2	Quiet	5 +
> 7 but < 15	≤ 3	Unsettled	4
> 15 but < 30	≤ 4	Active	3
> 30 but < 50	$= 4$ or 5	Stormy (minor)	2
≥ 50	> 6	Stormy (major)	1
≥ 100	> 7	Stormy (severe)	0

good skywave communications — at least for a short time. If the solar storm is of sufficient intensity, the effect of the delayed particles discussed earlier produces quick recombinations in the D layer to a point of total RF energy absorption. This phenomenon usually happens 18 to 40 hours after the initial flare outburst and results in a total communications blackout. When this occurs, it is said that we are having a magnetic storm. The aurora phenomenon happens at the same time. In general, during periods of peak sun activity, a strong propagation outburst almost always culminates with a radio communication blackout.

Other tools for predicting skywave propagation

Among the more popular tools for predicting skywave propagation for the radio Amateur is a worldwide network of radio beacons on the 14 and 28-MHz bands. The most popular system operates at 14.1 MHz. Several beacons from various parts of the world transmit on the same frequency 24 hours a day at predetermined time intervals. They are time synchronized so that when one station ends its transmission, the next one starts up. To begin, each station identifies itself at a preset power of 100 watts for 9 seconds. Then a 9-second carrier transmission follows at 10 watts, another one at 1 watt, and another at 0.1 watt. The station resumes with a last 9-second transmission of identification at the original 100 watts. The next station in the cycle follows using the same procedure until all eight stations recycle.

By knowing the stations' QTHs and the particular power transmitted in the cycle, you can establish what direction the skywave propagation favors and the amount of power required to work in a particular direction. The stations are as follows:

Cycle no.	Call	Location
0	4U1UN/B	United Nations, New York
1	W6WX/B	Stanford University, California
2	KH6O/B	Honolulu, Hawaii
3	JA2IGY/B	Mt. Asama, Japan
4	4X6TU/B	Tel Aviv, Israel
5	OH2B	Helsinki, Finland
6	CT3B	Madeira Island
7	ZS6DN/B	Transvaal, South Africa

Each Station Cycle:

```

100 W ID 10 W CAR 1 W CAR 0.1 W CAR 100 W ID
:-----:-----:-----:-----:-----:
 9 Sec   9 Sec   9 Sec   9 Sec   9 Sec

```

While this method is an ideal indicator for propagation forecasting, it is unfortunate that HF packet has taken up the spectrum lately to well below 14.1 MHz (down to 14.095 MHz, to be exact), to the point that detecting these weak beacons may now require the most selective, crunch-proof receivers.

Computer programs

Various programs for predicting skywave communications are available for the radio Amateur and the professional alike. While most programs consider only the solar flux for determining propagation, a few use the A-index and

several other parameters to determine the proper conditions. As I discussed earlier, long term prediction algorithms are generally used to overcome the day-to-day variations caused by the irregular behavior of the solar wind and its interaction with the magnetosphere and the ionosphere. Because solar disturbances are unpredictable in themselves, most long term programs concentrate on a median value of these variations.

The programs mentioned here come in MS-DOS format for the IBM and compatibles. Some programs are also available for other formats. Here's a brief examination of some of these programs.

MINIMUMUF is an effective simple program which uses the solar activity, input as either the number of sunspots or as the solar flux, as its main parameter for determining the MUF. After you type in the month and day, the solar flux as given by WWV, and choose the target location from an optional menu, the program calculates and plots the MUF for that particular area on a vertical scale against a UTC time table. You can obtain a printed copy of the information indicating all data; this also includes the coordinates of your location (if properly entered) and the coordinates for the target location, along with the bearing in degrees for the short path. The range to the target in statute miles is also given.

BANDAID is a menu-driven program with two versions — simple and fast — which takes advantage of an 8087 coprocessor. After a "HI" greeting in CW, the program asks you to make a choice between MUF, sunrise and sunset information, QSL information, beacon information, and several other options. A graphic feature can quickly pinpoint the QTH of an unknown call on a world map. Solar flux information is simple to input. The program uses the A-index in addition to the solar flux. The output is a horizontal graph containing four plots as a function of time (local or GMT, and target). From top to bottom, they are:

1. Highest possible frequency, HFP
2. Maximum usable frequency, MUF
3. Frequency of optimum transmission, FOT
4. Lowest usable frequency, LUF

The plot also prints the target information, the bearing in degrees, the distance to the target in miles, the flux, and the A-index, along with a qualification of the ionospheric conditions at the time. **BANDAID** is a good overall propagation forecasting program.

MUFMAP will draw a customized world map showing the probability of communications with all areas of the globe at a particular time as a function of frequency and your QTH. Although it takes a little time to create a map (approximately 4 minutes on an XT), several maps for predetermined time intervals can be saved to a disk, and a **MUFMOVIE** of an entire period can be played back quickly. This program also uses the solar flux to determine propagation.

MINIPROP is one of the later programs. It is also menu driven, and accepts standard data like the solar flux. The date is directly input if the computer is equipped with time and date information. The program outputs an organized report showing coordinates, latitudes and longitudes of originating and target locations, and sunrise and sunset information. The report also includes grayline information for both locations, short and long paths in kilometers and miles, bearings from both QTHs, the number of possible

INTERNATIONAL RADIO AND COMPUTERS, INC.

OUR 11TH YEAR

★ SALES

Kenwood, Icom & Yaesu Equipment & most Amateur Radio Products! Icom authorized dealer!

★ SERVICE

Optimized Alignment Service Installation of IRCI & Fox Tango Crystal Filters

Enhancement Kits
Tuning Upgraders
Bank Controllers

We service what we Sell

SEE US AT
THE 1990 DAYTON
HAMVENTION
Booths 431 & 432

★ FILTERS

8 & 10 Pole International Radio & Fox Tango Crystal Filters for Icom, Kenwood, & Yaesu; F. Tango Filters also for Drake, Collins & Heath

★ NEWSLETTERS & PUBLICATIONS

Icom, Kenwood, Yaesu Separate Newsletters, just \$11.00 annually. Years of Back Issues, Back Issue Index - \$4.00. User's Supplements.

★ HAM-IBM COMPATIBLE COMPUTERS

FCC approved, starting at \$429.00.
IBM Ham Public Domain Software at \$5.00 per disk.

Send 65¢/SASE for FREE Amateur Radio 16 page Catalog of products & services available or complete software catalog. STATE WHICH!

SEND TO



INTERNATIONAL RADIO AND COMPUTERS, INC.

(407) 879-6868 FAX No. (407) 878-8856

751 South Macedo Blvd., Port St. Lucie, FL 34983
9:00 AM to 5:00 PM, Monday through Friday

✓ 121

DURA-FLEX® shock mounts silence spring-generated RF noise.



- **DURA-FLEX neoprene elastomer** significantly advances antenna shock absorption technology.
- **Eliminates RF noise** in duplex radio systems from metal-to-metal contact in conventional steel springs.
- **Drastically cuts whip vibration** which can damage or break antennas with steel springs on high-vibration vehicles.
- **Solid brass adaptors** molded into neoprene; braid totally isolated through center cavity.
- **Field-proven** against heat, cold, humidity and abrasion extremes.
- **Models** for roof, trunk or magnetic mounting. 2 meter, 220 MHz or UHF.

the antenna specialists co.



© Stripes of Quality
a member of The Allen Group Inc.
30500 Bruce Industrial Parkway
Cleveland, OH 44139-3996
216/349-8400, Telex: 4332133, Fax: 216/349-8407

"helping the world communicate"®

✓ 120

CUSTOM CRYSTALS

Crystals for many applications

For over 40 years, ICM has manufactured the finest in quartz crystals for every conceivable purpose.

A wide selection of holders are available to fit most any requirement. Our computer database contains crystal parameters for thousands of equipment types.

Need crystals for communications, telemetry, industrial, or scientific applications? Let ICM's sales department assist you to determine which type of crystal is best for you.

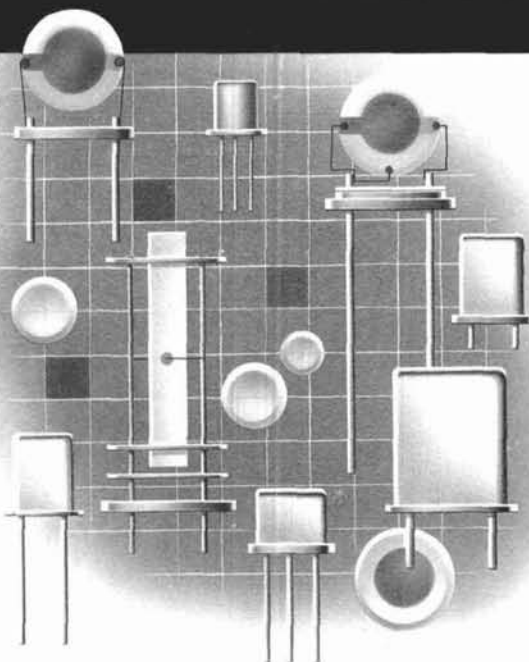

Can we solve your crystal problem?

For special purpose crystals, special holders, special sizes, call our crystal sales department. We will be pleased to provide recommended data.



International Crystal Manufacturing Co., Inc.

P.O. Box 26330, 701 W. Sheridan,
Oklahoma City, OK 73126-0330
Phone (405) 236-3741
Telex 747-147
Facsimile (405) 235-1904

hops, and several other parameters. The next screen outputs expected signal levels in dB over 0.5 mV at the frequencies (bands) of interest. Other information includes UTC and MUF data. The probability of propagation is coded with four distinctive degrees of reliability for ease of use. They are:

- A = 75 to 100 percent
- B = 50 to 75 percent
- C = 25 to 50 percent
- D = 1 to 25 percent

From another menu you can choose to graph, zoom, or print the data. The graph shows MUF (on vertical axis) against UTC (on horizontal). A selection from yet another menu lets you model a particular band with signal level expectations in dB above the 0.5 mV level. The coded probability indicated above is used throughout. The program identifies about 360 prefixes and has provisions for modifying the entries. Another feature is a DX compass which shows, in graph form, MUFs for UTCs entered. In other words, you can look at this feature as showing direction of band openings at a particular time.

IONSOUND is a newly introduced software tool which uses the sunspot number (or 2,800-MHz solar flux number). In addition to predicting propagation, it provides total end-to-end link reliability calculations in varied situations. It does this by considering signal-to-noise ratios which include an atmospheric noise model at the receiver location derived from ESSA-ERL-110-ITS-8. Also calculated are radiation elevation angles, E and F layer as well as mixed E/F modes, propagation delays, bearing/path distances, and TX/RX antenna elevation gains. The minimum number of hops is calculated for a given takeoff angle, and signal strengths are calculated using free space loss. The program accounts for polarization losses in the ionosphere and receive antennas, in addition to ground reflection losses. E and F layer absorption losses are used to determine the critical vertical frequency for the F2 layer; this in turn is used to calculate the oblique F2 frequency. Total link reliability is obtained by multiplication of the uncorrelated path availability and signal-to-noise availability. The final result is a simulated chirp plot showing propagation nodes and their bandwidths, along with a tabular output summary. The summary shows prediction of propagation anywhere from 1.8 to 30 MHz by considering such parameters as transmitter power, receiver bandwidth, transmitter and receiver antenna gains, and local noise conditions. The software is relatively low in cost and includes a 26-page manual on disk. It comes in both coprocessor (8087/287/387) and noncoprocessor versions. Text is supported in various color option selections (CGA, EGA, and VGA graphics).

IONCAP stands for Ionospheric Communications Analysis and Prediction. The program was initially designed for a mainframe computer and is coded in FORTRAN. A PC version, IONPC2.5, is now available. This particular program is used for determining the reliability of given paths under various conditions, rather than for casual forecasting. IONCAP is different from other programs in that it is oriented totally towards probability. All parameters have statistical distributions associated with them. In addition, prediction errors associated with the distributions can be determined. This means you can cite any confidence interval for which you want the predictions calculated.

An interface software package called NECDEC provides compatibility with the popular antenna analysis program, MININEC 3 (MN). To some extent, the original program follows the ANSI 66 Standard. NECDEC is produced in modular form; this allows any subsection to be upgraded without affecting the rest of the work. It is divided into seven independent subroutines.

Input. The input subroutines handle the input options. Along with input information, they contain numerical coefficients for ionospheric parameters and atmospheric noise, as well as tables of parameters for skywave circuit performance. Optional antenna parameters can be input via the program, even if they are obtained from a source other than MININEC.

Path geometry. The path geometry subroutines determine the areas of the ionosphere to be sampled, and evaluate the magnetic field at the sample areas.

Antenna. The antenna subroutines evaluate antenna gains and output antenna patterns.

Ionospheric parameter. The ionospheric parameter subroutines evaluate (in detail) electron density profiles of the D, E, F1, and F2 layers. Absorption equations using an empirical modification of the secant law are used in this part of the program.

MUF. The MUF subroutine is based on an electron density profile derived from monthly median parameters of the ionosphere.

System performance. The system performance subroutines evaluate the critical circuit performance parameters with two basic subroutines — one for shorter distances and one for longer. Among other factors considered are the general noise at the receiving site as combined with signal-to-noise statistics which determine the reliability of a skywave circuit.

Output. The output subroutines generate all output options required by the program.

IONCAP provides complex and comprehensive predictions of communications systems which consider large directional antenna systems, diversity reception for slow data, FSK or facsimile, and high powered transmitters. The program is intended for those concerned with maintaining adequate service (signal-to-noise ratios) at given geographical points over sustained periods of time during any sunspot conditions. IONCAP is advanced enough to allow for applications like back-to-back reuse of the same frequency spectrum (broadcasting two independent transmissions on the same frequency, but beamed to two different places on earth without interference to each other) or other forms of diversity. Advanced Amateurs may find this program of interest.

Conclusions

This three-part series was designed to provide more insight into the phenomenon of skywave communications. I hope that you find the information presented timely. My purpose was to clarify some of the many misconceptions about the ionosphere and the way HF communications interact. I have made an effort to present information on useful tools for maintaining reliable communications for both Amateur and professional operations. Because of space limitations, certain areas like selective fading, propagation via meteor scatter, radiation angle, multiple hop, and tropo scatter have been intentionally omitted. These articles were intended primarily to fill a certain gap in the literature by presenting information not found elsewhere. I would like to

New from AOR

**2000 Channels
5MHz to 2000MHz**

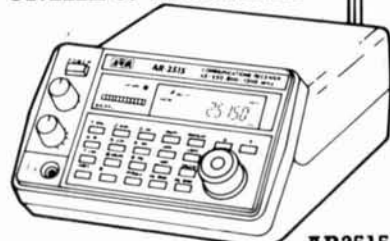

AR2515

- Covers 5MHz to 2000MHz in AM/FM/Wide FM modes. Continuous coverage
- 2000 Channel Memory 1984 Scan Frequencies & 16 Search Groups
- Scan/Search speeds up to 36 channels or increments per second
- Built in RS 232 computer interface
- 25 Day Satisfaction Guarantee. Full Refund if not Satisfied.
- Size: 3 1/2" H x 5 1/4" W x 7 1/4" D. Wt.: 2 lb. 10 oz.
- Supplied with AC & DC power cords. Telescopic antenna.

Total Price, Freight Prepaid (Express Shipping Optional)
*Upgrades of AR2002's to AR2515 specs Available

\$695.00



COMMUNICATIONS
10707 E. 106th St. Indpls., IN 46256

Toll Free 800-445-7717

Visa and MasterCard
(COD slightly higher)

In Indiana 317-849-2570 Collect FAX (317) 849-8794

161

NEW SUPER LONG PLAY TAPE RECORDERS

12 Hour Model — \$119.00*

Modified Panasonic Slimline, high quality, AC-DC Recorders provide 6 continuous hours of quality recording & playback on each side of cassette for a total of 12 hours.

- Built-in features include
- Voice level control
- Digital counter, etc.
- TDK DC 120 Cassette Furnished.



PHONE RECORDING ADAPTER

Records calls automatically. All Solid state connects to your telephone jack and tape recorder. Starts recording when phone is lifted. Stops when you hang up.

\$24.95*

FCC APPROVED

VOX VOICE ACTIVATED CONTROL SWITCH

Solid state. Self contained. Adjustable sensitivity. Voices or other sounds automatically activate and control recorder. Uses either recorder or remote mike. **\$28.50***

*Add for ship & hdlg. Phone Adapter & Vox \$1.50 ea. Recorders \$4.00 ea. Cal. Res. add tax. Mail order, VISA, M/C, COD's OK. Money Back Guarantee. Qty. disc. avail... Dealer inquiries invited. Free data.

AMC SALES INC. Dept. H. 9335 Lubec St., Box 928, Downey, CA 90241 Phone (213) 869-8519

160

When performance & price really count...



CRYSTEK CRYSTALS

The pulse of dependable communications

QUARTZ CRYSTALS FOR Industrial Equipment/Instrumentation

- Micro-processor control
- Computers/Modems
- Test/Measurement
- Medical

General Communications

- Channel element Service (VHF/UHF)
- Land Mobile 2-way
- Marine
- Aircraft
- Telemetry
- Monitors/Scanners/Pagers

Amateurs/2-Meter/General Coverage CB/Hobbyist/Experimenter

The Pulse of Dependable Communications...

Crystek Crystals offers their new 16 page FREE catalog of crystals and oscillators. Offering state of the art crystal components manufactured

For Optimum Stability and Reliability in Frequency Management

Custom Made Crystals Catalog

by the latest automated technology. Custom designed or "off the shelf." Crystek meets the need, worldwide. Write or call today!

CRYSTEK CORPORATION
DIVISION OF WHITEHALL CORPORATION

2351/2371 Crystal Drive • Ft. Myers, FL 33907
P.O. Box 06135 • Ft. Myers, FL 33906-6135

TOLL FREE 1-800-237-3061

PH 813-936-2109/TWX 510-951-7448/FAX 813-939-4226

TOLL FREE IN THE U.S.A. EXCEPT FLORIDA, ALASKA, HAWAII



NEW



SPECIAL INQUIRY & CRYSTAL CATALOG



Replacement Crystals Catalog

157



ICOM



VHF COMMUNICATIONS

SEE YOU IN DAYTON
BOOTH 310

9:00 am - 5:30 pm
weekdays
Weekends and evenings
by appointment.



280 Tiffany Avenue
Jamestown, New York 14701

Western New York's finest... amateur radio dealer!
1-800-752-8813 (For Orders Only)

158

108-1000 MHZ RADIO DIRECTION FINDING

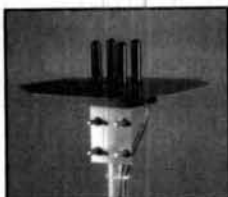

- ★ Interference Location
- ★ Stuck Microphones
- ★ Cable TV Leaks
- ★ ELT Search & Rescue

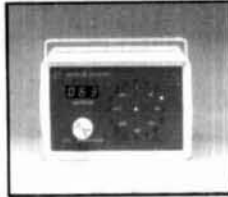

New Technology (patented) converts any VHF or UHF FM receiver into a sensitive Doppler shift radio direction finder. Simply plug into receiver's antenna and external speaker jacks. Models available with computer interface, synthesized speech, fixed site or mobile - 108 MHz to 1 GHz. Call or write for details.

DOPPLER SYSTEMS, INC.

P.O. Box 31819

Phoenix, AZ 85046

(602) 488-9755

FAX (602) 488-1295

160

159

BATTERIES "R" US...

You've bought our replacement batteries before...
NOW YOU CAN BUY DIRECT FROM US, THE MANUFACTURER!



ICOM
 CM2, BP2 7.2v @ 500MAH
 CM5, BP5 10.8v @ 500MAH
SUPER
 7S 13.2v @ 1200 MAH \$63.95
 8S 9.6V @ 1200 MAH \$59.95
 (base charge only-1" longer)
ICOM CHARGERS AVAILABLE

FOR ICOM: CONVERTIBLE BATTERY



8 Cells — Alkaline
 or NICAD Holder
 Complete with (8)
 Alkaline Batteries

\$26.00

BP-7
 13.2v @ 500MAH \$61.95
 13.2v @ 600MAH \$64.95
BP-8
 8.4v @ 800MAH \$61.95
 8.4v @ 1000MAH \$64.95



MAY SPECIAL ICOM LESS 10%

On all ICOM complete
 packs from published
 prices.

Look for JUNE's
 Special of the month.



**CUSTOM MADE BATTERY
 PACKS & INSERTS**
 Made to your specifications.
Introductory Offer!
KENWOOD INSERTS
 PB-21-\$13.75, PB-25-\$20.00,
 PB-26-\$20.00
ICOM INSERTS
 BP-5-\$23.00, BP-3-\$17.45,
 BP-7, BP-8



MasterCard and Visa
 cards accepted. NYS
 residents add 8 1/4%
 sales tax. Add \$3.50
 for postage and
 handling.



**SOURCE FOR ALL YOUR COMMUNICATION
 BATTERY REPLACEMENT NEEDS.**

W & W ASSOCIATES

29-11 Parsons Boulevard, Flushing, N.Y. 11354

WORLD WIDE DISTRIBUTORSHIPS AVAILABLE. PLEASE INQUIRE.

In U.S. & Canada Call Toll Free (800) 221-0732 • IN NYS (718) 961-2103 • Telex: 51060 16795 • FAX: (718) 461-1978

**MADE IN
 THE USA**

Send for free
 catalog &
 price list!

SIGNAL-TO-NOISE Voting Comparator



Improve coverage by adding receivers

- Expandable to 32 Channels
- Continuous Voting
- 19" Rack Mountable
- Select/Disable Switches for Manual Override
- Can be used with RF Links or Dedicated Lines
- LED Indicators
- Hundreds in Service
- More

—Competitively Priced—

For more information call or write:

Doug Hall Electronics

815 E. Hudson St.

Columbus, Ohio 43211 • (614) 261-8871

MICROWAVE ANTENNAS

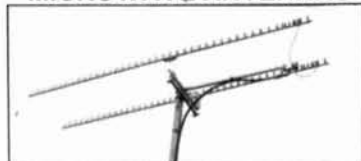

Loop Yagis, Power Dividers, Stacking Frames, Complete Array of 902, 910, 1269, 1296, 1691, 2304, 2401, 3456 MHz. For Tropo, EME, Weak Signal, OSCAR, ATV, Repeaters, WEFAX, Commercial point to point. Available in kit form or assembled and tested.

3333LYK	33el	loop Yagi Kit	902 MHz	18.5 dBi	\$89.00
2345LYK	45el	loop Yagi Kit	1296 MHz	21 dBi	\$89.00
2445LYK	45el	loop Yagi Kit	1269 MHz	21 dBi	\$89.00
1844LY	44el	loop Yagi (assem)	1691 MHz	21 dBi	\$99.00
2355LYK	55el	Superlooper Kit	1296 MHz	22 dBi	\$99.00
1345LYK	45el	loop Yagi Kit	2304 MHz	21 dBi	\$75.00
945LYK	45el	loop Yagi Kit	3456 MHz	21 dBi	\$75.00

Other models available. Call or write for catalog.

SEE YOU AT DAYTON 1990

DOWN EAST MICROWAVE

Bill Olson, W3HQT

Box 2310, RR1 Troy, ME 04987

(207) 948-3741

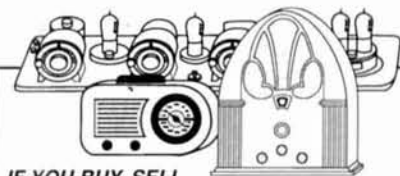

**IF YOU BUY, SELL
 OR COLLECT OLD RADIOS, YOU NEED...**

ANTIQUE RADIO CLASSIFIED

FREE SAMPLE COPY!

Antique Radio's Largest Monthly Magazine
 Classifieds - Ads for Parts & Services
 Articles - Auction Prices-Flea Market Info.
 Also: Early TV, Ham Equip., Books, Telegraph,
 Art Deco, 40's & 50's Radios & more...
 Free 20-word ad each month. Don't miss out!

6-Month Trial - \$11.

1-Year: \$20 (\$30 by 1st Class)

Foreign by air - Canada: \$32; Mexico: \$30; Other: \$60.

A.R.C., P.O. Box 802-A5, Carlisle, MA 01741

124

125

126

thank Dr. Mario Ierkic of the Arecibo Observatory, National Astronomy and Ionosphere Center; Dr. John Wolcott from the Los Alamos National Laboratory; Don Lucas, WØOMI, of Lucas Radio; and Jacob Handwerker, W1FM, for their inputs to these articles. Also many thanks to Bonnie Horishnyk; Rick Whiting, WØTN; and Earl Johnson, NØDTK, for reviewing this material. 

BIBLIOGRAPHY

1. D.R. Dorsey, Jr. "Radio-wave Propagation—A Tutorial." *Proceedings of the RF technology Expo 88*, Anaheim, California.
2. Lucien Boithias. *Radiowave Propagation*, McGraw-Hill Book Company, 1987.
3. "Estimating the Performance of Telecommunication Systems Using the Ionospheric Transmission Channel." NTIA Report 83-127, U.S. Department of Commerce.
4. "World Distribution and Characteristics of Atmospheric Radio Noise." International Telecommunications Union, NTIS Report 255-060, U.S. Department of Commerce.
5. Stephen W. Hawking, *A Brief History of Time*, Bantam Books, 1988.
6. *The Arecibo Observatory Publication*, National Astronomy and Ionosphere Center, Cornell University.
7. *NBS Special Publication 432*, NBS Time and Frequency Dissemination Services, U.S. Department of Commerce, National Bureau of Standards.
8. A. Wilmer Duff, *A Text-Book of Physics*, P. Blakiston's Son & Company, 1908.

JOB OPPORTUNITY

WORK FOR KENWOOD

Kenwood USA Corporation, the number one manufacturer of Amateur Radio equipment, is looking for a dynamic, outgoing individual to join the Amateur Radio Division sales team. Excellent communications skills, both written and telephone, are an absolute must. Duties include extensive convention travel and dealer sales working out of the California office. Must hold a valid Amateur Radio license. Excellent salary and benefits package. Send resume with salary history and requirements to:

Kenwood USA

ATTN: Wayne Yoshida
Communications and Test Equipment Group
P.O. Box 22745
Long Beach, CA 90801

EOE NON-SMOKING ENVIRONMENT

SATELLITE ESSENTIALS

Satellite TV is still full of the wonderment that made it so popular in the early '80s. The tinkerers are there, the programming is there, and never has the cost of becoming a dish owner been so low.

So, how do you find out about this exciting entertainment?

Through publications devoted specifically to satellite TV, that's how!

OnSat

America's Weekly Guide To Satellite TV

OnSat is unsurpassed for the most up-to-date listings of satellite programming. Dr. Dish, Mailbag, and the Transponder Service Watch are all geared to help you make the best use of your satellite TV system. A sample issue can be obtained for only \$1.

STV GUIDE

The Complete Monthly Guide To Satellite TV

STV Guide contains over 300 pages of programming information, product reviews, home troubleshooting, and information about satellite TV. A sample issue can be obtained for only \$2.

Both OnSat and STV Guide contain listings for over 120 channels and Prime Time Grids for over 50 channels. Subscribe to either the weekly OnSat or the monthly STV Guide for only \$48 per year.

To start receiving the best in satellite TV guides and information, call toll-free (800) 234-0021. VISA® and MasterCard® accepted.

STV Guide/OnSat
PO Box 2384 • Shelby, NC 28151-2384

THE BI-SQUARE ARRAY

Old favorite works wonders on new 17-meter band

By C. Drayton Cooper, N4LBJ, P.O. Box 5, Bowling Green, South Carolina 29703

Interest in antenna experimentation has always been high among Amateurs. Now that the 17-meter band is open to United States operators, more and more of us are concerned with erecting antennas designed to operate on this band. As DX competition increases, we are becoming more concerned with building antennas that will provide some gain and directivity.

There are a number of us who don't have the resources needed to reproduce the great, world-beating antenna systems of ham legends like W6AM or W4BPD. These giants

had acres of rhombics, V beams, and Sterba curtains. But there is an antenna that's functional on three bands, provides modest gain, directivity, is easy to put up, and requires only one support.

The antenna is the bi-square array. Don't look for this antenna in the modern literature; your search will be in vain. Contemporary publications have long since dropped it from their repertoire, but the older books describe it in their sections on collinear, phased antennas.

The bi-square antenna

Don't be misled by the commercial antenna with the same name. There is a company producing an antenna called the "bi-square," but it's a mini-bobtail curtain — not the traditional bi-square array. The traditional bi-square can be described briefly as a vertically polarized, 2-wavelength open loop, fed with open wire line or ladderline (see Figure 1). The antenna is somewhat more sophisticated than this description may lead you to believe. It operates as four collinear elements with each pair of elements in phase, yielding useful gain and broadside directivity on its design frequency.

It can be suspended from a central vertical support, much like an inverted V or "quad loop." The older literature presumed this to be a pole, or other nonconductive support. But most of us would hang it, as I have, from a tower. The fact that the tower is conductive seems to have little effect on my antenna.

One of the more interesting features of the bi-square array is that it's useful over about a 2:1 frequency range. It's been my experience that my 17-meter bi-square performs very nicely on both 20 and 15 meters. I've made numerous DX contacts on all three bands. Signal reports from the southeast United States to Europe on 17 meters are running 1 to

FIGURE 1

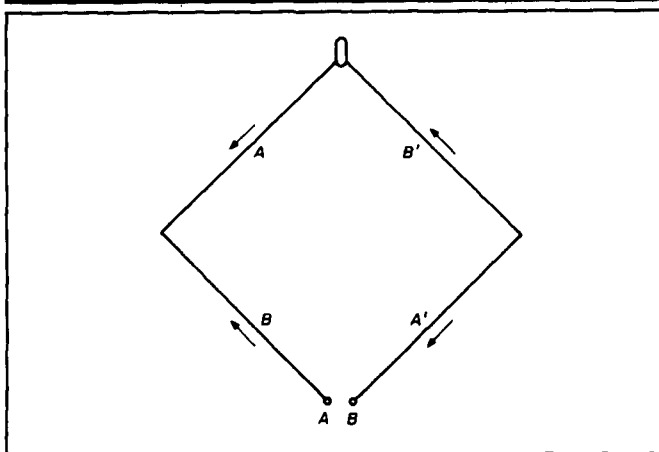

Because current flow reverses at half-wave points, elements A and A' are in phase. Elements B and B' are also in phase. In essence, this is a "harmonic antenna" which is end fed and cut to operate on the second harmonic. Essentially it is a 2-wavelength dipole folded back on itself.

**TE
SYSTEMS****RF POWER AMPLIFIERS**

NEW!

400 WATTS
(144-148 MHz)

TE SYSTEMS new HPA Series of high power amplifiers now available through select national distributors.

All amplifiers are linear (all-mode), automatic T/R switching, and incorporate optional GaAs FET preamp. Amps are usable with a wide input drive level range. Thermal shutdown protection and remote control capability included. All units are designed to ICAS ratings and meet FCC part 97 regulations. Approx. size is 2.8 x 10 x 11.5" and weight is 8 lbs.

Consult your local dealer or send directly for further product information.

SPECIFICATIONS

Model	Freq. MHz	Power Input	Power Output	Preamp NF-dB	Preamp Gain-dB	DC +Vdc	Power A	RF Conn.
0550G	50-54	10	400	.6	15	13.6	60	UHF
0552G	50-54	25	400	.6	15	13.6	55	UHF
1450G	144-148	10	400	.6	15	13.6	54	UHF
1452G	144-148	25	400	.6	15	13.6	50	UHF
2252G	220-225	25	220	.7	14	13.6	36	UHF
4450G	420-450	10	175	1.1	12	13.6	34	N
4452G	420-450	25	175	1.1	12	13.6	29	N

Models also available without GaAs FET preamp (delete G suffix on model #). All units cover full amateur band - specify 10 MHz bandwidth for 420-450 MHz amplifier. Continuous duty repeater amps also available.

Amplifier capabilities: 100-200 MHz, 225-400 MHz, 1-2 GHz, Military (28V), Commercial, etc. also available - consult factory.

**TE
SYSTEMS****TE SYSTEMS**

P.O. Box 25845
Los Angeles, CA 90025
(213) 478-0591

✓ 127



Factory Authorized Dealer & Service For

**KENWOOD
YAESU
ICOM**

Call Us For
Great Prices & Great Service

TOLL FREE ORDER LINE 1-800-344-3144
Continental U.S. & Texas

KCONAM, INC. THE HAM CENTER
SAN ANTONIO, TEXAS
SALES AMATEUR RADIO SERVICE
5707A Mobad San Antonio, Texas 78238 (512) 680-6110
FAX (512) 647-8007

✓ 128

R-4C Enhancements**MIX-4 Solid State R-4C 3rd Mixer**

The Solution to the One Remaining Problem with
the Drake / Sherwood R-4C

Noisy 6EJ7 third-mixer tubes have plagued R-4C owners for years. Eliminate frying, crackling, microphonics, and power-line buzz with our newest PC-board module. Easy to install in any R-4C.

Introduced & sold out at '89 Dayton Hamvention.®

Mobiler's Dream!

Can you use a 6 dB stronger signal? Would an additional 50% more bandwidth be helpful? Our SE-40 mobile antenna is the answer. Handles 600 watts for another 6 dB. SE-40, 40 - 10 meters; SE-75, 75 - 15 meters; SE-160, 160 - 20 meters.

Sherwood Engineering Inc.

1268 South Ogden Street, Denver, CO 80210
(303) 722-2257 Monday - Friday 9 A.M. - 5 P.M.

CABLE TV CONVERTERS

Why Pay A High Monthly Fee?
Save \$100's A Year

- All Jerrold, Oak, Hamlin, Zenith, Scientific Atlanta, and more.
- 60 Day Money Back Guarantee
- Shipment within 24 hours
- Visa/MC and C.O.D.

WE WILL BEAT ANYONE'S PRICE
No Illinois Orders Accepted

Electronic Engineering

P.O. Box 337, Barrington, IL 60011

FREE CATALOG

1-800-542-9425

INFORMATION

1-708-540-1106

✓ 129

FIGURE 2

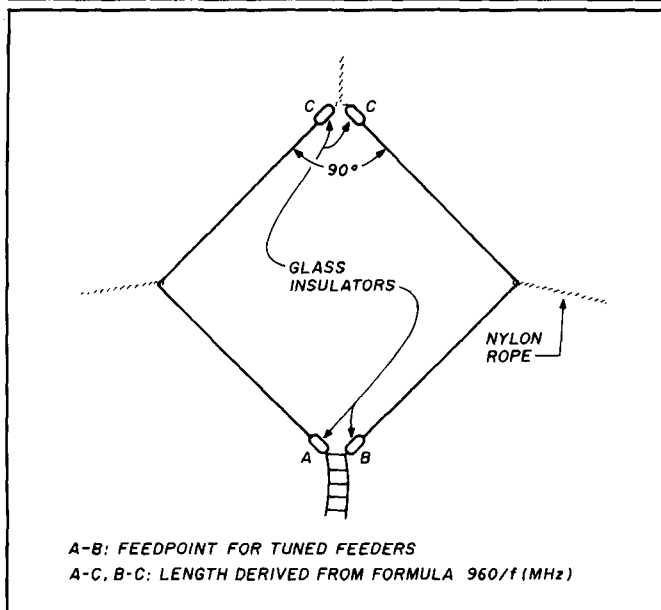

Antenna performs best when feedpoint is about 1/4 to 1/2 wavelength above ground. Performance is adequate and acceptable at lower heights, down to about 3 to 5 feet above ground.

FIGURE 3

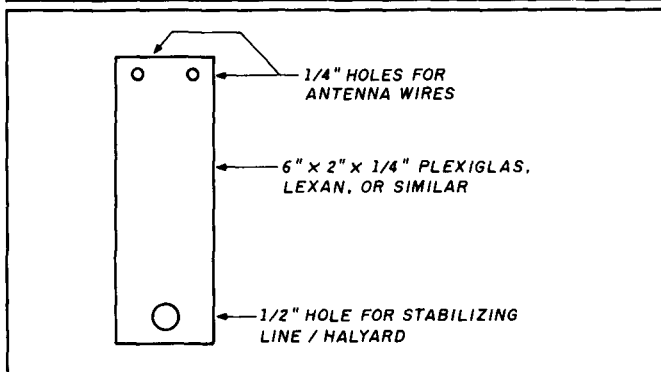

Good insulators can be made from a piece of Plexiglas™, Lexan™, or similar material cut to the dimensions indicated.

2 S-units better than they did on my 17-meter delta loop. I've noted a similar increase in signal strength on the African path as well.

I think it's safe to assume that the gain over a dipole would be on the order of 4 to 5 dB. Figures for the Lazy-H antenna, from which the bi-square array is directly derived, are on the order of 3.5 to 6.6 dB theoretical — depending on element spacing and height above ground. Bi-square array element spacing is on the order of 5/8 wavelength. If I'm correct in my assumptions, this would yield about 4 to 5 dB of gain.

Assembling a bi-square antenna

My self-supporting tower is 65 feet tall. At the top of the tower a yardarm extends out 3 feet on either side. A solid brass pulley with a halyard is mounted on this yardarm. In

a vintage edition of *The ARRL Antenna Handbook*, I found the formula for element length for the bi-square antenna. Using this formula, $960/\text{frequency (MHz)}$, I cut two 53-foot lengths of antenna wire for a full wavelength at 18.1 MHz. I tied two glass insulators to the halyard and connected one end of each antenna wire to these insulators (see Figure 2). I secured nylon ropes to the halfway points of both wires to serve as spreaders, and to form the diamond configuration once the antenna is pulled into the air. At the bottoms of the wires, or feedpoint, I joined two more glass insulators with a short piece of nylon rope. Figure 3 shows homemade insulators that you may use instead of glass insulators. Finally, I attached a stabilizing line to the bottom pair of insulators and pulled the whole assembly up. When I was satisfied with the overall "look" of the antenna — that it was squared up by the side ropes, and was hanging vertically and stable with the bottom stabilizing line fairly taut — I lowered it and attached the feedline.

This antenna requires balanced feedline. Years ago I used homebrew 600-ohm open wire, but today I use commercially available 450-ohm insulated ladderline. One side of the feedline is soldered to one side of the antenna; the other side is soldered to the opposite side of the antenna. When you've made these connections, hoist the antenna back into position. The bi-square array is ready to use!

Results

I was surprised to find that I received markedly better reports than I had with my previous antennas on the first day I used the bi-square antenna. I had been getting 559/569 reports from Europe on other antennas. Yet on the bi-square, broadside in that direction (as was my delta loop), the reports are consistently 569/599. Performance is good on 20 meters, but here the antenna becomes more of an "end fire" array with signal concentration in the plane of the antenna, rather than through it. I work Asiatic Russians (UA9, UA0) easily with consistent 589/599 reports. The antenna also works well on 15 meters, but since that band has never been one of my favorites, I haven't run comparative tests on it.

As a passing note, I suggest you listen for N4SU on 30, 40, and 20 meters. Dave runs bi-square arrays on these bands with excellent signal strengths. His system consists of two arrays, 90 degrees apart, with a switching arrangement that lets him broadside his signals north/south or east/west.

It's also possible (if you have the room) to use bi-square arrays in a parasitic setup. A second array, spaced 20'6" apart (for 17 meters) from the driven array, is tuned either as a director or reflector. Several of the older antenna publications describe an L/C network to tune the parasitic array.

Once you've established parasitic element tuning for director/reflector status, you can insert a simple remote SPST switch in the network, controlled from the operating position, which enables the antenna to fire in either direction. A remotely switched tuning stub on the parasitic element could give you the same results.

The advantages of the bi-square array are its low cost, gain, directivity, and ease of assembly. And, should you use one, you can be certain of having a built-in topic of conversation on your contacts. Everyone you work, with the possible exception of some old-timers with long memories, is going to ask, "What in the world is a bi-square array?" 

The World Famous
MOSLEY MODEL TA-33M
 YOU CAN CHANGE YOUR
 TA-33 TO A TA-34!!

NEW! **MOSLEY TA-34M**

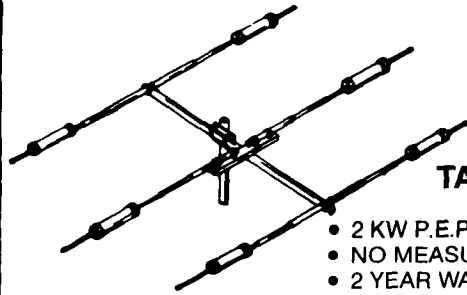

TA33/34 FEATURES

- 2 KW P.E.P.
- NO MEASURING
- 2 YEAR WARRANTY
- EASY, ASSEMBLY
- ALL STAINLESS STEEL HARDWARE
- CAN ADD 40 or 30 METERS
- LOW SWR

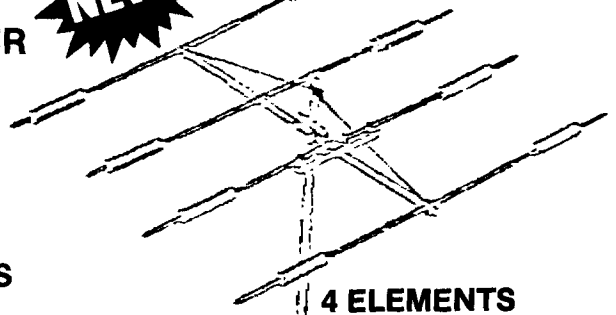

4 ELEMENTS
ALL ACTIVE ON 10/15/20
Specifications:

- Boom: 21'
- Turning Radius: 17' 9"
- Wt: 58 lbs.
- Sq. Ft.: 6.9
- Windload: 164 lbs.
- Power: 2.5 KW P.E.P.

SWR/Frequency Curves

Model TA-33

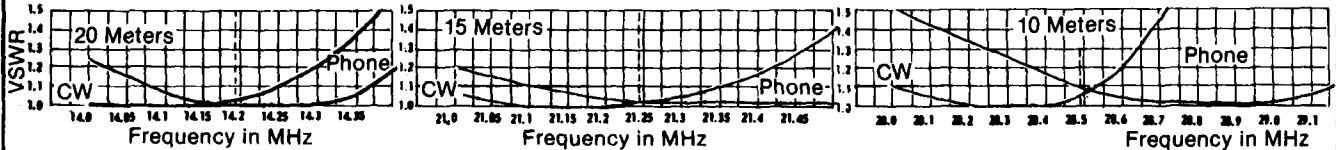

TA-34-XL uses a 2" heavy duty boom. Heavy duty hardware. No strut. Performance and specification the same. XL total weight 65 lbs.

MOSLEY

PRO-57-A
& PRO-67-A

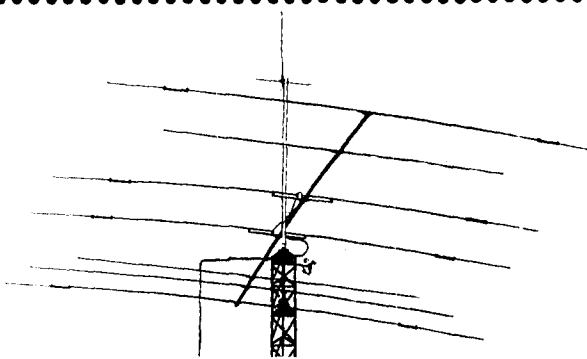

PRO-57-A & PRO-67-A FEATURES

- Covers 10/12/15/17/20 Meters
- PRO-67 has 2 Elements or 40 Meters
- Monobander Performance or 20/17/15/12/10
- 7 Elements on a 24 Foot Boom
- 2.5 KW DC-CW, 5 KW PEP-SSB
- PRO-57-A — VSWR 1.5:1 or Better!
- Easy Assembly, NO MEASURING!!!!
- Very Rugged Construction
- All Stainless Hardware Standard
- 2 Year Warranty

PURCHASE MOSLEY
 ANTENNAS DIRECT
 FROM THE FACTORY.
 FOR A FREE CATALOG
 ON OUR COMPLETE
 LINE OF ANTENNAS OR
 TO ORDER, PLEASE
 CALL OR WRITE.

Check out these **SUPER SAVERS.**

ANTENNA	REG.	SALE
TA-31-JR-M	\$119.95	\$ 84.95
TA-31-M	119.95	89.95
TA-33-JR-M	249.95	189.95
TA-33-M	342.95	252.95
TA-34-M	464.95	330.95
TA-34-XL	579.95	419.95
TA-40-KR	149.95	89.95
CL-33-M	449.95	318.95
CL-36-M	615.95	469.95
PRO-57	669.95	495.95
PRO-67	829.95	625.95
NEW WARC BANDS		
FULL SIZE MONO AND DUAL BAND!		
YB-12-A	\$239.95	\$156.95
YB-17-A	362.95	263.95
YB-23-A 12 & 17 Meters	439.95	356.95

SALE PRICES GOOD
THROUGH JUNE 15, 1990

To Order Call...
1-800-325-4016
 For Technical Info...
1-314-994-7872

PLUS SHIPPING/HANDLING INSURANCE

The 5th DECADE of
OUTSTANDING PERFORMANCE
 with **MOSLEY ANTENNAS**



1344 BAUR BOULEVARD, ST. LOUIS, MO 63132

NOW ALL THESE ANTENNAS ARE UPS SHIPPABLE

DID YOU KNOW THAT
ALL OF OUR ANTENNAS

- Are Hand-Crafted
- Have All Stainless Hardware Standard
- Use Seamless Aircraft Grade Aluminum
- Are Color-Coded and Pre-Drilled — No Measuring Required for Assembly
- Come with a 2 Year Warranty

For A HRO 72 Page
Communication Equipment Catalog
Send \$1.00 to any HRO Store

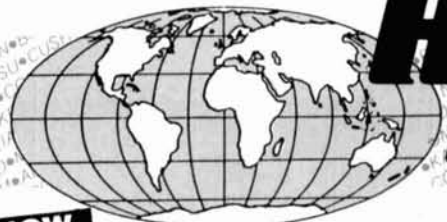

HAM RADIO OUTLET

LARGEST HAM OUTLET IN THE WORLD

NOW

9 STORE BUYING POWER

ICOM IC-765



100W GENERAL COVERAGE RECEIVER
HF ALL BAND TRANSCEIVER
Maximum Operation Flexibility

SALE! CALL FOR PRICE

ICOM IC-781



THE ULTIMATE
150 W, ALL BAND
HF TRANSCEIVER

GREAT PRICE!

ICOM IC-901

FIBER OPTIC
MULTI-BAND
TRANSCEIVER



2 METER AND 440 MHz
EXTRA-LARGE MULTI COLOR LCD
HM14 TOUCH TONE MICROPHONE

CALL FOR PRICE

ICOM A Models 25 WATTS
H Models 100 WATTS
IC-275A/275H, 138-174 MHz
IC-375A, 220 MHz
IC-475A/475H, 430-450 MHz



LOW PRICE!

HAM RADIO OUTLET NATIONWIDE TEAM



**RAPID DELIVERIES
FROM STORE NEAREST YOU**

ICOM HAND-HELD VHF/UHF



IC-32AT Dual Band Hand Held
IC-2GAT 2 Meter HT 7 WATT
IC-2SAT, 2MTR
IC-3SAT, 220 MHz
IC-4SAT, 440 MHz

ICOM IC-2400A

2m, 440 MHz



VHF/UHF DUAL BAND
FM TRANSCEIVER

ICOM IC-228A/H 2 METER MOBILES IC-448A 440 MHz MOBILE



FM TRANSCEIVER
20 Memories with Memory
Channel Lock-Out.

ICOM IC-725



100W GENERAL COVERAGE RECEIVER
HF ALL BAND COMPACT TRANSCEIVER

GREAT PRICE



Bob Ferrero W6RJ
President/Owner
Jim Rafferty N6RJ
VP-National
Sales Manager

ANAHEIM, CA 92801
2620 W. La Palma
(714) 761-3033, (213) 860-2040
Between Disneyland &
Knotts Berry Farm

ATLANTA, GA 30340
6071 Buford Hwy.
(404) 263-0700
Larry, Mgr. WD4AGW
Doraville, 1 mi. north of I-285

BURLINGAME, CA 94010
999 Howard Ave.
(415) 342-5757
George, Mgr. WB6DSV
5 miles south on 101 from SFO

OAKLAND, CA 94606
2210 Livingston St.
(415) 534-5757
Rich, Mgr. WA9WYB
IS-880 at 23rd Ave. Ramp

PHOENIX, AZ 85015
1702 W. Camelback Rd.
(602) 242-3515
Gary WB7SLY, Mgr.
East of Hwy. 17

SALEM, NH 03079
224 N. Broadway
1-800-444-0047
Curtis, Mgr. WB4KZL
28 miles north of Boston exit 1 I-93

SAN DIEGO, CA 92123
5375 Kearny Villa Rd.
(619) 560-4900
Tom, Mgr. KM6K
Hwy. 163 & Claremont Mesa Blvd.

WOODBRIIDGE, VA 22191
14803 Build America Drive
(703) 643-1063 1-800-444-4799
Linda, Mgr. KB4ZYT
Exit 54, I-95 South to US RT 1

FREE SHIPMENT
Most items over \$100
UPS surface

WALK IN STORE HOURS
10 AM-5:30 PM
CLOSED SUNDAYS

VAN NUYS, CA 91411
6265 Sepulveda Blvd.
(818) 988-2212
Al, Mgr. KBYRA
San Diego Fwy. at Victory Blvd.

CALL TOLL FREE

(FROM MOST AREA'S)

INSIDE CALIFORNIA CALL STORE NEAREST YOU

Call any of our 800 numbers coast to coast from most parts of the country..

MID-WEST/WEST

ANAHEIM, 9 to 5:30 PST

1-800-854-6046

SOUTHEAST

ATLANTA, 9 to 5:30 EST

1-800-444-7927

MID-ATLANTIC

WOODBRIIDGE, 9 to 5:30 EST

1-800-444-4799

NEW ENGLAND

SALEM, 9 to 5:30 EST

1-800-444-0047



Toll free including Hawaii. Local phone hours: 9:30 AM to 5:30 PM, Arizona, California, and Georgia customers call or visit nearest store. Arizona, California, Georgia and Virginia residents please add sales tax. Prices, specifications, descriptions subject to change without notice.

Japan Radio JST-135 Transceiver



The Japan Radio Company JST-135 is a commercial grade transceiver for the discriminating amateur. The attention given to design detail is truly exceptional. The JRC engineers have constructed the JST-135 to the highest standards, not down to a price. This transceiver's all-modular construction along with its advanced features, simply cannot be duplicated in other models. It is impossible to fully describe this product in a few short words. Please contact Universal to receive full information in the mail as well as current pricing.

Huge New 1990 Catalog

The new Universal 88 page communications catalog covers everything that is new for the amateur, shortwave listener and scanner enthusiast. Equipment, antennas, books and accessories are all shown with prices. Available for \$1 postpaid.

Universal Radio
1280 Aida Dr. Dept. HR
Reynoldsburg, OH 43068
Toll Free: 800 431-3939
In Ohio: 614 866-4267

Universal has been serving radio enthusiasts since 1942. Visit our large showroom east of Columbus, Ohio.

W6SAI BOOKS

by noted HR columnist Bill Orr, W6SAI.

BEAM ANTENNA HANDBOOK

All the latest computer generated information on beam antenna design. Includes WARC band antennas as well as all other HF bands. 286 pages ©1985 revised 1st edition.

RP-BA

Softbound \$11.95

ALL ABOUT VERTICAL ANTENNAS

Theory, design, construction and operation are fully covered for vertical antennas. Grounds and their importance get extra emphasis. Construction data for 25+ antenna designs. 192 pages ©1986 1st edition

RP-VA

Softbound \$10.95

THE RADIO AMATEUR ANTENNA HANDBOOK

Covers all kinds of antennas from HF to VHF, horizontal to vertical. Compiled from years of W6SAI's extensive writings. Great reference volume to have on hand. Chock full of proven antenna designs that work! 190 pages ©1978 1st edition

RP-AH

Softbound \$11.95

WIRE ANTENNA HANDBOOK

Many hams favor the simplicity of wire antennas — all you need are a few trees, a hank of wire and you're ready to go. Full of simple to build antennas that give good on-the-air results. 189 pages © 1972 1st edition

RP-WA

Softbound \$11.95

ALL ABOUT CUBICAL QUADS

Some feel the strange shaped quad is the ultimate DX'er's antenna. This book solves the mystery and shows you how easy it is to build an effective DX'er's antenna. 110 pages ©1972 1st edition

RP-CQ

Softbound \$9.95

Please enclose \$3.75 shipping and handling

HAM RADIO

Greenville, N.H. 03048



Order today! (603) 878-1441
or *FAX* us (603) 878-1951

NUTS & VOLTS

MAGAZINE

P.O. Box 1111-H
PLACENTIA, CA 92670
714-632-7721



Ham Radio
Computer Hardware
Computer Software
Plans-Kits
Schematics
Test Equipment
CB Gear
Satellite TV
Video
Components
Antique Electronics
Cable TV
Publications
Repairs-Services
New Products
Events Calendar

IF YOU ARE INTO ELECTRONICS AND SAVING MONEY IS IMPORTANT TO YOU, THEN YOU OWE IT TO YOURSELF TO TRY NUTS & VOLTS MAGAZINE. DISCOVER WHY THOUSANDS OF SMART PEOPLE NATIONWIDE TURN TO NUTS & VOLTS EACH MONTH TO MEET THEIR ELECTRONIC NEEDS. WHETHER YOU'RE BUYING, SELLING, OR JUST TRYING TO LOCATE THOSE UNIQUE OR HARD-TO-FIND ITEMS, FIND OUT HOW NUTS & VOLTS CAN HELP!

SUBSCRIBE TODAY!

CHECK MONEY ORDER VISA MC

Name _____

Address _____

City _____

State _____ Zip _____

Card No. _____ Exp. Date _____

CALL FOR ADVERTISING INFORMATION
DISTRIBUTOR INQUIRIES INVITED

Subscription Rates

U.S. FUNDS REQUIRED

3rd Class Mail - USA

One Year \$12.00
Two Years \$21.00
Lifetime \$60.00

1st Class Mail

One Year - USA \$20.00
Canada & Mexico \$22.00

Air Mail

Foreign - 1 Year \$55.00

Includes one FREE 40-word
Classified Ad

Toll Free ORDERS Only Line
1-800-783-4624

A National Publication For The Buying And Selling Of Electronic Equipment

NONRESONANT DELTA AND V BEAM ANTENNAS

By Robert Wilson, KL7ISA, 115 Dogwood Trail, Leesburg, Florida 34748

Nonresonant antennas have great appeal. They're effective on all frequencies, simple, and inexpensive. The Army uses sloping V antennas for tactical operations because they're nearly foolproof. Vertical half-rhombic antennas are also part of the Army inventory, and are often advertised in ham journals. The Voice of America uses nonresonant rhombics and sloping Vs because of their wide flexibility. Amateurs can benefit from similar antennas, scaled down to fit a home owner's lot.

You can make nonresonant antennas that work on all bands without tuning from a few simple properly terminated long wires. These antennas are fed with 50 to 800-ohm RF transformers, and are often terminated with noninductive resistors. Sloping V antennas are commonly terminated with two 400-ohm resistors, each with a dissipation of one-fourth the transmitter power. Rhombics are terminated with a single 800-ohm resistor with a dissipation of one-half the transmitter power.

While working on commercial nonresonant V antennas, I noticed that in some parts of the world stations with these antennas had trouble with poor grounds. Other areas had a problem with people or animals running into the wires. I found two useful antenna variations that solve these difficulties.

Tie wire sloping V antennas

The tie wire sloping V is a basic sloping V antenna with an improvement. In general, V antennas slope downward from a single tall pole to two short end poles, and each leg is grounded through a 400-ohm resistor. A tested version of the sloping V antenna is shown in **Figure 1**. However, unless the soil is permanently wet, the grounds tend to give erratic results. The solution is both simple and elegant — simply tie the two grounds together with a wire buried a few inches underground. This tie wire stabilizes the ground effect for the dummy loads when the soil is dry. The wire

FIGURE 1

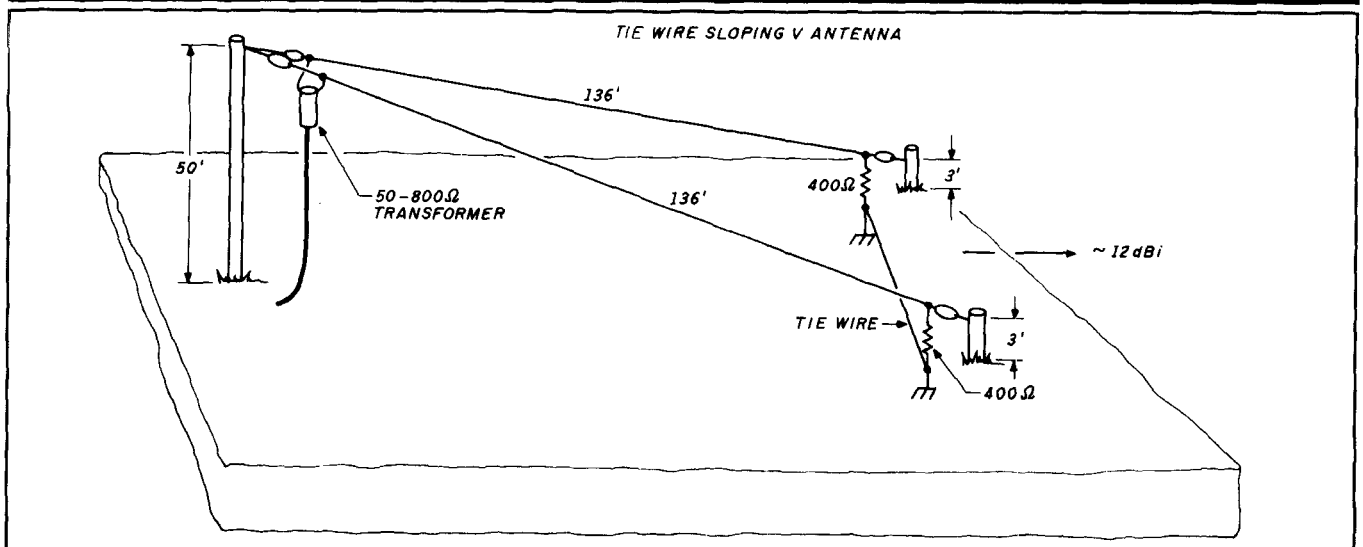

Tested version of the sloping V antenna.

HITACHI SCOPES AT DISCOUNT PRICES

Digital Storage Scopes



VC-6025 20MS/S
50MHz Bandwidth
2K Word Memory
Capacity
\$2349.00

Advanced storage functions create new dimensions in scopes such as one shot observation, flicker free display, bright display for even high speed event, trace observation for low speed event, hard copy by plotter and data output to computer.

VC-6045 100MHz 40MS/S 4K word Memory cap (call)

All Hitachi scopes include probes, schematics, and Hitachi's 3 year worldwide warranty on parts and labor. Many accessories available for all scopes.



\$425
List \$595
Save \$170
DC to 20MHz
Dual Channel



V-1060
List \$1595 **\$1,359**

- DC to 100MHz
- Dual Channel
- Delayed Sweep
- CRT Readout
- Sweep Time
- Autoranging
- Trigger Lock
- 2mV Sensitivity

	LIST	PRICE	SAVE
V-422 40MHz D.T., 1mV sens. DC Offset Vert Mode Trigger, Alt Mag	\$940	\$740	\$200
V-423 40MHz D.T., 1mV sens. Delayed Sweep, DC Offset, Alt Mag	\$1,025	\$825	\$200
V-425 40MHz D.T., 1mV sens. DC Offset, CRT Readout, Cursor Meas	\$1,070	\$849	\$221
V-660 60MHz D.T., 2mV sens. Delayed Sweep, CRT Readout	\$1,295	\$1,145	\$150
V-1065 100MHz D.T., 2mV sens. Delayed Sweep, CRT Readout, Cursor Meas	\$1,895	\$1,670	\$225
V-1100A 100MHz Q.T., 1mV sens. Delayed Sweep, CRT Readout, DVM, Counter	\$2,450	\$2,095	\$355
V-1150 150MHz Q.T., 1mV sens. Delayed Sweep, Cursor Meas, DVM, Counter	\$3,100	\$2,675	\$425

ELENCO PRODUCTS AT DISCOUNT PRICES

20MHz Dual Trace Oscilloscope



\$375
MO-1251

- 6" CRT
- Built in component tester
- TV Sync

FREE DMM

with purchase of
ANY SCOPE

SCOPE PROBES

P-1 65MHz, 1x, 10x \$19.95
P-2 100MHz, 1x, 10x \$23.95

35MHz Dual Trace Oscilloscope



\$495
MO-1252

- High luminance 6" CRT
- 1mV Sensitivity
- 6KV Acceleration Voltage
- 10ns Rise Time
- X-Y Operation • Z Axis
- Delayed Triggering Sweep

Top quality scopes at a very reasonable price. Contains all desired features. Two 1x, 10x probes, diagrams and manual. Two year guarantee.

PRICE BREAKTHRU on Auto Ranging DMMs



3 to choose from:
MDM-1180 **\$24.95**
MDM-1181 **\$27.95**
MDM-1182 **\$29.95**

- 3 1/2 LCD Display
- 27 Functions
- Auto /Manual Ranges
- Audible Continuity
- Data Hold (MDM-1182)
- .1% Accuracy (MDM-1181)



True RMS 4 1/2 Digit Multimeter

\$135 **M-7000**
.05% DC Accuracy
.1% Resistance with Freq. Counter and deluxe case



Multimeter with Capacitance and Transistor Tester

\$55 **CM-1500**
Reads Volts, Ohms, Current, Capacitors, Transistors and Diodes with case

Digital Capacitance Meter

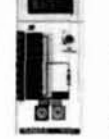

\$58.95 **CM-1550**
9 Ranges
.1pf-20,000ufd
.5% basic accy
Zero control with case

Digital LCR Meter

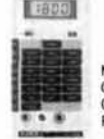

\$125 **LC-1801**
Measures Coils 1uH-200H Caps. .1pf-200uf Res. .01-20M

Bench DMMS



\$125 **M-3500**
3 1/2 digit 4 1/2 digit
1% accy .05% accy

\$175 **M-4500**
4 1/2 digit .05% accy



AC Current Meter

\$69.95 **ST-1010**
1000 Amps Data&Peak Hold 8 Functions Deluxe Case

Solderless Breadboards



9430 1,100 pins **\$15**
9434 2,170 pins **\$25**
9436 2,860 pins **\$35**
All have color coded posts

AC Clamp-On



Current Adapter **\$25.00** **ST-265**
0-1000A AC Works with most DMM

Wide Band Signal Generators



\$129 **SG-9000**
RF Freq 100K-450MHz
AM Modulation of 1KHz
Variable RF output

\$249 **SG-9500 with Digital Display and 150MHz built-in Freq Ctr**

TRIPLE POWER SUPPLY XP-620



Assembled **\$65**
Kit **\$45**

Contains all the desired features for doing experiments. Features short circuit protection all supplies

2 to 15V at 1A,
-2 to -15V at 1A
(or 4 to 30V at 1A)
and 5V at 3A

Function Generator



\$28.95 **#9600**

Provides sine, tri, squ wave from 1Hz to 1MHz AM or FM capability

Decade Blox



\$18.95 **#9610 or #9620**

#9610 Resistor Blox 47 ohm to 1M & 100K pot
#9620 Capacitor Blox 47pf to 10MFD

Digital Triple Power Supply



\$249 **XP-765**

0-20V at 1A
0-20V at 1A
5V at 5A

Fully Regulated, Short circuit protected with 2 Limit Cont., 3 Separate supplies
\$175 **XP-660 with Analog Meters**

Quad Power Supply



\$59.95 **XP-580**

2-20V at 2A
12V at 1A
5V at 3A
-5V at 5A

Fully regulated and short circuit protected
\$39.95 **XP-575 without meters**

LEARN TO BUILD AND PROGRAM COMPUTERS WITH THIS KIT!

INCLUDES ALL PARTS, ASSEMBLY AND LESSON MANUAL



MODEL
MM-8000

148.00

Starting from scratch you build a complete computer system. Our Micro-Master trainer teaches you to write into RAMs, ROMs and run a 8085 microprocessor, which uses the same machine language as IBM PC. You will write the initial instructions to tell the 8085 processor to get started and store these instructions in permanent memory in a 2816 EPROM. Teaches you all about input and output ports, computer timers. Build your own keyboard and learn how to scan keyboard and display. No previous computer knowledge required. Simple easy to understand instruction teaches you to write in machine language.

Four-Function Frequency Counters



\$179 **F-100 120MH**
\$259 **F-1000 1.2GH**

Frequency, Period, Totalize, Self Check with High Stabilized Crystal Oven Oscillator, 8 digit LED display

GF-8016 Function Generator with Freq. Counter



\$249

Sine, Square, Triangle Pulse, Ramp, .2 to 2MHz Freq Counter .1 - 10MHz

\$179 **GF-8015 without Freq. Meter**

WE WILL NOT BE UNDERSOLD!

UPS Shipping: 48 States 5%
(\$10 Max) IL Res., 7% Tax



C & S SALES INC.
1245 Rosewood, Deerfield, IL 60015
(800) 292-7711 (708) 541-0710

15 Day Money Back Guarantee
2 Year Warranty Prices subject to change
WRITE FOR FREE CATALOG

TABLE 1

Comparison of some V and delta antennas optimized for 14.3 MHz, but useful for 1.8 to 29.8 MHz.

Type	Gain (dBi)	Leg (feet)	Stub (feet)	Width (feet)	Apex (degrees)
V	+9.4	58.5	DNA*	68.8	72
Delta	+9.3	58.5	34.4	68.8	72
V	+9.9	72.3	DNA	85.0	72
Delta	+9.9	72.3	42.5	85.0	72
V	+11.0	113.5	DNA	92.4	48
Delta	+12.4	113.5	46.2	92.4	48
V	+12.8	206.4	DNA	137.6	36
Delta	+12.0	206.4	63.8	137.6	36

*Does not apply.

TABLE 2

"Magic" leg lengths in half waves for delta and V antennas. (Other delta dimensions are not recommended.)

Leg length (half wavelength)	Delta Gain (dBi)	V Gain (dBi)	Comments
1.7	9.3	9.4	Compact antennas
2.1	9.9	9.9	Compact antennas
3.3	12.4	11.0	Best delta tradeoff
6.0	12.0	12.8	
7.5	12.8	13.6	
8.7	12.9	13.5	
10.0	13.1	14.9	Highest gain size

has almost no effect on the pattern because it's embedded (more or less) in the reflection plane of the antenna.

Delta V antennas

While looking for proof of the tie wire effect, I developed several other antenna variations. One of these was the delta V antenna. The delta V is an elevated V beam, with the two ends coupled together through a third radiator element or tie wire. This section of the antenna has a single 800-ohm termination resistor in the center. Such a V beam variation has several advantages over a rhombic. It requires only three poles, fits on small lots, produces nearly as much gain as a V, covers a wide frequency range, is independent of local ground conditions, is virtually foolproof — and people won't run into the wires! **Table 1** shows a comparison of two similar standard V and delta V antennas. Note that the delta V has a unique property — the gain peaks sharply for certain "magic" leg lengths where all of the patterns and phases work together. These peaks are shown in **Table 2**. The most desirable small sizes are 1.7, 2.1, and 3.3 half wavelengths per leg.

Calculations

The free space field of such an antenna can be produced quickly using a BASICA program.* This program optimizes the apex angle for one band, but it's possible to use the same antenna from 160 to 10 meters. The best results, and the most gain, are achieved with the antenna placed at about one half wave above ground. There may be an

increase in indicated free space gain, shown by the computer program, due to reflection of the antenna image from the ground. This will be slightly different for every location and installation.

Program information

The program first calculates the two-dimensional free space pattern for a nonresonant wire of any selected length, given in half wavelengths. It then searches for the peak of the major lobe of this wire and gives you the value. You aren't required to use the free space optimum value calculated by the computer, but can select any value up to 89 degrees. Smaller angles may be useful for fitting the antenna to narrow lots, but there will generally be a loss of gain. Scaling the lengths to other bands and using the originally selected angle allows derivation of a pattern for any other frequency. The myth that rhombic-type antennas give high gain in one direction for all frequencies quickly evaporates when you're playing with V and rhombic programs. Instead, the patterns tend to split. However, these antennas will work effectively in one direction over at least a 2:1 frequency span, and will radiate reasonably in a forward direction over about a 15:1 frequency range. They tend to load well and often do not require tuners for the entire span. For radio Amateurs 14 MHz is a good center design frequency, while 11 MHz is excellent for commercial use.

After you set the desired angle the program rotates, calculates, and stores the vector sum of the pattern from the two wires. This is a theoretical free space V beam pattern with a phase center at some point between the two antenna wires. For the delta V, the program calculates the radiation pattern for the basic end stub wire. It rotates the stub pat-

* Program listings 1 and 2 are available from *Ham Radio Magazine* for an SASE with 25-cent postage.

FIGURE 2

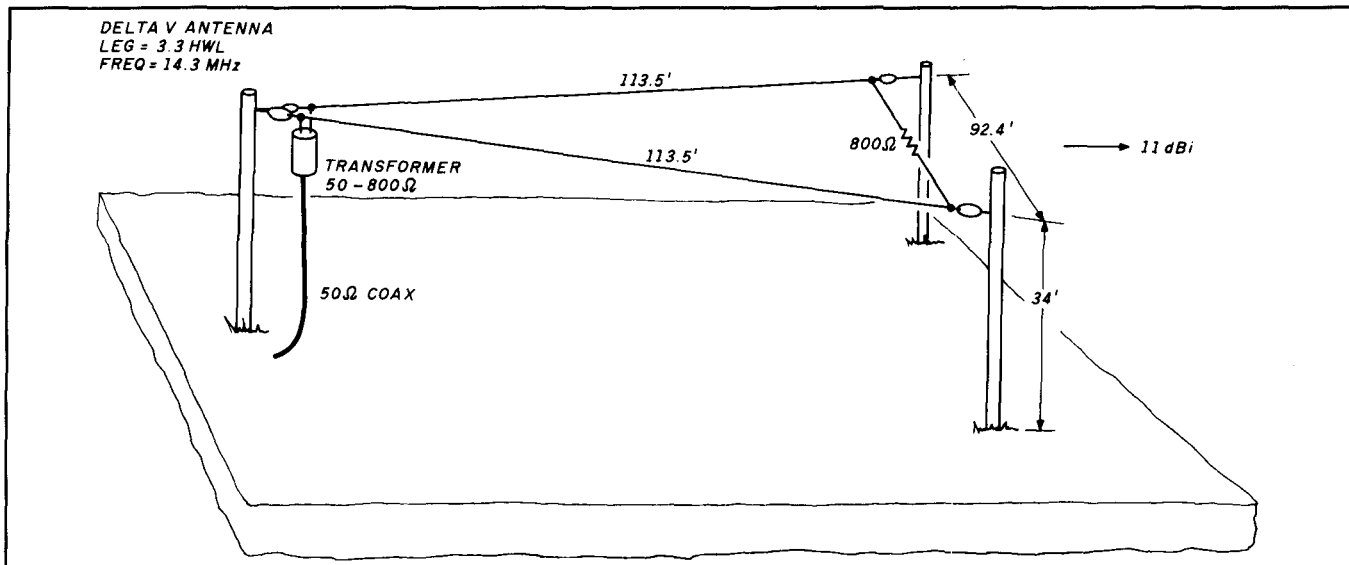

Delta V antenna optimized for 20-meter band. Antenna requires pie shaped lot size of 104 feet by 93 feet.

tern of one wire, adds it to the pattern of its mate, and stores the pattern that results. This pattern also has a common phase center.

The feed phase delay between the two antenna systems is calculated for the delta V and the two combined patterns are added by vector methods. The resultant pattern is normalized to an isotropic value and decibel gains of the field are calculated for each angle. As a result, the field radiated by the end stubs of a delta V antenna is largely overcome by the V element field, particularly if you select certain leg lengths.

Dimensions

Figure 2 shows a possible city lot-sized delta V antenna optimized for 20 meters, requiring two V legs 113.5 feet long. Each stub leg is 46.2 feet, for a total spacing between the front supports of 92.4 feet. An antenna of this size needs a V-shaped space 104 feet long by 93 feet wide. Antenna height should be about 34 feet. The apex angle of the V is 48 degrees. The two stubs are joined in the center by a single noninductive 800-ohm resistor. Loading should be adequate from 160 to 10 meters, depending largely on the quality of the transformer or 800-ohm feed system.

Dummy load

You can make the 800-ohm load resistor by paralleling fifty 39-k, 2-watt carbon resistors. Solder the resistors between two parallel copper wires for an 800-ohm, 100-watt noninductive resistor. If you use this resistor only on single sideband, slightly more than 200 watts may be sent to the antenna because half the power is radiated away before it ever gets to the resistor. I found that average output powers of more than 200 watts for more than a few seconds will permanently change the value of the resistors.

RF transformer

Make the transformer from a quality high frequency powdered iron RF toroid core. Not all cores are good for high

frequency transformers. Use only RF quality wideband power cores with cross sections of at least 1 by 1 cm and a diameter of about 5 cm. Palomar* part F-240 Mix 61 or T-200A Mix 2 are adequate up to 400 watts. Core T-400A Mix 2 should be good up to 1 kW. Wind this toroid core with 20 turns of nonoverlapping insulated wire to make an 800-ohm secondary. The best wire is no. 18 AWG Teflon™ covered stranded wire, but it's costly. You can wind the five-turn 50-ohm primary over the top of the secondary using the same or larger diameter wire. Distribute the primary evenly over the entire core. Twist the 50-ohm wire pair together using about two to four turns per inch to identify them and make sure they won't radiate. Leave the 800-ohm pair well separated to avoid arcing at high power and undesirable high impedance effects. It helps to have the two sets of wires come out on opposite sides of the toroid. For a more permanent (but not so pretty) transformer, secure the ends in place with nylon tie wraps and cover the entire transformer with a heavy coat of clear silicon glue. Expect to wait a week for all of the silicon to harden completely.

Conclusions

The delta V antenna should work well in one direction for the selected band, and should be entirely effective from 160 through 10 meters and other services in between. The regular tie wire V will tend to give more uniform gain over a wider band, but you may need to put fencing at the lower wire ends to keep people away. Remember that the apex (or pointed end) of the V points away from the target, not toward it. You'll find it necessary to use a computer great circle azimuth calculation program or great circle map to point your antenna correctly. If you use a compass, and correct properly for local magnetic declination, you should be right on target. I'm sure you'll like the simplicity, uniformity of operation, and all-band capability of the delta V and tie wire sloping V antennas. 

* Palomar Engineers, PO Box 455, Escondido, California 92025. Phone: (619)747-3343

MADISON ★ ★ ★ SHOPPER

CALL FOR ORDERS: 1 (800) 231-3057
1 (713) 520-7300 or 520-0050

NEW BEGINNING MAY 15
1 (713) 729-7300 or 729-8800
FAX 1 (713) 358-0051

TEXAS ORDERS CALL COLLECT.
ALL ITEMS ARE GUARANTEED
OR SALES PRICE REFUNDED.



New Yaesu FT-1000D Trades wanted
Kenwood TH215A, TH25AT Trade in your old HT
TS440 S/AT Call
New Kenwood TM-731A, mobile Call
ICOM IC-24AT Call



TS 790A Superior 2 Meter 70 cm Rig, 1.2 GHz Option Available Call
BW VS 300A 99.00
Penta 6146B 12.00
Penta 572B 79.00
Penta 3-500Z 99.00
Penta 811A 12.00
Penta 4CX250B 79.00
Icom 765 2695.00
NYE MB5A Tuner 629.00
Alpha Delta Transtrap HV 33.00
CSI Private Patch V 489.00

Ampire VHF, UHF GaAsFET preamps Call
831SP-PL259 Silverplate (Amphenol) 1.50
82-61 N Male (Amphenol) 3.50
82-202 1006 N Male (9913) 3.50
Double Female UHF 1.00
UG176 RG8X each 40
Surplus Elbow PL259-SO239 each \$1
Receiving tubes 50-90% off list price Call
3 Amp RF Meter, 2.5" Round New, Boxed 30.00
25 pF/10KV Doorknob Cap. 5.00
100mFd/450V axial cap 4.00
Throat Mike (new mil surplus) 5.00
Yaesu FT 747, 757/III Call
GGTE Morse Tutor 18.00



New Kenwood TS 950-SD Call
Ameco PT 3 Pre Amp 99.00
Larsen 2 meter on glass 49.95
Anteco 2M, 5/8, Mag. Mount, Comp. 25.00
YAESU FT-1000D Call for price



Kenwood TS 140S Call for trade
Van Gordon Windom WA2 44.00
Bird 43, elements/stock Call
Thousands of panel meters 3.95 up CALL
Belden 9913, 8267, 8214 Stock Call
MICA Capacitors Call

USED EQUIPMENT

All equipment, used, clean, with 90 day warranty and 30 day trial. Six months full trade against new equipment. Sale price refunded if not satisfied.
(800) 231-3057

POLICIES

Minimum order \$10.00. Mastercard, VISA, or C.O.D. All prices FOB Houston, except as noted. Prices subject to change without notice. Items subject to prior sale. Call anytime to check the status of your order. Texas residents add sales tax. All items full factory warranty plus Madison warranty.
Bird and Belden products in stock. Call today.

3621 FANNIN
HOUSTON, TEXAS 77004

MADISON

JUNE 1
12310 ZAVALLA STREET
HOUSTON, TEXAS 77085

✓ 131

BLACK DACRON® POLYESTER ANTENNA ROPE

- UV-PROTECTED
- HIGH ABRASION RESISTANCE
- REQUIRES NO EXPENSIVE POTTING HEADS
- EASY TO TIE & UNTIE KNOTS
- EASY TO CUT WITH OUR HOT KNIFE
- SIZES: 3/32" 3/16" 5/16"
- SATISFIED CUSTOMERS DECLARE EXCELLENCE THROUGHOUT U.S.A.

LET US INTRODUCE OUR DACRON® ROPE TO YOU • SEND YOUR NAME AND ADDRESS AND WE'LL SEND YOU FREE SAMPLES OF EACH SIZE AND COMPLETE ORDERING INFORMATION.

Dealer Inquiries Invited



MANUFACTURED BY
synthetic textiles, inc.
2472 EASTMAN AVE., BUILDING 21
VENTURA, CALIFORNIA 93003
(805) 658-7903

✓ 134

MININEC USERS

Tired of counting pulses?

ELNEC gives you all the power of MININEC, full plotting and analysis features, easy menu-driven input, and *no fussing with pulses!* Just tell ELNEC which wire to place a source or load on, and the distance from the end (in percent), and it's there to stay. Use ELNEC's powerful features to add, delete, and modify sources, loads, wires, and ground media, and the sources and loads *stay where you put them* - not on some obscure "pulse number" that moves every time a wire is changed. ELNEC has a host of other features to make antenna analysis fast, accurate, and easy. Like *true current sources* for phased array analysis. Change wire lengths without recalculating end coordinates. And much more.

Here's the best news: ELNEC is just \$49 postpaid (USA, Canada, Mexico). Two versions are available, optimized for coprocessor or non-coprocessor systems.

Roy Lewallen, W7EL
P.O. Box 6658
Beaverton, OR 97007

✓ 133



OPTO Keyer

- Safe OPTO Isolated output
- Built-in side tone
- 2 1/4" speaker
- Battery or DC powered
- Positive keying to 30 volts max.
- Unique "POWER/LOGIC" LED
- One Year Ace Systems Warranty

- See Your Ace Dealer -

- Amateur Electronics Supply
 - Barry Electronics
 - KJI Electronics
 - Madison Electronics
 - Oklahoma Comm. Center
 - R. F. Enterprises
 - R & L Electronics
 - Rivendell Electronics
- Ace Systems • RD 1 • Box 83 • Wilcox, PA 15870
(814) 965-5937

✓ 132

NEW PRODUCTS FROM THE POWER OF MIRAGE/KLM

NEW ANTENNA POWER FOR 6-METERS

Nothing on today's market can match the performance of these TWO newly designed antennas...The elements are grounded to the boom to prevent static build-up... Extremely broadbanded in their performance...With all stainless steel hardware and rugged construction for survivability...

6M-10

ELECTRICAL

Bandwidth.....50 - 52 MHz
Gain.....11.7 dBd
VSWR @ 50.1.....less than 1.2 to 1
Front-to-Back.....26 dBd
Feed Impedence.....50 Ohms
Balun.....4:1, 5kW PEP
Wavelength.....1.74

MECHANICAL

Elements.....10
Element Length.....116"
Boom Size.....2" o.d. x 34' 3 1/2"
Turn Radius.....21 3/4"
Windload.....4.4 sq. ft.
Weight.....29 lbs.
Mast.....2"

6M-14

ELECTRICAL

Bandwidth.....50 - 52 MHz
Gain.....14.0 dBd
VSWR @ 50.1.....less than 1.2 to 1
Front-to-Back.....25 dBd
Feed Impedence.....50 Ohms
Balun.....4:1, 5kW PEP
Wavelength.....3.10

MECHANICAL

Elements.....14
Element Length.....116"
Boom Size.....3" o.d. x 61'
Turn Radius.....35 1/2"
Windload.....10 sq. ft.
Weight.....43 lbs.
Mast.....2"

NEW PRE-AMP POWER FOR ALL BANDS

MIRAGE is in production on new pre-amps for the following bands:

- 6 Meters
- 2 Meters
- 1 1/4 Meters
- 70 Centimeters
- 23 Centimeters
(Coming Soon)

And each is available as a *mast mount* pre-amp or an *in-shack* model. Reasonably priced and rugged...these reliable pre-amps are ready now.

All of these new pre-amps will carry a *gain in excess of 20 dB* and the *lowest noise figure in the industry of less than 0.6 dB*.

MIRAGE/KLM

COMMUNICATIONS EQUIPMENT
Post Office Box 1000, Morgan Hill, CA 95038

(408) 779-7363
(800) 538-2140
(Outside CA)

FAX (408) 779-8845
TELEX 910-590-4460

INCREASE YOUR POWER WITH **MIRAGE/KLM**

Your shack just got more flexible with these 12 amplifiers.

NEW AMPLIFIER POWER FOR 50, 144, 220 MHz MARINE BAND AND 1.2 GHz

They all have our new low-noise GaAs-FET pre-amps with the lowest noise figure in the industry at less than 0.6 dB...and each with a gain in excess of 20 dB...high VSWR protection, over-power protection, and over-temp shut-down gives you all the flexibility you'll ever need.

2-Meter Power

B-5016-G	B-5030-G
50W in	50W in
160W out	300W out
144-148 MHz	144-148 MHz
B-108-G	
10W in	
80W out	
144-148 MHz	

220 MHz Power

C-5012-G	C-3024-G
50W in	30W in
120W out	240W out
220-225 MHz	220-225 MHz
C-5024-G	C-106-G
50W in	10W in
240W out	60W out
220-225 MHz	220-225 MHz

Marine Band Power

This handheld size amplifier can be used for just about anything in Marine band communications. Low-noise GaAs-FET pre-amp, gain in excess of 20 dB and high VSWR shut-down. In addition, this amp operates comfortably in 2-meters.

M-120-G

2W in
25W out
156.00-158.50 MHz

6-Meter Power

(Coming Soon)
TWO new amps for
50-52 MHz
Low Input
High Output

1.2 GHz Power

(Coming Soon)
TWO amps to use on
1200-1300 MHz
Low Input
High Output

MIRAGE/KLM

COMMUNICATIONS EQUIPMENT
Post Office Box 1000, Morgan Hill, CA 95038

(408) 779-7363
(800) 538-2140
(Outside CA)

FAX (408) 779-8845
TELEX 910-590-4460

Ham Radio Techniques

MAY PERAMBULATION

By Bill Orr, W6SAI

Ten meters has been great! Though the band will drop out during the coming summer months, it will roar back in the fall. As we "roll over" the top of the current sunspot cycle, and observe a gradual decline in sunspot numbers, past experience tells me that we'll experience fewer solar blackouts and fewer disturbed days like those melancholy periods that obliterated 10 meters during the last year. Ten meters should be a red hot band for the next few years, and that's nice.

What exciting opportunities the band offers! In addition to the traditional CW, SSB, RTTY, and SSTV, 10 meters offers packet radio, satellite operation, NBFM, and also AM. AM??? Yes! There's quite a bit of AM operation between 29.0 and 29.2 MHz.

I must admit that a good AM station, with a well-designed class B modulator and a Western Electric 387W double button carbon microphone, sounds pretty good these days compared with the run of the mill SSB rig with a cheap dynamic microphone! Ah, nostalgia...

Yes, AM is alive and healthy. Listen around 29 MHz. If you want more information on this branch of our hobby, write to *Electric Radio* magazine, Box 139, Durango, Colorado 81302. It's a first-rate publication devoted to AM and old-time ham gear that can be operated on today's bands.

A broadband 10-meter Yagi beam

How about a three-element Yagi that will cover the whole 1.7-MHz wide band? That's a rarity. A Yagi tuned up at the low end of the band (say, 28.5 MHz) won't work very well at the top end if you want to try FM operation. The gain

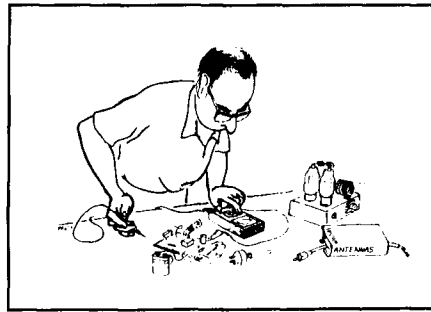

disappears, the front-to-back ratio deteriorates, and the SWR rises ominously. Sometimes the beam works better off the back than it does off the front!

The Yagi Optimizer (YO) program discussed last month* can provide an answer to this perplexing problem. It clearly shows that Yagi design is a mixture of tradeoffs. The secret of success lies in searching for the best combination of gain, front-to-back ratio, and

*The Yagi Optimizer program by Brian Beezley, K6STI, 507-1/2 Taylor Street, Vista, California 92084

FIGURE 1

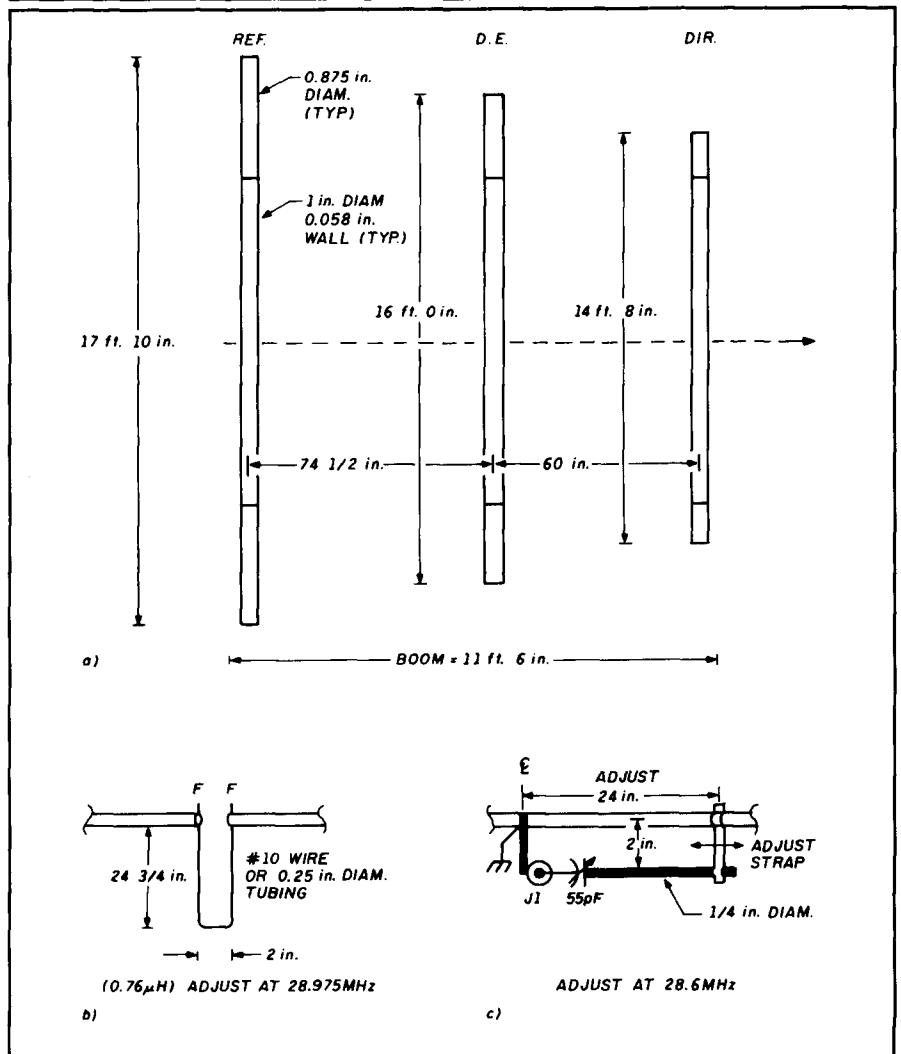

Beam is built on 2 × 0.065-inch tubing. Element center sections are 12 feet long (a). Hairpin match (with balun at F-F) provides SWR better than 1.75-to-1 across band (b). Gamma match doesn't require split driven element (c).

SWR that can be achieved within a given bandwidth. I've conducted such a search with the YO program and have come up with a practical Yagi that covers the whole 10-meter band. The essential characteristics are shown in **Figure 1**.

Forward gain is about 1.5 dB less than a narrowband design, but still a respectable 4.74 dBd at the design frequency. The front-to-back ratio averages 17 dB and the SWR across the band is below 1.75:1. Those figures are hard to beat!

Optimum SWR response across the band is achieved with a hairpin match and a split driven element. If a gamma match is used, SWR at the band edges rises to about 2.5:1. For those builders whose equipment can work into a SWR of that value, I've included dimensions for the gamma match section in **Figure 1**. The design is for 1.0-inch diameter antenna elements with tip sections of 0.875-inch diameter.

Elements are mounted atop a 2-inch diameter boom with U-bolts and a rectangular mounting plate 2 x 6 inches. The driven element is insulated from the bolts and plate by an insulating segment cut from PVC plastic water pipe (**Figure 2**). The two halves of the element are joined by a wood dowel plug sprayed with clear acrylic to protect it from the weather.

Adjusting the match

The beam is designed for a free space environment. Ground effects may require that the match system be adjusted. Resonant frequency of the antenna is 28.5 MHz, but for lowest SWR across the band the match is adjusted at 28.975 MHz.

In the case of the hairpin match, the variables are the inductance of the hairpin and the reactance of the driven element. The driven element is cut about 6 inches shorter than resonance; the final length is given in the program's table. The hairpin length isn't very critical; usually the beam can be tuned up by merely "touching up" the driven element length.

The gamma match can be used but rod length, capacitance of the series capacitor, and driven element length are interlocked. The driven element is set to the dimension given in the program's table and the gamma capacitor adjusted for lowest SWR at 28.6 MHz. Rod length may have to be adjusted to bring the SWR down across the

FIGURE 2

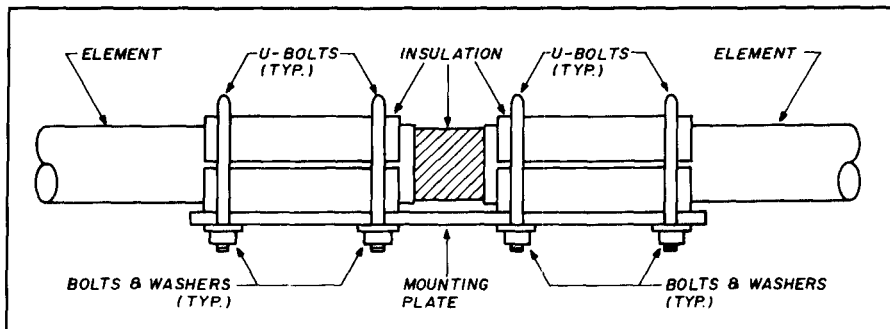

Driven element is split at center and joined by wood or phenolic dowel. Element is insulated from mounting plate and bolts by half sections of PVC water pipe cut to size.

band. If a reasonable SWR response isn't found, the driven element is shortened an inch on each end and the test repeated.

You can get good results by adjusting the match when the beam is only 15 to 20 feet in the air. The perfectionist will want to "touch things up" when the beam is in final position atop the tower.

Propagation prediction

Propagation prediction was easy when I was a newly licensed Amateur. I would come home from school and look up at the evening sky to see if there was a full moon. I would note the low clouds on the horizon and sniff the air. I could determine quickly if there would be DX that evening. My pal, W2LX, improved upon my techniques by watching the sea gulls that floated over Long Island Sound. Between the two of us, we knew when 20 meters was open for DX.

Well, propagation prediction is much more complicated today. World War II demands for reliable intercontinental communication led to the development of a whole new world of propagation prediction that included such unlikely things as spots on the sun and the solar cycle.

That took a lot of fun out of DX prediction. But it provided more reliable results than sea gulls or the smell of burning leaves in the fall.

A new science grew up which concerned itself with solar predictions of one kind or another. In 1948 the National Bureau of Standards provided a cookbook procedure for propagation prediction, and programs in BASIC, FORTRAN, and RPN were gradually developed which handled a lot of the tedious mathematics of prediction.

In 1982 the MINIMUF program was developed by the Naval Ocean Systems Center at Point Loma, California. This made practical the prediction of the maximum usable frequency (MUF) for a given path on the home computer.

Sheldon Shallon, W6EL, followed the propagation programs closely and released MINIPROP 1.0 in 1985. This was the most comprehensive program for microcomputers available, and it was widely used by Amateurs and commercial radio station personnel. Version 2.0 of MINIPROP (1987) contained superior prediction techniques used by the British Broadcasting Company and other features obtained from information provided by the International Radio Consultative Committee of the ITU (CCIR).

The present version of MINIPROP, 3.03, provides better MUF and signal level prediction than the earlier versions, and has a lot of "bells and whistles" of great interest to ardent DXers and ragchewers.

MINIPROP 3.03

MINIPROP 3.03 uses a unique new method of finding the strongest ionospheric mode at times and frequencies of your choice between 3 and 30 MHz. It takes into account effects of the D, E, and F layers of the ionosphere. You enter the locations of two stations, the date, and the sunspot number (or solar flux), and MINIPROP does the rest.

What do you get? Predicted short and long path signal levels on frequencies of your choice, MUF, and E layer cutoff at two-hour intervals throughout the day. Band openings are noted and beam heading, path length, and sunrise/sunset times for the path terminals are given.

TABLE 1

Partial printout of MINIPROP great circle bearings from my QTH to 350 worldwide locations

Short Path Great Circle Bearings
From W6SAI 37.30 N 122.30 W
Add or subtract 180 degrees for long path bearings

Prefix	Location	Degree	Prefix	Location	Degree
FK	New Caledonia	242	JD1/MT	Minami Torishima	286
FM	Martinique	95	JD1/O	Ogasawara	294
FO	French Polynesia	207	JT	Mongolia	330
FO/A	Austral Islands	208	JW	Svalbard	8
FO/M	Marquesas Islands	203	JX	Jan Mayen	20
FO0X	Clipperton	153	JY	Jordan	19
FP	St. Pierre/Miquelon	57	KC4	Antarctica	180
FR	Reunion	7	KC6/E	Micronesia	271
FR/G	Glorioso Island	23	KC6/W	Belau	283
FR/J	Juan de Nova	45	KG4	Guantanamo Bay	100
FR/T	Tromelin	9	KH0	Mariana Islands	283
FS	Saint Martin	93	KH1	Baker, Howland Is.	247
FT8W	Crozet	157	KH2	Guam	283
FT8X	Kerguelen Islands	211	KH3	Johnston Island	257
FT8Z	Amsterdam/St. Paul	261	KH4	Midway Island	276
FW	Wallis/Futuna	236	KH5	Palmyra, Jarvis	235
FY	French Guiana	99	KH5K	Kingman Reef	240
G	England	33	KH6	Hawaiian Islands	251
GD	Isle of Man	33	KH7	Kure Island	276
GI	Northern Ireland	33	KH8	American Samoa	231
GJ	Jersey	35	KH9	Wake Island	275
GM	Scotland	31	KL7	Alaska	335

In addition, you get an atlas giving great circle bearings from your location to all atlas locations, grayline information and optimum antenna radiation angle for the paths in question. Finally, the program provides predicted signal levels for the five primary HF bands. In summary, it will do everything except work the DX for you!

To get started with MINIPROP you need to know the latitude and longitude of your station. If you don't, you can use the MINIPROP atlas of more than 350 locations. For California, the general latitude figure for computation is 37.3 degrees; the longitude is 120 degrees. For the precise location of your QTH, consult a geographic atlas or aeronautical chart.

I determined my location from an aeronautical chart. In seconds MINIPROP printed the great circle path bearings from my QTH to 350 worldwide locations (Table 1). Next, I entered the smoothed sunspot number (SSN) and printed a MINIPROP DX compass for my QTH (Figure 3).

I then asked MINIPROP to compute the path between my location and India. I quickly received the printout shown in Table 2 giving the pertinent information. The short path prediction took the form of a graph (Figure 4). For

FIGURE 3

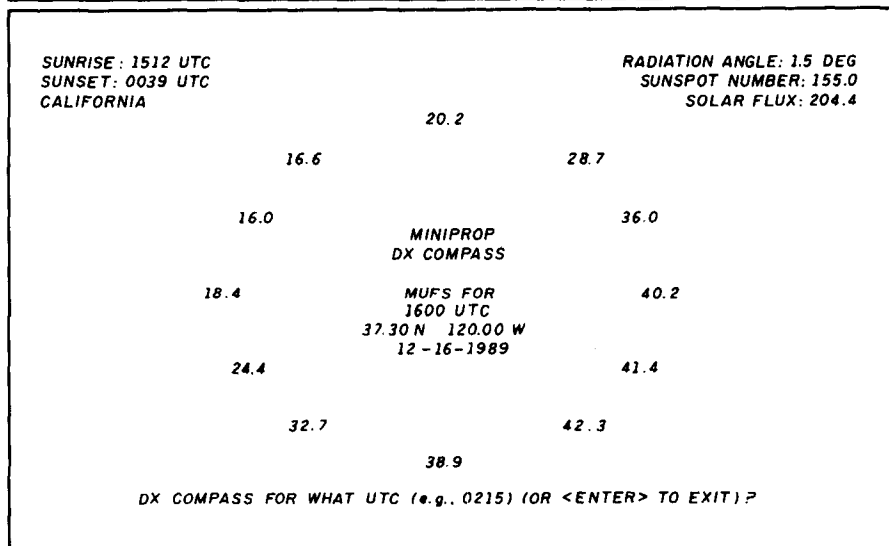

The MINIPROP DX compass for Northern California, December 16, 1989 shows MUF for twelve compass directions at 1600 UTC. Sunspot number of 155 was used.

0200 UTC, it seemed that 21 MHz was a good choice to work the elusive VU stations. A look at the signal levels for the period 0000 to 0530 UTC provided additional information.

The 15-meter band looked best around 0130 to 0200 UTC, and it appeared there might be a chance of

10 meters opening about the same time. But look at the 40-meter band! There's a long opening here, with reasonable signals from 0000 to about 0400 UTC.

You'll find enough good information in MINIPROP to amaze you. Armed with up-to-date solar flux data from

GREETINGS & GOOD NEWS FROM THE HAMS AT

RAMSEY

ELECTRONICS INC.

The worldwide acceptance of professional Ramsey service and lab equipment is giving us a chance to take a fresh look at the always-growing lineup of economical Ramsey ham kits and Mini-kits. Now that we're set up in our new factory building, we're working to make all our kits more fun and interesting than ever to build and to use. As we release both new kits and familiar ones with new step-by-step assembly manuals, we first want to say **THANK YOU** to all of you who have built our kits from brief instruction sheets. **YOU** are the people who showed us that U.S. hams, hobbyists and young newcomers really **DO** want to save money, learn and have fun by building your own electronic gear. Thanks!

If you've built our kits before, send us an SASE with your next order (marked with kit model number), include proof of purchase, and we'll be glad to send you the new instruction book as soon as it is ready.

If you can't make it to a major hamfest soon, call us, fax or mail your order for some of those kits that you've been wanting to try out. Check our Condensed Kit Listing on this page: Ramsey Kits are easier and more fun than ever!

Our Order Terms remain simple and friendly, and we hope to hear from you soon.

73 from the Hams at Ramsey!

John, N2HWA/VP5JR
Jim, KB2FEC

Bruce, WA2TMC
Tom, WA2YTM

COM-3

THE COMMUNICATIONS SERVICE MONITOR THAT WORKS HARDER FOR LESS.



TERMS: 10-day money-back guarantee • MC, Visa, personal checks welcome • COD is USA only and costs an extra \$4, and we need certified check or cash on COD's over \$50 • All shipping is UPS, so we need street address • Try to plan a \$20 order or add \$3 for handling on under-\$20 orders • NY customers must add 7% sales tax • Add 6% for shipping to a maximum of \$10 • Customers outside USA, add 15% Warranty: 90 days on kit parts, 1-year parts & labor on factory-wired units.

RAMSEY

Spring-Summer 1990 KIT NEWS

• A \$25 CMOS ELECTRONIC KEYSER WITH SIDETONE!

Why pay the same price for a "code practice oscillator" when the CW-7 will give you an ear for perfectly-formed CW and will also key your rig? Manual includes money-saving ideas on making keyer paddles too! CW-7 Electronic Keyer Kit, \$24.95 □ Case and Knob Kit, \$12.95

• GET IN ON 30 METER CW FUN!

Build a compact HR30 direct conversion receiver or QRP30 transmitter or both and enjoy leisurely 10.1 Mhz. DXing on family or business trips! Like our other popular QRP transmitters, our new 30-meter model features 8-10 KHz. VXO tuning, switch for choosing between 2 crystals, receiver protection T-R jack and comes with 10.107 Mhz. crystal. HR-30 Receiver Kit, \$24.95 □ QRP-30 VXO Transmitter Kit, \$29.95

• RAMSEY TRANSMITTER KITS FEATURE INTERNATIONAL QRP FREQUENCIES!

That's right — your QRP-80, 40 or 20 Meter Transmitter comes complete with a 3.060, 7.040 or 14.060 crystal, plus front-panel switching for an additional crystal of your choice.

• A TRUE HF-VHF ACTIVE ANTENNA FOR \$25!

You can pay lots more for an active receiving antenna, but we think you'll be happier with the price as well as the HF-VHF switchable performance of our new AA-7 Active Antenna. Includes whip antenna. AA-7 Active Antenna Kit, \$24.95 □ Case and Knob Kit, \$12.95

• RAMSEY Factory-Wired VHF POWER BOOSTERS:

These rugged RF power amps with receiver preamp turn your favorite 2M or 220 Mhz. HT into a 25-40 watt powerhouse for a fraction of the cost of a mobile rig! Install several permanently for versatile VHF work.

• ATTENTION TEACHERS & SCOUT LEADERS:

Ask for our new pamphlet ED-1 which details special support and pricing for group kit-building projects. Please specify number of kids to be involved and age range.

RAMSEY

PHONE ORDERS CALL 716-924-4560

FAX 716-924-4555

RAMSEY ELECTRONICS, INC. 793 Canning Parkway, Victor, NY 14564

CONDENSED KIT & PRODUCT LISTING ■ ASK FOR FREE CATALOG!

RAMSEY

FREQUENCY COUNTERS

"If it's built by Ramsey, it's Reliable."

CT-70	139.95	20Hz-550MHz Frequency Counter
CT-90	169.95	10Hz-600MHz Frequency Counter
CT-50	189.95	5Hz-600MHz Frequency Counter
CT-125	189.95	10Hz-1.25GHz Frequency Counter

CT-90 9 DIGIT 600 Mhz



\$169.95 WITH INCLUDED AC ADAPTER

FREQUENCY COUNTER ACCESSORIES

OV-1	59.95	0.1 PPM Oven Time Base
ET-1	11.95	External Time Base Kit
BP-4	8.95	NiCad Pack for all Counters
RA-1	14.95	Ham/SWL Receiver Adapter Kit (for CT-50 only)
PS-1	89.95	1.5 Ghz. Prescaler (wired & tested)
PS-2	59.95	600 Mhz. Prescaler (Kit: 49.95)
PS-2	69.95	Audio Frequency Multiplier (Kit: 49.95)
PR-2	49.95	Broadband Amplifier: low noise, high gain
LP-1	16.95	Low Pass Probe
HP-1	16.95	HI-Z Probe
DC-1	13.95	Direct Probe
AW-1	8.95	Telescoping Whip Antenna
RF-1	19.95	Sniff-It RF Probe for VOM/VTVM/Counters/Scopes
TB-7	4.95	Tilt Bail Kit for Counters
HX-1	5.95	Heavy Duty Transformer for Counters, MM7 Kit
CT001	1.00	Booklet: "How to Use Your Frequency Counter" (booklet free upon request with SASE)

SWL AND MONITORING RECEIVERS

See also our versatile FR-146 FM receiver for 135-175 Mhz.

SR-1	24.95	4-11 Mhz. AM Shortwave Receiver Kit
CSR-1	12.95	Shortwave Receiver Case Kit
AR-1	24.95	AM 108-138 Mhz. Aircraft Band Receiver Kit
CAR-1	12.95	Aircraft Receiver Case Kit
SC-1	24.95	Automobile AM Radio Shortwave Converter Kit
CSC-1	12.95	Case Kit for SC-1
CLG-1	2.95	Quality Cigarette Lighter Power Cord

HAM HF-BANDS KITS & STATION ACCESSORIES

CW-7	24.95	CMOS CW Keyer with Built-In Sidetone
CA-CW	12.95	Case and knob kit for CW-7 Keyer
HR-20	24.95	Amateur 20 Meter Receiver Kit
HR-30	24.95	Amateur 30 Meter Receiver Kit
HR-40	24.95	Amateur 40 Meter Receiver Kit
HR-80	24.95	Amateur 80 Meter Receiver Kit
HR-160	24.95	Amateur 160 Meter Receiver Kit
CHR-1	12.95	Case and Knob Kit for HR-series Receiver Kits
QRP-20	29.95	VXO 20 Meter Transmitter Kit with 14.060 crystal "A"
QRP-30	29.95	VXO 30 Meter Transmitter Kit with 10.107 crystal "A"
TX-30	39.95	6-watt 10.1-10.120 Mhz. 2-crystal VXO Transmitter
QRP-40	29.95	VXO 40 Meter Transmitter Kit with 7.040 crystal "A"
QRP-80	29.95	VXO 80 Meter Transmitter Kit with 3.560 crystal "A"
QRPP-1	12.95	Case and Knob Kit for Transmitters
AA-7	25.00	Active Antenna Kit for HF and VHF
CA-AA	12.95	Case and Knob Kit for AA7 Active Antenna

"HR-" receivers are NE602-based direct-conversion for SSB, CW, RTTY reception.



HAM & MONITORING VHF-UHF KITS AND ACCESSORIES

FR-146	29.95	Amateur 2-Meter and FM 135-175 Receiver Kit
FR-10	29.95	Amateur 10 Meter FM Receiver Kit
FR-220	29.95	Amateur 1.25 Meter (220 Mhz.) FM Receiver Kit
CFR-7	12.95	Case and Knob Kit for FM Receiver Kits
SA-7	14.95	Broadband Preamp Kit (20 db, 100 KHz-1GHz.)
PR-10	17.95	Ham Two-Meter Preamp Kit
PR-20	17.95	220 Mhz. Preamp Kit
PR-40	17.95	440 Mhz. Preamp Kit
PA-10	69.95	Two-Meter Power Booster (wired & tested)
PA-20	69.95	220 Mhz. Power Booster (wired & tested)
PA-44	79.95	440 Mhz. Power Booster (late Spring 1990)
PA-1	27.95	2-Meter Power Amplifier Kit
TR-1	6.95	RF-Sensed T-R Relay Kit
P-64	49.95	Packet Radio Kit for Commodore 64/128 HF or VHF
JM-7	12.95	RF Modulator/6-Meter ATV Kit

MAJOR HOBBY & FUN KITS

MM-5	24.95	25-Tune MelodyMaker/3-Door Doorbell-Annunciator
FM-7	29.95	Stereo FM Transmitter (NEW for 1990!)
SS-7	29.95	Speech Scrambler Kit
CSS-7	12.95	Speech Scrambler Case Kit
CT-127	29.95	Binary Thermometer Kit
SG-7	89.95	SPEED-Y Personal Radar Kit (Yes, it REALLY works!)

THOSE FAMOUS & FUN RAMSEY MINI-KITS ...

FM-1	5.95	FM Wireless Kit
FM-2	7.95	FM Wireless Kit with Mike Preamp Stage
MC-1	2.95	Sensitive Mike Cartridge
FM-3	16.95	Wireless FM Mini-mike Kit with case, battery
FM-4	12.95	High-Power FM Mike Kit
PB-1	14.95	Telephone Transmitter Kit
FR-1	14.95	FM Receiver Kit (tunes approx. 70-130 Mhz.)
BN-9	5.95	"Super Sleuth" Multi-Purpose 2-watt LM380 Amp Kit
ML-1	8.95	Color Organ Kit
MB-1	4.95	"Mad Blaster" Kit (also can be LOUD code oscillator!)
BL-1	3.95	LED Blinky Kit (flashes 2 jumbo LED's)
WL-1	6.95	Whisper Light Kit
SM-3	3.95	Siren Kit
UT-5	5.95	Universal 555 Timer-Oscillator Kit (Many applications)
VS-1	6.95	Voice Activated Switch kit
MD-3	16.95	Microwave (1.3 Ghz.) Intrusion Alarm Kit
TS-1	6.95	Touch Switch Kit (makes 2 complete touch switches!)
TD-1	5.95	Tone Encoder-Decoder Kit
LB-5	9.95	Infra-Red Beam Communications Receiver Kit
LB-6	8.95	Infra-Red Beam Communications Transmitter Kit

AND ... WHILE YOU'RE GETTING YOUR ORDER TOGETHER, remember that your local ham club or repeater association can save many service \$\$\$ for members with an E-Z Pay Lease on ...

COM-3	2795.00	Professional Communications Service Monitor
COM-7	3495.00	Spectrum Analyzer
RSC-10	2495.00	Synthesized Signal Generator

RAMSEY

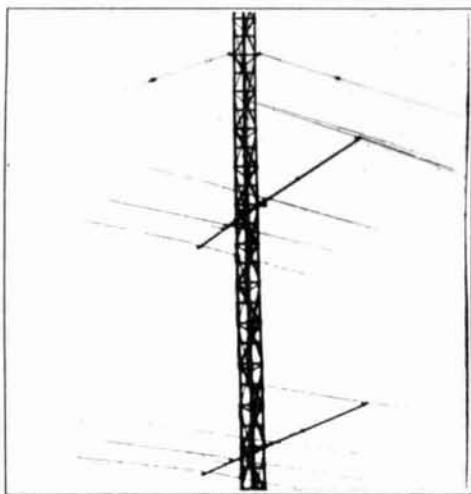

LTA 4 over 4 Championship Stacked Array

Some of the LOUDEST signals
this season will come from
LTA Championship Beams!
Get the competitive edge; step up to LTA.
To find out how you can be
Louder Than Anything,
call or write for
Championship Yagi's.

LTA Industries Inc.
Box 92 • Canfield, Ohio 44406
216•533•0087

✓ 139

VHF-UHF POWER DIVIDERS



RF power dividers provides the best way to feed in-phase 2 and 4 antenna arrays to maximize system gain and at the same time reduce losses to a minimum. Covering 144 thru 1296 MHz, this series of VHF/UHF power dividers are premier RF devices designed for a long service life with low SWR and broad operating bandwidth.

Extruded aluminum body with a durable enamel finish in addition to silicon sealing at connector flanges results in a ruggedized unit for all array installations. Available with N-type connectors only, these units are unconditionally guaranteed for 2 years.

MODEL	CONFIG.	PRICE
144-2P	(2 ports)	\$54.00
144-4P	(4 ports)	\$61.00
220-2P	(2 ports)	\$53.00
220-4P	(4 ports)	\$60.00
430-2P	(2 ports)	\$51.00
430-4P	(4 ports)	\$59.00
902-2P	(2 ports)	\$51.00
902-4P	(4 ports)	\$59.00
1296-2P	(2 ports)	\$52.00
1296-4P	(4 ports)	\$60.00

SHIPPING NOT INCLUDED

STRIDSBURG ENGINEERING, CO.

P.O. Box 7973 • Shreveport, LA 71107 • USA
Phone: (318) 865-0523

✓ 140

HAM LICENSE PREPARATION

WRITTEN TEST STUDY GUIDES

All word-for-word questions, multiple choices... answers. Choose Novice, Technician, General, Advanced or Extra Class Answer explanations supplied!

\$4.95 Each version + \$1.50 shipping.

All five manuals: \$22.95 postpaid.

HAM RADIO Q & A MANUAL

All 1,932 questions, multiple choices and answers found in every ham license exam, Novice through Extra Class.

\$9.95 Shipped postpaid.

MORSE CODE TEST PREPARATION

Set contains two 2-hr. cassette tapes

Code Teacher,	0-5 WPM	\$9.95
General Code,	3-15 WPM	\$9.95
Extra Code,	12-21 WPM	\$9.95

Plus \$1.50 shipping per set.

All Manuals/Code Tapes: \$49.95

New \$Part 97 Ham Rules: \$ 2.95

Order shipped same day received!
Credit card phone orders: 10 a.m. - 2 p.m.

W5YI MARKETING

P.O. Box #565101 - Dallas, TX 75356
Tel: (817) 461-6443 - 24 hours

EVERY ISSUE of

HAM RADIO



now available on microfiche!

The entire run of *Ham Radio Magazine* (March, 1968 thru last year) is ready to ship to you in one, easy to use format.

Our 24x microfiche is easy to read and very compact. We offer a hand held reader for \$75, and a desk model for \$220. Libraries have these readers.

As a bonus, you will receive *Ham Radio Horizons* (3/77 thru 12/80) free.

Everything is included, front cover to back - ads too!

Annual updates will be offered for \$10.

Send \$205 payment
(visa/mc accepted) to:

BUCKMASTER

BUCKMASTER PUBLISHING

Route 3, Box 56

Mineral, Virginia 23117

703/894-5777 visa/mc 800/282-5628

TABLE 2

"Quick Look" prediction for December 16, 1989 over California-India path. At 0200 UTC, 21 MHz looks like a good bet.

MINIPROP Short Path Predictions		12-16-89		Path Length: 12716 km		
Sunspot number: 155.0	Flux: 204.4	F Hops: 4P		Radiation Angle: 5 degrees		
TERMINAL A: 37.30 N 120.00 W California		Bearing to B: 340.2 degree				
TERMINAL B: 25.50 N 80.00 E India		Bearing to A: 17.4 degree				
Terminal A Sunrise/Set: 1512/0039 UTC		Terminal B Sunrise/Set: 0123/1148 UTC				
Quick Look Signal Levels in dB above 0.5 mV						
UTC	MUF	3.6 MHz	7.1 MHz	14.1 MHz	21.2 MHz	28.3 MHz
0000	14.5	23 a	28 a	26 B		
0030	18.0	28 a	30 a	27 A	24 D	
0100	21.7	27 a	29 a	27 A	24 B	
0130	26.3	24 a	28 a	26 A	23 A	21 D
0200	23.3	16 a	25 a	25 A	23 A	20 D
0230	21.3	8 a	22 a	24 A	22 B	
0300	19.8	1 a	19 a	23 a	22 C	
0330	18.5	-5 a	16 a	23 a	22 D	
0400	16.7	-10 a	14 a	22 a	21 D	
0430	15.4		13 a	21 b		
0500	13.7		11 a	21 c		
0530	14.0		11 a	21 c		

Signal levels not shown if below -10 dB or if predicted availability is zero. Availabilities A: 75-100 percent, B: 50-75 percent, C: 25-50 percent, D: 1-25 percent. a, b, c, d: Same as A-D, with high probability of reduced signal levels.

FIGURE 4

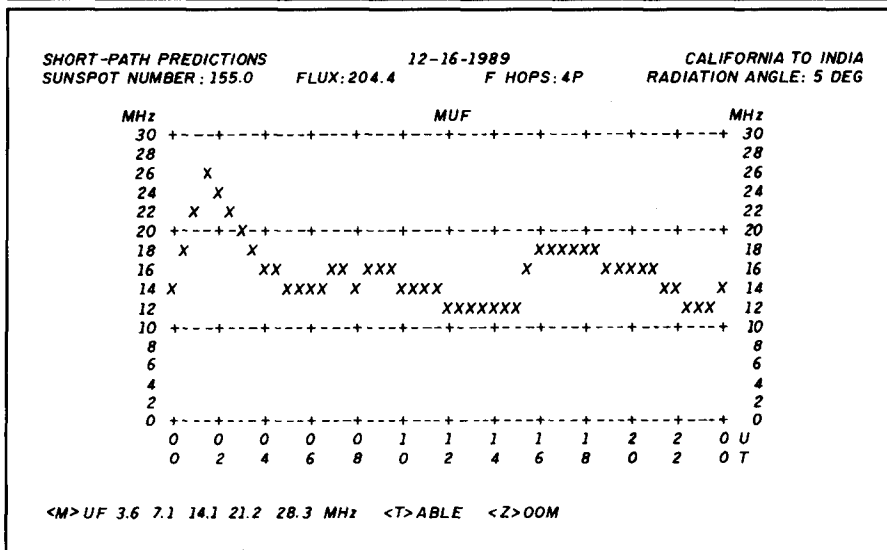

MINIPROP prints graph of California to India path for sunspot number of 155. X-axis is time in UTC. Y-axis is frequency in MHz.

WWV, MINIPROP provides you with the most accurate propagation information available.

Last fall I ran a test program from California to India using MINIPROP. Thanks to my MINIPROP data, I nailed Diego Garcia before the DX multitude descended! That made me feel very, very good!

MINIPROP will run on an IBM clone,

PS/2, or true compatible with a 320K (or bigger) memory, one 5-1/4 inch floppy or 3-1/2 inch drive, and PC-DOS or MS-DOS 2.11 or later. An 80-column monitor (monochrome or color) is required. A math coprocessor is recommended but not required.

For more information, contact W6EL Software, 11058 Queensland Street, Los Angeles, California 90034-3029.

The Dead Band quiz

My March column posed two brain teasers. The first asked you to identify the quotation, "Remain on patrol in vicinity of Rockall."

What was this signal? To whom was it sent, under what conditions? What was Rockall?

The quotation is from *The Cruel Sea*, the outstanding book by Nicholas Monsarrat. The coded wireless message from the British Admiralty to the frigate "Saltash" signified the end of World War II. Rockall is a sea mount, about 300 miles west of Scotland. *The Cruel Sea* is recommended reading for a dead band!

The second quotation: "Brain! Brain! What is Brain?" is well-known to avid "Trekkies." It's from the third season of *Star Trek* in the episode "Spock's Brain." It was said by "The Leader" as the crew of the Enterprise struggled to release Spock's brain from "The Controller."

Finally, kudos to the following who also solved the "snowplow" problem: W5UOJ, KR4N, OH1AXV, PA3FCV, and W9ZSJ who found the problem in the book *Differential Equations* by Ralph P. Agnew (McGraw-Hill, 1960). He says, "If you ever want to read differential equations for pleasure, try the book by Agnew."

INEXPENSIVE TRIBAND MOBILE ANTENNA

By Phil Salas, AD5X, 1517 Creekside Drive, Richardson, Texas 75081

It's not unusual today for many Amateurs to have VHF, UHF, and HF rigs in their cars. I have a Yaesu FT-727R dual band (144/450 MHz) handheld and a Cobra 146GTL CB SSB rig converted to 10 meters.

I've been using a shortened CB magnetic mount antenna for 10 meters. I mounted a cup holder on my dashboard (25 cents at Western Auto) and use this as a mount for my Yaesu 144/450-MHz rig. The small antenna on the handheld works okay through the windshield when I'm traveling around town. However, I've wanted an external antenna for the Yaesu so I can get more range. The only thing that stopped me from buying one of those dual band 144/450-MHz antennas was the thought of a third antenna (including my broadcast antenna) on my small car.

Radio Shack to the rescue! While wandering through my local Radio Shack, I saw a VHF/UHF/AIR magnetic mount mobile antenna. The Radio Shack part number is 20-018. For \$26.95 I thought I'd gamble and see if I could make it work on my three mobile bands. Because the antenna cable has a Motorola plug on it, I also purchased the Radio Shack 278-117 BNC-to-Motorola adapter.

Tests

I took the Radio Shack antenna to work and swept it with a return loss bridge. The antenna showed resonances at 38, 150, and 450 MHz. This definitely showed some promise.

I next took the unit and attached it to the top of my car. By using a VSWR meter, I found I could achieve a 1.6:1 VSWR on 146 MHz and a 1.3:1 VSWR at 446 MHz when I adjusted the spacing between the bottom mount and the top resonator to 13-1/2 inches (see Figure 1). Even better, the

FIGURE 1

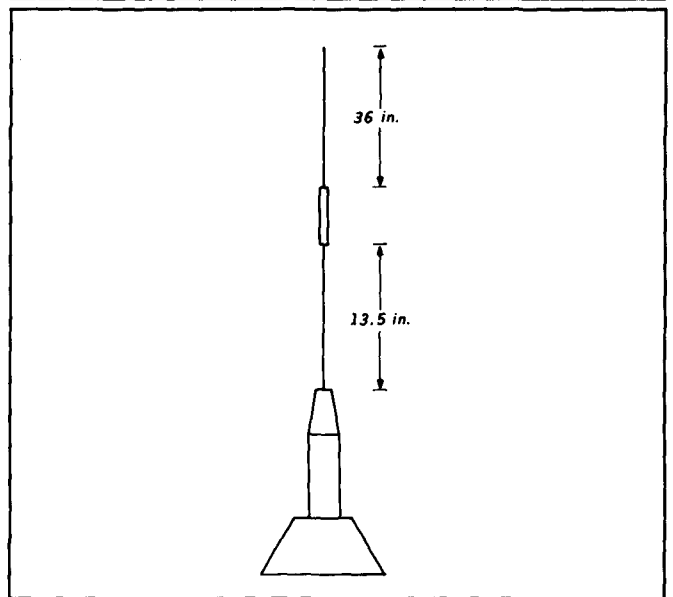

New spacing between bottom mount and resonator provides VSWR improvement.

measured VSWR of the VHF/UHF flex antenna supplied with the Yaesu was 2:1 at 146 MHz and 3:1 at 446 MHz.

A labor of love

A quick calculation indicated that a 36-inch top section in place of the 14-1/2 inch section that came with the antenna should give me resonance in the 10-meter band. I purchased a 0.1-inch diameter, 36-inch long welding rod from my local hardware store and was able to achieve nearly a 1:1 VSWR in the 10-meter band. But hold on — it gets even better.

2-1000 MHz In One Sweep!

AVCOM's New PSA-65A Portable Spectrum Analyzer

The newest in the line of rugged spectrum analyzers from AVCOM offers amazing performance for only \$2,855.

AVCOM'S new PSA-65A is the first low cost general purpose portable spectrum analyzer that's loaded with features. It's small, accurate, battery operated, has a wide frequency coverage - a must for every technician's bench. Great for field use too.

The PSA-65A covers frequencies thru 1000 MHz in one sweep with a sensitivity greater than -90 dBm at narrow spans. The PSA-65A is ideally suited for 2-way radio, cellular, cable, LAN, surveillance, educational, production and R&D work. Options include frequency extenders to enable the PSA-65A to be used at SATCOM and higher frequencies, audio demod for monitoring, log periodic antennas, carrying case (AVSAC), and more.

For more information, write, FAX or phone.

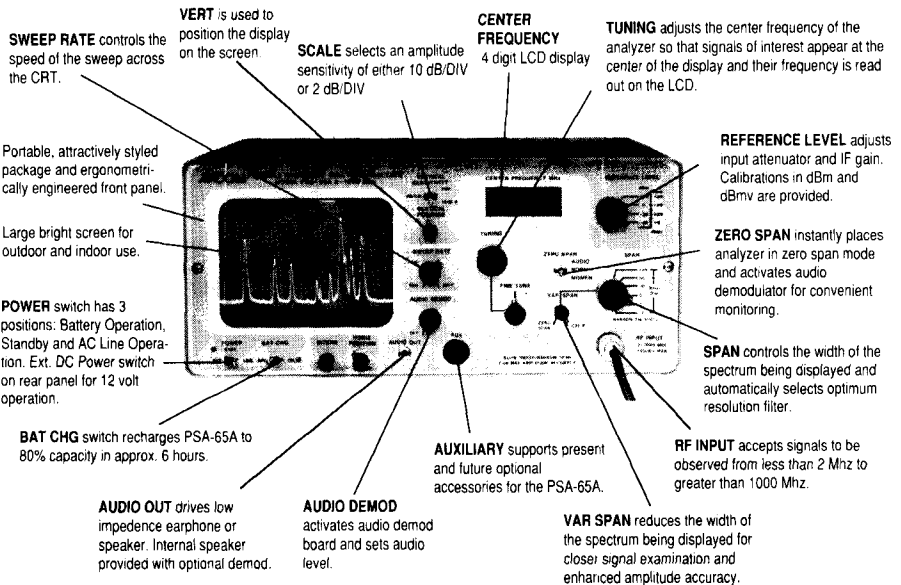

AVCOM

BRINGING HIGH TECHNOLOGY DOWN TO EARTH

500 SOUTHLAKE BOULEVARD
RICHMOND, VIRGINIA 23236
804-794-2500 FAX: 804-794-8284

✓ 141

Amplifier Repair

Alpha - Ameritron - AMP - Henry Dentrone - Heathkit - TenTec - Etc.

35 Years Experience as the Service Manager with a major manufacturer

Authorized TenTec Dealer

K4BWC



Visa & Master Card

OMEGA ELECTRONICS

4209 Live Oak Road
Raleigh, NC 27604
919-832-1025

TEN-TEC

All your TEN-TEC needs!
including *Aries-2* software for the Paragon.
Also carrying RF connectors and Dacron Rope.

M & N Electronics

RD#1, Box 66 - Orangeville, PA 17859

717-458-6243

SASE for free brochure

(your phone call re-imbursed with Radio Order)

✓ 142

DC-900 MHZ SWITCHES

Loss .15dB, Isol. Lo/70dB, Hi/50dB, Power 10W, VSWR 1.3, Set/Reset 4msec, 12-15 VDC, usable to 1200 MHz.
RRS1 (SPDT) - to switch two antennas, receivers or as Tx/Rx — \$77 + \$4 TRS1-to bypass a preamp, to insert a pad/filter, to build a matrix — \$98
10-900 MHZ PIN DUPLEXER
DUP1-Tx Power 100W, Tx/Rx Isol.40dB/50MHz, 30dB/150MHz, Loss .25dB/50MHz, .7dB/900MHz, VSWR Lo/1.2, Hi/1.5 — \$179

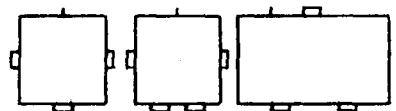

WILAM TECHNOLOGY
P.O. Box 5174, MASSENA, N.Y. 13662
(315) 769-8334

✓ 143

SUBSCRIBE

AND RENEW

TOLL-FREE



HAM RADIO

1 YR - \$22.95 2 YRS - \$38.95

3 YRS - \$49.95

Prices U.S. only



MASTERCARD

BILL ME

VISA

Please have your charge card ready.

DATATEL 800™

800-341-1522

Weekdays 8 AM - 9 PM EST • Saturdays 9 AM - 5 PM EST
IN MAINE CALL COLLECT (207) 236-2896

OUR 800 NUMBER IS FOR SUBSCRIPTION ORDERS ONLY!

For Errors or Change of Address CALL *ham radio*
direct at (603) 878-1441 8-5 EST

Make the
most of your
general
coverage
transceiver
with
*Monitoring
Times!*

Every month *Monitoring Times* brings everything you need to make the most of your general coverage transceiver: the latest information on international broadcasting schedules, frequency listings, international DX reports, propagation charts, and tips on how to hear the rare stations. *Monitoring Times* also keeps you up to date on government, military, police and fire networks, as well as tips on monitoring everything from air-to-ground and ship-to-shore signals to radioteletype, facsimile and space communications.

ORDER YOUR SUBSCRIPTION TODAY before another issue goes by. In the U.S., 1 year, \$18; foreign and Canada, 1 year, \$26. For a sample issue, send \$2 (foreign, send 5 IRCs). For MC/VISA orders (\$15 minimum), call 1-704-837-9200.

MONITORING TIMES

*Your authoritative source,
every month.*

P.O. Box 98 A
Brasstown, N.C. 28902

✓ 145

W6SAI BOOKS

by noted HR columnist Bill Orr, W6SAI.

ALL ABOUT VERTICAL ANTENNAS

Theory, design, construction and operation are fully covered for vertical antennas. Grounds and their importance get extra emphasis. Construction data for 25+ antenna designs. 192 pages ©1986 1st edition

RP-VA

Softbound \$10.95

THE RADIO AMATEUR ANTENNA HANDBOOK

Covers all kinds of antennas from HF to VHF, horizontal to vertical. Compiled from years of W6SAI's extensive writings. Great reference volume to have on hand. Check full of proven antenna designs that work! 190 pages ©1978 1st edition

RP-AH

Softbound \$11.95

INTERFERENCE HANDBOOK by WA6FQG

With homes rapidly filling with vulnerable electronic equipment, knowing how to solve interference problems is a must. WA6FQG has years of experience and tells you everything you need to know to solve even the thorniest interference problem. © 1981 1st edition

RP-IH

Softbound \$11.95

THE RADIO HANDBOOK 23rd edition

Great technical resource to have available in your Ham workshop. Full of all kinds of projects, antennas and the best compilation of HF and VHF amplifiers in the Amateur Radio field. Includes new easy-to-use charts, graphs and tables. Best value in Amateur Radio today. 1200 pages ©1986 23 edition

22424

(Reg \$29.95 SAVE \$3)

Hardbound \$26.95

Please enclose \$3.75 shipping and handling

HAM RADIO

Greenville, N.H. 03048



Order today! (603) 878-1441
or "FAX" us (603) 878-1951

Because the trap apparently isolated the top section from the bottom at 146 and 446 MHz, I surmised that the bottom section must look like a quarter wave at 146 MHz and a three-quarter wave at 446 MHz. I removed the trap and top section, and found that I could still achieve the low VSWR on both 146 and 446 MHz when the bottom rod extended 14 inches above the bottom mount. To do this, I had to purchase a new bottom section (0.2-inch diameter aluminum rod), as the original rod was just a little too short. Again, my local hardware store had what I needed. Now when I attach the top section, the new bottom rod extends 1/2 inch into the trap, giving the desired 13-1/2 inch section between the bottom mount and the trap.

Switching arrangement

Finally, I replaced the set screw on the bottom end of the resonator with a 10-24 thumb-tightened screw. This permits me to remove the top section of the antenna easily whenever I don't need the 10-meter capability. An inexpensive antenna switch mounted on my dash now selects either the handheld or the 10-meter rig. I made my switch out of a Radio Shack 275-403 DPDT toggle switch mounted in a Radio Shack 270-235 2-3/4 x 2-1/8 x 1-5/8 inch aluminum box, two BNC female connectors, and an SO-239 coax connector. To keep from damaging the off-line rig should I accidentally key it, I also added a 50-ohm termination on the switch (two 100-ohm, 2-watt resistors in parallel) as shown in Figure 2.

MICROWAVE MODULES EQUIPMENTS

Use your existing HF or 2M rig on other VHF or UHF bands.

RECEIVE CONVERTERS

MMc 144-28(HP)	\$ 99
MMc 435-28(S)	115
MMc 421-ATV	115
MMc 426-ATV	115
MMc 434-ATV	115
MMc 439-ATV	115
MMk 1691-137	330

LINEAR TRANSVERTERS

MMI 50-144	\$295
MMI 144-28	295
MMI 220-28	325
MMI 435-28(S)	399
MMI 50-28(S)	499

ANTENNAS

137 Wx:	
5XY-137-C	\$ 110
2M:	
10XY-2M	\$ 90
Circ Harness	20
70 cms:	
70/MBM28	\$ 65
70/MBM48	95
70/MBM88	135
900 MHz:	
DY20-900	\$ 89



LOOP YAGIS	
1268-LY	\$ 70
1296-LY	75
1691-LY	75
(Order connector extra)	

LOOP YAGI XTN Kits

(for increasing gain. Add to existing L.Y.)

1268-XTN	\$ 70
1296-XTN	70
1691-XTN	75

See us at DAYTON Booths 66 & 67

Send 75¢ (3 stamps) for detail specs of all VHF & UHF items and KV6 crystal filters.

Shipping: FOB Concord, Mass.

Prices subject to change without notice



si

(508) 263-2145

SPECTRUM INTERNATIONAL, INC.
Post Office Box 1084
Concord, MA 01742, U.S.A.

144

FIGURE 2

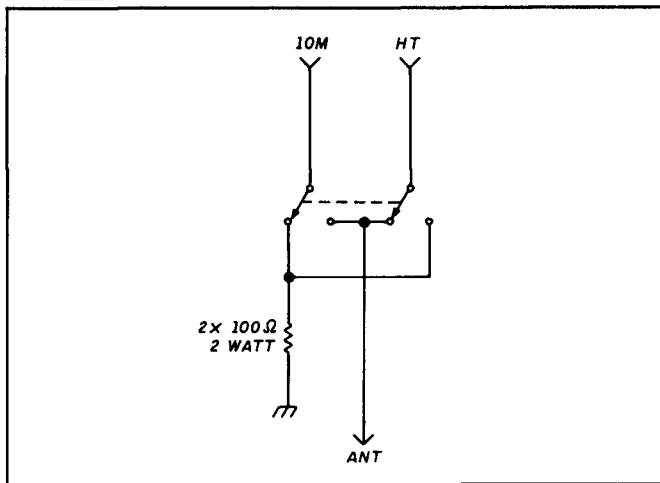

Resistors in switch line prevent accidental damage if unused rig is keyed inadvertently.

Results

How does it all work? Great! I have terrific coverage on VHF and UHF, and I still work all over the United States, Canada, and South America (and occasionally Europe) on 10 meters with ease. Even with the longer top section, the magnetic base holds the antenna on my car roof at higher speeds. Not a bad deal for less than \$35 worth of parts!

There you have it. This may be the simplest and quickest project around. You can find everything easily and inexpensively at your local Radio Shack and hardware stores.

Engineering Consulting's computer controlled Ham Shack
See system variables, control & reprogram all via packet!
Ultra Comshack 64 Repeater Controller
HF & VHF Remote Base*Autopatch*CW Practice*Rotor Control
*Voice Meters*Paging*Logging*Polite ID's*Packet Voice B.B.S.

Model CS64S
\$ 359.95

Includes: Interface, disk, cables, Manual

Ultra Options

Add duplex tel. Remote Base control & 3 way patch...TLCN...\$159.95
External relays; 3 DPDT relays +5
Open Col. Trans. Sw...CS 8...\$69.95
*Rotor control D.C. to digital display & Voice; for all rotors...MM1...\$59.95
*2 Voice Meters & 2 Alarm inputs; 8 Relay On/Off Control...PK8...\$159.95
*Reprogram & Control via Packet; Packet to Voice B.B.S. PK1...\$89.95
*EPROM Autoboot CART...\$109.95
*C64 & 1541 12V. Switching supply crystal controlled...DCPS...\$129.95
*Digital Voice Rec/PB 32 or 64 sec. voice Mailbox & ID Tail...DVM \$179.95
*Manual (REFUNDED) MM1...\$ 20.00

Controller Features

- *Change variables remotely from touchtones or Packet
- *Unlimited voice vocabulary!
- *Alarm Clock, auto execute
- *Individual 4 digit user codes
- *Disk & Printer logging of users, tel #'s, lapsed time
- *18 Rotating Polite ID's
- *16 External relay controls
- *2, 5, & CTCSS Tone Paging
- *CW Practice with voice
- *Security mode, T.tone mute
- *Voice announces each user when logging on

Autopatch & Reverse

- *1000 (18 digit) tel #'s stored
- *Quick dial & quick answer
- *Directed, general page
- *Selected restricted patch
- *Telephone control input
- Dual Combined Remotes**
- *18 Macro/Scan memories
- *Scan up/down; 100Hz steps
- *Monitor & lock modes
- *Operate splits, combine HF & VHF radios as Dual VFO's
- *Automatic mode selection
- *Talking S Meter; Voltmeter call sign when logging on
- *Voice Beacon rotating msg

Computer Control
YAesu FT-727R

Mini Cat

Allows H.T. to scan 100 Channels & programs H.T. for field use! Digital "S" Meter; comment fields; auto resume & delay; Scan Lock-outs; Loads FT727 in 15 sec. Hardware, cables, & disk included for C64 or IBM

Model 727 \$49.95

Touchtone Decoder
4 digit sequence; & QUAD expansion 4 relay option

2"x3" TSDQ

8/20 V & audio in; Field Program 50,000 Codes; Morn. & Latching; DPDT Relay; Wrong digit reset; LED for digit valid & latch; inc. 24 Pin connector

QUAD option adds: 2 Amp. relays; 5 digit master on/off control for each relay.

Model 727 \$49.95 TSDQ \$89.95 QUAD \$99.95

Decode-A-Pad
Touchtone to RS232 300 Baud Interface

Use with all computers
Decodes 16 touchtones
Includes Basic program

DAP \$ 99.95

12 Volt C64 SWITCHER
Crystal 60Hz
9VAC sv. 2A.
C64 & 1541
DCPS \$129.95

AUDIO BLASTER IC02; 04;2AT; FT-727; 411; 209; 470; 73/23; U16; TH25

← Miniature Audio Amp
Module installs inside all H.T.'s
1 watt audio amp! When it needs to be loud! Installs in 15 Min. Used by police, fire!

Model AB1S \$24.95

New Digital Voice Recorder

*Records 32 or 64 Sec. studio quality audio
*Use for auto CQ, ID, tail, Mailbox, Local or logic control; Up to 16 selectable messages!

Includes: 1 Watt audio amp; 1 Meg RAM; Mic & Spkr Jacks, vol. control; Reg. 9 to 12V; Interfaces to Ultra Com Shack 64 Ver 8.0; Provides Digital Voice CQ, ID tail, Mailbox, bulletins

DVM \$179.95

WE SHIP WORLDWIDE
Barry Electronics Corp.
 WORLD WIDE AMATEUR RADIO SINCE 1950
 Your one source for all Radio Equipment!



SEE You May 20th
 LIMARC, Greenvale, L.I.

KITTY SAYS: WE ARE NOW OPEN 7 DAYS A WEEK.
Saturday & Sunday 10 to 5 P.M.
 Monday-Friday 9 to 6:30 PM Thurs. to 8 PM
 Come to Barry's for the best buys in town.



FT-767GX, FT-757GXII, FT-747GX,
FRG-8800, FT-736R, FT-1000,
FT-4700RH, FT 212/712RH, FT-470

KENWOOD



ANTENNAS
 A.S. AES, Cushcraft, Hy-Gain,
 Hustler, KLM, METZ, Mosley,
 Urban, MODULOX, TONNA,
 Butternut Multi-Band

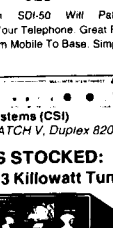

TS440S/AT, R-500D, TS-940 S/AT, TM 231A/
 431A, TM-2570A/50A, TR-751A, Kenwood
 Service Repair, TM-731A, TS-71181A,
 TH205AT, TH225A, TM-631A, TM-331A,
 TS140S, TS680S, RZ-1, TS-790A, TS950S,
 TH-75A, TH2646AT

AMPLIFIERS
 STOCKED:
 RF Concepts
 Mirage
 TE Systems

MARINE RADIOS
 ICOM MS, M56, M700TY, A-20
 AVIATION PORTABLE ICOM A-20

YAESU ICOM
 FT-23 IC29/4SAT
 FT-411 811-911 IC02A/732AT
 FT-1903/1123 IC2/4GAT/22AT
 FT-2008/7008 IC-A20/U16

Landmobile HT's
 ICOM U16, H16, V100 U400
 MAXON MOTOROLA
 YAESU FTH 2008/7008
 UNDEN, HEGENCY, KING,
 MARINE ICOM MS, M56, M700
 AVIATION ICOM A20 HT, TAD

ONV Safety
 belts-in stock

CES
 Simplex Autopatch S01-50 Will Patch
 FM Transceiver To Your Telephone. Great For
 Telephone Calls From Mobile To Base. Simple
 To Use. SDI-50

Panasonic

NEL-TECH DWX-100 Digital Voice Keyer
 FLUKE 77, 83, 85, 87 Multimeters

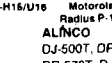

Wanted: HF Radio Technician

Computer Interfaces
 Stocked: MFJ-1270B,
 MFJ-1274, MFJ-1224, AEA
 PK-88, MFJ-1278T, PK-232 MB
 W/AFAX, DRST PRODUCTS

AR 900 Hand Held Scanner 100
 ch Covers 27-54, 108-174,
 406-512, 800-950 MHz

FREQUENCY
 COUNTERS:
 1MHz-1.0MHz

COMMERCIAL & HAM
 REPEATERS
 STOCKED.
 WRITE FOR
 QUOTES

Kantronics
 KAM, KPC II,
 KPC 2400, KPC IV,

VoCom/Mirage/Alinco
 Tokyo Hy-Power/TE SYSTEMS
 Amplifiers & 5/8" HT Gain
 Antennas IN STOCK

G&G ELECTRONICS ART.1,
 Air Disk, SWL, Morse Coach

MOTOROLA AUTHORIZED DEALER
 KACHINA COMMUNICATIONS DEALER

AUTHORIZED
SONY
 DEALER

DIGITAL FREQUENCY COUNTERS
 OPTOELECTRONICS model 1300 H/A, 0-1300MHz
 2210 H, 0-2200 MHz

Radios for Business,
 Gov't, 2-way, etc.
 Stocked & serviced,
 call for great prices!

Professional Soldering
 Station
 48 Watts
 \$79

METRON
 KW HF Mobile
 Amplifier
 Stocked

Long-range Wireless
 Telephone for export in stock

BENCHER PADDLES
 BALUNS, LOW PASS FILTERS
 IN STOCK

MIRAGE AMPLIFIERS
 ASTRON POWER SUPPLIES
 Belden Wire & Cable, Int'l Wire
 OPTO KEYS STOCKED

Media Monitors
 Amateur Radio Course

Alpha Delta
 Products
 Stocked

EIMAC
 3-500Z
 572B, 6JS6C
 12BY7A &
 6146B

Hy-Gain Towers &
 Antennas, and
 Rotors will be
 shipped direct to
 you FREE of
 shipping cost.

New TEN-TEC
 Corsair II, PARAGON,
 OMNI V

HEIL EQUIPMENT
 IN STOCK

AEA 144 MHz
 AEA 220 MHz
 AEA 440 MHz
 ANTENNAS

BIRD
 Wattmeters &
 Elements
 In Stock

AMERITRON AUTHORIZED DEALER

MAIL ALL ORDERS TO: BARRY ELECTRONICS CORP., 512 BROADWAY, NEW YORK CITY, NY 10012 (FOUR BLOCKS NORTH OF CANAL ST.)

NEW YORK CITY'S
 LARGEST STOCKING HAM DEALER
 COMPLETE REPAIR LAB ON PREMISES

COMMERCIAL RADIOS
 STOCKED: ICOM, Motorola,
 MAXON, Standard,
 Yaesu. We serve munic-
 ipalities, businesses, Civil
 Defense, etc Portables,
 mobiles, bases, re-
 peaters

WE NOW STOCK COMMERCIAL COMMUNICATIONS SYSTEMS
 HAM DEALER INQUIRES INVITED PHONE IN YOUR ORDER & BE REIMBURSED
COMMERCIAL RADIOS stocked & serviced on premises.
Amateur Radio Courses Given On Our Premises, Call
Export Orders Shipped immediately. TELEX 12-7670

ALL
 SALES
 FINAL

FAX: 212-925-7001

“Aqui Se Habla Espanol!”
 BARRY INTERNATIONAL TELEX 12-7670
 MERCHANDISE TAKEN ON CONSIGNMENT
 FOR TOP PRICES

Monday-Friday 9 A.M. to 6:30 P.M. Thursday to 8 P.M.
 Saturday & Sunday 10 A.M. to 5 P.M. (Free Parking)

IRT/LEX: Spring St. Station. Subways: BMT,
 “Prince St. Station”, IND: “F” Train-Buy Station.
 Bus: Broadway #6 to Spring St. Path-9th St/6th Ave.
 Station.

WE SHIP WORLDWIDE

WE SHIP WORLDWIDE

WE SHIP WORLDWIDE

WE SHIP WORLDWIDE

WE SHIP WORLDWIDE

WE SHIP WORLDWIDE

WE SHIP WORLDWIDE

WE SHIP WORLDWIDE

WE SHIP WORLDWIDE

WE SHIP WORLDWIDE

WE SHIP WORLDWIDE

WE SHIP WORLDWIDE

WE SHIP WORLDWIDE

WE SHIP WORLDWIDE

WE SHIP WORLDWIDE

WE SHIP WORLDWIDE

WE SHIP WORLDWIDE

WE SHIP WORLDWIDE

WE SHIP WORLDWIDE

WE SHIP WORLDWIDE

WE SHIP WORLDWIDE

WE SHIP WORLDWIDE

WE SHIP WORLDWIDE

WE SHIP WORLDWIDE

WE SHIP WORLDWIDE

WE SHIP WORLDWIDE

WE SHIP WORLDWIDE

WE SHIP WORLDWIDE

WE SHIP WORLDWIDE

WE SHIP WORLDWIDE

WE SHIP WORLDWIDE

WE SHIP WORLDWIDE

WE SHIP WORLDWIDE

WE SHIP WORLDWIDE

WE SHIP WORLDWIDE

WE SHIP WORLDWIDE

WE SHIP WORLDWIDE

WE SHIP WORLDWIDE

WE SHIP WORLDWIDE

WE SHIP WORLDWIDE

WE SHIP WORLDWIDE

WE SHIP WORLDWIDE

WE SHIP WORLDWIDE

WE SHIP WORLDWIDE

WE SHIP WORLDWIDE

WE SHIP WORLDWIDE

WE SHIP WORLDWIDE

WE SHIP WORLDWIDE

WE SHIP WORLDWIDE

WE SHIP WORLDWIDE

WE SHIP WORLDWIDE

WE SHIP WORLDWIDE

WE SHIP WORLDWIDE

WE SHIP WORLDWIDE

WE SHIP WORLDWIDE

WE SHIP WORLDWIDE

WE SHIP WORLDWIDE

WE SHIP WORLDWIDE

WE SHIP WORLDWIDE

WE SHIP WORLDWIDE

WE SHIP WORLDWIDE

WE SHIP WORLDWIDE

WE SHIP WORLDWIDE

WE SHIP WORLDWIDE

WE SHIP WORLDWIDE

WE SHIP WORLDWIDE

WE SHIP WORLDWIDE

WE SHIP WORLDWIDE

WE SHIP WORLDWIDE

WE SHIP WORLDWIDE

WE SHIP WORLDWIDE

WE SHIP WORLDWIDE

WE SHIP WORLDWIDE

WE SHIP WORLDWIDE

WE SHIP WORLDWIDE

WE SHIP WORLDWIDE

WE SHIP WORLDWIDE

WE SHIP WORLDWIDE

WE SHIP WORLDWIDE

WE SHIP WORLDWIDE

WE SHIP WORLDWIDE

WE SHIP WORLDWIDE

WE SHIP WORLDWIDE

WE SHIP WORLDWIDE

WE SHIP WORLDWIDE

WE SHIP WORLDWIDE

WE SHIP WORLDWIDE

WE SHIP WORLDWIDE

WE SHIP WORLDWIDE

WE SHIP WORLDWIDE

THE RF CONNECTION
 “SPECIALIST IN RF CONNECTORS AND COAX”
NEW FOR DAYTON 1990

Tired of low quality, unstable VHF/UHF/SHF transverters?
 See the solution at booths 156/157 at the Dayton Hamfest.
 Linear transverters with stable, phased locked LO's.
 Choice of temperature compensation or oversized reference
 crystals. Perfect for tower mounting 3HF media.
 Fully shielded phased locked reference oscillators with
 dual outputs +7dbm @ 50 ohms.
 Phased locked FM only transmitters and receivers.

83-822	PL-259 Teflon, Amphenol	1.75
PL-259/ST	UHF Male Silver Teflon, USA	1.50
UG-210/U	N Male RG-8, 213, 214, Amphenol	3.25
UG-218/U	N Male RG-8, 213, 214, Kings	4.00
9913/PIN	N Male Pin for 9913, 9086, 8214 fits UG-21D/U & UG-21B/U N's	1.50
UG-210/9913	N Male for RG-8 with 9913 Pin	3.95
UG-218/9913	N Male for RG-8 with 9913 Pin	5.75
UG-146A/U	N Male to SO-239, Teflon USA	6.00
UG-83A/U	N Female to PL-259, Teflon USA	6.00

“THIS LIST REPRESENTS ONLY A
 FRACTION OF OUR HUGE INVENTORY”

THE R.F. CONNECTION
 213 North Frederick Ave. #11
 Gaithersburg, MD 20877

(301) 840-5477
 VISA/MASTERCARD: Add 4%
 Prices Do Not Include Shipping

146

**SYNTHESIZED
 SIGNAL GENERATOR**

**MADE IN
 USA**

**MODEL
 SG-100F
 \$429.95
 delivered**

- Covers 100 MHz to 199.999 MHz in 1 kHz steps with thumbwheel dial
- Accuracy +/- 1 part per 10 million at all frequencies
- Internal FM adjustable from 0 to 100 kHz at a 1 kHz rate
- External FM input accepts tones or voice
- Spurs and noise at least 60 dB below carrier
- Output adjustable from 5-500 mV at 50 Ohms
- Operates on 12 Vdc @ 1/2 Amp
- Available for immediate delivery • \$429.95 delivered
- Add-on accessories available to extend freq range, add infinite resolution, AM, and a precision 120 dB attenuator
- Call or write for details • Phone in your order for fast COD shipment.

VANGUARD LABS
 196-23 Jamaica Ave., Hollis, NY 11423
 Phone: (718) 468-2720 Mon. thru Thu.

1500 + WATT TRANSMATCH KIT

BASIC KIT T MATCH \$169.95
BASIC KIT SPC \$189.95

INDIVIDUAL ITEMS—

rotary inductor 28uH	\$59.00
6:1 ball drives (Jackson Bros.)	\$15.00
0-100 turns counter (B&W)	\$65.75
turns counter, economy (Groth)	\$22.50
205 pf 4500 v dual sect.	\$79.00
25-245 pf 6000 v	\$44.00

OPTIONS—

enclosure (pictured in Sept. 86 CQ)	\$78.00
4:1 balun kit	\$22.50

OTHER KITS

G3RUH, PSK Packet Modem	\$111.00
G3RUH, OSCAR 13 Telemetry Demod.	\$144.95
QRP 20, 5w, 20 meter Transceiver (HR 1/89)	\$124.95
QRP 15, 5w, 15 meter Transceiver	\$129.95
W1FB 160/80 Pre Amp (QST 8/88)	\$22.95
K9CW Memory Contest Keyer	\$109.00
Yaesu FRG-9600, .1 to 60 MHz Converter	\$84.95
20m CW, 15w Transceiver (H.R. 6/87)	\$159.95
50W 75M SSB SCVR	\$179.95
3 Band QRP 12, 15, 17M (QST 10/89)	\$99.00
Micro 20 Hi-Performance RCVR	\$59.45
RX Noise Bridge	\$39.00

Many Other Kits Available

Factory Wired
 Complete Ameritron/Ten-Tec Line CALL
 B&W PT-2500A Amp \$1,695.00
 B&W VS 1500A Tuner \$415.00

We now stock Rohm towers, dials, terminals, chassis, ceramic standoffs, hardware, toroids, amp components, B&W coil stock, etc.

Shipping Extra
Catalog \$1.00

RADIOKIT • P.O. Box 973
Pelham, NH 03076 • (603) 635-2235

147

**Say You
 Saw It in
 Ham
 Radio**

Elmer's Notebook

Tom McMullen, W1SL

ELEMENTARY ELECTRONICS: ALTERNATING CURRENT AND CAPACITORS

In my April column I showed some of the interactions between inductance and alternating current (AC). There's a similar relationship between capacitors and AC as well. Let's look at how this works.

You've seen that when AC is applied to a resistor, the resulting current flow is right in step with the voltage. When the voltage is at its maximum value, the current is also at maximum, and so on. However, when an inductor is involved, the current gets behind the voltage. This is called current lag. Capacitors also separate the current and voltage peaks, but in the opposite direction; the voltage lags the current.

How does the current get ahead?

The current doesn't actually *gain* time, although at first glance it seems to do so. It's a relative thing, so when the voltage lags the current, it appears that the current is somehow getting ahead. Here's what happens.

Do you remember the experiment I

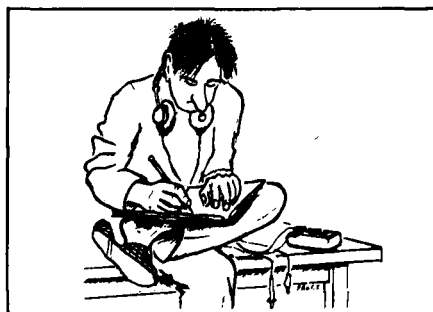

did with capacitors, resistors, and an LED? It required a definite amount of time for a capacitor to become fully charged when the voltage was applied through a resistor. The LED in the circuit glowed brightly at first, then slowly dimmed as the capacitor charged. This happened because the rush of current into the capacitor was large at first, then decreased as the capacitor became more fully charged. An "empty" capacitor has room for a lot of electrons, and a tremendous number of them rush to fill the space. As the capacitor fills up, the difference in potential (voltage) between the power supply and the capacitor drops and the electron flow decreases.

Figure 1 shows how this works. When the battery is first connected to the capacitor, the difference between the voltage across the battery and the voltage across the capacitor is very large, and the current rush is high. This is shown by the large peak near the left side of the graph. As time progresses and the voltage across the capacitor

builds up, the current flow decreases. (There's a formula for determining the rate of charge and discharge of a capacitor. It's used to calculate the time factor in various circuits. I'll explore how to use this formula in another column.)

Figure 2 shows the voltage and current relationship in the circuit just discussed. The voltage is behind the current by 90 degrees (or the current leads the voltage by 90 degrees — whichever way you want to express it).

This characteristic of capacitors has a profound effect on alternating current. The power source tries to charge the capacitor each time the voltage starts to build up. But by the time the voltage has reached a peak, the current has already stopped. When the second half of the cycle starts, the current and voltage are again out of step. This is obviously a very inefficient circuit; maximum work isn't being done when maximum pressure (voltage) exists! In fact, if you pick the instant where the voltage is maximum and check the current flow, the power being used by the circuit is apparently zero. (Watts = Voltage × Current.) Actually, it isn't often that simple. The capacitor has stored some voltage, and when the AC voltage is at or near zero, the capacitor tries to release the

FIGURE 1

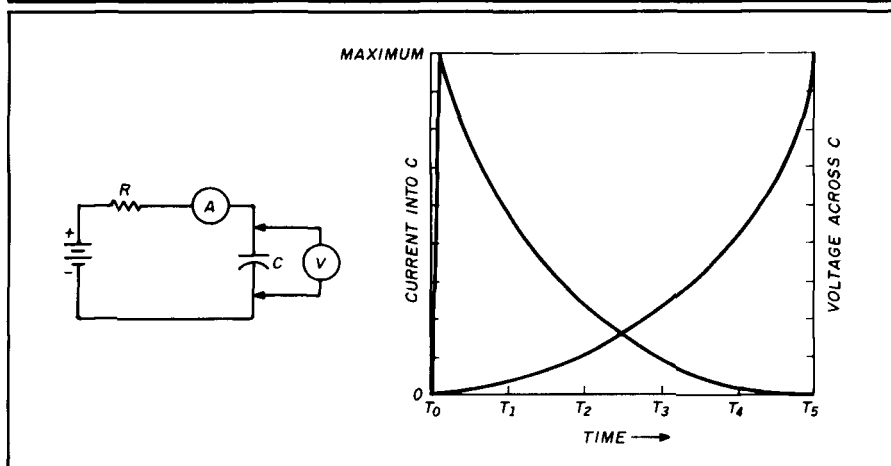

Charging current into a capacitor, and the voltage buildup across it, over a short period of time. Note that neither curve is linear.

FIGURE 2

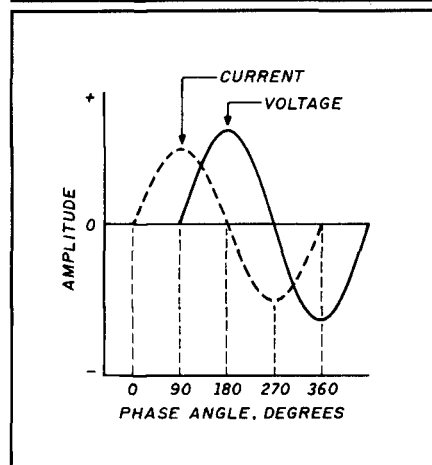

In an alternating current (AC) circuit, a capacitor causes the voltage to lag the current, although convention generally states that the current leads the voltage. Compare this to the phase difference shown for inductance in last month's column where the current lags the voltage.

stored voltage back into the circuit, allowing some current to flow.

The difference between what's really happening (actual power) and what seems to happen (apparent power) determines the efficiency of an AC circuit, and is covered by the term *power factor*. A circuit with a poor power factor isn't working very well (more about this in a future issue). The power factor is important in AC circuits like the circuit that feeds 110 volts AC to your house. A related phenomenon is very important in Amateur Radio circuits like antennas and transmission lines, where a poor power factor causes something called standing wave ratio, or SWR.

How do we use this leading current?

This voltage/current difference can be used to correct the phase shift caused by an inductance. Suppose you have an audio amplifier with an inductance for frequency-response purposes. The inductor will cause the current to lag the voltage by some number of degrees. Placing the correct capacitor value in the circuit to make the voltage lag the current by the same number of degrees will put the voltage and current back in step again.

You could also employ the voltage/current relationship to obtain 180 degrees of phase difference. (An early "phasing" type of single sideband generator used this trick.) With a pair of amplifiers, one with an inductor to provide a +90 degree shift and another with a capacitor to provide a -90 degree shift, the difference becomes 180 degrees (see Figure 3).

The formula

Of course, there must be a way to calculate the effect of capacitance and the phase shift it introduces. A formula for this has evolved, just as it has with inductance. The term for this effect is *capacitive reactance*; the symbol for it is X_c . Two other familiar symbols are also involved — π and frequency (f). The formula is:

$$X_c = 1/(2\pi fC)$$

where f = frequency in hertz, and C = capacitance in Farads.

These units are rather large for Amateur Radio uses where you're often working with radio frequency circuits. It's more convenient to use smaller

units for frequency, capacitance, and inductance. Here's a trick to remember. If you use MHz, μF , and μH together, you'll have fewer decimal places to contend with, and the answer will still be correct.

Now that you have this formula, you can predict the effect that a capacitor will have in a circuit. Let's say that you have a 0.00005- μF (50 pF) capacitor in a circuit working at a frequency of 3.5 MHz. Using the formula,

$$X_c = 1/(2\pi fC) = 1/(6.28 \times 3.5 \times 0.00005) = 1/0.00109 = 917.4 \text{ ohms.}$$

If this capacitor is placed across a 3.5-MHz signal, it will load it slightly. If it's placed in series, it will decrease the RF voltage in the same way a 917-ohm resistor would decrease voltage in a DC circuit.

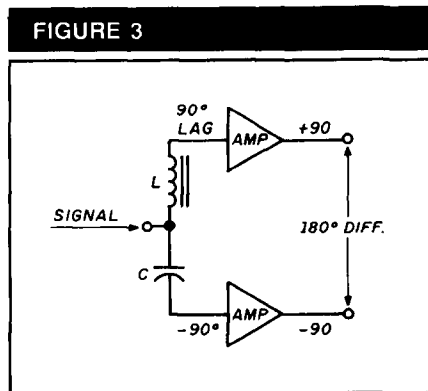

FIGURE 3
One use for both inductive and capacitive phase shift is to obtain a wide difference in phase, like the 180 degree difference at the output of these amplifiers.

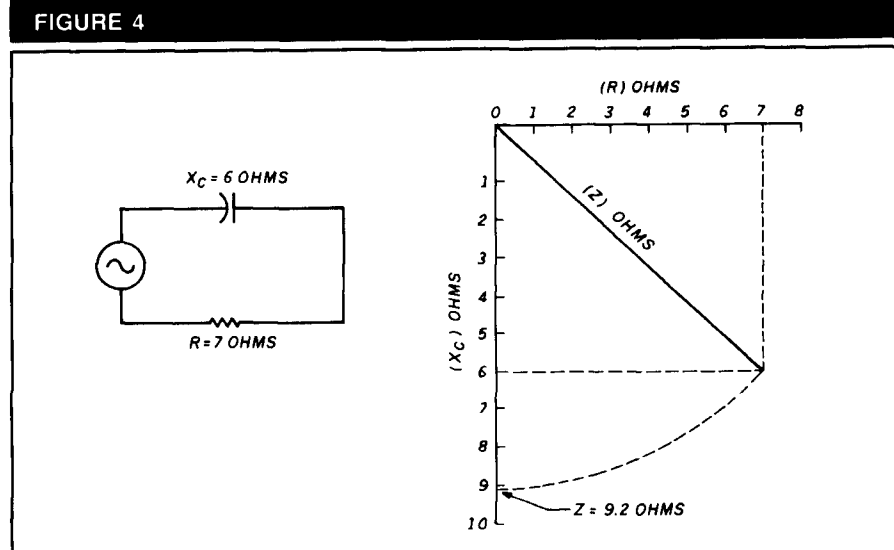

FIGURE 4
The vector diagram for capacitive reactance (X_c) and impedance (Z) is similar to that for inductive reactance, except that it is plotted below the horizontal resistance line.

Vectors, Act II

You thought you were through with vectors, didn't you? No such luck. Vectors are still with us, but you should find working with them easier this time around. You'll put them to work in more ways than one. All real-world circuits contain resistance in addition to capacitance. The vector diagram allows you to predict the effect of this combination. Impedance, Z , is again the symbol of interest, and can be obtained from a vector diagram as in Figure 4. The resistance is plotted horizontally; the reactance (X_c) is plotted vertically. Notice the difference between this vector and the one used for inductance in the last column. Both the capacitive reactance and its impedance vector are *below* the horizontal line. This is done by convention. It indicates that the capacitive reactance is negative (-), while the inductive reactance is considered positive (+).

Here's a little secret. When you look at some of the formulas in many electronics textbooks, you often see a lower case letter "j" with a minus sign in front of it (-j). It usually has a number associated with it: -j3.8, for instance. Engineers call this valuable tool the *j* operator. This -j is telling you that there's some reactance in the circuit, and that the reactance is capacitive (the current is leading the voltage). Sometimes the -j value will also have a units designator, like -j58 ohms for a capacitive reactance value, or -j2.3 A to show that a reactive (leading) cur-

FIGURE 5

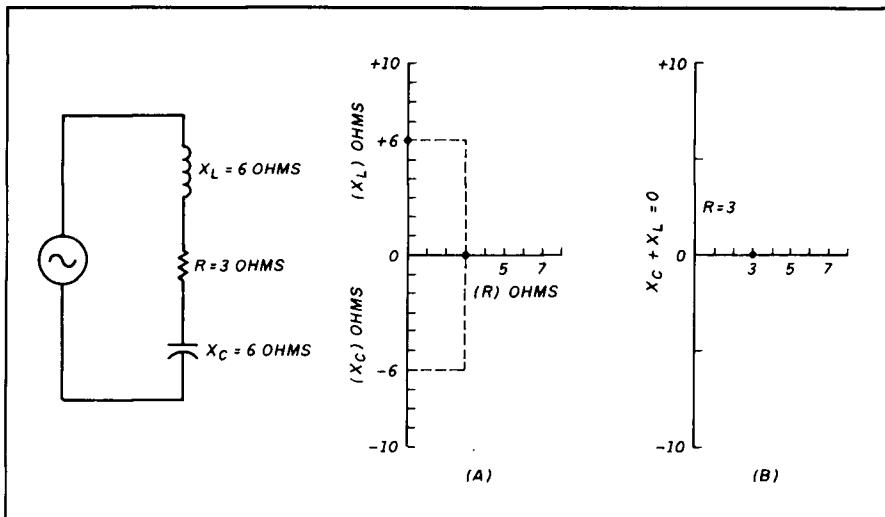

Inductive reactances and capacitive reactances cancel when added vectorially, as shown here. An X_L of +6 ohms and X_c of -6 ohms, with a resistance of 3 ohms plotted at (A), produces the vector diagram at (B) which shows only the 3-ohm resistance remaining. Such a circuit would appear to an AC signal as a 3-ohm resistor.

rent is flowing. You'll see a lot of these j operators in the design of transistorized circuits because most elements in a transistor have the same effect as placing a large capacitor across the signal.

It's important to know the effect of this capacitance so you can provide an inductance to counteract it; otherwise maximum power can't be transferred between stages. Some people place a + sign in front of the j when the reactance is positive (or inductive), and others don't.

Now let's get back to the vectors. To illustrate how the inductive and capacitive reactances cancel in a circuit, (A) in Figure 5 shows a vector diagram of an inductive reactance and one of a capacitive reactance, plotted along the same vertical line. The circuit also contains a resistor, which is plotted horizontally to the right. The plus (+) and minus (-) vectors cancel; the result of combining the two is shown in (B) of Figure 5. All that's left is the simple resistance, R.

How many degrees?

There are a couple of ways to find the phase angle of a reactance. One method involves measuring the angle between the impedance vector (Z) and the resistance line (R) as shown in Figure 4. You may often do this, even when calculating the angle by other methods, just to see if you're on the right track. (A misplaced decimal point can really mess things up!) To get an

idea of the magnitude of the angle, draw a horizontal line from the reactive (X_c) 7-ohm point and extend the resistive 7-ohm point to meet it. The line drawn from the 0 point to the intersection of these two 7-ohm lines is 45 degrees. The Z vector is less than this 45-degree line, so you know approximately where your answer should be if you use the second method correctly. The second method is to use the formula:

$$\text{Phase angle } \theta = \text{COS}^{-1}(R/Z)$$

which is:

$$\theta = \text{COS}^{-1}(7/9.2) = \text{COS}^{-1}(0.7608) = 40.46 \text{ degrees.}$$

You can also use the SIN-1 of X/Z , or the TAN-1 of X/R to obtain the phase angle. Phase angle, by the way, is designated by the Greek letter theta (θ). Most pocket calculators have these trig functions; if yours doesn't, you can find trig tables in most math textbooks. However, the vector diagram will suffice for rough approximations.

Conclusion

Capacitive reactance in an AC circuit is just as much a fact of life as the inductive reactance covered in the last column. Fortunately, both can be calculated and used to obtain the desired effect needed when working with AC power, audio, or RF circuits. Some familiar uses in the Amateur Radio world include matching between

stages in transmitters and receivers, getting correct phase shift for push-pull or parallel amplifiers, matching an output stage to a load, compensating for an antenna that's too long or too short, and (in digital circuits) delaying pulses in one part of a circuit to allow those in another part to catch up.

In my next column, I'll look at some more effects of combining X_L and X_c , at the power factor and what it does to a circuit, and clean up a few loose ends associated with alternating current circuitry. 

LOGWRITE™

Bring your station into the computer age with LOGWRITE, the menu driven, user friendly logging program written by Ed Troy (NG3V). LOGWRITE is the perfect accessory for the complete ham station. It simplifies your operation and gives you the competitive edge in contesting and DX'ing. LOGWRITE works with all IBM PC's and compatibles.

LOGWRITE's unique split screen feature allows for simultaneous logging and text processing. Logging features include:

- Instant call sign or prefix search
- Print, Edit, or View records
- Plenty of room for notes & addresses
- Automatic time/date stamping

Text processor features automatic word wrap, backspace correct, and scrolling. Throw away your pen and paper!

To order your copy of LOGWRITE, complete with instruction manual, send \$24.95 (Pa. residents add \$1.50 sales tax) to:

Aerospace Consulting
P.O. Box 536, Buckingham, PA 18912

Or call (215) 345-7184 to order with Visa/Mastercard. (Please specify 3.5 or 5.25 inch floppy.)
FAX (215) 345-1309

✓ 150

THE
ASOTRON
COMPACT ANTENNAS FROM 160-10 METERS



NO TUNERS!
NO RADIALS!
NO RESISTORS!
NO COMPROMISE!

FOUR EXCELLENT REVIEWS JUST DON'T HAPPEN BY CHANCE.
CALL US FOR A FREE CATALOGUE.

*See review in Oct. 73, 1984 *Sept. 73, 1985
*March 73, 1986 *Dec. 88, CQ

BILAL COMPANY
137 Manchester Dr.
Florissant, Colo. 80816
(719) 687-0650

✓ 149

Alpha Delta Limited Space High Performance Antennas...

- STAINLESS STEEL HARDWARE
- FULLY ASSEMBLED
- SEVERE WEATHER RATED COMPONENTS

• No-trap design. Unlike trap antennas, there are no capacitors to break down under high RF voltages, and a tuner may be safely used for multi-band operation if desired.

• Direct 50 ohm feed. Tuners usually not required when operating in resonant bands.

• Full power operation.

• Uses "ISO-RES" inductors.

• 12 ga. insulated solid copper wire.

(Smaller 14 ga. wire not used in any Alpha Delta antenna)

Model DX-A 160-80-40 Meter Quarter Wave Twin Sloper —

• The premier low frequency DX antenna.
• Combines the tremendous DX firepower of the quarter wave sloper with the wide bandwidth of the half wave dipole.

• One leg is 67', the other 55'. Installs like an inverted-V. Ground return through tower or down-lead \$49.95 each

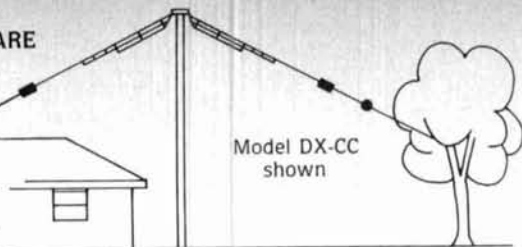

Model DX-CC shown

Model DX-CC "No-Trap" 80-40-20-15-10 Meter Dipole —

• Can be used as inverted-V.

• Only 82' overall length \$89.95 each

Model DX-DD "No-Trap" 80-40 Meter Dipole —

• Can be used as inverted-V.

• Only 82' overall length \$69.95 each

Model DX-EE "No-Trap" 40-20-15-10

Meter Dipole (30-17-12 meters with wide-range tuner)

• Can be used as inverted-V.

• Only 40' overall length \$84.95 each

Available from your local Alpha Delta Dealer or direct. Add \$4.00 shipping and handling (USA only). Exports quoted.



ALPHA DELTA COMMUNICATIONS, INC.



P.O. Box 571, Centerville, Ohio 45459 • (513) 435-4772

current solutions to current problems

✓ 151

★ NEW ★

2 Element Dual Band 'Computer Optimized' Yagi!



Special Introductory Price

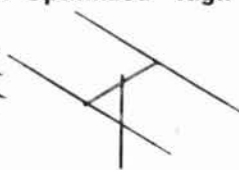

MODEL 1824 2L

Perfect for DX'ing the WARC Bands!

Performance:

Gain: 4 dBd

F/B: 10/12 dB

Coverage: 12/17 Meter band

SWR Typ.: 1.2:1

Power rating: < 1500 watts

Wind load: 2 ft.²

Weight: 16 lbs.

Boom: 8 ft.

Longest element: 26'3"

*New trap design for high strength and power handling. Aluminum is 6061-T6 for high strength and light weight.



SV Products
(219) 632-4642

4100 Fahlsing Road
Woodburn, IN 46797
Evenings & Weekends

✓ 152

NEMAL ELECTRONICS

- *Complete Cable Assembly facilities MIL-STD-45208
- *Commercial Accounts welcome- Quantity pricing * Same day shipping most orders
- *Factory authorized distributor for Alpha, Amphenol, Belden, Kings, Times Fiber

Call NEMAL for computer cable, CATV cable, Flat cable, semi-rigid cable, telephone cable, crimping tools, D-sub connectors, heat shrink, cable ties, high voltage connectors.

HARDLINE 50 OHM

FXA12 1/2" Aluminum Black Jacket.....	89/ft
FLC12 1/2" Cablewave corr. copper blk jkt	1.69/ft
FLC78 7/8" Cablewave corr.copper blk jkt	4.25/ft
NM12CC N conn 1/2" corr copper m/1	25.00
NM79CC N conn 7/8" corr copper m/1	54.00

COAXIAL CABLES (per ft)

1180 BELDEN 9913 very low loss	55
1102 RG8/U 95% shield low loss foam 11ga.....	36
1110 RG8X 95% shield (mini 8)	17
1130 RG213/U 95% shield mil spec MCV jkt.....	39
1140 RG214/U dbi silver shld mil spec.....	1.85
1705 RG142B/U dbi silver shld, teflon ins	1.50
1310 RG217/U 50 ohm 5000 watt dbi shld	98
1450 RG174/U 50 ohm .100" od mil spec	14

ROTOR CABLE-8 CONDUCTOR

8C1822 2-18ga and 6-22ga	25
8C1820 2-18ga and 6-20ga	39

CONNECTORS-MADE IN USA

NE720 Type N plug for Belden 9913	\$3.95
NE723 Type N jack for Belden 9913.....	4.95
PL259AM Amphenol PL25989
PL259TS PL259 teflon ins/silver plated.....	1.59
PL258AM Amphenol female-female (barrel).....	1.65
UG175/UG176 reducer for RG58/59 (specify).....	.22
UG21DS N plug for RGR,213,214 Silver.....	3.35
UG838 N jack to PL259 adapter, teflon	6.50
UG146A SO239 to N plug adapter, teflon	6.50
UG255 SO239 to BNC plug adapter, Amphenol.....	4.29
SO239AM UHF chassis mt receptacle,Amphenol.....	.89
UG88C BNC plug RG58, 223, 142	1.45

GROUND STRAP-GROUND WIRE (per ft.)

GS38 3/8" tinned copper braid40
GS12 1/2" tinned copper braid50
GS200 1-1/2" heavy tinned copper braid	2.00
HW08 8ga insulated stranded wire39
AW14 14ga stranded Antenna wire CCS14

Prices do not include shipping, \$3 minimum, Visa/Mastercard \$30 min, COD add \$3.00

Call or write for complete price list. Nema's new 40 page CABLE AND CONNECTOR SELECTION GUIDE is available at no charge with orders of \$50 or more, or at a cost of \$4 with credit against next qualifying order.

NEMAL ELECTRONICS, INC. 12240 NE 14th Ave. N. Miami, FL 33161
(305) 893-3924 Telex 6975377 24hr FAX (305)895-8178



Published Bi-Monthly

Read All About Your Favorite Modes Of Digital Communications!

★ Subscribe Today! ★

Digital Digest
4063 N. Goldenrod Road
Winter Park, FL 32792

\$16.00 Per Year
U.S. \$22.00 Elsewhere

Payable in U.S. Funds Only / Check or M.O. Preferred

Practically Speaking

Joseph J. Carr, K4IPV

POTPOURRI

This month I'm going to talk about servicing radio equipment, especially older equipment. In the last year or so, I've had to service some elderly vacuum tube receivers as I added to my collection of antique ham and consumer radio receivers. Although these techniques are especially suited to older equipment, they will also work for many types of modern equipment. For example, you'll find the multi-tap resistor (which I'll discuss later) in antique gear and in certain relatively recent solid-state (except for the finals) imported HF transceivers.

Tuning capacitor problems

Receiver, VFO, and transmitter RF problems are sometimes hard to diagnose. These problems can be so hairy that many Amateurs would rather not even bother with them. They are often very difficult to isolate and identify. That's why I was a bit disquieted when I first examined a Hallicrafters Model SX-100 general coverage shortwave receiver (the kind with the ham bands on an expanded bandspread dial) which I purchased at the Manassas, Virginia hamfest last year. I added this model to my collection of antique gear.

The big problems were in the main tuning capacitor. The capacitor problem manifested itself in several ways. The tuning was scratchy; it was loud; there were tunable oscillations; there were occasional abrupt, large changes of frequency while tuning; and the receiver would suddenly go dead, except for a little scratching while tuning.

Photo A shows the receiver's multi-section main tuning capacitor. The rotor plates are grounded to the chassis because they are electrically connected to the capacitor's own mounting plate. The electrical connection of the rotor to the frame is made using one or more brass or steel spring "U" or "finger" clips. These clips straddle the rotor shaft at the mounting plate (located on the rear face of the front mounting plate in Photo A).

I found this clip was no longer making good electrical contact between the rotor shaft and the mounting plate. Corrosion had built up around the

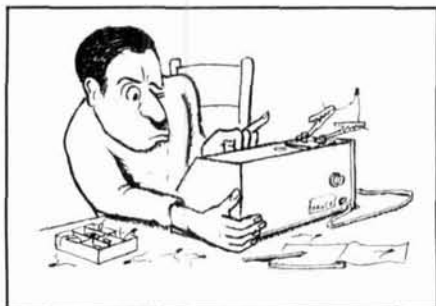

spring clip contact points and under the rivet (see Figure 1). It was simple to effect a repair; I cleaned the corrosion from beneath the clip by slipping a relay burnishing tool beneath the end of the clip and the mounting plate. This tool is made of very thin pieces of spring steel and looks very much like a feeler gauge.

PHOTO A

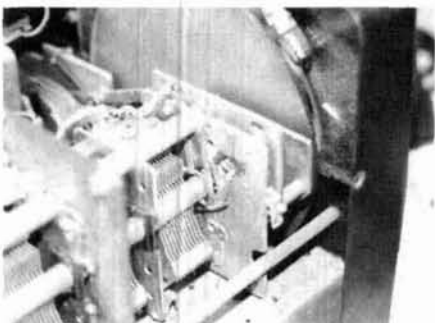

Main tuning capacitor on SX-100. Gum built up under spring clip caused oscillations and other problems.

FIGURE 1

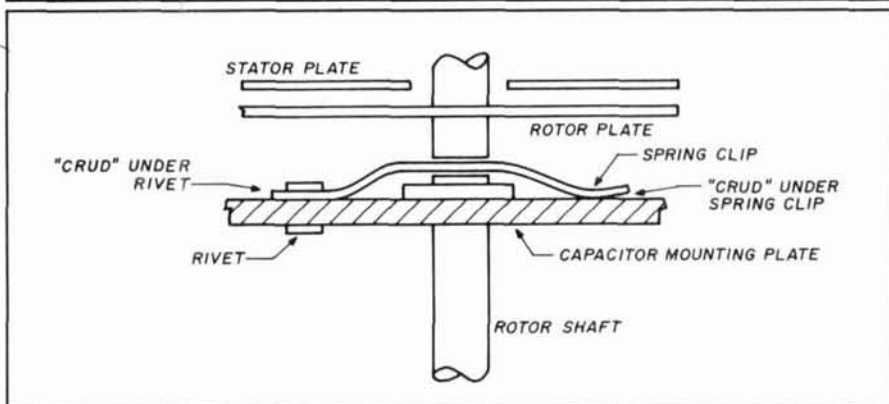

Detail of the grounding spring clip on the SX-100 capacitor.

Several years ago I bought a Hammarlund HQ-145 from a life-long friend who had purchased it new in 1960, but never stayed with either ham radio or shortwave listening. It had been stored unused for nearly 15 years. The HQ-145 exhibited exactly the same problem as the SX-100 and also had some other problems common to older gear.

Other variable capacitor problems

Dried bearing lubricant. The lubricant in the ballbearing race on the front mounting plate of the capacitor often dries out. You can use ordinary aerosol switch contact cleaner (or liquid alcohol) to dissolve the old lubricant. But don't press the button on the aerosol can too hard. You want to make a quick, delicate spritz to keep from spraying fluid all over the capacitor or between the plates. Use a cotton swab to clean out the mess of old lubricant and cleaning fluid. Once you've cleaned the bearing race, refill it with a dab of white lubricant, like Lubriplate[®], using a toothpick as an applicator. Be careful to keep lubricant from getting between the plates.

Shorted Plates. There are two things that cause short circuits between the plates of the variable capacitor. One is foreign matter (including dust or metal particles) that collects inside the plate assembly; the other is bent plates. You can often dislodge the foreign matter with a quick blast or two of dried compressed air. Electronics parts and supplies stores, some auto parts stores, and photo supply stores sell small cans (similar to aerosol cans) of dried compressed air just for this purpose. You usually have to buy a

nozzle attachment for the can, although I've seen one type with a plastic nozzle fitted to it.

Bent plates are another matter. If the bent plate is close to the surface, small needle nose pliers will be useful for rebending the plate to its original shape. Otherwise, you may have to use a small tool like the burnishing tool to work the plate gently into the correct shape and position. *Do not* use a file or other cutting tool. These tools leave filings that will short the plates together even more.

Some people "align" receivers and VFOs by bending the plates of the tuning capacitor; this isn't very smart. The original design was probably good enough to allow proper dial tracking using the right balance of main capacitor, trimmer capacitors, padder capacitors, and inductor settings.

Shorted capacitor. Sometimes you'll hear a scratching sound as the tuning capacitor is tuned across the band. This is a good indication that you have a short in the capacitor. However, the scratching could also be caused by the spring clip used to ground the rotor. One way to tell whether or not the capacitor is shorted at one point, and where that point is in the rotation of the capacitor, is to use an ohmmeter. Although you can use both analog and digital ohmmeters, analog meters are a little easier to work with in this application.

Set the ohmmeter to its highest resistance scale. Disconnect the capacitor from the circuit, and connect it across the probes of the ohmmeter. Tune the capacitor *very slowly* through its entire range while watching the ohmmeter. If there's a positional short, the ohmmeter will flick downscale when you've located it. You may need a good eye and a strong magnifying glass to see which of the many pairs of plates are actually shorted, but the problem should be visible.

Scummed, gummed, and gunked capacitors. Variable capacitors are natural depositories for all manner of nasty stuff — especially if the radio was used in a greasy environment. Airborne grease settles on the capacitor's plates; then dust settles on the grease. Cleaning up this type of mess is decidedly difficult. There are, however, several aerosol degreasers available from radio supply stores. You can also use a product like Birchwood Casey Gun Scrubber (available in gun shops).

Firearms suffer a fate similar to that of capacitors because they are lubricated, collect dust, and (above all) fill up with the residue of spent and unspent gunpowder that showers the piece when it's fired.

WARNING! *Do not use carbon tetrachloride to clean the capacitor.* Many early radio books recommended this chemical as a cleaner, but "Carbon Tet" is now known to be a health hazard.

Making odd value capacitors and resistors

There's a list of standard resistor and capacitor values that meet a large number of needs. However, there are cases when a project you're building requires an oddball part value. "Standard" resistor and capacitor values have also changed over the years, so you may find that the rig you're repairing has a bad component of an odd value which is no longer available. Whenever possible, you should replace the component with one of identical ratings — but there are times when that isn't possible.

Sometimes, a close standard value can be substituted for a "once" standard value without a deterioration of radio performance. For example, I had a receiver with a 16-k, 1-watt screen dropping resistor, and replaced it with a 15-k, 1-watt resistor with no problem. Remember, however, that the physical size of the new resistors is smaller than the older ones, especially among the carbon composition replacements (metal film, flame proof) used today.

Figure 2 shows two ways to obtain odd values of resistance. In Figure 2A, two or more resistors are connected in series. The total resistance is the sum of all the individual resistors or, in the case of the three resistors shown, $R_t = R_1 + R_2 + R_3$. The total wattage rating is the sum of the individual wattage ratings, if all three resistors are equal. (They would have equal voltage drops.) If you have unequal resistances, you must calculate either the voltage drops across each resistance or the total current through the resistors to find the power dissipation of each one, and prevent overloading one particular resistor. The following equations apply:

$$P = (V_d)^2/R \quad (1)$$

$$P = I^2/R \quad (2)$$

where:

FIGURE 2

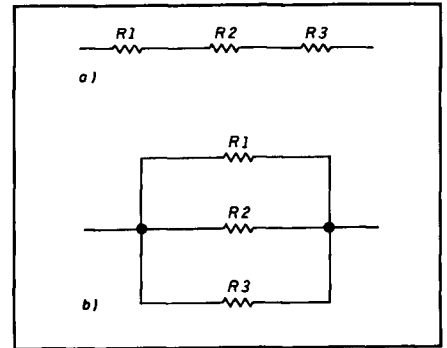

(A) Resistors in series, (B) resistors in parallel.

P is the power dissipation in the resistor

R is the resistance of the resistor

I is the current flowing in the resistor

V_d is the voltage drop across the resistor

To calculate the voltage drop across any one resistor, you must find the proportion of the whole that particular resistance represents. With n resistors in series, the voltage drop across the n th resistor is:

$$V_{di} = V \times \frac{R_i}{R_1 + R_2 + R_3 + \dots + R_n} \quad (3)$$

where:

V is the applied voltage across the entire series chain of resistors

V_{di} is the voltage drop across the n th resistor

R_i is the resistance of the n th resistor

$R_1, R_2, R_3,$ and R_n are the individual resistances of all n resistors in the series circuit

Figure 2B shows a parallel combination of resistors. The total resistance of a parallel combination is always less than the resistance of the lowest value resistor in the network. For all parallel resistor networks with n resistors:

$$R_t = \frac{1}{\frac{1}{R_1} + \frac{1}{R_2} + \frac{1}{R_3} + \dots + \frac{1}{R_n}} \quad (4)$$

In the special case of two resistors in parallel, you can use either Equation 4 or the modified version below:

$$R_t = \frac{R_1 R_2}{R_1 + R_2} \quad (5)$$

If the network is made up of identical resistors (all resistors having the same value), the total resistance is the value



Out of State 1-800-882-1343

(213)390-8003 FAX 213-390-4393

HOURS M-F 9:00 - 5:30 SAT 9:00 - 5:00 SE HABLA ESPANOL
QUICK SERVICE CENTER FOR REPAIR NEEDS

3919 SEPULVEDA BOULEVARD, CULVER CITY, CALIFORNIA 90230

ICOM IC-781



HF Equipment	List	Jun's
IC-781 Super Deluxe HF Rig	\$5995.00	Call \$
IC-765 New, Loaded with Features	3149.00	Call \$
IC-735 Gen. Cvg. Xcvr	1099.00	Call \$
IC-751A Gen. Cvg. Xcvr	1699.00	Call \$
IC-725 New Ultra-Compact Xcvr	949.00	Call \$
IC-726 HF/50 MHz All Mode	1299.00	Call \$

Receivers	List	Jun's
IC-R9000 100 kHz to 1999.8 MHz	5459.00	Call \$
IC-R7000 25-1300 + MHz Rcvr	1199.00	Call \$
IC-R71A 100 kHz - 30 MHz Rcvr	999.00	Call \$

VHF	List	Jun's
IC-228A/H New 25/45w Mobiles	509/539	Call \$
IC-275A/H 50/100w All Mode Base	1299/1399	Call \$
IC-28A/H 25/45w, FM Mobiles	469/499	Call \$
IC-2GAT, New 7w HT	429.95	Call \$
IC-2SAT Micro Sized HT	439.00	Call \$
IC-901 New Remote Mount Mobile	1199.00	Call \$

UHF	List	Jun's
IC-475A/H 25/75w All Modes	1399/1599	Call \$
IC-48A FM Mobile 25w	509.00	Call \$
IC-4SAT Micro Sized HT	449.00	Call \$
IC-4GAT, New 6w HT	449.95	Call \$
IC-04AT FM HT	449.00	Call \$
IC-32AT Dual Band Handheld	629.95	Call \$
IC-3210 Dual Band Mobile	739.00	Call \$
IC-2500A FM, 440/1.2 GHz Mobile	999.00	Call \$
IC-24AT New 2m/440 mini HT	629.95	Call \$
IC-2400 144/440 FM	899.00	Call \$

220 MHz	List	Jun's
IC-3SAT Micro Sized HT	449.99	Call \$
IC-375A All-Mode, 25w, Base Sta.	1399.00	Call \$

1.2 GHz	List	Jun's
IC-12GAT Super HT	529.95	Call \$

KENWOOD TS-950SD



HF Equipment	List	Jun's
TS-950SD New Digital Processor HF	\$4399.95	Call \$
TS-940S/AT Gen. Cvg. Xcvr	2499.95	Call \$
TS-440S/AT Gen. Cvg. Xcvr	1449.95	Call \$
TS-140S Compact, Gen. Cvg. Xcvr	949.95	Call \$
TS-680S HF Plus 6m Xcvr	1149.95	Call \$
TL-922A HF Amp	1982.95	Call \$

Receivers	List	Jun's
R-5000 100 kHz - 30 MHz	1049.95	Call \$
R-2000 150 kHz - 30 MHz	799.95	Call \$
RZ-1 Compact Scanning Rcvr.	599.95	Call \$

VHF	List	Jun's
TS-711A All Mode Base 25w	1059.95	Call \$
TR-751A All Mode Mobile 25w	669.95	Call \$
TM-231A Mobile 50w FM	459.95	Call \$
TH-225A New 2m HT	399.95	Call \$
TH-26AT Compact 2m HT	369.95	Call \$
TM-731A 2m/70cm, FM, Mobile	749.95	Call \$
TM-621 2m/220, FM, Mobile	729.95	Call \$
TM-701A 25w, 2m/440 Mobile	599.95	Call \$
TH-75A 2m/70cm HT	TBA	Call \$

UHF	List	Jun's
TS-811A All Mode Base 25w	1265.95	Call \$
TR-851A 25w SSB/FM	771.95	Call \$
TM-431A Compact FM 35w Mobile	469.95	Call \$
TH-46AT Compact 440 FM, HT	399.95	Call \$
TH-45AT 5w Pocket HT NEW	389.95	Call \$
TH-55 AT 1.2 GHz HT	524.95	Call \$
TM-531A Compact 1.2 GHz Mobile	569.95	Call \$

220 MHz	List	Jun's
TM-3530A FM 220 MHz 25w	519.95	Call \$
TM-331A Compact Mobile	469.95	Call \$
TH-315A Full Featured 2.5w HT	419.95	Call \$

YAESU FT-1000D



HF Equipment	List	Jun's
FT-1000D Top Performer	\$4399.00	Call \$
FT-747 GX Economical Performer	889.00	Call \$
FT-757 GX II Gen. Cvg. Xcvr	1280.00	Call \$
FT-767 4 Band New	2299.00	Call \$
FL-7000 15m-160m Solid State Amp	2279.00	Call \$

Receivers	List	Jun's
FRG-8800 150 kHz - 30 MHz	784.00	Call \$
FRG-9600 60-905 MHz	808.00	Call \$

VHF	List	Jun's
FT-411 New 2m "Loaded" HT	406.00	Call \$
FT-212RH New 2m, 45w Mobile	499.00	Call \$
FT-290R All Mode Portable	610.00	Call \$
FT-23 R/TT Mini HT	351.00	Call \$

UHF	List	Jun's
FT-712RH, 70cm, 35w Mobile	536.00	Call \$
FT-811 70cm built-in DTMF HT	410.00	Call \$
FT-790 R/II 70cm/25w Mobile	681.00	Call \$

VHF/UHF Full Duplex	List	Jun's
FT-736R, New All Mode, 2m/70cm	2025.00	Call \$
FEX-736-50 6m, 10w Module	294.00	Call \$
FEX-736-220 220 MHz, 25w Module	322.00	Call \$
FEX-736-1.2 1.2 GHz, 10w Module	589.00	Call \$
FT-690R MKII, 6m, All Mode, port.	752.00	Call \$

Dual Bander	List	Jun's
FT-4700RH, 2m/440 Mobile	996.00	Call \$
FT-470 Compact 2m/70cm HT	576.00	Call \$

Repeaters	List	Jun's
FTR-2410 2m Repeaters	1154.00	Call \$
FTR-5410 70cm Repeaters	1154.00	Call \$

Rotators	List	Jun's
G-400RC light/med. duty 11 sq. ft.	242.00	Call \$
G-800SDX med./hvy. duty 20 sq. ft.	390.00	Call \$
G-800S same/G-800SDX w/o presets	322.00	Call \$



ALINCO

DJ-160T
2 METER H.H.

DR-570T
2M/70CM MOBILE

DR-510T Dual Band Mobile
DR-110T 2 Meter Mobile
DJ-500T 2m/440 HT
DJ-100T Mini 2 Meter HT



Heath

HW2P
2m/440
MICRO-DELUXE HANDHELD

Call About The Complete
Line Of Pre-assembled
And Kit Form Amateur
Equipment



JUN'S BARGAIN BOX ICOM'FEST

IC-28H, 2m Mobile List \$499.00
SALE \$379.95

IC-2AT, 2m Handheld List \$319.95
SALE \$249.95

IC-3210 Dual Band Mobile List \$739.00
CALL FOR SUPER SALE PRICE

IC-2400 2m/440 Mobile List \$899.00
CALL FOR SUPER LOW PRICE

153

1990 U.S. CALL DIRECTORY (on microfiche)

Call Directory - by callsign\$10
Name Index - by last name\$10
Geographic Index - by state/city\$10

All three - \$25

\$3 shipping per order

BUCKMASTER PUBLISHING

Route 3, Box 56

Mineral, Virginia 23117

703/894-5777 visa/mc 800/282-5628

154

NEW!
The classic "Antenna Bible"
now in a thoroughly-revised, much-enlarged
edition

ANTENNAS 2nd edition

by John Kraus, W8JK
Ohio State University

Covers both theory and its applications to practical
systems. With design formulas, tables and refer-
ences. Over 1000 illustrations.

Modern, complete, a classic, *Microwave Journal*.
917 pages, hardcover. \$51.95
Add \$2.50 per book for shipping and handling U.S.,
\$5.00 elsewhere.

CYGNUS-QUASAR BOOKS
P.O. Box 85, Powell, Ohio 43065
Tel. 614-548-7895

155

TOWERS • TELESCOPING CRANK-UP • GUYED STACK-UP by ALUMA • TILT-OVERS

Easy to install. Low Prices. Crank-ups to 100 feet.

Over 36 types aluminum towers made—specials
designed and manufactured—write for details.

EXCELLENT FOR
AMATEUR COMMUNICATIONS



ALUMA TOWER CO.
BOX 2806HR
VERO BEACH, FL 32961-2806
(407) 567-3423 FAX 407-567-3432

156

ANTENNA SOFTWARE

MN 3.0 features analysis of current-fed antennas, polarization components (H, V, RCirc, LCirc, MaxLin, MinLin, Max), automatic frequency sweep, much easier placement of feeds & loads, and high-performance option (480 pulses/3-times faster no-8087). Analyze antennas in free space or over your particular ground. Compute forward gain, F/B, beamwidth, sidelobes, current, impedance, SWR, take-off angle, and patterns. Calculate the interaction among nearby antennas. MN 3.0, \$110. Option, \$35. MNjr 1.0, \$55 (basic features). Upgrade, \$55.

YO 3.0 features 2-4 times better accuracy, 20-40% faster computation, optimization of single Yagis over ground & stacked Yagis in free space, and 3-times faster no-8087 option. YO automatically optimizes Yagis for maximum forward gain, best pattern, and minimum SWR. YO can compute several trial designs per second. Display and print patterns in several formats. YO models gamma, T, hairpin, and beta matches, element tapering, mounting plates, and frequency scaling. YO 3.0, \$130. Option, \$35. YOjr 1.0, \$65 (basic features). Upgrade, \$65.

Antenna design library, file editor, and extensive documentation included. Add 6.25% Calif., \$5 overseas. U.S. check, cash, or int'l money order. For IBM PC, 3.5" or 5.25" disk.

Brian Beezley, K6STI, 507-1/2 Taylor, Vista, CA 92084

Electronic Repair Center Servicing

Amateur Commercial Radio

The most complete repair facility on the East Coast.

Large parts inventory and factory authorized warranty service for Kenwood, Icom and Yaesu.

SEND US YOUR PROBLEMS

Servicing "Hams" for 30 years, no rig too old or new for us.

HAMTRONICS, INC.

4033 Brownsville Road

Treose, Pa. 19047

215-357-1400



6M DIPLEXER



CU-2194 DIPLEXER, passive notch filter and combiner network allows simultaneous use of two transmitters or receivers on same antenna if frequency offset slightly. Operates over 30-76 MHz

FM, 65 watts max. Insertion loss 2 DB max; VSWR 2.0:1 max. 4x11x7, 9 lbs sh.

Used ~~\$99.50~~ \$79.50
Manual, partial repro \$10.00

Prices F.O.B. Lima, O. • VISA, MASTERCARD Accepted.
Allow for Shipping • Write for latest Catalog Supplement
Address Dept. HR • Phone 419/227-6573

FAIR RADIO SALES

1016 E. EUREKA • Box 1105 • LIMA, OHIO • 45802

Iron Powder and Ferrite TOROIDAL CORES

Shielding Beads, Shielded Coil Forms
Ferrite Rods, Pot Cores, Baluns, Etc.

Small Orders Welcome
Free 'Tech-Data' Flyer

AMIDON
Associates Since 1963

12033 Otsego Street, North Hollywood, Calif. 91607



HAMS SHOULD BE SEEN AS WELL AS HEARD!!

A PICTURE IS WORTH 100 WPM/CW!

ANY LICENSE CLASS HAM CAN COMMUNICATE USING LIVE TV ON THE UHF AND UP FREQUENCIES. TRANSMIT ANY VIDEO SOURCE, COMPUTER, PACKET, RTTY, VIDEO TAPE, LIVE CAMERA, NASA SATELLITE FEEDS, HAM MEETINGS, PUBLIC SERVICE ACTIVITIES, WEATHER, ETC.

READ AND LEARN ABOUT HAM TV ACTIVITY, PROJECTS, PUBLIC SERVICE AND VIDEO COMMUNICATIONS IN EACH ISSUE OF AMATEUR TELEVISION QUARTERLY, DEVOTED ENTIRELY TO HAM TV



SUBSCRIPTIONS: \$15 US, \$20 CANADA,
\$25 ELSEWHERE. SAMPLE \$4

ATVQ
AMATEUR TELEVISION QUARTERLY MAGAZINE
1545 LEE ST. SUITE 73
DES PLAINES, IL 60018
708-298-2269

of any one of them divided by the number of resistors in the network. Thus, three 100-ohm resistors in parallel have a total resistance of $100 \text{ ohms}/3$, or 33.33 ohms.

The total wattage rating of the parallel network is the sum of the individual wattage ratings — assuming that the resistors are equal, or very nearly so. Otherwise, you'll have to calculate the current in each resistor using Ohm's law ($I = V/R$) and then the power dissipation, in order to ensure that the wattage rating of any one resistor isn't exceeded.

Capacitors can also be combined to form other capacitance values, although somewhat less successfully in some circuits. This is because things like distributed or stray values of capacitance and inductance (yes, practical capacitors have an inherent inductance because of their construction) are sometimes unpredictable.

Figure 3A shows capacitors in parallel. The total capacitance of this network is the combination of like resistors in series; that is, it's the sum of the individual capacitances. The total working voltage of the combination is the lowest working voltage rating of all the capacitors. In other words, if 100 WVDC, and 600 WVDC capacitors are connected in parallel, then the WVDC rating of the combination is 100 WVDC.

Capacitors in series combine like resistors in parallel. You can calculate the total capacitance of a series capacitor network with the same equations used for parallel resistors, but substitute $C1$, $C2$, etc. for $R1$, $R2$, and so on.

If the capacitances are equal, the WVDC rating of the series combination is the sum of all individual WVDC ratings. Otherwise, the voltages combine in a manner that reflects the capacitance of each unit. This can be a problem if there's an AC component or (in the case of power supply circuits) a pulsating DC ripple riding on the DC level.

There's a special solution for balancing the voltage drop across series electrolytic capacitors (see **Figure 3B**). Connect a resistor in parallel with each capacitor. The value of this resistor is usually about 100 ohms per volt of the WVDC rating, roughly 27 to 470 k in common circuits. All resistors in the series stack should have the same value. The power rating of the resistors should reflect a good safety margin over the actual dissipation.

Is that transformer shorted?

The power transformer in a receiver or low power transceiver can be a little difficult to "ring out" using just an ohmmeter, but an open winding is obvious and shows up easily. In the case of a massive short, the transformer will grossly overheat. It may smoke, ooze tar, and will probably blow the fuse. But what about an "in between" case where a winding is partially shorted? **Figure 4** shows a method for testing the radio transformer. First, disconnect all of the secondary windings or remove all the tubes from the radio to reduce current drain. Next, connect the radio AC line cord to an outlet box which has a 25 to 40-watt, 115-volt AC lamp connected in series with one line of the outlet. Turn the radio on and apply AC power to the outlet box, noting the brightness of the lamp. A good transformer will barely glow if the transformer remains connected with the tubes removed; a bad transformer will cause the lamp to glow brightly.

FIGURE 3

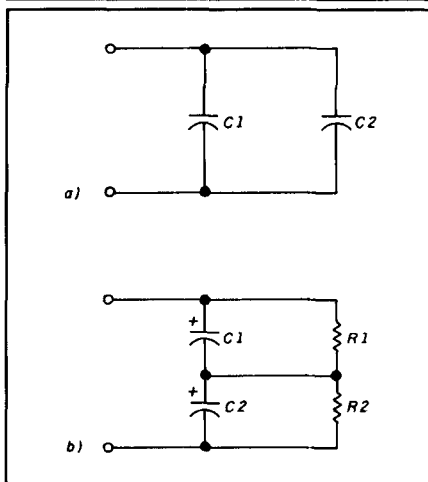

(A) Capacitors in parallel, (B) capacitors in series with balancing resistors.

FIGURE 4

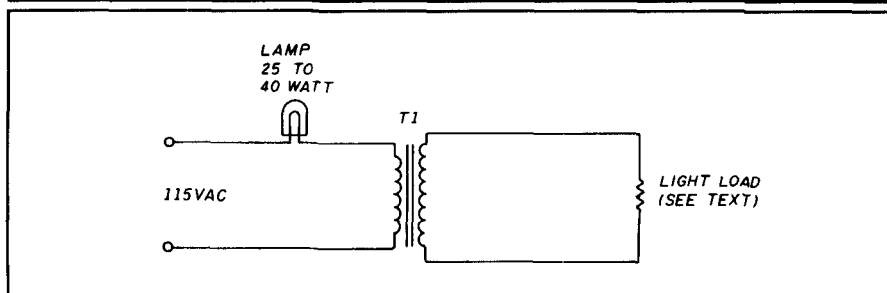

Test circuit for finding a shorted transformer.

Replacing the volume, tone, or RF gain controls

The volume control, tone control, and RF gain (if used) controls on a radio are either potentiometers or, on the very oldest sets, rheostats. You can buy new controls at radio/TV parts wholesalers. However, you'll need to know a few things before buying. Ask these questions:

- What's the resistance? (Measure across the two outer terminals.)
- Is it wirewound or carbon? (Look at the element; most are carbon.)
- Is the control audio or linear taper? (Use audio for volume controls and linear for the others.)
- Does the volume control have a loudness tap? (Look on the underside for a "spare" terminal.)
- Is the shaft half round or full round? Is it metal or an insulated material? Is the shaft smooth or "splined?"
- Is there a switch mounted on the rear of the control? If so, how many terminals are there?

Once you've selected the control, you'll probably find that its shaft is too long (a consequence of "universality"). **Figure 5** shows how to measure the shaft of the new control against the old one. Mark the shaft of the new control at the point indicated in the figure using a hacksaw blade or scribe. Next, place the control in a bench vise and cut the shaft off at the mark.

Replacing multi-tap resistors

Many receivers have multiple resistor packages containing two or more series resistors. These resistors are basically one long resistance element tapped at the desired points. They are often shown in schematics as separate resistors, although some appear as an

PRESENTING

THE K1FO 25 ELEMENT 432 MHz YAGI

Model FO-25-432



\$129.95

ELECTRICAL SPECIFICATIONS:

- Measured gain 16.5 dBd
- E-Plane beamwidth 22 deg
- H-Plane beamwidth 23 deg
- Solowake attenuation -17 dB
- 1st E-Plane -16 dB
- SWR 1.10:1 typical
- VSWR ratio 25 dB
- Impedance 50 ohm

MECHANICAL SPECIFICATIONS:

- Length 17ft.
- Boom 1.375" 6061 T-6 Aluminum
- Elements 3/16" Aluminum rod
- Wind survival 120+ MPH
- Mass up to 2" diameter
- Element Insulators Black Delrin
- Stainless Steel hardware (except U bolts)
- Coax connector N-type

ALSO AVAILABLE

FO-12-144, FO-16-220, FO-22-432, FO-33-432, FO-11-440
POWER DIVIDERS STACKING FRAMES

We supply those hard to find parts for the home builder
3/16" Delrin insulators \$12/100, Stainless keepers \$10/100
Add \$5 UPS SH for each antenna
\$7 west of Mississippi
PA residents add 6% state sales tax.

RUTLAND ARRAYS

1703 Warren Street • New Cumberland, PA 17070
(717) 774-5298 7-10 P.M. EST
Dealer inquiries are invited

FIGURE 5

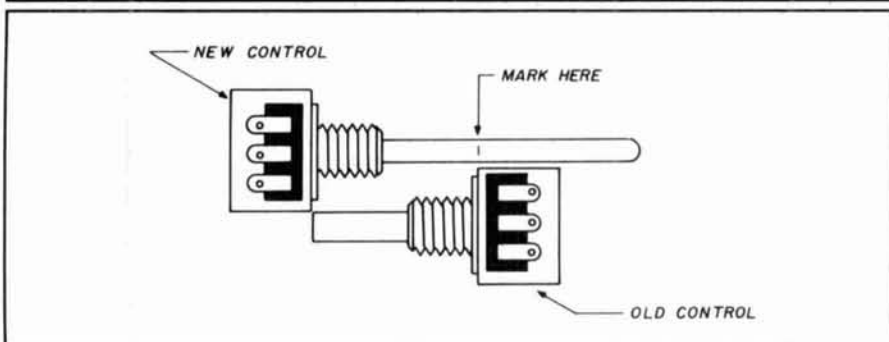

Measuring replacement potentiometer shafts.

FIGURE 6

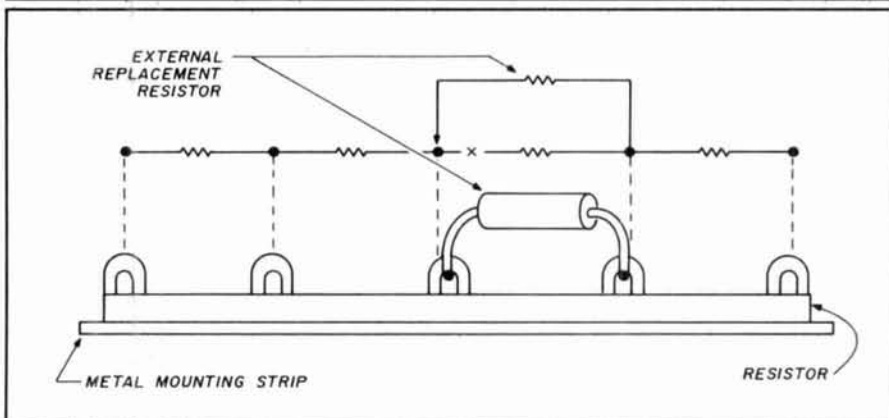

Replacing a bad section of a multi-tap resistor.

FIGURE 7

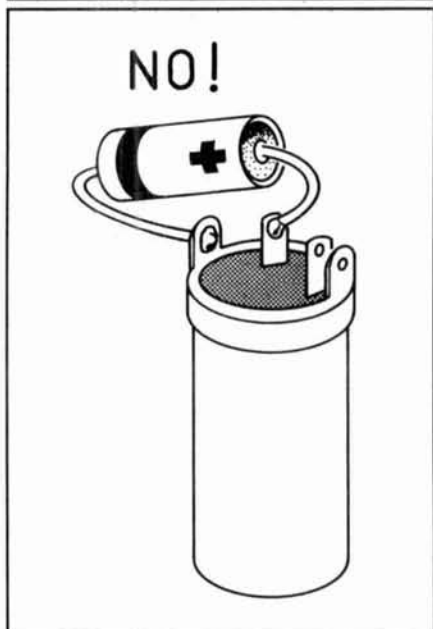

Bad practice! Don't permanently bridge a good electrolytic capacitor across a bad section of a multisection capacitor. Replace the whole capacitor.

assembly. When one section goes open, it can be bridged with a separate power resistor (see Figure 6). I've also shown two methods of mounting in Figure 6; select the one that seems reasonable at the time.

A bad practice!

Recently I went to visit a friend (not a ham — yet) who repairs and restores antique radio sets. He asked me, somewhat plaintively (knowing that I was a radio repairman "way back when" in 1959), if it was common in the olden days (thanks a lot!) to bridge a tubular electrolytic across an open section of a multisection electrolytic capacitor. Unfortunately, I had to tell him that this practice (see Figure 7) was all too common. But it's an extremely bad one and should be avoided whenever possible. The problem with this practice is that the original capacitor is still defective, and may later short out to ground — or to another section. So, in addition to knocking your receiver or transceiver off the air, the defective capacitor may also cause secondary damage to the rest of the power supply circuits. **TR**

✓ 163

PC SSTV V2.0 \$149.95

Turn your IBM PC or compatible into a complete slow scan TV system. You don't need another computer to send and receive images in up to 64 shades of gray. Works with most popular graphics cards and printers.

Includes:

- Demodulator Software
- Modulator Tutorial
- 75 Page Manual
- 75 Page Cassette

Requires:

- Ham transceiver
- PC with 640K
- Parallel Port Graphics Card
- Tape Recorder
- Serial port

Slow Scan Formats: 8, 12, 17, 24, 36, 48, 72 sec.



Software Systems Consulting

150 Avenida Cabrillo, Suite C
San Clemente, CA 92672
(714) 498-5784

✓ 164

Foreign Subscription Agents for Ham Radio Magazine

Ham Radio France
SM Electronic
20 bis, Ave des Clarions
F-89000 Auxerre
France

Ham Radio Canada
C.A.R.F.
P.O. Box 356
Kingston, ON
Canada K7L 4W2
Prices in Canadian funds
1 yr. \$38.00, 2 yrs. \$67.00
3 yrs. \$90.00

Ham Radio Japan
Katsumi Electronic Co., Ltd.
27-5 Ikegami
4 Chome, Ota-Ku
Tokyo 146, Japan
Telephone (03) 753-2405

Ham Radio England
c/o R.S.G.B.
Lambda House
Cranborne Road
Potters Bar
Herts EN6 3JW
England

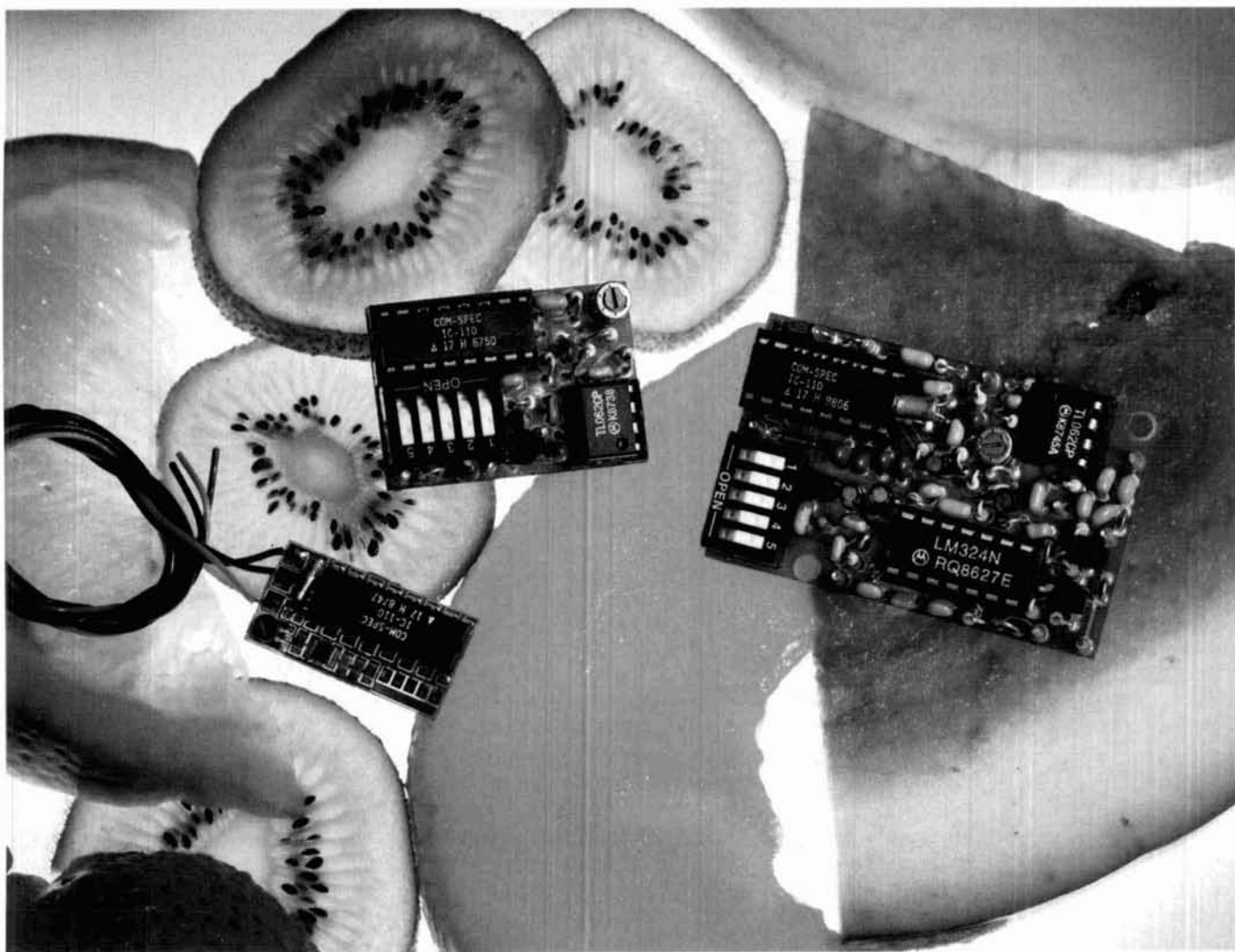

Choice Selection.

Now you can have it all! Take all the qualities you've come to depend on in our programmable CTCSS tone equipment: Astonishing Accuracy, Instant Programming, Unequaled Reliability; and add full spectrum tone versatility, multi-tone capability without diodes, a reprogrammable memory... It's our new harvest of CTCSS tone equipment.

The choice is yours! If standard CTCSS EIA tones do not suit your taste, select any 32 tones of your liking from 15.0Hz to 255.0Hz. And if you change your mind, no problem; the memory can be changed in your shop with our HHP-1 programmer, or at our factory for free. Your working tone is accessed by a simple DIP switch, so there's no fussing with counters or other test equipment.

Call today toll-free and find out more about this fresh new flexibility in tone signalling, and don't forget to ask about multi-tone switching without cumbersome diode networks or binary switches.

It's all brought to market by the people who introduce the freshest ideas in tone signalling, and of course our customary same day shipping and one year warranty apply.



TS-32P CTCSS ENCODER-DECODER Based on the time proven TS-32, the industry standard for over a decade. The TS-32P gives you the added versatility of a custom, changeable memory base. A low price of \$57.95 makes it an even sweeter deal.

SS-32P ENCODER Based on the equally popular SS-32 encoder. Available for CTCSS, or audible burst tones up to 6550.0Hz. Price is \$28.95.

SS-32SMP SUB-MINIATURE ENCODER Our smallest encoder for handheld applications. Now you can satisfy that customer that needs to access multiple repeater sites with a radio that has precious little space inside. At \$27.95, the price is small too.

HHP-1 HANDHELD PROGRAMMER For programming the 32 memory locations in any of our new programmable products, including our SD-1000 Two-Tone Sequential decoder. The HHP-1 is battery operated for field use, and will program ANY 32 tones from 15.0 to 6550.0Hz in .1Hz. increments. Price is \$199.95.



COMMUNICATIONS SPECIALISTS, INC.
426 West Taft Avenue • Orange, CA 92665-4296
Local (714) 998-3021 • FAX (714) 974-3420 • Entire U.S.A. 1-800-854-0547

Ace Systems

OPTO Iambic Keyer



• Ultra compact 5" x 5 1/4" x 1 1/2" • OPTO isolated output • Battery or DC powered • Full function Iambic Keyer • Adjustable speed and weight • One Year Ace Systems Warranty

- See Your Ace Dealer -

- Amateur Electronics Supply
 - Barry Electronics
 - KJL Electronics
 - Madison Electronics
 - Oklahoma Comm. Center
 - R. F. Enterprises
 - R & L Electronics
 - Rivendell Electronics
- Ace Systems • RD 1 • Box 83 • Wilcox, PA 15870
(814) 965-5937

✓ 166

Advanced Antenna Analysis Program

ELNEC is an all-new, powerful, easy-to-use antenna analysis program. Antenna description and changes are fast and easy.

ELNEC is completely menu-driven. All antenna descriptions and changes are done without exiting the program. Add, delete, modify sources, loads, and wires with a few keystrokes.

ELNEC uses the power of MININEC, yet completely frees you from the tedious chore of counting "pulses". Simply tell ELNEC which wire and where you want a source or load to go — ELNEC puts it there and keeps it there, even when wires, sources, and loads are added, deleted, or changed.

ELNEC is full-featured, with plotting, printing, saving and recalling files, and much, much more. Beamwidth, main lobe, sidelobe analysis are shown on the plot. An exclusive feature, ELNEC has *true current sources* for phased array analysis.

ELNEC runs on any PC-compatible computer with at least 360k of RAM, and CGA, EGA, or Hercules. Plots print on Epson-compatible 8.9 or 24 pin printers. Two versions are available, optimized for systems with and without a coprocessor.

ELNEC is an incomparable value at only \$49.00 postpaid (USA, Canada, and Mexico). Specify coprocessor or non-coprocessor version. Order or write for more information from:

Roy Lewallen, W7EL
P.O. Box 6658
Beaverton, OR 97007

✓ 167

**WRITE FOR
FREE
BOOK
CATALOG**

Ham Radio's Bookstore
Greenville, NH 03048

SHORT CIRCUITS

Dear Readers:

Well the gremlins were certainly at work when we put the March issue together. Here are a few errors you spotted as you browsed through the pages! Ed.

New Product Correction

In the new product listing, "Two Rotatable Dipoles," on page 73 of the March 1990 issue, there were two errors. The antenna elements are made from high strength 6061-T6 aluminum alloy, not T-60612. Also the address given was incorrect. SV Products is located in Woodburn, Indiana — not Illinois.

For those of you who are interested, SV Products has just released a new two-element dual band, computer optimized antenna — the Model 1824 2L — for the 12/17 meter band. This antenna has a new trap design that gives high mechanical strength and power handling capability. It's available at the introductory price of \$199.95. Contact Gary Nichols, SV Products, 4100 Fahlsing Road, Woodburn, Indiana 46797 for details.

K3OF Supercharger Boards Available; Missing Parts List Located

We neglected to mention that printed circuit boards are available for the project described in "Build Your Own Supercharger," by K3OF, March 1990, page 22. You can order them from FAR CIRCUITS, 18N640 Field Court, Dundee, Illinois 60118. The cost is \$2 for the small board with a single charging circuit and \$9.75 for the large board, which includes 8 charging circuits. Please include \$1.50 shipping and handling with each order.

We also forgot to include the parts list for those of you who'd like to build this handy little gadget. Here it is!

PARTS LIST

		Source/Approximate Cost			
For each regulator circuit		Jameco*	Cost	Radio Shack	Cost
U1	LM723CN		\$0.39	276-1740	\$0.99
Q1	Tip-3055 (or Tip31)		0.69	276-2020	1.59
			(0.49)	276-2017	(0.99)
C1	100-500 pF	MD220/50	0.10	272-124	0.20
R1,R3	1 k	R1K	0.10	271-1321	0.16
R2	5 k potentiometer	63P5K	0.89	271-217	0.69
R4	Value as required**		0.05		0.08
	14-pin dip socket	14LP	0.12	276-1999	0.45
	Cost per basic circuit		\$2.34		\$4.18
Miscellaneous and optional parts:					
R5	20 ohm	R20	\$0.05		
R6	750 ohm 1/2 watt				
S1	SPDT switch	MPC123	0.99	275-635	\$2.89
CR1	Full wave bridge rectifier, 4 A			276-1146	1.39
				272-1020	2.49
C2	2200 µF, 35 volts			276-1363	0.79
	Heat sink TO220	291-36H	0.39		
	LED as desired				
	PC board as required				
	Project box as desired				

Supply transformer: Any 18 to 24 volts AC or DC 0.5 A suggested. All resistors may be 1/4 watt except R6, which is 1/2 watt.

*Jameco Electronics, 1355 Shoreway Road, Belmont, California 94002. \$20 minimum order. Minimum quantity of 10 of each value resistor.

**Two 10 -ohm resistors may be paralleled for 5 ohms if a 4.7-ohm resistor isn't available. Radio Shack doesn't stock resistors below 10 ohms. Two 1.5-k 1/4-watt resistors may be paralleled for the 750-ohm 1/2-watt resistor (R6).

RELY ON JAN FOR 3-WAY HELP:

1. TECHNICALLY CORRECT CRYSTALS TO YOUR SPECS.
2. QUICK TURNAROUND WITH HUGE INVENTORY, PROMPT SERVICE, AND OUR EMERGENCY ORDER PLAN.
3. LOW PRICES.

QUARTZ CRYSTALS FOR
TWO-WAY — INDUSTRY
MARINE — AMATEURS
SCANNERS — CBs
MICROPROCESSORS



FOR FREE CATALOG,
CALL OR WRITE:

JAN CRYSTALS
P.O. BOX 06017
FORT MYERS, FL 33906
(813) 936-2397

SINCE
1965



TOLL-FREE: 1-800-JAN-XTAL

FAX ORDERS: 1-813-936-3750

✓ 178

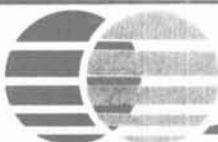

PacComm

- Advanced Technology
- Enduring Value

New! MICROSAT PSK

The 1st Non-Kit Satellite Modem!

Featuring high performance
at low cost!

Only **\$219⁹⁵**

- Completely assembled and tested - not a kit!
- Supports 1200 baud MSK transmit and PSK receive for MICROSAT access
- Supports 1200 baud PSK transmit and receive for terrestrial use
- Receives 400 baud satellite telemetry signals
- Doppler shift compensating radio tuning interface
- Easily attaches to any TNC modem disconnect header, cable provided
- Telemetry signals output via RS-232 port

AVAILABLE
IN
DECEMBER

For complete info & specifications
Call (813) 874-2980 To Order, Call
Toll Free: 1-800-223-3511
Major Credit Cards Accepted!

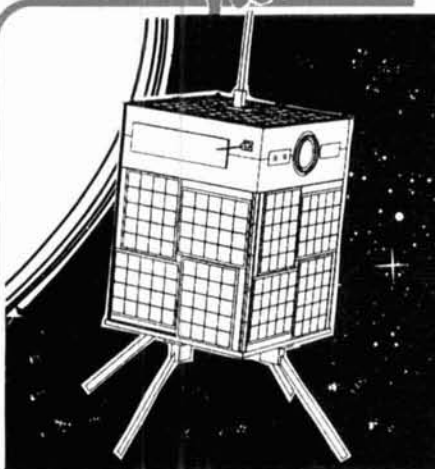

PacComm • 3652 West Cypress Street • Tampa, Florida 33607

Please send more info on the MICROSAT PSK Modem FREE Catalog

Name _____ Call _____

Address _____ Ph# _____

State _____ Zip _____ Card# _____ Exp. Date _____

MONEY BACK GUARANTEE! Add \$4.00 shipping/handling per order. FL residents add 6% sales tax.
Major Credit Card give number, expiration and signature. FAX: 813-872-8696

✓ 177



HamCall / CD-ROM

500,000 HAMS plus
1,000's of Public Domain
Amateur Radio Programs
and Data

CD-ROM Disc \$50.00
Questar Retrieval Software \$50.00
Shipping (per order) \$5.00
Sony CDU-6100 player \$549.00

BUCKMASTER Publishing

Rt. 3, Box 56
Mineral, Virginia 23117

703:894-5777

800:282-5628



✓ 179

The Radiokit DVR-60 Digital Voice Recorder

State of the art surface mount technology provides unequaled price/performance benefits in a unit that measures only 2 1/8" x 3 1/4" inches.

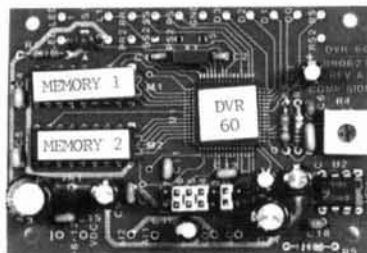

PRICE
\$149.95

Numerous Amateur/Commercial/Educational Applications:

- Repeater ID and Messaging
- Simplex Repeater
- Voice Mailbox
- Contester/DXER Voice Messaging, Interface with Popular Contest Logging Programs.
- Missed or Busted Call Playback. Works on ANY Audio Signal.
- Instant Replay of Emergency or Traffic Messages.
- Home Security
- Talking Sign
- Public Address System—Emergency Announcements

Specifications:

- Up to 16 Variable Length Messages
- 60 Seconds Recording/Playback Available as Shipped, User Expandable to 4 Minutes.
- Message Buffers Completely Soft Sektored
- Random Access Playback
- Selectable Continuous Loop on Record
- Manual or Computer Controlable
- 32KBPS Sampling Rate for Natural Sounding Audio
- Selectable Input Gain Levels, 0, 20, or 46. 2V PP Max
- Message Select: Up to 4 Lines Binary Code
- Signal to Noise Ratio 55 dB
- Power Requirements 9-15 VDC @ 50 ma Peak
- Distortion Less Than 2%
- Completely Wired and Tested. NOT a KIT.

1 Meg x 1 Drams \$9.95 ea.
30 Seconds Per DRAM

The DVR-60 is provided with full documentation. Four holes are provided on the PC board for mounting convenience. All input/output lines and component designations are clearly silk screened on the board.

OEM and Dealer Inquiries Welcome
Custom Design and Production Facilities Available

RADIOKIT • P.O. Box 973 • Pelham, NH 03076
(603) 635-2235

✓ 180

2x4Z BASE REPEATER ANTENNA

THE HIGHEST GAIN
DUAL BAND
BASE/REPEATER ANTENNA

HIGH POWER 200 WATTS

CENTER FREQUENCY

146.500 MHz

446.500 MHz

GAIN:

VHF - 8.2dB

UHF - 11.5dB

VSWR - 1.-1.2 or less

CONNECTOR:

N TYPE FEMALE

LIGHTNING PROTECTION

GROUNDED DIRECT

LENGTH: 16 FT.

WEIGHT: 5 LBS. 3 OZ.

WIND LOAD: 90 MPH

MOUNTING: UP TO 2 IN.

MAST

CAN SIMULCAST ON

BOTH BANDS

WATERPROOF

CONNECTING

JOINTS

UPS SHIPPABLE

AMATEUR SPECIAL



1275 NORTH GROVE ST.
ANAHEIM, CALIF. 92806
(714) 630-4541

CABLE: NATCOLGLZ
FAX (714) 630-7024

NEW OSCAR

BRIDGES HAMISPHERE

- Coming soon to a shack near you.
- Signals from space.
- Catch some free.
- We know how.
- You can too!
- Join AMSAT
- Free brochure for SASE

AMSAT
PO BOX 27
WASHINGTON, DC 20044

168

SERVICE MONITOR MEASUREMENTS MODEL FM 110

- Covers all business channels from 30MHz to 512MHz
- Monitor: 2uV, frequency error display, scope deviation display
- Generator: Calibrated output up to 10mV, Sinad display
- Built-in Tone Generator
- Full Duplex Capability

AMAZINGLY LOW
PRICE OF ONLY

\$2450.00

FOB - BATESBURG, SC



WE ACCEPT VISA, MASTERCARD & AMERICAN EXPRESS

AIE CORPORATION — MEASUREMENTS DIVISION
PO BOX 70, BATESBURG, SOUTH CAROLINA 29006 (803)532-9256



170

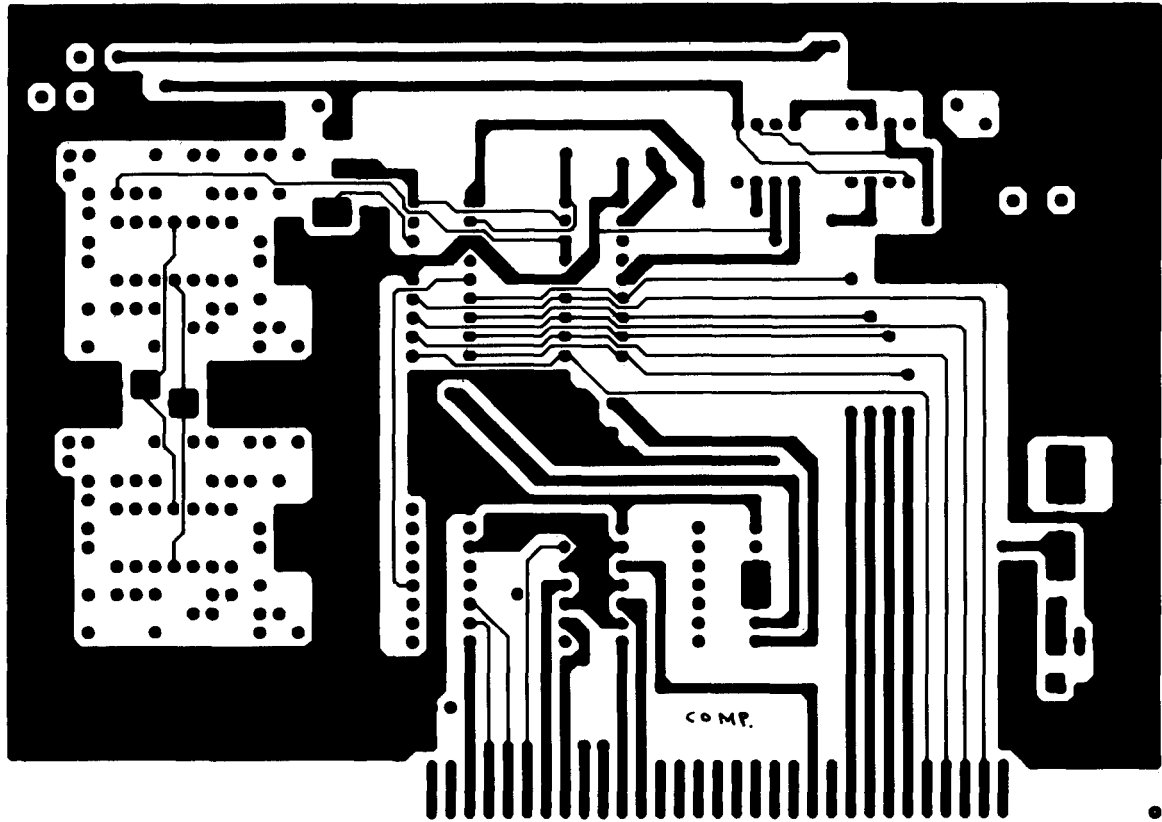

Double-sided Board Trouble

Those double-sided pc boards can be tricky. We gave you one side of WA4ADG's board in his March 1990 article "Digital Voice Storage in the Ham Shack," (page 56) and showed you where the components should be placed on the component side of the board, but we didn't print a reproducible copy of the side of the board. You'll find it above. There are also two changes in resistor values. Resistor R1 (Figure 1, page 61) should be 51 k, not 5.1 k. The resistor connected to pin 3 of IC1 (Figure 1, page 61) should be 18 k, not 36 k.

U.S. AMATEUR RADIO MAIL LISTS

Labels, floppy disks, CD-ROM, mag tape.

- Newly licensed hams
- All upgrades
- Updated each week

BUCKMASTER PUBLISHING

Route 3, Box 56
Mineral, Virginia 23117
703/894-5777 visa/mc 800/282-5628

✓ 171

RFI KIT

Use ferrite beads to keep RF out of your TV, stereo, telephone, etc. Kit includes one dozen beads, one dozen toroids 1/2" to 1 1/4" diameter, three "split beads" and our helpful RFI tip sheet. Everything needed to fix most RFI problems. \$15 + \$4 S&H U.S. and Canada. 7 1/4% tax in CA.

Free catalog and RFI tip sheet on request.

PALOMAR ENGINEERS

Box 455, Escondido, CA 92025
Phone: (619) 747-3343

✓ 172

MACINTOSH SOFTWARE

Largest software collection for the computer with world's friendliest user interface. Gray Line Map, Relational Database Logger, Morse and theory training programs, Contest Series with digitized voice, Satellite Tracker, Electronic Keyer Emulator and more. Send for free info. BOOTH 238 IN DAYTON.

ZCo Corporation

P. O. Box 3720, Nashua, NH 03061
(603) 888-7200 Fax (603) 888-8452

✓ 173

DX Forecaster

By Garth Stonehocker, KORYW

1989 DX Propagation Conditions

DX propagation conditions for 1989 were characterized by high maximum usable frequencies (MUFs) and many large solar flares with related disturbances of the geomagnetic field. This is typical during a near sunspot maximum year, when the solar flux average for that year is 214. The solar flux was high (237) in January and then decreased each month until April and May, when it dropped to 190 ± 1 . June bounced up to 242 with the highest daily maximum (326) thus far in sunspot cycle 22. July solar flux dropped to the year's monthly minimum of 183. The rest of the year showed a slight upward trend from August (218) to November (234); October and December were a bit lower.

For propagation and research purposes, solar activity is tracked in 27-day sun rotation cycles. The low months during the year lacked very high monthly 27-day maximums when compared with the high activity months. This effect is typical for the solar flare activity and flux which arrives at the earth as the sun rotates and brings its active regions into view.

Some propagation details

We define ionospheric conditions by vertically measuring the height (time of pulse travel) of the ionosphere at various frequencies (even continuously) to give the maximum frequency (foF2), or measuring the MUF for an oblique path between a pulse transmitter and its receiver. In creating **Table 1**, I looked at mid-latitude foF2s (MUFs are about three times foF2) for the months by using the highest diurnal median (the value available 50 percent of the days of the month) frequency for each month. I've also given the highest peak value of daily foF2 at any daytime hour during the month. These foF2s are displayed in a month-by-month summary for the year.

As you look over these numbers, compare the difference between peak and median foF2s. A comparison of the foF2s with the month-to-month



direction of the solar flux values shows an interesting effect. The ionosphere's foF2 is generated by an upward drift of ionization to around 250 to 350 km from its 80 to 180-km production altitude. The lower production altitude varies much more closely with solar flux ultraviolet than foF2 height. You'll note a few days delay in peak foF2 at a 27-day solar flux peak and a general smoothing across foF2 monthly averages for the real "median" values. The July minimum, which occurred between the two higher months of June and August, didn't decrease the foF2 median much — but geomagnetic disturbances can affect foF2 median much more quickly and to a greater degree. Remember that the decrease in mid-latitude foF2 resulting from geomagnetic disturbance is really the auroral zone (an oval of incoming solar wind particles) moving equatorward while pushing the ionospheric trough (low foF2) before it. The trough lost more of its ions. They moved up the magnetic field lines, ending up at 20 degrees north or south of the geomagnetic equator. This gave us the one long hop transequatorial propaga-

tion in late evenings in the Northern Hemisphere during the winter and equinoxial months. During disturbances mid-latitude foF2s go down and equatorial foF2s go up. You can see the mid-latitude foF2 decreases in some of the differences of the peak to median columns in **Table 1** as compared with the number and highest geomagnetic "A" values column for the month. Even months with a low flux have high foF2s — if there have been few disturbances. When raised by the 27-day SSN flux, the high SSN basic foF2 increases absorption in the D and E region to the point that the signal's strength decreases — even up to 10 meters. If we had Amateur bands between 6 and 10 meters, strengths would show increases near the MUF up there. Unless the MUF increases to 6 meters, there is no chance to witness this. You can, however, see an increase in the number of hours 10 meters is open. Enjoy the high MUFs or long openings and disturbance-related DX from unusual locations while you can. We still have a couple of years to go in this sunspot cycle. But the increase in solar flares and increased level of disturbances hold down MUF by as much as 20 to 40 percent on many days — down into the 10-meter range again.

Last minute forecast

The first week of the month favors nighttime openings on the lower frequency bands. Then the solar flux is expected to build up, causing the MUF to increase and lengthening time for openings for the higher frequency

TABLE 1

Month	foF2, MHz		Number and Highest "A"	Average Flux
	Median	Peak		
January	12.9	15.0	4/33	237
February	13.0	13.8	2/33	223
March	12.6	13.8	5/248	207
April	10.4	13.2	2/38	189
May	8.2	11.4	2/40	192
June	7.2	10.6	3/49	242
July	7.7	10.5	0	183
August	8.6	10.2	4/61	218
September	10.7	11.9	3/55	226
October	13.2	14.2	1/86	207
November	14.2	15.5	3/71	234
December	13.4	15.3	5/36	213

WESTERN USA

GMT	PDT	Directional Indicators								
		N	NE	E	SE	S	SW	W	NW	
0000	5:00	12	27	15	10	10	10	10	10	10
0100	6:00	12	20	25	10	10	10	10	10	10
0200	7:00	10	20	25	10	12	10	10	10	10
0300	8:00	12	20	27	10	15	10	10	10	10
0400	9:00	12	17	27	12	17	10	10	10	10
0500	10:00	12	15	15	15	20	10	10	10	10
0600	11:00	15	15	10	15	20	10	10	10	12
0700	12:00	15	17	10	25	20	10	10	10	12
0800	1:00	17	17	12	27	20	10	10	10	15
0900	2:00	27	20*	15	27	20	10	12	15	15
1000	3:00	20	15	15	27	20	12	15	17	17
1100	4:00	27	15	15	20	20	15	15	17	17
1200	5:00	15	12	10	15	20	15	15	30	30
1300	6:00	15	12	10	12	20	25	17	20	20
1400	7:00	17	12	10	10	20	25	27	27	27
1500	8:00	15	10	10	10	20	27	27	27	27
1600	9:00	15	10	10	10	20	27	27	20	20
1700	10:00	17	10	10	10	15	12	27	20	20
1800	11:00	27	10	10	10	12	10	27	17	17
1900	12:00	20	12	10	10	12	10	12	15	15
2000	1:00	17	12	10	10	10	10	10	15	15
2100	2:00	15	12	10	10	10	10	10	12	12
2200	3:00	15	15	12	10	10	10	10	12	12
2300	4:00	12	17	12	10	10	10	10	10	10

MAY

MID USA

GMT	MDT	Directional Indicators								
		N	NE	E	SE	S	SW	W	NW	
0000	6:00	12	15	15	10	10	10	10	10	10
0100	7:00	12	17	25	10	12	10	10	10	10
0200	8:00	12	27	27	10	15	10	10	10	10
0300	9:00	12	20	27	10	15	10	10	12	12
0400	10:00	15	30	15	12	17	10	10	12	12
0500	11:00	15	20	15	15	20	10	10	12	12
0600	12:00	17	17	25	15	20	10	10	15	15
0700	1:00	20	17	15	25	20	10	10	15	15
0800	2:00	27	17	15	27	20	12	12	17	17
0900	3:00	27	20	15	27	20	12	12	17	17
1000	4:00	15	15	12	27	20	15	15	20	20
1100	5:00	15	15	10	27	20	15	15	27	27
1200	6:00	17	12	10	15	20	17	17	27	27
1300	7:00	15	12	10	12	20	17	17	20	20
1400	8:00	15	12	10	10	20	25	27	27	27
1500	9:00	12	10	10	10	20	25	27	27	27
1600	10:00	12	10	10	10	20	27	27	27	27
1700	11:00	15	10	10	10	17	27	27	20	20
1800	12:00	17	12	10	10	15	15	27	17	17
1900	1:00	27	12	10	10	12	12	12	15	15
2000	2:00	30	12	10	10	12	10	10	15	15
2100	3:00	27	15	10	10	10	10	10	12	12
2200	4:00	15	15	12	10	10	10	10	12	12
2300	5:00	15	15	12	10	10	10	10	12	12

EASTERN USA

GMT	EDT	Directional Indicators								
		N	NE	E	SE	S	SW	W	NW	
0000	8:00	12	15	15	10	12	10	10	12	12
0100	9:00	12	17	15	10	15	10	10	12	12
0200	10:00	15	17	25	10	15	10	10	12	12
0300	11:00	15	30	27	10	20	10	10	12	12
0400	12:00	17	20	27	12	20	10	10	15	15
0500	1:00	27	20	15	15	20	10	10	15	15
0600	2:00	20	30	15	25	20	10	10	17	17
0700	3:00	17	20	15	25	20	12	12	30	30
0800	4:00	15	17	25	27	20	12	12	27	27
0900	5:00	15	15	12	27	20	15	15	15	15
1000	6:00	12	15	10	25	20	15	15	15	15
1100	7:00	12	12	10	12	20	15	15	12	12
1200	8:00	12	12	10	10	20	17	17	15	15
1300	9:00	12*	12	10	10	20	20	17	15	15
1400	10:00	12	12	10	10	20	25	27	17	17
1500	11:00	12	10	10	10	30*	27	27	27	27
1600	12:00	15	10	10	10	17	25	27	20	20
1700	1:00	15	10	10	10	15	12	27	27	27
1800	2:00	17	12	10	10	12	10	27	15	15
1900	3:00	27	12	10	10	12	10	10	15	15
2000	4:00	30	12	10	10	12	10	10	12	12
2100	5:00	27	12	10	10	10	10	10	12	12
2200	6:00	15	15	12	10	10	10	10	12	12
2300	7:00	15	15	12	10	10	10	10	12	12

High Performance

vhf/uhf preamps

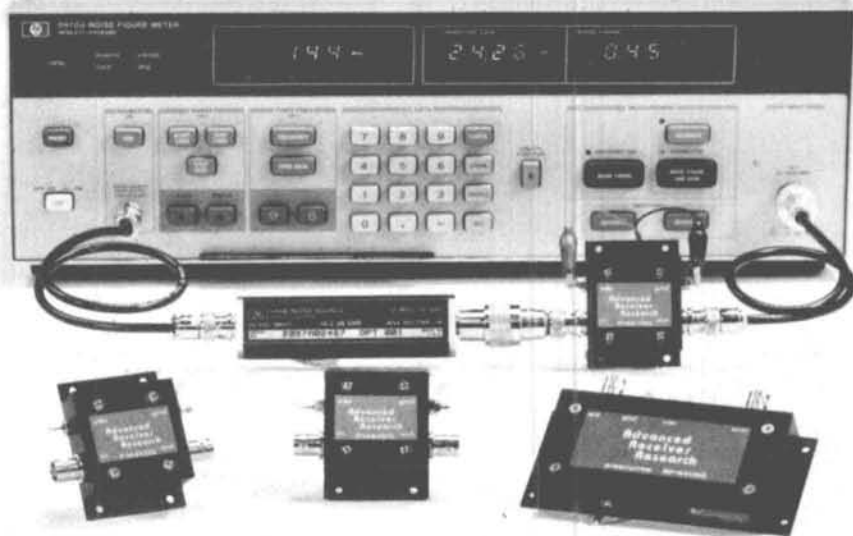

Receive Only	Freq. Range (MHz)	N.F. (dB)	Gain (dB)	1 dB Comp. (dBm)	Device Type	Price
P28VD	28-30	<1.1	15	0	DGFET	\$29.95
P50VD	50-54	<1.3	15	0	DGFET	\$29.95
P50VDG	50-54	<0.5	24	+12	GaAsFET	\$79.95
P144VD	144-148	<1.5	15	0	DGFET	\$29.95
P144VDA	144-148	<1.0	15	0	DGFET	\$37.95
P144VDG	144-148	<0.5	24	+12	GaAsFET	\$79.95
P220VD	220-225	<1.8	15	0	DGFET	\$29.95
P220VDA	220-225	<1.2	15	0	DGFET	\$37.95
P220VDG	220-225	<0.5	20	+12	GaAsFET	\$79.95
P432VD	420-450	<1.8	15	-20	Bipolar	\$32.95
P432VDA	420-450	<1.1	17	-20	Bipolar	\$49.95
P432VDG	420-450	<0.5	16	+12	GaAsFET	\$79.95

Inline (rf switched)						
	Freq. Range (MHz)	N.F. (dB)	Gain (dB)	1 dB Comp. (dBm)	Device Type	Price
SP28VD	28-30	<1.2	15	0	DGFET	\$59.95
SP50VD	50-54	<1.4	15	0	DGFET	\$59.95
SP50VDG	50-54	<0.55	24	+12	GaAsFET	\$109.95
SP144VD	144-148	<1.6	15	0	DGFET	\$59.95
SP144VDA	144-148	<1.1	15	0	DGFET	\$67.95
SP144VDG	144-148	<0.55	24	+12	GaAsFET	\$109.95
SP220VD	220-225	<1.9	15	0	DGFET	\$59.95
SP220VDA	220-225	<1.3	15	0	DGFET	\$67.95
SP220VDG	220-225	<0.55	20	+12	GaAsFET	\$109.95
SP432VD	420-450	<1.9	15	-20	Bipolar	\$62.95
SP432VDA	420-450	<1.2	17	-20	Bipolar	\$79.95
SP432VDG	420-450	<0.55	16	+12	GaAsFET	\$109.95

Every preamplifier is precision aligned on ARR's Hewlett Packard HP8970A/HP346A state-of-the-art noise figure meter. RX only preamplifiers are for receive applications only. Inline preamplifiers are rf switched (for use with transceivers) and handle 25 watts transmitter power. Mount inline preamplifiers between transceiver and power amplifier for high power applications. Other amateur, commercial and special preamplifiers available in the 1-1000 MHz range. Please include \$2 shipping in U.S. and Canada. Connecticut residents add 7-1/2% sales tax. C.O.D. orders add \$2. Air mail to foreign countries add 10%. Order your ARR Rx only or inline preamplifier today and start hearing like never before!

Advanced Receiver Research

Box 1242 • Burlington, CT 06013 • 203 582-9409



✓ 175

ATV CONVERTERS • HF LINEAR AMPLIFIERS



DISCOVER THE WORLD OF FAST SCAN TELEVISION
70 CM
33 CM

AMATEUR TELEVISION CONVERTERS
ATV2 420-450 \$44.95 Kit
ATV3 420-450 (GaAs-FET) \$49.95 Kit
ATV4 902-928 (GaAs-FET) \$59.95 Kit
AUDIO SQUELCH CONTROL for ATV \$39.95 Kit
2 METER VHF AMPLIFIERS
35 Watt Model 335A \$79.95 Kit
75 Watt Model 875A \$119.95 Kit
Available in kit or wired/tested

HF AMPLIFIERS per MOTOROLA BULLETINS

Complete Parts List for HF Amplifiers Described in the MOTOROLA Bulletins.
AN758 300W \$166.70 EB63 140W \$88.65
AN762 140W \$93.25 EB27A 300W \$139.20
AN779L 20W \$83.79 EB104 600W \$448.15
AN779H 20W \$93.19 AR305 300W \$382.52
AR313 300W \$403.00

NEW!! 1K WATT 2-50 MHz Amplifier

POWER SPLITTERS and COMBINERS
500 Watt PEP 2-Port \$69.95
1000 Watt PEP 2-Port \$79.95
1200 Watt PEP 4-Port \$89.95
100 WATT 420-450 MHz PUSH-PULL LINEAR AMPLIFIER - SSB-FM-ATV
KEB67-PK \$159.95
KEB67-PCB (PC Board) \$18.00
KEB67-I (Manual) \$3.00

UNIVERSAL DIGITAL FREQUENCY READOUT

FK-1 (Wired/tested) \$149.95
REPEATER CONTROLLER
RC-1000 (Wired/tested) \$239.95
HEAT SINK MATERIAL
Model 99 Heat Sink (6.5 x 12 x 1.6) \$22.00
CNS-8 Copper Spreader (8 x 8 x 3/8) \$22.00

We also stock Hard-to-Find parts

CHIP CAPS - Kenet/ATC
METALCLAD MICA CAPS - Unelco/Semco
RF POWER TRANSISTORS
MINI-CIRCUIT MIXERS
SBL-1 (1-500MHz) \$6.50
SBL-1X (10-100MHz) \$7.95
ARCO TRIMMER CAPACITORS
VK200-20/4B RF Choke \$1.20
56-590-65-3B Ferrite Bead \$.20
Broadband HF Transformers
Add \$ 3.50 for shipping and handling.

For detailed information and prices, call or write for our free catalog.

We ship worldwide.



CCI Communication Concepts Inc.
508 Millstone Drive • Xenia, Ohio 45385 • (513) 426-8600
FAX (513) 429-3811



WE SHIP WORLDWIDE

bands into the second and third weeks of May. But these weeks will include signals weakened by absorption and a chance of disturbance, with fading and fluttery signals around the 9th, 15th, and 24th. Paths to the south may have short 6-meter openings. Night-time DX paths may have better openings during the fourth and last weeks of the month. These paths are expected to be the most affected by the disturbances, but you may receive DX surprises from new countries.

The full moon occurs on the 9th; the lunar perigee is on the 26th. The Aquarid meteor shower (for meteor scatter and meteor burst DXers) peaks between May 4th and 6th, with rates of 10 and 25 per hour for the Northern and Southern Hemispheres, respectively.

If you want more help with your DXing, try a DX net. The 1990 edition of OE2DYL's popular list "DX Nets Around the World" (List 9) is available. It contains data on more than 100 active DX nets. The price is \$3, U.S. (airmail). The package price for editions 1 to 9 is \$12, U.S. (\$1 = 3 IRC. Sorry, no checks.) Send your order with an SASE to Dieter Konrad, Rosengasse 1, 5020 Salzburg, Austria.

Band-by-band summary

Six meters may have long skip openings to the southeast and southwest late afternoons on days when the solar flux is high. Ten, 12, 15, 17, and 20 meters will support DX propagation from most areas of the world during daylight hours and into the evening, with long skip out to 2000 miles (3500 km) per hop. Signals on the upper three bands will be strongest from the southern countries and occur near local noon. The propagation direction will follow the sun across the sky. Look to the east in the morning, the south at midday, and the west in the evening. Sporadic E short skip will be available at local noon on some days toward the end of the month.

Thirty, 40, 80, and 160 meters are the nighttime DX bands. Propagation follows the darkness path across the sky. Look to the east in the evenings, to the north and south around midnight, and toward the west in the predawn hours. Skip distances will generally decrease to 1000 miles (1600 km) on these bands. Sporadic E openings will be most frequently observed around sunrise and sunset toward the end of the month. **7M**

✓ 176

GAP Airwaves expands its Service to Include 2m and 6m with the CHALLENGER DX-V & DX-VI

Unique Multiband Antennas that Utilize the Patented GAP Elevated Launch Technology

The Revolution in Antenna Design

That . . .

- Launches RF from an elevated GAP
- Eliminates earth loss
- Comes pre-tuned, No adjustments necessary
- Uses 3 short radials @ 25 feet
- Assembles in less than 30 minutes
- Is self supporting w/drop in ground mount and is 31 feet high

but has NO!!!

- Traps
- Coils
- Transformers
- Baluns
- Resistors
- or Base Insulators

Challenger DX-V \$199*

Total bandwidth on
40, 20, 15, 10, 6, 2 meters
80 KHz on 80 meters

Challenger DX-VI \$219*

Total bandwidth on
40, 20, 15, 12, 10, 6, 2 meters
130 KHz on 80 meters

Best of all the ENTIRE antenna is always active!!

To Order Call—(407) 388-2905

* Plus shipping and handling
Florida residents add 6% tax

MasterCard



GAP
ANTENNA PRODUCTS
6010—Bldg J
N. Old Dixie Highway
Vero Beach FL 32967

NEW PRODUCTS

New Hardware for Rohn 25 Rotating Tower

Rotating Tower Systems, Inc. announces the availability of guy wire bearings and rotating base assemblies designed especially for use with Rohn 25 tower. This hardware lets you build a versatile and economical rotating tower using Rohn 25 towers sections and companion rotators. Rotating stacks of smaller monobanders, stacked tribanders, large VHF/UHF arrays, and antennas mounted at optimum heights are applications for a rotating tower made from these components. In addition, component design allows the rotating base unit to be mounted at any tower height minimizing the number of guy wire bearings. For information and prices write or call Rotating Tower Systems, Inc., Box 44, Prosper, Texas 75078. Phone: (214)347-2560.

Circle #305 on Reader Service Card.

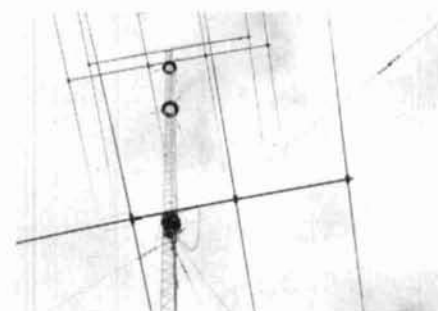

Reintroducing the Heights Tower System

Heights Tower Systems reintroduces its "standard" aluminum Heights tower. These towers are once again being manufactured to their original specifications.

Heights has a complete line of regular tapered towers and 34 configurations of telescoping crank-up towers. All are built of non-corrosive, high-tensile strength aluminum. Recommended tower configurations range from heights of 89 feet with 520 pounds of windload capacity up to 120 feet with 160 pounds of windload. Tower sections measure 8 feet in length. The tower can be assembled completely on the ground.

Hinged bases and fold over kits are also available. Hinged bases let you raise or lower the tower, "hinged," on two of three base legs via specially drilled stubs. Fold over kits, with screw or winch-operated folding plates, allow one person to fold over the tower. Fold over kits may be operated manually or can be motorized for electrical operation. An optional 4-foot stand mounts the fold over kit at your standing level. The folding plates may be installed at 8, 16, or 24-foot high junctures in the tower while being controlled from below. Most tower accessories, including the fold over kits, can be fabricated in regular or stainless steel, or aluminum, at your request.

For more information, write or call Heights Tower Systems, 1721 Indian Road, Lapeer, Michigan 48446. Phone: (313)667-1700.

Circle #312 on Reader Service Card.

New Analog Trainer from Elenco

Elenco Electronics, Inc., has a new analog trainer. Model XK-120 is designed for students who are learning the fundamentals of analog circuits. Circuits are easily assembled on the large 840-pin breadbox work area. The trainer has two DC power supplies and one AC supply which are all regulated and protected against shorts. Also provided is a function generator capable of producing sine, square, or triangle waveforms up to 100 kHz.

The trainer comes in a carrying case with a lid compartment for holding experiment parts. It's available in kit form with easy-to-follow instructions and a troubleshooting guide. The cost of the assembled version of the XK-120 is \$150; in kit form the price is \$110.

For more information contact Elenco Electronics, Inc., 150 W. Carpenter Avenue, Wheeling, Illinois 60090.

Circle #302 on Reader Service Card.

ICOM's Mini-Handheld Communications Receiver

The ICOM IC-R1 continuously covers 100 kHz to 130 MHz with AM, FM, and wide-FM modes. Measuring just 1.9" x 4" x 1.4", this tiny receiver features:

- built-in NiCd batteries
- multi-function scanning
- keyboard and tuning
- 100 memory channels
- built-in clock

The IC-R1 is also equipped with a power saver function, adjustable LCD contrast, a signal indicator, an external DC power jack with battery charge capability plus a large variety of other options from the "S" series handhelds.

For details contact ICOM America, Inc., 2380 116th Avenue, NE, P.O. Box C-90029, Bellevue, Washington, 98009-9029.

Circle #303 on Reader Service Card.

ALPHA DELTA Model CLP Rotor Control Line Transi-Trap Surge Protector

The ALPHA DELTA Model CLP Rotor Control Line Transi-Trap Surge Protector protects your communications equipment against lightning-induced surge voltages on the control lines to your rotor control and remote antenna switch boxes.

The protector features straightforward installation with no soldering and:

- Protects up to eight 16 AWG wire control line cables. Covers the most commonly used rotor and remote switch models. Requires no modification to control boxes.
- Uses eight NEMP-rated high surge current field-replaceable gas tube Arc-Plug cartridges. Each line is individually protected.
- Has quality G-10/FR4 glass epoxy pc board construction. Your control line connects directly to industrial grade pc board mount connectors for best low inductance discharge performance. Computer designed. No soldering required.
- Equally effective for modem/phone line protection. The low capacitance gas tube Arc-Plug cartridges accommodate high baud data transmission.

The Model CLP Control Line Transi-Trap Protector sells for \$49.94, with \$3 added for postage and handling. Transi-Trap coax cable surge protectors are also available. (Ohio residents add 6-1/2 percent sales tax.) Write Alpha Delta Communications, Inc., PO Box 571, Centerville, Ohio 45459 for more details. Phone: (513)435-4772.

Circle #307 on Reader Service Card.

NEW PRODUCTS

New Tower-mount Preamp

WI-COMM Electronics, Inc. offers a new tower-mount preamplifier in a weatherproof aluminum housing which covers the band from 10 to 900

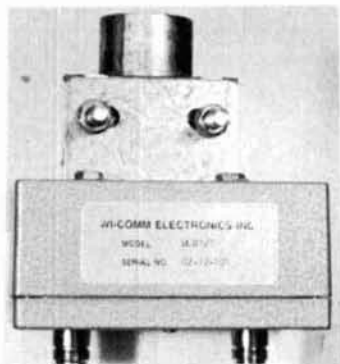

MHz. The preamplifier gain is 25 dB, noise figure is 3.1 dB typical, 1-dB gain compression is at +10 dBm minimum, VSWR in/out is 2:1, and powering is +12 to 15 volts. Power is supplied via the output connector by a wideband DC block (bias tee). Standard connectors are type N female. Lightning static protection at the input and reverse polarity protection on the DC supply line are included. Wideband DC block is also available, along with the RX-RX switch (SPDT) and the amplifier bypass switch module (insertion loss 0.15 dB maximum, isolation 50 to 70 dB at 900 MHz, set time 5 ms, through power 10 watt maximum, powering +12 to +15 volts, and VSWR is 1.3:1 typical). The SPDT switch can be used to combine two antennas at the preamp input; the bypass switch module can be used to insert a pad/filter into the signal path.

For additional information contact WI-COMM Electronics, Inc., Box 5174, Massena, New York 13662. Phone: (315)769-8334.

Circle #335 on Reader Service Card.

FAR Breadboards

FAR Circuits announces the addition of prototype breadboards to its line of circuit boards. The breadboards come in three different arrangements and can be used for a variety of small circuits and Amateur Radio projects. The cost of the boards is \$5 each plus \$1.50 per order for shipping and packing. The boards are made of single sided G-10, FR4 glass epoxy material and the copper is solder coated.

For further information write FAR Circuits, 18N640 Field Court, Dundee, Illinois 60118.

Circle #310 on Reader Service Card.

Custom Dual Band Quad Antenna

Custom Antenna Systems now makes a dual-band 2-meter 70-cm quad antenna for the new dual-band radios.

The DB2/70 is a compact, lightweight, high performance beam with five elements for 2 meters and 9 elements for 70 cms. This UHF/VHF dual-band antenna is broad banded and offers a 12.5-dB forward gain on 2 meters and 10.5 dB on 70 centimeters, with front-to-back ratio of 20 dB.

The DB2/70 is 5 feet long and takes a mast size of 1 to 1-3/8 inches. This antenna is end mounted, making it easy to install with only a light rotor. The match system provides low SWR with a 50-ohm feed and a standard PL-259 connector. This beam needs only one feedline, but you may feed both bands separately with a second.

Detailed instructions and precision manufactured components are included for ease of assembly. The boom is constructed of heavy wall

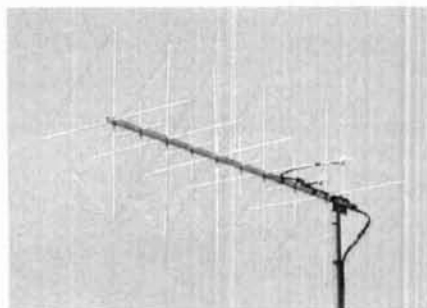

3/4-inch rigid square tubing; the element spreaders are 1/4-inch solid fiber glass rods. The antenna weighs approximately 3-1/2 pounds and will handle a wind load of 90+ mph.

The DB2-70 is available from Custom Antenna Systems. The price is \$109.95 plus shipping and handling. Contact Custom Antenna Systems, PO Box 17012, Munds Park, Arizona 86017 or call (602) 286-1236.

Circle #311 on Reader Service Card.

DX-88 HF Vertical Ground Tunable for 80 and 40 meters

Telex® /Hy-Gain®'s new DX-88 design uses the entire antenna on 80 or 40 meters. You can tune 80 or 40 meters to any point on the band without lowering the antenna. You can also adjust the other six bands to any frequency without affecting the tuning of any other band. The DX-88 handles maximum legal power, features unique traps for minimal loss and offers broadband VSWR of less than 2:1 on six of the eight bands. The self-supporting DX-88 comes with stainless steel hardware and enclosed coils of no. 12 gauge copper wire to reduce loading changes due to weather. With ground radials of 14 feet, the DX-88 requires only a small area for maximum operating efficiency. Optional kits for ground or roof radials, as well as for 160-meter

operation are available. The DX-88 can also be used as a dedicated SWL antenna and covers 12 bands from 11 to 90 meters. As with all Hy-Gain antennas, the DX-88 comes with a two-year limited warranty.

For detailed information, write to Telex/Hy-Gain, RF Consumer Department, 9600 Aldrich Avenue, South Minneapolis, Minnesota 55420 or call 612-887-5528.

Circle #313 on Reader Service Card.

Toll-free Literature Request Line

ICOM has installed a toll-free literature request hot line for their retail customers. Retail customers can request any ICOM literature by calling (800)999-9877. When you call, a recording will ask you to state your literature request and give your complete address.

**SAY YOU SAW IT
IN
HAM RADIO**

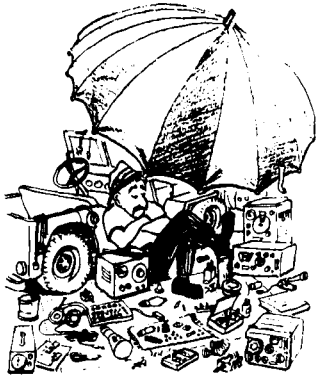

FLEA MARKET

RATES Noncommercial ads 10¢ per word; commercial ads 60¢ per word **both payable in advance.** No cash discounts or agency commissions allowed.

HAMFESTS Sponsored by non-profit organizations receive one free Flea Market ad (subject to our editing) on a space available basis only. Repeat insertions of hamfest ads pay the non-commercial rate.

COPY No special layout or arrangements available. Material should be typewritten or clearly printed (not all capitals) and must include full name and address. We reserve the right to reject unsuitable copy. **Ham Radio** cannot check each advertiser and thus cannot be held responsible for claims made. Liability for correctness of material limited to corrected ad in next available issue.

DEADLINE 15th of second preceding month.

SEND MATERIAL TO: Flea Market, Ham Radio, Greenville, N. H. 03048.

BEGINNER'S RADIO CLEARINGHOUSE. On a space available basis, we are going to offer you, OUR SUBSCRIBER, free of charge, a chance to find a home for your used equipment with a new Ham. Please send us a short description of what you want to sell along with price, name, address and phone number. Please limit your ad to 20 words or less.

FOR SALE: Moving to a smaller home. Wife orders shack cleaning. Completely retiring from Amateur Radio. Selling equipment stored over 20 years. Almost assembly-line new cosmetically. Needs simple repairs due to long storage. Offering: National NC98, NC125 receivers, NC-5 speaker, FME VHF 152 converter, DB-20 pre-selector, RCA B/C-S/W chassis for console, RCA B/C-F/M ditto, RCA MI series 20 watt pwr amp. Wilcox-Gay CW-3 rack mt rcr. All at a fraction of present value. Parts and tubes of all descriptions to meet your needs, receiving and transmitting, some quite rare. Home brew receivers for VLF freqs, 500 kHz to 18 kHz with IF's of 370 kHz, 262 kHz, 132 kHz and 85 kHz for the VHF buff, list available. Many parts and tubes FREE to real experimenters and builders especially novices. Tourists and other nearby hams welcome to visit. Call or write George Roberts, 500 West Leeland Hgts Blvd, Lehigh Acres, Florida 33936. Area code 813-369-6724 anytime on low rates. I am close to Ft. Myers.

SIGNAL/ONE CX-11A Transceiver, excellent \$2,595.00. Kenwood TSJ-930S/AT Transceiver, mint \$1295.00. SM-220 \$325.00. TSJ-711A like-new \$750.00. KLM 2M16LBX, new \$135.00. Alan, K6GA (714) 964-3912.

FOR SALE: Johnson 1KW antenna tuner, \$95.00. Ten-Tec 705-A desk microphone \$35.00. B&W 550A 5-position coax antenna switch \$20.00. D. Heise, AA6EE, 16832 Whirlwind, Ramona, CA 92065. (619) 789-3674.

STUFF YOUR MAILBOX with Electronic Catalogs, etc. Send \$3.00 to Information/HR, 3037 Audrey Drive, Gastonia, NC 28054.

EXTRA CLASS License Test Manuals used once—questions thru Oct. 1991. ARRL \$5, Ameco \$3 or both \$7. Only one each, include SASE in case sold. Nate Williams, W9GXK, 6915 Prairie Drive, Middleton, WI 53562. 100% guarantee to pass if you 100% guarantee to study.

YAGI BUILDERS. Tube traps, tubing, clamps and universal pipe for boom to mast or elements. Six band rotary dipole or Yagi. 10thru 40M. SASE for details. 1-800-833-3794, 1-2 PM EST. Brown Engineering, Inc, 5501 SW 25th Court, Hollywood, FL 33023.

WANTED FOR MUSEUM: Early microcomputers, SWTPC 6800, Sphere, Altair MITTS 6800 and other early micros. Also early microcomputer magazines. David Larsen, KK4WW, Blacksburg Group, PO Box 1, Blacksburg, VA 24063-0001. (703) 231-6478/763-3311.

WANTED: Ham equipment and other property. The Radio Club of Junior High School 22 NYC, Inc. is a nonprofit organization, granted 501(C) (3) status by the IRS, incorporated with the goal of using the theme of Ham Radio to further and enhance the education of young people nationwide. Your property donation or financial support would be greatly appreciated and acknowledged with a receipt for your tax deductible contribution. Meet WB2JKJ and the "22 Crew" at Knoxville, TN Hamfest on June 2. Joe Fairclough will be the featured speaker telling the incredible story of the first 10 years of education thru communication at the core of the Big Apple. Write us at: PO Box 1052, New York, NY 10002. Round the clock hotline: (516) 674-4072.

WANTED: Vibroplex Lightning Bug semi-automatic key (circa 1955). Nate Williams, W9GXK, 6915 Prairie Drive, Middleton, Wisconsin 53562.

BATTERY PACK REBUILDING: Don't pitch it—mail it—for FAST—PROFESSIONAL Rebuilding! Satisfaction guaranteed! ICOM: BP2/BP3 \$19.95, BP5 \$25.95, BP7/BP8/BP70 \$32.95. KENWOOD: PB21 \$15.95, PB21H \$21.95, PB25/25H/26 \$24.95. YAESU: FNB9 \$19.95, FNB10 \$23.95, FNB4/4A \$36.95. TEN-TEC: \$24.95 "U-DO-IT INSERTS" ICOM: BP3 \$16.95, BP5 \$22.95, BP7/8 \$27.50, KENWOOD: PB21 \$12.95, PB24/25/26 \$19.95, TEMPO: S1-15/SERIES \$22.95, YAESU: FNB4/4A \$32.95, FNB10 \$18.95, AZDEN: 300 \$19.95, "NEW PACKS" ICOM: BP5 \$34.95, BP8S \$58.95, YAESU: FNB2 \$19.95, FNB10S/FNB12 \$44.95, SANTEC: 142/1200 \$22.95. TELEPHONE/PAGER/COMPUTER/COMMERCIAL PACKS—Free catalog. Add \$3.00 shipping/order. PA +6%. VISA/MC add \$2.00. CUNARD, RD 6, Box 104, Bedford, PA 15522. (814) 623-7000.

WANTED: 2 meter transceiver base or mobile. Wanted: Interface for TRS-80 computer. WB6VOW, Bob Tibbits, 11023 Marcia Weldon, CA 93283. (619) 378-3146.

VIBROPLEX COLLECTOR'S GUIDE. W1MQ's new illustrated reference. Key Histories, identification guide, patents, more. 87 pages. Only \$14.95 plus \$2.00 s/h. Free info. Artifex Books, Box 88-H, Maynard, MA 01754.

TRI-BAND BEAM and tower complete with quiet hilltop custom contemporary QTH situated on 4-1/2 + acres in Frankestown, NH. Near ski areas, golf and fine dining. \$218,900. Call Norwood Realty (603) 673-8000.

EIMAC 8877/3CX1500A7 new warranty \$695.00. Eimac Socket/Chimney, for 8877 \$125.00. Jennings UCS-300-75 KV vacuum capacitor, variable \$135.00. RJ1A-26 vacuum relay \$75.00. Cardwell 2100PF-3KV variable capacitor \$60.00. RF Inductor 25uH-15A \$60.00. All—NEW. Alan, K6GA (714) 964-3912.

SLEP SPECIALS: Plate transformers for amplifier builders or replacement gonset P/N271-107 for Models 903, 913 linear amplifiers, 115VAC/1850V at 500MA, size 5-1/4 x 4-1/4 x 4-1/2 H, Wt. 18 lbs, new \$37.00. HP651B solid state audio oscillator, covers 10Hz thru 10MHz calibrated output, \$185.00. Military SG-66/ARM-5 aircraft omni signal generator, mil/diversion of ARC H-14, ideal for aircraft radio repair \$295.00. Military USM-207 frequency counter, late model solid state, eight digit readout 0-500MHz, high stability crystal oven oscillator, size 19W x 5H x 7ID, lab quality \$185.00. Military TS-510A signal generator 10MHz thru 420MHz, calibrated output, MIL/Version HP608D \$195.00, HP616A microwave signal generator 1.8GHz thru 4.2GHz \$275.00, have quantity, all lab calibrated/guaranteed, VISA/MC or check, add shipping. Write/phone Bill Slep (704) 524-7519. SLEP ELECTRONICS COMPANY, Highway 441, Otis, NC 28763.

FOR SALE: Santeck ST-200 ET 2m Handheld. 2 battery packs, DC1 12V converter, headset with PTT control \$165.00. Also IC-3SAT, New in box \$370.00. Daytime phone (603) 878-1441. Will ship UPS. Ask for Marty NB1H.

"SOFTSTART" Protect your valuable tubes and power supply diodes from DANGEROUS inrush surge currents. Can be retrofitted into most amplifiers. Completely assembled Amateur net for "SOFTSTART" is \$49.95 plus \$5.00 shipping in the 48 states. OMEGA ELECTRONICS, 4209 Live Oak Road, Raleigh, NC 27604. (919) 231-7373.

FREE LIST of low cost ham equipment. Write to Jim Braddy, WA4DSO, 3037 Audrey Drive, Gastonia, NC 28054.

WANTED: BUY & SELL. All types of Electron Tubes. Call toll free 1-800-421-9397 or 1-612-429-9397. C & N Electronics, Harold Bramstedt, 6104 Egg Lake Road, Hugo, MN 55038.

HAM SOFTWARE IBM/Compatibles 10 disks \$26.95. MC/VISA/Discover. N5ABV EAPCO/H, Bx 14, Keller, TX 76248-0014. (817) 498-4242. 1-800-869-7208.

CHASSIS AND CABINET KITS. SASE. K31WK, 5220 Harmony Grove Rd, Dover, PA 17315.

RTTY JOURNAL published 10 times per year for those interested in digital communications. Read about RTTY, AMTOR, MSO'S, PACKET, RTTY DX and Contesting. Plus technical articles concerning the digital modes. \$12.50 per year (foreign higher). RTTY JOURNAL, 9085 La Casita Ave, Fountain Valley, CA 92708.

CUSTOM MADE EMBROIDERED PATCHES. Your design, any shape and colors. Free ordering information, price list and random sample. HEIN, 79602 Manitou Trail, Glen Arbor, MI 49636-9711.

IBM-PC RTTY/CW. New CompRtty II is the complete RTTY/CW program for IBM-PC's and compatibles. Now with larger buffers, better support for packet units, pictures, much more. Virtually any speed ASCII, BAUDOT, CW. Text entry via built-in screen editor! Adjustable split screen display. Instand mode/speed change. Hardcopy, discopy, break-in buffer, select calling, text file transfer, customizable full screen logging, 24 programmable 1000 character messages. Ideal for MARS and traffic handling. Requires 256K PC or AT compatible, serial port, RS-232C TU. \$65. Send call letters (including MARS) with order. David A. Rice, KC2HO, 144 N. Putt Corners Rd, New Paltz, NY 12561.

BEAT THE COLD! Melbourne, FL QTH: 4:2:2 (3100 sq/ft) house, 1.6+ acres. 220V wired shack with coax races built in, RHON/25 pad, workshop, pool, sprinkler system, in the country no restrictions, many tall pines and oaks, easy commute to Cape Canaveral, close to fishing/beaches/shopping, SAE for details and photos, \$209,000. NODH4.

AVANTEK ATF10135, \$12.00, MMIC's. PC. board, SASE: WA3JAC, 7148 Montague St, Philadelphia, PA 19135.

"HAMLOG" COMPUTER PROGRAM. Full features, 18 modules. Autologs, 7-band WAS/DXCC. Apple, IBM, CP/M, KAYPRO, Tandy, C128 \$24.95. HR-KA1AWH, POB 2015, Peabody, MA 01960.

HF PACKET IMPROVEMENT—Digicom 64 revision "A" circuit now available. Board plugs directly into cassette port or remote mount via cable, both connectors included. Power derived from computer. Uses 7910 chip—no alignment required. Switch allows HF or VHF operation. Order Kit #154 for \$49.95 or Assembly #k154 for \$79.95, both include FREE DISK. Add \$3.50 s/h, CA add 6.25% tax. A & A Engineering, 2521 W. LaPalma #K, Anaheim, CA 92801. (714) 952-2114. MC or VISA accepted.

IMRA International Mission Radio Association helps missionaries. Equipment loaned. Weekday net, 14,280 MHz, 1-3 PM Eastern. Nine hundred Amateurs in 40 countries. Rev. Thomas Sable, S.J., University of Scranton, Scranton, PA 18510.

HOW TO DESIGN AND BUILD YOUR OWN COMPUTERIZED PRODUCT! New manual makes it easy! Simple step-by-step details from idea to finished product. Includes introduction to design, choosing the proper CPU, comparison between many CPUs & microcontrollers, circuit layout, sample schematics, programming, debugging, hints, tips, and more! \$8.00 complete. Satisfaction guaranteed. Details free. TRAVCO, 107 E. Vallette, Suite 1301M, Elmhurst, Illinois 60126.

HAM QTH. Hilltop woodland. Approx. 1500 ft. above sea level. 17.8 acres. Located in NH near Mass. border; perc-tested for single residence, solar exposure, privacy, access road is town-owned, owner-maintained. Phone and power lines within approx. 2500 ft. \$79,000. Call or write for details. (603) 547-2053. C.W. Farr, Broker, Rt 1, Box 223, Greenfield, NH 03047.

WANTED: Henry VBC 3000. Dick (716) 386-4092.

INTERESTED IN PUBLIC SERVICE? Join your Local Radio Emergency Associated Communications Team. In Pennsylvania call (717) 938-6943 or write REACT, 1160 Old Trail Rd, Etners, PA 17319.

RUBBER STAMPS: 3 lines \$5.00 PPD. Send check or MO to G.L. Pierce, 5521 Birkdale Way, San Diego, CA 92117. SASE brings information.

ELECTRON TUBES: Receiving, transmitting, microwave... all types available. Large stock. Next day delivery, most cases. DAILY ELECTRONICS, PO Box 5029, Compton, CA 90224. (213) 774-1255.

RECONDITIONED TEST EQUIPMENT \$1.25 for catalog. Walter, 2697 Nickel, San Pablo, CA 94806.

COMING EVENTS

Activities — "Places to go . . ."

SPECIAL REQUEST TO ALL AMATEUR RADIO PUBLICITY COORDINATORS: PLEASE INDICATE IN YOUR ANNOUNCEMENTS WHETHER OR NOT YOUR HAMFEST LOCATION, CLASSES, EXAMS, MEETINGS, FLEA MARKETS, ETC, ARE WHEELCHAIR ACCESSIBLE. THIS INFORMATION WOULD BE GREATLY APPRECIATED BY OUR BROTHER/SISTER HAMS WITH LIMITED PHYSICAL ABILITY.

MAY 5-6: SOUTH CAROLINA: Greenville Hamfest sponsored by the Blue Ridge ARS, American Legion Fairgrounds. Sat 8 to 5. Sun 8 to 3. Admission \$4/advance, \$5/gate. For tickets or information SASE to Blue Ridge ARS, POB 6751, Greenville, SC 29606.

MAY 5: NEW YORK: The Putnam Emergency Amateur and Radio League will have their PEARLFEST, John F. Kennedy Elementary School, Foggingtown Road, Brewster. 9 AM to 4 PM. Rain or shine. Admission \$3. For registration please contact Terri Cullum, N2GWV, 40 Mile Hill Road, Highland, NY 12528 or Jim Ward, N2EGS, 22 Trout Place Rd, 4 Mahopac, NY 10541.

MAY 5: MINNESOTA: The Paul Bunyan ARC's annual Hamfest, VFW Club, Bemidji. 8 to 3:30. For information write Carol Johnson, KA0AJD, 1503 Jefferson Ave SW, Bemidji, MN 56601. (218) 751-7920.

NEW BOOKS

UHF COMPENDIUM Part III and IV

Edited by K. Weiner, DJ9HO
This is one of the most long awaited books in Amateur Radio. It represents over two years of work and contains more than theory—it's chock full of practical, tested designs from some of Europe's most noted hams. Subjects covered include: notch filters, antennas and IF pre-amps, transistor drivers, transmit and receive converters, power amplifiers and much more. This book is guaranteed to be a best seller. Order yours today. (This book is imported and supplies will vary due to shipping delays.)
© 1989, 1st Edition

KW-UHF3 Softbound \$29.95

1990-1991 ARRL REPEATER DIRECTORY

Includes all the latest repeater listings available. Lists 13,000 repeaters, 2,200 digipeaters, and 475 beacon stations from 14 MHz to 24 GHz. Get your copy of this new book today. ©1990.
AR-RD90 Softbound \$5.95

ARRL CODE TAPES

Four new sets of code practice tapes from the ARRL. Each set consists of two 90 minute cassettes and gives you almost 3 full hours of practice. Great way to study when you can't get on the air.

AR-1 5-10WPM	\$9.95
AR-2 10-15WPM	\$9.95
AR-3 15-22WPM	\$9.95
AR-4 13-14WPM	\$9.95

THE FABULOUS RADIO NBD

by Brandon Wentworth, K6JLJ
Here is the story of one of WW's most important radio stations. Written from the first hand stories and actual experiences of the men who operated NBD. Includes technical descriptions of the equipment and antennas. Great history reading.
© 1984, 1st edition, 34 pages.

BH-NBD Softbound \$4.95

NEWNES Radio Amateur and Listener's Pocket Book

by Steven Money, G3FZX
Unique collection of useful information for the Radio Amateur and hi-tech listener. Full of hard-to-find information. Includes codes, symbols, formulae, frequencies, in addition to AMTOR, packet and SSTV Handy "pocket book" size. ©1987, 1st edition, 160 pages.

CRC-RA Hardbound \$19.95

WIRELESS ANTENNA HISTORY

A vertical design primer
by Walter Schulz, K3OOF
Starts with a well written history of radio's beginnings. Nine chapters cover radio from the first pioneers through the beginnings of radio astronomy. The vertical primer is a complete section on how to design, build and optimize a vertical antenna. Full of explanations and handy hints not found elsewhere.
© 1988, 1st edition, 140 pages.

GL-00F Softbound \$16.95

HINTS AND KINKS for the Radio Amateur

edited by K8CH & AK7M
This is the twelfth collection of ideas taken from QST's most popular column. Hints and Kinks. Other's hands on experience can save you hours with suggestions on how to "build a better mousetrap." Includes ideas on station accessories, operating, cw, computers, antennas, shop secrets and much more! Great new edition! © 1989, 12th edition.

AR-HK Softbound \$4.95

N6RJ'S SECOND OP MANUAL VERSION

Now available in "slide rule" format for non-computerized hams! Fully up-dated with all the latest prefixes, zones, postage and other information. GET YOURS TODAY! 2nd edition. © 1989.
CB-20P \$9.95

Please enclose \$3.75 for shipping and handling.

MAY 6: MASSACHUSETTS: NOBARC Mayfest, Dalton American Legion, Rt. Dalton. Rain or shine. Starts at Dawn. Admission \$1. For information call (413) 458-8452.

MAY 5: NEW YORK: Southern Tier Hamfest sponsored by the Southern Tier ARC, Marvin Park Fairgrounds, Rt 17C—Ex 64, Owego. 8 AM to 4 PM. Admission \$4/gate. Tailgate \$2/extra; Tables \$15; Banquet \$15/advance. Talk in on 146.16/76 or 146.52/52. Contact STARC, PO Box 7082, Endicott, NY 13760.

MAY 5: MINNESOTA: The Arrowhead Radio Amateur Club presents Swapfest '90, First United Methodist Church, 230 East Skyline Parkway, Duluth. 10 AM to 3 PM. Admission \$4. 4' tables \$5. Talk in on 146.34/94, for information contact Duane Flynn, KB0LC, 4907 Peabody Street, Duluth, MN 55801. (218) 525-4580.

MAY 2: MISSOURI: The 15th annual Columbia Hamfest '90 sponsored by the Central Missouri Radio Association, Midway Expo Center 2 miles west of Columbia. Flea Market opens 7:30 AM. Expo Center 9 AM. Tickets 3/57.50 advance; \$3/each at the door. For tickets Ben Smith, K0PCJ, 3301 Sinclair, Rt 3, Box 196A, Columbia, MO 65203. Information (314) 443-5168.

MAY 13: OHIO: The Athens County ARA's 11th annual Hamfest, City Recreation Center, Athens. 8 AM to 3 PM. Admission \$4. Spouses admitted free. For information write Carl J. Denbow, KABJXG, 83 Morris Avenue, Athens, Ohio 45701.

MAY 12: WISCONSIN: The Tri-County ARC's annual Hamfest, Jefferson County Fairgrounds, Jefferson. 8 AM to 2 PM. Admission \$2.50 advance; \$3/door. For information, tickets or tables SASE to TCARC, PO Box 112, Jefferson, WI 53549.

MAY 12: IOWA: The Clinton ARC's Hamfest 90, Iowa National Guard Armory, 1200—13th Avenue North, Clinton. Gates open 8 AM. Tickets \$3/advance; \$4/gate. Tables \$5. Talk in on 145.43 repeater. For information, tickets or tables contact Darryl Petersen, KD0PY, RR 1, Box 84, Bryant, IA 52727. (319) 682-7359.

MAY 19: ARKANSAS: Hamfest 90. Sponsored by the Northwest Arkansas ARC, Community Building, Rodeo Grounds, Springdale. Free admission. For information contact Mike Lorenz, N8FJJ, Rt 2, Box 160A, Prairie Grove, AR 72753. (501) 846-2516 evenings.

MAY 19: COLORADO: Swapfest by the Pikes Peak Radio Amateur Association, Rustic Hills Malls, Colorado Springs. No entry fee. Wheelchair accessible. For information contact Rick, WB7THT (719) 589-7685 or write PO Box 16521, Colorado Springs, CO 80935.

MAY 19: PENNSYLVANIA: Lancaster County Hamfest sponsored by the Ephrata Area Repeater Society, Ephrata Senior High School, 803 Oak Blvd. General admission 8 AM. Exams 9 AM. Entrance fee \$4. Tailgating \$3. Inside tables \$6. For information and reservations call Tom Youngberg, K3RZF (215) 267-2514 after 6 PM or write EARS, 906 Clearview Ave, Ephrata, PA 17522. All sites handi accessible.

MAY 20: NEW YORK: Long Island Mobile ARC's Hamfest, New York Institute of Technology, Rt 25A, Old Westbury. 9 AM to 4 PM. Admission \$5/gate, no advance. Exhibitors \$8. Contact Neil Hartman, WE2V (516) 482-5549 or Mark Nadel, NK2T (516) 796-2366.

MAY 20: NEW JERSEY: Bergen Amateur Radio Assn's Hamfest, Bergen Comm. College, 400 Paramus Rd, Paramus. Contact Jim Joyce, K2Z0, 286 Ridgewood Blvd No., Westwood, NJ 07675. (201) 664-6725.

MAY 20: ILLINOIS: The annual Hamfest sponsored by the Kankakee Area Radio Society, Will County Fairgrounds, Peotone. 8 AM to 2 PM. Indoor flea market and exhibitor tables (limited). Large outdoor flea market. ARRL booth. Free parking. Food and drink available. Admission \$2.50 advance, \$3.00 at the door. Setup kMay 20, 6-8AM. Talk in on 146.34/94. More information from KARS, c/o Frank DalCanton, KA9PWW, RR1, Box 381, Cebesane, IL 60922. Tel (815) 932-6703 after 4 PM CST or (815) 937-2452 before 4 PM CST.

MAY 19: MICHIGAN: Wexaukee ARA Hamfest, Cadillac Middle School, 500 Chestnut St, Cadillac, 8:30 to 2:30 PM. Admission \$3. Tables \$6. Talk in on 146.38/98 repeater. Contact John Craddock, KX6Z (a616) 797-5491 or Wexaukee ARA, PO Box 163, Cadillac, MI 49601.

MAY 19-20: WASHINGTON: Yakima ARC, W7AQ, celebrating its 60th anniversary, Queen Gym, 5502 West Chestnut Avenue, Yakima. Saturday 9-4, Sunday 9-1. Admission \$5 pre-registration. \$6/door. Features visiting Soviet Amateurs, swap-shop, exhibits and more. Talk in on 146.06/66. Contact Yakima ARC, PO Box 9211, Yakima, WA 98909. Mary Wildman, K87AMF (509) 248-5007.

MAY 20: PENNSYLVANIA: The Warminster AR's 16th annual Hamfest, Middletown Grange Fairgrounds, Penns Park Rd, Wrightstown. Starts 7 AM. Admission \$4. Spouse and kids free. For information contact Bill Cusick, W3GJC (215) 441-8048.

MAY 20: WEST VIRGINIA: 12th annual TSRAC Wheeling Hamfest/Computer Fair, Wheeling Park. 8 AM to 3 PM. Admission \$2/advance; \$3/gate. Free admission 16 years and under. Contact: TSRAC, Box 240, RD 1, Adena, OH 43901. (614) 546-3930.

MAY 26: NORTH CAROLINA: The 16th annual Dur-Ham-Fest sponsored by the Durham FM Association, under the south parking deck of the South Square Mall, Durham. Rain or shine. FCC exams. For information contact Sid Edwards, W4QWM, 1700 High St, Durham, NC 27712.

MAY 27: ILLINOIS: The Chicago ARC will hold its annual Hamfest and Auction, DeVry Institute of Technology, 3300 N. Campbell, Chicago. For details and reservations call (312) 545-3622.

MAY 27: MARYLAND: The Maryland FM Association's annual Memorial Day Hamfest, Howard County Fairgrounds, Rt 144, West Friendship. 8 AM to 3 PM. Donation \$4. Tailgating \$3. For reservations and information write Melvin Seyle, WA3KZR, 15809 Pointer Ridge Drive, Bowie, MD 20716. (301) 249-6147.

JUNE 2: TENNESSEE: The 24th annual Knoxville Hamfest and Computer Fair sponsored by the Radio Amateur Club of Knoxville, Knoxville Convention Center at the World's Fair Park. 8 AM to 5 PM. Admission \$5. Table reservations Frank Ambrister, N4OQJ, PO Box 9605, Knoxville, TN 37940. (615) 933-2539. License exams contact Ray Adams, N4BAQ, 4325 Felty Drive, Knoxville, TN 37918. (615) 687-5410.

JUNE 2: MAINE: Pine State ARC's Hamfest, Hermon Elementary School, Billing Road, Hermon. 8 AM to 2 PM. Admission \$2. Contact Roger W. Dole, KA1TKS, RR 2, Box 730, Bangor, Maine. (207) 848-3846.

JUNE 3: PENNSYLVANIA: The 36th annual "Breeze Shooters'" Hamfest-NEW LOCATION—Butler County Farm Show Grounds, Rt 68, Butler. 8 AM to 4 PM. Admission \$1/gate. Free tailgate Flea Market. Talk in on 147.96/36. Contact H. Rey Whanger, RD 2, Box 8, Cheswick, PA 15024. (412) 828-9383.

JUNE 3: VIRGINIA: Manassas Hamfest sponsored by the Ole Virginia Hams ARC, Prince William County Fairgrounds. Opens 8 AM. Admission \$5. All wheelchair accessible. For information contact Rosemary, K14VO (703) 361-5255.

JUNE 3: MICHIGAN: 13th annual Swap 'N Shop sponsored by the Chelsea ARC, Chelsea Fairgrounds. Handi parking. Donation \$2.50/advance; \$3/door. For information SASE to Robert Schantz, 416 Wilkinson St, Chelsea, MI 48118. (313) 475-1795.

OPERATING EVENTS

"Things to do . . ."

MAY 6: The Columbia ARC will operate N4QSL from 1500Z May 5 to 2100Z May 6 from the SC state capital grounds in conjunction with the annual Mayfest Celebration. QSL with SASE to CARC Mayfest, POB 5802, Columbia, SC 29250.

MAY 11: The Escondido Amateur Radio Society will operate a special event station in conjunction with the Annual Avocado festival. Listen for WA6VOO from 0000Z May 11 to 2400Z May 13. For commemorative certificate send QSL and large SASE to EARS, 2435 Our Country Road, Escondido, CA 92025.

MAY 19: The 41st annual ARMED FORCES DAY Communication Test. The Military-to-Amateur crossband operations will be conducted from 191300 UTS to 20/0245 UTC.

THROUGHOUT 1990 the Major Armstrong Memorial Amateur Radio Club (MAMARC) will sponsor events commemorating Major Edwin Howard Armstrong's achievements in the field of radio broadcasting. The club is seeking other Amateur operators around the world who are willing to research Major Armstrong's accomplishments and become official MAMARC special events stations. Major Armstrong was a pioneer responsible for the creation of Wideband FM and the inventor of the superheterodyne receiver. If you are interested in participating and becoming an official MAMARC special event station contact Barry Grupp, N2HDW, MAMARC, c/o 100th Birthday Committee, PO Box 581, Alpine, NJ 07620. Please SASE.

YOUTH LINK NET. Open to all Hams under age 18. Saturdays at 2000 UTC, 28.425 MHz. For more information contact Net Control, George Manning, WB5NMH, 602 Glendale St, Burkburnett, TX 76354.

FREE 1989-90 Florida two meter repeater directories are currently being distributed by the Hernando County Amateur Radio Assn. of Brooksville, FL. Ask for one at any official Florida Welcome Center or SASE to Repeater Directory, Hernando County ARA, POB 1721, Brooksville, FL 34605-1721.

AMATEUR EXAMS. May 19, July 14, September 8, November 17. St. Mary Medical Center, 3333 No. Seminary Street, Galesburg, IL 61401. 12 Noon to 2 PM. For information contact Larry Heller, KA9PCU, 1436 Brown Avenue, Galesburg, IL 61401. (309) 342-5977.

Monthly Ham Exams. The MIT UHF Repeater Association and the MIT Radio Society offer monthly ham exams, all classes Novice to extra: next-to-last Wednesday of each month, (May 23) 7:30 pm, MIT Room 1-150, 77 Mass Avenue, Cambridge, MA. reservation requested a couple of days in advance, walk-ins welcome; call the shack (617) 253-3776, or Nich Allenbernd (617) 437-0320. Exam fee \$4.95. Bring copies of your current license (if any) and Certificates of Completion (if any), two forms of picture ID, and a completed form 610, available from the FCC: (617) 770-4023.

LAUREL ARC monthly (except December) Amateur exam sessions for all license classes. No fee is charged. Pre-registration is required. Call (301) 725-1212, Maryland Radio Center, 8576 Laureldale Drive, Laurel, MD 20707.

AMATEUR RADIO CLASSES: For those people interested in obtaining a Novice (basic level) Ham license or upgrading to Tech/General, the Chelsea Civil Defense, in cooperation with QRA Radio Club, will sponsor Amateur Radio Communications classes evenings at Chelsea High School starting MARCH 7, 1989. For more information write Frank Masucci, K1BPN, 136 Grove Street, Chelsea, MA 02150. Please enclose your telephone number.

RF POWER TRANSISTORS

We stock a full line of Transistors & Tubes for amateur, marine, and business radio servicing



Partial Listing of Popular Transistors in Stock

P/N	Net/Ea	P/N	Net/Ea	P/N	Net/Ea
BFR96	\$ 2.75	MRF1946A	\$17.00	LOW NOISE FIGURE	
CD2664A	26.50	PT6619	19.75	MGF1402	\$17.95
ECG340	3.40	PT9847	22.75	MRF901	1.50
MRF134	16.00	RF120	21.00	MRF911 & 966	2.50
MRF136	21.00	SD1229	12.00	NE25537/25K205	3.25
MRF136Y	47.00	SD1272	12.00	NE41137/35K124	3.25
MRF137	24.00	SD1278-1	13.75	U309 & U310	1.75
MRF138	35.00	SD1405	16.00	2N4416 & J310	1.00
MRF141G	190.00	SD1407	25.00	3N204 & 3N211	2.00
MRF146	34.00	SD1428	29.50	OUTPUT MODULES	
MRF150	79.50	SD1429-3	16.00	(Partial listing only - call for numbers not listed)	
MRF151G	179.50	SFR2072	12.75	SAV4 440 LIN	49.50
MRF153	395.00	SFR3662	29.50	SAV6 158	42.50
MRF156	537.00	SFR3775	13.00	SAV7 144	42.50
MRF171	34.50	SFR3800	17.50	SAV12 144 HT	23.50
MRF172	58.75	2N1522	11.95	SAV15 222	58.75
MRF174	80.00	2N3553	3.00	SAV17 144 500	66.50
MRF208	16.50	2N3771	3.50	M57713 144 LIN	49.50
MRF212	19.50	2N3866	1.25	M57726 144	59.95
MRF221	12.00	2N4048	11.95	M47727 144	69.50
MRF224	16.00	2N4427	1.25	M57729 440	69.95
MRF237	2.00	2N5109	1.75	M57732L	33.00
MRF238	16.00	2N5179	1.00	M57737 144	48.50
MRF239	17.00	2N5589	13.00	M57741L MH	57.00
MRF240, A	16.50	2N5591	14.50	M57745	89.95
MRF245	32.00	2N5641	16.00	M57755	78.75
MRF247	24.75	2N5642	16.50	M57762 1296	68.75
MRF248	35.00	2N5643	19.00	M57764 806	74.00
MRF260	10.00	2N5944	11.00	M57712, M57733 use	
MRF261	10.50	2N5945	10.00	M57737, SC1019 SAV7	
MRF262	10.50	2N5946	12.50	SC1021 use SAU4	
MRF264	12.50	2N6080	9.00	MHW710-1, 2, 3	61.00
MRF309	60.00	2N6081	11.00	MHW820-2	82.00
MRF314A	33.00	2N6082, 3, 4	14.75	SPECIAL TUBES	
MRF315A	32.50	2N6097	2.50	6CA7 EL34	13.95
MRF316	64.50	2N6254	2.50	6CL6	11.75
MRF317	63.00	25B754	4.50	6CK6	9.95
MRF327	62.00	25C730	4.50	6HF5 GE	14.95
MRF406	13.50	25C1307	4.75	6JB6 GE	15.95
MRF412	22.00	25C1729	16.25	6J5SC GE	15.95
MRF421	26.50	25C1945	5.75	6KD6 GE	18.95
MRF422	36.00	25C1946	18.75	6L6C	11.95
MRF427	17.00	25C1946A	16.75	6LF6 GE	16.95
MRF428	50.00	25C1947	9.75	6LQ6 6M J6	15.95
MRF429	39.00	25C1955	9.00	12B7A	11.75
MRF433	11.00	25C1957	1.00	572B T160L	69.95
MRF448	73.50	25C1969	2.50	Match Set2	149.75
MRF449	22.50	25C1971	4.50	Match Set4	299.50
MRF449A	18.25	25C2028	1.95	7581A KT66	16.95
MRF450	13.50	25C2029	2.50	811A	15.95
MRF450A	14.25	25C2075	1.75	Match Set2	37.90
MRF453	18.50	25C2094	18.50	Match Set4	75.80
MRF454	14.00	25C2097	28.00	813	44.75
MRF454A	17.00	25C2097MP	62.00	833A	89.75
MRF455	11.25	25C2099	29.50	833C	99.75
MRF455A	12.75	25C166C	2.00	845	58.90
MRF458	20.00	25C2221	8.25	M2057 GE	22.75
MRF475	6.75	25C2237	7.00	5894	44.95
MRF476	4.00	25C2284A	24.75	6146B	14.95
MRF477	14.75	25C2289	13.75	6550A	16.95
MRF479	13.75	25C2290	14.75	7581 KT66	16.95
MRF485MP	19.75	25C2290MP	39.50	8950	19.50
MRF492	14.75	25C2783	28.50	3-500Z	114.75
MRF497	18.75	25C3101	12.25	4CX250B	79.95
MRF515	2.50	25C2312C	4.75	4CX300A	142.25
MRF555	3.00	25C2379	31.25	4CX1000A	459.95
MRF557	5.25	25C2509	9.00	8877	599.50
MRF559	2.25	25C2539	19.75	EMAC TUBES	
MRF607	2.50	25C2559	28.25	8874	359.50
MRF629	3.25	25C2630	23.00	8875	399.95
MRF630	3.75	25C2640	15.00	3CX800A7	339.95
MRF641	20.50	25C2641	16.00	3CX1200A7	469.00
MRF644	23.00	25C2642	28.25	3CX1500A7	699.50
MRF646	26.00	25C2694	46.75	3CX3000A7	719.95
MRF648	31.00	25C2695	31.75	4CX250B	99.95
MRF660	13.25	25C2782	32.75	4CX350A	199.50
MRF643, F	21.00	25C2879	21.00	3-500Z	134.75
MRF646	37.75	25C2904	32.50	4-400C	159.95
MRF673	29.75	25C2905	34.50		
MRF1946	15.00	40582	9.50		

Prices Subject to Change Without Notice
MATCHED & SELECTED TUBE AND TRANSISTOR FINALS
IN STOCK FOR AMATEUR AND COMMERCIAL EQUIPMENT
 Orders received by 1 PM PST shipped UPS same day.
 Next day UPS delivery available - We Export
 No extra charge for C.O.D. (cash) or VISA/MC Orders
 Ship/Hand. 1 lb. U.S. or Foreign Sm Pkt Air 8 oz. \$5.00
 Minimum Order \$20 Quantity Pricing Available

ORDERS ONLY - (800) 854-1927 - NO TECHNICAL

ORDER LINE - INFORMATION - TECH HELP
(619) 744-0728

FAX 619-744-1943



RF PARTS

1320 Grand Avenue
 San Marcos, CA 92069

ADVERTISER'S INDEX AND READER SERVICE NUMBERS

Listed below are the page and reader service number for each advertiser in this issue. For more information on their products, select the appropriate reader service number make a check mark in the space provided. Mail this form to ham radio Reader Service, I.C.A., P.O. Box 2558, Woburn, MA 01801.

Name _____ Call _____
 Address _____
 City _____ State _____ Zip _____

*Please contact this advertiser directly.

Please use before June 30, 1990.

We'd like to see your company listed here too. Contact Martin Durham at 603-878-1441 or FAX 603-878-1951 to work out an advertising program tailored to suit your needs.

READER SERVICE #	PAGE #	READER SERVICE #	PAGE #
___ 161	- Ace Communications, Monitor Div.....	___ 133	- Roy Lewallen, W7EL.....
___ 132	- Ace Systems.....	___ 167	- Roy Lewallen, W7EL.....
___ 166	- Ace Systems.....	___ 139	- LTA Industries Inc.....
___ 175	- Advanced Receiver Research.....	___ 142	- M & N Electronics.....
___ 107	- AEA.....	___ 131	- Madison Electronics Supply.....
___ 150	- Aerospace.....	___ 106	- MFJ Enterprises.....
___ 170	- AIE Corporation.....	___ 137	- Mirage/KLM.....
___ 109	- Ailnco Electronics Inc.....	___ 181	- Missouri Radio Center.....
___ 151	- Alpha Delta Communications Inc.....	___ 145	- Monitoring Times.....
___ 156	- Alumna Tower Co.....	*	- Mosley Electronics Inc.....
*	- Amateur Television Quarterly.....	___ 114	- Naval Electronics.....
___ 160	- AMC Sales, Inc.....	___ 169	- NCG.....
___ 117	- American Antenna.....	*	- Nema Electronics.....
*	- Amidon Associates.....	___ 135	- Nuts & Volts.....
___ 168	- AMSAT.....	*	- Omega Electronics.....
___ 120	- The Antenna Specialists Company.....	___ 182	- OPTOelectronics.....
___ 124	- Antique Radio Classified.....	___ 113	- PC. Electronics.....
___ 112	- Astron Corp.....	___ 177	- Pac-Comm Packet Radio Systems, Inc.....
___ 141	- AVCOM.....	___ 172	- Palomar Engineers.....
*	- Barker & Williamson.....	___ 148	- Radiokit.....
*	- Barry Electronics.....	___ 180	- Radiokit.....
___ 149	- Bilal Company.....	___ 138	- Ramsey Electronics, Inc.....
*	- Brian Beezley, K6STI.....	___ 146	- The RF Connection.....
___ 110	- Buckmaster Publishing.....	*	- RF Parts.....
*	- Buckmaster Publishing.....	___ 163	- Rutland Arrays.....
___ 154	- Buckmaster Publishing.....	*	- Sherwood Engineering Inc.....
___ 179	- Buckmaster Publishing.....	___ 111	- SIGN ON.....
___ 171	- Buckmaster Publishing.....	___ 118	- Software Systems.....
___ 136	- C&S Sales.....	___ 164	- Software Systems.....
___ 176	- Communication Concepts, Inc.....	___ 144	- Spectrum International Inc.....
___ 104	- Communications Specialists.....	___ 140	- Stridsburg Engineering Co.....
___ 157	- Crystek Crystals.....	___ 122	- STV/OnSat.....
___ 108	- Cushcraft Corporation.....	___ 152	- SV Products.....
___ 155	- Cygnus-Quasar Books.....	___ 134	- Synthetic Textiles, Inc.....
*	- Digital Digest.....	___ 127	- TE Systems.....
___ 159	- Doppler Systems.....	___ 116	- Tel-Com.....
___ 125	- Doug Hall Electronics.....	*	- Universal Radio.....
___ 126	- Down East Microwave.....	___ 147	- Vanguard Labs.....
___ 129	- Electronic Engineering.....	___ 158	- VHF Communications.....
*	- Engineering Consulting.....	___ 123	- W & W Associates.....
___ 162	- Fair Radio Sales.....	*	- W5YI Marketing.....
___ 174	- GAP Antenna Products.....	___ 143	- Wilam Technology.....
___ 130	- Ham Radio Outlet.....	*	- Yaesu USA.....
*	- Ham Radio's Bookstore.....	___ 173	- ZCo Corporation.....
*	- HAM-COM 90.....		
___ 119	- Hamtronics, NY.....		
*	- Hamtronics, PA.....		
*	- ICM.....		
___ 103	- ICOM America, Inc.....		
___ 115	- ICOM America, Inc.....		
___ 121	- Internation Radio and Computers Inc.....		
___ 178	- Jan Crystals.....		
___ 153	- Jun's Electronics.....		
___ 105	- Kantronics.....		
___ 128	- KComm, The Ham Center.....		
*	- Kenwood USA Corporation.....		
		___ 307	- Alpha Delta Communications Inc.....
		___ 311	- Custom Antenna Systems.....
		___ 302	- Elenco Electronics Inc.....
		___ 310	- ERF Circuits.....
		___ 312	- Heights Tower Systems.....
		___ 303	- ICOM America Inc.....
		___ 305	- Rotating Tower Systems Inc.....
		___ 313	- Telex/Hy-Gain.....
		___ 335	- Wi-Comm Electronics Inc.....

PRODUCT REVIEW/NEW PRODUCT

OEI OPTOELECTRONICS

The only name in HANDI-COUNTERS

Check These Incredible Features
On The All New UTC3000

- **10Hz to 2.4GHz Range.**
Simply amazing!
- **10 Digit LCD Display.**
1Hz resolution to over 150 MHz direct.
Readable in bright sunlight.
- **RF Signal Strength Bargraph.**
16 Segment, Zero, & Full Scale adjustment.
SEE the input signal!
- **Super Sensitivity.** <1mV 10-200MHz,
<5mV to 2GHz for efficient antenna pickup.
- **6 Functions.** Frequency, Period, Ratio
Time Interval, Average, & Prescale.
- **Hold Button.**
"Locks in" your exact Measurement FAST!
- **Extruded Aluminum Enclosure.**
Designed to fit every hand.
- **Priced Right! Only \$375.**
Includes Nicads, AC Charger/Adapter.

Or Select Our Most Popular
HANDI-COUNTER, the model 2210
that set the standard in handheld
frequency counter technology!
Value Priced at only \$219.

Professionals and Hobbyists all over
the world have chosen OEI for 16
years! **Shouldn't YOU?**

HANDI-COUNTERS! ...Only from OEI!
Choose the model that fits your needs...
and your budget! **CALL NOW!**

UTC3000

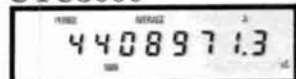

Period Average Mode



Display Showing All Annunciators

Model	UTC3000	2600H	2210	1300H/A	2400H	CCA	CCB
Function	Freq, Period Ratio, Interval, Avg, Prescale	Frequency	Frequency	Frequency	Frequency	Frequency	RF Indicator
Range	10Hz- 2.4GHz	10MHz- 2.4GHz	10Hz- 2.2GHz	1MHz- 1.3GHz	10MHz- 2.4GHz	10MHz- 550MHz	10MHz- 1.8GHz
Display	10 Digit LCD w/Function Annunciators	10 Digit LCD	8 Digit LED	8Digit LED	8 Digit LED	8 Digit LED	•
RF Signal Strength Indicator	16 Segment Adjustable Bargraph	16 Segment Adjustable Bargraph	•	•	•	LED with Adjustable Threshold	10 Segment Adjustable Bargraph
Price	\$375.	\$325.	\$219.	\$169.	\$189.	\$299.	\$99.

Sensitivity: <1 to <10mV typical. Time Base: ± 1 ppm.; ± 5 ppm, add \$75 - LED Models; ± 2 ppm add \$80 - LCD Models. Nicads & AC charger/adapter included. (9v Alkaline - CCB.) Carry Case, Antennas and Probes extra. One year parts & labor warranty on all products.



OEI OPTOELECTRONICS

5821 NE 14th Avenue • Ft. Lauderdale, FL 33334

**Toll Free Order Line:
1-800-327-5912**

FL(305)771-2050 • FAX(305)771-2052



Visa, MC, COD, Cash, M.O. accepted. Personal
Check allow 3 weeks. 5% Shipping, Handling,
(Maximum \$10) U.S. & Canada. 15% outside
continental U.S.A.

**ORDER
TOLL-FREE
1-800-821-7323**

**DEPENDABLE SERVICE
AT THE RIGHT PRICE . . . EVERYTIME**

MasterCard—VISA—Discover—COD

Missouri

RADIO CENTER

KENWOOD



TS-950SD

TRANSMIT THE ULTIMATE SIGNAL

- Digital Signal Processing
- Dual Frequency Receive
- Digital AF Filter • 100 Memories

**CALL FOR DETAILS AND
ORDER TODAY!**

YAESU



FT-1000

THE BEST OF THE BEST

- 200 Watts Output
- All Amateur Bands
- Dual Receive
- DDS-Direct Digital Synthesis

CALL FOR ALL THE DETAILS!

ICOM



IC-765 NEW HF TRANSCEIVER

- Built-in Automatic Antenna Tuner and Power Supply
- 99 Memories • 100 W Output
- 160-10M/General Coverage Receiver
- Band Stacking Registers

ALINCO



DR-570T

VHF/UHF TWIN BANDER

- 45W on 2M/35W on 70cm
- Receive on both Bands at Same Time
- Extended Receiver Range
- More Features for the Money Than Anyone Else

CALL TODAY!

KENWOOD



TS-140S AFFORDABLE DX-ing!

- HF Transceiver With General Coverage Receiver
- All HF Amateur Bands
- 100 W Output
- Compact, Lots of Features

YAESU



FT-736R VHF-UHF BASE STATION

- SSB, CW, FM on 2 Meters and 70 cm
- Optional 50 MHz, 220 MHz or 1.2 GHz
- 25 Watts Output on 2 Meters, 220 and 70 cm
- 10 Watts Output on 6 Meters and 1.2 GHz • 100 Memories

ICOM IC-725

NEW ULTRA-COMPACT HF TRANSCEIVER



- USB/LSB/CW, AM Receive
- Optional Module for AM Transmit and FM TX/RX
- 160-10M Operation • 100 W Output
- Receive 30 kHz to 33 MHz
- 26 Memories with Band Stacking Registers

AMERITRON



AL-80A AMPLIFIER

- Full Kilowatt Output
- 160-15 Meters
- 3-500 Z Tube for Maximum Life
- Precise and Easy Tuning
- Step-Start Inrush Protection™

SPECIAL SALE!

KENWOOD

TH-225A

HIGHER POWER 2 METER H.T.

- Now 5 Watts Output
- Odd Qff Sets
- Wideband Frequency Coverage
- Same Accessories as TH-215

CALL TODAY!

YAESU



FT-470

COMPACT DUAL BAND FM HANDHELD (2M/70CM)

- 21 Memories for Each Band
- Dual VFO's for Each Band
- Up to 5 Watts Power
- Built-in CTCSS
- Built-in 10-Memory DTMF Autodialer

ICOM IC-24AT

COMPACT DUAL BAND, FM

- 140-150 MHz; 440-450 MHz
- 5W Output
- Crossband Full Duplex
- 40 Double-Spaced Memories
- 4 DTMF Code Memories

CHECK OUT ALL THE FEATURES!

ASTRON



- RS7A . . . \$49
- RS12A . . . \$70
- RS20A . . . \$89
- RS20M . . . \$109
- VS20M . . . \$124
- RS35M . . . \$159
- VS35M . . . \$174
- RS50A . . . \$199
- RS 50M . . . \$219
- RM50M . . . \$259
- VS50M . . . \$232

uniden
HOT WINTER SPECIAL



HR-2600 10 Meter Mobile

\$229.95 Delivered

Great Deals On Scanners Too!
CALL

ASA



PK-232

MULTI-MODE TNC

- AMTOR, ASCII, Baudot, CW, FAX, NAVTEX, Packet
- PAKMAIL™ Mailbox With Third Party Traffic
- Two Radio Ports

THE ORIGINAL MULTI-MODE TNC

ICOM

2 Meter Sale

Your Favorite Mobiles At Tremendous Savings!

IC-228A, 25 watts

IC-228H, 45 watts

IC-28A, 25 watts

IC-28H, 45 watts

**DON'T WAIT—CALL TODAY
SAVE SAVE SAVE**

MFJ SALE MFJ

LARGEST STOCK OF ALL
YOUR MFJ FAVORITE
ACCESSORIES
CALL TODAY FOR
BEST PRICE



MFJ-1278

Multi-Mode Data Controller
CALL FOR EXTRA SAVINGS

102 N.W. Business Park Lane
Send SASE For Used List

Kansas City, MO 64150

Call Toll Free—9am - 6pm Mon.-Fri. 9am - 2pm Sat.
In Missouri Call—816-741-8118

WANTED: QUALITY USED GEAR, CASH OR TRADE

CUSHCRAFT • DIAMOND

HUSTLER • HYGAIN

ICOM • KANTRONICS • KENWOOD • MFJ • MIRAGE/KLM • RFOCONCEPTS • UNIDEN • YAESU

YAESU

Power ... and More!

FT-212RH

Frequency Synthesized VHF/UHF FM Transceiver

The compact, versatile FT-212RH is a 45 watt, 2 meter mobile that boasts a lot more than just high power. Inside its sturdy compact frame hides an impressive array of performance features plus high reliability...like 18 general purpose memories; one-touch call channel memory; two scanning range memories; CTCSS on any of the 37 standard tone frequencies may be programmed into any memory channel. Choice of standard, or optional, high performance tone encoding microphones. The FT-212RH and its 35 watt UHF counterpart, the FT-712RH are packed with state-of-the-art refinements... power and more!



- **Frequency Range:** 140-174 MHz on receive (144-148 MHz TX—Modifiable for MARS and CAP). Specifications guaranteed on amateur bands only.
- **Power Output:** 45 watts output with selectable 5 watt low power.
- **CTCSS:** Access any of the 37 standard CTCSS tone frequencies, plus 97.4 Hz can be displayed, selected and programmed into any memory for transmission.
- **19 Memories:** Each memory stores either programmable repeater shift or independent TX and RX frequencies.

- **Automatic Repeater Shift (ARS):** Enables selection of repeater transmitter offset automatically when tuned to a standard repeater subband.
- **Programmable Scanning:** Scans band, band segment or

memories. Scan auto-resume with carrier drop or after 5-second pause.

- **Tuning Steps:** Operator selectable steps in 5, 10, 12.5, 20 and 25 KHz increments.
- **CAT System Control:** Provides for external control of VFO frequency, mode and memory functions from operator's personal computer.
- **Amber Backlit LCD Display:** Automatically controls the brightness of the display backlighting and pilot lamps.
- **Tone Encoding Microphone:** Choice of standard, or optional high performance DTMF tone encoding microphones.
- **Digital Voice System (DVS-1):** Optional system which allows local and remote digital voice recording and playback.



FT-4700RH

Dual Band VHF/UHF Trunk Mountable FM Transceiver

- **Frequency Range:** 140-174 MHz on 2m (modifiable for MARS and CAP); 430-450 MHz on 70cm.
- **Power Output:** 50 watts on 2m; 40 watts on 70cm. Selectable 5 watts low power on both bands.
- **Full Duplex Cross Band Operation:**
- **Dual Receive:**
- **CTCSS Encode/Decode:**
- **Remote Control Kit Included:**
- **Amber Backlit LCD Display** and controls with dimmer switch.
- **20 Memories:**
- **Dual Antenna Ports:**
- **Programmable Scanning:**
- **MH-15C8 Mic** standard; **MH-15D8 Mic** optional.

For information on these and Yaesu's full line of products, call our literature desk toll-free at 1 (800) 999-2070.

YAESU
Performance without compromise.

KENWOOD

The Future is Here!



Kenwood — producing the finest Amateur Radio products for over three decades — introduces you to our world of affordable, high-quality, high performance products for today's active Radio Amateur. From HF to VHF, from base to mobile to HT, there's surely a Kenwood radio that will fit your needs and budget.

Being Number One means that we are committed to offer you the finest line of Amateur Radio products in the world. Take a look at the station equipment most winning contest and DXCC Honor Roll operators use. Read the Product Reviews. Compare our rigs against the rest. You'll see that we really are the best.

As the "pacesetter" in Amateur Radio, Kenwood continues to incorporate tomorrow's techniques and innovations into practical products today. Digital Signal Processing (DSP) in the TS-950SD is only one example. SSB Slope Tuning, the original "Dual Bander" concept, built-in antenna tuners for HF rigs, and many other techniques were all developed by Kenwood, and imitated by others. Leading edge technology, and superior field-proven performance — That's the Kenwood Experience!

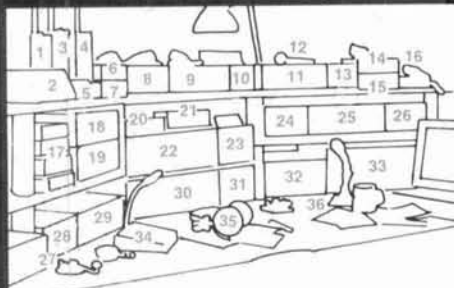

1) TH-26AT: Compact HT. 2) BC-11: Rapid Charger for TH-26AT. 3) TH-315A: 220 Deluxe HT. 4) TH-75A: Dual Band HT. 5) BC-10: Compact Charger. 6 & 7) TM-631A/731A: 144-220/144-450 MHz FM Dual Banders. 8) PS-50: Heavy Duty Power Supply. 9) TS-440S: HF Transceiver w/AT-440 (shown w/supplied MC-43S). 10) SP-430: External Speaker. 11) R-5000: High Performance Receiver. 12) HS-6: Small-size Headphones. 13) SP-430. 14) TM-2530A: Deluxe 2m, 25 W FM Transceiver (w/optional MC-48B mic.). 15) TM-3530A: Deluxe 220 MHz, 25 W FM Transceiver. 16) TM-701A: 144/450 MHz Compact Dual Bander Mobile Transceiver. 17) TM-231A/331A/431A/531A: 144, 220, 450, 1200 MHz Compact Mobile Transceivers. 18) TS-811A: 70 cm, 25 W and 19) TS-711A: 2m, 25 W, All Mode Base Station Transceivers. 20) PC-1A: Phone Patch (FCC part 68 Registered). 21) SW-2100: SWR/Power Meter. 22) TS-940S: Deluxe HF Transceiver w/AT-940 installed. 23) SP-940: Matching External Speaker. 24) SP-31: External Speaker. 25) TS-790A: All Mode Tri-band Satellite Transceiver. 26) PS-31: Matching Power Supply. 27) PS-430: Power Supply. 28) AT-250: External Automatic Antenna Tuner. 29) TS-680S: 160-6 m Multi-Bander. 30) TS-950SD: HF Transceiver w/DSP. 31) SP-950: Matching External Speaker. 32) SM-230: Deluxe Station Monitor. 33) TL-922A: HF Linear Amplifier. 34) MC-85: Multi-function Desk Mic. w/3 outputs and tone controls. 35) HS-6: Deluxe Headphones. 36) MC-60A: Base Station Mic.

KENWOOD U.S.A. CORPORATION
COMMUNICATIONS & TEST EQUIPMENT GROUP
P.O. BOX 22745, 2201 E. Dominguez Street
Long Beach, CA 90801-5745
KENWOOD ELECTRONICS CANADA INC.
P.O. BOX 1075, 959 Gana Court
Mississauga, Ontario, Canada L4T 4C2

KENWOOD

...pacesetter in Amateur Radio