

APRIL 1987 / \$2.50

ham radio

magazine

real coax



hr 

focus
on
communications
technology

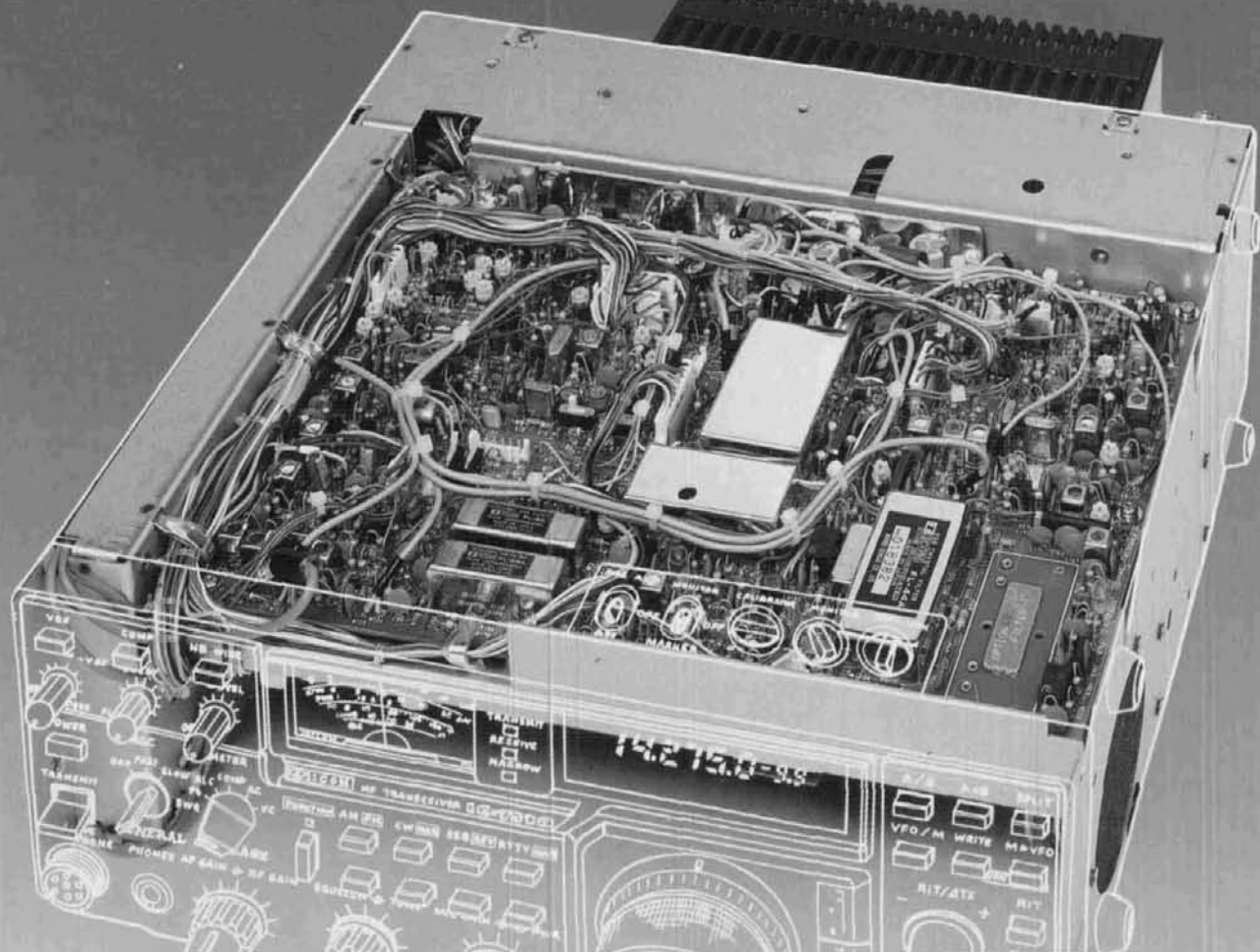

ICOM IC-751A

"IT'S WHAT'S INSIDE THAT COUNTS!"

- All HF Band Transceiver / General Coverage Receiver
- Advanced Circuit Designs
- All Modes Built-in USB, LSB, FM, AM, CW, RTTY
- Superb Frequency Stability
- Continuous Duty Operation
- Crystal Clear Signal Quality

Midsize Masterpiece! The deluxe IC-751A includes more high performance features and professional circuitry per cubic inch than any other HF transceiver. Its smooth-as-silk operation and long-term reliability produce the ideal contesting, DX'ing, mobiling and portable rig. Owning an IC-751A truly means "Going First Class!"

Unsurpassed Quality and Reliability. Quality and Reliability is important to you and it's important to ICOM. ICOM now covers you and your investment with its exclusive



one year warranty. There's more! The IC-751A's receiver boasts 105dB dynamic range for superb listening. The 100% duty cycle transmitter defies abuse and delivers 100 watts of exceptionally stable and clean RF output. Reliability. Quality. One year warranty. That's ICOM.

All Bands, All Modes Included. Operates 160 through 10 meters, it's easily modified for MARS operation, plus it includes general coverage reception from 100kHz to 30MHz. No compromise, no comparison!

32 Tunable Memories. Store both frequency and mode information. Use them to quick-access your favorite spots or as 32 preferred frequency-remembering VFOs.

A Modern Amateur's Delight! Special attractions include an electronic keyer, semi or full break-in rated to 40 WPM, panel selectable 500Hz/FL-32A CW filter, and volume control-tracking sidetone. SSB transmissions are enhanced with an RF speech processor and tone control to produce sparkling clear audio. PLUS there's a new rubberized tuning knob for velvet-smooth tuning and a full line of accessories and filters.

RF Power Control. Varies output independent of mic gain, ALC and speech processor action. Enjoy maximum "talk power" at any drive level!

To see the IC-751A, contact your local ICOM dealer.



ICOM

First in Communications

ICOM America, Inc., 2380-116th Ave NE, Bellevue, WA 98004 Customer Service Hotline (206) 454-7619
3150 Premier Drive, Suite 126, Irving, TX 75063 / 1777 Phoenix Parkway, Suite 201, Atlanta, GA 30349
ICOM CANADA, A Division of ICOM America, Inc., 3071 - #5 Road, Unit 9, Richmond, B.C. V6X 2T4 Canada

All stated specifications are approximate and subject to change without notice or obligation. All ICOM radios significantly exceed FCC regulations limiting spurious emissions. 751A187

Get It *All* Together With

K A M



Kantronics All Mode

KAM gives you CW, RTTY, ASCII, AMTOR, HF and VHF PACKET all together in one unit.

We combined the features of our UTU-XT and KPC-2 to give you the true all mode unit you've been asking for, the Kantronics All Mode (KAM™).

KAM features bargraph tuning and user programmable MARK and SPACE tones for RTTY and HF packet, as well as limiter/limiterless operation on HF for weak signal operation.

KAM's CW demodulator is also programmable for both center frequency and bandwidth.

KAM's RS-232/TTL terminal interfacing provides universal compatibility to all computers, including Commodores and PC compatibles.

If you're looking for increased sensitivity and the greatest amount of flexibility in an all mode unit, look to Kantronics. We've got it all together in the Kantronics All Mode.

Suggested Retail \$319.00

KAM's FEATURES

- Transmit and receive CW 6-99, RTTY/ASCII 45-300 baud, ARQ, FEC, SELFEC, Listen ARQ, VHF and HF Packet.
- HF and VHF radio ports.
- Command driven by your computer with over 100 software commands.
- User programmable baud rates for RTTY/ASCII—selectable in one-baud increments.
- User programmable MARK and SPACE tones on HF, you choose the tones.
- Selective RTTY Autostart operation.
- Separate CW demodulator filter with programmable center frequency and bandwidth.
- Separate CW keying relay for positive or negative keying.
- 12-pole programmable switched capacitance input filtering.
- Quartz synthesized AFSK or direct FSK operation.
- RS-232 or TTL level operation by jumper selection.
- 16K RAM (expandable to 32K), 256K EPROM, EEPROM for parameter storage.
- Compatible with any computer having an asynchronous serial I/O port.
- FCC Part 15 compliant.

NEW PROGRAM

EXTRA SPECIAL FEATURES

- ★ Simultaneous HF and VHF Packet connects & digipeating.
- ★ HF/VHF Gateway operation.

Kantronics

RF Data Communications Specialists

1202 E. 23 Street Lawrence, Kansas 66046 (913) 842-7745

KENWOOD

...pacesetter in Amateur radio

ALL NEW
FM mobile!

Here's One for You!

TM-221A/421A

2 m and 70 cm FM compact mobile transceivers

The all-new TM-221A and TM-421A FM transceivers represent the "New Generation" in Amateur radio equipment. The superior Kenwood GaAs FET front end receiver; reliable and clean RF amplifier circuits, and new features all add up to an outstanding value for mobile FM stations! The optional RC-10 handset/control unit is an exciting new accessory that will increase your mobile operating enjoyment!

- TM-221A provides 45 W. TM-421A is the first 35 W 70 cm mobile! Both models have adjustable 5 W low power.
- Selectable frequency steps for quick and easy QSY.

- TM-221A receives from 138-173.995 MHz. This includes the weather channels! Transmit range is 144-148 MHz. Modifiable for MARS and CAP operation. (MARS or CAP permit required.)
- The TM-421A covers 438-449.995 MHz. (Specifications guaranteed for Amateur band use only.)
- Built-in front panel selection of 38 CTCSS tones. TSU-5 programmable decoder optional.
- Simplified front panel controls makes operating a snap!
- 16 key DTMF hand mic., mic. hook, mounting bracket, and DC power cable included.
- Packet radio compatible!
- Kenwood non-volatile operating system. All functions remain intact even when lithium battery back-up fails. (Lithium cell memory back-up—est. life 5 yrs.)

- 14 full-function memory channels store frequency, repeater offset, sub-tone frequencies, and repeater reverse information. **Repeater offset on 2 m is automatically selected.** There are **two channels** for "odd split" operation.
- Programmable band scanning.
- Memory scan with memory channel lock-out.
- Super compact: approx. 1-1/2"Hx5-1/2"Wx7"D.
- New amber LCD display.
- Microphone test function on low power.
- High quality, top-mounted speaker
- Rugged die-cast chassis and heat sink.

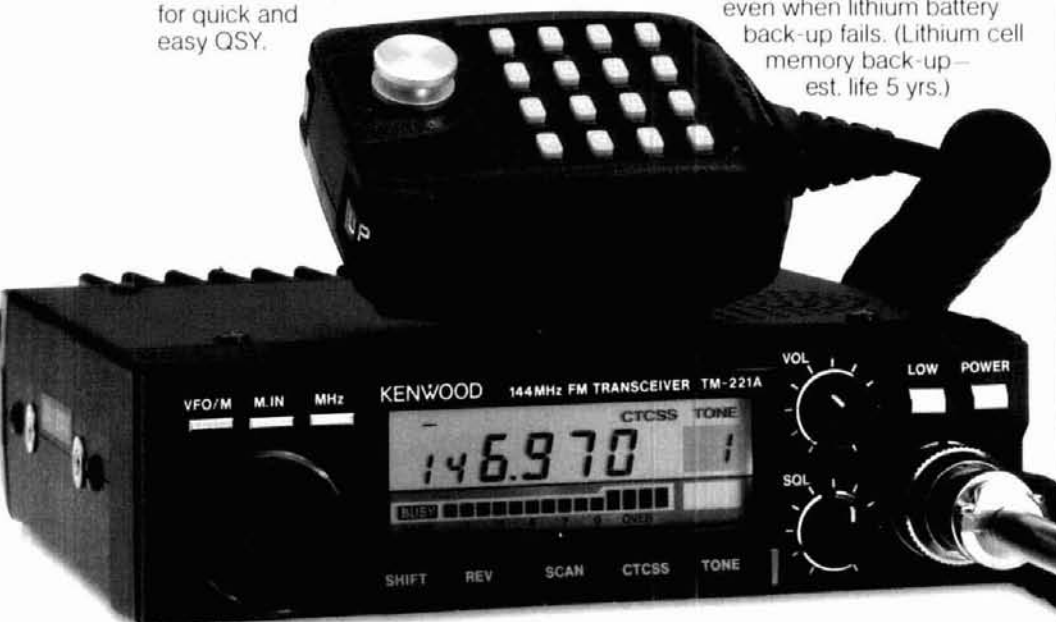

RC-10 Remote Controller

Optional telephone-style handset remote controller RC-10 is specially designed for mobile convenience and safety. All front panel controls (except DC power and RF output selection) are controllable from the RC-10. One RC-10 can be attached to **either or both** TM-221A and TM-421A with the optional PG-4G cable. When both transceivers are connected to the RC-10, **cross band, full duplex repeater** operation is possible. (A control operator is needed for repeater operation.)



Optional Accessories:

- RC-10 Multi-function handset remote controller
- PG-4G Extra control cable, allows TM-221A/TM-421A full duplex operation
- PS-50/PS-430 DC power supplies
- TSU-5 Programmable CTCSS decoder
- SW-100A Compact SWR/power/volt meter (1.8-150 MHz)
- SW-100B Compact SWR/power/volt meter (140-450 MHz)
- SW-200A SWR/power meter (1.8-150 MHz)
- SW-200B SWR/power meter (140-450 MHz)
- SWT-1 Compact 2 m

- antenna tuner (200 W PEP)
- SWT-2 Compact 70 cm antenna tuner (200 W PEP)
- SP-40 Compact mobile speaker
- SP-50B Mobile speaker
- PG-2N Extra DC cable
- PG-3B DC line noise filter
- MC-60A, MC-80, MC-85 Base station mics.
- MC-55 (8-pin) Mobile mic. with gooseneck and time-out timer
- MA-4000 Dual band antenna with duplexer (mount not supplied)
- MB-201 Extra mobile mount

Specifications and prices subject to change without notice or obligation
Complete service manuals are available for all The Kenwood transceivers and most accessories

KENWOOD

TRIO-KENWOOD COMMUNICATIONS
1111 West Walnut Street
Compton, California 90220

ham radio

magazine

APRIL 1987

volume 20, number 4

T. H. Tenney, Jr., W1NLB
publisher

Rich Rosen, K2RR
editor-in-chief
and associate publisher

Dorothy Rosa, KA1LBO
managing editor

Joseph J. Schroeder, W9JUV
Alfred Wilson, W6NIF
associate editors
Susan Shorrock
editorial production

editorial review board

Peter Bertini, K1ZJH
Forrest Gehrke, K2BT
Michael Gruchalla, P. E.
Bob Lewis, W2EBS
Mason Logan, K4MT
Vern Riportella, WA2LQQ
Ed Wetherhold, W3NQN

publishing staff

J. Craig Clark, Jr., N1ACH
assistant publisher

Rally Dennis, KA1JWF
director of advertising sales

Dorothy Sargent, KA1ZK
advertising production manager

Susan Shorrock
circulation manager

Therese Bourgault
circulation

Belden Wire and Cable
cover

ham radio magazine is published monthly by
Communications Technology, Inc.
Greenville, New Hampshire 03048-0498
Telephone: 603-878-1441

subscription rates

United States:

one year, \$22.95; two years, \$38.95; three years, \$49.95

Canada and other countries (via surface mail):

one year, \$31.00; two years, \$55.00; three years, \$74.00

Europe, Japan, Africa (via Air Forwarding Service): one year, \$37.00

All subscription orders payable in U.S. funds, via international
postal money order or check drawn on U.S. bank

international subscription agents: page 116

Microfilm copies are available from
University Microfilms, International
Ann Arbor, Michigan 48106
Order publication number 3076

Cassette tapes of selected articles from ham radio
are available to the blind and physically handicapped
from Recorded Periodicals,
919 Walnut Street, Philadelphia, Pennsylvania 19107

Copyright 1987 by Communications Technology, Inc.
Title registered at U.S. Patent Office

Second-class postage paid
at Greenville, New Hampshire 03048-0498
and at additional mailing offices
ISSN 0148-5989

Send change of address to ham radio
Greenville, New Hampshire 03048-0498

contents

8 real coax:
impedance and phase relationships
Forrest Gehrke, K2BT

19 simple modifications and adjustments
for the TS-930S
Marv Gonsior, W6FR

24 packet radio conference bridge
Bill Wade, WD5HJP

29 the TEXNET packet-switching
network
part 2: hardware design
Thomas H. Aschenbrenner, WB5PUC, and Thomas
C. McDermott, N5EG

47 practically speaking
grounding and shielding, part 1
Joe Carr, K4IPV

55 ham radio techniques:
Xingiang Province: the last frontier
Bill Orr, W6SAI

63 a three-tube 4CX250B linear amplifier
Dragoslav Dobricic, YU1AW

74 VHF/UHF world
33 cm: update
Joe Reisert, W1JR

89 understanding noise figure
Mike Gruchalla

118 advertisers index
and reader service
6 comments
97 DX forecaster
116 flea market

114 ham mart
102 new products
4 reflections
50 short circuits



**220 AT RISK —
ACT NOW**

comments close April 6.

REFLECTIONS
REFLECTIONS
REFLECTIONS

novice enhancement and the 220 MHz band: the FCC giveth...

Novices are back on phone — for the first time since the 1960s — as this issue of *ham radio* arrives in your mailbox. In its Report and Order of Novice Enhancement (effective March 21, 1987), the FCC expanded the Novice 10-meter allocation to 28.5 MHz and awarded new VHF/UHF allocations at 1-1/4 meters and 23 centimeters. Phone operation is now permitted on all three bands.

In brief, on 10 meters Novices (and Techs, who share Novice low band privileges) may now use digital (F1B) as well as CW from 28.1 to 28.3 MHz, plus CW and SSB from 28.3 to 28.5 MHz. The power limit remains 200 watts. On 1-1/4 meters, they're authorized all modes from 222.1 to 223.91 MHz, with a 25-watt power limit. On 23 centimeters, the Novice band is 1270-1295 MHz (all modes), but with only 5 watts.

There's one important limitation: while Novices will be permitted to *use* repeaters, they won't be permitted to be repeater control operators or trustees. Note: contrary to a widely circulated but erroneous interpretation of the new rules, Novices' signals may be repeated outside the Novice subbands, just as Techs' signals can be repeated on 10-meter cross-linked repeaters or through the satellites. This means that Novices will be able to communicate directly with higher class Amateurs on the other VHF/UHF bands through cross-linked repeaters.

They'll have to pass a more difficult exam, however. Instead of 20 questions, they'll face 30 — with the additional ten testing knowledge relevant to the new privileges.

So what's this going to mean for Amateur Radio? First, it means there are now 80,000+ Amateurs with phone and digital privileges on 10 meters and first-time access to all modes on VHF and UHF. Despite the diminished sunspot cycle activity, 10-meter operations should see a big boost. At its worst, 10 generally shows some life — and greatly increased activity on a "dead" band often confirms that its not really dead, but only lacking users! One-and-a-quarter meters should benefit at least as much as 10 — with equipment costs and performance about the same as 2 meters, and a well-established repeater system in place, this band could even become as busy as 2 meters! One unknown is just how well the newcomers will be received; the message is mixed on this, with some repeater groups already planning cross-band links to further expand Novice horizons, while others vow they'll install elaborate coding systems to keep Novices off their machines — or even shut their repeaters down entirely.

Twenty-three centimeters will also see some increase in activity, with good quality commercial equipment available from several suppliers. However, costs are high and activity low, so the effects here are not likely to be nearly as extensive.

What new Novice privileges will mean to the Amateur Radio service is yet to be determined. Though enhancement doesn't make the Novice a no-code entry-level license, it does radically augment its benefits by the addition of phone privileges. If this results in a big boost in newcomers, it may temper enthusiasm for a code-free license — perhaps the perceived problem with the Novice license hasn't been its requirement for 5 wpm code capability, but rather that its only former benefit was to permit the holder to work CW (and CW is *work* when you're new at it).

One thing enhancement seems sure to do is increase activity among present Novices, and that's good for Amateur Radio. The dropout level for Novices has always been unacceptably high, but the new phone privileges should substantially change that. Why? Because Novices will find both their investment (in new equipment) and return on that investment (fun) increasing to the point where they'll not only be unwilling to let their licenses expire, but will be stimulated to upgrade. All things considered, then, enhancement appears to be a big plus for Amateur Radio.

Before we become too euphoric, however, let's consider this:

...and the FCC taketh away!

Excitement over Novice enhancement was still growing — in fact, the news was still being spread — when the FCC dropped the other shoe . . . squarely on 220 MHz. In a Notice of Proposed Rule Making dated just two days after the Report and Order on Novice Enhancement, the Commission proposed reallocating 220-222 MHz to land mobile service use only!

As justification, the FCC cites "light loading" of the band in comparison to 2 meters, using ARRL's Repeater Directory listings as evidence. Even assuming this "evidence" is accurate (which it isn't, since the 220-MHz band supports many control links and a large, dynamic, and growing number of packet and other data communication users who've come to 220 MHz because 2 meters couldn't accommodate them), it's obvious the Commission's right hand doesn't know what its left is doing! You don't give 80,000 new users access to a finite band of frequencies, then cut that band by 40 percent! It's worth noting, at this point, that this proposal *did not* come from the FCC's Personal Radio Bureau, where Amateur Radio and our problems are well known and appreciated, but from the Office of Engineering and Technology, where they obviously aren't!

That's not to say this proposal wouldn't have made better sense 10 years ago. In fact, back then it might have even been to our advantage. Why? Because, along with taking 220-222 MHz away from Amateurs, the FCC is also proposing removing fixed and mobile service allocations from the 222-225 MHz segment and making that portion solely Amateur (though shared

(continued on page 50)

KENWOOD

...pacesetter in Amateur radio

NOW!
70 cm

All Mode Mobility!

TR-751A/851A

Compact all mode transceivers

It's the "New Sound" on the 2 meter band—Kenwood's TR-751A! Automatic mode selection, versatile scanning functions, illuminated multi-function LCD and status lights all contribute to the rig's ease-of-operation. All this and more in a compact package for VHF stations on-the-go!

• Automatic mode selection, plus LSB
144.0 144.1 144.5 145.8 146.0 148.0 MHz

CW	USB	FM	USB	FM
----	-----	----	-----	----

- Optional front panel-selectable 38-tone CTCSS encoder
- Frequency range 142-149 MHz (modifiable to cover 141-151 MHz)
- High performance receiver with GaAs FET front end
- VS-1 voice synthesizer option

- 25 watts high/5 watts adjustable low
- Programmable scanning—memory, band, or mode scan with "COM" channel and priority alert
- 10 memory channels for frequency, mode, CTCSS tone, offset. Two channels for odd splits.
- All mode squelch, noise blanker, and RIT
- Easy-to-read analog S & RF meter

- Dual digital VFOs
- Semi break-in CW with side tone
- MC-48 16-key DTMF hand microphone and microphone hook included
- Frequency lock, offset, reverse switches
- Digital Channel Link (DCL) option

Optional accessories:

- CD-10 call sign display
- PS-430, PS-30 DC power supplies
- SW-100A/B SWR/power meter
- SW-200A/B SWR/power meter
- SWT-1 2 m antenna tuner
- SWT-2 70 cm antenna tuner
- TU-7 38-tone CTCSS encoder
- MU-1 modem unit for DCL system
- VS-1 voice synthesizer
- MB-10 extra mobile mount
- SP-40, SP-50B mobile speakers
- PG-2N extra DC cable
- PG-3B DC line noise filter
- MC-60A, MC-80, MC-85 deluxe base station mics.
- MC-43S UP/DOWN mic.
- MC-55 (8-pin) mobile mic.
- MA-4000 dual band antenna with duplexer



Actual size front panel

TR-851A

70 cm SSB/CW/FM transceiver

The same winning features are yours on 70 cm with the TR-851A!

- Covers 430-439.999 MHz
- 25 W high power/5 W adjustable low
- MC-43S UP/DWN mic. and mic. hook included



KENWOOD

TRIO-KENWOOD COMMUNICATIONS
1111 West Walnut Street
Compton, California 90220

Complete service manuals are available for all Trio-Kenwood transceivers and most accessories. Specifications and prices are subject to change without notice or obligation. Specifications guaranteed for the 144-148 MHz Amateur band only.



comments

thoroughly debated by the membership.

**Dick Green, KA1LBW,
and Mike McAmis, WA3ECT**
Etna, New Hampshire 03750

a question of goals

Dear HR:

When we read about the [ARRL Board's approval in principle of a new Amateur Radio museum ("It Seems to Us," *QST*, October, 1986), we thought it was a nice idea.

Then we read an editorial by Craig Clark, N1ACH, in *ham radio* ("Reflections," October, 1986) and kicked ourselves for not thinking about this issue more carefully.

Craig pointed out, we think correctly, that the project will consume enormous amounts of time, energy, and money. In light of the Board's ambitious goals, set in 1984, to recruit new hams and ARRL members, it just doesn't make sense to divert our focus to an equally ambitious undertaking — one that probably will not increase the number of new licensees significantly.

We're all for keeping HQ and W1AW in good shape, but how many of us get a chance to visit Newington? Will a museum in Connecticut inspire non-hams across the nation to get a license? Wouldn't it be better to raise and spend \$2.7 million on recruiting new hams?

For that kind of money we could buy, stock, staff and operate several mobile displays which could present ham radio exhibitions and give license exams at schools, museums, fairs, clubs, and shopping centers throughout the country. Let's take Amateur Radio to the people instead of expecting them to come to us.

We urge all League members to read Craig's editorial and convey their feelings to their Division Directors immediately. This important issue should be

low-band operation

Dear HR:

K2RR's articles in the May and June issues ["Secrets of Successful Low-Band Operation," pages 16 and 17, respectively] prompt me to dash off a few lines on that subject.

Let me preface my remarks by setting the time frame and locations for my experiences on 80 and 40 meters. In the years 1956 through 1966, I was fortunate to operate from three locations in Europe and two in North Africa.

I will do my best to recall a few of the QSOs and without reference to the old log books, which are not now at hand.

October, 1958 saw me in North Africa on 40 meters (though on a few occasions, I did get down on 80 meters). One memorable QSO was with the late Jim Mills, ZL2BE. Jim ran several big rhombics, and knew that I could "borrow" some even bigger ones from the military. Well, to make a long story short, we had a QSO or two, using long path, short path, and probing the other paths as well. Hams at both ends of the circuit were somewhat amazed to hear us on what they considered a dead band. Needless to say, I have fond memories of QSOs like that, so many years ago. No one is more pleased than me to see the tremendous strides that have been made in the design of antennas and equipment in recent years.

Now, let me jump ahead to the 1960s and recount a few experiences on 80 meters. On 80, most any evening, I would be working other Europeans. We, of course, were in darkness, but the east coast of the U.S. was still in daylight. As the evening wore on, out of the noise would come the signal of, say, W1FRR (now

W1FC). Fred would say, "Hey, Warren, I've been calling you for an hour now. Didn't you hear me?" My retort: "No, Freddie, not a peep until just now."

One-way skip? Perhaps so, but how do you explain it? Was my signal going to the "F" layer, bouncing off the Atlantic in mid-path, then traveling in the "E" layer and then down to Fred? Theory has it that since my "E" layer had dissipated, and Fred's had not, the early evening path employed both "F" and "E" layer from east to west, or dark to daylight.

Now, let's see what we can do to explain the bending, or azimuthal divergence of radio signals. With the advent of large, directive arrays on the ham bands, Amateurs are experiencing what the commercial stations knew decades ago. Let me give you an example: a commercial point-to-point station in Slough, England, ran daily traffic with a similar station in Capetown, South Africa. The path between them was normally North-South, as you would expect. But on some occasions, both stations would have to slew their antenna arrays to a point off South America. I don't recall when this situation was first observed, nor do I remember when I read about it, but suffice it to say that it was not in recent times. By the way, this effect has occurred on numerous occasions over the past several years.

How do you explain this bending thing? Well, far more knowledgeable persons than I have explained it this way: *bending can take place when the layer is spherically stratified*. What makes this bending different from backscatter or side-scatter is that the signal is not diluted or fragmented, as it may be in a scattered signal.

I have many other thoughts on low-band DXing, but will save those for another time.

Kudos on your fine magazine and the folks who make it all happen.

Warren Lufkin, W0SII
Cheyenne, Wyoming 82001

KENWOOD

...pacesetter in Amateur radio

YES!
220 MHz

220: Kenwood Style!

TM-3530A

The first comprehensive
220 MHz FM transceiver

TM-3530A—25 watts of 220 MHz FM—Kenwood style! Features include built-in 7-digit telephone number memory, auto dialer, direct frequency entry and big LCD. All this makes the TM-3530A the most sophisticated rig on 220 MHz!

- **First** mobile transceiver with telephone number memory and auto-dialer (up to 15 seven-digit telephone numbers)
- Frequency range 220-225 MHz
- Automatic repeater offset selection—**a Kenwood exclusive!**
- Direct keyboard entry of frequency
- 23-channel memory for offset, frequency and sub-tone



- Big multi-color LCD and back-lit controls for excellent visibility
- Optional front panel programmable 38-tone CTCSS encoder **includes 97.4 Hz**

- Frequency lock switch
- Digital Channel Link (DCL) option
- High performance GaAs FET front end receiver

TH-31BT/31A

Kenwood's advanced technology brings you a new standard in pocket/handheld transceivers!

- 1 watt high, 150 mW low
- Super compact and lightweight (about 8 oz. with PB-21!)
- Frequency range 220-224.995 MHz in 5-kHz steps
- BT Series has built-in tone
- Repeater offset: -1.6 MHz, reverse, simplex
- **Supplied accessories:** rubber flex antenna, earphone, wall charger, 180 mAh NiCd battery and wrist strap
- Quick change, locking battery case

TH-31BT/31A optional accessories:

- **HMC-1** headset with VOX
- **SMC-30** speaker microphone
- **PB-21** NiCd 180 mAh battery
- **PB-21H** NiCd 500 mAh battery
- **DC-21** DC-DC converter for mobile use
- **BT-2** manganese/alkaline battery case
- **EB-2** external C manganese/alkaline battery case
- **SC-8/8T** soft cases with belt hook
- **TU-6** programmable sub-tone unit
- **AJ-3** thread-loc to BNC female adapter
- **BC-6** 2-pack quick charger
- **BC-2** wall charger for PB-21H
- **RA-9A** StubbyDuk antenna
- **BH-3** belt hook

- 16-key DTMF pad, with audible monitor
- Center-stop tuning—**another Kenwood exclusive!**
- **New** 5-way adjustable mounting system
- **Unique** offset microphone connector—relieves stress on microphone cord
- HI/LOW power switch (adjustable LOW power)



TH-31BT with DTMF pad shown.
Optional RA-9A attached.



TM-3530A optional accessories:

- **TU-7** 38-tone CTCSS encoder
- **MU-1** DCL modem unit
- **VS-1** voice synthesizer
- **PG-2N** extra DC cable
- **PG-3B** DC line noise filter
- **MB-10** extra mobile bracket
- **CD-10** call sign display
- **PS-430** DC power supply
- **MC-60A/MC-80/MC-85** desk mics.
- **MC-48B** extra DTMF mic. with UP/DOWN switch
- **MC-43S** UP/DOWN mic.
- **MC-55** (8 pin) mobile mic. with time-out timer
- **SP-40** compact mobile speaker
- **SP-50B** mobile speaker
- **SW-200B** SWR/power meter
- **SW-100B** compact SWR/power meter

KENWOOD

TRIO-KENWOOD COMMUNICATIONS
1111 West Walnut Street
Compton, California 90220

Complete service manuals are available for all Trio-Kenwood transceivers and most accessories.
Specifications and prices are subject to change without notice or obligation.

real coax: impedance and phase relationships

The device between
the transmitter and antenna
deserves better treatment

K2BT, author of the definitive series on phased verticals¹, examines in his own precise manner the extremely important and often neglected component that gets your signal from here to there. — Ed.

We all know that when using coaxial cable at radio frequencies, it may have a significant loss which must be considered. It's quite clear that a cable having a loss of 3 dB/100 feet at 30 MHz will deliver only half the available power to the antenna if we need to use 100 feet. But how many of us are aware that there's a further loss if the load is mismatched to the line? Or that a lossy coax can make a badly matched antenna look good in the shack? In fact, it's possible for a quite low-loss cable, if long enough, to indicate a 1:1 SWR at its input even though the output is open-circuited! And though coax losses at lower frequencies ordinarily can be neglected, as the SWR goes much above 5:1 we still can sustain a non-trivial loss and a different input impedance than we might have expected due to the high mismatch. (Incidentally, additional loss due to load mismatch can occur with any lossy circuit, not just coax.)

Those of you who've seen graphs of additional loss attributable to SWR may have wondered, as I did, just how this loss was calculated. These effects may be appreciated in a general way, but we might be hard pressed to attach numbers to some of these situations. The mathematical formulations dealing with this subject, strewn with Greek letters and unfamiliar trigonometric symbols, give the appearance of such formidability that we are dissuaded from looking any

further. And so we often approach the problem "assuming the lossless case...", knowing this is not reality but hoping we haven't missed it by much.

The purpose of this article is to help with such assessments and to place some of the calculations into a simplified and standardized format for ease of programming computers and calculators.

common approach: interpolation

Trying to assign loss at a given frequency when the ratings are given at other frequencies is the first problem we encounter. Most cable manufacturers publish loss figures at various frequencies — for example: 1, 10, 50, 100 MHz and so on, which are called attenuation constants and defined as the loss in decibels per 100 feet with a matched load. But if the operating frequency is 21 MHz, what now? We can "eyeball" interpolate, but it turns out we can do it to a high degree of precision using the manufacturer's ratings.

definitions

Before proceeding, we must come to some general understanding:

1. A transmission line is a uniform system consisting of two parallel conductors. "Uniform" means that the materials and geometry of the line and its surrounding medium remain constant throughout the length of the line. This applies whether the line is parallel wire, coaxial, stripline, or other configuration. This understanding about uniformity also applies to the electrical circuit coefficients that result from the materials chosen for this line.

2. The currents in the line conductors flow only in the direction of the line. It may seem redundant to state this in discussing distributed circuit transmission lines. However, under certain conditions some or all of the current may propagate around the conductors

Forrest Gehrke, K2BT, 75 Crestview Road,
Mountain Lakes, New Jersey 07046

instead of along them. Such transmissions are known as "waveguide modes" and are not explainable by distributed circuit theory. For lines with conductor separations that do not exceed a few inches, these waveguide modes are not supported except at frequencies in the very high GHz range. However, although these modes do not propagate any appreciable distance at the frequencies we are interested in, they are excited by any discontinuities in the line, whether caused by too sharp twists or bends or abrupt physical terminations of the line. These excitations die out quickly from their point of origin, traveling a distance no greater than a few times the conductor separation of the line. However, they are responsible for anomalous behavior that occurs in the vicinity of such discontinuities.

For now, so that "discontinuities" are not simply read as being only characteristic impedance variations, it should be clearly understood these are *physical* discontinuities. For example, the junction of an RG-8 line with an RG-174 line (two lines with the same characteristic impedance but very different physical dimensions) is such a discontinuity.

3. The frequency range of interest is generally 1 MHz to 1 GHz, a range more than sufficient for most Amateur Radio interest. Although coaxial transmission lines are used above and below this range, the equations presented in this article must be used with more knowledge about certain specific characteristics of the line. For example, as the frequency is reduced below 2 MHz, the characteristic impedance of the coax will have an increasingly significant reactive component. This may not be a show-stopper, but including that component in calculations will improve accuracy. As frequency is progressively lowered (less than 100 kHz), not only will we see a more reactive characteristic impedance, but the resistive component will rise — slowly at first — and then more rapidly. As we go above 1 GHz, losses at some point may rise disproportionately and unpredictably because of various problems such as insufficient braid coverage in flexible line allowing power loss by radiation. Waveguide mode anomalies — for example, those due to distortions caused by having been bent around too small a radius — also become more troublesome at these frequencies because the excited modes are operating over what are now larger fractions of wavelengths.

4. All discussion and equations assume steady-state conditions and no active elements.

ABCD network parameters

In a previous article discussing design of drive networks for phased vertical arrays,¹ I presented material on the ABCD network matrix parameters. ABCD matrix algebra was devised for the purpose of simplifying calculations of input/output impedances, current,

and voltage for four-terminal networks and for facilitating cascaded calculations when chaining networks. The parameters are defined in such a manner that whether a passive network is a length of coax, a Pi or T circuit, or anything else, so long as the parameters are identical — regardless of the differences in individual components or hookup — the input/output relationships are unchanged at the frequency for which the parameters are identical. For the purposes of the referenced article, I felt the subject of dealing with real coax to be an undue digression even though definitely related, particularly for phased arrays at higher frequencies, or even at lower frequencies when driving an element through an excessively mismatched line. Indeed, it is to fill in that gap that this article was written.

For the lossless case, the ABCD matrix parameters for a length of coax are:

$$\begin{matrix} A & \begin{bmatrix} \cos \theta & j Z_0 \sin \theta \\ j(\sin \theta)/Z_0 & \cos \theta \end{bmatrix} & B \\ C & & D \end{matrix}$$

θ = Electrical length (degrees or radians)
 Z_0 = Characteristic impedance

In order to account for loss, these parameters must be defined differently. We arrive at them and can go back to the lossless case simply by substituting zero for the loss terms.

$$\begin{matrix} A & \begin{bmatrix} \cosh \Gamma \ell & Z_0 \sinh \Gamma \ell \\ (\sinh \Gamma \ell)/Z_0 & \cosh \Gamma \ell \end{bmatrix} & B \\ C & & D \end{matrix}$$

Γ = $(\alpha + j\beta)$ Propagation constant
 ℓ = Physical length
 Z_0 = Characteristic impedance

At first glance this matrix looks much the same, but there are important differences: the familiar circular functions (sin, cos) are replaced with hyperbolic functions (sinh, cosh), and a term called the "propagation constant" appears for the angle. The propagation constant combines loss and length in the form of complex numbers.

propagation constant

Engineers refer to many of the coefficients involving transmission lines as "constants," a term not well chosen considering the inconstancy of some of them as frequency is changed. The propagation constant consists of two coefficients, the real term α , called the attenuation factor, and the complex imaginary term β , the phase factor. Both are unit factors — that is, they refer to a value per unit length. The calculation for any particular section of line implies a specific length; if the terms of the propagation constant are multiplied by the length in consistent units, whether length is in meters or feet will not matter because the result is total loss and total angle for that length of line. Angular units may be degrees or radians, consistent with the trigonometric functions being used, but the unit of loss must be in nepers.

attenuation factor α

American coaxial cable manufacturers typically use the decibel as the unit of attenuation, usually rating a cable in terms of decibel loss per 100 feet. We'll need to convert these loss figures into nepers. Both the neper and the decibel are logarithmic functions of the ratio of power flowing at two points in a circuit. Their mathematical definitions are:

$$\text{Decibel} = 10 \log_{10} (P1/P2) \quad (1A)$$

$$\text{Neper} = 0.5 \log_e (P1/P2) \quad (1B)$$

The decibel is based on decimal logarithms while the neper uses the natural or Napierian base, 2.71828... which is usually written as e . Appropriately, neper is a Latinized spelling of Napier, in honor of the Scottish mathematician who invented logarithms. The neper is by far the larger unit; for example, a 2:1 ratio of power is expressed as 3.0 decibels but only 0.35 neper. More precise conversion factors are:

$$1 \text{ neper} = 8.686 \text{ decibels}$$

$$1 \text{ decibel} = 0.1151 \text{ neper}$$

Even the decibel is usually too large to be used "per foot" for coax. Consequently, attenuation is quoted in decibels per 100 feet.

Rated loss figures for transmission lines are given in large MHz intervals (1, 10, 50, 100, and so on), which brings us back to the question of an accurate interpolation method for frequencies between them. We can produce an empirical interpolation by taking advantage of the known loss versus frequency characteristics of cable materials. Over the frequency range of interest there are two major loss contributions: loss in the conductors and loss in the dielectric material. We can say then that the total loss is equal to these two components:

$$\alpha_T = \alpha_C + \alpha_D \quad (2)$$

From various references we learn that the loss of round copper wire due to skin effect varies as the square root of the frequency. For any given cable this can be stated as:

$$\alpha_C = m \sqrt{f} \quad (3)$$

where m is a constant for any given cable type. The dielectric loss is found to vary directly with frequency:

$$\alpha_D = nf \quad (4)$$

where n is a constant for a given cable depending on the insulation used, its thickness, and so on. For a first approximation and to the degree that the constants m and n remain independent of frequency:

$$\alpha_T = m \sqrt{f} + nf \quad (5)$$

Using the rated loss α_{T1} and α_{T2} at two frequencies f_1

and f_2 for any given cable and these identities for the loss components, two simultaneous equations can be written. Substituting and solving for m in one equation and then back-substituting to solve for n we get:

$$m = \frac{\alpha_{T1} \cdot f_2 - \alpha_{T2} \cdot f_1}{f_2 \cdot \sqrt{f_1} - f_1 \cdot \sqrt{f_2}} \quad (6)$$

and

$$n = \frac{\alpha_{T2} - m \cdot \sqrt{f_1}}{f_1} \quad (7)$$

Let's test this interpolation method with a real example where we know in advance the result we should expect:

Amphenol rated RG-58/A coax:

0.44 dB/100 feet loss at 1.0 MHz

1.4 dB/100 feet loss at 10.0 MHz

3.3 dB/100 feet loss at 50.0 MHz

Using the loss values for 1.0 MHz and 50.0 MHz and solving for the two constants m and n in eqns. 6 and 7 specific to RG-58/A coax between these frequencies:

$$m = 0.435604 \text{ and } n = 0.004396$$

Let's see how well we can predict the manufacturer's rating at 10 MHz using these constants in eqn. 5:

$$\alpha_T = 0.435604 \cdot \sqrt{10} + 0.004396 \cdot 10 = 1.42 \text{ dB loss/100 ft.}$$

The manufacturer gave his ratings to two-digit accuracy; we can say we came tolerably close. This interpolation method is quite accurate over the span of frequencies 1 MHz to 1 GHz when using a 10:1 range of rated frequencies. For many applications, even larger ranges are acceptable, as the 50:1 ratio of this example shows. A word of caution: the constants for m and n shown above apply only to RG-58/A. Don't try to use the same values for m and n with another cable type unless the loss ratings are identical.

phase factor β

Technically the phase factor is defined in angular units per unit length, radians per meter in the MKS system. Multiplying this value by the total line length would give us the angular electrical length. Since frequency modifies this factor, a value independent of frequency has been found more useful. Furthermore, just as with attenuation, our concern is the line total. This more practical ratio is the velocity factor, vf , usually given as a decimal fraction or a percentage.² For our purpose it obviates the need to know β , but gives us the means to derive it if required. Velocity factor is a ratio of the propagation speed of electromagnetic waves through the line as compared to its speed in a vacuum. This latter velocity is the same as the speed of light, designated c , and is equal to 299.8×10^6 meters (983.5×10^6 feet) per second. If we divide either of these values by frequency in Hz,

we obtain the free space full wavelength, respectively, in meters or feet. Multiplying this length by the velocity factor of the line, one obtains the full-wave *electrical* length. Since there are 360 degrees or 2π radians in a full wave, we can also state this length in angular units.

A source of much confusion to many Amateurs — all the more confusing when electronics professionals sometimes thoughtlessly equate them — is the difference between angular electrical length and angular current or voltage phase change. Not helping matters are the descriptive terms used — for example, “delay line,” referring to a phasing line, with “delay” implying a time-related factor. There are applications in which a propagation time delay is truly meant (radar, for instance), but usually we mean relative phase change, which is *not* time related. (If it were, we’d never be able to advance it!) On the other hand, electrical length *always* refers to time; it is determined by the time required for a particular frequency wave to travel through a medium. For any line, *phase difference* can be varied by changing the termination impedance, but propagation time is invariant, being related only to the velocity of electromagnetic waves in the medium.

As we have seen, propagation time can be defined in several ways, all referring to velocity. The most obvious, time itself, is not easily measured directly. The more commonly used measuring sticks are wavelength and angle. Frequency, velocity, and time are directly and unchangeably related for any medium; when a piece of transmission line is said to be a quarter-wavelength long, this means the propagation time is 1/4 of the time required to travel a complete wavelength at a particular frequency. Since frequency is involved and there are 360 degrees in a complete wave cycle, we can also state it as the number of degrees represented by the time interval. But never confuse this angular representation of propagation time with the current or voltage phase angle difference that may exist between the input and output of this line; they have quite different meanings. It’s true that if we match a line with its characteristic impedance, its angular electrical length will be the same as the phase difference, but keep in mind how that coincidence is brought about. Antenna elements seldom meet that requirement without help; your chances of a coincidence is little better than your chance of being hit by a meteor.

Phase change is the angular difference in the voltage or current cycle measured between two points in a circuit under steady-state conditions. Furthermore, in most instances we are concerned with *relative*, not absolute phase change. Note the word “circuit”; phase change may occur in any circuit and can be made positive as well as negative in certain circuits.

An apt analogy for explaining the difference between angular phase change and angular propagation time is the count of the number of cars of a train between two markers along a railway. At the steady-state condition (a continuous line of cars between markers) only car length, not the speed of the train, would influence the count. Conversely, the time required for a particular car to pass by both markers — the propagation time — owes nothing to the count of cars between markers, only to velocity.

If propagation time has nothing to do with phase difference, then why so carefully measure the length of these “delay” lines? This stems from a need for a specific current or voltage phase difference. In my railway analogy, suppose a particular car count is wanted between markers. If the length per unit (degree, radian, or railroad car) can be controlled, then the total count can be predetermined. If 90 degrees is the phase difference desired and the termination impedance is made a pure *resistance*, then a quarter-wave line — that is, a 90-degree line, will produce the required phase change. The impedance qualification is absolutely essential, because the nature of the termination predetermines, or controls, the phase change. If the load isn’t a pure resistance, the phase change won’t be 90 degrees and all the care going into measuring the length of this line will be as useful as rearranging the deck chairs on the Titanic. For emphasis, let’s put this another way: it’s entirely possible, with certain termination impedances, for a 70-degree electrical length line to have a 90-degree phase difference in current.

solving complex hyperbolic functions

There are two approaches to solving complex hyperbolic functions: expansion of the complex hyperbolic function into functions of real circular and real hyperbolic angles, and direct evaluation of the complex exponents of ϵ . The first method is useful where real hyperbolic functions are available in calculators or computer programs or from textbook tables.

Expansion method.

$$\cosh(\alpha + j\beta)l = \cosh \alpha l \cdot \cos \beta l + j \sinh \alpha l \cdot \sin \beta l \quad (8)$$

$$\sinh(\alpha + j\beta)l = \sinh \alpha l \cdot \cos \beta l + j \cosh \alpha l \cdot \sin \beta l \quad (9)$$

These relationships expand the complex hyperbolic functions into functions of real circular and real hyperbolic angles. For every term in the expansion, including the j terms, the real function values may now be substituted. Compared to direct evaluation, which follows, this method offers simplicity of calculation, provided real hyperbolic function values are available. (You C language aficionados finally may have found a use for your hyperbolic functions, which are a standard component of most C compiler math libraries.)

From these expansions, we can get the terms for the lossless case for coax calculations. If α is zero, then the real hyperbolic sines equal zero and the hyperbolic cosines equal one resulting in:

$$\cosh(\alpha + j\beta)l = \cos \beta l \quad (10)$$

$$\sinh(\alpha + j\beta)l = j \sin \beta l \quad (11)$$

This means that the lossless case need not be provided as a separate calculation in a program. If the loss is entered as zero, a program using hyperbolic functions will carry out the calculations correctly. The angular units for these calculations had best be radians. Besides, published tables and computer functions for real hyperbolic always use radians for angular units. Loss must be in nepers.

Direct evaluation. For most of us the method using complex exponents of e (the Napierian base 2.71828...) offers the better solution because it requires access only to real circular functions:

$$\cosh(\alpha + j\beta)l = \frac{e^{(\alpha + j\beta)l} + e^{-(\alpha + j\beta)l}}{2} \quad (12)$$

and

$$\sinh(\alpha + j\beta)l = \frac{e^{(\alpha + j\beta)l} - e^{-(\alpha + j\beta)l}}{2} \quad (13)$$

It can be shown that:

$$e^{\alpha l} \cdot e^{j\beta l} = e^{\alpha l} \cdot (\cos \beta l + j \sin \beta l) \quad (14)$$

and

$$\frac{1}{(e^{\alpha l} \cdot e^{j\beta l})} = \frac{1}{[e^{\alpha l} \cdot (\cos \beta l + j \sin \beta l)]} \quad (15)$$

Note that eqns. 14 and 15 are the rectangular equivalent of the polar vector representation:

$$e^{\alpha l} \angle \beta l$$

and

$$e^{-\alpha l} \angle -\beta l$$

Either eqns. 14 and 15 or eqns. 16 and 17 may be used. Since many scientific calculators have polar/rectangular conversions, eqns. 16 and 17 would be a good choice. The problem is now reduced to one that can be handled by calculators or computers with real circular functions (phase may be in degrees if this suits the purpose). Loss must still be in nepers.

At line 140 of the complex hyperbolic functions, note the statement $S = 10^{(S/20)}$. This is the decibel-to-neper conversion. It avoids the use of the irrational number e . Instead, it is stated as a fractional exponent of 10. Because this equality may not be immediately obvious, here is its explanation:

As stated previously:

$$\text{dB} = 0.1151 \text{ neper} = \log_e \sqrt{P1/P2}$$

$$\text{or } e^{0.1151 \text{ dB}} = \sqrt{P1/P2}$$

$$\text{and dB} = 10 \log_{10} P1/P2$$

$$\text{or } 10^{\frac{\text{dB}}{10}} = \sqrt{P1/P2}$$

Taking the square root of both sides of this equation:

$$10^{\frac{\text{dB}}{20}} = \sqrt{P1/P2}$$

therefore

$$10^{\frac{\text{dB}}{20}} = e^{0.1151 \text{ dB}}$$

Put it down to the fact I don't like having to remember and type irrational numbers or odd fractional conversion factors. (Another of my favorites is $PI = 4 \cdot ATN(1)$. Let the computer remember PI , and to as many places as it can muster!)

example explains

I've always found that when learning a new calculation procedure, nothing breeds confidence like being able to duplicate the results of a step-by-step example calculation. I've therefore chosen an example which highlights some of the surprising things that can happen with real coax and a high mismatch.

The frequency is 14 MHz, using RG-58/A 50-ohm coax. The load is $10 - j10$. The electrical length is 2 wavelengths (4π radians or 720 degrees); since the velocity factor is 0.66, the physical length is 92.74 feet. The load current will be assumed to be $1 + j0$ amperes. Using the interpolation equations and the rated loss at 10 and 50 MHz, the loss at 14 MHz is 1.67 dB/100 ft. For our line length, the loss is 1.55 dB or 0.178 neper.

$$\text{COSH}(0.178 + j4 \cdot \pi) = 1.0159 + j0$$

$$\text{SINH}(0.178 + j4 \cdot \pi) = 0.1794 + j0$$

The ABCD matrix parameters:

$$A = 1.0159 + j0$$

$$B = 8.9612 + j0$$

$$C = 0.0035 + j0$$

$$D = 1.0159 + j0$$

Network calculations:

$$AZ_L + B = 19.1206 - j 10.1593$$

$$CZ_L + D = 1.0517 - j 0.0358$$

$$Z_{IN} = (AZ_L + B)/(CZ_L + D) = 18.490 - j 9.029$$

$$E_{IN} = I_L \cdot (AZ_L + B) = 21.652 \angle -27.983 \text{ (degrees)}$$

$$I_{IN} = I_L \cdot (CZ_L + D) = 1.052 \angle -1.952 \text{ (degrees)}$$

VSWR at load: 5.2:1

VSWR at input: 2.8:1

Total power into coax: 20.47 watts

Power dissipated in load: 10.00 watts

Total loss: -3.11 dB 10.47 watts

Normal loss: -1.55 dB 4.28 watts

SWR loss: -1.56 dB 6.19 watts

Efficiency: 48.8 percent

The first thing to notice is how this relatively small loss of 1.55 dB has given the VSWR as measured at the input of the line an optimistic look. The high

MFJ TUNERS

This may be the world's most popular 3 KW roller inductor tuner because it's small, compact, reliable, matches virtually everything and gives you SWR/Wattmeter, antenna switch, dummy load and balun — all at a great price!

Meet "Versa Tuner V". It has all the features you asked for, including the new smaller size to match new smaller rigs—only 10 3/4" W x 4 1/2" H x 14 7/8" D.

Matches coax, balanced lines, random wires—1.8 to 30 MHz. 3 KW PEP—the power rating you won't outgrow (250pf-6KV caps).

Roller inductor with a 3-digit turns counter plus a spinner knob for precise inductance control to get that SWR down to minimum every time.

Built-in 300 watt, 50 ohm dummy load, built-in 4:1 ferrite balun.



MFJ989B **\$349.95**

Lighted Cross-needle Meter reads SWR, forward and reflected power all in one glance. Has 300 and 3,000 watt ranges. Meter light requires 12 VDC.

6 position antenna switch (2 coax lines, through tuner or direct, random/balanced line or dummy load). SO-239 connectors, ceramic feed-throughs, binding post grounds.

Deluxe aluminum low-profile cabinet with sub-chassis for RFI protection, black finish, black front panel with raised letters, tilt bail.

MFJ's Fastest Selling TUNER

MFJ-941D **\$99.95**



MFJ's fastest selling tuner packs in plenty of new features. New styling! Brushed aluminum front. All metal cabinet. New SWR/Wattmeter! More accurate. Switch selectable 300/30 watt ranges. Read forward/reflected power.

New antenna switch! Front panel mounted. Select 2 coax lines, direct or through tuner, random wire/balanced line or tuner bypass for dummy load.

New airwound inductor! Larger more efficient 12 position airwound inductor gives lower losses and more watts out. Run up to 300 RF power output.

Matches everything from 1.8 to 30 MHz! dipoles, inverted vee, random wires, verticals, mobile whips, beams, balanced and coax lines.

Built-in 4:1 balun for balanced lines. 1000 V capacitor spacing. Black. 11 x 3 x 7 inches. Works with all solid state or tube rigs. Easy to use anywhere.

MFJ's 1.5 KW VERSA TUNER III

MFJ-962B **\$229.95**



Run up to 1.5 kw PEP and match any feedline continuously from 1.8 to 30 MHz: coax, balanced line or random wire.

Lighted Cross-needle Meter reads SWR, forward and reflected power in one glance. Has 300 and 3,000 watt ranges. 6 position antenna switch handles 2 coax lines, wire and balanced lines. 4:1 balun. 250 pf, 6 kv variable capacitors. 12 position ceramic inductor switch. New smaller size matches new rigs: 10 3/4" x 4 1/2" x 14 7/8" inches. Flip stand for easy viewing. Requires 12V for light.

MFJ's Best VERSA TUNER

MFJ-949C **\$149.95**



MFJ's best 300 watt tuner is now even better! The MFJ-949C all-in-one Deluxe Versa Tuner II gives you a tuner, cross-needle SWR/Wattmeter, dummy load, antenna switch and balun in a new compact cabinet. You get quality conveniences and a clutter-free shack at a super price.

A new cross-needle SWR/Wattmeter gives you SWR, forward and reflected power—all at a single glance. SWR is automatically computed with no controls to set. Has 30 and 300 watt scale on easy-to-read 2 color lighted meter (needs 12 V).

A handsome new black brushed aluminum cabinet matches all the new rigs. Its compact size (10 x 3 x 7 inches) takes only a little room.

You can run full transceiver power output—up to 300 watts RF output—and match coax, balanced lines or random wires from 1.8 thru 30 MHz. Use it to tune out SWR on dipoles, vees, long wires, verticals, whips, beams and quads.

A 300 watt 50 ohm dummy load gives you quick tune ups and a versatile six position antenna switch lets you select 2 coax lines (direct or thru tuner), random wire or balanced line and dummy load.

A large efficient airwound inductor—3 inches in diameter—gives you plenty of matching range and less losses for more watts out. 100 volt tuning capacitors and heavy duty switches gives you safe arc-free operation. A 4:1 balun is built-in to match balanced lines.

Order your convenience package now and enjoy.

2 KW COAX SWITCHES MFJ-1702 **\$19.95**



MFJ-1702. \$19.95. 2 positions. 60 dB isolation at 450 MHz.

Less than .2 dB loss. SWR below 1:1.2.

MFJ-1701, \$29.95.

6 positions. White markable surface for antenna positions.



MFJ's Smallest VERSA TUNER

MFJ-901B **\$59.95**



MFJ's smallest 200 watt Versa Tuner matches coax, random wires and balanced lines continuously from 1.8 thru 30 MHz. Works with all solid state and tube rigs. Very popular for use between transceiver and final amplifier for proper matching. Efficient airwound inductor gives more watts out. 4:1 balun for balanced lines. 5 x 2 x 6 inches. Rugged black all aluminum cabinet.

MFJ's Random Wire TUNER

MFJ-1601D **\$39.95**



MFJ's ultra compact 200 watt random wire tuner lets you operate all bands anywhere with any transceiver using a random wire. Great for apartment, motel, camping operation. Tunes 1.8-30 MHz. 2 x 3 x 4 inches.

MFJ's Mobile TUNER

MFJ-945C **\$79.95**



Designed for mobile operation! Small, compact. Takes just a tiny bit of room in your car. SWR/dual range wattmeter makes tuning fast and easy. Careful placement of controls and meter makes antenna tuning safer while in motion.

Extends your antenna bandwidth so you can operate anywhere in a band with low SWR. No need to go outside and readjust your mobile whip. Low SWR also gives you maximum power out of your solid state rig—runs cooler for longer life.

Handles up to 300 watts PEP RF output. Has efficient airwound inductor, 1000 volt capacitor spacing and rugged aluminum cabinet. 8x2x6 inches. Mobile mounting bracket available for \$5.00.

ORDER ANY PRODUCT FROM MFJ AND TRY IT-NO OBLIGATION. IF NOT SATISFIED, RETURN WITHIN 30 DAYS FOR PROMPT REFUND (less shipping).

• One year unconditional guarantee • Made in USA • Add \$5.00 each shipping/handling • Call or write for free catalog, over 100 products.

MFJ

MFJ ENTERPRISES, INC.
Box 494, Mississippi State, MS 39762

TO ORDER OR FOR YOUR NEAREST DEALER, CALL TOLL-FREE

800-647-1800

Call 601-323-5869 in Miss. and outside continental USA Telex 53-4590 MFJ STKV



Simple BASIC program calculates complex hyperbolic functions

Using the polar form for calculating the complex hyperbolic functions requires surprisingly few BASIC statements. It may be instructive to list these, which can be set up as subroutines to be called by the subroutines which are calculating the ABCD matrix values.

```
100 'Sinh S=dB total loss, T=total radians; s+jt returned.
110 FL = 1: GOTO 140
120 'Cosh S=dB total loss, T=total radians; s+jt returned.
130 FL = 0
140 S = 10^(S/20): GOSUB 170: S3 = S: T3 = T: GOSUB 190
150 IF FL = 1 THEN S = (S3 - S) / 2: T = (T3 - T) / 2: RETURN
160 S = (S3 + S) / 2: T = (T3 + T) / 2: RETURN
170 'Polar to rectangular; S=Mag., T=Angle (rad.); s+jt returned.
180 S2 = S: S = S2 * COS (T): T = S2 * SIN (T): RETURN
190 'Invert 1/(s+jt); s+jt returned.
200 U = 1: V = 0
210 'Divide (u+jt)/(s+jt); s+jt returned
220 Y = (S * S) + (T * T): S = S / Y: T = T / Y
230 'Multiply (u+jt)*(s+jt); s+jt returned
240 W0 = (S * U) - (T * V): T = (S * V) + (T * U): S = W0: RETURN
```

Comments prior to each subroutine indicate the operation performed, parameters to be passed, and parameters returned. All calculations are complex. Some of these routines are general purpose functions: polar-to-rectangular conversion, inversion, division, and multiplication.

Adding square root and rectangular-to-polar subroutines would complete a minimum set for handling the majority of complex algebra calculations. Though not necessary to the calculations in this article, they follow here:

```
300 'Square root. S=Real, T=j Term; s+jt returned.
310 'If S returned as 0, issue warning. J term may be minus or plus.
320 W0 = SQR ((S + SQR (S * S + T * T)) / 2)
330 IF W0=0 THEN T = -SQR (ABS (S)): S=0: PRINT "Sign OK j term?": RETURN
340 T = T / (2 * W0): S = W0 : RETURN
350 '
360 'Rect. to Polar. S=Real, T=j Term. S=Magnitude, T=Radians returned
370 PI = 4 * ATN (1)
380 Y = SQR (S * S + T * T): IF S = 0 THEN 450
390 W0 = ATN (T / S)
400 IF S > 0 THEN 440 ELSE IF T > 0 THEN 430 ELSE IF T = 0 THEN 420
410 T = W0 - PI: GOTO 480
420 T = PI: GOTO 480
430 T = W0 + PI: GOTO 480
440 T = W0: GOTO 480
450 IF T < 0 THEN 470 ELSE IF T = 0 THEN 480
460 T = PI / 2: GOTO 480
470 T = -PI / 2
480 S = Y: RETURN
```

To preserve accuracy, keep calculations in rectangular form as far as practical; avoid multiple polar/rectangular conversions except as necessary at input or output of data. By convention the variables S and U are real, while T and V are the j terms. (In polar/rectangular conversions, S is magnitude and T is the angle.) The returned variables are always S and T .

KENWOOD

...pacesetter in Amateur radio

NEW!

This HT Has it All!

TH-215A/415A

Full-featured Hand-held Transceivers

Kenwood brings you the greatest hand-held transceiver ever! More than just "big rig performance," the new TH-215A for 2 m and TH-415A for 70 cm pack the most features and the best performance in a handy size. And our full line of accessories will let you go from hamshack to portable to mobile with the greatest of ease!



- Wide receiver frequency range. Receives from 141-163 MHz. Includes the weather channels! Transmit from 144-148 MHz. Modifiable to cover 141-151 MHz (MARS or CAP permit required).
- TH-415A covers 440-449.995 MHz.
- 5, 2.5, or 1.5 W output, depending on the power source. Supplied battery pack (PB-2) provides 2.5 W output. Optional NiCd packs for extended operation or higher RF output available.
- CTCSS encoder built-in. TSU-4 CTCSS decoder optional.
- 10 memory channels store any offset, in 100-kHz steps. Each memory channel can store frequency, frequency step, offset, reverse switch position, and CTCSS frequency.
- Nine types of scanning! Including new "seek scan" and priority alert.
- Intelligent 2-way battery saver circuit extends battery life. Two battery-saver modes to choose, with power save ratio selection.
- Easy memory recall. Simply press the channel number!
- 12 VDC input terminal for direct mobile or base station supply operation. When 12 volts is applied, RF output is 5 W!
- New Twist-Lok Positive-Connect™ locking battery case.
- Frequency entry by keyboard or UP/DWN keys.
- Priority alert function.
- Monitor switch to defeat squelch. Used to check the frequency when CTCSS encode/decode is used or when squelch is on.

- Large, easy-to-read multi-function LCD display with night light.
- Audible beeper to confirm keypad operation. The beeper has a unique tone for each key. DTMF monitor also included.
- Supplied accessories: Belt hook, rubber flex antenna, PB-2 standard NiCd battery pack (for 2.5 W operation), wall charger, dust caps.

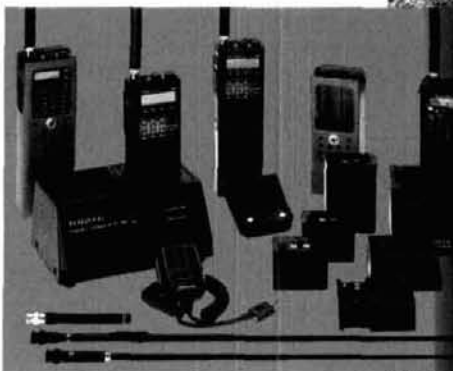

Optional Accessories:

- PB-1: 12 V, 800 mAh NiCd pack for 5 W output
- PB-2: 8.4 V, 500 mAh NiCd pack (2.5 W output)
- PB-3: 7.2 V, 800 mAh NiCd pack (1.5 W output)
- PB-4: 7.2 V, 1600 mAh NiCd pack (1.5 W output)
- BT-5 AA cell manganese/alkaline battery case
- BC-7 rapid charger for PB-1, 2, 3, or 4
- BC-8 Compact battery charger
- SMC-30 speaker microphone
- SC-12, 13 soft cases
- RA-3, 5 telescoping antennas
- RA-BB StubbyDuk antenna
- TSU-4 CTCSS decode unit
- VB-2530: 2m, 25 W amplifier
- LH-4, 5 leather cases
- MB-4 mobile bracket
- BH-5 swivel mount
- PG-2V DC cable
- PG-3C cigarette lighter cord with filter



TH-215A

TH-215A shown

KENWOOD

TRIO-KENWOOD COMMUNICATIONS
1111 West Walnut Street
Compton, California 90220

Complete service manuals are available for all Trio-Kenwood transceivers and most accessories. Specifications and prices are subject to change without notice or obligation.

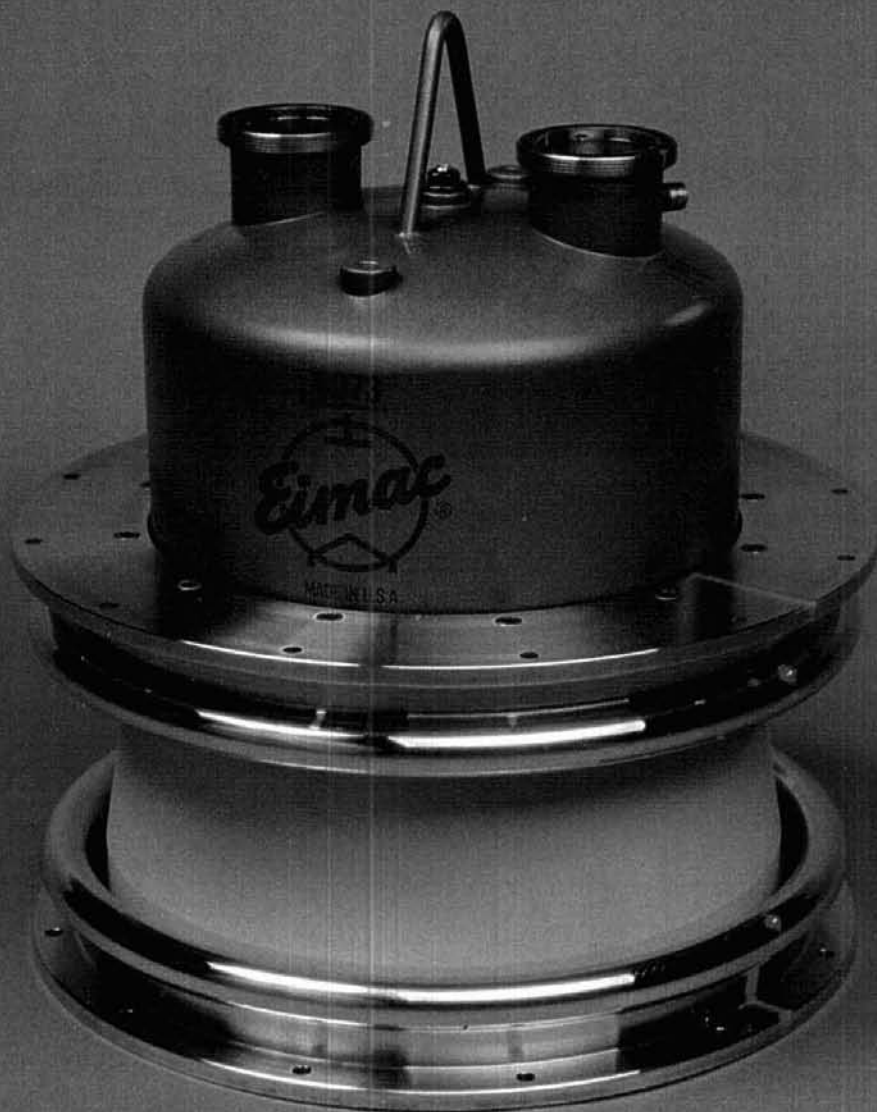

1.5 Megawatts at 50 MHz—And More! Delivered by EIMAC's 8973 Power Tetrode

The versatile super-power 8973 tetrode is designed for tough, on-the-job results under difficult circumstances. For CW or long-pulse service in plasma heating and accelerator applications, this rugged Varian EIMAC power tube fills your needs. Look at these demanding applications where the 8973 is operating today:

It takes a sturdy, reliable power tube to have on-the-job results like these and the 8973 is doing it, day after day.

And this is just the beginning!

The X-2242, available early in 1986, will provide 2.5 megawatts at 80 MHz and 1.5 megawatts at 130 MHz. All of this, plus 1.4

megawatts anode dissipation rating. The X-2242 is the same size as the 8973. That's a lot of power in a small package!

For a data sheet and technical literature on the 8973, contact Varian EIMAC, 301 Industrial Way, San Carlos, CA 94070 or call (415) 592-1221, TWX 910-376-4893.

User	Application	Frequency (MHz)	Power Output	Pulse Length
JET	ICH*	25-50	1.5 MW	20 seconds
JT-60	ICH*	110-130	750 kW	10 seconds
JFT-2M	ICH*	10-40	1.5 MW	300 milliseconds
KFA-Textor	ICH*	29-53	1.5 MW	3 seconds

*ICH = Ion cyclotron heating



VSWR at the load has caused an additional loss of 1.56 dB. And even though this line is a multiple of a half-wave, where we'd normally expect to see the load impedance repeated at its input, it is in fact quite different.

I must emphasize that these effects result from line loss. If we could magically produce a lossless line, none of these effects would be seen, no matter how high the VSWR. For all that, had I chosen a much lower loss line, these effects would be drastically reduced. Reflected wave power, which would not be lost in a lossless line, gets a piece taken out during each traverse of the line — just as with forward wave power. This is the reason for the additional loss due to the high VSWR.

summary

Real coax, except in the most benign circumstances (good load match, very low loss), gives rise to effects which can be startlingly different from assumptions based on a lossless line. Nor is it entirely a problem of efficiency and optimistic VSWR. A case in point is the 4-Square vertical phased array, whose reference element requires a small part of the total drive power (on the order of 5 percent). Because of the high VSWR associated with the feedline of this element, the assumption of zero losses (even at 80 meters) results in a non-trivial error in the calculated input impedance of this feeder, leading to a drive current phase error. Since good f/b ratio is a vector subtraction of large numbers looking for a zero sum, a small error can lead to a large f/b ratio change.

ABCD matrix algebra again demonstrates its versatility and flexibility for four-terminal network calculations. Except for adding complex hyperbolic functions to my computer program, and coax loss interpolation, no other changes were necessary. Given the parameters, it doesn't matter to the ABCD program what sort of network it is calculating.

acknowledgments

My thanks again to Mason Logan, K4MT, and Bob Booth, WB6SXV, for their encouragement and assistance. They pointed the way; I wrote about it. A special thanks to Bob, who provided the interpolation method.

references

1. Forrest Gehrke, K2BT, "Vertical Phased Arrays, Part 5," *ham radio*, December, 1983.
2. Some cable ratings give the dielectric constant of the insulating material — e.g., polyethylene has a dielectric constant of 2.26, which equates to a velocity factor, $vf = 1/\sqrt{2.26} = 0.67$.

bibliography

Radio Engineers' Handbook, F.E. Terman, McGraw-Hill, pages 19 and 178.
Transmission Lines, Robert Chapman, Schaum Outline Series in Engineering, McGraw-Hill.

ham radio

K.V.G. CRYSTAL PRODUCTS



9 MHz CRYSTAL FILTERS

MODEL	Application	Bandwidth	Poles	Price
XF-9A	SSB	2.4 kHz	5	\$53.15
XF-9B	SSB	2.4 kHz	8	72.05
XF-9B-01	LSB	2.4 kHz	8	95.90
XF-9B-02	USB	2.4 kHz	8	95.90
XF-9B-10	SSB	2.4 kHz	10	125.65
XF-9C	AM	3.75 kHz	8	77.40
XF-9D	AM	5.0 kHz	8	77.40
XF-9E	FM	12.0 kHz	8	77.40
XF-9M	CW	500 Hz	4	54.10
XF-9NB	CW	500 Hz	8	95.90
XF-9P	CW	250 Hz	8	151.20
XF-910	IF noise	15 kHz	2	17.15

10.7 MHz CRYSTAL FILTERS

WRITE FOR FULL DETAILS OF CRYSTALS AND FILTERS

Export inquiries Invited.

Shipping: \$3.75

MICROWAVE MODULES EQUIPMENTS

Use your existing HF or 2M rig on other VHF or UHF bands.

RECEIVE CONVERTERS

MMk 1691-137	269.95
MMk 1296-144G	189.95
MMc 439-ATV	94.95
MMc 432-2B(S)	69.95
MMc 144-2B(HP)	74.95
MMc 144-2B	54.95

LINEAR TRANSVERTERS

MMt 1296-144G	369.95
MMx 1268-144	289.95
MMt 432-2B(S)	289.95
MMt 144-2B(R)	349.95
MMt 144-2B	189.95
MMt 435-2B(S)	299.95

LINEAR POWER AMPLIFIERS

2M		70cm	
MML 144-30-LS	144.95	MML 432-30-L	219.95
MML 144-50-S	129.95	MML 432-50	229.95
MML 144-100-S	224.95	MML 432-100	439.95
MML 144-100-LS	249.95		
MML 144-200-S	439.95		

ANTENNAS

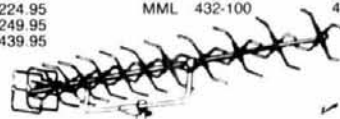

2M		LOOP YAGIS	
10XY-2M	\$74.95	1268-LY	\$49.95
70cm		1296-LY	49.95
70/MBM28	\$44.95	1691-LY	59.95
70/MBM48	64.95		
70/MBM88	94.95		
DY20-900 MHz	79.95		
		order loop yagi connector extra	

Send 66¢ (3 stamps) for full details of all our VHF & UHF equipments and KVG crystal products.

Shipping: FOB Concord, Mass.



si

(617) 263-2145

SPECTRUM INTERNATIONAL, INC.

Post Office Box 1084

Concord, MA 01742, U.S.A.

BASEBALL CAP

How about an attractive **BASEBALL** style cap that has name and call on it. It gives a jaunty air when worn at Hamfests and it is a great help for friends who have never met to spot names and calls for easy recognition. Great for birthdays, anniversaries, special days, whatever occasion. Hats come in the following colors: **GOLD, BLUE, RED, KELLY GREEN**. Please send call and name (maximum 6 letters per line).



UFBC-81 \$6.00

WA2SRF

ham radio magazine

I.D. BADGES

No ham should be without an I.D. badge. It's just the thing for club meetings, conventions, and get-togethers, and you have a wide choice of colors. Have your name and call engraved in either standard or script type on one of these plastic laminated I.D. badges. Available in the following color combinations (badge/lettering): white/red, wood-grain/white, blue/white, white/black, yellow/blue, red/white, green/white, metallic gold/black, metallic silver/black.

BOOKSTORE

Greenville, NH

03048

Please add \$3.50 for shipping and handling

UID Engraved I.D. Badge

\$2.50

Wide Dynamic Range and Low Distortion – The Key to Superior HF Data Communications

- Dynamic Range > 75 dB
- 400 to 4000 Hz
- BW Matched to Baud Rate
- BER < 1×10^{-5} for S/N = 0 dB
- 10 to 1200 Baud
- Linear Phase Filters



ST-8000 HF Modem

Real HF radio teleprinter signals exhibit heavy fading and distortion, requirements that cannot be measured by standard constant amplitude BER and distortion test procedures. In designing the ST-8000, HAL has gone the extra step beyond traditional test and design. Our noise floor is at -65 dBm, not at -30 dBm as on other units, an extra 35 dB gain margin to handle fading. Filters in the ST-8000 are all of linear-phase design to give minimum pulse

distortion, not sharp-skirted filters with high phase distortion. All signal processing is done at the input tone frequency; heterodyning is NOT used. This avoids distortion due to frequency conversion or introduced by abnormally high or low filter Q's. Bandwidths of the input, Mark/Space channels, and post-detection filters are all computed and set for the baud rate you select, from 10 to 1200 baud. Other standard features of the ST-8000 include:

- 8 Programmable Memories
- Set frequencies in 1 Hz steps
- Adjustable Print Squelch
- Phase-continuous TX Tones
- Split or Transceive TX/RX
- CRT Tuning Indicator
- RS-232C, MIL-188C, or TTL Data
- 8, 600, or 10K Audio Input
- Signal Regeneration
- Variable Threshold Diversity
- RS-232 Remote Control I/O
- 100-130/200-250 VAC, 44-440 Hz
- AM or FM Signal Processing
- 32 steps of M/S filter BW
- Mark or Space-Only Detection
- Digital Multipath Correction
- FDX or HDX with Echo
- Spectra-Tune and X-Y Display
- Transmitter PTT Relay
- 8 or 600 Ohm Audio Output
- Code and Speed Conversion
- Signal Amplitude Squelch
- Receive Clock Recovery
- 3.5" High Rack Mounting

Write or call for complete ST-8000 specifications.



HAL Communications Corp.

Government Products Division
Post Office Box 365
Urbana, Illinois 61801
(217) 367-7373 TWX 910-245-0784

simple modifications and adjustments for the TS-930S

Minor changes
let you align without
test equipment, improve
performance and reliability

The Kenwood TS-930S offers the serious Radio Amateur the opportunity to enjoy the high quality of an all solid-state, general coverage transceiver with a very effective built-in automatic antenna tuner, among a number of options. Furthermore, Kenwood's updated version, the TS-940S, provides all the same features plus improved cooling, increased memories, and keyboard data entry. For those using the TS-930S — and to some extent, those using the TS-940S — the following notes may be of interest.

memory backup

The TS-930S memory backup requires the use of three 1.5-volt AA batteries, which will easily last their shelf life. AA NiCads, however, may be substituted with good results; because the drain is only in the microampere region, recharging will be required only about once a year. This can be done by simply attaching some small clip-type probes to the polarity coded red and black leads that exit the battery housing on its left side (as viewed from the top, front of the radio).

i-f alignment

The rather laborious i-f alignment procedure outlined in the factory service manual may be greatly simplified by using the receiver's 100 kHz marker as a signal generator in conjunction with the S-meter. For convenience, and as a reference, the receiver's internal "S9" meter adjustment is used to set the marker

level to S9. This provides relatively accurate signal readings, consistent with those I would give by ear. Unfortunately, the incoming signals above that level will read high, but in reality those are only relative at best, and I prefer the convenience of accuracy below that point, where it's more useful. Some operators may prefer a setting of S8 as a compromise, depending on their particular needs.

The service manual's instructions for the alignment of L132 and L134 in the rf processor i-fs are quite complex. To simplify this procedure, you can use your voice as a signal generator while peaking the slugs as indicated on the *compression* scale of the radio's multimeter. Alternatively, a complex sound such as fan noise picked up by the microphone and detected in the monitor mode will suffice by just peaking the audio signal without the meter reading.

dial calibration

To align the TS-930's 10-MHz time base for basic dial calibration, the following procedure will provide a simple, yet very effective means of relatively accurate calibration. First, tune WWV to the highest frequency in which an S9 or stronger signal can be copied. With the receiver in the *a-m* mode, enable the 100 kHz marker and adjust the rf attenuator until the optimum beat note is heard in the form of the conventional "whooshing" sound, while adjusting TC1 for zero beat. The best results will be obtained when the two signals are of equal amplitude — i.e., when the strongest beat note is heard. Always perform this calibration when WWV is well above S9 to allow for the maximum adjustment range of the rf attenuator.

preventing failure in R400

In all TS-930S units with serial numbers below 4,100,000,* resistor R400 on the signal board is prone to failure. In my radio, the precursors of failure were

*There are obviously not 4.1 million TS-930Ss — the manufacturer's numbering system simply identifies products in this manner. Ed.

Marv Gonsior, W6FR, 418 El Adobe Place,
Fullerton, California 92635

**SPECIAL
KENWOOD
TM-3530A
25 watt
CALL
FOR PRICE**

MA.

TEL-COM

Electronic Communications

**NEW ENGLAND'S FACTORY-
AUTHORIZED SALES & SERVICE**

FOR

KENWOOD



ICOM

Also displaying the popular accessories needed to complete a HAM STATION . . .

- ARRL PUBLICATIONS • AEA PRODUCTS • AMPHENOL
- ALPHA DELTA • ASTRON • AUSTIN ANTENNAS • AVANTI
- BELDEN • BENCHER • B & W • DAIWA • ALINCO
- HUSTLER • KLM • LARSEN • MIRAGE • ROHN
- TELEX/HY-GAIN • TOKYO HY-POWER LABS
- TRAC KEYERS • VIBROPLEX • WELZ • ETC.

✓ 189

NEW
Novice Band
220 MHz
Equipment &
Antennas
In Stock

OPEN SIX DAYS A WEEK

Telephone 617/486-3400, 3040

675 Great Rd., (Rte. 119) Littleton, MA 01460
1 1/4 miles from Rte. 495 (Exit 31) toward Groton, Mass.

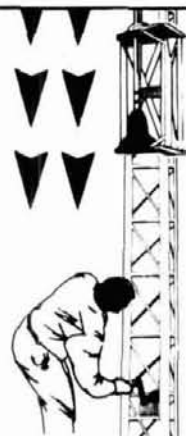

**SAVE
TIME
and
MONEY
with
THE
HAZER**

✓ 190

**Bring things down for
safety and convenience.**

Never climb your tower again with this elevator system. Antennas and rotator mount on HAZER, complete system trans tower in verticle upright position. Safety lock system operates while raising or lowering. Never can fall.

Complete kit includes winch, 100 ft. of cable, hardware and instructions. For Rohn 20 and 25 G Towers.

Hazer 2 - Heavy duty alum. 12 sq. ft. load **\$297.00** ppd.
Hazer 3 - Standard alum. 8 sq. ft. load **\$213.00** ppd.
Hazer 4 - Heavy galv. steel 16 sq. ft. load **\$278.00** ppd.
Ball Thrust bearing TB-25 for any of above **\$42.50** ppd.

KENPRO Antenna Rotors

KR-400 11 sq. ft. Azimuth Rotor **\$214.95** ppd.
KR-600 19 sq. ft. Azimuth Rotor **\$299.95** ppd.
KR-2000 27 sq. ft. Azimuth Rotor **\$549.95** ppd.
KR-5400 AZ-EL Satellite Rotor **\$399.95** ppd.
KR-001 C-64 Computer Interface **\$159.95** ppd.

Send for free details of aluminum towers specifically engineered for use with the Hazer.

Satisfaction guaranteed. Call today and charge to Visa, MasterCard or mail check or money order.

GLEN MARTIN ENGINEERING INC.
P.O. Box H 253
Boonville, Mo. 65233
816-882-2734



SSTV SOFTWARE

**Introducing A New Dimension
In SSTV**

Gest VideoTools

- MS/DOS based advanced software package for 1200 c Robot users.
- Create/transmit your own high resolution graphic images.

Full Paint Package Features;

- 65K on screen colors out of a range of 256K
- ICOM-based menus, mouse-driven, easy to learn, easy to use
- Over 70 functions
- Enlarge, reduce, save, load video image and image fragments
- Combine video images, graphics and text
- Full image processing including noise reduction filters
- Save images, live off air
- Animation
- Zoom
- Full function robot control through software
- Auto I.D.

Now available to amateur market
Send check or money order, \$599
per system to:

**Torontel Technology
Systems Ltd.**
**174 Bellamy Rd. North
Scarborough, Ontario
Canada M1J 2L5**
416-292-9952 ✓ 191

**This publication is
available in microform
from University
Microfilms
International.**



Please send information about these titles:

Name _____

Company/Institution _____

Address _____

City _____

State _____ Zip _____

Phone () _____

Call toll-free 800-521-3044. In Michigan, Alaska and Hawaii call collect 313-761-4700. Or mail inquiry to: University Microfilms International, 300 North Zeeb Road, Ann Arbor, MI 48106.

suggested by a VOX malfunction and a 15-minute delay in the ALC meter reaching zero. Several other 930 owners have told me that they've found R400 in their units discolored and too hot to touch; this strongly suggests a high probability of failure.

The measured power dissipated in this resistor is 1/2 watt with a 1.5-k value. The original rated dissipation of this resistor was either 1/4 or 1/2 watt (the reason for this uncertainty is that my failed resistor wasn't returned to me, and the manufacturer doesn't specify resistors in their parts lists). As originally designed, it was the only hot resistor on the signal board. In all models numbered above 4,100,000, Kenwood changed its value to 2 watts, so be sure to inspect this resistor for discoloration and measure its value. The existing resistor may be replaced by crushing its body and soldering the new one to the remaining leads; if you do it this way, you'll have to remove the signal board. Of course, if you're removing the board any way, you might as well replace the resistor.

R400 is difficult to find because it's not located in the area of its sequential grouping, but instead at the top left center of the signal board, as viewed from the bottom side of the radio (facing you). If you have the service manual — a bargain at \$15, by the way — you can find R400 at the intersection of C and 1.5.

ALC considerations

Some operators have been experimenting with the ALC time constants, with the objective of increasing the 930's "talk" power. They believe that some minor improvement may be accomplished by decreasing the decay time of the ALC, since this varies by the net tolerances of the components involved. However, any alteration (delay) of the *attack* time should be avoided because doing so will only increase the intermodulation distortion products. A senior Kenwood factory engineer has advised that any ALC indication *above zero* causes an increase in distortion; therefore, ALC should be used sparingly and in accordance with the operating instruction manual. Should the decay time be found to be excessive (that is, about 5 seconds from half scale), it may be reduced by changing R240 — located at the intersection of 4 and C/D (see page 39 of the service manual) — on the signal board to a smaller value. Unfortunately, unless you remove the board, you'll have to crush it, salvaging its leads for the replacement.

rf decoupling

Like most solid-state equipment, the TS-930S exhibits some degree of rf susceptibility, even under very low VSWR conditions. Coil cords make excellent antennas. So do any other cables to external units such as speakers, phone patches, and keyers. The

liberal use of ferrites, consistent with good shielding practices, will usually take care of most problems. It's axiomatic that all external leads should be decoupled.

Evidence of external rf entering the radio and resulting in distortion may be found as follows. Wearing headphones, turn off the monitor and determine whether a garbled SSB signal is heard. Next, place the multimeter in the Vc position and note if it remains well regulated under full power conditions, especially with a power amplifier in operation. Poor Vc regulation is a sure indication of a problem, either because of rf or in the regulator circuit itself.

improving transmitted audio, greater IMD suppression

Users of radios with serial numbers below 3,080,001 may not be aware that a Kenwood factory modification was inaugurated at that point for improved transmitted audio quality — i.e. improved IMD suppression. The modification consisted of increasing the collector current of the rf drivers and final transistors, the MRF485s and the MRF422s in their quiescent state. The effect is more pronounced in the reduction of the higher, odd order products. The full details can be found in Kenwood's Factory Service Bulletin No. 867 (March 29, 1983), entitled "TS-930S SSB TX Tone Quality." The enhanced performance occurs by operating the drivers and finals deeper in Class AB1, by increasing their collector idling currents from 50 and 500 to 70 and 1100 mA, respectively. To determine if this mod has already been incorporated in your radio, place the multimeter in the Ic position and compare the value you read to the 1100 mA. To some extent, the results of this mod account for the difference in transmit quality between the earlier and later versions of the 930.

Thanks to W4CG, a 5-dB improvement in the IMD of the radio may be readily obtained by replacing Q1, the rf pre-driver (a 2SC2075) with a Motorola MRF485. It's essential that the MRF485 be of current manufacture because early devices exhibited a thermal runaway problem which has since been corrected by Motorola. The new, improved version is identified by a narrow white horizontal stripe across the face, just above the device identification number. The MRF485 is an ultralinear device, especially designed for SSB service and therefore just a bit better in this application than the 2SC2075, while being fully interchangeable in form, fit, and function. Therefore, no parameter change is required. Replacing the device is actually quite simple. It can be a bit of a chore in the 930 because of the tedium of removing the rf board from its mounting; in the 940, the job is much easier.

quieting a noisy cooling fan

In most radios, the power supply fan will become

noisy after a year or two, depending upon the particular fan unit and the number of hours of use. Kenwood has developed a simple modification that greatly reduces or eliminates it. The mod consists of adding a small spring clip (Part No. 602-0549-04) to laterally load the fan shaft. Described in Kenwood's Service Bulletin No 893, the mod takes only about 30 minutes.

I've also found that a light Teflon™-loaded lubricating oil such as Tri-Flow™ is an excellent lubricant for the front bearing of both fans. However, unfortunately, neither fan is designed for lubrication of the rear bearings.

increasing dial light life

In order to save the multimeter dial lights, which are costly and based on a special pigtail design, Kenwood recommends that they normally be operated in the "dim" position. However, a 12-volt Radio Shack unit (No. 272-1141, 79¢) can be substituted and wired in series for the 28-volt source.

ergonomic "face-lifting"

Adding some 1-inch rubber extensions to the front mounting feet will make viewing the controls easier, thereby helping the operator's posture and possibly lessening eye strain. (This will be especially true for contest operators.) These rubber extensions are obtainable at parts supply houses or hardware stores

at a nominal cost. I cemented mine to the existing feet with 5-minute epoxy.

balanced modulator stability

I've observed a frequent, random imbalance between the capacitive and resistive balance adjustments. While the radio undoubtedly meets its carrier suppression spec, it is rather disconcerting to observe the imbalance occurring. Therefore, it's a good idea to check the balance periodically, using another receiver as a detector or an oscilloscope with a dummy load across the output of the radio. While the amount of carrier may be small, it may become quite annoying when it's amplified by a linear and a beam. When using an auxiliary receiver as the detector, advance the Processor In control fully clockwise and reduce the Processor Out control counterclockwise to the fully off position. This provides the best combination for checking without audio feedback.

conclusion

All of the foregoing procedures may be accomplished without test equipment and without following the detailed factory instructions, yet they should yield the same results. I hope that these methods and observations will, in some ways, add to your operating pleasure while using these fine radios.

ham radio

MIRAGE /KLM

ANTENNA POLARITY SWITCHER MODEL APS-1

The APS-1 is a self-contained control head designed to allow remote polarity switching of circular antennas such as the Mirage/KLM range of crossed yagis.



The APS-1 may be powered by the power adaptor (included) or may alternately be powered from a vehicle or other 13-17 VDC source.

In addition to switchable outputs for two antennas, the APS-1 also contains a 6-13 volt regulated DC power supply. This feature is designed for powering items such as preamplifiers, VHF/UHF converters, etc., but may also be used whenever a low-current stabilized variable voltage source is required.

SPECIFICATIONS:

Power Requirement (AC) 117V ± 10% AC 50/60 Hz 15 Watt

Power Requirement (DC) 11-16 VDC 500 mA

Outputs Two 12 VDC unregulated, switched (antenna relay supply).
One 6-13 VDC variable regulated auxiliary supply.

Total output current 500 mA with AC transformer that is included, 1 amp with optional high current transformer or external DC supply.
This unit has our popular five (5) year warranty.

✓ 188

P.O. BOX 1000

MORGAN HILL, CALIFORNIA 95037

(408) 779-7363



SEE US AT DAYTON



AMATEUR TELEVISION

ATV MADE EASY WITH OUR SMALL ALL IN ONE BOX TC70-1 TRANSCIVER AT A SUPER LOW \$299 DELIVERED PRICE!

CALL 1-818-4474565 AND YOURS WILL BE ON ITS WAY IN 24 HRS (VIA UPS SURFACE IN CONT. USA).

TC70-1 FEATURES:

- * Sensitive UHF GaAsfet tuneable downconverter for receiving
- * Two frequency 1 watt p.e.p. transmitter. 1 crystal included
- * Crystal locked 4.5 mHz broadcast standard sound subcarrier
- * 10 pin VHS color camera and RCA phono jack video inputs
- * PTL (push to look) T/R switching
- * Transmit video monitor outputs to camera and phono jack
- * Small attractive shielded cabinet - 7 x 7 x 2.5"
- * Requires 13.8vdc @ 500 ma. + color camera current

Just plug in your camera or VCR composite video and audio, 70cm antenna, 12 to 14 vdc, and you are ready to transmit live action color or black and white pictures and sound to other amateurs. Sensitive downconverter tunes whole 420-450 mHz band down to channel 3. Specify 439.25, 434.0, or 426.25 mHz transmit frequency. Extra transmit crystal add \$15.

Transmitting equipment sold only to licensed radio amateurs verified in the Callbook for legal purposes. If recently licensed or upgraded, send copy of license. Receiving downconverters available to all starting at \$59 (TVC-2G).

WHAT ELSE DOES IT TAKE TO GET ON ATV?

Any Tech class or higher amateur can get on ATV. If you have a camera you used with a VCR or SSTV & a TV set, your cost will just be the TC70 and antenna system. If you are working the AMSAT satellites you can use the same 70cm antennas on ATV.

DX with TC70-1s and KLM 440-27 antennas line of sight and snow free is about 22 miles, 7 miles with the 440-6 normally used for portable uses like parades, races, search & rescue, damage assessment, etc. Get 50 watts p.e.p. with the Mirage D24N or D1010N-ATV amp for greater DX or punching thru obstacles.

The TC70-1 has full bandwidth for color, sound, like broadcast. You can show the shack, home video tapes, computer programs, repeat SSTV, weather radar, or even Space Shuttle video if you have a home satellite receiver. See the *ARRL Handbook* chapt. 20 & 7 for more info & *Repeater Directory* for local ATV repeaters.

**PURCHASE AN AMP WITH THE TC70-1 & SAVE!
 50 WATT WITH D24N-ATV....\$499**
 All prices include UPS surface shipping in cont. USA

COMPLETE ATV STATION



TC70-1...\$299
 ATV Transceiver

Astron RS20M...\$129
 13.8 vdc 20A Power Supply

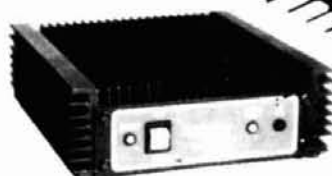

Mirage D24N....\$219
 (optional) all mode 70cm amp
 13.8vdc 9 amps @ 50 watts RF



KLM 440-27 14dbd \$107
KLM 440-14 11dbd \$77
KLM 440-6 8dbd \$62

HAMS! Call or write for full line ATV catalog....downconverters start at only \$59

packet radio conference bridge

AX.25-compatible bridge
links six stations
for routine or emergency
communications

From the beginning, packet radio has been essentially a point-to-point mode. Even with the TNC-2's multi-connect capabilities, it hasn't been possible for all participants in roundtable or net-type operations to be connected to everyone else in the net. Although makeshift arrangements have been devised, they've lacked the anti-collision and error-controlling capabilities of the AX.25 protocol.

In an effort to solve these problems, Tom Aschenbrenner, WB5PUC, has designed a truly error-controllable, AX.25-compatible conference bridge. Because it's combined with other network software components he's designed, the conference bridge is offered in two versions. The one described here fits into a replacement EPROM for a TNC-2 clone; the other is a part of the software installed in the 9600-baud network node controller board for TexNet.^{1,2}

A conference bridge module in a TNC-2 clone or a TexNet node provides full-protocol, multiple-station roundtable or net-type operation between packet stations. Typical operation is accomplished by each of the stations involved in the net connecting to the bridge-equipped node by using the Secondary Station Identifier (SSID) assigned to the conference bridge function. On the test nodes in operation in the Dallas area, the SSIDs are -2 and -3 on each node. The current version of the network software supports two independent conference bridges of six participants each. It's also possible to connect to the bridge through one digipeater if necessary.

typical conference bridge operation

To connect to a conference bridge, each station

connects as if it were connecting to any other packet station. A typical text sequence to a conference bridge would be:

```
C WB5PUC-2 < carriage return >
```

The operator's TNC does the connect routines.

The following will then appear on the operator's CRT:

```
***Connected to WB5PUC-2 < cr lf >  
(from TNC)
```

Welcome to the WB5PUC Conference Bridge. A Control-U shows all stations connected to this bridge.

At this point or at any other time, the response to a Control-U command to the bridge will bring up a text string listing the calls of all connected stations. For example:

```
N5EG-5 WD5HJP W5YR-7 WA5MWD-3  
connected
```

No additional commands are needed to operate the bridge.

In the normal operation mode, each operator receives a text string with a shorter header indicating the call of the originating station. For example:

```
WD5HJP > Transmitter power is now at 100  
watts.
```

```
N5EG-5 > OK Bill, try adjusting trimmer C15  
now.
```

```
W5YR-7 > What are you guys up to?
```

```
WD5HJP > Hi George, just adjusting the  
node's final amp.
```

When the QSO is over, those connected to the bridge simply disconnect as they would from any other packet connection, via a DISCONNECT command in the Command mode of the TNC.

operations test

A routine test of the emergency plan for the Point Beach, Wisconsin nuclear power plant in September, 1986, provided an intensive on-the-air test of an early version of the conference bridge software. Though not specifically designed for such use, the conference

Bill Wade, WD5HJP, Texas Packet Radio Society, 600 Via Sevilla, Mesquite, Texas 75150

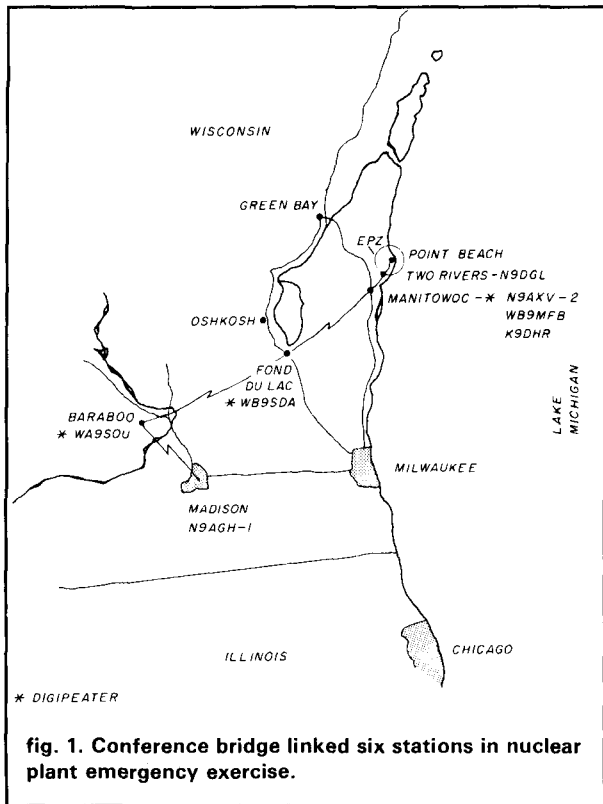

bridge served as the hub of an emergency communications network that included a link to the state capital. Overall, the bridge performed well in its original form; later modifications have been implemented to facilitate its use in emergencies.

The Nuclear Regulatory Commission (NRC) requires annual testing of every nuclear power plant's emergency plan. This test is designed to evaluate the ability of plant personnel and the utility company holding the facility's license to cope with an accident. The NRC measures their ability to assess the extent of danger to the public, their effectiveness in recovering control of the plant, and their ability to minimize damage to the surrounding environment. A succession of events pushes the plant engineering staff through a series of critical decisions; events are programmed into the scenario to simulate damage to the power plant and motivate recovery action by the staff.

For a realistic overview of the performance of the allied agencies that would be involved in an actual incident, the test scenario includes a simulated evacuation. State, county, and municipal emergency units become involved in the plan when supervisory NRC engineers and the utility's power plant engineers have recognized a possible threat to public safety. At some point in the escalation of the situation, the plant staff recommends evacuation, triggering activation of a number of government safety, information, and public assistance centers.

At that point, the power plant staff contacts the county and state emergency units and delivers its assessment of the situation. The complement of offices that become active in the evacuation phase of the emergency plan are the county Emergency Operations Center (EOC); the state Emergency Government Office (EGO); the Department of Human Resources Reception Centers that will process evacuees; the Joint Information Press Center (JIPC), the official information center for the emergency; and the off-site power plant Emergency Operations Facility (EOF), from which the NRC and utility supervisory engineers make their recommendations to the state and county emergency government.

Each of the 102 nuclear power plants in operation in the United States is surrounded by an Emergency Protection Zone (EPZ) with a radius of 10 miles. This EPZ is the area considered under immediate hazard in case of any airborne release of radioactivity. The Point Beach power plant EPZ includes three towns — Two Rivers, Shoto, and Two Creeks — and extends into Lake Michigan.

test scenario

This particular scenario began with a hypothetical earthquake tremor, causing a series of leaks in the cooling loops of the "B" power plant. Subsequent "damage" to the plant caused some injuries and contamination of plant employees and allowed the release of radioactive steam into the atmosphere. By 8 AM, after a damage assessment, the county and state government were notified that there was a "public danger"; the county emergency office notified the Manitowoc RACES EC, who activated the amateur emergency system. Stations equipped with 2-meter fm voice and packet equipment were established at each of the operations centers listed above, with the exception of the plant Emergency Operations Facility (EOF), not normally accessible to the public.

RACES participation

The Amateur community in Manitowoc County is actively involved with the county emergency government office! During the test, the five-station RACES system was centered around the Manitowoc County EOC, which has a permanent Amateur Radio station linked via microwave to a dedicated voice repeater (WB9MFB, 145.19/.79) located at the county transmitter facility. Four remotely-sited, linked voting receivers increase the effectiveness of this 60-mile diameter service area, 2-meter fm voice system. For packet operations, a permanent conference bridge-equipped packet digipeater (N9AXV-2, 145.01 MHz) utilizing an MFJ-1270 TNC-2 is installed at the transmitter site. The voice repeater and packet digipeater are converted 100-watt Motorola transceivers.

ANNOUNCING SOUND OFF MODEL 10



Sound Off Model 10 is a self-contained message generator complete with case and power supply. The Model 10 was designed specifically for applications where repetitive high quality natural voice announcements are required, i.e. Amateur repeater and commercial radio systems. The Model 10 stores your

natural voice message in nonvolatile EPROM with single message lengths of up to 32 seconds. The Model 10 provides for both single and continuous play modes. Factory settable internal timers can set timing intervals from seconds to 30 minutes or more. All control functions and timers are provided for this application. (COR sense, transmitter activity sense, PTT, ID timer.)

Models 20, 100 and 150 available for applications requiring random access multmessage capabilities in nonvolatile re-recordable message times of up to 4 minutes.

Model 10 prices start at \$219.00.

Now for the first time you can enjoy the truly unique operation of a Digital Voice Announcement System, designed specifically for Amateur Radio communications. The DVK-100 represents the latest technology in digital audio processing.

Create your own natural voice contest calls, CO's etc. Your voice is stored in digital memory, ready to be played back at the touch of a key. The Digital Voice Keyer is not a tape recorder or robotic sounding synthesizer but a true full fidelity natural voice record/playback system.

The DVK-100, is a must for the avid contestator and great audio accessory for any Ham Shack.

FEATURES

- Superior natural voice quality
- Micro-processor controlled
- 32 seconds of message time
- PTT/VOX operation
- Dynamic/condenser mic input
- Selectable monitor amplifier with preset level controls
- Selectable audio compressor
- Sealed membrane keyboard
- 4 independent voice memories
- Positive/negative keyed PTT
- FSD/EMI/RFI shielding
- Selectable end of transmission tone generator

✓ 185

The sound of the future is here today. Contact your local Amateur Radio dealer or NTL for further information.

\$249⁰⁰ SUGGESTED NET
AMATEUR PRICE

DEALER INQUIRIES INVITED



NEL-TECH LABS, INC.
28 DEVONSHIRE LANE • LONDONDERRY, NH 03053
603-434-8234

Other equipment used at all of the temporary public service Amateur stations included additional 2-meter fm voice transceivers for the RACES 145.19/.79 repeater. Voice fm was used to coordinate large file transfers and to back up the packet equipment. A variety of computers (chiefly IBMs and IBM clones and Commodore 64s) and TNCs (AEA, Kantronics, MFJ, and original TAPR 1's and 2's) were used without any compatibility problems. Each of the locations was equipped with the appropriate disk drives; some were also equipped with printers.

Operators at each of the centers connected to N9AXV-2, the conference bridge/digipeater at the county transmitter site. N9AGH-1 was at the Wisconsin State Emergency Government Office in Madison, the state capital. To reach the conference bridge, N9AGH-1 connected through two digipeaters, WA9SOU (in Baraboo) and WB9SDA (in Fond Du Lac), a link length of over 150 miles (see fig. 2). WB9MFB, at the county EOC, K9DHR, at the reception center in Manitowoc, and N9DGL, at the JIPC in Two Rivers, were all connected directly to the bridge.

Once the stations were connected, typical operation proceeded as in any other net. Net control was maintained by operators at WB9MFB, the county EOC. Traffic was passed simply by sending the text via packet from each of the sites. Since all stations on the bridge were getting identical copies of text, very little repetition was necessary.

impact of packet operation

The worth of the conference bridge and packet radio was demonstrated immediately. The test emergency was declared from the governor's office in Madison, and the message went out via the two-digipeater link to the conference bridge at the Manitowoc EOC. A parallel 75-meter phone system running from the state emergency office to the county EOC was also activated. The packet conference bridge delivered the message correctly, approximately 30 seconds ahead of the 75-meter phone link. The 75-meter system garbled the power plant emergency protection zone (EPZ) grid coordinates in the first message!

In some respects, use of the packet conference bridge became second nature. To simulate a system failure, Ron Shimek, WB9MFB, the county EC, disconnected power to the conference bridge, forcing the use of point-to-point packet communication. When they became aware of the system failure, packet operators set up point-to-point links to re-establish communication. Although throughput was slower, point-to-point operation did provide usable information. As a backup, a standby station had been set up to monitor activity and act as recorder for the entire test.



**HAM-COM 1987
&
ARRL
TEXAS STATE
CONVENTION**

**JUNE 5, 6 & 7 1987
ARLINGTON CONVENTION CENTER
ARLINGTON, TEXAS**

Exhibitor Info: (214) 521-9430
Registration Info: (214) 423-3498



**10th Annual
Ham-Com!**

**More Than 6,500
Registrants Expected!**

Be There!

test results

At the conclusion of the exercise, the Emergency Coordinator described the conference bridge as a key ingredient in the success of the test. In his report, he emphasized that federal observers had been impressed not only with the speed and accuracy of traffic handling, but also with the capability for time/date stamping of traffic (using the computer systems' real-time clocks) and for producing hard copy simultaneously at all sites.

Because all the stations in the emergency system were connected through the conference bridge, automatic status and warning updates were available at all sites. An NRC inspector mentioned to one of the participating Radio Amateurs that thanks to ham activity, he was never out of touch with any of the sites for the duration of the test. The Federal Emergency Management Authority (FEMA) observers indicated that they would encourage further use of packet radio and the conference bridge in future tests. WB9MFB's evaluation of the test suggested a broader role for the RACES group in both forthcoming tests and actual emergencies.

recommendations for future designs

The relatively few operation anomalies that caused some delays on the system were largely attributable to QRM originating outside the limits of the test area. The Manitowoc county transmitter site is about 3 miles from Lake Michigan; there is considerable channel activity from Milwaukee and Chicago to the south and from Michigan across the lake. All of the test activity took place on 145.01 MHz. Typically, there are periods of 10 to 20 minutes when the N9AXV digipeater squelch never closes. Selection of another frequency besides 145.01 MHz for operation would be desirable.

Connection of the conference bridge to a network system is also recommended. In this test, the state emergency government center was by necessity connected through a 145.01-MHz, two-digipeater link. Response time from that part of the system was proportionately slower, but still quite usable. Other situations without such a robust digipeater link would benefit from use of a backbone network system. The conference bridge software does allow connection to any network because of its compatibility with AX.25.

WB9MFB has suggested that a system monitor be set up in advance to record all activity during an emergency communications test. Packet operation offers a significant advantage in this regard, in that all text information is easily stored to disk. In this case, the system monitor provided a good backup to the NCS; later, when the EC and RACES group needed to do evaluation of their own, the stored information proved to be useful indeed.

Other recommendations include eliminating BBS activity on frequency during tests or actual emergencies to help avoid channel congestion. Operators from outside the test area occasionally interrupted RACES activity with inquiries about the test and the conference bridge.

implications of conference bridge operation

Amateurs who've handled traffic in hurricanes, tornados, or other disasters know that telephone systems are the first communications systems to become overloaded or destroyed. The Point Beach scenario demonstrated that utility companies and state agencies are still blindly tied to this relatively fragile communications resource. The ability of packet radio systems to handle high volumes of traffic quickly and accurately under difficult circumstances is being demonstrated regularly; as part of these systems, a conference bridge can provide reliable communications to the people that need it most.

references

1. Thomas H. Aschenbrenner, WB5PUC, and Thomas C. McDermott, N5SEG, "The TEXNET Packet-Switching Network — Part 1: System Definition and Design," *ham radio*, March 1987, page 29.

2. Thomas H. Aschenbrenner, WB5PUC, and Thomas C. McDermott, N5SEG, "The TEXNET Packet-Switching Network — Part 2: Hardware Design," *ham radio*, April, 1987 page 29.

ham radio

GLB PACKET RADIO GOES PORTABLE

THE FIRST CONTROLLER DESIGNED FOR PORTABLE AND SOLAR-POWERED STATIONS



- LOW 25 mA Current Drain.
 - Miniature size - Lightweight.
 - Rugged metal, shielded case.
 - Lithium Battery backup for RAM.
 - Onboard Watchdog for reliability.
 - Standard DB25 Connectors.
 - "Connected" Status output line.
 - Remote Commands in Unattended Mode with Hardware Lockout.
 - Retains all other PK-1 features.
 - Extra I/O lines for special applications.
- NEW SOFTWARE FEATURE:**
INTELLIGENT "BUDLIST" - Provides selective call sign filtering for Digipeating, Monitoring and Connecting.
- Model PK1-L**
Wired/Tested
List price — \$209.95
Amateur net — \$179.95

Power requirement: 9 to 15 Volts DC @ 25 mA typical
Dimensions: 4.6 X 5.9 X 1.0 inches **Total Weight:** 12 ozs.

See us at
Dayton
Booth 318

Please specify Call Sign, SSID Number, and Node Number when ordering.
Contact GLB for additional info and available options.
We offer a complete line of transmitters and receivers, strips, preselector preamps, CWID'ers & synthesizers for amateur & commercial use.
Request our FREE catalog. MC & Visa welcome

186

GLB ELECTRONICS, INC.

151 Commerce Pkwy., Buffalo, NY 14224 716-675-6740 9 to 4

MIRAGE/KLM

Expanding Our Horizons

Introducing Mirage/KLM 1.2-44 LBX

The first 1240 MHz to 1300 MHz
Made in the U.S.A.

- Factory Tested
- Completely Assembled
- Completely Weatherized Balun
- Also Available Soon . . .
Power Dividers

SPECIFICATIONS

Electrical

- Band Width 1240—1300 MHz
- Gain 18.2
- VSWR Better than 1.5 to 1
- Feed Imp. 50 Ohms
- Balun 4:1 Rigid Coax

Mechanical

- Beam Length 12' 4"
- Element Length 4.5"
- Mast 2" O.D.
- Windload 1 sq. ft.

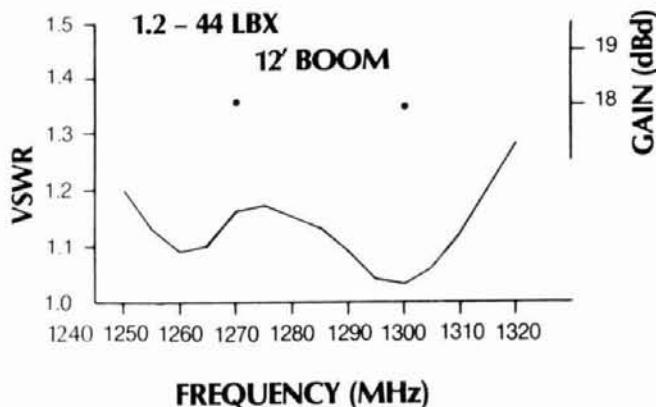

Mirage Communications Equipment, Inc.

P.O. Box 1000

Morgan Hill, CA 95037

(408) 779-7363

the TEXNET packet-switching network

part 2: hardware design

In last month's article,¹ we discussed network algorithms and the software layering. This month, we'll focus on the design and testing of hardware for the network, and on the results that have been achieved to date.

system partitioning

Partitioning hardware to minimize the number of signals that must connect between units offers three benefits: simplified cabling, easy measuring and modification of individual units, and flexibility in the construction of the network.

Figure 1 is a block diagram of a TEXNET network node. There are four main pieces: a local area network (LAN) radio, which in this case is a 1200-baud AFSK modem and 2-meter radio; an inter-processor (IP) radio (a 9600-baud FSK radio and modem) for use as the high-speed network trunk; a node control processor (NCP) that contains the microprocessor and communications ICs; and the power supply, which contains a three-state float charger, battery, and circuitry for automatic uninterrupted power should ac power fail.

LAN radio and modem

This channel is the primary method by which users with TNCs and 2-meter radios connect to a network node. By connecting the modem separately from the processor, any modem can be used — 300 baud, 1200

baud, 2400 baud, or whatever might be desired. **Figure 2** is a diagram of the modem, which is similar to the TAPR TNC-1 modem. We chose to implement an active filter equalizer with op-amps instead of a switched-capacitor filter IC. The modem includes a 45-second time-out timer to disable the transmitter should the controller fail for some reason. The strap allows setting the EXAR demodulator VCO center frequency, but better results can be obtained by adjusting the VCO frequency control pot and observing the received "eye" pattern on an oscilloscope from an AFSK signal known to be good. An eye pattern is observed on an oscilloscope by synchronizing the scope trigger with the recovered clock and displaying the data. Since the data displayed is not involved in triggering the scope, a random display of all data sequences is shown, but the zero crossings are fixed in time on the screen, yielding an open area in the center of a data bit (known as the "eye"). **Figure 3** shows a typical eye pattern, the recovered clock, and the slicing level (which decides between a 1 and a 0). The basic decision circuit is shown in **fig. 4**.

The radio is an ICOM-IC22S, a popular 2-meter transceiver, with the frequency hard wired to 145.05

Thomas H. Aschenbrenner, WB5PUC, and Thomas C. McDermott, N5EG, Texas Packet Radio Society, P.O. Box 831566, Richardson, Texas 75083-1566

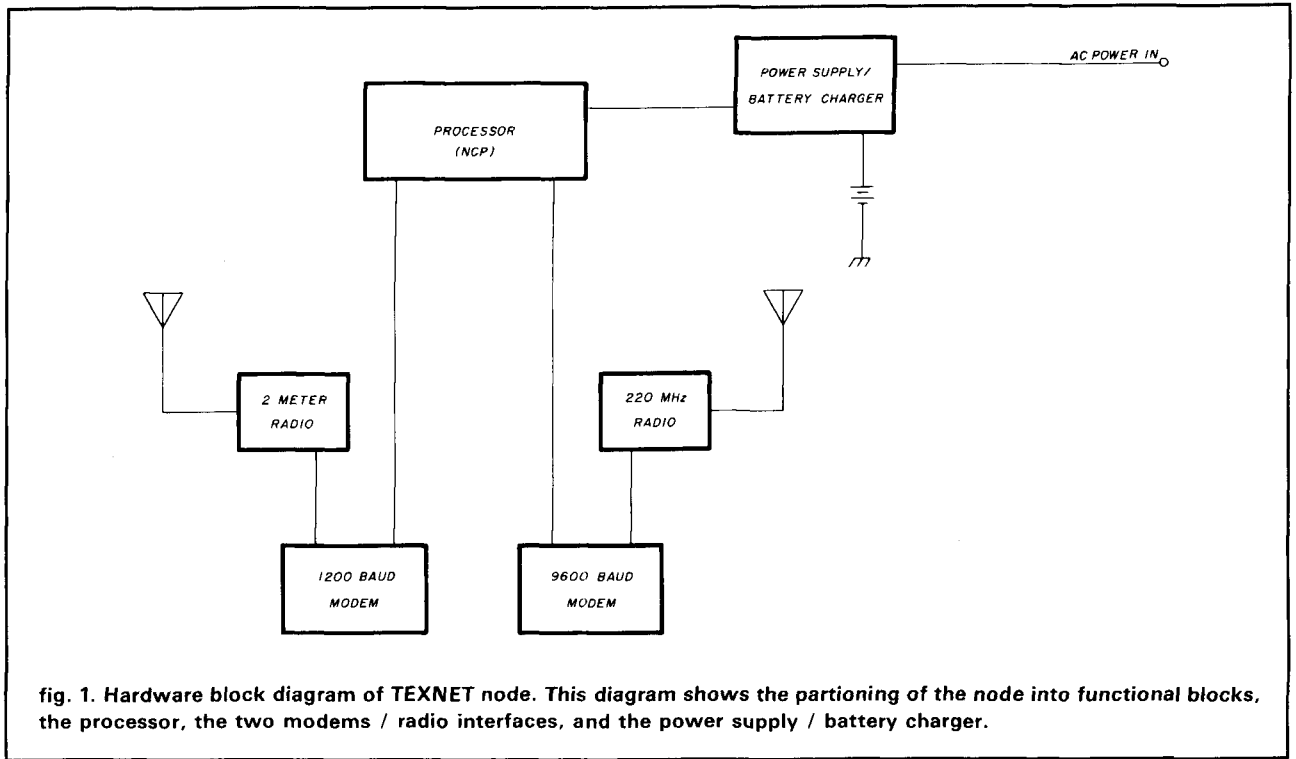

MHz. The transmit audio is injected after the microphone amplifier; the receive audio is tapped off prior to the audio PA in order to avoid the severe degradation of frequency response that results if the speaker and microphone leads are used for audio pick-off and injection.

IP radio and modem

The performance of the network trunks is very important in determining the overall throughput of the network as a whole. As each user sends traffic into a network node, all traffic is multiplexed (combined) onto the high-speed trunks. Thus the trunks carry a much greater amount of traffic than the user links. Because of this, we have decided to operate the trunks at 9600 baud, with rapid Transmit/Receive (T/R) switching. Rapid T/R switching is required because at 9600 baud, actual packets take relatively little time to transmit, and the T/R delay can determine the effective channel capacity.

Figure 5 illustrates the effective channel capacity versus T/R delay for a 9600-baud channel with no errors, and one acknowledgment packet for the entire transmission. Several different values are shown: one indicates the number of packets per transmission, another the number of bytes per packet, and a third for two values of DWAIT (digipeater waiting time, which allows a digipeater transmission priority). Because there are no digipeaters in TEXNET, DWAIT = 0. (A value of DWAIT = 80 ms is typical for 2-meter

channels.) Our experiments involved the use of a pair of Hamtronics FM-5 220-MHz fm transceivers and K9NG's modems. These radios are modified to operate FSK, and the received data signal is tapped off the quadrature detector in the receiver. Since these radios are PIN-diode switched between transmit and receive, we were able to make them operate with 40 ms T/R delay, although in practice 80 ms was allowed.

We encountered some difficulty in making the radios operate properly at 9600 baud. Apparently these problems were due in large part to variations in the performance of different FM-5 radios, which were designed not for high-speed data operation, but rather for fm voice operation. In an effort to improve the operation of the radios, a number of experiments were run, and modifications were made to the modem.

To understand this better, let's review the basics of frequency-shift-keyed (FSK) data transmission, the spectrum of a non-return-to-zero (NRZ) data signal at baseband, and the performance of i-f filters in the time domain. We'll see that all three have to be addressed properly to assure proper performance of the radios and modems.

An NRZ signal is one that toggles between logic 1 and logic 0 no more than once per bit period (see fig. 6). In an FSK system, two frequencies are transmitted — one for logic 1, the other for logic 0. At the output of the discriminator/quadrature detector at the receiver, the two frequencies are translated back to voltages. If the frequency of the transmitter were to

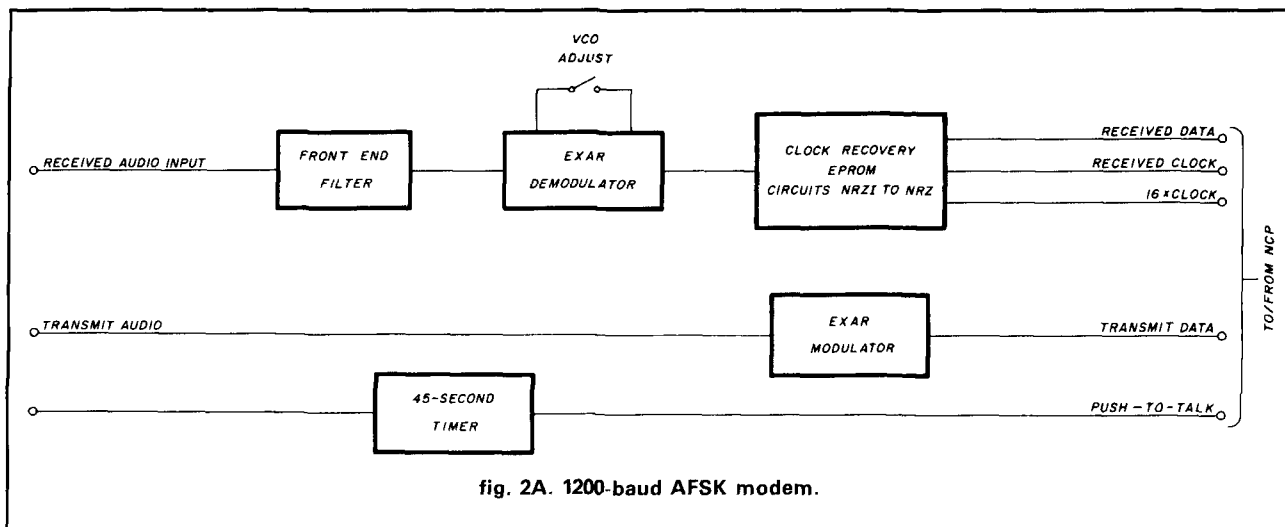

fig. 2A. 1200-baud AFSK modem.

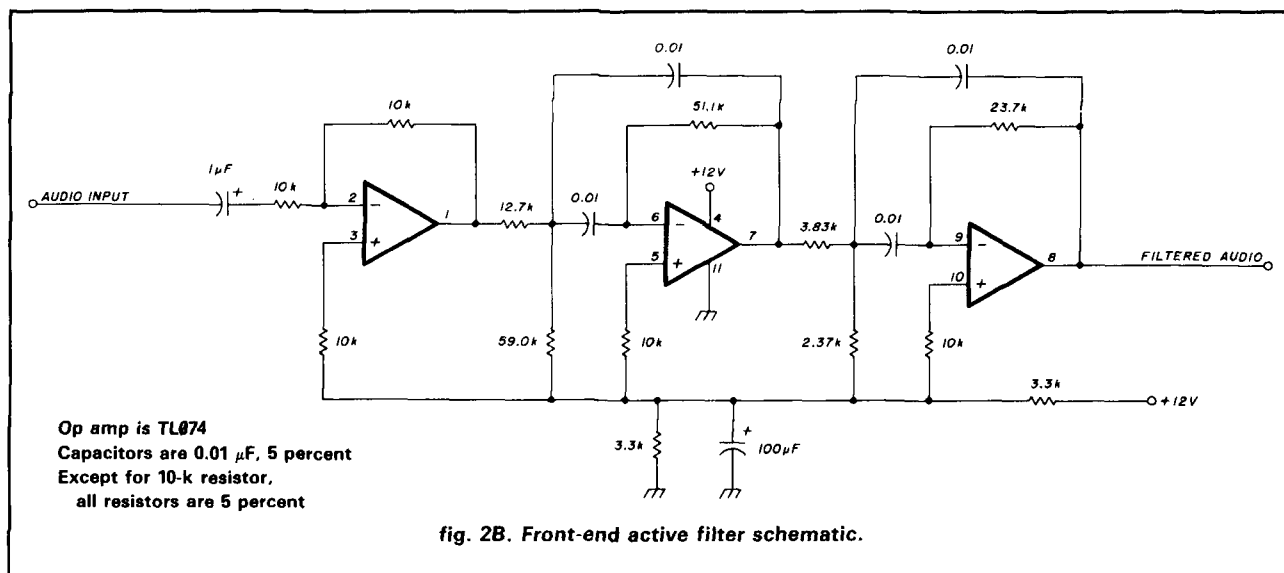

fig. 2B. Front-end active filter schematic.

vary slightly, then both the logic 0 and logic 1 voltages would also vary. A simple method to determine the correct "slicing level" for deciding between a logic 1 and a logic 0 is to choose the voltage halfway between the two. This is simple to do by using a low-pass filter with a time constant quite a bit longer than the data period to generate the slicing voltage level. Then the slicing threshold will "track" the logic 1 and 0 voltages automatically (see fig. 7). This requires, however, that the transmitted data have, on the average, the same number of ones as zeros; if they don't, the recovered slicing level will be biased off the true center point (fig. 7).

In HDLC, the code used for AX.25, there is no guarantee that the code will be dc-balanced (i.e., have same number of ones as zeros). In fact, the flag character contains two zeros and six ones, thus having a large dc offset from one-half. A simple way to solve

the problem is to use a pseudo-random scrambler to cause some apparent randomization of the data sequences. A self-synchronized descrambler is used on the receiving modem to recover the original bit stream. This is the method used on the K9NG modem to send and receive data, a 17-stage scrambler being used. With this arrangement, the average number of ones and zeros is nearly the same. Certain sequences into a scrambler can, however, produce long strings of ones or zeros. If a long string were to occur, our low-pass filter in the receiver would tend to drift off the center voltage, halfway between the 0 and 1. So we must compromise the time constant of the low-pass filter in the receiver slicing level circuit (which we would like to make very long) with the need for rapid T/R switching, where we need to acquire the proper level quickly. In addition, any capacitors used to couple the analog signal must have long time constants; if

SPECIAL



SYSTEM #1 \$399.00

Motherboard with bios and first 64K of RAM. Upgradable to a full 640K of RAM. Flip top case. K8XT (at look alike) keyboard. 150 watt power supply with all the power needed to run extra drives and cards.

SYSTEM #2 \$699.00

Motherboard with bios and first 256K of RAM. Upgradable to a full 640K of RAM. Flip top case. K8XT (at look alike) keyboard. 150 watt power supply. Dual Disk Drive card with cables. One floppy drive. DS DD 360K. A color graphics card with RGB and composite output.

(All you need is a monitor)

SYSTEM #3 \$999.00

Motherboard with bios and first 256K of RAM. Upgradable to a full 640K of RAM. Flip top case. K8XT (at look alike) keyboard. 150 watt power supply. Color graphics card with RGB and composite outputs. Multi I/O card with two disk drive ports, one parallel port, one serial port and one serial port option, one game port, clock and calendar with battery backup. Two floppy disk drives DS DD 360K and a composite monitor.

SHIPPING INFORMATION: PLEASE INCLUDE 10% OF ORDER FOR SHIPPING AND HANDLING CHARGES (MINIMUM \$2.50, MAXIMUM \$10). CANADIAN ORDERS, ADD \$7.50 IN US FUNDS. MICHIGAN RESIDENTS ADD 4% SALES TAX. FOR FREE FLYER, SEND 22¢ STAMP OR SALES.

HAL-TRONIX, INC. (313) 281-7773
Hours
12:00 - 6:00 EST Mon-Sat
12671 Dix-Toledo Hwy
P.O. Box 1101
Southgate, MI 48195

"HAL" HAROLD C. NOWLAND
WBZXH

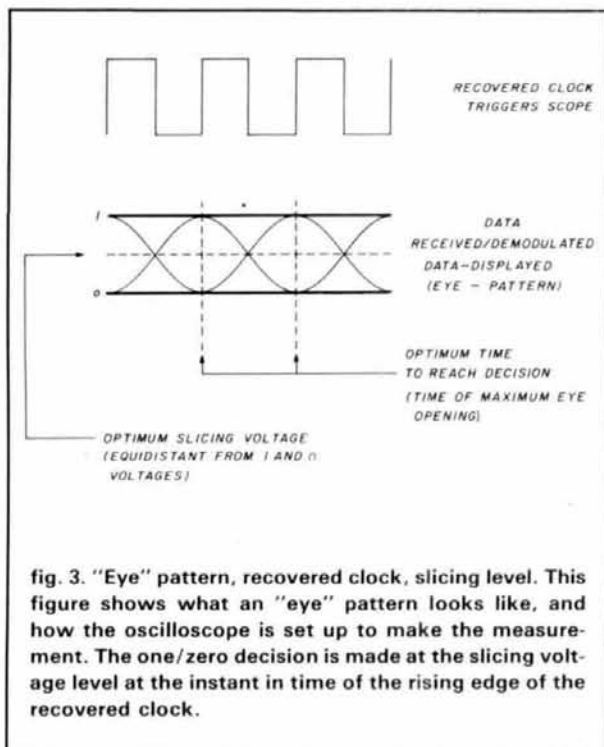

fig. 3. "Eye" pattern, recovered clock, slicing level. This figure shows what an "eye" pattern looks like, and how the oscilloscope is set up to make the measurement. The one/zero decision is made at the slicing voltage level at the instant in time of the rising edge of the recovered clock.

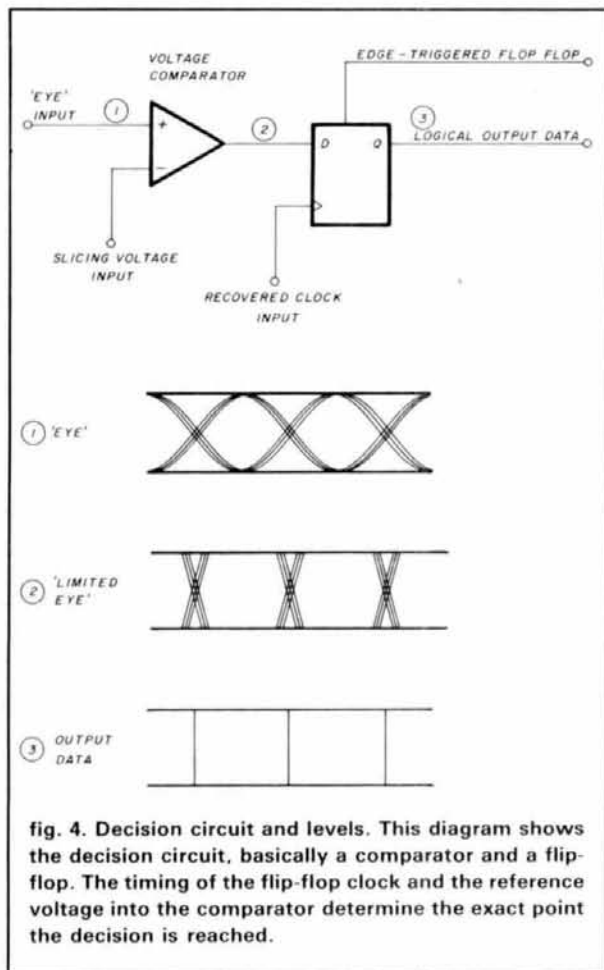

fig. 4. Decision circuit and levels. This diagram shows the decision circuit, basically a comparator and a flip-flop. The timing of the flip-flop clock and the reference voltage into the comparator determine the exact point the decision is reached.

WOW! AT LAST!! A VERY AFFORDABLE COMPUTER AT A VERY AFFORDABLE PRICE

POWERFUL FULLY PROGRAMMABLE WITH 2K OF MEMORY—PORTABLE—678 x 138 INCH MODULE SINGLE-KEY ENTRY COMMANDS—DURABLE 40 KEY MEMBRANE TYPE KEYBOARD—280A BASED FOUR CHIP DESIGN—EDUCATIONAL—UNIQUE SYNTAX CHECK REPORT CODES FOR ERROR IDENTITY—GRAPH DRAWING AND ANIMATED DISPLAY—ACCURATE TO 9 1/2 DECIMAL PLACES FOR FULL RANGE MATH AND SCIENTIFIC FUNCTIONS—AT AN AFFORDABLE PRICE

WE CANNOT TELL YOU THE MAKE OF THE COMPUTER BUT IT WAS MADE BY A FAMOUS WATCH COMPANY THEY USED TO SELL FOR \$99.95

WE BOUGHT OUT WHAT THE FACTORY HAD LEFT IN STOCK AND HAD TO REMOVE THE LABELS. THESE UNITS ARE UNPACKAGED. LESS THE 9V WALL ADAPTER AND MANUAL BECAUSE THIS IS A DISCONTINUED ITEM THERE IS NO WARRANTY

GET THEM WHILE THEY LAST LIMITED SUPPLY

BUY 1st UNIT FOR \$19.95 BUY 2nd FOR \$16.95 9V DC WALL ADAPTOR \$4.95
BUY 3rd UNIT Non-Operating For Parts \$10.95 MANUAL Over 150 Pages \$2.95

See September 1984 issue of 73 for TIMEX/RTTY article

CHIP BONANZA (AT THESE PRICES THEY ARE A STEAL)

2700	\$1.00 EA OR 10 FOR \$ 9.00
2716	\$2.25 EA OR 10 FOR \$20.00
2732	\$3.25 EA OR 10 FOR \$30.00
2764	\$4.00 EA OR 10 FOR \$36.00
2738	\$7.00 EA OR 10 FOR \$60.00
8502	\$4.95 EA OR 10 FOR \$49.50
8610	(REG. \$3.95)	\$1.95 EA OR 10 FOR \$19.00
86A09	(REG. \$19.95)	\$5.95 EA OR 10 FOR \$59.00
86A21	(REG. \$9.95)	\$2.95 EA OR 10 FOR \$29.00
4116	(or equivalent)	8 FOR \$ 5.99
4134	9 FOR \$12.95
329-2211	(SPECIAL)	\$ 2.95
TMS 9900NL MICRO-P 64 PIN 8 BIT DIB - 16 BIT CPU	\$ 4.95
TMS 9901NL MICRO-P PSI	\$ 2.95
TMS 9904NL MICRO-P CLOCK GEN AND DRIVER	\$ 5.95
TMS 9918ANL MICRO-P COLOR GRAPHICS AND DISPLAY	\$ 9.95
KEYBOARD (96x48 KEYS MEASURE 4 x 10 IN) TEX	\$ 9.95

APPLE II and APPLE II+ COMPUTER MAINFRAMES (fully populated) \$150
Power supply, case and keyboard, separately available. Call or Write Unit as described above. Fully assembled & tested. \$350 plus shipping.
APPLE POWER SUPPLIES \$29.95

Cassette Software:

1 have cassette software. send for list (reg. \$9.95-\$14.95)
H's Special Price: 1 for \$3.95, 3 for \$10.95, 6 for \$19.50, 10 for \$29.50, 20 for \$50.00 or we'll select 25 different cassettes (my choice) at 25 for \$50.00!!!

SHIPPING INFORMATION: PLEASE INCLUDE 10% OF ORDER FOR SHIPPING AND HANDLING CHARGES (MINIMUM \$2.50, MAXIMUM \$10). CANADIAN ORDERS, ADD \$7.50 IN US FUNDS. MICHIGAN RESIDENTS ADD 4% SALES TAX. FOR FREE FLYER, SEND 22¢ STAMP OR SALES.

HAL-TRONIX, INC. (313) 281-7773
Hours
12:00 - 6:00 EST Mon-Sat
12671 Dix-Toledo Hwy
P.O. Box 1101
Southgate, MI 48195

"HAL" HAROLD C. NOWLAND
WBZXH



they don't, the average voltage will drift as the low-frequency components from the scrambler charge and discharge the coupling capacitors.

Several modifications of the K9NG modem are

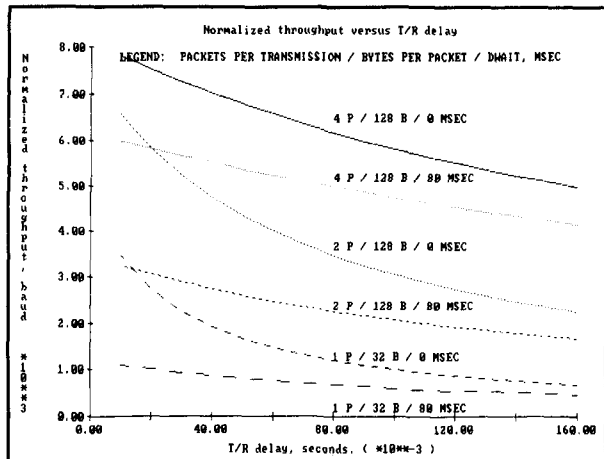

fig. 5. Effective channel capacity vs. T/R delay. This graph shows the effective capacity (baud rate) of a channel for different transmit/receive switching delays, with and without an additional delay, called DWAIT (digipeater wait time). TEXNET does not use digipeaters, so DWAIT = 0.

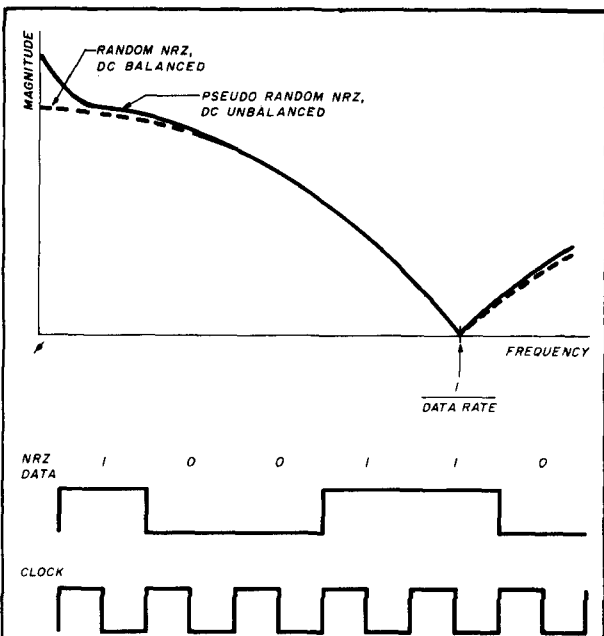

fig. 6. NRZ signal diagram. An NRZ signal has a value of logic zero or logic one for the entire period of the bit. The spectrum of a truly random signal is from dc, diminishing to zero at (1/bit time). A pseudo-random signal has a diminished spectrum near dc, theoretically vanishing.

associated with increasing the time constant of these circuits, where they're not critical to the T/R switching delay. A list of the modifications is included in fig. 8. The most significant improvement came with addition of a group-delay equalizer in the receive section of the modem. In order to appreciate the requirements for this, let's look at how filters work both in the frequency domain and the time domain. A typical i-f filter used in voice or CW work has very sharp "skirts." That is, the amplitude response decreases sharply from the filter center frequency. In addition, the response is relatively flat within the passband. This filter has a great deal of time delay distortion (see fig. 9). The time delay is minimum at the filter center frequency and rises sharply at both the upper and lower filter cutoff points. This causes no particular problems with voice, where the distortion of the waveform isn't important. But with wideband data signals, where we need to distinguish the value of data bits that are adjacent in time, the spectral energy nearer to the filter cutoff points will undergo a greater delay through the filter than the energy near to the center frequency. When this signal is converted to baseband (i.e., fm demodulated), it can be shown that frequencies near the fil-

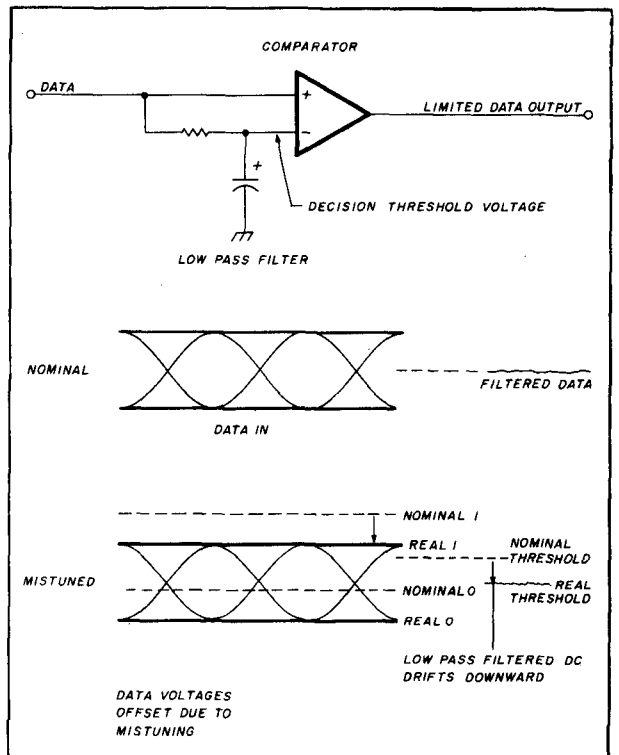

fig. 7. NRZ filtered, slicing level, low-pass filter to generate slicing level vs. frequency drift. If the NRZ is scrambled, so that the code is dc-balanced, then low-pass filtering the data will generate the correct logic-slicing voltage. As the one/zero voltages drift with receiver or transmitter mistuning, the slicing voltage will track automatically.

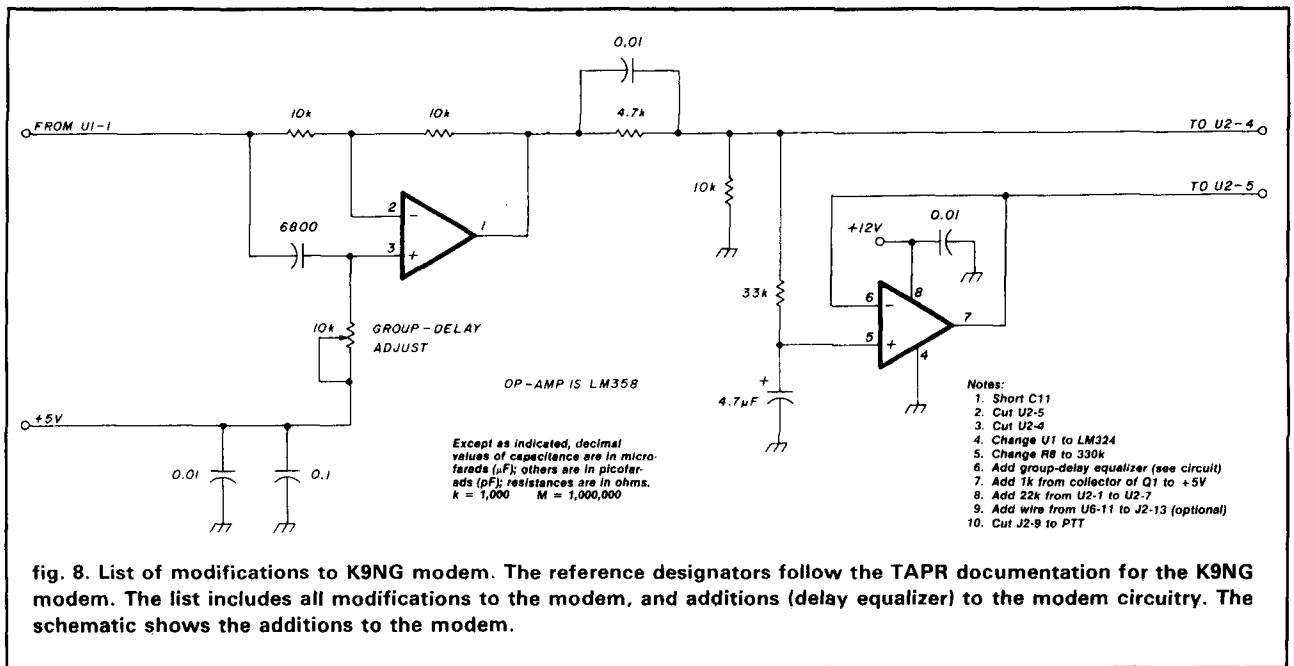
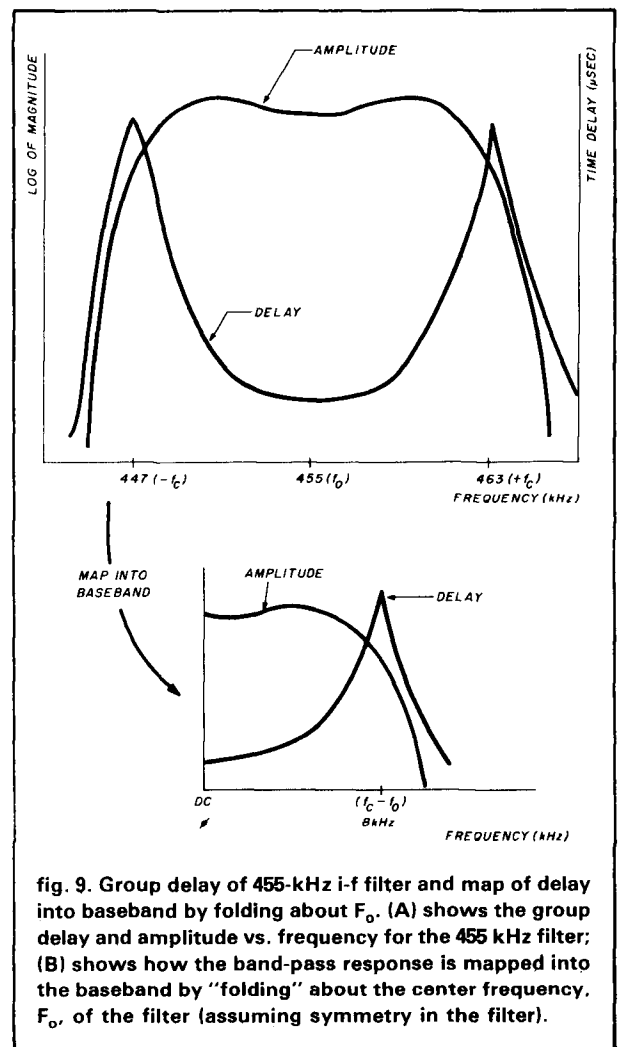

fig. 8. List of modifications to K9NG modem. The reference designators follow the TAPR documentation for the K9NG modem. The list includes all modifications to the modem, and additions (delay equalizer) to the modem circuitry. The schematic shows the additions to the modem.

ter center frequency correspond to the low-frequency spectrum of the NRZ (baseband) signal, while the frequencies near the filter cutoff (away from the filter center) correspond to the higher frequency components of the baseband signal. Thus we can "map" the time delay of the filter into baseband by "folding" the time response about the center frequency, which becomes the zero frequency of the baseband. Thus the filter produces small delay at low baseband frequencies, and larger delay at higher baseband frequencies.

The 455-kHz i-f filter in the FM-5 radio is a sealed ceramic unit; no adjustment is possible. Instead of designing a new filter with desirable time-delay characteristics, we instead built an active filter circuit, with flat amplitude response, but with an adjustable time-delay response. This network has maximum delay at dc, and decreasing delay at higher frequencies. The circuit is adjustable, so that we could construct an approximate inverse time delay to that caused by the i-f filter. Figure 10 shows the amplitude, phase, and time response of this baseband group-delay equalizer (active filter), and the baseband eye pattern with and without the delay being equalized. After delay equalization, it can be seen that the eye is much more open near the center of the bit, when the 1/0 decision is reached. Our measurements indicated a 7-dB improvement. We also provided about 1 dB of peaking of the frequency response, which opened the eye about 1 dB more, yielding an 8 dB improvement in the receiver. Actual tests with the radios indicated that this made the difference between usable and nonusable performance. Without the equalizer, the radios



SAVE \$7.05 with HOME DELIVERY (one year newstand cost \$30.00)



**SUBSCRIBE TO *ham*
TODAY *radio***

CALL NOW AND PLACE YOUR ORDER ON OUR
TOLL FREE ORDER LINE

1 (800) 341-1522

8 AM - 9 PM EST Orders Only

Have your credit card ready.

DATA TEL 800

For other information call *Ham Radio* direct
(603) 878-1441 8 A.M. - 4:30 PM

- 1 year 12 issues \$22.95**
- 2 years 24 issues \$38.95**
- 3 years 36 issues \$49.95**
(U.S. ONLY)

- Payment Enclosed
- Bill me later
- Check here if this is a renewal

(Attach Label)

Name _____

Address _____

City _____

State _____ Zip _____

Please allow 4-6 weeks for delivery of first issue.

FOREIGN RATES: Europe, Japan
and Africa, \$37 for one year by air for-
warding service. All other countries
\$31 for one year by surface mail.

Please
enter my
subscription



BUSINESS REPLY MAIL

First Class Permit No. 1 Greenville, NH

Postage Will Be Paid By Addressee

NO POSTAGE
NECESSARY
IF MAILED
IN THE
UNITED STATES



**ham
radio**

Greenville, NH 03048-9988



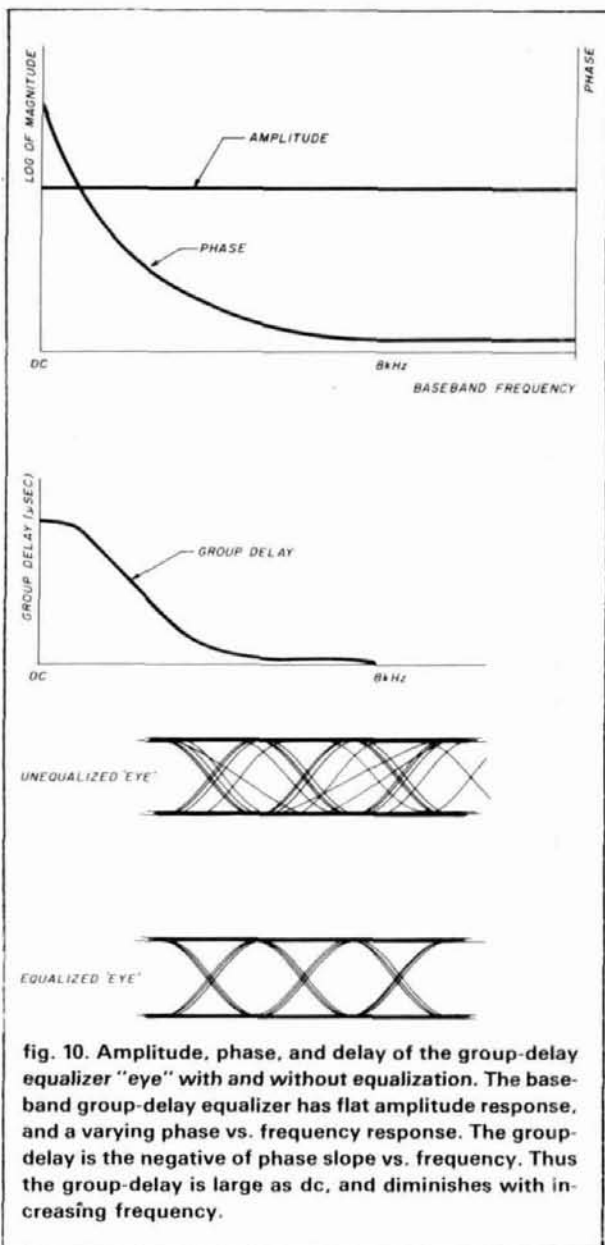

fig. 10. Amplitude, phase, and delay of the group-delay equalizer "eye" with and without equalization. The base-band group-delay equalizer has flat amplitude response, and a varying phase vs. frequency response. The group-delay is the negative of phase slope vs. frequency. Thus the group-delay is large as dc, and diminishes with increasing frequency.

"dribbled" (i.e., had a background error rate regardless of the strength of the received signal), which caused many packets to be lost.

One additional problem that had to be overcome on our "real" path test hop was insufficient image rejection in the FM-5. The test path is in an area where television channels 11 and 13 are very strong. The channel 11 video carrier is near the image frequency of our desired channels (the radio i-f is 10.7 MHz, so the image is 21.4 MHz lower than the signal frequency). **Figure 11** shows a simple filter; **fig. 12** shows its response (S11 and S12). This filter was extremely effective in eliminating the image response.

With these improvements, we've run a 12-mile path on 220.55 MHz at 9600 baud, at better than 98 percent

CONTINUOUS COVERAGE ANTENNAS FOR COMMERCIAL & AMATEUR SERVICE

Model AC 1.8-30

1.8 to 30 MHz

- SWR Max 2:1, 1.4:1 average from 1.8 to 30 MHz
- Can be installed in approximately 80 ft. space
- Ideal for commercial services for multi frequency operation without the need for antenna tuners or additional antennas
- Handles 1 KW, 2 KW PEP ICAS
- Higher power models available on special order. Contact your dealer or factory

\$159.50

SHIPPING & HANDLING
ADD \$4.00

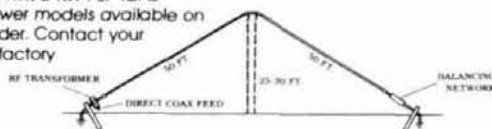

U.S. Patent No. 4,511,898

Model AC 3.5-30

3.5 to 30 MHz

- SWR less than 2:1 from 3.5 to 30 MHz
- Complete assembled. Balun terminated with standard SO-239 connector
- Power capability 1 KW - 2 KW PEP ICAS. Higher power model is available on special order.
- Designed for 50 ohm feedline
- Weather proof balun and balancing network

\$167.50

SHIPPING & HANDLING
ADD \$4.00

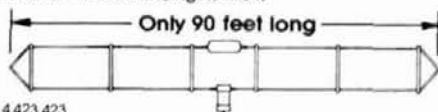

U.S. Patent No. 4,423,423

ALL OUR PRODUCTS MADE IN USA



BARKER & WILLIAMSON

Quality Communication Products Since 1932

At your Distributors. Write or Call

10 Canal Street, Bristol, PA 19007

(215) 788-5581



ALPHA DELTA

Model DELTA-4

Lightning Surge Protected
4 Position Coax Switch

Superior RF switching and equipment protection for Amateur, commercial and military communications stations. * Exclusive "center-off" ground position internally disconnects and grounds all antenna circuits for maximum protection when operator is away from the station. * Incorporates the famous Alpha Delta replaceable ARC-PLUG cartridge for active antenna protection while grounding other 3 antenna positions. An Alpha Delta FIRST! * Features custom designed cast aluminum housing with constant impedance micro-strip cavity construction for low loss performance from 1.5 to 450 MHz. No lossy wafer switch. * Positive detent ball bearing switch drive snaps firmly into place. * Handles full legal power. * Built with pride in the U.S.A.

Model DELTA-4 4 POSITION COAX SWITCH
(UHF CONNECTORS) \$69.95

Available from your Alpha Delta dealer or order direct. Please add \$4.00 shipping and handling, US only. Exports quoted.

ALPHA DELTA COMMUNICATIONS, INC.

PO Box 571

Centerville, OH 45459 (513) 435-4772

current solutions to current problems

I/O FOR REAL WORLD CONTROL



\$199.95 CALL OR WRITE FOR
MORE INFORMATION

MODEL
CIP/35A
SHOWN
WITHOUT
COVER

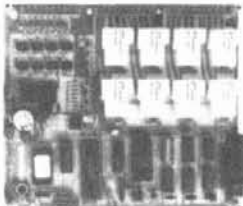

**NOW ANY PERSONAL
COMPUTER CAN HAVE THE
MOST COST EFFECTIVE
AND VERSATILE I/O BOARD
ON THE MARKET TODAY!**

- Serial Link Interface RS-232 or TTL
- 8 Relay Outputs, High Current AC/DC Form A & C
- 8 Opto-Isolated Inputs Plus 8 Bit Counter
- 8 Bit A/D with Span Adjust 0 to 5V, Provisions for up to 8 Input Channels
- EASILY Programmed & Controlled Using BASIC Statements
- Perfect for Lab Work, Machine Control, Security Systems, & Data Acquisition
- Unprecedented Usability as Attested by University, Government & Industrial Users
- Complete Documentation with Software Examples & Total Engineering Support

• IBM • HP • RADIO SHACK • COMMODORE *

* ALL REGISTERED TRADEMARKS

SIAS Engineering, Inc.

831 S. POWERS RD. / SALINA, KS 67401 / (913) 823-9209

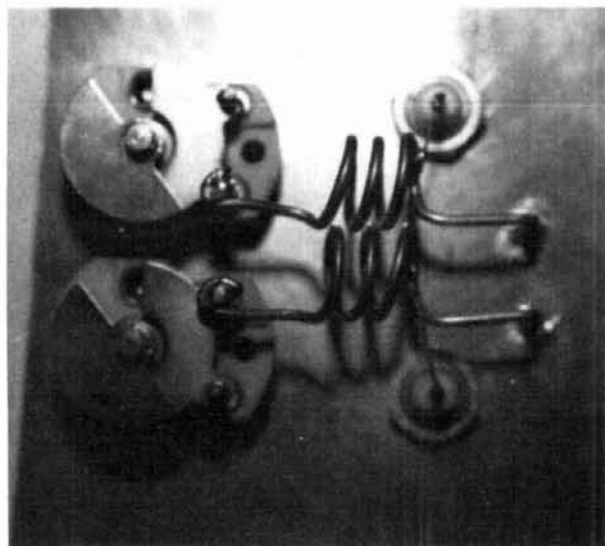

fig. 11. The 220-MHz front-end filter. Air-variable capacitors are necessary for adequate filter Q . The two resonators are closely coupled. The high tap position sets the loaded- Q of the resonators and prevents over-coupling, while maintaining low insertion loss. This filter is exceptionally difficult to tune properly.

reliability — 98 percent of the packets are received without error. This hop is such that 4-dB additional attenuation at one radio caused the packet reliability to be approximately 5 percent, and so was a stringent test of the radios and modems in that the radios were operated near the minimum acceptable received signal level.

The FM-5/K9NG modem experiments gave us valuable insight into proper modem/radio design. We

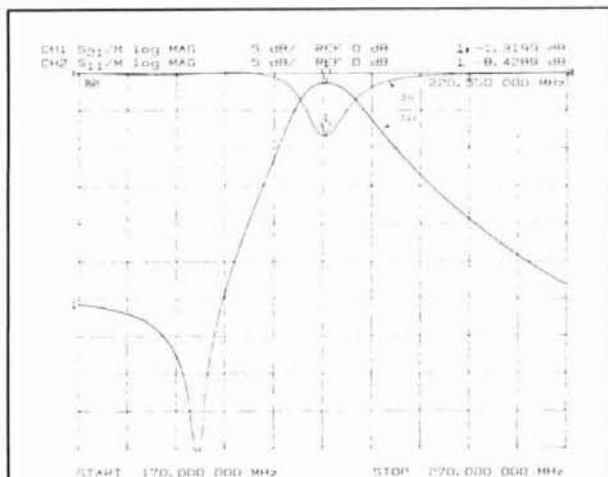

fig. 12. S11 and S12 of the filter. The forward transfer (insertion loss) of the filter is S12, while the return loss (related to input VSWR) is S11. This filter has about 1.3 dB insertion loss, and about 8 dB return loss. The notch is near the image frequency of the 220-MHz receiver.

181



INT'L MONTHLY MAGAZINE BY AND FOR ACTIVE RADIOAMATEURS

RADIOSPORTING

A magazine dedicated to quality and sportsmanship in amateur radio operating. Fresh, timely, practical and down to earth reading for little pistols and big guns. Written by world's best in their fields.

Includes DX News, QSL Info, 160 m, DXpeditioning, Propagation, Awards, contest rules and results, Traffic-Emergency, FCC News, New Products, Antennas, technical articles, equipment reviews and modifications, computer programs, Radio Funnies, Club Life, YL, RTTY, VHF/UHF, Mail Room, Classified Ads and much more in a magazine format with the speed of a bulletin.

RADIOSPORTING sponsors DX Century Award, Contest Hall of Fame, World Contest Championship and World Radio Championship contest.

"Your publication is superb! Keep it up!"

Joe Reisert, W1JR

"Your W2PV articles are priceless. Your magazine is super!"

Rush Drake, W7RM

"Let me congratulate you on a very impressive magazine. Just what I've been looking for as a DXer and Contester!"

Dick Moen, N7RO

"RADIOSPORTING, once received, cannot be tossed aside until it is read from cover to cover. Then reviewed again and again."

Chas Browning, W4PKA

Subscription rates: 1 year USA \$18, Canada CDN\$24, Overseas US\$21; 2 years \$33, \$44, \$39 respectively. Single issue \$2.

TRY US! SUBSCRIBE OR SEND \$1 FOR YOUR SAMPLE COPY.

RADIOSPORTING Magazine
PO Box 282, Pine Brook, NJ 07058, USA



182

plan to revise the modem circuits, utilizing surplus commercial 440-MHz equipment for the actual network.

NCP design

The next element in the system is a microprocessor performing as the network switching node. The node control processor (NCP, **figs. 13 and 14**) is an original design, though several modifications have been made since the original artwork was done. The design of the unit is conventional, with a few points emphasized for reliability.

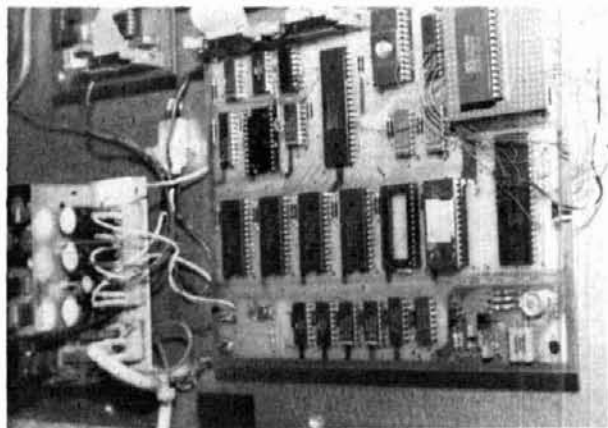

fig. 13. The Node Control Processor (NCP), version 1, with several modifications. A new version 2, which is a multi-channel super-set of the popular TNC-2 unit, is being designed.

The unit contains a Z80 operating at 4 MHz, 32K of EPROM, 32K of RAM, an SIO/2 serial communications IC for the serial HDLC ports, a counter/timer IC (labeled CTC and situated on the modification "ledge" overhanging the main board) for providing the interrupt clock time slices (of 8 ms), and two special circuits. Careful design of the NCP hardware and interrupt daisy chain to match the software was required for the computer to operate reliably at 9600 baud and support multiple HDLC channels simultaneously. All of the I/O devices utilize vectored interrupts through the Z80 interrupt daisy chain. **Figure 15** shows the entire TEXNET node prototype (both radios and modems, ac power supply, and the NCP).

We decided to develop our own board in order to keep costs down and allow the inclusion of two special circuits.

The first circuit is a reliable crystal oscillator. Many logic-gate type of crystal oscillators aren't reliable enough for use in remote, unattended computers. Numerous tests have shown that under certain voltage transients, gate-type oscillators won't start reliably. It's a nuisance to have to climb a tower to recycle the power just to restart a crystal oscillator, and inconvenient to users to have the network out of service during this time. The circuit chosen is a conventional Pierce type, with an additional transistor buffer amplifier. It was tested extensively and found to be robust. (One test to try on an oscillator is to feed the circuit from an adjustable voltage supply. Set the

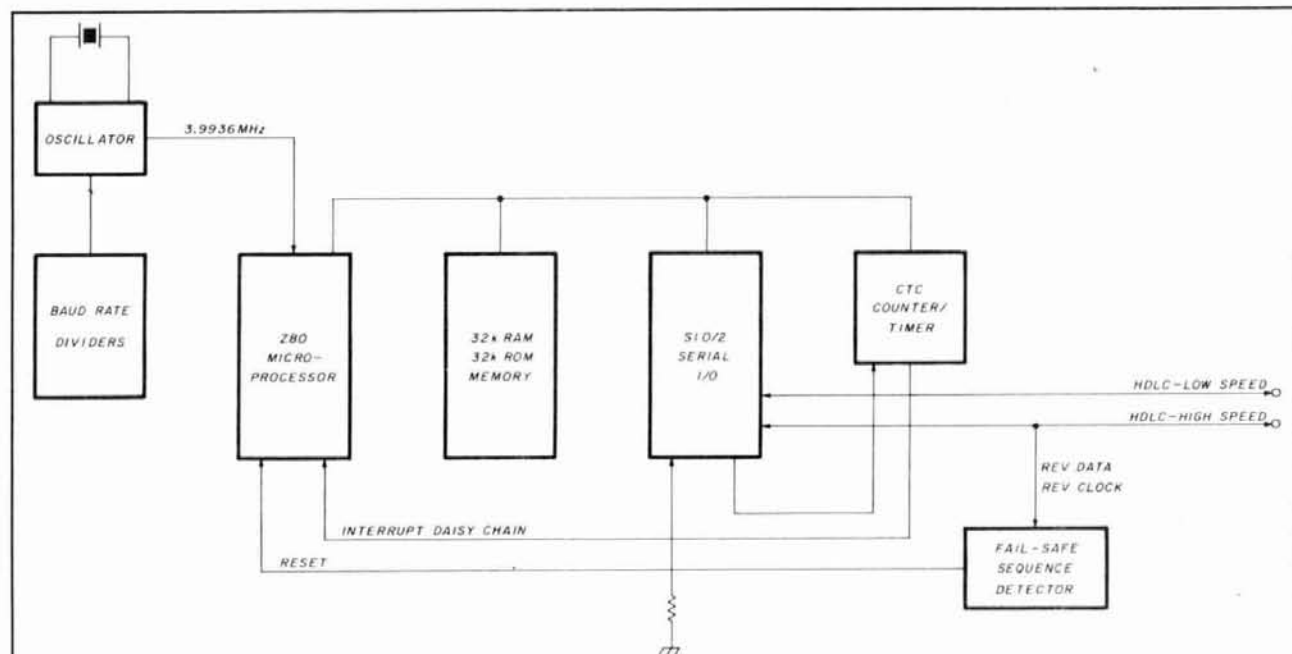

fig. 14. The NCP, showing the crystal oscillator, baud generator, microprocessor, 32 kbytes of EPROM, 32 kbytes of RAM, one HDLC synchronous communication IC, the counter-timer IC, and the fail-safe state machine.

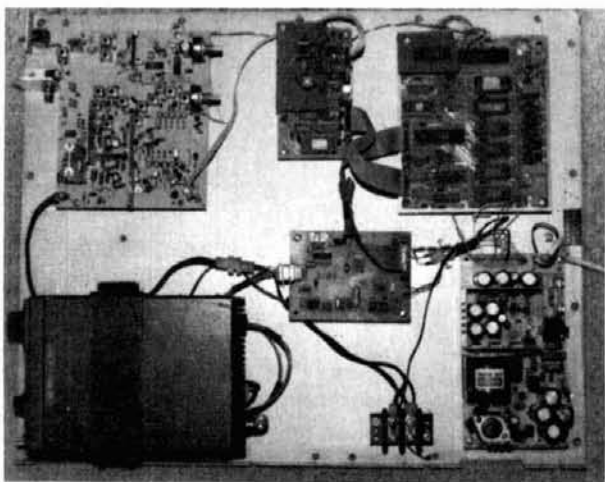

fig. 15. The complete TEXNET node prototype. This is the first prototype of the TEXNET node, which includes the NCP, high-speed modems, the 2-meter radio, the 220-MHz radio, and the ac power supply.

voltage to 0, turn on the power, and very slowly increase the supply potential to the nominal voltage — for example, over a period of 30 seconds. If the oscillator refuses to start, starts on the 3rd harmonic, or starts at the wrong frequency, the circuit should be rejected as unsuitable for unattended operation. Many logic-gate oscillators will fail this test.)

The second special circuit is a fail-safe state machine. This is an EPROM-based logic circuit that monitors the IP data and clock lines (from the high-speed trunk radio), completely independently of the processor or communication ICs. It searches for the presence of a very long (72 bit) sequence. If this sequence is ever detected, the state-machine activates the reset line on the microprocessor, thus restarting the node software. An EPROM contains both the value of the 72-bit sequence and the state-machine code necessary to operate the circuit. Each node is programmed with a different 72-bit sequence, which we've termed the "fire code." Any user of the network can cause the generation of a message with the fire code of a suspected node to be embedded in the message and sent via the network to the suspected node. Thus any node in the network can be rebooted (reset) from any other point within the network. There's a very small chance that ordinary user traffic through the network could resemble the fire code, but since the sequence is so long (72 bits), the mean time between false activation is calculated to be considerably more than 1 million years.

A new version of the NCP will include strappable options, and the circuitry for optional addition of the packet message system (PMS), a 5-megabit hard disk drive-based bulletin board that allows up to ten users

to be connected simultaneously. Automatically accessible from anywhere in the network, it's compatible with the WORLI command set (the most popular packet-radio bulletin board system). **Figure 16** shows the PMS prototype — the world's first turbo-charged TNC-2 clone! This test box contains an ac power supply (vertical), an MFJ-1270 (a TNC-2 clone) with WB5PUC ROM, a disk controller, and a 5-megabit hard drive. The Z80 microprocessor is removed from the TNC-2, and an adapter is plugged in its place. The Z80 plugs into the adapter. The ROM software for both the NCP and the TNC-2 are very similar, except that the NCP supports two radios (or more). The NCP is designed so that it is a superset of the TNC-2 hardware. (Further details will be found Part 3 of this series, which will address software design.)

This concept could be tested as a satellite gateway, perhaps with UOSAT-11, as a store-and-forward message system.

power supply

The power supply for the network node is extremely important in determining the reliability of the network. If the network is to be useful for handling emergency communications, it should be able to survive temporary power outages. Consequently, the TEXNET power supply utilizes a gelled-electrolyte (gel-cel) lead-acid battery, which can provide power for several hours and has a reasonably long life if properly charged and maintained.³ The power supply for the node utilizes +17 through +24 VDC as the input power source, unregulated (but filtered). The supply/charger (see **fig. 17**) regulates the input to +13.8 VDC through

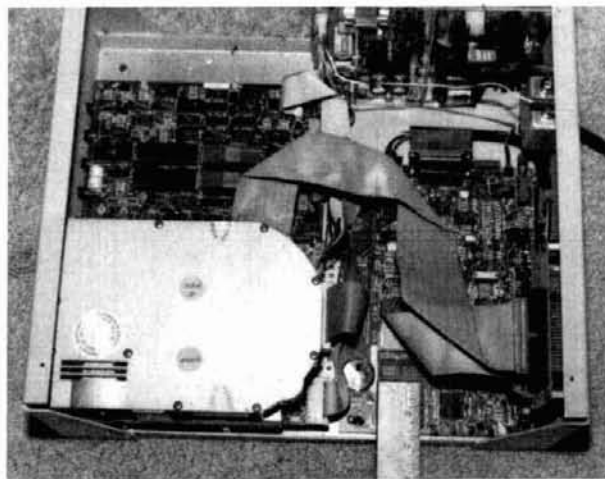

fig. 16. The Packet Message System (PMS), a 5-megabyte hard disk drive-based bulletin board, supports 10 simultaneous users. This prototype includes a TNC-2 clone, the hard drive controller boards, the 5-megabyte hard disk drive, and the ac power supply. A second version is connected to the node prototype, and is accessible from anywhere in the network.

a three-terminal, 10-amp regulator (LM396). The battery charge is controlled by a three-state temperature-compensated charger IC (a Unitrode UC3906). When the ac fails, a relay connects the battery to the load. A capacitor is used to hold up the +5 VDC load voltage for the switching time of the relay. Should the battery completely discharge (i.e., produce less than 12.0 volts dc), the relay protects the battery by disconnecting it from all loads, and the power fails.

The life of a battery is maintained only by very careful charging. This is the reason for the three-state charger. When the battery is initially depleted, it is charged at a constant current of C/10 (at 1/10 the ampere-hour capacity, that's a 10-AH battery charged

at a 1-amp current). When the battery voltage rises to nominal voltage (14.25 VDC), a controlled overcharge is initiated. Here the battery is charged at constant voltage (15.00 VDC) until the charge current decreases to C/100 (100 mA for a 10-AH battery). Failure to apply a controlled overcharge will result in the battery's receiving only 80 percent of its previous charge at 14.00 VDC. These voltages are for operation at +25 degrees C and for gel-cells. Liquid electrolyte batteries require different (i.e., lower) voltages. Variations in temperature require compensation in voltage; if compensation is not made, the battery will be severely undercharged at low temperatures and overcharged at high temperatures. The UC3906 contains most of the circuitry, and a temperature-dependent

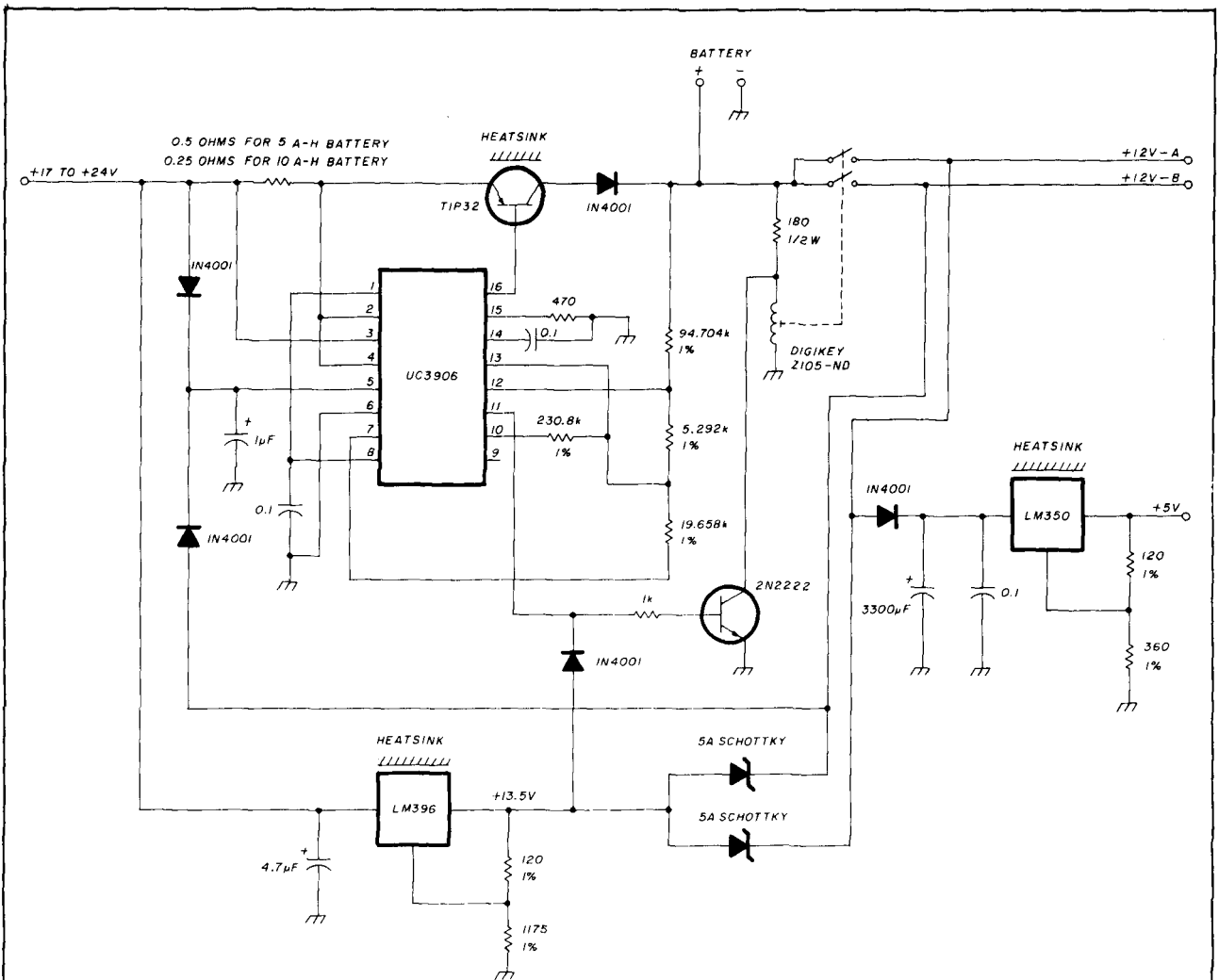

fig. 17. Schematic of battery charger/power supply. The battery charger/power supply is a three-state charger (see text) and power supply regulator. When ac power is present, the battery is charged and the three-terminal regulator supplies power to the node. When ac fails, the battery supplies power to the node. If the battery should completely discharge, the relay will disconnect all loads from the battery, thus protecting it. A large output capacitor on the +12VDC supply to the microprocessor voltage regulator supplies energy for the period of time it takes the relay to energize, preventing a momentary glitch in the +5VDC line.



RADIO HANDBOOK 23rd Edition

by Bill Orr W6SAI

Here are some of the highlights of this exciting new edition: New easy-to-use charts for Chebyshev and elliptic filter configuration, new data on power MOS-FETS, how to use state-of-the-art OP-AMPS, and home computer RTTY to name just a few examples. New projects include: GaAsFET preamps for 902 and 1296 MHz, easy-to-build audio CW filter, Economy two 3-500Z, 160 meter amplifier, multi-band amp using two 3CX800A7's, and a deluxe amplifier with the 3CX1200A7 tube. New antenna projects include: efficient Marconi design for 160 and 80 meters, computer generated dimensions for HF-Yagis, and a 2 meter slot beam. Also all the other information you count on Bill Orr for! You deserve the latest Radio Handbook.
23rd edition ©1986

22424 **Hardbound \$26.95**

Reg. 29.95 SAVE \$3

Please enclose \$3.50 to cover shipping and handling



ham radio magazine **BOOKSTORE**
GREENVILLE, NH 03048

voltage reference to accomplish this. An external pass-transistor increases the current handling capability to 1 amp. The relay/transistor circuit connects the battery to the load upon ac failure and disconnects the load when the battery is depleted.

Allowing the battery to remain connected to the load after it's depleted will destroy it. New Gel-Cel batteries can normally be expected to operate for six years when properly used; automotive-type batteries, which are designed for high surge currents, will normally have only about a three-year lifetime in a standby power applications and require different voltages. **Warning: this circuitry is meant only for 12-volt lead-acid gel-cel batteries; its use is not recommended for any other type of batteries. Using Ni-Cad batteries with this charger could result in an explosion.**

references

1. Thomas H. Aschenbrenner, WB5PUC, and Thomas C. McDermott, N5SEG, "The TEXNET Packet-Switching Network - Part 1: System Definition and Design," *ham radio*, March 1987, page 29.
2. Steve Good, K9NG, "Modifying the Hamtronics FM-5 for 9600 BPS Packet Operation," *Fourth ARRL Amateur Radio Computer Network Conference Proceedings*, page 45-51.
3. R. Valley, "IC Provides Optimal Lead-acid Battery Charging Cycles," *EDN*, October 31, 1985, page 163.

ham radio

the HAM STATION

P.O. Box 4405
220 N. Fulton Ave.
Evansville, IN 47710

Store Hours
MON-FRI: 9AM - 6PM
SAT: 9AM - 3PM
CENTRAL TIME

SEND SASE FOR NEW & USED SHEETS
WARRANTY SERVICE CENTER FOR:
ICOM, YAESU, TEN-TEC

TERMS:
Prices Do Not Include Shipping.
Price and Availability Subject to
Change Without Notice
Most Orders Shipped The Same Day

COD's Welcome

YAESU



FT-767

- HF/VHF/UHF Base Station
- Plug-in Modules for 6m, 2m, 440 MHz
- Loaded with Features
- \$ SPECIAL PRICE \$**
- FT-23R with DTMF Keypad
 - Mini 2 meter
 - 2w or opt. 5w
 - 10 memories
 - memory and band scan

TEN-TEC PARAGON



- General Coverage HF Transceiver
- Rec. 100 kHz-29.999 MHz
- TR 1.6 MHz-29.999 MHz
- Microprocessor Controlled Digital PPL Synthesizer, 10Hz Resolution
- 62 High Capacity Memories
- Dual Built-In VFO's
- American Made

WELZ



Power Meters

- Large Selection of Meters
- Always on Hand
- \$ SPECIAL PRICE \$**

concept

VHF/UHF AMPS

- High VSWR and Overdrive Protection
- 5 Year Warranty, 6 Months on RF Transistors
- All Units have GaAsFET Receive Pre-amps

ICOM



IC-μ2AT

- Pocket-Sized 2 Meter HT
- TX-140-150 MHz, RC 139-174 MHz
- 10 Memories and a LCD Readout

\$ SPECIAL PRICE \$



IC-735

- Most Compact and Advanced Full-Featured HF Transceiver on the Market.

\$ SPECIAL PRICE \$

DISCOUNTS ON RIGS AND ACCESSORIES FROM: AEA, ARRL, ALINCO, ALLIANCE, ALPHA-DELTA, AMECO, AMERITRON, AMP SUPPLY, ANTENNA SPECIALISTS, ASTRON, BENCHER, BUTTERNUT, B & W, CSI, CALLBOOK, CUSHCRAFT, DAIWA, DIAMOND, ENCOMM, HAL, HEIL, HUSTLER, ICOM, KDK, KANTRONICS, KENPRO, LARSEN, MFJ, MICROLOG, MIRAGE/KLM, NYE, PALOMAR, RF CONCEPTS, ROHN, SANTEC, SHURE, TE SYSTEMS, TELEX/HYGAIN, TEN-TEC, TOKYO HY-POWER, VIBROPLEX, W2AU BALUNS, WELZ, YAESU

For Orders and Price Checks Call **800-523-7731**

Indiana and Information
Call 1-812-422-0231

DESIGN EVOLUTION IN RF P.A.'s

Now with
GaAs FET
Preamp



- Linear (all mode) RF power amp with automatic T/R switching (adjustable delay). Amplifier useable with drive powers as low as 1/2 watt.
- Receive preamp option, featuring GaAs FETS (lowest noise figure, better IMD). Device NF typically 5 dB.
- Thermal shutdown protection incorporated
- Remote control capability built-in
- Rugged components and construction provide for superior product quality and performance
- All models include a complete operating/service manual and carry a factory warranty on all components
- Designed to ICAS ratings, meets FCC part 97 regulations
- Approximate size is 2.8 x 5.8 x 10.5" and weight is 5 lbs.

Specifications/price subject to change

MODEL	FREQUENCY 2	OUTPUT POWER	INPUT POWER	PREAMP
	(MHz)	(W)	(W)	NF GAIN
0508	50-54	170	1	- -
0508G	50-54	170	1	6 15
0510	50-54	170	10	- -
0510G	50-54	170	10	6 15
1410	144-148	160	10	- -
1410G	144-148	160	10	6 15
1412	144-148	160	30	- -
1412G	144-148	160	30	6 15
2210	220-225	130	10	- -
2210G	220-225	130	10	7 12
2212	220-225	130	30	- -
2212G	220-225	130	30	7 12
4410	420-450	100	10	- -
4410G	420-450	100	10	1.1 12
4412	420-450	100	30	- -
4412G	420-450	100	30	1.1 12

1. Models with G suffix have GaAs FET preamps. Non-G suffix units have no preamp.
2. Covers full amateur band. Specify 10 MHz Bandwidth for 420-450 MHz Amplifier.

★SEND FOR FURTHER INFORMATION★

TE SYSTEMS

TE SYSTEMS
P.O. Box 25845
Los Angeles, CA 90025
(213) 478-0591

EXPLORE HF PACKET TNC VHF/HF SWITCH KIT

FEATURES

- All CMOS logic switch
- Changes filter/timing parts for VHF or HF
- Self contained — Fits inside the TNC case
- No recalibration of tones
- Same precise tones as original
- Easy to build and install
- One hour average
- Prime quality parts

Now you can use your TAPR TNC-2 or TNC-1 (or any close clone — AEA, MFJ, Heath, Paccom, etc.) on both VHF at 1200 baud and HF at 300 baud. The flick of a switch changes critical filter and timing components to optimize the TNC's on board modem for VHF or HF operation. The APA switch uses all CMOS logic, has a current drain of less than 5ma and fits conveniently inside the TNC case. It is easy to build and install; takes less than an hour in most cases. APA supplies prime parts and IC and complete step by step instructions. You bought the best TNC — now make it complete. \$30 air-mail postage paid. Send check or money order (no credit cards please.)

AMATEUR PACKET ALASKA
AX.25 COMMUNICATIONS TRAIL
ESTER, ALASKA 99725

✓ 178

THE MULTIPLE RECEIVER SOLUTION



4 Channel Signal-to-Noise Voter

- Expandable to 32 Channel by Just Adding Cards
- Continuous Voting
- LED Indicators of COR and Voted Signals
- Built-in Calibrator
- Remote Voted Indicators Pinned Out
- 4 1/2 x 6 Double Sided Gold Plated 44 Pin Card
- Remote Disable Inputs
- MORE

Built, tested and calibrated with manual

\$350.00

NEW PRODUCT

Telephone interface now available
For more information call or write:

HALL ELECTRONICS
Voter Department
815 E. Hudson Street
Columbus, Ohio 43211
(614) 261-8871

✓ 179

COMB

Authorized Liquidator



12-BAND RADIO

World-Wide Listening Excitement...is yours with this incredible Magnavox Model D1835 Multiband Radio that's portable! Due to an overstock, it's yours at a **LOW liquidation price!**

- A Number of Listening Choices: 9 Short Wave Bands, Plus Long Wave and Local AM/FM Bands.
- Lets You Tune-In Overseas Broadcasts and Listen to Action All Over the World, Plus Receive Local Music, News, Weather, and Sports Broadcasts.
- Lightweight. Easy to Carry Anywhere.
- Compact. Fits in Your Purse or Attache.
- Large Rotary Tuning Knob.
- LED Slide Rule Tuning Indicator.
- Dynamic 3" Diameter Speaker.
- Telescoping 29 1/2" L FM/SW Antenna.
- Band Selector. Volume/Tone Controls.
- Uses 4 "AA" Cells (Not Included). Size: 5"H x 7 3/4"W x 1 1/2"D. FCC Registered.

90-Day Limited Factory Warranty On Parts/Labor.

Mfr. List Price **\$69.95**

\$44

Liquidation
Priced At

Item H-2360-7127-509

Shipping, handling: \$4.50 each



Credit card members can order by phone, 24 hours a day, 7 days a week.

Toll-Free: 1-800-328-0609

Sales outside the 48 contiguous states are subject to special conditions. Please call or write to inquire.

SEND TO: Item H-2360

C.O.M.B. Direct Marketing Corp.
1405 Xenium Lane N/Minneapolis, MN 55441-4494

Send Magnavox Multiband Radio(s) Item H-2360-7127-509 at \$44 each, plus \$4.50 each for ship. handling. (Minnesota residents add 6% sales tax. Sorry, no C.O.D. orders.)

My check or money order is enclosed. (No delays in processing orders paid by check.)

PLEASE CHECK: VISA MasterCard DISCOVER AMERICAN EXPRESS

Acct. No. _____ Exp. / _____

PLEASE PRINT CLEARLY

Name _____

Address _____

City _____

State _____ ZIP _____

Phone (____) _____

Sign Here _____

COMB COMB COMB

COMING SOON 1986-87 ARRL Repeater Directory

\$5.00 postpaid from ham radio Bookstore
Greenville, NH 03048 (603) 878-1441

Performance, Reliability, and Customer Support: The Winning Team

While attractive front panels and impressive magazine advertisements may initially glamorize any amateur radio item, they can also reflect the classic proverb of beauty being only skin deep. The favorable returns from any unit and the success of its manufacturer, however, are directly influenced by **after-purchase reliability and factory-backed service**. Knowledge of such performance records and readily available customer support encourage the peace of mind to use and enjoy a new unit to its maximum potential.

ICOM considers the aspect of service from two interrelated standpoints: daily in-field use and possible "down the line" repairs if, and when, needed. This concept is pursued by first building **professional communications quality and reliability into every unit**, confidently backing it with a full warranty, then substantiating that dependability with **uncompromised factory authorized service and customer support**. All ICOM HF transceivers and shortwave receivers reflect that philosophy with their **full one-year warranties**...and service centers that are not bottlenecked with backlogs (stout performers simply give less trouble). ICOM isn't playing down customer support, but building a positive long-term reputation on it!

Today's era of advanced technology and seemingly endless consumers tends to replace old-

time "concerned treatment" with attitudes of "being one of a vast number in line." Returning a unit for adjustment or repair and later attempting to check its status sometimes proves to be a frustrating experience. While no one is infallible, ICOM honestly strives to avoid an attitude of "too many customers to provide congenial service." ICOM's customer service **hotline** at (206) 454-7619, for example, will put you directly in touch with the main service department. The only prerequisite is **mutual understanding** in sharing this resource so everyone can have queries answered and radios repaired. If a problem can't be alleviated via telephone, ICOM strives for a service center "turnaround time" of three to five days.

Continuing that customer support, **ICOM is the only amateur radio company with four factory-owned service centers in North America**. The centers are located in Atlanta, Georgia; Dallas, Texas; Bellevue, Washington; and Vancouver, British Columbia. Most ICOM service centers are also situated near major airports to further minimize transportation problems.

The amateur radio industry is ICOM's major interest; it's not a sideline or spin-off of other pursuits. ICOM doesn't manufacture stereos, VCRs, or televisions. ICOM is communications industry oriented with secondary involvement in top quality marine, land mobile, and avionics equipment.

The stouthearted reliability of ICOM equipment is continuously praised in testimonial letters from proud owners. A few samples from those "believe it or not" files include stories of transceivers literally drowned in salt water two or three hours, yet continuing to operate flawlessly...of no failures to date in the IC-735 and IC-751 power amplifiers...of handheld transceivers dropped from towers, and one was even run over by a truck(!), yet continued to operate after outer case repairs (fortunately, ICOM handhelds include a separate metal frame to protect PC boards and a high impact plastic "outer case").

The next time you switch on a deluxe HF transceiver, compact VHF mobile rig or handheld FM unit, pause a couple of seconds and think about its less apparent aspect of customer support and service. Who would you call if a problem arose, what would be their attitude, and approximately how long might you anticipate being off the air? If you're a proud ICOM owner, those answers are reassuring rather than aggravating.

Again, ICOM's dedication to top performance, exceptional reliability and unsurpassed customer support may not be visible on a front panel or in a colorful ad, but they're **included in every ICOM item**. ICOM equipment is simple to use and the best in quality. It's "Simply the Best" and an increasing number of amateurs are proving that statement in their setups every day. Isn't it time you, too, joined the ICOM winning team?



GET ON THE AIR WITH THE BEST

All Novices Can Now Talk on 220MHz, 10 meters and 1.2GHz.

ICOM extends congratulations to privilege-enhanced Novices, and invites everyone to extend their horizons with ICOM!

ICOM is the only amateur radio manufacturer hosting a full product line especially geared toward privilege-enhanced Novices (and Technician: joining 10-meter activity). Whether your interests include 1.2GHz, 220MHz, HF bands, FM, CW, or SSB, choosing ICOM gear means going First Class.

Explore 1.2GHz DX attractions and local activities with pacesetter ICOM gear. The all mode IC-1271A base station transceiver includes numerous de-

luxe features and is expandable with your future interests. FM mobiling pleasures begin with ICOM's new 10 watt IC-1200A which is easy to install and operate. Every amateur enjoys handheld portable operations, and ICOM's deluxe IC-12AT handheld is ready to go.

Experience 220MHz activities using top quality ICOM equipment. For your multi-mode interests is the new IC-375A 25-watt base station transceiver: a true masterpiece of modern technology. ICOM's ultra slim IC-37A and compact IC-38A are ideal 25-watt mobile units. For a versatile and rugged handheld, choose the deluxe IC-03AT or the ever-popular IC-3AT.

Enjoy HF QSOs worldwide and depend on ICOM transceivers for top communications performance. The exciting new IC-761 offers you superb "everything in one cabinet" operation. Or there's the ICOM deluxe midsize transceivers, the IC-751A and IC-745. The IC-735 is today's most popular fixed/mobile rig. Also, friends, all ICOM HF transceivers include a full one-year warranty.

ICOM Accessories are interchangeable. Use them with ICOM's 2-meter and 440MHz gear when you upgrade!

Get on the Air with ICOM and explore 1.2GHz, experience 220MHz, and enjoy HF QSOs.



ICOM
First in Communications

ICOM America, Inc., 2380-116th Ave. N.E., Bellevue, WA 98004 Customer Service Hotline (206) 454-7619
3150 Premier Drive, Suite 126, Irving, TX 75063 / 1777 Phoenix Parkway, Suite 201, Atlanta, GA 30349
ICOM CANADA, A Division of ICOM America, Inc., 3071 - #5 Road, Unit 9, Richmond, B.C. V6X 2T4 Canada

Hamilton Worked All Quagmires



You'll
find us in
Dayton,
April 24-26

ege, inc.

EGE VIRGINIA
13646 Jefferson Davis Highway
Woodbridge, Virginia 22191
Information: (703) 643-1063
Service Dept: (703) 494-8750
Store Hours: M-Th: 10-6
F: 10-8
Sat: 10-4

Order Hours: M-F 9-7
Sat: 10-4

EGE NEW ENGLAND
8 Stiles Road
Salem, New Hampshire 03079
New Hampshire Orders,*
Info & Service: (603) 898-3750
or call 800-336-4799

Store Hours: MTWTF: 10-4
ThF: Noon-8

*Order & we'll credit you \$1 for the call



Our associate store
Davis & Jackson Road, P.O. Box 293
Lacombe, Louisiana 70445
Info & Service: (504) 882-5355



Terms: No personal checks accepted.
Prices do not include shipping. UPS
COD fee \$2.35 per package. Prices are
subject to change without notice or
obligation. Products are not sold for
evaluation. Authorized returns are sub-
ject to a 15% restocking and handling
fee and credit will be issued for use on
your next purchase. EGE supports the
manufacturers' warranties. To get a
copy of a warranty prior to purchase,
call customer service at 703-643-1063
and it will be furnished at no cost.

Spring Buyer's
Guide/Catalog
Available - Send \$1.

Antennas

Amateur HF Bands
Cushcraft, Butternut, KLM,
Mosley, Hy-Gain, Mini-
Products, B&W, Van Gorden,
Hustler, Larsen, Antenna
Specialists, Centurion, Smiley

Antennas in Stock
for Mobiles, Base Stations,
and Handhelds

Everything from mini rubber
duckies to huge monobanders

ASK FOR PACKAGE
DEALS ON ANTENNAS
AND ACCESSORIES

Also...

Antennas for Scanners, CBs,
Marine, Commercial, and
Short Wave Listening

YAESU ICOM KENWOOD



FT 23/73
Mini Handhelds
for 2m/440 MHz

FT 727R
2m/440 MHz Dual Band HT



FT 767GX
All Mode Transceiver
with CAT System



FRG 8800
General Coverage Receiver
All mode 150 kHz-30 MHz



FRG 9600
Scanning Receiver
or 60-905 MHz FM/AM/SSB



IC 751A
HF Transceiver with
General Coverage Receiver



IC 3200
2m/440 MHz Mobile



IC 271A
2m Transceiver



R 7000
General Coverage Receiver



Micro 2AT
Mini 2m Handheld



IC 02AT/04AT
Handheld for 2m/440 MHz



TS 440S
HF Transceiver
with Antenna Tuner



TS-940S
HF Transceiver with
General Coverage Receiver



TS 201B/401B
2m/440 MHz 45-Watt Mobile



TH 215AT
2m FM Handheld



TH 21BT/31BT/41BT
Mini Handhelds
for 2m/220 MHz/440 MHz



R 5000
General Coverage Receiver

**SPECIAL
PACKAGE
DEALS FOR
NOVICES**
Radios/Antennas
Call for info

TEN-TEC



RX 325
Short Wave Receiver



Corsair II
Model 561 CW/SSB
Transceiver

KDK



FM 240
Compact 2m Mobile Radio

More Radios

ALINCO
Radios Now in Stock

**SONY
PANASONIC**
Receivers

**REGENCY
BEARCAT**
Scanners

MIDLAND
CB Radios

COBRA
CBs, Radar Detectors, Phones

UNIDEN
CBs, Radar Detectors

WHISTLER
Radar Detectors
Southwestern Bell
Telephones

Towers

**UNARCO-ROHN
TRI-EX
HY-GAIN**

Ask for package quotes on
complete tower assemblies
including Phillystran, guy
wire, antennas, rotators, etc.

ROTATORS
Kenpro, Alliance, Daiwa,
Telex Hy-Gain

Computer Stuff

Packet Controllers
Katronics and MFJ

Amateur Software
Ham Data Software for
Commodore Computers
Ask for Descriptions

RTTY/Morse/Amtor
Hardware and Software and
packages by Kantronics,
Microlog, HAL, MFJ, & more

Accessories

AMPLIFIERS
Vocom, Daiwa, TE Systems,
Amp Supply, Mirage, Alinco,
Ameritron, Tokyo Hy-Power

ANTENNA TUNERS
Amp Supply, Ameritron, MFJ

**Switches, Couplers, Filters,
Connectors, Mikes, Keys,
Paddles, Headsets, Clocks,
Books, Power Supplies**

For Orders & Quotes Call Toll Free: 800-336-4799
In New England Call 800-237-0047 In Virginia Call 800-572-4201

grounding, shielding, and isolating: part 1

Most users of electronic equipment have to face problems of grounding, shielding, and isolating in order to prevent EMI (electromagnetic interference). Amateur Radio operators have an especially difficult problem because their equipment often must operate on the same desk as their high power radio transmitters. EMI is also caused by local electrical disturbances such as arcs, lightning discharges, and electrical motors.

The flip side of the EMI problem is prevention of interference to other equipment — such as televisions, radios, stereo systems, and other entertainment equipment — caused by Amateur transmitters. We must operate our stations in a manner that won't interfere with properly designed, properly operated equipment that's in good repair. Electronic equipment must do two things: respond to desired signals and reject undesired signals. There's not much we can do if the equipment fails to do the latter; if it meets both tests, however, our efforts can help profoundly.

In this installment, we'll discuss methods of preventing interference from outside and cross-interference between circuits or equipment in our own stations.

preventing EMI

Shielding and filtering of signal lines is the key to preventing EMI. Figure 1 shows a "generic" electronic device with several of the possible EMI protection methods used. This type of circuit could be a microphone input preamplifier, a receiver accessory, or some other piece of equipment. First, note that the entire instrument is built

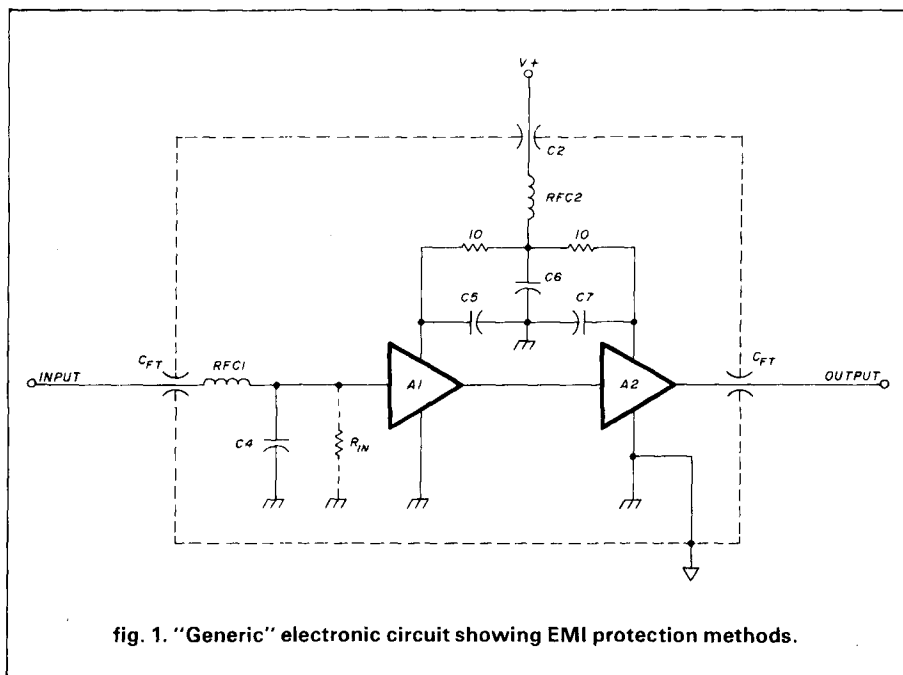

fig. 1. "Generic" electronic circuit showing EMI protection methods.

inside a shielded metal box, and the box is grounded. Points of entry and exit incorporate feedthrough "EMI filter" capacitors (C_{FT}) (500 pF to 0.002 μ F). Each stage is isolated from other stages by a resistor, and has its own decoupling capacitor ($C5$ and $C7$). The main power bus is decoupled ($C6$), and has a series rf choke ($RFC2$) to filter rf that gets past $C2$ and prevents it from interfering with the operation of the circuit. The input leads are similarly filtered with $RFC1$ and $C4$. The input resistance R_{IN} of the amplifier and the reactance of capacitor $C4$ also form a low-pass filter with a frequency response that rolls off at a 6 dB/octave rate from the -3 dB point defined by:

$$f(\text{Hz}) = \frac{10^6}{6.28 \cdot (C4) (R_{IN})}$$

where: f is the frequency in Hz, $C4$ is in μ F, and R_{IN} is in ohms.

One potential source of interference is noise and other EMI signals on power lines. I can recall troubleshooting digital instrumentation and computers in a medical school building. We found that the ac power lines were the source of the problem. Where sensitive electronic instruments are used, one might want to consider designing the electrical system to be either isolated from the building system or have separate neutral and ground conductors all the way back to the building's electrical service entrance ground.

Figures 2 and 3 show methods for dealing with power line noise. In fig. 2, we see an LC power line filter. Although the version shown here uses just one LC section, others are available (at higher cost) with two or more sections. These devices are shielded low-pass filters, and are mounted inside equipment as close as possible to the point where ac enters the cabinet.

PRICE CUTS

ARNOLD COMPANY

NEW PHONE: 214-395-2922 FOR SUPER FAST SERVICE!

LOWER PRICES

COMMANDER XT



XT System Foundation 640K Commander Mainboard 256k disk installed high grade system case 150 watt power supply w/ all hardware & speaker Manual
Special \$259

INTRODUCING OUR NEW TURBO AT COMPATIBLE



Dual Speed IBM AT Compatible

68 MHz 80286 AT Compatible Mainboard
112K Ram Installed (up to 1 Meg on board)
Built-in Clock/calendar - battery backup
Fully Compatible BIOS Written in U.S.A.
200 WATT 1A approved Power Supply
AT System Case with Keyboard
500K AT Tactile Fast Keyboard
1.2 MB or 384K Floppy Drive &
WD HD/Floppy Controller
Assembled and Tested
\$1069
\$49
Combo AT Parallel/Serial Card

Complete 20 Meg AT with TTL Monitor \$1699

Add \$15 Shipping

IBM PC/XT SOFTWARE ETC

COPY/PC	\$29.99
COPY/PC OPTION BOARD	\$89.99
MIRROR (Cassette Kiosk)	\$45.99
Tactile word Processor	\$19.99
Digital Driv'e Diagnet	\$95
PRINTMAS/16	\$39.99

PUBLIC DOMAIN SOFTWARE
\$4.00/Disk

PC FILE DATABASE	PC-CALL SPREADSHEET
PC WRITE	RETAIL SALES 2DISK
CHURCH MANAGEMENT	FARM ECONOMICS
STOCK TRACKING	COMMODITIES TRACKING
PC DEMO SYSTEM	PRO-COMM COMM
SIDERICK R/LOG	DOS-FILE UTILITIES

DIGITAL DRIVE DIAGNOSTIC

Test and Align your own drives using your computer. WITHOUT a Scope or costly equipment. Easy to use and accurate. Tests Speed, Clamping, Alignment, Azimuth, Hysteresis. For IBM PC compatible MS-DOS computers. Includes Dyan Alignment Disk, Program and Comprehensive Manual
\$89

TERMS:

Shipping \$3.00 per order unless otherwise stated. C.O.D. add \$1.90 extra. Texas residents add 6.25% tax. Certified Check or Money Order shipped same or next day. Personal checks may be held 10 days. C.O.D. orders welcomed. Give us a call (214) 395-2922. We ship UPS ground. Air available at extra charge. Give us a call for fast friendly service. FREE flyer sent with each order. VISA/MC ADD 4% Non-defective returns subject to restock fee.

ARNOLD COMPANY Computer/Electronic Supply P.O. Box 512, Commerce, Texas 75428.

BUDGET ENTRY SYSTEM

A Complete 1 Drive System of Economy
• Commander XT - board with 256k installed up to disk on board (if using Commander Base)
• 150 Watt Hard Disk ready Power Supply
• Extra Heavy Gauge System Case
• Color/Monochrome Graphic Adapter
• AT style keyboard with orange Return - Caps/num lock light
• Just slot it together, connect cables and start computing!
• All boards fully assembled and tested!
• Assembly instructions, 10 day money back offer, 90 day warranty!

Special \$447
Plus \$12.00 shipping each

THE EXECUTIVE SYSTEM

A 2 Drive System Loaded With Extras \$629

COMMANDER XT with 256K Memory Installed
Slide Case and 150 Watt Power Supply
AT Keyboard with Crisp Keystroke
DISK I/O (Floppy, Ser, EDC, Clock/Cal, Game Port)
Dual Ultra Quiet reliable flat height Drives
Color Graphics w/ TTL Display Card



TRS-80 MODEL III CPU BOARDS LIMITED SUPPLY!

Motherboards are surplus and come with 2 80 Character rom, and other components. Each is complete except ROM-RAM. One punch hole in each board is easily repaired. Not surkers that have had all the socketed chips removed! Each is a refurbishable unit. W/Doc. \$13.95

EVEREX MODEM



Latest Technology! 1200/300 Baud Internal Half-Duplex Modem for IBM. Includes Software. Features Full Hayes Compatibility. Introductory Price \$105
2400 Baud Modem \$209

MASTER POWER PANEL

All Steel - Surge protecting master power control panel with separate illuminated switch for each of five peripheral. All 1/2 inch bulk cable - 10 amp. Surge/Spike protection panel for continuously between Computer and Monitor.
Water-tight - 3/16" Special \$47.95



PROTECTED POWER STRIP
6 x 4 switched plus illuminated switch and speaker surge protection at low cost \$8.95

FLOPPY DRIVE CASE

New grey 2 piece non-aluminum case for 1/2 or 5/8 inch drives \$8.95 ea or 7
1500 5 1/4" Diskettes w/Envelopes, Labels 100 for \$39
1/2 inch Top Loading 5 1/4" Disk Box \$12.95

IBM PC/XT COMPATIBLES

COMMANDER XT



20 MEGABYTE MASTER BUSINESS SYSTEM
OUR MOST POPULAR SYSTEM ON SALE \$929

COMMANDER XT with 256K Memory installed
Slide Case with 150 Watt Power Supply
AT Keyboard with Crisp Keystroke
DISK I/O (Floppy, Ser, EDC, Clock/Cal, Game Port)
Ultra Quiet & Reliable Flat Height Drive
JD Modulator H/H/H Hard Drive & Controller
Color Graphics w/ TTL Display Card

20 Megabyte hard Disk System includes Drive, Controller, Cables Manual, 1 Year Warranty \$369

BUILD YOUR OWN CLONE

PACKAGED CASE 1150 WATT Mainboard/256K	\$259
COMMANDER XT & 17 speed Mainboard w/Commander BIOS. The Main include in the adjust! Up 640K on board.	\$100
Maximum compatible W/O	\$100
8 Meg 4 layer Ultra Stable Turbo W/BIOS & OK	\$139
DISK I/O (FDC, Floppy, Ser, Cal, Game, Cable)	\$85
Floppy Disk Controller only for 2 Dr. W/ Cables	\$30
HARD DRIVE CONTROLLER W/CABLES	\$99
ADAPTEC 20T0A RLL Hard Disk Ctrl Increase	\$139
Disk Capacity by 30%	\$59
Color/Mono Graphics Card (like IBM CGC)	\$65
Monochrome Display Card	\$65
Hard Compatible Mono Graph W/Port port	\$79
EVEREX ENHANCER EGA W/ported port	\$239
EVEREX 1200 BAUD INTERNAL MODEM	\$105
EVEREX 800M SPEED DUP BOARD FOR XT	\$109
Parallel printer adapter	\$28
Serial Async Comm. Adapter	\$35
AT PAR/SERIAL ADAPTER	\$59
AT FLOPPY/HARD DRIVE CONTROLLER	\$200
AT KEYBOARD	\$60
AT CASE	\$60
IBM 6 FT PAR/PRINTER CABLE	\$10
IBM 12 FT PRINTER PAR/PRINTER CABLE	\$17
IBM 6 FT SERIAL CABLE DB 25 M/F	\$10
COPY/PC OPTION BOARD	\$89.99
PC/XT KEYBOARD, OEM 5150 STYLE	\$55
SELECTRIC XT KEYBOARD GREAT FEEL	\$59
AT STYLE KEYBOARD FOR XT OUR FAVORITE	\$59
5 1/4" STYLE WITH SEPARATE CURSOR PAD	\$59
CASE - HIGH GRADE SLIDE XT TYPE	\$37
WHARFWARE	\$37
CASE - HIGH GRADE FLIP TOP	\$37
WHARFWARE	\$37
18 X 18 X 18 W/SPRING (BY 1281)	\$89.99
360 LATEST TECH JAPAN DRIVES	\$89.99
W/5 1/4" SYSTEM	\$27
256K RAM (8 CHIPS)	\$9
64K RAM (8 CHIPS)	\$9
640K (18 256K & 18 64K)	\$72
1/2" COMPOSITE VIDEO MONITOR	\$69
1/2" TTL MONOCHROME MONITOR	\$99.99
HIGH RES RGB MONITORS	from \$329
EGA MONITORS, MITSUBISHI FROM	\$499

IBM PC XT is a registered trademark of International Business Machines Corp.
Dealer Inquiries Welcome

Arnold Company Also stocks a full line of RF & Computer Connectors. Call us for competitive pricing

SPECIALISTS IN FAST TURN P.C. BOARDS

PROTO TYPE P.C. BOARDS AS LOW AS \$25.00

- SINGLE & DOUBLE SIDED
- PLATE THROUGH HOLES
- TEFLON AVAILABLE
- P.C. DESIGN SERVICES

FOR MORE INFORMATION _____



34374 EAST FRONTAGE ROAD
BOZEMAN, MT 59715 (406) 586-1190

✓ 172

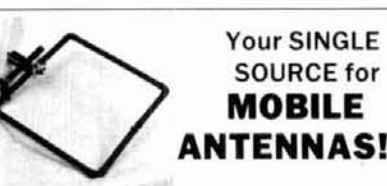

Your SINGLE SOURCE for MOBILE ANTENNAS!

NEW... 2 meter squared SSB mobile \$45.00

Bug Catchers... still the best HF mobile antenna 250 watt & 1kw sizes 80-10meters (we pay shipping on above items)
Call for other antennas available—both commercial and amateur

MISSION COMMUNICATIONS

11903 Alief Clodine Rd #500
Houston, Texas 77082
713-879-7764
telex 166872 MCON UT
(MC/VISA/COD)

✓ 173



RFI KIT

Use ferrite beads and toroids to keep RF out of your TV, stereo, telephone, etc.

Free catalog and interference tip sheet on request.

PALOMAR ENGINEERS

Box 455, Escondido, CA 92025
Phone: (619) 747-3343

IF YOU BUY, SELL OR COLLECT OLD RADIOS, YOU NEED...
Antique Radio's Largest-Circulation Monthly Magazine



ANTIQUERADIO CLASSIFIED

Articles - Classifieds - Ads for Parts & Services.
Also: Early TV, Ham Equip., Books, Telegraph, 40's & 50's Radios & more...
Free 20-word ad each month. Don't miss out!
Sample - Free. 6-Month Trial - \$10.
1-Year: \$18 (\$24 by 1st Class). Foreign - Write.
A.R.C., P.O. Box 2-A-2, Carlisle, MA 01741

✓ 170

AMATEUR RADIO MAIL LISTS

Self-stick 1x3 labels

*** NEWLY LICENCED HAMS ***
*** ALL NEW UPGRADES ***
*** UPDATED EACH WEEK ***
Total List = 462,728 (ZIP sorted)
Price is 2.5 cents each (4-up Cheshire)

BUCKMASTER PUBLISHING
Mineral, Virginia 23117
703-894-5777

✓ 171

✓ 169

✓ 200

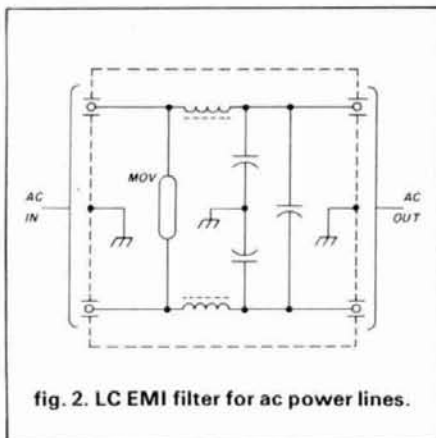

Some filters are available molded into the ac chassis connector.

Also in the circuit is a Metal Oxide Varistor (MOV) device used to suppress ac line transients above about 155 volts peak (some can reach 2000 volts for 30 microseconds). Power line transients can have surprisingly sharp rise times, and thus are capable of producing interference across a wide portion of the spectrum. Because of this some designs have these MOV devices ahead of the filter in order to reduce the intensity of peaks that contain high frequency components.

There is an issue regarding EMI filters that some people overlook: fusing. Ideally, the fuse should be as close as possible to the point where the ac line enters the cabinet. If the fuse is placed downstream from the filter, the equipment won't be protected if components of the EMI filter short to ground. If the ac power line is routed through the fuse holder before passing through the EMI filter, on the other hand, there's enough prefiltered wiring to form an antenna and radiate into the other circuits. As a result, I prefer to build the fuse either into the EMI filter (or an extra shielded compartment that also houses the EMI filter) or into a fused ac plug at the wall outlet.

The Topaz transformer shown in fig. 3 performs three functions. First, it isolates the equipment electrical system from the ac electrical system. Second, it frequency-limits the system to prevent high frequency transients

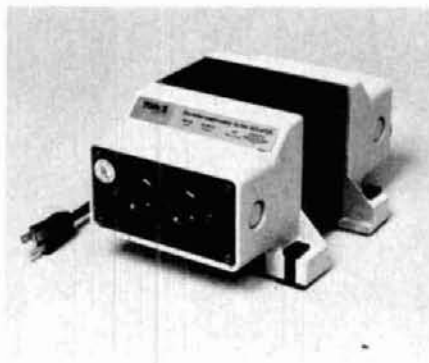

Power line isolation transformer (Courtesy Topaz Electronics, San Diego, CA).

and pulses from passing into the equipment. Third, it provides a locally isolated ac power mains system that isn't ground referenced, making death or serious injury less likely in the event of accidental contact with the 110 or 220 volt ac lines. *All workbenches should have isolated power.*

My opinion, which is shared by many others, is that no computerized or other digital equipment — or many types of analog and rf equipment — should be operated in a noisy power line environment without one of these transformers. This is especially true if

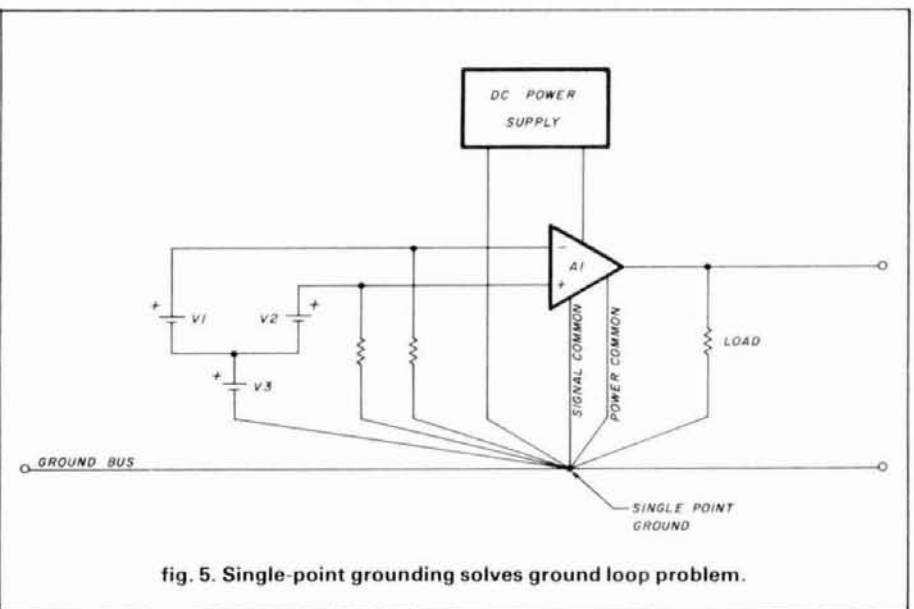
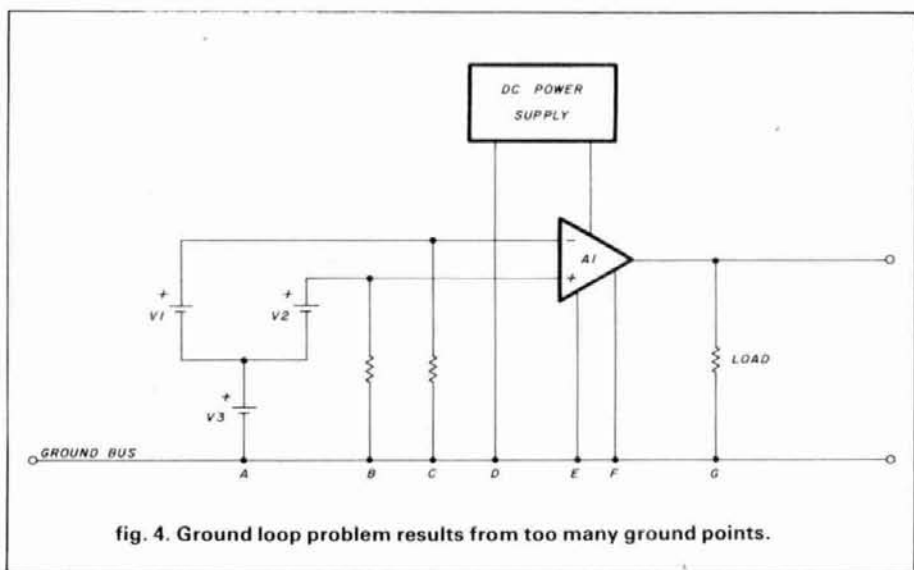

(continued from page 4)

220 AT RISK — ACT NOW

with radiolocation through 1990, when that use will be largely phased out). Not a bad tradeoff, to go from 5 MHz (shared with two other hungry services and thus a potential roosting place for every channel-seeking schemer who's come along in the last decade) to a 3-MHz band that's as firmly ours as any Amateur band can be, and thus likely to stay that way for the foreseeable future!

But this is not 10 years ago, and that "lightly occupied" 220-225 MHz band is indeed *fully* occupied, particularly in most major urban areas. Even without Novice enhancement, the proposed reallocation will cause severe disruption to important, established Amateur activities. With the addition of Novice operators to the already crowded — not "lightly loaded" — 220 MHz band, perhaps the pundits who thought this one up will then decide that it's really 2 meters that's "lightly loaded" and declare that 2 meters is the one to be shared with others!

Can this proposal be stopped? Very possibly not — but every effort must be made and made *quickly*. **The deadline for comments on General Docket 87-14 is April 6**, though several petitions to have this date extended are being filed. A minimum of one original and five copies of your comments are required; 11 copies are necessary if you wish each Commissioner to receive one. To be effective, cite occupancy facts and support use projections. "You can't do this to us!" isn't a very valid argument in Washington!

The FCC does indeed giveth . . . and may well taketh away, too!

— Joe Schroeder, W9JUV

short circuit

W6SAI

The inset table shown in **fig. 1** of W6SAI's February, 1987, column ("Ham Radio Techniques," page 45) should be corrected to read as follows: Tuned input network to match 420 ohms ($Q=4$)

f(MHz)	C ₁ (pF)	C ₂ (pF)	L ₁ (μH)
3.5	605	361	6.30
7.0	302	180	3.15
14.0	151	90	1.57
21.0	100	60	1.05
28.0	75	45	0.79

SHORT CIRCUIT HOTLINE

Building a current ham radio project? Call the Short Circuit Hotline any time between 9 AM and Noon, or 1 to 3 PM — Eastern time — *before* you begin construction. We'll let you know of any changes or corrections that should be made to the article describing your project.

(See "Publisher's Log," April, 1984, page 6, for details.)

603-878-1441

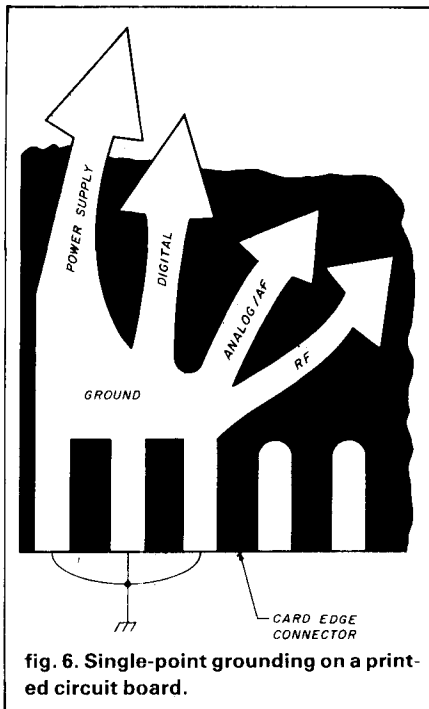

fig. 6. Single-point grounding on a printed circuit board.

the operation of the equipment is critical.

Although most Amateur equipment doesn't fall into this category, there are some cases where it might. For example, suppose you have a computer-controlled repeater transmitter. A power line transient could easily upset the program, causing it to "bomb" with the transmitter on . . . with no way for a control operator to turn it off without a personal visit to the site. While this problem is easily overcome by good design, I was told of one such situation in the Midwest, so I have to assume that others may also encounter it.

common-mode rejection

Other electrical devices nearby, as well as the ubiquitous 60-Hz field from building wiring, can induce signals into audio and low-frequency amplifier in-

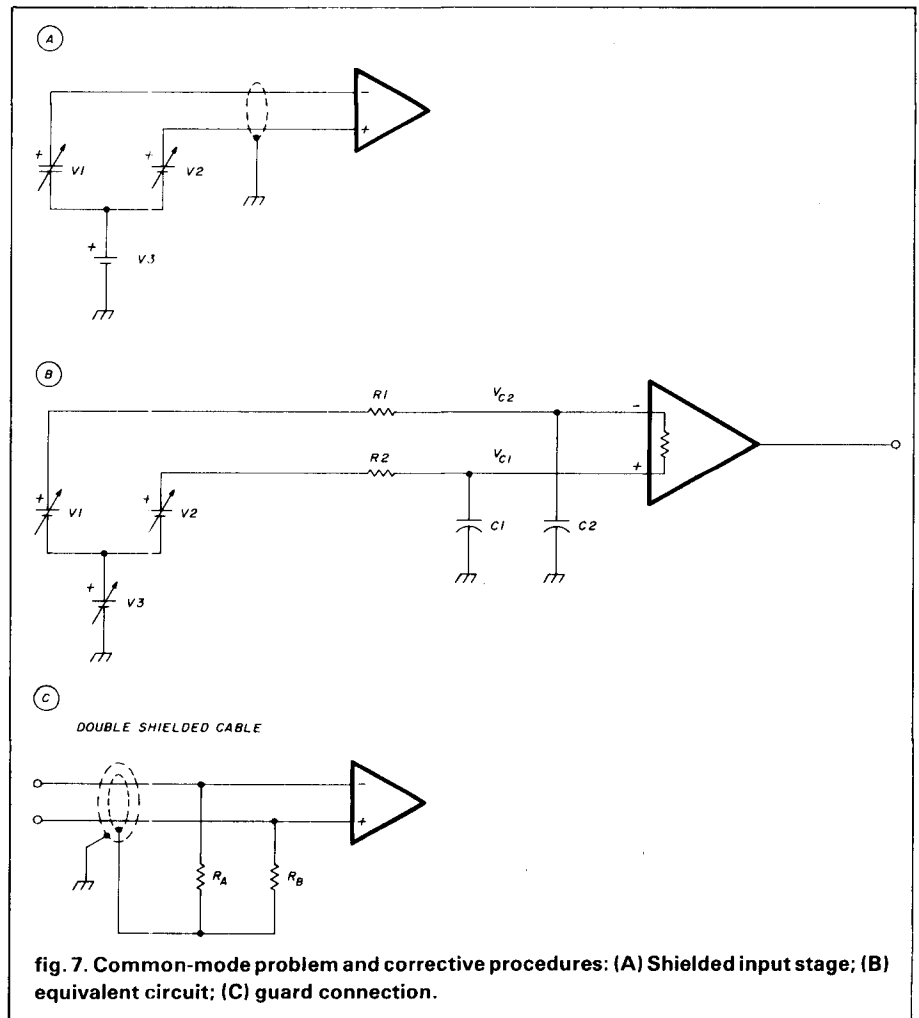

fig. 7. Common-mode problem and corrective procedures: (A) Shielded input stage; (B) equivalent circuit; (C) guard connection.

The BEST is still
"made in U.S.A."



MIRAGE/KLM

Under New Ownership

**American made RF Amplifiers and Watt/SWR Meters
of exceptional value and performance.**

• 5 year warranty • prompt U.S. service and assistance

RF AMPLIFIERS

2 METERS-ALL MODE

B23 2W in=30W out
(useable in: 100 mW-5W)

B108 10W in=80W out
(1W=15W, 2W=30W) RX preamp

B1016 10W in=160W out
(1W=35W, 2W=90W) RX preamp

B3016 30W in=160W out
(useable in: 15-45W) RX preamp
(10W=100W)

220 MHz ALL MODE

C106 10W in=60W out
(1W=15W, 2W=30W) RX preamp

C1012 10W in=120W out
(2W=45W, 5W=90W) RX preamp

C22 2W in=20W out
(useable in: 200mW-5W)

RC-1 AMPLIFIER REMOTE CONTROL

Duplicates all switches, 18' cable

WATT/SWR METERS

- peak or average reading
 - direct SWR reading
- MP-1** (HF) 1.8-30 MHz
MP-2 (VHF) 50-200 MHz

430-450 MHz ALL MODE

D24 2W in=40W out
(1W=25W)

D1010 10W in=100W out
(1W=25W, 2W=50W)

Available at local dealers throughout the world.

✓ 174

MIRAGE/KLM
COMMUNICATIONS EQUIPMENT, INC.

16890 Church St., Morgan Hill, CA 95037, (408) 779-7363

puts. It's wise to use differential amplifiers (where possible) for these applications because of their high common-mode rejection ratio (CMRR). Signals from desired sources are connected as differential signals (V1 and V2 in **fig. 4**) across the two inputs, while interference from the 60-Hz lines tends to be common mode because it affects both inputs equally.

It's sometimes possible, however, to manufacture a differential signal from a common-mode signal. This can occur in two ways; both involve the improper use of shields. One source of the problem is the ground loop, as shown in **fig. 4**. This problem arises from the use of too many grounds. In this example the shielded source, shielded input lines, the amplifier, and the power supply are all grounded to different points on the ground plane. Power supply dc currents flow from the power supply at point "D" to the amplifier power supply common at point "F," forming a voltage drop along the way. Similarly, other sources

also cause ground plane voltage drops. Known as ground loop signals, these signals form valid input signals from the amplifier's "point of view."

The cure for ground loop signals is shown in **fig. 5**. In this example we see that all of the ground connections within the equipment are routed to a single common grounding point. This effectively eliminates the ground loop voltage drops. Also, note that rather than allowing each line to have its own shield, a single shield around both lines is used.

When you're designing a new system — and have the opportunity to design the printed circuit boards — make sure that single-point grounding is used. **Figure 6** shows a method for minimizing the noise problems in a circuit board. Note that four different grounds are used: one each for the power supply, the digital signal, the analog signal, and rf. All four grounds are joined together at a single point on the card edge connector and then spread out to their respective circuits.

common-mode signals

Figure 7 shows the causes and cures for another form of signal error: common-mode signals *manufacturing* differential signals. The circuit in **fig. 7A** uses standard single shielding, but the equivalent circuit shown in **fig. 7B** reveals the problem. The shield produces a capacitance to ground with the input wires (C1 and C2). In addition, there are cable and source resistances in the circuit, represented in **fig. 7B** as R1 and R2. The system works well if $R1/XC1 = R2/XC2$, but even small imbalances in the RC networks will allow common-mode voltages to manufacture a differential signal. In that case, it's found that V_{C1} does not equal V_{C2} so the amplifier sees what it accepts as a valid input signal.

A "guard shield" (**fig. 7C**) circuit can be used to overcome this problem. The guard shield is driven by signals from the two input lines summed together through high-value resistances, R_A and R_B and, in many

To transform your shack into a DX powerhouse, combine the intelligence of Yaesu's FT-767GX HF/VHF/UHF base station and the muscle of our powerful FL-7000 HF amplifier.

You'll be amazed at how you can cut through pile-ups. Be heard anywhere in the world. And wake up otherwise inactive bands.

The brains of the operation: The FT-767GX. This intelligent HF/VHF/UHF base station includes four microprocessors for unparalleled flexibility and ease of operation.

Features include 160 to 10 meter transmit, including WARC bands. Optional plug-in modules for 6-meter, 2-meter and 70-cm operation. Receiver coverage from 100 kHz to 30 MHz. AM, FM, SSB, CW, AFSK modes built in. Ten memories that store frequency, mode, and CTCSS information (optional CTCSS unit for controlled-access repeaters). Memory check feature for checking memory status without affecting operating frequency. Dual VFOs with one-touch split frequency capability. VFO tracking for slaved VFO-A/VFO-B operation at a constant offset. Digital display in

10 Hz steps. Slow/fast main dial tuning. Synthesizer step programming at up to 99.99 kHz per step. Digital SWR meter. Digital RF power meter. Built-in RF preamplifier. Adjustable drive level from 0 to 100 watts. Blue fluorescent display. Built-in AC power supply.

Up to 30 minutes continuous transmit (100% duty cycle). Full CW break-in. Built-in CW electronic keyer. Audio peak filter for CW (Yaesu patent). CW and AM wide/narrow filters. Woodpecker noise blanker.

RF clipping speech processor. IF shift for both receive and transmit (TX side allows you to adjust voice frequency response pattern). IF monitor. IF notch filter. Audio low-pass filter.

Built-in antenna tuner with memory of settings on each band. Separate antenna connectors for each VHF or UHF optional unit. Separate beverage antenna receive input on rear panel. Quick turnaround time from TX to RX for AMTOR, Packet, and QSK CW. AGC slow/medium/fast/off selection. Push-pull MRF422 transistors



GET THE BRAINS.

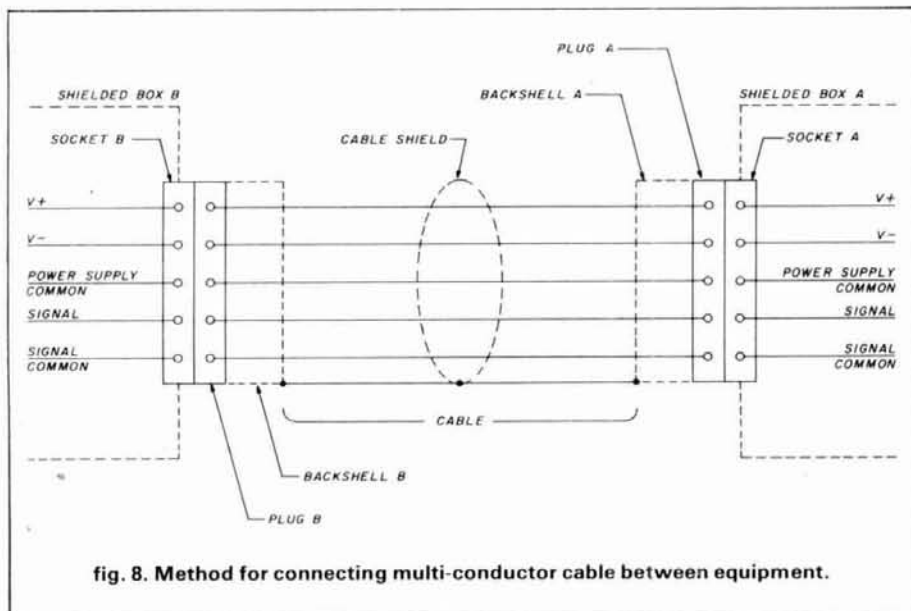

fig. 8. Method for connecting multi-conductor cable between equipment.

cases, a unity gain common-mode amplifier. The method has the effect of placing both sides of the cable capacitances at the same potential, so $V_{C1} - V_{C2} = 0$. The outer shield isn't strictly necessary, but is highly recommended in rf-rich environments.

don't run signals through shields

Another shielding scheme for connecting two pieces of related equipment is shown in fig. 8. This situation involves two pieces of equipment

(identified here as "A" and "B") that pass multiple connections back and forth, including signals and power. While traditionally not common in Amateur equipment, this arrangement is becoming more so with the increasing use of interfaces between computers and Amateur Radio equipment (as in packet radio). A common error made in constructing the multiconductor cables is to pass signal or power common return paths through the shield itself. All such common paths should have their own separate wire in the cable bundle. Some internal conductors may be individually shielded. The shield is connected to the shielded backshells of each connector, but doesn't carry signals. It's sometimes permissible to ground the shield to the chassis through a pin in each connector, provided that it too does not carry signals or power.

Next month, we'll take a look at station grounding and other methods of preventing TVI that we might cause.

ham radio



AND THE BRAWN.

(rated dissipation 290 watts each) operated at 24 volts for excellent intermodulation rejection in transmitter.

Enhanced C.A.T. system for external control of transceiver from personal computer. (Software for Apple IIe/MAC, Commodore C-64, and IBM-PC is available through your Yaesu dealer.) There's also data communication with the FL-7000 linear amplifier for hands-free amplifier operation.

The muscle to get you out: The FL-7000. This solid-state amplifier covers 160 to 15 meters, and includes

a built-in power supply, automatic tuner and lots of powerful operating features.

There's fast turnaround time for break-in (QSK) CW, HF packet radio, and AMTOR. Only 70 watts excitation for full output, and 1200 watts PEP input power. Fully protected push-pull parallel wideband "no-tune" amplifier circuit powered by 47V, 25A DC power supply. Yaesu's exclusive "DVC" (Direct Vertical Cooling Heatsink System) with bottom-mounted fan. Automatic antenna matching sensor

turns off amplifier and rematches tuner circuitry if SWR rises above 2:1. Hands-free automatic band change when used with FT-767GX, FT-757GX or FT-980. Lithium battery backup remembers antenna selection and tuner settings. Dual 2-speed fans with independent thermal sensors. Connection to up to four antennas, including automatic selection via optional unit. Eight front panel LED status indicators. And more.

Get the DX advantage. Just combine the FT-767GX's brains, the FL-7000's brawn, and your special operating knowledge. What an impact you'll make on the world!

YAESU

Yaesu USA

17210 Edwards Road, Cerritos, CA 90701
(213) 404-2700

Repair Service: (213) 404-4884
Parts: (213) 404-4847

Yaesu Cincinnati Service Center
9070 Gold Park Drive, Hamilton, OH 45011
(513) 874-3100

Prices and specifications subject to change without notice.

FREE SATELLITE TV



800-4-SATMAN

NEW 24 Page Buyer's Guide With Guaranteed Lowest Prices

- Explains all about FREE 100 channel Satellite TV and how to shop for an earth station!
- Lists GUARANTEED LOWEST PRICES...we will not be undersold, save 30-50% over local dealer prices!
- Tells how to easily and quickly Install-Your-Own earth station and save \$400 or more!
- Shows how to demonstrate and sell earth stations from your home and earn extra money!

uniden

MALCOA

WINTAGE

Panasonic

CHAPARRAL

Fuller Electronics, Inc.

The new SATMAN Buyer's Guide is a necessity for any prospective or current earth station owner who wants to save big money on name brand satellite products and also earn some extra money. Buy direct, Do-It-Yourself, and save with SATMAN. Toll free ordering, no sales tax (IL only), major credit cards accepted, huge in-stock inventories available, and fast UPS shipping anywhere in U.S. Check with SATMAN before you buy...We will not be undersold! Call now for your free 24 page SATMAN Buyer's Guide.

1-800-4-SATMAN

1-309-692-9582 Illinois



SATMAN

5017 N. MELODY • PEORIA, IL 61614 • 1-800-4-SATMAN

clip and save



SWL's: Are You Plagued By Phantom Signals?



Meet the Eliminator.

Don't let its small dimensions (4"x3"x2") fool you—the Grove **Minituner III** is a big weapon against images, intermod and phantom signals on your shortwave receiver!

This short wave/long wave pre-selector is designed to boost performance in the 100 kHz-30 MHz frequency range. If you own one of the popular general coverage communications receivers and are using an outside antenna, you **NEED** this extra measure of selectivity.

No power required. Simply connect between your receiver and antenna. Equipped for standard PL-259 connections. **Only \$39** (free UPS shipping; \$5 U.S. Mail/Parcel Post). Order TUN-3.



Grove Enterprises

140 Dog Branch Road
Brasstown, N.C. 28902

MC, Visa or COD call:

1-800-438-8155

Shop Grove for fantastic values in shortwave receivers, antennas, cable, performance boosting accessories and literature.

Call (704) 837-9200 or write to above address for free catalog!

THE PSOTRON
ANTENNAS FROM 180-10 METERS

NO TUNERS!
NO RADIALS!
NO RESISTORS!
NO COMPROMISE!

THREE EXCELLENT REVIEWS JUST
DON'T HAPPEN BY CHANCE.
CALL US FOR A FREE CATALOGUE.

Nov Review in EQ 7/1984 Sept 7/1985 March 7/1986

BILAL COMPANY
S.R. 2, Box 62, Dept. 2
Eucha, Ok. 74342 (918) 253-4094

166

We've Got Books Plenty of Books

Send SASE for free flyer

Ham Radio's Bookstore
Greenville, N. H. 03048

ham radio TECHNIQUES

Bill Over
W6SAI

Xinjiang Province: the last frontier

At last! I'd stuck the final red pin in the map of the world. Covered with red pins, one for each DX country confirmed, and hung proudly on the wall of the operating room, it instantly showed visitors my DX prowess.

I had some good ones. Andaman Islands? Yes. Burma? Yes. Franz-Joseph Land? Yes. Tibet? Yes. Hours of DX operation had covered the map except for a gaping hole near the center of Asia. A no-man's-land of zero Amateur activity! I'd worked many stations around the perimeter of this mysterious "black hole," which measured about 600 miles in diameter.

This blank zone encompassed what was once known as "Chinese Turkestan," with the city of Urumchi — now known as Urumqi — as the focal point of interest. Located in western China, nestled between India and the USSR, Xinjiang Province (as it's now known) has never, as far as I know, been on the ham bands. (There was a rumor, circa 1948, of a certain C5YY who was supposed to be active from Urumchi, but nothing ever came of this story.)

Rumor has it that a new station will soon be on the air in the western section of the People's Republic of China

using the call BY0AA. Perhaps this will be the station to represent the last frontier of DX — Xinjiang Province!

intermediates and prefixes

What seems simple now was rather complicated in the early days of radio. For example, you hear G6ZO working KH6BZF. You know it's a QSO be-

Table 1. Post-World War I international Amateur call numbers.

Number	Country
1	Italy, Luxembourg
2	England
3	Poland
4	Germany, Belgium
5	England
6	England
7	Denmark
8	France
9	Switzerland
0	Netherlands

tween England and Hawaii by the prefix letters of the calls. Easy. But return, in your mind's eye, to the early days. When Amateur Radio began back before World War I, the infant hobby had no assigned call letters. Hams used their initials or an abbreviation of their town or city. SNJ was in Hartford and HU was in Honolulu.

Just before the war, licensing was

Table 2. Original Amateur international intermediates (reprinted from QST, March, 1923).

A—Australia
 AU—Alaska*
 B—Belgium
 BE—Bermuda
 BZ—Brazil
 C—Canada and Newfoundland
 CH—Chile
 CR—Costa Rica
 D—Denmark
 E—Spain
 F—France
 FI—French Indo-China*
 G—Great Britain
 GI—Ireland*
 H—Helvetia (Switzerland)
 HU—Hawaiian Islands
 I—Italy
 IC—Iceland*
 J—Japan
 K—Germany
 L—Luxembourg
 LA—Norway*
 M—Mexico
 N—Netherlands
 O—South Africa
 P—Portugal
 PE—Palestine*
 Q—Cuba
 R—Argentina
 S—Scandinavia (Denmark, Finland, Sweden)
 SR—Republic of Salvador
 U—United States
 Y—Uruguay
 Z—New Zealand

*These intermediates have been self-assigned and are unofficial. They are in more or less general use, however.

instituted in the United States and call areas were initiated. About the same time, this happened in other countries. After the end of World War I, when Amateurs returned to the air, the situation was much clearer. In Europe, an agreement between countries assigned numbers to various countries

Table 3. "New" international intermediates (reprinted from QST, January, 1927).

NEW INTERNATIONAL INTERMEDIATES, EFFECTIVE 0000 G.M.T., FEB. 1, 1927.

EUROPE

- EA—Austria
- EB—Belgium
- EC—Czechoslovakia
- ED—Denmark and Faroe Ids.
- EE—Spain and Andorra
- EF—France and Monaco
- EG—Great Britain and Northern Ireland
- EH—Switzerland
- EI—Italy
- EJ—Jugo-Slavia
- EK—Germany
- EL—Norway, Spitzbergen and Franz Josef Land
- EM—Sweden
- EN—The Netherlands
- EO—Irish Free State
- EP—Portugal, Madeira Ids., and the Azores
- EQ—Bulgaria
- ER—Rumania
- ES—Suomi (Finland)
- ET—Poland, Esthonia, Latvia, Courland and Lithuania
- EU—U. S. S. R. ("Russia"), including Ukraine
- EV—Albania
- EW—Hungary
- EX—Luxemburg
- EY—Greece
- EZ—Zone of the Straits

ASIA

- AA—Arabia
- AB—Afghanistan
- AC—China (including Treaty Ports), including Manchuria, Mongolia, and Tibet.
- AD—Aden
- AE—Siam
- AF—French Indo-China
- AG—Georgia, Armenia and Azerbaijan
- AH—Hedjaz
- AI—India (and Baluchistan) and Goa
- AJ—Japan and Chosen (Korea)
- AK—(Unassigned)
- AL—(Unassigned)
- AM—Federated Malay States (with Straits Settlements)
- AN—Nepal
- AO—Oman
- AP—Palestine
- AQ—Iraq (Mesopotamia)
- AR—Syria
- AS—Siberia, including "Central Asia"
- AT—Turkey
- AU—(Unassigned)
- AV—(Unassigned)
- AW—(Unassigned)
- AX—(Unassigned)
- AY—Cyprus
- AZ—Persia

NORTH AMERICA

- NA—Alaska
- NE—Bermuda Id.
- NC—Canada, Newfoundland and Labrador
- ND—Dominican Republic
- NE—(Unassigned)
- NF—Bahama Ids.
- NG—Guatemala
- NH—Honduras
- NI—Iceland
- NJ—Jamaica
- NK—(Unassigned)
- NL—Lesser Antilles
- NM—Mexico
- NN—Nicaragua
- NO—British Honduras
- NP—Porto Rico and Virgin Ids.
- NQ—Cuba and Isle of Pines
- NR—Costa Rica
- NS—Salvador
- NT—Haiti
- NU—United States of America
- NV—(Unassigned)
- NW—(Unassigned)
- NX—Greenland

- NY—Panama
- NZ—Canal Zone

SOUTH AMERICA

- SA—Argentina
- SB—Brazil, Trinidad Id., and St. Paul Id.
- SC—Chile
- SD—Dutch Guiana
- SE—Ecuador and Galapagos Archipelago
- SF—French Guiana
- SG—Paraguay
- SH—British Guiana
- SI—(Unassigned)
- SJ—(Unassigned)
- SK—Falkland Ids. and Falkland Dependencies
- SL—Colombia
- SM—(Unassigned)
- SN—Ascension Id.
- SO—Bolivia
- SP—Peru
- SQ—(Unassigned)
- SR—(Unassigned)
- SS—(Unassigned)
- ST—(Unassigned)
- SU—Uruguay
- SV—Venezuela and Trinidad
- SW—(Unassigned)
- SX—(Unassigned)
- SY—(Unassigned)
- SZ—(Unassigned)

AFRICA

- FA—Abyssinia
- FB—Madagascar, Reunion Id., Comoro Id., etc.
- FC—Belgian Congo, Ruanda, Urundi
- FD—Angola and Kabinda
- FE—Egypt
- FF—French West Africa, including French Sudan, Mauritania, Senegal, French Guinea, Ivory Coast, Upper Volta, Dahomey, Civil Ter. of the Niger, French Togoland, etc.
- FG—Gambia
- FH—Italian Somaliland
- FI—Italian Libya (Tripolitania and Cyrenaica)
- FJ—Somaliland Protectorate and Socotra
- FK—Kenya, Zanzibar Protectorate, Uganda, Anglo-Egyptian Sudan, and Tanganyika Territory.
- FL—Liberia
- FM—Tunisia, Algeria, Morocco (including the Spanish Zone), Tangier
- FN—Nigeria
- FO—Union of South Africa, Northern and Southern Rhodesia, Bechuanaland Protectorate, and Southwest Africa
- FP—Portuguese Guinea and Cape Verde Ids.
- FQ—French Equatorial Africa and Cameroons
- FR—Rio de Oro and adjacent Spanish Zones, Ifni, and Canary Ids.
- FS—Sierra Leone
- FT—Eritrea
- FU—Rio Muni (Spanish Guinea) and Fernando Po
- FV—French Somaliland
- FW—Gold Coast Colony, Ashanti, Northern Territories and British Togoland
- FX—Seychelle Dependencies
- FY—(Unassigned)
- FZ—Mozambique

OCEANIA

- OA—Australia (and Tasmania)
 - OD—Dutch East Indies*
 - OE—Melanesia*
 - OH—Hawaiian Ids.
 - OI—Micronesia*
 - OO—Polynesia*
 - OP—Philippine Ids.
 - OZ—New Zealand
- * To be further partitioned when activity warrants.

SHIP STATIONS

Ship stations with amateur calls will place an X before their usual intermediate. E. g., Australian 3AA at sea, calling U. S. 1AW, would send "1AW NUXOA 3AA" The reply would be "3AA XOANU 1AW".

(see **table 1.**) By 1923, this system had been replaced by letters, and calls began to resemble those with which we're familiar today. An interesting identification scheme was adopted; these new "intermediates," as they were called, are listed in **table 2.**

Viewed from today's perspective, the use of the intermediate, written as a lower case letter, seems strange. English 6ZO would have had an intermediate call of g6ZO. But the intermediate wasn't sent *with* the call, but instead was combined with the intermediate of the station being called. For example, assume English 2SZ was calling New Zealand 4AA. The call sequence would have gone like this: 4AA 4AA 4AA zg 2SZ 2SZ 2SZ. When 4AA replied to 2SZ, the sequence was: 2SZ 2SZ zg 4AA 4AA.

This didn't lead to rapid, simple exchanges of QSOs, but it was a step in the right direction.

By 1927 the International Amateur Radio Union started a serious program to straighten out the international identification of Amateur calls. A new list was formed (**table 3**). The first letter of the prefix denoted the continent and the second the country. The cumbersome intermediate scheme still was used, but some hams were signing their call and intermediate together and using the French word "de" (from) between the call of the sending station and the station being called, much as is done today.

The United States intermediate "U" was replaced with "NU." Shortly thereafter, the Government started issuing full calls with the prefix letter "W" denoting the United States, as determined by the International Telecommunications Union. The old intermediate system faded into oblivion: government assigned prefixes were in use, and the intermediate "de" was accepted by Amateurs worldwide.

It wasn't an easy task to arrive at internationally accepted call letters. As I said, what seems so simple now was very complex in the early days.

Some old timers have lived through all the call letter changes. The famous call AC4YN was in use until the post-

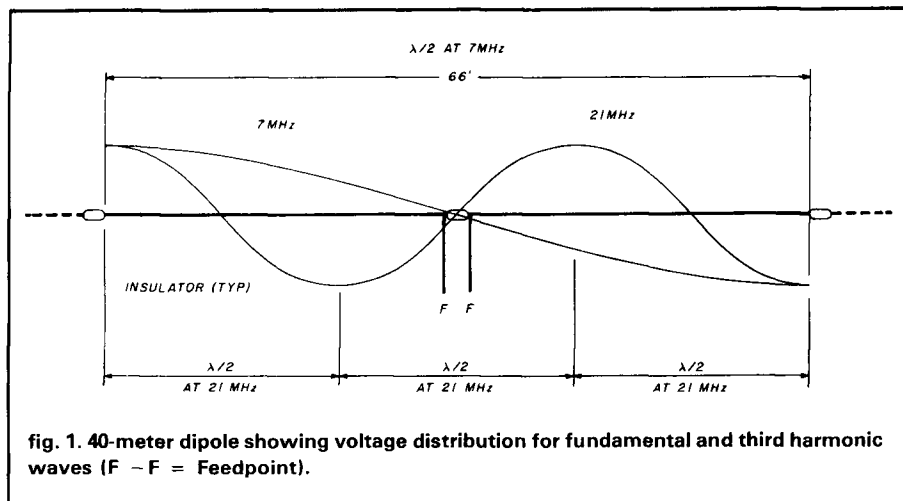

fig. 1. 40-meter dipole showing voltage distribution for fundamental and third harmonic waves (F - F = Feedpoint).

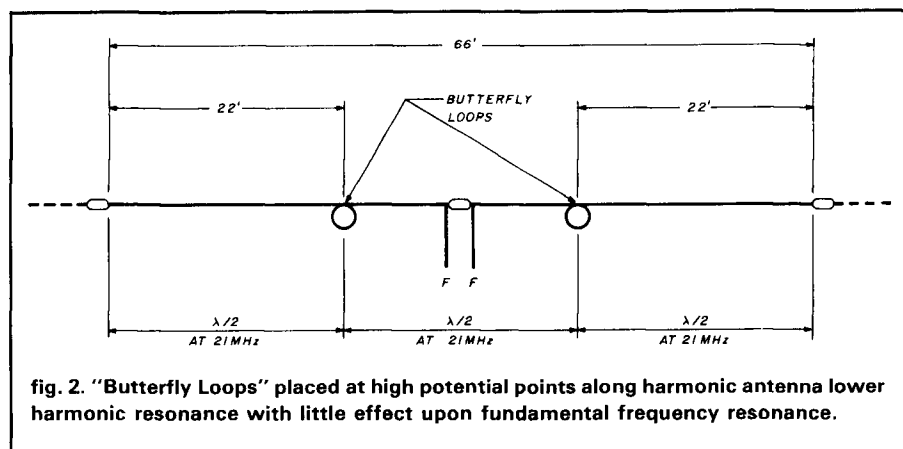

fig. 2. "Butterfly Loops" placed at high potential points along harmonic antenna lower harmonic resonance with little effect upon fundamental frequency resonance.

war period when China took over control of Tibet. The old prefix "FB," for Madagascar, was in use until that country achieved independence from France.

So the next time you hear an unusual prefix on the band, you can appreciate the years of trial-and-error effort that went into establishing a workable call sign system.

wire multiband antennas

It's well known among Amateurs that a center-fed dipole antenna will work (almost) on its third harmonic. Some hams have had good success using a 7-MHz dipole on the 21-MHz ham band. Unfortunately, because of end effects, the dipole isn't exactly resonant at the third harmonic, but at some frequency slightly above it. Thus a dipole cut for 7.1 MHz will be resonant at a frequency higher than the 21

MHz band. For resonance on the third harmonic, the wire should be 68.46, not 66 feet long (**fig. 1**). The general formula for a harmonic antenna is:

$$\text{Length (feet)} = \frac{492 (N - 0.05)}{f \text{ (MHz)}}$$

where N is the number of half waves in the antenna.

This formula holds true when the antenna is a straight wire. But what happens when the wire is bent back upon itself? Or, what happens when the wire is artificially loaded for harmonic resonance?

harmonic "loading"

Let's take the case of the 7-MHz dipole (**fig. 2**). As is, its fundamental resonance is 7.1 MHz. Its third harmonic resonance is 21.95 MHz. The problem is to load the antenna to a lower frequency in the 21-MHz region without

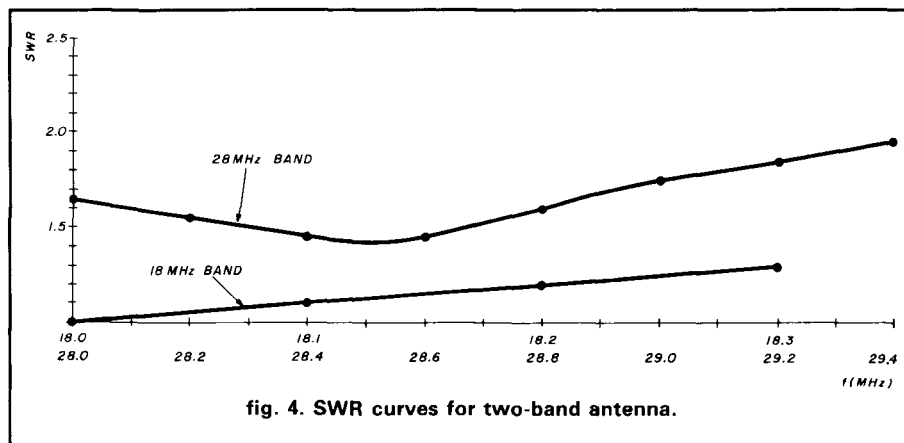
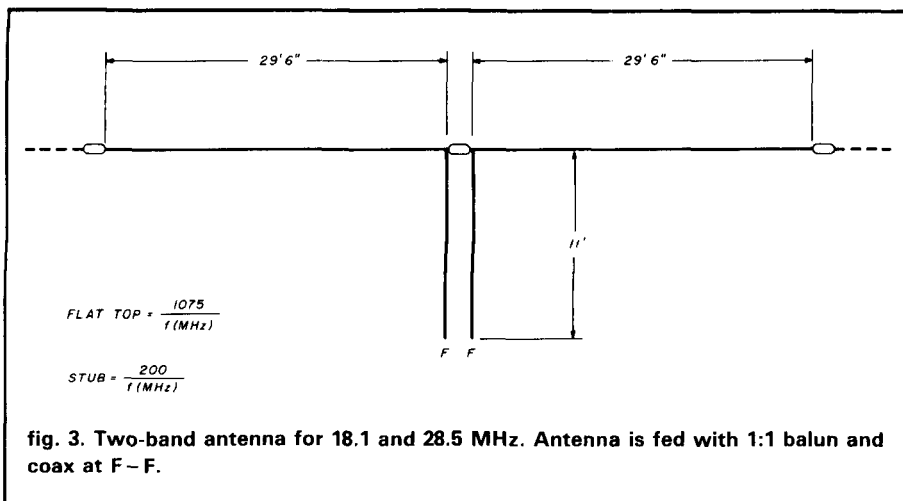

disturbing its resonance in the 40-meter band. This can be done by attaching "butterfly loops" at the high voltage points in the antenna corresponding to 21 MHz operation. The loops will have little, if any, effect on 7-MHz operation. The size of the loops must be determined experimentally, and they should be equal in size. The loop need not be round — almost any shape seems to work, and resonance is adjusted by changing the shape and size of the loop. I made my loops out of No. 12 enamel wire, with a diameter of about 1 foot. The loops were attached to the flat-top temporarily by means of small copper battery clips. After loop placement was adjusted for resonance at 21.2 MHz, the loops were soldered permanently to the antenna wire. I varied the loop diameter several times before I finally hit resonance (as determined by an SWR meter) at

my chosen frequency in the 15-meter band.

Another situation where this idea would work is the case of a 10-MHz dipole, whose third harmonic resonance is well above 30 MHz. It should be possible to place loading loops at the 10-meter high voltage points in the flat-top to bring antenna resonance within the 10-meter band. Someday I'm going to try this interesting antenna. If you hear me, you'll know the scheme works!

another two-band antenna

I have an experimental license (KM2XDW) for conducting tests on 18 MHz. Although most of the time I've used a dipole antenna, I've recently experimented with half-waves in phase, as shown in fig. 3. The old reliable "two half-waves in phase" design has been used for many years; un-

fortunately such an antenna cut for 18 MHz just wouldn't fit into the restricted space in my backyard. The solution was to make the flat-top shorter and increase the length of the folded center section. This section acts somewhat in the manner of a matching transformer, allowing the antenna to be fed with a 1-to-1 balun and a coax line.

The antenna, cut to fit the space, and its dimensions are shown in the drawing. Interestingly, it was found that the antenna also exhibited resonance in the 10-meter band! By luck, the total wire length in the antenna was just about 1-1/2 wavelengths on 10 meters. The VSWR curves for 18 and 28 MHz are given in fig. 4. Using the formulas given in fig. 3, the antenna may be cut for any two frequencies that have the ratio of 1.57 to 1. Thus, an antenna cut for 14 MHz will also present a second resonance at $14 \times 1.57 = 21.98$ MHz. That's a little too high in frequency to be of practical use, but by adding butterfly loops at the high voltage points on the wire for the harmonic frequency, that resonance can be lowered to the 21-MHz band with little, if any, effect on 14-MHz operation.

general case

These antenna examples show that by changing the shape of a long wire, and by adding capacitance at the high voltage points at a harmonic frequency, the higher resonance point may be moved about. The idea that resonances in a long wire fall only at approximate multiples of the fundamental frequency applies only when the wire lies in a straight line. In addition, the harmonic resonant frequency determined by the configuration of the wire can be further manipulated by proper application of capacitance loops. If you want a simple multiband antenna, center-fed with a coax line, you can run your own experiments along the lines of those shown here. Armed with an SWR meter and a notebook for keeping records of your experiments, the sky's the limit!

ham radio



YOU ALREADY OWN 75% OF A COLOR VIDEO STATION

It's true. With your transceiver, antenna, television set and audio tape recorder, you already have 75% of what's required to receive and send color video world-wide!

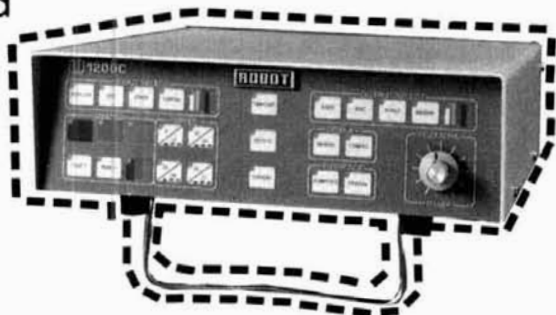

Add a **ROBOT**™ Video Transceiver and your station is complete.

Thousands of amateur video operators around the world are exchanging beautiful color images every day. Whether your favorite mode is SSB or FM or AM—direct, via repeater or satellite—you can join in the high-tech fun without modifying your present equipment. Just add a Robot to your station!

ROBOT

ROBOT RESEARCH, INC.
7591 Convoy Court
San Diego, California 92111
Phone (619) 279-9430

Please send me the following Robot equipment. I understand that if I am dissatisfied for any reason, I can return the unit and receive a full refund.

- 1200C high resolution video transceiver \$1295
- 450C standard resolution \$795
- 400C upgrade kit \$395
- More Information

Name _____ Call _____

Address _____

City _____ Zip _____

COD

Enclosed check or money order \$ _____

MC VISA # _____ Exp. Date: _____

OUR COMMITMENT TO YOU IS
QUALITY, ACTION & SERVICE.

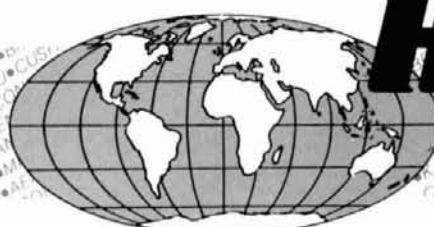

HAM RADIO OUTLET

LARGEST HAM OUTLET IN THE WORLD

7 STORE BUYING POWER

KENWOOD TS-940S



TOP-OF-THE LINE
HF TRANSCEIVER

GREAT PRICE, CALL

KENWOOD

TM-3530A



The First Comprehensive
220 MHz FM Transceiver

ARE YOU READY FOR
220 MHz OPERATION?

HAM RADIO HOME STUDY NOVICE VOICE COURSE



- Updated novice-voice questions
- 6 stereo code & theory cassette tapes
- 2 text books, code oscillator, key & battery
- Color Ham Bands wall chart & frequency list
- Sealed novice exam for a Ham friend to give you the code & theory test in your home
- FCC license application forms & instructions to your examiner. Ideal for spouse & the kids!

\$49.95



MA-40
40' TUBULAR TOWER
~~\$745~~ **SALE! \$549**

MA-550
55' TUBULAR TOWER
~~\$1245~~ **SALE! \$899**

- Handles 10 sq. ft. at 50 mph
- Pleases neighbors with tubular streamlined look

TX-455
55' FREESTANDING
CRANK-UP

- Handles 18 sq. ft. at 50 mph
- No guying required
- Extra-strength Construction
- Can add raising and motor drive accessories

Shown with optional
MARB rotator base

IN STOCK FOR QUICK DELIVERY
OTHER MODELS AT GREAT PRICES

hy-gain

CRANKUP SALE!

Single Strength
(handles 9 sq. ft.)

- HG37SS - 37' Tower
- HG52SS - 52' Tower

Heavy Duty
(handles 16 sq. ft.)

- HG54HD - 54' Tower
- HG70HD - 70' Tower

- All steel
- Includes base & rotor plate
- No guying required
- Hot dip galvanized
- Accessories available

CALL FOR PRICE!

KENWOOD R-5000



High Performance Receiver

- Covers 100 kHz - 30 MHz in 30 bands
- Superior dynamic range
- Computer control option

LOW PRICE!

YAESU

FT-727R

5w, Dual Band
2m/440 MHz

Enhanced Version
Now Available!

GREAT PRICE!



LUNAR

30w in, 160w out,
with low-noise
preamp!

MODEL
2M30-160P
for 2 meters
SALE!

\$219.95

From the Originator of the
QUALITY VHF AMP/PREAMP COMBO!

Full Line Now Includes
UHF Models with
GaAs FET PREAMP!



All Major Brands in Stock Now!

CALL TOLL FREE (800) 854-6046



Toll free including Hawaii. Phone Hrs: 7:00 am to 5:30 p.m. Pacific Time. California, Arizona and Georgia customers call or visit nearest store. California, Arizona and Georgia residents please add sales tax. Prices, specifications, descriptions subject to change without notice.





HAM RADIO OUTLET

LARGEST HAM OUTLET IN THE WORLD

SPECIAL ANTENNA PRICING FOR APRIL AND MAY

7 STORE BUYING POWER

ICOM IC-R71A



Superior Grade General Coverage Receiver

SALE! CALL FOR PRICE

ICOM IC-275A/275H **NEW**



138 - 174 MHz
IC-275A (25w) IC-275H (100w)
GREAT PRICE!

ICOM IC-1271A



1.2 GHz Transceiver:
The First Full-featured
1240-1300 MHz Transceiver

ARE YOU READY FOR
1.2 GHz OPERATION?

ICOM IC-28A/28H **NOW! IC-38A 220 MHz**



2-METER MOBILES
IC-28A (25w) IC-28H (45w)

LOW PRICE!

NOW! RAPID DELIVERIES



FROM STORE NEAREST YOU

ICOM HAND-HELD VHF/UHF



IC-02AT IC-2AT
IC-03AT IC-3AT
IC-04AT IC-4AT

ICOM IC-R7000



The Latest in ICOM's Long Line of HF Transceivers

CALL FOR LOW, LOW PRICE

ICOM IC-R7000



25 MHz-1300 MHz

IN STOCK FOR IMMEDIATE DELIVERY

ICOM IC-μ2A/μ2AT

NEW

Mini Hand-Held AT Model w/ TT Pad

GREAT PRICE!



All Major Brands in Stock Now!



Bob Ferrero W6RJ
President

Jim Rafferty N6RJ
VP So. Calif Div.
Anaheim Mgr.

ANAHEIM, CA 92801
2620 W. La Palma
(714) 761-3033, (213) 860-2040
Between Disneyland &
Knotts Berry Farm

ATLANTA, GA 30340
6071 Buford Hwy
(404) 263-0700
Neil, Mgr. KC4MJ
Doraville, 1 mi. north of I-285

BURLINGAME, CA 94010
999 Howard Ave.
(415) 342-5757
George, Mgr. WB6DSV
5 miles south on 101 from SFO

OAKLAND, CA 94606
2210 Livingston St.
(415) 534-5757
Al, Mgr. WA6SYK
17N-5th Ave./17S-16th Ave.

PHOENIX, AZ 85015
1702 W. Camelback Rd.
(602) 242-3515
Bob, K7RDH
East of Hwy. 17

SAN DIEGO, CA 92123
5375 Kearny Villa Rd.
(619) 560-4900
Tom, Mgr. KM6K
Hwy. 163 & Claremont Mesa Blvd.

VAN NUYS, CA 91401
6265 Sepulveda Blvd.
(818) 988-2212
Al, Mgr. K6YRA
San Diego Fwy
at Victory Blvd

STORE HOURS
10 AM-5:30 PM
CLOSED SUNDAYS



CALL TOLL FREE (800) 854-6046



Toll free including Hawaii. Phone Hrs: 7:00 am to 5:30 p.m. Pacific Time. California, Arizona and Georgia customers call or visit nearest store. California, Arizona and Georgia residents please add sales tax. Prices, specifications, descriptions subject to change without notice.



**PERFORMANCE
AND VALUE**
WITHOUT COMPROMISE

KRP-5000 REPEATER

Word is spreading fast—
"Nothing matches the KRP-5000
for total performance and value. Not GE, not even Motorola."
2 meters — 220 — 440

RF performance really counts in tough repeater environments, so the KRP-5000 receiver gives you 7 helical resonators, 12-poles of IF filtering, and a precise Schmitt trigger squelch with automatic threshold switching. The transmitter gives you clean TMO5-FET power.

Enjoy high performance operation with remote programmability, sequential tone paging, autopatch, reverse autopatch, 200-number autodial, remote squelch setting, status inputs, control outputs, and field-programmable Morse messages.

Call or write for the full performance story... and the super value price!

Micro Control Specialties
23 Elm Park, Groveland, MA 01834
(617) 372-3447

The first choice in
Transmitters - Receivers
Repeaters
Repeater Controllers
Power Amplifiers
Voice Mail Systems



KRP-5000 Repeater shown
with PA-100 Amplifier

157

W6SAI BOOKS

published by Bill Orr, W6SAI and Stu Cowan, W2LX

BEAM ANTENNA HANDBOOK

Completely revised and updated with the latest computer generated information on BEAM Antenna design. Covers HF and VHF Yagis and 10, 18 and 24 MHz WARC bands. Everything you need to know. 204 illustrations. 268 pages. ©1985. Revised 1st edition.

IRP-BA Softbound \$9.95

SIMPLE LOW-COST WIRE ANTENNAS

Primer on how-to-build simple low cost wire antennas. Includes invisible designs for apartment dwellers. Full of diagrams and schematics. 192 pages. ©1972 2nd edition.

IRP-WA Softbound \$9.95

ALL ABOUT CUBICAL QUAD ANTENNAS

Simple to build, lightweight, and high performance make the Quad at DX'ers delight. Everything from the single element to a multi-element monster. A wealth of information on construction, feeding, tuning and installing the quad antenna. 112 pages. ©1982. 3rd edition.

IRP-CQ Softbound \$7.95

THE RADIO AMATEUR ANTENNA HANDBOOK

A wealth of projects that covers verticals, long wires, beams as well as plenty of other interesting designs. It includes an honest judgement of gain figures, how to site your antenna for the best performance, a look at the Yagi-Quad controversy, baluns, slopers, and delta loops. Practical antenna projects that work! 190 pages. ©1978. 1st edition.

IRP-AH Softbound \$9.95

Please enclose \$3.50 for shipping and handling.



**ham
radio** magazine **BOOKSTORE**
GREENVILLE, NH 03048 (603) 878-1441

Join AMSAT...Today

*Amateur Radio Satellite OSCAR 10
provides:*

- A New Worldwide DX Ham Band open 10 hours a day.
- Rag Chew With Rare DX Stations in an uncrowded, gentlemanly fashion.
- Popular Modes In Use: SSB, CW, RTTY, SSTV, Packet
- Full Operating Privileges open to Technician Class licensee or higher.

Other AMSAT Membership Benefits:

Newsletter Subscription:

Dependable technical articles, satellite news, orbital elements, product reviews, DX news, and more.

Satellite Tracking Software

Available for most popular PCs.

QSL Bureau, AMSAT Nets, Area Coordinator Support, Forum Talks

Construction of Future Satellites For Your Enjoyment!

AMSAT Membership is \$24 a year, \$26 outside North America. VISA and MC accepted.

AMSAT
P.O. Box 27
Washington, DC 20044
301 589-6062

156

a three-tube 4CX250B linear amplifier

Who says
nobody builds
any more?

I had considered building a 2-meter linear amplifier using three 4CX250B tubes for some time. Initial calculations indicated that I could achieve good performance if I could simply translate a design on paper into an actual working unit.

To simplify the design effort I wrote a computer program that would perform precise calculations and simulations of plate and grid line operation for various operating conditions such as different plate voltages and currents, tight or loose coupling with the antenna, or reactive antenna impedances. Doing this yielded optimum Qs and efficient line values.

Many hams and clubs in Yugoslavia were interested in the design. Sketches were copied and distributed, and amplifiers built and tried. The initial design worked as planned. Modifications have since been incorporated; this article describes the best and final design. Several other published designs were checked against the computer program and found not to be optimum.

three tubes in parallel

This amplifier uses three tubes in parallel in which the screen is at both DC and RF ground potential. Many hams who have tried to build around the 4CX250B have given up because of the unavailability or cost of the sockets. Grounded screen operation offers a viable yet inexpensive alternative, provides stable operation, and requires no sockets.

Though the mechanical layout may seem primitive to the sophisticated VHF builder, it's really simple and efficient. Tube replacement is somewhat more difficult than with sockets, but it can be done quickly once you get used to it.

voltages

A schematic of the completed amplifier is shown in fig. 1.

The cathode is at -350 volts and the grid at -400 volts with respect to the screen (remember, it's grounded). To simplify the power supply design, voltage-dropping resistors (68k, 100W) and zener diodes are used. Additional protection is provided by slow-blow fuses. The plate voltage should not exceed 2.5 kilovolts unloaded and no less than 2.1 kilovolts loaded.

It's useful to include as many meters as possible — but if you choose not to, make sure that at least the plate and screen current are independently monitored.

Considering the relatively high voltage on the cathode, the filament transformer secondary should be well insulated from ground. One of the secondary leads is soldered directly to the tube pins and the other via a necessary RF choke.

RF section

The plate line is a quarter-wave section of stripline that is directly grounded at one end and connected to the tubes via a plate blocking capacitor, C_0 (see fig. 2 for details). The quality, values, and placement of these capacitors are critical and should be carefully considered. The following conditions must be satisfied:

- high capacitance value resulting in less than one ohm of capacitive reactance
- high Q
- placement close to the tubes

The blocking capacitors used in this design consist of two metal plates with a teflon (PTFE) dielectric. The lower plate is grounded (plate strip L_a) while the other is connected to the tube plates. I used teflon foil which measured between 0.3 and 0.5 mm in thickness and was perfectly smooth, with neither cracks nor slots. The upper metal sheet is extended up to the grounded side of the plate line, thereby increasing capacitance and aid-

By Dragoslav Dobričić, YU1AW, St. Supljikca 105/8. 26000 Pancevo, Yugoslavia.

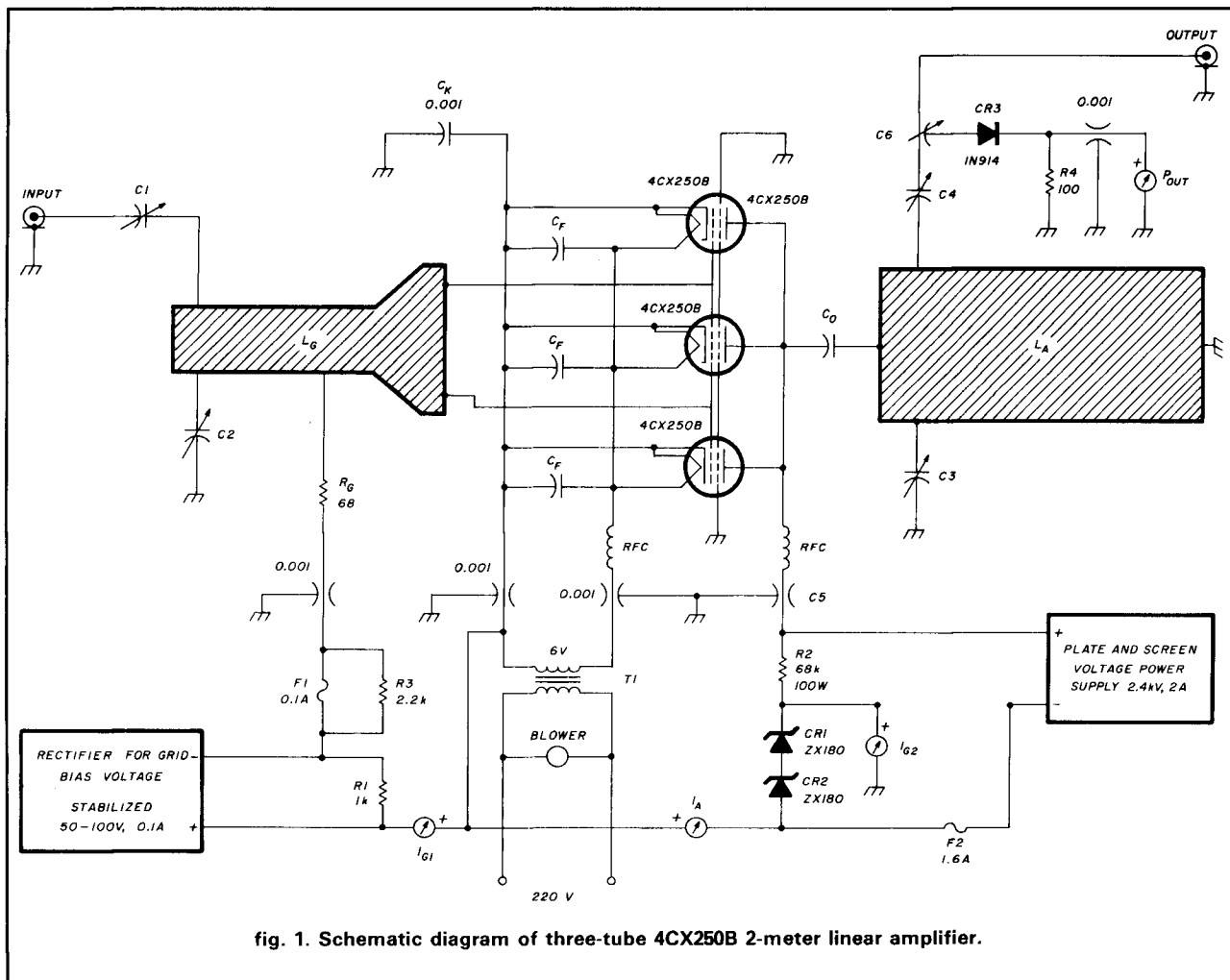

fig. 1. Schematic diagram of three-tube 4CX250B 2-meter linear amplifier.

ing in rf/dc isolation. An enlarged view is shown in **fig. 3**. Plate voltage is supplied through an RF choke to the location of lowest RF potential (almost zero). This improves amplifier stability while maintaining good RF/DC isolation.

Capacitor C5 (a section of single-sided glass-fiber PC board) is glued to the plate compartment wall and acts as a feedthrough capacitor. High voltage is introduced by means of a BNC connector. No additional steps are necessary to prevent feedback of the RF signal into the power supply.

As shown in **fig. 4** and **photo A**, there's an "ear" on both sides of the resonator, i.e., C4 and C5 stator plates. Rotor plates are soldered to the central pin of a female N connector (for C4) and grounded (for C5). Plate separation — and consequently capacitance — can be changed mechanically by adjusting a length of fishing line wrapped around a shaft made of brass or some insulated material.

The grid line is a half-wave 70-ohm impedance strip-line used instead of the quarter-wave line because input capacitances are rather high (see **fig. 5** and **photo B**).

An air-variable capacitor, C2, at the end of the line provides the resonant tuning control. Drive power is applied through C1 and bias is fed via a 68-ohm resistor at the point of minimum RF voltage. Using a resistor instead of a choke reduces the amplifier's tendency to oscillate. A resistor should always be used when high gain tetrodes are employed.

Grid connections are all soldered to the input strip through three small holes. C1 is connected to the input BNC connector with a length of coaxial cable with its plastic jacket removed (see **fig. 6**).

Cathode pins on the 4CX250Bs are 2, 4, 6, and 8. They should be connected together with a piece of copper strip the same width as the pin length. All number 3 pins should also be connected together and soldered to the cathodes. This places all cathodes and one side of all filaments at the same potential. Pin 1 is connected to the screen ring and can be used as a ground contact. Capacitor Ck should be connected between pins 1 and 2 using the shortest possible leads. Capacitor Cf should be connected between the remaining filament contact (pin 7) and pin 6 or 8. Pin 5 should not be used at all.

construction

Dimensions and details for the fabrication of the upper and lower plate, teflon spacer, grid line, and capacitors C3 and C4 are shown in **fig. 7**.

The amplifier cabinet is made from aluminum and has separate grid and plate compartments (**photo C**). Ventilation holes in the plate between the two compartments

permit air flow; air enters the grid compartment, is brought up to cool the plates and then exhausted through homemade teflon chimneys.

Though the air flow path is rather long, there is a negligible drop in air pressure along the way compared to that experienced at the plate's cooling fins. The 4CX250B tubes require a good-sized squirrel cage blower to overcome this pressure drop (**photo D**). In addi-

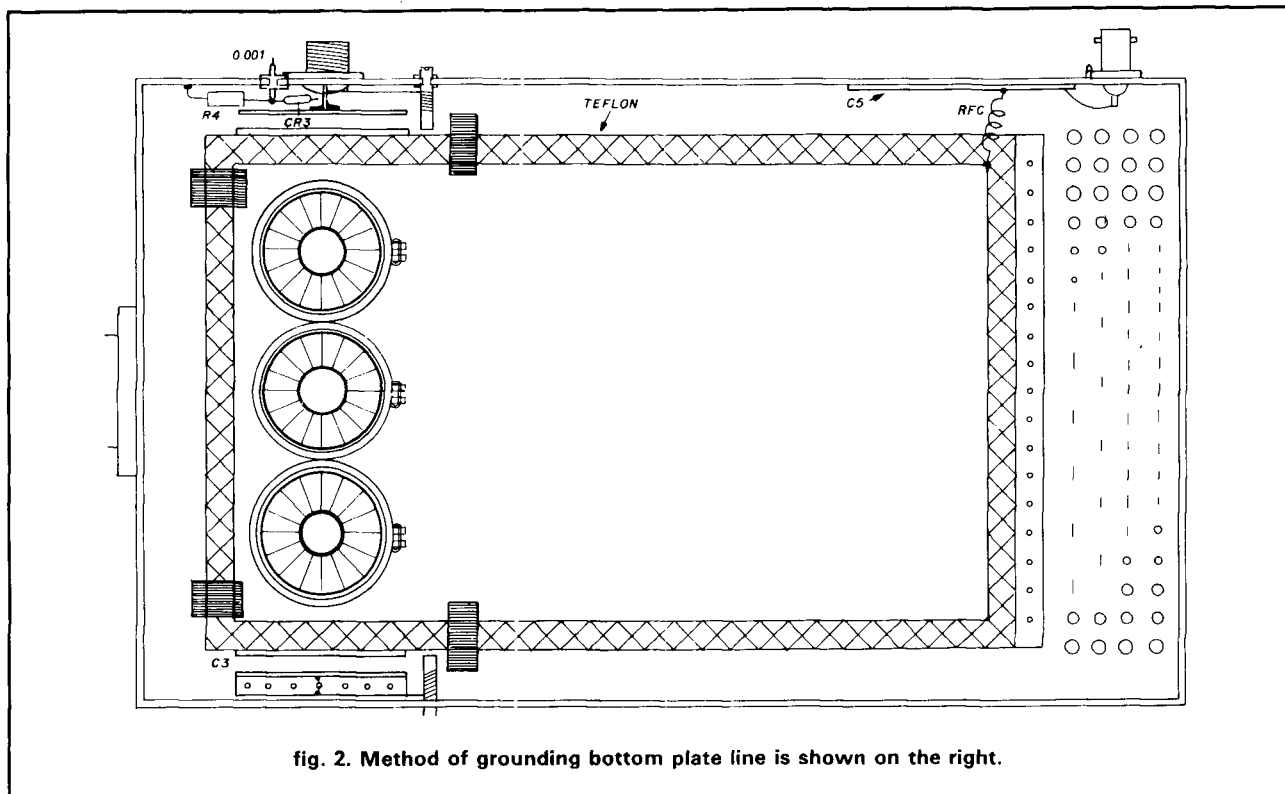

fig. 2. Method of grounding bottom plate line is shown on the right.

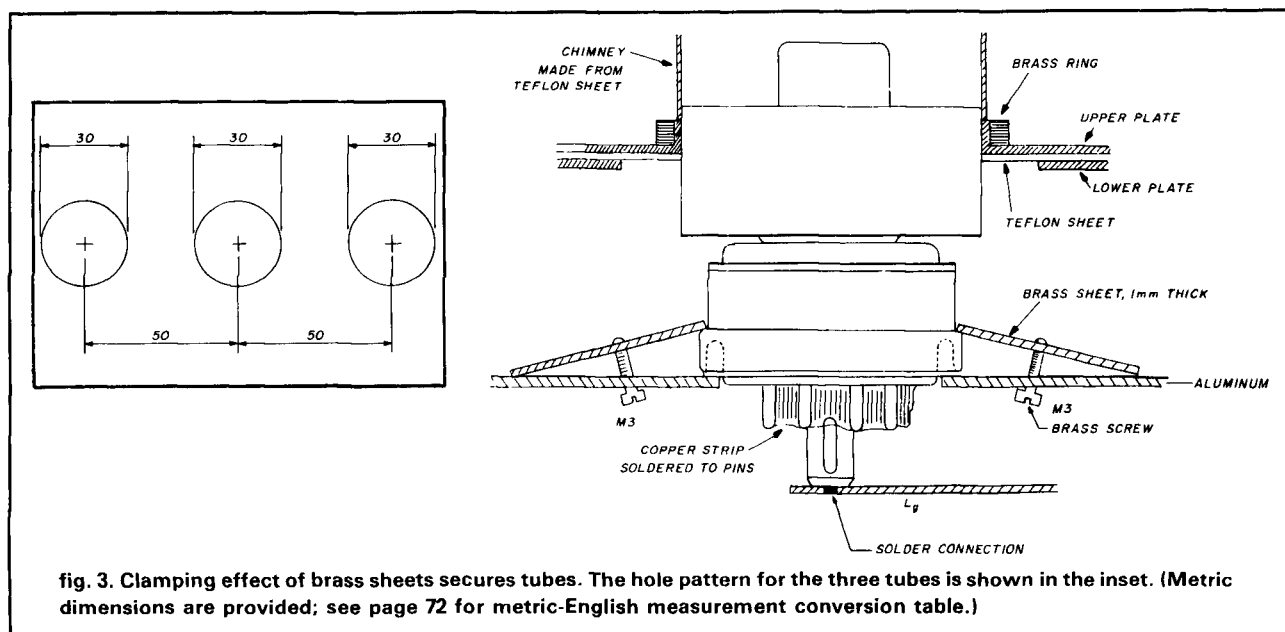
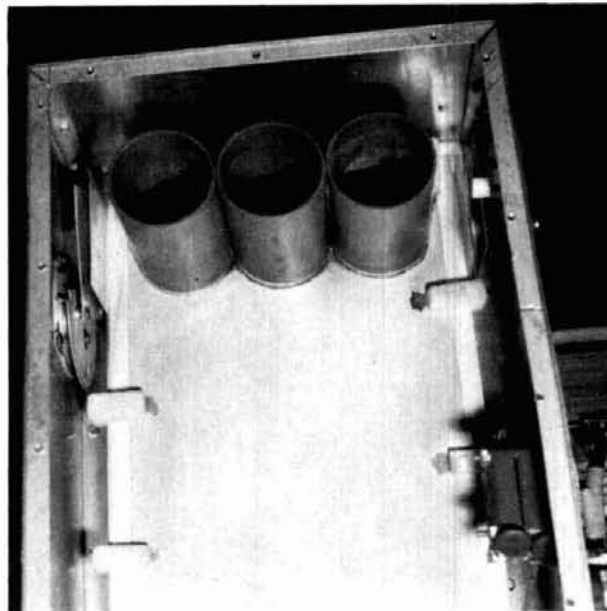
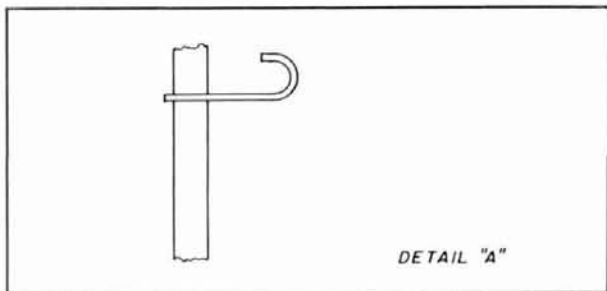
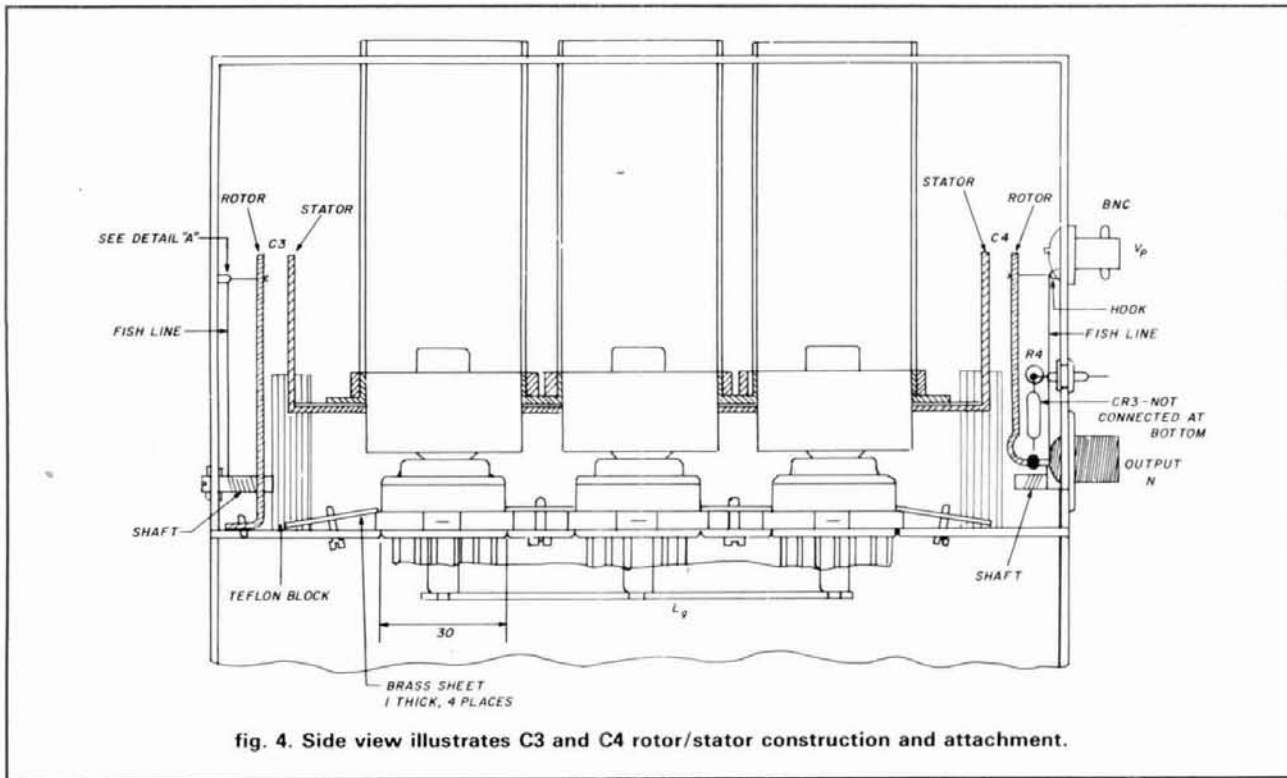

fig. 3. Clamping effect of brass sheets secures tubes. The hole pattern for the three tubes is shown in the inset. (Metric dimensions are provided; see page 72 for metric-English measurement conversion table.)



tion, good sealing between the aluminum plates is needed to prevent leaks and subsequent loss in air pressure. Holes between compartments should be round rather than slotted because elongated holes could become slot antennas, causing oscillation as a result of plate/grid coupling.

The plate line resonator (lower plate) is joined to the shield with brass screws. Good bonding is essential because of high currents at this location, so be sure to use as many screws as specified. The upper and lower parts of the plate line are held in place with slotted tefflon blocks that fit it securely to the resonator.

The tubes are mounted in the pre-drilled holes in the shield with the diameter chosen according to the screen ring dimensions. The screen ring is slightly larger than the ceramic body and good RF and DC contact is made. Each tube is secured at four locations and a single piece of brass is used to clamp adjacent tubes. To remove the

Photo A. Capacitance variation is achieved by mechanically adjusting length of fishing line.

tubes, reverse the procedure by loosening the clamps and rotating them 90 degrees. Do not apply too much pressure on the tubes because the screen ring could be damaged.

Plate chimneys are fabricated from thin tefflon sheet rolled and clamped to fit the plate radiator diameter (see

MISSOURI RADIO CENTER

102 N.W. Business Park Lane, Kansas City, MO 64150 816-741-8118

Call Toll Free — 9am - 6pm Mon. - Fri., 9am - 2pm Sat.
In Missouri Call — 816-741-8118

1-800-821-7323

TRADE INS ACCEPTED
MasterCard — VISA — COD Welcome

AEA
ALINCO
AMERITRON
ASTRON
AVANTI
B & W
BENCHER
BUTTERNUT
COMM SPEC
CUSHCRAFT
DAIWA

YAESU
VANGUARD
SANTAC
QUATRON
NYE VIKING
MIRAGE
MEI
ARSEN
KLM
KENWOOD
KDK

KENWOOD

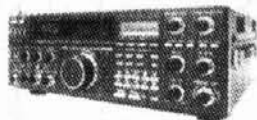

TS940S "DX-celence"

- Programmable Scanning
- High Stability, Dual Digital VFO's
- 40 Channel Memory
- General Coverage Receiver

KENWOOD



TS440S "DX-CITING"

- 100% Duty Cycle
 - 100 memories
 - Direct Keyboard Entry
 - Optional Built-in AT
- On Sale Now, Call For Price!

KENWOOD



TM-3530A

- 220 MHZ MOBILE FM TRANSCEIVER
- 220-225 MHz with 25 Watts
 - 7-Digit Telephone No. Memory
 - Direct Frequency Entry
 - 23-Channel Memory

KENWOOD



NEW TH-215A

"FULL FEATURED 2m HT"

- 141-163 MHz Receive
- 144-148 MHz Transmit
- 2.5w Output (5w Optional)
- 10 Memories
- Built-in CTCSS Encoder
- Nine Types of Scanning

YAESU



FT-757GX "CAT SYSTEM"

- All Mode Transceiver
 - Dual VFO's
 - Full Break-in CW
 - 100% Duty Cycle
- CALL FOR BEST PRICE!

YAESU



FT-767GX HF/VHF/UHF BASE STATION

- Add Optional 6m, 2m & 70cm Modules
- Dual VFO's
- Full CW Break-in
- Lots More Features

YAESU

FT23/73R

- Zinc-Aluminum Alloy Case
- 10 Memories
- 140-164 MHz, 440-450 MHz
- 600 MAh Standard Opt. 5w New "super handle"



YAESU

FT-109RH

220 MHZ H.T.

- 5 Watts Output
- Battery Saver
- 10 Memories
- Multiple Scanning Routines
- Power Meter



ICOM



IC-735 "NEW"

Can you put a price tag on reliability? Now ICOM offers a ONE YEAR WARRANTY on its HF Transceivers & Receivers purchased after August 1, 1986.

ICOM



IC-751A "NEW"

- 100 KHz - 30 MHz
- FM Standard
- 32 Memories
- QSK (Nominal Speed 40 WPM)

ICOM



IC-38A

- Full 25W, 5W low
 - 21 memories
 - Subtones built in RX 215-230 MHz
- CALL FOR BEST PRICE

ICOM

IC-μ2AT

- 140-163 MHz
- 10 Memories
- 1W, 1.5W optional
- 32 tones built-in



IC-03AT

- 220 to 224.995 MHz
- 2.5W, 5W Optional
- Built in subtone
- 10 Memories



Kantronics



KAM

Kantronics All Mode

- CW, RTTY, ASCII, AMTOR, HF & VHF Packet
- RS-232/FTL, Universal Compatibility
- Transmit and Receive CW 6-99 wpm, RTTY/ASCII 45-300 Baud, ARQ, FEC, SELFEQ, Listen ARQ, VHF and HF Packet



MFJ-1274

TNC 2 PACKET RADIO



- VHF and HF Packet
- Precision Tuning Indicator
- AX .25 Level 2 Version 2 Software
- TTL Serial Port
- More!

NOVICES

ARE YOU CONFUSED ABOUT YOUR NEW PRIVILEGES? CALL US FOR THE UP-TO-THE-MINUTE INFORMATION AND ASSISTANCE WITH YOUR GEAR.

✓ 162



PK 232

- Make any RS-232 compatible computer or terminal a complete digital operating position.
- Morse, Baudot, ASCII, AMTOR, Packet
- Loaded with features.



ASTRON CORPORATION



Power Supply

- RS7A \$48
- RS12A \$68
- RS20A \$88
- RS20M \$105
- VS20M \$125
- RS35A \$133
- RS35M \$149
- VS35M \$165
- RS50A \$189
- RS50M \$215
- RM50A \$219
- VS50M \$229

HUSTLER

HYGAIN

ICOM

• MOST ORDERS SHIPPED SAME DAY •

J.I.L.

KANTRONICS

KDK

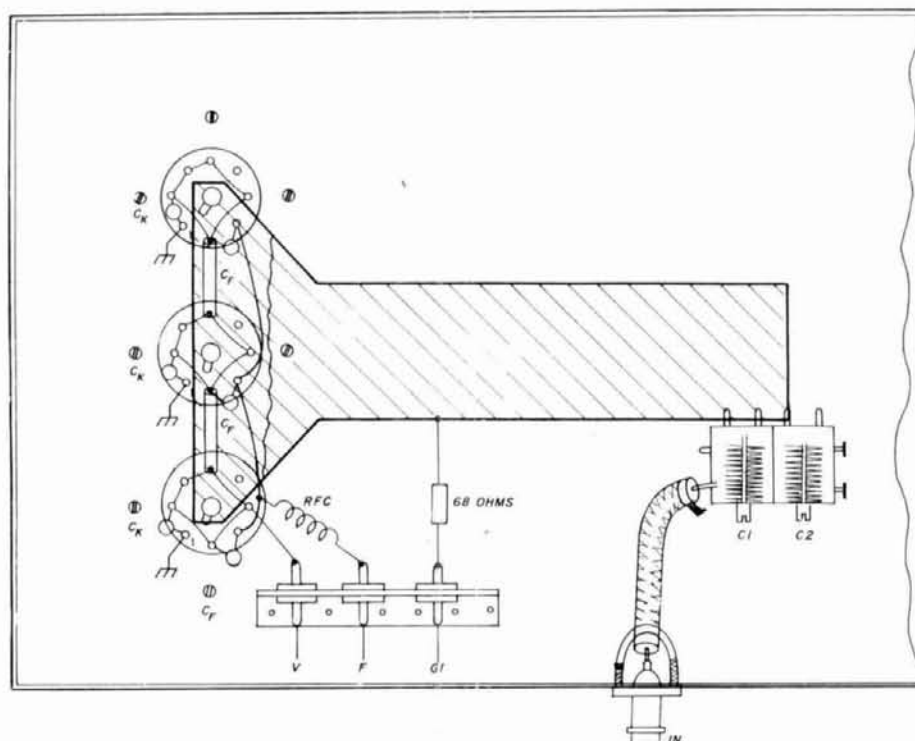

fig. 5. Half-wavelength grid line is utilized to handle high input impedances.

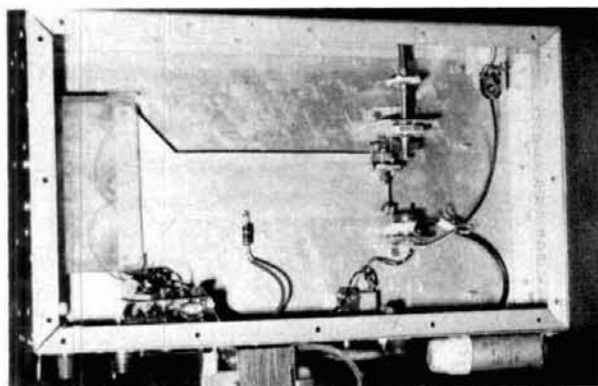

Photo B. Bottom view of grid compartment illustrates major component placement. Tube sockets are on the left.

photo E). An even less expensive solution would be to use paper heavy enough to withstand the expected temperatures. The plates can be connected to the plate resonator using finger stock or other material. The most important requirement is that good electrical contact is made.

adjustments

Switch on the amplifier in the following sequence. Turn on the filament voltage, bias voltage, and blower.

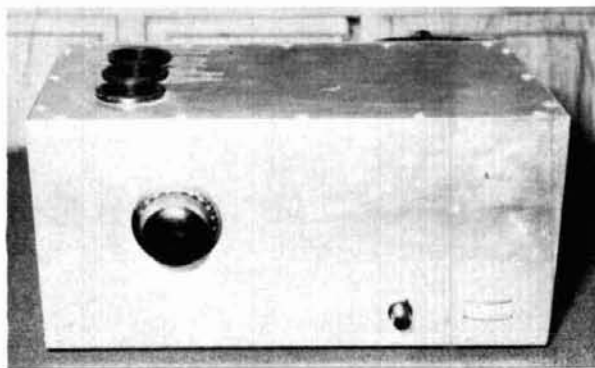
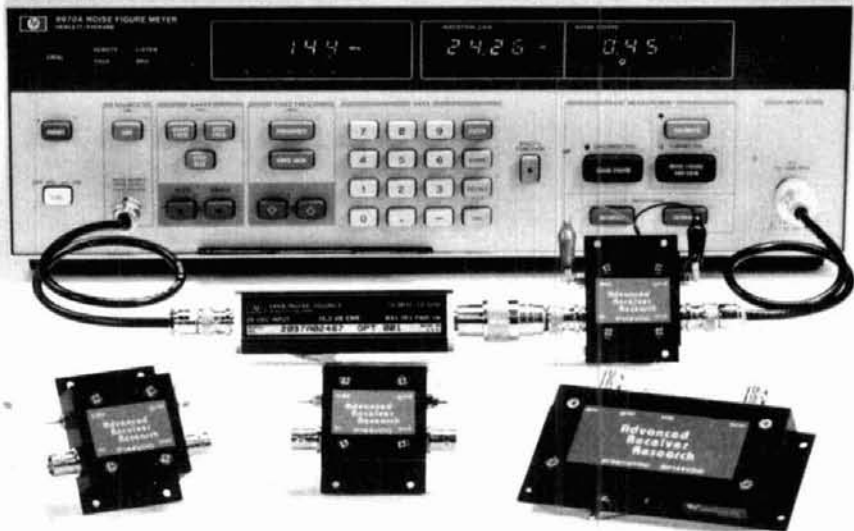

Photo C. Front view of 2-meter linear shows essentials are all there: input, tuning, and exhaust.

After a 1-minute warm-up, apply screen and plate voltage. If hash is heard in the receiver with the amplifier in standby mode (all voltages on), increase the bias voltage to -90 volts or more (negative). The bias voltage is normally adjusted for an idling plate current of 50 mA per tube.

Carefully increase the drive power while adjusting C1 and C2 for a plate current peak. Adjust C3 for a screen grid current peak, then repeat the first two steps with increased drive power. Adjust C4 for a final screen grid current of 8 mA per tube.

High Performance vhf/uhf preamps



Receive Only	Freq. Range (MHz)	N.F. (dB)	Gain (dB)	1 dB Comp. (dBm)	Device Type	Price
P28VD	28-30	<1.1	15	0	DGFET	\$29.95
P50VD	50-54	<1.3	15	0	DGFET	\$29.95
P50VDG	50-54	<0.5	24	+12	GaAsFET	\$79.95
P144VD	144-148	<1.5	15	0	DGFET	\$29.95
P144VDA	144-148	<1.0	15	0	DGFET	\$37.95
P144VDG	144-148	<0.5	24	+12	GaAsFET	\$79.95
P220VD	220-225	<1.8	15	0	DGFET	\$29.95
P220VDA	220-225	<1.2	15	0	DGFET	\$37.95
P220VDG	220-225	<0.5	20	+12	GaAsFET	\$79.95
P432VD	420-450	<1.8	15	-20	Bipolar	\$32.95
P432VDA	420-450	<1.1	17	-20	Bipolar	\$49.95
P432VDG	420-450	<0.5	16	+12	GaAsFET	\$79.95

Inline (if switched)						
	Freq. Range (MHz)	N.F. (dB)	Gain (dB)	1 dB Comp. (dBm)	Device Type	Price
SP28VD	28-30	<1.2	15	0	DGFET	\$59.95
SP50VD	50-54	<1.4	15	0	DGFET	\$59.95
SP50VDG	50-54	<0.55	24	+12	GaAsFET	\$109.95
SP144VD	144-148	<1.6	15	0	DGFET	\$59.95
SP144VDA	144-148	<1.1	15	0	DGFET	\$67.95
SP144VDG	144-148	<0.55	24	+12	GaAsFET	\$109.95
SP220VD	220-225	<1.9	15	0	DGFET	\$59.95
SP220VDA	220-225	<1.3	15	0	DGFET	\$67.95
SP220VDG	220-225	<0.55	20	+12	GaAsFET	\$109.95
SP432VD	420-450	<1.9	15	-20	Bipolar	\$62.95
SP432VDA	420-450	<1.2	17	-20	Bipolar	\$79.95
SP432VDG	420-450	<0.55	16	+12	GaAsFET	\$109.95

Every preamplifier is precision aligned on ARR's Hewlett Packard HP8970A/HP346A state-of-the-art noise figure meter. RX only preamplifiers are for receive applications only. Inline preamplifiers are if switched (for use with transceivers) and handle 25 watts transmitter power. Mount inline preamplifiers between transceiver and power amplifier for high power applications. Other amateur, commercial and special preamplifiers available in the 1-1000 MHz range. Please include \$2 shipping in U.S. and Canada. Connecticut residents add 7-1/2% sales tax. C.O.D. orders add \$2. Air mail to foreign countries add 10%. Order your ARR Rx only or inline preamplifier today and start hearing like never before!

Advanced Receiver Research

Box 1242 • Burlington, CT 06013 • 203 582-9409



✓ 158

MULTI-BAND SLOPERS*

ALSO: DIPOLES & LIMITED-SPACE ANTENNAS

Outstanding performance of WINN antennas is well known. Newer low SWR Coax lead - 3kw power - Compact - FULLY ASSEMBLED to your specified center frequency each band - Easy to install - Very low profile - Complete instructions - Your personal check accepted

4 BAND SLOPER - 160, 80, 40, 30, or 20M	60 ft. long	\$ 48 ppd
3 " "	60 ft. "	\$ 43 "
2 " "	40 ft. "	\$ 35 "
3 " " NO-TRAP DIPOLE - 160, 80, 40M	113 ft. long	\$ 71 "
2 " "	85 ft. "	\$ 55 "

5 BAND SPACE SAVER DIPOLE - 160 thru 10M * 46 ft. long
* Requires wide range tuner (80, 40, 20, 15M without tuner)

SEND SASE for complete details of these and other unique antennas

WINN ANTENNAS
312 394 3414
BOX 393-H MT. PROSPECT, IL 60056

✓ 159

SAY YOU SAW IT IN HAM RADIO

1 TO 1000 MHz SWEEP GENERATOR



RMSWG - 4
\$175.00

- SWEEP VARIABLE 1-250 MHz WITH LESS THAN 1 DB AMPLITUDE VARIATION
- AFTER WARM UP STABLE ± 100 KHz FOR 5 MINUTES
- 115 VAC INPUT

✓ 160

ROENSCH MICROWAVE
R.R. 1, Box 156B, PH: 816-963-2550
BROOKFIELD, MISSOURI 64628



The Professional Meter for Amateur Radio.



The standard of the electronics industry is setting a new standard for amateur radio use as well.

The Fluke 77 multimeter is ideal for testing and repairing any amateur radio gear. It's inexpensive, easy to use, and filled with professional features. Plus a full line of accessories let you measure high frequency, high voltage and current, and temperature. Made in the U.S.A. and backed by a 3-year warranty, the new Fluke 77 is the world's first handheld meter to combine analog and digital displays.

For a free brochure or the distributor nearest you, call toll-free 1-800-227-3800, ext. 229. Or write John Fluke Mfg. Co., Inc., P.O. Box C9090, Everett, WA 98206. Distributor programs available.

FROM THE WORLD LEADER
IN DIGITAL MULTIMETERS.

FLUKE 73	FLUKE 75	FLUKE 77
\$79†	\$109†	\$145†
Analog/digital display	Analog/digital display	Analog/digital display
Volts, ohms, 10A, diode test	Volts, ohms, 10A, mA, diode test	Volts, ohms, 10A, mA, diode test
Autorange	Audible continuity	Audible continuity
0.7% basic dc accuracy	Autorange/range hold	Touch-Hold™
2000+ hour battery life	0.5% basic dc accuracy	Autorange/range hold
3-year warranty	2000+ hour battery life	0.3% basic dc accuracy
	3-year warranty	2000+ hour battery life
		3-year warranty
		Multipurpose holster

† Suggested U.S. list price, effective January 2, 1987.

✓ 161



© 1987 Fluke

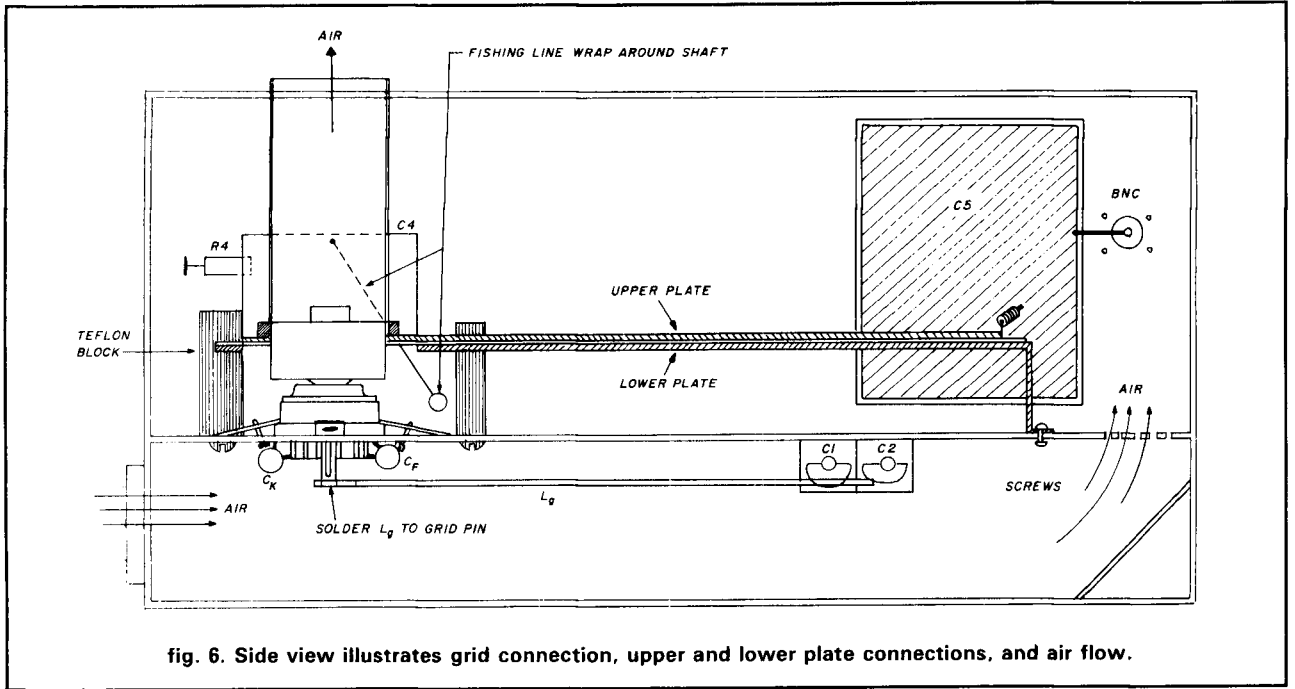

fig. 6. Side view illustrates grid connection, upper and lower plate connections, and air flow.

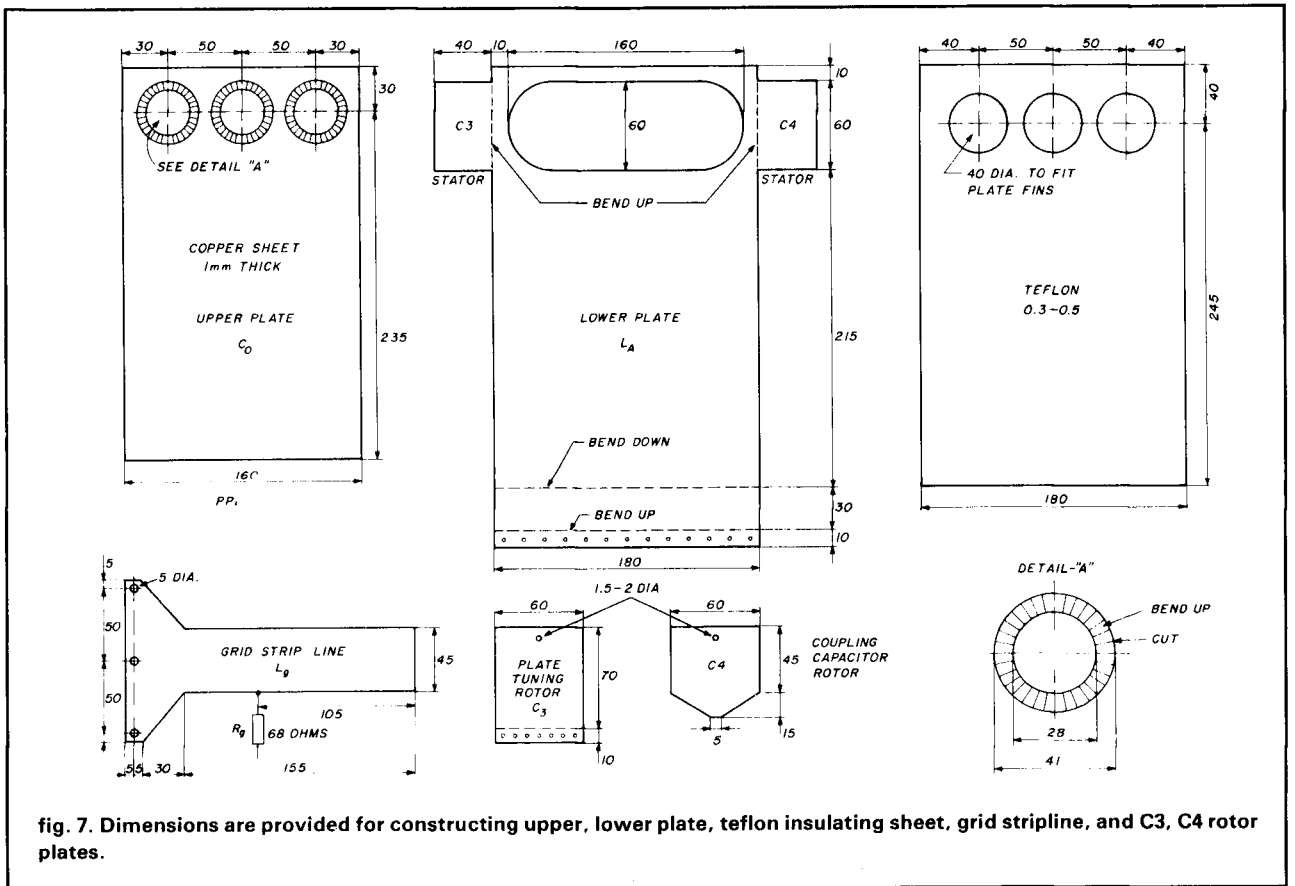

fig. 7. Dimensions are provided for constructing upper, lower plate, teflon insulating sheet, grid stripline, and C3, C4 rotor plates.

The final adjustments can be done by keying the amplifier with a series of dots (using an electronic keyer). This allows maximum drive voltages to be applied with-

out exceeding maximum power dissipation levels. All meters should indicate approximately 35 percent of maximum value. Negative screen grid current means that the

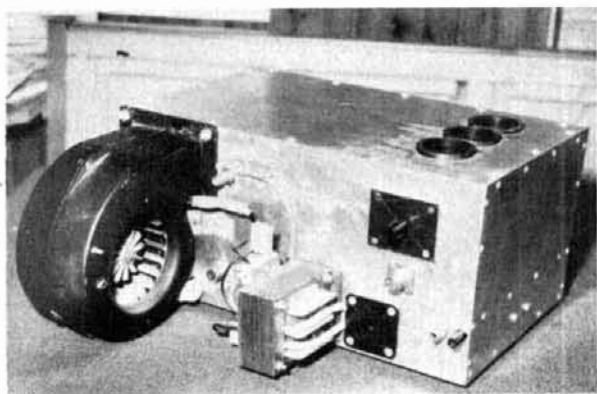

Photo D. Rear view of amplifier reveals same basic simplicity and effectiveness of construction.

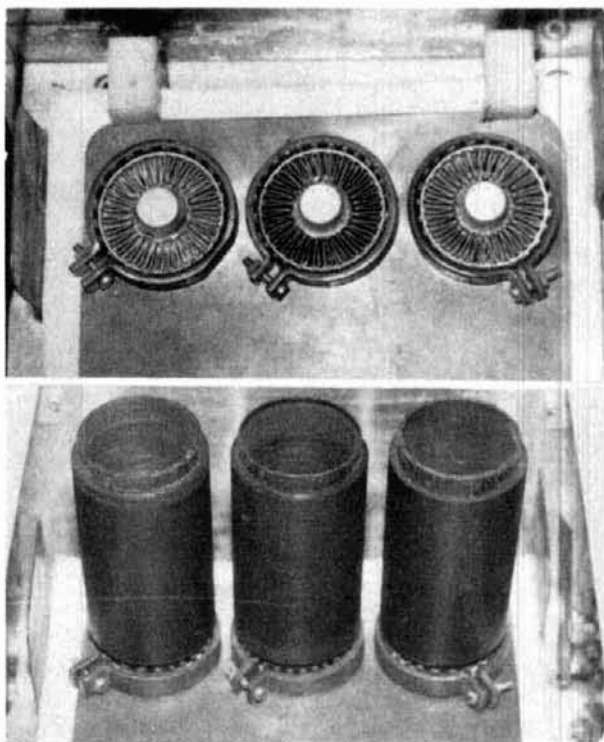

Photo E. "Before" and "after" views of chimney placement for the 4CX250B's.

drive power is too low and/or that the amplifier is too tightly coupled to the antenna.

single-tube SSB and CW ratings

At the ratings shown below, fm, a-m, RTTY, and SSTV operation are *not* recommended.

V_{g1}	= -65 volts
V_{g2}	= 350 volts
V_p	= 2.4 kV
I_{g1}	= 15 mA (max)

I_{g2}	= 8mA (max)
I_p	= 50mA (idle)
I_p	= 400mA (max)
P_{out}	= 650 watts (max)
P_{in}	= 960 watts (max)
P_{diss}	= 300 watts (max)
R_L	= 3.1 kilohms
Efficiency	= 68 percent

If all three tubes are closely matched, expect a tripling of output power and all currents. Equal power sharing (output) can be verified by measuring the temperature of air leaving the chimneys. If there appears to be an imbalance, increase idling current; the inequalities should become even more obvious.

determining component values

Computer simulation determined that the values of the following capacitors at resonance should be as follows:

$C1 = 35 \text{ pF}$	$C3 = 3 \text{ pF}$
$C2 = 10 \text{ pF}$	$C4 = 5 \text{ pF}$

Low losses, broad bandwidth, small temperature detuning, low RF voltages on the tube (resulting in longer life and little possibility of flashovers), and broad plate tuning make this a practical design. Note that all calculations were based on Eimac tube data and differences may occur if other manufacturers' tubes are employed.

Another useful feature of this amplifier is its low driving power requirement. Low cathode stray lead inductances help to reduce the drive requirements. It's possible to achieve between 1 and 2 dB of additional gain if a special effort is made to resonate (series) the value of C_k with the stray cathode lead inductances. It actually becomes necessary if you are drive-power limited.

additional hints

- Use as many screws as possible to join the cabinet together in order to reduce rf leakage.
- Use a type N — not an SO239 — for the output connector.
- Plate voltage may be supplied through a BNC connector and RG-58.
- Any departures from the dimensions called out on the drawings could result in degraded amplifier performance.
- The plate line should be cut from brass or copper sheet 1 mm thick and should be silver-plated, if possible.
- Both of the ZX180 zener diodes (180 volts, 12 watts) are mounted on heat dissipation devices.
- Other combinations of zener diodes or tube voltage regulators may be used to provide a regulated +360 volts.
- Resistor R3 (2.2k) acts like a fuse, delivering bias if the "slowblow" 0.1 A fuse is blown.

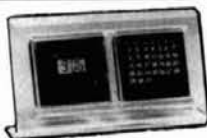

RECEIVE
THIS LCD
CALENDAR/
CLOCK FREE
WITH YOUR
SUBSCRIPTION

WHAT'S REALLY HAPPENING IN HOME SATELLITE TV?

STV[®] THE HOME SATELLITE TELEVISION MAGAZINE[™]

A monthly of 100-plus pages—has everything you need to know about where to find equipment, how to install it, system performance, legal viewpoints, and industry insights! With your subscription to **STV[®]** you will receive a **FREE LCD Calendar/Clock**.

- Only \$19.95 per year (12 monthly issues)
- \$1.00 for sample copy

IF YOU HAVE
A SATELLITE
SYSTEM, THEN
YOU REALLY
NEED ...



OnSat[®]

The best in satellite programming! Featuring: ★All Scheduled Channels ★Weekly Updated Listings ★Magazine Format ★Complete Movie Listing ★All Sports Specials ★Prime Time Highlights ★Specials Listing and ★Programming Updates!

- Only \$45.00 per year (52 weekly issues)
- 2 Years \$79.00 (104 weekly issues)
- \$1.00 for sample copy

Visa[®] and **MasterCard[®]** accepted (subscription orders only). All prices in US funds. Write for foreign rates.

Send this ad along with your order to:

STV[®]/OnSat[®]

P.O. Box 2384—Dept. HR • Shelby, NC 28151-2384
SUBSCRIPTION CALLS ONLY
TOLL FREE 1-800-438-2020

Conversion table for dimensions mentioned in art for this project.

millimeters	inches
0.3	.012
0.5	.019
1.0	.039
1.5	.059
2.0	.079
5	.197
10	.394
15	.591
28	1.102
30	1.181
40	1.575
41	1.614
45	1.772
50	1.969
60	2.362
70	2.756
105	4.134
155	6.102
160	6.299
180	7.087
215	8.465
235	9.252
245	9.646

acknowledgments

I wish to thank all those hams who believed in this unusual design and had the courage to try it.

ham radio

LOW BAND DX-ING COMPUTER PROGRAMS

by John Devoldere, ON4UN
for Apple IIe/c, MS-DOS,
Commodore C-128 Apple Macintosh
and Kaypro CPM Computers

Here's a collection of 30 super programs written by ON4UN. Just about every interest or need is covered—from antenna design and optimization to general operating programs. Antenna programs include: shunt and series input L network design, feedline transformer, shunt network design, SWR calculation, plus 11 more! General Ham programs include: sunrise/sunset, great circle distances, grayline, vertical antenna design program, sunrise calendar plus 9 more! Phew. When you sit down to use these programs you'll be amazed at what you have. Super value at a super low price. The best value in computer software available today. © 1986.

- UN-Apple IIe/c \$19.95
- UN-MS (MS-DOS) \$19.95
- UN-CPM/Kaypro \$19.95
- UN-C-128 (COMMODORE) \$19.95
- UN-MAC (MACINTOSH) \$24.95



Please enclose \$3.50 for shipping and handling



ham radio magazine **BOOKSTORE**

Greenville, NH 03048

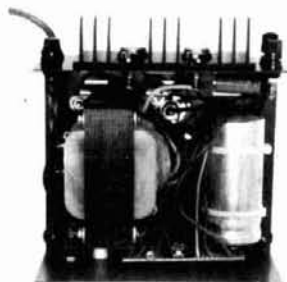

INSIDE VIEW - RS-12A

ASTRON POWER SUPPLIES

• HEAVY DUTY • HIGH QUALITY • RUGGED • RELIABLE •

RS and VS SERIES

SPECIAL FEATURES

- SOLID STATE ELECTRONICALLY REGULATED
- FOLD-BACK CURRENT LIMITING Protects Power Supply from excessive current & continuous shorted output.
- CROWBAR OVER VOLTAGE PROTECTION on all Models except RS-4A.
- MAINTAIN REGULATION & LOW RIPPLE at low line input Voltage.
- HEAVY DUTY HEAT SINK • CHASSIS MOUNT FUSE
- THREE CONDUCTOR POWER CORD
- ONE YEAR WARRANTY • MADE IN U.S.A.

PERFORMANCE SPECIFICATIONS

- INPUT VOLTAGE: 105 - 125 VAC
- OUTPUT VOLTAGE: 13.8 VDC \pm 0.05 volts (Internally Adjustable: 11-15 VDC)
- RIPPLE: Less than 5mv peak to peak (full load & low line)



MODEL RS-50A



MODEL RS-50M



MODEL VS-50M

RM-A Series

19" X 5 1/4" RACK MOUNT POWER SUPPLIES



MODEL RM-35A

Model	Continuous Duty (AMPS)	ICS* (AMPS)	Size (IN) H X W X D	Shipping Wt. (lbs.)
RM-35A	25	35	5 1/4 x 19 x 12 1/2	38
RM-50A	37	50	5 1/4 x 19 x 12 1/2	50
• Separate Volt and Amp Meters RM-35M	25	35	5 1/4 x 19 x 12 1/2	38
RM-50M	37	50	5 1/4 x 19 x 12 1/2	50

RS-A SERIES



MODEL RS-7A

MODEL	Continuous Duty (Amps)	ICS* (Amps)	Size (IN) H x W x D	Shipping Wt (lbs)
RS-4A	3	4	3 3/4 x 6 1/2 x 9	5
RS-7A	5	7	3 3/4 x 6 1/2 x 9	9
RS-7B	5	7	4 x 7 1/2 x 10 3/4	10
RS-10A	7.5	10	4 x 7 1/2 x 10 3/4	11
RS-12A	9	12	4 1/2 x 8 x 9	13
RS-20A	16	20	5 x 9 x 10 1/2	18
RS-35A	25	35	5 x 11 x 11	27
RS-50A	37	50	6 x 13 3/4 x 11	46

RS-M SERIES



MODEL RS-35M

MODEL	Continuous Duty (Amps)	ICS* (Amps)	Size (IN) H x W x D	Shipping Wt (lbs)
• Switchable volt and Amp meter RS-12M	9	12	4 1/2 x 8 x 9	13
• Separate Volt and Amp Meters RS-20M	16	20	5 x 9 x 10 1/2	18
RS-35M	25	35	5 x 11 x 11	27
RS-50M	37	50	6 x 13 3/4 x 11	46

VS-M SERIES



MODEL VS-20M

- Separate Volt and Amp Meters
- Output Voltage adjustable from 2-15 volts
- Current limit adjustable from 1.5 amps to Full Load

MODEL	Continuous Duty (Amps) @ 13.8VDC @ 10VDC @ 5VDC	ICS* (Amps) @ 13.8V	Size (IN) H x W x D	Shipping Wt (lbs)
VS-20M	16 9 4	20	5 x 9 x 10 1/2	20
VS-35M	25 15 7	35	5 x 11 x 11	29
VS-50M	37 22 10	50	6 x 13 3/4 x 11	46

RS-S SERIES



MODEL RS-12S

- Built in speaker

MODEL	Continuous Duty (Amps)	ICS* Amps	Size (IN) H x W x D	Shipping Wt (lbs)
RS-7S	5	7	4 x 7 1/2 x 10 3/4	10
RS-10S	7.5	10	4 x 7 1/2 x 10 3/4	12
RS-10L(For LTR)	7.5	10	4 - 9 - 13	13
RS-12S	9	12	4 1/2 x 8 x 9	13
RS-20S	16	20	5 x 9 x 10 1/2	18

VHF/UHF WORLD

Joe Reiser
W1JK

33 cm: update

One year ago this column was devoted to our newest UHF band, 33 cm (902-928 MHz).¹ Since that time, much has happened on this band, which is now just over 18 months old. Activity is growing fast, but more activity could really help popularize the band.

Last year's column was intended to be an "entry level" article. In this month's column, I'll present further information that will upgrade some of the circuits and the antenna described in the earlier article. I'll also discuss some commercial gear that has recently become available. With luck, the new information will encourage increased activity by helping others to become active on one of our newest and most exciting UHF bands.

latest activity

Weak-signal operation on 33 cm has been reported in the W1, W2, W3, W4, W7, W9, W0, VE2, and VE3 call areas. (Did I miss anyone?) Most of the activity is reportedly on the calling frequency of 903.1 MHz, as recommended in last year's column. There are also several fm repeaters active in the upper portion of the band, two of which are in the W1 call area. A California and a Massachusetts ATV repeater have also been reported as active, so the band is obviously being used for purposes other than weak-signal operation.

As a sign of acceptance of 33-cm contacts, the ARRL now counts 33-cm contacts separately for new multipliers and points in VHF/UHF contests. 33 cm also has its own VUCC (VHF/UHF Century Club) award for those who've worked at least 25 grid squares on this

band. Furthermore, the ARRL has announced that the Spring Sprint contests this year will include a separate 33-cm contest night. The tentative date is Friday, May 8, 1987 (7 to 11 PM, local time).

Several stations have also been active on portable expeditions. They've done quite well using low power (10 watts) and single 12-foot loop Yagi antennas. I've been successful in working only a few grids that way, so my total number of grids worked so far is a puny ten. However, while writing this month's column I heard that at least one ham has sent out several active "rovers" and worked the necessary 25 grids to claim the first 33-cm VUCC award.

propagation

Although initially some of us weren't sure what kind of propagation we'd experience on 33 cm, we expected it to be a blend of 70 (432 MHz) and 23 cm (1296 MHz). I think most of us now active on the 33-cm band feel that the typical propagation is more like 70 cm for casual contacts. Stations using 10 watts and a single 12-foot boom loop Yagi can easily cover a 100-mile range on SSB, with signal strengths as strong or stronger than can be anticipated on 70 cm.

Extended tropospheric propagation hasn't been well used because of the poor distribution of equipment available for 33 cm during the few openings this past year. The aurora, though absent in recent months, should return within the next year or two as solar cycle 22 begins. This will afford the best opportunity for auroral QSOs above 450 MHz, presently the highest frequency at which two-way Amateur

QSOs have been reported in this mode.

Aircraft scatter propagation on 33 cm seems to be as good or better than on 70 cm and more like the conditions experienced on 23 cm.^{2,3} Several stations have reported QSOs showing all the signs of aircraft scatter — a sudden appearance of a signal, reasonable signal strength, some flutter, then a gradual decrease in signal strength. Aircraft scatter is possible to about 500 miles, but 200 to 350 miles is near optimum.

While I haven't received any reports of activity, this band is a natural for 33-cm EME, since small-diameter (12 foot) dish antennas should be sufficient for such communications. The lack of EME operation on 33 cm is probably attributable to the fact that few, if any, Amateurs are using high power (greater than 150 watts) amplifiers on the band. I'm sure this QRP situation won't last very long!

As you know, I like to keep track of DX records on the frequencies above 50 MHz. At the present time the best DX reported on 33 cm is a mere 377 miles (606 km).⁴ Let me know if you break this record. Once again, I believe this record will be broken before this column is in print. What a great challenge we have on a new band!

33-cm antennas

As pointed out in last year's column, 33 cm is a transitional band for antenna design. Consequently, the loop Yagi is the most popular antenna type; it's easy to construct and has proved fairly successful.

Reference 1 included a description of a 33-element loop Yagi design on a 12-foot boom. This particular design is

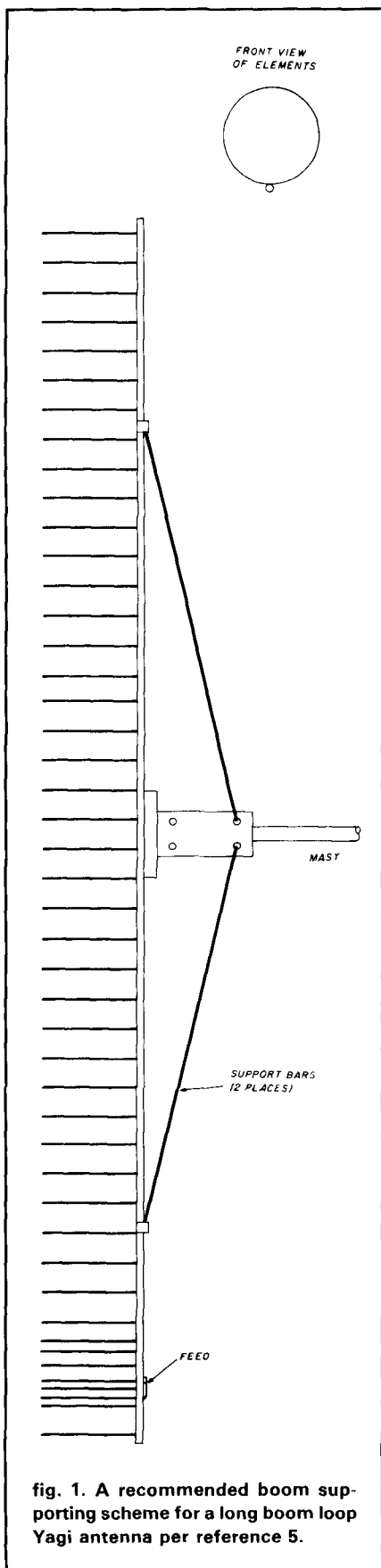

fig. 1. A recommended boom supporting scheme for a long boom loop Yagi antenna per reference 5.

probably not fully optimized, since it couldn't be scaled from any of the original designs shown in reference 5. However, it does have moderate gain (greater than 18 dBi) and a reasonably clean radiation pattern, as evidenced by the fact that most of the active 33-cm stations are using this or a similar design. Down East Microwave* sells a 33-element, 33-cm loop Yagi, but I don't know whether it's this or another design.

After a bit of head scratching on the subject of a simple approach for a higher gain antenna design, and a needle from Sam, W2PGC, I decided to build a 45-element loop Yagi scaled from the original 45-element, 23-cm optimized design described in reference 5. This would require a boom length of 17 feet, 2 inches.

After more thought about available materials and tubing sizes, I decided to use a 17-foot, 6-inch boom. The first part of the boom is the same length as the original design (12 feet) with the same diameter tubing (1 inch). A 6-foot length of 7/8-inch tubing is then inserted 6 inches into the director end of the boom for an overall length of 17 feet, 6 inches.

With this longer boom length and smaller diameter tubing on the front end, the overall strength of the boom will be decreased. A larger diameter boom could be used, but that would be more expensive and increase wind load, which is already high on a loop Yagi design. Therefore, I recommend a boom supporting structure similar to the one described in reference 5. A simplified sketch of it is shown in fig. 1.

Since there was a little extra boom available with a 5-foot, 6-inch extension, I added another director, making the new design one of 46, rather than 45, elements. The final design is shown in fig. 2; the driven element details are shown in fig. 3. This longer boom design uses the same element materials as the older 33-element design, with a slightly different element length taper schedule.

The gain of the 46-element loop Yagi should be about 20.5 dBi, a big

improvement over the 33-element design. The beamwidth is approximately 15 and 16 degrees in the E and H planes, respectively. Therefore, the recommended stacking distances per references 5 and 6 are 37 and 35 inches in the E and H planes, respectively.

Finally, the original 33-element loop Yagi described in reference 1 was designed for 902 MHz. As a purist, I thought that the new longer boom model should be moved slightly higher in frequency. Hence the spacings and element lengths on the 46-element loop Yagi differ slightly from those on the original 33-element design.

If anyone wants to extend the original 33-element design, I don't think it will matter much if the old spacing is maintained. All that will be necessary is to add the extra boom section and directors, placing them each 5.115 inches further out from the preceding director. Don't forget to always reference element spacings from reflector No. 2 in order to keep any tolerance buildup to a minimum. Also note that some of the director lengths of the original design should be changed as shown in fig. 2 if optimum performance is expected.

Several Amateurs are developing experimental long boom (12 feet or longer) Yagi designs, but they'll need to wrestle with the problems of boom corrections and impedance matching — a formidable problem on the UHF bands. I'll let you know how successful I am with mine!

Tonna Antennes (F9FT) has developed a short (8 foot, 4 inch) boom, 23-element Yagi. Marketed by The "PX" Shop,** it has a specified gain of 18.2 dBi with a 21- by 22-degree E and H plane beamwidth, respectively. Tonna Antennes circumvented the problem of boom corrections by mounting the elements above the boom on specially designed standoff insulators similar to those on their 23-cm designs. The feed system uses a folded dipole.

Needless to say, there will be some

*Down East Microwave (W3HQT), Box 1655A, RFD No. 1, Burnham, Maine 04922.

**The "PX" Shop (KC2PX), 52 Stonewyck Drive, Belle Meade, New Jersey 08502.

Or This Inexpensive It Really Shouldn't Be This Easy

Remember just a few years ago, how it took a roomful of equipment just to work RTTY. And if you wanted more than one mode it took a dedicated computer system costing thousands of dollars. The new AEA Pakratts are proving it doesn't take lots of equipment or money to enjoy working all bands in five different modes.

First, A Good Idea

The idea behind the Pakratt is very simple. One controller that does Morse, Baudot, ASCII, AMTOR, and Packet, and works both HF and VHF bands. Of course the decoding, protocol, and signal processing software must be included in the unit, and connection to the computer and transceiver have to be easy. The unit also has to be small and require only 12 volts, so it will work both in the shack and on the road.

Second, Computer Compatible

It doesn't matter what kind of computer you have, we have a Pakratt for you. The PK-64 works with the popular Commodore 64 or 128, and the PK-232 works with any other computer or terminal that has an RS-232 serial port. The PK-64 doesn't require any additional programs. Simply connect to the computer and transceiver and you're on the air. The PK-232 needs a terminal or modem program for your computer. The one you're using with your telephone modem will work just fine.

Fourth, AEA Quality and Price

Not many manufacturers like to discuss quality and price at the same time. AEA thinks you want high quality and low price in any product you buy, so that's what you get with the Pakratts. Ask any friend who owns AEA gear about our quality. The people who buy our products are our best salespeople. As for price, the PK-64 costs \$219.95, or \$319.95 with the HF option. The PK-64A, an enhanced software unit with a longer flexible computer cable, costs \$269.95 or \$369.95 with the HF option. The PK-232 costs \$319.95 with the HF modem included. All prices are Amateur Net and available from your favorite amateur radio dealer. For more information contact your local dealer or AEA.

Prices and specifications subject to change without notice or obligation.

PAKRATT™ Model PK-64



PAKRATT™ Model PK-232

Third, Performance and Features

The real measure of any data controller is what kind of on-air performance it gives. While the PK-64 and PK-232 use different types of modems, both give excellent performance on VHF. The optional HF modem of the PK-64 uses independent four-pole Chebyshev filters for both Mark and Space tones, and A.M. detection. The HF option can be factory or field installed.

The PK-232 uses an eight-pole bandpass filter followed by a limiter discriminator with automatic threshold correction. The internal modem automatically selects the filter parameters, CW Fc = 800 Hz, BW = 200 Hz; HF Fc = 2210 Hz, BW = 450 Hz; VHF Fc = 1700 Hz, BW = 2600 Hz.

The PK-64 uses on screen indicators to show status, mode, and DCD (Data Carrier Detect) while the PK-232 uses front panel indicators. Both units use discriminator style tuning for HF operation. And that's just the tip of the iceberg. Features like multiple connects on packet, hardware HDLC, CW speed tracking, and other standard AEA software features are included in both the PK-64 and PK-232.

AEA

Advanced Electronic Applications, Inc.
P.O. Box C-2160, Lynnwood, WA 98036-0918
206-775-7373 Telex 6972496 AEA INTL UW

more churning going on in 33-cm antenna design in the foreseeable future. Older designs will be improved and new designs will be forthcoming. Only time will tell whether the present antenna approaches are optimum for the 33-cm band.

circuit update

The converter/transverter designs in reference 1 have worked out quite well for many of us on the 33-cm band. Note that a few errors appeared in some of the figure captions in reference 1: the conversion loss of the transmit type upconverter shown in **fig. 3** should be 16 dB (not 9 dB), and the gain of the medium power amplifier in **fig. 12** should be 20 dB (not 30 dB).

Some additional comment on the hybrid modules are in order. Since reference 1 was published, the USA distributor for Toshiba has discontinued importing the SAU11 and SAU15 hybrid modules. However, I've been advised by Hiro Shiozawa, JA0JCJ, that he can provide some of the modules — particularly the Toshiba units — directly from Japan. I'd suggest that you write to him to make further arrangements.*

There are several other sources of suitable hybrid modules. The NEC MC-5809 driver module mentioned in reference 1 works just as well as the Toshiba SAU15 as a 100-milliwatt linear amplifier. Although I haven't tried it, the NEC MC-5843 shown in **fig. 12** of reference 1 should work as well as the Toshiba SAU11, albeit at a higher price.

Other substitutes for the high power module with 7 to 8 watts minimum output power (such as the NEC MC-5828, MC-5829, and MC-5842) are also available. Each has a different gain and output power. Of particular interest is the MC-5828, which sports an output power of 8 watts *minimum*, with only 1-milliwatt input power — all for \$42.50 in single quantities! The NEC distributor in the USA is California Eastern Labs.**

Although I have no specific part numbers or additional information, I

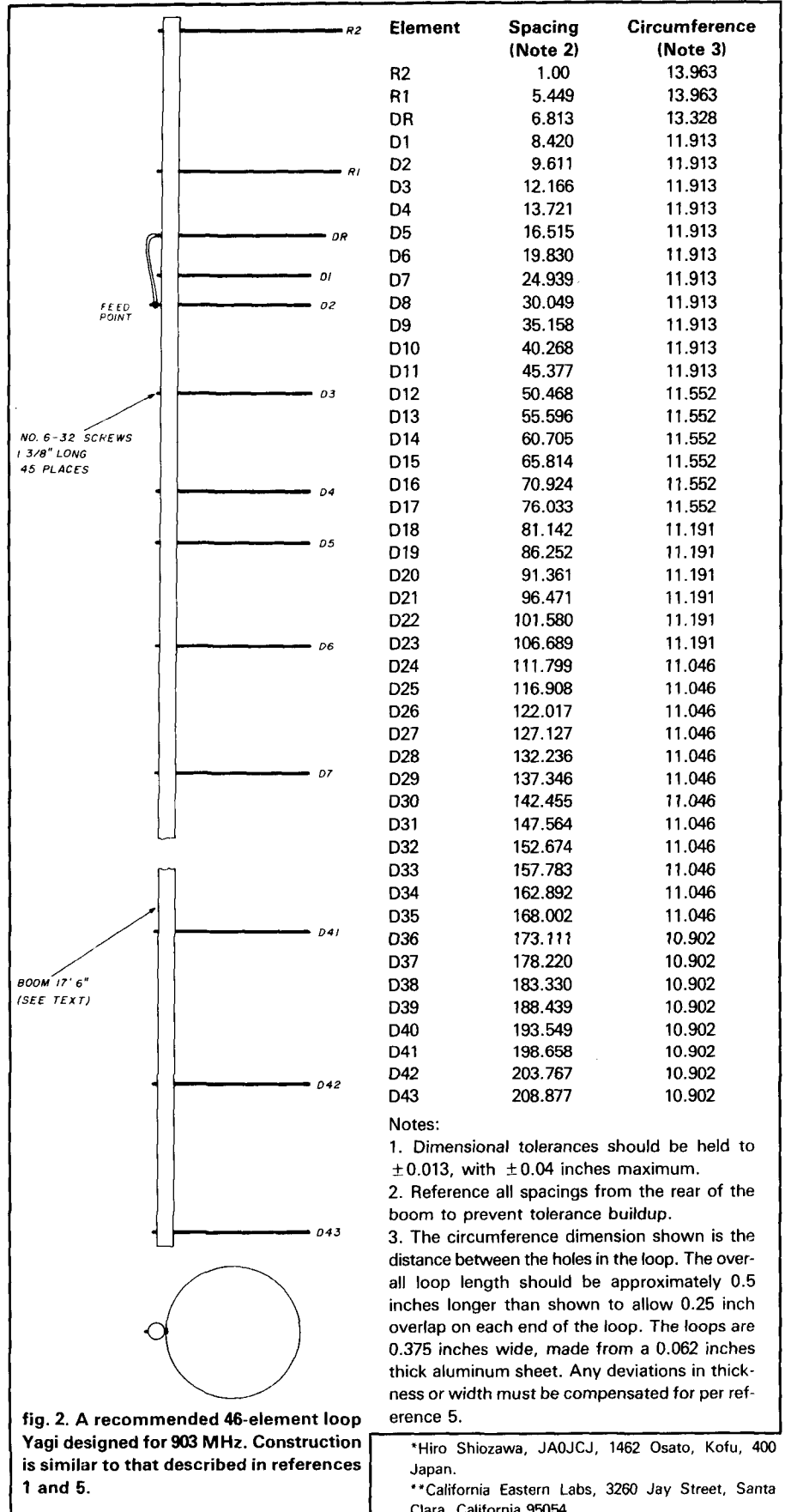

fig. 2. A recommended 46-element loop Yagi designed for 903 MHz. Construction is similar to that described in references 1 and 5.

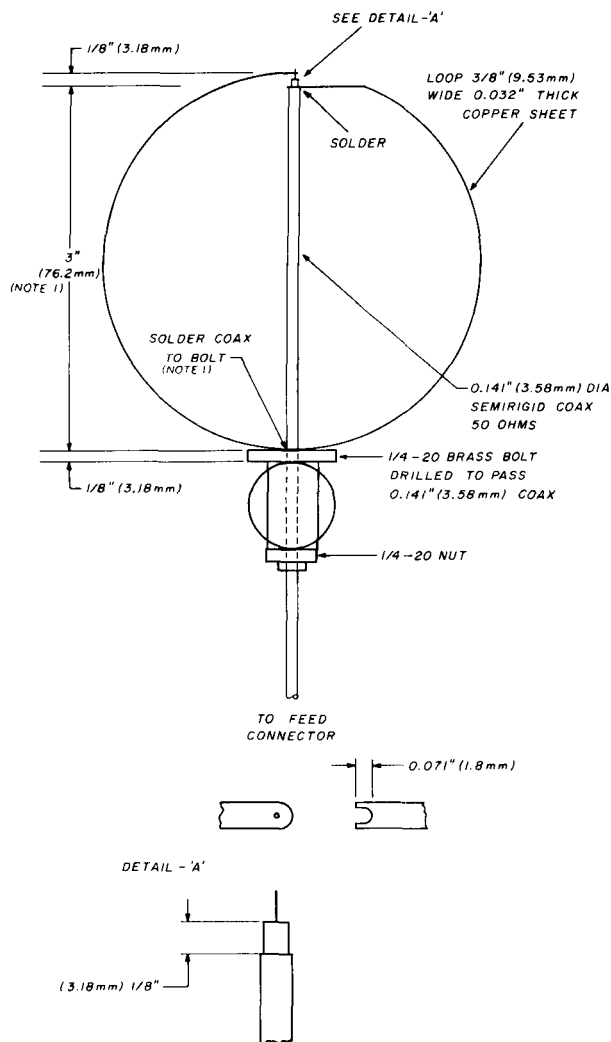

fig. 3. The feed system for the 46-element loop Yagi shown in fig. 2. Before soldering loop, adjust height (and length, if necessary) of loop for best VSWR.

know that Motorola also has a line of 33-cm hybrid power modules. The power levels are in the same class as the ones already mentioned, so if you're interested in using this type of module, I'd suggest that you also check the Motorola product line.

SSB with class-C amplifiers

The hybrid modules just described all operate in class C. In the past I speculated that you could run SSB through a class C amplifier with an acceptable IMD if certain parameters were taken into consideration. This is particularly advantageous when using solid-state "bricks" or hybrid modules,

because previous attempts to rework them for class B bias usually resulted in thermal runaway.⁷

Since then I've verified with on-the-air tests that this is indeed possible. Basically the trick I use is to rf-bias rather than dc-bias the class C module by applying a small amount of carrier to an SSB signal. The optimum seems to be about 1 watt of output from the 10-watt class C module with no modulation applied.

I have an older phasing type of SSB exciter, so I just unbalance the carrier until the output of the module is about 1 watt without modulation. I then operate SSB normally. This procedure will probably work with other class C

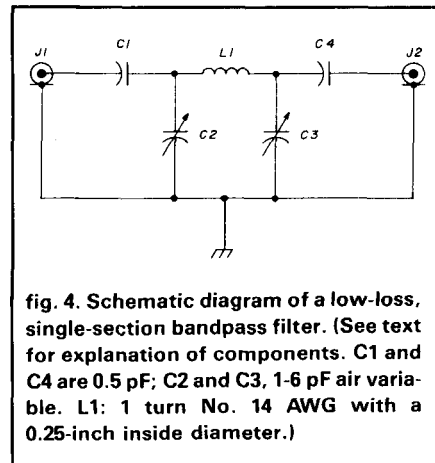

fig. 4. Schematic diagram of a low-loss, single-section bandpass filter. (See text for explanation of components. C1 and C4 are 0.5 pF; C2 and C3, 1-6 pF air variable. L1: 1 turn No. 14 AWG with a 0.25-inch inside diameter.)

circuits and devices if the rf bias is held to about 10 percent of the maximum output power. One precaution: don't transmit on SSB using this technique for long periods of time unless you have an adequate heat sink attached to the hybrid module. You could destroy it!

transverters

The circuits described in reference 1 can be easily assembled for transverter operation with a common local oscillator and power splitter as described. As proposed, the modular approach allows quick insertion of new or improved designs as they become available. This approach has worked out well for homebrewers like me.

Recently SSB Electronics introduced the model LT33S transverter. Available from Transverters Unlimited,* it operates at 903 MHz with a 144-MHz i-f and sports a low-noise GaAsFET preamplifier and 6 to 10 watts of transmitter output power. This particular unit is quite popular with 33-cm enthusiasts.

linear amplifiers

As suggested in reference 1, there are many choices of bipolar power transistors for solid-state linear power up to about 20 watts. Unfortunately, time and space won't permit me to discuss new solid-state linears too deeply at this time, but I will make a few suggestions.

*Transverters Unlimited (VE3CRU), Box 6286 Station A, Toronto, Ontario, Canada M5W 1P3.

The NEC NE0804 (5 watts), the NE0810 (11 watts), and the Thompson-CSF (formerly Solid State Microwave) SD1418 common emitter power transistors are recommended. They should work well using a circuit similar to that used on 23 cm by WB5LUA.⁸ All that's required for 33-cm operation is to lengthen the input and output lines and possibly change the value of the chip capacitor that shunts the base and collector of the transistor to ground.

Some medium power (40 to 100 watt) solid-state amplifiers are now being used. Typically they run class C with grounded base transistors. WA3JUF has proposed such a circuit using the Thompson CSF SD1414.⁹

high power amplifiers

For high power, tubes are strongly recommended. For power levels up to 100 watts, the ubiquitous 2C39/7289 is highly recommended. These tubes are plentiful and inexpensive.

W1RIL and others have modified the 70-cm 2C39/YD1050 amplifier described in *The UHF Compendium* to work on 33 cm.¹⁰ They shortened the half-wave plate line to 78 mm (as opposed to 175 mm), shortened the output coupling link, modified the input matching network as required, and obtained 50 to 100 watts output with reasonable gain.

A 3CU400/800 flat cavity amplifier design is recommended for medium power levels (300 to 500 watts).¹¹ Quarter- and half-wave cavity amplifiers using the 7650/7651 or the larger 7213/7214 tubes are highly recommended. They work well on these frequencies, can deliver high power, and are often seen at flea markets. I'm sure that many surplus or UHF TV "pulls" are also available. Stripline amplifiers will probably still work adequately at these frequencies.

filters

The filters shown in reference 1 work well. However, they are entry level filters with fairly wide bandwidth. The input filter is particularly wideband but more than sufficient to protect the input of the MRF901 preamplifier

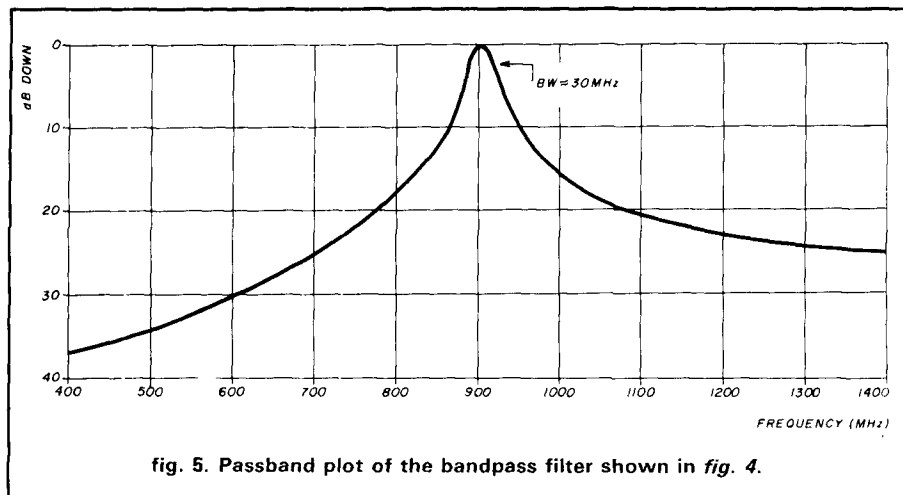

fig. 5. Passband plot of the bandpass filter shown in fig. 4.

design (shown in reference 1) if there are no local high power rf emitters such as UHF TV stations nearby.

Recently I developed an improved input filter with narrower half-power bandwidth — 30 versus 100 MHz — and less than 0.5 dB insertion loss. In addition, the 20-dB down points are only 300 MHz apart, as contrasted with the earlier design of 1000 MHz. It's similar to the design approach used in my 2-meter high dynamic range converter.¹²

A schematic of this single-section filter is shown in fig 4. C1 and C4 can be realized by connecting two 1.0-pF capacitors in series. C2 and C3 should be the piston or air-variable type if minimum insertion loss is desired. For lowest loss and best isolation, this filter should be built in its own shielded box (such as a Pomona Electronics 2417, 2428, or equivalent).

This filter is best tuned by adjusting C2 and C3 for minimum VSWR using a low power signal source. These capacitors will interact with each other, so alternate tuning until the VSWR is at a minimum. A typical passband plot of this filter is shown in fig. 5.

Likewise, the two-section bandpass filter shown in reference 1 is also an entry level filter. It has a half-power bandwidth of 50 MHz, which is a little too wide if a 28-MHz i-f is used. A slightly more complex three-section filter with a narrower half-power bandwidth, 36 MHz, and better skirt selec-

tivity of 100 MHz, rather than 350 MHz (30-dB down points), has been developed. A schematic is shown in fig. 6.

This filter is of the combline type with the input and output connections made directly to the resonators. The coupling is set by the spacing between resonators, the height of the filter enclosure, and the input/output tap position.

As with the single-section filter just described, the tuning capacitors should be of the low-loss piston or air-variable type. The resonators should be spaced 1 inch center-to-center and mounted midway between the top and bottom of the enclosure. The filter is built in a small shielded box (with 4 x 2 x 1-inch outside dimensions) such as the Hammond 1590L or equivalent. The most important parameter of the shielded box is the height inside the enclosure, which is about 0.8 inches. This filter can be tuned for minimum loss, but for best performance a sweep-tuned setup is required. A typical passband plot is shown in fig. 7.

preamplifiers

The MRF901 preamplifier in reference 1 has performed quite well. Until recently it has been my only preamplifier. Though its noise figure is too high (typically 3 dB) for serious weak-signal operation it makes an excellent second-stage postamplifier.

For a really low noise figure, use a GaAsFET preamplifier. I've recently

MADISON SPRING FLING

New rigs and old favorites, plus the best essential accessories for the amateur.

3621 FANNIN ST
HOUSTON, TX 77004-3913

CALL FOR ORDERS
1-713-520-7300 OR
1-713-520-0550
TEXAS ORDERS CALL COLLECT

ALL ITEMS ARE GUARANTEED OR SALES PRICE REFUNDED

EQUIPMENT

Kenwood TH205AT	Trade in your old HT
Kenwood TS 440	Call for trade
Icom R7000 25-2000 MHz	949.00
Icom IC735	849.00
Ten-Tec 2510 (Easy OSCAR)	439.00
KDK FM 240 NT	279.00
Mirage Amps	15% OFF
Tokyo Hy Power HL1K AMP No. 4CX250B	699.00

Trade in your old HT
Call for trade



IC28A List 429 Your Cost 369.00

ANTENNAS

Isopole 144 MHz	44.95
AOP-1, Complete Oscar Antenna	149.95
Butternut HF6V, 80-10 vertical	125.00
HF2V, 80 & 40 vertical	119.00
HF4B	189.00
Hustler G7-144	119.95
Hustler 6BTV	139.00
KLM HF World Class Series Antennas	Call Don
Alpha Delta Twin Sloper	49.00
Coax Seal	2.00/roll
B&W Dipoles	Less 10%
KLM KT-34A	399.00
W2AU, W2DU	Now Available
NEW KLM 1,2-44LBX	129.00
1296 Power Divider	Soon
Orion CD-78 + BS 80 75/80 rotatable dipole	299.00
GSRV	44.00

OTHER ANTENNAS

Diamond D-130 Discone 25-1300 MHz	79.00
Larsen Kulduck	17.00
Larsen 2M 1/2 wave telescope ant	25.00
Avanti AP151 3G on Glass Antenna	36.00
Anteco 2M, 5/8, Mag. Mount, Comp	25.00
Orion 2M 1/2 wave Handy Antenna	19.00
Van Gordon SLA-1 160-80-40 Sloper	44.00
Valor AB-5 Mobile	79.95
Stoner DA100 D Active Rx Antenna	190.00
DC Tenna Hitch 3/8" 24 Thread	
Fits 3/4" trailer hitches	29.95

KEYS

Benchner & Vibroplex	Less 10%
Benchner is now improved. Screws & springs, all stainless steel and extra hand polishing	
Nye ESK-001 Keyer	58.00

TUBES

Collins & Drake Replacement tubes	Stock
GE 6146B	12.95
3-500Z	109.95
GE Industrial Tubes	Call
GE 12BY7A	7.00
GE 6JS6C	12.95
GE 8950	16.00
12JB6 Sylvania	6.00
Hard to find Tubes 50-90% off list	
6JB6A	9.95
6JE6C/6LQ6	9.95
572B	69.00

BOOKS

We stock SAMS, TAB, ARRL, RSGB, Ameco Radio	
Pubs	Call
New 1987 Radio Database Book - International SW plus reviews	12.95

PARTS

1.5 Amp/400V full wave bridge rectifier	1.95
2.5A/1000PIV Epoxy diode	29 each or 19.00/100
0015/10KV or 001/20KV	1.95 each
3N201	.95
4 inch ferrite rod	1.95
365pF cap	1.95
Sanyo AAA, AA Nicads w/tabs	2.00
2, 4, 5, 6, 8 pin mic plugs	3.00
1/8, 1/4, watt carbon resistors	.05 each
Meters 0-3000 VDC 2 1/2" Square 0-1 Amp DC	9.95
Drake-Collins mike plug	2.00
Thousands of panel meters	3.95 up CALL
MICA Cap 0004/3KV	5.00 others CALL
Close out on rigs & accessories. All the time	Call
We may have what you're looking for	
Diodes 3A/1000 PIV	29
Duracell 9 Volt Battery - 2 Pak MN1604	3.49
DC Fan 3 1/2" Sq. x 1"	9.95
CINCH 12 pin conn fitz (Drake etc.) female	3.00

SERVICES

Complete KWM 2 Retube	179.00
Flat fee Collins rebuild	Call

USED EQUIPMENT

All equipment, used, clean, with 90 day warranty and 30 day trial. Six months full trade against new equipment. Sale price refunded if not satisfied.

KWM 380/2CW
ETO/ALPHA 77, Clean
ICOM IC 745
TenTec 505 Argonaut
YAesu FT 101E
YAesu FT 901 DM/CW
Kenwood TS-830S/CW
TS-430S/acc
TS-520S
Drake TR4cw, clean

Call for latest used gear list
(800) 231-3057

TOWER ACCESSORIES

1/4" E H S Guy cable, Rohn US, 1000 ft	250.00
3/16" E H S cable, Rohn US, 1000 ft	210.00
1/4" Guy Cable, 6100 #7 x 7 strand, import	18c/ft
3/16" Guy Cable, 3700 #7 x 7 strand, import	15c/ft
3/8" x 6 E&J Turnbuckle	7.95
3/16" Wire Rope Clips	40
1/4" wire clips	50
1/4 Thimbles	45
Porcelain 500D Guy Insulator (3/16)	1.99
Porcelain 502 Guy Insulators (1/4)	3.39

POLICIES

Minimum order \$10.00. Mastercard, VISA, or C.O.D. All prices FOB Houston, except as noted. Prices subject to change without notice. Items subject to prior sale. Call anytime to check the status of your order. Texas residents add sales tax. All items full factory warranty plus Madison warranty.

NEW AMPLIFIER LINE

Coming soon. How to buy a portable transceiver. The factors in order are size, features, reliability, parts availability outside USA. Call for information.

BIRD

STOCK ITEMS CALL

Power Range	Frequency Bands (MHz)					
	2-30	25-50	50-125	100-250	200-500	400-1000
5 watts	5A	5B	5C	5D	5E	
10 watts	10A	10B	10C	10D	10E	
25 watts	25A	25B	25C	25D	25E	
50 watts	50H	50A	50B	50C	50D	50E
100 watts	100H	100A	100B	100C	100D	100E
250 watts	250H	250A	250B	250C	250D	250E
500 watts	500H	500A	500B	500C	500D	500E
1000 watts	1000H	1000A	1000B	1000C	1000D	1000E
2500 watts	2500H					
5000 watts	5000H					

MADISON

Electronics Supply

3621 FANNIN
HOUSTON, TEXAS 77004
1-713-520-7300 OR 1-713-520-0550

New ICOM. Call on the IC-2A2, IC-38A, IC-03A2



Lunar 2M4 40P 109.00

ACCESSORIES

B&W VIEWSTAR ANTENNA TUNER	89.95
Heil HC3/HC4/HC5	Stock
Heil BM10 Boom Mike headset	CALL
Tri-H 5000A Remote Phone	\$189.00
Triplet 3360 VOM (same as FLUKE 77)	69.00
Daiwa NS660A 30/300/3000 watts	135.00
Alnico ELH 230D - Excellent buy	88.00
Nye MB5-A (for the big boys!)	529.00
Shure 444D	54.95
Ameco PT-2	84.95
New Tokyo HC 200A	115.00
Nel-Tech Labs Digital Voice Keyer DVK 100	335.00
Astatic SilverEagle & Base	66.00

BELDEN

9913 low loss, solid center, foil/braid shield	51c/ft
8214 RG8 Foam	45c/ft
8237 RG8	39c/ft
8267 RG213	55c/ft
8000 14 Ga stranded copper ant. wire	13c/ft
8448 8 conductor rotor cable	33c/ft
9405 Heavy duty 2-16 Ga 6-18 Ga	56c/ft
9258 RG8x	20c/ft
9269 RG-62A/U	16c/ft
8403 Mic Cable, 3 condctr & shield	45c/ft
100 feet 8214 w/ends installed	54.00
8669 7/16" tinned copper braid	1.00/ft

AMPHENOL

831SP-PL259 Silverplate	1.25
UG176 reducer RG8X	.30
831J Double Female UHF	2.00
82-61 N Male	3.00
82-97 N Female Bulkhead	3.00
82-63 Irline Female N	4.00
82-98 N elbow	9.00
31-212 BNC-RG59	1.50
31-216 UG201 A/U N Male-BNC Female	2.00
31-2 BNC-RG58	1.50
34025 N Male, RG58	3.00
34125 N Female UHF male	9.00
3128 BNC Female-PL 259	3.00
4400 N Male-50 239	7.00

PACKET POWER

AEA PK-232	299.00
Kantronics KPC 2400	299.00
Kantronics 2400	139.00
Kantronics Packet II	149.00
MFJ 1270	125.00
AEA PM-1	149.00
New AEA UDC-232 Firmware, No modem, List 279.00	249.00
New Kantronics KAM	299.00

See you at Dayton Flea Market, Spaces 2435-37.

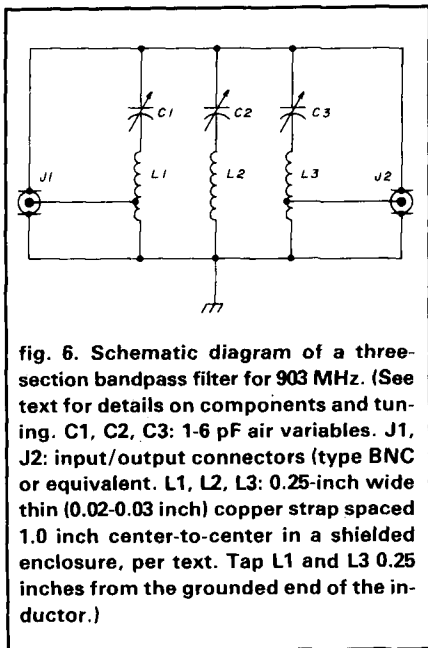

4:1 L-network transformer that worked well for me on the VHF bands and is relatively broadband with low loss. As a result, the output compression point is very high; this is a performance parameter some of the other matching schemes I've used didn't have.

To align the preamplifier properly, a good noise figure generator is recommended. However, adequate performance can be obtained by using a weak-signal source for tuning. After tuning C1 and C2 for best sensitivity, spread or compress the turns on L2 for maximum gain, typically 13 to 15 dB. Overall noise figure is a function of the construction and GaAsFET used, but 0.5 to 1 dB is typical. The device type isn't critical; the MGF1402, MGF1301, NE72019, or equivalent GaAsFETs should all work well.

to cover from 25 to 1000 MHz and from 1030 to above 1300 MHz, offers excellent frequency stability and weak-signal characteristics on the 33- and 23-cm bands.

commercial fm gear

As mentioned in reference 1, a portion of the 33-cm band is a citizens band in Japan. As a result, many low power (5 watt) fm transceivers are available in Japan, but not yet in the USA, although that situation could change any day now.

Table 1 shows a few of these transceivers. They're all citizens band type with typically 75 to 100 fixed channels between 903 and 905 MHz. These transceivers have F3E emission and a nominal 5 watts output power. They're very small and excellent for portable operation.

One channel on these transceivers is at 903.1125 MHz. W1XX and others have been using this channel at portable locations because it's close to the weak-signal calling frequency. However, if these transceivers become available in the USA, I hope that they'll be used only above 904 MHz so as not to interfere with weak-signal operations near 903.1 MHz.

summary

This month's column reviewed the current status of operation on the 33-cm band. New higher performance circuits and some equipment, both homebrewed and commercial, were recommended. Improvements to the circuits recommended in reference 1 were also discussed. I hope this information will stimulate increased activity. . . see you on 903.1 MHz, especially on Friday evenings — a recommended activity night — at 9 PM (local time)!

acknowledgments

I'd like to thank Bart Jahnke, KB9NM, of the ARRL for his help in locating the information on the Japanese fm citizens band gear.

SMIRK lives

Ray Clark, K5ZMS, president of SMIRK (Six Meter International Radio Klub) has recently informed me that

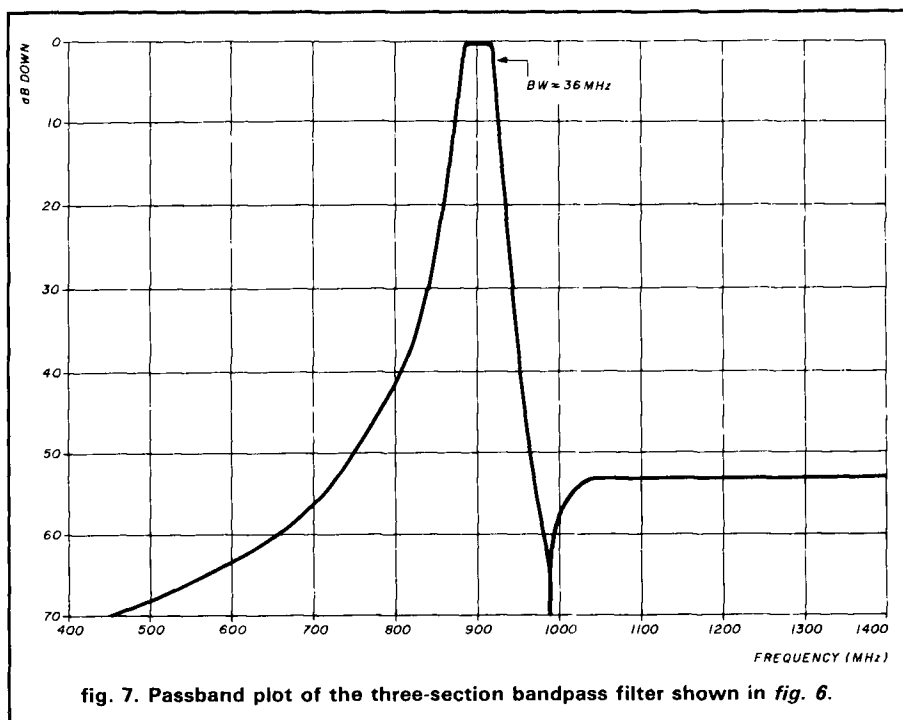

built one similar to the design shown in reference 13. A schematic is provided in fig. 8. The input circuit, a tuned tank, is easy to construct and provides a reasonable amount of selectivity, reducing the susceptibility to overload from high power emitters in the VHF range and below.

The output matching circuit uses a

receivers

Wide-frequency coverage receivers (such as Yaesu's FRG9600) are now available. Not necessarily weak-signal types, they have noise figures typically in the 6 to 10 dB range; a low-noise preamplifier ahead of the receiver is recommended for weak-signal operation. The new ICOM R-7000, designed

1987 CALLBOOKS



The "Flying Horse" sets the standards

Continuing a 66 year tradition, there are three new Callbooks for 1987.

The North American Callbook lists the calls, names, and address information for licensed amateurs in all countries from Canada to Panama including Greenland, Bermuda, and the Caribbean islands plus Hawaii and the U.S. possessions.

The International Callbook lists the amateurs in countries outside North America. Coverage includes South America, Europe, Africa, Asia, and the Pacific area.

The 1987 Callbook Supplement is a new idea in Callbook updates; it lists the activity in both the North American and International Callbooks. Published June 1, 1987, this Supplement will include all the new licenses, address changes, and call sign changes for the preceding 6 months.

Publication date for the 1987 Callbooks is December 1, 1986. See your dealer or order now directly from the publisher.

- | | |
|---|---------|
| <input type="checkbox"/> North American Callbook
incl. shipping within USA | \$28.00 |
| incl. shipping to foreign countries | 30.00 |
| <input type="checkbox"/> International Callbook
incl. shipping within USA | \$28.00 |
| incl. shipping to foreign countries | 30.00 |
| <input type="checkbox"/> Callbook Supplement, published June 1st
incl. shipping within USA | \$13.00 |
| incl. shipping to foreign countries | 14.00 |

SPECIAL OFFER

- | | |
|---|---------|
| <input type="checkbox"/> Both N.A. & International Callbooks
incl. shipping within USA | \$53.00 |
| incl. shipping to foreign countries | 58.00 |

Illinois residents please add 6½% tax.
All payments must be in U.S. funds.

RADIO AMATEUR callbook INC.



Dept. F
925 Sherwood Dr., Box 247
Lake Bluff, IL 60044, USA

Tel: (312) 234-6600

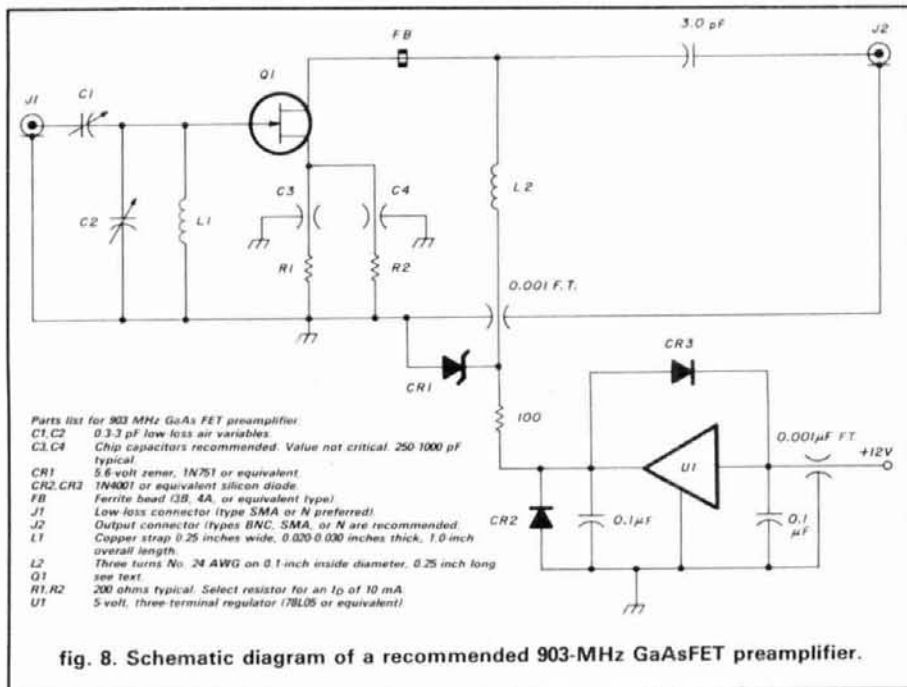

fig. 8. Schematic diagram of a recommended 903-MHz GaAsFET preamplifier.

"SMIRK is still alive and kicking." However, because of budgetary constraints, copies of the quarterly newsletter won't be sent to anyone who isn't a paid-up member. If you're a SMIRK member and haven't renewed your dues, send \$3 to Ray at his callbook QTH.

new award program

In order to stimulate more weak-signal operation on 70 cm (432 MHz), Art Holmes, WA2TIF, has instituted a new awards program. Basically, there's a monthly award for making at least 50 QSOs, a monthly award for 1000 points by multiplying number of QSOs times grids worked, and an endorseable award for working 100 or more different stations on the band. The only stipulation is that contacts made on nets and during contests don't count. Write Art at 11 Kerr Road, Rhinebeck, New York 12572, for further information.

new records

There have been some unusually late and long DX tropo openings this year. The one during the U.S.A. Thanksgiving weekend will be long remembered because so many North American records were broken. Al-

though this represents preliminary information, I'll list those new records that I've been able to document.

The 70-cm tropo record is now held by Ray, WB3CZG, FN10AX, for a QSO on November 29, 1986, with Kent, WA5VJB, EM12LQ, of approximately 1318 miles (2120 km). On the same date, a new 23-cm record of approximately 1287 miles (2070 km) was set between Ray, WB3CZG, FN10AX, and Dave, KD5RO, EM13PA. Finally on November 28 and 29, 1986, the 13-cm (2304 MHz) record was broken several times by WB5LUA, KD5RO, K9HMB, and W8YIO. When it was all over, Dave, KD5RO, EM13PA, and Lew, W8YIO, EN82BE, emerged as the new record holders for a distance of approximately 940 miles (1516 km).

Just before this great weekend, Tony, K5PJR, EM26OP, and Jim, WA5ICW/5, EMO4HX, set a new 6-cm (5760 MHz) tropo record of approximately 285 miles (459 km). November certainly was an exciting month for UHF and microwave records! Congratulations should go not only to the new record holders, but to all those who — if only for a few minutes — held the record. Great going! Keep it up!

The 1987 Handbook has it all!

The 1987 ARRL Handbook for the Radio Amateur is your source for the most up-to-date information on:

- Packet Radio and other forms of digital communication
- RF Circuits and design
- Power amplifiers
- Visual communication — ATV, SSTV, and FAX
- Propagation
- Operating
- Antennas and transmission lines
- Voice communication
- Space communication

The 64th edition has 40 chapters and over 1200 pages. It's packed with practical construction projects and there are many with printed-circuit board etching patterns. Every year the *Handbook* is updated to reflect changes in the state-of-the-art. Whether you are a radio amateur, engineer or technician you'll find the latest edition a must addition to your technical library. There is no change in price from last year! Paperbound: \$18 in the US, \$19 elsewhere; cloth: \$27 US, \$29 elsewhere. Payment must be in US funds. Add \$2.50 (\$3.50 for UPS) shipping and handling.



WA6P operated this solar powered packet station during 1986 Field Day as part of the McDonnell Douglas Amateur Radio Club and Southern California Amateur Club entry. The photographer was WA6AUF.

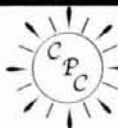

California Packet Concepts

Your COMPLETE Packet Source
making Packet Radio as easy as 1-2-3

Terminal Node Controller TNC II

Assembled and Burned In **169****

Complete Kit **135****

add for CMOS (1.35 ma vs 250 ma typical) **+9****

bare PCB (with Manuals) **35****

17 VDC Wall Supply **7****

Located CLONE Of the TAPR TNC 2

Complete TAPR Documentation
U.S.A. Assembly and Quality
Latest 1.1.4 Version Firmware Available
TAPR Style Enclosure
Modern Disconnect

IBM™ PC/XT COMPATIBLE CPC-XT

STD Assembled and Burned In or NO extra charge **899****

Minimum System
1 Floppy 8523 only
256K only (Assembled - No software) **699****

UPGRADES

TURBO (4 layer, 8MHz) **+49****

Color **+249****

Enhanced Keyboard **+24****

OPTIONS

Color Board (CSA) **84****

CSA Color 14" Monitor **329****

IBM Enhanced Style Keyboard (separate cursor pad) **84****

Segate ST-225 20 meg complete Hard Disk **424****

Tele Modem 1200 baud, internal **144****

640 K on Mother Board, 4.77 MHz
2 1.1 MB 5.1/5.25 Floppies
150 Watt Power Supply
AT Style Keyboard
Mono Graphics Video
Samsung 11" Amber Monitor
Multi 1.0 (Parallel Port)
Floppy 85232 Clock/Calendar
DOS 3.2 and GW-BASIC
Communications Software

Call for Quotes on Custom Configurations
Other OPTIONS Available
Printers - Available on request

Bulk Floppies **70c ea.**
GUARANTEED - (25 pc. min.)

RADIO KITS VHF/UHF/HF

The COMMANDER 2 meter Kit 154**

144 to 148 MHz in 10 KHz Steps/5 KHz offset
10 watt nominal, 15 watt maximum output
± 5 MHz Repeater Offset
0.5 MV receiver sensitivity

The EXPLORER 70 cm Kit 164**

440 to 450 MHz in 25 KHz Steps (40 chan)
5 watt nominal, 10 watt maximum output
± 5 MHz Repeater Offset
0.5 MV receiver sensitivity

The DSE HF Transceiver Kit 224**

80 meter version supplied
USB, LSB, CW
30 watts P.E.P. output
Digital frequency readout
(40, 20, 15, 10 meters available)

Power Supply Kit for Radios 39**

Matching style, 1.3 BV nominal

World Renowned Kits from DICK SMITH ELECTRONICS

The COMPLETE 1-2-3 Package 1299** (save over \$100)

includes TNC II, std CPC-XT, Commander
Complete with power supplies and cables
(All assembled and tested as a system for 48 hrs.)

- 1 year REPLACEMENT Guarantee on ALL Assembled Products (Ask us about the details)
- NO handling or Credit Card Fees!
- Shipping via UPS - FREE on TNC II
- California addresses must add 6% sales tax
- We welcome CUSTOM Quotes - dealers too!

149

Order Toll Free Outside CA. Questions & Information
1-800-233-0301 (Operator 1) 1-209-625-8429
telex 650 308 7918 (via Western Union Interface)

P.O. Box 4469, Visalia, CA 93278



IBM is a registered trademark of International Business Machines Corp.
Prices subject to change without notice.

grid square index

Recently Folke Rosvall, SM5AGM, created *The Radio Amateur's World Atlas*, a 24-page book of maps and tables which show the geographical coordinates of all 32,400 grid squares in the world, along with an extensive index of cities worldwide. I've been using this book for some time and find it quite helpful in locating grid squares of stations in the USA as well as DX stations anywhere in the world. Since most of my acquaintances seem to be unaware of this book, I thought I'd mention it because it's so helpful with my record keeping. It's available from Ham Radio's Bookstore for \$3.95 plus \$3.50 shipping and handling.

references

1. Joe Reiser, W1JR, "VHF/UHF World: 33 cm - Our Newest Band," *ham radio*, April, 1986, page 83.
2. Joe Reiser, W1JR, "VHF/UHF World: Microwave and Millimeter-wave Propagation - Part 1," *ham radio*, July, 1986, page 82.
3. Joe Reiser, W1JR, "VHF/UHF World: Microwave and Millimeter-wave Propagation - Part 2," *ham radio*, August, 1986, page 69.
4. Joe Reiser, W1JR, "VHF/UHF World: The Ubiquitous Diode - Part 1," *ham radio*, February, 1987, page 51.
5. Joe Reiser, W1JR, "VHF/UHF World: Designing and Building Loop Yagis," *ham radio*, September, 1985, page 56.
6. Joe Reiser, W1JR, "VHF/UHF World: Stacking Antennas - Part 1," *ham radio* April, 1985, page 129.
7. Joe Reiser, W1JR, "VHF/UHF World: Medium Power Amplifiers," *ham radio*, August, 1985, page 39.
8. Al Ward, WB5LUA, "1296-MHz Solid-State Power Amplifiers," *QST*, December, 1985, page 41.

9. Dave Mascaro, WA3JUF, "33-cm Circuits," *Mid-Atlantic States VHF Conference*, October 4, 1986.
10. K. Winer, DJ9HO, *The UHF Compendium: Part 1 and 2*, January, 1982, page 272 (out of print).
11. Robert I. Sutherland, W6PO, and William I. Orr, W6SAI, "A High-Power Cavity Amplifier for the New 900-MHz Band," *QST*, November, 1982, page 14.
12. Joe Reiser, W1JR, "VHF/UHF World: High Dynamic Range on 2 Meters," *ham radio*, November, 1985, page 54.
13. Joe Reiser, W1JR, "VHF/UHF World: Low-Noise GaAsFET Technology," *ham radio*, December, 1984, page 99.

Important VHF/UHF Events

- April 13: ARRL 144-MHz Spring Sprint Contest (evening)
- April 18: EME perigee
- April 21: ARRL 220-MHz Spring Sprint Contest (evening)
- April 22: Predicted peak of the Lyrids meteor shower at 1100 UTC
- April 24-26: Dayton Hamvention
- April 29: ARRL 432-MHz Spring Sprint Contest (evening)
- May 2-3: West Coast VHF Conference (contact WB6GFJ)
- May 5: Predicted peak of the Eta Aquarids meteor shower at 1300 UTC
- May 8: ARRL 902-MHz Spring Sprint Contest (evening)
- May 14: ARRL 1296-MHz Spring Sprint Contest (evening)
- May 15: EME perigee
- May 15-17: 13th Annual Eastern VHF/UHF Conference, Nashua, New Hampshire (contact W1EJ)
- May 23-24: ARRL 50-MHz Spring Sprint Contest (evenings)

ham radio

CADDELL COIL CORP.

35 Main Street
Poultney, VT 05764
802-287-4055

BALUNS

Get POWER to your antenna! Our Baluns are already wound and ready for installation in your transmatch or you may enclose them in a weatherproof box and connect them directly at the antenna. They are designed for 3-30 MHz operation. (See ARRL Handbook pages 19-9 or 6-20 for construction details.)

100 Watt (4:1, 6:1, 9:1, or 1:1 Impedance—select one)	\$10.50
Universal Transmatch 1 KW (4:1 Impedance)	14.50
Universal Transmatch 2 KW (4:1 Impedance)	17.00
Universal Transmatch 1 KW (6:1, 9:1, or 1:1—select one)	16.00
Universal Transmatch 2 KW (6:1, 9:1, or 1:1—select one)	18.50

Please send large SASE for info.

Subscribe Today

Call Toll Free (orders only)
1 (800) 341-1522

Have your credit card ready
Ham Radio Magazine

SAY YOU SAW IT IN

ham radio magazine

ham radio

Reader Service

For literature or more information, locate the Reader Service number at the bottom of the ad, circle the appropriate number on this card, affix postage and send to us. We'll hustle your name and address to the companies you're interested in.

101 113 125 137 149 161 173 185 197 209 221 233 245 257 269 281 293 305 317 329 341
102 114 126 138 150 162 174 186 198 210 222 234 246 258 270 282 294 306 318 330 342
103 115 127 139 151 163 175 187 199 211 223 235 247 259 271 283 295 307 319 331 343
104 116 128 140 152 164 176 188 200 212 224 236 248 260 272 284 296 308 320 332 344
105 117 129 141 153 165 177 189 201 213 225 237 249 261 273 285 297 309 321 333 345
106 118 130 142 154 166 178 190 202 214 226 238 250 262 274 286 298 310 322 334 346
107 119 131 143 155 167 179 191 203 215 227 239 251 263 275 287 299 311 323 335 347
108 120 132 144 156 168 180 192 204 216 228 240 252 264 276 288 300 312 324 336 348
109 121 133 145 157 169 181 193 205 217 229 241 253 265 277 289 301 313 325 337 349
110 122 134 146 158 170 182 194 206 218 230 242 254 266 278 290 302 314 326 338 350
111 123 135 147 159 171 183 195 207 219 231 243 255 267 279 291 303 315 327 339
112 124 136 148 160 172 184 196 208 220 232 244 256 268 280 292 304 316 328 340

Limit of 15 inquiries per request.

NAME _____ CALL _____

ADDRESS _____

CITY _____ STATE _____ ZIP _____

Please use before May 31, 1987

April 1987

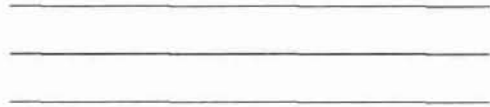

AFFIX POSTAGE
OR
POST OFFICE
WILL NOT
DELIVER

ham
radio
magazine

READER SERVICE CENTER
P.O. BOX 2558
WOBURN, MA 01888

ATTN: Reader Service Dept.

★Dustcovers★

by **KAGIL**™

- PROTECT your GEAR
- Waterproof PAK Nylon
- FIVE Colors
- Economical
- For ALL Amateur Radio Gear, Vintage thru Solid State. . .
- Custom covers
- MINI-covers

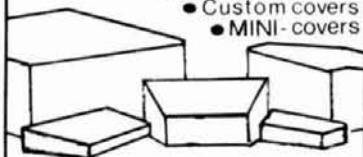

Send (SASE) Today ✓ 146
Samples & Brochure

KAGIL Dustcovers POB 06780
Portland, OR 97206

MAKE YOUR OWN CANOPIES

WE HAVE:

- ★ SNAP JOINTS & PARTS FOR 3/4" & 1" TUBING.
- ★ SILVER, WHITE OR BLUE TARPS.
- ★ BUNGEEES & ACCESSORIES.
- ★ COMPLETE PACKAGES AVAILABLE.
- ★ FREE BROCHURE ON REQUEST.

ELAINE MARTIN, INC.

POB 261, Dept. H
Highwood, IL 60040
Phone: 312-433-0106 ✓ 147

7 MILLION TUBES

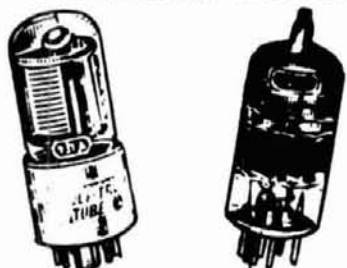

FREE CATALOG

Includes all Current, Obsolete, Antique, Hard-To-Find Receiving, Broadcast, Industrial, Radio/TV types. **LOWEST PRICES**, Major Brands, In Stock.

UNITY Electronics Dept. H
P.O. Box 213 ✓ 148
Elizabeth, NJ 07206

TELEWAVE ANTENNAS

FIBERGLASS COLLINEAR

COOL BLUE



Telewave's POWER MASTER ANTENNA™ line features heavy duty fiberglass, end fed antennas which are especially designed for the most adverse conditions. The cool blue color blends with the skyline yet absorbs the rays from the sun which assist in de-icing the antenna. All internal components are brass or copper, designed in a manner to allow for years of flexing without fracturing of any joints. The heavy duty tapered design with its strong interwoven fiberglass housing is fabricated to withstand wind loading of up to 125 MPH with 1/2 inch radial ice or 150 MPH wind loading without ice. The strong flexible action helps to de-ice the antenna with only a minimum of movement. The brass cap at the tip of the antenna is designed to exhibit DC ground potential while assisting on lightning protection. The unique design of each antenna provides two internal ground planes, eliminating the need for troublesome external ground planes. The broadband design of these antennas with their excellent VSWR and rugged construction makes these the most desirable antennas for any duplexing or multicoupling application. One set of heavy duty mounting clamps and one 12 inch jumper cable will be shipped standard with each antenna.

With the
MILLENNIUM SEAL™
of Quality

TELEWAVE, INC.

1155 TERRA BELLA, MOUNTAIN VIEW, CALIFORNIA 94043
(415) 968-4400 • TWX 910-3795055 • FAX (415) 968-1741
ORDER TOLL FREE — (800) 331-3396

Turn a few hours work into years of fun with Amateur Television.

Convert any TV receiver to a fast scan ATV monitor with the Communication Concepts ATV-2 converter. It allows you to monitor 430MHz ATV signals using channel 2, 3, or 4 on a standard TV set, without modification to the set. The circuit uses durable microstrip design for stability and simplicity. The combination of a dual RF stage, the microstrip design, and the hot-carrier diode double-balanced mixer reduces UHF TV intermod problems. An additional feature not found on other ATV downconverters

is the incorporation of a *post amplifier* stage (6dB min gain) following the double-balanced mixer. This is especially important and most noticeable on very weak signal reception. The converter requires an external 12 volt DC regulated power supply at 50 milliamps.

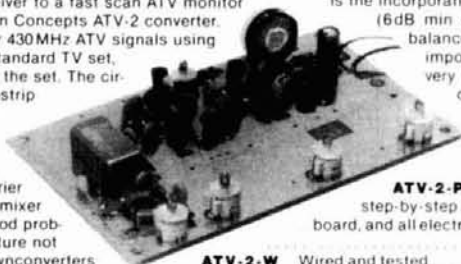

ATV-2-PK Kit includes detailed step-by-step instructions, printed circuit board, and all electronics components as shown **\$44.95**

ATV-2-W Wired and tested. **\$59.95**

CALL OR WRITE FOR OUR FREE SMALL PARTS BROCHURE.



CCI Communication Concepts Inc.



121 Brown Street • Dayton, OH 45402 • (513) 220-9677 ✓ 198

THE MOST AFFORDABLE REPEATER

ALSO HAS THE MOST IMPRESSIVE PERFORMANCE FEATURES

(AND GIVES THEM TO YOU AS STANDARD EQUIPMENT!)

BAND	WIRED	KIT
6M, 2M, 220 UHF	\$880	\$630
	\$980	\$730

(Also available for commercial bands!)



FEATURES:

- **SENSITIVITY SECOND TO NONE!** 0.15uV Typ.
- **SELECTIVITY THAT CAN'T BE BEAT!** Both 8 pole xtal filter & ceramic filter for > 100dB at ±12kHz. Helical resonator front end to combat desense & intermod.
- **Flutter-proof squelch.** Automatic frequency control, separate spkr amplifier.
- **CLEAN, EASY-TUNE TRANSMITTER,** up to 20W output. 50W with additional PA.

ACCESSORIES

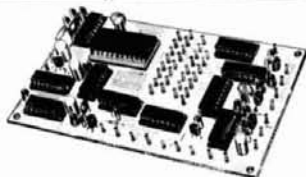

- **TD-2 DTMF DECODER/CONTROLLER** kit only \$78. Full 16 digits, 5 functions, toll call restrictor, programmable. Much more. Great for selective calling too!
- **AP-1 AUTOPATCH** kit only \$78. Reverse patch & phone line remote control std.
- **AP-2 Simplex Autopatch.** Use with above.

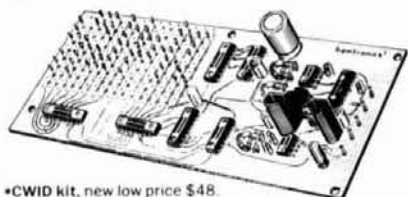

- **CWID kit,** new low price \$48. Field programmable, timers, the works!
- **COR-2 kit,** \$38. Audio mixer, local spkr amplifier, tail & time-out timers.
- **COR-3 kit,** \$48, with courtesy beep.



- **MO-202 FSK DATA MODULATOR** kit \$38. Run up to 1200 baud digital or packet radio signals through any FM transmitter.
- **DE-202 FSK DATA DEMODULATOR** kit \$38.

GaAs FET PREAMPS at a fraction of the cost of comparable units!

LNG -(*) GaAs FET PREAMP

ONLY \$49!

WIRED/TESTED



FEATURES:

- **Very Low Noise:** 0.7 dB VHF, 0.8 dB UHF
 - **High Gain:** 13-20dB, depending on freq
 - **Wide Dynamic Range:** to resist overload
 - **Stable:** new-type dual-gate GaAs FET
- * Specify tuning range desired: 26-30, 46-56, 137-150, 150-172, 210-230, 400-470, or 800-960 MHz.

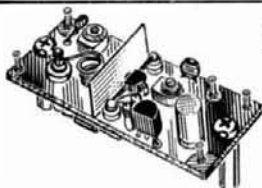

LNW -(*) MINIATURE GaAs FET PREAMP

Unbelievably Low Price ---

ONLY \$19/kit, \$34 Wired/tested

GaAs FET Preamp similar to LNG, except designed for **low cost & small size.** Only 5/8" W x 1-5/8" L x 3/4" H. Easily mounts in many radios.

* Specify tuning range desired: 25-35, 35-55, 55-90, 90-120, 120-150, 150-200, 200-270, or 400-500 MHz.

LNS -(*)

IN-LINE PREAMP

ONLY \$59/kit, \$79 wired/tested

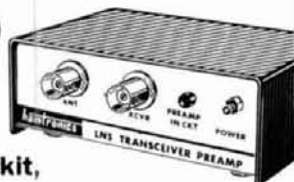

GaAs FET Preamp with features similar to LNG series, except **automatically switches out of line during transmit.** Use with base or mobile transceivers up to 25W. **Tower mtg. hardware supplied.**

* Specify tuning range desired: 120-175, 200-240, or 400-500 MHz.

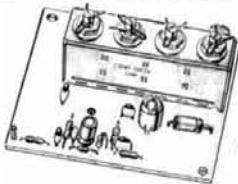

HRA -(*) HELICAL RESONATOR PREAMP

ONLY \$49 VHF or \$64 UHF

Low-noise preamps with helical resonators **reduce intermod & cross-band** interference in critical applications.

* Specify tuning range desired: 143-150, 150-158, 158-162, 162-174, 213-233, 420-450, 450-465, or 465-475 MHz.

HIGH QUALITY XMTR & RCVR MODULES FOR REPEATERS, LINKS, TELEMETRY, ETC.



FM EXCITERS:

- Kits only \$68. W/t \$146.
- TCXO and xtal oven available.
- 2W cont. Up to 3W intermittent.
- **TA51** for 10M, 6M, 2M, 150-174, 220 MHz.
- **TA451** for uhf.

FCC TYPE ACCEPTED FOR COMMERCIAL BANDS.

- **VHF & UHF LINEAR AMPLIFIERS.** For FM or SSB. Power levels from 10 to 45 Watts. Several models, kits starting at \$78.



R144/R220 FM RCVR

for 2M, 150-174, or 220 MHz. 0.15uV sens, 8-pole xtal & 10 pole ceramic i-f filters, helical resonator front end for exceptional selectivity. > 100dB at ±12kHz (best available anywhere!) Flutter-proof squelch. AFC tracks drifting xmtrs. Xtal oven avail. Kit \$138, w/t \$198.

- **R451 FM RCVR.** Same as above but UHF. Tuned line front end. 0.2uV sensitivity. Kit only \$138, w/t \$198.

- **R76 VHF FM RCVR** for 10M, 6M, 2M, 220. As above, but w/o AFC or hel.res. Kits only \$98 to \$118.

- **R110 VHF AM RCVR** for VHF aircraft or ham bands or UHF. Kit only \$98.

NOW—FCC TYPE ACCEPTED TRANSMITTERS, RECEIVERS, AND REPEATERS AVAILABLE FOR HIGH-BAND AND UHF. CALL FOR DETAILS.

RECEIVING CONVERTERS



Kit with Case \$49
Kit less Case \$39
Wired w/case \$69

UHF MODELS
Kit with Case \$59
Kit less Case \$49
Wired w/case \$75

Antenna Input Range	Receiver Output
28-32	144-148
50-52	28-30
50-54	144-148
144-146	28-30
145-147	28-30
144-144.4	27-27.4
146-148	28-30
220-222	28-30
220-224	50-54
222-224	28-30
432-434	28-30
436-437	28-30
432-436	144-148
432-438	50-54
439-25	61-25
902-928	422-448
902-922	430-450

TRANSMIT CONVERTERS

For SSB, CW, ATV, FM, etc. Can be linked with receive convy for transceiver. 1 to 2 W out. Linear PA's available up to 50W.	Exciter Input Range	Antenna Output
For VHF Model XV2 Kit \$75	28-30	144-146
Wired \$149 (specify band)	28-29	145-146
	28-30	50-52
	27-27.4	144-144.4
	50-54	220-224
	144-146	50-52
	144-146	28-30
For UHF Model XV4 Kit \$75	28-30	432-434
Wired \$139	28-30	435-437
	61-25	439-25
	144-148	432-436

HAMTRONICS, INC.

65-E Moul Rd.; Hilton NY 14468-9535

High quality equipment at reasonable prices surely appeals to me; but I want more details before I buy! Rush my copy of the 40-page Hamtronics catalog by return first class mail. I enclose \$1 (\$2 for overseas air mail).

Name _____
Address _____
City _____ State/ZIP _____

- Order by phone or mail • Add \$3 S&H per order (Electronic answering service evenings & weekends)
- Use VISA, MASTERCARD, Check, or UPS COD.

hamtronics, inc.

65-E MOUL ROAD • HILTON NY 14468-9535

Phone: 716-392-9430

Hamtronics® is a registered trademark

understanding noise figure

See why
optimized NF
doesn't imply
best output S/N

Noise figure is probably the most common parameter used to specify the noise performance of amplifiers and other systems where noise performance is a critical feature. However, the concept of noise figure is often misunderstood, and quite often misapplied.

This can result in a system with noise performance far less than ideal. For example, it might seem that an improvement in noise figure of a low-noise system would naturally result in lower total output noise and better output signal-to-noise ratio. However, this isn't always the case. It's quite easy to improve the noise figure to its optimum minimum value while causing an *increase* in output noise and a degradation in signal-to-noise ratio for any given signal. John Maxwell gives a good review of this problem in reference 1.

Noise figure is a "figure-of-merit" (a measure of "idealness") that demonstrates the amount of noise a system such as an amplifier adds to a signal-processing task such as amplification. If an amplifier were perfectly noiseless, it would add no additional noise and the noise figure would be zero. Similarly, a noise figure of 3 dB implies that the amplifier adds as much noise to the system as was initially present prior to amplifying (remember, a 3-dB increase in power is a doubling in power.) Also, the noise figure

is a measure of the amplifier's performance, not the circuit performance. That's why we may take a specific circuit and optimize the noise figure but actually degrade the output signal-to-noise ratio.

Noise figure, NF, is defined as 10 times the common logarithm of the "Noise Factor," F , and the noise factor is defined as the ratio of the total output noise power of a system (an amplifier, for example) to the output noise power due to the source alone.²

$$F = \frac{\text{Total output noise power}}{\text{Output noise power due to the source alone}} \quad (1)$$

$$NF = 10 \log F \quad (2)$$

The noise factor in **eqn. 1** is a ratio of the actual output noise of a system to the output noise that would be present due to the source alone if the system were perfectly noiseless. Two things are important to notice about **eqn. 1**: the first is that the noise factor is defined in terms of noise powers, and second is that it is defined at the output of the system. Examining **eqns. 1 and 2**, something is conspicuous by its absence — a signal. The noise figure apparently has no relation to any signal or to the S/N. In fact, you don't even need a signal to find the noise figure, and without a signal, you have an S/N of zero! Well, the noise factor (and noise figure in turn) may be loosely considered a noise-to-signal ratio where the source noise is both the signal and a component of the total noise.

However, the noise figure may be related to the S/N relatively simply. Consider an amplifier with the following parameters.

Michael E. Gruchalla, 2450 Alamo Avenue S.E.,
P.O. Box 9100, Albuquerque, New Mexico 87119

N_S = Source noise power delivered to the amplifier input

N_I = Amplifier equivalent input noise power

G_P = Amplifier power gain

P_S = Amplifier input signal power

Now, the numerator of **eqn. 1**, total output noise power, is actually the sum of the noise contributed by the amplifier and that contributed by the source. Also, a specific output power is given by the corresponding input power multiplied by the amplifier power gain. We can then write the noise factor as **eqn. 3**.

$$F = \frac{(N_S G_P + N_I G_P)}{N_S G_P} \quad (3)$$

Now, if we divide both the numerator and denominator by the output signal power ($P_S G_P$) and rearrange the terms, the results of **eqn. 4** are found.

$$F = \frac{P_S/N_S}{(P_S G_P) / [(N_S + N_I) G_P]} \quad (4)$$

In examining **eqn. 4**, we see that the numerator is simply the signal-to-noise ratio of the input source. Similarly, the denominator is the signal-to-noise ratio at the amplifier output. So the noise factor is equal to the input S/N divided by the output S/N.

$$F = \frac{S/N_{input}}{S/N_{output}} \quad (5)$$

This is commonly known as the "Friis Equation," in honor of H.T. Friis,³ who originally developed it in 1944. A subtle but important point to observe about the Friis equation is that the term S/N input is the S/N of the *input signal, not the S/N at the amplifier input*. Also, it should be understood that this is *not* the definition of noise factor, but rather a derived expression computed from the definition given in **eqn. 1**.

optimum source resistance

For any amplifier system, a value of optimum source resistance exists which will produce an optimum minimum noise figure. The problem lies in the fact that the value of optimum source resistance is rarely even close to the resistance of the source we wish to use. The NF of the source-amplifier combination is then less than optimum. It is often thought that a resistor could be added in series or shunt with the source to modify its *apparent* value as seen by the amplifier to become

the optimum source resistance. This would indeed improve the NF with respect to the apparent source resistance, but not with respect to the original source.

The addition of this resistor has two effects. First, it loads the source dissipating some of the signal power that would normally be available as amplifier input, causing the signal term of the S/N expression to be reduced. Second, it adds the resistor's thermal noise to the system, causing an increase in the noise term of the S/N. The net effect of adding the modifying resistor is that the output signal is reduced, and the output noise is increased, which results in an overall reduction in the S/N. However, the NF is reduced to its optimum minimum value! Is this contradictory? Can we truly improve the NF of a system **and** actually degrade the S/N? If this is true, is the NF a useful parameter at all?

Perhaps a practical example or two using the parameters of real components will clarify this problem. (For more detailed analyses, check references 1 through 4.) The basic difficulty lies in the fact that the addition of a series or shunt resistor to a given source resistance only modifies the apparent resistance of the source. The actual value remains unchanged. The source contributes a specific signal and a noise commensurate with its resistance. For some specific signal, this provides some source S/N. The modified source will exhibit a lower available signal for the same actual signal level due to the loading effect of the added modifying resistor. The thermal noise of the modified source may be higher or lower than the original source, depending on whether the added resistor was added in series or shunt. However, in all cases the source S/N for any given signal level of the original source will be reduced. The addition of a simple resistor to modify the source then in effect makes the source "more noisy," which in turn renders any noise of the amplifier system less significant. That can cause an improvement in the NF. However, since the signal has been made more noisy, the S/N is degraded.

examples

Consider the circuit shown in **fig. 1**. This is a classic model of a generalized amplifier showing the noise parameters.⁴ The source E_{NS} is the RMS noise potential of the source resistor R_S . The amplifier noise is referred to the amplifier input as two *equivalent* input noise sources: an input noise potential E_{NI} , and an input noise current I_{NI} . If you check the specifications of various high-performance amplifiers, you'll find these parameters. It should also be emphasized that as with almost all noise parameters, the total noise available from the sources is a function of the noise bandwidth, BW_N , and the frequency of measurement. Generally, the spot noise values (noise per Hertz of bandwidth) are specified as a function of frequency.

In the model, the amplifier input resistance is R_I and the voltage gain is A_V . Both of these are defined as noiseless because all noise contributions are included in the two equivalent input noise sources. It can be shown that the optimum source resistance that yields the best NF is given by eqn. 6.²

$$R_S (\text{optimum}) = E_{NI}/I_{NI} \quad (6)$$

With that optimum source resistance, the optimum NF is given by eqn. 7.²

$$NF (\text{optimum}) = 10 \log \left(1 + \frac{E_{NI} \cdot I_{NI}}{2kT} \right) \quad (7)$$

where: k = Boltzmann's constant = 1.38×10^{-23} watts-seconds/ $^{\circ}k$

T = Absolute temperature in $^{\circ}k$

As an example, consider the source as a magnetic phonograph cartridge with a source resistance of 1000 ohms and a noise bandwidth of 20 kHz. Also, consider an LF356 FET amplifier configured for a voltage gain of 100. The LF356 parameters from the data sheets are given below.

- R_I = 10^{12} ohms
- E_{NI} = 12 nV/Hz @ 1 kHz
- I_{NI} = 0.01 pA/ Hz @ 1 kHz (shot noise of input current)
- A_V = 100 (configured gain)

To simplify the example, the noise contributions of any circuit resistors are ignored. (If we were actually trying to optimize noise performance, those noises would be included.) Also, consider that the 1 kHz spot-noise values given are constant over the frequencies of interest. From eqn. 6, the optimum source resistance is found to be 1.2 megohms; from eqn. 7, the optimum NF at that source resistance is found to be 0.063 dB! This very low optimum NF is typical of FET-input devices, but the very high optimum R_S often results in poorer practical noise performance (S/N) than that provided by higher noise bipolar devices. This occurs because the optimum source resistance for typical bipolar elements is often much nearer the value of typical sources (such as our phonograph cartridge) than that of FET devices. This will be demonstrated below. The NF for this amplifier with the 1-k source is 9.9 dB. The output noise is 179 μ V RMS. (Note: noise signals must be added as powers or by adding their mean-square values.) Adding a 1,199,000-ohm resistor in series with the 1-k source provides an optimum 1.2-megohm source resistance to the amplifier. The output noise is then 2 mV RMS and the NF is indeed 0.063 dB. The optimum NF configuration will have an output noise eleven times higher than the less optimum unmatched case and in both cases the gain will be 100 (the 10^{12} -ohm amplifier input resistance does not load either

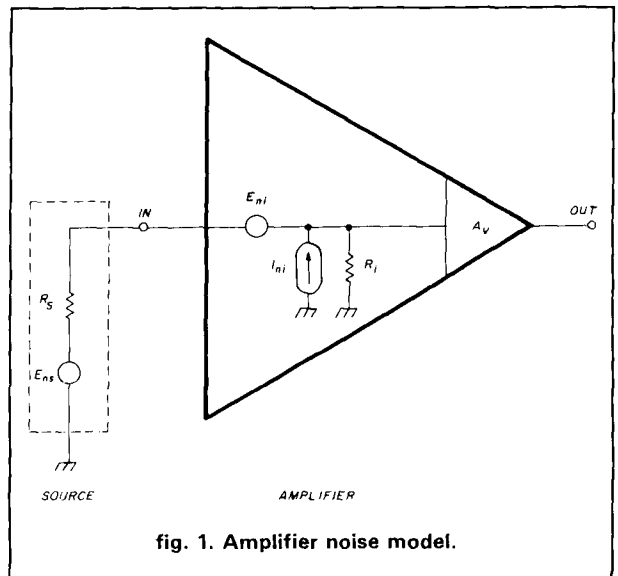

fig. 1. Amplifier noise model.

source configuration significantly). Then, for any given signal, the optimum NF configuration will exhibit an output S/N eleven times poorer than the unmatched configuration. So, even though the NF is poorer for the unmatched case, the noise performance is better: 21 dB better!

Now we'll try matching in a more optimum manner. Let the 1-k source be transformed to the optimum 1.2-megohm resistance with an ideal transformer having a 1:34.6 turns ratio. Note that this is not an optimum power match. We'll define the transformer as noiseless, but in a very accurate analysis its winding resistances would contribute some thermal noise that would have to be considered. Also, we'll adjust the amplifier gain to provide the same overall gain of 100 of the previous example to allow simple comparison. This does not affect the S/N or NF since both of these are independent of system gain and the transformer was defined as noiseless. Now the total output noise is 57.97 μ V and the noise due to the source alone is 57.55 μ V, resulting in the expected 0.063 dB NF. With the selected amplifier, this configuration will provide the best possible S/N for any given signal. It is 9.8 dB better than the simple unmatched case ($20 \log 170 \mu\text{V}/57.97 \mu\text{V}$) and 30.8 dB better than the resistive matched case.

This may still be a little confusing, and you may be convinced that NF is a useless parameter. Let's examine what was done in the examples above. First we started with a device with a 1-k source resistance and an amplifier with a 1.2-megohm optimum source resistance and gain of 100. Direct application of the source to the amplifier gave us a signal gain of 100 with a 179 μ V output noise and a 9.9 dB NF. Adding a 1,199,000-ohm series resistor gave us an optimum noise match with respect to the amplifier, with an out-

CONTROL YOUR SHACK FROM YOUR MOBILE /H.T.

Super ComShack 64

Repeater Controller/Dual Remote/Autopatch

Instant code practice mode controlled from your H.T.

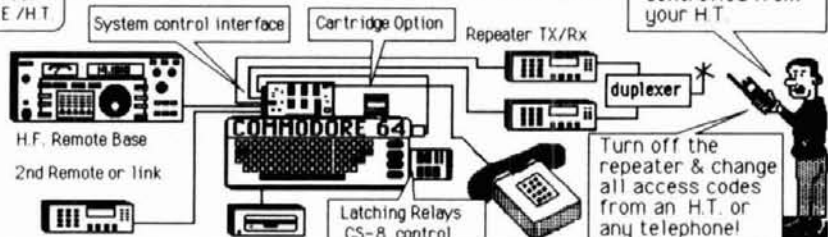

Turn off the repeater & change all access codes from an H.T. or any telephone!

Super Repeater Controller

- Remotely programmable with Touchtones/ change up to 9 sets of access codes from H.T. or telephone!
- Synthesized speech consisting of high quality male or female digitized human voice
- Dual Remote base (H.F. & V.H.F.)
- Autopatch & Super Repeater Controller
- Program voice ID tail message from your H.T.
- Automatic voice clock & activity timers
- Multiple commands can be executed at once (up to 16 digits per command string)
- Sub-audible tone & speed dial compatible
- Alarm clock & auto-execute command string!
- Optional autoboot cartridge (no disk drive needed)
- Send system commands from telephone line!

Special Club Features

- Generates random code practice @ any speed with voice readback after each 20 random code group!
- Set CW speed & pitch from your H.T.
- Input up to 22 vocab words & letters as ID or mail box message @ speed dial rates from H.T.
- Enable/disable up to 50; tel. #'s + wild cards

Autopatch Specifications

- 300 Touchtone loadable Autodial numbers plus 10 Emergency Autodial (quick access)
- 300 Reverse patch call signs uploaded from your H.T./general or directed page modes
- Incoming caller receives voice message to enter 3 digit code to selective page a call sign (D.P. mode)
- Phone number memory readback
- Enable/disable 50 area codes + wild card #'s
- Full or half duplex (repeater on/off)
- Storage of MCI/Sprint access codes
- Call waiting allows switching to second phone line
- Touchtones are regenerated onto the tel./speed dial
- Touchtone or dial pulse modes
- Reverse patch active in all modes

Dual Remote Base Specifications

- H.F. remote supports: Yaesu FT-757/767/980 Kenwood TS-440/940, Icom IC-735
- 2nd remote control data supports: Yaesu FT-727 FT-767 & Kenwood 711/811-or the-7950 or TS-2530/70 with RAP-1 (control card)
- 10 H.F. Memory channels/enter or recall
- Automatic USB/LSB/FM/AM mode select
- Scan up/down, fast, or 100hz steps
- Control CS-8 relay/latch/master reset /Status
- H.F./V.H.F. Monitor only or TX enable modes
- All control inputs are voice confirmed including frequency, mode, scan status, time, outputs on/off
- VHF remote, as Link input, & repeater can be active

System Options

- 8 Latching Relay control (CS-8) \$ 79.95
 - 3 DPDT 2A relays, 5 open collector outputs
 - user defined 2 letter function name & state
 - automatic PTT fan control/master all off code
- Optional CMOS auto-boot 72k EPROM Cartridge programmed with your parameters \$99.95
- Keypad Control for VHF remote; RAP-1 \$149.95
- Super ComShack Manual (credit later) \$15.00

MODEL CS64S-\$349.95 (wired and tested)

includes: computer interface, disk, cables & manual, duplex & simplex versions are supplied (some features not applicable when using simplex) (add \$4.00 shipping / Ca. residents add 6%)
MASTERCARD/VISA/CHECK/M.O./COD

Engineering Consulting

583 Candlewood St.
 Brea, Ca. 92621
 tel: 714-671-2009

SYNTHESIZED SIGNAL GENERATOR

MADE IN USA



MODEL SG-100F \$429.95 delivered

- Covers 100 MHz to 199.999 MHz in 1 kHz steps with thumbwheel dial
- Accuracy +/- 1 part per 10 million at all frequencies
- Internal FM adjustable from 0 to 100 kHz at a 1 kHz rate
- External FM input accepts tones or voice
- Spurs and noise at least 60 dB below carrier
- Output adjustable from 5-500 mV at 50 Ohms
- Operates on 12 Vdc @ 1/2 Amp
- Available for immediate delivery • \$429.95 delivered
- Add-on accessories available to extend freq range, add infinite resolution, AM, and a precision 120 dB attenuator
- Call or write for details • Phone in your order for fast COD shipment.

VANGUARD LABS ✓ 142

196-23 Jamaica Ave., Hollis, NY 11423
 Phone: (718) 468-2720 Mon. thru Thu.

TROUBLESHOOTING MICROPROCESSOR-BASED EQUIPMENT AND DIGITAL DEVICES

Attend this 4-day seminar and master the essentials of microprocessor maintenance. Gain a firm understanding of microprocessor fundamentals and learn specialized troubleshooting techniques.

Call or write for brochure with full details and current schedule. Fee is \$795.00

- 8 and 16 bit systems
- Signature analysis
- Logic analysis
- Machine-language programming
- Diagnostic programs
- Emulation
- Bus Systems

MICRO SYSTEMS INSTITUTE

Garnett, Kansas 66032
 (800) 247-5239 ✓ 143

Audio Blaster Module IC-02AT/IC-04AT/IC2AT

Module installs inside the radio in 15 Min. Boost audio to 1 watt! Low standby drain/Corrects low audio/1000's of happy users (Works in other H.T.'s too)

Used by Police, fire, Emergency, when it needs to be loud!
 "AUDIO BLASTER" Model AB1-\$19.95

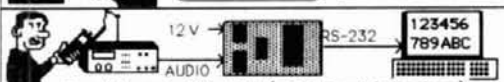

Touchtone to RS-232 (300 baud interface)

Program your computer in basic to decode multidigit "strings", sound alarms, observe codes. Simple to install, +12 VDC /audio, includes basic program for C64/VIC20/C128, all computers! "DECODE-A-PAD" Model DAP \$89.95

Touchtone 4 Digit Decoder & on/off latch

50,000 combinations



Repeater on/off Master control

Wired and tested +5 to +12 Volts/ User programmable to 50,000 codes/ All 16 digits/Send code once to turn on, again to turn off/ Momentary & Latching output/drives relay/LED latch indicator/Optional 4 digit extra custom latch IC's \$8.95 each/add as many latches as you want to your external board Model TSD \$59.95

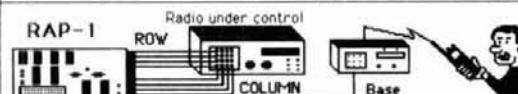

Remote Keypad Rows & Columns Controller Plus Two 4 digit decoders (on/off)/Will control frequency of any keypad entry radio such as the Kenwood 7950/2530/IC04-AT. Easy to install in parallel w/ existing keypad/Use with ComShack 64 as a freq controller or with Pro Search rotor control box/A versatile board for all remote control applications. The latches may be used for on/off or momentary

"REMOTE-A-PAD" Model RAP-1 \$149.95

Touchtone Decoder Kit

M957 Teltone 5 to 12v 15ma (SSI-201 compatible)/Inc. 3.58 Mhz Crystal/ 22 pin socket, Data Sheet, Sample circuits, decoder specs, all 16 touchtones, BCD/HEX No filters req Model TTK \$22.95

1986-87 CALL DIRECTORY

(on microfiche)

Call Directory \$8
 Name Index \$8
 Geographic Index \$8

All three — \$20
 Shipping per order \$3

BUCKMASTER PUBLISHING
 Mineral, Virginia 23117
 703-894-5777 ✓ 144

put noise of 2 mV and a 0.063 dB NF with the signal gain still 100. Since the gain was the same in both cases, the output signal would be the same for both for a given input signal. Then, since the output noise was higher in the second case than in the first, the S/N would be poorer, even though the NF was better.

What did we do wrong to get the lower NF case to give us a poorer noise performance? It's actually very simple. When we added the series resistance, the effective source seen by the amplifier was optimized, but the *actual* source resistance was unchanged. We inadvertently defined the source resistance in two different ways: as the real source resistance in one case and as the source plus a series resistance combination in the other. The 1-k source resistance is part of a circuit element that contributes both signal and noise. Adding a series resistance adds a circuit element that contributes only additional noise and no additional signal, so it should be expected that the S/N should be made poorer.

Looking back at eqn. 1, we see that the numerator is related to the source noise. If we define the source as the 1000-ohm resistance of our actual phonograph cartridge, we'll compute one value of output source noise, but if we use the 1.2-megohm resistance of the combined resistances, we'll find another (higher) value. As far as our amplifier is concerned, all components attached to its input constitute the source. However, to our actual source, only its elements constitute the source. When we add resistors to modify the source resistance, which value of source resistance should we use for the NF calculations? That depends upon what we're trying to find. If we wish to find the NF of an amplifier, everything tied to the input is then the source. If, however, we are trying to determine the NF of an amplifier with a specific source, only the actual source should be considered as the "source." In general, the actual source is the true source as far as the total circuit is concerned. Adding extraneous components to the source doesn't change its actual value, only its apparent value seen by the amplifier. Since it's the signal from a specific source that we're generally interested in processing, we should always compute the "output noise due to the source" in eqn. 1 from the actual source of interest and not that "seen" by the amplifier input.

With this in mind, let's go back to our original phonograph cartridge source and LF356 amplifier. We found that the NF computed from eqn. 2 with the source directly applied to the amplifier was 9.9 dB. When we added the 1,199,000-ohm resistor and defined the 1.2-Megohm source plus series resistance combination as the "source," we found an NF of 0.063 dB. Now, what would the NF be if we added the series resistor but still used the 1000-ohm value as the source resistance? It would be 30.9 dB! This clearly

shows that with respect to our actual source, the addition of a series resistor only makes the NF poorer.

If we could in some manner make the actual source resistance and the source resistance seen by the amplifier equal the optimum source resistance, we would achieve the best possible noise performance. For example, if we could place in series 1200 of our phonograph cartridge sources (with each delivering the same signal), we would achieve the optimum source resistance with the actual source. That would provide the optimum NF and a very good S/N because the available signal power would be 1200 times that of a single source. However, that solution is obviously very impractical. We could possibly redesign the source to exhibit the 1.2 megohm resistance, but that too is generally impractical. The transformer offers us a very practical means of *transforming* the source resistance to the optimum needed, and well-designed transformers can do this almost noiselessly. With a transformer, both the signal level and source impedance are scaled together: potentials and currents by the turns ratio, and resistances by the turns ratio squared. This maintains the source S/N, as seen by the amplifier, constant. So, in our example, the entire equivalent 1.2-megohm source resistance at the transformer output contributes signal, 34.6 times more than the 1k-ohm source with a 1,199,000-ohm series resistor, with the same noise contribution of the optimum 1.2-megohm resistance. That obviously results in a much better S/N than the simple addition of a series resistor because the signal has been increased along with the increase in the source resistance seen by the amplifier.

In some applications we have control of the design of the source and can tailor its resistance to optimize noise performance with a specific amplifier. However, in the majority of cases the source resistance is fixed and we must select, or design, an amplifier whose optimum R_S is close to the specified source, or use a transformer to provide noise matching. For example, the LM1897 amplifier has an optimum NF of 1.82 dB at an optimum source resistance of 5.33 k. That optimum NF is much poorer than the 0.063-dB value of the LF356. However, this amplifier provides a 3.87-dB NF with the 1-k source resistance, which is much better than the 9.9-dB value provided by the lower noise LF356 with the 1-k source resistance. The higher noise amplifier, with the specified source resistance, will actually provide a 6-dB higher S/N than the lower noise unit for any given signal. This is because the LM1897 has an optimum source resistance value that more closely matches the 1-k source than the LF356. This shows that just because one amplifier has lower optimum noise figure than another, it may not provide better noise performance in a specific configuration or application.



The monthly magazine with a natural blending of two popular hobbies — Ham Radio and Computers

- ★ Articles on Ham Radio & Most Personal Computers
- ★ Hardware & Software Reviews
- ★ Various Computer Languages
- ★ Construction Articles
- ★ Much Much More

Your #1 Source for PACKET Info

"...received my moneys worth with just one issue..."

—J. Trenbick

"...always stop to read CTM, even though most other magazines I receive (and write for) only get cursory examination..."

—Fred Blechman, K6UGT

U.S.A.....\$18.00 for 1 year
 Mexico, Canada.....\$32.00
 Foreign.....\$43.00(land)-\$68.00(air)
 (U.S. funds only)
 Permanent (U.S Subscription).....\$150.00
 Sample Copy.....\$3.50



Circulation Manager

1704 Sam Drive

Birmingham, Alabama 35235

Phone 205/854-0271

Name _____

Call Sign _____

Address _____

City _____ State _____

Zip _____ Phone _____

Date _____

Signature _____

✓ 141

Finally, there's the question of how the optimum NF source resistance relates to the optimum power match source resistance. That's very simple; they're totally unrelated. To demonstrate this, we can use a transformer to match the 1-k source resistance to the 10^{12} -ohm input resistance of the LF356, a turns ratio of 1:31,620. This will provide an optimum power match, but the NF will be 37.8 dB! That's considerably poorer than the 0.063 dB optimum NF provided at the optimum noise match. This is because the optimum noise source resistance is related to the equivalent input noise sources, and the optimum power match source resistance is related to the input resistance. In general, the equivalent input noise sources and the input resistance are unrelated, rendering the optimum matching resistances similarly unrelated.

The principal purpose in optimizing the power matching is to maximize power gain. In the case of optimizing noise performance, gain is not a particularly important consideration since additional gain stages may be added to obtain the total desired gain once the optimum noise performance is achieved. However, the process cannot be approached in reverse; you can't match for optimum gain and then optimize noise performance.

When using NF parameters specified for some specific device with which you are designing, you must carefully examine those specifications to be sure you understand what's presented. This is particularly true in the case of rf components. Quite often curves of optimum noise figure are presented showing the optimum NF as a function of frequency or bias current, but rarely is the actual value of the optimum source impedance given. Only at the optimum source impedance can the optimum NF be achieved. Since most rf measurements are made in systems of standard impedance such as 50 ohms, it might be assumed that the NF curves are given for that source impedance. If you make that assumption, you'll often find that you can't achieve the NF values specified. In other cases, only the NF curves at the measurement system impedance are given, providing no information for optimizing the source impedance for best NF. Even worse, you often can't tell from the provided information which source impedance was used. There are, of course, exceptions such as the NE388 series MESFET, but these are all too rare.

The situation is much better in the area of the lower frequency components. For those components, the "Contours of Constant Noise Figure" are quite often given. These show numerous curves of NF as a function of source resistance, operating point, frequency, etc. Using these data, one can quite effectively design low-noise audio, i-f and low-frequency rf amplifiers that provide the performance predicted by the mathematical design. In fact, performance somewhat

better than that specified for the part can often be achieved because the manufacturer must use conservative specifications to allow for a range of variation in the component line. In those cases where sufficient data isn't provided, you must make your own measurements of the various needed parameters. At lower frequencies that's relatively simple, but at the higher frequencies (i.e., greater than 100 MHz), that can be quite difficult without a collection of precision equipment.

In conclusion, noise figure can be an excellent figure-of-merit for assessment of the potential noise performance of amplifiers and other systems, but a thorough understanding of the parameter is necessary if it's to be successfully applied. The performance suggested merely by the good noise figure of a device may not be reflected in the actual signal-to-noise ratio achieved from the device in a practical application. In an application where the source characteristics are predefined, it's generally more important to use an amplifier with an optimum source resistance that closely matches the specified source resistance than to merely choose an amplifier with the lowest possible noise figure. In no case can the signal-to-noise ratio of a system be improved by modifying the source resistance with a series or shunt resistor for making the combined resistance equal to the optimum source resistance for the system. This process can indeed result in the optimum noise figure with respect to the apparent source seen by the amplifier, but will always degrade the output signal-to-noise ratio for any given signal. If the "source" element used for determining the noise figure is always chosen as the actual source alone, meaningful results will be obtained.

It should be understood that the parameter noise figure is simply a figure-of-merit. In practical systems, it's the actual signal-to-noise ratio that's of primary interest. However, the optimum noise figure for an amplifier (or other system) does represent the best possible performance that can be achieved with that amplifier when the source resistance is properly matched to the optimum resistance for the amplifier. If you always compute noise figure using the actual physical source as the source referred to in eqn. 1, you'll always arrive at a correct result.

references

1. J. Maxwell, "The Noise Figure Fallacy," *National Transistor Data Book, National Semiconductor Corporation, 2900 Semiconductor Drive, Santa Clara, CA 95051.*
2. C.D. Motchenbacher and F.C. Fitchen, *Low Noise Electronic Design*, John Wiley and Sons, New York, 1973.
3. H.T. Friis, "Noise Figures of Radio Receivers," *Proceedings of the IRE*, July, 1944, pages 419-422.
4. R.D. Hudson, *Infrared System Engineering*, John Wiley and Sons, New York, 1969.

ham radio

Interested in
SAVING MONEY?
Want to find
the **BEST BARGAINS**
on **NEW and USED ELECTRONIC EQUIPMENT** available?



**You'll Find Them
in the Nation's No. 1
Electronic Shopper Magazine**

NUTS & VOLTS

Now in our 7th Year

Nuts & Volts is published MONTHLY and features:

- NEW STATE-OF-THE-ART PRODUCTS •
- SURPLUS EQUIPMENT • USED BARGAINS
- 50% DISCOUNT TO SUBSCRIBERS ON
- CLASSIFIED ADS • EVENTS CALENDAR •
- NEW PRODUCTS • LOW COST DISPLAY
- AD RATES • NATIONAL CIRCULATION •
- AND A FREE 40-WORD CLASSIFIED AD
- WITH YOUR SUBSCRIPTION

SUBSCRIPTION RATES

- One Year - 3rd Class Mail \$10.00
- One Year - 1st Class Mail \$15.00
- One Year - Canada & Mexico (in U.S. Funds) . . \$18.00
- Lifetime - 3rd Class Mail (U.S. Only) \$35.00

ORDER NOW!

Send: Check Money Order Visa MasterCard

TO: **NUTS & VOLTS MAGAZINE**
P.O. BOX 1111-H
PLACENTIA, CALIFORNIA 92670
(714) 632-7721

Name _____
Address _____
City _____
State _____ Zip _____
Card No. _____
Exp. Date _____

**IF YOU'RE INTO ELECTRONICS,
THIS MAGAZINE WILL SAVE YOU MONEY!**

Dealer Inquiries Invited

✓ 140



HF Equipment
IC-735 HF transceiver/SW rcvr/mic † **Regular SALE**
 PS-55 External power supply..... 199.00 179⁹⁵
 AT-150 Automatic antenna tuner ... 445.00 349⁹⁵

Until 3-31-87 . . .
\$50 FACTORY REBATE on AT-150

FL-32 500 Hz CW filter 66.50
 EX-243 Electronic keyer unit 56.00
 UT-30 Tone encoder 17.50



IC-745 9-band xcvr w/1-30 MHz rcvr 1049.00 899⁹⁵
 PS-35 Internal power supply 199.00 179⁹⁵
 EX-241 Marker unit 22.50
 EX-242 FM unit 44.00
 EX-243 Electronic keyer unit 56.00
 FL-45 500 Hz CW filter (1st IF) 66.50
 FL-54 270 Hz CW filter (1st IF) 53.00
 FL-52A 500 Hz CW filter (2nd IF) 108.00 99⁹⁵
 FL-53A 250 Hz CW filter (2nd IF) 108.00 99⁹⁵
 FL-44A SSB filter (2nd IF) 178.00 159⁹⁵



IC-751A 9-band xcvr/1-30 MHz rcvr 1649.00 1399
 PS-35 Internal power supply 199.00 179⁹⁵
 FL-32 500 Hz CW filter (1st IF) 66.50
 FL-63 250 Hz CW filter (1st IF) 54.50
 FL-52A 500 Hz CW filter (2nd IF) 108.00 99⁹⁵
 FL-53A 250 Hz CW filter (2nd IF) 108.00 99⁹⁵
 FL-33 AM filter 35.25
 FL-70 2.8 kHz wide SSB filter 52.00
 RC-10 External frequency controller 39.25

Other Accessories:
 IC-2KL 160-15m solid state amp w/ps 1999.00 1699
 PS-15 20A external power supply 169.00 154⁹⁵
 PS-30 Systems p/s w/cord, 6-pin plug 299.00 269⁹⁵
 OPC Opt. cord, specify 2, 4 or 6-pin 10.00
 MB Mobile mount, 735/745/751A 24.50
 SP-3 External speaker 61.00
 SP-7 Small external speaker 49.00
 CR-64 High stab. ref. xtal (745/751) 63.00
 PP-1 Speaker/patch 159.25 149⁹⁵
 SM-6 Desk microphone 44.95
 SM-8 Desk mic - two cables, Scan. 78.50
 SM-10 Compressor/graph EQ, 8 pin mic 136.25 124⁹⁵
 AT-100 100W 8-band auto. antenna tuner 445.00 389⁹⁵
 AT-500 500W 9-band auto. antenna tuner 559.00 489⁹⁵
 AH-2 8-band tuner w/mount & whip 625.00 549⁹⁵
 AH-2A Antenna tuner system, only 495.00 429⁹⁵



Other Accessories - continued:
 GC-5 World clock Regular SALE 91.95 89⁹⁵
6-meter VHF Portable
 IC-505 3/10W 6m SSB/CW portable Regular SALE 549.00 489⁹⁵
 EX-248 FM unit 55.50
 LC-10 Leather case 39.50

VHF/UHF base multi-modes
 IC-551D 80W 6-meter SSB/CW Regular SALE 799.00 719⁹⁵
 EX-106 FM option 140.00 126⁹⁵
 BC-10A Memory back-up 9.50
 IC-271A* 25W 2 meters ... CLOSEOUT 859.00 699⁹⁵
 AG-20* Internal preamplifier 64.00
 IC-271H 100W 2m FM/SSB/CW 1099.00 969⁹⁵
 AG-25 Mast mounted preamplifier ... 95.00
 IC-275A 25W 2m FM/SSB/CW w/ps 1199.00 1049
 IC-471A* 25W 430-450 ... CLOSEOUT 979.00 769⁹⁵
 AG-1* Mast mounted preamplifier ... 99.50
 IC-471H* 75W 430-450 ... CLOSEOUT 1399.00 999⁹⁵
 AG-35* Mast mounted preamplifier 95.00

*Preamp \$99⁹⁵ with 271A/471A/471H Purchase

Accessories common to 271A/H and 471A/H
 PS-25 Internal power supply for (A) ... 115.00 104⁹⁵
 PS-35 Internal power supply for (H) ... 199.00 179⁹⁵
 SM-6 Desk microphone 44.95
 EX-310 Voice synthesizer 46.00
 TS-32 CommSpec encode/decoder ... 59.95
 UT-15 Encoder/decoder interface ... 14.00
 UT-15S UT-15S w/TS-32 installed ... 92.00

VHF/UHF mobile multi-modes
 IC-290H 25W 2m SSB/FM, TTP mic. ... Regular SALE 639.00 569⁹⁵
 IC-490A 10W 430-440 SSB/FM/CW 699.00 599⁹⁵

VHF/UHF/1.2 GHz FM
 IC-27A Compact 25W 2m FM w/TTP mic 429.00 369⁹⁵
 IC-27H Compact 45W 2m FM w/TTP mic 459.00 399⁹⁵
 IC-37A Compact 25W 220 FM, TTP mic 499.00 439⁹⁵
 IC-47A Compact 25W 440 FM, TTP mic 549.00 479⁹⁵
 PS-45 Compact 8A power supply ... 139.00 129⁹⁵
 UT-16/EX-388 Voice synthesizer ... 34.99
 SP-10 Slim-line external speaker ... 35.99

IC-28A 25W 2m FM, UP/DN mic. 429.00 369⁹⁵
 IC-28H 45W 2m FM, UP/DN mic. 459.00 399⁹⁵
 IC-38A 25W 220 FM 459.00 399⁹⁵
 IC-48A 25W 440-450 FM 459.00 399⁹⁵

HM-14 TTP microphone 55.50
 UT-28 Digital code squelch 37.50
 UT-29 Tone squelch decoder 43.00
 HM-16 Speaker/microphone 34.00
 IC-3200A 25W 2m/440 FM w/TTP. 599.00 499⁹⁵
 UT-23 Voice synthesizer 34.99

AH-32 2m/440 Dual Band antenna ... 37.00
 AHB-32 Trunk-lip mount 34.00
 Larsen PO-K Roof mount 20.00
 Larsen PO-TLM Trunk-lip mount 20.18
 Larsen PO-MM Magnetic mount 19.63
 RP-3010 440 MHz, 10W FM, xtal cont. 1229.00 1089
 IC-120 1W 1.2 GHz FM Mobile 579.00 499⁹⁵
 ML-12 1.2 GHz 10W amplifier 379.00 339⁹⁵
 IC-1271A 10W 1.2 GHz SSB/CW Base 1229.00 1069

AG-1200 Mast mounted preamplifier 105.00
 PS-25 Internal power supply 115.00 104⁹⁵
 EX-310 Voice synthesizer 46.00
 TV-1200 ATV interface unit 129.00 119⁹⁵
 UT-155 CTCSS encoder/decoder ... 92.00
 RP-1210 1.2 GHz, 10W FM, 99 ch. synth 1479.00 1289



Hand-helds
 IC-2A 2-meters Regular SALE 279.00 249⁹⁵
 IC-2AT with TTP 299.00 259⁹⁵
 IC-3AT 220 MHz, TTP 339.00 299⁹⁵
 IC-4AT 440 MHz, TTP 339.00 299⁹⁵
 IC-02AT 2-meters 369.00 299⁹⁵
 IC-02AT/High Power 399.00 339⁹⁵
 IC-03AT for 220 MHz 449.00 399⁹⁵
 IC-04AT for 440 MHz 449.00 389⁹⁵
 IC-u2A 2-meters 299.00 269⁹⁵
 IC-u2AT with TTP 329.00 289⁹⁵

Accessories for IC-u2A/T (CALL)
 IC-12AT 1W 1.2GHz FM HT/batt/cgr/TTP 459.00 399⁹⁵
 A-2 5W PEP synth. aircraft HT 599.00 499⁹⁵

Accessories for IC series
 BP-7 425mah/13.2V Nicad Pak - use BC-35 74.25
 BP-8 800mah/8.4V Nicad Pak - use BC-35 ... 74.25
 BC-35 Drop in desk charger for all batteries 74.50
 BC-16U Wall charger for BP7/BP8 20.25
 LC-11 Vinyl case for Dlx using BP-3 20.50
 LC-14 Vinyl case for Dlx using BP-7/8 20.50
 LC-02AT Leather case for Dlx models w/BP-7/8 54.50

Accessories for IC and IC-O series
 BP-2 425mah/7.2V Nicad Pak - use BC35 ... 47.00
 BP-3 Extra Std. 250 mah/8.4V Nicad Pak ... 37.50
 BP-4 Alkaline battery case 15.25
 BP-5 425mah/10.8V Nicad Pak - use BC35 58.50
 CA-5 5/8-wave telescoping 2m antenna 18.95
 FA-2 Extra 2m flexible antenna 11.50
 CP-1 Cig. lighter plug/cord for BP3 or Dlx ... 13.00
 CP-10 Battery separation cable w/clip 22.50
 DC-1 DC operation pak for standard models 23.25
 MB-16D Mobile mtg. bkt for all HTs 24.50
 LC-2AT Leather case for standard models ... 54.50
 RB-1 Vinyl waterproof radio bag 34.95
 HH-SS Handheld shoulder strap 16.95
 HM-9 Speaker microphone 47.00
 HS-10 Boom microphone/headset 23.25
 HS-10SA Vox unit for HS-10 & Deluxe only 23.25
 HS-10SB PTT unit for HS-10 23.25
 ML-1 2m 2.3w in/10w out amplifier ... SALE 99.95
 SS-32M Commspec 32-tone encoder 29.95

Receivers
 R-71A 100 kHz-30 MHz, 117V AC Regular SALE \$949.00 799⁹⁵
 RC-11 Infrared remote controller ... 67.25
 FL-32 500 Hz CW filter 66.50
 FL-63 250 Hz CW filter (1st IF) 54.50
 FL-44A SSB filter (2nd IF) 178.00 159⁹⁵
 EX-257 FM unit 42.50
 EX-310 Voice synthesizer 46.00
 CR-64 High stability oscillator xtal 63.00
 SP-3 External speaker 61.00
 CK-70 (EX-299) 12V DC option 12.25
 MB-12 Mobile mount 24.50
 R-7000 25 MHz-2 GHz scanning rcvr 1099.00 969⁹⁵
 RC-12 Infrared remote controller ... 67.25
 EX-310 Voice synthesizer 46.00
 TV-R7000 ATV unit 131.95 119⁹⁵
 AH-7000 Radiating antenna 89.95 (15)

HOURS • Mon. thru Fri. 9-5:30; Sat. 9-3
 Milwaukee WATS line: 1-800-558-0411 answered evenings until 8:00 pm Monday thru Thursday.
 WATS lines are for Quotes & Ordering only, use Regular line for other Info & Service Dept.
 All Prices in this list are subject to change without notice.

Order Toll Free: 1-800-558-0411 In Wisconsin (outside Milwaukee Metro Area) 1-800-242-5195

AMATEUR ELECTRONIC SUPPLY[®] Inc.

4828 W. Fond du Lac Avenue; Milwaukee, WI 53216 • Phone (414) 442-4200

AES[®] BRANCH STORES Associate Store

WICKLIFFE, Ohio 44092 28940 Euclid Avenue Phone (216) 585-7388 Ohio WATS 1-800-362-0290 Outside Ohio 1-800-321-3594	ORLANDO, Fla. 32803 621 Commonwealth Ave. Phone (305) 894-3238 Fla. WATS 1-800-432-9424 Outside Florida 1-800-327-1917	CLEARWATER, Fla. 33575 1898 Drew Street Phone (813) 461-4267 No In-State WATS No Nationwide WATS	LAS VEGAS, Nev. 89106 1072 N. Rancho Drive Phone (702) 647-3114 No In-State WATS Outside Nevada 1-800-634-6227	CHICAGO, Illinois 60630 ERICKSON COMMUNICATIONS 5456 N. Milwaukee Avenue Phone (312) 631-5181 Outside Illinois 1-800-621-5802
--	---	---	---	--

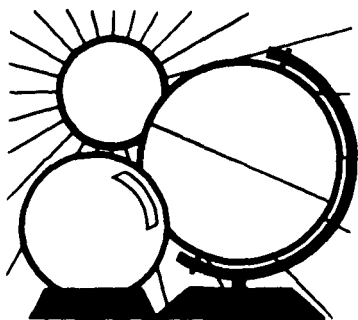

DX FORECASTER

Garth Stonehocker, KØRYW

a spring dx solution

Atmospheric noise from thunderstorms can be a problem when you're chasing DX during this time of the year. Noise is propagated via the ionosphere just like DX.

In March and April, spring storms occur in the northern hemisphere. Fronts of warm and cold air generate the first major thunderstorms of the year, with fast-moving cold fronts producing particularly potent thunderstorms. As a storm front approaches your area, you'll begin to hear a significant increase in the noise level. You'll first notice this increase at a one-hop distance (about 600 to 1200 miles) when the storm front is about one day west of your location. You can reduce the received noise a few dB by using a directional antenna such as a rotating Yagi or a phased vertical array. Determine the noise direction and work DX in the opposite direction, or do your best to null it out using a directional trade-off between signal and noise strengths. Antennas with a low take-off-angle (TOA) at the operating frequency are best because noise normally arrives at angles greater than 30 degrees.

As the front draws nearer, the noise level will usually decrease until it's within a ground-wave's distance (about 50 miles). Now, loud individual discharges will be heard. A horizontally polarized antenna is the best radiator to use to lower the noise as much as possible. As the storm approaches, its sounds

become part of the "local noise"; as it moves away, its noise decreases, then increases again as the front reaches the one-hop distance point a day or so later. The directional-low TOA antenna again becomes helpful. (Correlate your observations with storm progress reports on the local television weather program.)

In looking for rare DX, you can save time by tracking storms in order to pinpoint when and where the most favorable listening conditions are likely to occur.

Over the years of gathering information for and writing this column, I've kept an ear open for data that would verify the events and propagation conditions presented in previous *last-minute forecasts* and *highest band available charts* in this column. To track the accuracy of these predictions, I plot daily values of solar flux and geomagnetic A (index) on a 27-day epoch graph and find it's hard to be right much over 60 percent of the time.

To verify published data, I monitor the ham bands and keep data collection in mind while DXing. What I usually look for is the highest band with signals, then note where they're coming from and the time the band is changing (out or in) towards that direction. During the month, I get a better sense of how good that month's chart was.

What do you think? Could the chart information be better? Let me know how you think it's working.

last-minute forecast

DX conditions on the higher frequency bands, 10-30 meters, are expected to be best through the first week and a half. The probability of transequatorial openings should be greater during this period of higher-than-normal solar flux, especially if geomagnetic disturbances materialize as expected on the down slope of this short-term flux peak. This month is still within the spring equinox disturbance window, so be aware and take advantage of this opportunity to work some southern stations.

The lower frequency bands will probably be affected by the disturbances expected around April 8-10 and 15-20. However, these will affect east, north, and west paths with lower MUFs and lower signal strengths with QSB. Look for DX from unusual locations if the disturbance isn't too strong — K's greater than 5 or 6. Otherwise, the second and third weeks should be good for DX, with low atmospheric noise except when spring weather frontal thunderstorms pass your QTH.

The perigee of the moon's orbit (for moonbounce DX) is on the 18th, with the moon showing full phase on the 14th. There will be a short meteor shower, the Lyrid, on April 20-22, with a rate of five per hour — hardly much help for meteor-scatter DX. But a bigger shower, the Aquarid, starts before the end of April, peaks on May 5, and ends in mid-May. Its rate is 10 to 30 per hour.

On March 29, expect a total eclipse of the sun in the southern part of South America and Antarctica, going up to Southeast Europe and Asia.

Ten, twelve and fifteen meters, the day-only DX bands, will be open mid-day to early evening almost every day to southern areas of the world. The openings on the higher of these bands will be shorter (if they occur at all), closer to local noon, and provide a possibility of transequatorial openings.

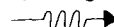

GMT	WESTERN USA									
	N	NE	E	SE	S	SW	W	NW		
0000	20	30	20	12	15	10	10	15		
0100	15	30	20	12	15	10	10	15		
0200	15	30	20	15	20	10	10	15		
0300	15	30	20	15	20	10	10	15		
0400	15	30	20	15	20	10	10	15		
0500	20	30	30	20	20	10	10	15		
0600	20	20	20	20	30	10	10	15		
0700	20	20	15	20	30	12	12	20		
0800	20	20	15	20	30	12	12	20		
0900	20	30	20	20	30	15	20*	20		
1000	20	30	20	20	30	20	20*	20		
1100	20	20	20	20	30	20	20	30		
1200	20	20	15	20	40	20	20	30		
1300	20	20	12	20	40	20	20	30		
1400	20	15	12	15	40	20	20	20		
1500	20	15	10	12	40	20	30	30		
1600	20	15	10	12	40	20	30	30		
1700	20	15	10	12	20	20	30	30		
1800	20	15	12	10	20	15	30	20		
1900	30	15	12	10	20	12	20	20		
2000	20	20	15	10	15	12	12	20		
2100	20	20	15	10	15	10	10	20		
2200	20	20	20	10	15	10	10	20		
2300	20	20	20	10	15	10	10	15		

GMT	MID USA									
	N	NE	E	SE	S	SW	W	NW		
0000	20	20	20	12	15	10	10	15		
0100	20	30	20	12	15	10	10	15		
0200	20	30	20	15	20	10	10	15		
0300	20	30	20	15	20	10	10	15		
0400	20	30	20	15	20	10	10	15		
0500	20	30	20	15	20	10	10	15		
0600	20	20	20	15	20	10	10	15		
0700	20	20	12	15	40	20	20	20		
0800	20	15	12	12	40	20	30	30		
0900	20	15	10	12	40	20	30	30		
1000	20	15	10	12	40	20	30	30		
1100	20	15	10	10	20	20	30	30		
1200	30	15	12	10	20	12	30	20		
1300	30	20	12	10	20	12	20	20		
1400	20	20	15	10	20	12	12	20		
1500	20	20	15	10	20	12	12	20		
1600	20	20	15	10	15	10	10	20		
1700	20	20	20	10	15	10	10	15		
1800	20	20	20	10	15	10	10	15		
1900	20	20	20	10	15	10	10	15		
2000	20	20	20	10	15	10	10	15		
2100	20	20	20	10	15	10	10	15		
2200	20	20	20	10	15	10	10	15		
2300	20	20	20	10	15	10	10	15		

GMT	EASTERN USA									
	N	NE	E	SE	S	SW	W	NW		
0000	20	20	20	12	20	10	10	15		
0100	20	20	20	12	20	10	10	15		
0200	20	30	20	15	20	10	10	20		
0300	20	30	20	15	20	10	10	20		
0400	20	30	20	15	20	10	10	20		
0500	20	30	20	15	20	10	10	20		
0600	20	30	20	15	20	10	10	20		
0700	20	30	20	15	20	10	10	20		
0800	20	30	20	15	20	10	10	20		
0900	20	20	15	20	40	20	20	20		
1000	20	20	12	20	40	20	20	20		
1100	20	20	12	20	40	20	30	20		
1200	20	20	12	15	40	20	20	20		
1300	15	20	12	12	40	20	20	20		
1400	20	20	15	20	40	20	20	20		
1500	20	20	12	20	40	20	20	20		
1600	15	20	12	15	40	20	20	20		
1700	20	20	12	20	40	20	20	20		
1800	20	30	20	20	30	20*	20	20		
1900	20	30	20	20	30	15	15	20		
2000	20	30	20	20	30	12	12	20		
2100	20	30	20	20	30	12	12	20		
2200	20	30	20	20	30	12	12	20		
2300	20	30	20	20	30	12	12	20		

The italicized numbers signify the bands to try during the transition and early morning hours, while the standard type provides MUF during "normal" hours.
 *Look at next higher band for possible openings.

DOWN EAST MICROWAVE

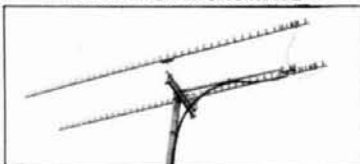

MICROWAVE ANTENNAS AND EQUIPMENT

- Loop Yagis • Power Dividers • Linear Amplifiers • Complete Arrays • Microwave Transverters • GaAsFET Preamps
- TROPO • EME • Weak Signal • OSCAR • 902 • 1280 • 1296 • 2304 • 2400 • 3456 MHz

2345 LY	45el	loop Yagi	1296 MHz	20dBI	\$93
1345 LY	45el	loop Yagi	2304 MHz	20dBI	\$80
3333 LY	33el	loop Yagi	902 MHz	18.5dBI	\$93

Above antennas assembled and tested. Kits available.

All Aluminum and Stainless Construction.

Add \$8 UPS S/H, \$11 West of the Mississippi.

2318 PA Linear Amp 1W in 18W out 1296 MHz 13.5V. \$245 ppd.

2335 PA Linear Amp 10W in 35W out 1296 MHz 12.5V. \$295 ppd.

NEW! MICROWAVE TRANSVERTERS

BY LMW ELECTRONICS

1296TRV6D 6W, GaAsFET, T/R Sequencer, Output Meter \$489

2304TRV2D 2W, GaAsFET, T/R Sequencer, Output Meter \$589

Add \$6 for shipping UPS/48

Stripped down version, kits also available

Write For FREE Catalog

DOWN EAST MICROWAVE

Bill Olson, W3HQT

Box 1655A RFD #1, Burnham, ME 04922 U.S.A.

(207) 948-3741



✓ 137

AUTHORIZED KENWOOD I-COM RADIO DEALER



✓ 138

H. L. HEASTER, INC., 203 Buckhannon Pike, Clarksburg, W. Va. 26301 Clarksburg Phone (304) 624-5485 or W. Va. Toll-Free 1-800-352-3177

HAROLD HEASTER, KABOHX, 91 Ridgefield Place, Ormond Beach, Fl. 32074 Florida Phone (904) 673-4066

NEW NATION-WIDE TOLL-FREE TELEPHONE 1-800-84-RADIO
1-800-84-72346

Call us for a quotation, WE WILL SAVE YOU MONEY!

MOBILE RADIO MOUNTS

MM 10013

MM 1007



- Government • Industrial
- Commercial • Recreational

All New 1987 Y-5 Catalog FREE



IIX Equipment Ltd.



P.O. Box 9 Oaklawn, IL 60454 (312) 423-0605

✓ 139



The RC-850 Repeater Controller . . . when only the best will do.

With an RC-850 controller, your repeater becomes fully remotely programmable – command codes, timers, autodial numbers, ID and tail messages . . . virtually every parameter can be easily changed. Touch-Tone programming from your radio or the phone with synthesized voice confirmation.

The patch supports local and radio-linked remote phone lines, so you can extend your patch coverage to match your RF coverage. Now you can have a full featured patch even if you can't get a phone line at your site. The 250 autodial slots meet everyone's needs, with up to 35 digit storage for MCI/Sprint.

The easy-to-use mailbox lets you include phone numbers, times, or frequencies as parts of messages. And it's so smart, it'll leave you a message if you miss a reverse patch or an alarm.

Selective call capabilities range from two-tone to numeric display paging, so you'll always be available. And its voice response metering continuously stores low and high readings – so you can find out how cold it gets, how high the reflected power reads . . . and when.

Individual user access codes, with callsign readback, give you *secure* access to selected functions to completely prevent horseplay.

Advanced Computer Controls continues to lead the way in advanced repeater technology, changing the face of amateur repeaters every day. ACC controllers offer users, control operators, and site managers features and tools to make operation more convenient, useful, and FUN!

The industry's top-of-the-line controller – for *your* repeater.

ACC

advanced
computer
controls, inc.

2356 Walsh Avenue
Santa Clara, CA 95051

(408) 727-3330

✓ 130



SUBSCRIBE —AND RENEW— TOLL-FREE

**ham
radio** magazine

1 YR - \$22.95 2YRS - \$38.95

3 YRS - \$49.95

Prices U.S. only

MASTERCARD

VISA

Please have your charge card ready

BILL ME

DATATEL 800™

800-341-1522

Weekdays 8 AM - 9 PM EST • Saturdays 9 AM - 5 PM EST

IN MAINE CALL COLLECT (207) 236-2896

OUR 800 NUMBER IS FOR SUBSCRIPTION ORDERS ONLY!

For Errors or Change of Address CALL *ham radio*
direct at (603) 878-1441 8-5 EST

The HF4B "Butterfly"TM
A Compact Beam
for 20-15-12-10 Meters



- Unique design reduces size but **not** performance.
- No lossy traps: full element radiates on all bands.
- Retrofit kit for 17 meters coming soon.
- Turns with TV rotor
- Only 17 lbs.

HF ANTENNAS FROM BUTTERNUT

Butternut Verticals

Butternut's HF verticals use highest-Q tuning circuits (not lossy traps!) to outperform all multiband designs of comparable size!

Model HF6V

- 80, 40, 30, 20, 15 and 10 meters automatic band-switching
- Add-on kit for 17 and 12 meters available now
- 26 ft tall

Model HF2V

- Designed for the low band DXer
- Automatic band-switching on 80 and 40 meters
- Add-on units for 160 and 30 or 20 meters
- 32 feet tall - may be top-loaded for additional bandwidth

For more information see your dealer or write for a free brochure



BUTTERNUT ELECTRONICS CO

405 East Market Lockhart, Texas 78644



Twenty, thirty, and forty meters are both day and night bands. Twenty meters is the maximum usable band for DX in the northern directions these days during the daytime; it then teams up with 30 meters to extend this coverage into evenings. Forty meters becomes the main over-the-pole DX daytime band, with some hours covered by 30.

Eighty and one-sixty meters, the night-only DX bands, will exhibit short-skip propagation during daylight hours, then lengthen for DX at dusk. These bands follow the darkness path, opening to the east just before your sunset, swinging more to the north-south near midnight, and ending up in the Pacific areas during the hour or so before dawn. Eighty is the maximum usable band for some night hours now during the sunspot minimum part of the cycle; consequently, signal strength quality can be expected to improve. Remember the DX windows of 3790-3800, 1825-1830, and 1850-1855.

ham radio

SPECIALIZED COMMUNICATIONS FOR TODAY'S RADIO AMATEUR!



If you are ACTIVE in FSTV, SSTV, FAX, OSCAR, PACKET, RTTY, EME, LASERS, or COMPUTERS, then you need

" SPEC-COM !"

Published 10 Times
Per Year
By WBØQCD
(Serving Amateur Radio Since 1967!)

48 Pages per issue. Loaded with News, Articles, Projects, and Ads.

SIGN UP TODAY AND GET 3 BACK ISSUES "FREE"!

Join our growing membership at the regular \$20 per year rate and we will send you 3 back issues (of your choice) absolutely "free"! We also have 2 and 3 year discounts at just \$38 and \$56. Foreign surface and air mail subscriptions also available, please write for details. Add \$2.00 for a special 19-year "master article index" issue. Allow 2-3 weeks for your first issue. Special TRS-80C, Commodore 64, Apple, IBM Software Catalog Available!

THE SPEC-COM JOURNAL

P.O. BOX H,
LOWDEN, IOWA 52255



Credit Card Orders (5% added)

Iowa Residents Add 4% State Sales Tax



SSB ELECTRONIC TRANSVERTERS & PREAMPLIFIERS

LT 2S	144/28 XVRTR 20W GaAsfet DBM	TBA
LT33S	902/144 Xvrtr 20W GaAsfet	\$549
LT23S	1296/144 Xvrtr 10W GaAsfet	\$549
MICRO-13	2304/144 XVRTR 0.5W GaAsfet	\$429
MICRO-X	10368/144 Xvrtr 0.1W GaAsfet	\$599
DX	series low noise GaAsfet preamps	from \$129
MV	series mast mounted GaAsfet preamps	\$199
K	series rx cnvtrs GaAsfet DBM	from \$129

TRANSVERTERS UNLIMITED

T220/28	220 Mhz Xvrtr 28 or 50 IF, 20 W	\$220
T144/28	144 Mhz Xvrtr 28 or 50 IF, 25 W	\$199
PA23200	1296 Mhz 2 tube PA, 200W +	\$299
PA23150	1296 2tube PA, 150 + W	\$249
PA1325	2304 1tube PA, 25 + W	\$429
HF400	High power relay 2kw at 144 Mhz	\$129
RK500	Medium power relay 1KW at 144 Mhz	\$ 69

Call or write for catalogue.

199

TRANSVERTERS UNLIMITED

BOX 6286 STATION A
TORONTO, ONTARIO
CANADA M5W 1P3

HANS PETERS (VE3CRU)

(416) 759-5562

Sub Problem?

Contact Sue. She'll

fix it for you!

(603) 878-1441

Ham Radio

Greenville, N. H. 03048

MR. NICAD

REPLACEMENT BATTERIES FOR COMMUNICATIONS

Nickel-Cadmium, Alkaline, Lithium, etc.

ICOM - BP-3 Repack - \$12.00
BP-2, BP-5, BP-8 Repacks.

NEW HOT ROD PACKS FOR ICOM 2A, 2AT,
02AT, B CELL 10v - 800 MAH, 10 CELL
12.5V - 500 MAH.....\$49.95 ea.

Yaesu, Kenwood, Santec, Azden,
Tempo, Standard, Cordless Phone
etc.

MR. NICAD
E.H. YOST & CO.

EVERETT H. YOST RR #1 BOX #37
KBRXI SAUK CITY, WI 53583
(608) 643-3194

Send for nicad battery price list.

✓ 134

BLACK DACRON® POLYESTER ANTENNA ROPE

- UV-PROTECTED
- HIGH ABRASION RESISTANCE
- REQUIRES NO EXPENSIVE POTTING HEADS
- EASY TO TIE & UNTIE KNOTS
- EASY TO CUT WITH OUR HOT KNIFE
- SIZES: 3/32" 3/16" 5/16"
- SATISFIED CUSTOMERS DECLARE EXCELLENCE THROUGHOUT U.S.A.

LET US INTRODUCE OUR DACRON® ROPE TO YOU • SEND YOUR NAME AND ADDRESS AND WE'LL SEND YOU FREE SAMPLES OF EACH SIZE AND COMPLETE ORDERING INFORMATION

✓ 135

MANUFACTURED BY:
synthetic textiles, inc.
2422 EASTMAN AVENUE, BUILDING 21
VENTURA, CALIFORNIA 93003 (805) 658-7903

GIVE YOUR EARS A BREAK!



**AUTO-KALL
AK-10**

✓ 136

The **AUTO-KALL AK-10** is a DTMF selective calling unit. It connects to the external speaker jack on your VHF/UHF FM transceiver, scanner, etc. Your speaker remains silent until someone sends your personal 3-digit Touch-Tone™ code. That means you (and the XYL!) don't have to listen to all the chatter all the time. But if someone wants to reach you they can. Great for families with two or more hams, activation of emergency nets, etc.

- Assembled and ready to use
- Set your personal code in seconds with small rotary switches. No jumpers to solder.
- Speaker resets automatically to silent standby and leaves red LED on to tell you know someone called if you were away from the rig.
- 8-15 VDC CMOS circuitry provides for low-current operation
- Built-in speaker
- External speaker jack also provided
- Measures only 1 1/4 x 3 x 5 1/2 inches
- Decodes all 16 digits

Motron Electronics
695 W. 21st
Eugene, OR 97405
503-687-2118



AUTO-KALL AK-10
\$89.95 Plus 3.00 shipping handling

117 VAC power supply and audio patch cord included.

*Touch-Tone is Trademark of AT&T

The RC-85 Repeater Controller . . . the affordable controller for any repeater.

The RC-85 controller offers the high tech basics of repeater control. Of course, much of what we consider the "basics" aren't found *anywhere else, at any price*. Remote programming lets you configure the operating characteristics of your repeater, and change them at any time - without a trip to the hill. Non-volatile memory remembers your parameters, even after a power loss.

Synthesized speech makes it easy for users to interact with the repeater. Commands are acknowledged, and information is available to users, through remotely programmable ID, tail, and bulletin board messages. And since your repeater talks, it's friendly and fun to use.

The patch includes ten emergency autodial numbers, and 190 user loadable autodial slots. With toll restrict, "cover tone", and more.

The remote base capability lets you connect a transceiver to your repeater, for remotely commanded linking to other repeaters and simplex channels. With full frequency control! Frequency agile linking is invaluable in public service communications.

There's even more . . . a talking s-meter so users can check how well they're getting into the repeater, a site alarm for security, remote control logic outputs for controlling other equipment at the site.

There's never been a better time to upgrade your repeater system with ACC's products, unmatched in the industry in quality, sophistication, and performance. With well written, illustrated, easy to read manuals, training tapes, and telephone support.

Please call or write now for the rest of the story on all our repeater products, including controllers, digital voice storage units, and other Touch-Tone control products.

You'll be GLAD you did.

✓ 130

ACC

advanced
computer
controls, inc.

2356 Walsh Avenue
Santa Clara, CA 95051

(408) 727-3330

NEMAL ELECTRONICS

HARDLINE — 50 OHM

Nemal No.	Description	Per Ft.
FXA12	1/2" Aluminum Black Jacket	89
FLC12	1/2" Corr. Copper Bk. Jkt.	159
FLC78	7/8" Corr. Copper	392
NM12AL	N Conn. 1/2" Alum. (Male or Female)	22.00
NM12CC	N Conn. 1/2" Copper (Male or Female)	22.00
NM78CC	N Conn. 7/8" Copper (Male or Female)	54.00

COAXIAL CABLES

Nemal No.	Description	100 Ft.	Per Ft.
1100	RG 8 95% Shielded Mil. Spec.	28.00	32
1102	RG8 95% Shielded Foam	30.00	32
1110	RG8X 95% Shield (mini 8)	15.00	17
1130	RG213/U Mil. Spec. 96% Shield	34.00	36
1140	RG214/U Mil. Spec. - Dbl. Silver	155.00	165
1180	Belden 9913 Low Loss	46.00	50
1705	RG142B/U Teflon/Silver	140.00	150
1310	RG217/U 5/8" 50 ohm Dbl. Shield	80.00	85
1470	RG223/U Mil. Spec. Dbl. Silver	80.00	85
1450	RG174 95% Shielded Mil. Spec.	12.00	14

ROTOR CABLE — 8 COND.

Nemal No.	Description	100 Ft.	Per Ft.
8C1822	2-18 Ga., 5-22 Ga.	19.00	21
8C1620	2-16 Ga., 5-20 Ga. Heavy Duty	34.00	36

* Shipping \$3.00 - 100 Ft. / Conn. \$3.00 / C.O.D. \$2.00

CONNECTORS — MADE IN U.S.A.

Nemal No.	Description	Each
NE720	Type N for Belden 9913	4.25
NE723	N Female Belden 9913	4.75
PL258AM	Amphenol Barrel	1.45
PL259	Standard Plug for RG8, 213	10/5.90 or 65
PL259AM	Amphenol PL259	10/7.90 or 89
PL259TS	PL259 Teflon/Silver	1.59
UG210	Type N for RG8, 213, 214	3.00
UG83B	N Female to PL259	6.50
UG88C	BNC RG58	1.25
UG146	S0239 to Male N	6.50
UG175/6	Adapter for RG58/59 (specify)	10/2.00 or 22
UG255	S0239 to BNC Amphenol	3.75
KA51-18	TNC RG58	4.35
AM9501-1	SMA RG142B	8.95
S0239AM	Amphenol S0239	89

GROUND STRAP — BRAID

Nemal No.	Description	Per Ft.
GS38	3/8" Tinned Copper	30
GS12	1/2" Tinned Copper	40
GS316	3/16" Tinned Copper	15
GS316S	3/16" Silver Plated	35

GROUND WIRE — STRANDED

Nemal No.	Description	Per Ft.
HW06	6 Ga. insulated stranded	35

Call or write for complete price list. Nemal's 32-page Cable & Connector Selection Guide is available at no charge with orders of \$50.00 or more, or at a cost of \$4.00 individually.

NEMAL ELECTRONICS, INC.
12240 N.E. 14 Ave., No. Miami, FL 33161

(305) 893-3924 • Telex 6975377

24-Hr. FAX (305) 895-8178

✓ 133



product

REVIEW

the DEO QSK-1500

When I was a Novice back in the 1960s, my club station had a Johnson Ranger I, a Hammarlund HQ-120, and a Johnson TR switch. I spent hours on the air and really enjoyed being able to work full break-in CW. I got spoiled in that first year of being a ham, not having to listen to the clunking of relays and switches.

Since then I've dreamed of operating break-in CW again. Until recently, however, I never had a fully QSK-compatible radio. When I finally acquired one of the new do-it-all-but-burp-the-baby radios, QSK was once again possible. But I couldn't operate high power QSK. What to do?

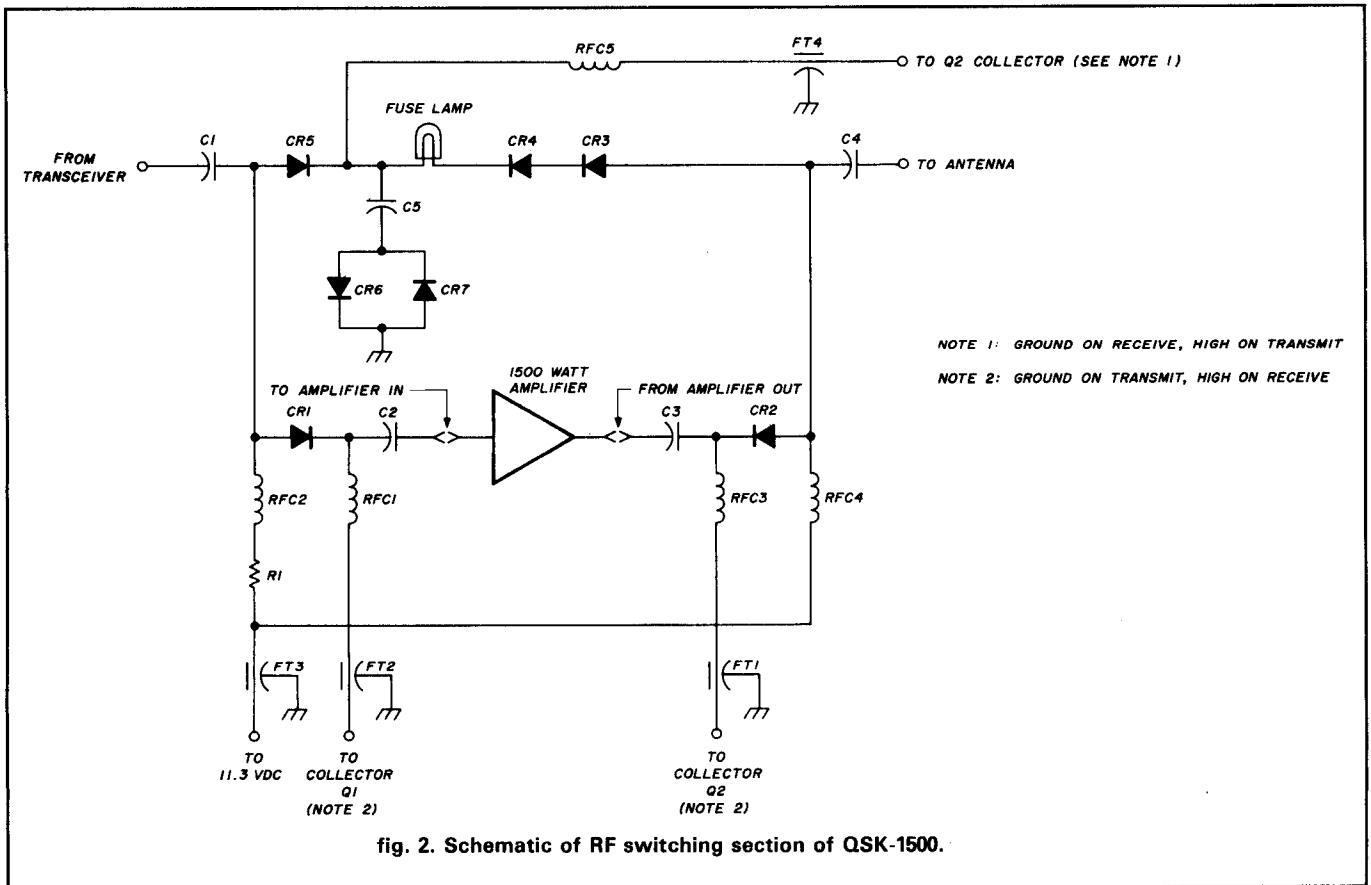
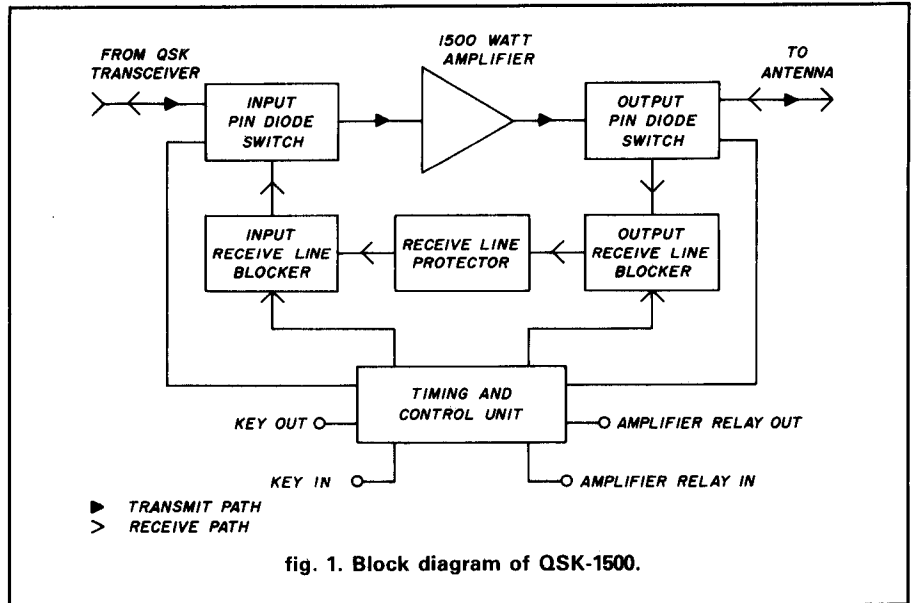

QSK — what is it?

Basically stated, QSK is the ability to hear between the dots and dashes while transmitting a CW signal. A number of methods can be used to effect QSK operation: separate transmit and receive antennas, a vacuum tube TR switch such as the Johnson mentioned above, and expensive vacuum switches.

Each of these designs, however, presents a number of difficulties. Not everyone has a receiver with an AGC circuit capable of operating in the presence of a strong rf field without "folding up" or the space necessary for separate transmit and receive antennas. The TR switch had two significant problems: it created a tremendous amount of TVI and caused attenuation on the receive signal (commonly called "suck-out"). Vacuum switches require complex, precisely timed circuits to prevent "hot-switching" and aren't cheap to manufacture. Another problem was that some of these schemes introduced distortion onto the transmitted signal.

modern technology to the rescue

Several technological advances in the late 1960s brought QSK closer to reality for the average ham. Until the late 1970s, however, TENTE was the only manufacturer to offer a QSK-compatible radio.

By 1980, transceiver manufacturing took a quantum leap forward and QSK-compatible radios were available from almost all radio manufacturers. Unfortunately, one problem remained; unless you owned either an Ehrhorn Alpha 77 or 78, you couldn't operate high-power QSK. Several after-market, add-on QSK units were introduced, but they suffered many of the same problems as other units.

In mid-1984, John ("Doc") Sheller, KN8Z, designed a solid-state QSK switch that solved many of the problems of earlier QSK units, using state-of-the-art PIN diodes as rf switches.

PIN stand for layer doping (P), intrinsic layer (I), pure and no doping (N) layer. The thickness of the intrinsic layer determines the characteristics of the diode and allows the manufacturer to custom-design the diode for any of many different kinds of applications. A PIN diode is a solid-state device that acts like a variable resistor at rf frequencies. The amount of forward dc bias applied to the PIN diode determines the resistance (impedance) to rf signals. Doc's design is unique in that it has no moving parts — no relays — and can hot-switch high power rf. It needs only low dc voltage biasing to control rf currents, and by design, doesn't introduce any significant waveform distortion on the transmitted signal.

how it works

A block diagram and schematic (figs. 1 and 2) illustrate how the QSK-1500 works. The received signal travels from the antenna through the output line blocker, the receive line protector, and the input receive line blocker into the

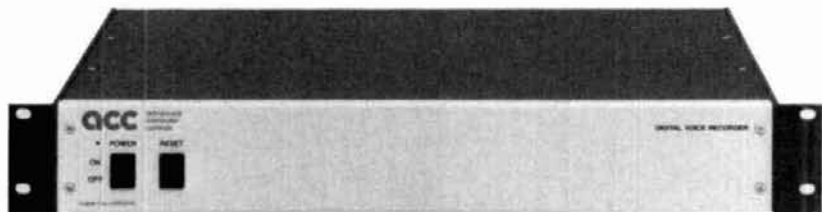

The Digital Voice Recorder ... lets your repeater speak your mind.

ACC's Digital Voice Recorder allows you to remotely record your voice over the air, with digital storage in its huge memory array. PCM voice recording results in the highest possible fidelity, so that you sound like you.

The voice mailbox gives your repeater users computer bulletin-board like capability, from any radio with mic and Touch-Tone pad. With messages stored in voice, your users don't need special gear to enjoy the latest in communications technology, from anywhere.

Your repeater's IDs and other messages can consist of remotely recorded DVR audio tracks. Which can provide information to your users — about your system, club meetings, special events. And you can make your repeater the friendliest around, with holiday, birthday, and anniversary greetings. With its no compromise high quality PCM digital audio processing, even famous celebrities can sound like they're at your repeater site!

The DVR connects easily to your RC-850 or RC-85 controller. Or to your standalone repeater. And one DVR can support up to three repeaters, for a cost effective installation.

The Digital Voice Recorder is the neatest thing to happen to repeaters since ACC's repeater controllers. Request our audio demonstration tape, so you can hear for yourself.

acc

advanced
computer
controls, inc.

2356 Walsh Avenue
Santa Clara, CA 95051

(408) 727-3330

✓ 130

MAKE CIRCUIT BOARDS THE NEW, EASY WAY



WITH TEC-200 FILM

JUST 3 EASY STEPS:

- Copy circuit on TEC-200 film using any plain paper copier
- Iron film on to copper clad board
- Peel off film and etch

SATISFACTION GUARANTEED
convenient 8½ x 11 size

5-Sheets for \$3.95
10 sheets only \$5.95

add \$1.00 postage — NY res. add sales tax

The MEADOWLAKE Corp.

DEPT. HR., P.O. Box 497
Northport, New York 11768 ✓ 131

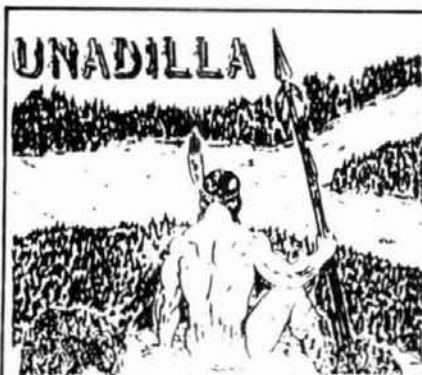

CONTACT YOUR DEALER FOR MORE INFORMATION

Amateur Radio Baluns-
Traps-Remote Coaxial Switches

Or Write To:

UNADILLA DIV. of ANTENNA'S ETC.
P.O. Box 215 BV ANDOVER, MA. 01810

617-475-7831 ✓ 132

THE STANDARDS OF EXCELLENCE

SUPERIOR WEAK SIGNAL PERFORMANCE COMMERCIAL MODEM

COMPARE with ANY unit at ANY Price

Now Available With
PACKET RADIO

THE WORLD OF VHF/HF PACKET*,
CW, RTTY, ASCII AND NEW DUAL
AMTOR** IS AS CLOSE AS YOUR
FINGERTIPS WITH THE BRILLIANTLY
INNOVATIVE STATE-OF-THE-ART
MICRO-COMPUTER CONTROLLED
EXL-5000E.



SHOWN WITH OPTIONAL KANTRONICS KPC2400
AND MFJ-1270 TNC-2

Everything built in — nothing else to buy!

SPECIAL SALE
\$795

- AUTOMATIC SEND/RECEIVE—ANY SPEED ANY SHIFT • BUILT IN COMPUTER GRADE 5" MONITOR • EXTERNAL MONITOR JACK • TIME CLOCK ON SCREEN • TIMED TRANSMISSION AND RECEIVING • SELCAL • CRYSTAL CONTROLLED AFSK MODULATOR • PHOTOCOUPLER CW, FSK KEYS • ASCII KEY ARRANGEMENT • 15 CHANNEL BATTERY BACK-UP MEMORY • 1,280 CHARACTER DISPLAY MEMORY • SPLIT SCREEN TYPE-AHEAD BUFFER • FUNCTION SCREEN DISPLAY • PARALLEL PRINTER INTERFACE • SPEEDS: CW 5-100 WPM (AUTOTRACK), 12-300 BAUD (ASCII AND BAUDOT); 12-600 BAUD TTL; 100 BAUD ARQ/FEC AMTOR • ATC • RUB-OUT FUNCTION • AUTOMATIC CR/LF • WORD MODE • LINE MODE • WORD WRAP AROUND • ECHO • TEXT CURSOR CONTROL • USOS • DIDDLE • TEST MESSAGES (RY AND QBF) • MARK AND BREAK (SPACE AND BREAK) SYSTEM • VARIABLE CW WEIGHTS • AUDIO MONITOR CIRCUIT BUILT IN • CW PRACTICE FUNCTION • CW RANDOM GENERATOR • BARGRAPH LED METER FOR TUNING • OSCILLOSCOPE OUTPUTS • BUILT IN 100-120 / 220-240 VAC 50/60HZ AND 13.8VDC POWER SUPPLIES • AND MUCH, MUCH MORE • SIZE: 14W x 14D x 5H •

EXCLUSIVE DISTRIBUTOR: DEALER INQUIRIES INVITED FOR YOUR NEAREST DEALER OR TO ORDER
AMATEUR-WHOLESALE ELECTRONICS TOLL FREE...800-327-3102
46 Greensboro Highway, Watkinsville, Georgia 30677 Telephone (404) 769-8706 Telex: 4930709 ITT



MANUFACTURER:
TONO CORPORATION
98 Motosoja Machi, Maebashi-Shi, 371, Japan

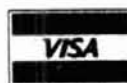

*PLEASE CALL FOR DETAILS

**Dual Amtor: Commercial quality, the EXL-5000E incorporates two completely separate modems to fully support the amateur Amtor codes and all of the CCIR recommendations 476-2 for commercial requirements.

Specifications Subject to Change.

✓ 124

VHF-UHF POWER DIVIDERS



RF power dividers provides the best way to feed in-phase 2 and 4 antenna arrays to maximize system gain and at the same time reduce losses to a minimum. Covering 144 thru 1296 MHz, this series of VHF/UHF power dividers are premier RF devices designed for a long service life with low SWR and broad operating bandwidth.

Extruded aluminum body with a durable enamel finish in addition to silicon sealing at connector flanges results in a ruggedized unit for all array installations. Available with N-type connectors only, these units are unconditionally guaranteed for 2 years.

MODEL	CONFIG.	PRICE
144-2P	(2 ports)	\$51.00
144-4P	(4 ports)	\$58.00
220-2P	(2 ports)	\$50.00
220-4P	(4 ports)	\$57.00
430-2P	(2 ports)	\$48.00
430-4P	(4 ports)	\$56.00
902-2P	(2 ports)	\$48.00
902-4P	(4 ports)	\$56.00
1296-2P	(2 ports)	\$49.00
1296-4P	(4 ports)	\$57.00

SHIPPING NOT INCLUDED

STRIDERSBORG ENGINEERING, CO.

P.O. Box 7973 • Shreveport, LA 71107 • USA
Phone: (318) 865-0523

✓ 125

Light Weight/ High Strength ALUMINUM Tubing for Masts and Telescoping Elements

How many antennas have you seen ruined by the failure of the mast? If you are stacking antennas, or have a beam antenna, our Light Weight/High Strength Aluminum masts will increase the survivability of your antenna system. These masts will increase the survivability of your antenna system. These masts are 67% lighter and 50% stronger than galvanized steel tubing. Example of weight difference: 1/4" wall x 2" OD x 24' long; A1-39#, Steel-112#.

Sizes available:
1-1/2" to 8" OD x 1/8" to 3/4" wall x 24' long
1/4" to 2" OD x .058" wall x 12' long (drawn for telescoping)

Club and volume discounts are offered. MC & VISA accepted.
For a complete stock/price list, please write or call.

Metal & Cable Corp., Inc.

(formerly Exmet, Inc.)

P.O. Box 117, 2170 E. Aurora Rd.

Twinsburg, Ohio 44087

(216) 425-8455

See you in Dayton at Booth 313.



✓ 126



SERVICE CENTER

for

ICOM, KENWOOD

and **YAESU**

Fully equipped repair shop Amateur,
Marine and Land Mobile repairs.

FCC NABER Lic

Mon-Fri 10:00-4:00 pm

(206) 776-8993

**PACIFIC RIM
COMMUNICATIONS**

Bob KG7D

23303 56th Ave. West

Mountlake Terrace, Wa 98043



& C.O.D.S. Welcome

✓ 127

front end of the transceiver. This circuit completely bypasses the conventional circuit path through the amplifier. The receiver is prevented from seeing the tank circuit of the amplifier by PIN diode CR2, which is reversed biased. PIN diodes CR3, 4, and 5 are forward biased and offer a very low impedance path for the receive signal. Typical insertion loss is less than 0.5 dB.

As you might expect, the transmit path is a little more complicated. Keying the transmitter triggers the timing circuit. The amp relay line is grounded, keying the amplifier. The input and output receive line blockers CR3, 4, and 5 are reverse biased with 525 volts dc; input and output PIN diodes CR1 and 2 are forward biased. The key-out line is closed and keys the transmitter. Rf flows from the transceiver through C1, CR1, and CR2 into the rf amplifier, it then flows through CR2, CR4, and C3 to the antenna. The reverse biasing of CR3, 4, and 5 prevents any rf from passing through the receive line. As soon as the morse character is completed, all the PIN diodes reverse state and the unit is back in a receive mode. PHEW!

So that's how this thing works. When you think about it, it's really quite simple. (For a more complete explanation of PIN diodes and how they work, see Doc's article on PIN diodes that appeared in the January, 1986, issue of *ham radio*.)

hookup and use

Setting up the QSK-1500 requires making four control cables. DEO recommends that you use RG-58 or other shielded cable to eliminate the possibility of rf getting into one of the units. Line 1 connects your key or keyer to the QSK-1500's timing circuit; line 2 connects your transceiver's amplifier control circuit to the timing circuit again. Line 3 connects the timing circuit back to the transceiver's keying line, and line 4 connects the timing circuit to the RF amplifier.

Rf connections are straightforward and can be followed by referring to fig. 1. Now you're ready to run a few tests. Turn your transceiver on. If everything is working correctly, you should hear nothing. This is because the receive line diodes aren't "on," so there's no receive path to your receiver. When you turn on the QSK-1500's power supply, the LEDs should light up; you should also hear signals. After a few more simple tests, you're ready to crank up the power and operate.

Once testing was complete, I was excited to see how QSK could actually be used. Tuning the low end of 160, I decided to look for a European or two; finding a fairly strong G3 calling CQ, I dropped my call in a couple of times, only to hear him start calling CQ again. I stopped calling immediately and waited for him to complete his CQ. Again I called, only to have him call another European. Stopping again, I realized how much QRM could be eliminated if more hams operated break-in CW — no more long-winded responses at 5 wpm while the DX station was calling again. QSO rates would increase dramatically, and many more of the "deserving" would get through.

Measure Up With Coaxial Dynamics Model 83000A RF Peak Reading Wattmeter

Take a PEAK with Coaxial Dynamics "NEW" Model 83000A, designed to measure both FWD/RFL power in CW and FM systems simply and quickly.

Then with a "FLIP" of a switch, measure "PEAK POWER" in most AM, SSB or pulse systems. Our Model 83000A features a complete selection of plug-in-elements plus a 2 year warranty. This makes the Model 83000A an investment worth looking at. So go ahead, take a "PEAK", you'll like "WATT" you see!

Contact us for your nearest authorized Coaxial Dynamics representative or distributor in our world-wide sales network.



**COAXIAL
DYNAMICS,
INC.**

15210 Industrial Parkway
Cleveland, Ohio 44135
216-267-2233
1-800-COAXIAL
Telex 98-0630

Service and Dependability... a Part of Every Product
See us at Dayton Booth #400-401



✓ 128

DEALER
INQUIRES
INVITED

ANTENNES
TONNA

The **X** Shack

52 Stonewyck Drive
Belle Mead, New Jersey 08502

IVARS - KC2PX
MARA - SALES



MICROWAVE MODULES LTD.

QST



MON-SAT (201) 874-6013

10AM - 3PM ORDERS
7PM - 10PM ORDERS/TECHNICAL

CALL FOR CATALOG

VISA/MASTERCARD

✓ 129

GET A BIRD'S EYE VIEW

From GrafTrak II™ and your IBM® PC

1985 July 16 16:02
From Moon
396522 km, over
27.2° n 76.1° w

NEW VERSION
Includes Rotator Control and More!

19833 km across
SSI GrafTrak II

FRANK KER OSCAR 10 → 1985 JUL 11 18:14:43

FRAC
ZOOM 1
SRT
OBS
EPOCH
ASTRO
MOVE
HELP
QUIT

LAT 8.5° n	ECHO 197 ms	ELEV 61.7°
LOH 141.7° w	FRQ 145,8093	AZIM 143.3°
HGT 28938 km	DOP -697 Hz	ORBIT 1562
RNG 23571 km	DRFT 5 Hz	78

HOUSTON OSCAR 11 → 1985 JUL 11 03:44:33

FRAC
ZOOM 4
SRT
OBS
EPOCH
ASTRO
MOVE
HELP
QUIT

LAT 30.2° n	ECHO 8 ms	ELEV 29.5°
LOH 93.5° w	FRQ 145,8228	AZIM 9.9°
HGT 691 km	DOP -2628 Hz	ORBIT 7253
RNG 1245 km	DRFT -528 Hz	27

LONDON OSCAR 9 → 1985 JUL 11 04:14:24

FRAC
ZOOM 4
SRT
OBS
EPOCH
ASTRO
MOVE
HELP
QUIT

LAT 49.2° n	ECHO 6 ms	ELEV 28.9°
LOH 18.0° w	FRQ 145,8246	AZIM 182.4°
HGT 484 km	DOP -432 Hz	ORBIT 28889
RNG 929 km	DRFT -11669 Hz	92

GrafTrak II™ provides realtime graphic display of a flat projection map which moves under the selected Satellite/Sun/Moon/Star coverage circle and updates once per second. Spherical projection views and graphic screen dumps to an IBM/Epson/Okii printer can also be produced. Requires an IBM PC, PC/XT, PC/AT, or true compatible, an IBM Color/Graphics Monitor Adapter or true compatible, 8087 math coprocessor, minimum 256K RAM with 512K recommended, DOS 2.0 or later, and either two 360K floppy drives or one 360K floppy and one hard drive.

SILICON EPHEMERIS™ provides tabular data output to the screen, printer, or disk file for the following operating modes: 1 observer to 16 satellites, 16 observers to 1 satellite, schedule for 1 observer to 2 observers and 1 satellite, rise and set times for 1 satellite, time ordered rise and set times for 16 satellites, Almanac for Sun and Moon, 16 observers to Sun/Moon, schedule for 1 observer to Moon, window between 2 observers and Moon, schedule for 1 observer to Sun. Requires either an IBM PC, PC/XT, PC/AT, or true compatible, and IBM Monochrome or IBM Color/Graphics Monitor Adapter or true compatible, an optional 8087 math coprocessor, 256K RAM, DOS 2.0 or later, and one 360K floppy drive.

Each package includes SED, an editor program to construct and modify Satellite/Observer database files. These products can be run from a hard disk and are not copy protected.

GrafTrak II™ and SILICON EPHEMERIS™ are priced at \$119.95 each or \$199.95 for both. Texas residents add sales tax. Order by check, money order, MasterCard, or VISA.

Silicon Solutions, Inc. • P.O. Box 742546 • Houston, Texas 77274-2546 • (713) 661-8727

122

IBM is a registered trademark of IBM Corporation.

GrafTrak II and Silicon Ephemeris are trademarks of Silicon Solutions, Inc.

ALL BAND TRAP VERTICAL ANTENNAS!

FULL 1/4th WAVE - All Bands! Automatic Selection with proven Hi-Q Traps. 5 Models-ALL self supporting - Ground or roof mount. HEAVY Double wall seamless Aluminum lower section - HI STRENGTH FIBERGLASS TUBING OVER -ALL NO WOBBLY, LUMPY TRAPS - NO UNSIGHTLY CLAMPS needed - Same size all the way up 1 1/4" Traps hidden inside. You can use it in a 1 ft. sq. Backyard! Neighbors will never know this is a Hi-Power ALL Direction DX Antenna. FOR APARTMENTS, ROW HOUSES, MOBILE HOMES - CONDOS etc. where minimum space and neat appearance is MANDATORY! Instant "Drive In" ground mount (included). Use with or without radials (included) (All angle roof mount - Extra) COMPLETELY PRETUNED - NO ADJUSTMENTS NEEDED EVER! NO TUNER NEEDED Over All Bands (except 80 meter - 400 KC) SWR 1-1 to 2-1 at Band edges, Stnd, SO239 connector - 52 ohm for any length RG58U - RG8U feedline. Matches ALL MAKES TRANCEIVERS. 2000 Watt PEP, input power. Shipped - PREPAID IN USA. Assembles in 10 min. using only screwdriver. WEATHERPROOF!

No. AVT80-10 5 Band 25'6" \$199.95
No. AVT40-10 4 Band 18'9" \$139.95
No. AVT20-10 3 Band 11'4" \$109.95
No. AVT80-10 W 8 Band 22' \$279.95
No. AVT40-10 W 7 Band 15'5" \$199.95

SEND FULL PRICE FOR PP DEL IN USA (Canada, HI, AK, are \$10.00 extra for postage, clerical, Customs etc.) or order using VISA, MASTER CARD or AMER EXP. Ph 1-308-236-5333 9AM-6PM weekdays. We ship in 2-3 days (per cks 14). All Antennas Guaranteed for 1 year. AVT160 base loading coil - - - \$199.95 Bidirectional 8 Band Vertical Beam! Free Int.

WESTERN ELECTRONICS
Dept. AH Kearney Ne, 68847

OPPORTUNITY

Established ethical ten-year-old mail-order business for sale. Instant name/logo recognition and excellent reputation worldwide. Ideal for technically competent amateur seeking satisfying career either as substitute for present employment or as a retirement business. Minimum overhead expense and significant small-business tax advantages. Can be carried on from a home anywhere as a "mom and pop" closely-held corporation (as it is at present) or expanded to any extent desired. Combines present hobby with a proven source of income—an ideal combination. Insignificant competition, the principal sales item is in constant demand worldwide for use in all ham rigs, old and new, factory-made or "home-brew". No manufacturing, inventory, or storage problems, the physically-small principal item is obtained from an assured source—the top-rated manufacturer of this speciality in Japan. Additional opportunities to expand applications and profits through R & D are limited only by initiative, imagination, and technical competence.

Monthly sales averaging \$10,000 for the last three years have provided reasonable salaries and good dividends because of generous profit margins and legitimate tax allowances for home-office rental, pro-rata car operating expense, ham and office equipment depreciation, etc. Easy ownership transfer without interruption of cash flow. "Hand-holding" is available during transition.

Detailed information will be sent only to those judged to have the best chance of success. Accordingly, serious inquirers should write giving biographical data including age, education, technical background, and experience. Box 498 Greenville, NH 03048

The only problem I've had with this unit occurred one evening when I was working in the shack and had the radio on, but the QSK unit off. I dropped a hammer, tripping the radio's VOX. Later when I sat down to operate, I turned the rest of the equipment on, only to find that the receive line through the transmit antenna was dead! Since I could still receive through the Beverages (which bypass the QSK 1500 on receive), I ruled out the possibility of a radio problem. A quick call to DEO solved my problem immediately. Doc suggested I check the receive line fuse lamp; sure enough, it was blown. Inserting a new lamp cured the problem quickly and simply. Doc did advise me, however, to always make sure the QSK 1500 is turned on whenever the transceiver is. Without the fuse lamp, there's the possibility of damaging the PIN diodes, necessitating some fairly extensive repairs.

Doc reports that contesters who have QSK-1500 units have been pleased with the results; I'm anxiously awaiting the next contest to see for myself. I've had a lot of fun operating QSK. I expect the QSK-1500 is one review unit I'll use for quite awhile.

The QSK-1500 consists of a power supply and a control unit. The power supply measures 3 x 6 x 4 inches and the control unit 3 x 7 x 9 inches. One bit of warning: don't place the QSK-1500 on top of a radio, an amplifier, or any other heat-generating unit. The PIN diodes alone create plenty of heat in normal operation, and damage might result from improper placement.

Priced at \$299 (plus \$6 shipping and handling), the QSK-1500 is available from either Design Electronics of Ohio, 4925 S. Hamilton, Groveport, Ohio 43125, or from Universal Electronics, 1280 Aida Drive, Columbus, Ohio 43068.

— de N1ACH



new ICOM catalog

ICOM America, Inc., has released its new 24-page, full product line color catalog. The new catalog includes all new products including the Micro 4AT 440-MHz handheld and the IC-275 all-mode VHF and IC-475 all-mode UHF base station.

For your copy, contact ICOM America, Inc., 2380 116th Avenue N.E., Bellevue, Washington 98004.

Circle #303 on Reader Service Card.

220 MHz is alive and well at Falcon

FALCON produces 11 different Base/Repeater and 9 different Mobile amplifiers. 7 of these amplifiers are for the 220 MHz operator.

For example, consider the following two MOSFET Base/Repeater amplifiers. Remember, FALCON is the only manufacturer bringing you amplifiers with the advantages of RF power MOSFET's.

Model 4112C

RF Power In.....

RF Power Out.....

10 Watts in - 100 Watts out

..... 1 W to 15 Watts

..... 10 Watts in - 100 Watts out

..... 3 Watts in - 50 Watts out

Model 6135C

RF Power In.....

RF Power Out.....

2 Watts in - 100 Watts out

..... 300 mW to 3 Watts

..... 2 Watts in - 100 Watts out

..... 1 Watt in - 70 Watts out

Features:

- Frequency range 220-225 MHz
- New, long life MOSFET transistors
- Low broadband noise (Low desense)
- Automatic Internal or External Keying
- Use for FM, SSB, CW
- Excellent high order intermod specs
- 8 3/4" x 19" rack panel, 13.8 VDC
- Continuous Duty (With customer fan)
- Built-in Thermal Protection
- 1 Year Warranty Made in the U.S.A.



P.O. Box 8979 • Newport Beach, CA 92658

(714) 760-3622

"See the FALCON Dealers at Dayton for New Models"

Say You Saw It In CQ

Announcing New 6- & 8-Pole Crystal Filters For ICOM, Kenwood & Yaesu Radios

- ICOM 730/735/740/745/751/R70/R71A SSB 2.1kHz, 8-Pole - Exact replacement for FL-44A. Model IR455H1.05X - \$99
- ICOM IC-271/471/1271/ CW 400Hz, 8-Pole - Great for DXing or EME. Model IR10.7H400C - \$115

- Kenwood TS-930/940/830/R-2000 CW Super Selective 250Hz 8-Pole 455 kHz Filter - Comes mounted on high-quality glass PC board for the TS-930 and TS-940, drops into the TS-830. Model IR455H125C - \$125

- TS-940/930/830 Super Selective CW Switch Kit - This new kit allows you to add another CW bandwidth. For example, on the 930/940/830, if you already have 400Hz or 500Hz filters installed, you can now select a set of IR1250Hz filters. Our 250Hz matched set allows for a lower noise floor for super quiet DXing.

- 9 mHz 8-Pole Crystal Filters for Experimenters - All 8-Pole Filters - \$60 All 6-Pole Filters - \$50

- | | | | |
|-------------------|---|-----------------|------------------|
| For SSB | | For FM | |
| A. 2.4kHz @ 6dB | B. 2.1kHz @ 6dB | A. 1.5kHz @ 6dB | B. 30kHz @ 6 dB |
| C. 1.8kHz @ 6dB | D. 2.2kHz @ 6dB | For CW | |
| ★ E. 2.2kHz @ 6dB | A. 600Hz @ 6dB | A. 600Hz @ 6dB | ★ B. 600Hz @ 6dB |
| For AM | A. 6.0kHz @ 6dB | ★ (6-pole) | |
| ★ B. 6.0kHz @ 6dB | \$5.00 shipping and handling on all orders. | | |

For more information, call
International Radio, Inc.
120 747 So. Macedo Blvd.
Port St. Lucie, FL 33452
Send S.A.S.E. (39¢) for latest catalog. (305) 879-6868



POCKET SIZED!!
1-500 MHz
FREQUENCY COUNTER
BUILT, TESTED, AND
READY-TO-GO!
ONLY \$49.95 Prepaid



HAND HELD!!
1-1300 MHz
FREQUENCY COUNTER
BNC INPUT CONNECTOR
ONLY \$79.95 Prepaid



PICK UP THOSE WEAK SIGNALS! FULLY ENCLOSED PA-19E HAS 5-200 MHz RANGE. POWER SUPPLY OPTION AT NO CHARGE WITH THIS PREAMPLIFIER.
ONLY \$24.95 Prepaid
Without case . . . \$9.95



PA-20E PRE-AMP FULLY ENCLOSED WITH A DC-1000 MHz RANGE AND POWER SUPPLY OPTION.
ONLY \$34.95 Prepaid
Without case . . . \$19.95

✓ 119

Specify type of radio when ordering pre-amplifiers.

DIGITREX ELECTRONICS

division of NCI West Coast:
10073 North Maryann Call Ray Lukas
Northville, MI 48167 805-497-2397

Personal checks, money orders, MasterCard or Visa are welcome. Or call in a C.O.D. PHONE (313) 348-7313 NOW!



"GO-ANYWHERE" METER

Quality, shirt pocket, digital multimeter tests electrical equipment—at home, in your car, on your job, and even in the back woods! Case folds to approx. 4.5" H x 3" W x 1/2" thick. Measure up to 500V ac/dc and 20 megohms.
ONLY \$35., includes probes and carrying case. Satisfaction guaranteed. 30 day money-back return. **ONE YEAR WARRANTY.**

Call TOLL FREE: 1-800-221-5749
In CT: 203-877-4417
Mon-Fri, 9-5:30, EST.

Only 1/2" thick



84 RESEARCH DRIVE • MILFORD, CT 06460

Send DM1000 pocket meter(s) at \$35. each plus \$2. each for shipping and handling. CT residents add 7 1/2% sales tax.
 My check or money order is enclosed.

Charge: VISA® MasterCard®

Acct No. _____

Exp. / _____ Signature _____

NAME _____

ADDRESS _____

CITY _____

STATE _____ ZIP _____ HRM3

800-882-1343



IC-735 List Juns

IC-735 Gen. Cvg. Xcvr	\$999.00	Call \$
IC-751A Gen. Cvg. Xcvr	1649.00	Call \$
R7000 Gen. Cvg. Rcvr.	1099.00	Call \$
R71A Gen. Cvg. Rcvr.	949.00	Call \$
IC-27A/H FM Mobile 25w/45w	429/459	Call \$
IC-28A/H FM Mobile 25w/45w	429/459	Call \$
IC-37A FM Mobile 25w	499.00	Call \$
IC-47A 440 Mobile 25w	549.00	Call \$
IC-04AT UHF HT	449.00	Call \$
IC-48A UHF 45w	459.00	Call \$
IC-38A FM Mobile 25w	459.00	Call \$
IC-02AT FM HT	399.00	Call \$
IC-μ2AT Micro HT	329.00	Call \$



TS-440S/AT

TS-940SAT Gen. Cvg. Xcvr	\$2249.95	Call \$
TS-430S Gen. Cvg. Xcvr	819.95	Call \$
TS-711A All Mode Base 25w	899.95	Call \$
TR-751A All Mode Mobile 25w	599.95	Call \$
TM-201B FM Mobile 45w	369.95	Call \$
TM-2530A FM Mobile 25w	429.95	Call \$
TM-2550A FM Mobile 45w	469.95	Call \$
TM-2570A FM Mobile 70w	559.95	Call \$
TH-205 AT, NEW 2m HT	259.95	Call \$
TH-215A, 2m HT Has It All	349.95	Call \$
TH21BT 2M HT	259.95	Call \$
TH31BT 220 HT	269.95	Call \$
TH41BT 440 HT	269.95	Call \$



FT-757GX

FT-757 GX Gen. Cvg. Xcvr	995.00	Call \$
FT-767 4 Band New	1895.00	Call \$
FT-270RH FM Mobile 45w	439.95	Call \$
FT-290R All Mode Portable	579.95	Call \$
FT-23 R/T Mini HT	299.95	Call \$
FT-209RH RM Handheld 5w	359.95	Call \$
FT-726R All Mode Xcvr	1095.95	Call \$
FT-727R 2M/70CM HT	479.95	Call \$
FT-2700RH 2M/70CM 25w	599.95	Call \$



3919 Sepulveda Blvd.
Culver City, CA 90230

MULTI BAND TRAP ANTENNAS

TRAP DIPOLES:

Model	Bands	Traps	Length	Price
D-42	10/15/20/40	2	55"	\$59.95
D-52	10/15/20/40/80	2	105"	84.95
D-56	10/15/20/40/80	6	82"	109.95
D-66	10/15/20/40/80/160	6	163"	129.95

TRAP VERTICALS - "SLOPERS":*

Model	Bands	Traps	Length	Price
V5-41	10/15/20/40	1	28"	44.95
V5-52	10/15/20/40/80	2	49"	59.95
V5-53	10/15/20/40/80	3	42"	69.95
V5-64	10/15/20/40/80/160	4	73"	89.95

*Can be used without radials
*Feed line can be buried if desired
*Permanent or Portable Use

ALL TRAP ANTENNAS are Ready to use - Factory assembled - Commercial Quality - Handle full power - Comes complete with: Deluxe Traps, Deluxe center connector, 14 ga Stranded CopperWeid ant wire and End Insulators. Automatic Band Switching - Tuner usually never required - For all Transmitters, Receivers & Transceivers - For all class amateurs - One feedline works all bands - Instructions included - 10 day money back guarantee!

SINGLE BAND DIPOLES (Kit form):

Model	Band	Length	Price
D-15	15	22"	18.95
D-20	20	33"	19.95
D-40	40	66"	22.95
D-80	80/75	130"	25.95
D-160	160	260"	34.95

Includes assembly instructions, Deluxe center connector, 14 ga Stranded CopperWeid Antenna wire and End Insulators.

COAX CABLE: (includes PL-259 connector on each end)

Type	Length	With antenna purchase	Separately
RG-58	50'	\$8.00	\$11.95
RG-58	90'	12.00	16.95

DELUXE CENTER CONNECTOR

- NO RUST Brass Terminals
- NO Jumper Wires Used
- NO Soldering
- Built in Lightning Arrestor
- With 50/259 Neoprene
- Handles Full Power
- Completely Sealed Weatherproof
- Easy Element Adjustments
- Commercial Quality

CE-1 \$8.95

DELUXE ANTENNA TRAPS: Completely sealed & weatherproof - Solid brass terminals - Handles Full Power - NO jumpers - NO Soldering. Instructions included.

For 4-band Dipole Ant.
40/20/15/10 \$36.00/pr.
For 5-band Dipole Ant.
80/40/20/15/10 \$38.00/pr.

ORDER DIRECT FROM FACTORY. All orders shipped US Postpaid. VISA/MC - give card #, Exp. date, Signature

SPI-RO MANUFACTURING, INC.
Dept. 103, P.O. Box 1538
Hendersonville, NC 28793

Dealer Inquiries Invited

The QSYer - the best thing next to your FT-757GX - or your ICOM IC-735!

The popular 757 QSYer now has a brother, the 735 QSYER for the ICOM IC-735! Both units are deluxe frequency-entry keypads containing their own pre-programmed microprocessor, audio speaker and power supply in operation. They allow immediate switching to any frequency in the transceiver's range, while the rig retains absolutely all of its operator's controls. They install in seconds, connecting to the rig's data terminal and power supply output. Their durable metal enclosures are painted classic metallic gray and black.

\$89.50 plus \$2.50 shipping and handling, and 4% sales tax for GA residents. MasterCard and Visa customers please send name, card number, expiration date, and signature, or call us at 404-879-0241. 10 day money-back guarantee.

In Canada, call Atlantic Ham Radio, Ltd. at 416-636-3636.

Stone Mountain Engineering Co.
Box 1573 • Stone Mtn., GA 30086



computer rotor control interface

The most often requested new feature for satellite enthusiasts is automatic control of the antenna pointing via a personal computer. While the KENPRO KR0-5400A provides the electro-mechanical interface to the rotor motors, the actual hardware interface to the computer is provided by the KR-010. The KR-010 consists of analog-to-digital converters for both the elevation and azimuth channels and also provides the drive signal for driving the motors in the desired direction. An internal microcomputer provides the RS-232 serial capability at 9600 Baud without handshaking.

The KR-010 attaches to the serial port of the computer and operates with the tracking software (available only from the AMSAT software exchange, not from ENCOMM or KENPRO) written for AMSAT by W3IWI and W0SL. KENPRO and ENCOMM provide the software needed to point the antenna from data entered into a basic program in real time. Subroutines of the automatic tracking program which apply to the KR-010/KR-5400A combination and information on how to install them in the W0SL package is supplied with the KR-010.

The suggested retail price is \$269.95. For details, contact Encomm, Inc., 1506 Capital, Plano, Texas 75074.

Circle #302 on Reader Service Card.

new from RF Concepts

Ken Holladay, K6HCP, and Everett Gracey, WA6CBA, the co-founders of Mirex Communications, have formed RF Concepts, a new company whose products include a state-of-the-art, all-mode 2-meter, 170-watt VHF amplifier with a GaAsFET receive pre-amp; a 450 MHz 100-watt UHF amplifier with a GaAsFET receive pre-amp; a 130-watt 220-225 MHz amplifier with a GaAsFET pre-amp; and a 30-watt HT amplifier, also with a GaAsFET receive pre-amp. Other products include a repeater amplifier for 440 MHz, 220 MHz, and 144 MHz and a full-function repeater controller.

On the drawing boards is a new dual-band amplifier, 144/440 and base station amplifiers, and state-of-the-art switching power supplies from 10 to 35 amps.

For further information, contact RF Concepts, 2000 Humboldt Street, Reno, Nevada 89509

Circle #301 on Reader Service Card.

RAMSEY

RAMSEY ELECTRONICS

QUALITY TEST GEAR YOU CAN COUNT ON

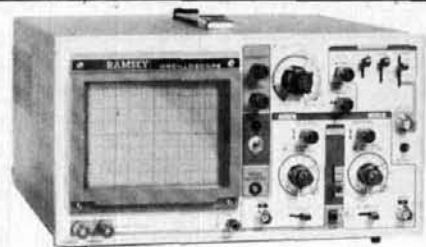

INCLUDES 2 HOOK-ON PROBES
\$369.95*
20 MHz DUAL TRACE
 Features component testing circuit for resistors, capacitors, digital circuits and diodes—TV sync filter—high sensitivity—Z axis—XY mode—built-in calibrator—5X horizontal magnifier

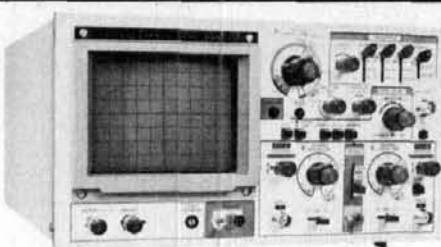

INCLUDES 2 HOOK-ON PROBES
\$499.95*
35 MHz DUAL TRACE
 wide frequency bandwidth—optimal sensitivity—delayed triggering sweep—hold off—ALT trigger—single sweep TV sync 5X magnification—XY or XYZ operation—HF/LF noise reduction



NEW
INCLUDES 2 HOOK-ON PROBES
\$449.95*
15 MHz DUAL TRACE PORTABLE
 Field/bench applications—built-in charger and battery pack—up to 2 hours operation per charge—5X horizontal magnification—high brightness CRT—front panel trace rotator

RAMSEY OSCILLOSCOPES

All Ramsey oscilloscopes feature unsurpassed quality at an unbeatable price. Of heavy duty construction, they are suitable for hobby, service and production applications.

*Add an additional \$10.00 for each unit for shipping.

MODEL	BAND WIDTH	# TRACES	CRT SIZE	VERTICAL SENSITIVITY	MAXIMUM TRIG FREQ	USEABLE MAXIMUM BANDWIDTH
2200	20 MHz	(2)	8x10CM	5 mV per div	35 MHz	30 MHz
2500	15 MHz	(2)	3.5 inch	2 mV per div	30 MHz	25 MHz
3500	35 MHz	(2)	8x10CM	1 mV per div	50 MHz	60 MHz

All include high quality 1:1, 10:1 hook on probes, instruction/service manual with schematic and component layout, 1 year warranty.

MINI-100 COUNTER



\$119.95 CHARGER, NICAD BATTERIES, AC ADAPTER INCLUDED

CT-70 7 DIGIT 525 MHz



\$139.95 WIRED, INCLUDES AC ADAPTER

CT-90 9 DIGIT 600 MHz



\$169.95 WIRED INCLUDES AC ADAPTER

CT-50 8 DIGIT 600 MHz



\$189.95 WIRED INCLUDES AC ADAPTER

CT-125 9 DIGIT 1.2 GHz



\$189.95 WIRED INCLUDES AC ADAPTER

MODEL	FREQ RANGE	SENSITIVITY	ACCURACY	DIGITS	RESOLUTION	PRICE
MINI-100	1-500 MHz	Less than 250mv	1 PPM	7	100 Hz, 1 KHz	119.95
CT-70	20 Hz-550 MHz	< 50mv to 150 MHz	1 PPM	7	1Hz, 10Hz, 100Hz	139.95
CT-90	10 Hz-600 MHz	< 10mv to 150 MHz < 150mv to 600 MHz	1 PPM	9	0.1Hz, 1Hz, 10Hz	169.95
CT-50	5 Hz-600 MHz	LESS THAN 25 mv	1 PPM	8	1Hz, 10Hz	189.95
CT-125	10 Hz-1.25 GHz	< 25mv @ 50 MHz < 15mv @ 500 MHz < 100 mv @ 800 MHz	1 PPM	9	0.1Hz, 1Hz, 10Hz	189.95
CT-90 WITH DV-1 OPTION	10 Hz-600 MHz	< 10mv to 150 MHz < 150mv to 600 MHz	0.1 PPM	9	0.1Hz, 1Hz, 10Hz	229.90

RAMSEY FREQUENCY COUNTERS

Ramsey Electronics has been manufacturing electronic test gear for over 10 years and is recognized for lab quality products at breakthrough prices. Our frequency counters have features and capabilities of counters costing twice as much. BP-4 Nicad battery pack for CT-70, CT-90 and CT-125 Frequency Counters. \$8.95.

✓ 118



RAMSEY D-4100 COMPACT DIGITAL MULTITESTER

\$249.95

test leads and battery included

NEW

Compact sized reliability and accuracy. This LCD digital multitester easily fits in your pocket, you can take it anywhere. It features full overload protection • 3 1/2 digit LCD readout • recessed input jacks • safety probes • diode check function • 2000 hours battery life



RAMSEY D-5100 HANDHELD DIGITAL AUTORANGING METER

\$49.95

Includes Probes 1 Year Warranty

Has TOUCH-HOLD feature to allow readings to be logged or referred to before making the next reading. Up to 10 AMP current capability and a continuity function which beeps on zero Ohms.



PR-2 COUNTER PREAMP

\$44.95

wired includes AC adapter

PR-2 kit **\$39.95**

PR-2 COUNTER PREAMP

The PR-2 is ideal for measuring weak signals from 10 to 1,000 MHz • flat 25 db gain • BNC connectors • great for sniffing RF • ideal receiver/TV preamp



PS-2 AUDIO MULTIPLIER

\$69.95

wired

PS-2 kit **\$49.95**

PS-2 AUDIO MULTIPLIER

The PS-2 is handy for high resolution audio resolution measurements, multiplies up in frequency • great for PL tone measurements • multiplies by 10 or 100 • 0.01 Hz resolution & built-in signal preamp/conditioner



PS-10B 1 GHz PRESCALER

\$89.95

wired includes AC adapter

PS-10B 1 GHz PRESCALER

Extends the range of your present counter to 1 GHz • 2 stage preamp • divide by 1000 circuitry • super sensitive (50 mV typical) • BNC connectors • 1 GHz in, 1 MHz out • drives any counter

MINI KITS—EASY TO ASSEMBLE—FUN TO USE—FOR BEGINNERS, STUDENTS AND PROS

TONE DECODER A complete tone decoder on a single PC board. Features: 400-5000 Hz adjustable range via 20 turn pot, voltage regulation, 567 IC. Useful for touch-tone burst detection, FSK, etc. Can also be used as a stable tone encoder. Runs on 5 to 12 volts. Complete kit, TD-1 \$5.95	COLOR ORGAN See music come alive! 3 different lights flicker with music. One light each for, high, mid-range and lows. Each individually adjustable and drives up to 300 W. runs on 110VAC. ML-1 Kit, \$8.95	VIDEO MODULATOR Converts any TV to video monitor. Super stable, tunable over ch 4-6. Runs on 5-15V accepts std. video signal. Best unit on the market! Complete kit, VD-1 \$7.95	FM WIRELESS MIKE Transmits up to 300' to any FM broadcast radio, uses any type of mike. Runs on 3 to 9V. Type FM-2 has added sensitive mike preamp stage. FM-1 Kit \$3.95 FM-2 Kit \$4.95	SUPER SLEUTH A super sensitive amplifier which will pick up a pin drop at 15 feet! Great for monitoring baby's room or as general purpose amplifier. Full 2W rms output, runs on 6 to 15 volts, uses 8-45 ohm speaker. BN-9 Kit \$5.95	NEW TELEPHONE TRANSMITTER Low cost with professional performance. Features include: self phone line powered, tunable from 76 to 100 MHz, polarity ambidextrous, compact size (1 1/2" x 1 1/2"), easily installs anywhere on the phone line or inside the instrument itself. TB-1 Kit \$14.95	NEW FM RECEIVER For built-in applications or hobby experimentation. Full featured super-heterodyne receiver, microvolt sensitivity, 10.7 MHz IF, integrated circuit detector, 50 mw audio amplifier, DV external power source, operation on standard FM broadcast band as well as large portions on each side, compact (6" square), for bug detection or reception. FR-1 Kit \$14.95	FM MINI MIKE A super high performance FM wireless mike kit! Transmits a stable signal up to 300 yards with exceptional audio quality by means of its built in electret mike. Kit includes case, mike, on-off switch, antenna, battery and super instructions. This is the finest unit available! FM-3 Kit \$14.95 FM-3 Wired and tested 19.95
40 WATT 2 mtr PWR AMP Simple Class C power amp features 8 times power gain 1 W in for 8 out, 2 W in for 15 out, 5 W in for 40 W out. Max output of 50 W, incredible value, complete with all parts, less case and T-R relay. PA-1, 40 W pwr amp kit \$22.95 TR-1, RF sensed T-R relay kit 6.95	VOICE ACTIVATED SWITCH Voice activated switch kit provides switched output with current capability up to 100 mA. Can drive relays, lights, LED or even a tape recorder motor. Runs on 9VDC. VS-1 KIT \$6.95	LED BLINKY KIT Alternately flashes 2 jumbo LEDs. Use for name badges, lights, warning panel lights. Runs on 3 to 15 volts. BL-1 Kit, \$2.95	MAD BLASTER Produces LOUD ear-shattering and attention getting siren like sound. Can supply up to 15 watts of obnoxious audio. Runs on 6-15 VDC. MB-1 Kit \$4.95	90 Hz TIME BASE Runs on 5-15 VDC. Low current (25ma) 1 mini/month accuracy. TB-6 Kit \$5.50 TB-6 Assy \$9.95	WHISPER LIGHT An interesting kit, small mike picks up sounds and converts them to light. The louder the sound, the brighter the light. Includes mike, controls up to 300 W. runs on 110 VAC. WL-1 Kit \$6.95	SIREN Produces upward and downward wail. 5 W peak audio output, runs on 3-15 volts, uses 3-45 ohm speaker. Complete kit, SM-3 \$2.95	UNIVERSAL TIMER Provides the basic parts and PC board required to provide a source of precision timing and pulse generation. Uses 555 timer IC and includes a range of parts for most timing needs. UT-5 Kit \$5.95

ACCESSORIES FOR RAMSEY COUNTERS

- Telescopic whip antenna—BNC plug \$ 8.95
- High impedance probe, light loading 16.95
- Low pass probe, audio use 16.95
- Direct probe, general purpose use 13.95
- Tilt bail, for CT-70, 90, 125 3.95

PHONE ORDERS CALL

716-586-3950

TELEX 466735 RAMSEY CI

FAX 716-586-4754



TERMS: • satisfaction guaranteed • examine for 10 days; if not pleased, return in original form for refund • add 0% for shipping and insurance to a maximum of \$10.00 • foreign add 15% for surface mail • COD add \$2.50 (COD in USA only) • orders under \$15.00 add \$1.50 • NY residents add 7% sales tax • 90 day parts warranty on all kits • 1 year parts & labor warranty on all wired units.

RAMSEY ELECTRONICS, INC.
 2575 Baird Ave.—Dept. HR
 Penfield, N.Y. 14526

★ QUALITY PARTS ★ DISCOUNT PRICES ★ FAST SHIPPING!
ALL ELECTRONICS CORP.

SEND FOR FREE 1987 CATALOG... 48 PAGES!

EDGE CONNECTORS
 ALL ARE .156" SPACING

22 EDGE CONNECTOR \$1.25 ea
 solder lug style 10 for \$11.00

22/44 EDGE CONNECTOR \$2.00 ea
 PC style 10 for \$18.00

32/44 EDGE CONNECTOR \$2.50 ea
 solder lug style 10 for \$21.00

28/56 EDGE CONNECTOR PC style \$2.50 ea
 solder lug style 10 for \$21.00

36/72 EDGE CONNECTOR PC style \$3.00 each
 solder lug style 10 for \$27.00

43/88 EDGE CONNECTOR PC style \$4.50 each

COMPUTER GRADE CAPACITORS

1,400 mfd 200 Vdc 3" x 2" dia. \$2.00
 4,400 mfd 60 Vdc 1 1/4" x 3/8" dia. \$2.50

7,500 mfd 200 Vdc 1 1/2" x 1" dia. \$3.00

12,000 mfd 40 Vdc 4 1/4" x 2" dia. \$2.50

22,000 mfd 25 Vdc 4 3/4" x 2" dia. \$2.50

48,000 mfd 10 Vdc 3" x 2 1/2" dia. \$2.50

66,000 mfd 15 Vdc 3 1/4" x 1" dia. \$3.00

72,000 mfd 15 Vdc 4" x 2" dia. \$3.50

100,000 mfd 10 Vdc 4" x 2 1/2" dia. \$3.00



COMMODORE PRINTER/PLOTTER
 Commodore Model # 1500
 Four color X-Y plotter. Standard VIC serial interface allows easy connection to Commodore 64 computers. Up to 80 characters per line in four sizes.
 4 inch paper
 CAT # COM-1500
 \$49.95 each
 EXTRA pen sets \$1.50 per set.

2K 10 TURN MULTI-TURN POT
 SPECTROL 1000 2K-7501
 \$5.00 EACH

SOLID STATE BUZZER
 Star # SMB-00L
 8 Vdc
 \$1.00 each
 10 for \$9.00

POLARITY SWITCH
 Designed to control an external coaxial relay on a satellite TV system IDEAL FOR THE EXPERIMENTOR AS PARTS. Heavy chassis box containing a 5 Vdc relay. CA 358 up amp and other parts.
 Catalog # RPS \$1.75 each 10 for \$15.00

WALL TRANSFORMER
 11.5 Vdc
 1.95
 Amp.
 INPUT 120 Vac
 SIZE 3 3/4" X 2 7/8" X 2 5/8"

3 3/4" X 2 7/8" X 2 5/8"
 CAT # DTX-11519
 \$6.50 each

48 KEY ASSEMBLY FOR COMPUTER OR HOBBYIST
 NEW T1 KEYBOARDS. Originally used on computers, these key boards contain 48 S.P.S.T. mechanical switches. Terminates to 15 pin connector. Frame # 4 of CAT # KP-48 \$2.40 each

3 1/2" SPEAKER
 8 ohm impedance
 Full range speaker
 8" magnet
 15" mounting centers
 \$2.50 each 10 for \$20.00

TELEPHONE COUPLING TRANSFORMER
 500 ohm c.t. to 600 ohm c.t.
 P.C. board mount
 CAT # ST-1 \$1.25 each

XENON FLASH TUBE
 3 1/4" long x 1/8" dia. Flash tubes designed for use with compact camera flash units. Mounts in 14 pin DIP socket.
 CAT # FLT-1 2 for \$1.00

SPRING LEVER TERMINALS
 Two color coded terminals on a variety of 3/16" bakelite plate.
 Great for speaker enclosures or other applications.
 75¢ EACH 10 for \$6.00

MINIATURE 6 VDC RELAY
 Aromat #R50 6V
 Super Small
 50 T. 600
 GOK coil
 contact
 1 amp @ 30 vdc. Highly sensitive.
 1000 cycles @ 12000 cpm
 Operates from 4.5 Vdc
 COIL 120 ohms
 CONTACTS 1A @ 6V
 Mounts in 14 pin DIP socket
 \$1.50 each
 10 for \$13.50

13 VDC RELAY
 CONTACTS 5 PIN C
 10 amp @ 120 vdc
 Energize coil through open contact
 COIL 13 vdc 500 ohms
 SPECIAL PRICE \$1.00 each

4PDT RELAY
 14 pin DIP style
 3 amp contacts
 USED but fully tested
 \$1.70 each
 Specialty coil voltage required
 Either 24 vdc or 120 vdc
 LARGE QUANTITIES AVAILABLE
 SOCKETS FOR RELAY 75¢ each

MINIATURE TOGGLE SWITCHES
 ALL ARE RATED 5 AMPS @ 25 VDC

S.P.D.T. (on-on)
 PC style
 non-threaded bushing
 75¢ each
 10 for \$7.00

S.P.D.T. (on-off)
 Solder lug terminals
 \$1.00 each
 10 for \$9.00

S.P.D.T. (on-off)
 PC style
 non-threaded bushing
 75¢ each
 10 for \$7.00

D.R.D.T. (on-on)
 Solder lug terminals
 \$2.00 each
 10 for \$18.00

D.R.D.T. (on-off)
 Solder lug terminals
 \$2.00 each
 10 for \$18.00

RECHARGEABLE NI-CAD BATTERIES

AAA SIZE 1.25V 500mAh \$1.85
 AA SIZE 1.25V 500mAh \$1.85
 AA w/IR indicator \$2.00
 C SIZE 1.2V 1200mAh \$3.50
 SUB-C SIZE (batter top) \$3.50
 D SIZE 1.2V 1200mAh \$3.50

LED'S
 STANDARD JUMBO DIFFUSED T-1-3/4
 RED 10 for \$1.00
 GREEN 10 for \$1.00
 YELLOW 10 for \$1.00

FLASHER LED
 5 volt operation
 red/jumbo T-1
 \$1.00 each

NEW GREEN FLASHER
 CAT # LED-45 \$1.00

BI-POLAR jumbo T-1 size 2 for \$1.70

D.P.S.T. LIGHTED ROCKER SWITCH
 115 vdc lighted rocker
 snap mounts
 4 x 1 1/2" hole
 1500 cycles
 16 amp
 \$1.50

MINI-PUSH BUTTON
 S.P.S.T. momentary normally open
 1/2" bushing
 Red body
 75¢ each
 10 for \$7.00

NI-CAD CHARGER
 Will charge most every size Ni-cad battery available.
 CAT # UNCH-C \$12.50

LED HOLDERS
 Two piece holder for jumbo LED
 10 for \$5.00

CLEAR CLIP LITE LED HOLDER
 Make LED a fancy indicator. Clear 4 for \$1.00

QUANTITIES LIMITED
 MINIMUM ORDER \$10.00
 USA \$3.00 SHIPPING
 (IN CALIFORNIA 1 800 258 6666) FOREIGN ORDERS
 ALASKA HAWAII INCLUDING SUFFICIENT SHIPPING
 949 978 0000 N.J.C. 0213 380 8000 CALIF. RES. ADD 6%

S.P.S.T. TOGGLE SWITCH
 Cherry elect. #E-21 N.O. or N.C. 0.1A contacts. Suitable for alarms and other low energy circuits.
 1 1/2" lever
 45¢ EACH 10 FOR \$4.20

CARLING (on-off) RATED 1/2 amp # 125 Vac.
 All plastic body and terminals.
 CAT # STS-1 \$1.00 each
 10 for \$9.50
 LARGE QUANTITIES

TRANSISTORS

2N708 4 for \$1.00
 2N2222A 3 for \$1.00
 2N2222A 4 for \$1.00
 2N2904 3 for \$1.00
 2N2905 3 for \$1.00
 2N2905 4 for \$1.00
 PNP 100 40 \$1.00
 TIP 121 \$1.00
 TIP 125 75¢

PHOTO-FLASH CAPACITORS
 150 VDC 130 VOLT
 CAPA PFC-170
 75¢ each

400 NFD 130 VOLT
 CAPA PFC-400 \$1.00 ea

3rd TAIL LIGHT TAIL LIGHT
 5 line high-tech lamp
 Could be used as a third auto tail light, emergency warning light, or special-effects lamp.
 Red reflective lens 5/8" x 2 1/2" x 5 1/2"
 1/8" mounted on a 1/2" high pedestal with up-down swivel adjustment. Includes 12 replaceable bulbs.
 CAT # TLB \$3.95 each.

RELAYS
 10 AMP SOLID STATE
 CONTROL 3 1/2 vdc
 1.0A 141 vdc 10 amp
 CAT # R-10
 \$9.50 EACH 10 FOR \$90.00

ULTRA-MINIATURE 5 VDC RELAY
 Futaba
 FBZ1NEED05M20
 High sensitivity
 COIL 120 ohms
 CONTACTS 1A @ 5V
 Mounts in 14 pin DIP socket
 \$1.25 each
 10 for \$12.50

TRANSFORMERS
 120 volt primaries

5.6 volts @ 150 ma \$2.00
 6.3 volt @ 600 ma \$1.75
 12 VCT @ 200 ma \$2.00
 12 VCT @ 400 ma \$2.00
 12 VCT @ 1 amp \$2.00
 12 VCT @ 2 amp \$4.85
 12 VCT @ 3 amp \$4.85
 18 volts @ 150 ma \$2.00
 24 VCT @ 1 amp \$2.50
 24 VCT @ 2 amp \$4.85
 24 VCT @ 3 amp \$4.85
 24 VCT @ 4 amp \$11.00

LIGHT ACTIVATED MOTOR SENSOR
 This device contains a photo cell which remains constant in an ambient light. When an object or person passes within its field of view, the motor it keeps for several seconds then resets. Could be used as a door annunciator or modified to trigger other devices.
 5 1/2" X 4" X 1". Operates on 6 Vdc. Requires 4 AA batteries (not included).
 Catalog # L280 \$2.75 per unit

TI SWITCHING POWER SUPPLY
 Compact, well regulated switching power supply designed to power Texas Instruments computer equipment.
 INPUT 14-25 vdc @ 1 amp
 OUTPUT 12 vdc @ 500 ma
 5 vdc @ 1.2 amp
 5 vdc @ 200 ma
 SIZE 4 1/2" x 4 1/2" x 1 1/2"
 \$3.50 each

13.8 VDC REGULATED POWER SUPPLY
 These are solid state, fully regulated 13.8 vdc power supplies. Both feature 100% solid state construction for long protection and L.E.D. power indicator U.L. listed.
 2 amp constant, 4 amp surge \$20.00 each
 3 amp constant, 5 amp surge \$27.50 each

COOLING FAN
 ROTRON # MK7243
 225 Vac
 4 1/8" square metal frame fan.
 CAT # CF-220 \$5.50 ea
 10 for \$50.00 / 100 for \$500.00

FLASHER LED
 5 volt operation
 red/jumbo T-1
 \$1.00 each

NEW GREEN FLASHER
 CAT # LED-45 \$1.00

BI-POLAR jumbo T-1 size 2 for \$1.70

WALL TRANSFORMERS
 All plug directly into 120 vac outlet

4 VDC @ 70 ma \$2.00
 6 VDC @ 90 ma \$3.50
 8 VDC @ 250 ma \$3.00
 8 VDC @ 500 ma \$3.00
 12 VDC @ 200 ma \$3.50
 18 VAC @ 1A VA and \$3.50
 24 VDC @ 250 ma \$3.50
 MULTI-VOLTAGE @ 200 ma 3.4, 6.7, 9.4, 12 VDC \$7.50

8" 15 WATT SPEAKER
 C.T.S. Model 88079
 Full range speaker.
 100-1000Hz
 Ideal for PA systems
 Mounting holes for line-matching transformer.
 CAT # 88-15 \$3.50 ea
 Case of 6 pcs \$25.00 per case

220 Vac COOLING FAN
 ROTRON # MK7243
 225 Vac
 4 1/8" square metal frame fan.
 CAT # CF-220 \$5.50 ea
 10 for \$50.00 / 100 for \$500.00

MINI-BOX
 Romona #2104
 \$1.00 EACH

Heavy-duty black phenolic project box with cover and screws 2 1/2" X 1 1/2" X 1 1/2"

TI SWITCHING POWER SUPPLY
 Compact, well regulated switching power supply designed to power Texas Instruments computer equipment.
 INPUT 14-25 vdc @ 1 amp
 OUTPUT 12 vdc @ 500 ma
 5 vdc @ 1.2 amp
 5 vdc @ 200 ma
 SIZE 4 1/2" x 4 1/2" x 1 1/2"
 \$3.50 each

COOLING FAN
 ROTRON # MK7243
 225 Vac
 4 1/8" square metal frame fan.
 CAT # CF-220 \$5.50 ea
 10 for \$50.00 / 100 for \$500.00

FUSES

3AG (AGC) SIZE 1 1/2, 2, 3, 4, 5, 6 AMP
 GMA SIZE 1/4, 1/2, 3/4, 1 AMP
 of any ONE amperage 75¢

TI SWITCHING POWER SUPPLY
 Compact, well regulated switching power supply designed to power Texas Instruments computer equipment.
 INPUT 14-25 vdc @ 1 amp
 OUTPUT 12 vdc @ 500 ma
 5 vdc @ 1.2 amp
 5 vdc @ 200 ma
 SIZE 4 1/2" x 4 1/2" x 1 1/2"
 \$3.50 each

COOLING FAN
 ROTRON # MK7243
 225 Vac
 4 1/8" square metal frame fan.
 CAT # CF-220 \$5.50 ea
 10 for \$50.00 / 100 for \$500.00

ALL ELECTRONICS CORP.
 201 S. Vermont Ave.
 #11-30 8000
 VAN NUYS, CA 91410
 818 978 1800

MAIL ORDERS TO:
 PO BOX 20366
 Los Angeles, CA 90006

TELEPHONE: 1 800 258 6666
 FAX: 818 978 1800
 FAX: 818 978 1800

TI SWITCHING POWER SUPPLY
 Compact, well regulated switching power supply designed to power Texas Instruments computer equipment.
 INPUT 14-25 vdc @ 1 amp
 OUTPUT 12 vdc @ 500 ma
 5 vdc @ 1.2 amp
 5 vdc @ 200 ma
 SIZE 4 1/2" x 4 1/2" x 1 1/2"
 \$3.50 each

COOLING FAN
 ROTRON # MK7243
 225 Vac
 4 1/8" square metal frame fan.
 CAT # CF-220 \$5.50 ea
 10 for \$50.00 / 100 for \$500.00

QUANTITIES LIMITED
 MINIMUM ORDER \$10.00
 USA \$3.00 SHIPPING
 (IN CALIFORNIA 1 800 258 6666) FOREIGN ORDERS
 ALASKA HAWAII INCLUDING SUFFICIENT SHIPPING
 949 978 0000 N.J.C. 0213 380 8000 CALIF. RES. ADD 6%

S.P.S.T. TOGGLE SWITCH
 Cherry elect. #E-21 N.O. or N.C. 0.1A contacts. Suitable for alarms and other low energy circuits.
 1 1/2" lever
 45¢ EACH 10 FOR \$4.20

CARLING (on-off) RATED 1/2 amp # 125 Vac.
 All plastic body and terminals.
 CAT # STS-1 \$1.00 each
 10 for \$9.50
 LARGE QUANTITIES

THE DIGITAL NOVICE
 by Jim Grubbs, K9EI

Now that novices have digital privileges, there are thousands of new Amateurs anxiously awaiting to get on-the-air. Who's going to answer their questions however? Jim Gubb's new book, The Digital Novice is written with beginner's needs in mind. Each of the popular digital modes is fully covered with a brief history and full description of how it works. Hardware and software are covered in clear, concise terms. The book finishes with a look toward the future. Four appendixes cover; Morse, Baudot, AMTOR and ASCII Codes and has a glossary full of commonly used but misunderstood terms. Great for beginners and experts alike. ©1987 1st edition

□ JG-DN Softbound \$9.95
 Pre-Publication Special Save \$1.00

YAGI ANTENNA DESIGN
 by Dr. James Lawson, W2PV

Based upon the popular Ham Radio Magazine series, this book includes notes, charts, graphs as well as other additional information not found in the original text. W2PV was known world-wide as one of the most knowledgeable experts on antenna design and optimization. This book is full of his contest winning "trade secrets." Eight chapters cover: Performance calculations, Simple Yagi antennas, Yagi antenna performance optimization, Loop antennas, The effects of ground, Stacking, Practical design, and Practical Amateur Yagi antennas. A wealth of information at a modest price—Lawson's book should sell for much more—every Ham should get a copy for their bookshelf. ©1986 1st edition

□ AR-YD Hardbound \$14.95

RADIO DATABASE INTERNATIONAL
 1987 Edition

One of the problems SWL's encounter is having an up-to-date and accurate program schedule for international broadcasters. While no listing can ever be 100% accurate, this new book represents thousands of hours of research and is one of the most accurate SWL international broadcasting listings available. Stations are listed by frequency and language format. Also included is power output and to whom the programming is directed and other helpful information. Covers 2 to 26 MHz short-wave bands. A Buyer's Guide gives you information on selected portable and tabletop radios. A number of tutorial articles have been included to help you get the most from your radio. ©1986

□ IBS-RDI Softbound \$12.95

KODE MASTER

(for Novice, General or Extra Class students)

Prepare for your next code exam using computer generated QSOs. Each QSO contains callsigns, names, QTH's equipment info plus many of the other exchanges commonly found in Ham QSO's. QSO's can be displayed on the screen by one character at a time, by each sentence or after the completion of the QSO for checking. With a printer you can print out a hard copy. Available in 5 wpm for Novices, 13 wpm for Generals and 20 wpm for Extra class students.

□ UB-KN Novice Class (for C-64) \$14.95
 □ UB-KG General Class (for C-64) \$14.95
 □ UB-KE Extra Class (for C-64) \$14.95

ANTENNA SYSTEM

This nifty antenna modeling and development program will help you get the most from your antenna projects while eliminating much of the drudgery of antenna calculations. Part one covers standard design antennas—dipoles, verticals and Yagi designs. Part two designs shortened dipole antennas for space limited hams. Great for shortened 160/80 meter antennas. All dimensions are listed. At this price it's not an engineering program but a neat program to have around.

□ UB-AS (for C-64) \$9.95

ham radio BOOKSTORE
 GREENVILLE, NH 03048

VISA
 MasterCard

New

WE SHIP WORLDWIDE

Barry Electronics Corp.

WORLD WIDE AMATEUR RADIO SINCE 1950
Your one source for all Radio Equipment!

For the best buys in town call:
212-925-7000
Los Precios Mas Bajos en
Nueva York ...

KITTY SAYS: WE ARE NOW OPEN 7 DAYS A WEEK.
Saturday & Sunday 10 to 5 P.M.
Monday-Friday 9 to 6:30 PM Thurs. to 8 PM
Come to Barry's for the best buys in town.



ONV Safety
Belts-in stock

ICOM

ICR71A, 751A, 745, 28AH, 38A, 48A, MicroTM, R-7000, 1271A, 275AH, 3200A, 475AH, 735.



SMART PATCH

CE5 Simplex Autopatch 510 SA Will Patch FM Transceiver To Your Telephone Great For Telephone Calls From Mobile To Base. Simple To Use.

PRIVATE PATCH III
Duplex 800 in stock

Budwick ANT. Products

FLUKE 77 Multimeter



Nye MBV-A
3 Kilowatt Tuner



Ten-Tec Tuner 229A

MFJ Models
422, 313, 989B, & 941D

SANGEAN Portable Shortwave Radios

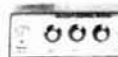

HEIL EQUIPMENT
IN STOCK



NEW TEN TEC

Corair II, PARAGON, Century 22, RX-325

Tri-Ex Towers
Hy-Gain Towers
& Antennas, and
Rotors will be
shipped direct to
you FREE of
shipping cost

SEE US AT DAYTON - SPACE 2279-72

Texas Radio

BUGCATCHER

MOBILE HF ANTENNA

NEW IMPROVED MODELS!

8-BAND COVERAGE - All Amateur, MARS, and CAP frequencies from 10 to 80 meters!

BANDSWITCHING - Switches instantly to pre-tunes frequencies on any band!

HIGH-Q RESONATOR - High-Q air inductor provides maximum efficiency on all bands!

FUNCTIONAL DESIGN - Provides low wind loading, easier tuning, and more pleasing appearance! Rugged construction for long life and reliability! New fold-over feature!

300 WATT CAPACITY - Conservative rating!

COMPLETE ANTENNA - READY TO MOUNT

PRICE \$74.95

1000 WATT MODEL AVAILABLE - \$84.95
Shipping prepaid with check or money orders. Shipping added to credit card sales and orders-out of the lower 48 States.

TEXAS RADIO PRODUCTS
5 East Upshaw Temple, Texas 76501
(817) 771-1188

112

MICROCOMPUTER REPEATER CONTROL

\$129

introducing the MICRO REPEATER CONTROLLER RPT-2A, a new concept in LOW COST, EASY TO INTERFACE, microcomputer repeater control. Replace old logic boards with a state of the art microcomputer that adds NEW FEATURES, HIGH RELIABILITY, LOW POWER, SMALL SIZE, and FULL DOCUMENTATION to your system. Direct interface (drop in) with most repeaters. Detailed interface information included. Original MICRO REPEATER CONTROL article featured in QST Dec. 1983.

- Two CW ID Messages
- Time Out Timer
- Pre Timeout Warning MSG
- Post Timeout CW MSG
- Courtesy Beep
- Auxiliary Inputs
- Reconfigurable COR Input
- High Current PTT Interface
- Sine Wave Tone Generator
- Low Power 9-15 VDC @ 200 ma
- Size 3.5" x 3.5"
- All Connectors Included

RPT-2A Kit Only \$129 plus \$3.00 shipping

PROCESSOR CONCEPTS
P.O. BOX 26023
ST. PAUL, MN 55126
(612) 484-9176 7pm-10pm evenings

CALL OR WRITE FOR FREE CATALOG AND SPECIFICATIONS

113

TUBES — 2000 TYPES DISCOUNT PRICES!

Early, hard-to-find, and modern tubes. Also transformers, capacitors and parts for tube equipment.
Send \$2.00 for 20 page wholesale catalog.

Antique Electronic Supply
688 W. First St. • Tempe, AZ 85281
602/894-9503

114

KENWOOD

We Give You the Best in Amateur and Commercial Radios. Call Us. It's Jan KB2RV, Kitty WA2BAP, Mark K2CON
See You March 22nd DVRA, Trenton, NJ
See You Apr 5th, at BARA, Paramus, NJ (Sperch)

TS440SAT, R-5000, R-7000, TS-940 SAT, TM-201B, TR3600A, TM-2570A/S0A/S0A, TR-751A, Kenwood Service Repair, TH 2123141 BT, TM-211A, 411A, TS-1118A11A, TM3530A, TR200SAT, TR215SAT

YAESU

FT-767GX, FT-980, FT-757GX, FRG-8800, FT-726, FRG-9600, FT-270770RH, FT-2700RH

Land Mobile HT
Wilson Maxon
Yaesu FT-112, FT-113, FT-1143
ICOM IC-M (Marine) M700
Tango M-1

ICOM IC2AT/12AT
IC02AT
IC-3104AT
IC-A2U16

YAESU FT-2317/3727R
FT-2709RH
FT-1903/1123

AMERITRON AMPLIFIER AUTHORIZED DEALER

Yaesu FTR-2410, Wilson
ICOM IC-RP 3010 (440 MHz)
ICOM IC-RP 1210 (1.2 GHz)

Computer interfaces stocked:
MFJ-1224, AEA CP-1, DR-DX, PK-87, PK-64A, PK-64, DR-QSO, PK-232, PM-1

ALPHA AMPLIFIERS

Complete Butternut Antenna Inventory in Stock!

DIGITAL FREQUENCY COUNTERS
Trionyx, Model TR-1000, 0-600 MHz

AMP SUPPLY STOCKED
Long range Wireless
Telephone for export in stock

BENCHER PADDLES, BALUNS, IN STOCK

MIRAGE AMPLIFIERS
ASTRON POWER SUPPLIES
Saxton Wire & Cable

AE AEA 144 MHz
AE AEA 220 MHz
AE AEA 440 MHz
ANTENNAS

Waltmeters & Elements In Stock

BIRD

KANTRONICS
UTU, KAM, UTU-XT, KPC 2400, KPCII

EIMAC
3-5002
572B, 6JS6C
12B7A & 4-400A

Soldering Station,
48 Watts, \$68
MICROLOG-ART 1, Air Disk, SWL, Morse Coach

NEI-TECH DVX-100 Digital Voice Keyer
COMPU-FIRE EXTINGUISHERS

VoCom/Mirage/Daiwa
Tokyo Hy-Power/TE SYSTEMS
Amplifiers & 518 HT Gain
Antennas IN STOCK

MAIL ALL ORDERS TO BARRY ELECTRONICS CORP., 512 BROADWAY, NEW YORK CITY, NY 10012.

New York City's LARGEST STOCKING HAM DEALER COMPLETE REPAIR LAB ON PREMISES

"Aqui Se Habla Espanol!"
BARRY INTERNATIONAL TELEX 12-7670
MERCHANDISE TAKEN ON CONSIGNMENT FOR TOP PRICES
Monday-Friday 9 A.M. to 6:30 P.M. Thursday to 6 P.M.
Saturday & Sunday 10 A.M. to 5 P.M. (Free Parking)
AUTHORIZED DIST. MCKAY DYMEK FOR SHORTWAVE ANTENNAS & RECEIVERS
Subways: IRT/LEX "Spring St. Station"
BMT "Prince St. Station"
IND "F" Train Bwy. Station"
Bus: Broadway #6 to Spring St.
Path—9th St. 86th. Avn. Station

Commercial Equipment Stocked: ICOM, MAXON, Midland, Standard, Wilson, Yaesu. We serve municipalities, businesses, Civil Defense, etc. Portables, mobiles, bases, repeaters.

We Stock: AEA, ARRL, Alpha, Ameco, Antenna Specialists, Astatic, Astron, B & K, B & W, Bencher, Bird, Butternut, CDE, CES, Collins, Communications, Spec. Connectors, Covercraft, Cushcraft, Daiwa, Dentron, Digimast, Drake, ETO (Alpha), Eimac, Encom, HeilSound, Henry, Hustler (Newtronics), Hy-Gain, Icom, KLM, Kantronics, Larsen, MCM (Daiwa), MFJ, J.W. Miller, Mini-Products, Mirage, Newtronics, Nye Viking, Palomar, RF Products, Radio Amateur Clubbook, Rockwell Collins, Saxton, Shure, Telex, Tempo, Ten-Tec, Tokyo Hi Power, Trionyx TUBES, W2AU, Waber, Wilson, Yaesu Ham and Commercial Radios, Vocom, Vibroplex, Curtis, Tri-Ex, Wacom Duplexers, Repeater, Phelps Dodge, Fibon Intercoms, Scanners, Crystals, Radio Publications.

WE NOW STOCK COMMERCIAL COMMUNICATIONS SYSTEMS
HAM DEALER INQUIRES INVITED. PHONE IN YOUR ORDER & BE REIMBURSED
COMMERCIAL RADIOS stocked & serviced on premises.
Amateur Radio Courses Given On Our Premises, Call
Export Orders Shipped Immediately. TELEX 12-7670

ALL SALES FINAL

Barry Electronics Commercial Radio Dept. offers the Best in two-way communications for Businesses, Municipalities, Civil Defense, Broadcasting Companies, Hospitals, etc. Sales and Service for all brands: Maxon, Yaesu, Icom, Tad, Octagon, Regency/Wilson, Midland, Standard, Uniden, Shinway, Fujitsu, Seas, Spillsbury, Neutec, etc. Call or write for information. 212-925-7000.

AMATEUR RADIO LOG

station _____
log book number _____
from _____ to _____

Printed by the Ham Radio Publishing Group

RETURN OF AN OLD FAVORITE

AVAILABLE NOW!

\$2.95 each — 3 for \$6.95

Please enclose \$3.50
Shipping and handling

Ham Radio's Bookstore

Greenville, NH 03048

NEW!

PAC-COMM TNC-220

HF / VHF Terminal Node Controller

\$124.95
KIT

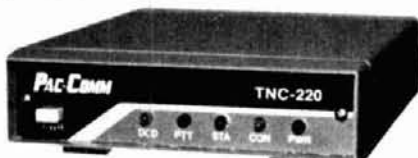

\$159.95
ASSEMBLED

The TNC-220 is a new, low-cost Packet Terminal Node Controller evolved from the Pac-Comm TNC-200 (TAPR TNC-2). It uses more large scale integrated circuits and fewer components to provide greater functionality, reliability and sensitivity with reduced size and cost. The single-chip modem used for both 300 baud HF and 1200 baud VHF operation has two radio ports. Switching between ports is done entirely in software and no cable changing, no switch setting and no retuning is required! The HF port has an active bandpass filter and provides either FSK or AFSK keying. An optional tuning indicator slides inside the cabinet. A standard modem disconnect header will connect accessory high-speed or satellite modems.

- Two radio ports
- 7910 single-chip modem
- 300 and 1200 bauds
- Enhanced command set
- Multi-color status LED's
- Supports RS-232 and TTL computers
- Active HF bandpass filter
- Tuning indicator option
- 12 volt DC operation
- Premium quality case
- 6" w x 2" h x 7" d

The TNC-220 has the familiar TAPR command set and AX.25 Level 2 Version 2 protocol running on a Z-80 processor with 32k bytes of EPROM and 16k bytes of battery-backed RAM. A Zilog 8530 SCC performs all packet HDLC in hardware. The terminal port can select either RS-232 or TTL for your C-64/128, VIC-20 or other TTL computer. Five large, color-coded LED's clearly indicate status at a glance. The power switch is now located on the front panel. The TNC-220 is enclosed in a rugged extruded aluminum cabinet with an attractive two-tone blue front panel. All indicators and controls have large, clear labels.

Tech Line (813) 874-2980
Write For Free Packet Catalog

ORDER DIRECT 800-223-3511 FREE UPS BROWN



Pac-Comm Packet Radio Systems, 3652 West Cypress St., Tampa, FL 33607 ✓ 105

ham
radio magazine

Come see us in Dayton Booth 68.

NEW! LOW COST AC POWERLINE DISTURBANCE MONITORS

- **MODEL LDM-120** ONLY \$99
DETECTS, STORES AND DISPLAYS WORST CASE LINE VOLTAGE VARIATION DUE TO BROWN-OUTS, SAGS AND SURGES. 1½ AND 3 CYCLE RESPONSE TIMES 60-160 VOLT RANGE.
- **MODEL LSM-120** ONLY \$139
DETECTS, STORES AND DISPLAYS WORST CASE PEAK SPIKE VOLTAGE. NORMAL AND COMMON MODE SELECTION 100 V-2.5 KV RANGE.

COMPLETE STANDALONE INSTRUMENTS WITH INTERNAL AUDIBLE ALARM AND EXTERNAL TTL ALARM OUTPUT. FULLY ISOLATED. 1 YEAR WARRANTY.

CATCH THOSE GLITCHES!



4425 CANOGA AVE WOODLAND HILLS, CA 91364
(818) 346-7870

CALL OR WRITE FOR LITERATURE ✓ 106

COMMODORE 64 LADDER NETWORK ANALYSIS PROGRAM "ALADYN-64"

This program is a menu-driven design tool with a built-in circuit file editor, fast calculations and graphic output to either the screen or printer. Useable for circuits which operate from VLF through Microwave. Circuit elements include R's, L's, C's, transmission lines, transistors and FET's. Output format rectangular or Smith chart.

\$59.95 PPD. Check or M.O.

INTERCEPTOR ELECTRONICS INC.
ROUTE 1, BOX 439, ROUND HILL, VA
22141-9307 PHONE (703) 338-4905

✓ 107

LCR METER w/ D Factor

"...MEASURES BOTH YOUR COIL'S
INDUCTANCE AND LOSS FACTOR"



Measurement range

* The industry's first handheld, low-cost, LCR meter with D Factor

L: 0.1µH - 1.999 H
C: 0.1 pF - 199 µF
R: 0.1Ω - 19MΩ
D: 0.01 - 19.99

\$199.95
Freight pd.
CA RES. + tax

✓ 108



AMERICAN RELIANCE, INC.
9241 E. VALLEY BLVD. (800) 654-9838
ROSEMEAD, CA 91770 CA (818) 287-8400

Electronic Repair Center

Servicing

Amateur Commercial Radio

The most complete repair facility on the East Coast.

Large parts inventory and factory authorized warranty service for Kenwood, Icom and Yaesu.

SEND US YOUR PROBLEMS

Servicing "Hams" for 30 years, no rig too old or new for us.

HAMTRONICS, INC.

4033 Brownsville Road

Trevoze, Pa. 19047

215-357-1400



Full Feature Remotely Programmable Repeater Controller for under \$600

✓ Field tested for over 2 years

✓ Full 2 year warranty

FREE

Free Full Color Brochure

Call Toll-Free

1-800-621-8387

ext. 244, 8 am - 5 pm Mountain Time

Or Write:

S-COM
INDUSTRIES

See us at Dayton
Booths 304 & 305

P.O. Box 8921 • Fort Collins, CO 80525

Want to Advertise in HAM RADIO?

Call Rally Dennis
(603) 878-1441
today for more
information

ALL NEW!

DUAL BAND ANTENNAS FOR ULTIMATE PERFORMANCE!!

Model	Description	Sug. List
2X4Z	Base/Repeater 200 Watt Gain 146 MHz 8.2dB, 446 MHz 11.5dB	\$168.95
2X4SR	Mobile with Mag. Mt. 150 Watt Gain 146 MHz 3.8dB, 446 MHz 6.2dB	71.90
2X4SDY	Mobile with Mag. Mt. 100 Watt Gain 146 MHz 2.15 dB, 446 MHz 3.8dB	65.95
HT 702	146/446 MHz Hand Held BNC	50 Watt 29.95
C7-71	Base/Repeater 920 MHz 50 Watt 7.14 dB Gain	\$115.95
C202N	Mobile 920 MHz with Mag. Mt. 5 dB Gain 50 Watt	72.95
1234E	Base/Repeater 200 Watt Gain 446 MHz 8.5dB, 1.2 GHz 10.1dB	\$178.95
124X	Mobile with Mag. Mt. 100 Watt Gain 446 MHz 2.5dB, 1.2 GHz 3.5dB	104.95
1221S	1.2 GHz Base/Repeater 100 Watt Gain 15.5dB, 21 Step colinear	\$158.95
1210M	1.2 GHz Mobile with Mag. Mt. 50 Watt Gain 8.8dB	76.95
415M	High power duplexer 146 MHz 400 Watt 446 MHz 250 Watt	59.95
412N	UHF/GHz Duplexer 446/1400MHz Max. 70 Watt	68.95



1275 NORTH GROVE ST.
ANAHEIM, CALIF. 92806
(714) 630-4541
CABLE: NATCOLGLZ
FAX (714) 630-7024

✓ 110

Dealer prices may be
different than list.

Prices and specifications subject to
change without notice or obligation.

NEW CODE TAPES

NEW CODE TAPES FROM AVC INNOVATIONS

by John Karpicke N9AVC

QSO TRAINER

This tape has been designed to teach you to copy complete words instead of letter by letter, simply, with a minimum of effort and fuss. Using the standard QSO format, beginners and old timers alike will find that their code speed will improve dramatically as they learn the secrets of word copying. For years, high speed pros have used this tried and true method—learn their secrets and join the fun! Two 60 minute tapes complete with instruction sheet.

□ AVC-QT \$14.95

QSO MASTER

Takes you past the General class code requirement and heads you toward the Extra class ticket. Four thirty minute programs cover 8, 10, 12 and 14 wpm. Two 60 minute tapes with instructions.

□ AVC-QM \$12.95

QSO PRO

One more jump and you've got your Extra! These tapes are designed with that goal in mind. Maximize your copying skills with four programs that cover 16, 18, 20 and 22 wpm. Two 60 minute tapes with instructions.

□ AVC-QP \$12.95

Please enclose \$3.50 shipping and handling

ham
radio magazine

BOOKSTORE



Greenville, NH 03048

HAM MART

Ham Radio's guide to help you find your local dealer

California

JUN'S ELECTRONICS
3919 SEPULVEDA BLVD.
CULVER CITY, CA 90230
213-390-8003
800-882-1343 Trades
Habla Espanol

Colorado

COLORADO COMM CENTER
525 EAST 70th AVE.
SUITE ONE WEST
DENVER, CO 80229
(303) 288-7373
(800) 227-7373
Stocking all major lines
Kenwood Yaesu, Encomm, ICOM

Connecticut

HATRY ELECTRONICS
500 LEDYARD ST. (SOUTH)
HARTFORD, CT 06114
203-527-1881
Call today. Friendly one-stop shopping
at prices you can afford.

Delaware

AMATEUR & ADVANCED COMMUNICATIONS
3208 CONCORD PIKE
WILMINGTON, DE 19803
(302) 478-2757
Delaware's Friendliest Ham Store.

DELAWARE AMATEUR SUPPLY
71 MEADOW ROAD
NEW CASTLE, DE 19720
302-328-7728
800-441-7008
Icom, Ten-Tec, Microlog, Yaesu,
Kenwood, Santec, KDK, and more.
One mile off I-95, no sales tax.

Florida

AMATEUR ELECTRONIC SUPPLY
1898 DREW STREET
CLEARWATER, FL 33575
813-461-4267
Clearwater Branch
West Coast's only full service
Amateur Radio Store.
Hours M-F 9-5:30, Sat. 9-3

AMATEUR ELECTRONIC SUPPLY
621 COMMONWEALTH AVE.
ORLANDO, FL 32803
305-894-3238
Fla. Wats: 1 (800) 432-9424
Outside Fla: 1 (800) 327-1917
Hours M-F 9-5:30, Sat. 9-3

Georgia

DOC'S COMMUNICATIONS
702 CHICKAMAUGA AVENUE
ROSSVILLE, GA 30741
(404) 866-2302 / 861-5610
ICOM, Yaesu, Kenwood, Bird...
9AM-5:30PM
We service what we sell.

Hawaii

HONOLULU ELECTRONICS
819 KEEAUMOKU STREET
HONOLULU, HI 96814
(808) 949-5564
Kenwood, ICOM, Yaesu, Hy-Gain,
Cushcraft, AEA, KLM, Tri-Ex Towers,
Fluke, Belden, Astron, etc.

Idaho

ROSS DISTRIBUTING COMPANY
78 SOUTH STATE STREET
PRESTON, ID 83263
(208) 852-0830
M 9-2; T-F 9-6; S 9-2
Stock All Major Brands
Over 7000 Ham Related Items on
Hand

Illinois

ERICKSON COMMUNICATIONS, INC.
5456 N. MILWAUKEE AVE.
CHICAGO, IL 60630
312-631-5181
Hours: 9:30-5:30 Mon, Tu, Wed & Fri;
9:30-8:00 Thurs; 9:00-3:00 Sat.

Indiana

THE HAM STATION
220 N. FULTON AVE.
EVANSVILLE, IN 47710
812-422-0231
Discount prices on Ten-Tec, Cubic,
Hy-Gain, MFJ, Azden, Kantronics,
Santec and others.
SASE for New & Used Equipment List.

Maryland

MARYLAND RADIO CENTER
8576 LAURELDALE DRIVE
LAUREL, MD 20707
301-725-1212
Kenwood, Ten-Tec, Alinco, Azden. Full
service dealer.
T-F 10-7 SAT 9-5

Massachusetts

TEL-COM, INC.
675 GREAT ROAD, RTE. 119
LITTLETON, MA 01460
617-486-3400
617-486-3040
The Ham Store of New England
You Can Rely On.

Michigan

ENCON PHOTOVOLTAICS
Complete Photovoltaic Systems
27600 Schoolcraft Rd.
Livonia, Michigan 48150
313-523-1850
Amateur Radio, Repeaters, Satellite,
Computer applications.
Call Paul WD8AHO

Minnesota

TNT RADIO SALES
4124 WEST BROADWAY
ROBBINSDALE, MN 55422 (MPLS/ST.
PAUL)
TOLL FREE: (800) 328-0250
In Minn: (612) 535-5050
M-F 9 AM-6 PM
Sat 9 AM-5 PM
Ameritron, Bencher, Butternut, ICOM,
Kenwood

Missouri

MISSOURI RADIO CENTER
102 NW BUSINESS PARK LANE
KANSAS CITY, MO 64150
(800) 821-7323
Missouri: (816) 741-8118
ICOM, Kenwood, Yaesu
Same day service, low prices.

Nevada

AMATEUR ELECTRONIC SUPPLY
1072 N. RANCHO DRIVE
LAS VEGAS, NV 89106
702-647-3114
Dale Porray "Squeak," AD7K
Outside Nev: 1 (800) 634-6227
Hours M-F 9-5:30, Sat. 9-3

Dealers: *YOU SHOULD BE HERE TOO!*
Contact Ham Radio now for complete details.

mateur Radio Dealer

New Hampshire

RIVENDALL ELECTRONICS
8 LONDONDERRY ROAD
DERRY, N. H. 03038
603-434-5371
Hours M-S 10-5; THURS 10-9
Closed Sun/Holidays

New Jersey

ABARIS SYSTEMS
276 ORIENTAL PLACE
LYNDHURST, NJ 07071
201-939-0015
Don WB2GPU
Azden, Larsen, KLM, Mirage, Newmar,
Vocom, W1JC, many others.
M-F 10 am-9 pm
SAT 9 am-7 pm
VISA/MC

KJI ELECTRONICS
66 SKYTOP ROAD
CEDAR GROVE, NJ 07009
(301) 239-4389
Gene K2KJI
Maryann K2RVH
Distributor of: KLM, Mirage, ICOM, Lar-
sen, Lunar, Astron. Wholesale - retail.

QEP's
110-4 ROUTE 10
EAST HANOVER, N. J. 07936
201-887-6424
In N.J. 1-800-USA-9913
Bill KA2QEP
Jim N2GKW
VISA/Mastercard
Belden Coaxial Cable
Amphenol Connectors
Hours: 9:30 am-7:00 pm

New York

BARRY ELECTRONICS
512 BROADWAY
NEW YORK, NY 10012
212-925-7000
New York City's Largest Full Service
Ham and Commercial Radio Store.

VHF COMMUNICATIONS
915 NORTH MAIN STREET
JAMESTOWN, NY 14701
716-664-6345
Call after 7 PM and save! Supplying all
of your Amateur needs. Featuring ICOM
"The World System." Western New
York's finest Amateur dealer.

North Carolina

F & M ELECTRONICS
3520 Rockingham Road
Greensboro, NC 27407
1-919-299-3437
9AM to 7PM Closed Monday
ICOM our specialty — Sales & Service

Ohio

AMATEUR ELECTRONIC SUPPLY
28940 EUCLID AVE.
WICKLIFFE, OH 44092 (Cleveland Area)
216-585-7388
Ohio Wats: 1 (800) 362-0290
Outside Ohio: 1 (800) 321-3594
Hours M-F 9-5:30, Sat. 9-3

DEBCO ELECTRONICS, INC.
3931 EDWARDS RD.
CINCINNATI, OHIO 45209
(513) 531-4499
Mon-Sat 10AM-9PM
Sun 12-6PM
We buy and sell all types of electronic
parts.

UNIVERSAL AMATEUR RADIO, INC.
1280 AIDA DRIVE
REYNOLDSBURG (COLUMBUS), OH
43068
614-866-4267
Featuring Kenwood, Yaesu, Icom,
and other fine gear. Factory author-
ized sales and service. Shortwave
specialists. Near I-270 and airport.

Pennsylvania

**HAMTRONICS,
DIV. OF TREVISE ELECTRONICS**
4033 BROWNSVILLE ROAD
TREVISE, PA 19047
215-357-1400
Same Location for over 30 Years

LaRUE ELECTRONICS
1112 GRANDVIEW STREET
SCRANTON, PENNSYLVANIA 18509
717-343-2124
ICOM, Bird, Cushcraft, Beckman,
Larsen, Amphenol, Astron, Belden,
Antenna Specialists, W2AU/W2VS,
Tokyo Hy-Power Labs, WELZ, Daiwa,
Sony, Saxton, Vibroplex, Weller.

Tennessee

MEMPHIS AMATEUR ELECTRONICS
1465 WELLS STATION ROAD
MEMPHIS, TN 38108
Call Toll Free: 1-800-238-6168
M-F 9-5; Sat 9-12
Kenwood, ICOM, Ten-Tec, Cushcraft,
Hy-Gain, Hustler, Larsen, AEA,
Mirage, Ameritron, etc.

Texas

MADISON ELECTRONICS SUPPLY
3621 FANNIN
HOUSTON, TX 77004
713-520-7300
Christmas?? Now??

KENNEDY ASSOCIATES
AMATEUR RADIO DIVISION
5707A MOBUD
SAN ANTONIO, TX 78238
Stocking all major lines. San Antonio's
Ham Store. Great Prices — Great
Service. Factory authorized sales and
service.
Hours: M-F 10-6; SAT 9-3

MISSION COMMUNICATIONS
11903 ALEIF CLODINE
SUITE 500 (CORNER HARWIN &
KIRKWOOD)
HOUSTON, TEXAS 77082
(713) 879-7764
Now in Southwest Houston—full line
of equipment. All the essentials and
extras for the "ham."

Wisconsin

AMATEUR ELECTRONIC SUPPLY
4828 W. FOND DU LAC AVE.
MILWAUKEE, WI 53216
414-442-4200
Wisc. Wats: 1 (800) 242-5195
Outside Wisc: 1 (800) 558-0411
M-F 9-5:30 Sat 9-3

Solid Brass MORSE KEY KIT



- Precision engineered and fabricated by: R. A. Kent (Engineers). England
- Ball race bearings for smooth, trouble-free performance
- Solid silver contacts
- Machined hardwood weighted base with non-slip feet
- Easy assembly

Exclusive U.S. Distributor:

Total Electronic Concepts (TEC)
Post Office Box H 400 Lincoln, MA 01773
(617) 259-0125

Introductory Price: KIT \$49.95  
ASSEMBLED \$59.95

plus \$5.00 postage and handling. Massachusetts residents add 5% Tax.

Please send SASE for further information. ✓ 201

flea market

RATES Noncommercial ads 10¢ per word; commercial ads 60¢ per word **both payable in advance.** No cash discounts or agency commissions allowed.

HAMFESTS Sponsored by non-profit organizations receive one free Flea Market ad (subject to our editing) on a space available basis only. Repeat insertions of hamfest ads pay the non-commercial rate.

COPY No special layout or arrangements available. Material should be typewritten or clearly printed (not all capitals) and must include full name and address. We reserve the right to reject unsuitable copy. **Ham Radio** cannot check each advertiser and thus cannot be held responsible for claims made. Liability for correctness of material limited to corrected ad in next available issue.

DEADLINE 15th of second preceding month.

SEND MATERIAL TO: Flea Market, Ham Radio, Greenville, N. H. 03048.

HOT/NEW PACKET PROGRAMS FOR YOUR IBM PC. Several telecommunications programs to choose from, especially written to interface your packet controller with your PC or compatible/clone. Features like Full Screen, Line Screen editing, Split Screens, ASCII, Binary, X-Modem or user defined file transfers, DOS shell, Macro Keys, Command Files, many types of time/date/oper. ID. Multi-page brochures explain them all. Software Support. Write for new information and pricing. **KALT & ASSOCIATES, 2440 E. Tudor Rd, Suite 138, Anchorage, AK 99507. (907) 248-0133. Charge Cards accepted.**

HOMEBREW PROJECTS LIST SASE. WB2EUF, Box 708, East Hampton, NY 11937.

FOR SALE: Tower, Rotator, Antenna Package — Tri-Ex W-67 Tower, motorized extension from 22' (nested) to 67' plus mast height. Hand winch operated tilt-over feature. CDE Ham III Rotator. Wilson DB-33 (10/15 meter beam). Cushcraft 20 meter beam. Very good condition. Package price \$1250 firm. WA1USO, Fred Moller, Old Fitzwilliam Rd, Jaffrey, NH 03452. (603) 532-7635.

PERFORATED ENCLOSURES 17 x 8.5 x 7.5 deep with grey paint and 17 x 8.5 x 11 deep with iridite finish. Unpainted blank front panel. Approximately 50 each. \$10 and \$15 respectively. Quantity discount available. Don Reed, K0IFO, 911 North Lynn, Independence, MO 64050. (816) 252-9436

DISCOVER "THE RADIO WORKS". See what we are doing with high performance HF and VHF antennas, parts, and accessories. Unusual 48 page discount catalog. 22 cents SASE. **THE RADIO WORKS, HRAPR, Box 6159, Portsmouth, VA 23703 (804) 484-0140.**

R-390A RECEIVER: \$195 check; \$115 repairable. Parts, tubes, sections. Info SASE. Mint military-spec pull-over 12A77, 6AG5: \$15/dozen. CPRC-26 six meter transceiver (see Ham Radio, March 1985) \$17.50 apiece, \$32.50 pair (add \$4.50/unit shipping). Baytronics, Box 591, Sandusky, OH 44870. (419) 627-0460 evenings.

Foreign Subscription Agents for Ham Radio Magazine

Ham Radio Austria
Karin Ueber
Postfach 2454
D-7850 Loerrach
West Germany

Ham Radio Belgium
Sierelohouse
Brustelsteenweg 416
B-9218 Genit
Belgium

Ham Radio Holland
Postbus 413
NL-7800 Ar Emmen
Holland

Ham Radio Europe
Box 2084
S-194 02 Upplands Vasby
Sweden

Ham Radio France
SM Electronic
20 bis, Ave des Clairons
F-89000 Auxerre
France

Ham Radio Germany
Karin Ueber
Postfach 2454
D-7850 Loerrach
West Germany

Canada
Send orders to
Ham Radio Magazine
Greenville, NH 03048 USA
Prices in Canadian funds
1 yr \$41.85, 2 yrs \$74.25
3 yrs \$99.90

Ham Radio Italy
Via Maniago 15
I-20134 Milano
Italy

Ham Radio Switzerland
Karin Ueber
Postfach 2454
D-7850 Loerrach
West Germany

Ham Radio England
c/o R.S.G.B.
Alma House
Crabtree Road
Potters Bar
Herts EN6 3JW
England

VHS VIDEO CASSETTES \$29.50 total price for a box of 10 delivered anywhere in continental U.S. Call for 24-hour order information. KB6MT (714) 990-9622.

WANTED TO BUY zip code and directory published before 1980 publication No. 65. Bernard Fair, 19455 Houghton, Detroit, MI 48219.

S.S.B. CRYSTAL FILTERS. 9.0 MHz, 2.2 kHz bandwidth, six pole, with data \$20.00 postpaid. OEM quantity available. ICL7117 D.V.M.I.C.'s direct drive 3-1/2 digit LED same as 7107 plus hold, with data; \$6.00, 2/\$10.00 postpaid. Dentrone Scout C.A.P. transceiver, 4MHz, 100 watts, new; \$250.00. A.C.P.S. \$75.00 postpaid. George Mistic, 14481 Watt, Novelty, Ohio 44072.

1 Hz Resolution frequency synthesizer. For info SASE to A & A Engineering, 2521 W. LaPalma Avenue, #K, Anaheim, CA 92801. (714) 952-2114.

LEARN MORSE CODE IN 1 HOUR. Amazing new easy technique. Moneyback guarantee. \$10. Bahr, 2549H Temple, Palm-bay, FL 32905.

SUPERFAST MORSE CODE SUPEREASY. Subliminal cassette. Moneyback guarantee. \$10. Bahr, 2549H Temple, Palm-bay, FL 32905.

TEN-TEC now shipping new-boxed USA made latest 1987 factory models Corsair II, Century 22, Argosy II transceivers. Titan linear amplifier 229A 2kw antenna tuner plus accessories, antenna. For the best Ten-Tec deal write or phone Bill Slep (704) 524-7519, SLEP ELECTRONICS COMPANY, Highway 441, Otto, NC 28763.

WANTED Schematic for Bearcat 100 Electro, Model BC-100 Scanner. Please contact Ralph E. Smith, 857 Rougemont, St. Foy, Quebec City, Canada.

HEATH Deluxe antenna tuner Model SA2060 — a beauty — best offer. (401) 789-1817 FOB.

CHASSIS, CABINET KITS. SASE. K3IWK, 5120 Harmony Grove Road, Dover, PA 17315.

COLLINS KWM-380. Fully updated. Excellent condition. Full service manual. Write or call. W3IRE, 9436 Howes Road, Dunkirk, MD 20754. (301) 257-3041.

BACK ISSUES OF HAM RADIO Magazine from March 1968 to June 1974. Complete your collection. Individual issues \$4.00 each. KX9P (319) 377-3563.

IBM/APPLE COMPUTER program "Hamlog". 18 modules logs auto-sorts 7-band WAS/DXCC. Full feature. Also CP/M. Apple \$19.95, IBM \$24.95. HR-KA1AWH, PB2015, Peabody, MA 01960.

LO COST Sensitive-Selective HF receiver system. Ideal/1st station set. Enhanced Noise 10/15/40/80m coverage. Send 2 stamps for free info. I. Megeff, KD2EF, 729 Lori Drive #101, Palm Springs, FL 33461.

HOBBY, EDUCATIONAL, INDUSTRIAL PRODUCTS. 70 kits. Amplifier, FM transistor, VU meter, door bell, alarm system, power supply. Send \$3.00 to HOBBY ELECTRONIC, PO Box 1339, Claremont, NH 03743 or call (603) 543-0033.

COLLECTORS: Have Karl Pierson KP-81 communications receiver for sale. Complete system—receiver, speaker cabinet and book. Open to offers. Cal, KL7HEM, 10300 Silver Knolls, Reno, NV 89506.

IBM-PCRTTY/CW. New CompRtty II is the complete RTTY/CW program for IBM-PC's and compatibles. Now with larger buffers, better support for packet units, pictures, much more. Virtually any speed ASCII, BAUDOT, CW. Text entry via built-in screen editor! Adjustable split screen display. Instant mode/speed change. Hard-copy, disc-copy, break-in buffer, select calling, text file transfer, customizable full screen logging, 24 programmable 1000 character messages. Ideal for MARS and traffic handling. Requires 256k PC or AT compatible, serial port, RS-232C TU. \$65. Send call letters (including MARS) with order. David A. Rice, KC2HO, 25 Village View Bluff, Ballston Lake, NY 12019.

TRS60 4P/KANTRONICS UTU RTTY. Split-screen, 10 user keys, file transfer. Runs in Mod 4 (80 char) mode. \$30 to COM-MPRO RTTY, c/o KB6IC, 3711 Gayle Avenue, Omaha, NE 68123.

COMPUTERS COMMODORE 64 and XT repair. ABS (201) 758-6673.

CODE PROGRAMS. Apple/C-64. 31 modes, graphics, menus, wordprocessor, etc. LARESCO, POB 2018, 1200 Ring Road, Calumet City, IL 60409. (312) 891-3279.

SOLAR ELECTRIC PANELS and System Components. 1st quality for home or repeaters. Lowest prices in country. KA8DSS, RADIANT DISTRIBUTORS, 3900 Dursum, Ada, MI 49301. (616) 874-8899.

WA9GRF RF SOFTWARE \$15.00 disk contains HF/VHF/UHF/L-BAND propagation and Smith Chart impedance matching programs. Specify Commodore-64 or MS-DOS BASIC. Lynn Genig, 6417 Morgan RD, Monroeville, IN 46773.

REMEMBER TROLLEY CARS? *Trolley Treasures: The Wartime Years in New Jersey* (1939-1947), a 4-volume photodocumentary history, includes 1600 unpublished, original photographs plus extensive historical notes. Volume I, *The Compromise Road Cars of Public Service Coordinated Transport*, ready now. SASE for details. To order, contact Trolley Themes, A.W. Mankoff, 2237-3 Woodside Lane, Sacramento, CA 95825. (\$14.95 plus \$1.50 S&H).

UHF PARTS. GaAs Fets, MMICs, trimmers, chip caps, teflon pcb, and other builder parts. SASE brings list. MICROWAVE COMPONENTS, 11216 Cape Cod, Taylor, MI 48180.

\$\$\$\$\$SUPER SAVINGS on electronic parts, components, supplies and computer accessories. Free 40-page catalog for SASE. Get on our mailing list. BCD ELECTRO, PO Box 830119, Richardson, TX 75083 or call (214) 690-1102.

SHOW IT IN STYLE Full color OSL's by Smith Printing. From your prints/slides. Sample packet. SASE. 20420 Calhaven Drive, Saugus, CA 91350 (805) 251-7211.

WANTED: For Drake 4C the noise blanker 4NB (dead or alive). H. Schroefter, Dorfstr. 14, 3131 Gollau/Luechow, West Germany.

ANTIQUE RADIOS. —schematics, tubes and literature. Send SASE to VRS (HR), 376 Cilley Rd, Manchester, NH 03103 for large list.

HAM MONITOR SCOPE Millen 90932 \$85, audio signal generator HP200-CD \$125, Precision E-200-C AM/FM signal generator \$45, Yaesu FRG-7 general coverage receiver \$125, Johnson phone patch \$25, trade for TR-9000. K6KZT, 2255 Alexander, Los Osos, CA 93402

YAESU OWNERS: Hundreds of modifications and improvements for your rig. Select the best from fourteen years of genuine top-rated Fox-Tango Newsletters by using our new 32-page Cumulative Index. Only \$5 postpaid (cash or check) with \$4 Rebate Certificate creditable toward Newsletter purchases. Includes famous Fox-Tango Filter and Accessories Lists. Milt Lowens, NAML (Editor), Box 15944, W. Palm Beach, FL 33416. Telephone (305) 683-9587.

RTTY JOURNAL—Now in our 35th year. Join the circle of RTTY friends from all over the world. Year's subscription to RTTY JOURNAL, \$10.00, foreign \$15.00. Send to: RTTY JOURNAL, 9085 La Casita Ave., Fountain Valley, CA 92708.

IMRA International Mission Radio Association helps missionaries. Equipment loaned. Weekday net, 14.280 MHz, 2-3 PM Eastern. Eight hundred Amateurs in 40 countries. Brother Frey, 1 Pryer Manor Road, Larchmont, New York 10538.

RUBBER STAMPS: 3 lines \$4.50 PPD. Send check or MO to G.L. Pierce, 5521 Birkdale Way, San Diego, CA 92117. SASE brings information.

ELECTRON TUBES: Receiving, transmitting, microwave... all types available. Large stock. Next day delivery, most cases. DAILY ELECTRONICS, PO Box 5029, Compton, CA 90224. (213) 774-2255.

CUSTOM MADE EMBROIDERED PATCHES. Any size, shape, colors. Five patch minimum. Free sample, prices and ordering information. HEIN SPECIALTIES, Inc., Dept 301, 4202 N. Drake, Chicago, IL 60618.

RECONDITIONED TEST EQUIPMENT \$1.25 for catalog. Walzer, 2697 Nickel, San Pablo, CA 94806.

COMING EVENTS Activities — "Places to go . . ."

SPECIAL REQUEST TO ALL AMATEUR RADIO PUBLICITY COORDINATORS: Please indicate in your announcements whether or not your Hamfest location, classes, exams, meetings, flea markets, etc., are wheelchair accessible. This information would be greatly appreciated by our brother/sister hams with limited physical ability.

MICHIGAN: April 5. The South Eastern Michigan Amateur Radio Association's 29th annual Hamfest Swap and Shop, 8 AM to 3 PM, Grosse Pointe North High School, 707 Vernier Road, Grosse Pointe Woods. ARRL, DX and Packet forums. Tickets \$1.00 advance; \$3.00 at the door. Tables \$8.00 advance; \$10.00 at the door. Talk in on SEMARA repeater 147.70/10 and 146.52 simplex. For information: SEMARA Hamfest, PO Box 646, St. Clair Shores, MI 48080 or phone Fred Lewis, NK8M (313) 881-0187.

MINNESOTA: April 4. 10th annual Rochester Area Hamfest sponsored by the Rochester ARC, John Adams Junior High School, 1525 NW 31st Street, Rochester. Doors open 8:30 AM. Large flea market, speakers, programs, refreshments and plenty of free parking. Talk in on 146.22/82. W0MXXW. For further information contact: RARC c/o W0BYEE, 2253 Nordic Ct. NW, Rochester, MN 55901.

NEW JERSEY area Chaverim, an organization of Jewish Amateur radio operators completing its 4th successful year, invites all hams and those interested in Amateur Radio to join, particularly those in Monmouth and Ocean counties of NJ. We meet the first Sunday of the month in the Jewish Community Center. Grant Avenue, Deal. Write POB 192, West Long Branch, NJ 07764.

OHIO: April 24, 25, 26. DAYTON HAMVENTION.

The Dayton Amateur Radio Association is now accepting applications for its 1987 Scholarship Program. Any licensed Amateur graduating from high school in 1987 is eligible to enter. For information and application forms write DARA Scholarship Committee, 317 Ernst Avenue, Dayton, Ohio 45405.

OHIO: April 24. The 18th annual B*A*S*H* will be held on FRIDAY NIGHT of the Hamvention, at the Conference Center (Madison Room) of the HARA ARENA AND CONFERENCE CENTER, (the same location as the Hamvention) starting at 7:00 PM. There is no admission charge, and free continuous entertainment. Hot dinner, sandwiches, snacks and beverages are available. Two exciting top awards, and many others. Stay right at HARA when the Hamvention closes on Friday evening and meet your friends and join us for an evening of fun and entertainment. Sponsored by the Miami Valley FM Association, PO Box 263, Dayton, Ohio 45401

OHIO: April 24. The Dayton-Cincinnati Chapter 9 of the QCWA announces the 1987 QCWA Banquet, Friday night of the Dayton Hamvention. Neil's Heritage House in Dayton. CODG bar at 6:30; dinner at 7:30. Tickets \$13.00 each. Contact Bob Ding, KA4LAU, 657 Dell Ridge Drive, Dayton, Ohio 45429. QCWA membership is not required to attend.

NEW JERSEY: May 9. The Cherryville Repeater Association's annual Hamfest, Hunterdon Central High School, Flemington, 8 AM to 4 PM. Indoor tables plus tailgating, FCC exams, forums displays and more. Talk in on 146.52, 147.975/.375. For further information or reservations call Bill Inkrote, K2NJ (201) 788-4080 or Don Mazak, NR2H (201) 782-1114.

COLORADO: June 20. The Grand Mesa Repeater Society will hold its 8th annual Western Slope Amateur Radio and Computer Swapfest, 9 AM to 4 PM, National Guard Armory, 482-28 Road, Grand Junction. Free admission. Swap tables \$5.00 each. Indoor swapfest, Amateur Radio exams, auction and refreshments. Talk in on 146.22/.82 and 449.20. For tables or information SASE to Les Scott, W0VF, 2105 Yellowstone Rd, Grand Junction, CO 81503 or call (303) 242-5296.

CALIFORNIA: May 1, 2, and 3: The Fresno Amateur Radio Club will hold its 45th annual Hamfest, Fresno Airport Holiday Inn. Air conditioned dealer spaces and swap tables. FCC exams. Good programs and parking. Demonstrations and forums. Talk in on 146.34-94. For information: Glen T. Caine, Fresno ARC, PO Box 783, Fresno, CA 93712 or (209) 292-4611.

INDIANA: April 4. The 4th annual Columbus Amateur Radio Club Swapfest, Bartholomew County Fairgrounds in Columbus, 8 AM to 5 PM. FCC testing. Advance setup Friday, April 3 with overnight security provided. Free parking. Talk in on 146.790 and 444.950. For information: Dave Mann, KA9UUP, 458N Country Club Rd, Columbus, IN 47201 (812) 342-6302

NEW YORK: May 3. The Suffolk County Radio Club's indoor/outdoor flea market, 8 AM to 2 PM, Republic Lodge No. 1987, 585 Broadhollow Road, Rt. 110, Melville, L.I. General admission \$3.00. Spouse and kids under 12 free. Indoor tables \$10. each. Outdoor spaces \$7.00 each. Includes one free admission. Talk in on 144.61/145.21 and 146.52 simplex. For information: Bill Sullivan, N2ETG (516) 689-9871 evenings.

TENNESSEE: April 5. The Clarksville Amateur Transmitting Society is sponsoring their annual Swapfest, National Guard Armory, Hwy 414, Clarksville. Tables \$5.00 each. Free admission. Talk in on 146.52 or 146.805-.600 or packet 145.03. For tables or information call WD4DBJ, Larry, (615) 232-6141.

NEW JERSEY: May 3. The Tri-County Radio Association's annual Indoor Hamfest/Flea Market, Passaic Township Community Center, Stirling, 9 AM to 3 PM. Donations \$3.00. Tables \$8.00; w/power \$10.00. Reserved tailgating. Refreshments. Talk in on 147.855/.255, 146.52 and 444.975/449.975. For information: Dick Franklin, W2EUF, POB 182, Westfield, NJ 07090. (201) 232-5955.

ARKANSAS: May 2. The Northwest Arkansas ARC will hold its 7th annual Hamfest, Rogers Youth Center, 315 West Olive Street, Rogers, 8 AM to 4 PM. Doors open 6 AM for exhibitors. General admission and parking free. Nearby recreational areas and parking for RV's and campers. Talk in on 16/76 or 03/63. For information: Roy Milliner, AF5W, 2014 S. 16th Street, Rogers, AR 72756 (501) 636-6750.

VIRGINIA: May 3. The Lynchburg ARC will hold its annual Swapfest, Brookville High School grounds, Route 460 West, just outside Lynchburg. Rain or shine. Starts 9 AM. Admission \$1.00. Tailgaters pay general admission plus \$2.00. VE exams beginning 1 PM. Please pre-register. For more information write Lynchburg ARC, PO Box 4242, Lynchburg, VA 24502.

OKLAHOMA: April 5. The Great Plains ARC's 6th annual Northwest Oklahoma Eyeball and Swapmeet, Mooreland, starting 9 AM. Admission \$2.00. Dealer and swap tables available at no charge. Covered dish dinner at noon. Local airport. VE tests Saturday, April 4. Campsites available. Talk in on 147.72/12, 146.13/73 and 146.52 simplex. For information write Gerald Bowman, WG5Z, Box 356 Mooreland, OK 73852 or call (405) 994-5600.

MINNESOTA: April 4. The 10th annual Rochester Area Hamfest, sponsored by the Rochester ARC, John Adams Junior High School, 1525 NW 31st Street, Rochester. Doors open 8:30 AM. Admission \$2.50 advance, \$3.00 at the door. Spouse and harmonics free admission. Tables \$8.00. Selling space \$4.00, bring own tables. License exams. Walk-ins only. Talk in on 146.22/82, W0MXXV. For information and advance tickets: RARC c/o W8OYEE, 2253 Nordic Ct NW, Rochester, MN 55901.

RHODE ISLAND: May 16. The RI Amateur FM Repeater Service will hold their annual Spring Flea Market and Auction, American Legion Fairmount Post 85, 870 River Street, Woonsocket. Flea market opens 9 AM and spaces are \$5.00 each. Auction from noon to 5 PM. Free admission. Food and beverages available. Talk in on 34/94 and 52 simplex. For information: Rick Fairweather, K1KYI, Box 591, Harrisville, RI 02830 or call (401) 56-8-0566, 7-9 PM.

MASSACHUSETTS: April 25. The Montachusett ARA will hold a flea market, Knights of Columbus Hall, Electric Avenue. 9:30 to 3 PM. Doors open 8 AM for sellers. Admission \$1.00. Tables \$8.00. Refreshments available. Talk in on 144.85/145.45 and 52. For reservations send check payable to MARA, c/o James Beauregard, 7 Mountain Avenue, Fitchburg, MA 01420.

SOUTH CAROLINA: May 2 and 3. The Blue Ridge Amateur Radio Society's 48th annual Greenville Hamfest and Electronic Flea Market, American Legion Fairgrounds, Greenville. Saturday 8 AM to 5 PM. Sunday 8 AM to 3 PM. Admission \$3.50 advance and \$5.00 at gate. Indoor/outdoor flea market, license exams, free parking, food. For tickets or information SASE to Blue Ridge ARA, PO Box 6751, Greenville, SC 29606.

NEW HAMPSHIRE: May 9. New England's favorite — The Hoss-traders Spring Tailgate Swapfest, Deerfield Fairgrounds. Admission \$2.00 per person including sellers and commercial dealers. Friday night camping at nominal fee only after 4 PM. Profits benefit Shriners' Burns Hospital. Last year's gift over \$13,500! For map, SASE to WA11VB, RFD Box 57, West Baldwin, ME 04091.

PENNSYLVANIA: May 3. The Delaware County ARA is sponsoring their 8th annual Hamfest, Drexel Hill Middle School, State Road and Penn Avenue, Drexel Hill. Doors open 8 AM. Setup 7 AM. Admission \$3. Reserved indoor tables/elect. available for \$3.00 per space. License exams. Refreshments available. Talk in on 147.96/36, 224.5 and 146.52. For registration and information write

Hamfest, DCARA, PO Bkox 236, Springfield, PA 19064 or call Barbara, N3DLG (215) 535-1616.

ONTARIO: April 11. The 6th annual Durham Region Flea Market sponsored by the South Pickering ARC, Pickering High School, Church Street N., Pickering Village, Ajax. Admission \$3.00. Children under 12 free. Tables \$6.00 each plus admission. For information: VE3DAX (416) 683-7562; VE3NBE (416) 839-9208; VE3JPP (416) 282-3983.

WEST VIRGINIA: April 5. Charleston WV Area Hamfest and Computer Show in Charleston Civic Center, 8 AM to 5 PM. Admission \$4.00. Forums, SSTV, Packet, Flea Market and Swap Tables. Computer demos, ARRL booth. Talk in on 6.22/6.88. For information: Ollis Rinehart, K8TIK, 1258 Ridge Drive, South Charleston, wV 25303. (304) 768-9534.

WISCONSIN: May 2. The Ozaukee Radio Club will sponsor its 8th annual Cedarburg Swapfest, Circle B Recreation Center, Highway 60 and County J, Cedarburg, 8 AM to 1 PM. Admission \$2.00 advance, \$3.00 at the door. 4 tables \$3.00 each. Food and refreshments available. For tickets, reservations or information SASE to 1987 ORC Swapfest, 101 E. Clay Street, Saukville, WI 53080 or phone (414) 284-3271.

TEXAS: April 18. The Austin ARC's Spring Swapfest, Mancha-ca Fire Station on FM 1626. Open 7 AM. Free admission and parking. Tables \$2.00. Talk in on 146.18/78. For info: Dave Harper, WD5N, 109 W. 38, Austin, TX 78705. Tel (512) 454-9206 evenings.

NEW JERSEY: May 17. The Bergen County ARA is sponsoring its Spring Hamfest, Bergen Community College, 400 Paramus Road, Paramus, 8 to 4 PM. Rain or shine. Buyers free. Sellers \$5 per space, tailgate only. License exams. Talk in on 146.19/79 and 520 simplex. For further information: Jim, KK2U (201) 445-2855, 444 Berkshire Rd, Ridgewood, NJ 07450.

WISCONSIN: April 5. The Madison Area Repeater Association, (M.A.R.A.) is please to announce its 15th annual Madison Swapfest, Dane County Exposition Center Forum Building, Madison. Doors open 7:30 AM for flea market sellers and 8 AM for the general public. An all-you-can-eat pancake breakfast available at the Swapfest. Admission \$2.50 advance and \$3.00 at the door. Children twelve and under admitted free. Flea market tables \$5.00 each/advance and \$6.00/door plus admission. The deadline for tickets and table reservations is March 31, 1987. For tickets, tables or information write M.A.R.A., PO Box 3403, Madison, WI 53704 or call (608) 274-5153 day or night.

OPERATING EVENTS

"Things to do . . ."

April 25. The Great River ARC of Dubuque, Iowa will operate N9GBY from 1600Z to 2300Z at the site of the annual Boy Scouts of America Grant Pilgrimage in Galena, Illinois. For a QSL card SASE to N9GBY, PO Box 141, Galena, IL 61036.

April 11. The St. Charles ARC will operate W0H0SI from 1400Z to 2200Z to celebrate its 15th anniversary near its original meeting site in St. Charles, MO. For certificates SASE to St. Charles ARC, PO Box 1429, St. Charles, MO 63302.

April 10, 11, 12. The Lanierland ARC will operate W4IKR 1400Z to 2200Z each day. To honor the 50th anniversary of the completion of the Appalachian trail, the 2000 mile hiking trail from Springer Mt. in Georgia to Mt. Katahdin in Maine. For commemorative certificate send QSL and 9x12 SASE (39 cents) to Lanierland ARC, PO Box 2182, Gainesville, GA 30503.

THE FOUNDATION FOR AMATEUR RADIO, INC. plans to award 26 scholarships for academic year 1987-88 to assist licensed Radio Amateurs who plan to pursue a full-time course of studies beyond high school and are enrolled or have been accepted by an accredited university, college or technical school. For further information write FAR Scholarships, 6903 Rhode Island Avenue, College Park, MD 20740 prior to May 31, 1987.

ARMED FORCES DAY 1987 May 16. The 38th annual Armed Forces Day Communication Test. Traditional military-to-Amateur cross band operation and broadcast of the Secretary of Defense message are the featured highlights and include operations in CW, SSB and RTTY.

CHARGE YOUR CLASSIFIED ADS

to your MC or VISA write or call
HAM RADIO MAGAZINE
 Greenville, NH 03048
 (603) 878-1441

RF TRANSISTORS

		2-30 MHz 12V (* - 28V)		
P/N	Rating	Net Ea.	Match Pr.	
MRF412, A	80W	\$18.00	\$45.00	
MRF421	Q 100W	22.50	51.00	
MRF422*	150W	38.00	82.00	
MRF426, A*	25W	12.00	42.00	
MRF433	12.5W	18.00	30.00	
MRF449, A	Q 30W	12.50	30.00	
MRF450, A	Q 50W	14.00	31.00	
MRF453, A	Q 80W	15.00	35.00	
MRF454, A	Q 80W	15.00	34.00	
MRF455, A	Q 80W	12.00	28.00	
MRF458	80W	20.00	46.00	
MRF475	12W	3.00	9.00	
MRF476	3W	2.75	8.00	
MRF477	40W	11.00	25.00	
MRF479	15W	10.00	23.00	
MRF485*	15W	8.00	15.00	
MRF492	Q 90W	16.75	37.50	
SRF2072	Q 65W	13.00	30.00	
SRF3662	Q 110W	25.00	54.00	
SRF3775	Q 75W	14.00	32.00	
SRF3795	Q 90W	16.50	37.00	
3800	Q 100W	18.75	41.00	
2SC2290	80W	19.75	45.50	
2SC2879	Q 100W	25.00	56.00	

Q = Selected High Gain Matched Quads Available

		VHF/UHF TRANSISTORS		
P/N	Rating	MHz	Net Ea.	Match Pr.
MRF224	40W	136-174	13.50	32.00
MRF237	4W	136-174	3.00	—
MRF238	30W	136-174	13.00	30.00
MRF239	30W	136-174	15.00	35.00
MRF240, A	40W	136-174	18.00	41.00
MRF245	80W	136-174	28.00	65.00
MRF247	75W	136-174	27.00	63.00
MRF607	1.75W	136-174	3.00	—
MRF641	15W	407-512	22.00	49.00
MRF644	25W	407-512	24.00	54.00
MRF646	40W	407-512	26.50	59.00
MRF648	60W	407-512	33.00	69.00
SD1441	150W	136-174	74.50	170.00
SD1447	100W	136-174	32.50	78.00
2N5591	25W	136-174	13.50	34.00
2N6080	4W	136-174	7.75	—
2N6081	15W	136-174	9.00	—
2N6082	25W	136-174	10.50	—
2N6083	30W	136-174	11.50	24.00
2N6084	40W	136-174	13.00	31.00

		MISC. TRANSISTORS & MODULES		
MRF134	\$18.00	MRF497	14.25	
MRF136	21.00	2N1522	10.50	
MRF136Y	70.00	2N3966	1.25	
MRF137	24.00	2N4048	10.50	
MRF138	35.00	2N4427	1.25	
MRF140	89.50	2N5590	10.00	
MRF148	35.00	2N5642	13.75	
MRF150	89.50	2N5643	15.00	
MRF172	82.00	2N5646	18.00	
MRF174	80.00	2N5945	10.00	
MRF208	11.50	2N5946	13.00	
MRF212	16.00	2SC2097	29.50	
MRF221	10.00	2SC2237	13.50	
MRF260	7.00	2SC1960	3.00	
MRF261	9.00	S10-12	13.50	
MRF262	9.00	SAV6	34.50	
MRF264	13.00	SAV7	34.50	
MRF406	14.50	SC1019	59.90	
MRF428	55.00	SC1027	47.50	
NE41137	3.50	M57737	47.50	

Selected, matched finals for Icom, Atlas, Yaesu, KLM, Kenwood, Cubic, TWC, etc. Technical assistance and cross-reference on CD, PT, SD, SRF and 2SC P/Ns.

Quantity parts users — call for quote
WE SHIP SAME DAY • C.O.D./VISA/MC
 Minimum Order — Twenty Dollars
 (619) 744-0728
 FAX: (619) 744-1943



RF PARTS

1320-16 Grand Avenue
 San Marcos, CA 92069

Step up

to the world's most-advanced antenna system!

WITH NOT A SINGLE WATT WASTED IN LOSSY TRAPS! (There aren't any!)

Hams in over 50 DXCC countries have done so already!

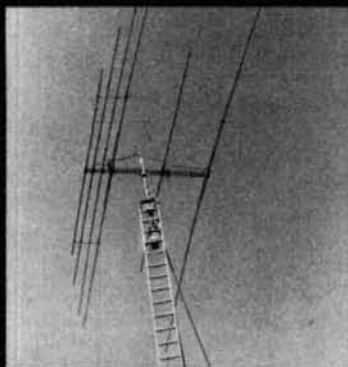

The DJ2UT-Multiband-Systems offer:

- Maximum gain plus F/B ratio with low VSWR across each band
- 2 kW CW output power
- 10/15/20/(30) 40-meter bands with up to 7 band coverage incl. WARC bands with self-supporting "TWIN-BOOM" and boom-legths from 8 to 20 ft
- Air-core teflon dielectric coax-balun and stainless-steel hardware at no extra cost
- traditional Blackforest craftsmanship

The DJ2UT-MULTIBANDERS provide the superior full-size monoband-beam performance required during the present sunspot minimum.

For further information contact:

SOMMER

H.J. Theiler Corp.
P.O. Box 5369
Spartanburg, SC 29304
(803) 576-5566

or our distributor in Canada:
Dollard's Radio West
P.O. Box 58236
762 S.W. Marine Drive
Vancouver, B.C. V6P 6E3

Selected dealerships available.

ADVERTISER'S INDEX AND READER SERVICE NUMBERS

Listed below are the page number and reader service number for each company advertising in this issue. To get more information on their advertised products, use the bind-in card found elsewhere in this issue, select the correct reader service number from either the ad or this listing, check off the numbers, fill in your name and address, affix a postage stamp and return to us. We will promptly forward your request to the advertiser and your requested information should arrive shortly. If the card is missing, send all the pertinent information on a separate sheet of paper to: *ham radio* magazine, Attn: Reader Service, Greenville, NH 03048.

READER SERVICE #	PAGE #	READER SERVICE #	PAGE #
130 - Advanced Computer Controls.....	99, 101, 103	194 - MFJ Enterprises	13
158 - Advanced Receiver Research	69	157 - Micro Control Specialties	62
153 - AEA	76	143 - Micro Systems Institute	92
111 - All Electronics Corp	110	172 - Midland Technologies	48
180 - Alpha Delta Communications	37	174 - Mirage Communications	51
* - Amateur Electronic Supply	96	184 - Mirage Communications	28
178 - Amateur Packet Alaska	43	188 - Mirage Communications	22
124 - Amateur Wholesale Electronics.....	104	173 - Mission Communications	48
108 - American Reliance, Inc.	112	162 - Missouri Radio Center	67
156 - AMSAT	62	136 - Motron Electronics.....	101
132 - Antennas Etc.....	103	110 - NCG	113
114 - Antique Electronic Supply	111	185 - Nel-Tech Labs, Inc.	26
200 - Antique Radio Classified	48	133 - Nema Electronics	101
169 - Arnold Co	48	140 - Nuts & Volts	95
150 - ARRL	83	* - Opportunity	106
154 - Astron Corp	73	187 - P.C. Electronics	23
* - Barker & Williamson	37	105 - Pac-Comm Packet Radio Systems, Inc.	112
* - Barry Electronics	111	127 - Pacific Rim Communications	104
166 - Bilal Company	54	170 - Palomar Engineers	48
144 - Buckmaster Publishing	92	113 - Processor Concepts	111
171 - Buckmaster Publishing	48	129 - The PX Shack	105
* - Butternut Electronics	100	151 - Radio Amateur Callbook	82
* - C.O.M.B.	43	182 - Radiosporting	38
* - Caddell Coil Corp	84	118 - Ramsey Electronics, Inc.	109
149 - California Packet Concepts	84	* - RF Parts	117
128 - Coaxial Dynamics, Inc.	105	164 - Robot Research, Inc.	59
198 - Communication Concepts, Inc.	87	160 - Roensch Microwave	69
103 - Communications Specialists	120	109 - S-Com	113
141 - CTM	94	167 - Satman	54
* - Dayton Hamvention	119	181 - Sias Engineering Co	38
119 - Digitrex	107	122 - Silicon Solutions	106
137 - Down East Microwave	99	104 - Sommer	118
121 - Eaglestone	107	* - Spec-Com	100
175 - EGE, Inc.	46	192 - Spectrum International	17
* - Engineering Consulting	92	116 - Spi-Ro Manufacturing Co	108
* - Falcon Communications	107	117 - Stone Mountain Engineering Co	108
161 - Fluke Manufacturing Co	69	125 - Stridsburg Engineering Co	104
186 - GLB Electronics	27	155 - STV/OnSat	72
165 - Grove Enterprises.....	54	135 - Synthetic Textiles, Inc.	101
138 - H.L. Heaster, Inc.	99	177 - TE Systems	43
193 - HAL Communications Corp.	18	189 - Tel-Com	20
183 - Hal-Tronix	32	145 - Telewave, Inc.	87
179 - Hall Electronics	43	106 - Testware	112
* - Ham-Com 1987	26	112 - Texas Radio Products	111
* - Ham Radio Magazine	99	191 - Torontel Technology Systems Ltd.	20
163 - Ham Radio Outlet	60, 61	201 - Total Electronic Concepts	115
* - Ham Radio's Bookstore.....	17, 42, 62, 72, 110, 111	199 - Transverters Unlimited.....	100
* - The Ham Station.....	42	148 - Unity Electronics	87
* - Hamtronics, NY	88	* - University Microfilm Int.	20
* - Hamtronics, PA	113	142 - Vanguard Labs	92
176 - ICOM America, Inc.	44, 45	195 - Varian	16
197 - ICOM America, Inc.	CII	159 - W9INN Antennas	69
139 - IIX Equipment Ltd.	99	123 - Western Electronics	106
107 - Interceptor Electronics, Inc.	112	102 - Yaesu Electronics Corp	CIII
120 - International Radio	107	168 - Yaesu Electronics Corp	52, 53
115 - Jun's Electronics	108	134 - E.H. Yost Co	101
146 - Kagil	87		
196 - Kantronics.....	1		
* - Trio-Kenwood Communications	2, 5, 7, 15, CIV		
152 - Madison Electronics Supply	80		
147 - Elaine Martin, Inc.	87		
190 - Glen Martin Engineering, Inc.	20		
131 - The Meadowlake Corp	103		
126 - Metal & Cable Corp.....	104		

PRODUCT REVIEW/NEW PRODUCTS

* - Design Electronics of Ohio	102
302 - Encomm, Inc.	108
303 - ICOM America, Inc.	106
301 - RF Concepts	108
* - Universal Electronics	102

*Please contact this advertiser directly.

Limit 15 inquiries per request.

Please use before May 31, 1987.

DAYTON **HAMVENTION**

April 24, 25, 26, 1987

Early Reservation Information

• General Chairman, Jim Simpson, WB8QZZ

• Asst. General Chairman, Bill McNabb, WD8SAY

Grand banquet tickets are limited, please place your reservations early.

- **Giant 3 day flea market • Exhibits**
- **Door prizes • License exams**
- **CW proficiency test**

Flea Market Tickets

We increased Flea Market area by nearly 400 spaces this year and all were sold out by January 10.

Special Awards

Nominations are requested for "Radio Amateur of the Year", "Special Achievement" and "Technical Achievement" awards. Contact: Awards chairman, Box 44, Dayton, OH 45401.

License Exam

Novice thru extra exams scheduled Saturday & Sunday by appointment only. Send current FCC form 610, copy of present license and check for \$4.35 (payable to ARRL/VEC) to: Exam Registration, 8830 Windbluff Point, Dayton Oh 45459

Slide Show

35 mm slide/tape presentation about the HAMVENTION is available for loan. Contact Dick Miller 2853 La Cresta, Beavercreek, OH 45324

Parking

Free parking is available at Hara Arena. In addition, there will be free shuttle bus service from all major motels and designated parking lots. Parking and road information will be available on DARA's 146.34/.94 repeater.

Free Bus Service

Free Bus Service will be provided between many Motels and Hara Arena. See the schedules at the motel registration desks. Avoid parking problems at the Arena by taking the HAMVENTION buses.

Campers & Trailers

Campers and Trailers may be parked at Montgomery County Joint Vocational School. A HAMVENTION bus will provide transportation between the camper parking area and the Arena. No campers or travel trailers will be permitted to park in the Arena lot or Flea Market area.

Wheelchairs

Wheelchairs will be available. Send S.A.S.E. for details to "Wheelchair" P.O. Box 44, Dayton, OH 45401.

Alternate Activities

HAMVENTION is for everyone. We have planned activities for the YL or your non-ham family members.

Deadlines

Award Nominations: April 4
Lodging: April 4
License Exams: March 28
Advance Registration and banquet: USA - April 11
Canada - April 4

Information

General Information: (513) 433-7720
or DARA Box 44 Dayton, OH 45401
Flea Market Information: (513) 223-0923
Lodging Information: (513) 223-2612
(No Reservations By Phone)

This is the year for you to attend the internationally famous Dayton HAMVENTION. Come with your friends to hear enlightening forums, see the latest equipment, and visit a flea market that has everything! No matter what you are looking for, you can find it in Dayton!

HAMVENTION is sponsored by the Dayton Amateur Radio Association Inc.



Food for thought.

Our new Universal Tone Encoder lends its versatility to all tastes. The menu includes all CTCSS, as well as Burst Tones, Touch Tones, and Test Tones. No counter or test equipment required to set frequency—just dial it in. While traveling, use it on your Amateur transceiver to access tone operated systems, or in your service van to check out your customers' repeaters; also, as a piece of test equipment to modulate your Service Monitor or signal generator. It can even operate off an internal nine volt battery, and is available for one day delivery, backed by our one year warranty.

- All tones in Group A and Group B are included.
- Output level flat to within 1.5db over entire range selected.
- Separate level adjust pots and output connections for each tone Group.
- Immune to RF
- Powered by 6-30vdc, unregulated at 8 ma.
- Low impedance, low distortion, adjustable sinewave output, 5v peak-to-peak
- Instant start-up.
- Off position for no tone output.
- Reverse polarity protection built-in.

Group A

67.0 XZ	91.5 ZZ	118.8 2B	156.7 5A
71.9 XA	94.8 ZA	123.0 3Z	162.2 5B
74.4 WA	97.4 ZB	127.3 3A	167.9 6Z
77.0 XB	100.0 1Z	131.8 3B	173.8 6A
79.7 SP	103.5 1A	136.5 4Z	179.9 6B
82.5 YZ	107.2 1B	141.3 4A	186.2 7Z
85.4 YA	110.9 2Z	146.2 4B	192.8 7A
88.5 YB	114.8 2A	151.4 5Z	203.5 M1

- Frequency accuracy, $\pm .1$ Hz maximum - 40°C to + 85°C
- Frequencies to 250 Hz available on special order
- Continuous tone

Group B

TEST-TONES:	TOUCH-TONES:	BURST TONES:			
600	697 1209	1600	1850	2150	2400
1000	770 1336	1650	1900	2200	2450
1500	852 1477	1700	1950	2250	2500
2175	941 1633	1750	2000	2300	2550
2805		1800	2100	2350	

- Frequency accuracy, ± 1 Hz maximum - 40°C to + 85°C
- Tone length approximately 300 ms. May be lengthened, shortened or eliminated by changing value of resistor

Model TE-64 \$79.95

 **COMMUNICATIONS SPECIALISTS**

426 West Taft Avenue, Orange, California 92667
(800) 854-0547/ California: (714) 998-3021



One of the most complex operating controls of our high-performance mobiles.



You don't have to sacrifice performance to gain simplicity in your mobile operation.

Yaesu's 2-meter FT-211RH and 440-MHz FT-711RH give you all the performance you look for in a sophisticated, microprocessor-controlled mobile.

With controls that couldn't be more straightforward and easy to learn. Which means no

radios are based on the very same technology.

To begin with, you get an autodialer mic with 10 lithium backed memories, each capable of storing any key sequence up to 22 digits long.

Plus you get: 45 watts output (35 watts on 440 MHz). LCD readout. 10 memories that store frequency, offset and PL tone.

(7 memories can store odd splits.) Scan all memories or selected memories at 2 frequencies per second. Band scan at 10 frequencies per second. Tx offset storage. Priority channel scan.

Tuning via tuning knob, or up/down buttons. PL tone board (optional). PL display.

Independent PL memory per channel. PL encode *and* decode. LCD power output and "S"-meter display. Eight-key control pad. Keypad lock. High/low power switch (low power: 5 watts VHF, 3 watts UHF).

What's more, each radio is perfect for overhead mounting. Just remove a few screws and flip the control panel 180°

Discover the 2-meter FT-211RH and 440-MHz FT-711RH at your nearest Yaesu dealer today. If you can turn a knob and push a button, you'll have high-performance mobile operation mastered.

YAESU



operating complexities to interfere with your driving.

In fact, if you own our handheld FT-23R, you've already learned how to use our FT-211RH and FT-711RH. Because all three



Yaesu USA 17210 Edwards Road, Cerritos, CA 90701 (213) 404-2700. Repair Service: (213) 404-4884. Parts: (213) 404-4847
 Yaesu Cincinnati Service Center 9070 Gold Park Drive, Hamilton, OH 45011 (513) 874-3100.

Prices and specifications subject to change without notice. PL is a registered trademark of Motorola, Inc.

KENWOOD

...pacesetter in Amateur radio

All New Compact HF

“DX-citing!”

TS-440S Compact high performance HF transceiver with general coverage receiver

Kenwood's advanced digital know-how brings Amateurs world-wide "big-rig" performance in a compact package. We call it "Digital DX-citement"—that special feeling you get every time you turn the power on!

Covers All Amateur bands

General coverage receiver tunes from 100 kHz—30 MHz. Easily modified for HF MARS operation.

Direct keyboard entry of frequency

All modes built-in USB, LSB, CW, AM, FM, and AFSK. Mode selection is verified in Morse Code.

Built-in automatic antenna tuner (optional)

Covers 80-10 meters.

VS-1 voice synthesizer (optional)

Superior receiver dynamic range

Kenwood DynaMix™ high sensitivity direct mixing system ensures true 102 dB receiver dynamic range. (500 Hz bandwidth on 20 m)

100% duty cycle transmitter

Super efficient cooling permits continuous key-down for periods exceeding one hour. RF input power is rated at 200 W PEP on SSB, 200 W DC on CW, AFSK, FM, and 110 W DC AM. (The PS-50 power supply is needed for continuous duty.)

Adjustable dial torque

100 memory channels
Frequency and mode may be stored in 10 groups of 10 channels each. Split frequencies may be stored in 10 channels for repeater operation.

TU-8 CTCSS unit (optional)

Subtone is memorized when TU-8 is installed.

Superb interference reduction

IF shift, tuneable notch filter, noise blanker, all-mode squelch, RF attenuator, RIT/XIT, and optional filters fight QRM.

MC-43S UP/DOWN mic. included

Computer interface port

5 IF filter functions

Dual SSB IF filtering

A built-in SSB filter is standard. When an optional SSB filter (YK-88S or YK-88SN) is installed, dual filtering is provided.

VOX, full or semi break-in CW

AMTOR compatible

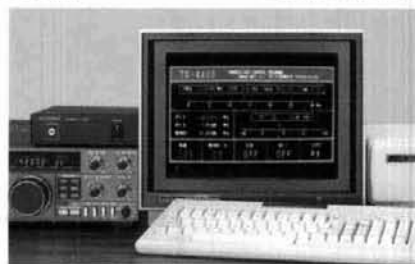

Optional accessories:

- AT-440 internal auto. antenna tuner (80 m—10 m)
- AT-250 external auto. tuner (160 m—10 m)
- AT-130 compact mobile antenna tuner (160 m—10 m)
- IF-232C/IC-10 level translator and modem IC kit
- PS-50 heavy duty power supply
- PS-430/PS-30 DC power supply
- SP-430 external speaker
- MB-430 mobile mounting bracket
- YK-88C/88CN 500 Hz/270 Hz CW filters
- YK-88S/88SN 2.4 kHz/1.8 kHz SSB filters
- MC-60A/80/85 desk microphones
- MC-55 (8P) mobile microphone
- HS-5/6/7 headphones
- SP-40/50B mobile speakers
- MA-5/VP-1 HF 5 band mobile helical antenna and bumper mount
- TL-922A 2 kw PEP linear amplifier
- SM-220 station monitor
- VS-1 voice synthesizer
- SW-100A/200A/2000 SWR/power meters
- TU-8 CTCSS tone unit
- PG-2S extra DC cable.

Kenwood takes you from HF to OSCAR!



Complete service manuals are available for all Trio-Kenwood transceivers and most accessories. Specifications and prices are subject to change without notice or obligation.

KENWOOD

TRIO-KENWOOD COMMUNICATIONS
1111 West Walnut Street
Compton, California 90220