

# ham radio magazine

*Design RF filters  
on your  
home computer*

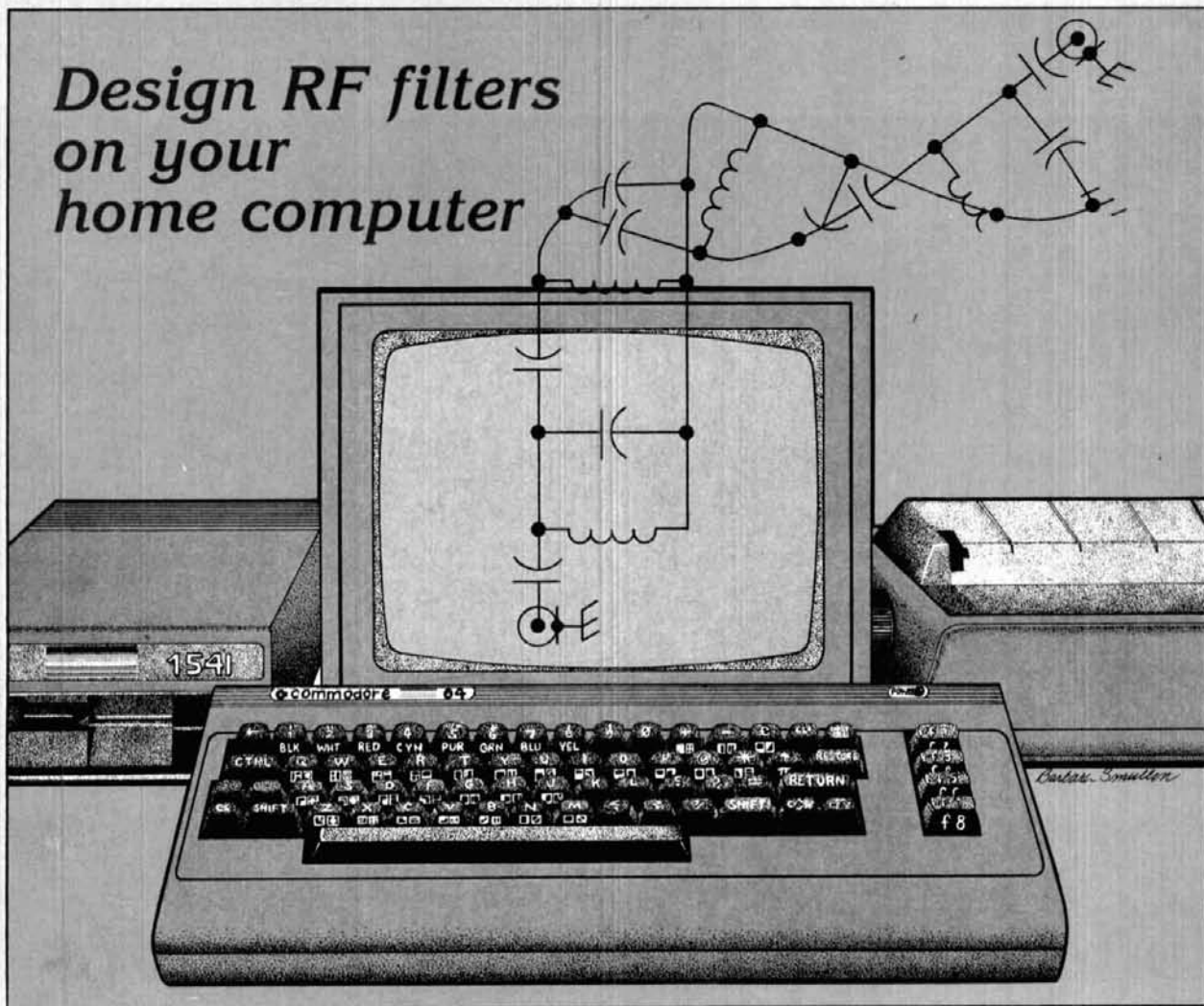

focus  
on  
communications  
technology

monolithic RF amplifiers • VSWR bridges • modifying the Yaesu FT 301 for 30-meter coverage • converting mobile microphones for handheld VHF transceivers • remote repeater programming • plus W1JR, W6SAI, KØRYW, W9JUV, W6MGI, and K4IPV

ICOM HF Transceiver

# IC-745



## High Performance Maximum Flexibility

The IC-745 is a full featured, high performance HF base station transceiver with a 100dB dynamic range receiver. PLUS features usually found only in more expensive units.

Compare these exceptional Standard Features:

- 100KHz - 30MHz Receiver
- 100 Watt RF output / 100% Duty Cycle
- Passband Tuning AND IF Shift
- Adjustable Noise Blanker (width and level)
- Adjustable AGC
- Receiver Preamp
- 16 tunable Memories with lithium battery backup



- Wide selection of filters and filter combinations (opt.)
- Continuously adjustable transmit power
- 10Hz/50Hz/1KHz Tuning rates with 1MHz band steps
- IC-HM12 Microphone with Up/Down Scan

**Other Standard Features.** Included as standard are many of the features most asked for by experienced ham radio operators: dual VFO's, RF speech compressor, tunable notch filter, program band scan, memory scan, all-mode squelch and VOX.

**Options.** Internal IC-PS35 power supply, external IC-PS15 or IC-PS30 system supply, IC-SM8 two-cable desk mic, EX241 marker, EX242 FM module, EX243 electronic keyer, IC-SM6 desk mic, and a variety of filters.

Filter	-6dB Width	Center Freq. MHz
FL45	500 Hz	9.000
FL54	270 Hz	9.000
FL44A	2.1 KHz	0.455
FL52A	500 Hz	0.455
FL53A	250 Hz	0.455

The IC-745 is the only transceiver today that has so much flexibility at a suprisingly low price...see it at your local ICOM dealer.

 **ICOM**  
First in Communications

# Kantronics "SMARTS"

Presenting three intelligent, versatile, compatible terminal units.

"SMART" means an internal microprocessor is used to improve performance and add versatility. The "Smart" Kantronics TU's can transmit and receive CW/RTTY/ASCII/AMTOR or Packet when combined with your computer and transceiver.

Any computer with a serial RS232 or TTL port can connect directly to a Kantronics TU. A simple terminal program, like one used with a telephone modem, is the only additional program required. Kantronics currently offers Pac-term and UTU Terminal Programs for IBM, Kaypro, Commodore 64, VIC 20, and TRS-80 Models III, IV, and IVP. Disk version \$19.95. Cartridge \$24.95.

**UTU** The Universal Terminal unit (UTU) is the original "Smart" amateur TU. CW, RTTY, ASCII, and AMTOR can all be worked with this single unit. Switched capacitance filters and LED display tuning make using the UTU easy for even the Novice. 12 Vdc 300mv power supply required. Suggested retail \$199.95.

**UTU-XT** The UTU-XT is an enhanced version of the UTU. Programmable baud rates, tone frequencies, and tone shifts give special versatility. Automatic Gain Control and Threshold Correction circuits greatly enhance sensitivity and selectivity. A RTTY signal detect circuit mutes copy with no carrier, and the CW filter center frequency and bandwidth are programmable. Power supply is provided. Suggested retail \$359.95.



**NEW!**

**KPC-2** Kantronics AX.25 Version 2 TNC features a built-in HF modem, full duplex operation, multiple connects, and over 100 software commands. A serial RS-232 or TTL (C-64/VIC-20) port gives universal compatibility. The enhanced generic command structure fits any computer, even PC compatibles. All this combines to make KPC-2 the only TNC you'll ever need. Suggested retail \$219.00.

For more information contact your local Kantronics dealer or write:

136

**Kantronics**

1202 E. 23rd Street 19131 842-7745  
Lawrence Kansas 66046



# KENWOOD

...pacesetter in Amateur radio

**NEW!**  
Computer Interface!

## “DX-cellence!”

### TS-940S

The new TS-940S is a serious radio for the serious operator. Superb interference reduction circuits and high dynamic range receiver combine with superior transmitter design to give you no-nonsense, no compromise performance that gets your signals through! The exclusive multi-function LCD sub display graphically illustrates VBT, SSB slope, and other features.

- 100% duty cycle transmitter. Super efficient cooling system using special air ducting works with the internal heavy-duty power supply to allow continuous transmission at full power output for periods exceeding one hour.
- High stability, dual digital VFOs. An optical encoder and the flywheel VFO knob give the TS-940S a positive tuning “feel.”
- Graphic display of operating features. Exclusive multi-function LCD sub-

display panel shows CW VBT, SSB slope tuning, as well as frequency, time, and AT-940 antenna tuner status.

- Low distortion transmitter. Kenwood's unique transmitter design delivers top “quality Kenwood” sound.
  - Keyboard entry frequency selection. Operating frequencies may be directly entered into the TS-940S without using the VFO knob.
  - QRM-fighting features. Remove “rotten QRM” with the SSB slope tuning, CW VBT, notch filter, AF tune, and CW pitch controls.
  - Built-in FM, plus SSB, CW, AM, FSK.
  - Semi or full break-in (QSK) CW.
  - 40 memory channels. Mode and frequency may be stored in 4 groups of 10 channels each.
  - Programmable scanning.
  - General coverage receiver. Tunes from 150 kHz to 30 MHz.
  - 1 yr. limited warranty. Another Kenwood First!
- Optional accessories:  
• AT-940 full range (160-10m) automatic antenna tuner • SP-940 external

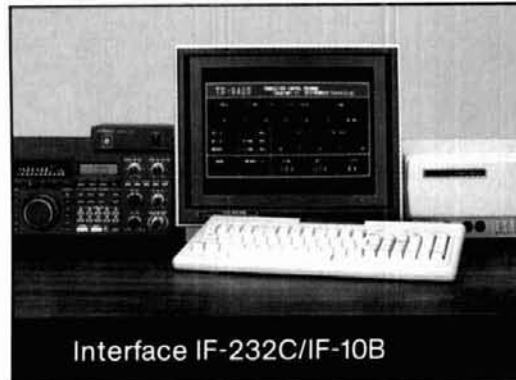

Interface IF-232C/IF-10B

speaker with audio filtering • YG-455C-1 (500 Hz), YG-455CN-1 (250 Hz), YK-88C-1 (500 Hz) CW filters; YK-88A-1 (6 kHz) AM filter • VS-1 voice synthesizer • SO-1 temperature compensated crystal oscillator • MC-42S UP/DOWN hand mic. • MC-60A, MC-80, MC-85 deluxe base station mics. • PC-1A phone patch • TL-922A linear amplifier • SM-220 station monitor • BS-8 pan display • SW-200A and SW-2000 SWR and power meters.

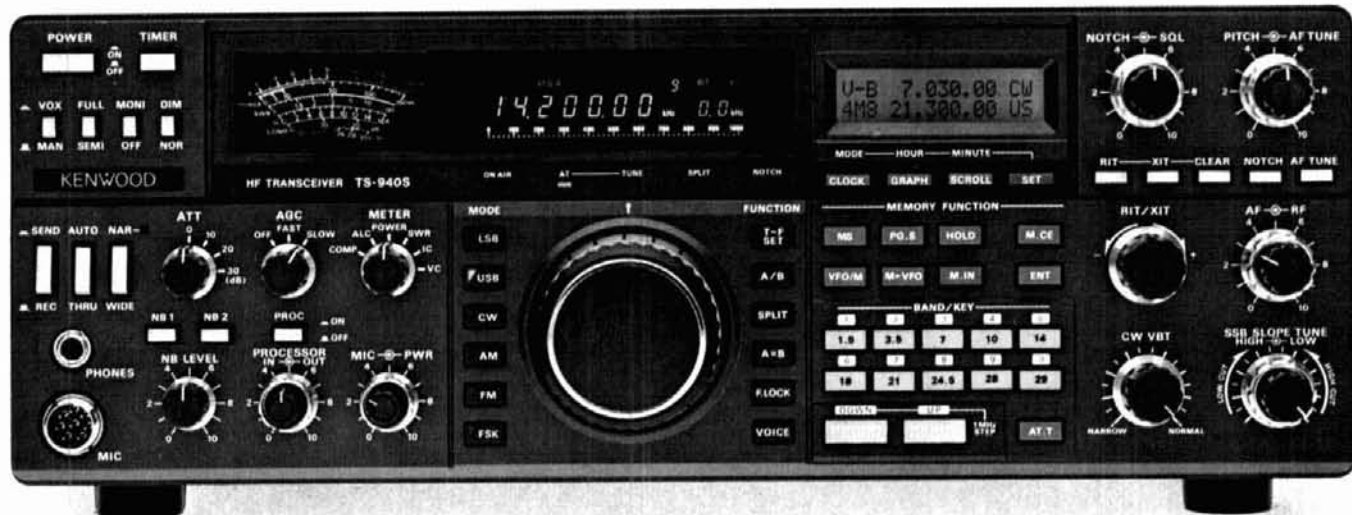

25th  
Anniversary

Complete service manuals are available for all Trio-Kenwood transceivers and most accessories. Specifications and prices are subject to change without notice or obligation.



More TS-940S information is available from authorized Kenwood dealers.

## KENWOOD

TRIO-KENWOOD COMMUNICATIONS  
1111 West Walnut Street  
Compton, California 90220



# ham radio

magazine

**MARCH 1986**

volume 19, number 3

**T. H. Tenney, Jr., W1NLB**  
publisher

**Rich Rosen, K2RR**  
editor-in-chief  
and associate publisher

**Dorothy Rosa, KA1LBO**  
assistant editor

Joseph J. Schroeder, W9JUV  
Alfred Wilson, W6NIF  
associate editors  
Susan Shorrock  
editorial production

#### editorial review board

Peter Bertini, K1ZJH  
Forrest Gehrke, K2BT  
Michael Gruchalla, P.E.  
Bob Lewis, W2EBS  
Mason Logan, K4MT  
Ed Wetherhold, W3NQN

#### publishing staff

**J. Craig Clark, Jr., N1ACH**  
assistant publisher

**Rally Dennis, KA1JWF**  
director of advertising sales

Dorothy Sargent, KA1ZK  
advertising production manager  
Susan Shorrock  
circulation manager

Therese Bourgault  
circulation

cover art:  
Barbara Smullen

ham radio magazine is published monthly by  
Communications Technology, Inc.  
Greenville, New Hampshire 03048-0498  
Telephone: 603-878-1441

#### subscription rates

United States:  
one year, \$22.95; two years, \$38.95; three years, \$49.95  
Canada and other countries (via surface mail):  
one year, \$31.00; two years, \$55.00; three years, \$74.00  
Europe, Japan, Africa (via Air Forwarding Service): one year, \$37.00  
All subscription orders payable in U.S. funds, via international  
postal money order or check drawn on U.S. bank

international subscription agents: page 112

Microfilm copies are available from  
University Microfilms, International  
Ann Arbor, Michigan 48106  
Order publication number 3076

Cassette tapes of selected articles from ham radio  
are available to the blind and physically handicapped  
from Recorded Periodicals,  
919 Walnut Street, Philadelphia, Pennsylvania 19107

Copyright 1986 by Communications Technology, Inc.  
Title registered at U.S. Patent Office

Second-class postage paid  
at Greenville, New Hampshire 03048-0498  
and at additional mailing offices  
ISSN 0148-5989

Send change of address to ham radio  
Greenville, New Hampshire 03048-0498



## contents

- 10 build narrowband RF filters**  
Bob Lombardi, WB4EHS
- 22 monolithic RF amplifiers**  
Jerry Hinshaw, N6JH
- 37 VSWR bridges**  
Will Herzog, K2LB
- 42 modifying the Yaesu FT-301 for  
30-meter coverage**  
Warren Offut, AF9Q
- 55 practically speaking**  
Joe Carr, K4IPV
- 63 ham radio techniques**  
Bill Orr, W6SAI
- 68 VHF/UHF world**  
Joe Reisert, W1JR
- 79 the weekender: converting mobile  
microphones for handheld VHF tran-  
sceivers**  
Edward A. Richley, KD8KZ, and Frank M. Caimi,  
WB3JCC
- 89 remote repeater programming using a  
computer and a telephone**  
John R. Kaiser, KD9BC
- 117 the Guerri report**  
Ernie Guerri, W6MGI
- 118 advertisers index**      **110 ham mart**  
**and reader service**      **103 new products**  
**9 comments**              **6 presstop**  
**97 DX forecaster**        **4 reflections**  
**112 flea market**

# REFLECTIONS REFLECTIONS

## an increasingly important design tool

Years back the typical approach to filter design was to decide on the required characteristics, choose the best topography, or type, consult charts (e.g. the ITT *Handbook*), evaluate formulas, and — voila! — the circuit evolved.

Perhaps after this procedure was applied it met one's specific goals in terms of passband, stopband, ripple, and VSWR responses, in addition to input and output matching. At best, however, even at this paper design stage, it involved an iterative process whose speed of convergence to the required performance parameters greatly depended on the accuracy of the educated guesses made by the filter designer. A designer with good hands-on RF experience was often successful, but nevertheless needed time to determine if the design was truly optimum.

The fun would then begin in earnest with the selection of physically-realizable components (reasonable inductor  $Q$ ), construction, and tweaking. If the designer was fortunate enough to have a sweeper, delay lines, a wide video bandwidth scope, and other necessary test instrumentation, an actual circuit could be built, aligned, and applied. But even then the nagging thought would persist: *is this an optimum design?* And what if one particular characteristic — ripple, perhaps — were changed for improvement in another response . . . better stopband rejection, for example?

This process changed, to a large extent, with the advent of the personal computer and filter software routines. Thanks to programs like the one WB4EHS describes in "Build Narrowband RF Filters," this month's lead article, it's possible for a newcomer to filter design to input his requirements and let the microcomputer manipulate the formulas and other data, thereby effecting the best possible design in *seconds*. If this weren't enough of an improvement, the designer can now interact with the computer and investigate other possibilities if further tradeoffs are to be considered.

At *ham radio* we recognize the importance of the use of computers as useful tools for the Radio Amateur and have included, in past issues, articles describing the use of computers and appropriate software to aid in the design process, much as slide rules and hand-held calculators were used before. Review the five-year cumulative index in the December, 1985, issue for reference to recent computer-related design articles.)

This doesn't mean what we're becoming yet another computer-oriented magazine . . . but on the other hand, we won't ignore relatively new procedures that provide useful circuits with greater speed, accuracy, and applications.

Rich Rosen, K2RR  
Editor-in-Chief

# KENWOOD

...pacesetter in Amateur radio

**NEW!**  
Computer Interface!

## Complete Control...

### IF-232C Level translator

IF-10A Computer interface for TS-711A/TS-811A

IF-10B Computer interface for TS-940S

IC-10 IC kit for TS-440S computer control

**Attention "computing" hams! The Kenwood IF-Series computer interface units will enable you to connect your TS-711A, TS-811A, TS-940S, or TS-440S transceivers to your home computer. RS-232C standard is used, so the interface units are compatible with any computer!**

The IF-10A and IF-10B computer interface boards and IC-10 IC kit are designed to be installed inside the transceivers. Control is performed via the computer RS-232C port and



Short Wave Listener's map and directory—simply select the QTH you'd like to listen to, and the pre-programmed frequency is "dialed up!"

Display frequency, band, and mode data. Control your rig via keyboard!



through the IF-232C level translator. The level translator performs two functions: (1) converts voltage levels from the RS-232C port to the TTL levels in the transceiver, (2) acts as a noise suppressor. A complete interface "kit" would include the appropriate computer interface units (IF-10A, IF-10B, or IC-10) and the IF-232C level translator.

The applications of automated station control are almost endless! Just imagine...work DX from your hand-held...operate OSCAR "automatically"...remote operation of your station...or put together the "ultimate" contest station....

#### • Interchangeable commands

This means that one program may be used with several rigs, to minimize program changes.

#### • Simultaneous operation of the computer and transceiver is possible

#### • Powerful, easy-to-understand instruction set

#### • Wide variety of commands

Memory input and recall, frequency selection, frequency step, sub-tone frequency, offset, antenna tuner, DCS, scan, and many, many more functions are accessible with the Kenwood computer interface unit!

#### • AC-10 AC power adapter (optional)

More IF-232C and computer interface information is available from authorized Kenwood dealers.



# KENWOOD

TRIO-KENWOOD COMMUNICATIONS  
1111 West Walnut Street  
Compton, California 90220

CRT display shown is a sample program, not available from Trio-Kenwood Communications.

Complete service manuals are available for all Trio-Kenwood transceivers and most accessories. Specifications and prices are subject to change without notice or obligation.

**25<sup>th</sup>**  
Anniversary



A COURT RULING OF GREAT POTENTIAL POSITIVE BENEFIT TO AMATEUR RADIO has been reached in the case of Thernes vs City of Lakeside Park (Kentucky). In its decision in favor of John Thernes, WM4T, in his three-year-old antenna dispute with Lakeside Park, the U.S. Court of Appeals for the 6th Circuit ordered an earlier district court's judgment against Thernes vacated and the case remanded to the district court for reconsideration.

In A "Dissenting" Opinion Judge Krupanski Argued The Two Other Judges weren't hard enough on the city; referring to PRB-1, he said the city's anti-Amateur antenna ordinance was "arbitrary and capricious and deprived the appellate of equal protection under the law" since it applied to Amateur antennas but not similar TV structures. He condemned the city's position as "patently frivolous, discriminatory, and without factual support" and the ordinance as "a license to discriminate," concluding "I would reverse the (lower court's) decision, declare the ordinance unconstitutional, and award costs against the city including attorney's fees."

Strong Language, Indeed, In This First Application of PRB-1, even though the issue in W4MT's case is far from resolved. Now it's up to the original trial court to make the determination of the effect of the FCC's preemption on the constitutionality of Lakeside Park's antenna zoning ordinance. If that decision favors Amateur Radio (assuming Lakeside Park even wishes to continue the long-term court battle), then PRB-1 should be a very strong influence in favor of Amateur antennas and towers throughout the country.

The FCC Has Also Adopted A Limited Preemption Ruling On Satellite Dishes vs zoning and other local ordinances. In a January 14 decision, the Commission said, in essence, that local regulation should apply equally to all types of antennas, and satellite earth station antennas must not be burdened with special limitations not applicable to other antennas.

"AUTOMATIC CONTROL" FOR DIGITAL AMATEUR COMMUNICATIONS ABOVE 50 MHz was approved by the commission in a January 13 report and order on PR Docket 85-105. However, there will still be an important limitation with respect to packet since Part 97 requires a control operator be present when third-party traffic is being handled and defines third-party traffic as any message not originated by the station operator.

EXPANSION OF 40-METER PHONE FOR U.S. CARIBBEAN AREA AMATEURS has been announced by the FCC; Generals, Advanced, and Extras may operate phone from 7075-7100 kHz from Puerto Rico, Virgin Islands, and other FCC-administered Caribbean areas after 0001Z February 28.

THE AMATEUR MILLIMETER WAVE SPECTRUM WILL SEE MAJOR CHANGES ON MARCH 1, with the loss of 260 MHz plus the 1215-1240 MHz slice of the 23 cm band. No immediate crowding of the Amateur mm-wave bands is likely, however, as we'll still have over 12,000 MHz of mm-wave spectrum available. The final implementation of WARC '79 is the reason; the new mm-wave frequencies are 47.0-47.2, 76-81, 119.98-120.02, and 142-149 GHz. the deleted bands are 48-50, 71.0-71.5, 165-170, and 240-241 GHz.

ALL FOUR "INDEPENDENT" NATIONAL VECs HAVE NOW JOINED CARE, the national organization established to support and promote the Volunteer Examination program. In addition several regional VECs have also signed up, along with a number of individual VEs including some accredited by the ARRL. Inquiries about CARE can go to Jim Georgias, W9JUG, at DeVry Institute of Technology, (312) 929-8500, or to CARE, Box 686, Glenview, IL 60025.

"Zero Defects" For Their Paperwork Was Achieved By All VECs for the first time during the month of December! Paperwork errors have been a major VEC program problem since its inception, but continued pressure from the FCC and educational efforts by individual VECs finally paid off when not one error was found in 3651 sets of December exam submissions.

Tardy Submissions Have Also Dropped Drastically over the past year; in December, 1984 27 percent arrived late at Gettysburg. Just under 3 percent were past deadline last December.

POSSIBILITY OF A NEW "CONSUMER RADIO SERVICE" WILL BE THE TOPIC of an FCC meeting scheduled as this Presstop goes to press. The commission is expected, in response to the first of several petitions by the Personal Radio Steering Group, to inaugurate a study of the public's need for radio communications and how it relates to the General Mobile Radio Service, the sophisticated UHF portion of the Citizens Radio Service. The PRSG has proposed an evolutionary change of GMRS into a more flexible service utilizing narrow-band technology and directed toward personal rather than business needs.

A SIZEABLE INCREASE IN NOVICE LICENSES LED THE U.S. AMATEUR POPULATION to another all-time high of 415,856 at the end of December. All license classes showed increases over the preceding month, but Novices were up a whopping 1529! According to FCC analysis, 2233 Novices were newly licensed in December, 1985, versus only 818 the month before and 1196 in October. In addition the December, 1984, figure was only 1409 new Novices, so there's apparently a highly successful upsurge in Novice training efforts. ARRL has also launched a strong effort to get Novices who've let their licenses expire in the past two years renew, with expectation that a valid license in hand will restimulate interest.

With the VEC Program Running Smoothly And Recruitment/Training paying off so well, 1986 could be a banner year for the Amateur Service even without new Novice privileges.

# KENWOOD

...pacesetter in Amateur radio

**NEW**  
Compact 45 W 2 m

## 45 Affordable Watts!

### TM-201B/401B

#### Super-compact mobile transceivers

The TM-201B boasts a powerful 45 watts output, easy-to-operate front panel controls, and ultra-compact size. The GaAsFET receiver front end provides high sensitivity and wide dynamic range. Receive and transmit characteristics are tailored for minimum distortion and excellent audio quality. Both the TM-201B and the TM-401B are supplied with a high-quality external speaker, 16-key DTMF microphone and mounting bracket.

- 45 watt output, with HI/LO power switch (TM-401B has 25 watts output.) 5 W low.
- Dual digital VFOs  
TM-201B covers 142-149 MHz, includes certain MARS and CAP frequencies  
TM-401B covers 440-450 MHz
- 5 memories plus "COM" channel, with lithium battery back-up



- Programmable, multi-function scanning
- High quality external speaker supplied
- Audible beeper confirms operation

#### Optional accessories:

- PS-430 power supply
- TU-3 or TU-3A two frequency tone encoder
- FC-10 frequency controller
- MC-55 (8-pin) mobile microphone
- SP-40 compact mobile speaker

- SP-50 deluxe mobile speaker
- SW-100A/B SWR/power meters
- SW-200A/B SWR/power meters
- SWT-1 2 m antenna tuner
- SWT-2 70 cm antenna tuner
- PG-2K extra DC cable
- PG-3A DC line noise filter
- MB-201 extra mobile bracket



#### Optional FC-10 frequency controller

Convenient control keys for frequency UP/DOWN, MHz shift, VFO A/B, and MR (memory recall or change memory channel).

More information on the TM-201B/401B is available from authorized dealers.



25<sup>th</sup>  
Anniversary

## KENWOOD

TM-401B is similar to the TM-201B, but covers 440-450 MHz and is 25 watts.  
Specifications and prices subject to change without notice or obligation.  
Complete service manuals are available for all Trio-Kenwood transceivers and most accessories.

TRIO-KENWOOD COMMUNICATIONS  
1111 West Walnut Street  
Compton, California 90220

# AFFORDABLE PACKET RADIO FROM MFJ

An identical TAPR TNC 2 clone with a new cabinet and added features ... for an incredible \$129.95!



MFJ-1270  
\$129.95

Join the exciting packet radio revolution and enjoy error-free communications ... for an incredible \$129.95!

MFJ brings together efficient manufacturing and TAPR's (Tucson Amateur

Packet Radio) leading edge technology to bring you affordable packet radio. You get a nearly identical clone of the widely acclaimed TAPR TNC 2 with identical software and hardware. It's in a new cabinet and includes a TTL serial port for extra versatility.

Here are MFJ's latest and hottest products for improving your station's performance.

## SUPER KEYBOARD

MFJ-496  
\$169.95



Price slashed 50% to \$169.95! Get a full feature Super Keyboard that sends CW/RTTY/ASCII for the price of a good memory keyer.

You get the convenience of a dedicated keyboard—no program to load—no interface to connect—just turn it on and it's ready to use.

This 5 mode Super Keyboard lets you send CW, Baudot, ASCII, use it as a memory keyer and for Morse Code practice. You get text buffer, programmable and automatic message memories, error deletion, buffer preload, buffer hold.

## TRIPLE OUTPUT LAB POWER SUPPLY

MFJ-4002 \$149.95

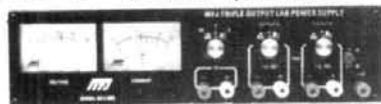

Lab quality power supply gives you plenty of voltage and current for all your analog and digital circuits. 3 completely isolated outputs: 2 variable 1.5-20 VDC at 0.5 amp and a fixed 5 VDC at 1 amp. Connect in series or parallel for higher voltage and current. It's short circuit protected, has excellent line (typ. 0.01%/V) and load regulation (typ. 0.1%). Lighted meters monitor volt./cur. 12x3x6 in. 110 VAC.

## CROSS-NEEDLE SWR/WATT METER

MFJ-815 \$59.95

MFJ's cross-needle SWR/Wattmeter gives you SWR, forward and reflected power—all at a single glance! SWR is automatically computed

—no controls to adjust. Easy-to-use push buttons select three power ranges that give you QRP to full legal limit power readings. Reads 20/200/2000 W forward, 5/50/500 W reflected and 1:1 to 1:5 SWR on easy-to-read two color scale. Lighted meter. Needs 12 V. ±10% full scale accuracy. 6½ x 3¼ x 4½ inches.



## 2 KW COAX SWITCHES

Instantly select any antenna or rig by turning a knob. Organizes coax cables and eliminates plugging and unplugging. Unused terminals are grounded to protect

your equipment for stray RF, static and lightning. 2 KW PEP, 1 KW CW. For 50 to 75 ohm. Negligible loss, SWR, and crosstalk gives high performance. SO-239s. Convenient desk or wall mounting.

MFJ-1702, \$19.95. 2 positions. Cast aluminum cavity construction gives excellent performance up to 500 MHz with better than 60 dB isolation at 450 MHz. Heavy duty, low loss switch has less than 20 milliohm contact resistance, less than 0.2 dB loss and SWR below 1:1.2. 2½ x 1 inches.

MFJ-1701, \$29.95. 6 positions. White markable surface for recording ant. positions. 8½ x 1½ x 3 in.

MFJ-1702  
\$19.95



\$29.95 MFJ-1701



## ANTENNA CURRENT PROBE

MFJ-206 \$79.95

This new breakthrough MFJ Antenna Current Probe lets you monitor RF antenna currents—no connections needed! Determine current distribution, RF radiation pattern and polarization of antennas, transmission lines, ground leads, building wiring, guy wires and enclosures.

- Indicate transmission line radiation due to high SWR, poor shielding or antenna unbalance.
- Detect re-radiation from rain gutters and guy wires that can distort antenna field patterns.
- Detect RF radiation from ground leads, power cords or building wiring that can cause RFI.
- Determine if ground system is effective.
- Pinpoint RF leakage in shielded enclosures.
- Locate the best place for your mobile antenna.
- Use as tuned field strength meter.

Monitors RF current by sensing magnetic field. Uses an electrostatically shielded ferrite core, FET RF amplifier, op-amp meter circuit for excellent sensitivity, selectivity. 1.8-30 MHz. Has sensitivity, bandswitch, tune controls, telescoping antenna for field strength meter. 4 x 2 x 2 inches.



## MFJ's Best VERSA TUNER

MFJ-949C \$149.95



MFJ's best 300 watt tuner is now even better! The MFJ-949C all-in-one Deluxe Versa Tuner II gives you a tuner, cross-needle SWR/Wattmeter, dummy load, antenna switch and balun in a new compact cabinet. You get quality conveniences and a clutter-free shack at a super price.

A new cross-needle SWR/Wattmeter gives you SWR, forward and reflected power—all at a single glance. SWR is automatically computed with no controls to set. Has 30 and 300 watt scale.

Run up to 300 watts RF output—and match coax, balanced lines or random wires from 1.8 thru 30 MHz. Tune out SWR on dipoles, vees, long wires, verticals, whips, beams/quads. 10x3x7 in.

## DIGITAL SWR/WATTMETER

MFJ-818  
\$89.95



Fully automatic Digital SWR/Wattmeter reads SWR 1:1 to 1:9.9 directly and instantaneously—no SWR knob to set. Huge 0.6 inch bright orange digits make across-the-room reading easy. 12 segment LED bar graph wattmeter gives instantaneous PEP readings up to 200 watt RF output.

Good, bad, mismatch tri-color LEDs indicate SWR conditions. Small size (5½ x 4¼ x 1 in.) and easy-to-read digital display makes it ideal for mobile use. For 50 ohm systems. 1.8-30 MHz. 12 VDC or 110 VAC with MFJ-1312. \$9.95.

## MOBILE ANTENNA MATCHER

MFJ-910 \$19.95

Lower your SWR and Get more power into your mobile whip for solid signals and more QSOs. Your solid state rig puts out more power and generates less heat. For 10-80 meter whips. Easy plug-in installation. Complete instructions. Fits anywhere, 2½x2½in.



ORDER ANY PRODUCT FROM MFJ AND TRY IT-NO OBLIGATION. IF NOT SATISFIED RETURN WITHIN 30 DAYS FOR PROMPT REFUND (less shipping).  
• One year unconditional guarantee • Add \$5.00 each shipping/handling • Call or write for free catalog, over 100 products.

# MFJ

MFJ ENTERPRISES, INC.  
Box 494, Mississippi State, MS 39762

TO ORDER OR FOR YOUR NEAREST DEALER, CALL TOLL-FREE

800-647-1800

Call 601-323-5869 in Miss. and outside continental USA Telex 53-4590 MFJ STK







## comments

### digital can do more

Dear HR:

I want to let you know how much I enjoyed the December issue of *ham radio*, with its emphasis on Digital Communications. I think you should be commended for your efforts to move Amateur Radio into the digital age. There are, however, a few comments I wish to make on the subject.

First, we must get across the idea that "digital" and "data" are not synonymous. There are many uses for digital transmission besides that of data. For example, digital voice, digital graphics, and digital video (both freeze frame and full motion) are areas where the Amateur community should be conducting experiments and demonstrations. Packet radio for data is great, but so much more can be done. Very sophisticated digital voice processors should soon drop in price (some, such as CVSD chips, are cheap now) and hopefully, 2.4 kbps LPC voice processing chips such as the Texas Instruments 320.

Second, I believe the data rate limitations you quoted in your editorial on page 5 (and also quoted on page 30 [by WA1FHB in "A Packet Radio Primer" — Ed.]) are too conservative. Paragraph (a)(1), Part 97.69 of the FCC Regulations on Digital Communications states that "The sending speed shall not exceed the following:" and

goes on to give the limit in baud depending on the frequency of transmission. The definition of a baud is a unit of modulation rate. Modern digital radio systems may have many bits per second for each baud. Four-level, eight-level, 16-level, 64-level and 256-level systems have been demonstrated and many of these are used in microwave systems today. Our radio, the International Mobile Machine Corporation's *Ultraphone*<sup>™</sup> has demonstrated 64 kbps with 16-level modulation in an RF channel not much wider than a 20 kilohertz (4 bits per signaling element). This was done on a frequency of 455 MHz. With the same 4 bits per signaling element, this would allow 1200 bps on frequencies below 28 MHz, 4800 bps on frequencies between 28 and 50 MHz, 78.4 kbps on frequencies between 50 and 220 MHz and 224 kbps above 220 MHz — a 4:1 expansion of your limits. It should be noted that you don't get something for nothing; these high level modulation schemes require a higher signal-to-noise ratio and more signal processing.

It is well known that in some cases, combining high level modulation with the proper error correcting code can enhance the performance of the link over lower level modulation. The article on Hermes ["AMTOR, AX.25, and HERMES," by Jerome T. Dijk, W9JD, — Ed.] was a good start on the right type of coding. Much work needs to be done on both modulation and coding before standards are set. However, it would be nice to see someone coming out with PSK/DPSK radios.

To give one example, Bolt Beranek and Newman, Inc. have been working on digital voice at 300 bps (see *Electronic Design*, October 3, 1985, page 92). Although still experimental, and

requiring a ridiculous amount of computing power (256 68000 processors), this, when combined with a four-level DPSK modulation with a 1/2 rate coding (and interleaving) would give a very interesting HF system running at 300 baud. A good experiment would be to determine the amount of interleaving processing delay that would be tolerable.

A second near term example might be using 2.4 LPC voice processing with a four-level dpsk 4800 bps modem and 1/2 rate error correcting coding on 10 meters. This system should be feasible for Amateurs to construct in the next year or so at a reasonable cost.

Another example might be high resolution (i.e., 600 pixels) freeze frame video (or computer-generated graphics or fax) with errorless packet transmission at 4800 baud on 10 meters. This might take 10 to 15 minutes to send, but would provide a high quality, error-free picture. Signal processing of the image could lower the transmission time significantly. New, lower-cost CCD video cameras will make this concept very feasible.

A fourth example might be full-motion, color video on 6 and 2 meters and higher. Systems now exist that can transmit these at 56 kbps and with VHSIC technology, the cost could come down to make this feasible for Amateurs.

Some of the above examples are still far out, but still are reasonable goals for Amateur Radio. I think that the future is digital radio and that low cost, spectrally efficient modulation and coding are the keys that will make digital radio feasible for Amateurs. Fortunately, this modulation and coding can be implemented in software on signal processing chips such as the Texas Instruments TMS-320. We need two things to happen: one is for knowledgeable Amateurs to develop these new modems, and the second is for manufacturers to develop radios that will accept these modems.

Allen D. Dayton, KA4JFO  
Fairfax, Virginia

# build narrowband RF filters

...and learn  
useful RF techniques  
as well

**LC bandpass filters have been extensively covered** in the professional literature. While some of this has spilled over into the Amateur press, some confusion still remains about what type of filter to use in a given application, and how to go about designing, building, and aligning it. In this article I hope to clear up some of this confusion and help you choose, design, build, and evaluate the filter you need. The BASIC program (written in Commodore 64 BASIC, but translatable to others) will be presented to perform the math for you.

The filters we're describing here are narrowband, capacitively-coupled designs (see fig. 1; note that the program prints out the capacitor values using these designators, so keep this figure in mind for future reference.) By narrowband, I'm specifically referring to the results of the following, well-known relationship<sup>1,2,3</sup>:

$$Q_{bp} = \frac{f_o}{BW_{3dB}} \quad (1)$$

$f_o$  = mean center frequency (below)  
 $BW_{3dB}$  = passband width

For these filters,  $Q_{bp}$  must be  $\geq 10$ . For  $Q_{bp} < 10$  other design techniques are better. References 1 and 2 are recommended for coverage of this sort of design, based on lowpass filters, and for converting them to bandpass.

Like most bandpass filters, these filters have a geometric symmetry about the center frequency:

$$f_o = \sqrt{f_u f_l} \quad (2)$$

$f_u$  = upper passband edge  
 $f_l$  = lower passband edge

Because of this, the response of the attenuation versus frequency of these filters does not follow the arithmetical symmetry one might expect. Attenuation increases more rapidly on the low side of the passband.

Also, like most BPFs, these filters have passband versus stopband characteristics that are inevitably a compromise between passband ripple and attenuation at some out-of-band frequency. The optimally flat Butterworth (no-ripple) designs will have the poorest attenuation out-of-band. The Chebychevs, with varying amounts of ripple, will give more attenuation at the same out-of-band frequency, with the highest ripple designs giving the largest amount of attenuation. This attenuation also carries the price of being the most difficult of the filter types to build with real-world components.

Choosing the right filter for a job, then, becomes an exercise in compromise. In the front end of a receiver, for example, the ripple of the Chebychev might mean stations not copied (DX not worked). You might put up with a little less rejection of an out-of-band signal to hear those. Later on in the rig, a little gain can frequently be spared — perhaps the Chebychev should go there. One of the advantages of the program is that it allows you to compare designs before you plug in your soldering iron.

By Bob Lombardi, WB4EHS, 1874 Palmer Drive,  
Melbourne, Florida 32935

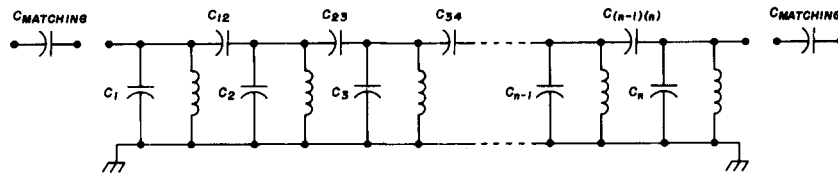

fig. 1. General form of filter, showing matching capacitors and their placement.

## using the program

To design a filter with this program, you need to know a few things: first, the center frequency ( $f_o$ ) and passband width. Both of these are entered in MHz. Next you need to know the required passband characteristics (i.e., Butterworth or 0.01 dB, 0.1, 0.5, or 1.0 dB ripple Chebychev), what inductor you plan to use, and how much attenuation is required at some frequency ratio.

This last one may be unfamiliar to you. This frequency ratio is expressed as:

$$\frac{f}{f_c} = \frac{BW_x}{BW_3} \quad (3)$$

where  $BW_x$  is the bandwidth at some attenuation  $x$ , and  $BW_3$  is the (3dB) passband width, as defined before. Often, you won't know  $BW_x$  directly, but will know that there is some undesired frequency ( $f_{un}$ ), such as a broadcaster, or mixing product that you want to attenuate. You can solve for  $BW_x$  by using the geometric symmetry of the filter, as follows:

$$f_o = \sqrt{f_{un} f_{ot}} \quad (4)$$

then

$$\frac{f_o^2}{f_{un}} = f_{ot}$$

and  $BW_x = |f_{un} - f_{ot}|$

$f_{ot}$  = the other frequency you need

You then divide this number by the bandwidth to get the ratio,  $f/f_c$ , that the program queries for. It is entered as a single number (i.e., 3 or 4.237) rather than as a ratio.

The filter that results will inevitably have some characteristic impedance that will never be the one you're looking for — per Murphy. To overcome this, a simple matching capacitor can be calculated for you by the program. It can match either end to another impedance, and does this by making the end sections a capacitive divider, with one capacitor in series with the input and output. It will recalculate the changed capacitor in the *body* of the filter for you. The only hazard here is that a large change in impedance may

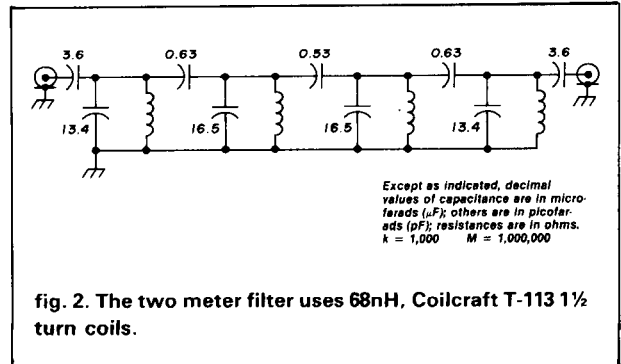

fig. 2. The two meter filter uses 68nH, Coilcraft T-113 1/2 turn coils.

make one of the capacitors go negative in value. If this happens, you can redesign the filter with a bigger inductor, or else use another matching method of your own.

## sample filter

To illustrate the process, here's a filter that I needed for a 2-meter transverter. The bandwidth at 50 dB down was determined by a local NOAA Weather radio signal at 162.55 MHz that I wanted to knock down as much as possible. The 3 dB bandwidth of the filter was determined by a need to cover all 4 MHz of 2 meters in the peak of the passband. My inputs to the computer are the requirements that I have for the filter:

Type of filter: 0.5 dB ripple Chebychev

Frequency Ratio  $f/f_c$ : 4.13

Desired Attenuation at  $f/f_c$ : 50dB

At this point, the computer responds that an  $N = 4$  (4 pole) filter will provide 61.08 dB (at  $f_{un}$ ) and then asks for the center frequency (145), bandwidth (8), and the coil used ( $0.068 \mu$ H) It then calculates its responses. Its outputs are:

Coupling Capacitors:

C12 = .6334 pF

C23 = .5327 pF

C34 = .6334 pF

Resonating Capacitors:

C1 = 17.08 pF

C2 = 16.55 pF

C3 = 16.55 pF

C4 = 17.08 pF



It concludes by telling me that the characteristic impedance of the filter is 2050 ohms and asks me if I want to match to another. I request 50 ohms, both ends, add 3.47 pF to the end sections and change the end resonators, C1 and C4, to 13.613 pF (17.08-3.47).

Although this filter was touchy to align, it was built and aligned using sophisticated equipment, then measured on a Hewlett Packard Network Analyzer. The graphs of attenuation versus frequency for it are in fig. 3 along with its schematic fig. 2.

### building the filters

Of course all this is pretty meaningless without working filters that fit your needs — and the program, like all mathematical models, is perfectly capable of generating answers that solve its equations, but are completely absurd in the real world ... all of which requires the introduction of some sound ideas for building these filters.

To begin with, filters using conventional discrete coils and caps get progressively harder to build and align as frequency increases. The Amateur with the typical test equipment described below and good components and assembly techniques should have no trouble getting these filters to work up through 75 to 100 MHz. Those with high-quality equipment or access to it can expect to go to beyond 2 meters. Above 200 MHz, filter construction and alignment without large amounts of equipment demands other techniques, which will not be discussed here.

When it comes to components, the rule is to get the highest  $Q$  that you can obtain. Low  $Q$  causes losses in the filter, evidenced by higher insertion loss and changes in the passband shape. Capacitors are rarely a problem because they tend to have much higher  $Q$ s than coils. In an inductor:

$$Q = \frac{X_L}{R} = \frac{2\pi fL}{R} \quad (5)$$

where  $R$  is the ohmic resistance of the wire and  $X_L$  is the inductive reactance. From this definition, it follows that you should use the largest practical size wire you can.  $Q$  is also affected by coil diameter, winding pitch, and core or support material. Adding a core always degrades  $Q$  as does shielding a coil.

The tradeoff here is that airwound, large diameter coils are fine at VHF, but too large at HF. Thankfully, iron powder and ferrite toroids provide increased inductance, virtually perfect shielding, and reasonable  $Q$ s from MF to the low VHF region. Amidon Associates provides data that allows you to predict  $Q$  and the number of turns to wind a given coil, on request.

While  $Q$  may not be a major concern with capacitors, stray reactances are. At RF, they contain enough

table 1.

Type of Filter	Minimum Component $Q$							
	$n =$	2	3	4	5	6	7	8
Butterworth	2	2	2	3	3	4	4	5
0.10 dB Chebychev	2	3	3	5	7	10	14	17
0.50 dB Chebychev	3	4	4	7	10	14	20	30
1.0 dB Chebychev	3	5	5	8	12	17	26	35

This table gives an approximate minimum component  $Q$  for use in a *lowpass* filter of the given order. For a bandpass filter, this value must be multiplied by the passband  $Q$ ,  $Q_{bp}$ .

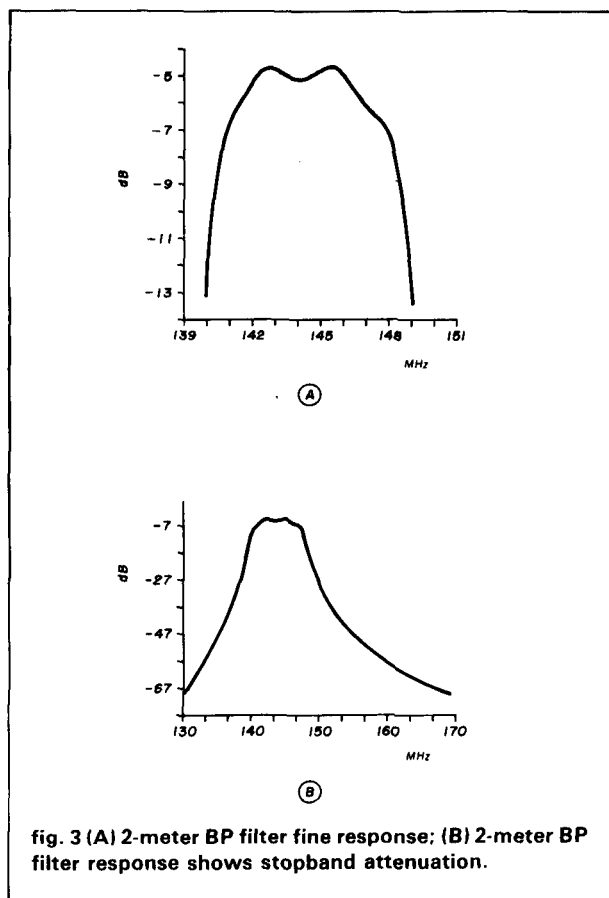

fig. 3 (A) 2-meter BP filter fine response; (B) 2-meter BP filter response shows stopband attenuation.

stray inductance to present themselves as something far from a perfect capacitor. For example, a 0.001  $\mu$ F ceramic disk capacitor with 1/4 inch leads appears as a series-resonant circuit (0 ohms) at 55 MHz, while a 0.01 is self-resonant at 15 MHz.<sup>4</sup> For this reason, it is imperative to keep leads as short as possible.

As for the type of capacitor to use, ultraminiature dipped ceramics are best at and above 6 meters, although their typical 50 VDC breakdown is low for transmitters. Through the HF spectrum, silver micas are an acceptable substitute. SMs have a higher stray inductance, but it's rarely a problem. They're available in higher voltage ratings, too.

# EIMAC Tubes Provide Superior Reliability at radio station K WAV — over 112,000 hours of service!



Ken Warren, Chief Engineer at K WAV reports that their 10 kW FM transmitter went on the air in November, 1972, equipped with EIMAC power tubes. The original tubes are still in operation after over 13 years of continuous duty!

Ken says, "In spite of terrible power line regulation, we've had no problems with EIMAC tubes. In fact, in the last two years, our standby transmitter has operated less than two hours!"

Transmitter downtime means less revenue. EIMAC tube reliability gives you *more* of what you need and *less* of what you don't want. More operating time and less downtime!

EIMAC backs their proven tube

reliability with the longest and best warranty program in the business. Up to 10,000 hours for selected types.

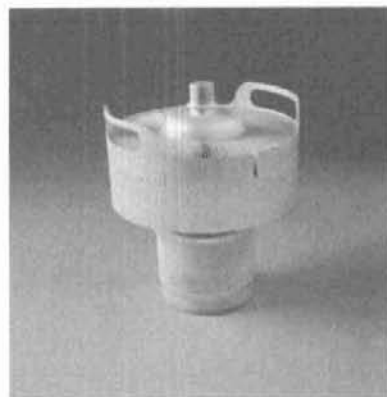

Quality is a top priority at EIMAC, where our 50-year charter is to produce long-life products.

Send for our free Extended Warranty Brochure which covers this program in detail.

Write to:

Varian EIMAC  
301 Industrial Way  
San Carlos, CA 94070  
Telephone: (415) 592-1221



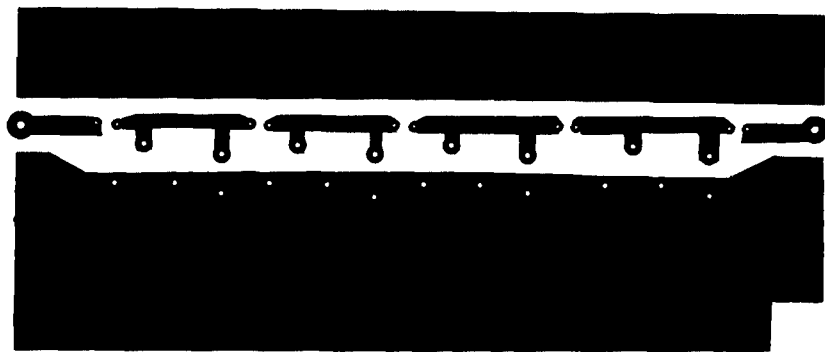

fig. 4. Full size version of the "universal" 4 section filter card.

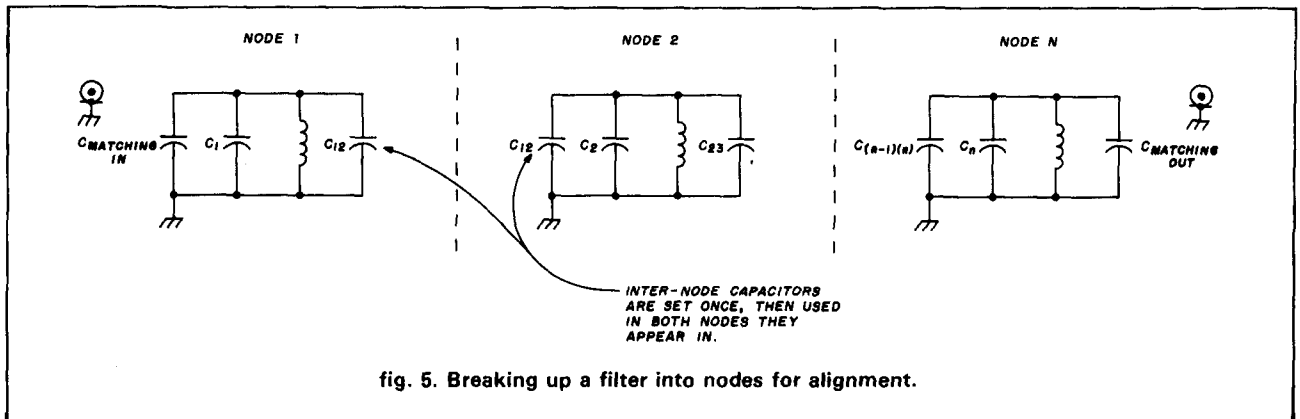

fig. 5. Breaking up a filter into nodes for alignment.

Inductors also show stray reactance — in this case, capacitance between adjacent turns. This has the effect of making the inductor appear smaller than it is, and is especially noticeable as frequency increases.

One last word on component  $Q$ . The filter type chosen imposes some constraints on the minimum  $Q$  you can live with. Table 1, derived from reference 2, presents the approximate minimum  $Q$  for a lowpass filter of the given type and order. For bandpass filters, this must be multiplied by the  $Q_{bp}$ , derived previously. From this, you can see how high-order Chebyschevs would be difficult to realize, based on component  $Q$  alone.

Component layout requires some thought. While an etched PC board is not necessary, at least through 6 meters, some readers may want to etch one anyway. The optimum layout is linear, with the components appearing as they are drawn on the schematic. If you must "bend" this line to fit into a space, try to keep input away from output and break grounds between them. A U-shaped layout isn't asking for trouble—it's begging.

Figure 4 is a "universal" four-pole filter prototyping board I've used from 1 to 200 MHz. It's etched on double-sided G-10, with the back solid groundplane.

Components are soldered directly to the lands or the lands are jumpered out with copper foil for smaller numbers of sections. Top and bottom groundplanes are jumpered together by wires.

If you choose not to etch a board, or can't etch a board, take heart. Many prototypes in engineering labs are built in a style called "dead bug"; components going to ground are soldered to a piece of unetched PC material and those not grounded are supported by their leads going to those that are, or to each other. The only precautions necessary are to keep ground connections as short as possible and to not lay unshielded coils with their axes parallel to each other, or with turns touching. Toroids can be placed in any orientation to each other and can touch ground without trouble. As in etched boards, the best layout is a straight line.

### alignment

It should be obvious that the only differences between, say, a 1.0 dB Chebyshev and a Butterworth of the same order are small component value differences. Knowing the value of the components is the most important step in getting the filter working.

There are many ways for measuring component



fig. 7. Narrow-band filter CAD program listing.

```

1 REM LC BANDPASS FILTER DESIGN FOR      NARROW BAND FILTERS
3 REM PROGRAMMED BY BOB LOMBARDI WB4EHS
100 PRINT CHR$(147)
105 Q=0:DIM K(7),C(8)
110 PRINT:PRINT:PRINT
120 PRINT "BANDPASS FILTER DESIGN PROGRAM":PRINT:PRINT
122 PRINT"THIS PROGRAM COMPUTES VALUES FOR"
123 PRINT "PARALLEL RESONANT, CAPACITIVELY"
124 PRINT"COUPLED BANDPASS FILTERS":PRINT"THAT ARE (RVON)NARROW BAND(RVOF)
-(Q)10)"
125 PRINT "ENTER THE NUMBER OF THE DESIRED"
126 PRINT "ROUTINE":PRINT:PRINT
130 PRINT"1 FOR BUTTERWORTH":PRINT
131 PRINT"2 FOR 0.01 DB CHEBYCHEV":PRINT
132 PRINT"3 FOR 0.1  DB CHEBYCHEV":PRINT
133 PRINT"4 FOR 0.5  DB CHEBYCHEV":PRINT
134 PRINT"5 FOR 1.0  DB CHEBYCHEV":PRINT
145 INPUT Q:IF Q<0 AND Q>5 THEN GOTO 135
146 ON Q GOTO 1000,1100,1200,1300,1400
1000 REM BUTTERWORTH SECTION
1010 GOSUB 4000
1015 IF N=2 THEN Q=1.414:K(1)=0.707
1020 IF N=3 THEN Q=1.000:K(1)=0.707:K(2)=K(1)
1025 IF N=4 THEN Q=0.765:K(1)=0.841:K(2)=0.541:K(3)=K(1)
1030 IF N=5 THEN Q=0.618:K(1)=1.000:K(2)=0.556:K(3)=K(2):K(4)=K(1)
1035 IF N=6 THEN Q=0.518:K(1)=1.169:K(2)=0.605:K(3)=0.518:K(4)=K(2):K(5)=K(1)
1040 IF N=7 THEN Q=0.445:K(1)=1.342:K(2)=0.667:K(3)=0.527:K(4)=K(3)
1042 IF N=7 THEN K(5)=K(2):K(6)=K(1)
1045 IF N=8 THEN Q=0.390:K(1)=1.519:K(2)=0.736:K(3)=0.554:K(4)=0.510
1047 IF N=8 THEN K(5)=K(3):K(6)=K(2):K(7)=K(1)
1060 GOTO 2500
1100 REM 0.01 DB CHEBYCHEV SECTION
1110 R=.01:GOSUB4500
1115 IF N=2 THEN Q=1.483:K(1)=0.708
1120 IF N=3 THEN Q=1.181:K(1)=0.682:K(2)=K(1)
1125 IF N=4 THEN Q=1.046:K(1)=0.737:K(2)=0.541:K(3)=K(1)
1130 IF N=5 THEN Q=0.977:K(1)=0.780:K(2)=0.540:K(3)=K(2):K(4)=K(1)
1135 IF N=6 THEN Q=0.937:K(1)=0.809:K(2)=0.550:K(3)=0.518:K(4)=K(2):K(5)=K(1)
1140 IF N=7 THEN Q=0.913:K(1)=0.829:K(2)=0.560:K(3)=0.517:K(4)=K(3)
1142 IF N=7 THEN K(5)=K(2):K(6)=K(1)
1145 IF N=8 THEN Q=0.897:K(1)=0.843:K(2)=0.567:K(3)=0.520:K(4)=0.510
1147 IF N=8 THEN K(5)=K(3):K(6)=K(2):K(7)=K(1)
1160 GOTO 2500
1200 REM 0.1 DB CHEBYCHEV SECTION
1210 R=0.1:GOSUB 4500
1215 IF N=2 THEN Q=1.638:K(1)=0.711
1220 IF N=3 THEN Q=1.433:K(1)=0.662:K(2)=K(1)
1225 IF N=4 THEN Q=1.345:K(1)=0.685:K(2)=0.542:K(3)=K(1)
1230 IF N=5 THEN Q=1.301:K(1)=0.703:K(2)=0.536:K(3)=K(2):K(4)=K(1)
1235 IF N=6 THEN Q=1.277:K(1)=0.715:K(2)=0.539:K(3)=0.518:K(4)=K(2):K(5)=K(1)
1240 IF N=7 THEN Q=1.262:K(1)=0.722:K(2)=0.542:K(3)=0.516:K(4)=K(3)
1242 IF N=7 THEN K(5)=K(2):K(6)=K(1)

```

# FREE SATELLITE TV



800-4-SATMAN



## NEW 24 Page Buyer's Guide With Guaranteed Lowest Prices

- Explains all about FREE 100 channel Satellite TV and how to shop for an earth station!
- Lists GUARANTEED LOWEST PRICES...we will not be undersold, save 30-50% over local dealer prices!
- Tells how to easily and quickly Install-Your-Own earth station and save \$400 or more!
- Shows how to demonstrate and sell earth stations from your home and earn extra money!

The new SATMAN Buyer's Guide is a necessity for any prospective or current earth station owner who wants to save big money on name brand satellite products and also earn some extra money. Buy direct, Do-It-Yourself, and save with SATMAN. Toll free ordering, no sales tax (IL only), major credit cards accepted, huge in-stock inventories available, and fast UPS shipping anywhere in U.S. Check with SATMAN before you buy... We will not be undersold! Call now for your free 24 page SATMAN Buyer's Guide.

**1-800-4-SATMAN**

1-309-692-9582 Illinois



5017 N. MELODY • PEORIA, IL 61614 • 1-800-4-SATMAN

# PAC-COMM

## Introduces the TNC-200



- Official TAPR TNC-2 design
- Top quality components throughout
- Standard AX.25 Version 2 protocol
- Full duplex hardware HDLC
- Five terminal data rates to 9600 baud
- Modem adaptable for HF packet
- 16K battery backed-up RAM
- 32K EPROM, software clock
- Latest multiconnect software
- Five labeled LED status indicators
- Level 3 networking compatibility
- Choose CMOS version for low power (100ma typical) or NMOS for lower cost

Assembled and tested	CMOS - \$ 219.95
	NMOS - \$ 199.95
Full kit with cabinet	CMOS - \$ 169.95
	NMOS - \$ 154.95
Full kit without cabinet	CMOS - \$ 144.95
	NMOS - \$ 129.95
Hard-to-find-parts kit	CMOS - \$ 84.95
	NMOS - \$ 79.95
Bare PC board + assy manual	\$ 39.95
Reference manual (100 + pg)	\$ 9.95
Cabinet with end plates	\$ 29.95

Macintosh Owners: MACPACKET/TNC200 gives pull-down menus, split screens, file transfers, automatic routing and more!!  
MACPACKET/TNC200 \$69.95

Free UPS shipping in continental USA

Discount 10% for orders of five or more TNC-200s to the same address

ORDER TOLL FREE (24 hours)

800-835-2246 ext. 115

(Kansas 800-362-2421 ext. 115)

Information 813-689-3523



(No COD)



Florida addresses add 5%

PAC-COMM PACKET RADIO SYSTEMS, INC.

4040 W. Kennedy Blvd. Tampa, FL 33609

Int'l TELEX 6502881526 WUI

```

1245 IF N=8 THEN Q=1.251:K(1)=0.728:K(2)=0.545:K(3)=0.516:K(4)=0.510
1247 IF N=8 THEN K(5)=K(3):K(6)=K(2):K(7)=K(1)
1260 GOTO 2500
1300 REM 0.50 DB CHEBYCHEV SECTION
1310 R=0.5:GOSUB 4500
1315 IF N=2 THEN Q=1.950:K(1)=0.723
1320 IF N=3 THEN Q=1.864:K(1)=0.647:K(2)=K(1)
1325 IF N=4 THEN Q=1.826:K(1)=0.648:K(2)=0.545:K(3)=K(1)
1330 IF N=5 THEN Q=1.807:K(1)=0.652:K(2)=0.534:K(3)=K(2):K(4)=K(1)
1335 IF N=6 THEN Q=1.796:K(1)=0.655:K(2)=0.533:K(3)=0.519:K(4)=K(2):K(5)=K(1)
1340 IF N=7 THEN Q=1.790:K(1)=0.657:K(2)=0.533:K(3)=0.516:K(4)=K(3)
1342 IF N=7 THEN K(5)=K(2):K(6)=K(1)
1345 IF N=8 THEN Q=1.785:K(1)=0.658:K(2)=0.533:K(3)=0.515:K(4)=0.511
1347 IF N=8 THEN K(5)=K(3):K(6)=K(2):K(7)=K(1)
1360 GOTO 2500
1400 REM 1.0 DB CHEBYCHEV SECTION
1410 R=1.0:GOSUB 4500
1415 IF N=2 THEN Q=2.210:K(1)=0.739
1420 IF N=3 THEN Q=2.210:K(1)=0.645:K(2)=K(1)
1425 IF N=4 THEN Q=2.210:K(1)=0.638:K(2)=0.546:K(3)=K(1)
1430 IF N=5 THEN Q=2.210:K(1)=0.633:K(2)=0.535:K(3)=K(2):K(4)=K(1)
1435 IF N=6 THEN Q=2.250:K(1)=0.631:K(2)=0.531:K(3)=0.510:K(4)=K(2):K(5)=K(1)
1440 IF N=7 THEN Q=2.250:K(1)=0.631:K(2)=0.530:K(3)=0.517:K(4)=K(3)
1442 IF N=7 THEN K(5)=K(2):K(6)=K(1)
1450 IF N=>8 THEN PRINT "CAN'T DO 8 POLE 1 DB CHEBYCHEV. CALCULATING 7 POLE."
1455 IF N=8 THEN N=7:GOTO 1440
1460 GOTO 2500
2500 REM CALCULATION AND DISPLAY ROUTINE
2510 PRINT "WHAT IS THE DESIRED CENTER?"
2511 INPUT "FREQUENCY (IN MHZ)";FO
2515 FO=FO*1E6
2520 INPUT "WHAT IS THE 3 DB BW (IN MHZ)";BW:BW=BW*1E6
2530 INPUT "WHAT IS THE INDUCTOR (IN UH)";L:L=L*1E-6
2540 W=2*pi*FO
2550 QB=FO/BW
2560 QD=QB*Q
2570 FOR I=1 TO N-1
2575 K(I)=K(I)/QB
2580 NEXT I
2590 CR=1/((W*W)*L)
2600 RE=W*L*QD
2610 FOR I=1 TO N-1
2670 K(I)=K(I)*CR
2680 NEXT I
2690 ON N-1 GOSUB 2700,2720,2740,2760,2780,2800,2820
2695 GOTO 2900
2700 C(1)=CR-K(1):C(2)=C(1):RETURN
2720 C(1)=CR-K(1):C(2)=CR-K(1)-K(2):C(3)=C(1):RETURN
2740 C(1)=CR-K(1):C(2)=CR-K(1)-K(2):C(3)=CR-K(2)-K(3):C(4)=C(1):RETURN
2760 C(1)=CR-K(1):C(2)=CR-K(1)-K(2):C(3)=CR-K(2)-K(3):C(4)=CR-K(3)-K(4)
2770 C(5)=C(1):RETURN
2780 C(1)=CR-K(1):C(2)=CR-K(1)-K(2):C(3)=CR-K(2)-K(3):C(4)=CR-K(3)-K(4)

```

```

2785 C(5)=CR-K(4)-K(5):C(6)=C(1):RETURN
2800 C(1)=CR-K(1):C(2)=CR-K(1)-K(2):C(3)=CR-K(2)-K(3):C(4)=CR-K(3)-K(4)
2805 C(5)=CR-K(4)-K(5):C(6)=CR-K(5)-K(6):C(7)=C(1):RETURN
2820 C(1)=CR-K(1):C(2)=CR-K(1)-K(2):C(3)=CR-K(2)-K(3):C(4)=CR-K(3)-K(4)
2825 C(5)=CR-K(4)-K(5):C(6)=CR-K(5)-K(6):C(7)=CR-K(6)-K(7):C(8)=C(1):RETURN
2900 PRINT:PRINT:PRINT
2910 PRINT "COUPLING CAPS ARE (IN PF)"
2915 FOR I=1 TO N-1
2920 PRINT "C";I;I+1;": ";K(I)*1E12
2930 NEXT I
2935 PRINT
2940 PRINT "RESONATING CAPS ARE (IN PF)"
2945 FOR I=1 TO N
2950 PRINT"C";I;": ";C(I)*1E12
2960 NEXT I
2970 PRINT "THIS FILTER HAS A CHARACTERISTIC Z"
2975 PRINT"OF";RE;"OHMS.":PRINT
2980 INPUT "MATCH TO ANOTHER Z";A$:IFA$<>"Y" AND A$<>"N"THEN GOTO 2980
2985 IF A$="N"GOTO 3100
2990 INPUT"NEW SOURCE AND LOAD Z <50,50>";RS,RL
2992 PRINT
2995 TM=SQR(RE*RS-RS*RS):TN=SQR(RE*RL-RL*12)
3000 CY=1/(W*TM):CZ=1/(W*TN)
3005 PRINT "ADD";CY*1E12;" PF TO THE SOURCE END"
3006 PRINT"AND ADD";CZ*1E12;" TO THE LOAD END."
3010 PRINT:PRINT"THEN CHANGE C(1)TO";(C(1)-CY)*1E12;"PF"
3020 PRINT"AND CHANGE C(";N;") TO "(C(N)-CZ)*1E12;"PF."
3100 PRINT:PRINT
3110 INPUT "ANOTHER FILTER (Y OR N)";A$
3115 IFA$<>"Y"ANDA$<>"N" THEN 3110
3120 IF A$="Y"THEN 120
3200 END
4000 REM FILTER ORDER CALCULATION ROUTINE
4010 REM BUTTERWORTH SECTION
4020 PRINT "ENTER FREQUENCY RATIO F/FC AS A NUMBER, I.E.3":INPUT WR
4025 INPUT"DESIRED ATTENUATION AT F/FC";AD
4030 FOR N=2TO 8
4040 AC=10*(LOG(1+WR↑(2*N)))/(LOG(10))
4050 IF AC=>AD GOTO4070
4060 NEXT:GOTO 4100
4070 PRINT "N=";N;"AT A CALCULATED A=";AC;"DB":RETURN
4100 PRINT"THE REQUIRED ATTENUATION IS OUT OF RANGE FOR A BUTTERWORTH FILTER"
4110 PRINT"OF UP TO 8 POLES."
4120 PRINT"A LOW RIPPLE CHEBYCHEV MAY WORK.":GOTO 130
4130 STOP
4500 REM CHEBYCHEV CALCULATION ROUTINE
4510 DEF FNCS(X)=0.5*(EXP(X)+EXP(-X))
4520 DEF FNASH(X)=LOG(X+SQR(X↑2+1))
4530 PRINT"ENTER THE FREQUENCY RATIO F/FC AS A NUMBER I.E.,3":INPUT WR
4540 INPUT "DESIRED ATTENUATION AT F/FC";AD
4560 EP=SQR(10↑(R/10)-1)
4565 N=2

```

33 cm. • 23 cm. • 13 cm.



### LOOP YAGIS AND AMPLIFIERS FROM DOWN EAST MICROWAVE

• TROPO		• WEAK SIGNAL		
• EME	• OSCAR MODE L & MODE S	• 2304	• 2400 MHz	
• 902	• 1269	• 1296	• 2304	
2345LY	45 el loop Yagi	1296 MHz	20 + dBi	\$85
2445LY	45 el loop Yagi	1269 MHz	20 + dBi	\$85
1345LY	45 el loop Yagi	2304 MHz	20 + dBi	\$75
3333LY	33 el loop Yagi	902 MHz	18.5 dBi	\$85

above antennas are assembled and tested.  
All aluminum and stainless construction. Kits also available.  
Add \$8 (\$11 west of Rockies) per antenna for UPS shipping.

2 & 4 way power dividers, complete arrays available  
2316 PA Linear Amp 1w in 18w out 1296 MHz 13.5 V \$230  
2335 PA Linear Amp 10w in 36w out 1296 MHz 13.5 V \$280  
include \$5 for UPS Blue — 48 states.

Write about Higher Power, 2304 linears, GaAs Fet preamps  
Free catalog

### DOWN EAST MICROWAVE

Bill Olson, W3HOT

Box 1655A, RFD 1, Burnham, ME 04922

(207) 948-3741

✓ 124

## FREE CATALOG!

Features Hard-to-Find Tools  
and Test Equipment



Jensen's new catalog features hard-to-find precision tools, tool kits, tool cases and test equipment used by ham radio operators, hobbyists, scientists, engineers, laboratories and government agencies. Call or write for your free copy today.

**JENSEN®**  
TOOLS INC.

Dept. HR  
7815 S. 46th Street  
Phoenix, AZ 85044  
(602) 968-6241

✓ 205

## LEARN ALL ABOUT TROUBLESHOOTING MICROPROCESSOR-BASED EQUIPMENT AND DIGITAL DEVICES

Attend this 4-day seminar and master the essentials of microprocessor maintenance. Gain a firm understanding of microprocessor fundamentals and learn specialized troubleshooting techniques. Fee is \$745.00.

### CURRENT SCHEDULE

- Atlanta, GA — Mar 18-21
- Tampa, FL — Mar 25-28
- Chicago, IL — April 15-18
- Cincinnati, OH — April 21-24
- Greensboro, NC — April 29-May 2
- Milwaukee, WI — May 13-16

MICRO SYSTEMS INSTITUTE

Garnett, Kansas 66032

(913) 898-4695

✓ 143

## MICROCOMPUTER REPEATER CONTROL

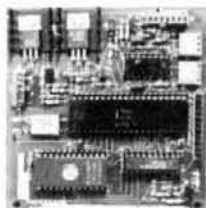

**\$129**

✓ 152

Introducing the MICRO REPEATER CONTROLLER RPT-2A, a new concept in LOW COST, EASY TO INTERFACE, microcomputer repeater control. Replace old logic boards with a state of the art microcomputer that adds NEW FEATURES, HIGH RELIABILITY, LOW POWER, SMALL SIZE, and FULL DOCUMENTATION to your system. Direct interface (drop in) with most repeaters. Detailed interface information included. Original MICRO REPEATER CONTROL article featured in QST Dec. 1983.

- Two CW ID Messages
- Time Out Timer
- Pre Timeout Warning MSG
- Post Timeout CW MSG
- Courtesy Beep
- Auxiliary Inputs
- Reconfigurable COR Input
- High Current PTT Interface
- Sine Wave Tone Generator
- Low Power 9.15 VDC @ 200 ma
- Size 3.5" x 3.5"
- All Connectors Included

RPT-2A Kit Only \$129 plus \$3.00 shipping

### PROCESSOR CONCEPTS

P.O. BOX 32908  
MINNEAPOLIS, MN 55432  
(612) 780-0472 7pm-10pm evenings



CALL OR WRITE FOR FREE CATALOG AND SPECIFICATIONS



**OC-1 ONLY \$59.95**

Complete with  
Shipping/Handling USA

**OC-2 ONLY \$79.95**

**ON CALL** is a complete selective call system so you don't have to monitor the frequency, or it can be used as a decoder for controlling equipment at the repeater site and at home.

- Compare these features:
- 4 digit 16 tone sequential decoder programmable, 43,680 different codes, DTMF Format with Auto reset
  - 1 AMP SPST relay output, momentary or latched for external paging device, such as Auto horn, tape recorder, speaker Audio etc.
  - Flashing LED call indicator. (Energizes when your code has been accessed)
  - easy connection to any radio
  - 12-16 volt DC operation
  - Size: OC-1 - 3.1 x 2.15 x .5 in.  
OC-2 - 2.3 x 3.75 x .875 in.

• can be used for clubs or emergency groups for help situations

To Order: Send Check or Money Order To

E. Carter Rd.  
PO Box 384  
Westmoreland, NY  
13490  
or Phone  
315-733-3719

MC/VISA

NYS Residents  
Add Sales Tax

**CURRENT DEVELOPMENT CORPORATION**

✓ 120

## SYNTHESIZED SIGNAL GENERATOR

MADE IN  
USA



**MODEL SG-100F**  
**\$429.95**  
delivered

- Covers 100 MHz to 199.999 MHz in 1 kHz steps with thumbwheel dial
- Accuracy +/- 1 part per 10 million at all frequencies
- Internal FM adjustable from 0 to 100 kHz at a 1 kHz rate
- External FM input accepts tones or voice
- Spurs and noise at least 60 dB below carrier
- Output adjustable from 5-500 mV at 50 Ohms
- Operates on 12 Vdc @ 1/2 Amp
- Available for immediate delivery
- \$429.95 delivered
- Add-on accessories available to extend freq range, add infinite resolution, AM, and a precision 120 dB attenuator
- Call or write for details
- Phone in your order for fast COD shipment.

✓ 168

### VANGUARD LABS

196-23 Jamaica Ave., Hollis, NY 11423  
Phone: (718) 468-2720 Mon. thru Thu.

```

4570 B=(FN ASH(1/EP))/N
4580 WC=(FN CS(B))*WR
4590 CN=(2*WC↑2-1)
4600 AC=10*LOG(1+EP↑2*CN↑2)/LOG(10)
4610 IF AC=>AD THEN PRINT"N=";N;"AT A CALCULATED A=";AC;"DB":RETURN
4620 N=3
4630 B=(FN ASH(1/EP))/N
4640 WC=(FN CS(B))*WR
4650 CN=(4*WC↑3-3*WC)
4660 AC=10*LOG(1+EP↑2*CN↑2)/LOG(10)
4670 IF AC=>AD THEN PRINT "N=";N;"AT A CALCULATED A=";AC;"DB":RETURN
4700 N=4
4710 B=(FN ASH(1/EP))/N
4720 WC=(FN CS(B))*WR
4730 CN=(8*WC↑4-8*WC↑2+1)
4740 AC=10*LOG(1+EP↑2*CN↑2)/LOG(10)
4750 IF AC=>AD THEN PRINT "N=";N;"AT A CALCULATED A=";AC;"DB":RETURN
4800 N=5
4810 B=(FN ASH(1/EP))/N
4820 WC=(FN CS(B))*WR
4830 CN=(16*WC↑5-20*WC↑3+5*WC)
4840 AC=10*LOG(1+EP↑2*CN↑2)/LOG(10)
4850 IF AC=>AD THEN PRINT "N=";N;"AT A CALCULATED A=";AC;"DB":RETURN
4900 N=6
4910 B=(FN ASH(1/EP))/N
4920 WC=(FN CS(B))*WR
4930 CN=(32*WC↑6-48*WC↑4+18*WC↑2-1)
4940 AC=10*LOG(1+EP↑2*CN↑2)/LOG(10)
4950 IF AC=>AD THEN PRINT "N=";N;"AT A CALCULATED A=";AC;"DB":RETURN
5000 N=7
5010 B=(FN ASH(1/EP))/N
5020 WC=(FN CS(B))*WR
5030 CN=(64*WC↑7-112*WC↑5+56*WC↑3-7*WC)
5040 AC=10*LOG(1+EP↑2*CN↑2)/LOG(10)
5050 IF AC=>AD THEN PRINT "N=";N;"AT A CALCULATED A=";AC;"DB":RETURN
5100 N=8
5110 B=(FN ASH(1/EP))/N
5120 WC=(FN CS(B))*WR
5130 CN=(128*WC↑8-256*WC↑6+160*WC↑4-32*WC↑2+1)
5140 AC=10*LOG(1+EP↑2*CN↑2)/LOG(10)
5150 IF AC=>AD THEN PRINT "N=";N;"AT A CALCULATED A=";AC;"DB":RETURN
5200 PRINT"THE DESIRED ATTENUATION IS NOT WITHIN RANGE OF THIS PROGRAM"
5210 PRINT "FOR THE CHOSEN FILTER TYPE."
5220 PRINT"A HIGHER RIPPLE DESIGN MAY MEET YOUR RE-QUIREMENTS."
5230 GOTO 130
    
```

READY.





# Presenting two small cases for a lot of mobile power.

You won't find a 45-watt, 2-meter FM mobile rig that's built smaller than the Yaesu FT-270RH.

Nor will you find a dual-band FM mobile that offers the crossband full-duplex capability found in the 25-watt Yaesu FT-2700RH.

It shouldn't be surprising. We've been coming up with a lot of innovative concepts lately.

The FT-270RH measures just 2 x 6 x 7 inches. Conveniently fitting its high-power punch into many small spaces of your car. Places where other 45-watt mobiles just won't fit.

The FT-2700RH is small too. Smaller than other dual-banders. But with one big difference: a "DUP" button. Push it, and you're operating full duplex, 2 meters on one VFO, 440 MHz on the other. Each at 25 watts. So you can simultaneously

transmit and receive in true telephone style.

Once installed, you'll find the FT-270RH and the FT-2700RH equally simple to operate. Just turn the rig on, dial up a frequency, select offset or duplex split, and you're on the air.

Each rig gives you 10 memories for storing your favorite frequencies. Dual VFO capability. A clean, uncluttered LCD display for easy readout. Push-button jumps through the band in 1 MHz steps. Band scanning with programmable upper and lower limits. And priority channel operation.

You don't even have to take your eyes off the road to determine your operating frequency and memory channel. An optional voice synthesizer announces them both at the push of a button on the microphone. The FT-2700RH announces both your

2-meter and 440 MHz operating frequencies.

Also, tone encode and encode/decode capability is programmable from the front panel, using an optional plug-in board.

So when you need a lot of power in a compact mobile radio, discover Yaesu's FT-270RH and FT-2700RH. There's nothing else like them on the road.

## YAESU

**Yaesu Electronics Corporation**  
6851 Walthall Way, Paramount, CA 90723  
(213) 633-4007

**Yaesu Cincinnati Service Center**  
9070 Gold Park Drive, Hamilton, OH 45011  
(513) 874-3100

Prices and specifications subject to change without notice.

✓ 204



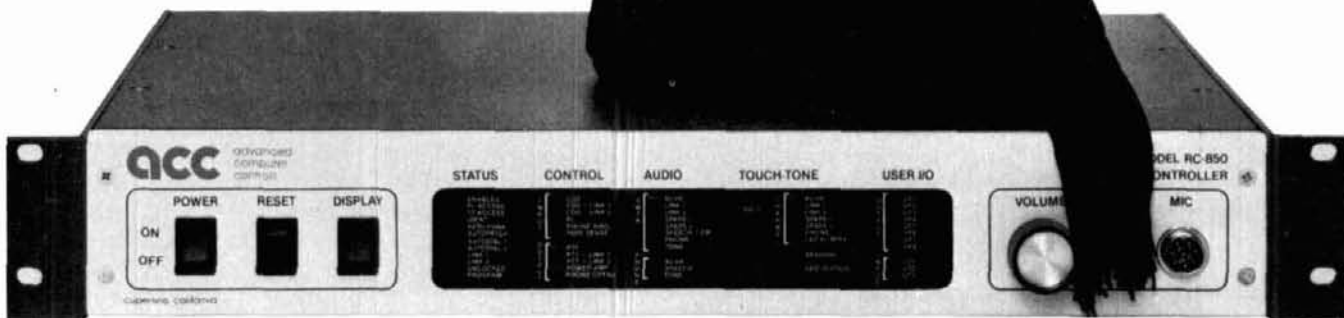

## The RC-850 Repeater Controller just got a whole lot smarter.

Our new Version 3 software makes the best repeater controller **EVEN BETTER**.

The autopatch now supports remote telephone lines linked by radio, so that you can extend your autopatch coverage to match your RF coverage. You can have autopatch even if you can't get a phone line at your site. The 250 autodial numbers meet the needs of even the largest groups, with up to 35 digit storage for MCI and Sprint.

The easy-to-use Electronic Mailbox lets you include phone numbers, times, or frequencies as parts of messages. And it's so smart, it'll leave you a message if you miss a reverse patch, or if an alarm condition occurs.

Selective call and signalling capabilities range from two-tone sequential to numeric display paging, so you'll always be available. And its voice response metering is enhanced to continuously store low and high readings – so you can find out how cold it gets, how high the reflected power reads . . . and *when*.

Of course, a controller so feature-packed gives you **secure control**. Individual user access codes, with user callsign readback, can control access to selected functions to completely prevent horseplay.

ACC's amateur radio controllers are anything but "amateur". They're used by the U.S. Army, Navy, Forest Service, and other government and commercial users around the country. But, of course, you'll also find them on the leading amateur radio repeaters in North America and abroad.

There's never been a better time to upgrade your repeater system with an ACC controller, unmatched anywhere in quality, sophistication, and performance, with documentation and support to match.

Please call or write now for the rest of the story on all our repeater products, including controllers, digital voice storage units, and other Touch-Tone control products.

You'll be GLAD you did.

**ACC**

advanced  
computer  
controls, inc.

10816 Northridge Square, Cupertino, CA 95014

(408) 749-8330



values; a bridge can give quite accurate results, and commercial or homebrew capacitance meters abound. Lacking one of the above, a grid dip meter will do nicely. All you need are some capacitors and coils that will serve as your standards (known values). Using these, an unknown coil or cap can be measured by establishing it in a resonant circuit and measuring the frequency. The *ARRL Handbook*, at least up through the 1982 edition, included a chart for determining LC values using standards of 100 pF and 5 $\mu$ H, although you can use any standard you choose.<sup>4</sup> A frequency on the order of 10 MHz is fine for checking capacitors.

You'll find that the values the program prints out for capacitors are generally not standard and will have to be made up by paralleling one or two with a trimmer. Use the grid dipper to set the value. Likewise, coil values will not work out to an exact number of turns (e.g., 9.39 turns). What you'll have to do, if you're not using a variable coil, is wind the nearest whole number of turns and adjust the coil manually. This is done by setting the grid dip meter to the proper frequency and either squeezing together or spreading apart turns until the value is correct. Fix the turns in place with coil dope. Keep your hands clear while measuring!

Now that the parts are all the correct value, assemble the filter's nodes by shorting all of the caps around an inductor to ground (see **fig. 5**). All of the resulting sections are then tuned to the geometric center frequency,  $f_0$ , of the filter. Tune only one adjustment per node! If the parts are properly measured, this should be a very small "tweak"; none may be required below 50 MHz. Connect the filter into its final configuration.

Once the components and sections are tested and assembled, it's best to verify that the filter you have is the one you really wanted (see test setup in **fig. 6**). The signal source can be a cheap generator, either purchased or home-brewed, that puts out several milliwatts of RF. If the RF voltmeter can't read frequency, use a counter. A sweep generator and receiver make an excellent combination, although a sweeper makes some means of accurately measuring the output frequency critical.

If two voltmeters are available, use one to keep the output from the source at the same level. If only one is available, set the source to some level and then sweep it across the filter's passband (still without the filter in line) while recording its level variation for a baseline. Then put the filter in line and sweep the generator across its range, say from the expected 3 dB points, or slightly beyond, while recording levels through the filter. A power meter permits immediate comparison of dB levels; a voltmeter requires a few minutes with a calculator. Once the readings are in dB, plot them versus frequency and see if you get what you expected. Without exceptional shielding in

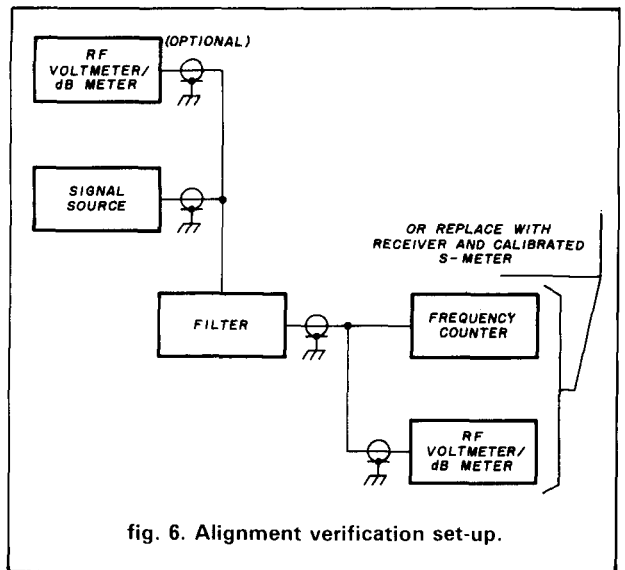

fig. 6. Alignment verification set-up.

the generator and a more sophisticated detector, it won't be possible to determine stopband response. It's generally valid to assume that if your passband is within your expected limits, the stopband will be also.

If the transmission characteristics of your filter are not as desired, it may be necessary to try to tweak it in. No amount of advice can help here, however, so make sure you've performed all the preliminary steps properly before you start ripping it apart. Many of these filters — especially those built below 30 MHz — work perfectly the first time. Keep track of what you've done, and recheck it often. If worse comes to worst, retune all nodes and start over again. (If it's any consolation, it does get easier with practice.)

If possible, build some practice filters in the HF range to familiarize yourself with the program and alignment methods. Once you've done that, you should have no problems.

Since the program (**fig. 7**) might be a little long for typing in, I'll be happy to copy it for you. Just send a formatted disk with a self-addressed disk mailer and a check or money order for \$3 to me at the address listed at the beginning of the article, and I'll return two verified copies ASAP. Please feel free to contact me about the program or alignment methods. Unfortunately, I can only reply to queries accompanied by SASE.

## references

1. Chris Bowick, *RF Circuit Design*, Howard W. Sams & Co., 1982, Chapters 2 and 3.
2. Arthur B. Williams, *Electronic Filter Design Handbook*, McGraw-Hill, 1981, pages 2-8 through 5-24.
3. Wes Hayward, W7ZOI, *Introduction to Radio Frequency Design*, Prentice-Hall, 1982, pages 90-101.
4. *The Radio Amateur's Handbook*, American Radio Relay League, 1982, pages 16-21, 17-9.

ham radio

# monolithic RF amplifiers

There's a new building block  
for HF through 2300 MHz

The monolithic developments that have revolutionized digital electronics at low frequencies are just now being applied to the creation of new types of RF devices. In spite of their novelty, monolithic microwave integrated circuits (MMICs) may soon prove as revolutionary in high frequency techniques as digital ICs have in low-frequency work. At present, entire RF amplifiers are available as MMICs, but soon other RF monolithic devices, subsystems and even entire RF front ends will be built. Silicon and gallium arsenide digital circuitry will also move into the microwave region, making digital RF "front ends" possible. All of these technologies may make the advanced Amateur equipment of the 1990s vastly more capable than today's.

However, even the first RF amplifier MMICs, which are now available, open exciting new possibilities for high performance and small size in Amateur equipment. They are useful in all Amateur bands from HF up to at least 2300 MHz, and should easily find application in receiver and low-power transmitter stages. They are very simple to use; only the DC blocking capacitors and a bias resistor need to be added externally to make amplifiers with bandwidths that can span multiple decades. Furthermore, these MMIC amplifiers now cost less than \$3.00 each in small quantities.

This article describes the design of the simplest form of an amplifier stage using one of these MMICs. The amplifier as described is useful as a building block in many types of equipment, and the description provides

enough background so that the reader should be able to go on to build more complex, multistage cascades.

## MMIC amplifier device characteristics

One company that produces commercially available silicon MMIC parts is AvanteK, which offers RF amplifiers in low-cost plastic packages. The main RF characteristics of these amplifier MMICs are summarized in **Table 1**. AvanteK offers four versions of their MMIC amplifiers: the MSA 0104, MSA 0204, MSA 0304, and MSA 0404. (The 04 suffix indicates the plastic package style). The four amplifiers provide different gains and bandwidths and four different output power capabilities.

The MSA 01 has the highest gain, but the gain begins to decrease at a lower frequency than for the other three amplifiers. The MSA 01 also has the lowest DC bias requirements, so it's of interest when low current drain is important. Because of its low bias, however, it has a low output power, too.

The next two devices, the MSA 02 and 03, have approximately equal gains. The chief difference between them is that the MSA 03 is specified for higher bias and will provide a bit more output power than the 02.

The fourth member of the family, the MSA 04, has the lowest gain, but the gain is flat to higher frequencies. It also requires the highest bias current and produces the highest output power of the group. **Figure 1** summarizes the gain-versus-frequency responses for the four, each operating at its suggested bias conditions.

I selected the MSA 03 for general-purpose use because it provides reasonably high gain and fair output power capability, and because the lowest current

By Jerry Hinshaw, N6JH, 4558 Margery Drive,  
Fremont, California 94538

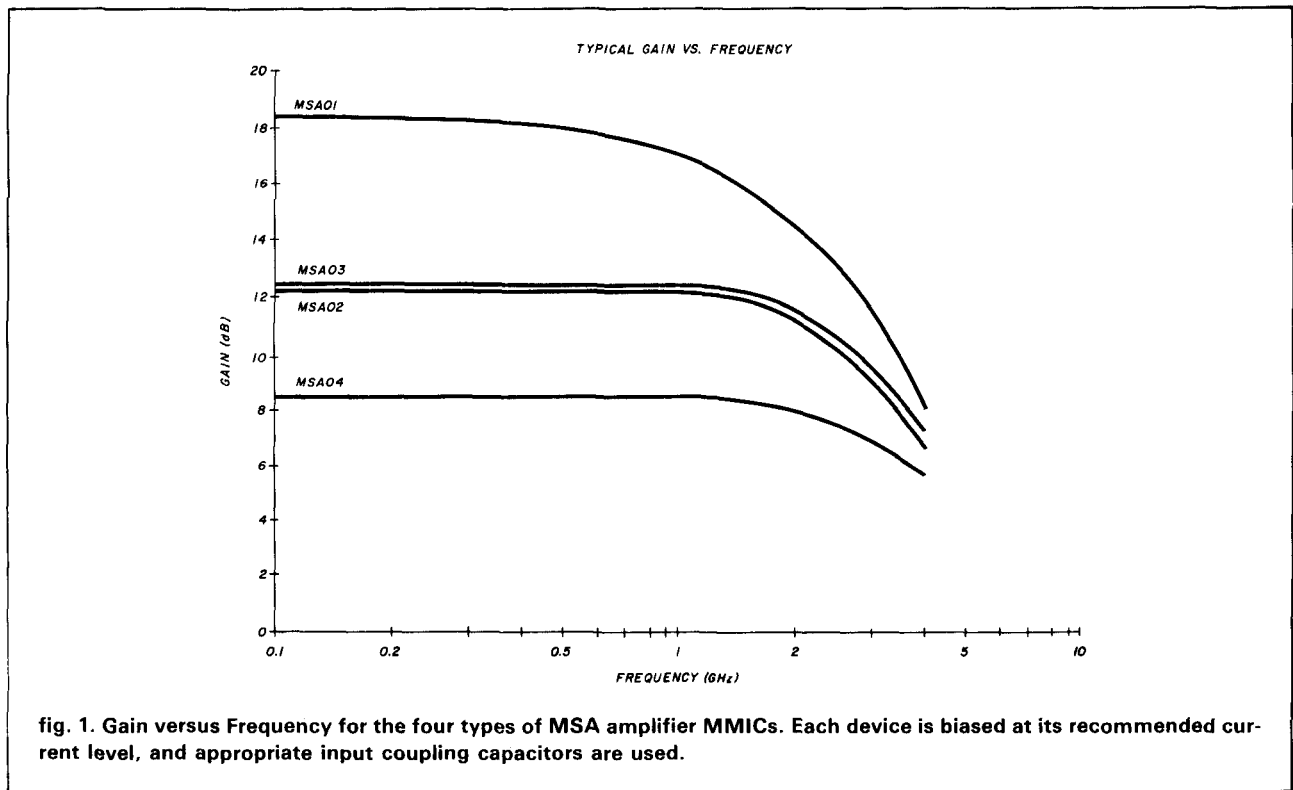

**table 1. Summary of MSA 01 – 04 characteristics. The two-digit suffix on each part number indicates package style; the –04 indicates the low-cost molded plastic package.**

MMIC MODEL	MSA 01	MSA 02	MSA 03	MSA 04
Gain in dB at 1 GHz	17	13	12	8
Noise Figure at 500 MHz, dB	5	6	6	6
Output Power P1dB at 1 GHz, dBm	1.5	4	10	12

drain is not of much interest in fixed station applications. Therefore, the remainder of this article describes an amplifier built around this device. But the techniques used apply to all four types of MMIC amplifiers, and only the biasing needs to be altered to use another member of the device in the same circuit layout.

### MSA 03 monolithic amplifier design

The design of an amplifier block using these monolithic devices is simplified greatly by the fact that no matching needs to be calculated. Maximum gain occurs over a very broad bandwidth with 50-ohm input and output terminations because the device is internally matched. Thus, the only design precautions we must take are to ensure that the device "sees" the

proper input and output terminations, namely 50 ohms, and that the correct bias is present.

The first part of this circuit design is satisfied by connecting 50-ohm input and output lines to the package. These input and output connections can be of any desired type — coax, microstrip or stripline, or even waveguide — but the package's leads must be properly transitioned to the connections. The leads are small ribbons, identical to those on transistor packages, and are like those on the commonly-used MRF 901, so they lend themselves to surface mounting on a microstrip circuit board. Microstrip is probably the preferred method of connection, since it's the simplest approach that can give good, repeatable RF performance. So we now have the input and output circuitry "designed." The circuitry consists simply of a random length of microstrip with a 50-ohm characteristic impedance. In microstrip, the impedance of a trace depends mainly on the width of the line, but also upon the thickness and dielectric constant of the substrate material. For commonly available fiberglass epoxy boards, the dielectric constant is about 4.3 in the low GHz range, and so, for a 1/16 inch (1.6 mm) thick board, a trace approximately 0.09 inches (2.3 mm) wide has a characteristic impedance of about 50 ohms. This is a convenient width for construction of the amplifier module because it permits easy connection to output connectors and is a fair match to the widths of many available chip capacitors.

The next step of the simple design process is to

determine the values for the two capacitors needed to provide DC isolation. Although the monolithic amplifier contains most of the circuitry necessary for a complete gain block inside its package, it does not contain the input and output blocking capacitors. These components are not included because it is difficult to make good capacitors of reasonable size right on the silicon integrated circuit chip using monolithic techniques. Therefore, the manufacturer has omitted the DC blocking capacitors, and the designer must provide them externally.

This requirement can, however, be a plus rather than a liability because it allows us to set the low frequency response of the amplifier as we choose. The gain of an amplifier built with one of these monolithic circuits can extend to an arbitrarily low frequency, although not to DC, by the proper selection of capacitor. In other words, the series capacitors used for input and output coupling cause the gain of the unit to fall off fairly rapidly below a certain frequency. This high-pass frequency response is useful in some systems. For instance, it might be that we do not want low frequency gain in the front-end stages of a UHF receiver because excess gain could lead to overloading and distortion caused by signals from strong local broadcast stations.

As a first approximation to calculate the corner frequency of the amplifier, which is what the frequency where the gain has dropped to half its midband value is called, pick a coupling capacitor with a reactance of about 50 ohms at the desired corner frequency. The reactance of a capacitor is equal to

$$X_c = \frac{1}{6.28 \times \text{frequency} \times \text{capacitance}} \quad (1)$$

Since we want to know the capacitance at a certain frequency where the reactance is equal to 50 ohms, we can rearrange this formula to

$$C = \frac{1}{6.28 \times \text{frequency} \times 50} \quad (2)$$

For example, to get a corner frequency of 100 MHz, the capacitors would be approximately 32 pF each, and the gain would be down from the midband value by 6 dB (each of the two coupling capacitors produces a 3 dB drop in the gain of the unit). Note, however, that this formula gives only an approximate value.

Next, the bias decoupling circuitry must be provided. The package used for these monolithic gain circuits has only four leads, and in order to make it possible to connect the grounds with low impedance, two of the leads are internally dedicated as grounds. This means that the two remaining leads are for the input and output, leaving none for a separate bias lead. The bias current for the amplifier must be supplied via

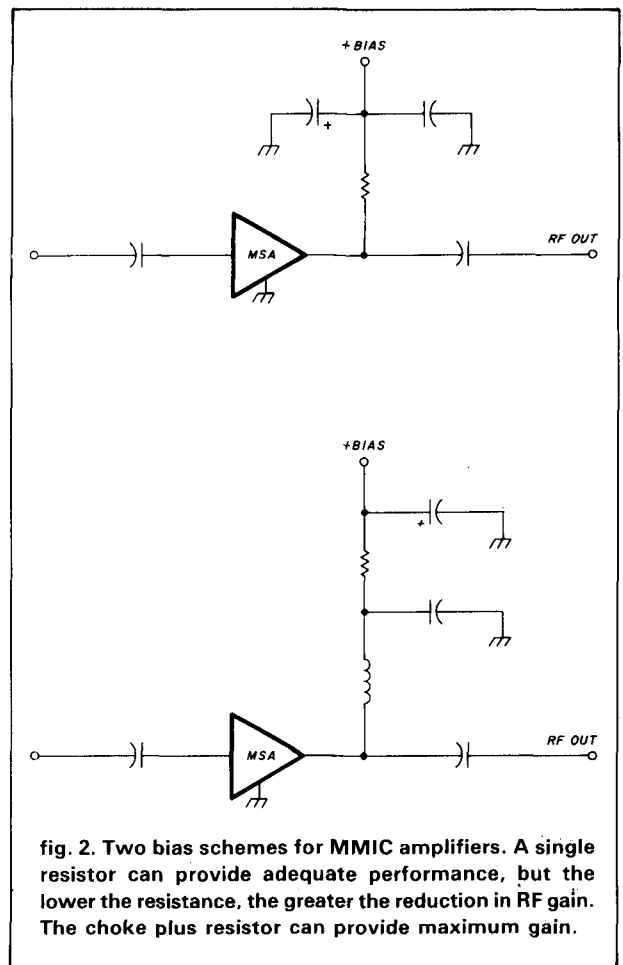

fig. 2. Two bias schemes for MMIC amplifiers. A single resistor can provide adequate performance, but the lower the resistance, the greater the reduction in RF gain. The choke plus resistor can provide maximum gain.

its output lead. Thus, it is up to the designer to provide a biasing circuit on the output lead, which is able to supply the necessary currents to the active stages of the device. At the same time the bias decoupling must not seriously degrade the RF connection of the output — if it does, the gain will be reduced excessively.

To bias the amplifier we need a circuit that presents a high impedance load at the operating frequencies of the amplifier stage to prevent diversion of RF power from the output into the biasing network. At the same time, however, it must also have low resistance to the flow of direct current. A small inductor fills this need well at high frequencies. The bias circuit must also reduce the supply voltage to the desired collector potential, so a series resistor is needed. **Table 2** gives a few values of resistance that adapt the monolithic amplifier to various supply voltages. If the bias voltage is relatively high, a resistor alone — without the RF choke — will also work well, and will reduce the RF gain only slightly. This is especially true when the resistance needed turns out to be greater than several hundred ohms. These two biasing schemes are shown in **fig. 2**.

# How to beat the high cost of cheap meters.



You get what you pay for.  
**So get the Fluke 70 Series.**

You'll get more meter for your money, whether you choose the affordable 73, the feature-packed 75 or the deluxe 77.

All of them will give you years of performance, long after cheaper meters have pegged their fishhook needles for the last time.

That's because they're built to last, inside and out. So they're tough to break. They don't blow fuses all the time. You don't even have to replace batteries as often.

And they're backed by a 3-year warranty. Not the usual 1-year.

Of course, you may only care that the world-champion 70 Series combines digital and analog displays with more automatic features, greater accuracy and easier operation than any other meters in their class.

You may not care that they have a lower overall cost of ownership than all the other "bargain" meters out there.

But just in case, now you know.

For a free brochure or your nearest distributor, call toll-free **1-800-227-3800, ext. 229.**

FROM THE WORLD LEADER  
 IN DIGITAL MULTIMETERS.



#### FLUKE 73

\$79\*  
 Analog/digital display  
 Volts, ohms, 10A, diode test  
 Autorange  
 0.7% basic dc accuracy  
 2000+ hour battery life  
 3-year warranty



#### FLUKE 75

\$99\*  
 Analog/digital display  
 Volts, ohms, 10A, mA, diode test  
 Audible continuity  
 Autorange/range hold  
 0.5% basic dc accuracy  
 2000+ hour battery life  
 3-year warranty



#### FLUKE 77

\$139\*  
 Analog/digital display  
 Volts, ohms, 10A, mA, diode test  
 Audible continuity  
 "Touch Hold" function  
 Autorange/range hold  
 0.3% basic dc accuracy  
 2000+ hour battery life  
 3-year warranty  
 Multipurpose holster

\* Suggested U.S. list price, effective November 1, 1985.  
 \*\* Patent pending.

WORLDWIDE DISTRIBUTION

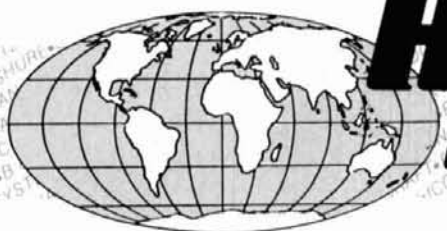

# HAM RADIO OUTLET

NEW OAKLAND LOCATION

## 6 STORE BUYING POWER

### KENWOOD TS-940S



TOP-OF-THE LINE  
HF TRANCEIVER

~~\$1799.95~~

GREAT PRICES. CALL

### KENWOOD HAND-HELD

#### TH-21AT/41AT

Compact.  
Only 2.4"W, 4.74"H,  
11"D. Outstanding  
performers in an  
ideal package size.



#### TR-2600A

Deserves its well-  
earned reputation  
as the leading HT

CALL FOR LOW,  
LOW PRICE

CALL TOLL FREE

### US TOWER CORPORATION

#### MA-40 40' TUBULAR H.D. MAST

Regular \$745  
SALE! \$549

#### MA-550 55' TUBULAR H.D. MAST

Regular \$1245  
SALE! \$899

Why You Should Buy:

1. Will handle 10 Sq. Ft. 50 mph
2. Pleases neighbors with tubular streamlined look
3. In stock for quick delivery
4. Other models at great prices

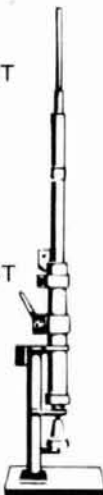

IN STOCK FOR IMMEDIATE DELIVERY



#### ELH-230D



2 METER  
3 IN/30 OUT

CALL FOR PRICE

NEW OAKLAND  
LOCATION

### ICOM

#### IC-R7000



25 MHz-1300 MHz

### ICOM

SIMPLEX-REPEATER-  
SATELLITE



#### IC-271H

2 Meters  
100 Watts  
All mode

#### IC-471H

430-450MHz  
74 Watts  
All mode



GREAT PRICES. CALL



#### W-51

### TOWER SALE

51' CRANK-UP 9 SQ. FT.  
WINDLOADING

\$899

UNBELIEVABLE  
PRICE!



FREE  
SHIPMENT  
Most items UPS  
surface

## All Major Brands in Stock Now!

## CALL TOLL FREE (800) 854-6046



Toll free including Alaska & Hawaii. Phone Hrs: 9:30 a.m. to 5:30 p.m. Pacific Time. California and Arizona customers call or visit nearest store. California and Arizona residents please add sales tax. Prices, specifications, descriptions subject to change without notice.





WORLDWIDE DISTRIBUTION

NEW OAKLAND LOCATION



# HAM RADIO OUTLET

## 6 STORE BUYING POWER

### ICOM IC-R71A



Superior Grade General Coverage Receiver

\$799

SALE! CALL FOR PRICE

### ICOM IC-37A



IC-27A (25W,2M,FM)

IC-27H (45W,2M,FM)

IC-37A (25W,220MHz,FM)

IC-47A (25W,70cm,FM)

CALL FOR LOW, LOW PRICE

### ICOM IC-735



The Latest in ICOM's Long Line of HF Transceivers

CALL FOR LOW, LOW PRICE

### ICOM IC-R7000



25 MHz-1300 MHz

ADVANCE ORDERS TAKEN NOW FOR FIRST SHIPMENT

### ICOM LATEST EDITION

### IC-3200A DUAL BANDER

Covers Both 2 Meters & 70 cm



AT GREAT LOW, LOW PRICES

### ICOM IC-1271A

NEW



1.2 GHz Transceiver: The First Full-featured 1240-1300 MHz Transceiver AT GREAT LOW, LOW PRICES

### ICOM HAND-HELDS

#### VHF/UHF



IC-02AT  
IC-04AT



IC-2AT  
IC-4AT



IC-3AT

CALL FOR LOW, LOW PRICE

## All Major Brands in Stock Now!



Bob Ferrero W6RJ  
President

Jim Rafferty N6RJ  
VP So. Calif Div.  
Anaheim Mgr.

ANAHEIM, CA 92801

2620 W. La Palma  
(714) 761-3033, (213) 860-2040  
Between Disneyland & Knott's Berry Farm

BURLINGAME, CA 94010

999 Howard Ave.  
(415) 342-5757: George, Mgr. WB6DSV  
5 miles south on 101 from SFO

OAKLAND, CA 94606

2210 Livingston St.,  
(415) 534-5757: Don, Mgr. N6IPE  
Hwy. 17 to 23rd Ave. Exit

SAN DIEGO, CA 92123

5375 Kearny Villa Rd.  
(619) 560-4900: Glenn, Mgr. K6NA  
Hwy. 163 & Claremont Mesa Blvd.

PHOENIX, AZ 85015

1702 W. Camelback Rd.  
(602) 242-3515: Bob, K7RDH  
East of Hwy. 17

VAN NUYS, CA 91401

6265 Sepulveda Blvd.  
(818) 988-2212: Al, Mgr. K6YRA  
San Diego Fwy. at Victory Blvd.



## CALL TOLL FREE (800) 854-6046

Toll free including Alaska & Hawaii. Phone Hrs: 9:30 a.m. to 5:30 p.m. Pacific Time. California and Arizona customers call or visit nearest store. California and Arizona residents please add sales tax. Prices, specifications, descriptions subject to change without notice.



**table 2. Values of bias resistors for the MSA 03 device for various supply voltages. The power ratings for the resistors include a 2:1 derating factor.**

Model	Suggested bias current, milliamps	Supply voltage		
		+ 12	+ 15	+ 24
MSA 01	17	390 ¼ W	560 ¼ W	910 ½ W
MSA 02	25	270 ¼ W	390 ½ W	750 1 W
MSA 03	35	200 ½ W	300 ½ W	510 1 W
MSA 04	50	130 ½ W	200 1 W	360 1 W

Regardless of whether a resistor or an inductor is used to provide bias directly, decouple its far end to ground with a good bypass capacitor to prevent interaction of the external power supply with the RF circuitry. This capacitor, like the RF coupling capacitors in the input and output leads, must be chosen with an eye on the operating frequency range. Because we wish this amplifier to work at VHF and above, the capacitors must be suitable and must not have self-resonances below the operating frequency range. If good performance much above 1 GHz is desired, leadless chip capacitors should be used; the more familiar leaded types of capacitors are self-resonant at too low a frequency to be useful here. For VHF and below, though, small ceramic capacitors with short leads work well. With the selection of the coupling and bias circuit elements, the design is done.

### construction

This section describes the construction of a single-stage RF amplifier as an example of how useful these gain blocks can be, and suggests what can be expected in terms of actual performance. The amplifier described here is useful as a building block for larger systems or as a test amplifier for use when more gain is needed in a breadboard.

This amplifier was designed to provide useful gain from about 100 to greater than 1300 MHz, using the Avantek MSA-0355-21 device. This device is packaged in a ceramic case, but it is electrically similar to the plastic-package MSA-0304 type. I used it because when I began this project, the plastic devices had not yet been introduced. The device is biased at 35 milliamperes and uses 13-volt direct current. The bias circuit is a simple hand-wound coil, decoupled at the DC end with two capacitors, and a series resistor to drop the 13-volt supply to the required level at the MSA device's output lead. **Figure 3** is a schematic diagram of the test amplifier.

The amplifier was built on a piece of 1/16 inch (1.6

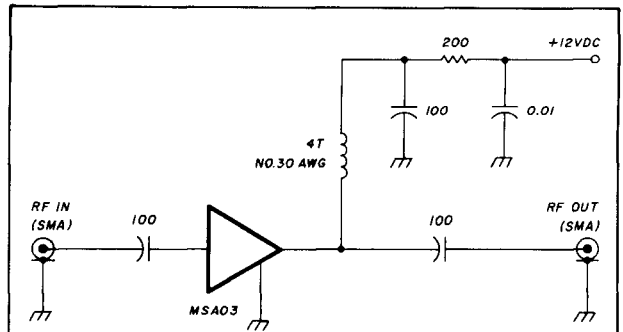

**fig. 3. The schematic diagram of the test amplifier described in the text. The 100 pF capacitors are chips, the 0.01  $\mu$ F capacitor is a ceramic disc. The coil consists of 5 to 10 turns of No. 30 AWG insulated wire-wrap wire wound on a No. 60 drill.**

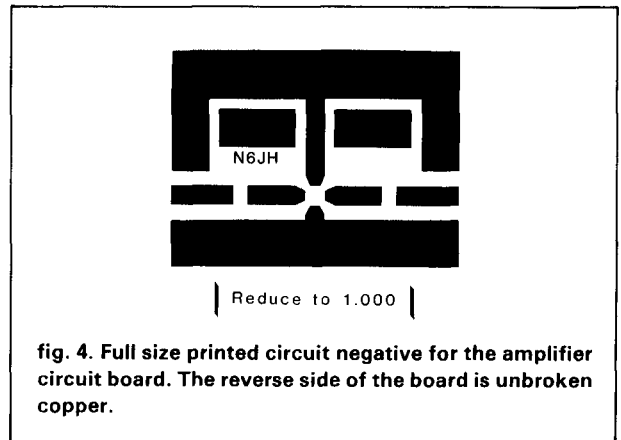

**fig. 4. Full size printed circuit negative for the amplifier circuit board. The reverse side of the board is unbroken copper.**

mm) thick fiberglass epoxy, double-clad printed circuit board stock. One side of the board was left untouched so that its uninterrupted copper conductor can serve as the groundplane for the microstrip traces, which are etched or hand-cut onto the other side. **Figure 4** is a full-size negative of the same design that can be used to make an etched circuit board to duplicate the amplifier. The prototype was built on a hand-cut board which has approximately the same pattern of traces as on the negative. Reference 3 describes one method of making hand-cut RF boards.

The components are all mounted to the top side of the board as indicated in **fig. 5**. The input and output coupling capacitors are chips, and are carefully soldered across the gaps in the 50 ohm microstripline leading to and from the device. At the output, a small RF choke connects to a pad on the circuit board which is bypassed to ground at high frequency by a chip capacitor and by a ceramic disc capacitor for lower frequencies. This pad also is the terminus for the dropping resistor, whose resistance depends on the sup-

# ST-8000 HF-MODEM



The ST-8000 HF MODEM is a high-performance, fully adjustable modulator/demodulator for use in high-frequency radio data systems. The HF Modem features fully adjustable frequencies and baud rates, memories, diversity, regeneration, print squelch, CRT tuning indicator, and multiple AM or FM detectors. The bandwidths of the input filter, Mark filter, Space filters, and post-detection filters are tracked with the selected data rate (10 to 1200 baud) to assure optimum signal recovery for all signals. Front panel parameters may be controlled from an external ASCII terminal or computer. A full complement of I/O interface options allows use of the ST-8000 with virtually any terminal and radio system. Install the HAL DS3100ASR CRT terminal and ST-8000 HF Modem in your communications system and enjoy the benefits of a data system designed for radio operators.

- Tuneable from 500 to 4000 Hz in 1 Hz steps
- Set 10 to 1200 Baud in 1 baud increments
- Four input band-pass filters
- 32 matched Mark and Space filter bandwidths
- Mark and Space 7-pole linear phase LP filters
- Filter BW and selection computed and set by microprocessor front panel controls
- RTTY shifts from 40 to 3500 Hz
- Eight programmable non-volatile memories
- Split or transceive RX/TX tone selection
- FM or AGC-controlled AM signal processing
- 65 to + 20 dBm dynamic range (AM or FM)
- Exclusive HAL Digital Multi-Path Correction (DMPC™)
- M/S, Mark Only (MO) or Space Only (SO) detector modes using Adaptive Threshold Detector (ATD™)
- Adjustable Print Squelch and non-diversity Amplitude Squelch
- Exclusive HAL Infinite Resolution Diversity Control (IRDC™)
- Digital signal regeneration
- ASCII/Baudot code and speed conversion
- Quick Brown Fox and RYRY... test message generator
- Programmable Selective-call (SEL-CAL) printer control
- Transmitter PTT KOS control
- Antispace
- RS232C, MIL-188C, or TTL Terminal I/O
- LP1200 Option for polar or neutral loop
- 8, 600, or 10K ohm input impedance
- 8 or 600 ohm output with adjustable level
- AFSK or FSK transmitter outputs
- Remote terminal or computer control of all demodulator parameters
- Exclusive HAL Spectra-Tune™ and X-Y Mark/Space CRT tuning indicators with automatic trace on/off control
- 100-130/200-250 VAC, 44-440 Hz power
- 3.5" high rack mounting cabinet (14" deep)
- Shielded and filtered for radio system use

™ Infinite Resolution Diversity Control (IRDC), Spectra-Tune, Digital Multi-path Correction (DMPC), and Adaptive Threshold Detector (ATD) are trade marks of HAL Communications; patents pending.

Write or call for complete ST-8000 specifications. We think you will agree that it opens new frontiers in radio data communications. Contact the Government & Commercial Products Division for price and delivery information.



**HAL Communications Corp.**  
Government & Commercial Products Division  
1201 W. Kenyon Road  
P.O. Box 365  
Urbana, IL 61801-0365  
(217) 367-7373 TWX: 910-245-0784

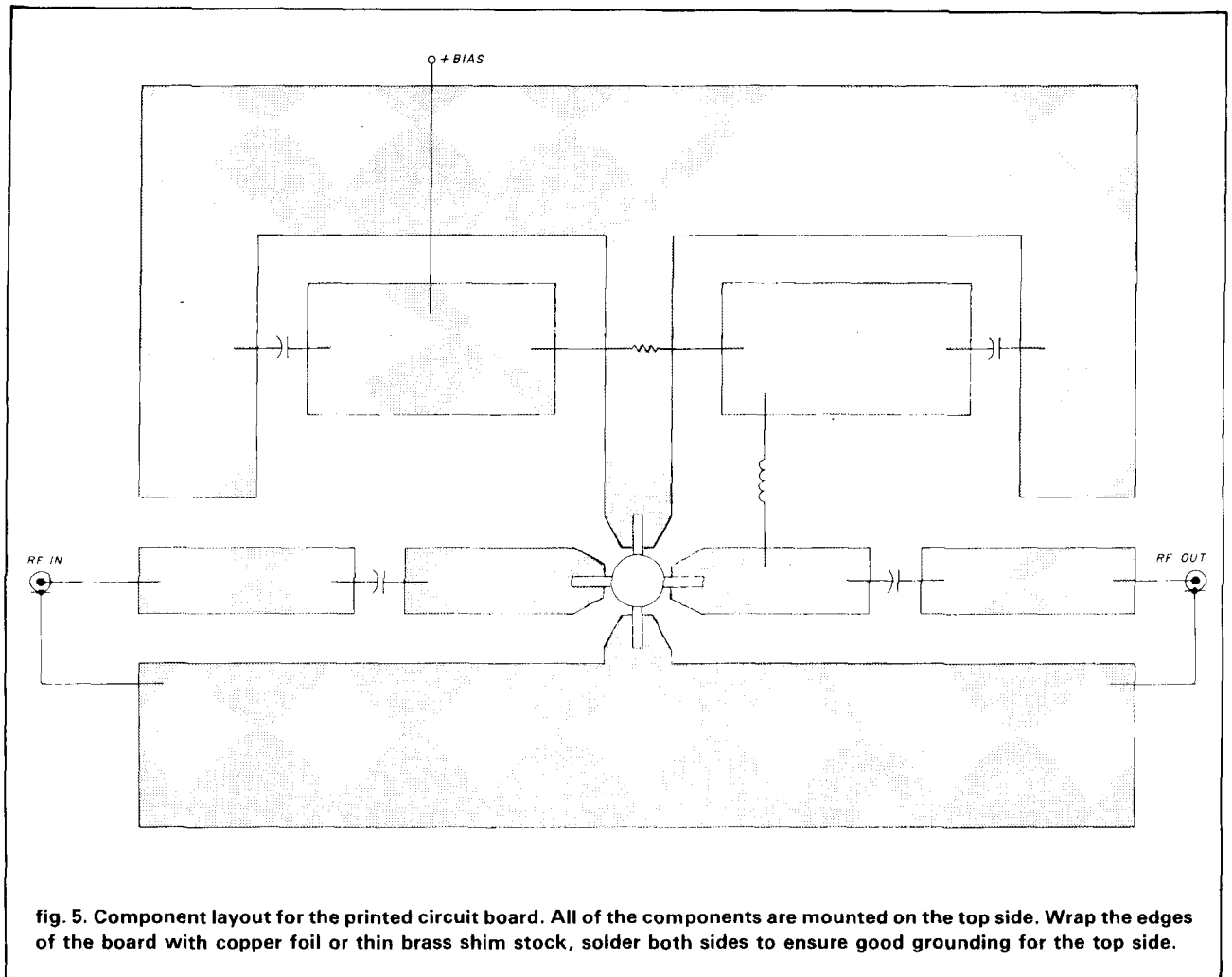

fig. 5. Component layout for the printed circuit board. All of the components are mounted on the top side. Wrap the edges of the board with copper foil or thin brass shim stock, solder both sides to ensure good grounding for the top side.

ply voltage you intend to use. For 13- to 15-volt supplies, 200 ohms is appropriate, and sets the bias to about 35 milliamperes.

The device itself is mounted in a 0.150 inch (3.8 mm) diameter hole drilled through the substrate. This hole provides clearance for the package so that the four leads are flush with the microstrip transmission lines to which they connect. The input and output are soldered directly to their respective lines. The two ground leads are treated somewhat differently; they must be connected to the microstrip groundplane by physically short junctions to reduce their impedance to the minimum. Two methods have been used with good results: the first is to connect the circuit board's top and bottom grounds together with small strips of copper or brass run through the hole drilled to clear the amplifier's package. The ground leads can then be soldered to the top plane; the strips provide a short path to the bottom groundplane. A second approach is to bend the device's two ground leads downward, starting right at the package, and solder the leads to the bottom groundplane. Either method works, but I pre-

fer the former for best high-frequency use and reserve the second technique for lower frequencies, say below 1000 MHz. Whichever method you use, keep in mind that small physical length and good soldering are critical.

Connectors at the input and output complete the assembly. I used SMA connectors so that I could evaluate the performance of the amplifier board at its maximum frequency, but other connectors can be used with good results. Solder the center pins of the connector to the microstripline and the outer conductor to ground, preferably on both sides of the board, but certainly on the bottom side. The clearances can be tight, so be sure that the outer conductor of the connectors does not contact the microstrip line. **Figure 6** is a photograph of the completed prototype amplifier used for evaluating the MSA 03 device, and for the testing procedure described below.

The entire amplifier board has only four capacitors, two connectors, one coil, one resistor and a monolithic amplifier, all mounted on a simple circuit board. *That's all.* Let's see how well it performs.



## AMATEUR TELEVISION

**INTRODUCING OUR NEW SMALL ALL IN ONE BOX TC70-1  
ATV TRANCEIVER AT A SUPER LOW \$299 DELIVERED PRICE.**

### TC70-1 FEATURES:

- 10 pin VHS color camera and RCA jack video inputs.
- Crystal locked 4.5 MHz sound subcarrier.
- PTL (Push To Look) T/R switching.
- Dual gate GaAsfet tuneable downconverter.
- Two frequency 1 watt pep xmr. 1 xtal incl.
- Xmit video monitor outputs to camera and jack.
- Small 7 x 7 x 2.5" for portable, mobile, or base.
- Draws only 500 ma (exc. camera) at 13.8 vdc.

Just plug in your camera, VCR, or computer composite video and audio, 70 cm antenna, 12 to 14 vdc, and you are ready to transmit live action color or black and white pictures. Sensitive downconverter tunes the whole 420-450 MHz band down to channel 3 on your TV set to receive. Both video carrier and sound subcarrier are crystal controlled. Specify 439.25, 434.0, or 426.25 MHz. Extra crystal \$15.

### WHAT ELSE DOES IT TAKE TO GET ON ATV?

Any tech class or higher amateur can get on ATV. If you already have a source of video and a TV, it costs about the same as getting on 2 meters.

DX with TC70-1s and KLM 440-27 antennas line of sight and snow free is about 15 miles, 7 miles with the 440-6 for portable use such as parades, races, search and rescue, etc. You can add one of the two ATV engineered linear amps listed below for greater DX.

AT 70 cm, antenna height and gain is all important. Foliage can absorb much of the power. Also low loss tight braided coax such as the Saxton 8285 must be used.

The TC70-1 has full bandwidth for color, sound, and computer graphics. You can now show the shack, computer programs, home video tapes and movies, repeat SSTV or even space shuttle video if you have a TVRO.

**20 WATT SPECIAL \$399**

**SAVE \$9 on the TC70-1 & ELH 730G  
when purchased together**

### ACCESSORIES:



Mirage D24N 50 watt amp ..... \$189  
ATV, SSB, FM. 9 amps.

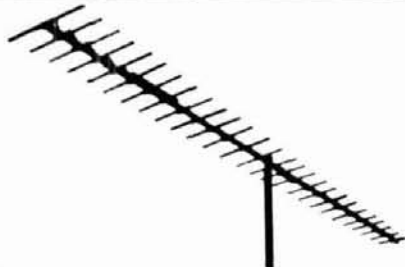

KLM 440-27 14.5 dbd antenna ..... \$89  
KLM 440-6 8 dbd antenna ..... \$38

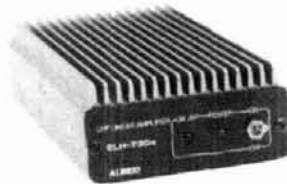

Alinco ELH-730G 20 watt amp ..... \$109  
ATV, SSB, FM. 4.5 amps.



## performance

The data sheet for the MSA 03 indicates that we

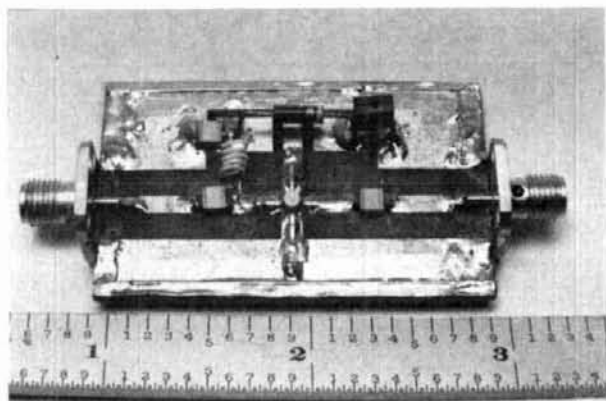

fig. 6. Photograph of the completed amplifier prototype. The ruler scale is in inches. The input connector is on the right.

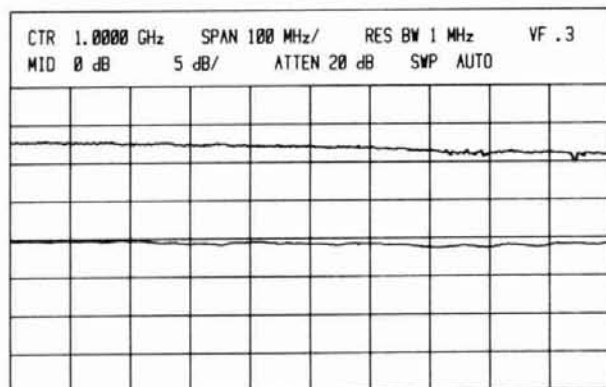

fig. 7. Swept gain response of the test amplifier. The lower trace is the RF signal generator alone, while the upper trace shows the amplifier's gain added to the generator signal. The sweep covers 500 to 1500 MHz, and the vertical scale is 5 dB per division.

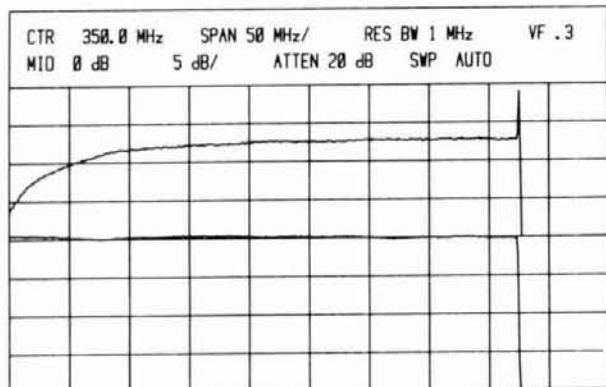

fig. 8. Low frequency gain response of the test amplifier, from 100 to 500 MHz. The gain of the amplifier rolls off as expected at low frequency.

should expect about 12 dB gain at low frequency and that this gain should drop to about 10 dB somewhere between 1 and 2 GHz. The gain should continue to roll off to about 8 dB at 2300 MHz and down to 6 dB at 3300 MHz. The performance of the test amplifier was measured between 100 MHz and 3 GHz, and the measured data corresponded well to these predicted values. **Figure 7**, as an example, shows the gain between 500 and 1500 MHz, as seen on the screen of a spectrum analyzer. The lower trace is the reference sweep from just the signal generator, while the upper response is made with the amplifier in the line between the signal source and the spectrum analyzer. Therefore, the difference between the two traces is the gain of the amplifier. It is clear that the amplifier is nearly "flat" — that is, its gain doesn't vary by much over this frequency range, but remains a constant 12 to 13 dB.

Below 500 MHz, the gain remains flat down to the point at which the input and output coupling capacitors begin to significantly reduce the gain, as explained above. **Figure 8** shows the response from 100 to 500 MHz. The gain of the amplifier is down to nearly unity (0 dB) a bit below 100 MHz. The "spike" at the right edge of the trace is a discontinuity caused by the signal generator's stopping its sweep, and is not a resonance in the circuit as it might at first appear to be.

Gain is not the only important amplifier parameter of interest. A second, major item is the amplifier's ability to handle relatively high signal levels. This ability is clearly important in a transmitter chain, and it's also vital in a receiver because the power-handling capability of an amplifier determines the upper end of this dynamic range.

Two common measures of the power handling capability of an amplifier are used. One is the *1 dB compression point*. This is the output power level at which the amplifier's gain is reduced 1 dB from the gain imparted to small signals. This point marks the onset of serious distortion in a "linear" amplifier, and

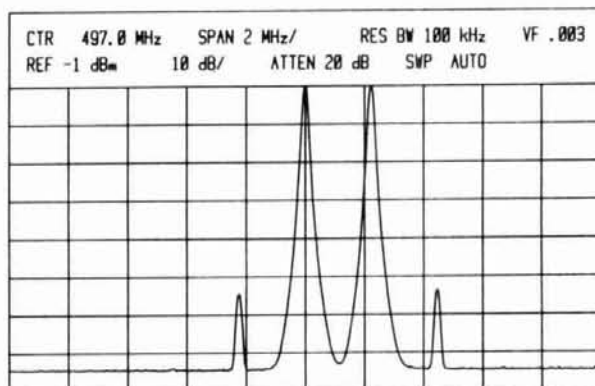

fig. 9. Two-tone intermodulation output of the amplifier.



in general, it is also not many dB from the saturation point of the amplifier. The data sheet for the MSA 03 lists the 1 dB compression point (at 35 milliamperes bias) as about 10 milliwatts for signals below 1 GHz, dropping to about 4 milliwatts at 2 GHz.

A second measure of the power handling capability of an amplifier is the *third order intercept point*, which is the imaginary point at which certain distortion products would be equal in power with the fundamental output of the amplifier. Reference 4 describes all of this succinctly. Practically speaking, third order intermodulation is measured by sending two signals of equal amplitude into an amplifier and observing the output on a spectral display. The display will show the two fundamental signals and will also show (at some level below the fundamental) a pair of responses spaced above and below the two fundamental tones by exactly the spacing between the fundamental signals. These are the third order intermodulation products.

Figure 9 shows this situation clearly. In it, two test tones at about 500 MHz, but spaced by about 2 MHz, have been passed through the test amplifier and the output displayed on a spectrum analyzer. The two fundamental signals are at a level of about -1 dBm each, and the third order products are seen to be about 55 dB below that level. Because the third order products are predicted to rise at 2 dB for each 1 dB increase in the amplitude of the fundamental signals, the four traces would (theoretically) be equal at about +26 dBm. This figure is somewhat higher than expected, as the data sheet suggests a third order intercept point of +23 dBm for this frequency and bias condition. However, the measurement is subject to some error, especially in the precise measurement of power level, so this test indicates that the amplifier's performance is approximately equal to the data sheet's predictions.

### conclusion

These MMIC amplifiers offer a powerful new flexibility to RF designers; their cost is low enough so that Amateur experimenters can afford to use them. They make it possible to build high frequency equipment more easily than ever before, and with better results. I predict that you'll be seeing many of them in designs over the next few years, and that they will open up the microwave bands to a lot of new operation.

### references

1. Craig P. Snapp, Jose F. Kukielka, and Northe K. Osbrink, "Practical Silicon MMICs Challenge Hybrids," *Microwaves and RF*, November, 1982.
2. Ralph S. Carson, *High Frequency Amplifiers*, John Wiley & Sons, New York, 1975.
3. J. Hinshaw, "No Etch Circuit Boards," 73, September, 1984, pages 34-35.
4. J.R. Fisk, "Receiver Noise Figure Sensitivity and Dynamic Range — What the Numbers Mean," *ham radio*, October, 1975, page 8.

ham radio

## PACKET RADIO GOES PORTABLE

### GLB ELECTRONICS

presents



#### Model PK1-L

- LOW 25 mA Current drain.
- Designed for portable or solar-powered stations.
- Miniature size—Lightweight
- Rugged all metal, shielded enclosure
- On-board Lithium Battery RAM backup.
- On-board watchdog for reliability.
- Standard DB-25 Connectors.
- Output signal indicates "Connected" Status.
- Does not require squeezed audio.
- Comes with 8K of RAM.
- Remote Command Mode for Unattended operation.
- Hardware command lockout for security.
- Commands compatible with our Model PK1.
- Retains all other features of the Model PK1.
- Extra I/O lines for special applications.

Power requirement:  
9 to 15 Volts DC @ 25 mA typical

Dimensions:  
4.6 X 5.90 X 1.0 inches

Total Weight:  
12 ozs.

PK1L—Wired and Tested \$239.95  
List— \$209.95  
Amateur net—

#### GLB MODEL TNC-2A KIT

Just when you thought TAPR TNC-2 Kits were a thing of the past, GLB—the first commercial producer of Packet Controllers—joins the "TAPR Revolution" at last!

Hardware | by TAPR  
Software |  
Documentation |



GLB Model TNC-2A Kit  
**COMPLETE KIT ONLY**  
**\$154.95 NMOS**  
**\$169.95 CMOS**  
+ shipping

Contact GLB for information on our full line of Packet Controllers

## GLB ELECTRONICS, INC.

151 Commerce Pkwy.,  
Buffalo, NY 14224  
716-675-6740 9 to 4

128

## I LARGE STOCK of VACUUM TUBES and GAS-FILLED TUBES

Transmitting tubes  
Pulse Modulators  
Rectifiers  
Vacuum Capacitors  
Receiving Tubes

## II VINTAGE TEST EQUIPMENT

Circa 50's & 60's

We're Clearing Our Shelves

Remember that old GR impedance bridge you used to use back in the college lab? Well, we have IT!! We also have the following: RF Generators . . . Boonton, HP, GR Signal Generators . . . HP, GR O'Scopes . . . Tektronix, Lumatron VTVM's . . . Rack mount HP & Others Scope Plug-ins . . . Tek, Lumatron Time/Event counters . . . HP, Berkley Tube type power supplies . . . rack mount . . . Lambda, Kepco  
Panel Meters: Analog . . . GE, ImA-5A

Circle 200 on reader service card for I above, 298 for II

**UNITED ELECTRONICS Newark, NJ**

# TOO GOOD TO BE TRUE?

## PAKRATT™ Model PK-64

shown with enhanced  
HFM-64 option installed



## ★ MORSE ★ BAUDOT ★ ASCII ★ AMTOR ★ PACKET ★

### FIRST FIVE MODE DATA CONTROLLER

The Pakratt model PK-64 by AEA is the world's first computer interface that offers Morse, Baudot, ASCII, AMTOR and Packet all in one box (hardware and software included) at a price many competitors charge for Packet alone (from \$219.95 Amateur net). Do not let the low price fool you; coming from any other company but AEA it WOULD be too good to be true. The PK-64 works with virtually any voice transceiver. The Pakratt is the easiest of any to hook up and have operating in just a few minutes.

In Packet mode, the PK-64 offers virtually all the features of every other Packet controller on the market, plus many important features left out by others due to cost constraints. For example, we have included a hardware HDLC, true Data Carrier Detect (DCD), multiple connect with up to ten stations simultaneously and full implementation of version 2.0 of the AX.25 protocol.

Because the PK-64 was designed specifically for the Commodore 64 (or C-128 and SX-64) computer, we have been able to do many things not economically feasible with general RS-232 interface controllers. For ex-

ample, the Pakratt includes true split screen operation with on-screen status indicators and an on-screen tuning indicator.

### ENHANCED HFM-64 MODEM OPTION

The standard PK-64 will operate all modes with a phase-lock-loop (PLL) detector roughly equivalent to all popular packet modems in the marketplace (except we have included extra filtering). The enhanced HFM-64 modem option offers true independent dual channel filtering with A.M. detection (like the famous CP-100 Computer Patch™). The enhanced HFM-64 option also offers a hardware LED tuning indicator (like the CP-100) and a front panel variable threshold control for setting maximum sensitivity under various band conditions. We recommend the HFM-64 option for anyone keenly interested in weak-signal heavy-QRM HF operation. For anyone desiring to operate FM RTTY with the standard North American tone pair or CW receive, the HFM-64 is required. The HFM-64 is field installable with no soldering or test equipment required.

### WORKS WITH THE POPULAR C-64 COMPUTER

AEA designed the PK-64 around the

low-cost C-64 because of the special architecture features making it especially suited to Amateur Radio applications. The C-64 should not be viewed as a mainframe, but rather a very economical accessory to your data communications system. Many owners of expensive computers such as IBM, TANDY, APPLE, KAYPRO, ATARI, etc., are now buying the low cost C-64 and dedicating it to their operating position. They simply cannot find software for their machine that even approaches the power and user friendliness of the PK-64. Plus, think of the convenience of having only one controller and keyboard to go from one mode to another without having to re-do cabling!

The PK-64 is so complete that all you need to do is wire up a microphone connector to the end of a cable (provided) and you are ready to go. There is no need to track down special terminal software, cabling or even a power supply. It all comes with the PK-64. So do not be the last on your block to own the most exciting new product in years. See the PK-64 at your favorite dealer or write for our specification sheet now.

*Prices And Specifications Subject To  
Change Without Notice Or Obligation*

**Advanced Electronic Applications, Inc.**  
P.O. Box C-2160, Lynnwood, WA 98036-0918  
(206) 775-7373 Telex 6972496 AEA INTL UW

**AEA** Brings you the  
Breakthrough!

# SAVE \$7.05\* with home delivery

**SAVE \$7.05\*** with home delivery

\*(One year newsstand cost \$30.00)

Here's my address label, enter my subscription.  Payment enclosed  
 Bill me later

1 Year . . . . . 12 issues . . . . . \$22.95  
2 Years . . . . . 24 issues . . . . . \$38.95  
3 Years . . . . . 36 issues . . . . . \$49.95 U. S. prices only

Name \_\_\_\_\_ State \_\_\_\_\_ Zip \_\_\_\_\_

Address \_\_\_\_\_

City \_\_\_\_\_

Check here if this is your renewal (attach label)

Subscribe to **ham**  
**radio**  
MAGAZINE

Please allow 4-6 weeks for delivery of first issues.

**Foreign rates:** Europe, Japan and Africa, \$37.00 for one year by air forwarding service. All other countries \$31.00 for one year by surface mail.

Please  
enter my  
subscription



NO POSTAGE  
NECESSARY  
IF MAILED  
IN THE  
UNITED STATES

**BUSINESS REPLY CARD**

First Class    Permit No. 1    Greenville, NH

Postage Will Be Paid By Addressee

**ham  
radio**

Greenville, NH 03048



# vswr bridges

Simple device requires careful design for accurate, reproducible results

**Some conventional VSWR bridges** have a bad reputation; there's much confusion. They may have a fairly flat forward output vs. frequency response and even a good reflected null at a given frequency, but at high known VSWRs, they don't seem to do the desired job. Sometimes the reflected power is even larger than the forward! Now — in this era of transistorized amplifiers, some don't seem to provide the necessary protection. It would appear that their design and construction, therefore, need more attention.

## what's a bridge?

Conventional VSWR bridges are devices that sample voltage and current components to a load. They all use a voltage divider and a current divider, although sometimes these are combined to look more like a pickup loop or short transmission line. The sum of these normalized samples is the forward output voltage. Usually RF detectors are built-in to provide DC outputs. It sounds simple, and it is; but it works as accurately as possible to produce the samples, and then independently adds or subtracts them. These components enter into the basic definition of forward or reflected power.

## why so much discussion?

Obviously, there are several pitfalls — in design, construction, and measurement interpretation. If there weren't, there wouldn't be so many articles on the subject or so much discussion about it. Bridge circuits are often evaluated in terms of reflectivity, where the ratios are between the forward and reflected output voltages, usually expressed in dB, and by forward voltage vs. frequency measurements. A troublesome bridge may have an honest reflectivity ratio of only 14 dB, yet the user may think it's better! Let's examine some of the reasons for this.

## how good?

A reflectivity ratio of 14 dB corresponds to a VSWR ratio of 1.5:1, so measurements would then have a corresponding uncertainty. A true 5:1 forward-to-reflected voltage ratio is a 25:1 power ratio, or 14 dB reflectivity. Most practical bridge circuits should reliably hold a 26 dB reflectivity ratio, corresponding to a 1.1:1 VSWR uncertainty, in normal production practice. (Often a lowpass harmonic filter is used after the bridge, adding its 1.1:1 VSWR, too. A lab instrument can hold 35 dB, and with further adjustment, 50 dB.

## diode knee — a big deal!

The measurements will vary with temperature and/or level because of the diode's offset voltage. This threshold of the diode will suppress a small reflected voltage and make one think that the bridge is much better than it actually is. Even with "hot carrier" silicon diodes, this is a factor. Forward-biasing the diodes helps, but may substitute the problem of having an output even if there is no input signal. Nonlinearity of the scale calibration at low signal levels is usually a "diode knee" effect, and therefore temperature-sensitive. It's best, then, to be at a level high enough that results aren't affected by the diode knee. A diode threshold of 0.5 volts means that any reflected samples below that won't give any output indication.

## good ground presents bigger problem

Many construction problems are partly ground-oriented. One must remember that for RF purposes, the concept of a ground exists only as a reference point for one's thinking. RF impedance and transmission line effects limit the usefulness of that concept. Often, it's no more than an aid to sloppy thinking, because of the confusion it creates. The "ground" lead of every component is a separate RF ground, but all the common resistance and inductance — which counts greatly in circuits such as these bridges — doesn't show on the schematic. Where the ratios between signals are very large, the ground location must be correspondingly large.

By Will Herzog, K2LB, 406 Yarmouth Road, Rochester, New York 14610



## sampling voltage not easy

The voltage divider's bottom capacitor's lead must be the reference ground. Normally the capacitive reactance of this capacitor is low, to present a source impedance to pump the current transformer up and down, by the voltage sample amount. Some designs use a voltage transformer instead of a capacitive divider; these designs can represent an even more difficult design problem for phase control at higher powers. In most cases, the detector level is well below the RF power level, so all RF power line and ground currents must be kept out of the voltage sample and the detector. The detector's ground is the bottom of the filter capacitor that follows the rectifier diode.

## voltage divider compensation

The inductance in series with the voltage divider's bottom capacitor must be as small as is practical. A small amount may be compensated for by placing an inductor in series with the top capacitor so that the resonant frequency of the top capacitor and the added inductor are equal to that of the bottom capacitor and its (minimal) lead inductance. Previously, attempts were made to keep the stray inductance of the top capacitor short as well — yet this teaches that longer can be better!\* The filtering for the output leads also must not insert ground currents into either the detectors or into the voltage sample. A 100-microhenry choke is an appropriate value to use for 2-30 MHz because its parallel resonance (i.e., the highest impedance or best filtering point) is about 12 MHz, the center of the band. Often we shield or filter these output leads, but forget about where the bypass capacitors or shield(s) are grounded.

## current sample

Most current transformer designs use an electrostatic shield to prevent capacitive coupling from the coaxial line to the current sample, but forget that the capacitance from both ends of the sampling inductor and its load resistors to ground must also be small, so the voltage sample doesn't inject an extra component into the current sample.

## current transformer paradox

There is an intrinsic error caused at the low-frequency end by the inductance of the secondary. The primary magnetic field in the transformer is directly in phase with the actual primary current. Any delay in the field's buildup is an inductive effect that would retard the current. This delay is a consideration in a voltage transformer, but in a current transformer the current itself is the thing to be measured or referenced. The impedance of the primary must be kept small

enough to not affect the current. So the magnetic field builds up to nearly the speed of light. But it's the rate-of-change of this field that induces the internal secondary voltage. Note that this is the theoretical open circuit voltage. It's not the same as the terminal voltage that we can see, measure, and use. For our sine wave current, the phase of this induced voltage must be at a maximum at the same time that the primary current is going through zero; thus, there's always exactly 90 degrees between them. The induced voltage lags the current by 90 degrees (or more conventionally stated, the current leads the induced voltage by 90 degrees). The actual terminal voltage is then further delayed to nearly a 180-degree total because a second, never-quite-90 (let's assume 88) degree phase shift adds to this to make an overall 178-degree current lag in the dividing transformer. The 88-degree shift is caused by the inductive reactance of the winding, its resistance, and the load resistor.

## current sample termination resistors

We then also have a 2-degree leading current sample from the second terminating resistor, since the reference ground was considered as the junction of the two resistors. Note that if the outputs are to be equal, the resistors for each polarity of current samples must be equal. It's nice to have highly stable 1 percent resistors. This 2-degree error is caused by insufficient inductance of the secondary itself. So this inductance must be large compared to the termination resistors so that we get as close as practical to a 90-degree phase shift of the current lagging the induced voltage. The actual error is the angle determined by the arctangent of the ratio of the secondary's reactance, at the lowest frequency, to the terminating resistance.

## it can be compensated

One can look at it as though there's a constant current driving the transformer at the time when the sample should be; but there's a small phase lag of the actual current driving the termination. Shunting the termination resistors with a second series combination consisting of a resistor and capacitor can correct for this phenomenon and for core loss! This works by modifying the termination by unloading and presenting a slightly capacitive load at the lowest frequencies.\*

## current sample terminations

The required turns ratio for the current transformer is determined by considering the practical value of terminating resistors for the output voltage desired, and by how much power is to be wasted in them. To sim-

plify the current transformer design, one might think that lower values of ohms, such as 5 ohms, would lead to better bridges, but the output must then be kept low because of the power allowable in these resistors; but then the desired output voltage is low, and that leads to diode-knee effects and problems of temperature and stability. All designs are a compromise, with time and money determining when to shoot the engineer and ship the radio.

### **transformer phase delay**

Any transformer has a phase delay of its output compared to its input because of the transmission line effects of its wire. This limits the bandwidth for most designs. *I measured the phase delay of several transformers by using a vector voltmeter, with its reference probe across a 10-ohm resistor threaded through the core (lead length must be 1/4 inch maximum) and the other probe across the normal termination resistor. Ten to 30 degrees seems typical at 30 MHz for 2 to 30 MHz designs. But one commercial design had a 180-degree shift at 35 MHz!*

### **two are better than one**

One way of reducing the transformer phase delay and helping to alleviate some of the problems described above, is to use two transformers, connected in series, rather than only one. The first core encircles the transmission line, and its output is simply passed through the second core to be its one-turn primary. The second core then requires fewer turns because the effective turns ratio is the product of the turns on each transformer. So two 7-turn transformers connected in series give the same ratio as one 49-turn transformer. The total length of wire required is then less, lowering the total phase delay. The two-transformer design also allows the link-turn to be grounded to help act as a second electrostatic shield to increase the "common-mode rejection."

### **current sample compensation**

I propose a way to correct for the transformer's phase delay by adding an extra inductor in series with the terminating resistor (about 0.02 to 0.1 microhenries in series with 56 ohms at 30 MHz), so the current-sample voltage seen by the detector diode is not only the transformer's secondary current through its termination resistor, but also has an extra leading voltage component because of the added inductor. This works because the voltage across and inductor leads the current through it to shift the current sample's phase just enough to make up for the transformer's delay.\* Previous procedures called for reducing the inductance of the current transformer's terminating

resistors — I'm saying to increase it, even build it in! Quarter-inch lead length variation can be significant.

### **tolerance adjustment handle**

A variable resistor across the current sample, to shunt some of it, can serve as a stable null adjustment control. Low inductance film types are now available. Most variable capacitors that have enough range are quite expensive, and are either large in size or subject to drift with temperature.

### **misinterpreting the results**

Here's how I kid myself into making a bad bridge look good for a test. Let's assume that I have the normal setup of a (transmitter) generator driving the voltage sample divider, then into the current transformer, and then to the (antenna) design nominal load, usually 50 ohms. The forward output is the largest output side, where the two equal samples add, and the reflected output is the null output, where the two equal samples subtract. The samples are usually diode detected to provide DC outputs to the forward and reflected meter(s). The usual test for the bridge is to set the null, making the two samples equal at that point by shifting the amplitude of one of them. I assume that the two current samples must be equal also. But because of the diode knee, the fact that this null might not be very deep is usually hidden, and we usually accept some reflected power at this null because there is no phase control. I assume that the two samples are really equal, and I assume that they both hold constant with frequency. If they aren't, I fix it, so I succeed in making the bridge work into 50 ohms (because I've nulled/gimmicked/set it for the desired result at this point). But when I use this bridge, these errors could be great enough for me to be bothered by the forward power variations not holding power, and the reflected power indications could become virtually useless. So one can't extrapolate from this simple alignment-test that the bridge will perform at other frequencies or with various loads.

### **bridge makes a VSWR**

At the high frequency end, the shunt capacitance of the voltage sampler and the series leakage inductance of the current sampler and its leads cause the VSWR into the bridge itself to never be the same as the load presented to the bridge. This is a larger effect when the bridge is a low-power one, but is mostly a function of layout and can usually be compensated for by adding a small series inductance at the input to complete a "T" lowpass filter. For fair comparison

\*Patent applied for, Harris Corporation, 1680 University Avenue, Rochester, New York 14610.



The monthly magazine with a natural blending of two popular hobbies — Ham Radio and Computers

- ★ Articles on Ham Radio & Most Personal Computers
- ★ Hardware & Software Reviews
- ★ Various Computer Languages
- ★ Construction Articles
- ★ Much Much More...

*"...received my moneys worth with just one issue..."*

—J. Trenbick

*"...always stop to read CTM, even though most other magazines I receive (and write for) only get cursory examination..."*

—Fred Blechman, K6UGT

U.S.A.....	\$15.00 for 1 year
Mexico, Canada .....	\$25.00
Foreign .....	\$35.00(land) - \$55.00(air)
(U.S. funds only)	
Permanent (U.S. Subscription) .....	\$100.00
Sample Copy .....	\$3.50



Circulation Manager  
1704 Sam Drive  
Birmingham, Alabama 35235  
Phone 205/854-0271

Name \_\_\_\_\_

Call Sign \_\_\_\_\_

Address \_\_\_\_\_

City \_\_\_\_\_ State \_\_\_\_\_

Zip \_\_\_\_\_ Phone \_\_\_\_\_

Date \_\_\_\_\_

Signature \_\_\_\_\_

✓ 119

or evaluation, directional coupler bridges should not be put in series and read all at once.

### is it symmetrical?

The usual way to check the forward sample's null is to run the bridge backwards — i.e., reverse the coax connections and the metered outputs to see that the bridge is symmetrical. Actually, the impedance to the coax ports should be the same both ways, but the reflected null outputs should not! The backwards null should indicate higher because the impedance at that point really isn't the same. The presence of the voltage sample, or the current transformer, makes it different. So this effect will cause even a perfect bridge to be one-sided at its high frequency end, if the null is checked in both directions. This presents a potential interpretation problem, and explains why input and output labels should be used. This effect is greatest for low-power units.

ham radio

**AVAILABLE NOW**



### THE 1986 ARRL HANDBOOK FOR THE RADIO AMATEUR

Great gift idea for a ham friend or for yourself!

The new 1986 ARRL HANDBOOK is chockfull of projects, ideas, hints and kinks, theory and thousands of other handy things for your hamshack. New items include: switching power supplies, data and telemetry transmission, a section on conjugate matching by Walt Maxwell, data interface and Packet Radio, and remote control aircraft to name just a few examples. New projects include: 30 amp power supply, ATV monitoring instruments, digital frequency synthesizer, 1500 watt output 160 meter amplifier, state-of-the-art preamps for all Amateur VHF/UHF frequencies and much, much more. A grand total of 244 new pages! This is the reference book to have. Order your's today. ©1985 Over 1100 pages.

- AR-HB86
- AR-BB86

Softbound \$17.95  
Hardbound \$26.95



Please enclose \$3.50 to cover shipping and handling



**ham radio** magazine **BOOKSTORE**  
GREENVILLE, NH 03048

# E-X-P-A-N-D REPEATER SITE CAPABILITIES



**IN STOCK – THE LARGEST SELECTION OF CAVITIES, DUPLEXERS AND FILTERS AVAILABLE FOR IMMEDIATE DELIVERY !**

Improve and expand your communications performance with reliable Telewave High "Q" Cavities, Duplexers, & Filters. Telewave Cavities are ideal for use in frequency-congested areas, where protection is required from transmitter interference, spurious radiations, and receiver desensitization.

#### **Bandpass, Bandpass Band Reject, & Notch Cavities**

**30 to 50 MHz and 66 to 88 MHz**  
Single, Double and Triple Cavities  
in 5", 6", 8", and 10" diameters.

**66 to 88 MHz and 118 to 174 MHz**  
Single, Double and Triple Cavities  
in 5", 8", 10", and 12" diameters.

**220 to 400 MHz and 406 to 512 MHz**  
Single, Double and Triple Cavities  
in 4", 5", 6", 8", and 10" diameters.

**806 to 960 MHz and 1.1 to 1.3 GHz**  
Single Cavities available in  
4", 6", 8" diameters.

When frequencies are specified, all cavities are tuned prior to shipping. Telewave quality cavities are engineered for stability in temperature and stress extremes, and require no further adjustments.

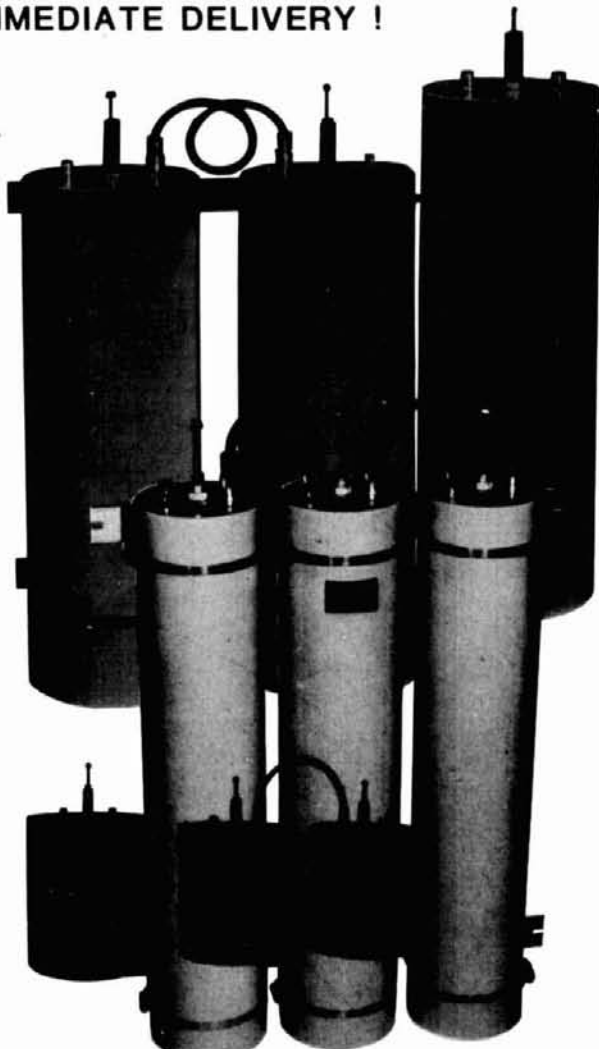

GSA Number 00K86AGS0646



**Telewave, Inc.**

(415) 968-4400



**1155 Terra Bella Ave., Mountain View, CA 94043**

**in Canada – contact Telewave Ltd., 11151 Horseshoe Way #4  
Richmond, B.C. Canada V7A4S5 (604) 274-8300**

# modifying the Yaesu FT-301 for 30-meter coverage

Five straightforward steps  
convert this transceiver  
for 10-10.5 MHz operation

The Yaesu FT-301 is an attractive looking modern transceiver marketed in the very late 1970s and early 1980s. It was built in four basic models identified as the FT-301, FT-301D, FT-301S, and FT-301SD. The suffix D denotes the model with a built-in frequency counter which drives a digital frequency readout. The suffix S denotes the QRP version, for which the final power amplifier is not included. It uses the driver as the output amplifier, and is rated at 10 watts output. The full power version was designed to run about 230 watts input, and is rated at 100 watts output.

The FT-301's operating capability includes SSB (upper and lower sideband), CW, AM, and FSK. The rig is all solid-state, including the final amplifier, and has provisions for the usual crystal filters for controlling receiver bandwidth. Also included is a noise blanker, an optional RF speech processor, marker generator, RIT, and provision for an external VFO option. The transceiver operates on 13.5 volts, and draws 21 amperes on transmit (3.1 amperes for the S model), and 1.1 amperes on receive.

The transceiver covers the Pre-WARC 10 through 160-meter bands (the 10 meter band is divided into four 500 kHz segments designated 10A, 10B, 10C, and 10D), and one additional position on the bandswitch designated AUX. It is this last position that can be converted to provide coverage of the range 10.0 to 10.5 MHz, including the 30-meter Amateur band from 10.1 to 10.15 MHz.

The AUX position was originally intended by Yaesu to be an option that could provide coverage of the 27-MHz Citizen Band. Altering it to cover the 30-meter band is not difficult, but does require some care and patience. Fortunately, the conversion can be accomplished with the tools and test equipment found in

most Amateur stations. Conversion has no effect on the operation of the other bands in the transceiver.

The conversion project is divided into five steps, one of which is not required in the dial (nondigital) models. These steps cover conversion of the digital display PB-1542; the band oscillator crystal unit PB-1441; the bandpass filter unit PB-1442B; the tunable filter trimmer unit PB-1446; and the output low-pass filter unit PB-1445. (The PB designations above are the same as shown in the documentation included in the Yaesu instruction manual for the FT-301.)

## overview of the transceiver block diagram

Understanding the principles employed in the design of this transceiver will make the description of the conversion steps easier to follow.

In the transmit mode, the signal originates at 9 MHz, where crystal filters and a balanced mixer provide upper and lower sideband capability, and where provision is also included to generate CW, AM, and FSK signals.

The 9-MHz signal is heterodyned to the desired output operating frequency by being mixed with a pre-mix frequency in a 500-kHz segment located between 13.9985 MHz and 39.0 MHz, with its exact location dependent upon the band in use. This pre-mix frequency is itself the heterodyne product of two frequencies set by the main tuning VFO (between 5.0 and 5.5 MHz), and a band-determining crystal. (An exception is the 80-meter band, for which the 5.0-5.5 MHz VFO output is used directly as the pre-mix frequency.) Table 1 shows the data as presented in the Yaesu instruction manual, to which a final line has been added showing the proper frequency relationships for 30-meter band coverage.

The same pre-mix frequency is used in the receive mode, and several of the same tuned circuits are switched so that they serve the same frequency-determining function for receive as for transmit. Consequently, one set of modification steps serves for both transmit and receive, and essentially the same

By Warren Offutt, AF9Q, 1012 Hawthorne Lane,  
Geneva, Illinois 60134

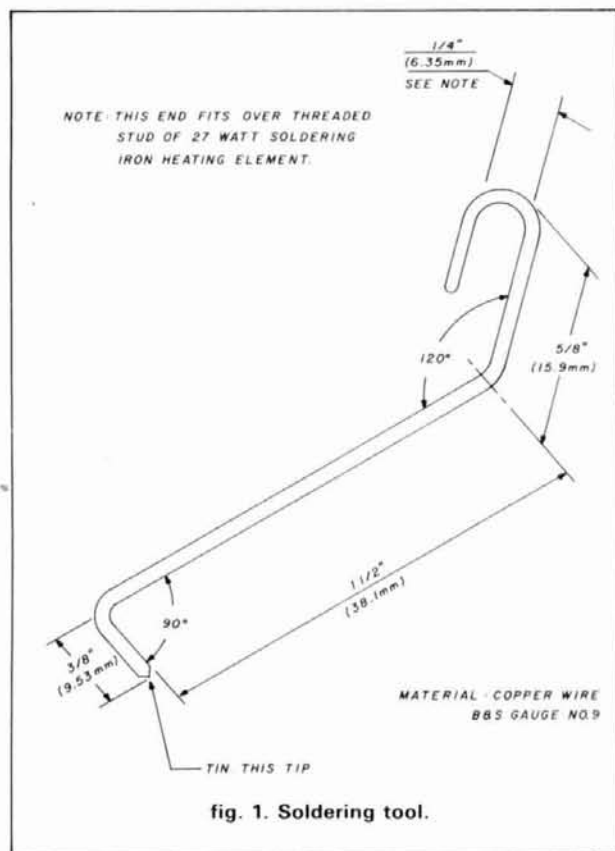

AUX setting of bandswitch used for 30 meters.

set of low-pass filters, with the proper filter selected by the bandswitch for the band in use.

### conversion steps

The five conversion steps may be tackled in any order you prefer; however, the order described below is recommended. In this order, you'll become familiar with the transceiver's interior by accomplishing the easier tasks first. None of the steps is unreasonably difficult, nor is any likely to cause problems with adjustment. You will have to fabricate one special soldering iron tip, which is described below. The conversion is not for the rank beginner in electronics, but you don't need to be a PhD either. Carefully follow the description and instructions below, work slowly, and you'll be rewarded with very attractive results. (The work should take about five or six hours.)

### parts and tools needed

Only ordinary tools are needed for completion of this project. They include the following:

- miniature wire cutters and needle-nose pliers
- electronics grade forceps, with locking handle
- assorted small screwdrivers with conventional flat blades
- plastic hex alignment tool to fit T-1006 in the band-pass filter unit
- small (27 watt) soldering iron, with screw-on tip (Ungar or Radio Shack)
- medium-size soldering iron (approximately 60 watts)
- flashlight and magnifying glass (or magnifying glasses you can wear)
- proper size Phillips screwdrivers (see below)
- grip-dip meter (optional, but desirable)
- dummy load (50 ohm)
- RF wattmeter or equivalent power meter

Be sure the Phillips screwdrivers really fit the screw heads properly. When they are correctly matched, the screwdriver securely grabs the screw; when they are

table 1. Frequency relationships.

band	frequency MHz	crystal MHz	premix out MHz
160 meters	1.5- 2.0	16.0	10.5-11.0
80 meters	3.5- 4.0	none	5.5- 5.0
40 meters	7.0- 7.5	21.5	16.0-16.5
20 meters	14.0-14.5	28.5	23.0-23.5
15 meters	21.0-21.5	35.5	30.0-30.5
11 meters	27.0-27.5	41.5	36.0-36.5
10 meters A	28.0-28.5	42.5	37.0-37.5
10 meters B	28.5-29.0	43.0	37.5-38.0
10 meters C	29.0-29.5	43.5	38.0-38.5
10 meters D	29.5-30.5	44.0	38.5-39.0
WWV	5.0	13.9985	13.9985
30 meters	10.0-10.5	24.5	19.0-19.5
	VFO: 5.0-5.5 MHz	IF: 9.0 MHz	

steps that align the receiver also align the transmitter.

The front panel band-peaking control adjusts a set of three permeability-tuned circuits, which resonate the receiver mixer, RF stage, and transmitter driver. Each band has its own set of trimmer capacitors. The permeability-tuned coils permit the user to peak the tuned circuits for the band in use, and also set the proper L/C ratio over the 1.5-30 MHz frequency range.

Finally, the output of the transceiver is connected to the 50-ohm antenna coaxial receptacle through a



poorly mated, it is impossible to crack free a tight screw. *Don't bypass this step.* Four of the screws you'll have to remove are hard to reach, and have been glyptal-locked in place. You'll need a good match between the screwdriver and the screw head. It seems to me that Japanese screws have shallower wells than the American screwdrivers can accommodate, and it's sometimes necessary to file or grind off a little of the screwdriver point in order for it to seat properly.

The grid-dip meter is optional, but it is very handy for checking and preliminary alignment.

You'll have to fabricate a special tip for the soldering iron. **Figure 1** shows its design. A convenient source of hard copper wire of the proper gauge is the copper rod sold in hardware stores for replacing the pull rod in a ball-type toilet tank valve. It is 105 mils in diameter, and is equivalent to B&S 9 gauge wire.

Materials for the project include the following:

- HC-25U crystal, 24.50000 MHz
- 5 signal diodes, 1N914 or equivalent
- 1 good quality fixed ceramic capacitor 15 or 20 pF
- 2 good quality fixed ceramic capacitors 45 pF
- 3 miniature compression trimmers, 200 pF
- miscellaneous hookup wire, insulating tubing, etc.

The crystal should be ordered for a 30-pF load capacitance, fundamental frequency of 24.50000 MHz, parallel resonance, and 0.001 percent accuracy.

Standard width (5/8-inch/1.59-cm) compression trimmers may be used, but if you can find the narrower version (3/8 inch/0.95 cm), such as Calectro Catalog No. R1-248, 55-300 pF), installation is easier. The capacitance when resonated will be between 100 and 175 pF.

## preparation

Disconnect all cables from the FT-301 transceiver, and remove the top cover by snapping out the four cover locks. Lift the cover free, but be careful not to tear free the speaker cable. It has an in-line connector that may be released to permit setting the cover aside in a safe place.

Turn the transceiver over, placing it on a soft protective surface. Remove the twelve small screws that hold the bottom cover in place (four on the bottom, four each on the left and right sides), and carefully lift the cover free and place it aside.

Position the transceiver with the front panel toward you (and the rear apron away from you), upside down, so you're looking into the bottom of the chassis. This is the position in which **steps 1** through **4** are completed, and is the position to which directions below apply.

Inspect the transceiver to familiarize yourself with the general layout. Make notes to assist in reassembly when you're finished. It goes without saying that you

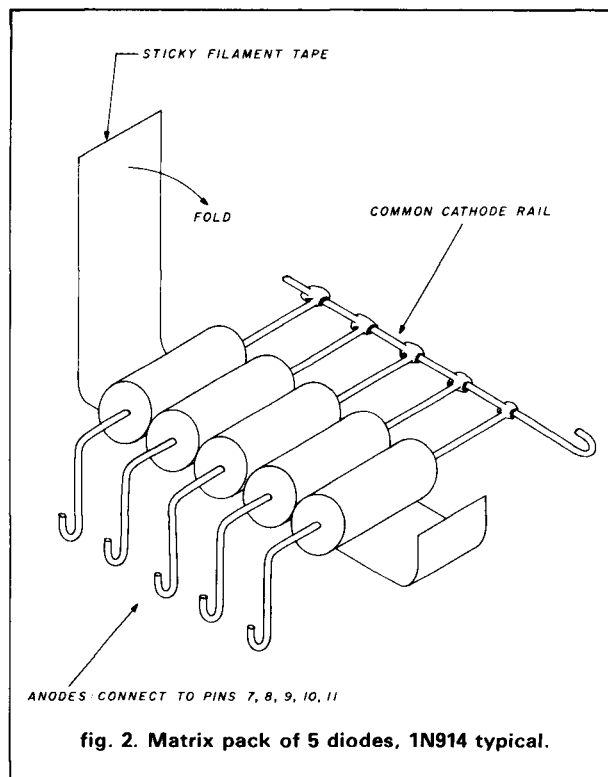

fig. 2. Matrix pack of 5 diodes, 1N914 typical.

should be satisfied that the rig works properly before you begin; no modification should ever be started unless the equipment is in good working order to start with. Otherwise, if problems arise, you may never know their true cause.

## step 1: conversion of the digital display

If the model you are converting does not have the digital display, but is instead the analog dial model, skip this step and go directly to **step 2**.

Locate the display logic unit, PB-1542 — the vertical printed wiring board, immediately behind the center of the front panel, and parallel to it. It is the board on which the LED digit displays are mounted. Along the bottom edge of this board (which is now "up" because the rig is upside down), you'll find a row of 15 terminals, part of a 15-pin receptacle/plug combination which connects the board to a small cable harness (which itself has an in-line receptacle/plug combination 1 inch (2.54 cm) or so further toward the rear). Counting from your left, identify pins 7, 8, 9, 10, and 11. (Pins 14 and 15 have no wires connected to them; be sure you count correctly.) These five pins must be pulled to ground when in the AUX band position so that the display reads 10 to the left of the decimal point.

A few words of explanation may be helpful at this point. The digital display is not entirely a genuine frequency counter. The digits to the left of the decimal

# SPRING SPECIALS POWERFUL PACKET.

New rigs and old favorites, plus the best essential accessories for the amateur.

3621 FANNING ST  
HOUSTON, TX 77004-3913

CALL FOR ORDERS  
1-713-520-7300 OR  
1-713-520-0550

ALL ITEMS ARE GUARANTEED OR SALES PRICE  
REFUNDED

## EQUIPMENT

Kenwood	Call for prices on all Kenwood
Kenwood TS940S, contesters' delight	Call
Icom R7000 25-2000 MHz	795.00
Alpha (ETO)	List-15%
Icom IC3200	489.95
Santec ST20T Handi Talkie	289.00
Regency UC102 VHF 2 Channel Handi Talkie	150.00
Icom IC735	749.00
Ten-Tec 2510 (Easy OSCAR)	489.00

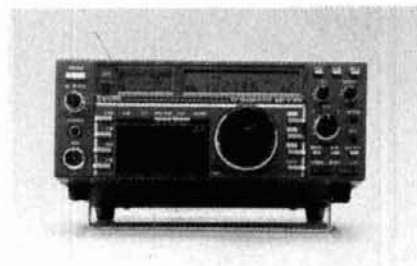

## ACCESSORIES

B&W VIEWSTAR ANTENNA TUNER	89.95
Heil HC3/HC4/HC5	Stock
Heil BM10 Boom Mike headset	53.95
CSI Private Patch III	469.95
FLUKE 77 auto-ranging digital multimeter	125.00
Bird 43 Wattmeter	Call
Bird Elements, H/59.00, A-E/48.00	In Stock
Daiwa CN620B, 20-200, 2000W	109.95
Daiwa CN630 140-450, 20-200W	129.00
Stabylex 35SR, 35 amp 12VDC, 25 amp cont. overvoltage protected	149.00
Alnico ELH 230D, Excellent buy	79.00
Nye MB5-A (for the big boys!)	529.00
Shure 444D	54.95

## KEYS

Bencher & Vibroplex	Less 10%
Bencher is now improved. Screws & springs, all stainless steel and extra hand polishing	
Vibroplex Carrying Case	20.00 w/purchase
MFJ Super keyboard #496	169.00
Nye ESK-001 Keyer	58.00

## TUBES

Collins & Drake Replacement tubes	stock
GE 6146B	11.95
Eimac 3-500Z	109.95
GE Industrial Tubes	Call
GE 12BY7A	6.00
GE 6JS6C *	11.95
Cetron 572B	69.00

## BOOKS

We stock SAMS, TAB, ARRL, RSGB, Ameco Radio Pubs.	Call
Some of the best buys are the RSGB books.	

CALRAD 65-287 SWR, Relative Power Meter 3-150MHz, KW+	32.95
---	-------

## PACKET POWER

AEA PK-64, does RTTY, ASCII, AMTOR also	199.00
AEA PK-80 TAPR II	199.00
NEW Kantronics Packet II	199.00
Icom 271A Great packet radio	Call

## SERVICES

Alignment, any late model rig	50.00
Flat fee Collins rebuild	Call

## QUANTITY DISCOUNTS Save 206.00

Want a good discount? Get three of your friends and order Madison's special four lot prices. For example:

ICOM IC27A	1270.00
------------	---------

Call for four lot prices on other rigs



## ANTENNAS

Isopole	44.95
A4	269.00
402CD	279.95
424B	84.00
215WB New, 15 EI, 2M beam	79.95
AOP-1, Complete Oscar Antenna	149.95
Butternut HF6V, 80-10 vertical	125.00
HF2V, 80 & 40 vertical	119.00
HF4B	189.00
Hustler G7-144	119.95
Ham4 Rotator, T2X, CD45-2	Call
KLM HF World Class Series Antennas	Call Don
Alpha Delta Twin Sloper	49.00
Coax Seal	2.00/roll
B&W Dipoles	Less 10%
Hy-Gain TH7DXS	489.00
Explorer 14	349.00
Discover 1 element 40M	169.00
2 element 40M	369.00
3 element only	249.00
V2S (2meter)	59.00
HG52SS 52 ft. crankup tower	1199.00
Prepaid freight when you order other Hy-Gain items with tower	
KLM KT-34A	339.00
40M-2	299.00

## OTHER ANTENNAS

Larsen Kuldock	17.00
Avanti AP151 3G on Glass Antenna	36.00
Anteco 2M, 5/8, Mag Mount, Comp	25.00
Avanti APR450-5G on glass	39.00
Philly Stran	Call

## SURPLUS

Collins parts 75S/32S/KWM2/75A4/KWS-1 Specify part No.	
24 Pin Solderless dip sockets	25/each
Signal Batteries Exact Replacement	
Yaesu 208/207	25.00/each
150MFD/400V DC	1.95
1.5 Amp/400V full wave bridge rectifier	1.95
2.5A/1000PIV Epoxy diode	29 each or 19.00/100
0015/10KV	1.95
3N201	.95
4 inch ferrite rod	1.95
365pF cap	1.95
Sanyo AAA, AA Nicads w/tabs	2.50 ea
2, 4, 5, 6, 8 pin mic plugs	3.00
Drake—Collins mike plug	2.00
Close out on rigs & accessories. All the time	Call
We may have what you're looking for	

## BELDEN

9913 low loss, solid center, foil/braid shield	45c/ft.
8214 RG8 Foam	43c/ft.
8327 RG8	37c/ft.
8267 RG213	52c/ft.
8000 14 Ga stranded copper ant. wire	13c/ft.
8448 8 conductor rotor cable	31c/ft.
9405 Heavy duty 2-16 Ga 6-18 Ga	52c/ft.
9258 RG8x	19c/ft.
8403 Mic Cable, 3 condctr & shield	80c/ft.
100 feet 8214 w/ends installed	45.00
8669 7/16" tinned copper braid	1.10/ft.
International Wire RG214, non-mil. good cable	.70c/ft.
International Wire 9085 exact replacement for Belden 9913	.36c/ft.

## AMPHENOL

831SP PL259 Silverplate	1.25
UG176 reducer RG8X	.30
831J Double Female UHF	2.00
82-61 N Male	3.00
82-97 N Female Bulkhead	3.00
82-63 Inline Female N	4.00
82-98 N elbow	9.00
New 82-202-1006 N Male fits 9913	5.00

## TOWER ACCESSORIES

1/4" E.H.S. Guy cable, Rohn US, 1000 ft	250.00
3/16" E.H.S. cable	210.00
1/4" Guy Cable, 6100 #7 x 7 strand, import	15c/ft.
3/16" Guy Cable, 3700 #7 x 7 strand, import	12c/ft.
3/8 x 6 E&J Turnbuckle	7.95
3/16" Wire Rope Clips	.40
1/4" wire clips	.50
1/4 Thimbles	.45
Porcelain 500D Guy Insulator (3/16)	1.99
Porcelain 502 Guy insulators (1/4)	3.39

## COMPUTER STUFF

Kantronics UTU-XT	319.00
Fits any computer (even yours!)	
Software available	19.00
Morse University (Great CW program for C-64)	39.00

## USED EQUIPMENT

All equipment, used, clean, with 90 day warranty and 30 day trial. Six months full trade against new equipment. Sale price refunded if not satisfied.

## POLICIES

Minimum order \$10.00. Mastercard, VISA, or C.O.D. All prices FOB Houston, except as noted. Prices subject to change without notice. Items subject to prior sale. Call anytime to check the status of your order. Texas residents add sales tax. All items full factory warranty plus Madison warranty. KS6Q is January's Winner.

## DON'S CORNER

Winter is just about at its end and pre-Dayton Spring rumors are starting to fly!

One has it that a major Japanese manufacturer is just completing engineering and is gearing up to produce a handheld that covers 144 and 440 MHz. The technology is disarmingly simple and will amount to a major step forward in radio design.

Another concerns the current lack of activity on 900 MHz. Who'll be the first to have a radio for sale? Will they be in compliance with the JA personal radio band plan or will they conform to the ARRL version? It's too soon to tell. This band has a tremendous amount of potential for digital and other forms of specialized communication as well as for voice.

Spread spectrum has also now been authorized above 420 MHz. Ham Radio, December 85 has a complete primer by N9NB. Who will be the first in this exciting new field of Amateur Communication?

For those of you looking for a smaller radio, check out the Kenwood TS-430, ICOM IC-735 and Yaesu FT-757. These radios are fully featured and offer state-of-the-art performance at close to the same price. Call today to get all the details and place your order.

73 and Good DX!

## DON

# MADISON

## Electronics Supply

3621 FANNING  
HOUSTON, TEXAS 77004

1-713-520-7300 OR 1-713-520-0550

# NEW from BARKER & WILLIAMSON!

## 1.8 - 30 MHz. Continuous Coverage Antenna for Commercial and Amateur Service

### Model AC 1.8 - 30

The AC 1.8 - 30 Antenna uses only 80 feet horizontally, and, when space is limited, can be short-ened even further with only slight loss of radiation efficiency.

U.S. Patent No. 4,511,898

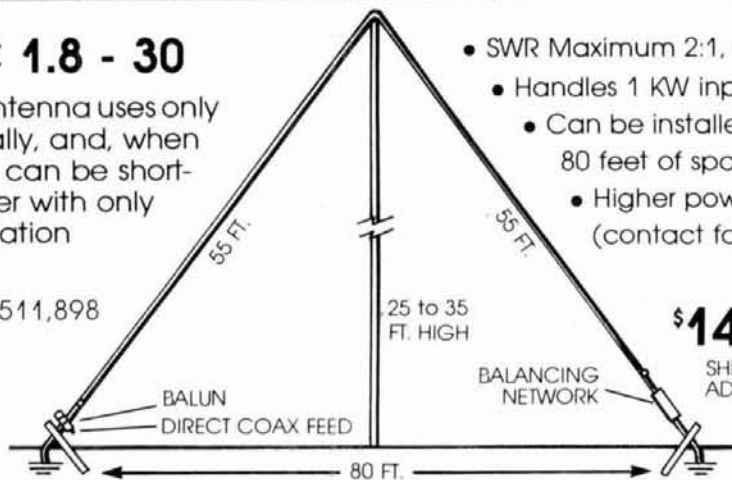

- SWR Maximum 2:1, 1.4:1 Average
- Handles 1 KW input ICAS
- Can be installed in approximately 80 feet of space
- Higher power models available (contact factory)

**\$149.50**

SHIPPING AND HANDLING ADD \$4.00



### BARKER & WILLIAMSON

Quality Communication Products Since 1932  
At your Distributors write or call, 10 Canal Street, Bristol PA 19007  
**(215) 788-5581**

ALL OUR PRODUCTS MADE IN USA



**148 PAGES  
OVER 500 NEW  
PRODUCTS**



Don't miss out on our new 86-87 catalog due to be released in April. Increased number of pages with exciting new products and enhanced data section.

Please reserve my copy of the 1986 Dick Smith Catalog. I enclose \$4 to cover shipping.

Name .....

Address .....

City .....

Zip .....

DICK SMITH ELECTRONICS INC.  
P.O. Box 2249 Redwood City CA 94063  
EVERYTHING FOR THE ELECTRONICS ENTHUSIAST!



## TOWERS by ALUMA

### HIGHEST QUALITY ALUMINUM

- TELESCOPING (CRANK-UP)
- GUYED (STACK-UP)
- TILT-OVER MODELS

Easy to install. Low Prices.  
Crank-ups to 100 ft.

EXCELLENT FOR  
AMATEUR COMMUNICATIONS



Mobile Trailer Type



Mobile Truck Type

Over 36 types aluminum and steel towers made—specials designed and made—write for details

SPECIAL  
Four Section 50 Ft.  
Van Mounted Crank-Up  
Aluma Tower

### ALUMA TOWER CO.

BOX 2806HR  
VERO BEACH, FLA. 32960-2806  
(305) 567-3423 TELEX 80-3405

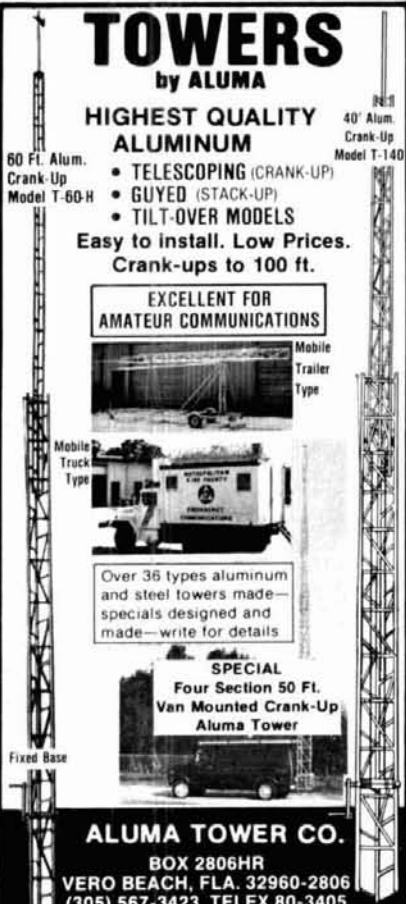

## POPULAR PA 19 Wideband Preamp

- Over 8,000 sold since 1976
- 0.5 - 200 MHz bandwidth
- 19 dB gain
- 50  $\Omega$  in/output
- Increase sensitivity of receivers or counters
- Built, tested & ready-to-go

ONLY \$9.95 PPD

## NEW POCKET SIZED 500 MHz Freq. Counter

- Compact design-pocket sized
- Measures frequency from 1 MHz to 500 MHz to within 1 kHz
- Built-in telescoping antenna
- Uses 1 standard 9 volt battery
- All units pre-tested and calibrated to .001%
- Professional and dependable performance at a low cost

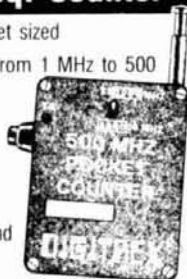

✓ 123

ONLY \$49.95 PPD

### DIGITREX

1005 BLOOMER  
ROCHESTER, MI 48063

WEST COAST DISTRIBUTOR

R. LUKASZEWICZ

20610 ALAMINOS DRIVE SAUGUS, CA 91350  
(805) 252-6021

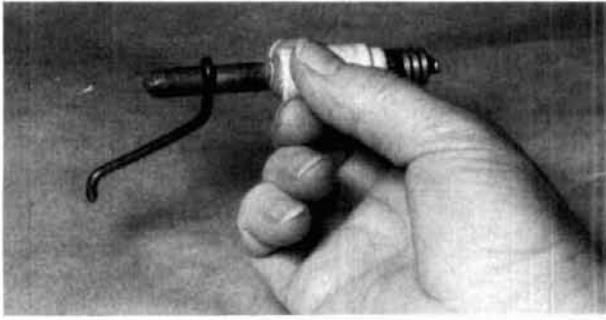

Assembly of soldering tool behind screw-on tip with old tip end removed.

point are "forced," in that a diode matrix activated by the bandswitch commands a display of 28 for 10 meters, 21 for 15 meters, etc. The diode matrix is located in the counter mixer unit (the square box a few inches further toward the rear). Unfortunately, the diode matrix is potted in a 14-DIP package, and altering the 27-MHz section to yield 10 is not possible. We shall use the five diodes to construct an external diode matrix, which will have the same effect as reprogramming the matrix in the DIP package. As a matter of fact, it's easier to do the job as described below than it would be if it were possible to reprogram the DIP package because no disassembly of the counter mixer unit will be required.

Form the five diodes in a small pack as shown in **fig. 2**. The cathodes should be connected together as a common bus. Carefully position the diode pack on the up-facing surface of the 15-pin receptacle, and connect the five diode anode leads to pins 7, 8, 9, 10, and 11. (Pin 11 causes the first digit to be 1; pins 7, 8, 9, and 10 cause the second digit to be 0.) With care (watch out for solder bridges!), solder the five diode leads to the correct pins. Inspect your work.

Now, locate the black wire, the far end of which connects to the AUX lug on the bandswitch wafer (SW2A-1 in the Yaesu documentation) closest to the front panel. If your rig doesn't have the 27-MHz option installed, the near end of the black wire will be found connected to pin 13 of the same group to which you just connected the diodes. If your rig has the 27-MHz option installed, the near end will be found connected to one of the center lugs (pin 6, but double check) of the cable in-line receptacle-plug combination mentioned above. When you've located the correct wire, disconnect its near end from whichever place you found it, and connect it now to the common rail of the new five diode matrix you just installed. The purpose is to ground the common bus of the five diodes when the bandswitch is in the AUX position. Using some sticky filament tape or equivalent, fasten the five diodes down neatly to the top of the 15-pin receptacle.

You've now completed the conversion of the digital display. You may check your work by connecting the power supply to your rig and turning it on. With the bandswitch in the AUX position, the display should operate normally, and the first two digits should read 10. Before you consider this step completed, run through the other band positions, and verify that the display reads the correct digits to the left of the decimal point for each band. If not, the likely cause is either that you connected to wrong pins, or (more likely), that you have a short or solder bridge between two pins. You should not encounter such problems if you work very carefully and take your time. It's very satisfying to see that 10-MHz frequency displayed, but don't be fooled: the rig isn't yet on 30 meters! Carefully redress the wires around the display unit to their original positions, and go on to **step 2**.

## **step 2: conversion of the band oscillator crystal unit PB-1441**

This one is easy. On your left you'll find a flat horizontal metal shield plate. It has access holes for various alignment trimmers and is held in place with eight screws. Remove them, noting their position carefully (they're not all the same length). Remove the flat shield and lay it aside in a safe place.

A few inches behind the front panel, in the first compartment under the shield, you'll find a crystal socket board with eight, nine, or ten crystals in it. Eight crystals are for the existing bands, 160 through 10 meters. The ninth crystal (if present) is for the JYJ/WWV option. The tenth crystal (if present) is in the AUX socket and is for the 27-MHz option.

Incidentally, if your rig does not have the option to receive WWV on 5 MHz, this would be an ideal time to add it. The WWV crystal should meet the same specifications mentioned above and have a frequency of 13.99850 MHz. The WWV trimmer closest to the front panel tunes the circuit for oscillation; the WWV trimmer one step toward the rear apron adjusts for zero beat with WWV. This option works well only with the mode switch in the LSB position.

The crystal socket in the rear row, closest to the center of the rig, is the proper place for the new 24.50000 MHz crystal for the 30-meter band. You may install it now.

It will be necessary to pad the existing AUX trimmer with a 15 to 20-pF capacitor. The easiest way is to form the leads of the capacitor so it can lie alongside the AUX trimmer, and carefully tack-solder the leads to the AUX trimmer leads. The proper two AUX trimmer leads are (a) the lead facing the rear of the chassis, and (b) the lead facing the center of the chassis. Work with a clean, hot iron, and pre-tin the new capacitor leads. Don't overheat the trimmer. This task is easy if done with care.



Some of the subsequent steps depend on this circuit oscillating properly. The likelihood is that correct oscillation will be obtained if the AUX trimmer is set at mid value. However, a simple additional test can be used to verify proper operation as follows.

The sixth harmonic of 24.5 MHz is at 147 MHz, which falls conveniently in the 2-meter band. Assuming you have (or can borrow) a 2-meter HT, tune it to 147 MHz, and then listen for the squelch to open when you tune the AUX trimmer. (Power must be applied to the FT-301, of course, and the bandswitch must be in the AUX position. The FT-301 should be in the receive mode.) With the HT antenna within a few inches of the crystal compartment, the 147-MHz signal should be at full quieting. The proper setting of the AUX trimmer should be about 1/4 turn less capacitance than that at which oscillation starts; in other words, don't crowd the maximum capacitance setting at which the circuit begins to oscillate. You may, if you wish, use the HT to judge the position at which oscillation is strongest.

When you're satisfied with the oscillator operation, you may proceed to **step 3**. (Note: you may find that the 24.5-MHz crystal oscillates just fine without the extra 15 or 20-pF capacitor. If so, the extra capacitor may be omitted; however, to be sure you are optimally tuned, it's a good idea to add it, especially since it's easy to do.)

### step 3: conversion of the bandpass filter unit

The compartment next to the crystal compartment of **step 2** is the bandpass filter unit PB-1442B. It is located one compartment away from the crystal compartment, toward the rear of the transceiver. Within this compartment, locate bandpass filter T-1006, which is toward your left and toward the rear. It is the filter that connects to the AUX lugs on bandswitch wafers SW2A-6 and 7. The primary connection has a piece of hookup wire from the AUX lug on wafer 6 (an easily accessible lug toward the center). The secondary connection has a piece of shielded cable that connects to the AUX lug on wafer 7 (also easily accessible).

Assuming you have a grid-dip meter available, temporarily tack-solder one of the 45-pF capacitors from the AUX lug on wafer 6 to ground, and, similarly, the other 45-pF capacitor from the AUX lug on wafer 7 to ground. In other words, you'll be shunting the primary and secondary of the filter, each with a 45-pF capacitor. Leave the leads long, and form them open so you can insert the grid-dip meter coil into first the primary, and then the secondary capacitor lead loop.

Power to the FT-301 should be removed. The bandswitch should be in the AUX position. You should find a weak dip on the primary side with the grid-dip meter

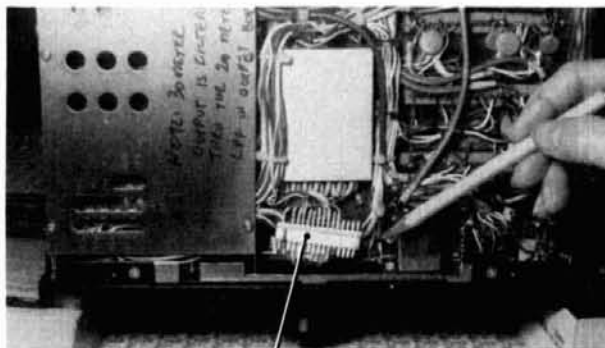

In-line cable receptacle which obscures diode-pack installation beneath

Install the 5-diode matrix pack under the in-line cable receptacle.

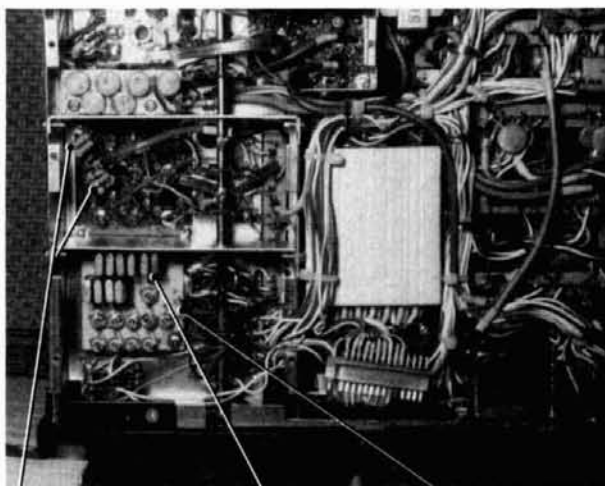

T-1006 padding  
Capacitors

New crystal

Oscillator padder

New crystal, oscillator padder, and padding capacitors across T-1006.

somewhere between 19 and about 25 MHz. You should find a strong dip on the secondary side in the same general range.

With the alignment tool, adjust the core in T-1006 until the strong dip on the secondary side is at 19 MHz. (The weak dip on the primary side should be somewhere between 19 and about 20 MHz; don't worry about the exact value.)

Unsolder the two capacitors from their temporary positions, and, after trimming their leads, solder them permanently at the terminals of T-1006, one shunting the primary and the other shunting the secondary.

If you don't have a grid-dip meter, you may omit the above temporary installation of the capacitors and go immediately to their final installation at the terminals of T-1006. In this case, you won't be able to adjust the core of T-1006 until later.

(The above does not result in an optimal bandpass filter. However, optimal operation over the full range



of 10.0 to 10.5 MHz is not needed. The above approach is more than adequate for the Amateur 30 meter-band and also allows good reception of WWV on 10 MHz.)

You've now completed the conversion of the band-pass filter unit.

#### step 4: conversion of the tunable filter trimmer unit

The trimmer unit, PB-1446, is located in the center of the transceiver, and the trimmer adjustments are now facing down toward your workbench. We're not going to modify the trimmer unit itself; instead, we're going to augment it with three new trimmers to be located next to the permeability-tuned coils.

Immediately behind (toward the rear of the rig) the bandpass filter unit of the previous step, you'll find three compartments housing the permeability-tuned coils. The actual permeability-tuning mechanism is facing down toward the workbench. Each of the three compartments contains one (or two) wafers of band-switch SW2A, and also contains the wires connecting to the underside of the above mentioned trimmer unit.

Using a clean, hot, medium-size soldering iron (about a 60-watt rating is suitable), very quickly unsolder the three flexible braid shields from the three postage-stamp-size PC boards at the base of the permeability-tuned coils, and carefully fold the shield braids back. Also, in the rearmost of the three compartments, unsolder the parallel resistor pack from the same PC board, and carefully fold it back to give full access to the switch wafer.

With a magnifying glass and flashlight, identify the AUX lugs on wafer sections SW2A-9, 10, and 11. (The wafer sections are numbered from the front panel to the rear.) You'll find that the desired lugs are not easily accessible; they're on your left side and are the next-to-lowest lugs. On each of the above wafer sections, the AUX lugs are jumper connected to the lugs for bandswitch positions 10D, 10C, 10B, and 10A. The lug next to the AUX lug is the 10D lug. It's necessary to remove the jumper from the AUX lugs (on just these three wafers, don't remove the jumper on wafer SW2A-8). The jumper wires are wrapped once around the lug.

This is the time for a steady hand; don't attempt this step if you're tired or in a bad mood. It's certainly possible to accomplish the task without damaging anything with the soldering iron. You'll have to dress the various leads to the side a bit to get best access. Plan the job, and practice it once or twice with a cold iron so you can get the feel of the task before you begin.

With the aid of the special soldering tool and a long, thin screwdriver or scratch awl, carefully unsolder and unwrap the jumper wires from the three AUX lugs, one on each of the identified wafers. Don't man-

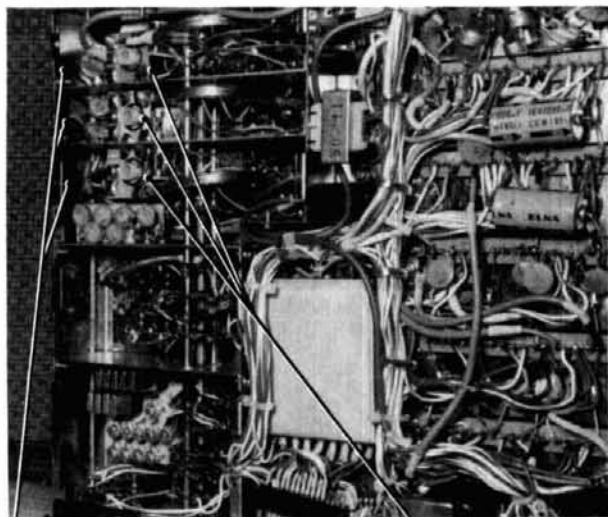

Tunable Filter Compartments

New compression trimmers

**Tunable filter unit showing new compression trimmer locations.**

handle the lugs. The lug material is thinner gauge than is conventional in American-made switches; treat it with respect. In the two rearmost compartments, you'll have enough room to reach in with a small pair of wire cutters and snip off the unwrapped 1/4-inch (0.635 cm) or so of lead. In the forward compartment, however, such luxury is absent and you'll have to settle for just bending the lead end out of the way, or working it back and forth until it breaks off at the 10D lug.

Prepare three pieces of thin, bare, stranded (flexible) hookup wire, each about 3 inches (7.6 cm) long. Form a suitable hook in the end of each, and carefully solder one of the wires to the now-empty AUX lug on the rearmost wafer, SW2A-11. Bring the free end of the wire up where it is readily accessible. Using the other two wires, do exactly the same thing on the AUX lugs of wafers SW2A-10 and SW2A-9.

The three compression trimmers are to be mounted alike. There's room (just barely) for them to be installed vertically (actually, at about a 60- or 70-degree angle) alongside the compartment shields, one in each of the three compartments, with the adjustment screws facing toward your right, and slightly up. It's necessary to trim the lugs on the compression trimmers so they can fit; the ground end of each trimmer is to be soldered to the postage-stamp-size PC board immediately next to (or under) the corresponding shield braid wire. The other lug on each compression trimmer is connected to the stranded wire you connected to the AUX lug in the same compartment. Be sure to slip a piece of insulation over the bare wire after you've cut it to length so it won't short to the chassis when the compression trimmer is lowered into its final position.

The purpose of the above is to separate the AUX lugs from the 10-meter positions and give each of the three AUX lugs its own compression trimmer to ground.

After the compression trimmers are properly installed, their adjustment screws should be accessible with a long, thin screwdriver or alignment tool. Following installation of the three trimmers and inspection of your work, reinstall the resistor pack lead in the rear compartment and return the three shield braids to their original position.

Now stop and breathe a sigh of relief. The worst is over. The rig will now operate on 30 meters, although **step 5** should be completed before you return the rig to service.

## alignment

You may now connect the power cables and turn the transceiver on. Set the band-peaking control on the front panel to a point midway between the 40- and 20-meter band positions. The pointer should be just barely past the numeral 6. Tune the rig to 10.110 MHz, and use the grid-dip meter as a signal source at that frequency. When you've found the grid-dip meter signal, tune the two compression trimmers closest to the front panel for maximum signal. Also peak band-pass filter T-1006 for best reception. If you weren't able to check the adjustment of the crystal tuning earlier, this is a good time to do it.

Connect a dummy load and some kind of power meter to the antenna terminal. Set the mode switch to the CW position and key the rig. Set the drive control so that modest output is obtained and adjust the third compression trimmer (the most rear) for maximum RF output.

Now, observing the RF output, gently peak the second compression trimmer. If the maximum output does not occur at the same compression trimmer adjustment as you obtained for best receiver sensitivity, turn the band-peaking control on the front panel slightly toward the 20-meter position and repeat the alignment of the two front-most compression trimmers on receive. Then check the adjustment for maximum transmitter power as above. It should not take more than one or two tries to find a satisfactory set of adjustments.

At this point you should have no trouble hearing 30-meter signals on the air, and, at the right time of day, a very strong WWV on 10 MHz. You might find the receiver gain to be a little lower on this band than on the other bands. Much of the reason is because of the 9-MHz trap in the antenna lead. If you wish, simply short it out or tune it somewhat lower than 9 MHz and accept the slight compromise with 9-MHz suppression. (The 9-MHz trap is T-1401, and is located on trimmer unit PB-1446.) In any case, the receiver gain is entirely adequate for everyday use.

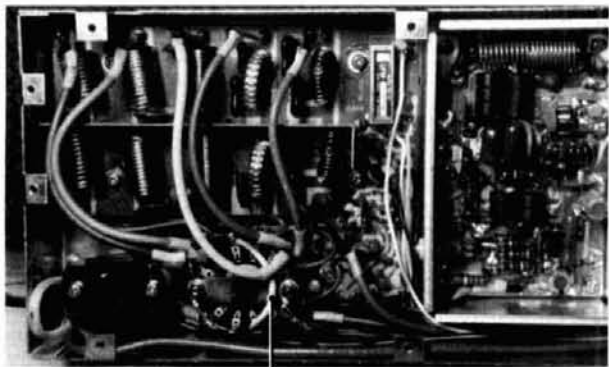

One of the two new jumpers Connecting 20 meter LPF to the AUX terminals

### Low-pass output filter assembly on rear apron.

You may find it easy to overdrive the final, and that the drive control must be set back to a lower level than customary. The reason is that the exciter drive-level potentiometer serving the 10-meter band also serves the 30-meter band now. Readjust it if you wish, following the instructions for the VR Unit PB-1448 found in the instruction manual. It is easier, in my opinion, to simply reduce the drive level using the front panel control. You're now ready for the final conversion step.

## step 5: conversion of the output low-pass filter unit

In the original design of the FT-301, Yaesu didn't include any low-pass filtering for the 10- and 11-meter bands. Even though the power amplifier is push-pull and is essentially linear, it's good practice to use a filter on the output. There is not sufficient room to include a low-pass filter specially dedicated to the new 30-meter band position.

A practical alternative that works well for me is using the 20-meter low-pass filter for 30 meters as well as for 20 meters. With this arrangement, no second harmonic was detectable at a listening location about 3/4 mile (1.2 km) from my location. Higher harmonics should be suppressed by the 20-meter filter, which is a conventional constant k design, without m-derived notch sections.

Remove the power cables and turn the transceiver so the rear apron faces forward. Remove the power amplifier (assuming you do not have the QRP version). The low-pass filters are located in the compartment along the rear apron. With the power amplifier (or the rear cover, for the QRP model) removed, both filters and the wafers of switch SW2B are visible. It is necessary to get at both wafers. Proceed as follows:

Locate the shaft coupling that couples the rear end of the shaft of SW2A to the forward end of the shaft of SW2B. Loosen the two rear set screws. Be sure you understand what position the switch is left in, and

which lug on the SW2B wafers correspond to AUX and to 20-meter positions.

There are four screws holding the PC board with the filter coils and four screws holding the mounting plate for SW2B. Remove all eight. *Be especially cautious removing the latter four; it's easy to distort the switch lugs, and once bent out of shape it is a terrifying job to repair them.* Here's where you'll need caution and well-fitting screwdrivers.

With the eight screws removed, lift the PC board and switch body together as a loose assembly, gaining access to the lugs on both wafers.

As before, remove the jumpers that connect the AUX lugs to the 10D lugs on both wafers. Solder a new jumper of fairly heavy wire connecting the AUX lug on the top wafer to the 20-meter lug on the same wafer. Do the same on the bottom wafer. The purpose is to use the 20-meter filter on 30 meters as well as on 20 meters.

After inspecting your work, reassemble the filter assembly, remembering to have SW2B in the correct position with respect to SW2A before tightening the shaft coupling. To ensure proper mechanical alignment, tighten the shaft coupling while holding SW2B firmly against its mounting surface, before you tighten the four switch plate mounting screws.

To avoid losing the four switch mounting screws, position the transceiver vertically with the front panel facing down. (Two old copies of the Callbook are just the right size for supporting the edges of the front panel so that no mechanical stress is placed on the knobs.)

With reassembly of the low-pass filter unit and replacement of the rear panel/power amplifier, you've completed the conversion.

## final cleanup

Reassembly is easy, and follows the reverse order as disassembly. You'll want to make one final alignment before replacing the shield plate. The final alignment should be done at about 10.125 MHz and should follow the same procedure as above. The receiver alignment should be done while listening to a weak signal on the air. Adjust T-1006 this time for maximum RF drive in the transmit position; doing this makes it a little easier to tune it to the peak position.

You may notice a large amount of 1-MHz marker leakthrough on 9 MHz while working on the receiver. With the shields replaced and the rig buttoned up, this will no longer be a problem.

No special instructions are needed to enjoy 30 meters. The rig operates on this band just as if it came factory equipped with the capability. Signal reports on the air have been good, and I enjoy having WWV on 10 MHz conveniently at hand.

ham radio

## K.V.G. CRYSTAL PRODUCTS



### 9 MHz CRYSTAL FILTERS

MODEL	Applic- ation	Band- width	Poles	Price
XF-9A	SSB	2.4 kHz	5	\$53.15
XF-9B	SSB	2.4 kHz	8	72.05
XF-9B-01	LSB	2.4 kHz	8	95.90
XF-9B-02	USB	2.4 kHz	8	95.90
XF-9B-10	SSB	2.4 kHz	10	125.65
XF-9C	AM	3.75 kHz	8	77.40
XF-9D	AM	5.0 kHz	8	77.40
XF-9E	FM	12.0 kHz	8	77.40
XF-9M	CW	500 Hz	4	54.10
XF-9NB	CW	500 Hz	8	95.90
XF-9P	CW	250 Hz	8	131.20
XF-910	IF noise	15 kHz	2	17.15

### 10.7 MHz CRYSTAL FILTERS

WRITE FOR FULL DETAILS OF CRYSTALS AND FILTERS

Export inquiries Invited.

Shipping \$3.50

## MICROWAVE MODULES EQUIPMENTS

Use your existing HF or 2M rig on other VHF or UHF bands.

### RECEIVE CONVERTERS

MMk1691-137	\$259.95
MMk1296-144G	159.95
MMc439-ATV	94.95
MMc432-2B(S)	79.95
MMc144-2B(HP)	84.95
MMc144-2B	64.95

### LINEAR TRANSVERTERS

MMI1296-144G	\$329.95
MMx1268-144	259.95
MMI435-2B(S)	299.95
MMI432-2B(S)	279.95
MMI144-2B(R)	319.95
MMI144-2B	189.95

### LINEAR POWER AMPLIFIERS

2M:		70cm:	
MML144-30-LS	\$109.95	MML432-30-L	\$219.95
MML144-50-S	149.95	MML432-50	199.95
MML144-100-S	209.95	MML432-100	379.95
MML144-100-LS	249.95		
MML144-200-S	399.95		

## ANTENNAS

2M:			
10XY-2M	\$69.95		
70cm:		LOOP YAGIS	
70/MBM28	\$39.95	1268-LY	\$49.95
70/MBM48	64.95	1296-LY	49.95
70/MBM88	94.95	1691-LY	59.95
		order loop yagi connector extra	



Send 66¢ (3 stamps) for full details of all our VHF & UHF equipments and KVG crystal products.

Shipping: FOB Concord, Mass.



# si

(617) 263-2145  
SPECTRUM  
INTERNATIONAL, INC.  
Post Office Box 1084  
Concord, MA 01742, U.S.A.

## BASEBALL CAP

How about an attractive **BASEBALL** style cap that has name and call on it. It gives a jaunty air when worn at Hamfests and it is a great help for friends who have never met to spot names and calls for easy recognition. Great for birthdays, anniversaries, special days, whatever occasion. Hats come in the following colors:  
**GOLD, BLUE, RED, KELLY GREEN**  
Please send call and name (maximum 6 letters per line).

UFBC-81 \$6.00

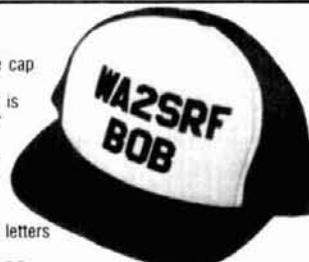

## I.D. BADGES

No ham should be without an I.D. badge. It's just the thing for club meetings, conventions, and get-togethers, and you have a wide choice of colors. Have your name and call engraved in either standard or script type on one of these plastic laminated I.D. badges. Available in the following color combinations (badge/lettering): white/red, woodgrain/white, blue/white, white/black, yellow/blue, red/white, green/white, metallic gold/black, metallic silver/black.

UID Engraved I.D. Badge

\$2.50

Ham Radio's Bookstore

Greenville, NH 03048

Please Enclose \$2.00  
to cover shipping and handling



# **MSO**

## **MICRO SUPPLY**

ORGANIZATION INC.

# *the packet radio alternative.*

The **MSO** complete packet radio system an alternative dedicated packet radio computer system with communications software, (Copylink) and a TAPR TNC-2 clone. Use your SANYO computer and software for an unattended RBBS, or use any of the thousands of public domain software programs available to the CP/M user. The system also comes with the complete micropro software package for word processing, (Wordstar) Spreadsheets (Calcstar) and a database, (Infostar) for your QSO's log, contest club member list or any other record keeping needs!! Also included is a spelling checker, (Spellstar), mailing label maker, (Mailmerge) and basic computer programming language.

At Micro Supply Organization we offer the lowest prices on Sanyo computers and software. With prices like these you can afford the convenience of owning and operating more than one computer. We also offer the User Support-Hotline for questions concerning your computer or about software availability. Whether you need one or a dozen computers, Micro Supply Organization is the place to get them!

### **USER SUPPORT HOTLINE**

# **805/393-2247**

All systems carry full 90 day warranty.

### **CASH PRICE ONLY**

Check in advance. Add 3% for VISA/MC. Shipping & handling charges will be added to each order.

For our catalog with complete details and prices, send \$1.00 to:

Micro Supply Organization, Inc.  
4909 Stockdale Hwy #180  
Bakersfield, CA 93309



MON. - FRI. 7am - 5pm PST • SAT. 9am - 5pm PST

## **Get more for your money!**

### **SANYO** **MBC 1160**

Including this **FREE** software:

- **Communication Program**
- **Wordstar • Spellstar**
- **Mailmerge • Calcstar**
- **Infostar • BASIC**

### **8-Bit Integrated Computer with 640KB Formatted Mini Floppy Disk Capacity**

- Z-80A CPU with no-wait mode and large 64KB RAM/4KB ROM memory capacity for fast execution.
- CP/M operating system with editor, assembler and all standard utilities.
- No-glare amber monitor display screen for easy viewing.
- 80-character x 25-line display. 256 characters in 8 x 12-dot matrix cells.
- Two internal double-sided, double-density, double-track 5¼" slim-type mini floppy disk drives with 640KB formatted capacity.
- Interfaces for one Centronics printer and one RS-232C port.
- Optional interface for hard disk drive and for external 8" floppy disk drive.



## **The Packet Radio Controller**

An identical TAPR TNC-2 clone with identical software and hardware. Features the latest AX.25 version 2.0 software, hardware HDLC for full duplex, true Data Carrier Detect for HF, 16K RAM simple operation plus more.

**\* Special Printer  
Pricing when  
purchased with  
above system.**

Complete  
package  
only

# **\$799**

# At last! A \$999 Facsimile And it's portable. **DATAFAX**

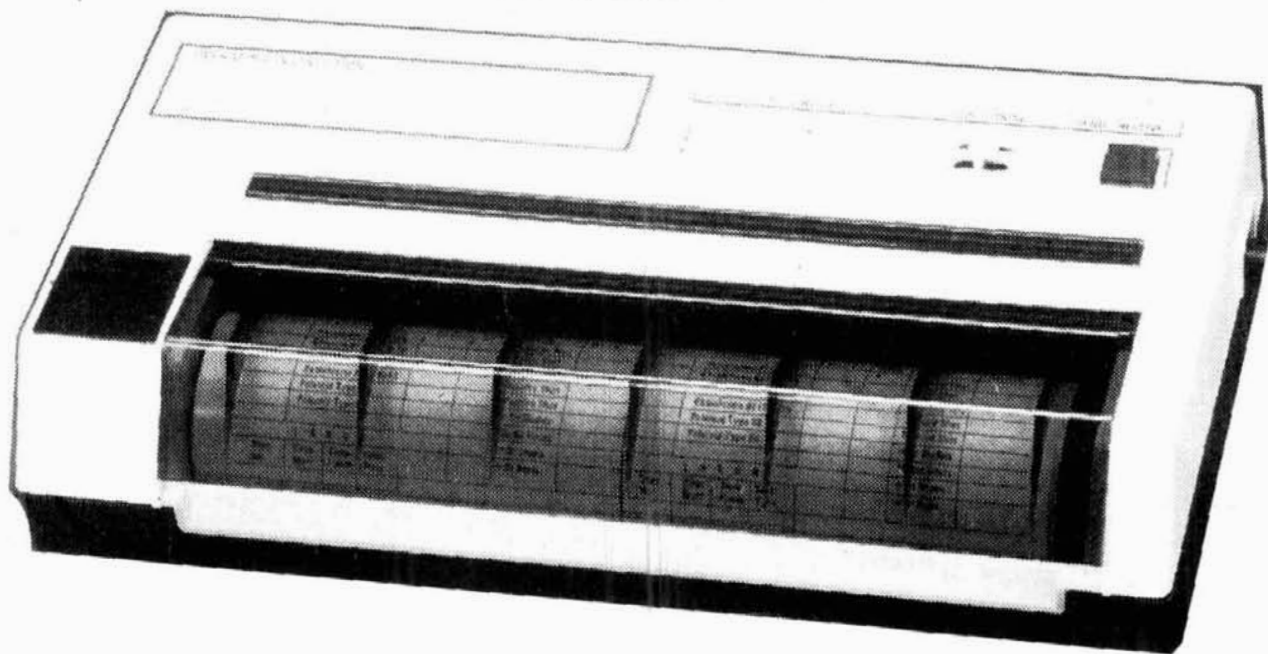

## *Immediate Document Transfer Anywhere There's a Phone*



If you are one of today's active business people who needs quick, accurate information in or out of the office... the **DATAFAX 300** is for you!

As long as you have access to a phone, you can send or receive copies of documents such as: sales and purchase orders, drawings, contracts, signatures, sketches, letters, schematics, charts, reports, printouts, revisions, security logs, estimates, proposals, etc. etc. - anywhere, anytime. Penned, penciled, typed or drawn, information can be sent without transcribing or time consuming keyboard entry.

## *Loaded With Features*

At only 10 lbs. the **DATAFAX 300** is easily portable with its convenient carrying case. Add special features such as simple 2-button operation, a coupler that attaches to virtually any phone, a rechargeable battery eliminating power requirements, Group II compatibility, and you'll find the **DATAFAX 300** the most versatile communication tool at any price.



**MSC**  
**MICRO**  
**SUPPLY**  
THE ORGANIZATION

**805/393-2247**

All systems carry full 90 day warranty. Check in advance. Add 3% for VISA/MC. Shipping & handling charges will be added to each order.

**CASH PRICE ONLY** For our catalog with complete details and prices, send \$1.00 to:

Micro Supply Organization, Inc.  
4909 Stockdale Hwy. #180  
Bakersfield, CA 93309

✓ 206

MON. - FRI. 7am - 5pm PST • SAT. 9am - 5pm PST

March 1986  53



# ★ QUALITY PARTS ★ DISCOUNT PRICES ★ FAST SHIPPING! ★ ALL ELECTRONICS CORP.

SEND FOR FREE NEW 1986 CATALOG... 48 PAGES!

### SOLID STATE BUZZER



Star # SMB-06L  
6 vdc  
TTL Compatible  
**\$1.00 each**  
10 for \$9.00

### 2K 10 TURN



MULTI-TURN POT SPECTROL #MOD 534-7161  
**\$5.00 EACH**

### ± 12 Vdc or 24Vdc POWER SUPPLY

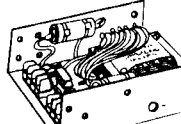

DELTRON MODEL QD12/15-1.7 Dual plus and minus 12Vdc open frame power supply. Can be used as 24Vdc @ 1.5 amp. INPUT: either 115 Vac or 230 Vac. Fully regulated computer grade supply 1 7/8" x 4 3/4" x 2 3/8"  
**\$12.50 each** 10 for \$110.00

### SOUND AND VIDEO MODULATOR FOR T.I. COMPUTER



T.I. # UM1381-1. Designed for use with T.I. computers. Can be used with video sources. Built-in A/B switch. Channel 3 or 4 selection switch. Operate on 12 vdc. Hook-up diagram included.  
CAT# AVMOD WERE \$10.00 **REDUCED TO \$5.00 EACH**

### SLIM LINE COOLING FAN

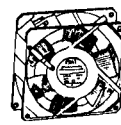

Etri # 99XM182 low noise fan Measures 3 3/8" square x 1" deep 21 cfm 23 db. 1700 rpm  
**SPECIAL PRICE . . . \$12.50 each**

### EDGE CONNECTORS

ALL ARE 1.56" SPACING.

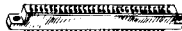

22/44 EDGE CONNECTOR  
PC style \$2.00 each  
10 for \$18.00

22/44 EDGE CONNECTOR solder lug style \$2.50 each

28/56 EDGE CONNECTOR  
PC style \$2.50 each  
10 for \$22.00

36/72 EDGE CONNECTOR  
PC style \$3.00 each

43/86 EDGE CONNECTOR  
PC style \$4.50 each

### SPECIALS

1 AMP 50 VOLT DIODES (N400) TAPE AND REEL  
100 for \$4.50  
1000 for \$30.00

SOLDER TAIL I.C. SOCKETS  
24 PIN 100 for \$22.00  
10 for \$2.50  
1000 for \$200.00

### MICRO-CASSETTE MECHANISM



Micro-cassette tape transport for standard MC60 or MC45 micro-cassettes. 3 Vdc operation. Contains: drive motor, belt, head, capstan, pinch wheel and other components. 3 1/2" X 2 1/4" X 5/8"  
CAT# MCMEC \$3.00 each 10 for \$27.50

### 220 Vac COOLING FAN



ROTRON # MX77A3  
Muffin XL  
220 Vac  
4 1/8" square metal frame fan  
CAT# CF-220 \$6.50 ea  
10 for \$60.00 / 100 for \$500.00  
QUANTITIES AVAILABLE

### DELUXE CASSETTE MECHANISM



ALPINE #160295  
New, high quality auto-reverse deck with pre-amp. Operates on 12-14 Vdc. Designed for "soft touch" operation of fast-forward, rewind, seek and repeat functions. Overall dimensions: 5 1/4" X 3 9/16" X 2 1/2". Includes spec sheet and hook up diagram.  
CAT# DCMEC \$12.75 each  
2 for \$24.00

### TRANSISTORS

2N706	4 for \$1.00
2N2222A	3 for \$1.00
PN2222A	4 for \$1.00
2N2904	3 for \$1.00
2N2904	3 for \$1.00
2N2905	3 for \$1.00
NJ2955	\$1.50
2N3055	\$1.00
PMD 10K40	\$1.00
TIP 121	75¢
TIP 125	75¢

### \*SPECIAL PRICE\* TRANSISTOR

plastic transistor  
PN3569 TO-92 N.P.N.  
100 for \$8.00  
1000 for \$60.00  
LARGE QUANTITIES AVAILABLE

### LINE CORDS

TWO WIRE  
6' 18/2 SPT-1 flat 3 for \$1.00  
6' 18/2 SPT-2 flat 2 for \$1.00  
6' 16/2 SJT round \$1.25 each

THREE WIRE  
6' 18/3 flat \$1.50 each  
8' 18/3 round \$2.00 each  
8' 16/3 round \$4.00 each

### RELAYS

#### 10 AMP SOLID STATE

CONTROL: 3 - 32 vdc  
LOAD: 140 vac 10 amp  
SIZE: 2 1/2" x 3 3/4" x 7/8"  
**\$9.50 EACH** 10 FOR \$90.00

#### ULTRA-MINIATURE 5 VDC RELAY

Fujitsu # FBR211NE0005M20  
High sensitivity  
COIL: 120 ohms  
CONTACTS: 1 amp  
Mounts in 14 pin DIP socket  
**\$1.25 each** 10 for \$10.00

#### MINIATURE 6 VDC RELAY

Aromat #RSD-6V  
Super Small  
S.P.D.T. relay  
GOLD cobalt contacts rated  
1 amp @ 30 vdc. Highly sensitive,  
TTL direct drive possible. 120 ohm coil.  
Operate from 4.3 - 6 vdc.  
COIL: 120 ohms **\$1.50 each**  
1 1/4" x 1 1/2" x 1 1/8" 10 for \$13.50

### 3 1/2" SPEAKER



8 ohm impedance.  
Full range speaker.  
8 oz magnet  
4 diagonal mounting centers.  
**\$2.50 each** 10 for \$20.00

### SPRING LEVER TERMINALS



Two color coded terminals on a sturdy 2 3/4" x 3 3/4" bakelite plate.  
Great for speaker enclosures or power supplies.  
**75¢ EACH** 10 for \$6.00

### XENON FLASH TUBE



3/4" long X 1/8" dia. Flash tube designed for use in compact camera flash units. Ideal for experimenters.  
CAT# FLT-1 2 for \$1.00

### TRANSFORMERS

120 volt primaries

5.6 volts @ 750 ma.	\$3.00
6 volts @ 150 ma.	\$1.25
6.3 volt @ 600 ma.	\$3.00
12 V.C.T. @ 200 ma.	\$2.00
12 V.C.T. @ 400 ma.	\$3.00
12 V.C.T. @ 1 amp	\$4.00
12 V.C.T. @ 2 amp	\$4.85
12 V.C.T. @ 4 amp	\$7.00
16 volts @ 650 ma.	\$3.50
24 V.C.T. @ 200 ma.	\$2.50
24 V.C.T. @ 1 amp	\$4.85
24 V.C.T. @ 2 amp	\$6.75
24 V.C.T. @ 3 amp	\$9.50
24 V.C.T. @ 4 amp	\$11.00
36 V.C.T. @ 135 ma.	\$3.00

### CASSETTE MIKE



Dynamic cassette mike with 3.5mm plug and on/off switch.  
**\$1.50 EACH** 10 FOR \$13.50

### TWIST-LOCK CONNECTOR



Same as Switchcraft #12CL5M. 5 conductor in-line plug and chassis mount jack. Twist-lock style.  
**\$2.50/SET**

### COMPUTER GRADE CAPACITORS

2,000 mfd. 200 VDC 1 3/4" DIA. x 5" HIGH	\$2.00
3,600 mfd. 40 VDC 1 3/8" DIA. x 3 3/4" HIGH	\$1.00
6,400 mfd. 60 VDC 1 3/8" DIA. x 4 1/4" HIGH	\$2.50
9,700 mfd. 50 VDC 1 3/8" DIA. x 4 1/2" HIGH	\$3.00
31,000 mfd. 15 VDC 1 3/4" DIA. x 4" HIGH	\$2.50
72,000 mfd. 15 VDC 2" DIA. x 4 3/8" HIGH	\$3.50
185,000 mfd. 6 VDC 2 1/2" DIA. x 4 1/2" HIGH	\$1.50

### 13 VDC RELAY



CONTACTS: S.P.N.C.  
10 amp @ 120 vac  
Energize coil to open contact.  
COIL: 13 vdc 650 ohms  
**SPECIAL PRICE \$1.00 each**

### 4PDT RELAY



14 pin KH style  
3 amp contacts  
USED but fully tested  
**\$1.70 each**  
Specify coil voltage desired  
Either 24 vdc or 120 vac  
LARGE QUANTITIES AVAILABLE  
SOCKETS FOR KH RELAY  
75¢ each

### MINIATURE TOGGLE SWITCHES

ALL ARE RATED 5 AMPS @ 125 VAC

<b>S.P.D.T. (on-on)</b> PC style non-threaded bushing. <b>75¢ each</b> 10 for \$7.00	<b>S.P.D.T. (on-on)</b> Solder lug terminals. <b>\$1.00 each</b> 10 for \$9.00 100 for \$80.00	<b>S.P.D.T. (on-off-on)</b> Solder lug terminals. <b>\$1.00 each</b> 10 for \$9.00 100 for \$80.00
<b>S.P.D.T. (on-off-on)</b> PC style non-threaded bushing. <b>75¢ each</b> 10 for \$7.00	<b>S.P.D.T. (on-on)</b> PC lugs threaded bushing. <b>\$1.00 each</b> 10 for \$9.00 100 for \$80.00	<b>D.P.D.T. (on-on)</b> Solder lug terminals. <b>\$2.00 each</b> 10 for \$19.00 100 for \$180.00

### WALL TRANSFORMERS

all plug directly into 120 vac outlet



4 VDC @ 70 ma.	\$2.00
6 VAC @ 500 ma.	\$3.50
6 VDC @ 750 ma.	\$4.50
9 VDC @ 500 ma.	\$3.50
12.5 VAC @ 265 ma.	\$3.00
18 VAC @ 18 VA and 8.5 VAC @ 1.28 VA	\$4.50
24 VAC @ 250 ma.	\$3.00
MULTI-VOLTAGE @ 500 ma.	\$3.45
3, 4, 5, 6, 7, 9 or 12 VDC	\$7.50

### TI SWITCHING POWER SUPPLY

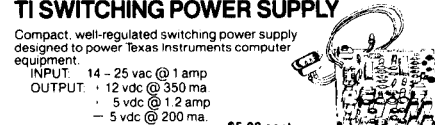

Compact, well-regulated switching power supply designed to power Texas Instruments computer equipment.  
INPUT: 14 - 25 vac @ 1 amp  
OUTPUT: 12 vdc @ 350 ma  
5 vdc @ 1.2 amp  
5 vdc @ 200 ma.  
SIZE: 4 3/4" x 4 1/4" x 1 1/4" high  
**\$5.00 each**

### 13.8 VDC REGULATED POWER SUPPLY

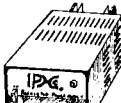

These are solid state, fully regulated 13.8 vdc power supplies. Both feature 100% solid state construction, fuse protection, and L.E.D. power indicator U.L. listed.  
2 amp constant, 4 amp surge **\$18.00 each**  
3 amp constant, 5 amp surge **\$25.00 each**

### RECHARGEABLE NI-CAD BATTERIES



AAA SIZE 1.25V 500MAH **\$1.85**  
AA SIZE 1.25V 500MAH **\$1.85**  
AA with solder tab **\$2.00**  
C SIZE 1.2V 1200MAH **\$3.50**  
D SIZE 1.2V 1200MAH **\$3.50**

### STANDARD JUMBO DIFFUSED T 1 1/2

RED	10 for \$1.50	100 for \$13.00
GREEN	10 for \$2.00	100 for \$17.00
YELLOW	10 for \$2.00	100 for \$17.00

### D.P.S.T. LIGHTED ROCKER SWITCH



115 vac lighted rocker. snap mounts in 7/8" x 1 1/8" hole. Orange lens. 16 amp contact  
**\$1.50**

### MINI-BOX



Pomona #2104.  
**\$1.00 EACH**

Heavy-duty black phenolic project box with cover and screws. 2 3/8" X 1 1/2" X 1 1/2"

### D.C. CONVERTER

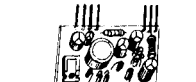

Designed to provide a steady 1.5 vdc @ 240 ma. from a battery supply of 3.5 to 6.25 volts.  
2 1/8" x 1 1/2" x 1 1/8"  
**\$1.50 each**

### 7 CONDUCTOR RIBBON CABLE



Spectra-strip red marker strip. 28 ga. stranded wire.  
**\$5.00 per 100' roll**

### UNIVERSAL CHARGER



Will charge 4-AA, C, D, or AAA ni-cads or one 9 volt ni-cad at one time...  
**\$11.00 per charger**

### FLASHER LED



5 volt operation  
red jumbo T 1 3/4 size  
**\$1.00 each**

### BI-POLAR jumbo T 1 3/4 size

2 for \$1.70

### MINI-PUSH BUTTON



S.P.S.T. momentary normally open 1/4" bushing. Red button.  
35¢ each  
10 for \$3.00

### FUSES



3AG (AGC) SIZE  
1, 1 1/2, 2, 2 1/2, 3, 4, 5, 6 AMP  
GMA SIZE  
1, 2, 3, 4, 5 AMP  
5 of any ONE amperage 75¢

### LED HOLDERS

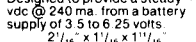

Two piece holder for jumbo LED  
10 for 85¢ 100 for \$5.00

### CLEAR CLIPLITE LED HOLDER

Make LED a fancy indicator. Clear.  
4 for \$1.00

### SNAP SWITCH



Cherry elect. #E-21. N.O. or N.C. 0.1A contacts. Suitable for alarms and other low energy circuits.  
1 1/8" lever.  
**45¢ EACH** 10 FOR \$4.20

### ROTARY ACTION MICRO



OMRON #C-563-C41  
Clockwise action micro used in coin operated mechanisms and low torque operations.  
RATED: 5 amps @ 125 Vac.  
**\$1.25 each** 10 for \$11.00  
LARGE QUANTITIES AVAILABLE

**ALL ELECTRONICS CORP.**  
LOS ANGELES, CA STORE  
905 S. Vermont Ave.  
213 380-8000

VAN NUYS, CA STORE  
6228 Sepulveda Blvd  
818 997-1806

MAIL ORDERS TO:  
P.O. BOX 20406  
Los Angeles, CA 90006

TWX 5101010163 ALL ELECTRONIC

EASYLINK MBX - 62887748

VISA

MasterCard

TOLL FREE ORDERS ONLY  
1-800-826-5432  
(ORDER ONLY)  
(IN CALIFORNIA: 1-800-258-6666)

ALASKA, HAWAII,  
OR INFORMATION  
SHIPPING  
(213) 380-8000 NO C.O.D.!

QUANTITIES LIMITED  
MINIMUM ORDER \$10.00  
USA: \$3.00 SHIPPING  
FOREIGN ORDERS:  
INCLUDING SUFFICIENT  
SHIPPING  
CALIF RES. ADD 6 1/2%

## build a bench power supply

A popular project for Amateurs and other electronic hobbyists is the direct current (DC) power supply for the shop workbench. Amateurs are often tempted to build their own power supplies because commercial models may be relatively expensive, especially

when "junkbox" parts are readily available. We also often find that voltage and current rating, in particular, are not to our liking. For example, many  $\pm 12$  VDC power supplies offer only 100 or 500 mA of current — which seems terribly little!

The DC power supply described below can be easily built by almost

anyone, is easily adapted to other voltages or currents and as shown, is already more flexible than most commercial bench power supplies.

In designing this power supply, my selections were dictated by my own needs, which are, I hope, similar to yours. Because I work a lot with operational and other linear IC amplifiers,

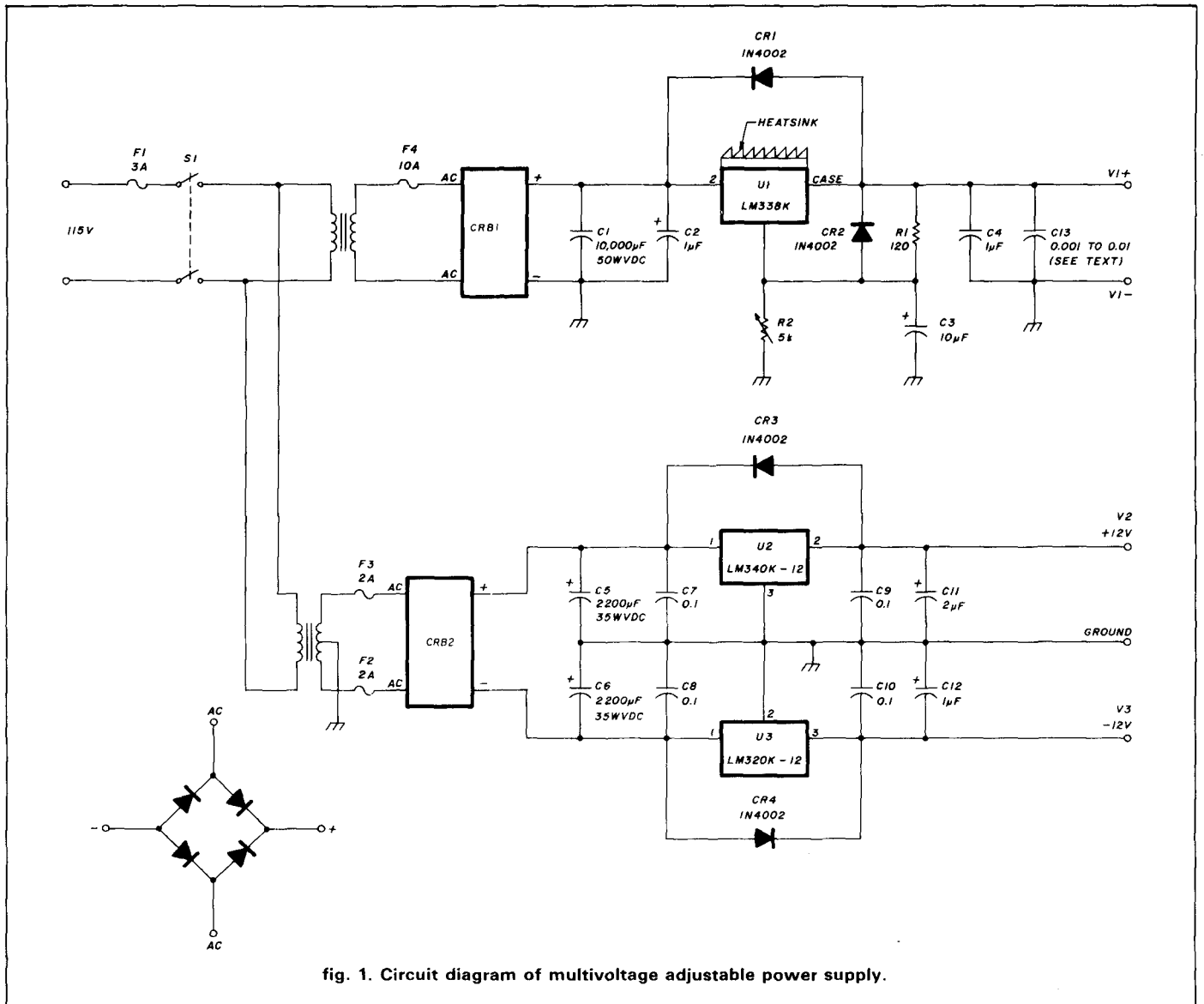

fig. 1. Circuit diagram of multivoltage adjustable power supply.

I needed either  $\pm 12$  VDC or  $\pm 15$  VDC at a current of 500 mA or more per voltage (e.g.,  $-12$  VDC at 500 mA, or more). Because some of my projects have been extensive, and also because 1-ampere components are so easily available, I built a  $\pm 12$  VDC dual-polarity power supply that provides 1 ampere at both voltages.

The DC power supply also had to provide a variable 0 to 15 VDC at 5 amperes. In addition, a supply capable of being adjusted for 5 volts would power TTL digital circuits that include most of today's 64K single-board microcomputers.

Digital projects are not my only reasons for needing a brutish variable voltage power supply. Sometimes I repair (or operate) my 2-meter FM mobile rig in the house. And others will occasionally ask me to look at, test, fix

or otherwise wave a magic wand over VHF-FM marine radios — some of which are merely high-priced versions of popular ham rigs! For these jobs, I set the output voltage to  $+13.8$  VDC (or  $+13.6$  VDC for some models), and can deliver up to 68 watts with the 5

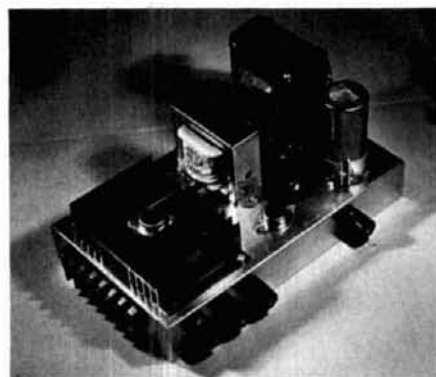

fig. 2. Completed power supply.

#### parts list

T1	12.6 VAC RMS at 5 amperes (or more!)
T2	25.6 VAC RMS at 3 amperes center-tapped
CRB1	50-volt PIV at 12 amperes bridge rectifier
CRB2	50 volt PIV at 1 ampere bridge rectifier (note: 1000 volt PIV used in the original).
C1	10,000 $\mu$ F/35 to 50 WVDC (or two 5000 $\mu$ F in parallel)
C2	1 $\mu$ F/35 to 50 WVDC
C3	10 $\mu$ F/25 WVDC
C4	1 $\mu$ F/25 WVDC
C5,C6	2200 $\mu$ F/35 WVDC
C7,C8,C9,C10	0.1 $\mu$ F/50 WVDC
C11,C12.	1 $\mu$ F/25 WVDC
C13	0.001 $\mu$ F to 0.01 $\mu$ /50WVDC disc ceramic
CR1 — 4	1N4002 (or any 1N4XXX up to 1N4007)
R1	120 ohms/0.5 watt
R2	5000 ohm potentiometer
S1	SPDT switch rated for 110 VAC or higher
U1	LM338K
U2	LM-340K-12 (or "K" packaged 7812) LM340K-12
U3	LM320K-12 (or "K" packaged 7912)
F1	3-ampere fuse
F2,F3	2-ampere fuse
F4	10-ampere fuse

**Miscellaneous:** four chassis-mounted fuseholders, heatsink for U1 (see fig. 2), chassis or cabinet, output terminals of your selection (most will use binding posts or barrier strips).

amperes of current available. This power supply will handle a 50-watt mobile rig nicely.

Another design requirement was that all voltages be regulated. This requirement not only allows precise operation, but also reduces rectifier ripple to nearly zero. While most of the projects I build don't specifically require voltage regulation, none are harmed by it. On the other hand, projects that require voltage regulation usually can't do without it, so I provide regulated voltages to all projects.

In the sections below, we'll discuss the design of the power supply, paying some attention to the rules of thumb used. These rules will permit you to design and build similar power supplies of your own. After all, the circuit for the  $+12$  VDC fixed supply is good for any 100 mA to the 3-Ampere, three-terminal IC voltage regulator.

#### design

The power supply has two sections, as evidenced by the 1.0- to-15 VDC at 5 ampere variable and  $\pm 12$  VDC at 1 ampere (per side) dual polarity fixed supplies. Because custom transformers are neither cheap nor easily obtained, I used separate transformers for this project.

The requirement for most three-terminal IC voltage regulators is that the input voltage be  $+2.5$  volts higher than the rated output voltage. For the 12 VDC supplies, therefore, we need 14.5 VDC or more from the rectifier/filter circuit; for the 0 to 15 VDC supply, we need 17.5 VDC from the rectifier/filter.

So how do we obtain the needed voltages? In most cases, we will have to specify the AC secondary voltage of the transformers, so we must be able to relate that specification (an RMS voltage) to the required voltage. Keep in mind that for sine waves, the output of the rectifier is very nearly the peak voltage of the transformer secondary winding. In order to find the minimum RMS voltage rating, we must multiply the required DC voltage needed by 0.707. For the 12 VDC supplies, where the input must be 14.5

VDC or more, then:  $0.707 \times 14.5 = 10.5$  volts RMS, which means that the RMS rating of the transformer secondary must be 10.5 VAC RMS (or more). For the 0 to 15 VDC supply, where the voltage to the regulator input must be 17.5 volts DC or more:  $0.707 \times 17.5 = 12.4$  VAC RMS (or more). In both cases, the next higher "standard" transformer rating is 12.6 VAC RMS.

The transformer used for the 0 to 15 VDC at 5-ampere supply needs a secondary current of 5 amperes or more. Being conservative in such matters (by virtue having had to repair too many burned-out power supplies over the past two decades), I selected a 12.6 VAC RMS at 8 ampere model from a mail-order catalog, though I would have preferred 10 amperes). Note: surplus military transformers are usually derated considerably, so they can generally be used by Amateurs at a higher rating.

The  $\pm$ VDC dual polarity supply presents a special problem because we would ordinarily need two 12.6 VAC transformers, one for each polarity. For this case, I selected a 25.2 VAC RMS (or higher) transformer that has a center-tapped secondary winding. With the center tap used as the ground (or common) reference, we essentially have two 12.6 VAC RMS transformers sharing a common secondary.

The current rating of the 25.2 VAC RMS transformer needs to be at least 2 amperes (1 ampere for each polarity), plus a safety margin. This extra rating is needed because I used a single fullwave bridge rectifier as if it were two halfwave bridge rectifiers. This rectification scheme requires a 40 percent margin, or 0.8 amperes in this case. Thus, the transformer rating had to be 25.2 VAC RMS (or higher) at 2.8 amperes (or more). My local Radio Shack had one on sale (but not in the catalog!) that was rated at 25.6 VAC RMS at 3 amperes with a center-tapped secondary. It filled the bill nicely.

Rectifiers CRB1 and CRB2 were selected according to two different rating criteria: peak inverse voltage (PIV)

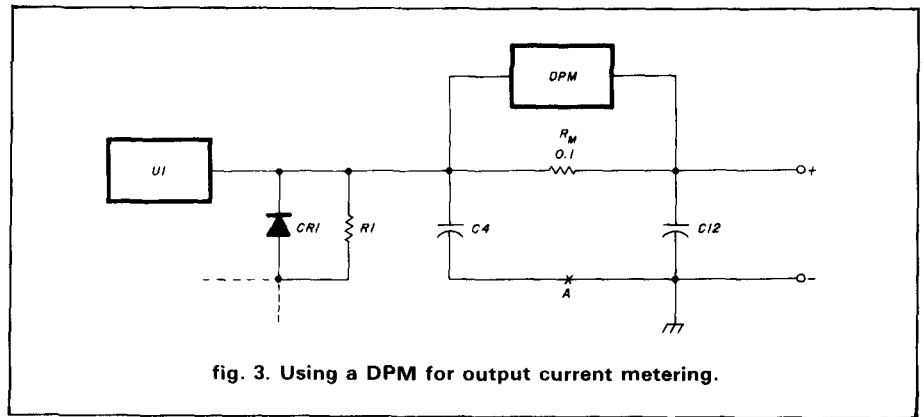

fig. 3. Using a DPM for output current metering.

and forward current. Although both rectifiers were bought as pre-made bridge "stacks," yours can be made from discrete rectifier diodes as shown in the inset in fig. 1.

The required PIV voltage rating is determined from the applied forward voltage, and is a minimum rating; higher PIV is permitted, and may even be desirable. The usual rule of thumb is that the PIV rating of the diode in a filtered DC power supply be 2.82 times the applied RMS forward voltage. Since 12.6 VAC RMS is applied, the minimum acceptable PIV rating is  $2.82 \times 12.6$  VAC RMS, or 36 volts. The next higher standard PIV rating is 50 volts PIV.

The forward current for CRB1 is 5 amperes; and for CRB2 it is 1 ampere. Because I prefer a substantial margin, I selected a 12-ampere chassis-mounted model for CRB1. Rectifier CRB2 was rated at 1 ampere at 1000 volts PIV because these are almost universally available, and stacks greater than 1 ampere are both more expensive and less easily obtained.

The filter capacitors are selected according to a  $2000 \mu\text{F}/\text{ampere}$  rule of thumb, so  $10,000 \mu\text{F}$  was used for C1 and  $2000 \mu\text{F}$  was used in each of the 12 VDC supplies (C7 and C8). In both cases, the voltage rating (WVDC) must be greater than the rectified output voltage — or not less than 25 WVDC given that standard voltages must be used. For a margin of safety, I selected 50 WVDC for C1 and 35 WVDC for C7 and C8.

The other capacitors in the circuit are for noise immunity protection. The lone exception is the optional capacitor, C13. This capacitor is needed by those who work on transmitters or other devices that emit RF energy. Radio frequency signals that get onto the output leads are transferred into the power supply and become a source of problems. Place a  $0.001 \mu\text{F}$  to  $0.01 \mu\text{F}$  disk ceramic capacitor across the output. This capacitor must be mounted directly on the output terminals, not on the circuit board. In general, use a value closer to  $0.001 \mu\text{F}$  if you work only on VHF equipment, and closer to  $0.01 \mu\text{F}$  if HF and lower frequencies are anticipated. Keep in mind that the HF value might be indicated if you plan to monitor 2 meters while operating on HF, even though the power supply will never be used for HF equipment.

There are four 1N4002 (or any 1N4XXX-series diode up to 1N4007) rectifier diodes in this circuit. These diodes are used to protect the IC voltage regulator, especially at turn-off. Charge stored in the various capacitors can be dumped back into the regulators in a disastrous manner, and the diodes provide a less dangerous path. Normally, diodes CR1 through CR4 are reverse-biased.

## construction

Figure 2 shows the construction of the power supply. Although I used a simple aluminum chassis and bottom plate, you might opt for a cabinet. My





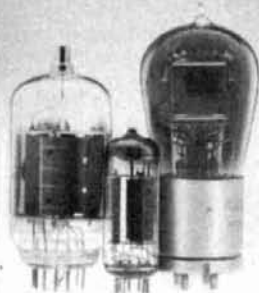

## TUBES—2,000 TYPES DISCOUNT PRICES!

New 20-pg. wholesale catalog for the radio collector/hobbyist. Antique, hard-to-find and modern tubes. Also transformers, capacitors and parts for tube equipment, and books, etc.

### Antique Electronic Supply

688-F W. First Street  
Tempe, AZ. 85281  
602/894-9503

## 40m Phased Array —the Easy Way!

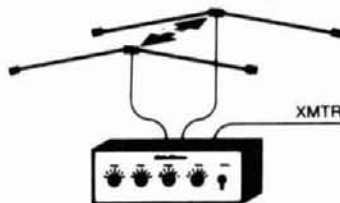

### OPTI-PHASOR™ by BaileyTech

- Change direction instantly
- High F/B, adjustable phasing
- Low SWR over entire 40m band
- Just 2 dipoles gives 4 db gain

\$119.95 Also available with matched dipoles and feed lines

Check, MO, VISA, M/C  
Call or Write for Complete Catalog.  
TET Antennas, Larsen, Hy-Gain,  
Alpha Delta, etc.

## SULTRONICS

1587 U.S. 68 N Xenia, OH 45385  
(513) 376-2700 ✓ 164

## AUTHORIZED KENWOOD I-COM RADIO DEALER



H. L. HEASTER, INC., 203 Buckhannon Pike, Clarksburg, W. Va. 26301 Clarksburg Phone (304) 624-5485 or W. Va. Toll-Free 1-800-352-3177

HAROLD HEASTER, K8B0HX, 91 Ridgefield Place, Ormond Beach, FL 32074 Florida Phone (904) 673-4066

NEW NATION-WIDE TOLL-FREE TELEPHONE 1-800-84-RADIO  
1-800-84-72346

Call us for a quotation, WE WILL SAVE YOU MONEY!

## Measure Up With Coaxial Dynamics Model 85A Termination Wattmeter

A direct-reading instrument for servicing 50 ohm communication systems and maintaining them at peak operation.

The Model 85A features:

- Dry load no coolant required.
- Replaceable connectors, interchangeable without affecting instrument calibration.
- Four power ranges easily switchable — 0-3/15/50 and 150 watts full scale.
- Frequency Range: 20 to 512 MHz
- Accuracy:  $\pm 5\%$  OFS
- Temperature Compensated

Contact us for your nearest authorized Coaxial Dynamics

representative or distributor in our world-wide sales network.



COAXIAL  
DYNAMICS, INC.



15210 Industrial Parkway  
Cleveland, Ohio 44135  
216-267-2233 1-800-COAXIAL  
Telex: 98-0630

Service and Dependability... A Part of Every Product

✓ 114



For more than 4 years, **QEX**, THE ARRL Experimenters' Exchange has filled the gap between the experimenter's personal notebook and the content requirements of mass-circulation periodicals. **QEX** with its new look and expanded content should be even more appealing to those interested in expanding the technical frontiers of amateur radio. You are invited to watch the results of the metamorphosis of **QEX** when it goes from a newsletter to a mini-technical journal effective with the March issue! Use the order form to sign up to receive **QEX** each month.

# NOW!

## Better than Ever Improved Graphics

### QEX ORDER FORM ARRL - 225 MAIN STREET NEWINGTON, CT 06111 USA

- Renewal  New Subscription

For 12 issues of QEX in the U.S.

- ARRL Member \$6.00  Non-Member \$12.00

In Canada, Mexico, and U.S. by First Class Mail

- ARRL Member \$11.00  Non-Member \$17.00

Elsewhere by Airmail

- ARRL Member \$21.00  Non-Member \$27.00

Remittance must be in U.S. funds and checks must be drawn on a bank in the U.S. Prices subject to change without notice. Or charge my:

( ) VISA ( ) Mastercard ( ) Am. Express

Signature \_\_\_\_\_

Acct. No. \_\_\_\_\_

Good from \_\_\_\_\_ Expires \_\_\_\_\_

Name \_\_\_\_\_

Address \_\_\_\_\_

City \_\_\_\_\_ State \_\_\_\_\_ Zip \_\_\_\_\_ HR

✓ 110

March 1986 **hr** 59



JÄ

# THE MOST Ku READY SATELLITE TV SYSTEM IN THE WHOLE VIDE WORLD.

Luxor has been Ku ready long before the rest of the world ever heard of satellite television.

Then came the eighties when we introduced America to its first Ku and C-band block receiver: Luxor's 9570 Mark II.

Today there's a full line of Luxor Systems. Like our 9995, designed as an inexpensive stand alone or for multiple television installations.

And now the Luxor 9900—the world's easiest to use Satellite Television System.

Call Luxor at  
1-800-245-9995.

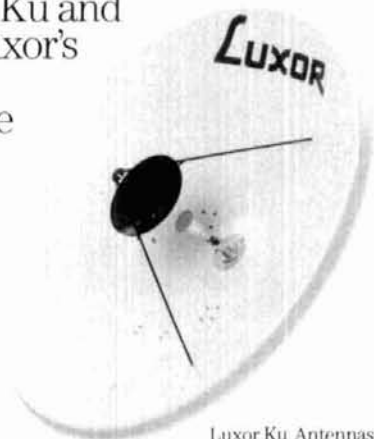

Luxor Ku Antennas.



9995 Block Receiver.



Microwave  
Block Downconverter.



9570 Mark II Block Receiver.



9900 Block Receiver.

## LUXOR®

*Luxor of Scandinavia.  
The birthplace of Satellite Television.*

## ASTRON POWER SUPPLIES

• HEAVY DUTY • HIGH QUALITY • RUGGED • RELIABLE •

### RS and VS SERIES

#### SPECIAL FEATURES

- SOLID STATE ELECTRONICALLY REGULATED
- FOLD-BACK CURRENT LIMITING Protects Power Supply from excessive current & continuous shorted output.
- CROWBAR OVER VOLTAGE PROTECTION on all Models except RS-4A.
- MAINTAIN REGULATION & LOW RIPPLE at low line input Voltage.
- HEAVY DUTY HEAT SINK • CHASSIS MOUNT FUSE
- THREE CONDUCTOR POWER CORD
- ONE YEAR WARRANTY • MADE IN U.S.A.

#### PERFORMANCE SPECIFICATIONS

- INPUT VOLTAGE: 105 - 125 VAC
- OUTPUT VOLTAGE: 13.8 VDC  $\pm$  0.05 volts (Internally Adjustable: 11-15 VDC)
- RIPPLE: Less than 5mv peak to peak (full load & low line)

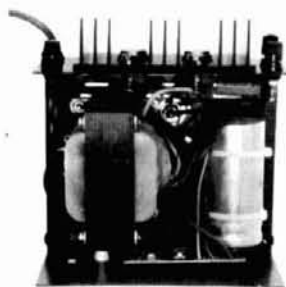

INSIDE VIEW - RS-12A



MODEL RS-50A



MODEL RS-50M



MODEL VS-50M

### RM-A Series



MODEL RM-35A

#### 19" X 5 1/4" RACK MOUNT POWER SUPPLIES

Model	Continuous Duty (AMPS)	ICS* (AMPS)	Size (IN) HXWXD	Shipping Wt. (lbs.)
RM-35A	25	35	5 1/4 x 19 x 12 1/2	38
RM-50A	37	50	5 1/4 x 19 x 12 1/2	50
• Separate Volt and Amp Meters				
RM-35M	25	35	5 1/4 x 19 x 12 1/2	38
RM-50M	37	50	5 1/4 x 19 x 12 1/2	50

### RS-A SERIES



MODEL RS-7A

MODEL	Continuous Duty (Amps)	ICS* (Amps)	Size (IN) H x W x D	Shipping Wt (lbs)
RS-4A	3	4	3 1/4 x 6 1/2 x 9	5
RS-7A	5	7	3 1/4 x 6 1/2 x 9	9
RS-7B	5	7	4 x 7 1/2 x 10 3/4	10
RS-10A	7.5	10	4 x 7 1/2 x 10 3/4	11
RS-12A	9	12	4 1/2 x 8 x 9	13
RS-20A	16	20	5 x 9 x 10 1/2	18
RS-35A	25	35	5 x 11 x 11	27
RS-50A	37	50	6 x 13 3/4 x 11	46

### RS-M SERIES



MODEL RS-35M

- Switchable volt and Amp meter

MODEL	Continuous Duty (Amps)	ICS* (Amps)	Size (IN) H x W x D	Shipping Wt (lbs)
RS-12M	9	12	4 1/2 x 8 x 9	13
RS-20M	16	20	5 x 9 x 10 1/2	18
RS-35M	25	35	5 x 11 x 11	27
RS-50M	37	50	6 x 13 3/4 x 11	46

### VS-M SERIES



MODEL VS-20M

- Separate Volt and Amp Meters
- Output Voltage adjustable from 2-15 volts
- Current limit adjustable from 1.5 amps to Full Load

MODEL	Continuous Duty (Amps) @13.8VDC@10VDC@5VDC	ICS* (Amps) @13.8V	Size (IN) H x W x D	Shipping Wt (lbs)
VS-20M	16 9 4	20	5 x 9 x 10 1/2	20
VS-35M	25 15 7	35	5 x 11 x 11	29
VS-50M	37 22 10	50	6 x 13 3/4 x 11	46

### RS-S SERIES



MODEL RS-12S

- Built in speaker

MODEL	Continuous Duty (Amps)	ICS* Amps	Size (IN) H x W x D	Shipping Wt (lbs)
RS-7S	5	7	4 x 7 1/2 x 10 3/4	10
RS-10S	7.5	10	4 x 7 1/2 x 10 3/4	12
RS-10L(For LTR)	7.5	10	4 x 9 x 13	13
RS-12S	9	12	4 1/2 x 8 x 9	13
RS-20S	16	20	5 x 9 x 10 1/2	18



# ham radio TECHNIQUES

Bill W6SAI

## more on the G5RV antenna

Although the G5RV multiband wire antenna has been popular overseas for some years, it's not well known in this country. But I've written about it occasionally in this column, and from the feedback I get in my mail, interest in this antenna appears to be growing. And why not? It's an inexpensive antenna that allows operation on more than one Amateur band without the necessity of using an auxiliary antenna tuner.

The basic antenna, popularized some years ago by R.L. Varney, G5RV, is shown in fig. 1. The design covers 7, 14, and 28 MHz, supposedly with a low value of SWR on each band, and is fed with a 75-ohm coax line. In practice, the measured SWR on the line is below 1.5:1 at the low frequency ends of the 10- and 20-meter bands, but is quite high across the 40 meter band.

Since most ham equipment is standardized on a 50-ohm transmission line, the G5RV design provides less than optimum performance when this coax is used for the feeder.

In 1981, W5ANB designed a modified version of the G5RV antenna<sup>2</sup> that provided good performance on the 7, 18, and 28 MHz bands when fed with a 50-ohm transmission line (fig. 2). Because the 18 MHz band is, as of this writing, not yet open to Amateur communications, the W5ANB antenna is useful only on the 7- and 28-MHz bands. Even so, this design demonstrates that changing the antenna dimensions moves the SWR response curve between various Amateur bands.

There the matter rested until Brian Austin, ZS6BKW, derived a computer

program for the G5RV antenna that permits the designer to vary the antenna parameters and observe the results. The starting point of his investigation was the G5RV and the W5ANB models. Brian experimented with various modifications of these

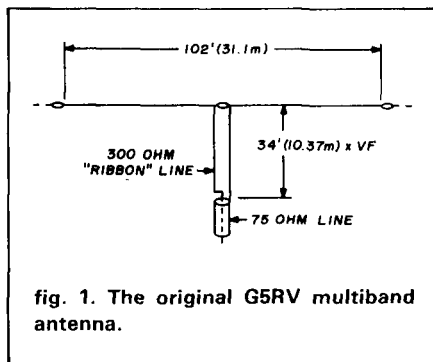

fig. 1. The original G5RV multiband antenna.

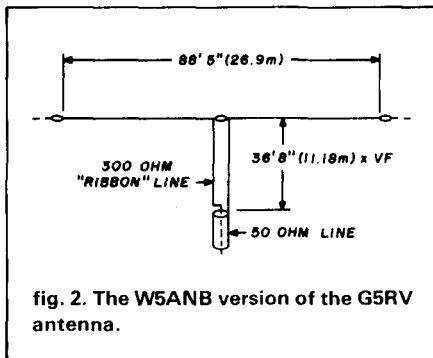

fig. 2. The W5ANB version of the G5RV antenna.

designs and tested his results on a model antenna range. The experiments eventually provided a G5RV-type antenna that produced a better impedance match to a 50-ohm line on various bands than did either of the two earlier designs.

## the ZS6BKW multiband antenna design

Dimensions for the ZS6BKW antenna design are shown in fig. 3.

The antenna is fed with a 50-ohm coax line and provides a good match to it on the 7, 14, 18, 24, and 28 MHz bands. Only the 21 MHz band is omitted. The respective SWR curves for this antenna are shown in fig. 4.

This design looks like the long-sought-after multiband antenna, but note that the two-wire transformer section must be built using 400-ohm line. Unfortunately, this line is not commercially available, although a home-made line can be built from No. 14 gauge wire spaced 0.9 inch (22.8 millimeters) between centers. Alternatively, a commercial 450-ohm ladder line with a polyethylene dielectric may be used. This oversized line has holes punched in the insulating web and the impedance is close enough to the desired value to provide satisfactory operation.\*

Although the design doesn't call for it, I believe it's a good idea to place a 1:1 balun at the junction of the coax line and the two-wire transformer section. Alternatively, the coax can be wound into an RF choke coil to suppress unwanted antenna currents from travelling down the outside of the outer shield of the line. Four turns of line wound into a coil whose diameter is about 15 times the diameter of the cable will suffice.

## the ZS6BKW antenna using 300-ohm line

Brian, ZS6BKW, determined from his computer program that by changing the lengths of the antenna sections, the design could be modified to use a 300 ohm line for the two-wire transformer. This line is universally

\*Saxton No. 1562 line (450 ohms), manufactured by Saxton Products, 215 North Route 303, Congers, New York 10920.

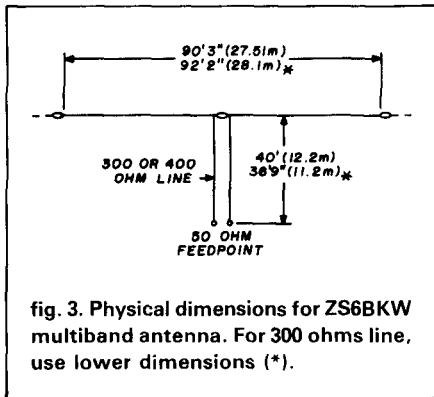

fig. 3. Physical dimensions for ZS6BKW multiband antenna. For 300 ohms line, use lower dimensions (\*).

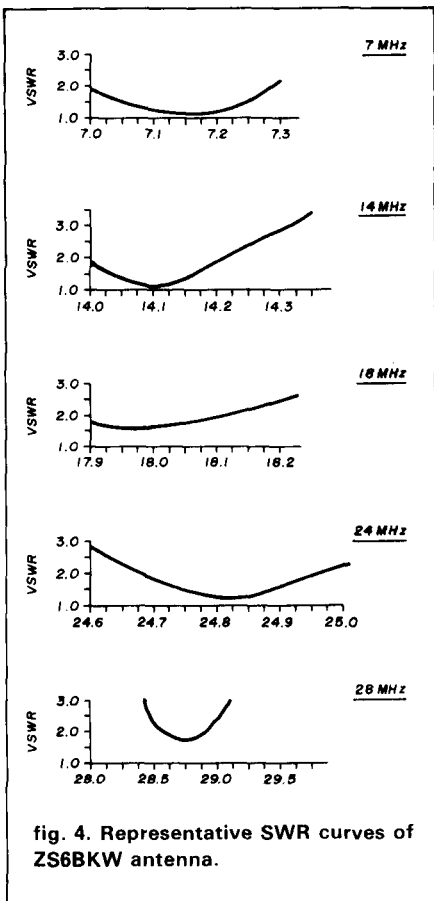

fig. 4. Representative SWR curves of ZS6BKW antenna.

available. The SWR curves for the various bands for this antenna are very close to those shown in fig. 4. This modified version seems to be the inexpensive, five-band wire antenna desired for many years by radio Amateurs!

### building the ZS6BKW multiband antenna

A complete set of physical dimensions for the ZS6BKW antenna is

given in fig. 3. It's easy to construct. Just string the flat top out between two supports and attach the transmission line so that it departs at right angles to the antenna. No special precautions need be observed beyond simply waterproofing the joint between the two-wire line and the coax line to prevent moisture from entering the coax.

The SWR curves on each band are affected by the height of the antenna above ground. If you want to alter the shape of the SWR curve on a particular band, you can change the antenna's elevation — but remember that if you do this, the SWR curves for the other bands will also change. The best SWR curves for all bands were found at an antenna elevation of about 42 feet (13 meters) above ground, although good results were obtained with the antenna as low as 23 feet (7 meters).

Tests were run on the ZS6BKW antenna configured as an inverted-V. The apex of the V was 40 feet (12 meters) high. When the angle between the wires was lowered from 180 degrees to 90 degrees, it was found that the resonant frequency dropped about 80 kHz in the 14 MHz band and about 125 kHz in the 24 and 28 MHz bands. This was thought to be due to the additional capacitance between the ends of the antenna and ground.

### the RF light bulb revisited

In my October, 1985, column, I spoke about the QRM-possibilities of the RF-actuated light bulb and voiced the hope that "some enterprising Radio Amateurs would have appropriate facilities at hand to examine RF light bulbs."

The investigation had been taken up by the ARRL, which ran extensive tests on the bulbs and filed comments with the FCC on Docket 83-806, which concerns the regulations that may be required for these devices.

Paul Rinaldo, W4RI, Editor of *QST*, forwarded a copy of the ARRL filing to me. The extensive tests indicated that with a typical American Phillips SL-18 lamp, "... interference may be

expected in residential environments from RF lighting devices to broadcast band receivers and, to varying extents, HF receivers when the antenna is located near the bulb. However, the RF noise emanating from the test lamp was insufficient to cause interference to a typical Amateur Radio station with outside antennas if the lamp is inside or located in an adjoining residence."

The report continues, "From the point of view of interference potential to Amateur Radio stations, the League believes it both necessary and sufficient for the Commission to require labelling of each RF light bulb to provide user information to educate consumers and users about interference potential to radio receivers . . . This is important not only from the point of view of the licensed Amateur who might purchase a bulb for his own use but also to insure that the neighbor of a licensed Amateur who suffers interference to a broadcast receiver from an RF light bulb does not wrongfully blame the Amateur for "causing" the interference."

### good show, ARRL!

However, the battle over the RF light bulb continues. In the fall of 1985, the FCC relaxed certain regulations governing the use, marketing, and certification of RF lighting devices and ISM (industrial-scientific-medical) devices, all of which broadcasters claim will interfere with AM reception.<sup>3</sup> National Association of Broadcasters (NAB) Staff Engineer Michael Rau stated that the relaxed rules makes AM reception "especially vulnerable" because they do not address interference experienced below 30MHz.

A battle seems to be brewing between the NAB, which represents broadcasters, and the NEMA (National Electrical Manufacturers Association), which states that the FCC is being "very realistic in its simplification of administrative responsibilities and certification laws involving the marketing of RF lighting devices."

So there you are. The NAB and the NEMA are both pulling and hauling on the FCC with regard to regulations



**NEW from TEN-TEC**  
Easy-to-use, low-cost OSCAR  
Mode B station



Model 2510 Mode B OSCAR station.

Eliminates separate converters and other equipment. Transmits 435-435.5 MHz; receives 145.5-146 MHz and down converts to 28-30 MHz. GaAs FET preamplifier. 10 watts on both SSB and CW. Runs on 12 volts DC.

**LIST PRICE \$549**

Call or write TODAY for your price.

**the  
HAM STATION**

PO Box 4405 • 220 N. Fulton Ave.  
Evansville, IN 47710

For Orders or price checks call

(800) 523-7731  
Indiana (812) 422-0231  
For Service (812) 422-0252

Amex, MC, VISA and CODs welcome. Freight FOB Evansville

## 7 MILLION TUBES

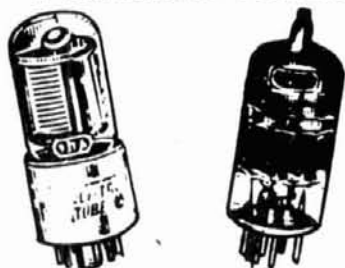

### FREE CATALOG

Includes all Current, Obsolete, Antique, Hard-To-Find Receiving, Broadcast, Industrial, Radio/TV types. **LOWEST PRICES**, Major Brands, In Stock.

**UNITY Electronics Dept. H**  
P.O. Box 213  
Elizabeth, NJ 07206

**SAY YOU SAW IT  
IN  
HAM RADIO**

# TOUCH TONE® CONTROL

NEVER BEFORE HAS SO MUCH CONTROL...  
COST SO LITTLE!!

MODEL CS-16 \$164 Amateur net MODEL CS-1688 \$189 Amateur net

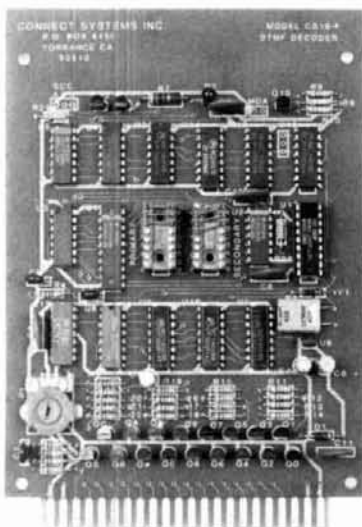

Two independent user programmable three digit passwords permit hierarchy control.

The secondary (user) password can only access 8 of the 16 latched (ON/OFF) functions.

However full 16 function control is available to control operators using the primary password. Additionally secondary password access can be enabled/disabled with a special primary password command.

**Our CS-16 puts repeater control ops... IN CONTROL.**

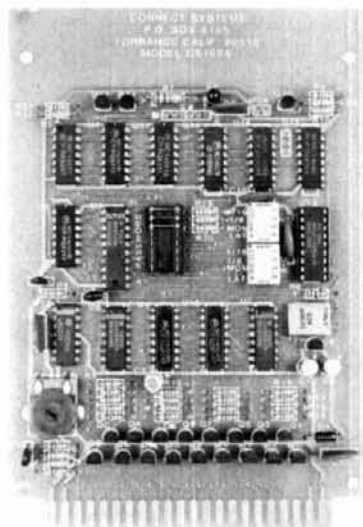

Our new CS-1688 is the most powerful touch tone controller in the industry! DIP switch programmability allows you to choose any of these ten mode/function combinations...

#### OUTPUT FUNCTIONS

D	1	2	3	4	5	6	7	8	9	0	A	B	C
D-7 GROUP							8-C GROUP						
1.	8	LATCHED	and	8	MOMENTARY								
2.	8	LATCHED	and	1	OF 8	SELECT							
3.	8	MOMENTARY	and	8	LATCHED								
4.	8	MOMENTARY	and	1	OF 8	SELECT							
5.	1	OF 8	SELECT	and	8	MOMENTARY							
6.	1	OF 8	SELECT	and	1	OF 8	SELECT						
7.	1	OF 8	SELECT	and	8	LATCHED							
8.										16	LATCHED		
9.										16	MOMENTARY		
10.													1
													OF 16
													SELECT

#### COMMON FEATURES

- Open collector (can drive relays directly) and logic outputs for each of the 16 functions
- SSI-202 central office quality XTAL controlled tone decoder
- Adjustable pre-amp accommodates 10MV-2 volt input
- Retransmission of control tones can be eliminated by use of either open collector or data strobe logic outputs
- Operates from 10-25 volts DC. Reverse polarity protected
- 4 1/2" x 6 1/2" glass board with 44 pin gold plated edge connector
- Comes complete with manual and mating connector

Add \$3.00 P&H California residents add sales tax

Call or write for information on these signaling products also:

**Model CS-10 DIP relay board**... packages 10 DIP relays.

**Model CS-100**... A 19" rack mount that houses a control card and two CS-10's. All inputs and outputs available on convenient barrier strips.

#### TYPICAL REPEATER CONTROL APPLICATIONS

H/I/O POWER — PL/COR — TIGHT/LOOSE SQUELCH — OPEN/CLOSED SQUELCH — REPEATER ON/OFF — AUTOPATCH ON/OFF — TOLL RESTRICT ON/OFF — RINGBACK ON/OFF — LONG/SHORT HANGTIME — ANTENNA 1/ANTENNA 2 — REMOTE BASE ON/OFF — F<sub>1</sub>/F<sub>2</sub> — AUX LINK ON/OFF — TONE MUTING ON/OFF — SPARE TRANSMITTER IN/OUT — ETC. ETC.

#### SELECTOR MODE APPLICATIONS

1 OF N FREQUENCIES — 1 OF N PHONE LINES — 1 OF N ANTENNAS — 1 OF N REPEATERS ETC.

**CONNECT SYSTEMS INCORPORATED**

23731 Madison St.  
Torrance, CA 90505  
Phone (213) 373-6803



\* AT&T

# 1986 CALLBOOKS



## The "Flying Horse" has a great new look!

It's the biggest change in Callbook history! Now there are 3 new Callbooks for 1986.

The North American Callbook lists the amateurs in all countries in North America plus those in Hawaii and the U.S. possessions.

The International Callbook lists the calls, names, and address information for licensed amateurs in all countries outside North America. Coverage includes Europe, Asia, Africa, South America, and the Pacific area (exclusive of Hawaii and the U.S. possessions).

The Callbook Supplement is a whole new idea in Callbook updates. Published June 1, 1986, this Supplement will include all the activity for both the North American and International Callbooks for the preceding 6 months.

Publication date for the 1986 Callbooks is December 1, 1985. See your dealer or order now directly from the publisher.

- |   |         |
|---|---------|
| <input type="checkbox"/> North American Callbook<br>incl. shipping within USA                 | \$25.00 |
| incl. shipping to foreign countries   | 27.60   |
| <input type="checkbox"/> International Callbook<br>incl. shipping within USA                  | \$24.00 |
| incl. shipping to foreign countries   | 26.60   |
| <input type="checkbox"/> Callbook Supplement, published June 1st<br>incl. shipping within USA | \$13.00 |
| incl. shipping to foreign countries   | 14.00   |

### SPECIAL OFFER

- |   |         |
|---|---------|
| <input type="checkbox"/> Both N.A. & International Callbooks<br>incl. shipping within USA | \$45.00 |
| incl. shipping to foreign countries   | 53.50   |

Illinois residents please add 6 1/4% sales tax.  
All payments must be in U.S. funds.

RADIO AMATEUR  
**callbook** INC.



Dept. F  
925 Sherwood Dr., Box 247  
Lake Bluff, IL 60044, USA

Tel: (312) 234-6600



concerning certification of ISM equipment and the residential use of consumer RF devices that might cause radio interference. The outcome of this interplay of forces will probably affect Amateur Radio in the future.

## CW and all that

I've noticed a great improvement in CW operation on the 20-meter band during the past few decades. The electronic key and the keyboard have produced some high-class signals whizzing along at 30 to 40 WPM. In general, the average code speed has increased greatly over that used by Amateurs in the past.

When I first operated 20 meters in the late 1930's, there were a few speed merchants on the air, but most Amateurs plodded at 8 to 10 WPM. Why were communications so slow in those bygone days? Because Amateur Radio was much less sophisticated then—and a good bug key cost the equivalent of two weeks' wages! The hand key was king.

But code champions existed then, too. Code speed contests at the larger Amateur Radio conventions were popular.

Copying high speed code by pencil or typewriter was an art, as the following story of a high speed CW contest as seen through the eyes of one contestant, taken from the November, 1933, issue of *QST*, suggests. The contest started out at 8 WPM and the code speed was gradually increased by 5 WPM each minute until only one contestant was left . . . .

*At 8 words a minute, you sit back and twiddle your thumbs, you yawn, and wish to heaven that the "lid" would get off the air. At 15, you take up your pencil and leisurely jot the stuff down on a piece of paper. At 20, you see the first signs of life. For a minute or two you sit back and copy, and then, on second thought, you hitch your chair forward a bit and straighten the paper. At 25, you quit "laying behind"; you decide to close the gap until you are about a word behind the sender. Not so bad, now. At 30, the fun begins. You can read it all right,*

*but the pencil seems to be getting a little sluggish — better make a grab for a "mill." At 35, you begin for the first time to think about errors: "How many am I allowed on a 5-minutes' run of this? At 40, it gets hotter, and darn suddenly, too. The last 5 words a minute have more mustard on them, it seems, than the first 30. You are holding your own with many a crack commercial radio or telegraph operator now. You quit worrying about single wrong letters and start hoping you can put a typewritten line down without leaving a word out. At 45, the jig is up. You quit, but half a dozen of the chaps go on. You make a grab for the transcription (if a judge) and by dint of much mental agility you may contrive to "follow" the transmission, but you are glad you are no longer trying to put it down on the typewriter. At 50 words a minute, the dots and dashes get blurred and jumbled. The letter O, instead of being designated by three ordinary dashes, comes through as one dash, and that one exceptionally staccato. The common "and's" and "the's" whiz by undeciphered. At 55, it is just a lot of static — no sense now in trying to hear anything . . . .*

## today's speed merchants

It seems that 40- or 50-WPM QSOs can be heard daily on most of the Amateur bands. The keyboard and the code reader have made great strides for Amateur communication. But how many hams can copy 45 WPM on a "mill?" I know a few that can, and there must be others. I also know a handful of old-time Amateurs who can copy up to 100 WPM in their head! Now, that's CW ability!

What is the world's CW speed record today? I don't believe I know. Does anybody out there know?

## references

1. R.L. Varney, "An Effective Multiband Aerial of Simple Construction," *RSGB Bulletin*, July, 1958, pages 19-20.
2. T. Nicholson, "Compact Multiband Antennas Without Traps," *QST*, November, 1981, pages 26-27.
3. E. Wytkind, "FCC Relaxes RF Light Policies", *Radio World*, October, 1985, page 6.

ham radio

## MAKE CIRCUIT BOARDS THE NEW, EASY WAY



### WITH TEC-200 FILM

#### JUST 3 EASY STEPS:

- Copy circuit on TEC-200 film using any plain paper copier
- Iron film on to copper clad board
- Peel off film and etch

**SATISFACTION GUARANTEED**  
convenient 8 1/2 x 11 size

**5-Sheets for \$3.95**  
**10 sheets only \$5.95**

add \$1.00 postage — NY res. add sales tax

## The MEADOWLAKE Corp.

Dept. G, P.O. Box 497  
Northport, New York 11768

✓ 141

## CANOPIES

### All weather protection for outdoor shows

- SLANT, PEAK OR FLAT ROOFS
- FREE STANDING - FAST SET-UP
- NO TOOLS REQUIRED -
- SNAPS TOGETHER
- WHITE OR BLUE TARPS
- FITS IN THE TRUNK OF A CAR
- JOINTS & PARTS

**PACKAGE COMPLETE -**  
**READY TO USE**  
**MONEY BACK GUARANTEE**

Free brochure on request

**Elaine  
Martin  
inc.**

P.O. BOX 261  
HIGHWOOD, IL 60040  
(312) 433-0106

✓ 179

## 162.5-172.5 MHz RECEIVER

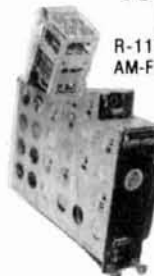

R-1170/ARR-52A 162.5-172.5 MHz AM-FM video solid-state sonobuoy receiver has five plug-in modules and 31 crystal-controlled channels. Conversion possible for 2-meters, VHF weather, satellite TV. (See 10/74 CQ Mag.) Requires 18 VDC; 7.5 x 2.5 x 10, 9 lbs sh. Used .....\$39.95

**SCHEMATIC** packet for either R-1170 or R-962 .....\$4.00 ea.

Prices F.O.B. Lima, O. • VISA, MASTERCARD Accepted.  
Allow for Shipping • Send for FREE CATALOG '86  
Address Dept. HR • Phone: 419/227-6573

**FAIR RADIO SALES**  
1016 E. EUREKA • Box 1105 • LIMA, OHIO • 45802

✓ 182

# Iron Powder and Ferrite TOROIDAL CORES

Shielding Beads, Shielded Coil Forms  
Ferrite Rods, Pot Cores, Baluns, Etc.

Small Orders Welcome  
Free 'Tech-Data' Flyer

**AMIDON** Associates Since 1963

12033 Otsego Street, North Hollywood, Calif. 91607

In Germany: Elektronikiaden, Wilhelm — Mellies Str. 88, 4930 Detmold 18, West Germany  
In Japan: Toyomura Electronics Company, Ltd., 7-9, 2-Chome Sota-Kanda, Chiyoda-Ku, Tokyo, Japan



✓ 175

**COM-SHACK 64**  
SIMPLEX AUTO-PATCH  
& REMOTE H.F. BASE

**MODEL CS-64**  
\$229.95

Includes Software (Program Disk), Hardware Interface & Instruction Manual

**NEW!**

- Simplex autopatch and H.F. remote base with clear voice messages
- Control your Yaesu FT-757 transceiver with your VHF/UHF portable or mobile
- Switch between the H.F. remote and the autopatch with DTMF tones
- Voice ID & all control functions & H.F. frequency are voice announced with your programmable access codes
- Autopatch works on any telephone line — tone or dial pulse
- Call waiting compatibility — after beep answer second incoming call while on the patch!
- Automatic redial last number [in dial pulse mode]
- Ring detect & automatic voice alert of incoming telephone call
- Inactivity timer turns off system [user programmable]
- Store 8 H.F. memory frequencies + shift VFO's & change bands
- Fast scan & slow scan + dial up any frequency with DTMF tones all from your handheld VHF/UHF portable or mobile
- Use the autopatch or the remote base both for the price of one!
- User defined timing window, access codes, call sign
- Simple to install hardware interface cables, connectors supplied
- Hook mic. input, PTT, spkr outputs & FM squelch connection 3 pin H.F. data cable and you are in control
- You supply — 1 Commodore 64 or 128 & 1 disk drive + base station
- No additional power supply required
- With human voice synthesized by Covox™.

Send Check or M.O. to  
**ENGINEERING CONSULTING**  
583 CANDLEWOOD ST., BREA, CA 92621  
(714) 671-2009

### TOUCHTONE™ DECODER KIT

MODEL TTK  
\$22.95

- SSI201 DTMF Receiver
- Receive all 16 DTMF digits
- No additional filtering
- Output BCD or hex format
- Low power (29 ma @ 12V)
- Kit includes 358 Mhz crystal, 22 pin IC socket, resistor, capacitors, data sheet and schematics

### 4-DIGIT SEQUENCE DECODER

WIRED & TESTED  
MODEL TSD  
\$59.95

- Completely wired & tested
- User programmable • LED status indicator • Open collector output
- Control relays: mute audio • Control link on/off
- Custom IC insures high reliability & small size
- Fits inside most rigs: runs on 12 VDC (35 ma)
- All 16 digits allow more than 50,000 combinations
- Makes excellent private call on busy repeaters!
- Use it to turn on audio or sound an alarm
- Momentary and latching outputs

Mastercard and Visa accepted  
Prices include postage & handling, U.S.A.  
California addresses add 6%

### "DECODE-A-PAD"

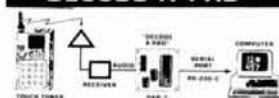

TOUCHTONE™ DTMF MODEL DAP-1  
to RS-232-C \$89.95  
300 BAUD INTERFACE

- Use your computer to decode DTMF touchtones
- Receive all 16 digits as fast as they can be transmitted
- Easily program your computer in BASIC to decode multidigit "strings", display digits, sound alarms, observe secret codes, control relays
- Simple to use, just provide +12 VDC and audio, hook two wires to the RS-232-C serial input on your computer, enter a simple BASIC program and begin to decode
- Sample BASIC program and instructions included
- Data indicator
- Wired and tested

### TUNE THE WORLD FROM YOUR HANDHELD VHF/UHF RADIO

2 FOUR DIGIT DTMF DECODERS, PLUS 16 DIGIT KEYPAD CONTROL

Model RAP-1 \$149.95  
REMOTE-A-PAD™

- Audio tones from any source, are converted to solid state switches which control any 16 digit keypad of a radio or other device
- Some examples you can control include the Pro-Search™ Rotator (rotate beam remotely); Remote controls: ICOM IC-701 or ICOM IC-211 when using the RM-2 controller; Kenwood 7950, IC751; Arden PCS 4000; handhelds such as Yaesu FT-208, FT-708, ICOM IC-02AT, and many more
- Two (four-digit) pro-

grammable access codes are used to operate relays or other on/off functions

- LED decoder status indicators and momentary plus steady state decoder outputs are provided
- All CMOS low power drain (30ma); SSI 201 Decoder
- Hook eight wires (4 rows and 4 columns) in parallel with the existing keypad of the radio you wish to control remotely
- Connect audio from any source, 12 volts D.C. and you are in control
- The dual 4 digit decoders will turn your links on and off using your programmable access code.

Name	Qty.	Model No.	Total
_____	_____	CS-64	_____
_____	_____	TTK	_____
_____	_____	TSD	_____
_____	_____	DAP-1	_____
_____	_____	AB-1	_____
_____	_____	RAP-1	_____
_____	_____	Tax [CA]	_____
<b>ENGINEERING CONSULTING</b>			<b>Total</b>
583 CANDLEWOOD ST., BREA, CA 92621, (714) 671-2009			

## reflector antennas: part II

Last month's column dealt primarily with the electrical and mechanical considerations for designing a parabolic dish type of antenna. Various design tradeoffs were discussed, especially in regard to choosing the proper  $f/d$  (focal length to diameter ratio).<sup>1</sup>

This month's column will continue in the same vein, with last month's material to be repeated only as required. Emphasis will instead be placed on additional considerations, recommended feed systems, and some typical construction techniques. You should then be able to build your own parabolic dish or design a feed system for an existing dish and place it in service.

## other parameters

Last month's column emphasized the  $f/d$  ratio and the comparatively low efficiency 50-60 percent of the operating parabolic dish antenna, but the apparent disparity between 50-60 percent and the efficiencies shown in **table 2** were not explained. The reason for the disparity is that there are other factors that must be considered when calculating efficiency. So as not to be chided for passing over the subject too lightly, I'll briefly discuss some of these parameters here.

As discussed last month, aperture illumination and spillover are not the only factors that reduce the efficiency of a parabolic dish type of antenna.

Other losses include but are not limited to structural imperfections, reflector surface accuracy, reflector porosity, polarization errors, and feed system blockage, among others.

It should go without saying that the shape of the reflector must follow a parabolic taper throughout its surface. Any departure from a true parabolic curve causes random phase errors which decrease performance. This includes the supporting ribs and the reflector surface tolerance and has been covered extensively in the literature.<sup>2</sup>

It should also be mentioned that the required accuracy of the parabolic

curve is a function of the  $f/d$  ratio of this dish;  $f/d$  ratios greater than 0.45 require tighter tolerances than those under 0.45. As rule of thumb, the mechanical tolerances of the reflector should be held to 0.05 wavelength, with a maximum of 0.1 wavelength at the highest frequency of operation. This suggests a tolerance of 0.5 inches (1.3 cm) for the 1296 MHz (23 cm) band. Typically the reflector tolerances for a well constructed reflector should add up to a loss of only about 0.2 dB.

The reflector has another form of loss due to the porosity of the surface. If the reflector isn't made of solid material, some of the energy imping-

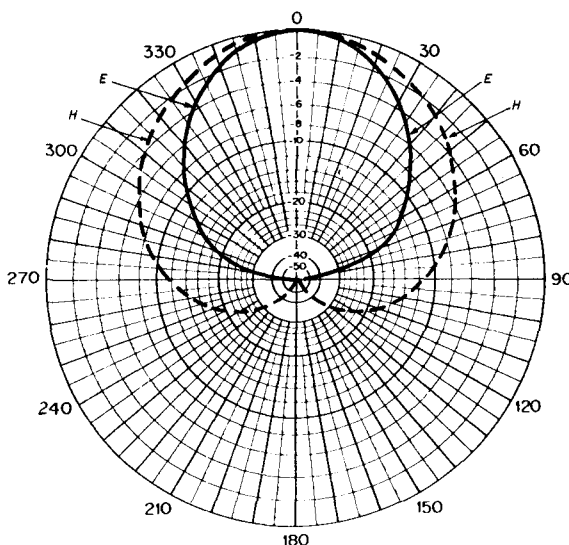

fig. 1. Typical E and H patterns of a splasher or reflector/driven element type feed as described in the text. Note the considerable difference between each plane's beamwidth.



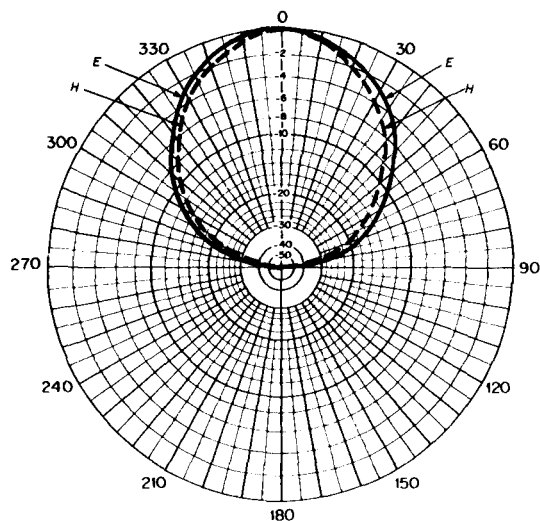

fig. 2. This is the approximate pattern of the EIA feed system as described in the text. Note that the E and H planes are clean and have similar beamwidths.

ing on the surface will pass through it. This is a function of the largest dimension of the holes and the diameter of the wire in the screen. As a rule of thumb, the losses due to a typical mesh type of reflector will be 0.3 to 0.5 dB when the largest dimension across the mesh is about 0.1 wavelength at the frequency of operation.<sup>3</sup> Therefore, 1 inch (2.54 cm) diameter chicken wire screen should not be used above 23 cm.

Polarization errors are caused by the type of feed and the  $f/d$  ratio of the dish. Lower  $f/d$  ratio (0.25 to 0.4) designs have greater cross polarization losses than higher  $f/d$  ratio (0.45 to 0.6) dishes. The additional loss due to polarization is typically 0.15 to 0.2 dB.

Another factor to be considered is aperture blockage, which is affected by the size of the feed as well as the feed holding structure. Intuitively, the larger the feed structure, the larger the aperture blockage and the lower the gain. Often Amateurs fail to recognize that the feed supporting structure also contributes to aperture blockage.

The total aperture blockage can be determined by adding up the cross sectional area of the feed and supporting structure and comparing it to the overall surface area of the dish using the following equation<sup>3</sup>:

$$L = 10 \log \left[ 1 - 2 \left( \frac{B}{A} \right) \right]^2$$

where  $L$  is loss in dB,  $B$  is the aperture blockage area and  $A$  is the area of the dish with both  $A$  and  $B$  in the same unit of measure. For example, a 20-foot (6.1-meter) diameter dish has an area of 314 square feet (29.2 square meters). If the total aperture blockage due to feed and supports is 5.75 square feet (0.534 square meters), the degradation will be approximately 0.32 dB.

The losses due to these factors will be approximately 1 to 2 dB, depending upon how well the dish is designed and built. Adding this to the approximately 1 dB of illumination taper discussed in reference 1 yields a 2 to 3 dB typical loss versus the total aperture of the dish. Therefore a typically well constructed parabolic dish has only 50 to 60 percent efficiency based on its physical aperture.<sup>4</sup>

### feed systems

Ironically, the feed system becomes the most important item in the design of a parabolic dish type of antenna. This is true even if you can build a perfect reflector with no deviation from a true parabolic taper, since you still must illuminate the dish properly for maximum efficiency.

Let's reiterate what's required of the feed system. First, it must provide the proper taper at the rim of the dish. Hence the RF level of the feed must be down approximately 10 dB at the rim of the dish from the level at the center of the dish.<sup>5</sup> Also remember that the space attenuation at the rim of the dish, because of the angle off boresight, increases the feed pattern taper and must be considered as shown in fig. 7 of reference 1.

Next, the feed system should have a clean lobe-free pattern that's relatively symmetrical in both E and H planes. A 10 percent difference between E and H beamwidth is acceptable. Also remember that most feeds are not circularly symmetrical, even though the parabolic dish is! Hence, there's further mismatch. If you desire to use circular polarization for OSCAR or EME operation, the feed design is even more critical.

A simple feed pattern is shown in fig. 1. This is the pattern for a typical dipole with a reflector that's often referred to as a "splasher" or dipole-disc feed, which used to be one of the most popular feed systems.

Note that the beamwidths in the E and H planes are quite different. Since the beamwidths are so dissimilar, either the E or H plane can be optimized for the particular dish at the expense of the other plane. Hence it is not a recommended feed system for a parabolic dish type of antenna, except where performance is not critical.

Figure 2 shows the pattern of the EIA feed.<sup>6</sup> Note that it has a clean pattern as well as similar E and H beamwidths. This is the ideal combination for an efficient feed system.

Finally, you have to know the taper of the feed in order to place the proper attenuation point at the rim of the dish. Figure 3 includes a handy graph for doing this. Using fig. 3 you can estimate the attenuation off boresight if you know the  $-10$  dB beamwidth. If you know the beamwidth at another level, it can be normalized to the graph. For example, if the half power ( $-3$  dB) beamwidth of your feed is



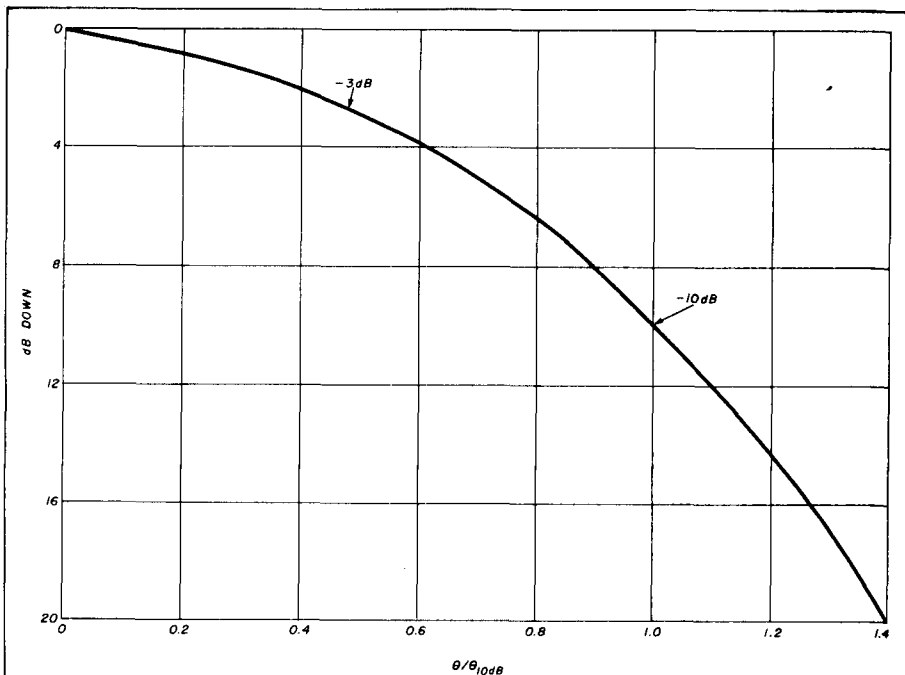

fig. 3. This graph represents a universal pattern which can be used to estimate the beamwidth of a typical feed pattern if the beamwidth is known at 10 dB below the main beam. If the beamwidth is known at another level, it can be normalized to the pattern as explained in the text.

60 degrees, the  $-10$  dB beamwidth will be approximately 1.92 times this value ( $1/0.52$ ) or 115 degrees. Conversely, if the  $-10$  dB beamwidth is 120 degrees, the  $-3$  dB beamwidth will be 0.52 times 120 degrees, or 62.4 degrees.

Let's discuss some typical parabolic dish feeds often used by Amateurs. They are (but are not limited to): the "splasher," the EIA reference antenna, and the rectangular and circular waveguides.

The dipole in front of a disc reflector shown in fig. 4A has been around about as long as any type of feed as discussed above.<sup>5</sup> It's relatively simple to construct, has a built-in balun, and has a relatively small reflector, causing relatively little aperture blockage.

However, the splasher type of feed exhibits a large difference in E and H plane beamwidths, typically 105 and 165 degrees, respectively, at the  $-10$  dB points. If the E plane is matched to the dish, the H plane will be severely over-illuminated. If the H plane is properly illuminated, the E plane will be under-illuminated. Consequently this

feed system is not recommended except in applications where gain and spillover are not critical.

The EIA feed<sup>6</sup> overcomes the shortcomings of the splasher by placing another dipole in the H plane as shown in fig. 4B. This helps to equalize the beamwidths as shown in fig. 2. This type of feed is one of the most popular types used on 70 cm EME.

The rectangular waveguide or horn (fig. 4C) is quite common in professional applications. It can be designed to have nearly equal E and H plane beamwidths. However, it is usually large and somewhat difficult to design, especially on the lower frequency bands. It's also more difficult to design if circular polarization is required. Typical design information is available in reference 7.

Relatively easy to design and build,<sup>8</sup> the cylindrical horn is often assembled from coffee cans or lengths of large-diameter tubing. Like the splasher, it has unequal E and H patterns. However, if a "choke" collar is placed near the mouth of the cylinder as shown in fig. 4E, the external surface radiation

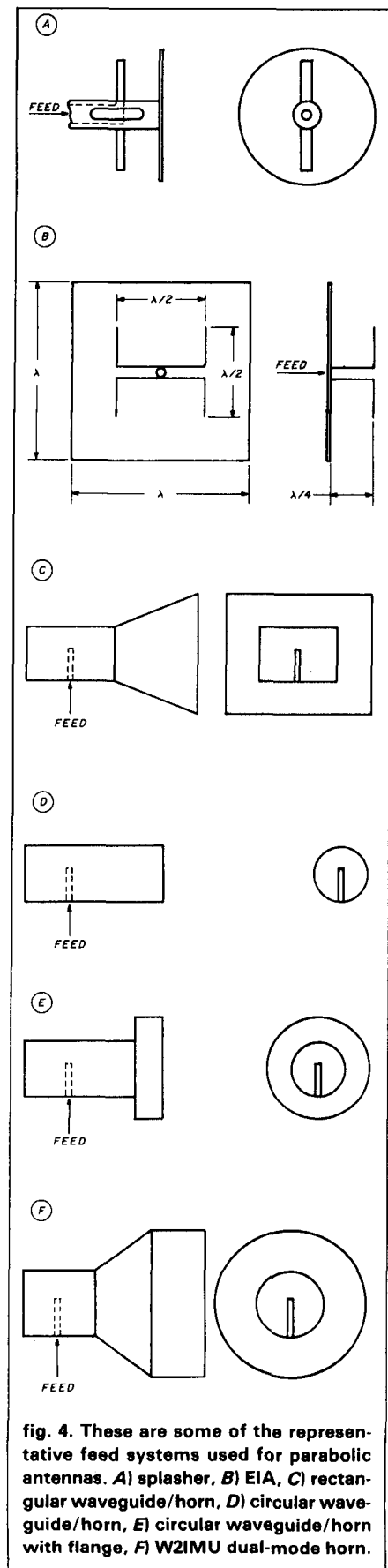
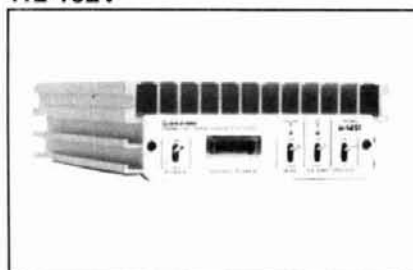

fig. 4. These are some of the representative feed systems used for parabolic antennas. A) splasher, B) EIA, C) rectangular waveguide/horn, D) circular waveguide/horn, E) circular waveguide/horn with flange, F) W2IMU dual-mode horn.

## VHF AMPLIFIERS AND PREAMPS

**HL-102V**

**HL-22V**

**HRA-2**

**HRA-7**

MODEL	HL-102V 220 MHz AMPLIFIER + PREAMP	HL-22V 220 MHz FM AMPLIFIER 20 WATT	HRA-2 MAST MOUNTED GaAsFET PREAMP 2 METERS	HRA-7 MAST MOUNTED GaAsFET PREAMP 70 CM
Sugg. Retail	\$259.95	\$99.95	\$129.95	\$129.95
Description	220 MHz all mode amp with low noise FET type preamplifier. 90 Watts out from 10 OR 25 Watts drive.	220 MHz VHF FM Amplifier GaAsFET Preamplifier	Mast mounted pre-amplifier using GaAsFET technology for lowest noise in the active device.	Mast mounted pre-amplifier using GaAsFET technology for lowest noise in the active device.
Frequency Range	220-225 MHz	220-225 MHz	HRA-2: 2 Meters	HRA-7: 70 CM
Modes	SSB, CW, FM	FM	SSB/FM	SSB/FM
Supply Volts @ Amps	DC + 13.8V @ 18A	DC + 13.8V @ 5 AMPS	9-12 @ 200 mA	9-12 @ 200 mA
R.F. Power-Out (AVG)	90 W	20 W	GAIN: HRA-2 20 dB	GAIN: HRA-7 18dB
R.F. Power-In (NOM)	10 OR 25 W	3 W	Noise Fig.: HRA-2 1.0 dB	Noise Fig.: 0.8 dB
Connector In/Out	TYPE 'M'	TYPE 'M'	TYPE 'N'	TYPE 'N'
Pre-amp Type	F.E.T.	GaAsFET	GaAsFET Semiconductor Helical Resonator	GaAsFET Semiconductor Helical Resonator
Output Meter Type	LIGHTED METER	L.E.D.	N/A	N/A
Dimensions	172W x 60H x 263D m/m	100W x 35H x 150D m/m	180W x 82H x 75D m/m	180W x 82H x 75D m/m
Weight	2.5 Kg	520g	550g	550g

## HF ANTENNA COUPLERS

**HC-2000**

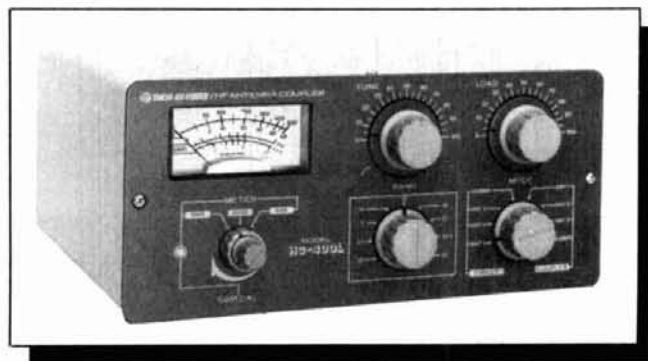
**HC-400**

SPECIFICATIONS	HC-2000	HC-400	HC-200
Band of Operation	1.9-3.5-7-10-14-18.21-24.5-28	1.9-3.5-7-10-14-18.21-24.5-28	3.5-7-10-14-18-21-24.5-28
Power Metering	Pwr-VSWR Two Meters	Pwr-VSWR Coaxial Meter	Fwd.-Rev.-V.S.W.R.
Input (Watts)	2000 W PEP Max @ 50 Ohms (500 on 1.9)	400 W PEP Max @ 50 Ohms	200 W PEP Max
Impedance Range	10-500 Ohms	10-250 Ohms	10-250 Ohms
Size (W x H x D) MM	100 X 34 X 149	326 X 130 X 400	210 X 84 X 187
Weight	9.6 kgm	3.4 kgm	2.2 kgm
Connector Type	6 UHF plus Balanced Output	4 UHF plus 1 Terminal	4 UHF plus 1 Terminal
Suggested Retail	\$379.95	\$229.95	\$99.95



# R&L ELECTRONICS 575 main st.

# HAMILTON, OHIO 45013

Large  
Stock

**YAESU**   
*The radio.*

**KENWOOD**

 **ICOM**



**FT-757GX**



**TS-940S**



**IC-735**

WE STOCK ALL MAJOR LINES OF AMATEUR RADIO EQUIPMENT, ANTENNAS, TOWER, AND RADIO ACCESSORIES.



COD'S WELCOME!

STORE HOURS  
Monday-Friday  
10:00 A.M. to 6:00 P.M.  
Saturday 10:00 A.M. to  
3:00 P.M.

CALL OR WRITE FOR OUR FREE CATALOGUE

WE SERVICE WHAT WE SELL!

BUY — SELL — TRADE  
**513.868.6399**

193

 **TUBES**  
**and IC's**  
**FAST DELIVERY**  
**LOWEST PRICES**  
call Toll Free (800) 221-5802

In-depth inventory - Industrial & Receiving Tubes

Here are 2 dozen examples

3-500Z	\$85.00	PL259	10/4.95
572B	65.00	PL258	10/7.95
811A	12.00	UG175/	
6146B	8.75	176	10/1.55
M2057	15.00	UG255U	1.55 ea
8950	12.50	UG273	2.20 ea
4CX250B	58.00	M358	2.25 ea
6883B	9.50	8122	130.00
813	29.00	MRF450	12.95
SD1088	17.95	MRF492	19.95
2N3055	.70	6LF6	8.26
2N6084	11.95	6JS6C	7.46
		6CA7	6.91

Major Manufacturers Factory Boxed and Full line of Sylvania ECG Replacement Semiconductors



Minimum order \$25.00

Allow \$3 UPS charge

**TRANSLERONIC INC.**



Box H, 1365 39th ST., BROOKLYN, NY 11218  
Tel. 718-633-2800/Watts Line 800-221-5802  
FAX # (718) 633-4375



STILL LOOKING FOR QUALITY  
**WIRE & CABLE**  
AT THE RIGHT PRICE?

RG-213 MIL SPEC. 97% SHIELD	28.5¢/ft
RG-214 MIL SPEC. DBL SILVER SHIELD	\$1.50/ft
RG-174 MIL SPEC. 97% SHIELD	10¢/ft
RG-8X (MINI 8) FOAM 95% SHIELD	12.5¢/ft
RG-8U FOAM 95% SHIELD	24.5¢/ft
RG-58A/U MIL SPEC. 97% SHIELD	12¢/ft
RG-11A/U MIL SPEC. 97% SHIELD	28¢/ft
RG-59U MIL SPEC. 97% SHIELD	12¢/ft
300 OHM KW TWIN LEAD	16¢/ft
450 OHM HD LADDER LINE. POLY INS	10¢/ft
450 OHM HD LADDER LINE. BARE. 100 ft. ROLL	\$13.00
4 CONDUCTOR ROTOR CABLE	8¢/ft
6 CONDUCTOR ROTOR CABLE	14¢/ft
8 CONDUCTOR ROTOR CABLE (2x18-6x22)	16.5¢/ft
8 CONDUCTOR ROTOR CABLE HD (2x16-6x18)	34¢/ft
14 GA STRANDED COPPERWELD. 70 ft. ROLL	\$6.50
14 GA STRANDED COPPERWELD. 140 ft. ROLL	\$12.00
14 GA HD STRANDED COPPER	8¢/ft
12 GA HD SOLID COPPERWELD	10¢/ft
14 GA HD SOLID COPPERWELD	8¢/ft
18 GA HD SOLID COPPERWELD	4¢/ft

\*SOLD IN CONTINUOUS LENGTHS TO 5000 FT. IN 50 FT. MULTIPLES ONLY

**LA CUE, INC.**

132 Village Street  
Johnstown, PA 15902  
orders only  
**1-800-637-3300**

138

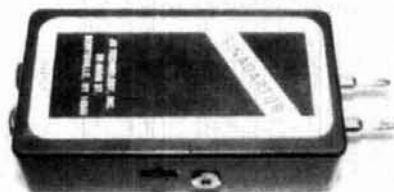

NOW **Sinad** CAN  
BE MEASURED WITH  
YOUR VOM

- Quickly tune Receivers, Cavities, Preamps, etc.
- Works with your VOM or AC VTVM that has 2.5V full scale sensitivity or better.
- Fast accurate measurements.
- Sinad measurement displayed on meter in "dB" scale.
- Self contained, pocket size, go anywhere instrument.
- Powered by standard 9V battery or optional AC adaptor.

SINADAPTOR SAI-01

**\$79.95**

Please add \$3.50 shipping & handling



NY res. add 7% sales tax

**J.S. Technology, Inc.**  
39 Main Street  
Scottsville, NY 14546  
(716) 889-3048

188

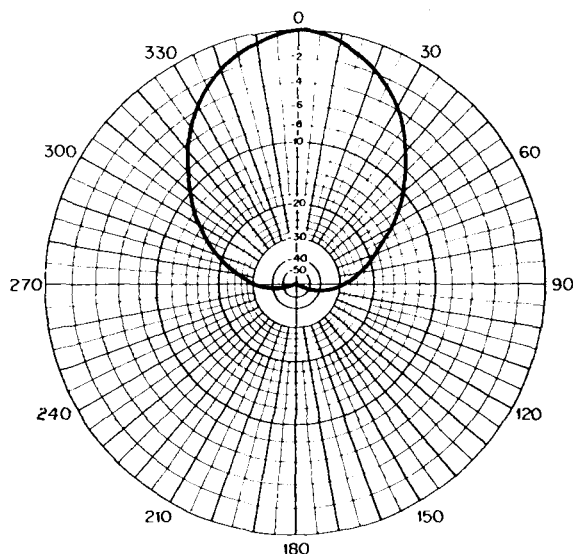

fig. 5. This is the approximate E plane pattern for the W2IMU dual-mode feed horn. The H plane beamwidth is virtually identical so it is not shown.

that causes this problem can be controlled. An improved circular waveguide feed with a choke is discussed in references 9, 10 & 11.

Dick Turrin, W2IMU, had patented a circular waveguide horn called the dual-mode feed.<sup>12</sup> Described in reference 3, it is shown in fig. 4F. The tapered section plus the larger diameter outer horn suppresses some of the other waveguide modes and forms symmetrical beamwidths as shown in fig. 5. This particular design is well suited for circular polarization on dishes with 0.5 to 0.6 f/d ratios and is presently the most widely used feed system on 23 cm EME.

Other feeds that are sometimes used by Amateurs include two-element quads or circular loops<sup>12</sup> and short Yagis.<sup>13</sup> K4QIF uses a quad loop in front of a plane reflector, which is well suited for a 0.45 f/d ratio parabolic antenna.

The least critical applications of parabolic antenna designs can use simple feeds such as a splasher quads, or the circular (coffee can) waveguide feeds. Where high performance is required, such as on EME, the EIA dual dipole, circular waveguide with chokes, or the dual mode circular polarization feed horns are preferred.

## mechanical considerations

Numerous methods can be used for designing and constructing parabolic reflector dishes. The most popular techniques among Amateurs are the rigid solid dish, the stressed dish, and the trussed rib designs.

Solid surface and rigid dishes are very popular especially in commercial designs. Usually very accurate, they hold their shapes quite well. Many have perforated surfaces to allow some wind to pass through. However, the larger diameter units are usually very heavy — 500 to 2000 pounds (225 to 900 kg) — and can be quite expensive, even on the surplus market. One enterprising Amateur, WB6IOM, built his own version using honeycomb material for the reflector.<sup>14</sup> Recently the TVRO industry has manufactured dishes using petals that are often lighter in weight and less expensive than rigid designs. They are not always as strongly built as the others, but are usually sufficient for Amateur work through about 4.5 GHz.

At one time, stressed dishes were quite popular since they're relatively easy to build.<sup>15,16</sup> They can be tricky to handle and keep within tolerances when they exceed about 12 feet (3.7 meters) in diameter at 23 cm or 20 feet

(6.1 meters) at 70 cm (432 MHz). To overcome these shortcomings, Amateurs have devised ingenious guy wire schemes that tension the surface and maintain the shape. However, this usually isn't sufficient, especially in extreme climates, so some Amateurs have even added 1 or more sets of guy lines behind the dish!

The preferred mechanical method of parabolic dish reflector design is the trussed rib type. There are many ways to accomplish this construction technique. Some use tubing, while others use angle stock. Basically this method is preferred, since it rigidly supports the rib and prevents distortion.

Some of the trussed methods are shown in fig. 6. Figure 6A shows the angle material method used by the engineers at NBS. The tubing method shown in fig. 6B was described in detail by VK3ATN.<sup>17</sup> The method shown in fig. 6C recently tried for TVRO applications, is quite easy to use for high f/d ratios and is particularly easy to build since only one curved surface is required.

The trussed rib design is recommended for Amateur applications.

Regardless of the construction method chosen, it should be strong. Additional ribs should be used every 5 to 6 feet (2 meters) out from the dish center. Always use as many ribs as practical, since they increase stability and are likely to maintain tolerances more easily, especially on the reflector material. Twelve to 16 ribs should be a minimum, with 20 or more on the larger diameter dishes (i.e., those measuring over 20 feet or 6 meters). They should be attached to a large strong hub structure at the center of the dish.

## feed mounting considerations

As mentioned, the feed size and weight are important. This is especially true on larger diameter dishes with a high f/d ratio, since the feed will have to be mounted very far from the reflector. This again emphasizes the need for a moderate size feed system that's as light as possible.

# Gunnplexers & accessories 10 & 24 GHz



A. Microwave Associates 10 GHz Gunnplexer. Two of these transceivers can form the heart of a 10 GHz communication system for voice, mcw, video or data transmission, not to mention mountaintop DXing! MA87141-1 (pair of 10 mW transceivers) \$251.95. Higher power units (up to 200 mW) available. B. Microwave Associates 24 GHz Gunnplexer. Similar characteristics to 10 GHz unit. MA87820-4 (pair of 20 mW transceivers) \$739.20. C. This support module is designed for use with the MA87141 and MA87820 and provides all of the circuitry for a full duplex audio transceiver system. The board contains a low-noise, 30-MHz fm receiver, modulators for voice and mcw operation, Gunn diode regulator and varactor supply. Meter outputs are provided for monitoring received signal levels, discriminator output and varactor tuning voltage. RXMR30VD assembled and tested \$119.95. D. Complete, ready to use communication system for voice or mcw operation. Ideal for repeater linking. A power supply capable of delivering 13 volts dc at 250 mA (for a 10 mW version), microphone, and headphone and/or loudspeaker are the only additional items needed for operation. The Gunnplexer can be removed for remote mounting to a tower or 2 or 4 foot parabolic antenna. TR19GA (10 GHz, 10 mW) \$399.95. Higher power units available. TR24GA (24 GHz, 20 mW) \$639.95. Also available: horn, 2 and 4 foot parabolic antennas, Gunn, varactor and detector diodes, search and lock systems, oscillator modules, waveguide, flanges, etc. Call or write for additional information. Let ARR take you higher with quality 10 and 24 GHz equipment!

## Advanced Receiver Research

Box 1242 • Burlington CT 06013 • 203 582-9409



## STATION MANAGER/ADVANCED A General Purpose Logging Program

Designed for the IBM® PC,® XT,® enhanced PC jr.® Menu driven; prompts for easy use; full color displays; multiple logs (each up to 1,000 entries with user editing), several reporting methods including one by partial callsign.

**\$59.00** includes: 90 pg. User's Guide & Diskette (source code included)  
**\$20.00** — User's Guide only (may be applied to full purchase price)  
 Ohio residents include sales tax

WATCH FOR STATION MANAGER/CodeTutor To be released soon 148

## OMEGA CONCEPTS

Professional software for the Radio Amateur™

P.O. Box 615  
 Troy, OH 45373



T.L. Jones (KB80A)  
 Author

IBM is a registered trademark of International Business Machine Corp

## SIMPLEX / DUPLEX AUTOPATCH



NOVAX I \$89.95  
 NOVAX II \$189.95  
 IT'S NOT JUST ANOTHER AUTOPATCH

YOUR OWN PRIVATE AUTOPATCH  
 NOVAX MOBILE CONNECTION  
 NOVAX interfaces your standard 2 meter, 220, 450, etc. base station and telephone, using a high speed scan switching technique so that you can make and receive calls automatically from your automobile or with your HT. Easy installation. Use it as half duplex, using two transceivers, interface HF or other audio sources, remote switch, emergency alert etc. etc.

FEATURES	NOVAX I	NOVAX II
• 2 min. Call duration timer	YES	YES
• Up to 45 sec. activity timer	YES	YES
• Single digit Access Control	YES	NO
• OTM (Touch Tone) phone connection	YES	YES
• 4 digit Access Control (Programmable)	NO	YES
• Tail Restraint	NO	YES
• LED Digital Displays	NO	YES
• Vinyl covered alum. case size	8" x 6" x 2"	10" x 8" x 1 1/2"
• Directly interface with Repeater	NO	YES
• History Char System (with Initial Memory)	NO	YES "Option" - \$29.95
• Ring Back Inverse autopatch	YES	YES
• Price	\$89.95 (incl. 1000 calls) \$189.95 (incl. 1000 calls & 1000 calls)	\$189.95 (incl. 1000 calls & 1000 calls)

N.Y.S. Res. add approx. Sales Tax  
 To order, send check/money order to: URGENT DEVELOPMENT CORPORATION  
 E. Carter Rd., P.O. Box 384, Westmoreland, Pa. 15380  
 or phone 315-733-3719

## SPECIALIZED COMMUNICATIONS FOR TODAY'S RADIO AMATEUR!



If you are ACTIVE in FSTV, SSTV, FAX, OSCAR, RTTY, EME, LASERS or COMPUTERS, you need "THE SPEC-COM JOURNAL™"  
 Published 10 Times Per Year  
 By WBØQCD

CALL TOLL-FREE 1-800-628-2828 ext. 541

...and place your subscription order today! Our Membership Services HOTLINE is good for all 50 U.S. States including Hawaii & Alaska and ALL of CANADA! U.S. subscriptions \$20 per year. Foreign slightly higher. Back issues are also available for \$2.00 each prepaid.



THE SPEC-COM JOURNAL  
 P.O. BOX H,  
 LOWDEN, IOWA 52255



Credit Card Orders (5% added)

Iowa Residents Add 4% State Sales Tax

## Electronic Repair Center Servicing

Amateur Commercial Radio

The most complete repair facility on the East Coast.

Large parts inventory and factory authorized warranty service for Kenwood, Icom and Yaesu.

## SEND US YOUR PROBLEMS

Servicing "Hams" for 30 years, no rig too old or new for us.

## HAMTRONICS, INC.

4033 Brownsville Road  
 Trevoze, Pa. 19047  
**215-357-1400**





On small dishes with low  $f/d$  ratios, the feed can be mounted on a pipe or an arm with a "goose necked" shape. This is often found on commercial installations where the feed is integrated with a waveguide that also supports the feed system. In either case, some support or guying structure should be provided to hold the feed relatively close to its designated resting place and keep it firmly in place.

Probably the most common Amateur construction technique uses a tripod or quadpod mount to hold the feed system. In either case, adequate supporting structure is required behind the reflector to hold these supporting poles firmly in place. Failure to do so will incur unacceptable droop in the feed system. EMEers may also want to mount relays and a preamplifier behind the feed, which is an additional stress on the feed holding structure.

The feed mounting is an area that requires much forethought before the reflector is constructed. The distance from the feed to the reflector should be able to be moved in or out as well as up and down slightly for proper alignment, as will be discussed shortly. Don't forget that the support mechanisms also reduce the overall antenna gain by blocking the reflected signal.

## phase center

One thing I didn't mention previously was the importance and use of the focal point. The calculated focal point of a parabolic antenna is where the phase center of the feed should be located. The phase center of a feed is the point from which the signal appears to emanate. Although it's not easily determined, it can be "guesstimated" with sufficient accuracy.

The phase center of the dual-dipole feed or a Yagi antenna is located near the front of the structure as shown in **figs. 7A and 7B**. The phase center of a horn is usually located a few inches/centimeters just inside the open end of a horn, and can be estimated using simple geometry as shown on **fig. 7C**, assuming that the angle shown is the same as the sub-

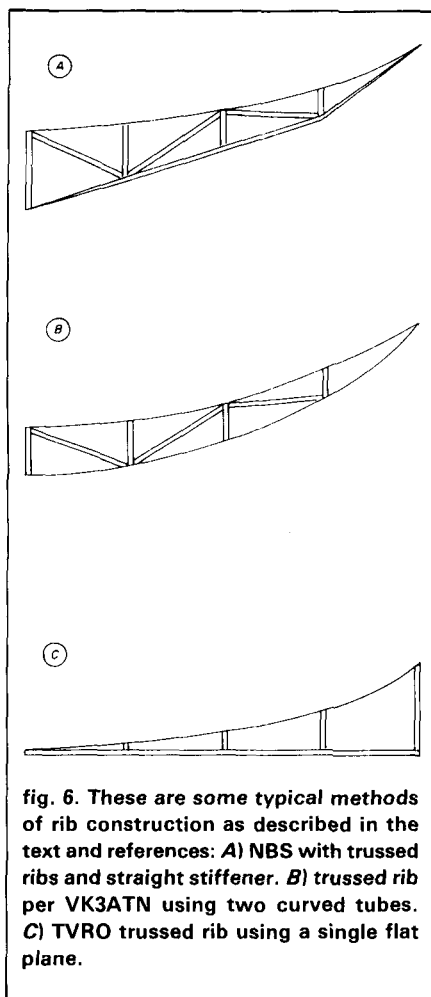

**fig. 6.** These are some typical methods of rib construction as described in the text and references: **A)** NBS with trussed ribs and straight stiffener. **B)** trussed rib per VK3ATN using two curved tubes. **C)** TVRO trussed rib using a single flat plane.

tended angle of the dish being fed (see **ref. 1, fig. 6**).

One feed system that I didn't mention previously is the log periodic array (LPA). It would appear at first glance to be a super feed, especially if wide bandwidth or several Amateur bands are to be covered.

However, in the LPA, the phase center is a function of frequency. Therefore, every time you vary frequency up or down, the phase center moves inversely. As a result, an LPA feed would be optimally matched to the reflector at one frequency only, a compromise that most Amateurs are unwilling to make. Furthermore, the E and H plane beamwidths of most LPA designs are usually quite dissimilar and therefore are not optimum, as discussed earlier.

Finally, the placement of the feed at the focal point is of only secondary importance. If the feed is located either too close or too far from the reflector, the gain may decrease slightly. If the feed is misaligned or skewed off axis, the main beam of the dish will shift slightly. This is normally not of great importance as long as the dish is moved an appropriate number of degrees one way or the other to compensate for any misalignment.

## reflector design

So far the reflector has been mentioned only in passing. It's very important because even if the structure were sufficiently strong and mechanically perfect, a rough or distorted reflector surface could produce less gain.

As mentioned earlier, if any form of mesh or screen such as hardware cloth or chicken wire is used for the reflector, the hole size must be considered according to the frequency of operation, as previously discussed. One-inch (2.54 cm) chicken wire is often used through 23 cm. You can always upgrade the reflector later by replacing the screen with a mesh with smaller holes or by simply laying new mesh over the older mesh. This technique can be extended to just covering the inner portion of the reflector where most of the signal is concentrated.

The conductivity of the reflector surface is not overly important because the mesh is operating in a relatively high impedance (377-ohm) environment. Galvanized mesh is recommended. Rust won't necessarily affect performance unless the porosity of the surface begins to deteriorate. In fact, some experts say that a rusty mesh will have to virtually fall apart before it stops acting as a good reflector!

The rigidity of a mesh reflector must be such that it won't sag. This is partially a function of the number of ribs and supports. If there are too few ribs or supports, the mesh will have less support and hence be more likely to vary from the true parabolic shape.

A few other pointers are in order.

The mesh used for the reflector is normally purchased in rolls and must be formed to the parabolic shape. Depending on the size and placement of the mesh, it may be better to cut it up into smaller pie-shaped pieces and overlap each section, preferably at the ribs. The mesh should be tied off

at numerous points on the ribs. Overlap is recommended. It should, if possible, be up to one quarter wavelength at the lowest frequency of operation<sup>3</sup>. Ohmic contact is not required.

Some individuals have attempted to improve performance by extending the reflector without changing the feed system. This can be quite counterproductive, especially if the reflector geometry doesn't exactly follow the parabolic curve. If the reflector is extended, the feed pattern must be widened accordingly. This is sometimes done when a person decides at a later date to extend a dish that is too small — but it can only be done if the feed is redesigned, too.

Dick Turrin, W2IMU, has suggested that a different tactic is more applicable.<sup>18</sup> If you're tempted to extend the reflector without changing the feed, then the reflector extension should be bent away at a right angle to the present reflector. In effect, this will deflect extraneous signals away instead of possibly bringing them in with improper phasing, thereby introducing noise pick or decreasing performance.

### designing a parabolic dish antenna

We finally have most of the parameters in place, so let's get on with the design. First select the diameter of the reflector to be built. In order to do this, you must first determine the desired gain. Then consult the gain equations and/or fig. 2 in reference 1 to determine the minimum diameter of the reflector.

Always choose a reflector diameter that will guarantee the desired gain. Err slightly on the larger diameter side to be sure your gain objectives will be met, but don't go overboard or the antenna will cover your entire backyard! Remember that every time you double the reflector diameter, the mechanical problems will at least quadruple!

Also remember that even if you can build the dish, you still have to place it on a mast and tower so you can rotate it! Furthermore, the reflector and feed mounting must be sufficiently

rigid so that none of the mechanical dimensions change, either from variations in weather (temperature, wind, ice, etc.) or when the position of the antenna is rotated in either the azimuthal or elevation plane!

Before you can design the reflector, you must first decide which feed you will be using. Let's assume that you choose to use the EIA dual-dipole feed system. It will be necessary to determine the optimum  $f/d$  ratio for this feed.

Let's start by deciding that an  $f/d$  ratio of 0.5 is desired, as previously suggested. Figure 6 in reference 1 shows that the subtended angle for a dish with an  $f/d$  ratio of 0.5 is approximately 106 degrees. Next determine the "space attenuation" at the rim of the reflector by consulting fig. 7 in reference 1. We see that the edge taper for 53 degrees (one-half the subtended angle) is approximately 2 dB.

Next examine the pattern of the EIA feed in fig. 2 of this month's column. At a beamwidth of  $\pm 53$  degrees, the E plane beamwidth is down approximately 10 dB. This is not a great match for an  $f/d$  ratio of 0.5 since 10 dB plus the 2 dB edge taper adds up to 12 dB edge illumination, not the recommended 10 dB per reference 1.

An iterative procedure can be used if the 10 dB edge taper is not attained on the first try. At an  $f/d$  ratio of 0.55, the edge taper is approximately 1.8 dB at 50 degrees. At 50 degrees off bore-sight, the EIA pattern is approximately 8 dB below the main beam for a 10 dB total. This is a better choice for this feed system. However, any  $f/d$  ratio between 0.5 and 0.55 would probably be satisfactory for the EIA-type feed system.

You may have noticed that the H plane beamwidth of the EIA feed is narrower than the E plane, but this not be a significant problem, as discussed in reference 1. The overall gain will only be slightly less than the desired value because of under-illumination, but this is better than over-illumination!

For those interested in other feed systems, the W2IMU dual-mode horn is near optimum for an  $f/d$  ratio of 0.6.

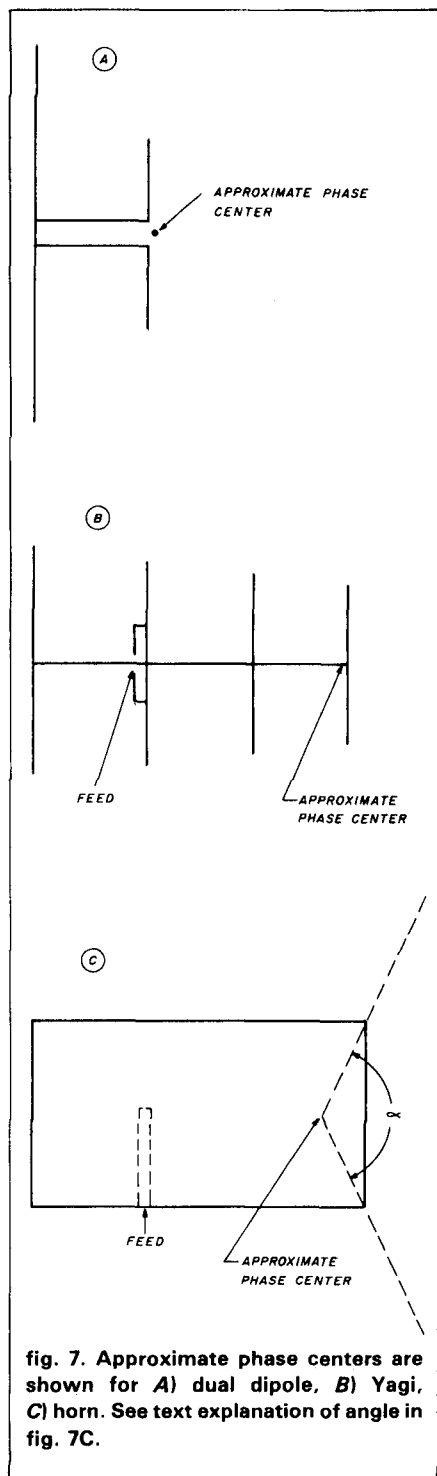

fig. 7. Approximate phase centers are shown for A) dual dipole, B) Yagi, C) horn. See text explanation of angle in fig. 7C.

You can determine this as we just did for the EIA feed by examining the pattern on **fig. 5**. Most of the circular horns in reference 9 are applicable for low (less than 0.5) f/d ratios.

## evaluation of performance

The antenna evaluation methods mentioned in reference 6 are quite applicable to evaluating the performance of a parabolic dish type of antenna. The primary things to check are the beamwidth and the level of the first sidelobes. They should be close to the values shown on **fig. 3** and **table 2** in reference 1.

One other parameter, quite predominant in this type of antenna, is the possibility of skewing of the pattern off boresight. Most other types of antennas such as Yagis are quite straightforward in performance. All that's necessary is to look up at the boom and aim.

However, as just mentioned, a shift of the feed system of a reflector type of antenna may cause the main beam to be skewed slightly. Therefore, when evaluating a dish, first peak the signal and check that it's in the direction indicated on the rotator. If not, adjust the positioning of the feed or the rotator accordingly. For EME this can best be done by pointing the antenna at the Sun and peaking for maximum Sun noise.

## improvements in performance

Time and space do not permit lengthy discussion of changes and improvements, but I will mention some briefly. Radomes are possible, but they can cause extra wind load and other problems. Most Amateurs simply stow their antennas during severe weather rather than risk storm damage.

Other feed systems than those described in this column will undoubtedly work, as long as they match the requirements outlined above. Likewise, new mechanical structures may be devised. Other variations may also be applicable if they meet the criteria presented here — for example, the use of an offset feed system.<sup>18</sup>

## summary

The intent of this two-part series was to better acquaint the reader with the various aspects of designing a reflector type of antenna. Limitations of time and space, however, allowed us only to scrape the surface of parabolic dish antenna design.

As I stated earlier, the field of reflector antenna design is constantly being developed. Material is frequently being published on the subject and improvements are still being made. The greatest areas of improvement are in efficiency and low noise pickup. These improvements frequently require special feed designs, secondary reflectors or offset feed systems, considerations which are presently out of the reach of the typical Amateur. We can only hope that some day many of these improvements will be more easily adapted by Amateurs.

The material presented in these two articles should be more than sufficient for use in the design and construction of a good parabolic dish antenna. Build a strong structure, but keep weight down whenever possible. Use more ribs and inner rims than may initially appear to be necessary. Study the references cited. The rest is up to you. Good luck!

## acknowledgements

I would particularly like to thank Dick Turrin, W2IMU, who over the last decade or so has shared his expertise and insight with me and so many others and thereby improved parabolic antenna design. I'd also like to thank Ed O'Connor, W2TTM, who prepared a list of questions he'd like answered in this two-part series. I've tried to cover as many of his suggestions as time and space allowed; any further ideas readers may have would be appreciated for use in future columns.

## important VHF/UHF events:

- March 1: *EME perigee*  
 March 21: *TE propagation optimum ± 2 weeks*  
 March 28: *EME perigee*  
 April 14: *ARRL 144-MHz Sprint contest*  
 April 22: *ARRL 220-MHz Sprint contest*  
 April 25-27: *Dayton Hamvention*  
 April 30: *ARRL 432-MHz Sprint contest*

## references

1. Joe Reiser, W1JR, "VHF/UHF World: Reflector Antennas, Part 1," *ham radio*, February, 1986, page 51.
2. John Ruze, "Antenna Tolerance Theory — A Review", *Proceedings of the IEEE*, Volume 54, No. 4, April, 1966, pages 633-640.
3. The Crawford Hill VHF Club, W2NFA, "Technical Note No. 5, A Paraboloidal Reflector Antenna for 1296 Mc/s." Contact Dick Turrin, W2IMU, to arrange for copies.
4. Joe Reiser, W1JR, "VHF/UHF World: Stacking Antennas, Part 1," *ham radio*, April, 1985, page 129.
5. Samuel Silver, *Microwave Antennas, Theory and Design*, MIT Radio Lab Series, No. 12, Boston Technical Publishers, 1964.
6. Joe Reiser, W1JR, "VHF/UHF World: Measuring and Determining Antenna Performance," *ham radio*, May, 1984, page 110.
7. *Reference Data for Radio Engineers*, 6th edition, Howard W. Sams, Indianapolis, Indiana, 1979, chapter 27.
8. Norman J. Foot, WA9HUV, "Cylindrical Feed Horn for Parabolic Reflectors," *ham radio*, May, 1976, page 16.
9. Norman J. Foot, WA9HUV, "Second-Generation Cylindrical Feedhorns," *ham radio*, May, 1982, page 31.
10. Norman J. Foot, WA9HUV, "Cylindrical Feedhorns Revisited," *ham radio*, February, 1986, page 20.
11. R. H. Turrin, "Dual-Mode Small-Aperture Antennas," *IEEE Transactions on Antennas and Propagation*, March, 1967, page 307.
12. Joe Reiser, W1JR, VHF/UHF World: 220 MHz EME Requirements," *ham radio*, September, 1984, page 45.
13. Joe Reiser, W1JR, "How to Design Yagi Antennas," *ham radio*, August, 1977, page 22.
14. Peter Laakmann, WB6IOM, "A Large Homebrew Parabolic Reflector," *ham radio*, August, 1970, page 8.
15. Allen Katz, K2UYH, "Simple Parabolic Antenna Design," *CQ Magazine*, August, 1966, page 10.
16. Richard T. Knadle Jr., K2RIW, "A Twelve-Foot Stressed Parabolic Dish, QST, August, 1972, page 16.
17. T.R. Naughton, VK3ATN, "Parabolic Reflector Antennas," *ham radio*, May, 1974, page 12.
18. Private correspondence and conversations with Dick Turrin, W2IMU.

## ham radio

### HAZER YOUR ROHN 25 G Tower

- Never climb your tower again with this elevator system.
- Antenna and rotator mount on HAZER, complete system trams tower in verticle upright position.
- Safety lock system on HAZER operates while raising-lowering & normal position. Never can fall.
- Weight transferred directly to tower. Winch cable used only for raising & lowering. Easy to install and use.
- Will support most antenna arrays.
- High quality materials & workmanship.
- Safety - speed - convenience - smooth travel.
- Complete kit includes winch, 100 ft. of cable, hardware and instructions.

Hazer 2-Heavy duty alum. 12 sq. ft. load \$297.00 ppd.  
 Hazer 3-Standard alum. 8 sq. ft. load 213.00 ppd.  
 Hazer 4-Heavy galv. steel, 16 sq. ft. load 278.00 ppd.  
 Ball thrust bearing TB-25 for any of above 42.50 ppd.

As an alternative, purchase a Martin M-13 or M-18 aluminum tower engineered specifically for the HAZER system, or a truly self-supporting steel tower.

GLEN MARTIN ENGINEERING INC.  
 P.O. Box H 253 Boonville, Mo. 65233  
 816-882-2734



**ASTRON — SALE!**  
 RS-7A 45.00 RS-35A 123.75  
 RS-12A 62.75 RS-35M 138.95  
 RS-12M 78.95 VS-35M 156.95  
 RS-20A 79.95 RS-50A 179.95  
 RS-20M 96.45 RS-50M 203.25  
 VS-20M 114.95 VS-50M 223.95

**KLM**  
 2M16LBX, 220-22LBX, 432-30LBX-90.50  
 2M-14C-85.50 2M-22C-108.50  
 435-18C-110.50 435-40CX-144.50

**KENPRO ROTORS**  
 KR400/KR500 125.95/154.95  
 KR-5400/KR-5600 247.50/309.95

**HENRY AMPS**  
 2 KD CLASSIC 965.00  
 2002A/2004A Less Relay - 1250./1350.  
 3002A/3004A Less Relay - 2100./2100.

**NYE-VIKING**  
 MB-V-A \$489.95

**MIRAGE**  
 A1015 - 235.50 C-22A - 85.95  
 B23A - 83.95 C-106 - 169.95  
 B215 - 245.50 C-1012 - 246.95  
 B108 - 149.95 D-24N - 177.50  
 B1016 - 235.50 D-1010N - 279.50  
 B3016 - 199.50 D-3010N - 251.00  
 MP-1 - 99.95 MP-2 - 99.95

**FOR THE BEST DEAL IN TOWN CALL THE BEST NUMBER AROUND 1-800-HAM-7373**

CUSHCRAFT AOP-1 OSCAR PAK-133.50 RINGO RANGER II (2-220-440)-33.95  
 KENWOOD TS-940S/AT - CALL US! YAesu FT-757GX - CALL US!  
 KENWOOD TR2600A H.T. - CALL US! YAesu FT-726R - CALL US!

**KENWOOD**  
 FACTORY AUTHORIZED DEALER  
 CALL US FOR AMERICA'S LOWEST  
 PRICE ON ALL YOUR KENWOOD NEEDS

**CUSHCRAFT**  
 215WB - 73.00 A-3 200.45  
 4218XL - 91.00 A-4 267.45  
 R-3 - 250.95 40-2CD 267.45  
 OTHER MODELS IN STOCK — CALL

**CUE DEE THE SWEDISH BOOMER**  
 USED BY MANY TOP '10' CONTESTERS  
 144-15AN 2MTR15EL 75.95

**PARABOLIC**  
 1296-28 IW TRANSVERTER 339.95  
 1269-144 3W UP CONV. 319.95  
 1296 DUAL TUBE AMP CAVITY 439.95  
 2PORT POWER DIVIDERS (2-220-432) 50.95  
 4PORT POWER DIVIDERS (2-220-432) 55.95  
 1296 2PORT DIVIDER 57.95  
 1296 4PORT DIVIDER 62.95  
 1269/96 DISH FEEDS 89.95  
 2304 DISH FEEDS 89.95  
 1296 SLUG TUNERS 65.95

**TONNA F9FT ANTENNAS**

TONNA 902 ANTENNAS ARE HERE CALL FOR QUOTES

OTHER GREAT, HIGH PERFORMANCE ANTENNAS BY TONNA (CALL FOR SPEC. SHEET!!)

5 EL. 6 METER YAGI 69.95 13 EL. 2MTR YAGI 59.94 1269 /1296 Quad Array 339.95/  
 21 EL. 70cm YAGI 56.95 23 EL. 1296/69 YAGI 46.95 19 EL. 70cm YAGI 44.95  
 (ATV MODELS IN STOCK) 17 EL. 2MTR SUPER YAGI 88.00 2MTR OSCARTWIST 65.95  
 70cm OSCARTWIST 68.95 55 EL. 1296 SUPER YAGI 68.95 2 x 9 EL. (18el)  
 2 x 19 EL (38el.) 9 ± 19 el OSCAR ANTENNA 2M & 70cm ON A COMMONBOOM-GREAT  
 WATCH OUR AD FOR NEW LINES!! FOR STACKING 75.92

16 S. Mountain Blvd. — Rt. 309 HOURS: Monday thru Friday 9:00 a.m. - 3:30 p.m.  
 Mountaintop, PA 18707 Saturdays 10 a.m. - 12 p.m.

See You At Dayton! MC/VISA/C.O.D.

**SSB ELECTRONIC**  
 K6001 6 To 10 DBM RCV CONV. 115.95  
 K2001 2 To 10 DBM RCV CONV. 115.95  
 K7001 70cm To 10 DBM RCV CONV. 115.95  
 K2301G 23cm To 10 or 2 RCV  
 CONV.G.F. FRONT END AND DBM 159.95  
 TV-144-28-10 10W 2MTX XVRTR 209.95  
 TV-432-28-10 10W 70cm XVRTR 299.95  
 TV-220-28-10 10W 1/4M XVRTR 269.95  
 DX-144 PREAMP N.F. < .4db 130.95  
 DX-220 PREAMP N.F. < .5db 145.95  
 DX-432 PREAMP N.F. < .5db 130.95  
 (WON DAYTON 1985 N.F. CONTEST)  
 DX-1296S PREAMP N.F. .5db 156.95  
 DX-2320 PREAMP N.F. < .8db 166.95  
 PA-2310 1269/1296 10W LINEAR AMP 275.95  
 LT-23S 1296 10W LINEAR TRANSVERTER 810.95  
 2MIF 810.95  
 LSM-24 1269-2 OSCAR MODE L XMIT CONV. 1W 299.95  
 OUTPUT, 2M I.F. 299.95  
 MICROLINE 13 1/2W 2.3GHZ XVRTR SYSTEM 2M I.F. 410.95  
 MICROLINE 13 3W 2.3GHZ XVRTR SYSTEM, 2M I.F. 875.95  
 SLA-13 2304 3W AMP 285.95

**MAST MOUNTED PREAMPS:**  
 MV144V 250W R.F. SWITCH WITH 12V  
 SUPPLY INTERFACE 175.95  
 MV432V 150W R.F. SWITCH WITH  
 INTERFACE 185.95  
 MV-144S-01 1KW THRU PWR WITH  
 SEQUENCER 309.95  
 MV-432S-01 500W THRU PWR WITH  
 SEQUENCER 319.95  
 MV-1296S 100WTHRU PWR WITH  
 SEQUENCER 349.95  
 OTHER HIGH QUALITY PRODUCTS IN  
 STOCK CALL FOR CATALOGUE

**FREE UPS On Mutek And SSB Products!**

TERMS: Prices are subject to change without notice. Some COD's may require a deposit prior to shipment. Unauthorized returns will not be accepted. All returns subject to 15% handling. Orders placed will be considered firm. Refunds will not be issued in cash or bank credit, but will be issued for future purchases. All prices FOB Mountaintop, PA or origin and do not include shipping unless indicated. We are not responsible for damages by delivering carrier.

**DESIGN EVOLUTION IN RF P.A.'s**

Now with GaAs FET Preamp



- Linear (all mode) RF power amp with automatic T/R switching (adjustable delay). Amplifier useable with drive powers as low as 1/2 watt.
- Receive preamp option, featuring GaAs FETs (lowest noise figure, better IMD). Device NF typically .5 dB.
- Thermal shutdown protection incorporated
- Remote control capability built-in
- Rugged components and construction provide for superior product quality and performance
- All models include a complete operating/service manual and carry a factory warranty on all components
- Designed to ICAS ratings, meets FCC part 97 regulations
- Approximate size is 2.8 x 5.8 x 10.5" and weight is 5 lbs.

MODEL	FREQUENCY	OUTPUT POWER	INPUT POWER	PREAMP
	(MHz)	(W)	(W)	NF GAIN
0508	50-54	170	1	- -
0508G	50-54	170	1	6 15
0510	50-54	170	10	- -
0510G	50-54	170	10	6 15
1410	144-148	160	10	- -
1410G	144-148	160	10	6 15
1412	144-148	160	30	- -
1412G	144-148	160	30	6 15
2210	220-225	130	10	- -
2210G	220-225	130	10	7 12
2212	220-225	130	30	- -
2212G	220-225	130	30	7 12
4410	420-450	100	10	- -
4410G	420-450	100	10	1.1 12
4412	420-450	100	30	- -
4412G	420-450	100	30	1.1 12

1. Models with G suffix have GaAs FET preamps. Non-G suffix units have no preamp.
2. Covers full amateur band. Specify 10 MHz Bandwidth for 420-450 MHz Amplifier.

★ SEND FOR FURTHER INFORMATION ★

**TE SYSTEMS**  
 P.O. Box 25845  
 Los Angeles, CA 90025  
 (213) 478-0591

This publication is available in microform from University Microfilms International.



Please send information about these titles:

Name \_\_\_\_\_  
 Company/Institution \_\_\_\_\_  
 Address \_\_\_\_\_  
 City \_\_\_\_\_  
 State \_\_\_\_\_ Zip \_\_\_\_\_  
 Phone ( ) \_\_\_\_\_

Call toll-free 800-521-3044. In Michigan, Alaska and Hawaii call collect 313-761-4700. Or mail inquiry to: University Microfilms International, 300 North Zeeb Road, Ann Arbor, MI 48106.

# the weekender



## converting mobile microphones for handheld VHF transceivers

Many Amateurs purchase hand-held transceivers and use them for both portable and mobile operation. By adding additional external antennas, power amplifiers, speakers, and such, performance comparable to larger mobile rigs can be approached. Handheld units are considerably larger than mobile microphones, however, and can be inconvenient to use while driving. This is especially true when antenna cords, power cords, and speaker cords all run from different connectors on the handheld unit. Realizing this, manufacturers make special accessory microphones available; this article shows how to adapt readily available microphones — perhaps those already on hand — for mobile use at a considerable savings.

Most VHF rigs, including the popular ICOM 2A, have a single jack for an external microphone. When a suitable DC current is drawn from this connection, the transmitter is activated and an audio signal is applied to this same line. Thus, a microphone with a bias current is used to both turn on the transmitter and deliver audio.

The bias current is usually less than a milliamp and the available voltage will be about 3 volts (see **fig. 1**). The input impedance is then on the order of a few thousand ohms. **Table 1** outlines the measured characteristics of an ICOM 2AT.

By Edward A. Richley, KD8KZ, Bldg. 7, Apt. 201, 41 High Point Circle South, Naples, Florida 33940, and Frank M. Caimi, WB3JCC, P.O. Box 650163, Vero Beach, Florida 32965

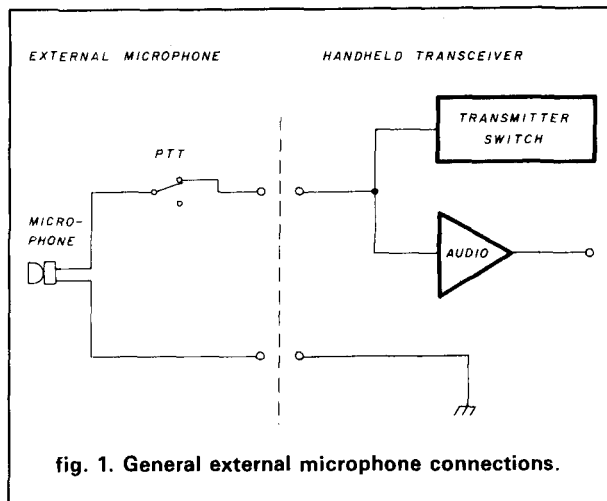

fig. 1. General external microphone connections.

table 1. Terminal characteristics of IC-2AT microphone input.

voltage	current
5.5	0*
4.1	74 $\mu$ A
4.0	103 $\mu$ A
3.5	270 $\mu$ A

\*Unit does not transmit.

Many high quality mobile microphones are available on the surplus market and at hamfests these days. Because they're often intended for a particular piece of commercial radio equipment, they may have electrical requirements that differ significantly from those outlined above. For example, flea markets have seen a flood of the Shure Brothers Model EM33G11 with a General Electric Label. This is a very comfortable, solid little microphone, complete with a Velcro® pad on the back (see **fig. 2**). Unfortunately, it's a dynamic microphone with very low impedances and a single switch contact. A variety of ceramic microphones, with extremely high output impedance, are also available for next to nothing (see **fig. 3**). We'll show how to modify both types at minimal cost — and in a single evening.

### dynamic microphone modifications

A dynamic microphone is basically a low-impedance speaker operated as a microphone. The voltage output from such a microphone is only a millivolt or so. This must be raised to 100 mV into a load of a few thousand ohms for an adequate audio level. For this purpose, a small audio transformer could be used; this approach will work, but such transformers are quite



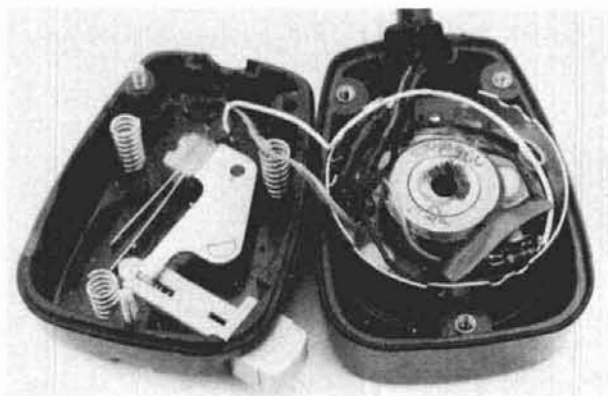

fig. 2. Dynamic microphone with modifications.

rare and don't allow for additional gain. For this reason, a solid-state approach has been selected and used with excellent results.

With a dynamic microphone, it's also possible to include a speaker/microphone in the same unit. The Shure EM33G11, for example, has only a single, normally open switch contact. This is sufficient for speaker/mike operation using the circuit shown in fig. 4. In this circuit, Q1 acts as a grounded-base amplifier with very low input impedance and adequate gain. Switch S1 is the push-to-talk button and serves to connect the amplifier as a load to the microphone input. When S1 is open, the dynamic element is connected as a speaker. When S1 is closed, enough bias current flows through Q1 to turn on the transmitter. C1 serves as a bypass to effectively ground the base to audio signals. C2 serves to ensure that radiated power does not cut off Q1. R2 affects the microphone gain and may need to be adjusted. The selection of

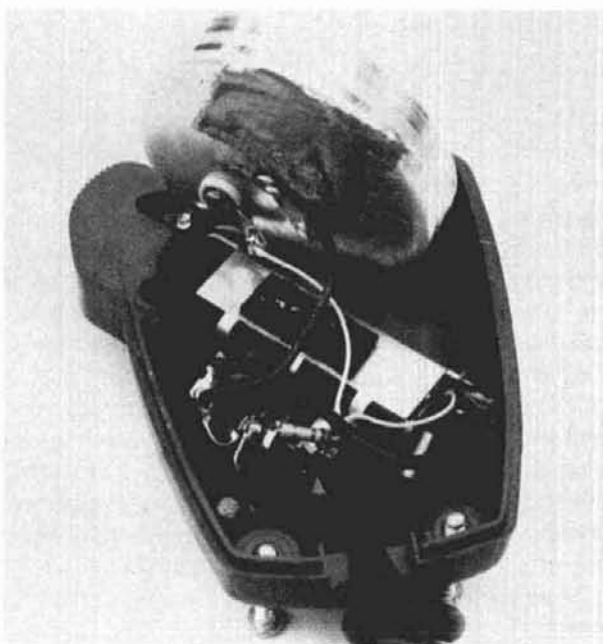

fig. 3. Ceramic microphone with modifications.

Q1 should be made so that sufficient gain is available with only 1 mA of collector current. This choice is somewhat critical because the bias current is below 1 mA. Type 2N930 has a minimum  $h_{fe}$  of 150 at 1 mA and is commonly available. The 820 kilohm bias resistor creates about 550  $\mu$ A of bias current to turn on the transmitter. Slight adjustment of this value may be necessary with different devices.  $h_{ib}$  is the input impedance in a common base configuration and is specified for the 2N930 as 25-32 ohms. This provides a slight mismatch to the 8-ohm dynamic microphone, but the gain of the device more than makes up for the difference. Furthermore, the output impedance of this

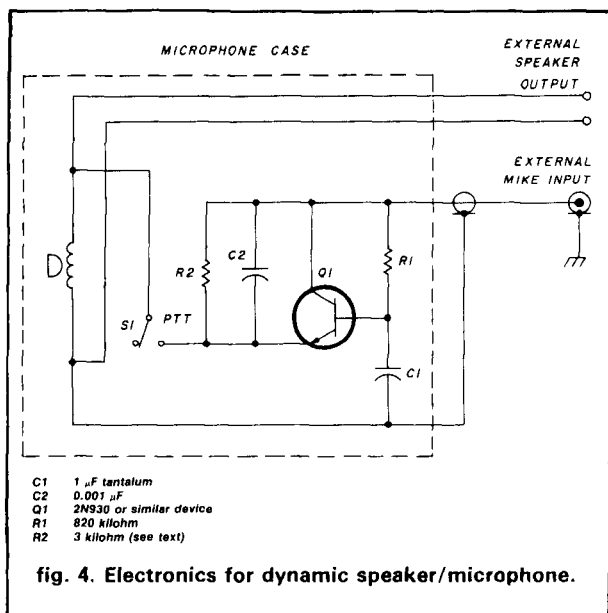

fig. 4. Electronics for dynamic speaker/microphone.

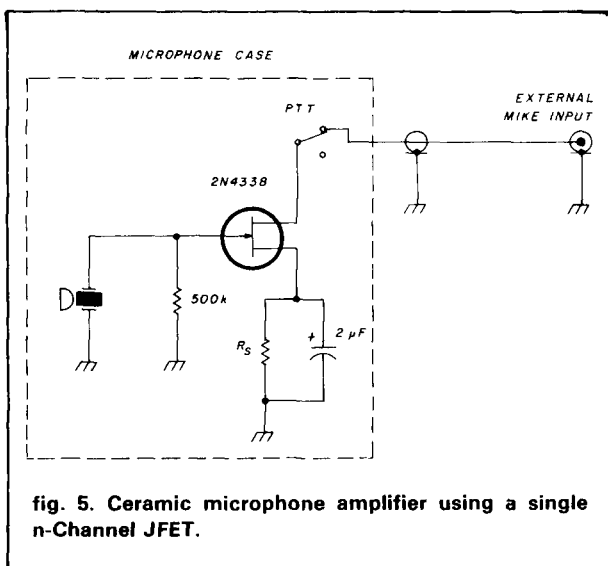

fig. 5. Ceramic microphone amplifier using a single n-Channel JFET.

device is at least 1 Megohm ( $h_{ob} < 1 \mu\text{mho}$ ), so that an expression for the voltage gain is:

$$A_V = R_L / (R_{mic} + h_{ib}) \quad (1)$$

With no additional load beyond that of the radio itself, the amplifier voltage gain is about 300. Thus, for a 1 mV signal from the microphone, a very substantial 300 mV will be available at the microphone input terminals. This was found to be more than adequate gain, and a further load of 3 kilohms was added in the form of R2.

The entire circuit of fig. 4 can be built into the microphone body. The area between the speaker magnet and the shielding ring is more than adequate. Be sure to run the shielded lead of the cord from the

amplifier output; this helps to reduce RF feedback. To make the dual phone plug connector at the radio, be sure to first make all cable connections to the plugs. (This is very important because once the two plugs are glued in place, there is no way to re-wire them). Then insert both plugs in their appropriate jacks and carefully fill the space between with epoxy to provide proper positioning. Let the epoxy set overnight. *Be careful to not glue the plugs to the radio!* When the glue has hardened, both plugs can be removed together as one dual unit.

### ceramic microphone modification

Ceramic microphones operate on a completely different principle. In operation, sound pressure waves cause minute movement of a diaphragm which is mechanically coupled to a piezoelectric material. Induced mechanical stresses result in accumulation or depletion of charge between electrodes deposited on the material. Because the associated capacitance is relatively small, substantial voltages (typically as high as 100 mV) can be produced in proportion to the sound pressure input. Unlike the dynamic microphone, very little current is available for driving the load impedance since charge equalization between the electrodes requires relatively few electrons. Ceramic microphones are therefore very high impedance devices.

The design of an amplifier required to drive the transmitter input must take into consideration the microphone impedance, the load impedance, and whatever voltage gain is required to produce sufficient audio level. The ceramic microphone we used was a Johnson CB microphone purchased at a flea market for less than \$3.00. Using an RMS-reading voltmeter, we determined an average output level of 35 mV into a 300 kilohm load. Since 250 mV RMS is the desirable input voltage to the IC-2AT, the required voltage gain for the proposed amplifier is  $250 \text{ mV} / 35 \text{ mV} = 7$  or 17 dB.

Typical single-stage high input impedance amplifiers utilizing FETs can achieve the required gain. Voltage gain for the circuit shown in fig. 5 is given by  $A_V = g_m R_L$  where  $g_m$  is the FET transconductance at operating current and  $R_L$  is the AC load resistance.

Several trade-offs result when designing for high gain using the fixed load resistance of the ICOM. The AC load resistance ( $R_{input} = 10 \text{ kilohm}$ ) is approximately equal to the series/parallel combination of R52, R51, R55, R56, R57, and the base-emitter characteristic of Q23 (as indicated in the ICOM schematic provided with the 2AT), while the DC resistance is given by the data of table 1. A voltage margin at the FET drain sufficient to accommodate the amplified output signal requires a quiescent drain voltage several hundred millivolts below the supply voltage. As shown in table 1 the open circuit supply voltage is 5 volts;

# Barry Electronics Corp.

WORLD WIDE AMATEUR RADIO SINCE 1950  
Your one source for all Radio Equipment!

For the best buys in town call:  
212-925-7000  
Los Precios Mas Bajos en  
Nueva York...



"March into BIG SPRING SAVINGS at BARRY'S"

KITTY SAYS: WE ARE NOW OPEN 7 DAYS A WEEK.  
Saturday & Sunday 10 to 5 P.M.  
Monday-Friday 9 to 6:30 PM Thurs. to 8 PM  
Come to Barry's for the best buys in town.



ONV Safety belts-in stock

IC—R71A, 751, 745, 27AH, 37A, 47A, R-7000, 127A, 271AH, 3200A, 471A/H, 735



ICOM

## KENWOOD

Antennas A-5 Cushcraft Hustler KLM METZ Mini-Products Mosley

R-600, R-1000, R-2000, TS-940/SAT TS-430S, TR-3600A, TM2570A/50A/30A TW-4000A, Kenwood Service/Repair, TH213/14/1AT, TM-211A/411A & TS-711A/811A

COMPU-FIRE EXTINGUISHERS EXL-5000E RTTY/AMTOR TERMINAL

VoCom/Mirage/Daiwa Tokyo Hy-Power Amplifiers & 5/8" HT Gain Antennas IN STOCK

Soldering Station, 48 Watts, \$68

JRC Soldering Iron in Stock MICROLOG-AIR I Air Disk, SWL, Morse Coach

KANTRONICS UTU, Interface II, UTU-XT, Challenger, Packet Comm. II

EIMAC 3-500Z 572B, 6J56C 12B7Y2A & 4400A

BIRD Wattmeters & Elements In Stock

AEA 144 MHz AEA 220 MHz AEA 440 MHz ANTENNAS

FT-ONE, FT-980, FT-757GX, FRG-8800 FT-726R, FRG-9600, FT-270RH, FT-2700RH

Yaesu ICOM Land Mobile HT Midland Standard Wilson Maxon Yaesu FT-C 2202, FT-4703 FT-1903/1123 IC-04AT Icom IC-M12 (Marine) M700 IC-A2018 Tempo M-1



AMERITRON AMPLIFIER AUTHORIZED DEALER

Yaesu FTR-2410, Wilson ICOM IC-RP 3010 (440 MHz) ICOM IC-RP 1210 (1.2 GHz)

Computer Interfaces stocked: MFJ-1224 AEA CP-1, PK-80, DR-DX CP-100, PK-64, Dr. QSO, Morse University

ALPHA AMPLIFIERS Complete Butternut Antenna Inventory in Stock!

DIGITAL FREQUENCY COUNTERS 10MHz 0.1Hz 0.01Hz 0.001Hz 0.0001Hz 0.00001Hz 0.000001Hz

Long range Wireless Telephone for export in stock

BENCHER PADDLES, BALUNS, AUDIO FILTERS, IN STOCK MIRROR AMPLIFIERS ASTRON POWER SUPPLIES Saxton Wire & Cable

SMART PATCH CES Simple Adapter for 510 SA and Patch FM Transceiver To Your Telephone Great For Telephone Calls From Mobile To Base Simple To Use \$19.95

PRIVATE PATCH III in stock

FLUKE 77 Multimeter



Nye MBV-A 3 Kilowatt Tuner

SANTEC ST-222AP ST-20T ST-442UP HT 7

MFJ Models 422, 313, 989, & 941D MURCH Model 2000 A, A.L.S. B in stock

SANGEAN Portable Shortwave Radios

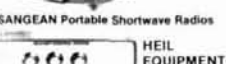

HEIL EQUIPMENT IN STOCK

To Ex Towers Hy Gain Towers & Antennas and Rotors will be shipped direct to you FREE of shipping cost

New TEN TEC 2591HT, Corsair II, Argosy II, Century 22

## MULTI BAND TRAP ANTENNAS

TRAP DIPOLES:	Model	Bands	Traps	Length	Price
	D-42	10/15/20/40	2	55	\$59.95
	D-52	10/15/20/40/80	2	105	64.95
	D-56	10/15/20/40/80	6	99	109.95

TRAP VERTICALS - "SLOPERS":	Model	Bands	Traps	Length	Price
	VS-31	10/15/20	1	12'	42.95
	VS-41	10/15/20/40	1	27'	44.95
	VS-52	10/15/20/40/80	2	52'	59.95
	VS-53	10/15/20/40/80	3	49'	69.95

\*Can be used without radials \*Feed line can be buried if desired \*Permanent or Portable Use

ALL ANTENNAS are Ready to use - Factory assembled - Commercial Quality - Handle full power - Comes complete with Deluxe Traps, Deluxe center connector, 14 ga Stranded Copper Weld ant. wire and End Insulators. Automatic Band Switching - Tuner usually never required - For all transmitters, Receivers & Transceivers - For all class amateurs - One feedline works all bands - Instructions included - 10 day trial!

COAX CABLE: (includes PL-259 connector on each end)	Type	Length	With antenna purchase	Separately
	RG-58	50'	\$8.00	\$11.95
	RG-58	90'	12.00	16.95

DELUXE CENTER CONNECTOR

- NO RUST Brass Terminals
- NO jumper wires used
- NO Soldering
- Built in Lightning Arrestor
- With 50-239 Receptacle
- Handles Full Power
- Completely sealed, weatherproof
- Easy element adjustments
- Commercial quality

CE-1 \$8.95

DELUXE ANTENNA TRAPS: Completely sealed & weatherproof - Solid brass terminals - Handles Full power - NO jumpers - NO Soldering - Instructions included

For 4 band Dipole Ant. 40/20/15/10 \$36.00/pr  
For 5 band Dipole Ant. 80/40/20/15/10 \$38.00/pr

ORDER DIRECT FROM FACTORY. All orders shipped US Postpaid VISA/MC give card #, Exp. date, Signature

SPI-RO MANUFACTURING, INC.  
Room 103, P.O. Box 1538  
Hendersonville, NC 28793  
Dealer Inquiries Invited

ORLANDO HAMCATION AND COMPUTER SHOW  
MARCH 7, 8, 9, 1986  
FLORIDA STATE ARRL CONVENTION



REGISTRATION  
\$5.00 ADVANCE • \$7.00 AT DOOR  
FOR INFORMATION  
PLEASE SEND  
SELF ADDRESSED STAMPED  
ENVELOPE TO:  
HAMCATION CHAIRMAN  
P.O. BOX 15142  
ORLANDO, FL 32858  
(305) 422-ARRL  
FREE PARKING AVAILABLE

MAIL ALL ORDERS TO BARRY ELECTRONICS CORP., 512 BROADWAY, NEW YORK CITY, NY 10012.

### New York City's LARGEST STOCKING HAM DEALER COMPLETE REPAIR LAB ON PREMISES

"Aquí Se Habla Español"  
BARRY INTERNATIONAL TELEX 12-7670  
MERCHANDISE TAKEN ON CONSIGNMENT FOR TOP PRICES  
Monday-Friday 9 A.M. to 6:30 P.M. Thursday to 8 P.M.  
Saturday & Sunday 10 A.M. to 5 P.M. (Free Parking)  
AUTHORIZED DIST. MCKAY DYMEK FOR SHORTWAVE ANTENNAS & RECEIVERS  
IRTILEX "Spring St. Station"  
Subways: BMT "Prince St. Station"  
IND "F" Train Bwy. Station"  
Bus: Broadway #6 to Spring St.  
Path—9th St. Ave. Station

Commercial Equipment Stocked: ICOM, MAXON, Midland, Standard, Wilson, Yaesu. We serve municipalities, businesses, Civil Defense etc. Portables, mobiles, bases, repeaters

Local Ham Club Speeches Given

We Stock: AEA, ARRL, Alpha, Ameco, Antenna Specialists, Astatic, Astron, B & K, B & W, Bash, Bencher, Bird, Butternut, CDE, CES, Collins, Communications Spec, Connectors, Covercraft, Cushcraft, Daiwa, Dentron, Digimax, Drake, ETO (Alpha), Eimac, Encomm, Heil Sound, Henry, Hustler (Newtronics), Hy Gain, Icom, KLM, Kantronics, Larsen, MCM (Daiwa), MFJ, J.W. Miller, Mini Products, Mirage, Newtronics, Nye Viking, Palomar, RF Products, Radio Amateur Callbook, Robot, Rockwell Collins, Saxton, Shure, Telex, Tempo, Ten Tec, Tokyo Hi Power, Trionyx TUBES, W2AU, Wabur, Wilson, Yaesu Ham and Commercial Radios, Vocon, Vibroplex, Curtis, Tri Ex, Wacom Duplexers, Repeater, Phelps Dodge, Fanon Intercoms, Scanners, Crystals, Radio Publications.

WE NOW STOCK COMMERCIAL COMMUNICATIONS SYSTEMS  
DEALER INQUIRIES INVITED. PHONE IN YOUR ORDER & BE REIMBURSED  
COMMERCIAL RADIOS stocked & serviced on premises.  
Amateur Radio Courses Given On Our Premises, Call ALL SALES FINAL  
Export Orders Shipped Immediately. TELEX 12-7670

## CALL LONG DISTANCE ON YOUR HANDHELD

The Model 335A will deliver 35 watts of power using the latest state-of-the-art circuitry. The amplifier will operate SSB or FM and is compatible with most handheld transceivers, including the TR2400, TR2500, IC-2AT, Yaesu, Santec, and Ten-Tec. Only 300 mw input will deliver 5 watts out; 3 watts in will deliver 35 watts out. Maximum input drive level is 5 watts.

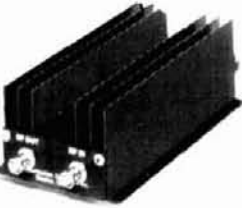

Our products are backed by prompt factory service and technical assistance. To become familiar with our other fine products in the amateur radio market, call or write for our free product and small parts catalog.

Model 335 A  
Kit \$69.95  
Wired & Tested \$89.95

VISA CCI Communication Concepts Inc.  
2648 North Aragon Ave. • Dayton, Ohio 45420 • (513) 296-1411



moreover, the unit will not transmit without a minimum current being drawn. As a consequence, the quiescent drain voltage must be several hundred millivolts below approximately 4 volts. A suitable operating point was chosen as  $V_D = 3.5 \text{ V}$ ,  $I_D = 270 \mu\text{A}$ .

These requirements pose a very severe set of constraints for the FET. The main problem is that a FET with a very low cut-off  $V_{GS}$  must be chosen. Very few FETs have a value of  $I_{DSS}$  below 1 mA. This is the maximum drain current that can be drawn. Thus, in our application, the device will have to be operated near cut-off. By writing a simple loop equation for the FET circuit, the constraint on cut-off voltage becomes clear:

$$V_{GS} + V_{DS} + I_D \cdot R_{DC} = 5 \text{ V}$$

or

$$V_{GS} < 5 \text{ V} - I_D \cdot R_{DC} = 3.5 \text{ V}$$

The FET must have a  $V_{GS}$  cut-off of less than 3.5 volts. A 2N4338 (or equivalent) meets this specification albeit with a lower transconductance than FETs with higher  $V_{GS}$  cut-off. The available transconductance is lowered further by operation at the  $270 \mu\text{A}$  bias current available at the microphone terminals. Specified gate-to-source voltages,  $V_{GS}$  between 0 to  $-0.25$  volt, yield a transconductance of 800 microsiemens for the desired operating conditions. Thus, the available voltage gain is given by  $800 \text{ microsiemens} \times 10 \text{ kilohm} = 8$ . Surprisingly, this meets the minimum design requirement previously specified for gain and provides adequate margin for AC voltage variations at the drain. The source resistor value  $R_S$  is adjusted to provide the  $270 \mu\text{A}$  bias current and depends upon the manufacturer's tolerance spread for the 2N4338. A value less than 1 kilohm is probably optimal. Some variation of circuit gain is expected over temperature extremes.

This design proved to be operational but lacked flexibility of gain control and was therefore abandoned. In addition, most electronic junk boxes typically do not contain a 2N4338, and since other FETs will not function adequately, an alternate, though more complex, design was developed.

### preferred design

Because operational amplifiers commonly provide high gain, noise immunity, low distortion, and stable characteristics, they're often used to replace discrete device amplifiers. The circuit shown in fig. 6 utilizes a Bipolar/MOS op-amp in place of the FET of fig. 5. The op-amp can operate from supply voltages as low as 2 volts with current drain of only  $350 \mu\text{A}$  and can therefore be powered from the ICOM microphone input circuitry.

Compared to conventional op-amps, the basic prin-

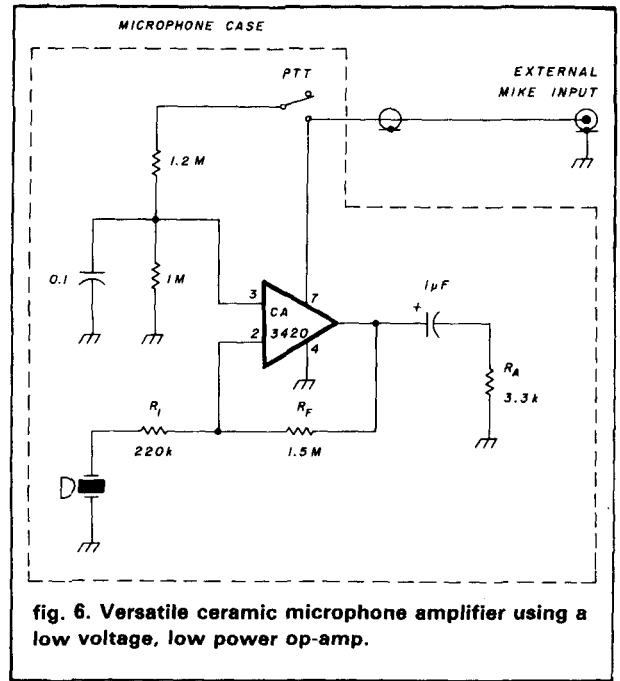

fig. 6. Versatile ceramic microphone amplifier using a low voltage, low power op-amp.

ciple underlying operation of this design is uncommon. For this design, the op-amp quiescent current is supplied by the IC-2A upon closure of the PTT switch. Sufficient current flows to enable the transmit circuitry, thereby changing the mode from receive to transmit. Audio signals from the microphone are amplified by the voltage ratio  $R_F/R_I$  and appear at the output terminal. Only the AC portion of this signal flows in the load resistor  $R_A$ . The AC load current must, in turn, appear superimposed on the DC supply current. It is this AC power supply current that flows in the ICOM microphone circuit and causes modulation of the transmitter. Because the op-amp's power supply rejection ratio and CMRR are large ( $> 10^6$ ), voltage variations induced at the power terminals by the microphone signal do not induce unwanted feedback or gain variations.

Typical quiescent current specifications of  $350 \mu\text{A}$  for the CA3420 are sufficiently near the ideal DC supply current for the ICOM microphone circuit that the op-amp DC load need not be augmented. We measured the DC voltage at the power supply terminal and found ample headroom for the output signal.

As shown in fig. 6, operation within the common mode voltage range is guaranteed by the 1.2 and 1.0 Megohm bias resistors. This choice of operating point places the output stage in the center of its linear region. The  $0.1 \mu\text{F}$  capacitor is necessary to remove the output signal from the input of the op-amp. The ratio of  $R_F$  to  $R_I$ , the input impedance of the radio, and the value of  $R_A$  determine the overall gain:

$$\text{gain} = (R_F/R_I) (R_{INPUT}/R_A) \quad (2)$$

# MICROWAVE MODULES LTD.

*A Connoisseurs Choice in VHF/UHF*

CONVERTERS SOLID STATE AMPLIFIERS

TRANSVERTERS

## MMT 144/28R

144Mhz. TRANSVERTER  
High Quality DBM  
Repeater Offset  
GaAsFET Receiver  
25 WATTS OUTPUT

\$335.00

Selectable Input:  
3w,10w,25w

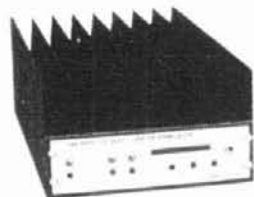

5mw to 300mw 28Mhz. Drive



## MML 144/200-S

144Mhz. SOLID-STATE LINEAR  
GaAsFET Pre-Amp  
Bargraph Display  
200 WATTS OUTPUT

\$385.00

MODELS AVAILABLE FOR  
50Mhz,432Mhz  
1296Mhz  
OSCAR MODE B & L  
AMATEUR TELEVISION

AVAILABLE FROM:

THE "PX" SHACK

VHF/UHF  
EQUIPMENT



Ivars Lauzums KC2PX  
52 Stonewyck Drive  
Belle Mead, New Jersey 08502  
(201) 874-6013



MICROWAVE  
MODULES LTD

Hours: 11am - 3pm  
6pm - 10pm



SEE US AT DAYTON

✓ 154

$R_A$  is typically 3.3 kilohm for satisfactory performance. Slight (plus or minus 6 dB) tailoring of the gain can be accomplished by adjusting  $R_A$ . In fact, less sensitive microphones can be used as long as the ratio of  $R_F$  to  $R_I$  is changed proportionately. Values of  $R_A$  below 1.5 kilohm are not recommended.

This circuit has been in use for over a year and has performed admirably in all types of weather.

### summary

Although generally provided with electret microphones, both ceramic and dynamic microphones can be made to work with handheld transceivers by the addition of only a small amount of circuitry. In the case of dynamic microphones, a speaker/microphone combination can be easily constructed. Some variation in the circuitry may be necessary for different microphones and transceivers, but the general techniques should remain the same. These ideas should enable Amateurs to have a wide choice of affordable mobile microphones for use with existing transceivers.

ham radio

ICOM  
SPECIAL  
IC-735  
\$764.00  
W/hand held mic



**TEL-COM** ★  
*Electronic Communications*

Authorized Dealers For

**KENWOOD & ICOM**

Also displaying the popular accessories needed to complete a HAM STATION . . .

- ARRL PUBLICATIONS • AEA PRODUCTS • AMPHENOL
- ALPHA DELTA • ASTRON • AUSTIN ANTENNAS • AVANTI
- BELDEN • BENCHER • B & W • DAIWA • HAM-KEY
- HUSTLER • KLM • LARSEN • MIRAGE • ROHN
- TELEX/HY-GAIN • VIBROPLEX • WELZ • ETC.

✓ 165

KENWOOD  
SPECIAL  
NEW  
TM-2550A  
\$414.00

OPEN SIX DAYS A WEEK

Telephone 617/486-3400, 3040

675 Great Rd., (Rte. 119) Littleton, MA 01460

1 1/4 miles from Rte. 495 (Exit 31) toward Groton, Mass.



# ham radio

## Reader Service

For literature or more information, locate the Reader Service number at the bottom of the ad, circle the appropriate number on this card, affix postage and send to us. We'll hustle your name and address to the companies you're interested in.

101 113 125 137 149 161 173 185 197 209 221 233 245 257 269 281 293 305 317 329 341  
102 114 126 138 150 162 174 186 198 210 222 234 246 258 270 282 294 306 318 330 342  
103 115 127 139 151 163 175 187 199 211 223 235 247 259 271 283 295 307 319 331 343  
104 116 128 140 152 164 176 188 200 212 224 236 248 260 272 284 296 308 320 332 344  
105 117 129 141 153 165 177 189 201 213 225 237 249 261 273 285 297 309 321 333 345  
106 118 130 142 154 166 178 190 202 214 226 238 250 262 274 286 298 310 322 334 346  
107 119 131 143 155 167 179 191 203 215 227 239 251 263 275 287 299 311 323 335 347  
108 120 132 144 156 168 180 192 204 216 228 240 252 264 276 288 300 312 324 336 348  
109 121 133 145 157 169 181 193 205 217 229 241 253 265 277 289 301 313 325 337 349  
110 122 134 146 158 170 182 194 206 218 230 242 254 266 278 290 302 314 326 338 350  
111 123 135 147 159 171 183 195 207 219 231 243 255 267 279 291 303 315 327 339  
112 124 136 148 160 172 184 196 208 220 232 244 256 268 280 292 304 316 328 340

*Limit 15 inquiries per request.*

NAME \_\_\_\_\_ CALL \_\_\_\_\_  
ADDRESS \_\_\_\_\_  
CITY \_\_\_\_\_ STATE \_\_\_\_\_ ZIP \_\_\_\_\_



AFFIX POSTAGE  
OR  
POST OFFICE  
WILL NOT  
DELIVER

**ham**  
**radio**  
*magazine*

READER SERVICE CENTER  
P.O. BOX 2558  
WOBURN, MA 01888

ATTN: Reader Service Dept.

THE STANDARDS OF EXCELLENCE

# **SUPERIOR WEAK SIGNAL PERFORMANCE COMMERCIAL MODEM**

## **COMPARE with ANY unit at ANY Price**

New Available With  
PACKET RADIO

**THE WORLD OF VHF/HF PACKET\*,  
CW, RTTY, ASCII AND NEW DUAL  
AMTOR\*\* IS AS CLOSE AS YOUR  
FINGERTIPS WITH THE BRILLIANTLY  
INNOVATIVE STATE-OF-THE-ART  
MICRO-COMPUTER CONTROLLED  
EXL-5000E.**

**SPECIAL SALE**

**\$649**

With Packet Radio — \$795



SHOWN WITH OPTIONAL PACKET TNC

**Everything built in — nothing else to buy!**

• AUTOMATIC SEND/RECEIVE—ANY SPEED ANY SHIFT • BUILT IN COMPUTER GRADE 5" MONITOR • EXTERNAL MONITOR JACK • TIME CLOCK ON SCREEN • TIMED TRANSMISSION AND RECEIVING • SELCAL • CRYSTAL CONTROLLED AFSK MODULATOR • PHOTOCOUPLER CW, FSK KEYS • ASCII KEY ARRANGEMENT • 15 CHANNEL BATTERY BACK-UP MEMORY • 1,280 CHARACTER DISPLAY MEMORY • SPLIT SCREEN TYPE-AHEAD BUFFER • FUNCTION SCREEN DISPLAY • PARALLEL PRINTER INTERFACE • SPEEDS: CW 5-100 WPM (AUTOTRACK), 12-300 BAUD (ASCII AND BAUDOT); 12-600 BAUD TTL; 100 BAUD ARQ/FEC AMTOR • ATC • RUB-OUT FUNCTION • AUTOMATIC CR/LF • WORD MODE • LINE MODE • WORD WRAP AROUND • ECHO • TEXT CURSOR CONTROL • USOS • DIDDLE • TEST MESSAGES (RY AND QBF) • MARK AND BREAK (SPACE AND BREAK) SYSTEM • VARIABLE CW WEIGHTS • AUDIO MONITOR CIRCUIT BUILT IN • CW PRACTICE FUNCTION • CW RANDOM GENERATOR • BARGRAPH LED METER FOR TUNING • OSCILLOSCOPE OUTPUTS • BUILT IN 100-120 / 220-240 VAC 50/60HZ AND 13.8VDC POWER SUPPLIES • AND MUCH, MUCH MORE • SIZE: 14W x 14D x 5H • 1 YEAR LIMITED WARRANTY •

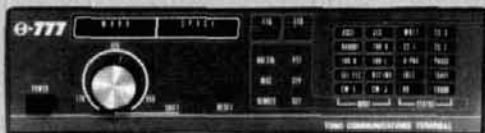

**Θ-777 THE MOST ADVANCED COMPUTER INTERFACE  
EVER DESIGNED FOR COMMERCIAL AND AMATEUR USE.**

RTTY, BIT INVERSION (RTTY), ASCII, AMTOR (MODE A (ARQ), MODE B (FEC AND SEL-FEC), MODE L), CW, ANY SPEED ANY SHIFT (ASCII AND BAUDOT)\*

**SPECIAL SALE \$249**

- **AUTO DECODING:** Automatically decodes signal and displays mode, speed and polarity on the CRT — **COMPARE!**
- **28 BAR-LED'S** and LED'S plus a Bar-Graph Tuning Indicator indicate function, mode, and status — **COMPARE!**
- The awesome power of the Θ-777 is limited only by the imagination of the user and the terminal program of the computer.
- Use with *Any* computer that has RS232 or TTL I/O, IBM, Apple, Commodore, TRS80, etc.

**Everything Built In - Including Software — Nothing Else To Buy!**

• \*SPEEDS: CW 5-100 WPM (AUTOTRACK), 12-200 BAUD (ASCII AND BAUDOT); 12-600 BAUD TTL, AND RS232 OR TTL LEVEL DATA CONNECTION - 100-2400 BAUD (ASCII) OR 45.5-200 BAUD (BAUDOT) • SELCAL • MEMORY: 15 CHANNELS • 768 CHARACTER INPUT BUFFER • AUTO PTT • CW ID • DIDDLE • USOS • ECHO • AUTO CR/LF • ATC • RUB-OUT • CW PRACTICE GENERATOR • VARIABLE CW WEIGHTS • TEST MESSAGE (RY AND QBF) • FULL CRT FUNCTION DISPLAY • MARK - AND - BREAK (SPACE - AND - BREAK) SYSTEM • XTAL AFSK • AUDIO MONITOR • OSCILLOSCOPE OUTPUTS • AND MUCH, MUCH MORE • POWER SUPPLY REQUIREMENTS: 13.8 V DC, 700MA • SIZE: 9W x 10D x 2 1/2H • 1 YEAR LIMITED WARRANTY •

EXCLUSIVE DISTRIBUTOR: DEALER INQUIRIES INVITED FOR YOUR NEAREST DEALER OR TO ORDER:

**AMATEUR-WHOLESALE ELECTRONICS TOLL FREE...800-327-3102**

8817 S.W. 129th Terrace, Miami, Florida 33176 Telephone (305) 233-3631 Telex: 80-3356

MANUFACTURER:

**TONO CORPORATION**

98 Motosoja Machi, Maebashi-Shi, 371, Japan



\*PLEASE CALL FOR DETAILS

\*\*Dual Amtor: Commercial quality, the EXL-5000E incorporates two completely separate modems to fully support the amateur Amtor codes and all of the CCIR recommendations 476-2 for commercial requirements.

Specifications Subject to Change.

Uncle Ben says...

**"I give you  
much more than  
just the lowest price..."**

When you get that exciting new piece of equipment *from me*, you know you are going to be completely happy... I see to it, personally! I also give you earliest delivery, greatest trade-in allowances, my friendly assistance in every possible way.

Just ask any of the many thousands of hams all over the world who have been enjoying my friendly good service for over a half a century.

73, Uncle Ben, W2SOH



"Uncle Ben" Snyder, W2SOH  
the head man of

**HARRISON**

"HAM HEADQUARTERS,  
USA®" ...Since 1925!

• **CALL ME...**

(516) 293-7995

**HARRISON**  
**HAS THEM ALL!**  
**KENWOOD**

• **WRITE ME...**

For my prompt,  
personal reply.

• **SEE ME...**

At one of the world's largest  
Ham Supply Centers!



Kenwood TH21AT, 31AT, 41AT



Kenwood TM-2570A



Kenwood TS-940S



Kenwood TS-430S



Kenwood TR-2600, TR-3600



Kenwood TS-711A (2m)  
TS-811A (70 cm)

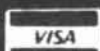

**HARRISON** RADIO

...Since 1925!

**CHARGE IT!**

"HAM HEADQUARTERS, USA"

2263 Route 110 (at Smith St.)

E. Farmingdale, NY 11735

1-(516) 293-7995

# remote repeater programming using a computer and a telephone

Upgrade your  
old controller  
with this simple  
Apple program

**Back in 1983**, the repeater association that I belong to decided that it was time to upgrade our 2-meter repeater controller. The old controller still was working well enough, but was really starting to show its age. The IDer used diodes to "memorize" the call sign. After the third change of call, the foils started to pull away from the PC board. We knew it was time for a change.

At the time, we really didn't have the money for a full-featured, controller, but a local ham, WA9FBO, was designing a controller that he planned to market. The controller was based on the Motorola 6809, a microprocessor with which he was familiar. It had all the necessities of a good repeater controller: auto-patch, CW, voice ID, and reverse patch, to name a few. We decided to go ahead with WA9FBO's controller.

After the new controller was installed into a 1962-model G.E. Stationmaster, the fun began. The new controller has the capability of building "macros" for customizing the system to the users' tastes. To build these macros, you have to send standard DTMF tones to the controller, either over the air or telephone. Our group uses the telephone method, except during emergencies.

Every so often an improvement to the operating system required starting over again from scratch. Usually this meant no more than changing a couple of PROM chips. But doing this meant removing the power from the controller, thereby erasing all the macros. In our case, 45 minutes later, they were all reloaded and back in operation — if nobody made a mistake. We knew there had to be a better way!

While I suppose it would have been possible to tape record the tones for playback when needed, doing so would have required tape recording after each change

to the system. To enter all the macros by hand presented an additional drawback because there aren't many telephones equipped with 16-button pads! What follows is what we feel is a much better solution.

## a better way

In almost every Amateur Radio group, there are probably a few members with the required equipment to handle the task. What you'll need is someone with a computer that has autodialing capabilities. It can be any kind computer and any kind of dialer; mine is part of a modem that I use for information retrieval. Also, a nice thing to have, but by no means necessary, is a word processing program because it makes making changes a lot easier.

The program presented here (**fig. 1**) was written for Apple II series (except the IIc) computers with at least one disk drive and a Hayes Micromodem IIe (but not the Micromodem II, which doesn't have touch-tone capabilities). All macro data is stored as standard Apple text files, such as those produced from word processors such as Apple Writer, Screen Writer and Apple Works (printed as a Text-ASCII file). It is written for DOS 3.3, but should be easily changed for PRODOS. The same basic idea of the program should be easy to convert to other computers.

When entering the program by hand, it isn't necessary to enter all the REM statements; they're included only for program clarity. If you're rewriting the program for another computer, remember to first get it to run, and then add the niceties such as screen formatting. And finally, if the computer doesn't support text files, or you don't have a word processor, DATA statements work just as well, but are not as easy to use in making changes.

As presented, the program is more or less a structured program and makes use of subroutines where allowed. The reason that the subroutines are at the front of the program is for program execution speed. The comments following the REM statements explain what the modules do.

The kind of performance that can be expected from the program depends on certain variables. Of greatest

**By John R. Kaiser, KD9BC**, 803 Central Street, Oshkosh, Wisconsin 54901



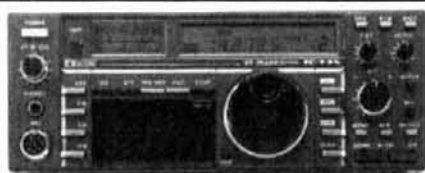

HF Equipment	Regular	SALE
IC-735 HF transceiver/SW rcvr/mic	849.00	729 <sup>95</sup>
PS-55 External power supply	160.00	144 <sup>95</sup>
AT-150 Automatic antenna tuner	349.00	314 <sup>95</sup>
FL-32 500 Hz CW filter	59.50	
EX-243 Electronic keyer unit	50.00	
IC-745 9-band xcvr w/1-30 MHz rcvr	999.00	769 <sup>95</sup>
PS-35 Internal power supply	160.00	144 <sup>95</sup>
EX-241 Marker unit	20.00	
EX-242 FM unit	39.00	
EX-243 Electronic keyer unit	50.00	
FL-45 500 Hz CW filter (1st IF)	59.50	
FL-54 270 Hz CW filter (1st IF)	47.50	
FL-52A 500 Hz CW filter (2nd IF)	96.50	89 <sup>95</sup>
FL-53A 250 Hz CW filter (2nd IF)	96.50	89 <sup>95</sup>
FL-44A SSB filter (2nd IF)	159.00	144 <sup>95</sup>
HM-10 Scanning mobile microphone	39.50	
SM-6 Desk microphone	39.00	
HM-12 Extra hand microphone	39.50	
MB-12 Mobile mount	19.50	



IC-751 9-band xcvr/1-30 MHz rcvr	1399.00	1089
PS-35 Internal power supply	160.00	144 <sup>95</sup>
FL-32 500 Hz CW filter (1st IF)	59.50	
FL-63 250 Hz CW filter (1st IF)	48.50	
FL-52A 500 Hz CW filter (2nd IF)	96.50	89 <sup>95</sup>
FL-53A 250 Hz CW filter (2nd IF)	96.50	89 <sup>95</sup>
FL-33 AM filter	31.50	
FL-70 2.8 kHz wide SSB filter	46.50	
HM-12 Extra hand microphone	39.50	
SM-6 Desk microphone	39.00	
RC-10 External frequency controller	35.00	
MB-18 Mobile mount	19.50	

IC-720A 9-band xcvr • (CLOSEOUT)	1349.00	699 <sup>95</sup>
PS-15 20A external power supply	149.00	134 <sup>95</sup>
FL-32 500 Hz CW filter	59.50	
FL-34 5.2 kHz AM filter	49.50	
BC-10A Memory back-up	8.50	
SM-5 8-pin electret desk mic	39.00	
MB-5 Mobile mount	19.50	

Other Accessories:	Regular	SALE
PS-15 20A external power supply	149.00	134 <sup>95</sup>
CF-1 Cooling fan for PS-15	45.00	
EX-144 Adaptor for CF-1/PS-15	6.50	
PS-30 Systems p/s w/cord, 6-pin plug	259.95	234 <sup>95</sup>
OPC Opt. cord, specify 2, 4 or 6-pin	5.50	
SP-3 External base station speaker	49.50	
SP-5 Remote speaker for mobiles	25.00	
CR-64 High stab. ref. xtal (745/751)	56.00	
PP-1 Speaker/patch (specify radio)	139.00	129 <sup>95</sup>
SM-8 Desk mic - two cables, Scan.	69.95	
SM-10 Compressor/graph EQ, 8 pin mic	119.00	
AT-100 100W 8-band auto. antenna tuner	349.00	314 <sup>95</sup>
AT-500 500W 9-band auto. antenna tuner	449.00	399 <sup>95</sup>
AH-1 5-band mobile antenna w/tuner	289.00	259 <sup>95</sup>

# ICOM

Other Accessories cont. Regular SALE  
 AH-2 8-band tuner w/mount & whip 549.00  
 GC-4 World clock • (CLOSEOUT) • 99.95 79<sup>95</sup>

HF linear amplifier Regular SALE  
 IC-2KL 160-15m solid state amp w/ps 1795.00 1299

6-meter VHF Portable Regular SALE  
 IC-505 3/10W 6m SSB/CW portable 449.00 399<sup>95</sup>  
 BP-10 Internal Nicad battery pack 79.50  
 BP-15 AC charger 12.50  
 EX-248 FM unit 49.50  
 LC-10 Leather case 34.95

VHF/UHF base multi-modes Regular SALE  
 IC-551D 80W 6-meter SSB/CW 699.00 599<sup>95</sup>  
 EX-106 FM option 125.00 112<sup>95</sup>  
 BC-10A Memory back-up 8.50  
 SM-2 Electret desk microphone 39.00

IC-271A 25W 2m FM/SSB/CW 699.00 569<sup>95</sup>  
 AG-20 Internal preamplifier\* 56.95  
 IC-271H 100W 2m FM/SSB/CW 899.00 759<sup>95</sup>  
 AG-25 Mast mounted preamplifier\* 84.95

IC-471A 25W 430-450 SSB/CW/FM xcvr 799.00 699<sup>95</sup>  
 AG-1 Mast mounted preamplifier\* 89.00  
 IC-471H 75W 430-450 SSB/CW/FM 1099.00 969<sup>95</sup>  
 AG-35 Mast mounted preamplifier\* 84.95

Accessories common to 271A/H and 471A/H  
 PS-25 Internal power supply for (A) 99.00 89<sup>95</sup>  
 PS-35 Internal power supply for (H) 160.00 144<sup>95</sup>  
 PS-15 External power supply 149.00 134<sup>95</sup>  
 SM-6 Desk microphone 39.00  
 EX-310 Voice synthesizer 39.95  
 TS-32 CommSpec encode/decoder 59.95  
 UT-15 Encoder/decoder interface 12.50  
 UT-15S UT-15S w/TS-32 installed 79.95

VHF/UHF mobile multi-modes Regular SALE  
 IC-290H 25W 2m SSB/FM, TTP mic. 549.00 479<sup>95</sup>  
 IC-490A 10W 430-440 SSB/FM/CW 649.00 579<sup>95</sup>

VHF/UHF/1.2 GHz FM Regular SALE  
 IC-27A Compact 25W 2m FM w/TTP mic 369.00 299<sup>95</sup>  
 IC-27H Compact 45W 2m FM w/TTP mic 409.00 359<sup>95</sup>  
 IC-37A Compact 25W 220 FM, TTP mic 449.00 329<sup>95</sup>  
 IC-47A Compact 25W 440 FM, TTP mic 469.00 399<sup>95</sup>  
 PS-45 Compact 8A power supply 112.95 99<sup>95</sup>  
 UT-16/EX-388 Voice synthesizer 29.95  
 SP-10 Slim-line external speaker 29.95

IC-3200A 25W 2m/440 FM w/TTP 549.00 489<sup>95</sup>  
 UT-23 Voice synthesizer 29.95  
 AH-32 2m/440 Dual Band antenna 32.95  
 Larsen PO-K Roof mount 20.00  
 Larsen PO-TLM Trunk-lip mount 20.18  
 Larsen PO-MM Magnetic mount 19.63

IC-1271A 10W 1.2 GHz SSB/CW Base 999.00 889<sup>95</sup>  
 ATV-1200 ATV interface unit TBA  
 PS-25 Internal power supply 99.00 89<sup>95</sup>  
 EX-310 Voice synthesizer 39.95  
 UT-15S CTCSS encoder/decoder 79.95

IC-120 1W 1.2 GHz FM Mobile 499.00 449<sup>95</sup>  
 ML-12 1.2 GHz 10W amplifier 339.00 299<sup>95</sup>

Repeaters Regular SALE  
 RP-3010 440 MHz, 10W FM, xtal cont. 999.00 899<sup>95</sup>  
 RP-1210 1.2 GHz, 10W FM, 99 ch. synth 1199.00 1089  
 Duplexer 1210 1.2 GHz duplexer 1199.00 1089  
 Cabinet for RP-1210 249.00

Limiters Offer! • Matching preamp\* only \$100 extra with purchase of IC-271A/H or IC-471A/H.

## Order Toll Free Use your Credit Card!

Hand-held Transceivers Regular SALE  
 Deluxe models Regular SALE  
 IC-02AT for 2m 349.00 289<sup>95</sup>  
 IC-04AT for 440 MHz 379.00 319<sup>95</sup>

Standard models Regular SALE  
 IC-2A for 2m 239.50 189<sup>95</sup>  
 IC-2AT with TTP 269.50 199<sup>95</sup>  
 IC-3AT 220 MHz, TTP 299.95 239<sup>95</sup>  
 IC-4AT 440 MHz, TTP 299.95 239<sup>95</sup>

Accessories for Deluxe models Regular  
 BP-7 425mah/13.2V Nicad Pak - use BC-35 67.50  
 BP-8 800mah/8.4V Nicad Pak - use BC-35 62.50  
 BC-35 Drop in desk charger for all batteries 69.00  
 BC-60 6-position gang charger, all batts SALE 359.95  
 BC-16U Wall charger for BP7/BP8 10.00  
 LC-11 Vinyl case 17.95  
 LC-14 Vinyl case for Dlx using BP-7/8 17.95  
 LC-02AT Leather case for Dlx models w/BP-7/8 39.95

Accessories for both models Regular  
 BP-2 425mah/7.2V Nicad Pak - use BC35 39.50  
 BP-3 Extra Std. 250 mah/8.4V Nicad Pak 29.50  
 BP-4 Alkaline battery case 12.50  
 BP-5 425mah/10.8V Nicad Pak - use BC35 49.50  
 CA-2 Telescoping 2m antenna 10.00  
 CA-5 5/8-wave telescoping 2m antenna 18.95  
 FA-2 Extra 2m flexible antenna 10.00  
 CP-1 Cig. lighter plug/cord for BP3 or Dlx 9.50  
 DC-1 DC operation pak for standard models 17.50  
 LC-2AT Leather case for standard models 34.95  
 RB-1 Vinyl waterproof radio bag 30.00  
 HH-SS Handheld shoulder strap 14.95  
 HM-9 Speaker microphone 34.50  
 HS10 Boom microphone/headset 19.50  
 HS-10SA Vox unit for HS-10 & Deluxe only 19.50  
 HS-10SB PTT unit for HS-10 19.50  
 ML-1 2m 2.3w in/10w out amplifier SALE 79.95  
 SS-32M Commspec 32-tone encoder 29.95

Receivers Regular SALE  
 R-7000 25-2000 MHz, 117V AC 899.00 789<sup>95</sup>  
 RC-12 Infrared remote controller TBA  
 R-71A 100 kHz-30 MHz, 117V AC \$799.00 649<sup>95</sup>  
 RC-11 Infrared remote controller 59.95 49<sup>95</sup>  
 FL-32 500 Hz CW filter 59.50  
 FL-63 250 Hz CW filter (1st IF) 48.50  
 FL-44A SSB filter (2nd IF) 159.00 144<sup>95</sup>  
 EX-257 FM unit 38.00  
 EX-310 Voice synthesizer 39.95  
 CR-64 High stability oscillator xtal 56.00  
 SP-3 External speaker 49.50  
 CK-70 (EX-299) 12V DC option 9.95  
 MB-12 Mobile mount 19.50

MasterCard VISA (2)

HOURS • Mon. thru Fri. 9-5:30; Sat. 9-3  
 Milwaukee WATS line: 1-800-558-0411 answered evenings until 8:00 pm Monday thru Thursday.  
 Please use WATS lines for Ordering  
 use Regular lines for other Info and Service dept.

All Prices in this list are subject to change without notice.

# Order Toll Free: 1-800-558-0411 In Wisconsin (outside Milwaukee Metro Area) 1-800-242-5195

## AMATEUR ELECTRONIC SUPPLY Inc.

4828 W. Fond du Lac Avenue; Milwaukee, WI 53216 - Phone (414) 442-4200

AES BRANCH STORES				Associate Store
<b>WICKLIFFE, Ohio</b> 44092 28940 Euclid Avenue Phone (216) 585-7388 Ohio WATS 1-800-362-0290 Outside Ohio 1-800-321-3594	<b>ORLANDO, Fla.</b> 32803 621 Commonwealth Ave. Phone (305) 894-3238 Fla. WATS 1-800-432-9424 Outside Florida 1-800-327-1917	<b>CLEARWATER, Fla.</b> 33575 1898 Drew Street Phone (813) 461-4267 No In-State WATS No Nationwide WATS	<b>LAS VEGAS, Nev.</b> 89106 1072 N. Rancho Drive Phone (702) 647-3114 No In-State WATS Outside Nevada 1-800-634-6227	<b>CHICAGO, Illinois</b> 60630 ERICKSON COMMUNICATIONS 5456 N. Milwaukee Avenue Phone (312) 631-5181 Outside Illinois 1-800-621-5802

```

1 REM
2 REM
3 REM : TOUCH TONE MACRO PROGRAM
4 REM : BY JOHN R. KAISER KD9BC
5 REM : COPYRIGHT 1985 BY J.R.K.
6 REM
7 REM
8 REM
9 REM : PROGRAM TO LOAD REPEATER MACROS
10 REM : OVER THE TELEPHONE LINES USING
11 REM : AN APPLE II, II+, OR IIe AND A
12 REM : HAYES MICROMODEM IIc
13 REM
14 REM
15 REM
16 REM ***** GOTD START OF PROGRAM
17 REM
18 GOTD 77
19 REM
20 REM ***** SUBROUTINE THAT FETCHES EACH NUMBER
21 REM
22 FOR F = 1 TO REC
23 LET S# = S#(F); REM GET SINGLE LINE FROM TOTAL FILE
24 FOR I = 1 TO LEN (S#)
25 LET D1# = MID# (S#,I,1); REM GET SINGLE LETTER FROM LINE
26 REM
27 REM ***** "PRINT" D1# AT 3,33
28 POKE 1312,128 + ASC (D1#); REM SCREEN MAPPED BYTE
29 GOSUB 36; REM DIAL THE NUMBER
30 NEXT I
31 NEXT F
32 RETURN
33 REM
34 REM ***** SUBROUTINE THAT DIALS THE NUMBER
35 REM
36 LET D = - 1
37 FOR J = 1 TO 16; REM CHECK FOR VALID NUMBER
38 IF D1# = MID# (V#,J,1) THEN LET D = J - 1
39 NEXT
40 IF D < 0 THEN GOTD 47; REM NOT A VALID NUMBER
41 POKE - 16253 + SLOT # 16,D + 48; REM DIAL NUMBER
42 FOR J = 1 TO DL
43 NEXT J
44 POKE - 16253 + SLOT # 16,D + 32; REM SILENCE BETWEEN NUMBERS
45 REM FOR J=1 TO DL / 2; REM USE THESE TWO LINES
46 REM NEXT J ; ONLY IF EXTRA DELAY IS NEEDED
47 RETURN
48 REM
49 REM ***** READ THE TEXT FILE INTO S# ( )
50 REM
51 LET J = 1
52 ONERR GOTD 59
53 PRINT D#;"VERIFY";FILE#
54 PRINT D#;"OPEN ";FILE#
55 PRINT D#;"READ ";FILE#
56 INPUT S#(J)
57 LET J = J + 1
58 GOTD 55
59 PRINT D#;"CLOSE ";FILE#
60 POKE 216,0
61 IF PEEK (222) = 6 THEN GOTD 67; REM FILE NOT FOUND
62 LET REC = J - 1; REM NUMBER OF LINES IN FILE
63 GOTD 100; REM GOTD MAIN PROGRAM
64 REM
65 REM ***** FILE NOT FOUND ERROR MESSAGE
66 REM
67 PRINT "FILE NOT FOUND:"
68 PRINT "INSERT PROPER DISK AND PRESS RETURN.;"
69 INPUT A#
70 GOTD 87; REM GET NAME OF FILE
71 REM
72 REM ***** START OF THE PROGRAM
73 REM
74 REM ***** INITIALIZE VARIABLES
75 REM
76 LET DL = 30; REM USED TO CONTROL SPEED OF DIAL, LESS = FASTER
77 LET SLOT = 2; REM THE SLOT NUMBER THAT THE MODEM IS IN
78 LET D# = CHR# (4); REM CONTROL-D USED FOR DISK ACCESS ON APPLE
79 LET D# = CHR# (17); REM CONTROL-Q USED FOR MODEM ACCESS ON HAYES
80 LET V# = "D1234567890#ABC"; REM USED FOR VALID CHECK
81 DIM S#(500); REM 500 LINES IN FILE-SIZE ACCORDINGLY
82 REM
83 REM ***** GET THE NAME OF THE TEXT FILE
84 REM
85 TEXT
86 HOME
87 PRINT "ENTER THE NAME OF FILE TO WORK FROM"
88 INPUT FILE#
89 PRINT
90 PRINT "PLACE DISK WITH ";
91 INVERSE
92 PRINT FILE#
93 NORMAL
94 PRINT "IN DRIVE #1 AND PRESS RETURN.;"
95
96 GOTD 51; REM READ IN TEXT FILE
97 REM
98 REM ***** SET UP DISPLAY FOR THE REST OF THE PROGRAM
99 REM
100 HOME
101 PRINT " S.O.L.A.R. MACRO LOADER"
102 PRINT
103 PRINT " NUMBER BEING DIALED IS -->"
104 VTAB 5
105 HTAB 1
106 PRINT "-----"
107 VTAB 7
108 POKE 34,6
109 REM
110 REM ***** SET UP HAYES MICROMODEM IIc
111 REM
112 PRINT D#;"PR#2"
113 POKE - 16253 + SLOT # 16,32
114 PRINT D#;
115 REM
116 REM ***** DIAL THE REPEATER
117 REM
118 LET S# = "000-0000"
119 FOR I = 1 TO LEN (S#)
120 LET D1# = MID# (S#,I,1)
121 GOSUB 36
122 NEXT I
123 REM
124 REM ***** WAIT FOR REPEATER TO ANSWER THE PHONE
125 REM
126 POKE - 16253 + SLOT # 16,0
127 FOR J = 1 TO 4000
128 NEXT J
129 REM
130 REM ***** SEND THE MACRO FILE
131 REM
132 GOSUB 22
133 REM
134 REM ***** HANG UP THE PHONE
135 REM
136 PRINT
137 POKE - 16253 + SLOT # 16,0
138 PRINT D#;"PR#2"
139 REM
140 REM ***** THAT'S IT, RETURN SYSTEM TO NORMAL
141 REM
142 PRINT CHR# (4);"PR#0"; REM USE "PR#3" IF USING 80 COLUMNS
143 HOME
144 END

```

fig. 1. Touchtone program listing.

concern is the speed at which your local telephone company or the repeater controller will accept and process the tones. In the case of our group, the program is able to send a file of 3540 digits in 10 minutes

and 45 seconds. That's with the variable DL set to 10 — not bad considering the relative slowness of Applesoft BASIC.

ham radio

**AR-200 XL**  
MEDIUM DUTY ANTENNA ROTOR

Select a Heading - Antenna Turns and Stops Automatically.

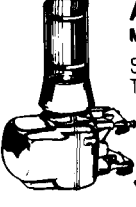

**\$6995**

**SIDEBAND SQUELCH**

- Fits inside most HF-SSB transceivers
- Requires human voice to activate
- Ignores static, noise and heterodynes
- On/off switch only—no adjustments!
- Connects to audio leads and 9/12 VDC
- Fully assembled and tested \$99.95
- Complete with comprehensive manual
- Used worldwide in commercial and military transceivers

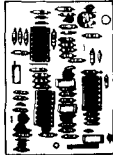

**CMC COMMUNICATIONS**  
5479 Jetport, Tampa, FL 33614 (813) 885-3996 112

**CADDELL COIL CORP.**

35 Main Street  
Poultney, VT 05764  
802-287-4055

**BALUNS**

Get POWER to your antenna! Our Baluns are already wound and ready for installation in your transmatch or you may enclose them in a weatherproof box and connect them directly at the antenna. They are designed for 3-30 MHz operation. (See ARRL Handbook pages 19-9 or 6-20 for construction details.)

100 Watt (4:1, 6:1, 9:1, or 1:1 Impedance — Select one) \$ 9.50  
 Universal Transmatch 1 KW (4:1 Impedance) 13.50  
 Universal Transmatch 2 KW (4:1 Impedance) 16.00  
 Universal Transmatch 1 KW (6:1, 9:1 or 1:1 — select one) 15.00  
 Universal Transmatch 2 KW (6:1, 9:1 or 1:1 — select one) 17.50

Please send large SASE for info.

**ALL BAND TRAP "SLOPER" ANTENNAS!**

FULL COVERAGE! ALL BANDS! AUTOMATIC SELECTION with PROVEN Weatherproof sealed Traps - 18 Ga. Copperweld Wire! GROUND MOUNT SLOPERS - No Radials needed! Ground to rod or house water faucet! Connect Top to Trees, Buildings, Poles, etc. at ANY angle from Straight to 60 degrees for excellent "SLOPER" DX Antenna Gain or bend it anywhere you need to! 2000 Watt PEP input, max. Permanent or portable Use. Installs in 10 minutes. SMALL - NEAT - ALMOST INVISIBLE - No one will know you have a Hi-Power DX Antenna. Ideal For COND'Os APARTMENTS - RESTRICTED AREAS - Pre-tuned for 2-1 or less SWR over ALL bands (except 80-160-300kc). No adjustments needed - EVER. COMPLETELY ASSEMBLED, with 50 ft. RG-58U Coax feedline and PL259 connector - Built in lightning arrester - ready to hookup! FULL INSTRUCTIONS!

No. 1080S - 80-40-20-15-10 - 1 trap 49 ft. - \$49.95  
 No. 1040S - 40-20-15-10 - 1 trap 25 ft. - \$48.95  
 No. 1020S - 20-15-10 - 1 trap 13 ft. - \$47.95  
 No. 1016S - 160-80-40-20-15-10 - 2 traps 83 ft. - \$79.95

SEND FULL PRICE FOR PPDEL IN USA (Canada \$6.00 extra for postage etc) or order using VISA, MASCARD - AMER EXP. Give Number Ex Date. Ph-1-308-236-5333 weekdays. We ship in 2-3 days (For Cks 14 days) Guaranteed 1 yr - 10 day money back trial.

**WESTERN ELECTRONICS**  
Dept. AH Kearney, Nebraska 68847



**\$30.00 OFF**

### Save \$30 on the RAMSEY 20MHz Dual Trace Oscilloscope

Unsurpassed quality at an unbeatable price, the Ramsey oscilloscope compares to others costing hundreds more. Features include a component testing circuit for resistor,

capacitor, digital circuit and diode testing • TV video sync filter • wide bandwidth & high sensitivity • internal graticule • front panel trace rotator • Z axis • high sensitivity x-y mode • regulated power supply • built-in calibrator • rock solid triggering

Was \$399.95 NOW ONLY **\$369.95** high quality hook on probes included



### NEW RAMSEY 1200 VOM MULTITESTER

Check transistors, diodes and LEDs with this professional quality meter. Other features include, decibel scale • 20K volt metering system • 3 1/2" mirrored scale • polarity switch • 20 measuring ranges • safety probes • high impact plastic case

**\$19.95** test leads and battery included



**NEW**

### RAMSEY D-4100 COMPACT DIGITAL MULTITESTER

Compact sized reliability and accuracy. This LCD digital multimeter easily fits in your pocket, you can take it anywhere. It features full overload protection • 3 1/2 digit LCD readout • recessed input jacks • safety probes • diode check function • 2000 hours battery life

**\$22.95** test leads and battery included

### NEW 35 MHz DUAL TRACE OSCILLOSCOPE



A heavy duty and accurate scope for service as well as production use. Features include • wide frequency bandwidth • optimal sensitivity • extremely bright display • delayed triggering sweep • hold off • ALT trigger • single sweep • TV sync • 5X magnification • XY or XYZ operation • HF/LF noise reduction

3500 Dual Trace Oscilloscope

**\$499.95** includes 2 high quality probes

### ALL OSCILLOSCOPES INCLUDE 2 PROBES

### NEW 15 MHz DUAL TRACE PORTABLE OSCILLOSCOPE



Ideal for field/bench applications, this scope can display up to 15 MHz signals. Internal battery pack allows up to 2 hours operation on a single charge. Features include • built-in battery charger • 5X horizontal magnification • high brightness CRT • front panel trace rotator • internal rechargeable battery pack

2500 Portable Oscilloscope

**\$449.95** includes 2 high quality probes

### MINI KITS—EASY TO ASSEMBLE, FUN TO USE BEGINNERS & PROS WILL HAVE A GREAT TIME WITH THESE KITS

### FM MINI MIKE

A super high performance FM wireless, mike kit. Transmits a stable signal up to 300 yards with exceptional audio quality by means of its built in electret mike. Kit includes case, mike, on-off switch, antenna, battery and super instructions. This is the finest unit available

FM-3 Kit \$14.95  
FM-3 Wired and Tested \$19.95

### Color Organ

See music come alive! 3 different lights flicker with music. One light each for, high, mid-range and lows. Each individually adjustable and drives up to 300 W. runs on 110VAC.

Complete kit, ML-1 \$8.95

**Video Modulator Kit**  
Converts any TV to video monitor. Super stable, tunable over ch. 4-6. Runs on 5-15V accepts all video signals. Best and on the market! Complete kit, VD-1 \$7.95

**Led Blinky Kit**  
A great attention getter which alternately flashes 2 jumbo LEDs. Use for name badges, buttons, warning panel lights, anything! Runs on 3 to 15 volts. Complete kit, BL-1 \$2.95

**Super Sleuth**  
A super sensitive amplifier which will pick up a pin drop at 15 feet! Great for monitoring baby's room or as general purpose amplifier. Full 2W rms output, runs on 6 to 15 volts, uses 8-45 ohm speaker. Complete kit, BN-9 \$5.95

**CPO-1**  
Runs on 3-12 Vdc. 1 watt out, 1 KHz good for CPO, Alarm, Audio Oscillator. Complete kit, \$2.95

### FM Wireless Mike Kit

Transmits up to 300' to any FM broadcast radio, uses any type of mike. Runs on 3 to 9V. Type FM-2 has added sensitive mike preamp stage.

FM-1 Kit \$3.95 FM-2 Kit \$4.95

### Whisper Light Kit

An interesting kit, small mike picks up sounds and converts them to light. The louder the sound, the brighter the light. Includes mike, controls up to 300 W. runs on 110 VAC. Complete kit, WL-1 \$6.95

**Tone Decoder**  
A complete tone decoder on a single PC board. Features: 400-5000 Hz adjustable range via 20 turn pot, voltage regulation, 567 IC. Useful for touch-tone burst detection, FSK, etc. Can also be used as a stable tone encoder. Runs on 5 to 12 volts. Complete kit, TD-1 \$5.95

### Universal Timer Kit

Provides the basic parts and PC board required to provide a source of precision timing and pulse generation. Uses 555 timer IC and includes a range of parts for most timing needs.

UT-5 Kit \$5.95

### Mad Blaster Kit

Produces LOUD ear shattering and attention getting siren like sound. Can supply up to 15 watts of obnoxious audio. Runs on 6-15 VDC. Complete kit, MB-1 \$4.95

**Siren Kit**  
Produces upward and downward wail characteristic of a police siren. 5 W peak audio output, runs on 3-15 volts, uses 3-45 ohm speaker. Complete kit, SM-3 \$2.95

### 30 Watt 2 mtr PWR AMP

Simple Class C power amp features 8 times power gain. 1 W in for 8 out, 2 W in for 15 out, 4 W in for 30 out. Max output of 35 W, incredible value, complete with all parts, less case and T-R relay.

PA-1, 30 W pwr amp kit

**\$22.95**  
**6.95**

TR-1, RF sensed T-R relay kit

### Power Supply Kit

Complete triple regulated power supply provides variable 6 to 18 volts at 200 ma and -5 at 1 Amp. Excellent load regulation, good filtering and small size. Less transformers, requires 6-3V (a 1 A and 24 VCT. Complete kit, PS-3LT \$6.95

### CT-70 7 DIGIT 525 MHz COUNTER

Lab quality at a breakthrough price. Features • 3 frequency ranges each with pre amp • dual selectable gate times • gate activity indicator • 50mV @ 150 MHz typical sensitivity • wide frequency range • 1 ppm accuracy

**\$119.95** wired includes AC adapter  
CT-70 kit..... \$99.95  
BP-4 nicad pack..... 8.95

### CT-50 8 DIGIT 600 MHz COUNTER

**\$169.95** wired  
CT-50 kit..... \$139.95  
RA-1 receiver adapter kit..... 14.95

### CT-90 9 DIGIT 600 MHz COUNTER

The most versatile for less than \$300. Features 3 selectable gate times • 9 digits • gate indicator • display hold • 25mV @ 150 MHz typical sensitivity • 10 MHz timebase for WWV calibration • 1 ppm accuracy

**\$149.95** wired includes AC adapter  
CT-90 kit..... \$129.95  
OV-1 0.1 PPM oven timebase..... \$9.95  
BP-4 nicad pack..... 8.95

### CT-125 9 DIGIT 1.2 GHz COUNTER

**\$169.95** wired includes AC adapter  
BP-4 nicad..... \$8.95

### DM-700 DIGITAL MULTIMETER

Professional quality at a hobbyist price. Features include 26 different ranges and 5 functions • 3 1/2 digit, 1/2 inch LED display • automatic decimal placement • automatic polarity

**\$119.95** wired includes AC adapter  
DM-700 kit..... \$99.95  
MP-1 probe set..... 4.95

### PR-2 COUNTER PREAMP

The PR-2 is ideal for measuring weak signals from 10 to 1000 MHz • flat 25 db gain • BNC connectors • great for shifting RF • ideal receiver/TV preamp

**\$44.95** wired includes AC adapter  
PR-2 kit..... \$34.95

### PS-2 AUDIO MULTIPLIER

The PS-2 is handy for high resolution audio resolution measurements, multiplies up in frequency • great for PL tone measurements • multiplies by 10 or 100 • 0.01 Hz resolution • built-in signal preamp/conditioner

**\$49.95** wired  
PR-2 kit..... \$39.95

### PS-10B 1.5 GHz PRESCALER

Extends the range of your present counter to 1.5 GHz • 2 stage preamp • divide by 1000 circuitry • super sensitive (50 mV typical) • BNC connectors • 1 GHz in, 1 MHz out • drives any counter

**\$79.95** wired includes AC adapter

### ACCESSORIES FOR RAMSEY COUNTERS

Telescopic whip antenna—BNC plug... \$ 8.95  
High impedance probe, light loading... 16.95  
Low pass probe, audio use... 16.95  
Direct probe, general purpose use... 13.95  
Tilt bail, for CT-70, 90, 125... 3.95



PHONE ORDERS CALL  
**716-586-3950**

TELEX 466735 RAMSEY CI



RAMSEY ELECTRONICS, INC.  
2575 Baird Rd.  
Penfield, N.Y. 14626

## NEW BOOKS

### RADIO SYSTEMS FOR TECHNICIANS

by D. C. Green

This brand new book is your single volume source book on the theory and application for transmission and reception of radio frequency signals. This book discusses the principles of both AM and FM transmission, how to build and use antennas and transmission lines, radio wave propagation, the use of landline, radio wideband systems, the various stages of selectivity and sensitivity and the modes and operations of radio receivers and transmitters. Every aspiring technician or Radio Amateur should have a copy of this book in their shack. © 1985 1st edition 280 pages.

22464 Softbound \$12.95

### RADIO DATA REFERENCE BOOK

5th Edition

by G. R. Jesop, G6JP and R. S. Hewes, G3TDR

A brand new edition of the reference "bible" for all Amateurs and electronic enthusiasts. Perfect complement to ARRL HANDBOOK. Covers units and symbols, basic calculations, resonant circuits and filters, circuit design, antennas and transmission lines, radio and TV services, geographical and meteorological data, materials and engineering data and mathematical data. © 1985 5th edition 244 pages.

RS-RDR Hardbound \$14.95

### AMATEUR RADIO SOFTWARE

by John Morris, GM4ANB

Brand new from RSGB, this computer source book is chock full of computer programs, hints, tips and handy ideas for computer owners and users. Nearly 100 programs include contest logging routines, EME, construction, Morse training, and Packet Radio to name just a few. Morris' approach to writing this book was twofold. One was to give the computer user programs that had been de-bugged and were ready to type in and run. The second was as a source book for programming ideas and expansion. Most programs are written in BASIC so at least a fundamental knowledge of simple programming will be helpful to get maximum use from this book. © 1985 328 pages 1st edition.

RS-ARS Hardbound \$14.95

### 1986 WORLD RADIO TV HANDBOOK

40th Edition

Often referred to as the SWL's bible, this 40th anniversary edition is sure to be a best seller. Its loaded with all the latest call signs, schedules, frequencies, and other important information for TV and radio broadcasters around the world. Covers LF, MF and SW broadcasting services as well as TV stations around the world. Also includes equipment reviews and other special features. If you haven't seen a copy before, you don't know what you're missing! © 1986 40th edition.

GL-WRTV86 Softbound \$19.95

### RADIO RECEIVERS chance or choice

by Rainer Litche

A compilation of critical technical and operator reviews of most of the SWL receivers on the market today. Tests were conducted by the author, a well known European electronic engineer. Reviews include Panasonic, Sony, Kenwood, Drake, Hitachi, ICOM, Bearcat, Yaesu and Zenith to name just a few. Also includes selected older models. Intro section covers SWL basics in simple terms. © 1985 1st Edition 223 pages.

GL-RR Softbound \$18.50

### ARRL COMPUTER NETWORKING CONFERENCES 1-4

Pioneer Papers on Packet Radio 1981-1985

This collection of Packet Radio papers should be in every Packet enthusiasts shack! Written during the formative years of Packet development, these papers (too numerous to mention them all) cover theory, practical applications, protocols, software and hardware subjects. You also get a complete up-to-date collection of all published "Gateway", the ARRL Packet Radio newsletter. As big as the ARRL HANDBOOK, this new book is sure to be the ARRL's next best seller! © 1985 over 1000 pages.

AR-CNC Softbound \$17.95

Please enclose \$3.50 shipping and handling

### HAM RADIO'S BOOKSTORE

Greenville, NH 03048

# TIRED OF THE TAIL WAGGIN' THE DOG?

## GO TEN-TEC ULTIMATE

TEN-TEC's ULTIMATE high frequency mobile antenna complements today's smaller cars with a sleek high performance design measuring less than 6 1/2 feet and weighing a bare 12 ounces. You'll never have to fold the ULTIMATE antenna... or guy it with fishing line to keep it vertical and resonant at highway speeds. There's less mass to resist the wind, yet the ULTIMATE is ruggedly built, easy to install, and packs a no compromise punch so necessary in mobile operations.

The ULTIMATE features a longer coil housed in a durable fiberglass shaft. Air is forced from the coil housing and replaced with helium, a stable gas that mixes with no other elements so it helps eliminate corrosion.

A telescoping stainless steel whip helps facilitate tuning. The mounting ferrule is chrome-plated brass and fits standard 3/8" x 24 mounts.

Seven "easy-on-easy-off" antennas cover 10 through 80 meters. Switchable Mobile Matcher available for all bands.

See your dealer or write

**TEN-TEC, INC.**  
SEVIERVILLE, TENNESSEE 37862

# ICOM



BIG Winter Savings On The  
ICOM Gear You Have Been  
Waiting For ...

IC 735, 745 & 751

These Savings Are For A Limited  
Time Only. So Call And  
Order Soon.

Also featuring: AEA, Larsen, Van  
Gorden, Vibroplex, Nye, Falcon, Lead-  
ing Edge, ARRL Public, Kagle, Ham-  
tronics, Prowriter, Elephant Disks,  
Debcu, Trionyx & more

Visit us at Dayton Hamvention

# VHF

## COMMUNICATIONS

915 N. Main Street  
Jamestown, NY 14701

Western New York's finest... amateur radio dealer!

VISA (716) 664-6345



# DOCKING BOOSTER

Converts Your HT to a Powerful Mobile Unit



30 or 50 watts output  
16 DB GaAs FET pre-amp  
Fits on most car doors  
Mic hang-up clip  
Icom, Yaesu, Kenwood  
2 Meters & 70 cm

**\$149<sup>95</sup>**

CMC COMMUNICATIONS, INC.  
5479 Jetport Industrial Blvd. • Tampa, FL 33614  
Phone: 813-885-3996

**DO YOU  
KNOW  
WHERE  
TO FIND  
REAL  
BARGAINS**



on **NEW** and **USED**  
**ELECTRONIC** Equipment?

*You'll Find Them  
in the Nation's No. 1  
Electronic Shopper Magazine*

## NUTS & VOLTS

*Now in Our 5th Year*

Nuts & Volts is published MONTHLY and features:  
**NEW STATE-OF-THE-ART PRODUCTS •  
SURPLUS EQUIPMENT • USED BARGAINS  
• LOW COST AD RATES • PRIVATE AND  
COMMERCIAL CLASSIFIEDS • NATIONAL  
CIRCULATION • NEW PRODUCT NEWS  
SECTION • AND A FREE CLASSIFIED AD  
WITH YOUR SUBSCRIPTION**

### SUBSCRIPTION RATES

- One Year - 3rd Class Mail ..... \$10.00  
 One Year - 1st Class Mail ..... \$15.00  
 One Year - Canada & Mexico (in U.S. Funds) .. \$18.00  
 Lifetime - 3rd Class Mail (U.S. Only) ..... \$35.00

### ORDER NOW!

SEND:  CHECK  MONEY ORDER  
 VISA  MASTERCARD

TO: **NUTS & VOLTS MAGAZINE**  
**P.O. BOX 1111-H**  
**PLACENTIA, CALIFORNIA 92670**  
**(714) 632-7721**

Name \_\_\_\_\_  
Address \_\_\_\_\_  
City \_\_\_\_\_  
State \_\_\_\_\_ Zip \_\_\_\_\_  
Card No. \_\_\_\_\_  
Exp. Date \_\_\_\_\_

**IF YOU'RE INTO ELECTRONICS,  
THIS MAGAZINE WILL SAVE YOU MONEY!**

Dealer Inquiries Invited

147

## QUALITY ETCHED PC BOARDS IN LESS THAN 5 MINUTES.

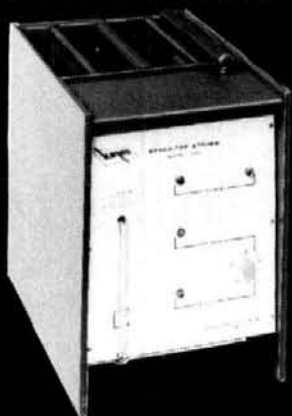

Convenient economical, high quality production of 12" x 12" panels is obtained using Kepro's Bench-Top Spray Etcher, only \$765. Kepro—the one stop source for all your Prototype and Short Run PCB needs.

# kepro



Kepro Circuit Systems, Inc.

Write for full line catalog or call  
1-800-325-3878 • 1-314-343-1630 (Missouri)

630 Axminster Drive • Fenton, MO 63026-2992



# COLORADO COMM CENTER

## KENWOOD



**TR-2600**  
2.5W/300MW (swt)  
Channel 2 Meter  
hand held  
transceiver  
• LCD Readout  
• 10 Memories w/  
Lithium Back up  
• Band and  
Memory Scan



**TH-21AT**  
• Compact Pocket  
Size  
• 1 Watt  
• 0 Pt. 500 M A  
Battery

**TH-2570**



• First 70 Watt FM Mobile • First with Memory &  
Autodialer • 23 Channel Memory • Front  
Panel Programmable CTCSS



**TS-940S**  
"DX-celence"

• Programmable Scanning  
• High Stability Dual Digital VFO's  
• 40 Channel Memory  
• General Coverage Receiver



**800-227-7373**

- AEA
- ALINCO
- ASTRON
- AVANTI
- B&W
- BENCHER
- BUTTERNUT
- CUSHCRAFT
- DAIWA
- HAM-KEY
- HUSTLER
- HYGAIN
- ICOM
- KANTRONICS
- KDK
- KENPRO
- KENWOOD
- KLM
- LARSEN
- MFJ
- MIRAGE
- NYE VIKING
- QUATRON
- SANTEC
- WELZ
- YAESU

**COD'S WELCOME**

## YAESU



**FT-209RH**  
• 5 Watts  
• 10 Memories  
• LCD  
• Compact

**FT-2700R**

• Duo-Band Full Duplex  
• 25 Watt

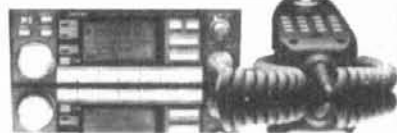

**FRG-9600**

• 100 Memories  
• 60 MHZ - 905 MHZ Continuous



4262 Lowell Blvd. • Denver, Co. 80211 • 433-3355

115

## SPRING SUNSPOT SALE! SAVE \$700

### COMPUTERIZED DX EDGE

Generate your own Greyline display. Xantek has adapted their best selling DX Edge to the computer world and it comes at a very reasonable price. This computerized operating aid brings into your ham shack the ability to know and predict when and where DX is going to appear. When you are using the program, the computer will automatically update the information as the sun progresses across the face of the Earth. To make the computerized DX Edge even easier to use, the display is keyed to the DXCC list and the 40 CQ zones. Disk and documentation included. This is something you've Got to have! ©1985.

□ XN-C64 (For Commodore C-64) REG 34.95

Now JUST \$27.95

Please add \$3.50 for postage and handling

**ham radio** BOOKSTORE  
GREENVILLE, NH 03048

## DIRECTION FINDING?

- ★ Interference Location
- ★ Stuck Microphones
- ★ Cable TV Leaks
- ★ Security Monitoring



- ★ VHF and UHF Coverage
- ★ Computer Interface
- ★ Speech Synthesizer
- ★ 12 VDC Operation

**New Technology** (patent pending) converts any VHF or UHF FM receiver into an advanced Doppler shift radio direction finder. Simply plug into receiver's antenna and external speaker jacks. Uses four omnidirectional antennas. Low noise, high sensitivity for weak signal detection. Call or write for full details and prices.

**DOPPLER SYSTEMS, INC.** 5540 E. Charter Oak, (602) 998-1151  
Scottsdale, AZ 85254

178

## WRITE FOR FREE BOOK CATALOG

Ham Radio's Bookstore  
Greenville, NH 03048

## Crystal Filters

For most Ham Rigs from:  
KENWOOD - YAESU - HEATHKIT  
Also DRAKE R-4C/7 Line, COLLINS 75S3-B/C,  
and ICOM (FL44A Twin Only)

Finest 8-pole Construction  
ALL POPULAR TYPES IN STOCK  
CW - SSB - AM

Phone for Information or to Order.  
VISA/MC or COD accepted.

**FOX-TANGO Corp.**  
Box 15944, W. Palm Bch, FL 33416  
Telephone: (305) 683-9587

# Message Master™

## Real-voice message system For any repeater or base

Now you can communicate vital information even when the station you are calling is not on the air — with Message Master. Message Master is a solid state voice recording system which can record messages just by listening to you speak, store messages in memory, and deliver messages on demand. If you can't be there to deliver your messages let Message Master deliver them for you - any messages in any language and in your own voice!

Message Master connects easily to any radio system for remote access: repeaters, base stations, even transceivers. It can even be connected to an autopatch device to exchange messages between your radio system and the telephone network.

Message Master is a multi-user system with mailbox style personalized message service for a hundred users. With 8 minutes of message storage it can store hundreds of messages simultaneously making it ideal for large, active repeater groups.

Would you like your callsign identifications, tail messages, and bulletin messages sent in real-voice? Message Master can send them too. Record several identification messages and it will even send a different ID each time. Almost like magic, Message Master knows when to send identifications and tail messages so it needs no special control signals from your base or repeater.

Call or write for further information before you make another wasted call.

Commercial users: Ask for a brochure on the Message Master Electronic Dispatcher with group and all call messaging.



- Create messages just by talking. Message Master's 'real-voice' technique saves YOUR VOICE in digital memory to deliver messages in your own voice, language and dialect.
- Mailbox-style operation gives individual message delivery service to 100 system users.
- Easily added to any repeater or base station for remote operation with only four connections.
- Special features include callsign identifications, tail messages, and bulletin messages.
- Digital message storage provides instant playback of stored messages.
- Modular memory meets your exact needs from 2 to 1 minutes of total message storage.

## Serving all your repeater needs

- Mark 4 Repeaters and Repeater Controllers are THE PERFORMANCE LEADERS with real voice, more autodial numbers more synthesized voice and more features.
- Mark 3 Repeaters offer the winning combination of high performance and high value.
- LR-1 Repeaters boast superb RF circuitry at an economical price.
- MR-4 Receivers with 7 helical resonators are the only receiver to choose in harsh RF environments.
- PA-100 Amplifiers with rugged TMOS power FETs give you a continuous duty high power signal.



COMING SOON: A 4-channel receiver voting system which operates on true signal-to-noise ratio to extend your coverage by linking remote receivers.

✓ 137



KENDECOM INC.  
MICRO CONTROL SPECIALTIES

23 Elm Park  
Groveland, MA 01834  
(617) 372-3442

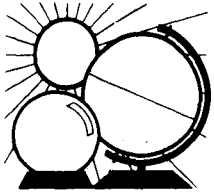

## DX FORECASTER

Garth Stonehocker, KØRYW

### springtime QRN

**How's the noise affecting your DX?** The weakest DX signal that can be heard is limited by the noise level at your receiver. The readability is lowered considerably by that noise you hear. But where's the noise coming from?

One way of classifying noise sources is by identifying it as local or distant. Your receiver could be one local source of noise; yet most HF receivers used today, if kept in good repair, are good enough not to add appreciable noise that would affect amplification and detection of weak DX. Other sources of local electrical noise are power lines, electric motors, automobiles, televisions and computers, and solid-state type transmitters nearby.

If you're not located in the city near a factory, machine shop, or even in the country near a noisy power line, you're fortunate. If so, you've probably found, controlled, or scheduled around the worst of it. Finding local noise sources is an intriguing, frustrating form of transmitter hunting, an art on which several articles have been written.

If none of these local nuisances can be pinpointed as the source of your noise problem, then you'll have to consider the possibility of a more distant source — atmospheric noise. The cumulative effects of thunderstorms are propagated to your antenna via the same ionospheric layers you're using to communicate. The effects may also result from local storms within your ground wave propagation distance (50 to 100 miles or 80 to 160 km).

Potent thunderstorm noise at this time of year results from the following

situation: In March and April, spring storms bring rain to much of the northern hemisphere. Fronts of warm and cold air generate the first major thunderstorms of the year. Fast-moving cold fronts produce particularly potent thunderstorms. As a storm front approaches your area, a significant increase in the noise level is heard. You'll first notice this increase at a one-hop distance away (about 600 to 1200 miles or 960 to 1920 km) when the storm front is about one day west of your location. The noise level will usually decrease after that until the storm reaches within a ground-wave's distance. Now, loud individual discharges can be heard. As the storm draws nearer, its sounds become part of the "local noise"; as it moves away, its noise decreases, then increases again as the front reaches the one-hop distance point a day or so later. (You can correlate this with storm progress reports on local television.) You can save time in looking for rare DX by tracking storms in order to pinpoint when the most favorable listening conditions are likely to occur.

### last-minute forecast

The first and last weeks of the month are expected to produce the best higher frequency band, 15 to 30 meters, DX openings of the month. Whatever 27-day solar cycle variation is to occur, the rise in solar activity will take place during these days. Some transequatorial openings, mainly during geomagnetically disturbed periods can be expected. The middle two weeks can probably best be spent on the lower bands for DX openings to the east, north, and west during the night. During the disturbed magnetic periods keep your ear trained on the unusual rare DX you need for WAC. You may be lucky; March is the first month of the equinoxial geomagnetic disturbed period of each year, so you can expect disturbance and no real quiet in between. Expect also the intensity and length of the disturbances to increase throughout the month. April, however, is usually more

disturbed than March. Spring equinox occurs on March 20th at 2203 UTC. The moon is full on the 3rd and at perigee on the 1st and 28th.

### band-by-band summary

*Ten and twelve meters*, the highest day-only DX bands, are nearest the MUF for southern hemisphere paths. They will be open most days when the solar flux is above 75 during the 7 to 10-hour period centered on local noon. These bands open on paths toward the east and close toward the west. The paths are up to 2400 miles (4000 km) in single-hop length, and on occasion double that during evening transequatorial openings.

*Fifteen meters*, a day-only DX band open most of each day, has lower signal strengths and greater multipath variability than 10 and 12 meters. It will be best when the MUF is slightly above to slightly below this band — a transition period that occurs right after sunrise and just before sunset. Transequatorial openings will occur, with distances similar to 10 and 12 meters.

*Twenty, thirty, and forty meters* are both daytime and nighttime DX bands. Twenty is the maximum usable band for DX in the northern directions during the day. In combination with 30 meters, it provides nighttime paths for the day-only bands. Forty meters becomes the main over-the-pole DX daytime band, with some hours covered by 30 meters.

*Eighty and one sixty meters*, the night-only DX bands, exhibit short-skip propagation during daylight hours, then lengthen at dusk. These bands follow the darkness path, opening to the east just before local sunset, swinging more to the north-south near midnight, and ending up in the Pacific areas for a few hours before dawn. On some nights, 80 meters, with its higher signal strengths, will be the best band to use. One-sixty is also expected to provide good conditions most of the days. Please remember the DX windows of 3790 to 3800, 1825 to 1830, and 1850 to 1855 kHz.

# THE MOST AFFORDABLE REPEATER

ALSO HAS THE MOST IMPRESSIVE PERFORMANCE FEATURES

(AND GIVES THEM TO YOU AS STANDARD EQUIPMENT!)

Band	Kit	Wired
10M,6M, 2M,220	\$680	\$880
440	\$780	\$980

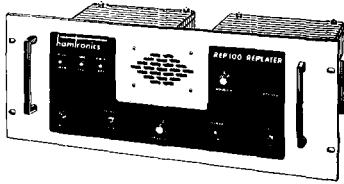

## FEATURES:

- SENSITIVITY SECOND TO NONE; 0.15 uV (VHF), 0.2 uV (UHF) TYP.
- SELECTIVITY THAT CAN'T BE BEAT! BOTH 8 POLE XTAL FILTER & CERAMIC FILTER FOR > 100 dB AT ± 12KHZ. HELICAL RESONATOR FRONT ENDS TO FIGHT DESENSE & INTERMOD.
- OTHER GREAT RECEIVER FEATURES: FLUTTER-PROOF SQUELCH, AFC TO COMPENSATE FOR OFF-FREQ TRANSMITTERS, SEPARATE LOCAL SPEAKER AMPLIFIER & CONTROL.
- CLEAN, EASY TUNE TRANSMITTER; UP TO 20 WATTS OUT (UP TO 50W WITH OPTIONAL PA).

## HIGH QUALITY XMTR & RCVR MODULES FOR REPEATERS, LINKS, TELEMETRY, ETC.

- **R144/R220 FM RCVRs** for 2M or 220 MHz. 0.15uV sens.; 8 pole xtal filter & ceramic filter in i-f, helical resonator front end for exceptional selectivity, > 100dB at ± 12KHz, best available today. Flutter-proof squelch. AFC tracks drifting xmtrs. Xtal oven avail. Kit only \$138.
- **R451 FM RCVR** Same but for uhf. Tuned line front end, 0.3 uV sens. Kit only \$138.
- **R76 FM RCVR** for 10M, 6M, 2M, or 220. As above, but w/o AFC or hel. res. Kits only \$118. Also avail w/4 pole filter, only \$98/kit.
- **R110 VHF AM RECEIVER** kit for VHF aircraft or ham bands or Space Shuttle. Only \$98.

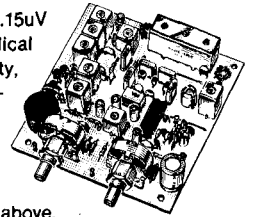

- **T51 VHF FM EXCITER** for 10M, 6M, 2M, or 220 MHz. 2 Watts continuous, up to 3W intermittent. \$68/kit.
- **T451 UHF FM EXCITER** 2 to 3 Watts. Kit only \$78. Xtal oven avail.
- **VHF & UHF LINEAR AMPLIFIERS.** For either FM or SSB. Power levels from 10 to 45 Watts to go with exciters & xmtg converters. Several models. Kits from \$78.

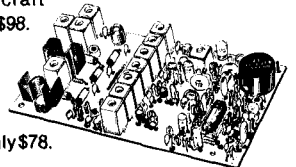

NOW—FCC TYPE-ACCEPTED TRANSMITTERS & RECEIVERS AVAILABLE FOR HIGH-BAND & UHF. CALL FOR DETAILS.

## RECEIVING CONVERTERS

Models to cover every practical rf & if range to listen to SSB, FM, ATV, etc. NF = 2dB or less.

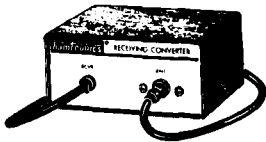

Antenna Input Range	Receiver Output
28-32	144-148
50-52	28-30
50-54	144-148
144-146	28-30
145-147	28-30
144-144.4	27-27.4
146-148	28-30
144-148	50-54
220-222	28-30
144-148	144-148
222-226	144-148
220-224	50-54
222-224	28-30

### VHF MODELS

Kit with Case	\$49
Less Case	\$39
Wired	\$69

### UHF MODELS

Kit with Case	\$59	432-434	28-30
Less Case	\$49	435-437	28-30
Wired	\$75	432-436	144-148
		432-436	50-54
		439.25	61.25

SCANNER CONVERTERS Copy 806 MHz band on any scanner. Wired/tested ONLY \$88.

## TRANSMIT CONVERTERS

For SSB, CW, ATV, FM, etc. Why pay big bucks for a multi mode rig for each band? Can be linked with receive converters for transceive. 2 Watts output vhf, 1 Watt uhf.

Exciter Input Range	Antenna Output
28-30	144-146
28-29	145-146
28-30	50-52
27-27.4	144-144.4
28-30	220-222*
50-54	220-224
144-146	50-52
50-54	144-148
144-146	28-30

For VHF, Model XV2  
Kit \$79  
Wired \$149  
(Specify band)

For UHF, Model XV4  
Kit \$99  
Wired \$169

\*Add \$20 for 2M input

VHF & UHF LINEAR AMPLIFIERS. Use with above. Power levels from 10 to 45 Watts. Several models, kits from \$78.

## LOW-NOISE PREAMPS

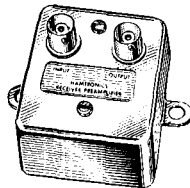

Hamtronics Breaks the Price Barrier!

\*  
No Need to Pay \$80 to \$125 for a GaAs FET Preamp.

### FEATURES:

- Very Low Noise: 0.7dB VHF, 0.8dB UHF
- High Gain: 13 to 20dB, Depending on Freq.
- Wide Dynamic Range for Overload Resistance
- Latest Dual-gate GaAsFET, Very Stable

MODEL	TUNES RANGE	PRICE
LNG-28	26-30 MHz	\$49
LNG-50	46-56 MHz	\$49
LNG-144	137-150 MHz	\$49
LNG-160	150-172 MHz	\$49
LNG-220	210-230 MHz	\$49
LNG-432	400-470 MHz	\$49
LNG-800	800-960 MHz	\$49

## HELICAL RESONATOR PREAMPS

Low-noise preamps with helical resonators reduce intermod and cross-band interference in critical applications. 12 dB gain.

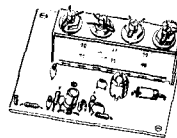

Model	Tuning Range	Price
HRA-144	143-150 MHz	\$49
HRA-220	213-233 MHz	\$49
HRA-432	420-450 MHz	\$59
HRA-( )	150-174 MHz	\$54
HRA-( )	450-470 MHz	\$64

## MINIATURE PREAMPS

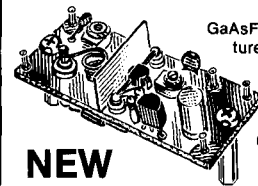

GaAsFET Preamps with features similar to LNG, except designed for LOW COST and SMALL SIZE: only 5/8" W x 1-5/8" L x 3/4" H. Easily mounts inside many radios.

NEW

MODEL	TUNES RANGE	KIT	WIRED
LNW-144	120-150 MHz	\$19	\$34
LNW-160	150-200 MHz	\$19	\$34
LNW-220	200-270 MHz	\$19	\$34
LNW-432	400-500 MHz	\$19	\$34

## IN-LINE PREAMPS

NEW

GaAsFET Preamp with features like LNG. Automatically switches out of line during transmit. Use with base or mobile transceivers up to 25W. Tower mtg hdwr incl.

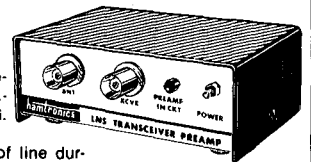

MODEL	TUNES RANGE	KIT	WIRED
LNS-144	120-150 MHz	\$68	\$98
LNS-160	150-180 MHz	\$68	\$98
LNS-220	200-240 MHz	\$68	\$98
LNS-432	400-500 MHz	\$68	\$98

## ACCESSORIES

- **MO-202 FSK DATA MODULATOR.** Run up to 1200 baud digital or packet radio signals through any FM transmitter.
- **DE-202 FSK DATA DEMODULATOR**
- **COR-2 KIT** With audio mixer, local speaker amplifier, tail & time-out timers.
- **COR-3 KIT** with "courtesy" beep".
- **DTMF DECODER/CONTROLLER KITS**
- **AUTOPATCH KITS.** Provide repeater autopatch, reverse patch, phone line remote control of repeater, secondary control.
- **CWID KITS** • **SIMPLEX AUTOPATCH**

- Send \$1 for Complete Catalog (Send \$2.00 or 4 IRC's for overseas mailing)
- Order by phone or mail • Add \$3 S & H per order (Electronic answering service evenings & weekends)
- Use VISA, MASTERCARD, Check, or UPS COD.

# hamtronics, inc.

65-E MOUL ROAD • HILTON NY 14468

Phone: 716-392-9430

Hamtronics® is a registered trademark

**WESTERN USA**

GMT	PST										
	4:00	5:00	6:00	7:00	8:00	9:00	10:00	11:00	12:00	1:00	2:00
0000	20	20	20	20	20	20	20	20	20	20	20
0100	20	40	40	40	40	40	40	40	40	40	40
0200	20	40	40	40	40	40	40	40	40	40	40
0300	20	40	40	40	40	40	40	40	40	40	40
0400	20	40	40	40	40	40	40	40	40	40	40
0500	30	40	40	40	40	40	40	40	40	40	40
0600	30	40	40	40	40	40	40	40	40	40	40
0700	40*	40	40	40	40	40	40	40	40	40	40
0800	40	40	40	40	40	40	40	40	40	40	40
0900	40	40	40	40	40	40	40	40	40	40	40
1000	40	40	40	40	40	40	40	40	40	40	40
1100	40	40	40	40	40	40	40	40	40	40	40
1200	40	40	40	40	40	40	40	40	40	40	40
1300	40	40	40	40	40	40	40	40	40	40	40
1400	40	40	40	40	40	40	40	40	40	40	40
1500	30	20	20	20	20	20	20	20	20	20	20
1600	30	20	20	20	20	20	20	20	20	20	20
1700	40	20	20	20	20	20	20	20	20	20	20
1800	40	20	20	20	20	20	20	20	20	20	20
1900	40	20	20	20	20	20	20	20	20	20	20
2000	40	20	20	20	20	20	20	20	20	20	20
2100	40	30	30	30	30	30	30	30	30	30	30
2200	40	30	30	30	30	30	30	30	30	30	30
2300	40	30	30	30	30	30	30	30	30	30	30

**MID USA**

GMT	MST										
	5:00	6:00	7:00	8:00	9:00	10:00	11:00	12:00	1:00	2:00	3:00
0400	40	40	40	40	40	40	40	40	40	40	40
0500	40	40	40	40	40	40	40	40	40	40	40
0600	30	40	40	40	40	40	40	40	40	40	40
0700	30	40	40	40	40	40	40	40	40	40	40
0800	30	40	40	40	40	40	40	40	40	40	40
0900	30	40	40	40	40	40	40	40	40	40	40
1000	40	40	40	40	40	40	40	40	40	40	40
1100	40	40	40	40	40	40	40	40	40	40	40
1200	40	40	40	40	40	40	40	40	40	40	40
1300	40	40	40	40	40	40	40	40	40	40	40
1400	40	40	40	40	40	40	40	40	40	40	40
1500	40	40	40	40	40	40	40	40	40	40	40
1600	40	40	40	40	40	40	40	40	40	40	40
1700	40	40	40	40	40	40	40	40	40	40	40
1800	40	40	40	40	40	40	40	40	40	40	40
1900	40	40	40	40	40	40	40	40	40	40	40
2000	40	40	40	40	40	40	40	40	40	40	40
2100	40	40	40	40	40	40	40	40	40	40	40
2200	40	40	40	40	40	40	40	40	40	40	40
2300	40	40	40	40	40	40	40	40	40	40	40

**EASTERN USA**

GMT	EST										
	7:00	8:00	9:00	10:00	11:00	12:00	1:00	2:00	3:00	4:00	5:00
0400	30	30	30	30	30	30	30	30	30	30	30
0500	30	30	30	30	30	30	30	30	30	30	30
0600	30	30	30	30	30	30	30	30	30	30	30
0700	30	30	30	30	30	30	30	30	30	30	30
0800	30	30	30	30	30	30	30	30	30	30	30
0900	30	30	30	30	30	30	30	30	30	30	30
1000	30	30	30	30	30	30	30	30	30	30	30
1100	30	30	30	30	30	30	30	30	30	30	30
1200	30	30	30	30	30	30	30	30	30	30	30
1300	30	30	30	30	30	30	30	30	30	30	30
1400	30	30	30	30	30	30	30	30	30	30	30
1500	30	30	30	30	30	30	30	30	30	30	30
1600	30	30	30	30	30	30	30	30	30	30	30
1700	30	30	30	30	30	30	30	30	30	30	30
1800	30	30	30	30	30	30	30	30	30	30	30
1900	30	30	30	30	30	30	30	30	30	30	30
2000	30	30	30	30	30	30	30	30	30	30	30
2100	30	30	30	30	30	30	30	30	30	30	30
2200	30	30	30	30	30	30	30	30	30	30	30
2300	30	30	30	30	30	30	30	30	30	30	30

The italicized numbers signify the bands to try during the transition and early morning hours, while the standard type provides MUF during "normal" hours.

\*Look at next higher band for possible openings.

ham radio





- **Technical Forums**      Personal Computer, Packet Radio, ARRL, AMSAT, Antennas, RTTY, SSTV/ATV, FCC, Electrical Safety and many, many others.

---

- **New Products**      See, touch and feel the latest in high-tech equipment.

---

- **Giant Flea Market**      Starting at noon Friday, all day Saturday and Sunday. All spaces are **SOLD OUT**.

---

- **License Exams**      Novice through Extra, by reservation only. Send a completed form 610, a copy of your present license and a check or money order for \$4.25 payable to ARRL/VEC. Indicate the desired time. Send to: License Exam, Attn. Tom Holmes, 8830 Windbluff Pt., Dayton, OH 45459. **Deadline: March 29.**

---

- **Alternate Activities**      HAMVENTION is for everyone. We have planned activities for the YL or your non-ham family members.

---

- **Special Awards**      Nominations are requested for "Radio Amateur of the Year," "Special Achievement" and "Technical Achievement" Awards. Contact: Awards Chairman, Box 44, Dayton, OH 45401. **Deadline: April 1.**

---

- **CW Awards**      See how fast you can copy the International Morse Code (World record is 72.5 WPM). All participants receive an award indicating their maximum speed.

---

- **Admission**      Registration: \$8.00 in advance, \$10.00 at the door.  
Banquet (Roy Neal, K6DUE, Speaker): \$14 in advance, \$16.00 at the door, **if available.**  
Ladies Luncheon: \$6.75.  
Last Day for advance tickets: April 5 (Canada), April 12 (U.S.).

---

- **Housing**      Most motel rooms in the Dayton area have been set aside for the HAMVENTION. Write: Dayton HAMVENTION Housing, 1980 Kettering Tower, Dayton, OH 45423-1980. **NO RESERVATIONS WILL BE ACCEPTED BY TELEPHONE.**

---

- **Parking**      Free parking is available at Hara Arena. In addition, there will be free shuttle bus service from all major motels and designated parking lots. Parking and road information is available on DARA's 146.34/.94 repeater.

---

- **Other Information**      Special air fares are available on Piedmont and USAir. A free slide show about the HAMVENTION is available for club meetings. Wheelchairs and handicap parking are available. For more information . . . Write: Box 44, Dayton, OH 45401 or call (513) 433-7720.

This is the year for you to attend the internationally famous Dayton HAMVENTION. Come with your friends to hear enlightening forums, see the latest equipment, and visit a flea market that has everything! No matter what you are looking for, you can find it in Dayton!



# Eureka!

We just struck gold with a miniature, high quality and very reliable DTMF decoder at a rock bottom price of \$59.95. Our DTD-1 will decode 5040, 4 digit codes with the security of wrong digit reset. It contains a crystal controlled, single chip DTMF decoder that works great in bad signal to noise environments and provides latched and momentary outputs. Why carry that heavy gear when its size is only 1.25 x 2.0 x .4 inches and it comes with our etched in stone, legendary, one year warranty.

Instead of sifting through the field...searching, use our super quick one day delivery and cash in on a rare find.

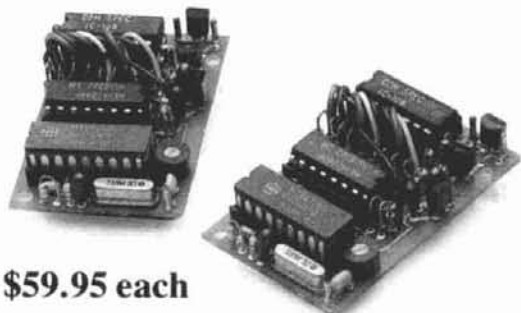

**\$59.95 each**

**COMMUNICATIONS  
SPECIALISTS**

426 W. Taft Ave., Orange, CA 92665-4296  
Local (714) 998-3021 • FAX (714) 974-3420  
Entire U.S.A. 1-800-854-0547



# ICOM R71-751-R7000\* COMPUTER INTERFACE



MEC 71α



MICROCOMPUTER ELECTRONICS CORPORATION NOW OFFERS THE M.E.C. 71α COMPUTER CONTROL INTERFACE THAT WILL CONTROL AND EXPAND THE CAPABILITY OF THE ICOM R71A.



**MAIN MENU** Control center for entire system. Showing: 24HR UTC time; radio freq. & mode; memory CH, freq, mode plus ID functions for your selection.

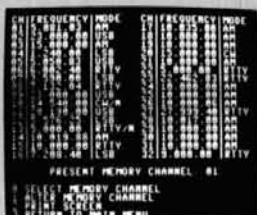

**32 CH RADIO MEMORY** Showing freq to 10 Hz, mode, filter w/n. Load/change any memory, mode, filter direct from keyboard and print command.

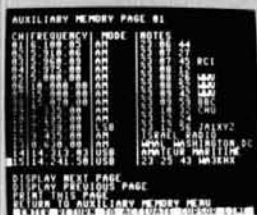

**AUXILIARY MEMORY** Showing page 1 of 47 pages each having 15 memories. Freq, mode, UTC time and room for your notes. Auto log feature allows instant logging of receiver freq, mode, time.

- **Easy to use.** No computer knowledge needed, automatic program loading. No disk or tape required (except for aux memory storage).
- **Menu driven** to aid user at each step.
- **No radio modification necessary** (ICOM EX309 — not supplied — required).
- **AUTO LOG** Allows logging of radio freq, mode and time by press of a key.
- **UNLIMITED STORAGE** via computer disk or tape (store 705 CH per disk side). Let your imagination run wild.
- **Software update.** As new software is developed MEC will make it available to owner subscribers.

- **HARD COPY** via computer printer of all memory channels.
- **KEYBOARD** memory loading.

**INTRODUCTORY PRICE**  
**\$199.95**  
(+ \$4.00 UPS)

EX309 required but not included. Price: \$39.00  
Dealer Inquires invited.

EEB is the exclusive distributor for Micro-computer Electronics Corp's products worldwide.  
EEB is an authorized ICOM dealer and service center.

## GET ALL THE DETAILS. WRITE OR CALL EEB TODAY



- Prices & specs subject to change
- Shipping charges not included
- Returns subject to 20% restock charge
- Free catalog in USA; all others 3 IRC's

ORDER TOLL FREE 800-368-3270  
Tech Info — VA orders 703-938-3350

**ELECTRONIC EQUIPMENT BANK**  
516 Mill Street NE  
Vienna, VA 22180 USA

126

## AZOTIC INDUSTRIES

2026 W. BELMONT  
CHICAGO, IL 60618  
312-975-1290

### ELECTRONIC COMPONENTS & SUPPLIES

- RF CONNECTORS
- UG CONNECTORS
- AUDIO CONNECTORS
- LINEAR IC'S
- DIGITAL IC'S
- TRANSFORMERS
- METERS
- COMPUTER CABLES
- DISKETTES
- IDC CONNECTORS
- D-SUBMINIATURE
- TEST EQUIP
- TRANSISTORS
- DIODES
- TRIM CAPS
- RELAYS
- SWITCHES
- TOOLS

VISIT OUR RETAIL STORE  
HRS. MON-FRI 10-5 SAT 10-2  
PHONE ORDERS WELCOMED  
312-975-1290

177



CURLY CODE

- Exciting NEW learning experience lets the code RHYTHM build "unforgettable" shapes in your mind's eye. Sounds ADD to the shape you already SEE: so never change your mind about them! Shapes ARE the characters: write them!
  - BEGINNERS: no "study" because: Only EIGHT shapes give you HALF of EVERYTHING and nearly ALL the LETTERS. Know EVERYTHING: only 2 more endings each!
  - EXPERTS: break your "learning plateau" by letting shapes form at "any" speed.
  - CLUBS: 20% discount on 10 or more sets.
  - PRICE: Complete set (Manual, Wall chart, Pocket card, Beginner's chart): \$11.50  
Manual alone (no discount): \$6.50
- MINDS  
eYe  
Minds eye Publications, Dept. H-11  
P.O. Box 131C, McLean, VA 22101

144

## BELDEN 9913 / 9914 CABLE "N" Connectors \$3.25 Crimp or Solder Type

FOX INTERNATIONAL, INC.

717 W. UNION HILLS DR., #3-190  
PHOENIX, AZ 85027.  
(602) 582-4124



"We Specialize In Custom Connectors"

184

## THE COMMODORE COMBINATION!

THE  
COMMODORE  
HAM'S  
COMPANION

COMMAND  
POST

As featured on Radio Sweden,  
Radio Netherlands and the  
W5YI Report.

The Commodore Ham's Companion: A 160 page paperback guide to using your Commodore computer in the hamshack. Good solid information on where to find software and hardware to use for CW, RTTY, AMTOR, SSTV, packet, propagation prediction, antenna modeling, satellite tracking and much more. Includes a list of over 80 sources of Commodore amateur radio software and hardware and a bibliography of over 60 magazine articles and reviews about using Commodore machines in the hamshack.

Command Post: A 32 page reprint of the popular Command Post column that includes Basic language program listings you can type in for CW and RTTY send and receive, dupe checking, program exchange and more. It also serves as a tutorial on the basics of interfacing Commodore machines for control operations.

Commodore Ham's Companion \$15<sup>99</sup>  
Command Post \$9<sup>99</sup>  
**SPECIAL \$19<sup>99</sup>** for both books when ordered together.  
**\$2.50 First Class shipping and handling applies on all US orders.**  
Mastercard and Visa accepted.

**Q&A**  
PUBLISHING  
P.O. Box 3042  
Springfield, IL  
62708

155





product

# REVIEW

## Butternut WARC Kit

The FCC recently opened the 24.890 MHz band (12 meters) for Amateur operation. Like many others, I began operation on the new band with a makeshift antenna and transmatch. In my case, the antenna was the HF6-V vertical manufactured by Butternut Electronics Corporation.

A few weeks later I obtained a Model A-18-24 WARC band conversion kit for the HF6-V. The kit consisted of two clamps and rod and capacitor assemblies which, when installed on the vertical radiator, would allow resonant operation on the 12- and 17-meter bands.

Each rod and capacitor assembly forms a parallel resonant circuit and decouples the length of the radiator above it in a manner similar to that of a conventional L-C trap. Installation of this kit has a negligible effect on the tuning of the antenna on the original six bands.

The kit required only about half an hour to install and "tweak." The SWR across the 12-meter band is less than 1.3:1.

Currently, we in the United States don't have permission to transmit on the 17-meter band; checks there have been limited to use of a noise bridge and my ears. The A-18-24 and HF6-V combination shows a definite resonance near 18.1 MHz. Signals from commercial stations in that region are also louder than with the unmodified antenna. I'm sure that readers in countries that have access to 17 meters can verify my observations with on-the-air QSO's.

—K1THP



## mobile antenna matcher

MFJ Enterprises, Inc., has announced the introduction of the MFJ-910, a mobile antenna matcher. This device lowers SWR by capacitively matching a mobile antenna to 50 ohms, resulting in more power out of the transmitter and into the antenna, especially if a solid-state

rig is being used. The MFJ-910 matches mobile antennas 10 through 80 meters.

One of the best features of this mobile antenna matcher is its compact size (only 2-1/2 x 2-1/2 inches) so it can be tucked into a corner of a car trunk or mounted inconspicuously with the mounting holes provided.

Installation is easy: simply connect the antenna to the SO-239 connector labeled "out" and the transmitter to the SO-239 connector labeled "in". This mobile antenna matcher retails for \$19.95 each, plus \$5 for shipping and handling.



For more information, contact MFJ Enterprises, Inc., P.O. Box 494, Mississippi State, Mississippi 39762.

Circle #318 on Reader Service Card.

## one-tube radio kit

A new one-tube radio kit providing the experimenter or antique radio buff the opportunity to experience early radio construction and operation is available from Antique Electronic Supply.

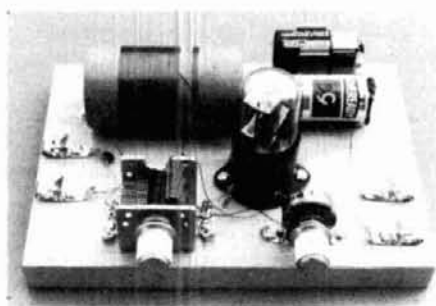

The kit comes complete with breadboard, tube, and other parts. Batteries and headphones are optional. The kit and a 20-page catalog covering tubes, parts, books, and other items of interest to radio collectors and experimenters are available from George A. Fathauer, Antique Electronic Supply, 688 West First St., Tempe, Arizona 85281. The price of the kit is \$16.95 plus \$3.00 for shipping and handling.

## custom fitted case for ICOM handhelds

Delta-Zulu has announced the release of its

newest case, designed to fit the popular ICOM 2AT/3AT/4AT series of handheld transceivers and fill the need for a lightweight, compact case that allows user access to all controls. The new case, available in black or burgandy cloth-backed vinyl, features a unique zippered battery door that allows quick changing of standard sized battery packs and a transparent window for access to the touchtone pad. Its bottom seams are designed to improve stability when the unit is placed upright on a flat surface, reducing tipover.

Delta-Zulu cases come with a limited 90-day materials and workmanship warranty and are available from the manufacturer for \$24.95 each. U.S. shipping is free.

For information, contact Crowley Manufacturing Co., 95 Federal St., Lynn, Massachusetts 01905.

Circle #317 on Reader Service Card.

## meet the "gripmate"

Few jobs are more frustrating than those that require "three or more hands" — two to hold the work and a third or more to apply solder or perform some other operation. The smaller the component, the more difficult it usually proves to position it accurately and firmly.

The "GRIPMATE" is one of those why-didn't-I-think-of-it-before? inventions — a clamp that provides up to four extra hands, each able to grip small components, wiring and other items in an infinite number of positions.

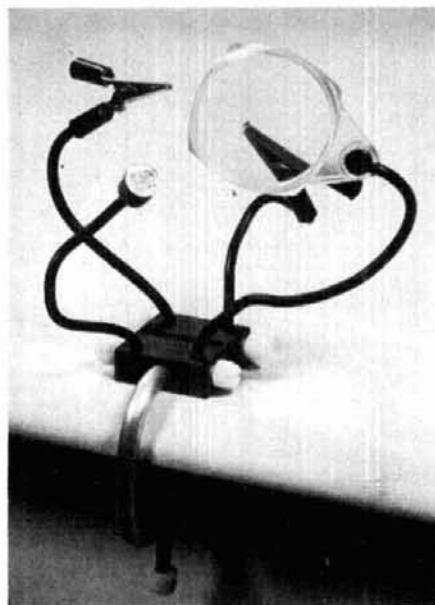

A base block clamps easily to a bench, cabinet or apparatus in any plane, carries four semi-rigid insulated wires (stayput arms), each fitted with an alligator clip to hold the job. Any of the arms can be replaced with one attached to a 48-mm diameter 2.5x safety magnifying glass for close-up work, or a small magnet when this is more appropriate than the clip.

The Super "GRIPMATE" kit, consisting of the

**"HAM HOTLINE"  
THE PROVEN MONEYMAKER**

The "Ham Hotline" is a complete mailing list of novice amateur radio operators and current hams who have renewed, upgraded or modified their FCC licenses. These ham enthusiasts have proven to be excellent prospects for radio equipment, accessories and publications.

The Hotline is **UPDATED EVERY TWO WEEKS** with an average of 8,000 names and addresses each month. And, because we know the Hotline is the most up-to-date amateur radio listing available, we'll guarantee 98% deliverability.

Target your sales efforts to your most likely buyers. Call DCC Data Service today and begin your subscription to the "Ham Hotline" . . . the proven moneymaker.

DCC Data Service ✓ 122  
1990 M Street, N.W. Suite 610  
Washington, D.C. 20036  
Toll-free 1-800-431-2577  
In DC & AK 202-452-1419

**REPEATER VOTER**

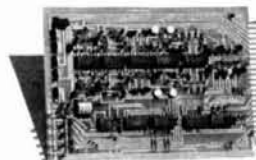

**4RV Four Channel Repeater Voter**

- Signal to Noise Type
- Expandable to 32 Channel by Just Adding Cards
- Designed for Commercial and Amateur Service
- Continuous Instant Voting
- Dual or Single 12 Volt Supply
- LED Indicators of COR and Voted Signals
- Front Mounted Level Pots
- Built in Calibrator
- Remote Voted Indicators Pinned Out
- 4 1/2" x 6" Double Sided Gold Plated 44 Pin Card
- Unswitched Audio Input
- On Board Audio Switching and Mixing
- Audio Mixer Input Available for External Input
- Open Collector or Relay Contact Input
- Open Collector NPN Output
- Remote Disable Inputs
- More

4RV Kit including board and parts with 20 page manual . . . \$200.00  
Built, tested, and calibrated with manual . . . \$350.00

For more information call or write:

(614) 261-8871  
VOTER Hall Electronics  
815 E. Hudson Street  
Columbus, Ohio 43211

**Invitation to  
Authors**

*ham radio* welcomes manuscripts from readers. If you have an idea for an article you'd like to have considered for publication, send for a free copy of the *ham radio* Author's Guide. Address your request to *ham radio*, Greenville, New Hampshire 03048 (SASE appreciated).



base block, C-clamp, four 'stayput' arms, magnifier and magnet arms costs \$19.95 plus sales tax (where applicable). Shipping and handling are included in the price.

For more information about "GRIPMATE" contact Gripmate Enterprises, Inc., P.O. Box 6179, Arlington, Virginia 22206-168.

Circle #316 on Reader Service Card.

**sinadaptor**

J.S. Technology, Inc. has announced the availability of a new product to expedite field or bench servicing of communications equipment. The sinadaptor model SAI-01 is a pocket-sized unit designed to plug directly into a VOM to provide sinad measuring capability anywhere radio systems require servicing.

The instrument is compatible with any VOM, AC VTVM, FET volt meter or other meter with AC measurement capability (analog or digital). The only requirements are that the meter have 2.5 VAC sensitivity or better and that the meter have a dB scale. The sinadaptor has been designed with very low output impedance so that the meter impedance does not effect accuracy.

By simply plugging the instrument into a VOM, connecting the VOM's test leads between the sinadaptor and the speaker leads of the receiver being tested, sinad measurement is displayed directly on the VOM's dB scale. For information, contact J.S. Technology, Inc., 39 Main Street, Scottsville, New York 14546.

Circle #315 on Reader Service Card.

**new handheld**

Encomm, Inc. has announced the newest addition to the SANTEC brand of radios. The ST-20T, described as a "smarter" handheld, features a large easy-to-read LCD atop a 32-function, 16-key keyboard. It provides two seven-digit auto-dial functions for automatically selecting and dialing through the repeater auto-patch. All keyboard functions are accessible with one finger and minimal keystrokes, saving time and providing a very user-friendly interface. Its frequency range is 142-150.995 MHz for MARS and CAP users; other ranges from 140 to 176 MHz are available for export. Transmitter power is rated at 3.5 watts nominal and 5 watts maximum, depending upon the power supply voltage or battery used. Accessories and batteries are compatible with other popular models having similar slide-off battery packs.

For more information contact Encomm, Inc., 1506 Capital Ave, Plano, Texas 75074.

Circle #314 on Reader Service Card.

**new from Heath**

Four new Amateur Radio kits have been introduced by Heath Company. The HD-1420 Very Low Frequency (VLF) Converter allows a standard shortwave receiver to tune the 10 to 500 kHz band using the receiver's 3.5 to 4.0 MHz band. The HD-1422 Antenna Noise Bridge reveals the cause of any mismatch between a station's transmitter and its antenna. The HD-1424 Active SWL Antenna allows a shortwave radio to receive signals between 300 kHz to 30 MHz. And the HD-1530 Touch Tone Decoder is used in a series with the speaker of a receiver or scanner.

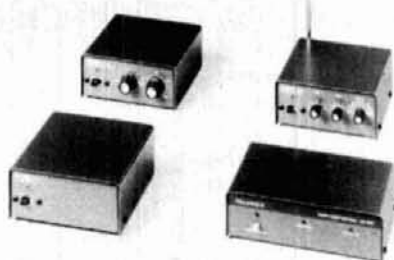

For a free copy of Heath's new catalog describing these new products and hundreds of others, contact Heath Company, Dept. 150-592, Benton Harbor, Michigan 49022. (In Canada write Heath Company, 1020 Islington Avenue, Dept. 3100, Toronto, Ontario, M8Z3.)

Circle #313 on Reader Service Card.

**remote data interrogator  
for repeater tone panel**

Communications Specialists has announced the availability of its new DI-16 Data Interrogator. Designed for remote retrieval of accumulated time and hit information from the TP-38 Shared Repeater Tone Panel, it may also be used to remotely access the TP-38 for enabling or disabling repeater subscribers. The DI-16 interfaces with a simplex control base station on the repeater channel to establish a DTMF communications link with the TP-38 at the repeater site. Upon receipt of the proper command, the TP-38 will transpond data back to the DI-16 and show it on a four-digit LED display.



Provision is made for hard copy printout of the data on a Radio Shack Model TP-10 Serial Printer if desired. The DI-16 may also be connected to a host computer serial port for process-

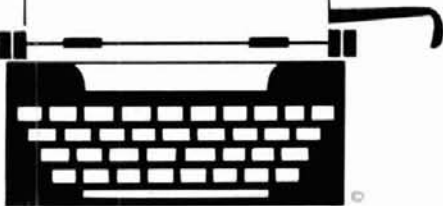



ing of the information for air time billing or other special purposes. All programmable functions of the TP-38 Shared Repeater Tone Panel may be performed remotely with the DI-16, eliminating the need for trips to the repeater site. The DI-16 uses a sixteen-digit keyboard and a high-visibility four-digit LED display. An automatic PTT keying circuit and an output port for a serial printer or computer adaptation are standard equipment. It is powered by 12 VDC and comes complete with 120 VAC power supply. Its size is 7.5 x 7.8 x 2.7 inches. The DI-16 is priced at \$249.95 and is available for immediate shipment from factory stock. A full one-year warranty is included.

For information, contact Communications Specialists, Inc., 426 West Taft Avenue, Orange, California 92665-4296.

Circle #312 on Reader Service Card.

### miniature GaAsFET preamp

Hamtronics, Inc., recently announced a new low-cost, miniature receiver preamp for the VHF and UHF bands. The model "LNW" is similar to the popular LNG GaAsFET preamp, which itself represented a breakthrough in GaAsFET preamp pricing.

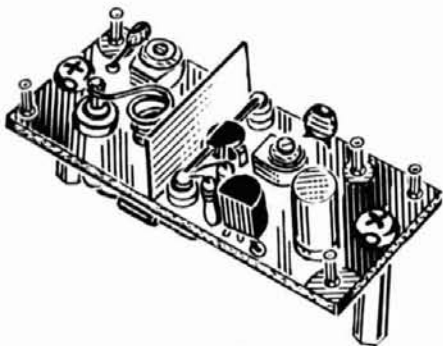

The heart of the preamp is a new dual-gate GaAsFET that provides stable operation over a wide range of load impedances. Typical gain of the unit is 18 dB, and the typical noise figure is 0.8 dB. The unit measures only 5/8 x 1-5/8 inches. Mounting standoffs are provided to allow the preamp to be built into transceivers and receivers. It is easy to connect in series with the receive signal path using miniature coax.

Several models of the preamp are available:

model	nom frequency	tuning range
LNW-144	146 MHz	120-150 MHz
LNW-160	160 MHz	150-200 MHz
LNW-220	220 MHz	220-270 MHz
LNW-432	446 MHz	400-500 MHz

The price of the unit is only \$19 in kit form and \$34 assembled and tested.

A complete 40-page catalog including a full description of this and other products is available from Hamtronics, Inc., 65-F Moul Road, Hilton, New York 14468-9535. (Include \$1 for first-class mailing. For mailing overseas, enclose \$2).

## Don't buy from Hamtronics . . .

**Unless you want the best possible equipment at the lowest possible price! ! !**

The "wheeler-dealer" is back and he's beating everyone else's "deals."

We all know there's no such thing as a free lunch . . . so How Can We Do This?

- **We don't** run alot of ads featuring sale items
- **We don't** spend alot of money on full page ads
- **We don't** have sales on just the fastest selling products
- **We don't** short cut you on service. We are a factory warranty repair facility for everything we sell!
- **We don't** mail out free catalogs
- **We don't** have a free WATS number.

You and every other Ham customer is paying for all these do-dads and sales gimicks.

**Hamtronics** puts the savings into your pocket.

**Hamtronics** guarantees to meet or beat any advertised price on every item we sell.

### Hamtronics Has It All!

Let **Hamtronics** be your Ham Radio equipment dealer. We're celebrating our 35th year in the Ham business at the same location.

## HAMTRONICS, INC.

A DIVISION OF TREVOSE ELECTRONICS  
4033 BROWNSVILLE RD., TREVOSE, PA 19047  
(215) 357-1400



✓ 132

### THE JOY OF QRP: STRATEGY FOR SUCCESS

The experts reviewed Ade Weiss's (W0RSP) book and wrote: **George Dobbs, G3RJV, Radcom**: "I am most impressed both with the scope and content of the book . . . the sections on objectives, planning, operating techniques, band selection and propagation would help any Amateur whatever power is being used — SPRAT. "a comprehensive guide to the whole subject of QRP . . . a great book for QRP'rs and a lot of QRQ operators would benefit from reading it." **Doug DeMaw, W1FB, QST**: "I found the book easy to read, and the text is interesting throughout. I would have no hesitation in recommending W0RSP's book to any Amateur interested in QRP operation. In fact, it will provide great reading for nearly any active ham." **Bill Welsh, W6DDB, Novice Ed., CQ**: "151 pages covering QRP from basics to fine points in 8 interesting chapters. . . Novices will have no difficulty understanding the explanations." **Fred Bonavita, W5QJM, QRP Quarterly**: "In no other place have I encountered such a well-founded statement of the philosophy of QRP operating." POSTPAID:\$10.95 (U.S.), \$12.95 (Foreign)

Q  
R  
P

✓ 192

MILLIWATT BOOKS, 833 Duke St. #83, Vermillion, SD 57069

## DRAKE R-4/T-4X OWNERS AVOID OBSOLESCENCE

**PLUG-IN SOLID STATE TUBES!**  
Get state-of-the-art performance.  
Most types available

**INSTALL KITS TO UPGRADE  
PERFORMANCE!**

- BASIC Improvement
- Audio Bandpass Filter
- Audio IC Amplifier

**TUBES \$23 PPD    KITS \$25 PPD**

OVERSEAS AIR \$7

**SARTORI ASSOCIATES, W5DA  
BOX 832085  
RICHARDSON, TX 75083  
214-494-3093** ✓ 159

### MICROWAVE MODULES TRANSVERTERS & CONVERTERS

MMT1296/144G	1296MHZ, 144IF, 2W, GAASFET	\$319
MMT432/28-S	432MHZ, 28 or 50 IF, 10W	\$269
MMT220/28	220MHZ, 28 or 50 IF, 15W	\$219
MMT144/28	144MHZ, 28 or 50 IF, 15W	\$179
MMT144/28R	144MHZ, 28IF, GAASFET, DBM, 25W	\$299
MMC144/28HP	144MHZ, 28IF, GAASFET, DBM	\$ 79

### SSB ELECTRONIC TRANSVERTERS, PREAMPS, LINEARS

MICROLINE-13	2304MHZ, 144IF, GAASFET, 0.5W	\$319
LT23S	1296MHZ, 144IF, GAASFET, 10W	\$599
LT30S	902MHZ, 144IF, GAASFET, 10W	\$599
DX2320	2304MHZ, GAASFET, 0.8DB NF	\$159
DX1296	1296MHZ, GAASFET, 0.6DB NF	\$149
MV1296	1296MHZ, GAASFET, 1.0DB NF, SW	\$269
DX432	432MHZ, GAASFET, 0.5 DB NF	\$129
MV432S01	432MHZ, GAASFET, 0.7DB NF, SW	\$239
DX220	220MHZ, GAASFET, 0.4DB NF	\$129
MV220S01	220MHZ, GAASFET, 0.5DB NF, SW	\$229
DX144	144MHZ, GAASFET, 0.3DB NF	\$129
MV144S01	144MHZ, GAASFET, 0.5DB NF, SW	\$229
PA2310	1296/1269MHZ LINEAR 10W OUT	\$269
SLA-13	2304MHZ LINEAR 3W OUT	\$279
DCW15A	SEQUENCER for MV PREAMPS	\$ 79

### TUBE AMPLIFIERS

T1296/200	1296MHZ, 200 + W, 2tube	\$275
PA2325	2304MHZ, 25 + 1tube	\$325
WATER COOLING	JACKETS for 2C39, 7289 etc	\$ 10

ALL PRICES IN US\$. AIR MAIL SHIPPING INCLUDED ✓ 167

## TRANSVERTERS UNLIMITED

BOX 6286 STATION A  
TORONTO, ONTARIO    HANS PETERS (VE3CRU)  
CANADA M5W 1P3    (416) 759-5562 EVENINGS



## software toolbox

Communications Electronics Specialists Inc. (CES) has announced the release of the CES BeamCalc Software Toolbox for Commodore 64 and Apple II computers. The program assists Amateur Radio Operators with beam heading calculations from their location to locations in most areas of the world. The operator simply enters his latitude and longitude and then selects a specific location. The program provides the beam heading in degrees relative to true north, latitude and longitude of the selected location, distances in statute and nautical miles, time difference from GMT, DX Zone number, postal rates, numbers of IRC coupons, and QSL bureau information. Included in the CES BeamCalc Toolbox are program segments for radio line-of-sight calculations, satellite tracking, moon tracking, and solar outage predictions.

CES BeamCalc is menu-driven and comes with a detailed operating guide.

For information, contact CES, Inc., 803C South Orlando Ave., Winter Park, Florida 32789.

Circle #311 on Reader Service Card.

## RF design programs

RF Notes No. 2 is the second in a series of RF design aid programs for problems frequently experienced in radio frequency design. RF Notes No. 2 contains four programs that can aid in such activities as inductor design, including design of single-layer coils (both close and space-wound) and toroid coil design. Complex impedance matching circuit design includes L, PI, T, and wideband configurations. In addition, a short program for capacitor applications evaluation is included. The price is \$60.00. Designed for the color or monochrome IBM-PC with 128K, RF Notes No. 2 requires a graphics card.

For information, contact Etron RF Enterprises, P.O. Box 4042, Diamond Bar, California 91765.

Circle #310 on Reader Service Card.

## DTMF encoder/decoder

Cetec Vega's new Model ED-707 mobile encoder/decoder is built to endure hard use. Designed for tough service, it's rugged and dependable, and includes a comprehensive selection of operational features including the following: selective, group, and all-call (2 to 6-digit messages); single-tone transpond; full DIP-switch programmability; command reset; audi-

ble encode sidetone; fully sealed keypad with 12 DTMF digits; horn switch, speaker switch, and new "T" switch; and wrong-digit reset or wrong-digit lockout (jumper selectable).

The fully sealed keypad has a positive tactile feel. It encodes 12 DTMF characters with audible sidetone beep, while producing a PTT output (with preset off-delay period). Also included are speaker, horn, reset, and "T" switches, with LEDs to indicate the state of the speaker and horn switches. Adjustable timers are provided for sounder/horn, tone-burst transpond, off delay, PTT delay, and interdigit time.

For details, contact Cetec Vega, 9900 Baldwin Place, El Monte, California 91731.

Circle #309 on Reader Service Card.

## multicomm 2.0

MULTICOMM 2.0, an updated version of MULTICOMM 1.0 is now available from Multi-Comm Communications Software, Inc. MULTI-COMM 2.0 includes Morse code transmit capability, a faster menu screen, user-definable function keys, and a terminal screen memory feature.

The new program includes ASCII, RTTY, and Morse Code Communications, with full teletype (Baudot) emulation, definable function keys, an Active Menu, file transmit and receive, and simultaneous printing, and many other features, for \$49.95.

IBM-PC (and Compaq) system requirements are: 128K RAM, 1 disk drive and an 80 column monitor. RTTY communications requires a terminal unit with an RS-232 interface. Telephone communications requires a standard modem.

MULTICOMM 2.0 is available for a limited time at only \$39.95.

For further details, contact Multicomm Communications Software, 1806 Foxwood Drive, Houston, Texas 77008.

Circle #308 on Reader Service Card.

## circuit design/analysis software

Hayward Electronic Systems, Inc., has announced that it will supply LADPAC, a software package for the design and analysis of radio frequency ladder circuits. Ladder networks are used extensively for electronic filtering and impedance matching.

LADPAC will design lowpass, highpass, traditional bandpass, coupled resonator LC bandpass, and crystal ladder filters. A special feature is a routine for the design of pseudo-elliptic lowpass filters. LADPAC analyzes networks for transducer gain, impedance match (return loss), phase, and group delay. Impedances may be plotted on a built-in Smith chart. A special routine draws and edits the schematics of circuits designed by other LADPAC programs.

Hardware requirements for running LADPAC are an IBM-PC or compatible, DOS 2.0 (or later

**EXMET**, your source for METALLURGICAL ASSISTANCE and DISCOUNTED PRICING on Aluminum Tubing and Shapes, plus Carbon, Alloy, SS, and Galvanized Tubing. Examples below are only a small fraction of our stock. Please call or write for additional stock sizes.

### Aluminum Tubing (Alloy 6061-T6)

O.D. x Wall	Length	Price per Length
1/2" x .058"	12 ft.	\$ 10.26
7/8" x .058"	12 ft.	18.40
1" x .058"	12 ft.	21.82
1-1/4" x .058"	12 ft.	27.35
1-1/2" x .058"	12 ft.	33.37
1-1/2" x .125"	24 ft.	76.20
2" x .058"	12 ft.	44.93
2" x .250"	12 ft.	193.92
3" x .065"	12 ft.	76.14

Stainless Steel, Carbon Steel, Alloyed Steel, and Galvanized Steel Tubing in stock that meets ASTM Standards.

Policies: All prices FOB Twinsburg, Ohio. Payment by MC or Visa, check or money order or COD. Minimum order \$50.00. Volume and Club discounts available. Ohio residents add 5 1/2% Sales Tax.

**EXMET, INC.**

2170 E. Aurora Rd., P.O. Box 117  
Twinsburg, Ohio 44087 • 216-425-8455

See You At Dayton! ✓ 181

version), at least one 5.25-inch disk drive, 192 kilobytes of RAM, and a color graphics adapter. A dot-matrix printer is recommended.

LADPAC and LADPAC 87, which provides enhanced operating speed (but requires the 8087 co-processor), are each priced at \$149 each. For further details, contact Hayward Electronic Systems, 7700 SW Danielle Avenue, Beaverton, Oregon 97005.

Circle #306 on Reader Service Card.

## logging software

The Log, the latest Amateur Radio software from Cynwyn, runs on the 16K or 32K Radio Shack Color Computer and is available in cassette or RD-DOS versions. When loaded into the computer, it tests for memory and configures itself to the maximum advantage of the available memory automatically. It provides fields for entering all standard logbook data as well as a "Remarks" field. The program — which will search log entries by call sign, QTH, and date — allows operators to obtain hard-copy printouts of their logbooks. The user with a 32K disk system can store up to 13,600 contacts per disk.

The log is available for \$19.95 per cassette and \$24.95 per disk. (Add \$2.00 for shipping. Call signs should be included with orders.)

For information, contact Cynwyn, Suite 2F, 4791 Broadway, New York, New York 10034

Circle #307 on Reader Service Card.

## metroplex network

Metroplex, a key link in the North American Teleconference Net, is now on the air with its satellite broadcast news service, specially designed for transmission on Amateur repeaters and remote bases.

The Metroplex Network carries three exciting programs, co-produced by Metroplex and Westlink Radio, for the Amateur Radio Community: an up-to-the-minute national news program and a national Amateur Radio swap-and-shop program every week, as well as all four North American Teleconference Radio Nets (NATRNs) each year.

Network-affiliated club stations downlink the programs from a commercial satellite transponder for a very low annual fee or receive the programs via a UHF link or a telephone company dialup line. Many clubs already have the basic antenna systems that are required.

The total package is available every Monday evening at 10 PM EST/7 PM PST and Friday nights for NATRN.

All news and production personnel are working professionals who have volunteered their time for this informative way to help unite the world of Amateur Radio.

To become a network affiliate, or to learn more about it, contact Alex Magocsi, WB2MGB, at the Metroplex Network, Leonia, NJ 07605 or call 201-592-7614 for recorded information.

Circle #305 on Reader Service Card.

## Introducing the BUTTERFLY™ Beam from Butternut!

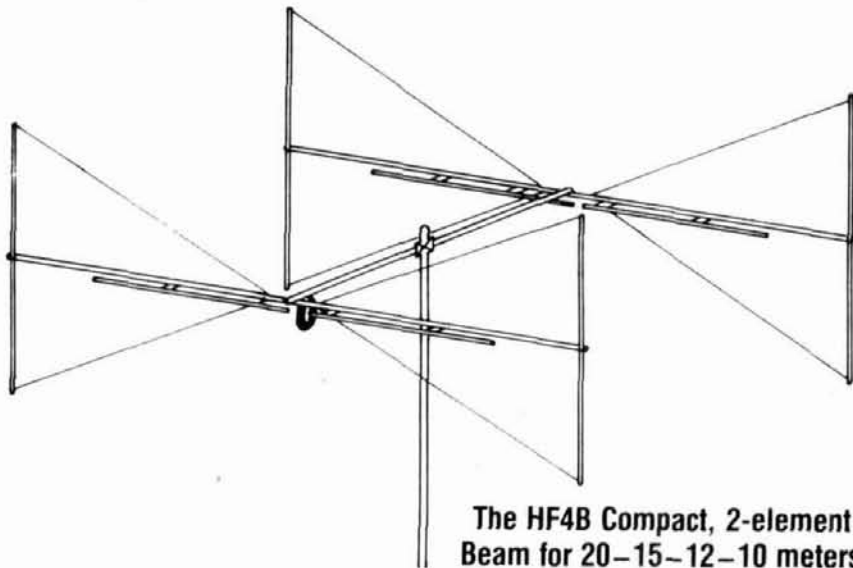

The HF4B Compact, 2-element  
Beam for 20-15-12-10 meters

### Compact Size

The HF4B's 12½-foot elements and 6-foot boom are ideal for home-station use and for weekend retreats, condos, apartments and other places where oversized beams are prohibited. Its light weight (17 pounds) means it can be turned with a tv rotator, yet it is robustly constructed in the best tradition of our world-famous Butternut verticals.

### Performance

The HF4B BUTTERFLY™ has not sacrificed performance for compactness. Its unique design with fanned elements and L-C circuits avoids use of power-robbing traps yet provided high-efficiency operating on all bands. The BUTTERFLY™ outperforms anything in its class.

The HF4B offers an SWR of 1.5:1 or less at resonance. Its 2:1 bandwidth is 200 kHz on 20 meters, 450 kHz on 15, 1.7 MHz on 10, and across the entire 12 meter band. And it will handle the legal power limits both CW & SSB. Gain is at least 3 dB on 20, 4.5 dB on 15 and 5 dB on 10 & 12 meters. Front-to-back is up to 18 dB on 10, 12 and 20m, and up to 15 dB on 15m.

See your authorized  
Butternut dealer

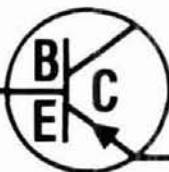

## BUTTERNUT ELECTRONICS CO.

405 East Market Street  
Lockhart, Texas 78644

Please send all reader inquiries direct

## COMPACT 75 M SSB TRANSCEIVER



Dimensions 2" x 6" x 6"

Complete Kit  
**\$199.95**

plus \$3.00  
shipping and  
handling

### RECEIVER:

Frequency 3.8-4.0 MHz  
Sensitivity 0.5 µV for 10 dB S/N  
Selectivity -6 dB @ 2.4 KHz  
AGC Range +60 dB in = +3 dB out  
Audio Output >350 mW into 8 ohms

### TRANSMITTER:

Frequency 3.8-4.0 MHz  
Output 30 watts into 50 ohms  
IMD -30 dB  
Harmonics 2<sup>nd</sup> -47 dB, 3<sup>rd</sup> -55 dB  
SWR Immunity 30:1 @ all phase angles  
ALC Amplified, fast response rate (quasi-processing)

### POWER REQUIREMENTS:

Voltage 28 Vdc regulated  
Current 2A transmit, 65 mA receive

✓ 194

1985-86  
CATALOG  
50¢

RADIO KIT

RADIO KIT  
BOX 411H  
Greenville, NH  
03048  
(603) 878-1033  
telex 887697

CALL TOLL FREE  
& COMPARE

# DISCOUNTS FOR AMATEURS

**EGE's Exclusive Warranty**  
Ege offers an extended  
1-year warranty\* on Icom,  
Kenwood, & Yaesu  
Transceivers

\*18 months on radios with 1-yr. mfg. warranty



**IC-751**

HF transceiver with General  
Coverage Receiver.  
39 memories.  
Built-in SSB filter, passband  
tuning, noise blanker.

**IC-98AT**

Small, light HTs for 2m  
or 440 MHz. 10  
memories and scan.  
Keyboard entry. LCD  
display. Battery packs  
and accessories.



**New IC-A2 in stock**  
Aircraft handheld

## Antennas

HF, VHF, SWL, scanner, marine,  
commercial and CB for Mobile or  
Base use. Manufacturers include  
Cushcraft, Mini-Products, B&W,  
Van Gorden, KLM, Butternut,  
AEA, Mosley, Hustler, Telex Hy-  
Gain, Larsen, and others.

## Towers

Unarco-Rohn, Hy-Gain, and Tri-  
Ex. Ask for special quotes on  
packages including cable, guys,  
connectors, turnbuckles, etc.

## Accessories

Everything an amateur needs by  
Kenpro, Alliance, Ameritron, TE  
Systems, Mirage, Tokyo Hy-Power,  
Daiwa, MFJ, Ten-Tec, Santec,  
Benchner, Amphenol, Astron, B+K  
Precision, Welz and more.

## Computer Stuff

Packet Radio; RTTY/Morse  
hardware and software by Hal,  
Kantronics, AEA, Microlog, MFJ;  
Amateur software by Ham Data.

## Books

On every topic. Call and ask for  
the book or subject you need.

## KENWOOD



**TS-940**

HF transceiver with general  
coverage receiver. All-mode. 40  
memories. Keyboard entry. Built-  
in audio filter, optional automatic  
antenna tuner, speech processor,  
AC power supply.



**New TM-2530A/50A/70A**  
25/45/70-watt mobile 2m rigs. 23  
memories. Scanning. Telephone  
number memories. Easily  
modified for MARS and CAP.

**New 201B also in stock**

## YAESU



**FT-757GX**

HF transceiver with general  
coverage receiver. 8 memories.  
Dual VFO's. Programmable  
memory scanning. CAT system  
computer control.

**Get the whole story!**  
**Send \$1 for our new**  
**Winter 1986 Buyer's**  
**Guide—Catalog.**

## More Helpers

- **Shortwave** by Kenwood, Icom, Yaesu, Sony, Panasonic
- **Marine** radios by Regency, Polaris and Icom
- **Commercial Land Mobile** by Yaesu and others
- **Telephones** by Southwestern Bell, AT&T, Panasonic and Cobra
- **CBs** Uniden, Midland, Cobra
- **Scanners** Regency & Bearcat
- **Radar Detectors** Uniden & Whistler

**New England  
Grand Opening  
March 1 & 2**  
Visit with Yaesu  
factory representative.  
Door prizes each day!

**ege, inc.**  
VIRGINIA

13646 Jefferson Davis Highway  
Woodbridge, Virginia 22191  
Information & Service: (703) 643-1063  
Service Department: (703) 494-8750

**Orders & Quotes Toll  
Free: 800-336-4799**  
(In Virginia: 800-572-4201)

Store Hours: MTT: 10 am—6 pm  
WF: 10 am—8 pm  
Sat: 10 am—4 pm  
Order Hours: M-F 9 am-7 pm  
Sat 10 am-4 pm

**ege, inc.**  
NEW ENGLAND

8 Stiles Road  
Salem, New Hampshire 03079  
**New Hampshire Orders,\***  
Information & Service: (603) 898-3750

**New England  
Orders & Quotes:  
800-237-0047**

Store Hours: Monday—Closed  
TWSat: 10 am—4 pm  
ThF: 12 noon—8 pm  
Sun: 12 noon—5\*

\*Order and we'll credit you with \$1 for the call  
\*\*Closed some Sundays for Hamfests. Call first

**LACOMBE**  
DISTRIBUTORS  
LOUISIANA

Our Associate Store:  
Davis & Jackson Road, P.O. Box 293  
Lacombe, Louisiana 70445  
Information & Service: (504) 882-5355

**Terms:** No personal checks accepted. Prices do  
not include shipping. UPS COD fee: \$2.35 per  
package. Prices are subject to change without  
notice or obligation. Products are not sold for  
evaluation. Authorized returns are subject to a  
15% restocking and handling fee and credit will  
be issued for use on your next purchase. EGE  
supports the manufacturer's warranties. To get a  
copy of a warranty prior to purchase, call  
customer service at 703-643-1063 and it will be  
furnished at no cost.

**Hard to get through on our  
800 numbers?**

Call before 10 a.m. or after 5 p.m., or call one of  
our regular numbers. If you pay for the call and  
order, we'll credit your order with \$1.

Dealer Inquiries Invited



## microprocessor-based repeater controller

After two years of field testing, S-COM Industries has introduced the MRC-100 repeater controller. The unit is fully user-configured. Reliable microprocessor based circuitry offers user customization for individual needs.



Remote programmability is simple; it's not  
necessary to visit the repeater site. MRC-100  
software allows more options than conventional  
hard wired controllers.

Deluxe features include autopatch/reverse  
patch, a sophisticated polite identifier, paging,  
clock and calendar, logic input and outputs, and  
CTCSS (Continuous Tone-Controlled Squelch  
System). With built-in programmable security and  
"personality" features, macro capability, and  
CW, the MRC-100, built with industrial grade  
components, is designed and tested for reliability.

The MRC-100 will support a second control  
receiver and comes with a power adapter for battery  
backup. A full two-year warranty is included.

For information contact S-COM Industries,  
P.O. Box 8921, Fort Collins, CO 80525.

Circle #304 on Reader Service Card.

## new catalog

The 1986 Grove Enterprises catalog of receiving  
accessories and publications is now available.  
Grove, a leading mail-order discount dealer  
of scanners and short-wave receivers, also  
manufactures preamplifiers, antennas, tuners,  
filters and other accessories for listening. Grove  
publishes books in the field and also *Monitoring Times*,  
a 40-page monthly tabloid covering all aspects  
of monitoring the radio spectrum.

For a free copy of the new Grove catalog and  
a sample of *Monitoring Times*, write Grove Enterprises,  
P.O. Box 98, Brasstown, North Carolina  
28902.

Circle #303 on Reader Service Card.

## SPECIAL SALE — SAVE \$5 EACH

**Have a name — but need the Call Sign?  
Traveling — and want to meet local Hams?**

1985-1986 Amateur Radio

## NAME INDEX

By Name and Call. 583 pages

1985-1986 Amateur Radio

## GEOGRAPHICAL INDEX

By State, City, Street No. and Call. 653 pages

No frills directories of over 462,000 U.S.  
Radio Amateurs. 8 1/2 x 11, easy to read  
format.

NAME INDEX—~~\$25.00~~ \$19.95

GEOGRAPHICAL INDEX—~~\$25.00~~ \$19.95

**BUY BOTH SPECIAL \$35.95**

Add \$3.50 shipping to all orders

**ham  
radio** magazine

**BOOKSTORE**

Greenville, NH 03048



# W6SAI BOOKS

## INTERFERENCE HANDBOOK by William R. Nelson

Great sourcebook on interference problems. Complete explanation of RFI/TVI sources, how to track them down and a how-to section on curing these problems. Includes TV and stereo fixes and vehicle noise suppression. Also covers grounds and grounding. 247 pages ©1981. 1st edition.

IRP-IH Softbound \$8.95

## VHF HANDBOOK FOR THE RADIO AMATEUR by Herb Briar, W9EGQ and Bill Orr, W6SAI

Every active VHF'er should have a copy of this Handbook in their shack. Contains plenty of info on: FM, antennas, repeaters, propagation, satellites and much, much more. Full of projects and schematic diagrams as well as test equipment. 336 pages. ©1974. 3rd edition.

IRP-VH Softbound \$11.95

## RADIO HANDBOOK

The very latest in state-of-the-art techniques! Over 1100 pages cover: antennas, amplifiers, theory, semiconductors, plus much more. Full of projects and schematics— from high power amplifiers to "weekender" types. Excellent value at a great low price! 1136 pages. ©1981. 22nd edition.

I21874 Hardbound \$12.95

## BEAM ANTENNA HANDBOOK

Completely revised and updated with the latest computer generated information on BEAM Antenna design. Covers HF and VHF Yagis and 10, 18 and 24 MHz WARC bands. Everything you need to know. 204 illustrations. 268 pages. ©1985. Revised 1st edition.

IRP-BA Softbound \$9.95

## SIMPLE LOW-COST WIRE ANTENNAS

Primer on how-to-build simple low cost wire antennas. Includes invisible designs for apartment dwellers. Full of diagrams and schematics. 192 pages. ©1972 2nd edition

IRP-WA Softbound \$7.95

## ALL ABOUT CUBICAL QUAD ANTENNAS

Simple to build, lightweight, and high performance make the Quad at DX'er's delight. Everything from the single element to a multi-element monster. A wealth of information on construction, feeding, tuning and installing the quad antenna. 112 pages. ©1982. 3rd edition.

IRP-CQ Softbound \$6.95

## THE RADIO AMATEUR ANTENNA HANDBOOK

A wealth of projects that covers verticals, long wires, beams as well as plenty of other interesting designs. It includes an honest judgement of gain figures, how to site your antenna for the best performance, a look at the Yagi-Quad controversy, baluns, slopers, and delta loops. Practical antenna projects that work! 190 pages. ©1978. 1st edition.

IRP-AH Softbound \$7.95

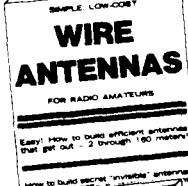
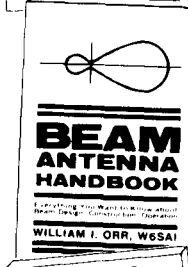

Please enclose \$3.50 to cover shipping and handling.



**ham radio** magazine **BOOKSTORE**  
GREENVILLE, NH 03048 (603) 878-1441

# RF TRANSISTORS

FRESH STOCK - NOT SURPLUS  
TESTED — FULLY GUARANTEED

P/N	2-30 MHz 12V (* = 28V)		Match Pr.
	Rating	Each	
MRF406	20W	\$14.50	\$32.00
MRF412,/A	80W	18.00	45.00
MRF421	100W	25.00	56.00
MRF421C	110W	—	60.00
MRF422*	150W	38.00	62.00
MRF428,/A*	25W	18.00	42.00
MRF428**	150W	55.00	125.00
MRF433	12.5W	12.00	30.00
MRF435*	150W	42.00	90.00
MRF449,/A	30W	12.50	30.00
MRF450,/A	50W	14.00	31.00
MRF453,/A	60W	15.00	35.00
MRF454,/A	80W	16.00	36.00
MRF455,/A	60W	12.00	28.00
MRF458	80W	20.00	46.00
MRF460	60W	18.00	42.00
MRF464*	80W	25.00	60.00
MRF466*	40W	18.75	48.00
MRF475	12W	3.00	9.00
MRF476	3W	2.75	8.00
MRF477	40W	11.00	25.00
MRF479	15W	10.00	23.00
MRF485*	15W	6.00	15.00
MRF492	90W	18.00	40.00
SRF2072	75W	15.00	33.00
SRF3662	110W	28.00	60.00
SRF3775	75W	15.50	34.00
SRF3795	85W	16.50	37.00
CD2545	50W	23.00	52.00
SD1076	70W	17.00	40.00
SD1451	50W	15.00	36.00

Selected High Gain Matched Quads Available

VHF/UHF TRANSISTORS				
Rating	MHz	Net Ea.	Match Pr.	
MRF212	10W	136-174	\$16.00	—
MRF221	15W	136-174	10.00	—
MRF222	25W	136-174	14.00	—
MRF224	40W	136-174	13.50	32.00
MRF231	3.5W	66-88	10.00	—
MRF234	25W	66-88	15.00	39.00
MRF237	4W	136-174	3.00	—
MRF238	30W	136-174	12.00	—
MRF239	30W	136-174	15.00	—
MRF240	40W	136-174	18.00	—
MRF245	80W	136-174	28.00	65.00
MRF247	75W	136-174	27.00	63.00
MRF250	50W	27-174	20.00	46.00
MRF260	5W	136-174	7.00	—
MRF261	10W	136-174	9.00	—
MRF262	15W	136-174	9.00	—
MRF264	30W	136-174	13.00	—
MRF607	1.75W	136-174	3.00	—
MRF641	15W	407-512	22.00	—
MRF644	25W	407-512	24.00	54.00
MRF646	40W	407-512	26.50	59.00
MRF648	60W	407-512	33.00	69.00
2N3666*	1W	30-200	1.25	—
2N4427	1W	136-174	1.25	—
2N5591	25W	136-174	13.50	34.00
2N5642*	20W	30-200	13.75	34.50
2N5945	4W	407-512	10.00	—
2N5946	10W	407-512	12.00	—
2N6080	4W	136-174	6.25	—
2N6081	15W	136-174	7.50	—
2N6082	25W	136-174	8.90	—
2N6083	30W	136-174	9.30	24.00
2N6084	40W	136-174	11.75	28.50

TMOS FET				
MRF134*	5W	2-200	\$10.50	—
MRF137*	30W	2-200	22.50	—
MRF138**	30W	1.5-150	35.00	—
MRF150**	150W	1.5-150	80.00	—
MRF172*	80	2-200	65.00	—

Selected, matched finals for Kenwood, Yaesu, Icom, Atlas, etc. Technical assistance and cross-reference information on CD, PT, RF, SRF, SD P/Ns.

QUANTITY DISCOUNTS AVAILABLE  
WE SHIP SAME DAY C.O.D./VISA/MC  
INFORMATION AND CALIF. ORDERS: (619) 744-0728  
OUTSIDE CALIF. ORDER DESK: 800-854-1927



**RF PARTS**

1320-16 Grand Ave., San Marcos  
California 92069 (619) 744-0728

**PRICE REDUCTION**

**DX EDGE \$16.95**

GRAYLINE AND LONG PATH PREDICTOR

Price Slashed on 2nd OP \$2.95

PREFIX CALLS TIME ZONES BEAM HEADINGS REGULAR \$19.90 PLUS SHIPPING

plus \$3.50 S&H

**JUST \$18.95**

**HAM RADIO'S BOOKSTORE**

GREENVILLE NH 03048



# HAM MART

*Ham Radio's guide to help you find your local dealer*

## California

**C & A ROBERTS, INC.**  
18511 HAWTHORN BLVD.  
TORRANCE, CA 90504  
213-370-7451  
24 Hour: 800-421-2258  
Not The Biggest, But The Best —  
Since 1962.

**FONTANA ELECTRONICS**  
8628 SIERRA AVENUE  
FONTANA, CA 92335  
714-822-7710  
714-822-7725  
The Largest Electronics Dealer in San  
Bernardino County.

**JUN'S ELECTRONICS**  
3919 SEPULVEDA BLVD.  
CULVER CITY, CA 90230  
213-390-8003  
800-882-1343 Trades  
Habla Espanol

## Colorado

**COLORADO COMM CENTER**  
4262 LOWELL BLVD.  
DENVER, CO 80211  
(303) 433-3355  
(800) 227-7373  
Stocking all major lines  
Kenwood Yaesu, Encomm, ICOM

## Connecticut

**HATRY ELECTRONICS**  
500 LEDYARD ST. (SOUTH)  
HARTFORD, CT 06114  
203-527-1881  
Call today. Friendly one-stop shopping  
at prices you can afford.

## Delaware

**AMATEUR & ADVANCED COMMUNI-  
CATIONS**  
3208 CONCORD PIKE  
WILMINGTON, DE 19803  
(302) 478-2757  
Delaware's Friendliest Ham Store.

**DELAWARE AMATEUR SUPPLY**  
71 MEADOW ROAD  
NEW CASTLE, DE 19720  
302-328-7728  
800-441-7008  
Icom, Ten-Tec, Microlog, Yaesu,  
Kenwood, Santec, KDK, and more.  
One mile off I-95, no sales tax.

## Florida

**AMATEUR ELECTRONIC SUPPLY**  
1898 DREW STREET  
CLEARWATER, FL 33575  
813-461-4267  
Clearwater Branch  
West Coast's only full service  
Amateur Radio Store.  
Hours M-F 9-5:30, Sat. 9-3

**AMATEUR ELECTRONIC SUPPLY**  
621 COMMONWEALTH AVE.  
ORLAND, FL 32803  
305-894-3238  
Fla. Wats: 1 (800) 432-9424  
Outside Fla: 1 (800) 327-1917  
Hours M-F 9-5:30, Sat. 9-3

## Georgia

**DOC'S COMMUNICATIONS**  
702 CHICKAMAUGA AVENUE  
ROSSVILLE, GA 30741  
(404) 866-2302  
ICOM, Yaesu, Kenwood, KDK, Bird...  
9AM-5:30PM  
We service what we sell.

## Hawaii

**HONOLULU ELECTRONICS**  
819 KEEAUMOKU STREET  
HONOLULU, HI 96814  
(808) 949-5564  
Serving Hawaii & Pacific area for 53  
years.

## Illinois

**ERICKSON COMMUNICATIONS, INC.**  
5456 N. MILWAUKEE AVE.  
CHICAGO, IL 60630  
312-631-5181  
Hours: 9:30-5:30 Mon, Tu, Wed & Fri;  
9:30-8:00 Thurs; 9:00-3:00 Sat.

## Indiana

**THE HAM STATION**  
220 N. FULTON AVE.  
EVANSVILLE, IN 47710  
812-422-0231  
Discount prices on Ten-Tec, Cubic,  
Hy-Gain, MFJ, Azden, Kantronics,  
Santec and others.

## Massachusetts

James Millen Components by  
**ANTENNAS ETC.**  
16 HANSOM ROAD  
ANDOVER, MA 01810  
617-475-7831  
Bezels, binding posts, capacitors, con-  
densers, chokes, coils, ceramics, H.V.  
connectors, plate caps, hardware  
knobs, dials, scopes and grid dippers.  
Inquire SASE or visit.

**TEL-COM, INC.**  
675 GREAT ROAD, RTE. 119  
LITTLETON, MA 01460  
617-486-3400  
617-486-3040  
The Ham Store of New England  
You Can Rely On.

## Michigan

**ENCON PHOTOVOLTAICS**  
Complete Photovoltaic Systems  
27600 Schoolcraft Rd.  
Livonia, Michigan 48150  
313-523-1850  
Amateur Radio, Repeaters, Satellite,  
Computer applications.  
Call Paul WD8AHO

## Minnesota

**TNT RADIO SALES**  
4124 WEST BROADWAY  
ROBBINSDALE, MN 55422 (MPLS/ST.  
PAUL)  
TOLL FREE: (800) 328-0250  
In Minn: (612) 535-5050  
M-F 9 AM-6 PM  
Sat 9 AM-5 PM  
Ameritron, Bencher, Butternut, Icom,  
Kenwood

## Missouri

**MISSOURI RADIO CENTER**  
102 NW BUSINESS PARK LANE  
KANSAS CITY, MO 64150  
(800) 821-7323  
Missouri: (816) 741-8118  
ICOM, Kenwood, Yaesu  
Same day service, low prices.

## Nevada

**AMATEUR ELECTRONIC SUPPLY**  
1072 N. RANCHO DRIVE  
LAS VEGAS, NV 89106  
702-647-3114  
Dale Porray "Squeak," AD7K  
Outside Nev: 1 (800) 634-6227  
Hours M-F 9-5:30, Sat. 9-3

## New Jersey

**KJI ELECTRONICS**  
66 SKYTOP ROAD  
CEDAR GROVE, NJ 07009  
(301) 239-4389  
Gene K2KJI  
Maryann K2RVH  
Distributor of: KLM, Mirage, ICOM, Lar-  
sen, Lunar, Astron. Wholesale - retail.

**Dealers:** *YOU SHOULD BE HERE TOO!*  
*Contact Ham Radio now for complete details.*

# Amateur Radio Dealer

## New York

### BARRY ELECTRONICS

512 BROADWAY  
NEW YORK, NY 10012  
212-925-7000  
New York City's Largest Full Service  
Ham and Commercial Radio Store.

### VHF COMMUNICATIONS

915 NORTH MAIN STREET  
JAMESTOWN, NY 14701  
716-664-6345  
Call after 7 PM and save! Supplying all  
of your Amateur needs. Featuring ICOM  
"The World System." Western New  
York's finest Amateur dealer.

## North Carolina

### F & M ELECTRONICS

3520 Rockingham Road  
Greensboro, NC 27407  
1-919-299-3437  
9AM to 7PM Closed Monday  
ICOM our speciality — Sales & Service

## Ohio

### AMATEUR ELECTRONIC SUPPLY

28940 EUCLID AVE.  
WICKLIFFE, OH 44092 (Cleveland Area)  
216-585-7388  
Ohio Wats: 1 (800) 362-0290  
Outside Ohio: 1 (800) 321-3594  
Hours M-F 9-5:30, Sat. 9-3

### DEBCO ELECTRONICS, INC.

3931 EDWARDS RD.  
CINCINNATI, OHIO 45209  
(513) 531-4499  
Mon-Sat 10AM-9PM  
Sun 12-6PM  
We buy and sell all types of electronic  
parts.

### UNIVERSAL AMATEUR RADIO, INC.

1280 AIDA DRIVE  
REYNOLDSBURG (COLUMBUS), OH  
43068  
614-866-4267  
Featuring Kenwood, Yaesu, Icom,  
and other fine gear. Factory author-  
ized sales and service. Shortwave  
specialists. Near I-270 and airport.

## Pennsylvania

### HAMTRONICS, DIV. OF TREVSE ELECTRONICS

4033 BROWNSVILLE ROAD  
TREVSE, PA 19047  
215-357-1400  
Same Location for over 30 Years.

### LaRUE ELECTRONICS

1112 GRANDVIEW STREET  
SCRANTON, PENNSYLVANIA 18509  
717-343-2124  
ICOM, Bird, Cushcraft, Beckman,  
Larsen, Amphenol, Astron, Belden,  
Antenna Specialists, W2AU/W2VS,  
Tokyo Hy-Power Labs, WELZ, Daiwa,  
Sony, Saxton, Vibroplex, Weller.

### THE VHF SHOP

16 S. MOUNTAIN BLVD., RTE. 309  
MOUNTAINTOP, PA 18707  
717-474-9399  
Lunar, Microwave Modules, ARCOS,  
Astron, KLM, Tama, Tonna-F9FT,  
UHF Units/Parabolic, Santec, Tokyo  
Hy-Power, Dentron, Mirage,  
Amphenol, Belden

## Texas

### MADISON ELECTRONICS SUPPLY

3621 FANNIN  
HOUSTON, TX 77004  
713-520-7300  
Christmas?? Now??

## Wisconsin

### AMATEUR ELECTRONIC SUPPLY

4828 W. FOND DU LAC AVE.  
MILWAUKEE, WI 53216  
414-442-4200  
Wisc. Wats: 1 (800) 242-5195  
Outside Wisc: 1 (800) 558-0411  
M-F 9-5:30 Sat 9-3



### SERVICE CENTER

for  
**ICOM, KENWOOD**  
and **YAESU**

Fully equipped repair shop Amateur,  
Marine and Land Mobile repairs.

FCC NABER Lic  
Mon-Fri 10:00-4:00 pm

(206) 776-8993

## PACIFIC RIM COMMUNICATIONS

Bob KG7D  
23332 58th Ave. West  
Mountlake Terrace, Wa 98043  
VISA MASTERCARD & C.O.D.S. Welcome

# MORE BOOKS

## AMECO STUDY GUIDES

### Designed for VEC Exams

AMECO Study Guides are taken from the FCC Amateur Exam syllabus, PR-1035 and have answers keyed to ARRL's recently released study material. These study guides are compatible with ARRL and all other VEC Exams. While nothing can guarantee that you will pass, AMECO Study Guides will make sure that you are fully prepared and ready to go when you sit down for the exam. Written in clear, concise, easy-to-read format, each question fully explained. Novice and General books cross referenced to AMECO's 102-01 for a more thorough explanation.

127-01 Novice Class	Softbound \$2.95
112-01 General Class	Softbound \$4.95
126-01 Advanced Class	Softbound \$4.95
117-01 Extra Class	Softbound \$4.95
1AM-1 Get All Four	\$14.95

## ARRL Q&A LICENSE MANUALS

ARRL Q&A License Manuals are keyed to the latest FCC Exam syllabi now in use by the Volunteer Examiners. These books are written in an easy-to-read conversational style that enhances understanding without scaring the student away. All technical subject areas are explained in clear terminology and with plenty of illustrations, diagrams and schematics. Rules are also fully covered. Each book has the official ARRL multiple choice question Pool with answers and a key to the FCC Exam syllabus for reference to other study publications. These are the study guides to have. All books. © 1985 1st Editions.

1AR-TG General	Softbound \$5.00
1AR-AG Advanced	Softbound \$5.00
1AR-EG Extra	Softbound \$5.00
1AR-SG Get All Three	\$12.95

## FIRST STEPS IN RADIO



by Doug DeMaw, W1FB

This new anthology has been taken from DeMaw's '84 and '85 series in QST magazine. It has been written to give beginners the basic electronic theory needed for upgrading and the ins and outs of how radios work. Using a building block approach, DeMaw first explains what the different components are, then assembles them into basic circuits and ends up with how these circuits work in your radio. You also get articles on antennas, propagation and beginners level RFI problems and suggestions on how to resolve them. Great review for more experienced Hams. Perfect for the beginner. © 1985.

1AR-FS	Softbound \$4.95
--------	------------------

## LANDMOBILE AND MARINE RADIO TECHNICAL HANDBOOK



by Edward Noll, W3FQJ

This is THE HANDBOOK for those who operate, install or service two-way radios. Covers private landmobile services, marine radiotelephone and radiotelegraph, marine navigation and Citizen's Band. An excellent reference book for those studying to pass the NABER technician certification exam. Areas covered include: transmission characteristics and modulation systems, basic solidstate theory, digital and microprocessor electronics, antenna systems, test equipment, repeaters and much more. © 1985 1st edition 576 pages.

122427	\$24.95
--------	---------

## THE COMMODORE



### HAM'S COMPANION by Jim Grubbs, K9EI

Here's your guide to using the Commodore C-64 computer in your Ham shack. Good solid information on where to find software and hardware for CW, RTTY, AMTOR, SSTV, propagation prognostication, antenna modeling, satellite tracking and much more. Includes a list of over 80 sources of software and hardware. Also includes a bibliography of over 60 magazine articles and reviews about using the Commodore. ©1985, 160 pages, 1st edition.

1JG-CC	Softbound \$15.95
--------	-------------------

Please add \$3.50 to cover  
postage and handling.

**Ham Radio's Bookstore**  
Greenville, NH 03048

# flea market



**RATES** Noncommercial ads 10¢ per word; commercial ads 60¢ per word both payable in advance. No cash discounts or agency commissions allowed.

**HAMFESTS** Sponsored by non-profit organizations receive one free Flea Market ad (subject to our editing) on a space available basis only. Repeat insertions of hamfest ads pay the non-commercial rate.

**COPY** No special layout or arrangements available. Material should be typewritten or clearly printed (not all capitals) and must include full name and address. We reserve the right to reject unsuitable copy. Ham Radio cannot check each advertiser and thus cannot be held responsible for claims made. Liability for correctness of material limited to corrected ad in next available issue.

**DEADLINE** 15th of second preceding month.

**SEND MATERIAL TO:** Flea Market, Ham Radio, Greenville, N. H. 03048.

**SCHEMATICS:** Radio receivers 1920's/60's. Send brand name, model No., SASE. Scaramella, PO Box 1, Woonsocket, RI 02895-0001.

**ANTIQUE RADIO CLASSIFIED** "The National Publication for Buyers and Sellers of Old Radios and Related Items". Published monthly—features articles, regular columns, photos, and ads. Sample copy \$1.50. ARC, 9511-23, Sunrise, Cleveland, Ohio 44133.

**IBM-PC RTTY/CW** CompRtTy II is the complete RTTY/CW program for the IBM-PC and compatibles. Virtually any speed ASCII, BAUDOT, CW. Text entry via built-in editor, 10,000 character transmit/receive buffers. Adjustable split screen display. Instant mode/speed change. Hardcopy, diskcopy, break-in buffer, select calling, text file transfer, customizable full screen logging, 24 programmable 1000 character messages. Now with WRU (simple mailbox). Ideal for MARS and traffic handling. Requires 128k PC, XT, AT, PCjr, PC-DOS, serial port, RS-232CTU \$65. Send call letters (including MARS) with order. Mention Ham Radio Magazine and take \$10 off. David A. Rice, KC2HD, 7373 Jessica Drive, North Syracuse, NY 13212.

**2 METER MINIATURE** remote base. 60/w tube, add COR for repeater, with outside cabinet \$75. 6 & 10 500/w base linear \$150. Palomar 65/w mobile 10m linear \$45. Palomar 1-kw SWR/power meter \$50. K6KZT, 2255 Alexander, Los Osos, CA 93402.

**PILOTS** and Aircraft owners. Repair your own Avionics. Commercial test equipment for Comm. Nav. and Pulse. Will trade for ham equipment. WA1VJB, Don Nicolson, RR1, Box 438A, Jericho, Vermont 05465. (802) 899-4095.

## Foreign Subscription Agents for Ham Radio Magazine

Ham Radio Austria  
Karin Ueber  
Postfach 2454  
D-7850 Loerrach  
West Germany

Ham Radio Belgium  
Sierehouse  
Brusselsesteenweg 416  
B-9218 Gent  
Belgium

Ham Radio Holland  
Postbus 413  
NL-7800 Ar Emmen  
Holland

Ham Radio Europe  
Box 2084  
S-194 02 Upplands Vastby  
Sweden

Ham Radio France  
SM Electronic  
20 bis. Ave des Clairons  
F-89000 Auxerre  
France

Ham Radio Germany  
Karin Ueber  
Postfach 2454  
D-7850 Loerrach  
West Germany

Canada  
Send orders to  
Ham Radio Magazine  
Greenville, NH 03048 USA  
Prices in Canadian funds  
1 yr. \$29.95, 2 yrs. \$53.90  
3 yrs. \$75.40

Ham Radio Italy  
Via Maniago 15  
I-20134 Milano  
Italy

Ham Radio Switzerland  
Karin Ueber  
Postfach 2454  
D-7850 Loerrach  
West Germany

Ham Radio England  
c/o R.S.G.B.  
Alma House  
Craborne Road  
Potters Bar  
Herts EN6 3JW  
England

**THE GOOD SAM HAMS** invite RV operators to check in the Good Sam Ham net 14.240 Sundays 1900Z also 3.880 Tuesdays at 2359Z. Net control N5BDN, Clarksville, IN

**OLD RADIO** transcription discs wanted. Any size, speed. W7FIZ, Box 724 HR, Redmond, WA 98073-0724.

**RTTY-EXCLUSIVELY** for the Amateur Teleprinter. One year \$10.00. Beginners RTTY Handbook \$8.00. PO Box RY, Cardiff, CA 92007.

**UHF PARTS.** We stock GaAs Fets, Trimmers, and many of those impossible to find parts for the UHF builder. For example: MGF 1202 at \$10.00, Finger Stock at \$7.50 per 16' strip. SASE brings list. Microwave Components, 11216 Cape Cod, Taylor, MI 48180.

**IMRA,** International Mission Radio Association helps missionaries. Equipment loaned. Weekday net, 14.280 MHz, 2-3 PM Eastern. Eight hundred Amateurs in 40 countries. Brother Frey, 1 Fryer Manor Road, Larchmont, New York 10538.

**RUBBER STAMPS:** 3 lines \$4.50 PPD. Send check or MO to G.L. Pierce, 5521 Birkdale Way, San Diego, CA 92117. SASE brings information.

**ELECTRON TUBES:** Receiving, transmitting, microwave... all types available. Large stock. Next day delivery, most cases. Daily Electronics, PO Box 5029, Compton, CA 92224. (213) 774-1255.

**CUSTOM MADE EMBROIDERED PATCHES.** Any size, shape, colors. Five patch minimum. Free sample, prices and ordering information. Hein Specialties, Inc., Dept 301, 4202 N. Drake, Chicago, IL 60618.

**RECONDITIONED TEST EQUIPMENT** \$1.25 for catalog. Walter, 2697 Nickel, San Pablo, CA 94806.

**PRINTED CIRCUIT BOARDS** and kits for QST articles. Call or write for information. AGA Engineering, 7970 Orchid Drive, Buena Park, CA 90620. (714) 521-4160.

**PACKET/ASCII/BAUDOT/CW** for IBM-PC. SASE to: Emile Alline, 773 Rosa, Metairie, LA 70005.

**WANTED** NC400 receiver. Any condition. W2PUA, 112 Tilford Road, Somerdale, NJ 08083. (609) 783-4175

**CABLE TV CONVERTERS/DESCRAMBLERS.** Guaranteed lowest prices in US. Jerrold, Hamlin, Zenith—Many others. Lowest dealer prices! Orders shipped within 24 hours! Complete illustrated catalog, \$2.00. Pacific Cable Co., Inc., 7325-1/2 Reseda Blvd, #1010, Reseda, CA 91335. (818) 716-5914.

**RESISTORS** any value/quantity, 1/4 watt @\$.01, 1/2 watt @\$.015 (\$1.00 minimum). Quantity discounts, 1,000+. Send wattage(s), value(s), quantity(s), and remittance. T.O.R.C.C.C. Electronics, Box 47148, Chicago, Illinois 60647. (312) 342-9171.

**CHASSIS** and cabinet kits. SASE K3IWK, 5120 Harmony Grove Road, Dover, PA 17315.

**FREE** Ham Radio Equipment (HF, VHF, Teletype) for non-profit institution willing to pick up. SASE for details. Robert Clark, 930 Chestwood Ave, Tallahassee, FL 32303.

**CAPACITORS** Ceramic disk — 50 volts. All values @\$.10 plus \$1.00 shipping per order. T.O.R.C.C.C. Electronics, Box 47148, Chicago, IL 60647. (312) 342-9171. \*FM\*3\*

**IC-25A FOR SALE:** \$225 or best offer. Good condition, used only as a mobile radio. Call Craig (603) 878-1441, 9-5 EST, M-F only.

**ELECTRON TUBES** Radio, TV & Industrial Tykpes—Huge Inventory. Call Toll Free (800) 221-5802 or write Box HR, Transleteronic, Inc., 1365 39th Street, Brooklyn, NY 11218 (718) 633-2800.

**UPDATE YOUR ICOM 02/04AT.** Expand frequency range to a 20 MHz window and increase scan rate by 20X. Complete kit \$34.95 plus \$3.00 shipping and handling to M.C.S., PO Box 374, Deerfield, IL 60015.

**CIRCUIT BOARDS** guaranteed lowest quotes and Free twelve hour prototypes. Single and double sided boards. Small through large production quantities. Mail specifications. Hobbyists: any schematic, 6" x 9" maximum etched on a 3" x 4" board \$1.75. (larger boards—\$2.75). Send remittance and artwork or print your own circuit boards. Kits of all sizes. Guaranteed lowest prices. Basic kit \$3.00. Materials for two 3" x 4" boards (included) or SASE for catalog. T.O.R.C.C.C. Electronics, Box 47148, Chicago, Illinois 60647. (312) 342-9171.

**WORLD TOP BAND** Frequency Allocations Listing. Handy "Top Band" operating and contains all currently available CW and SSB allocations for countries on ARRL DXCC list. (317 total, 10 no authorization, 61 no information available). Also includes QST sent/received column for keeping track of cards. \$5.50 USA, Canada and Mexico. \$7.50 elsewhere. Dennis Peterson, N7CKD, 4248 A Street SE, Space 609, Auburn, WA 98002.

**WANTED:** Heath Curve Tracer IT-3121 kit/assembly. Mission School needs 10 units. Call Manilla, P.I. 832-1773 or write Mission POB 1651 MCC Makati M.M, P.I.

**SALE:** HW101 with power supply—manual. Best offer over 150. Single bander (20m) offer. Both prof. wired. Excellent condition. W2PUA, 112Tilford Road, Somerdale, NJ 08083. (609) 783-4175.

**CB to 10M CONVERSIONS.** FM kits, frequency modification hardware, books, plans, high-performance CB accessories. Free catalog. CBCL, Box 31500HR, Phoenix, AZ 85046. (602) 996-8700.

**CABLE TV CONVERTERS & EQUIPMENT:** Plans and parts. Build or buy. SASE for information. C & D Electronics, PO Box 1402, Dept. HR, Hope, AR 71801.

**RIW-19** 432 MHz beams by K3IPW. SASE for information.

## COMING EVENTS

Activities — "Places to go . . ."

**CALIFORNIA:** FCC exams, Novice-Extra. Sunnyvale VEC ARC. (408) 255-9000 24 hour. 73, Gordon, W6NLG, VEC

**OHIO:** The all new 17th Annual B\*A\*S\*H — New Location, new entertainment, new food — will be held on Friday night of the Hamvention, April 25, 1986. The new location is in the Conference Center at the HARA Arena and Exhibition Center, (the same location as the Hamvention) starting at 7 PM. There is no admission charge, and free continuous entertainment. Food and beverages available. Two exciting top awards, and many others. Stay right at HARA when the Hamvention closes on Friday evening and meet your friends and join us for an evening of fun and entertainment. Sponsored by the Miami Valley FM Association, POBox 263, Dayton, Ohio 45401.

**MASSACHUSETTS:** Chelsea Civil Defense will sponsor Amateur Radio evening classes at Chelsea High School starting March 10, 1986. Novice, basic level ham license, Technician or General license. Minimal charge for materials only. For more information about Amateur Radio and classes write: Frank Masucci, 136 Grove Street, Chelsea, MA 02150. Please include phone number.

**INDIANA:** The Morgan County Amateur Radio Association is sponsoring the Indiana Hamfest, March 9, Indiana State Fairgrounds Pavilion Building, Indianapolis. Admission \$5.00 at the door. Flea market table \$8.00 by reservation only. Flea market space, no table, \$3.00. Reserved table setup Saturday, March 8, 3-9 PM. Space setup Sunday, March 9, 6-8 AM. Free parking. Talk in on 145.25. For table reservations SASE before March 1 to Aileen Scales, KC9YA, 3142 Market Place, Bloomington, IN 47401 (812) 339 4446.

**FLORIDA:** 16th North Florida Ham/Swapfest, Saturday and Sunday, March 15-16, Fort Walton Beach. Admission \$3.00 at door. XYLs and kids free. ARRL/VEC exams Saturday. Indoor flea market and dealers. RV parking. contact Hud Huddleston, 925 Forest Avenue, Fort Walton Beach, FL 32548. (904) 862-2566.

**NEW JERSEY:** The Delaware Valley Radi Association's 14th annual Flea Market, Amateur Radio and Computer equipment, Sunday, March 23, 8 AM to 2 PM, New Jersey National Guard 112th Field Artillery Armory, Eggerts Crossing Road, Lawrence Township. Advance registration \$3.00 by March 10, \$4.00 at door. Sellers bring own tables. Talk in on 146.07-.67 repeater. For registration and/or spaces SASE to KB2ZY, Box 441B, RD -1, Stockton, NJ 08559.

**NEW JERSEY:** The Old Bridge Amateur Radio Association's annual indoor/outdoor electronic Flea Market, April 6, Knights of Columbus Hall, Pine Street, Old Bridge. Sellers contact Bob Navin, N2DFJ, at (201) 251-6449 or Sam Ugliarolo, WB2HAE, at (201) 583-2168. Talk in on 147.120 and 146.520.

**NEW YORK:** The Westchester Emergency Communications Association's 2nd annual Hamfest and Electronics Fair, WECAFEST '86, Sunday, March 16, Westchester Community College, Valhalla. General admission \$2.00. People under 16 admitted free. Flea market, ham radio equipment testing, FCC license exams and more. Plenty of free parking. Dealer booths \$10 each by reservation only. For reservations or information: WECAFEST '86, PO Box 348, Millwood, NY 10546.

**GEORGIA:** The Columbus, GA, ARC will sponsor a Hamfest, Saturday, March 22, 9 AM to 5 PM and Sunday, March 23, 9 AM to 3:30 PM, Columbus Municipal Auditorium, Columbus. Flea market, free coffee and free parking for self-contained RVs (no hookups). Activities for spouses and kids. Indoor tables \$6.50 per day. Contact Joe Mills at (404) 687-3050 or CARC, PO Box 6336, Columbus, GA 31906 for table rentals. FCC exams given Saturday morning 9 AM EST at the Colonial Inn. Contact Billy Bedgood (404) 323-5579 for exam information. Details on Saturday night buffet dinner available at Hamfest site. Talk in on 146.01/61. For more information: Billy Bedgood (404) 323-5579 or Bill Haycock (404) 327-7345 or CARC at address above.

**NEW JERSEY:** The Splitrock Amateur Radio Association's first annual evening Hamfest, March 14, VFW Post 3401, Tabor Road, Morris Plains. Starts 7 PM. Admission \$1.00. Sellers tables \$7.00. Suggest advance booking. Free parking. Talk in on 146.365/146.965. For information: SARA, PO Box 3, Whippany, NJ 07981.

**WISCONSIN:** The Madison Area Repeater Association (MARA) announces its 14th annual Swapfest, Sunday, April 6, Dane County Exposition Center Forum Building, Madison. Doors open 7:30 AM for flea market sellers and 8 AM for public. Admission \$2.50 advance and \$3.00 at the door. Children 12 and under admitted free. Flea market tables \$5.00 each advance, \$6.00 at the door plus admission. Advance tickets and tables by March 31, 1986. FCC exams by Four Lakes ARC during Swapfest. Preregistration requested but walkins will be accepted. For information/reservations: MARA, PO Box 3403, Madison, WI 53704 or (608) 222-4744.

**KENTUCKY:** The Lincoln Trail Amateur Radio Club's Hamfest, March 22, Prichard Community Center, Elizabethtown. Talk in on 146.38/98. For information or reservations: Hubert Hensley, WD4GDA, PO Box 387, Vine Grove, KY 40175 (502) 877-2234.

CALL TOLL FREE FOR QUOTES

# TNT RADIO SALES INC. 1-800-328-0250

1-612-535-5050 (IN MINNESOTA-COLLECT)

## EXPLOSION OF VALUES!

- ICOM** **KENWOOD**  
**KANTRONICS** **TELEX HY-GAIN**  
**MIRAGE** **HUSTLER**  
**AEA** **KLM**  
**SANTEC** **ROHN**  
**KDK** **MFJ**  
**NYE VIKING** **AMERITRON**  
**WELZ** **BENCHER**  
**LARSEN** **BUTTERNUT**

**CALL NOW!**  
**1-800-328-0250**  
 FOR ABSOLUTE  
**LOWEST PRICE BUSTERS!**

**INVENTORY REDUCTION PRICED TO GO!**

We must make room for your trade-ins. Check now for lowest prices on previously owned bench-tested equipment!

**NEW! ICOM R7000 RCVR**  
 Covers continuous 25 mhz to 2 ghz!  
 99 memories—scans—etc., etc.  
 Loaded with features. Available November, 1985.

VISA/MASTER CARD  
 FREE SHIPPING  
 ON MOST RIGS FOR CASH!



S.A.S.E. FOR OUR  
 "BENCH-TESTED"  
 USED EQUIPMENT LISTING

MON-FRI 9 AM - 6 PM CENTRAL TIME  
 SATURDAY 9 AM - 5 PM

4124 West Broadway, Robbinsdale, MN 55422 (Mpls./St. Paul)

166

**NEW HAMPSHIRE:** The annual Interstate Repeater Society's Flea Market, Saturday, March 15, Hudson Lions Club, Lions Avenue, Hudson, 9 AM to 4 PM. Doors open 8 AM. Admission \$1.00. Tables \$8.00 each. Free parking. Talk in on 25/85 and 52. For information or table reservations: Richard Everhart, WB8YGR, 25 Briand Drive, Nashua, NH 03063. (603) 889-3479.

**NEW JERSEY:** Shore Points ARC invites everyone to Springfest '86, Saturday, March 22, 9 AM to 2 PM, Atlantic County 4H Center, Egg Harbor City. Indoor selling space and covered tailgating. Sellers \$5.00 per day (bring own table). Buyers \$2.50 advance, \$3.00 at door. Talk in on 146.985 and .52. For information: SPARC, PO Box 142, Absecon, NJ 08201.

**MINNESOTA:** Rochester area Hamfest, Saturday, April 5, John Adams Junior High School, 1525 NW 31st St, Rochester. Doors open 8:30 AM. Large indoor flea market, radio and electronics items. Refreshments and plenty of free parking. Talk in on 146.22/82. W0MXW. For information: RARC, WB0YEE, 2253 Nordic Ct. NW, Rochester, MN 55901.

**ILLINOIS:** Lamarsfest '86, sponsored by the Libertyville & Mundelein ARS. March 23, Lake County Fairgrounds, Grayslake. Doors open 8 AM. Large indoor electronic and radio swap fest. Tables available by reservation. Donation \$2.00 advance, \$3.00 door. Talk in on 146.52 simplex. Waukegan Rptr 147.63-03. For information or reservations: LAMARS, Box 751, Libertyville, IL 60048.

**MARYLAND:** The Baltimore Amateur Radio Club (BARC) will present the 1986 Greater Baltimore HamBoree and Computerfest, April 6, Maryland State Fairgrounds Exhibition Complex, Timonium. Indoor flea market, large dealers display area. Outdoor tailgating. Food service, free parking. Gates open 8 AM. Admission \$4.00. Children under 12 free. For information: GBHRC, PO Box 95, Timonium, MD 21093-0095. (301) 561-1282.

**NEW JERSEY:** The Chestnut Ridge Radio Club's 9th annual Flea Market, Saturday, March 22, Education Building, Saddle River Reformed Church, East Saddle River Road and Weiss Road, Upper Saddle River. Tables \$10.00 first, \$5.00 each additional. Tailgating \$5.00. Contact: Jack Meagher, W2EHD. (201) 768-8360.

**MICHIGAN:** 25th annual Michigan Crossroads Hamfest sponsored by the Southern Michigan Amateur Radio Society, Saturday, March 22, Marshall High School, Marshall. 8 AM to 3 PM. Setup 6:30 AM. Tickets \$2.00 at door, \$1.50 advance. Table space 50 cents/foot. For reservations SASE to SMARS, PO Box 934, Battle Creek, MI 49016 or phone Wes Chaney, N8BDM (616) 979-3433. Amateur Radio license exams, Novice through Extra, given at Hamfest. Preregistration requested but walk-ins will be accepted. Send Form 610, SASE \$4.00, check or MO to ARRL/VEC: License Exam, PO Box -2, Pleasant Lake, MI 49272.

**MASSACHUSETTS:** The MIT UHF Repeater Association and the Mit Radio Society offer monthly Ham Exams. All classes Novice to Extra. Wednesday, March 19, 1986, 7 PM, MIT Room 1-134, 77Mass Ave, Cambridge, MA. Reservations requested 2 days in advance. Contact: Ron Hoffmann (617) 253-5820/646-1641 or Craig Rodgers at 225-6616. Exam fee \$4.00. Bring copy of current license, 2 forms of picture ID and completed form 610 (available from FCC in Boston, 223-6609).

**MICHIGAN:** The South Eastern Michigan Amateur Radio Association (SEMARA) will hold its 28th annual Hamfest Swap and Shop, April 6, 8 AM to 3 PM, Grosse Pointe North High School, 707 Vernier Road, Grosse Pointe Woods. Advance tickets \$1.00. At the door \$3.00. Advance tables \$8.00. At the door \$10.00. ARRL, DX and RTTY forums. Talk in on 147.75/15 and 146.52. For information: SEMARA Hamfest, PO Box 646, St. Clair Shores, MI 48080 or phone Fred Lewis NK8M (313) 881-0187.

### OPERATING EVENTS "Things to do . . ."

**MARCH 2:** From Alamo Plaza, San Antonio, Texas, next to the Alamo, W5SC will operate a special event station to celebrate Texas Independence Day as part of the Texas Sesquicentennial activities. 0600Z to 0600Z, 10, 15 and 20 meters, lower portions of General CW and voice bands. QSL and No. 10 SASE to W5SC, 90 Brews Blvd., San Antonio, TX 78209.

**MARCH 22** The Macon Amateur Radio Club, W4BKM, will operate special event station from the Cherry Blossom Festival in Macon, Georgia, the Cherry Blossom capital of the world. 10 AM to 5 PM EST. For a Cherry Blossom certificate, send large SASE to Mona Wigherington, N4MPR, 2898 Williamson Drive, Lizella, GA 31052.

1986 marks the 50th anniversary of the Greater Cincinnati Amateur Radio Association. A number of special events are planned. Watch for announcements here.

**CHARGE**

**YOUR CLASSIFIED ADS**  
 to your MC or VISA, write or call  
**HAM RADIO MAGAZINE**  
 Greenville, NH 03048  
 (603) 878-1441

**Bind 'em and Find 'em**



Keep those valuable issues of Ham Radio like new. Prevent smears, tears and dog ears. Bind 'em together and enjoy for years to come. You'll be happy you did!

### HAM RADIO BINDERS

Beautiful buckram bound, rich brown material with gold embossing. These binders will really dress up your collection of Ham Radio. Year stickers included.

- HR-BDL \$6.95 ea.
- 3 for \$17.95

Please add \$3.50 for shipping and handling, U.S. only.

**HAM RADIO'S BOOKSTORE**  
 GREENVILLE, NH 03048

**THEY'RE ALL NEW FOR 1986! Order NOW.**

Significant changes for 1986 mandate that all hams get both the North American and International Callbooks. *DX'ers and Contester's note* — Having both books is the only way you'll have all Foreign Amateur listings.

**NORTH AMERICAN CALLBOOK**

The old US Callbook has been expanded and now contains the listings of all hams in North America plus Hawaii and US Possessions. This improved operating aid has all the latest calls and QTH information available at press time and will be an invaluable reference guide. With calls from Panama to Greenland, every ham should have a copy of this new book in their shack.  
©1985.

**CB-US86** Softbound \$21.95

**INTERNATIONAL CALLBOOK**

The Foreign Callbook is no more! In its place, the new International Callbook includes all Amateurs outside of the North American continent. All the latest callsigns and QTH's are listed to help ensure you get that prized QSL card. Universally recognized as the source of information. Order your's today.  
©1985.

**CB-F86** Softbound \$20.95

**CB-USF86** special \$39.95 **SAVE \$2.95**

Order Both and Save.  
Reg. Price \$42.90

Please enclose \$3.50 to cover shipping and handling.

**ham radio** magazine  
**BOOKSTORE**  
GREENVILLE, NH 03048 (603) 878-1441



**HF ANTENNAS —  
The Easy Way**

by John Haerle, WB5IIR



This book has been published as a memorial to WB5IIR's work as

an Amateur Radio teacher. Originally given as a series of speeches or papers, this tutorial is an excellent source book on antenna theory and applications. Examples of areas covered are: *Fundamentals*, antenna and feedline terminology, baluns, ground systems, lightning protection, *The Basic Antenna*, the dipole, the zepp, G5RV, Windom, *Special Antennas*, the sloper, DDDR, Beverage, folded unipole, *Beams*, WBJK, Yagi, two element quad, and the *160 meter band story*. John's writing is in an easy-to-understand conversational style and is full of examples and handy tips and hints. There are no drawings or illustrations but John's prose paints pictures for clear and complete understanding of the information being presented. ©1984 1st Edition.

**JH-AT** Softbound \$11.95

Please add \$3.50 for shipping and handling.

**Ham Radio's Bookstore**  
Greenville, NH 03048



RECEIVE THIS LCD CALENDAR/CLOCK FREE WITH YOUR SUBSCRIPTION

**WHAT'S REALLY HAPPENING IN HOME SATELLITE TV?**

**STV** THE HOME SATELLITE TELEVISION MAGAZINE™

A monthly of 100-plus pages—has everything you need to know about where to find equipment, how to install it, system performance, legal viewpoints, and industry insights! With your subscription to **STV**® you will receive a FREE LCD Calendar/Clock.

- Only \$19.95 per year (12 monthly issues)
- \$1.00 for sample copy

**IF YOU HAVE A SATELLITE SYSTEM, THEN YOU REALLY NEED ...**



**OnSat**

The best in satellite programming! Featuring: ★All Scheduled Channels ★Weekly Updated Listings ★Magazine Format ★Complete Movie Listing ★All Sports Specials ★Prime Time Highlights ★Specials Listing and ★Programming Updates!

- Only \$45.00 per year (52 weekly issues)
- 2 Years \$79.00 (104 weekly issues)
- \$1.00 for sample copy

Visa® and MasterCard® accepted (subscription orders only). All prices in US funds. Write for foreign rates.

Send this ad along with your order to:

**STV®/OnSat®**

P.O. Box 2384—Dept. HR • Shelby, NC 28151-2384

**SUBSCRIPTION CALLS ONLY**

**TOLL FREE 1-800-438-2020**



# Join AMSAT...Today

*Amateur Radio Satellite OSCAR 10 provides:*

- A New Worldwide DX Ham Band open 10 hours a day.
- Rag Chew With Rare DX Stations in an uncrowded, gentlemanly fashion.
- Popular Modes In Use: SSB, CW, RTTY, SSTV, Packet
- Full Operating Privileges open to Technician Class licensee or higher.

*Other AMSAT Membership Benefits:*

**ORBIT Magazine Subscription:**  
Dependable technical articles, satellite news, orbital elements, product reviews, DX news, and more.

**Satellite Tracking Software**  
Available for most popular PCs.

**QSL Bureau, AMSAT Nets, Area Coordinator Support, Forum Talks**

**Construction of Future Satellites For Your Enjoyment!**

AMSAT Membership is \$24 a year, \$26 outside North America. VISA and MC accepted.

**AMSAT**  
**P.O. Box 27**  
**Washington, DC 20044**  
**301 589-6062**

✓ 108

## NEMAL ELECTRONICS

Your Authorized  
Distributor For



BELDEN

### INTRODUCTORY SALE!

Belden No.	Nemal No.	Description	Per 100 ft.	Per ft.
8214	1102B	RG8 /U Foam 96%	\$45.00	.50
8237	1100B	RG8/U Poly 96%	39.00	.44
8241	1500B	RG59/U Poly 96%	13.00	.15
8267	1130B	RG213/U Poly 96%	53.00	.59
9269	1600B	RG62A/U Poly 96%	15.00	.17
8216	1450B	RG174/U Poly 96%	12.00	.14
9913	1180	Low Loss 50 Ohm	46.00	.58

### OTHER QUALITY CABLES

Nemal No.	Description	Per 100 ft.	Per ft.
1110	RG8X 95% Shield (mini 8)	15.00	.17
1130	RG213/U Mil Spec. 96% Shield	34.00	.36
1140	RG214/U Mil Spec. - Silver	155.00	1.65
1705	RG142B/U Teflon - Silver	140.00	1.50
1310	RG217/U 5/8" 50 Ohm Dbl. Shld.	80.00	.85
1470	RG223/U Mil Spec. - Silver	80.00	.85

### ROTOR CABLE — 8 COND.

8C1822	2-18 Ga., 6-22 Ga.	19.00	.21
8C1620	2-16 Ga., 6-20 Ga. Heavy Duty HARDLINE — 1/2"	34.00	.36

FXA12	Smooth Alum. w/black jacket	79.00	.89
FLC12	Corrug'd. Copper (EQ. Helix LDF)	159.00	1.69

### CONNECTORS — MADE IN U.S.A.

NE720	Type N for Belden 9913		4.75
PL259	Standard Plug for RG8, 213		.65
PL259AM	Amphenol PL259		.89
PL259TS	PL259 Teflon/Silver		1.59
UG21D	Type N for RG8, 213, 214		3.00
UG175	Adapter for RG58		.22

Call or write for complete Price List

COD add \$2.00.

Shipping: Cable — \$3.00 per 100 ft.

Florida Residents add 5%.

Connectors — and 10%, \$3.00 minimum

Orders under \$20 Add \$2 Handling

Nemal's new 32-page Cable & Connector Selection Guide now available at no charge with orders of \$50 or more or at a cost of \$4.00 individually.

## NEMAL ELECTRONICS

12240 N.E. 14th Ave., Dept. Q., Miami, FL 33161

✓ 146

Telephone (305) 893-3924

## One source for amateur radio books, tapes and computer programs.

# PROPAGATION PUBLISHING

Over 125 books, tapes and computer programs to keep you up to date in the ham world, or to help you upgrade for that new ticket. Send your name and address for a FREE copy of the new Propagation Publishing catalog.

### SPECIAL!

## Handbook of Electronic Tables & Formulas

by Sams Engineering Staff

This handbook contains the information that you need, in a one-stop reference. Basic formulas and laws are given in Part 1. Useful, but hard to remember constants and standards are in Part 2. Part 3 contains established symbols and codes. Items of interest to electronics technicians are in Part 4. Part 5 covers circuit design data. The filter and attenuator configurations and formulas are particularly useful. Part 6 contains tables and formulas. This is one fact-filled book that should be on your bench.

Postpaid in USA

**\$20.95**

Please send check or money order. Illinois residents please add 6% sales tax.

### We are looking for authors!

We want authors with new ideas for books in the amateur radio field. If you have a book in work or just thinking about one, send an outline and sample chapter to us for review. We can give your book the national exposure needed to make it a success.



**PROPAGATION PUBLISHING**

P.O. Box 5255, Morton, Illinois 61550

✓ 153



# ICOM

# KENWOOD YAESU

ICOM	List	Juns
<b>HF Equipment</b>		
IC-751 Xcvr	1399.00	Call \$
IC-745 Xcvr	999.00	Call \$
IC-735 Xcvr	849.00	Call \$
PS-55 Power Supply	160.00	139.95
PS-35 Power Supply	160.00	139.95
<b>Receivers</b>		
IC-R-7000	899.00	Call \$
IC-71A	799.00	599.95
<b>VHF/UHF</b>		
IC-02AT 2m, HT	349.00	Call \$
IC-2AT	269.00	Call \$
IC-271A 2m, Base	699.00	Call \$
IC-27A Compact	369.00	Call \$
IC-3AT, HT	299.00	Call \$
IC-37A Compact Mobile	449.00	Call \$
IC-04AT 440 MHz, HT	379.00	Call \$
IC-4AT	299.00	Call \$
IC-471H 75w, 440 MHz	1099.00	Call \$
IC-47A	469.00	Call \$
RP-3010 UHF, Repeater	999.00	Call \$
IC-1271A 1.2 GHz Base	999.00	Call \$
IC-120 Mobile	499.00	Call \$



KENWOOD	List	Juns
<b>HF Equipment</b>		
TS-940S w/AT	1999.95	Call \$
wo/AT	1799.95	Call \$
TS-430S	899.95	Call \$
TS-830S	949.95	Call \$
TS-530S	749.95	Call \$
TS-670 Quad Bander	699.95	Call \$
<b>Receivers</b>		
R-2000	599.95	Call \$
R-1000	499.95	Call \$
<b>VHF/UHF</b>		
TR 2600A 2m, FM, HT	339.95	Call \$
TR 3600 440, HT	349.95	Call \$
TH 21AT Compact 2m	229.95	Call \$
TH 31AT Compact 220	239.95	Call \$
TH 41AT Compact 440	239.95	Call \$
TM 4000A 2m/70cm	599.95	Call \$
<b>Super Special Call \$</b>		
TM 2570A 70w, 2m	549.95	Call \$
TM 2550A 45w, 2m	459.95	Call \$
TM 2530A 25w, 2m	399.95	Call \$
TM 211A 2m, Mobile	369.95	Call \$
TM 411A 70 cm	449.95	Call \$
TS-711A 2m, All Mode	799.95	Call \$
TS-811A 440, Base	899.95	Call \$

YAESU	List	Juns
<b>HF Equipment</b>		
FT ONE Xcvr	2859.00	Call \$
FT 757GX Xcvr	879.95	Call \$
FT 980 CAT System	1659.00	Call \$
FT-77 Compact Xcvr	599.00	Call \$
<b>Receivers</b>		
FRG 8800		
150 kHz - 30 MHz	569.00	Call \$
FRG 9600		
60 - 905 MHz	649.00	Call \$
<b>VHF/UHF</b>		
FT-203R/TT 2m, HT	259.95	Call \$
FT-209 RH	349.00	299.95
FT-103R/TT 220 MHz	279.95	Call \$
FT-703R/TT 440 MHz	299.95	Call \$
FT-709 RH		
440 MHz, HT	349.00	299.95
NC-15		
Quick Charger	79.00	Call \$
FT-270 RH		
w/FTS-8 2m	439.00	Call \$
FT-726R All Mode		
OSCAR	925.00	Call \$
6m Module	215.95	Call \$
SU-726	109.95	Call \$
430/726	299.95	Call \$
440/726	299.95	Call \$
HF/726	225.95	Call \$
FT-2700RH w/FTS-8	599.95	Call \$
FT-2700H w/FTS-8	599.95	Call \$
FT-209RH w/FTS-6	359.95	Call \$
FT-709RH w/FTS-6	359.95	Call \$

**JUN'S**  
**ELECTRONICS**  
800-882-1343  
INCLUDES ALASKA HAWAII

ENCMM		List	Juns	List	Juns
<b>Santec</b>				<b>Welz</b>	
ST-20T 2m HT	349.95	Call \$		Power Meters, Acces.	Call \$
ST-200ET 2m	199.95	Call \$		<b>Tokyo Hy-Power</b>	
ST-400ET 440 MHz	249.95	Call \$		VHF/UHF Amps/ Tuners	Call \$
<b>KDK</b>					
FM-240 2m	369.00	Call \$			
FM-740 440 MHz	429.00	Call \$			

AEA Products In Stock  
Kantronics Products In Stock  
Astron Products In Stock  
Bencher Products In Stock  
Mirage Products In Stock  
Ameritron Products In Stock

• AMATEUR • TWO WAY • MARINE  
• CELLULAR MOBILE PHONE • SCANNER  
• Free U.P.S. Cash Order (Most Item, Most Place)  
• Shoppers, call us last, save \$\$  
• SE HABLA ESPANOL

**(213)390-8003** 3919 Sepulveda Blvd. Culver City, CA 90230

135

### AMATEUR RADIO MAIL LISTS

Self-stick 1x3 labels

\*\*\* NEWLY LICENCED HAMS \*\*\*  
\*\*\* ALL NEW UPGRADES \*\*\*  
\*\*\* UPDATED EACH WEEK \*\*\*

Total List = 462,728 (ZIP sorted)  
Price is 2.5 cents each (4-up Cheshire)

BUCKMASTER PUBLISHING  
Mineral, Virginia 23117  
703:894-5777

111

### MULTI-BAND SLOPERS

ALSO DIPOLES & LIMITED-SPACE ANTENNAS

Outstanding performance of WINN antennas. Is well known. Now enjoy multi-band BIG-SIGNAL reports! Automatic bandswitching • Very low SWR • Coax feed • 3kw power • Compact • FULLY ASSEMBLED to your specified center frequency each band • EASY TO INSTALL • Very low profile • Complete instructions • Your personal check accepted

4 BAND SLOPER - 160, 80, 40, 30, or 20M	60 ft long	\$ 48 ppd
1 --	50 ft "	\$ 43 --
2 --	40 ft "	\$ 35 --
3 --	30 ft "	\$ 27 --
4 --	20 ft "	\$ 19 --
NO-TRAP DIPOLE - 160, 80, 40M	113 ft long	\$ 71 --
1 --	85 ft "	\$ 55 --
2 --	60 ft "	\$ 41 --
3 BAND SPACE-SAVER DIPOLE - 160 thru 10M*	46 ft long	\$ 85 ppd

\* Requires wide range tuner (80, 40, 20, 15M without tuner)

SEND SASE for complete details of these and other unique antennas  
WINN ANTENNAS 312-394-3414  
BOX 393-H MT. PROSPECT, IL 60056

171

**SAVE SAVE SAVE SAVE**  
**1983-84 ARRL**  
**AMATEUR RADIO CALL DIRECTORY**  
**WAS \$15.75 NOW \$4.95 SAVE \$10.80**

Please add \$3.50 to cover shipping and handling



**Ham Radio's Bookstore**  
GREENVILLE, NH 03048



# THE GUERRI REPORT

by Ernie Guerri, W6MGI

## millimeter waves part II: applications

Last month I discussed the domain of millimeter waves and some of the components used in this emerging part of the spectrum. This month we'll look at a variety of applications and see why there's so much interest, in professional circles, in moving into the mm wave region.

Military applications continue to lead the way in mm wave activity. Of special value to the military is the fact that mm waves are more difficult to intercept than microwaves because of the very narrow beams of the antennas used at mm-wave frequencies. This advantage, combined with considerable spectrum available for frequency-hopping, makes for LPI (Low Probability of Intercept). The fact that relatively low power is used for many current mm wave applications is actually a benefit because it makes the unwanted detection of signals even more difficult. It should be noted, however, that special tubes that can deliver 500kW of peak pulse power at 100GHz are available!

Military applications should be of particular interest over the next several years, as high-tech countries gain significant advantage in key electronic areas by virtue of their ability to implement mm wave technology.

## commercial, scientific applications

The principal commercial applications for mm waves will be the same as for microwaves — telecommunica-

tions and data transmission. The mm region opens some significant opportunities in very wideband data/video transmission that were difficult to accomplish in the microwave region because of spectrum crowding and antenna beamwidth considerations. As computer graphics become an essential part of business communications, the relatively wide bandwidths needed for animated graphics can easily be accommodated in the region above 30 GHz. We can also expect that the fidelity with which complex waveforms can be transmitted in the mm region will give rise to new coding techniques that will permit more efficient spectrum utilization, lower error rates, and greater data security than has previously been possible. And — as if we weren't already up to our ears in data — there will be a vast expansion of telephone, FAX, and real-time video capacity with simpler, smaller terminals.

The management of Earth's resources and related scientific applications will also benefit from developments in the mm region. Experiments have already confirmed that mm-wave radar, combined with synthetic aperture techniques, can yield details of the Earth's surface, and sub-surface, that weren't even detectable with microwave techniques.

One scientific domain that will reap special benefit is deep space radio-astronomy. Because the Earth's atmosphere attenuates so much of the mm region, very little data on intergalactic radiation in this part of the

spectrum exists. As more mm equipment becomes available for Space Shuttle missions or orbital laboratories, a whole new "picture" of the structure of space, and of the physical mechanisms at work, is likely to emerge.

Another especially promising area for practical applications of mm wave technology is air transport safety. Because of the excellent spatial resolution and high doppler rates possible at radar frequencies above 30 GHz, small, lightweight aircraft collision-avoidance systems (CAS) will become more practical and accurate. CAS depends on knowing the position of potentially dangerous encounters with extreme accuracy and on having dependable information regarding the direction and closing rate of oncoming aircraft. These technical requirements are made to order for the characteristics of mm waves.

Last, but not least, are possibilities just now being observed in medical and biological research. Some researchers have noted that the very shallow tissue penetration of low-power mm waves can give a "radar" image of thermal activity, blood flow, and other physical and neurological functions that is not possible with more conventional techniques. This is very new work, and reliable data is being developed by only a handful of investigators. However, a few pioneers are wasting no time in exploring the prospect that this new RF domain can bring improved levels of health and well-being to all of us.

ham radio



New

New

# THE STANDARD OF EXCELLENCE

## Definitely Superior!

# AZDEN PCS-5000

COMMERCIAL — GRADE



**UNPRECEDENTED WIDE FREQUENCY RANGE:** Covers 140,000-153,000 MHz in steps that can be set to any multiple of 5 kHz up to 50 kHz.

**CAP/MARS/NAVY MARS, BUILT IN:** The wide frequency range facilitates use of CAP and ALL MARS FREQUENCIES including NAVY MARS. **COMPARE!**

**TINY SIZE:** Only 2 inches high, 5½ inches wide and 7¼ inches deep!

**MICROCOMPUTER CONTROL:** Gives you the most advanced operating features available.

**UP TO 11 NONSTANDARD SPLITS:** **COMPARE** this with other units!

**20 CHANNELS OF MEMORY IN TWO SEPARATE BANKS:** Retains frequency, offset information, PL tone frequency.

**DUAL MEMORY SCAN:** Scan memory banks separately or together. **ALL** memory channels are tunable independently. **COMPARE!**

**MEMORY SCAN LOCKOUT:** Allows you to skip over channels you don't want to scan.

**TWO RANGES OF PROGRAMMABLE BAND SCANNING:** Limits are quickly reset. Scan ranges separately or together with independently selective steps in each range. **COMPARE!**

**BUSY SCAN AND DELAY SCAN:** Busy scan stops on an occupied channel. Delay scan provides automatic auto-resume.

**DISCRIMINATOR CENTERING (AZDEN EXCLUSIVE PATENT):** Always stops on frequency desired when scanning.

**PRIORITY MEMORY AND ALERT:** Unit constantly monitors one memory channel for signals, alerting you when channel is occupied.

**LITHIUM BATTERY BACKUP:** Memory information can be stored for up to 5 years even if power is removed.

**FREQUENCY REVERSE:** Allows you to listen to repeater input frequency.

**ILLUMINATED KEYBOARD WITH ACQUISITION TONE:** Keys are easily seen in the dark, and actuation is positively verified audibly.

**CRISP, BACKLIGHTED LCD DISPLAY:** Easily read no matter what the lighting conditions!

**DIGITAL S/R/METER:** Shows incoming signal strength and relative transmitter power.

**MULTI-FUNCTION INDICATOR:** Shows a variety of operating parameters on the display.

**FULL 16-KEY TOUCHTONE PAD:** Keyboard functions as auto-patch when transmitting.

**MICROPHONE CONTROLS:** Up/down frequency control and priority channel recall.

**PL TONE GENERATOR BUILT IN:** Instantly program any of the standard PL frequencies into the microcomputer. **COMPARE!**

**TRUE FM, NOT PHASE MODULATION:** Unsurpassed intelligibility and audio fidelity. **COMPARE!**

**HIGH/LOW POWER:** Select 25 watts or 5 watts output — fully adjustable.

**SUPERIOR RECEIVER:** Sensitivity is better than 0.15 microvolt for 20-db quieting. Commercial-grade design assures optimum dynamic range and noise suppression. **COMPARE!**

**DIRECT FREQUENCY ENTRY:** Streamlines channel selection and programming.

**OTHER FEATURES:** Rugged dynamic microphone, built-in speaker, mobile mounting bracket, remote speaker jack, and all cords, plugs, fuses and hardware are included.

EXCLUSIVE DISTRIBUTOR: DEALER INQUIRIES INVITED FOR YOUR NEAREST DEALER OR TO ORDER:

**AMATEUR-WHOLESALE ELECTRONICS TOLL FREE...800-327-3102**

8817 S.W. 129th Terrace, Miami, Florida 33176 Telephone (305) 233-3631 Telex: 80-3356

MANUFACTURER:

**JAPAN PIEZO CO., LTD.**

1-12-17 Kamirenjaku, Mitaka, Tokyo, 181 Japan

Telex: 781-2822452





## THINGS TO LOOK FOR (AND LOOK OUT FOR) IN A PHONE PATCH

- One year warranty.
- A patch should work with any radio. AM, FM, ACSB, relay switched or synthesized.
- Patch performance should not be dependent on the T/R speed of your radio.
- Your patch should sound just like your home phone.
- There should not be any sampling noises to distract you and rob important syllables. The best phone patches do not use the cheap sampling method. (Did you know that the competition uses VOX rather than sampling in their \$1000 commercial model?)
- A patch should disconnect automatically if the number dialed is busy.
- A patch should be flexible. You should be able to use it simplex, repeater aided simplex, or semi-duplex.
- A patch should allow you to manually connect any mobile or HT on your local repeater to the phone system for a fully automatic conversation. Someone may need to report an emergency!
- A patch should not become erratic when the mobile is noisy.
- You should be able to use a power amplifier on your base to extend range.
- You should be able to connect a patch to the MIC and EXT. speaker jack of your radio for a quick and effortless interface.
- You should be able to connect a patch to three points inside your radio (VOL high side, PTT, MIC) so that the patch does not interfere with the use of the radio and the VOL. and SQ. settings do not affect the patch.
- A patch should have MOV lightning protectors.
- Your patch should be made in the USA where consultation and factory service are immediately available. (Beware of an inferior offshore copy of our former PRIVATE PATCH II.)

**ONLY  
PRIVATE PATCH III  
GIVES YOU ALL  
OF THE ABOVE**

# PRIVATE PATCH III

## SIMPLEX SEMI-DUPLEX INTERCONNECT

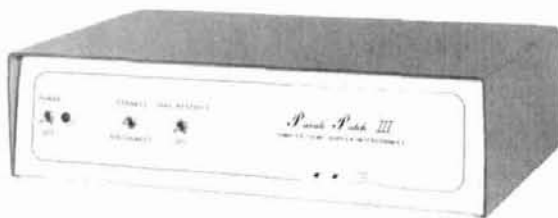

The telephone is the most powerful mode of communications . . .  
**PRIVATE PATCH III gives you full use of your home telephone from  
your mobile and HT radios!**

With only three simple connections to your base station radio, PRIVATE PATCH III will give you more communications power per dollar than you ever imagined possible.

Suddenly the utility of your radio is drastically increased. There are new sounds . . . dial tones, ring tones, CW ID and the sound of voices you never expected to hear on your mobile or HT radio! What a convenience!

PRIVATE PATCH III frees you from memberships, cliques and other hassles common to many repeater autopatches. You can call who you want, when you want and for as long as you want. You can even receive your incoming calls!

**To Learn more about PRIVATE PATCH III and the advantages of the VOX concept, call or write for our four page brochure today!**

### PARTIAL LIST OF FEATURES

- OPERATES SIMPLEX, THROUGH REPEATERS, OR DUPLEX ON REPEATERS • VOX BASED • TOLL RESTRICT (Digit counting and programmable first digit lockout) • SECRET CODE DISABLES TOLL RESTRICT FOR ONE TOLL CALL—Automatic re-arm • AUTOMATIC BUSY SIGNAL DISCONNECT
- CONTROL INTERRUPT TIMER (Maintains positive mobile control) • CW ID When you connect again or disconnect. Free ID chip. • SELECTABLE TONE OR PULSE DIALING • MOV LIGHTNING PROTECTORS • THREE DIGIT ACCESS CODE (e.g. ★91) • RINGOUT (Reverse patch) Ringout inhibit if channel busy
- RESETTABLE THREE MINUTE TIMER • SPARE RELAY POSITION • 115VAC SUPPLY

Options:  
FCC approved coupler  
12 VDC or 230 VAC power

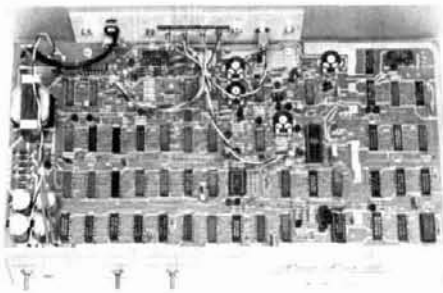

### DEALERS

- |  |   |
|--|---|
| AMATEUR ELECTRONIC SUPPLY<br>Milwaukee WI, Wickliffe OH,<br>Orlando FL, Clearwater FL,<br>Las Vegas NV | MADISON ELECTRONICS SUPPLY<br>Houston, TX       |
| BARRY ELECTRONICS CORP.<br>New York, NY  | MIAMI RADIO CENTER CORP.<br>Miami FL            |
| COLES COMMUNICATIONS<br>San Antonio TX   | MIKES ELECTRONICS<br>Ft. Lauderdale, Miami FL   |
| EGE, INC.<br>Woodbridge, VA  | N&G DISTRIBUTING CORP.<br>Miami FL              |
| ERICKSON COMMUNICATIONS<br>Chicago IL  | PACE ENGINEERING<br>Tucson AZ                   |
| HAM RADIO OUTLET<br>Anaheim CA, Burlingame CA,<br>Oakland CA, Phoenix AZ,<br>San Diego CA, Van Nuys CA | THE HAM STATION<br>Evansville IN                |
| HENRY RADIO<br>Los Angeles CA  | TEXAS TOWERS<br>Plano, TX                       |
| INTERNATIONAL RADIO<br>SYSTEMS<br>Miami, FL  | TNT RADIO SALES<br>Robbinsdale, MN              |
| JUNS ELECTRONICS<br>Culver City CA   | WESTCOM<br>San Marcos, CA                       |
|  | CANADA:<br>DOLLARD ELECTRONICS<br>Vancouver, BC |
|  | SKYWAVE RADIO SYSTEMS, LTI<br>Burnaby, B.C.     |

**CONNECT  
SYSTEMS  
INCORPORATED**

(213) 373-6803

23731 Madison St., Torrance, CA 90505



# The DX is better out here. Ask anyone who owns an FT-726R.

It's true. Linking up to OSCAR 10 is the one sure way to bring the world into your ham shack. No matter where your shack is.

FT-726R owners know. You'll find them working the world from their apartments. Attics. And from their antenna-restricted neighborhoods.

They'll even boast of a signal quality and DX potential that would make any 20-meter operator envious. Regardless of where we are in the sunspot cycle.

In fact, the FT-726R is the world's most popular link to OSCAR 10.

And for good reason. This 2-meter, 10-watt rig gives you full cross-band duplex capability. Simply plug in two

optional modules, one for 435-MHz operation, another for cross-band duplex.

You can set up your earth station just about anywhere. All you need is the 726 and two Yagi antennas: 435-MHz for transmit and 2-meters for receive.

Even as a conventional base station, the FT-726R is a real standout.

You can choose from three operating modes: SSB, FM or CW. Expand to three-band operation with your choice of optional modules for 10 meters, 6 meters, 430-440 MHz and 440-450 MHz.

Then store your preferred frequencies and modes into the eleven memories for instant recall. With

pushbutton transfer capability to either of two VFO registers. And versatile scanning functions you'd expect from a Yaesu radio.

Plus you get a lot more extras, including a built-in speech processor, all-mode squelch and a noise blanker.

So no matter where your shack is, let Yaesu's FT-726R introduce you to OSCAR 10. The world is waiting.

## YAESU

**Yaesu Electronics Corporation**  
6851 Walthall Way, Paramount, CA 90723  
(213) 633-4007

**Yaesu Cincinnati Service Center**  
9070 Gold Park Drive, Hamilton, OH 45011  
(513) 874-3100



# KENWOOD

...pacesetter in Amateur radio

All New Compact HF!

## “DX-citing!”

### TS-440S Compact high performance HF transceiver with general coverage receiver

Kenwood's advanced digital know-how brings Amateurs world-wide "big-rig" performance in a compact package. We call it "Digital DX-citement"—that special feeling you get every time you turn the power on!

- Covers All Amateur bands  
General coverage receiver tunes from 150 kHz—30 MHz. Easily modified for HF MARS operation.
- Direct keyboard entry of frequency
- All modes built-in  
USB, LSB, CW, AM, FM, and AFSK. Mode selection is verified in Morse Code.
- Built-in automatic antenna tuner (optional)  
Covers 80-10 meters.
- VS-1 voice synthesizer (optional)

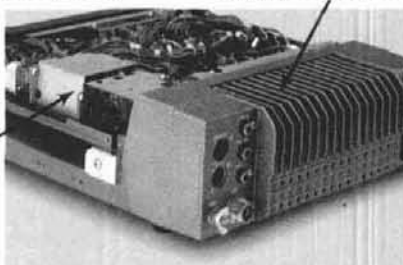

- Superior receiver dynamic range  
Kenwood DynaMix™ high sensitivity direct mixing system ensures true 102 dB receiver dynamic range.
- 100% duty cycle transmitter  
Super efficient cooling permits continuous key-down for periods exceeding one hour. RF input power is rated at 200 W PEP on SSB, 200 W DC on CW, AFSK, FM, and 110 W DC AM. (The heavy duty PS-50 power supply is needed for continuous duty.)

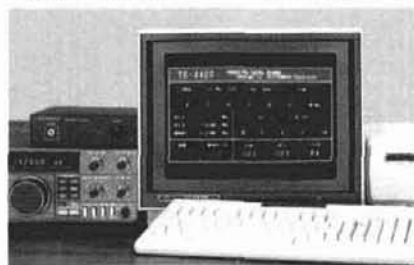

- 100 memory channels  
Frequency and mode may be stored in 10 groups of 10 channels each. Split frequencies may be stored in 10 channels for repeater operation.
- TU-8 CTCSS unit (optional)  
Subtone is memorized when TU-8 is installed
- Superb interference reduction  
IF shift, tuneable notch filter, noise blanker, all-mode squelch, RF attenuator, RIT/XIT, and optional filters fight QRM in today's crowded bands.
- MC-42S UP/DOWN mic. included
- Computer interface port
- 5 IF filter functions
- Dual SSB IF filtering  
A built-in SSB filter is standard. When an optional SSB filter (YK-88S or YK-88SN) is installed, dual filtering is provided.
- Full or semi break-in CW; AMTOR compatible.



#### Optional accessories:

- AT-440 internal auto. antenna tuner (80 m—10 m)
- AT-250 external auto. tuner (160 m—10 m)
- AT-130 compact mobile antenna tuner (160 m—10 m)
- IF-232C/IC-10 level translator and modem IC kit
- PS-50 heavy duty power supply
- PS-430/PS-30 DC power supply
- SP-430 external speaker
- MB-430 mobile mounting bracket
- YK-88C/88CN 500 Hz/270 Hz CW filters
- YK-88S/88SN 2.4 kHz/1.8 kHz SSB filters
- MC-60A/80/85 desk microphones
- MC-55 (8P) mobile microphone
- HS-4/5/6/7 headphones
- SP-40/50 mobile speakers
- MA-5/VP-1 HF 5 band mobile helical antenna and bumper mount
- TL-922A 2 kw PEP linear amplifier
- SM-220 station monitor
- VS-1 voice synthesizer
- SW-100A/200A/2000 SWR/power meters
- TU-8 CTCSS tone unit
- PG-2C extra DC cable.

Kenwood takes you from HF to OSCAR!



25th Anniversary

## KENWOOD

Complete service manuals are available for all tri-Kenwood transceivers and most accessories. Specifications and prices are subject to change without notice or obligation.

TRIO-KENWOOD COMMUNICATIONS  
1111 West Walnut Street  
Compton, California 90220