

SEPTEMBER 1983 / \$2.50

NBC's Roy Neal, K6DUE:  
Working W5LFL from Space

# ham radio magazine

- rf synthesizers
- fail-safe power
- locating orbiting satellites
- effective ground techniques
- local weather radar



**hr** 

focus  
on  
communications  
technology

## LINEAR TRANSLATORS

**NEW!**

# ICOM IC-745

## A New Transceiver Worth Celebrating!



**9 HAM BANDS!**

**GENERAL COVERAGE RECEIVER!**

**16 MEMORIES!**

**SCANNING!**

**PASSBAND TUNING!**

**VARIABLE NB & AGC!**

What's the celebration about? The IC-745... a new all ham band HF transceiver with SSB, AM, CW, RTTY and an FM option... plus, a 100kHz - 30MHz general coverage receiver.

And... the IC-745 has a combination of features found on no other transceiver at such an incredibly low price.

**Compare these exceptional features:**

- 100kHz - 30MHz Receiver
- 16 Memories
- Full function Metering with a built in SWR Bridge
- IF Shift and Pass Band Tuning
- 10Hz / 100Hz / 1KHz Tuning Rates with 1MHz band steps
- Optional Internal AC Power Supply

- Adjustable Noise Blanker (width and level)
- Continuously Adjustable AGC with an OFF position
- Receiver Preamp
- 100% Transmit Duty Cycle

**Other Standard Features:**

- 100 Watt Output Transmitter with exceptionally low IMD
- VOX
- Speech Compressor
- Tunable Notch Filter
- RIT and XIT
- All Mode Squelch
- Scanning
- ICOM System Compatibility

**Optional Accessories:**

- IC-PS15 External Power Supply

- IC-PS740 Internal Power Supply for the ultimate in Portability
- IC-2KL Linear Amplifier
- IC-SP3 External Speaker
- IC-MB12 Mobile Mounting Bracket
- IC-AT100 Antenna Tuner (100W)
- IC-AT500 Antenna Tuner (500W)
- IC-BC10 Memory Backup
- IC-EX241 Marker Module
- IC-EX242 FM Module
- IC-EX243 Electronic Keyer
- IC-FL52A 500Hz 455kHz CW Filter
- IC-FL45 500Hz 9MHz CW Filter

- IC-FL54 270Hz 9MHz CW Filter
- IC-FL53A 250Hz 455MHz CW Filter
- IC-FL44A 2.1kHz 455kHz SSB Filter
- IC-SM6 Desk Mic
- IC-HM12 Hand Mic

The IC-745 is the only transceiver today that has such features standard... the number of options and accessories available... and such a low price.

ICOM is... *Simply the Best* in quality built ham equipment today. See the IC-745 at your local authorized ICOM dealer or contact ICOM for more information.



# MFJ RTTY / ASCII / CW COMPUTER INTERFACE

Lets you send and receive computerized RTTY/ASCII/CW. Copies all shifts and all speeds. Copies on both mark and space. Sharp 8 Pole active filter for 170 Hz shift and CW. Plugs between your rig and VIC-20, Apple, TRS-80C, Atari, TI-99, Commodore 64 or most other personal computers. Uses Kantronics software and most other RTTY/CW software.

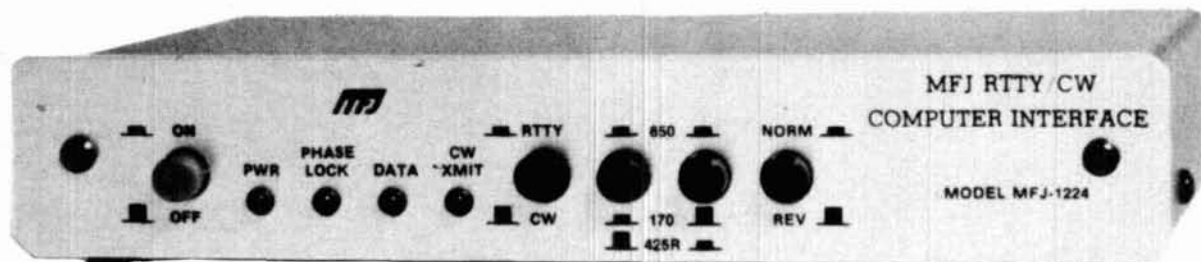

- Copies on both mark and space tones.
- Plugs between rig and VIC-20, Apple, TRS-80C, Atari, TI-99, Commodore 64 and most other personal computers.
- Uses Kantronics software and most other RTTY/CW software.

This new MFJ-1224 RTTY/ASCII/CW Computer Interface lets you use your personal computer as a computerized full featured RTTY/ASCII/CW station for sending and receiving.

It plugs between your rig and your VIC-20, Apple, TRS-80C, Atari, TI-99, Commodore 64, and most other personal computers.

It uses the Kantronics software which features split screen display, 1024 character type ahead buffer, 10 message ports (255 characters each), status display, CW-ID from keyboard, Centronic type printer compatibility, CW send/receive 5-99 WPM, RTTY send/receive 60, 67, 75, 100 WPM, ASCII send/receive 110, 300 baud plus more.

You can also use most other RTTY/CW software with nearly any personal computer.

A 2 LED tuning indicator system makes tuning fast, easy and positive. You can distinguish between RTTY/CW without even hearing it.

Once tuned in, the interface allows you to copy any shift (170, 425, 850 Hz and all shifts between and beyond) and any speed (5 to 100 WPM on RTTY/CW and up to 300 baud on ASCII).

Copies on both mark and space, not mark only or space only. If either the mark or space is lost the MFJ-1224 maintains copy on the remaining tone. This greatly improves copy under adverse conditions.

A sharp 8 pole active filter for 170 Hz shift and CW allows good copy under crowded, fading and weak signal conditions. Uses FET input op-amps.

An automatic noise limiter helps suppress static

crashes for better copy.

A Normal/Reverse switch eliminates retuning while stepping thru various RTTY speeds and shifts.

The demodulator will even maintain copy on a slightly drifting signal.

A +250 VDC loop output is available to drive your RTTY machine. Has convenient speaker output jack.

Phase continuous AFSK transmitter tones are generated by a clean, stable Exar 2206 function generator. Standard space tones of 2125 Hz and mark tones of 2295 and 2975 Hz are generated. A set of microphone lines is provided for AFSK out, AFSK ground, PTT out and PTT ground.

FSK keying is provided for transceivers with FSK.

High voltage grid block and direct outputs are provided for CW keying of your transmitter. A CW transmit LED provides visual indication of CW transmission. There is also an external hand key or electronic keyer input jack.

In addition to the Kantronics compatible socket, an exclusive general purpose socket allows interfacing to nearly any personal computer with most appropriate software. The following TTL compatible lines are available: RTTY demod out, CW demod out, CW-ID input, +5 VDC, ground. All signal lines are buffered and can be inverted using an internal DIP switch.

For example, you can use Gafco software with Apple computers, or RAK software with VIC-20's. Some computers with some software may require some external components.

DC voltages are IC regulated to provide stable

AFSK tones and RTTY/ASCII/CW reception.

Aluminum cabinet. Brushed aluminum front panel. 8x1 1/4x6 inches. Uses 12-15 VDC or 110 VAC with optional adapter, MFJ-1312, \$9.95.

## RTTY / ASCII / CW Receive Only SWL Computer Interface



\$ 69<sup>95</sup>  
MFJ-1225

Use your personal computer to receive commercial, military and amateur RTTY/ASCII/CW traffic.

The MFJ-1225 automatically copies all shifts (850, 425, 170 Hz shift and all others) and all speeds.

It plugs between your receiver and VIC-20, Apple, TRS-80C, Atari, TI-99, Commodore 64 and most other personal computers.

It uses Kantronics software which features CW receive 5-99 WPM, RTTY receive 60, 67, 75, 100 WPM, and ASCII receive 110, 300 baud, plus more.

An automatic noise limiter helps suppress static crashes for better copy, while a simple 2 LED tuning indicator system makes tuning fast, easy and positive.

In addition to the Kantronics compatible socket, a general purpose socket provides RTTY out, RTTY inverted out, CW out, CW inverted out, ground and +5VDC for interfacing to nearly any personal computer with most appropriate software.

Audio in, speaker out jacks. 4 1/2x1 1/4x4 1/4 in. 12-15 VDC or 110 VAC with adapter, MFJ-1312, \$9.95.

ORDER ANY PRODUCT FROM MFJ AND TRY IT-NO OBLIGATION. IF NOT DELIGHTED, RETURN WITHIN 30 DAYS FOR PROMPT REFUND (LESS SHIPPING).

- One year unconditional guarantee
- Made in USA.
- Add \$4.00 each shipping/handling
- Call or write for free catalog, over 100 products.

# MFJ

MFJ ENTERPRISES, INC.  
Box 494, Mississippi State, MS 39762

TO ORDER OR FOR YOUR NEAREST DEALER, CALL TOLL-FREE  
800-647-1800. Call 601-323-5869 in Mississippi and outside continental U.S.A. Telex 53-4590.



# "DX-traordinary."



Superior dynamic range, auto. antenna tuner, QSK, dual NB, 2 VFO's, general coverage receiver.

## TS-930S

The TS-930S is a superlative, high performance, all-solid state, HF transceiver keyed to the exacting requirements of the DX and contest operator. It covers all Amateur bands from 160 through 10 meters, and incorporates a 150 kHz to 30 MHz general coverage receiver having an excellent dynamic range.

Among its other important features are, SSB slope tuning, CW VBT, IF notch filter, CW pitch control, dual digital VFO's, CW full break-in, automatic antenna tuner, and a higher voltage operated solid state final amplifier. It is available with or without the AT-930 automatic antenna tuner built-in.

### TS-930S FEATURES:

- **160-10 Meters, with 150 kHz-30 MHz general coverage receiver.**  
Covers all Amateur frequencies from 160-10 meters, including new WARC bands, on SSB, CW, FSK, and AM. Features 150 kHz-30 MHz general coverage receiver. Separate Amateur band access keys allow speedy band selection. UP/DOWN bandwidth in 1-MHz steps. A new, innovative, quadruple "UP" conversion, digital PLL synthesized circuit provides superior frequency accuracy and stability, plus greatly enhanced selectivity.
- **Excellent receiver dynamic range.**  
Receiver two-tone dynamic range, 100 dB typical (20 meters, 50-kHz spacing, 500 Hz CW bandwidth, at sensitivity of 0.25  $\mu$ v, S/N 10 dB), provides the ultimate in rejection of IM distortion.
- **All solid state, 28 volt operated final amplifier.**  
The final amplifier operates on 28 VDC for lowest IM distortion. Power input rated at 250 W on SSB, CW, and FSK, and at 80 W on AM. Final amplifier protection circuits with cooling fan, SWR/Power meter built-in.
- **CW full break-in.**  
CW full break-in circuit uses CMOS logic IC plus reed relay for smooth, quiet operation. Switchable to semi-break-in.

- **Automatic antenna tuner, built-in.**  
Covers Amateur bands 80-10 meters, including the new WARC bands. Tuning range automatically pre-selected with band selection to minimize tuning time. "AUTO-THRU" switch on front panel.
- **Dual digital VFO's.**  
10-Hz step dual digital VFO's include band information. Each VFO tunes continuously from band to band. A large, heavy, flywheel type knob is used for improved tuning ease. T.F. Set switch allows fast transmit frequency setting for split-frequency operations. A=B switch for equalizing one VFO frequency to the other. VFO "Lock" switch provided. RIT control for  $\pm 9.9$  kHz.
- **Eight memory channels.**  
Stores both frequency and band information. VFO-MEMO switch allows use of each memory as an independent VFO, (the original memory frequency can be recalled at will), or as a fixed frequency. Internal Battery memory back-up, estimated 1 year life. (Batteries not Kenwood supplied).
- **Dual mode noise blanker ("pulse" or "woodpecker").**  
NB-1, with threshold control, for pulse-type noise. NB-2 for longer duration "woodpecker" type noise.
- **SSB IF slope tuning.**  
Allows independent adjustment of the low and/or high frequency slope of the IF passband, for best interference rejection. HIGH/LOW cut control rotation not affected by selecting USB or LSB modes.
- **CW VBT and pitch controls.**  
CW Variable Bandwidth Tuning control tunes out interfering signals. CW pitch controls shifts IF passband and simultaneously changes the pitch of the beat frequency. A "Narrow/Wide" filter selector switch is provided.
- **IF notch filter.**  
100 kHz IF notch circuit gives deep, sharp, notch, better than -40 dB.
- **Audio filter built-in.**  
Tuneable, peak-type audio filter for CW.
- **AC power supply built-in.**  
120, 220, or 240 VAC, switch selected (operates on AC only).

- **Fluorescent tube digital display.**  
Six digit readout to 100 Hz (10 Hz modifiable), plus digitalized sub-scale with 20-kHz steps. Separate two digit indication of RIT frequency shift. In CW mode, display indicates the actual carrier frequency of received as well as transmitted signals.
- **RF speech processor.**  
RF clipper type processor provides higher average "talk-power," improved intelligibility.
- **One year limited warranty on parts and labor.**
- **Other features:**
  - SSB monitor circuit, 3 step RF attenuator, VOX, and 100-kHz marker.
- **Optional accessories:**
  - AT-930 automatic antenna tuner.
  - SP-930 external speaker with selectable audio filters.
  - YG-455C-1 (500 Hz) or YG-455CN-1 (250 Hz) plug-in CW filters for 455-kHz IF.
  - YK-88C-1 (500 Hz) CW plug-in filter for 8.83-MHz IF.
  - YK-88A-1 (6 kHz) AM plug-in filter for 8.83-MHz IF.
  - SO-1 commercial stability TCXO (temperature compensated crystal oscillator). Requires modifications.
  - MC-60A deluxe desk microphone with UP/DOWN switch, pre-amplifier, 8-pin plug.
  - TL-922A linear amplifier (not for CW QSK).
  - SM-220 station monitor (not for pan-adapt).
  - HS-6, HS-5, HS-4, headphones.

More information on the TS-930S is available from all authorized dealers of Trio-Kenwood Communications, 1111 West Walnut Street, Compton, California 90220.

# KENWOOD

...pacesetter in amateur radio



Specifications and prices are subject to change without notice or obligation.

# SAVE \$10.50\* with home delivery

\*(One year newsstand cost \$30.00)

Here's my address label, enter my subscription.  Payment enclosed

Bill me later

1 Year . . . . . 12 issues . . . . . \$19.50 U. S. prices only

2 Years . . . . . 24 issues . . . . . \$32.50

3 Years . . . . . 36 issues . . . . . \$42.50

Name \_\_\_\_\_ Zip \_\_\_\_\_

Address \_\_\_\_\_ State \_\_\_\_\_

City \_\_\_\_\_

Check here if this is your renewal (attach label)

## Subscribe to **ham radio** magazine

Please allow 4-6 weeks for delivery of first issues.

**Foreign rates:** Europe, Japan and Africa, \$28.00 for one year by air forwarding service. All other countries \$21.50 for one year by surface mail.

Please  
enter my  
subscription



**BUSINESS REPLY CARD**

First Class    Permit No. 1    Greenville, NH

Postage Will Be Paid By Addressee

**ham  
radio**

Greenville, NH 03048

NO POSTAGE  
NECESSARY  
IF MAILED  
IN THE  
UNITED STATES



# ham radio

magazine

SEPTEMBER 1983

volume 16, number 9

**T. H. Tenney, Jr., W1NLB**  
publisher

**Rich Rosen, K2RR**  
editor-in-chief  
and associate publisher

**Dorothy Rosa Leeds**  
assistant editor

**editorial staff**

Alfred Wilson, W6NIF  
Joseph J. Schroeder, W9JUV  
Leonard H. Anderson  
associate editors  
Susan Shorrock  
editorial production

Mike Brown  
Cover

**publishing staff**

J. Craig Clark, Jr., N1ACH  
assistant publisher

Rally Dennis, KA1JWF  
director of advertising sales  
Dorothy Sargent, KA1ZK  
advertising production manager

Susan Shorrock  
circulation manager

Therese Bourgault  
circulation

ham radio magazine  
is published monthly by  
Communications Technology, Inc  
Greenville, New Hampshire 03048-0498  
Telephone: 603-878-1441

**subscription rates**

United States: one year, \$19.50  
two years, \$32.50; three years, \$42.50  
Canada and other countries (via Surface Mail)  
one year, \$21.50; two years, \$40.00  
three years, \$57.00

Europe, Japan, Africa (via Air  
Forwarding Service) one year, \$28.00

All subscription orders payable in  
United States funds, please

**foreign subscription agents**

Foreign subscription agents are  
listed on page 95

Microfilm copies  
are available from  
University Microfilms, International  
Ann Arbor, Michigan 48106  
Order publication number 3076

Cassette tapes of selected articles  
from *ham radio* are available to the  
blind and physically handicapped  
from Recorded Periodicals  
919 Walnut Street, 8th Floor  
Philadelphia, Pennsylvania 19107

Copyright 1983 by  
Communications Technology, Inc  
Title registered at U. S. Patent Office

Second-class postage  
paid at Greenville, N.H. 03048-0498  
and at additional mailing offices  
ISSN 0148-5989

Postmaster send Form 3579 to *ham radio*  
Greenville, New Hampshire 03048-0498



## contents

**14 linear translators**

James Eagleson, WB6JNN

**32 a fail-safe amplifier power supply**

Geoffrey H. Krauss, WA2GFP

**41 ham radio techniques**

Bill Orr, W6SAI

**48 rf synthesizers for hf communications:  
part 2**

Craig Corsetto, WA6OAA

**61 10-GHz weather radar**

Dave Ingram, K4TWJ

**67 installing effective ground systems**

Bradley Wells, KR7L

**72 locate orbiting satellites**

John L. Hill, W0ZWW

**81 special report: working W5LFL from  
space**

Roy Neal, K6DUE

**110 advertisers index  
and reader service**

**12 comments**

**84 DX forecaster**

**95 flea market**

**98 ham mart**

**89 new products**

**10 presstop**

**88 product reviews**

**7 reflections**

**83 technical forum**

When two recent American Everest expeditions mounted the Larsen® Kūlduckie® antenna on their radios, it wasn't just because it was there. It was because they knew Larsen performance and reliability would be there when needed the most—even at the top of the world.

Extreme altitude, sub-zero temperatures and unpredictable conditions demand more than most antennas give in a lifetime. For Larsen Kūlduckie antennas, it's all in a day's work.

We design our portable antennas to give more than what's expected. Copper plated radiating elements turn power into stronger communications—not heat. Double-soldered connections at maxi-

mum stress points allow 180 degree bends in all directions. And not one, but two layers of low dielectric loss, heat-shrinkable tubing protect the element, while a top coat of PVC provides a sleek finish.

You can expect more from our service too. Our prompt delivery, personal attention and no nonsense warranty back you up every step of the way.

So whether you're leading an expedition up the face of Everest, or just hiking through the back country, Larsen Kūlduckie portable antennas will keep you on top of the situation with peak performance. We'd be glad to show you how they'll work for you.

Write for our free amateur catalog.

# LARSEN IS ON TOP OF THE WORLD



A World Of Difference  
In Performance

**Larsen Antennas**

IN USA: Larsen Electronics, Inc. /11611 N.E. 50th Ave. /P.O. Box 1799/Vancouver, WA 98668/206-573-2722  
Telex 152-813 LARSEN ELC VANC

IN CANADA: Canadian Larsen Electronics, Ltd. /283 E. 11th Ave., Unit 101/Vancouver, B.C. V5T  
2C4/604-872-8517 Telex 04-54666 CDN LARSEN VCR

Larsen®, Kūlrod® and Kūlduckie® are registered trademarks of Larsen Electronics, Inc.



# REFLECTIONS

## a personal phone call

If I could pick up the phone and call you right now, I'd ask each one of you personally how you feel about *ham radio magazine*.

Something akin to this actually happened at Dayton this year, when more than 400 readers took the time to express their views, needs, and concerns to me at our booth. But this number — impressive as it is — represents less than one percent of our subscribers . . . and we need to hear from the other ninety-nine percent.

Since I can't call each one of you personally, I'm doing the next best thing: asking you to take advantage of the survey form printed on this page and the next, and let us know, very clearly, how you feel about *ham radio*.

I see this magazine (and all magazines, for that matter) as a conduit of thoughts — a communications channel. Editors are in a privileged situation. Information arrives from all directions, and can be directed, stopped or modified. Add to that an editor's own personal interests and inclinations and one can see that the different directions a magazine can take are many. But my desire is to provide material that you want to read and use.

Because Radio Amateurs are such a diverse group, I fully expect to hear completely opposing viewpoints expressed with fervent conviction. The majority will rule, of course. But the minority will be heard. And we'll do what we can to try to meet their needs, too, without compromising our primary mission, which is to provide the Amateur community with the most useful and informative technical material in the Amateur Radio publishing field.

We all have vested interests in this wonderful hobby; each and every one of us, at one time or another, has expressed our views privately or in the presence of large groups. All I'm asking is for you to do the same now in responding to the questions that follow.

Many of the questions, you'll notice, have been asked before in other surveys. We have to ask them again because an accurate, up-to-date reader profile helps us make the short and long-term decisions that result in a magazine that suits your interests as closely as possible. Some questions ask you to rate the magazine by itself and in comparison to others in the field. (Besides being curious, we at *ham radio* prefer to work with fact rather than fiction.) Other questions attempt to determine, very specifically, your present and future needs. We're only human. Maybe we've left out an area or two you would like to see discussed. Write it down!

What is at stake are your needs. Correspondence and communications — dozens of letters and phone calls each day — coupled with our best intentions and understanding indicate that *ham radio* should continue to provide a technically sophisticated subject menu. With your help we'll be able to vary your diet, make it fuller and more satisfying. Don't stop now — take pen in hand and as neatly as possible (please think of our poor compilers) respond to the survey questions. All of your opinions are wanted and needed. Thank you.

Rich Rosen, K2RR  
Editor-in-Chief

## 1983 reader survey

Please reply to the questions below and return this page (or a photocopy) to READER SURVEY, Ham Radio Magazine, Greenville, New Hampshire 03048 by November 1, 1983.

### ABOUT YOUR AMATEUR INTERESTS

- a. Class of license held \_\_\_\_\_  
Check here if no license held \_\_\_\_\_
- b. Number of years licensed \_\_\_\_\_
- c. In which modes do you operate? (Check all that apply)

|        | Exclusively | More than 50% | Less than 50% | Never |
|--------|-------------|---------------|---------------|-------|
| CW     |             |               |               |       |
| SSB/AM |             |               |               |       |
| A5     |             |               |               |       |
| RTTY   |             |               |               |       |
| FM     |             |               |               |       |
| Packet |             |               |               |       |
| Other  |             |               |               |       |

- d. What frequency ranges do you work? (Check all that apply.)

|                   | Exclusively | More than 50% | Less than 50% | Never |
|-------------------|-------------|---------------|---------------|-------|
| l-f (1750 meters) |             |               |               |       |
| m-f (160 meters)  |             |               |               |       |
| h-f               |             |               |               |       |
| vhf               |             |               |               |       |
| uhf               |             |               |               |       |
| microwave         |             |               |               |       |

- e. How much of your equipment do you build?  
100% \_\_\_\_\_ 75% \_\_\_\_\_ 50% \_\_\_\_\_ 25% \_\_\_\_\_  
Less than 25% \_\_\_\_\_ None \_\_\_\_\_

- f. When you build equipment, do you prefer to build:  
 from a kit \_\_\_\_\_ from "scratch" \_\_\_\_\_
- g. What was the most complex piece of equipment you've built in the last 5 years? \_\_\_\_\_
- h. How many hours a week do you spend on Amateur Radio operation and activities? \_\_\_\_\_
- i. About how much do you spend each year on Amateur equipment?  
 \$100-\$500 \_\_\_\_\_ \$500-\$1000 \_\_\_\_\_ \$1000-\$2000 \_\_\_\_\_  
 \$2000-\$4000 \_\_\_\_\_ \$4000+ \_\_\_\_\_
- j. From what source do you obtain your books about Amateur Radio?  
 dealer \_\_\_\_\_ Ham Radio's Bookstore \_\_\_\_\_  
 other mail order \_\_\_\_\_ at shows \_\_\_\_\_
- k. Do you own a personal computer?  
 Yes \_\_\_\_\_ No \_\_\_\_\_  
 If "yes," what kind? \_\_\_\_\_  
 If "no" do you:  
 Plan to purchase within one year \_\_\_\_\_  
 Do not plan to purchase \_\_\_\_\_

## ABOUT HAM RADIO MAGAZINE

- a. From the following list, please choose the five areas of interest you would most like to see addressed in *ham radio* magazine on a regular basis. Enter your choices, in order of preference (favorite first) in the spaces below:

- |                                      |                           |                           |
|--------------------------------------|---------------------------|---------------------------|
| antennas                             | new product announcements | test equipment (to build) |
| awards                               | News in Amateur Radio and | test equipment (to buy)   |
| book reviews                         | current events            | test equipment (to use)   |
| computers and Amateur Radio          | opinion                   | theory (simple)           |
| construction (simple)                | operating events          | theory (intermediate)     |
| construction (intermediate)          | product reviews           | theory (advanced)         |
| construction (advanced)              | Questions and Answers     | other (please specify)    |
| contests                             | radio history             | 1. _____                  |
| DX                                   | receivers                 | 2. _____                  |
| FCC news                             | satellites                | 3. _____                  |
| future technology                    | social events             | 4. _____                  |
| interviews                           | speech synthesis          | 5. _____                  |
| international Amateur Radio journals | surplus (conversions)     |                           |
| license upgrading                    |                           |                           |

- b. To which Amateur Radio publications do you subscribe?  
*ham radio* \_\_\_\_\_ QST \_\_\_\_\_ CQ \_\_\_\_\_ 73 \_\_\_\_\_ Other \_\_\_\_\_
- c. Of the publications listed above, which one suits your needs best? \_\_\_\_\_
- d. In general, how do you feel about *ham radio* magazine?  
 best in the field \_\_\_\_\_ better than most \_\_\_\_\_ satisfactory \_\_\_\_\_ unsatisfactory \_\_\_\_\_
- e. In regard to technical content only, do you feel *ham radio* magazine is:  
 about right \_\_\_\_\_ too technical \_\_\_\_\_ not technical enough \_\_\_\_\_
- f. In regard to clarity and readability, do you find *ham radio* magazine:  
 well-designed and edited, easy to read \_\_\_\_\_ satisfactory \_\_\_\_\_ needlessly complex \_\_\_\_\_
- g. In general, do you feel that the articles in *ham radio* are:  
 about right \_\_\_\_\_ too long \_\_\_\_\_ too short \_\_\_\_\_
- h. Have you ever purchased Amateur equipment as a result of reading about it in *ham radio* advertising?  
 Yes \_\_\_\_\_ No \_\_\_\_\_
- i. Have you ever purchased Amateur equipment as a result of reading about it in *ham radio* editorial content?  
 Yes \_\_\_\_\_ No \_\_\_\_\_
- j. Have you ever purchased *commercial or industrial* equipment as a result of reading about it in *ham radio* advertising?  
 Yes \_\_\_\_\_ No \_\_\_\_\_
- k. Would you be interested in reading about current developments in *commercial or industrial* radio equipment in the pages of *ham radio*? Yes \_\_\_\_\_ No \_\_\_\_\_
- l. Looking back over the past three months (June, July, August) what one article or feature in *ham radio* did you *most* enjoy? \_\_\_\_\_  
 Which article or feature did you *least* enjoy? \_\_\_\_\_
- m. If you could tell the editors of *ham radio* how the magazine could be improved, what would you say?  
 \_\_\_\_\_

## ABOUT YOU

- a. Your age: \_\_\_\_\_
- b. Occupation: \_\_\_\_\_
- c. Income Range (check one): Below \$7500 \_\_\_\_\_ \$7500-\$12,999 \_\_\_\_\_ \$13,000-\$19,999 \_\_\_\_\_  
 \$20,000-\$29,999 \_\_\_\_\_ \$30,000-\$49,999 \_\_\_\_\_ \$50,000+ \_\_\_\_\_

Thank you for taking the time to complete this survey.

# COMMUNICATORS AND RADIO OPERATORS

The Central Intelligence Agency has excellent career opportunities for individuals with experience in HF radio, Morse intercept, satellite communications, or radio-teletype operations. If you are looking for the challenge of a CIA career . . . you could join a very select group of dedicated men and women who use their professional skills in unique and rewarding assignments throughout the world.

## Skills / Experience:

Applicants should have experience as communicators, telecommunications specialists, radiomen, Morse intercept operators, or be radio amateurs with general license or higher. Morse code ability at 12 gpm is preferred; other applicants will be tested for Morse aptitude. Minimum touch typing speed of 30 wpm is required.



## Central Intelligence Agency

An Equal Opportunity Employer

## Personal Qualifications:

U.S. citizen (self and spouse); high school graduate or GED; availability for extensive overseas service. Must meet security and medical standards. Civil Service status *not* required.

Starting salaries \$15,398-\$18,215 depending on qualifications, plus substantial overseas benefits.

## Attention Military Personnel:

Apply now if you are scheduled for separation within the next six months.

Send resume to:  
Personnel Representative (JV)  
P.O. Box 1925  
Washington, D.C. 20013

TEXAS RESIDENTS:  
CIA recruiters will be at  
the ARRL "Com-Vention" in  
Houston October 7-9, 1983.

# presstop de W9JUV

1500 WATTS PEAK OUTPUT WILL BE THE NEW LEGAL LIMIT for U.S. Amateurs effective August 29. Acting on PR Docket 82-624, the Commissioners agreed on the new output limits for both SSB and CW July 18. 200 watts out will be the new limit for Novice bands, but 30 meters is still 250 watts input. In addition, AM users will be "grandfathered" use of 1000 watts DC carrier input until June, 1990, as the new limit represents a power decrease for them. At the same time, the FCC deleted the requirement for each Amateur to have instrumentation to assure compliance with the rules on power limits--but individual operators better be sure they're operating within the limits should the FCC decide to inspect their stations!

Next Major New Issue Likely To Appear On The Commission's Agenda is "broadcasting," specifically the endless feuding that occurs between participants in some Amateur nets and individual operators. Expect the subject to surface as a Notice of Inquiry this fall.

OSCAR 10'S NOT-QUITE-AS-PLANNED INITIAL ORBIT apparently resulted from an after-separation collision with the launch vehicle's third stage. Supporting indications include telemetry data from vibration sensors and an apparent change in the radiation pattern of OSCAR 10's 2-meter antenna, a change that could have resulted from collision damage.

The Important Damage Was To The Kick Motor, Which Fired OK for the first burn but did not respond to final burn commands July 25. Though this leaves the orbit significantly off nominal, its final 3951 by 35505 km elliptical path will still provide long openings for users throughout the world. The fact that OSCAR 10 is up and fully operational reflects tremendous credit on its designers, builders and controllers. Just getting a satellite as sophisticated as OSCAR 10 up and operating is a challenge to the most experienced professionals, and for a group of "Amateurs" to accomplish the feat despite a potentially catastrophic accident is almost beyond belief! Congratulations to AMSAT's "Amateurs!"

OSCAR 10's Transponders Should Be Turned On for users by sometime in mid August.

SUPPORT FOR CONTINUING CW LICENSE REQUIREMENTS HAS COME from an unexpected source, the U.S. Air Force, which has advised the FCC it's reinstating Morse proficiency for its radio operator training course. This probably means that a no-code Amateur licensee would not be eligible for Air Force MARS without demonstrating CW ability.

Senator Barry Goldwater Has Strongly Restated His Opposition to "No-Code" in a "Dear Mark" letter to FCC Chairman Mark Fowler. In it he says "I completely support (the ARRL's) Comments" against no-code, and says he believes it would be "a grave mistake to remove the code as a license requirement..." The QCWA also filed strong comments against no-code.

A Decision On No-Code Appears Likely By Year's End, but at this time no one seems to want to make odds as to which way it will go.

"AMATEUR RADIO'S NEWEST FRONTIER," THE NEW AMATEUR RADIO VIDEOTAPE production, is well on its way to release. NBC's Roy Neal, K6DUE, and Westlink's WA6ITF did the taping in mid-July at the ARRL, FCC, AMSAT's Goddard facilities, and with NASA in both Huntsville and Houston. Editing and dubbing were completed July 24, and the new 16-minute Amateur Radio promotional piece should be available about September 1 on VHS and 3/4-inch tape.

THE FCC'S NEW "NO-MAILBACK" NOVICE EXAMS MUST CONSIST of one, two, or three questions from each of 20 FCC-provided groups of 10 questions each. The answers are not included, perhaps because the examiner, as a higher class licensee, should already know what the correct answer--or sometimes answers--is. In addition, it might also give a better opportunity for the examiner to determine if the applicant really knows what he should or is simply parroting back answers from a "study guide."

A Copy Of The FCC's List Of 200 Questions and details on how to administer the new Novice exam are available from ham radio for a business size (#10) SASE.

W5LFL'S OPERATION FROM THE SPACE SHUTTLE IS STILL ON SCHEDULE for the end of September. The ARRL is still trying to arrange for a "900" information line to be operational about a week before launch. Information on that line is to be updated frequently, particularly if it pertains to W5LFL's on-the-air activities.

145.55 MHz Should Be W5LFL's Prime Transmit Frequency, with several alternates to be announced shortly before launch along with about 20 receive channels.

"SUPER STRICT" INTERPRETATIONS OF THE FCC'S "BUSINESS COMMUNICATIONS" action that was announced in last month's Presstop were not what the Commission intended. The FCC's action actually changed little in the rules, but was simply meant to be a reorganization and clarification of business communications-related items already there.

Public Service Type Operations Such As Parade or walkathon coordination and the Eye Bank Net are still permitted. Amateur-related operations such as Hamfest "Talk-Ins" and even on-the-air swap nets are also still legitimate. In its release, the FCC stated: "The Order was not intended to impose any new restrictions or to cut back on what Amateurs have legitimately been doing all along. What was intended was to alert the Amateur community to the fact that the Amateur Radio Service should not be used in lieu of other radio services for the transmission of business messages."

Catalysts For The FCC's Action Were Two Recent West Coast Episodes, one in which a "citizens' posse" began using a local repeater as an auxiliary police communications channel. In the other a government facility wanted its employees with Amateur licenses to patrol its fences and gates while using 2 meters for coordination.

PRIVATE RADIO BUREAU CHIEF JIM MCKINNEY HAS RESIGNED to become Chief of the FCC's Mass Media Bureau. Jim, who's long been a knowledgeable supporter of the Amateur Service, is replaced by Private Radio Bureau Deputy Chief Bob Foosaner.

# RECEIVE WEATHER CHARTS IN YOUR HOME!



## You can DX and receive weather charts from around the world.

Tune in on free, worldwide government weather services. Some transmitting sites even send weather satellite cloud cover pictures!

## You've heard those curious facsimile sounds while tuning through the bands — now capture these signals on paper!

Assemble ALDEN's new radiofacsimile Weather Chart Recorder Kit, hook it up to a stable HF general-coverage receiver, and you're on your way to enjoying a new hobby activity with many practical applications. Amateurs, pilots, and educators can now receive the same graphic printouts of high-quality, detailed weather charts and oceanographic data used by commercial and government personnel.

## Easy to assemble — Backed by the ALDEN name.

For over 40 years, ALDEN has led the way in the design and manufacture of the finest weather facsimile recording systems delivered to customers worldwide. This recorder kit includes pre-assembled and tested circuit boards and mechanical assemblies. All fit together in a durable, attractive case that adds the finishing professional touch.

## Buy in kit form and save \$1,000!

You do the final assembly. You save \$1,000. Complete, easy-to-follow illustrated instructions for assembly, checkout, and operation. And ALDEN backs these kits with a one-year limited warranty on all parts.

## Easy to order.

Only \$995 for the complete ALDEN Weather Chart Recorder Kit.

To order, fill out and mail the coupon below. For cash orders enclose a check or money order for \$995. Add \$5 for shipping and handling in the U.S. and Canada, plus applicable sales tax for CA, CO, CT, IA, MA, NY, WI. (Export price is \$1250 F.O.B. Westborough, MA. Specify 50 or 60 Hz.) To use your MasterCard or Visa by phone, call (617) 366-8851.

## ALDEN ELECTRONICS

Washington Street, Westborough, MA 01581

|                                                                                                                                                                                                                                                                                                                                                                                                           |                         |  |  |  |  |  |  |  |  |  |  |
|-----------------------------------------------------------------------------------------------------------------------------------------------------------------------------------------------------------------------------------------------------------------------------------------------------------------------------------------------------------------------------------------------------------|-------------------------|--|--|--|--|--|--|--|--|--|--|
| NAME: _____                                                                                                                                                                                                                                                                                                                                                                                               |                         |  |  |  |  |  |  |  |  |  |  |
| CALLSIGN: _____                                                                                                                                                                                                                                                                                                                                                                                           |                         |  |  |  |  |  |  |  |  |  |  |
| ADDRESS: _____                                                                                                                                                                                                                                                                                                                                                                                            |                         |  |  |  |  |  |  |  |  |  |  |
| CITY: _____                                                                                                                                                                                                                                                                                                                                                                                               | STATE: _____ ZIP: _____ |  |  |  |  |  |  |  |  |  |  |
| <input type="checkbox"/> I've enclosed a check or money order for \$995.00 and \$5.00 for shipping and handling, plus applicable sales tax.                                                                                                                                                                                                                                                               |                         |  |  |  |  |  |  |  |  |  |  |
| <input type="checkbox"/> Charge to: <input type="checkbox"/> MasterCard  <input type="checkbox"/> Visa                                                                                                                          |                         |  |  |  |  |  |  |  |  |  |  |
| ACCOUNT # (ALL DIGITS)                                                                                                                                                                                                                                                                                                                                                                                    |                         |  |  |  |  |  |  |  |  |  |  |
| <table border="1" style="width: 100%; height: 20px;"> <tr> <td style="width: 12.5%;"></td> <td style="width: 12.5%;"></td> <td style="width: 12.5%;"></td> <td style="width: 12.5%;"></td> <td style="width: 12.5%;"></td> <td style="width: 12.5%;"></td> <td style="width: 12.5%;"></td> <td style="width: 12.5%;"></td> <td style="width: 12.5%;"></td> <td style="width: 12.5%;"></td> </tr> </table> |                         |  |  |  |  |  |  |  |  |  |  |
|                                                                                                                                                                                                                                                                                                                                                                                                           |                         |  |  |  |  |  |  |  |  |  |  |
| EXPIRATION DATE                                                                                                                                                                                                                                                                                                                                                                                           |                         |  |  |  |  |  |  |  |  |  |  |
| <table border="1" style="width: 100%; height: 20px;"> <tr> <td style="width: 25%;"></td> <td style="width: 5%;"></td> <td style="width: 25%;"></td> <td style="width: 5%;"></td> <td style="width: 25%;"></td> <td style="width: 5%;"></td> <td style="width: 25%;"></td> </tr> </table>                                                                                                                  |                         |  |  |  |  |  |  |  |  |  |  |
|                                                                                                                                                                                                                                                                                                                                                                                                           |                         |  |  |  |  |  |  |  |  |  |  |
| SIGNATURE REQUIRED IF USING CREDIT CARD _____                                                                                                                                                                                                                                                                                                                                                             |                         |  |  |  |  |  |  |  |  |  |  |

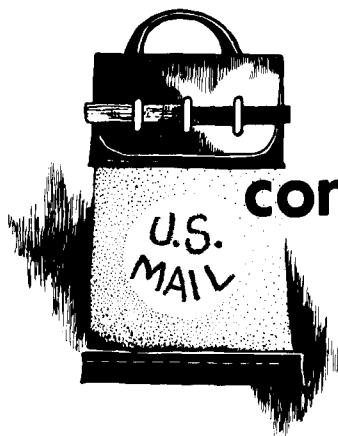

## comments

### PEP talk

#### Dear HR:

The article by VK3AFQ (*ham radio*, June, 1983), demonstrates one of the fallacies of defining the legal power limit in terms of PEP output. The metering device described, like the commercially available in-line "wattmeters," is designed to work with a 50-ohm non-reactive load. Not all Amateur stations are equipped with suitable transmatches to arrive at a perfectly matched line at all frequencies within a band — let alone homebrew rigs designed to work into balanced feedline or oddball impedances.

Nor is the statement by Rich Rosen, Editor-in-Chief, that the FCC proposal would increase our power to 1500 PEP output, strictly true. Under present rules there is no limit to transmitted PEP, but practically, the limit is at least 3000 watts (one kilowatt input, plate-modulated a-m phone). The power limit for CW, fm, RTTY, and SSTV would be doubled, while the limit for SSB would remain essentially unchanged.

Actually, PEP is useful as an equipment design parameter, but is quite irrelevant to the purpose behind the legal power limit. It is mean, or average, output power that determines the effective field strength of a signal, not the power developed on occasional voice peaks. I believe that if the FCC goes ahead and replaces the relatively simple input power limit with something as complicated to measure as PEP output, the practical effect will be the elimination of a power limit al-

together. Many otherwise law-abiding Amateurs will rationalize illegal power by claiming to lack the facilities to make the necessary measurements to comply voluntarily under the new rules. The FCC simply does not have the facilities to routinely inspect Amateur Radio stations for transmitter power.\*

**Donald Chester, K4KYV**  
**Woodlawn, Tennessee**

\*It's now official — see *presstop* for details.

### simpler "panadaptor"

#### Dear HR:

I've been an *hr* subscriber since April, 1972, and I can't remember an issue in which I've found more first class technical articles than your February, 1983, number. Congratulations!

Rick Ferranti's "Design Notes on a Panoramic Adapter/Spectrum Analyzer" was particularly interesting. As someone who has worked with a similar homebrew project, I'd like to offer a couple of additional notes.

If you have a receiver with a narrowband CW filter and you don't mind poking a few holes in the cabinet, it may be possible to simplify the panoramic adaptor and reduce the parts count by using the receiver's internal mixer, i-f amplifier chain, and filter. This technique involves substituting an external swept oscillator for the tunable local oscillator of the receiver and substituting the detector and video amplifier of the spectrum analyzer (Ferranti's **fig. 11**) for the receiver's product detector and audio

chain. The swept oscillator is connected to the LO port of the receiver's internal mixer stage in place of the internal tuneable LO; and the i-f output is picked off after, rather than before, the receiver's high selectivity filter.

Before this arrangement, the external circuits which comprise the panoramic adaptor consist only of: (1) a sweep oscillator, (2) a new "local oscillator" for the receiver having the same tuning range as the receiver's own LO but which can be swept in frequency by the sawtooth output of the sweep oscillator, (3) the detector/video amplifier, and (4) the oscilloscope used to display the signal. For this circuit to function properly, both the tuneable local oscillator and the AGC bus of the receiver must be disabled. The receiver's mixer and i-f amplifiers should have wide dynamic range for best results. Sweep speeds ranging from 50 to 2000 milliseconds are desirable to avoid ringing effects, and these are practical if a long persistence (P7) CRT is used for the display. Finally, it should be noted that this technique is suitable only for receivers that have the same tuneable LO tuning range on each band; but this is true of most modern receivers that use a crystal-controlled first converter stage.

Ferranti's design has the advantage of making it possible to sweep across a wide band of frequencies, regardless of the i-f and LO frequencies of the receiver with which it is used. Using the scheme I recommend, this performance is harder to obtain.

If the highest LO frequency is less than 3 or 4 MHz (this would be true of most "Collins type" receivers using 455 or 500 kHz mechanical filters), there is a simple solution, using the Exar XR-205 "Monolithic Waveform Generator" chip as a swept LO. This chip has a guaranteed sine wave output of at least 2 MHz, and individual chips will run as high as 4 MHz. The frequency can be swept over a wide range, and the sweep is extremely linear with applied voltage.

Where the operating frequency of the LO is higher but still too low to permit the oscillator to be swept by a voltage-variable capacitor of reasonable size, some form of heterodyne scheme is a must. Ferranti's 32.82 MHz VCO (fig. 5) can be used, mixed with the output of a fixed crystal oscillator. After passing the difference frequency through a lowpass filter, the resultant would be injected at the LO port of the receiver's mixer stage. Even with this added complication, the recommended circuit will have a far lower parts count than Ferranti's double conversion technique, and there should be fewer critical adjustments.

Miles B. Anderson, K2CBY  
Sag Harbor, New York

## more 10-meter beacons

Dear HR:

A 10-meter beacon, using callsign KA1YE/B, transmits from Connecticut on 28.284 MHz. It sends a 30-second carrier followed by "KA1YE/B SE CT" and operates continuously at a 4 watt output level to a vertical antenna.

The May, 1983, issue of *Practical Wireless* lists 19 worldwide beacons. A list of active beacons is maintained by Willi, HB9AVE. He would appreciate information from any groups or individuals either operating or planning to operate a 10-meter beacon. There is a limited amount of space allocated for beacon operation on 10 meters here in the States, so some prior listening and coordination is highly recommended before activating a beacon.

I am willing to act as a clearing-house for U.S. beacon information and activities. If anyone is planning to put a 10-meter beacon on the air, or knows about any other beacons active or planned for the U.S., I would appreciate hearing about it.

W. Keith Hibbert, KA1YE  
25 Hillcrest Road  
Niantic, Connecticut 06357

# The Circular Advantage



2M-14C

For OSCAR 10 and Russian Satellite Communications

KLM's Circular Polarized antennas have been specifically designed to optimize OSCAR 10 and Russian satellite operation. Quality workmanship and superior design, yield virtually perfect circular patterns over the satellite operational bandwidth. Enjoy less Multi-Path Distortion, less Flutter, Fade, and better S/N Ratios, with comparable performance on transmit.

Both the 2M-14C and 435-18C sport virtually unbreakable 3/16" rod parasitic elements anchored thru the boom, folded dipole driven elements produce excellent physical and electrical symmetry for years of constant performance.

### Specifications: (2M-14C)

|                               |                              |
|-------------------------------|------------------------------|
| BANDWIDTH: .. 144-150 MHz     | BOOM LENGTH: ..... 12'9"     |
| GAIN: ..... 11 dBdc           | VSWR: ..... 1.2:1            |
| BEAMWIDTH: ..... 48°          | WINDLOAD: ..... 1.25 sq. ft. |
| FEED IMP: ..... 50 ohm unbal. | WT. (LBS): ..... 7.5         |
| BALUN: ..... 4:1.2KW          | ELLIPTICITY: ..... 3 dB Max. |
| CIRCULARITY SWITCHER: .....   | INCLUDED                     |

The 435-18C is a star performer, an optional CS-2 circularity switcher puts left, and right-hand circular control in your shack, and doubles as a two port divider/impedance transformer for single feed line convenience.

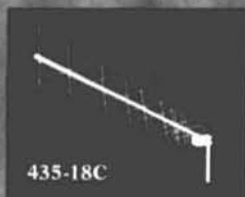

435-18C

### Specifications: (435-18C)

|                               |                               |
|-------------------------------|-------------------------------|
| BANDWIDTH: .. 420-450 MHz     | GAIN: ..... 12 dBdc           |
| BOOM LENGTH: ..... 7.3 ft.    | VSWR: ..... 1.5:1             |
| BEAMWIDTH: ..... 44°          | FEED IMP: ..... 50 ohm unbal. |
| WT. (LBS): ..... 4.5          | BALUN: ..... 2-4:1. 1KW       |
| MAST DIA: ..... Cen-Rear/1/2" | ELLIPTICITY: ..... 3dB MAX.   |
| CIRCULARITY SWITCHER .....    | (CS-2) OPTIONAL               |

See your local KLM dealer or write for our complete catalog

**KLM** electronics Inc.  
P.O. Box 816, Morgan Hill, CA 95037

# linear translators

## Narrowband technology and linear systems show advantages over conventional fm designs

**Narrowband techniques on VHF**, namely SSB and CW, have attracted increasing interest among Amateurs over the past few years. While fm and repeaters provide excellent service to thousands of hams, it is apparent in heavily-populated areas that we cannot go on forever with modes requiring 30 to 40 kHz per QSO (the spectrum needed for a repeater input and output). Several solutions to this problem have been proposed, including single-sideband fm, spread-spectrum techniques, and, more recently, ACSB.<sup>1</sup> With a 3:1 to 4:1 advantage of SSB over fm a 3 MHz repeater pair could support as many as 300 repeater channels using SSB-based techniques. Use of these narrower modes places a new requirement on the "repeatering" techniques which are nicely met by LTs or linear translators.

### what is a linear translator?

A linear translator (LT) is a multi-mode repeater — with several important differences from fm repeaters.<sup>(a)</sup> The basic difference between a translator and a repeater is in detection (**fig. 1**). A repeater detects an incoming signal and then uses the resulting audio (or video) to remodulate a transmitter. A translator merely converts the signal to a convenient i-f frequency, amplifies it, and re-converts it to the desired output frequency without ever detecting the signal; that is, the entire system operates at rf frequencies rather than remodulating a transmitter with detected audio or video. All rf stages in a *linear* translator must operate in their linear region. No limiting or logarithmic processing can be applied. In this way it differs from the fm broadcasting translators used in fringe areas to improve weak signal reception.

A repeater can receive only one frequency and one mode at a time, and retransmit what it hears via only one mode. A translator does basically the same thing but it does it at rf, so that if its i-fs are linear, any mode or signal inserted at the input is reproduced at the output. Even multiple signals at the input will be reproduced at the output.

**By James Eagleson, WB6JNN, 280 Manfre Road, Watsonville, California 95076**



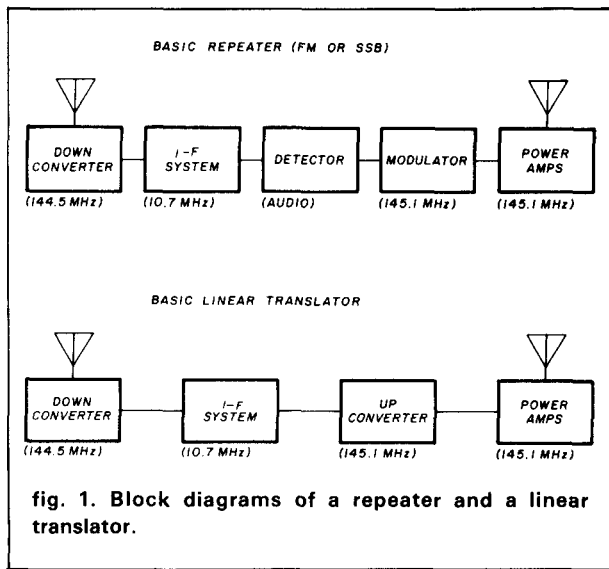

### history of LTs

In early 1980, two linear translators were placed into operation in the San Francisco Bay area.

One machine, built by Narrow Band Communicators, Inc. (NBC, Inc.),<sup>(b)</sup> is an in-band translator using a standard 600 kHz split. It incorporates two independently AGC'd 10-kHz-wide i-fs and can support as many as four SSB QSOs with minimal interference or two, low-deviation fm QSOs.

The other LT, built by Project OSCAR in cooperation with the Bay Area Two Twenty Group (BATTG),<sup>(c)</sup> uses an input of 1296.3 MHz and an output of 1269.3 MHz. Its i-f bandwidth is 30 kHz. Its proposed uses as an SDLT (Satellite Development Linear Translator) are:

- ... to act as a regional "repeater."
- ... to provide net and bulletin services.
- ... to provide a source of 1269 MHz signal for OSCAR, Phase III, mode L (24 cm/436 MHz) operation.
- ... to provide multiple-channel capability for SSTV, Packet Radio and RTTY users.
- ... to provide experimental data needed to build satellite interties, i.e. interlink translators between satellites.
- ... to provide an economical means of accessing the proposed commercial geosynchronous satellite with an amateur channel add-on.
- ... to provide intra/interstate network interties via unused LT channels.

### comparing linear translators and fm repeaters

A linear translator provides all the same functions normally provided by an fm repeater. These include

extending the coverage of mobile transceivers; extending the coverage of stations with low power, poor locations, or limited antennas; providing a fixed monitoring frequency; and making available a known frequency, power level, and location useful for station evaluation. Additionally, a translator can provide multi-mode operation; multi-station operation; CW (A1); and telemetry, remote sensing, and codestore (mailbox or bulletin) capabilities, all independent of main channel use. With narrowband techniques, both voice and data channels can use an LT simultaneously with only moderate interference.

Although the basic difference between repeaters and LTs is in detection, some operational differences also exist. First, a linear translator does not produce a squelch tail. Also any frequency variations by the incoming signals will also appear at the output — with the same variation. While the noise output of a linear translator is 10-20 dB less than that of an unscelched fm repeater, its noise floor may be detected by stations close in unless some form of squelch or COR system is used. Another difference is that fringe-area stations may not be able to hear other fringe-area stations, even though all stations local to the LT will easily hear and be able to work both (fig. 2).

### LT design approaches

**SSB translator.** Sensitivity: 6-9 dB improvement

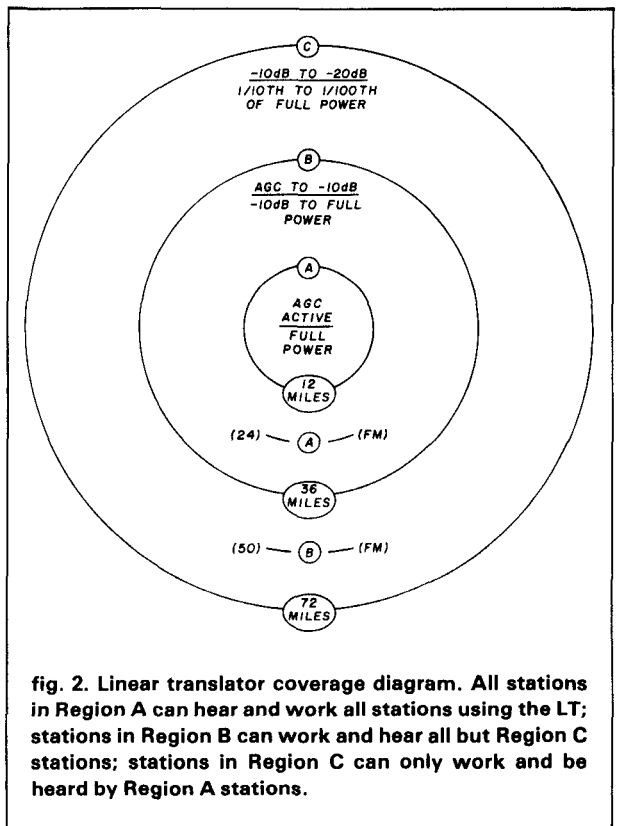

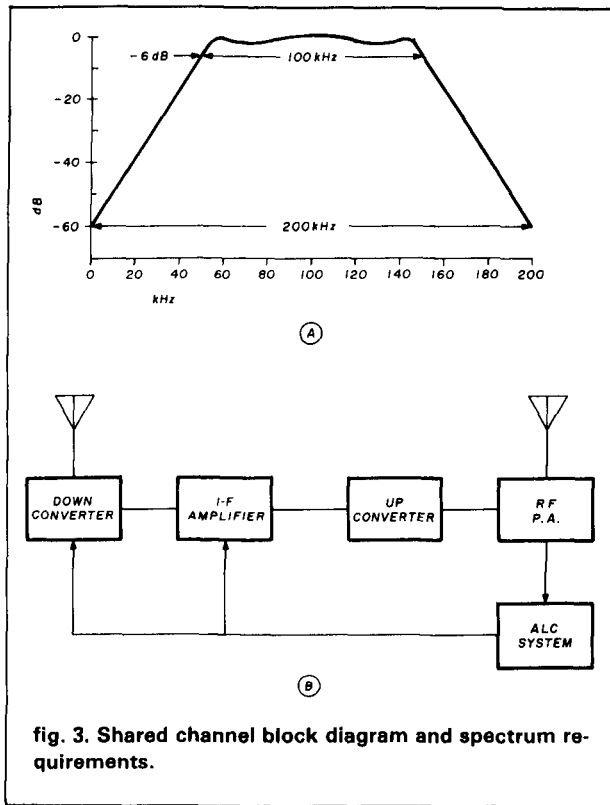

fig. 3. Shared channel block diagram and spectrum requirements.

over an fm repeater;<sup>(d)</sup> Power output: 200 watts PEP at altitudes limited to 100-watt carrier power on fm; Range: advantage is 1.4:1 over equivalent fm repeater. Using signal-to-noise-ratio enhancement techniques such as ACSB can make this as much as 2:1.<sup>(e)</sup>

**Shared-channel translator.** In this system, all stations share one "channel" and derived ALC or AGC is a function of the output of the entire passband (see fig. 3). While this technique has the advantage of simplicity and works reasonably well for satellite translators, in which there are only small relative power or range differences between stations, the system is not well suited for land-based use. Several problems exist when using the shared-channel translator with terrestrial LTs that do not occur with multi-i-f LTs.

Selectivity is one of the problems. A 20-kHz i-f filter with a 2:1 shape factor is 40 kHz wide at its -60-dB points. On the other hand, two side-by-side 10-kHz filters are 30 kHz wide at the -60 dB points, since each filter is narrower to start with (fig. 4).

Strong signals can desensitize the gain stages in this system and a form of squelch or COR (carrier-operated relay) is needed to reduce or eliminate the LT's noise output when it is not in use. With the

single 20-kHz-passband kind of system, the sensitivity of this COR is 3 dB worse than that of a system using two 10 kHz i-fs.<sup>(f)</sup>

**The ARTOB LT.** A third method, suggested by Italian ARTOB experimenters,<sup>2</sup> uses multiple i-fs for independent AGC control of smaller portions of a satellite's total passband. This prevents any one station from creating interference on other segments of the passband. The Italian system uses three 30-kHz i-fs yielding a total passband width of 90 kHz. The in-band, 2-meter NBC translator uses a slightly different approach, with two 10-kHz i-fs plus one 3-kHz "single channel" i-f. AMSAT Canada, in their SYN-CART proposal,<sup>(9)</sup> suggests using one 100-kHz general-purpose i-f flanked by two 10-kHz, special-service i-fs (one for data and one for bulletin, net, and special uses). All of these systems were developed about the same time to meet specific requirements.

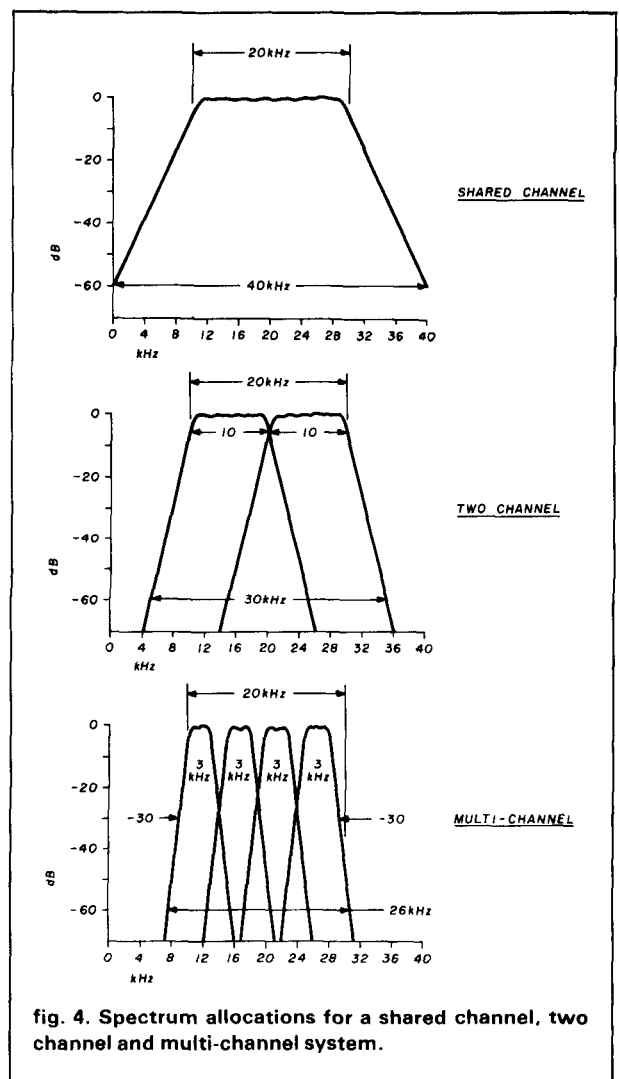

fig. 4. Spectrum allocations for a shared channel, two channel and multi-channel system.

# NCG WORLD BAND COMMUNICATIONS



Just  
Slightly  
Ahead



## 15M

Tested and Proven 15 Meter Mobile Transceiver USB and CW

Power-High 10 watts, Low 2 watts

VFO Tuning, Noise Blanker

Fine Tune  $\pm 1$  kHz

Digital Frequency Counter

13.8 VDC @ 3A Neg. Ground

9.5" L x 9" W x 2.5" H

All this PLUS the freedom of DXing

Regular Price: \$305.00

**SPECIAL PRICE: NOW \$279.00**

## 160/10M

ALL NEW, with the features you have been waiting for  
HF 160-10 meters SOLID STATE Transceiver 200 watt PEP  
All 9 HF Bands ready to go

AC/DC Power supply built in

3-Step Tuning 1 kHz/100Hz/25Hz

4 memories, Auto Scan

Automatic Up/Down Tuning Advanced Systems

Dual VFO, Solid State-Adjustment Free, IF Tuning, IF Offset

Noise Blanker, Mic. Compressor

VOX, CW Side tone, AC 120V DC 13.8 RTTY-Fax operation

USB-LSB CW (Narrow CW filter optional).

Regular Price: \$1075.00

**SPECIAL PRICE: NOW \$949.50**

N.C.G. CO.



1275 North Grove Street

Anaheim, CA 92806

(714) 630-4541

Mail Order COD  
Visa Master Charge  
Cable: NAT COLGLZ

Prices and specifications subject to change without notice or obligation  
Calif. Res. add Sales Tax

✓ 169

## YOU'LL NEVER GET A BETTER DEAL

### HUSTLER ANTENNAS

SF2 - "Buck Buster" 5/8" Wave  
2 Meter Antenna w/3/8 x 24"  
Threaded Base -  
3dB gain

**\$8<sup>95</sup>**

HOT - EASY ON/OFF  
TRUNK MOUNT  
with 3/8 x 24" Swivel Ball  
for CG144 & SF-2



**\$14<sup>95</sup>**

CG144  
5.2dB gain  
Collinear  
w/3/8 x 24"  
Threaded Base

**\$23<sup>95</sup>**

G6144 - 6dB  
Base  
Antenna

**\$68<sup>50</sup>**

G7144 - 7dB  
Commercial  
Grade Base  
Antenna

**\$98<sup>00</sup>**

### And many other Hustler Antennas & Mounts

|               |                  |             |                  |
|---------------|------------------|-------------|------------------|
| BBL144 .....  | 25 <sup>95</sup> | MRK-1 ..... | 13 <sup>75</sup> |
| BBLT144 ..... | 35 <sup>00</sup> | SFM .....   | 24 <sup>25</sup> |
| BBLT440 ..... | 24 <sup>75</sup> | THF .....   | 13 <sup>95</sup> |
| HLM .....     | 13 <sup>95</sup> | UHT-1 ..... | 8 <sup>95</sup>  |

**CESCO STOCKS THE ENTIRE HUSTLER  
VHF/UHF & COMMERCIAL LINE  
DEALER INQUIRIES INVITED**



COMMUNICATIONS, INC.

2115 AVENUE X  
BROOKLYN, N.Y. 11235  
(212) 646-6300  
(800) 221-0860  
TELEX: 235125

✓ 122

## PROGRAMMABLE CTCSS ENCODER/DECODER

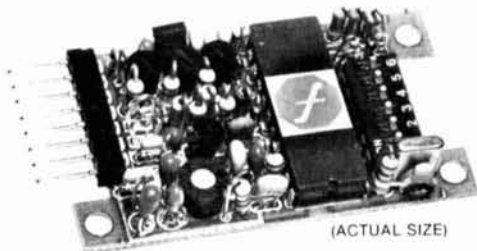

(ACTUAL SIZE)

- All 37 EIA Tones
- Quartz Accurate
- Universal

**\$54.<sup>95</sup>**

**IMMEDIATE DELIVERY AVAILABLE  
FROM NEW YORK AND CALIFORNIA  
DISTRIBUTION CENTERS**

For more information call TOLL-FREE

(800) 828-6884

NY: (800) 462-7242

CANADA: (416) 884-3180



**FERRITRONICS**  
MOBILE DATA SYSTEMS

1319 PINE AVE.  
NIAGARA FALLS NY 14301

✓ 136

## advantages of multiple i-fs

With the use of multiple i-fs, any i-f can be turned on or off at any time to help control interference, reduce noise from unused channels, or to allow re-use of the edge of one LT by the edge channel of an adjacent one. Out-of-channel noise and i-f-caused distortion products can be more closely controlled by the use of multiple, narrow i-fs. A 20-kHz-wide LT using five 3-kHz-wide i-fs has a -60 dB bandwidth of 24 kHz; by contrast, a single i-f system has a -60 dB width of 40 kHz.

Under low-use conditions, when the number of stations is fewer than ten (the normal situation on a 20-kHz-wide LT), better control of AGC pumping by strong stations can be maintained. With a multiple 3 kHz channelized LT all stations can provide full output regardless of the ratio of the strongest to weakest station. Intermodulation-related interference between the various channels can still occur, but even this is improved by the multiple i-f technique.

A multiple i-f channel system can dedicate specific channels for special uses. SYNCART has a hard-limiting fm-AFSK (ASCII) 15 kHz channel for data transmission, a general-purpose, 100 kHz-wide channel for operation similar to present OSCAR satellites, a special 100-kHz i-f for RTTY, SSTV, and ASCII narrowband techniques, and a reserved 15-kHz i-f for educational, bulletin, net, and emergency uses (fig. 5). Terrestrial LTs could have 1-kHz i-fs for CW/FSK, 3-kHz i-fs for SSB, 10-kHz i-fs for fm or shared SSB, or some combination providing multiple uses.

## system design

Design considerations for a linear translator are somewhat different from those for an fm repeater.<sup>(h)</sup> For one thing, many integrated circuits, such as the CA 3089 or MC 1357, are not available for linear receivers.

The general scarcity of knowledge about LTs is reflected in the lack of surplus or commercial linear translators, the unavailability of step-by-step LT repeater handbooks, and the absence of experienced commercial LT users. Even AMSAT, probably the most experienced developer of LTs for the OSCAR satellites, has not published much on their design and construction.

## building a linear translator

**The power amplifier.** Multi-station LT operation requires better than average linearity in the PA stages, with greater than 40 dB third-order IM distortion the goal. A maximum output of 100 watts from the amplifier, using two 80-watt stages, should produce an amplifier capable of meeting the design goal. The

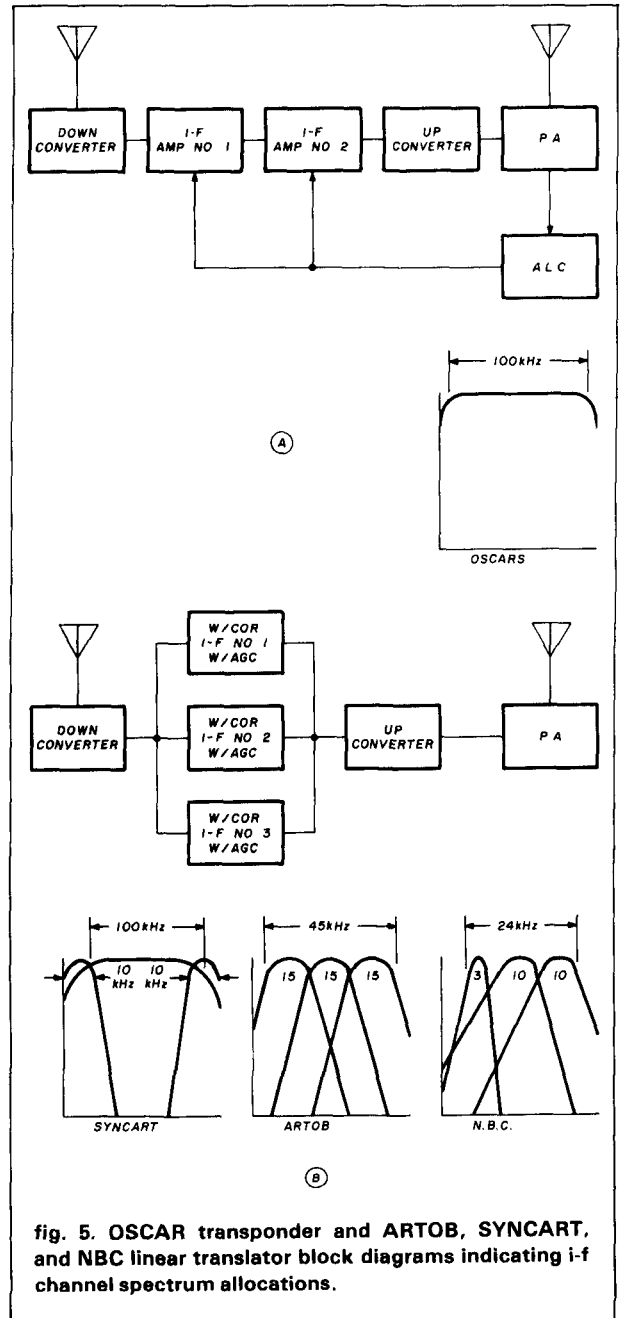

fig. 5. OSCAR transponder and ARTOB, SYNCART, and NBC linear translator block diagrams indicating i-f channel spectrum allocations.

addition of a 3 dB or higher gain antenna brings the ERP level up to 200 watts.

**Transmit chain.** An output power level of 100 watts helps define the gain required between the transmit up converter and the output port (fig. 6). Using a high-level, double-balanced, diode-ring mixer — such as the Mini-Circuits SRA-1H, the Cimmaron CM-1H, or equivalent — IM<sub>3</sub> products should be 40 dB below each output tone at an input signal level of 0 dBm PEP. This translates to an output level of

SCHOOLS/CLUBS/NOVICES-TECH/GENERALS-TO-BE:

# At last; A video-taped step-by-step Ham Radio theory course you can understand.

The Larry Horne N2NY Ham MasterTapes series is a proven, highly effective video teaching technique expertly taped and edited by New York's leading professionals in studio and field videotape production. Everyone involved in these videotape courses is also an active licensed amateur. The graphics highlight important details in the live video. Practical working examples of every ham radio component, device or system covered in the FCC study guide can be easily understood.

Schools or clubs, until now, were not able to provide working models of each system covered in the N2NY Ham MasterTapes. The carefully thought out demonstrations on videotape also eliminate worrying about getting tricky gadgets to work on command in front of an information-hungry class of prospective novices or techs.

The N2NY Ham MasterTapes provide the kind of basic understanding of concepts that build a foundation of theory background not only for passing the FCC tests, but also to stimulate the young beginner's interest in electronics. People who enter a career in electronics, communications, computers or robotics motivated by their Amateur radio experience provide leadership in the future of our country. The Ham MasterTapes will be used to help teach beginners theory and operating practices to get licensed and get on-the-air.

Why use Videotape to help teach and understand Amateur radio? The hobby has badly needed better, clearer, high-tech teaching aids to help newcomers get into our wonderful world of Amateur Radio. Not only does the beginner have to demon-

strate knowledge of operating skills, customs and techniques, he must also acquire a technical background on more kinds of communication systems than a working engineer might encounter in his lifetime.

These sixteen 1/2-hour programs completely cover all the material needed to understand Novice and Tech/General Theory and operations. The courses are written to include the new 200-question FCC syllabus used beginning September, 1983.

## Ham MasterTapes™

THE N2NY HAM RADIO COURSE ON VIDEOTAPE

© 1983 N2NY Productions, Inc.

Only \$199.95. Order direct and specify Beta or VHS format. Call or write: Larry Horne, N2NY or Virginia Hamilton, KA2RQJ at Ham MasterTapes, 295 Park Avenue South, New York, NY 10010. 212-673-0680.

## The T.E.L. Model CS-1100 Total Communication System.

AT LAST! There is a state-of-the-art CW/RTTY/ASCII communications system that meets the sophisticated operator's demands for a quality product.

### Feature

CMOS upprocessor based.  
Membrane Switch front panel.  
16 chr Intelligent LED display.  
Super Narrow Filters.  
Built-in 110 VAC supply.  
500 chr Buffer (all modes).  
Parallel Data Port.

### Benefit

No RFI problems.  
Insures reliability.  
Readable to 12 feet.  
No tuning required.  
No extras to buy.  
Review received text.  
Connect to any printer or computer.

CW Operation: Send/Rcv 5-90 wpm with Automatic Speed Tracking, Four-99 chr memories with ability to insert text, will key any rig.

RTTY/ASCII: Receive at 60, 67, 75, 100 wpm and 110, 300 Baud with One Button Speed Selection.

A 30 day unconditional guarantee and 1 year parts/labor warranty assure satisfaction. Dealer inquiries invited.

Send for a free data package and comparison sheet.



**Random Access Inc.**  
P.O. Box 61117 Raleigh, N.C. 27661

More Details? CHECK — OFF Page 110

179

141

## KENPRO

WHEN ONLY THE BEST WILL DO . . .

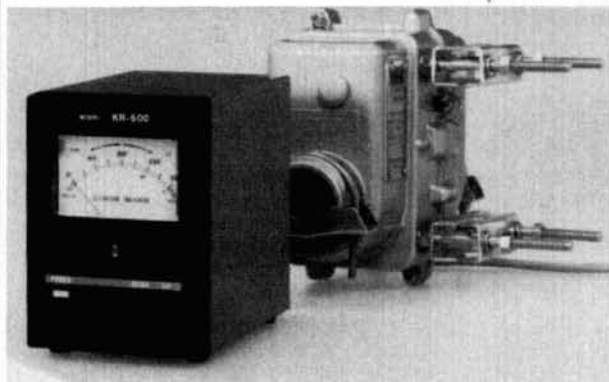

KR 500 ELEVATION ROTOR

THE WORLD STANDARD

AVAILABLE ONLY THROUGH FULL-TIME AMATEUR DEALERS

DISTRIBUTED BY

## SPECTRUM WEST

5717 N.E. 56th St.  
Seattle, Washington 98105

Phone 206/382-2132  
TLX DUFFINTLSEA

158

September 1983 19

approximately  $-7$  dBm PEP from the mixer (normal losses) with another 1 dB lost in the image bandpass filter. The resultant input to our transmit PA amplifiers is  $-8$  dBm PEP. An output level of  $+50$  dBm requires  $+50 - (-8)$  or 58 dB gain for achieving our goal. Fig. 7 can be used to work with different power levels.

I do not recommend using lower cost double balanced mixers for the upconverter. A 10 to 25 watt system might be able to make use of them, but the spurious-free output of the high-level mixers is easier to filter than that of the "standard level" units. The addition of a local oscillator buffer helps drive the high-level mixer LO ports to  $+17$  dBm. If standard level mixers are used, all ports must be terminated in 50 ohms at all rf, i-f, LO, harmonic, and image frequencies. Not doing so can affect linearity and spurious content significantly.

**The front end.** Next in importance to the transmit chain is the front end of the LT. Too much gain can produce intermodulation products, desensitization, crossmodulation products, and other related problems. Too little gain reduces sensitivity for weak-signal reception (poor noise figure) and makes the choice of i-f gain more critical. The best choice for a mixer for the receive converter (down converter) is the double-balanced, diode-ring mixer. Although its inherent loss worsens the front end gain, other kinds of mixers (especially the bipolar) provide gain at the expense of poorer noise figure performance (10 dB typical versus 6.5 dB for a double balanced mixer), poorer IM, desense, or crossmod, or poorer port-to-

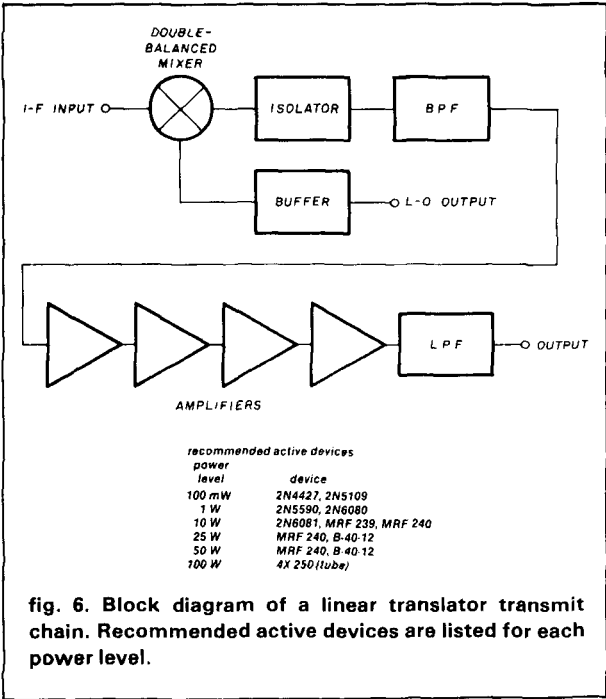

fig. 6. Block diagram of a linear translator transmit chain. Recommended active devices are listed for each power level.

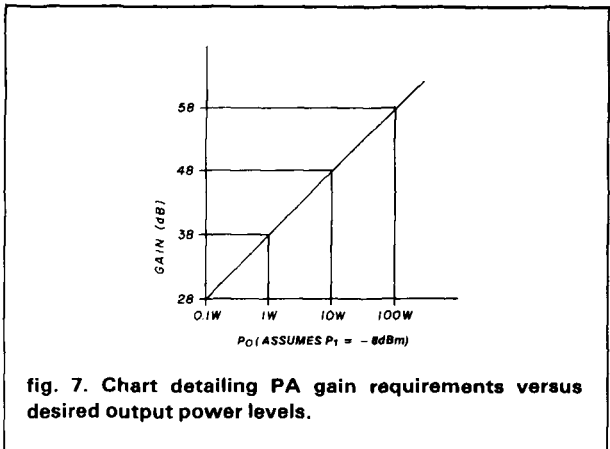

fig. 7. Chart detailing PA gain requirements versus desired output power levels.

port isolation.<sup>3</sup> The best compromise seems to be a good low-noise preamp followed by a good double balanced mixer feeding an i-f amplifier with a 2-4 dB noise figure.

The preamp's gain should not exceed 25-30 dB, and it should have a noise figure of less than 2.5 dB. This is easily obtained with single-stage GaAs FETs with noise figures under 1.0 dB. The J-310 and U-310 JFETs can also be used in two-stage preamps yielding a 1.8-2.2 dB noise figure with 25 dB gain. Another good choice is the CP-640 or 643. These units can give reasonable noise figure and excellent high-level performance at higher voltages. The older FETs (such as the MPF-102 and 40673) should be avoided because they do not provide the IMD, crossmod, and desense performance required for LT service.

A word of caution concerning GaAs FETs. Though they provide excellent performance with less than 0.5 dB noise figure and better than 100 milliwatts 1 dB compression point performance on 2 meters, they can be destroyed by improper handling. Oscillations resulting from improper terminations, insertion into systems not having adequate TX/RX isolation in the duplexer system, and static discharges (even when the device is not turned on) can all cause failure. Careful handling is necessary.<sup>4</sup>

**Noise floor output.** The noise floor is the amplified output of the noise generated in the front end and i-f amplifier stages. In an fm repeater this noise is equal to the output of any station received by the system but it is squelched off when no signal is present and masked by signals when they are there. In an LT, the noise output depends on the gain of the system, overall noise figure, and the amount of external noise amplified by the system. Since it's not desirable for a repeater to transmit constant noise, some control is needed.

For high-altitude, balloon-borne LTs like the AR-TOB experiments, or for orbiting LTs such as the OSCARs and RS, no COR or squelch is required.

## MAIL THIS CARD TODAY for your **FREE** Heathkit® Catalogs

The new full-color Computer Catalog describes our complete line—including the new, 16-bit/8-bit Z-100 computer! The latest Heathkit Catalog has over 400 easy-to-build kit products for home, car and hobby uses.



307-099

### COMPUTER CATALOG

Hardware and software



122-099

### HEATHKIT CATALOG

Over 400 electronic kits

Name \_\_\_\_\_

Address \_\_\_\_\_

City \_\_\_\_\_

State \_\_\_\_\_ Zip \_\_\_\_\_

Ham Radio

**Heathkit®**

PC 115

**FREE**

*Heathkit  
Catalogs*

Post Office  
will not  
deliver mail  
without stamp

**Heath Company**

Benton Harbor, MI 49022



# High-tech. Low-price.



HW-5400: a price performance triumph! A microprocessor enhanced, synthesized HF SSB transceiver...NOW ONLY **\$649<sup>95</sup>**

## SIMPLY SPECTACULAR

Don't let the low price fool you... HW-5400 *outperforms* comparable transceivers on 80-10 meters. This masterpiece of kit engineering is solid state, broadbanded and synthesized for rock solid stability and accuracy. It operates on USB, LSB and CW with automatic sideband selection, full break-in (QSK) and 16 memories. The power amplifier transistors from Motorola are VSWR protected. Plus *superior receiver quality* with super sensitivity and dynamic range.

## HIGH-TECH CONVENIENCE

Seven mode and function symbols give you total transceiver status at a glance. Patent-pending dual-speed tuning squeezes out new QSO's at 50 Hz steps...or flies through bands in 1 kHz steps. *Split Memory Access* lets you review or change transmit frequency while in receive, without missing a word. And the Frequency Entry Keypad option instantly synthesizes QSY to any point in the band. Matched with Split Memory Access, this option will give you contest-winning DX control.

Treat yourself to the pride of building and operating the HW-5400 and HWA-5400-1 Power Supply/Speaker. It's the perfect transceiver system that leads the way in price...and performance.



## FREE CATALOG!

Get full details and specs in the latest Heathkit catalog. Write today: Heath Company, Dept. 122-094, Benton

Harbor, MI 49022. Or visit your local Heathkit Electronic Center.\*

## There's more for the Ham at Heath

See our complete line including the SS-9000 computer controllable transceiver, QRP transceiver, coax switcher, amplifier and antenna tuners.

Order toll free MasterCard and Visa 800-253-0570.



# Heathkit®

Heath  
Company

Everyone is far enough from the LTs so that by setting the noise output at about 30 dB below the maximum LT output level no one complains about the passband noise — even though it is transmitted continuously.

The terrestrial situation is different. Stations may be within one or one hundred miles of an LT, and a 40-dB stronger signal is received at the closer location. At this close station, the noise output of the LT will be heard quite clearly. The answer, of course, is squelch or COR. For the NBC machine we chose to operate the PA systems using COR. Single-channel or multiple-channel systems could use squelch on each channel.

**Noise floor versus full output level.** A 30-dB full-output to noise-output ratio has been adopted by the ARTOB and OSCAR LTs. Will that suffice for a terrestrial LT? There are several arguments for and against it.

The argument for it is that, almost universally, the typical ham operator begins to feel that a signal is strong when it approaches a 30 dB signal-to-noise ratio (SNR). While we rarely obtain 30 dB SNR on the hf bands (at least signal-to-interference levels are more typically in the 5-15 dB range), if there is only noise behind the signal, 25-30 dB SNR is where most of us would start calling it S-8 or S-9.

On the other hand, weaker stations using a system set with the AGC 30 dB above the noise floor are clearly at a disadvantage. A signal arriving at 10-15 dB above the noise floor, for example, would have an output 15-20 dB below the typical strong signal. This means that fringe area stations could access the LT and work stations local to the machine, but would not be heard by another station in their own area or in some other fringe area of the LT.

It is my opinion that an LT using COR or squelch or both can provide more gain so that weaker signals will be more intelligible. The additional noise will be squelched off when the LT is not in use and stronger stations will reduce the gain through AGC action thus reducing the background noise, with a subsequent improvement in SNR. This can be especially helpful in single- or multi-channel systems where AGC pumping of one signal by another signal is less of a factor.

**Recommendations.** *SSB repeater:* AGC at 12-15 dB above noise floor; *Multi i-f LT:* AGC at 18-25 dB above noise floor. Certain i-fs, especially narrower, single-station ones, can have a 1-3 dB higher AGC setting. *Shared channel:* AGC at 25-30 dB above noise floor.

Measurements are made using 2.4-kHz instrumentation or receiver bandwidth. Noise output is directly related to the noise bandwidth by this formula:  $dB$

$change = 10 \log B_1/B_2$ . Consequently, if a wideband output meter is placed on an LT with a 30 dB SNR in a 2.4-kHz bandwidth, the meter would see only a 20 dB SNR (if the LT's entire passband is 24 kHz wide).

**i-f amplifier gain.** The i-f amplifier must provide enough gain to bring the equivalent noise input of the preamp/converter up to a level that is 30 dB below the desired maximum output level (AGC maximum level). This assumes, of course, that our design goal is 30 dB AGC to noise output ratio. We've previously shown that the front-end gain consists of 25-30 dB preamp gain with a mixing loss of about 7 dB, leaving a front-end (down converter) gain of about 18-23 dB. For our purposes, we will assume 20 dB.

An additional factor must be considered. All preamps internally generate their own noise. Noise figure is the ratio of a preamp's actual noise output relative to what its output should be if it did not add any noise of its own to the system. In other words, while a perfect 10-dB gain preamp would give  $-140 dBm + 10 dB$  or  $-130 dBm$  noise output, a typical low noise figure preamp would actually give about 2 dB more noise output, that is,  $-128 dBm$ . Consequently, a signal arriving only 10 dB above Johnson-Kelvin noise yields a 10 dB SNR with our perfect preamp, but only 8 dB SNR in our practical preamp.

The formula for determining the Equivalent Noise Input ( $N_{equiv}$ ) of any receiver is:

$$N_{equiv} = -174 dBm + 10 \log B_{Hz} + NF_{dB}$$

For our LT system, assuming a system noise figure of 3 dB and a bandwidth of 2400 Hz,  $N_{equiv}$  is:

$$N_{equiv} = -174 + 34 + 3 = -137 dBm$$

For a noise output 30 dB below full output, our output noise level is:

$$N_{out} = P_{out,max} - SNR_{Desired}$$

Since we've settled on 30 dB for this case, and we've determined that 0 dBm is our  $P_{out,max}$  i-f noise output is:

$$N_{out} = 0 dBm - 30 dB = -30 dBm$$

The required i-f gain to achieve this noise output is:

$$G_{i-f} = N_{out} - (N_{equiv} + G_{DnCv})$$

For our example:

$$\begin{aligned} G_{i-f} &= -30 dBm - (-137 dBm + 20 dB) \\ &= -30 dBm + 117 dBm \\ &= 87 dB \end{aligned}$$

### too much gain

Just as we've previously indicated that 60 dB or more gain in the PA stages begins to get difficult to

# hy-gain®

## HF BROADBAND VERTICALS WORK THE WORLD

Hy-Gain broadband vertical antennas load the new auto-tune solid state rigs, require minimal space and provide low angle radiation without the expense or the problems of support structures.

**18AVT/WBS** (80-10 meters) The most successful vertical antenna of all and for good reasons. Broadband performance covers the 40, 20, 15 and 10 meter bands in their entirety. Automatic 5 band switching is accomplished by mechanically superior, highly efficient factory tuned Hy-Q traps with large coils for consistent performance at 2:1 or lower VSWR on 40-10 meter band edges; bandwidth on 80 meters is approximately 40 kHz with VSWR below 2:1. A factory tuned matching network for 50 ohms impedance is dc grounded for lightning protection and reduced precipitation static. The mechanical integrity of this antenna is so stable that performance does not change with the weather. The 18AVT withstands winds to 80 mph (128 km/h) without guying. All stainless steel hardware is included.

**14AVQ/WBS** (40-10 meters) Offers very similar construction and the same excellent broadband performance as 18AVT over the entire 40, 20, 15 and 10 meter bands; automatic band switching with mechanically superior large-coil Hy-Q traps and very low angle radiation pattern. The smaller, low visibility size also makes the 14AVQ very suitable for roof mounting. The optional 14RMQ roof mounting kit includes base plate, mast and radial/guy wires. All antenna hardware is stainless steel.

**18 HTS** (80-10 meters, 160 meters with optional loading coil) The superb reliability of the 18 HTS is manifest in installations now over 20 years old. And, with the improvements we made over the years, the 18HTS is now better than ever. Automatic band selection is achieved through a unique stub decoupling system which effectively isolates various sections of the antenna so that an electrical  $\frac{1}{4}$  wavelength (or odd multiple  $\frac{1}{4}$  wavelength) exists on all bands. For example, outstanding broadband performance on 20, 15 and 10 meters is achieved with an extended  $\frac{3}{4}$  wave collar. On 80 meters bandwidth is approximately 250 kHz at 2:1 VSWR. With the optional base loading coil exceptional performance is also provided at 160 meters. The galvanized tower requires no guying and withstands winds to 100 mph (160 km/h). A special hinged base allows complete assembly at ground level and permits easy raising and lowering. Includes stainless steel hardware. WARC kits to be available.

Other Hy-Gain vertical multiband antennas are available though not shown here. The 12AVQS (20, 15, 10 meter) is similar to 18AVT above but with VSWR of 1.5:1 or less on all bands. The 18VS (80-10 meter) comes with a base loading coil and may be installed on a short mast driven into the ground. All include stainless steel hardware.

### PHASE FOR GAIN

Any two identical Hy-Gain verticals can be phased for excellent gain and directivity. A great system for beam performance on 40, 80 and 160 meters or for 10, 15 and 20 meters where space is limited. Send for our free technical report "Phased Verticals".

Hy-Gain Verticals that work the world  
at better Amateur Dealers.

# TELEX® hy-gain®

TELEX COMMUNICATIONS, INC.

9600 Aldrich Ave. So., Minneapolis, MN 55420 U.S.A.  
Europe: Le Bonaparte—Office 711, Centre Affaires Paris-Nord, 93153 Le Blanc-Mesnil, France.

HF Vertical Antenna SWR Curves

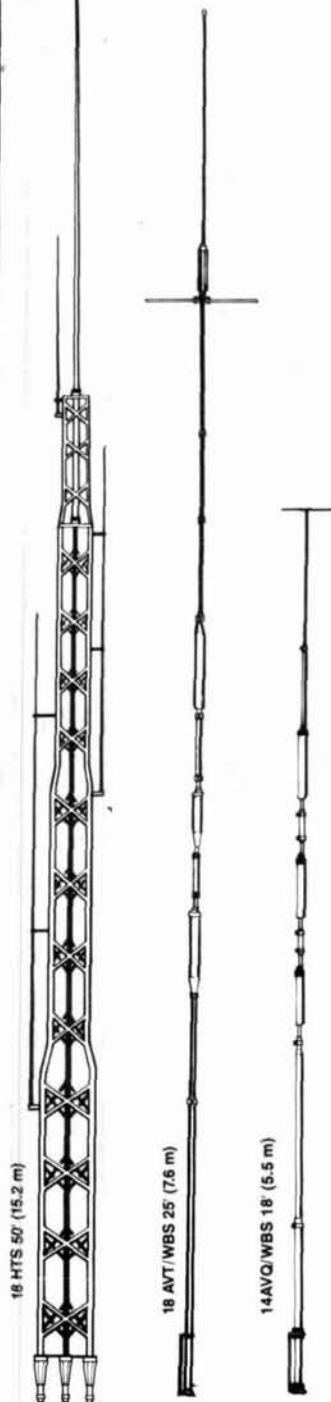
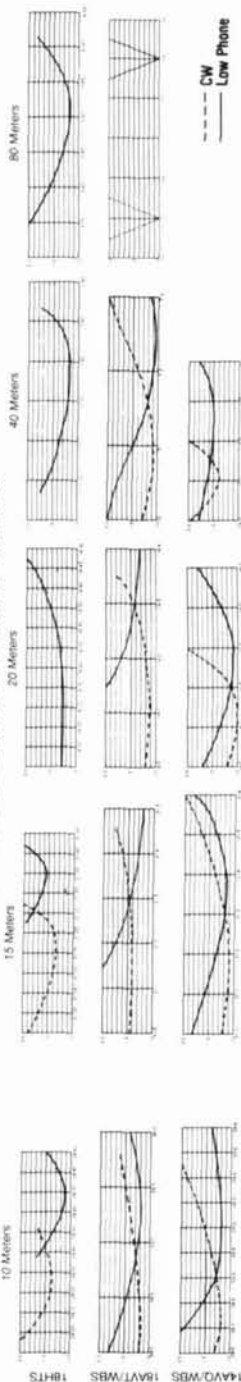

UNGAR®

# The Professionals' Choice.

## Introducing Ungar's New Lightweight Heat Gun For Heavyweight Jobs.

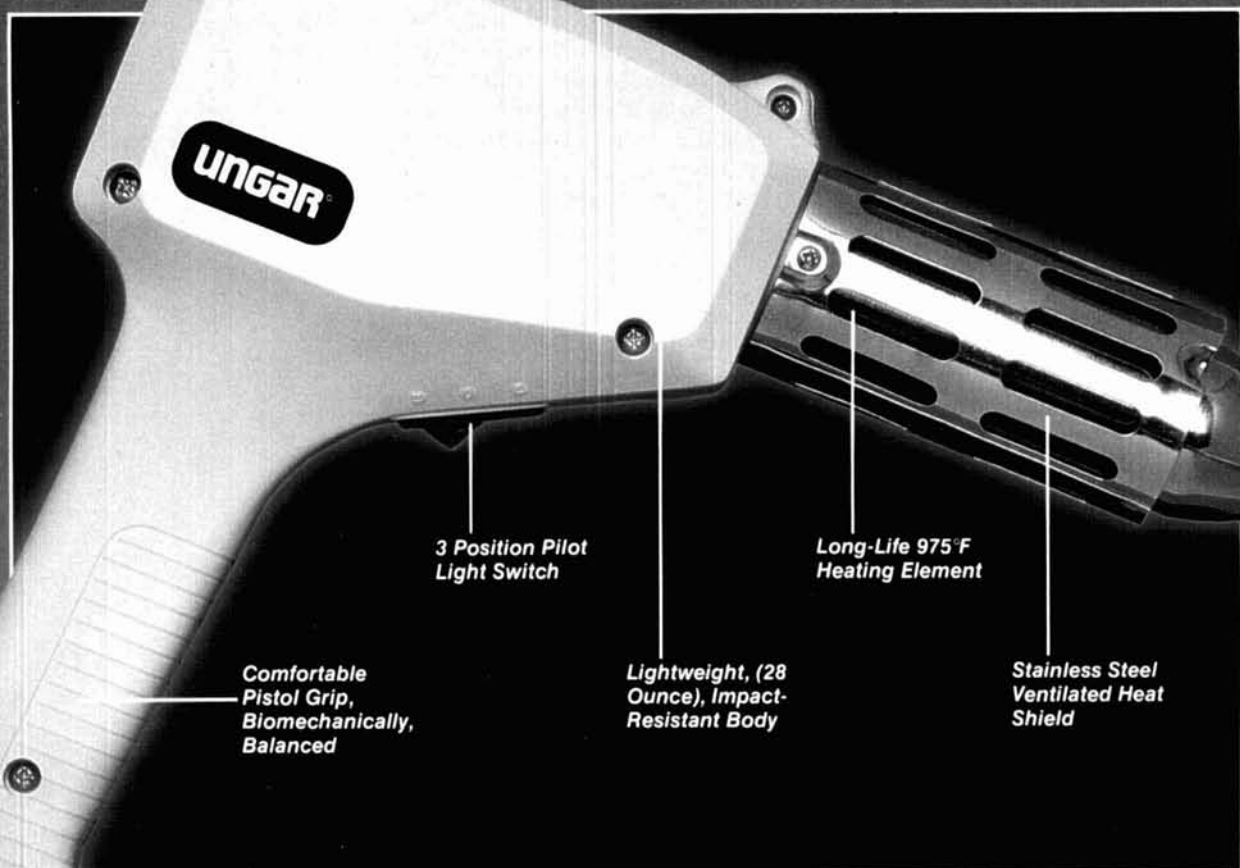

Comfortable Pistol Grip, Biomechanically, Balanced

3 Position Pilot Light Switch

Lightweight, (28 Ounce), Impact-Resistant Body

Long-Life 975°F Heating Element

Stainless Steel Ventilated Heat Shield



Cure Thermoset Adhesives

Shrink Tubing

Heat Liquids

Form Plastics

Peel Paint

At Ungar, we've designed the ultimate heat gun for the hard-working pro. Feature for feature, no other heat gun can make your job quicker, easier or safer.

To begin with, our new 6977 is the lightest heat gun of its kind (28 ounces). You can use it for hours on end with maximum control and minimum fatigue. The contoured handle provides a firm grip and remains cool at all times.

The 6977 is a high-temp, high air volume heat gun with power

for the heaviest jobs. It delivers 975°F to the nozzle in seconds and is perfect for curing adhesives, forming plastics, shrinking tubing, peeling paint and just about any other tough job you'll ever run across.

And the 6977 can take it in the real world. The body is made of rugged, impact-resistant Valox® 855. It features a proven, reliable high-rpm motor, low noise operation, long-life heating element and a 6-foot, 3-conductor ground cord.

A wide range of optional attachments can provide additional versatility. The new Ungar 6977 heat gun... light years ahead of the competition, is Underwriter's Laboratory, Inc. listed. For more information, contact your local Ungar distributor or call Ungar in California 1-213-774-5950.

**UNGAR®**

Division of Eldon Industries, Inc.  
Compton, California 90220

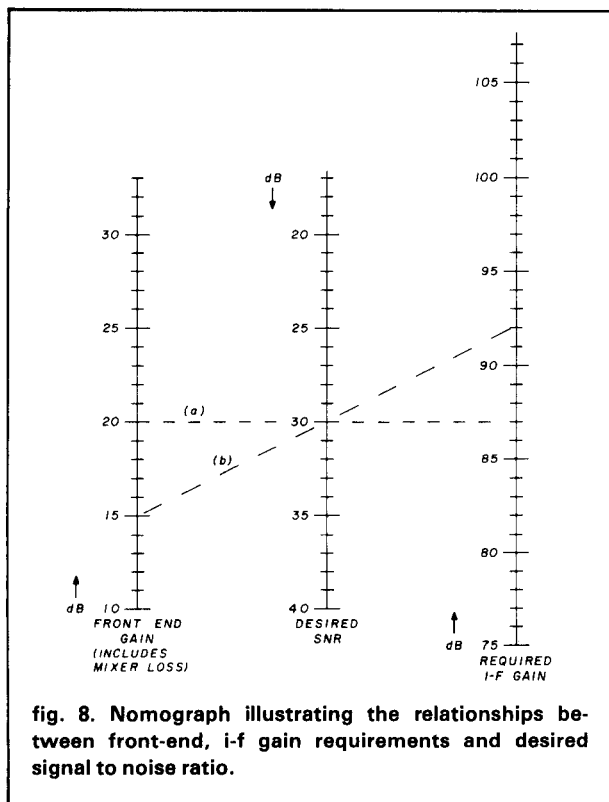

control, gain exceeding 75-85 dB also begins to get unmanageable at most i-fs. This is why most fm radios use two i-fs, 10.7 MHz and 455 kHz, before detection. The amount of gain required to provide good fm limiting (about 90 - 100 dB at i-fs), exceeds the gain practical on any one given frequency. The same technique is applied to the LT design, that of splitting up the gain-producing stages at two different frequencies.

With a practical limit of 85 dB on any given frequency, a translator that uses a single i-f can set the noise floor no higher than about -30 dBm, or about 30 dB below full output. This gain is reasonable for multi-i-f or broadband single-i-f systems (assuming care is taken in shielding and layout), but cannot be pushed further for a repeater-type system (fig. 8).

### a different approach

An approach I've wanted to try but have not yet had the opportunity to get to is the use of two lower gain i-fs on frequencies separated by the TX/RX offset split. The signal would be converted to 10.7 MHz, amplified by a factor of 50 dB, converted to 11.3 MHz (600 kHz up), amplified another 50 dB, and then converted to the output frequency.

This has two advantages. The same local oscillator can be used for both receive and transmit conversion, since the transmit i-f is already 600 kHz above the receive i-f. Also, improved frequency stability can

be achieved using a subharmonic output from a stable oscillator. This means that any receiver LO drift is tracked precisely by the transmit LO (which is the same in this case), and drift of the i-f to i-f converter oscillator is divided by the same ratio used to obtain the 600-kHz injection signal. Example:

$$\begin{aligned}
 144.510 \text{ MHz} - 133.810 \text{ MHz} &= 10.700 \text{ MHz} \\
 10.700 \text{ MHz} + 0.600 \text{ MHz} &= 11.300 \text{ MHz} \\
 11.300 \text{ MHz} + 133.810 \text{ MHz} &= 145.110 \text{ MHz}
 \end{aligned}$$

The 600 kHz can be derived from a 4.8-MHz crystal (divide by 8). Its drift at 4.8 MHz will likely be less than 100 Hz over moderate temperature excursions, thus the 600 kHz will drift only 100/8 Hz, or 12.5 Hz.

### clamping the offset to 600 kHz

For in-band translators or SSB repeaters using normal offsets (600 kHz on 2 meters, 1.6 MHz on 220, and so forth), the one-frequency i-f scheme presents a slight problem in another area. If the offset i-fs are not used, the drift between the upconverter and downconverter LOs can be as high as 200-400 Hz. This is unacceptable on SSB.

NBC's solution was simple. The receiver's LO was made into a VCO (voltage-controlled oscillator) and slaved to the transmit LO after both were divided down to 600 kHz. Using this phase-locked loop (PLL) provides for nearly perfect 600-kHz offset with an error only as large as the drift of the 600-kHz reference oscillator divided by whatever divide ratio one is using. In fact, the NBC system uses a standard 10.240-MHz reference oscillator (as used in many CB sets and ham rigs), dividing everything down to a standard 10-kHz reference frequency using standard, well-proven CB-type PLL circuitry and parts. Thus our TX/RX offset accuracy is 10.240/0.600 MHz, or seventeen times better than that of the 10.240 MHz oscillator. Since this may drift less than 100 Hz under normal temperature conditions, our offset drift will typically run less than 100/17, or about 6 Hz (fig. 9A,B).

### other problems

LTs have a new set of problems not generally seen on fm repeaters. The first problem is impulse noise. While an fm repeater in the presence of noise squelches more tightly, an LT will break squelch and retransmit that noise with the degree of fidelity its i-f selectivity allows. There are two methods of preventing this: 1. use a more sophisticated squelch system than the usual level detector, or 2. prevent noise from getting to the detector by using an effective form of noise blanking.

Single-channel systems (SSB repeaters, multiple-single channel systems) could use the ratio squelch systems developed by Kahn some years ago (fig.

**10A and B).** This device is sensitive to voice characteristics and triggers a squelch detector driven from an audio (or i-f) ratio detector or discriminator.

Single-channel systems can also use sub-audible carriers for COR (fig. 10C) or squelch triggering. If each station transmits a carrier, say, within  $\pm 100$  Hz of the frequency where the COR or squelch is tuned (whether an audio detector or narrowband 300-Hz i-f filter is used really doesn't matter), only signals at that frequency trigger the system. Noise, being

broadband, needs to be much stronger to trigger the system.

If the entire passband of the LT is converted to audio frequencies, a series of af filters driving individual detectors can be used to cover the entire passband in 1-kHz steps (fig. 10D). If any one detector is triggered by audio in its frequency range, it will turn on the LT. The 1-kHz selectivity still provides some discrimination against triggering on noise by reducing it by 4 dB. Additionally, this provides greater sensitivity to weaker desired signals in the smaller bandwidths.

Another system uses two detectors with a comparator so that one averages noise, pulses, or signals present and the other sees the peak value (fig. 10E). CW, SSB, or fm have a fairly low peak to average ratio, so that if the comparator's gate signals were set to trigger only on signals whose peak to average value was less than 4:1, most pulse-type noise would not trigger it, since its peak to average is typically much higher than 4:1.

None of the above systems have been tried on the NBC LT. Reports on your experiments would be appreciated. We have chosen merely to monitor the system and reduce i-f gain when noise becomes a problem. This isn't elegant, but it works!

Noise blankers present a particular problem in LT service. While it is not difficult to produce a noise gate and the associated detector scheme, it is difficult to operate any NB system in a full-duplex system. The transmitter signal is usually strong enough, even after a duplexer, to cross-modulate the noise blanker.

Here are a few suggestions for resolving the noise blanker problem. The first is to detect and trigger on out-of-band noise pulses. Collins has used this technique for years and many CB sets have NBs tuned at 24 MHz rather than 27 MHz so that stronger signals aren't detected in the pulse detector circuit, causing crossmodulation products in the system. For 2 meters or other VHF/UHF frequencies one can tune just below or just above the band to find a 100-200 kHz range that is free of strong signals, convert it to an appropriate i-f, then build the pulse detector around that. A notch filter at the output frequency of the LT might also be required to protect the NB downconverter.

A more standard i-f-type noise blanker immediately following the downconverter of the LT could be used if run through a 30-kHz crystal filter to remove the output and strong adjacent signals. This will not be quite as effective due to the narrow bandwidth (pulses will tend to ring and broaden), but is used effectively in many 2-meter SSB rigs. Strong signals on immediately adjacent channels ( $\pm 20$ -30 kHz) may also cause some problems. Use of a 40-60 kHz filter

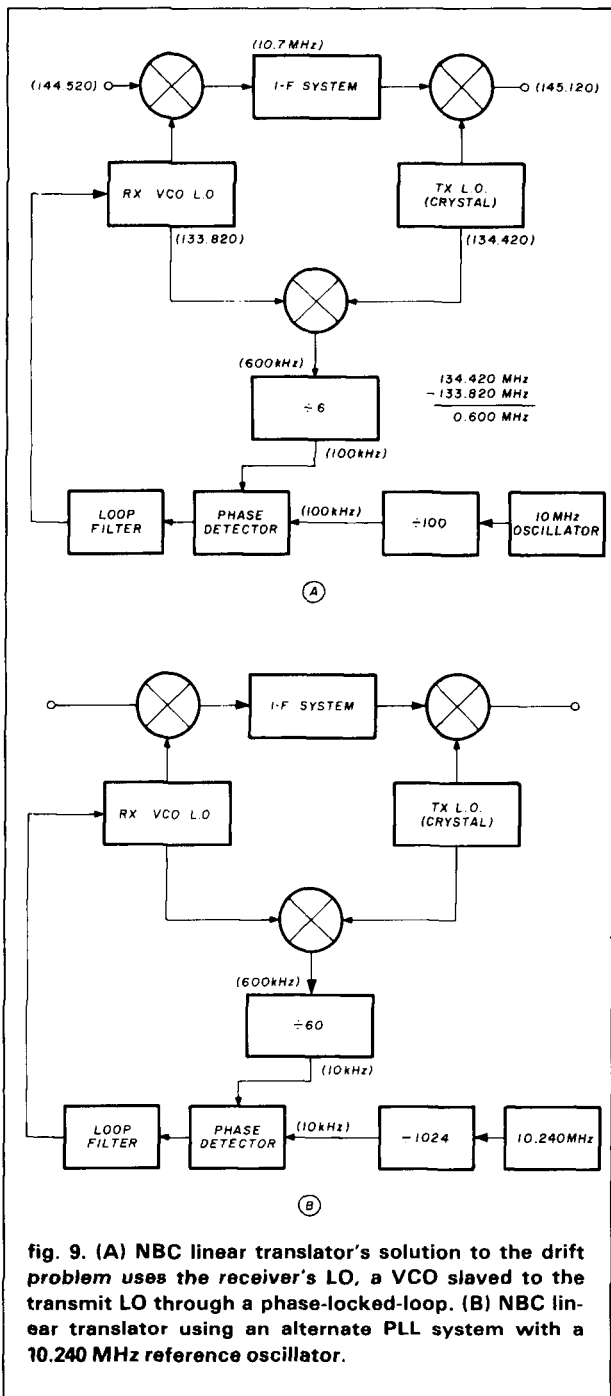

fig. 9. (A) NBC linear translator's solution to the drift problem uses the receiver's LO, a VCO slaved to the transmit LO through a phase-locked-loop. (B) NBC linear translator using an alternate PLL system with a 10.240 MHz reference oscillator.

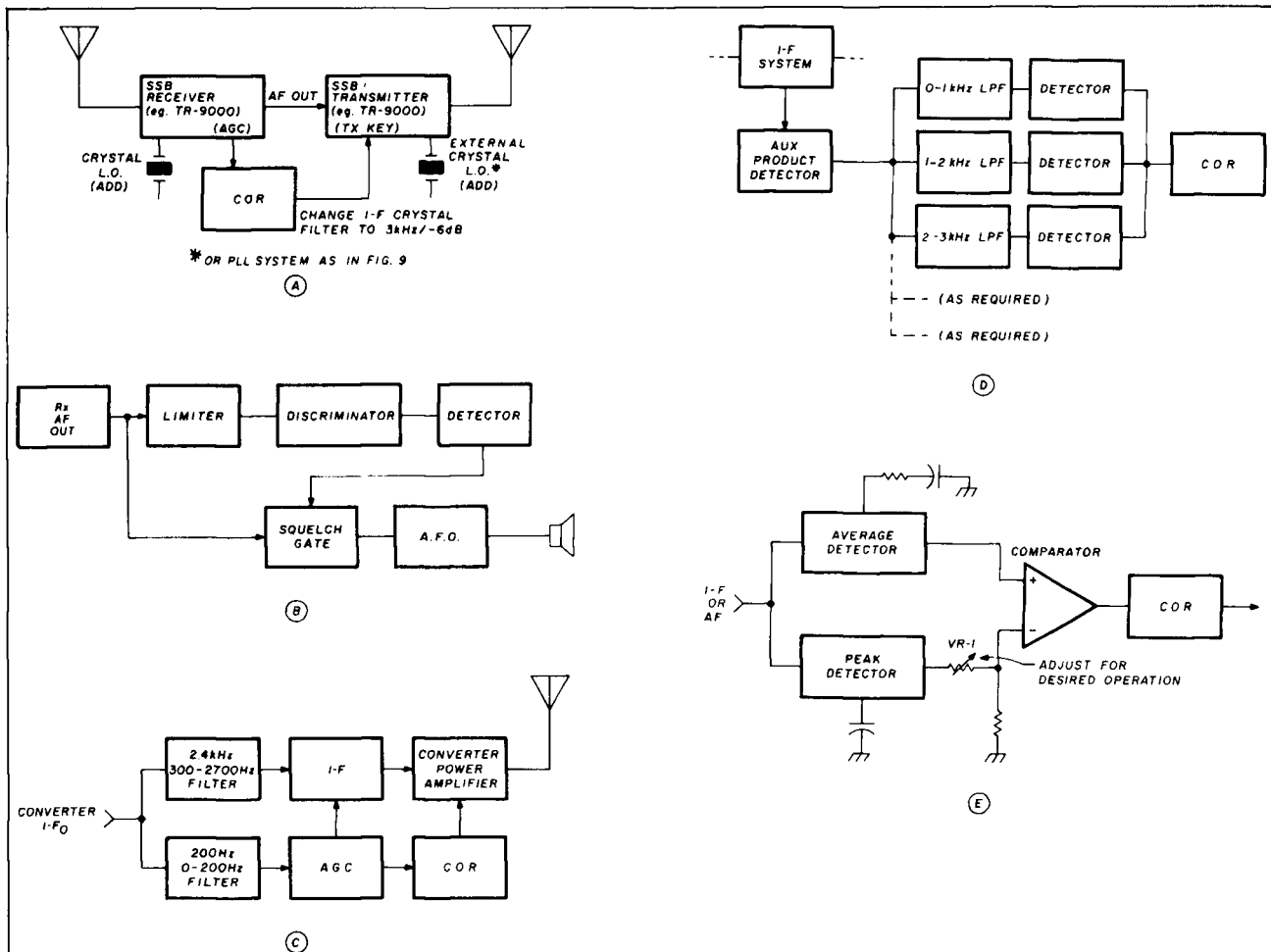

fig. 10. (A) SSB repeater block diagram. Use external TX and RX LO's or PLL system of fig. 9(A) and (B); (B) Ratio squelch design developed by Kahn is useful in both single and multi-channel systems; (C) Single-channel system use of sub-audible carriers for COR or squelch triggering. AF filtering off a detector or appropriate i-f filters can be used; (D) An alternate method of turning on an LT uses a series of 1 kHz bandwidth audio filters that drive individual detectors; and (E) An alternate COR system uses a comparator fed by an average and peak detector circuit. Decision is based on the ratio of average to peak levels received at the comparator.

might improve pulse sensitivity giving better blanking, but would increase the risk of adjacent channel crossmodulation.

With either technique some further crossmodulation protection can be obtained by using an averaging AGC having a slow attack and release characteristic. This will clamp CW, a-m, or fm signals (including SSB) when they start approaching the crossmodulation level, but will not clamp fully on quicker noise pulses. This technique is used quite effectively on many h-f ham rigs, but can be difficult to set up properly (as can be seen by other hf rigs having similar noise blankers that don't work). Fortunately, we are working with a single band and only a few kinds of noise on VHF, so that level setting of the AGC and its attack/release characteristic is not as critical.

I should point out that the reduction of gain which

prevents crossmodulation of the noise blanker by signals will also reduce sensitivity to noise pulses so that such signals will at some point, in essence, turn off the blanker.

For the NBC translator we use an attenuator in front of the i-f amplifier to reduce the overall gain (prior to AGC) so that the normal noise floor and external interference are both dropped below COR threshold. This also reduces weaker station levels, but without some kind of noise blanker those stations can't be copied anyway. The argument in favor of the use of a noise blanker in spite of these technical problems is that they extend the weak signal capability of the LT by 6-12 dB in typical environments. Mountain-top locations may be quiet enough, however, to obviate the need for a blanker.

A comment on i-f clean-up filters should be inter-

jected here. Unlike repeaters whose bandwidth is automatically limited by de-emphasis and modulator bandwidth, an LT passes all i-f generated noise to the output frequency. Since the crystal filter is normally placed at the very front of the i-f strip to provide best IMD/selectivity performance, it does not limit the output of noise from any of the following i-f stages. The only selectivity limiting noise output from the i-f stages is provided by the interstage transformers and tuned circuits. At 10.7 MHz we see a noise bandwidth of about 120-250 kHz at the 3 dB points and only about 30 dB down at the 500-1000 kHz points. Needless to say, this is unacceptable at the output of the LT.

Fig. 11 illustrates several ways to improve this situation. The best (and most expensive) is to use an input and output filter on each i-f so that the noise output is essentially limited to the bandwidth of each i-f. A good compromise, though not best in terms of adjacent-channel and front-end and IM considerations, is to use a single filter as wide as all i-fs combined in front of the first couple of i-f stages, then split (or convert) the signal to individual i-f amplifiers

each having individual filters. This controls the channel to channel IMD and noise outputs. Only noise from active channels can reach the upconverter and PA stages. Additionally, IMD products created in the first i-f will not spill over into the second i-f, and the output clean-up filter of i-f number 1 will not allow IMD products outside of its passband to be passed to the upconverter.

In areas of high signal congestion, better selectivity at the input may be more desirable. In this case, filters are placed at the input of each i-f with one clean-up filter at the output-combining point of the system. This causes broader i-f noise and IMD output and loses some of the advantages of shutting off unused i-fs to reduce output bandwidth.

Last, unlike fm repeaters, an LT will likely see positive feedback or regeneration when there is insufficient TX/RX isolation because of poor shielding, filtering, or inadequate duplexers. This shows up as what most people would term distortion, though it is really regeneration or noise pumping. Oscillations can also occur. Squelch and COR setting can also be aggravated as can the ratio of AGC to noise floor.

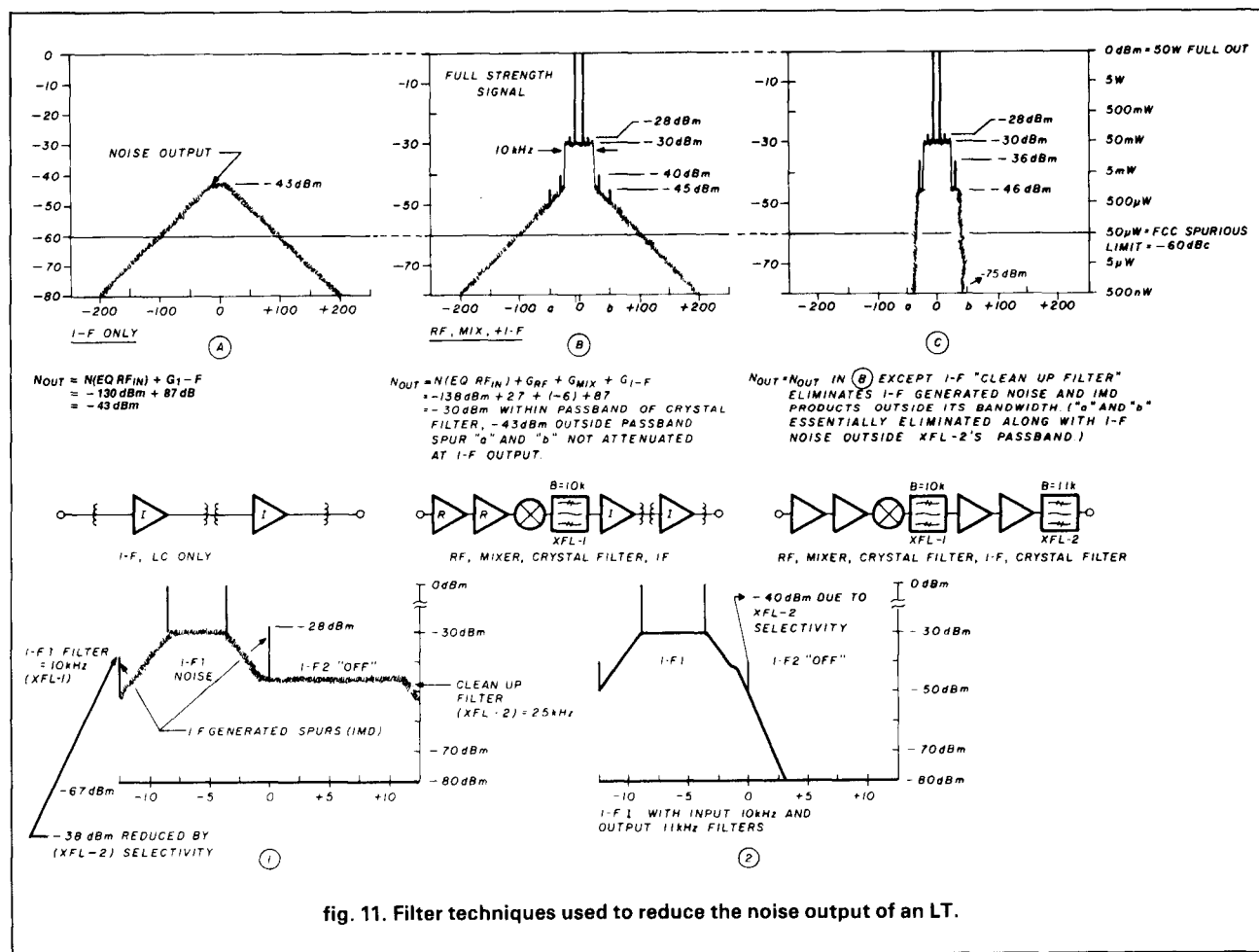

fig. 11. Filter techniques used to reduce the noise output of an LT.



## summary

Current exploration of narrowband modes by the FCC, coupled with our understanding of the bandwidth, DX, and multipath advantages of SSB, now make the time right for hams, as the most experienced users of VHF/UHF SSB, to contribute once more to experimentation and expansion of the state-of-the-art. Building an LT is, at least, challenging, and, at most, could help develop a new technology.

I would be happy to assist anyone wishing to build an LT. For a complete set of schematics of the NBC LT, send \$1.50 and a large SASE directly to me. I'll also respond to questions; just enclose an SASE with all inquiries.

## notes

(a) FCC practice in fm and TV broadcasting is to give the name "translators" to stations that receive signals and change them to another frequency to extend coverage. AMSAT and many satellite agencies tend to use the term "transponder." My feeling is that after many years of such use in aviation, "transponder" has come to mean a device that returns a specifically coded signal when interrogated by a radar pulse; a "translator" merely translates, with no other modification or detection, an incoming signal from one frequency to another.

(b) The two meter, in-band Linear Translator is located in Twaine Harte, California and provides 50 watts ERP at 144.52/145.12 MHz in keeping with suggested ARRL Two Meter Band Planning. Information can be obtained by writing Neil Lewis, WB6VIV, 8119 Phaeton Drive, Oakland, California 94605. For specific technical information, contact the author. (SASE requested in either case.)

(c) This machine was taken off the air in 1981 for modifications and has been overhauled to act as a development LT for Project OSCAR's SYNCART satellite project. It should be back on the air by the time this is published, with input at 1296.3 MHz and 145.7 MHz with output at 435.415 MHz. Inquiries concerning it should be addressed to Project OSCAR, c/o the author at his home address. (SASE required.)

(d) Fm receiver selectivity = 18 kHz, typical SSB receiver selectivity = 2.4 kHz, typical SNR improvement (SSB over fm) =  $10 \log 18/2.4 = 9 \text{ dB}$ .

(e) Note the 9-dB bandwidth advantage (particularly below threshold for fm) coupled with the additional 6 to 18 dB SNR improvement given by use of ACSB. This offsets most, if not all, of fm's noise-limiting capability.

(f) Sensitivity improvement =  $10 \log 20/10 = 3 \text{ dB}$ .

(g) This proposal has been reworked recently by AMSAT Canada and Project OSCAR. The original host launch was cancelled due to delays in the Space Shuttle program. Two possible upcoming launches will not allow time for a SYNCART-style transponder to be developed. Work continues, however, on SYNCART development for possible later launches.

(h) This section, although describing an LT design, can be used to improve fm repeater designs.

## references

1. UHF Task Force Report, "Spectrum Efficient Technology for Voice Communications," FCC Office of Plans and Policy, February, 1978.
2. Piero Moroni, I5TDJ, "A New Transponder for Amateur Satellites," *AMSAT Newsletter*, June, 1978.
3. James R. Fisk, W1HR, "Receiver Sensitivity and Dynamic Range," *ham radio*, October, 1975.
4. Product Highlight File, *ORBIT Magazine* #9, January, 1982.

ham radio

# ANYWAY YOU LOOK AT IT.... ADM HAS YOUR ANTENNA

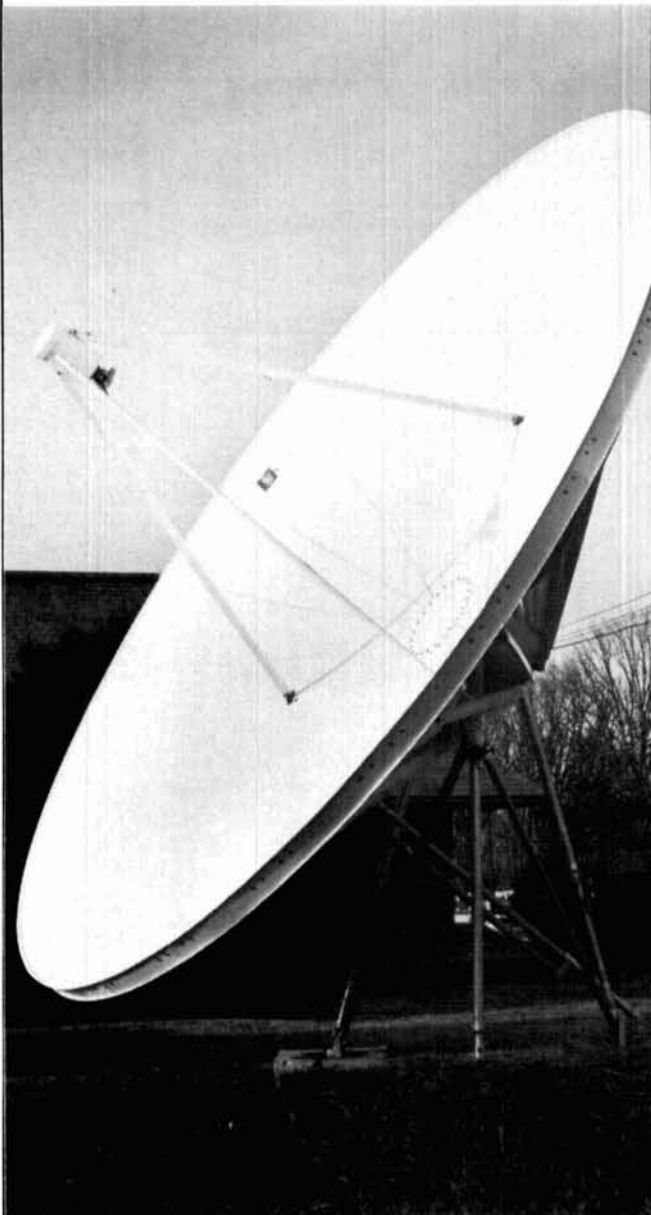

ADM 11, ADM 13, ADM 16, ADM 20  
Sturdy Aluminum & Steel  
Construction

Easy Assembly & Installation

ANTENNA DEVELOPMENT &  
MANUFACTURING, INC.

P.O. Box 1178, Hwy. 67 South  
Poplar Bluff, MO 63901

(314) 785-5988 686-1484

✓ 113

# a fail-safe amplifier power supply

## An improved method of providing dc voltages to GaAs FET amplifiers

**It has long been recognized** that certain semiconductor devices require a pair of voltages of opposite polarity for proper operation. Amateurs have begun using one of these devices, the gallium-arsenide field-effect transistor (GaAs FET), in low-noise preamplifiers on the bands above 100 MHz. But the (N-channel) GaAs FET requires that a negative voltage always be present between its gate and source leads whenever a positive voltage is present between the drain and source leads of the same device. Failure to provide the negative gate-source voltage ( $-V_{GS}$ ) before the positive drain voltage ( $+V_{DS}$ ) is provided leads to the destruction of the device.

### single dc lead

The problem of providing gate-source bias voltage at a time no later than the drain-source voltage is provided, is rather easily solved if both positive and neg-

ative voltages are available for the amplifier. However, because full advantage of the low noise-figure of a GaAs FET preamplifier is obtained only if the amplifier is mounted at the antenna feed, it is often undesirable to provide three dc wires (+ voltage, - voltage, and ground) to the antenna-mounted preamplifier. A preamplifier can be operated with a single positive voltage if some form of self-biasing configuration is used. Typically, self-bias is provided by a resistor from the device source lead to ground; however, a very low-loss bypass capacitor must parallel the source resistor to effectively place the device source lead at rf ground potential. The bypass capacitor is generally of the chip capacitor type, and may often be self-resonant at the Amateur band of interest.<sup>1</sup> However, as the frequency of use is increased to beyond about 3 GHz, even the best available bypass capacitors add undesired reactance; the GaAs FET device is best operated with the source lead connected directly to the circuit ground. When this connection is made, the pair of opposite-polarity voltages are again required, and the problems of power supply sequencing and number of supply wires are again encountered. Because it is very desirable to provide a single voltage, generally of positive polari-

**By Geoffrey H. Krauss, WA2GFP, 16 Riviera Drive, Latham, New York 12110**

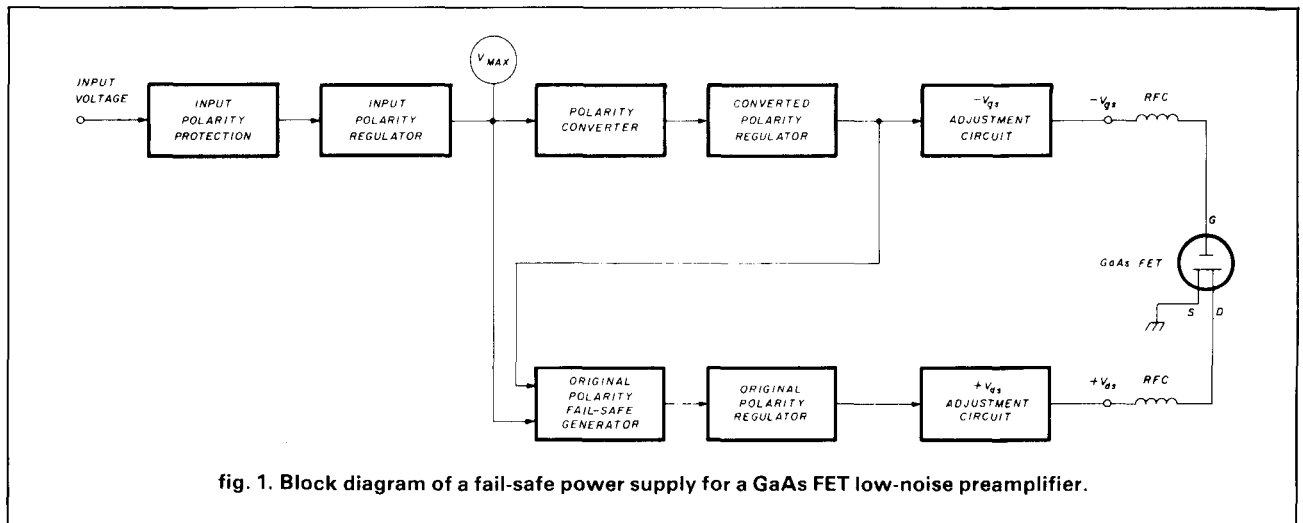

fig. 1. Block diagram of a fail-safe power supply for a GaAs FET low-noise preamplifier.

ty, along the inner conductor of the coaxial cable to the preamplifier output, with the coaxial cable outer shield providing its normal ground connection, some form of power supply at the preamplifier is necessary to provide both polarities of voltage in proper sequence.

My fail-safe power supply (fig. 1) was developed to solve this problem (and was subsequently found to be novel enough to be granted a patent in the United States). It is, in some ways, very much similar to the power supply described by Norman Foot, WA9HUV, in an earlier issue of this magazine.<sup>2</sup> My patented circuit has several features worth consideration by anyone planning to power a GaAs FET preamplifier from a single polarity voltage supply.

### GaAs requirements

Consider first the voltage and current requirements of a typical (low-noise) GaAs FET device:  $V_{gs}$  usually must never exceed  $-6$  volts, at a very small current (generally less than 1 microampere);  $V_{ds}$  is generally about  $+3$  volts at about 10 milliamperes in operation and must generally never exceed  $+6$  volts or a maximum current of 50-100 milliamperes. It is important to reduce the supply voltage to a voltage no greater than the 6-volt maximum voltage, as soon as possible in any proposed power supply. This maximum voltage  $V_{max}$  is provided by an input polarity regulator, utilizing a 78L05 integrated circuit. The input polarity regulator is itself protected from receiving an input voltage of improper polarity by the use of a so-called "idiot diode",  $CR_1$ . An input capacitor,  $C_1$ , is used to prevent input voltage surges when the power supply is in the presence of a larger rf field (as may occur with the power supply at the antenna). The input polarity regulator device  $U_1$  is suitably bypassed

and is protected from reverse voltages, during power-down, by diode  $CR_2$ . The net result is a positive voltage at test point TP1 which is less than the maximum safe drain voltage, provided at a very early point in the power supply, and protected against both reverse-polarity and overvoltage faults by diodes  $CR_1$  and  $CR_2$ .

The positive voltage is converted to a negative voltage in a polarity converter using a relatively new integrated circuit,  $U_2$ , the ICL7660 from Intersil, Inc. The ICL7660 requires only two associated components, the pair of  $10 \mu F$  capacitors  $C_4$  and  $C_5$ , in order to generate a negative voltage at test point TP2 of about  $-4.5$  volts. While I have tried the polarity converter circuit using a 555 timer integrated circuit, as suggested by WA9HUV (and the 555 timer circuit does work as intended), the three-component circuit of fig. 2 is somewhat simpler, more compact, and more reliable. The negative output voltage is of almost the same magnitude as the positive input voltage and requires neither a voltage doubler nor operating voltages greater than the maximum voltage of the GaAs FET, a preferred feature in case of component failure in the polarity converter.

Because the amplifier noise figure and, to a somewhat lesser extent, the amplifier gain are directly related to the device drain current  $I_d$  (set by the gate voltage  $V_{gs}$ ), the converted-polarity voltage must be highly regulated. The converted polarity regulator uses a series resistor,  $R_1$ , and a zener diode,  $CR_4$ , to provide this regulated voltage;  $-3.3$  Vdc is provided at test point TP3. The zener diode  $CR_4$  also prevents a positive voltage from ever appearing at the device gate.  $CR_4$  is shunted by filter capacitor  $C_6$  to remove any noise components generated by the zener. The regulated negative voltage appears across potenti-

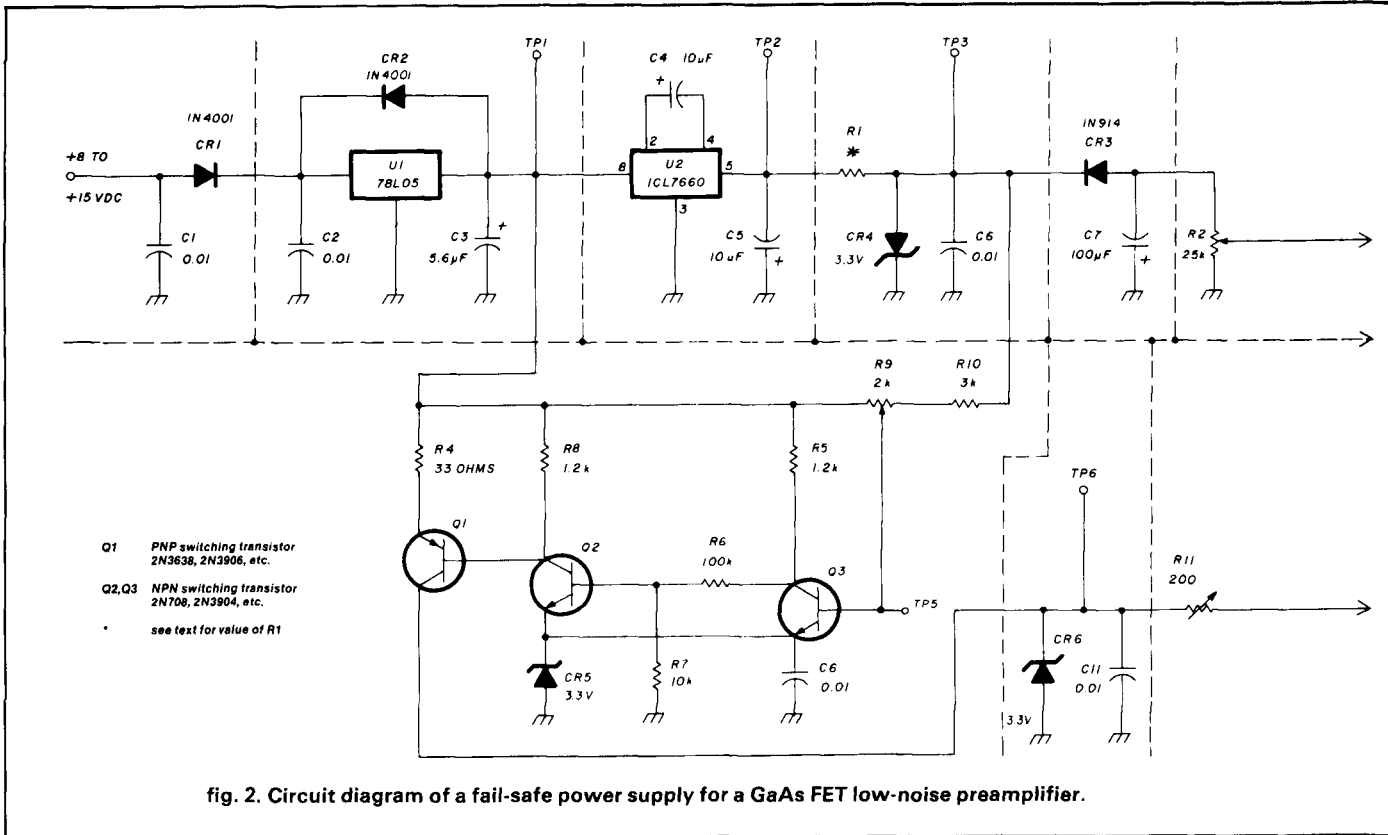

fig. 2. Circuit diagram of a fail-safe power supply for a GaAs FET low-noise preamplifier.

ometer  $R_2$ , which is adjusted to set the amplifier device voltage  $-V_{gs}$ .

### failure mode protection

The input-regulated voltage  $V_{max}$  and the converted-polarity regulated voltage at test point TP3 are used in an original-polarity fail-safe voltage generator subcircuit to provide a positive voltage for the amplifier device drain circuit *only* if the negative amplifier device gate voltage is present. Reason dictates that a switch, transistor  $Q_1$ , is open until the negative voltage at TP3 is present; that is, when the  $Q_1$ - $Q_3$  circuit of **fig. 2** fails in an open condition, with voltage and current not supplied to the subsequent original-polarity regulator subcircuit, which uses zener diode  $CR_6$ . Compare this approach to that of the crowbar/regulator  $U_2$  circuit discussed in WA9HUV's article, in which failure of the crowbar circuit no longer reduces positive regulator  $U_2$  input and thereby allows positive drain voltage to continue to be supplied to the amplifier device. My original-polarity fail-safe generator uses a Schmitt-trigger circuit (transistors  $Q_2$  and  $Q_3$ , zener diode  $CR_5$  and resistors  $R_5$ - $R_8$ ). The switching input voltage of the trigger is determined by the setting of potentiometer  $R_9$ , and operates as follows: if the proper  $-3.3$  Vdc is present at TP3,

then the voltage at trigger input test point TP5 can be adjusted to be sufficiently close to the zener voltage of diode  $CR_5$ , so that transistor  $Q_3$  is cut off. The voltage at the base of transistor  $Q_2$  is then greater than the voltage across zener diode  $CR_5$ , and transistor  $Q_2$  is saturated, turning on transistor  $Q_1$  and allowing a current, set by resistor  $R_4$ , to flow into zener diode  $CR_6$ . This provides a regulated  $+3.3$  volts at positive regulator test point TP6. If the negative voltage at test point TP3 decreases, for any reason, by an amount determined by the setting of potentiometer  $R_9$ , the voltage at test point TP5 increases (becomes more positive) by an amount adjusted to raise the base of transistor  $Q_3$  above the voltage of zener diode  $CR_5$ . Transistor  $Q_3$  switches into saturation and transistor  $Q_2$  switches into the cut-off condition, cutting off current flow through transistor  $Q_1$  and reducing the voltage at positive regulator test point TP6 toward zero.

Resistor  $R_1$  can be selected, in the 100-500 ohm range, to cause one of two results to occur when the fault condition causing the negative regulator test point TP3 voltage to be less than the design value is cleared. For lower values of resistor  $R_1$ , clearing of a fault (such as a short across zener diode  $CR_4$ ) causes the trigger to reset and the circuit to return to normal

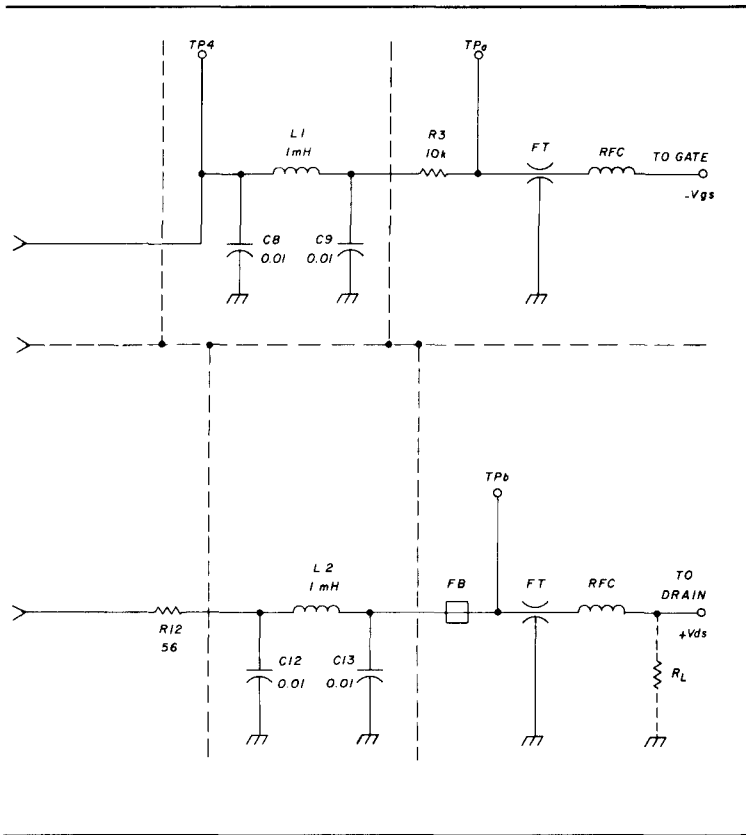

operating condition. For higher values of resistor  $R_1$ , clearing of a fault and return of the TP3 voltage to about  $-3.3$  Vdc can cause the positive drain voltage to remain at about 0 volts until the main input power is removed and reapplied. This latter condition, somewhat dependent upon the setting of potentiometer  $R_9$ , is observable if the total current into the power supply is monitored. It can be useful in providing an automatic fault alarm, even while the device is being protected by the application of a safe negative  $V_{gs}$  and simultaneous removal of  $V_{ds}$ .

The amplifier device drain voltage  $V_{ds}$  is set by potentiometer  $R_{11}$  in conjunction with fixed resistor  $R_{12}$ . Typically, the drain voltage  $V_{ds}$  has an effect upon the amplifier noise figure and gain, although this effect is somewhat less than the effect of varying the device drain current, which is varied by adjustment of the gate voltage  $-V_{gs}$  at potentiometer  $R_2$ .

One problem which will be encountered, but was not addressed in WA9HUV's article, is the possibility of voltage spikes occurring at the oscillation frequency of the polarity converter subcircuit. These spikes are generated by the squarewave switching inherent in either the 555 timer or ICL7660 converter integrated circuits. The first step necessary to prevent these spikes from showing up at either the amplifier  $-V_{gs}$

input at test point TP4, or the drain voltage  $+V_{ds}$  input test point TP6, is to build the power supply in a separate shielded box mounted next to the preamplifier shielded box. The negative and positive voltages are then run through short, shielded wires to the preamplifier input feed-through capacitors FT. As a second step, the converter "hash" is suppressed by a  $\pi$ -section lowpass filter ( $L_1$ ,  $C_8$  and  $C_9$  or  $L_2$ ,  $C_{12}$  and  $C_{13}$ ) placed after adjustment potentiometers  $R_2$  and  $R_{11}$ . Ideally, each of the filters should be in its own little shielded enclosure within the main power supply shield enclosure.

The additional circuit of diode  $CR_3$  and capacitor  $C_7$  is an added protective measure. During normal operation the voltage drop across diode  $CR_3$  will provide a maximum gate voltage of slightly less negative magnitude than the zener voltage of diode  $CR_4$ . The voltage drop across diode  $CR_3$  is substantially constant and the initial setting adjustment of potentiometer  $R_2$  takes this voltage drop into account. However, during power supply turn-off, under either normal operation or because of a decrease in the voltage at TP3, the previously-charged storage capacitor,  $C_7$ , maintains a sufficiently negative voltage at the gate output to prevent destruction of the protected device while the voltage at the drain connection rapidly falls to zero. Typically, drain voltage will fall to zero in under ten milliseconds, while the voltage at gate test point TP4 requires about one second to fall to zero magnitude, providing an additional degree of GaAs FET protection.

### circuit test

The circuit test should be carried out before the power supply is connected to the companion preamplifier. A dc load resistor,  $R_L$ , is connected to approximate the desired amplifier device drain load. For a typical 3.0 Vdc drain voltage at a typical 10 milliamperere drain current.  $R_L$  is a 300 ohm, 1/8-watt resistor. Since the amplifier device gate electrode does not draw any appreciable current, the gate end of series-protection resistor  $R_3$  is left open.

Apply a positive voltage in the 8 to 15-volt dc range to the power supply input and check for the following voltages, using a voltmeter with at least 20K ohm resistance (all voltages are  $\pm 10$  percent):  $+5.0$  Vdc at TP1; about  $-4.5$  Vdc at TP2; and  $-3.3$  Vdc at TP3. The voltages at TP4 and TPa should be variable from zero to about  $-2.8$  Vdc, which is less than the voltage at TP3 because of the drop in diode  $CR_3$ .

The positive-polarity portion of the power supply is tested by adjusting potentiometer  $R_9$  until a 3.3-volt dc level appears at TP6. The operation of the fail-safe generator subcircuit is tested by temporarily placing a short circuit from TP3 to ground and noting that

the voltage at TP6 falls to zero. Some adjustment of potentiometer  $R_9$ , while monitoring the TP5 voltage, may be required to obtain the proper operation of the trigger circuit. Potentiometer  $R_{11}$  is then adjusted for the desired target drain voltage at TPb, with the dummy drain resistance,  $R_L$ , connected.

As a final check before connecting the power supply to the amplifier, monitor the TPa and TPb voltages with an oscilloscope (preferably starting at one volt per division and working down to the greatest sensitivity possible) and look for spikes in the kHz repetition frequency range. If such spikes should be found, increased values of the lowpass filter components may be necessary.

## applications

The fail-safe preamplifier power supply has been used with, among other circuits, a  $\pi$ -network input/output preamplifier for 1296 MHz.<sup>3</sup> A number of different GaAs FET devices were tested; optimum noise performance could be obtained by varying the potentiometers  $R_2$  and  $R_{11}$  in a noise-figure measurement test setup. The same devices in the same preamplifiers were also tested with a source-resistance-biasing scheme; a small but discernable increase in noise figure was found above the case where the device source leads were directly grounded and the fail-safe power supply used.

A very-low-noise receiver was built at 3456 MHz, using a simple single-balanced mixer<sup>4</sup> built on G-10 printed circuit board stock and garden-variety mixer diodes (HP2810). While the use of G-10 board is not recommended at this frequency, and resulted in a mixer conversion loss of about 13 dB (and a noise figure estimated at about 15 dB), a two-stage GaAs FET preamplifier with 29 dB of gain completely overcame the mixer noise. The preamplifier is almost identical to a well-known TVRO preamplifier,<sup>5</sup> with the exception of an NE21889 device used in the input stage and improved input matching through the use of a pair of 1/8 inch wide by 1/4 inch long copper foil "flapper" capacitors. The power supply recommended by the manufacturer requires a +15 volt supply and a -15 volt supply, in addition to a pair of 747 dual operational amplifier integrated circuits, a handful of zener diodes, and other components. In my receiver, that power supply was replaced by a pair of power supplies as shown in **fig.2**, allowing not only the independent setting of the drain voltages of each stage (which could not be done with the manufacturer's recommended power supply), but also the independent setting of the drain current of both stages, to provide a preamplifier noise figure of about 1.0 dB at the indicated 29 dB gain figure. Application of the usual series-stage gain and noise figure formulas will show that the overall converter (preamplifier plus

mixer) gain is about 16 dB, with a total noise figure of about 1.1 dB. This illustrates that the poor mixer specs are, in fact, overcome by the superior gain of the preamplifier.

## conclusion

A power supply circuit requiring only a single polarity of input voltage, yet offering a high degree of fail-safe protection for GaAs FET amplifiers — especially for the microwave Amateur bands — is now available. Any questions addressed to the author accompanied by an SASE will be answered.

## license grant

*United States patent laws prevent anyone, unless specifically licensed by the patent owner, from "making, using or selling" any circuit covered by the claims of my U.S. patent 4,320,447; this includes the circuit of fig. 2 as well as the circuit used in reference 2. The patent owner, being the author of this article, therefore expressly grants a non-assignable license to any licensed Amateur Radio operator in the United States of America, to make and use the fail-safe amplifier power supply covered by the claims of U.S. Letters Patent 4,320,447 for use with amplifiers operating only in the authorized U.S. Amateur Radio bands and only for Amateur Radio activity. This limited license cannot be sub-licensed. Use of the circuit covered by the claims of Patent 4,320,447 with amplifiers operating on non-Amateur bands or for non-Amateur use, or the sale of the circuit for any use, are all expressly excluded from this license; grants and terms of such licenses can be discussed directly with the patent owner.*

## references

1. Geoffrey Krauss, WA2GFP, "A Low Noise Preamplifier for 2304 MHz," *ham radio*, February, 1983, page 12. See also: VHF + Technology, *QEX*, #11, December, 1982.
2. Norman Foot, WA9HUV, "Safe Power for Your Low-Noise GaAs FET Amplifier," *ham radio*, November, 1982, page 18.
3. Geoffrey Krauss, WA2GFP, "Low-Noise Preamplifiers for 1296 MHz," *QST*, June, 1982, page 36.
4. D. Evans, G3RPE, and G. Jessup, G6JP, *VHF/UHF Manual, 3rd Edition*, RSGB, 1976, page 4.41.
5. "Two Stage 3.7-4.2 GHz. LNA," *Microwave Journal*, August, 1981, page 90. (Also available as Application Notes from California Eastern Laboratories, Democracy Way, Santa Clara, California 95050).

## bibliography

- Krauss, Geoffrey H., WA2GFP, "VHF Preamplifiers," *ham radio*, December, 1979, page 50.
- Krauss, Geoffrey, WA2GFP, "First Building Blocks for Microwave Systems," *ham radio*, December 1980, page 52.
- Krauss, Geoffrey H., WA2GFP, "Low-Noise, Low-Cost 10-60 MHz Pre-amp," *ham radio*, May, 1981, page 65.
- Krauss, Geoffrey H., WA2GFP, "Interesting Preamplifier for 144 MHz," *ham radio*, November, 1981, page 50.
- Krauss, Geoffrey H., WA2GFP, "A Low-Noise Preamplifier for 2304 MHz," *ham radio* February, 1983, page 12.

**ham radio**

# THE SANTEC TRIO

|                  | 144              | 440              | 220              |
|------------------|------------------|------------------|------------------|
| FREQ. COVERAGE   | 142 — 149.95MHz  | 440 — 449.975MHz | 220 — 224.995MHz |
| REPEATER OFFSETS | ± 600kHz         |                  |                  |
| POWER OUTPUT     | 3.5W/High Option | 3.0W/High Option | 2.5W/High Option |

144, 440, and now 220 MHz!

The Santec ST series of handheld transceivers is now complete! With the introduction of the new **ST-220/μP** which covers 220.000 — 224.995 MHz in 5 kHz steps, Santec brings its unparalleled technology and quality to a third complete band. Now you can get it right on three bands with Santec.

All of the little Santec ST radios are identical in form and features, varying only in power output and individual band characteristics. All share: 10 memories with stored offsets; priority memory scan; 24 hr. format clock; three output power levels; wide band operation; low "quiet time" standby drain; three modes of bandscan; and a full two year extended service plan. Now there are three great handhelds which get it right the Santec way!

Distributed by  
**Encomm, Inc.**  
 2000 Avenue G, Suite 800, Plano, Texas 75074  
 Phone (214) 423-0024 TLX 79-4783 ENCOMM DAL

## PREVENT HI-TECH HEADACHES

Our Isolators eliminate equipment interaction,



clean up interference, curb damaging power line spikes and lightning bursts.

### ISO-1 Isolator

3 isolated sockets; quality spike suppression; basic protection... \$76.95

### ISO-3 Super-Isolator

3 dual isolated sockets; suppressor; commercial protection... 115.95

### ISO-17 Magnum Isolator

4 quad isolated sockets; suppressor; laboratory grade protection... 200.95

**ESP® Electronic Specialists, Inc.**  
 171 S. Main St., Box 389, Natick, MA 01760

Toll Free Order Desk 1-800-225-4876  
 MasterCard, VISA, American Express

✓ 133

## APPLIED INVENTION

THE SOURCE FOR SOLID STATE / STATE OF THE ART

### GaAs FETS by MITSUBISHI

- 2W — Ku Band Very low noise and medium power 1.4
- MGF 1100 Dual Gate GaAs FET 2.5dBm @ 4GHz \$ 7.35
- MGF 1202 (1402 chip in a 1200 package) \$ 9.70
- MGF1404 GUARANTEED 0.85dBm @ 4GHz \$66.60
- MGF1402 0.4 dBm @ 432, 1.1 dBm @ 4GHz \$14.00
- MGF1412 GUARANTEED 0.8, 0.9 or 1.0 dBm @ 4GHz \$21. — \$34.75
- MGF1801 10GHz linear PO 150mW \$40.75

### MITSUBISHI X BAND Hybrid Integrated Circuits with tuneable

Dielectric Resonator (0.12MHz/°C) GaAs FET Oscillators

- FO-1010X 10.4 GHz, 15mw out, UER100 Flange \$39.37
- FO-1210Y 11.5 or 12.0 GHz, UER120 Flange \$39.37
- FO-UP11KF Complete Heterodyne Rx, 10.468 GHz LO \$36.22
- Can be used for 12.5 GHz terrestrial and DBS
- FO-DP13KF Doppler Module 10.525 GHz UER100 Flange \$43.05
- X-Band 15 dBm die cast horn antenna (UER100) \$17.85
- GaAs FET Preamp 1.7 2.1 GHz, 2.0 2.35 GHz, 2.0BNF \$49.00

### At THE SOURCE for RYKON Universal Audio Active Filters NEW

- R5620 digitally programmed switched capacitor audio filter \$ 7.85
- R5621 dual section resistor programmed SCF \$ 6.51
- R5622 quad section resistor programmed SCF \$11.07
- Out performs National MF 10! Application notes \$ 2.00

### OPTOELECTRONICS from MITSUBISHI and SIEMENS

CW LASER DIODES, HIGH OUTPUT HLEDS, PIN PHOTO DIODES. CALL

MITSUBISHI BIPOLAR POWER TRANSISTORS FOR 900/1296 CALL

25C2931, 2, 3, 4 (1.4 to 30 Watts PD)

- MRF 901 Substitute 25C2876, F1=7GHz, 2.2dBm @ 1GHz \$ 1.50
- NEC 64535 direct replacement Siemens BFD 74 \$ 9.66
- LEADLESS DISK CAPS 100, 220, 470, 680, pf 10/\$ 2.50
- MICROWAVE CHIP CAPS Very low loss VITRAMON P7800 series:
  - G02(0.7 1.4 GHz) G04(1.3 2.6 GHz) G01(2.6 4.2GHz) \$ 1.25
  - VITRAMON VHF/UHF/NPO chips 10, 100, 1000 pf 5/\$ 2.50
  - A-B type FW5N 1000pf discoidal Feedthru \$ 0.75
- STRIPLINE SHUTTLE TRIMMERS (VOL TRONCS) 0.1 2.5, 0.5 9.0pf \$ 3.34
- H-O SEALED CERAMIC PISTON TRIMMERS (VOL TRONCS) 0.6 9.0pf \$ 3.58
- SAPPHIRE TRIMMERS Johanson 0.4 2.5pf \$ 9.47
- For WAZGF preamp Sprague 0.6 4.5pf \$ 9.47

Thermo Electric Heat Pumps & Sub-Minature Cryogenic Refrigerators CALL

3M GX250 glass/te board, Er=2.55 @ 10GHz 0.031 \$0.31/sq in

0.062 \$0.52/sq in

E.F. JOHNSON SMA's: Sq flange female \$3.50, Male cable \$ 2.88

PROMPT SERVICE SEND FOR CATALOG MINIMUM ORDER \$5.00

VISA/MASTERCARD Accepted CASH prepay take 5% discount

SSH \* ITEMS (UPS) \$3.75 ALL OTHER ITEMS \$2.50 (1st CLASS)

NY STATE RESIDENTS ADD 7% SALES TAX

R. D. 2 ROUTE 21 HILLSDALE, NY 12529

518-325-3911 ✓ 114

## CABLE TV CONVERTERS VIDEO ACCESSORIES

BUY DIRECT & SAVE

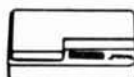

40 CHANNEL CONVERTER  
**\$38** Regular \$69

Advanced Solid State design and circuitry allows you to receive mid & super band channels. Restores programming to Video Recorders.



36 CHANNEL REMOTE CONTROL CABLE CONVERTER  
**\$88.00**

DIAMOND D-56 WIRELESS THE ULTIMATE CABLE T.V. CONVERTER



56 CHANNEL INFRARED REMOTE CONTROL  
**\$139.00**

Send \$1 for Complete Catalog  
 VISA • MASTERCARD • COD

**DIRECT VIDEO SALES**

P.O. BOX 1329

JEFFERSONVILLE, INDIANA 47130

CALL

1-812-282-4766

✓ 132

More Details? CHECK—OFF Page 110

# Complete 10 ft. satellite TV system now \$1395!

**SAVE \$1200!**

List Price 2595.00 Item No. SAT44321C  
Shipped Motor Freight Collect

## 10 FOOT PARABOLIC

### What the system will do:

Receives up to 60 channels of TV direct from satellites to your home receiver. Movies, sporting events, religious programs, other TV stations and much more.

### What the system includes:

1. A 10 foot parabolic antenna made of reflective metal bonded with fiberglass. Weather-resistant and virtually maintenance-free. Comes in 4 sections.
2. Polar mount. Includes azimuth and elevation adjustments for precise satellite-to-satellite tracking.
3. LNA mount complete with rotor. Enables LNA to be remotely positioned for horizontal or vertical polarity. Control console included. Extension tubes, extra.
4. KLM Sky Eye V satellite receiver. Features the latest in single conversion electronics, a large signal strength meter, video invert and variable audio subcarrier tuning (5.5-7.5 MHz). Remotely powered downconverter included for mounting near the LNA and dish antenna. Optional RF modulator available.
5. Amplica low noise amplifier. Rated at 120° K, uncooled. Takes the weak signals reflected from the dish and brings them up to a level usable by the downconverter. Uses GaAs FET transistors for maximum performance. Powered through the coax feed line. Cast aluminum, weatherproof housing.
6. Scalar feed horn. Provides 0.5 dB gain improvement over conventional rectangular types. Virtually eliminates system noise.

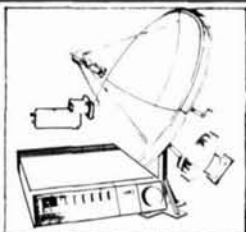
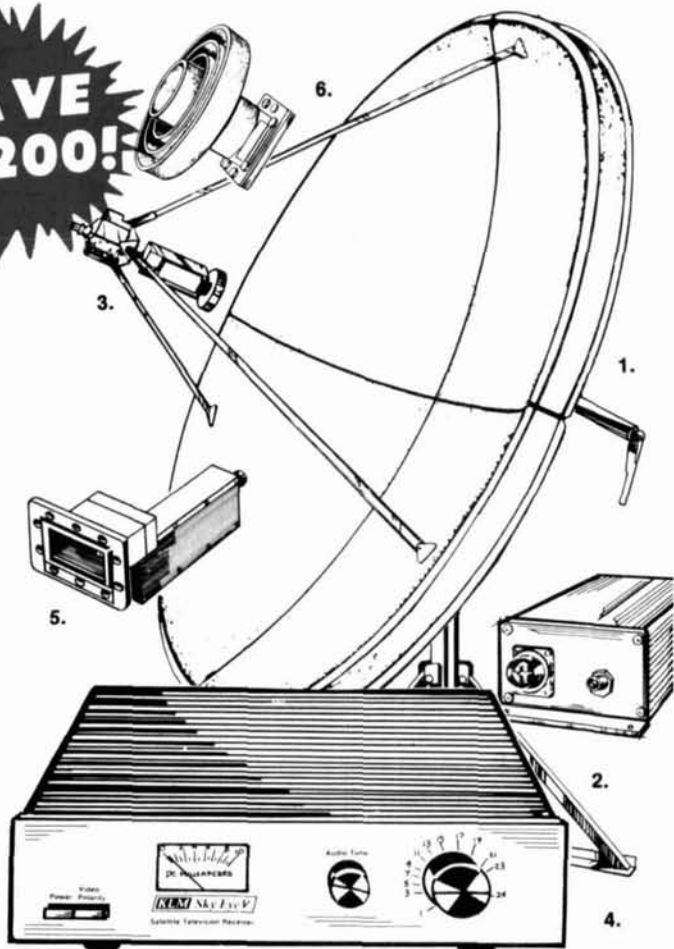

### "Satellite TV Basics" VHS video tape

Now you can use your VCR to learn all about satellite TV! This full color VHS video cassette covers the principles of satellite TV, equipment and programming. Running time: 12 min.

**49.95** List Price 79.95  
Item No. SHL001  
Add 1.40 shipping & handling

### "The World of Satellite Television"

The handbook that provides all the information you'll need to selecting, installing and troubleshooting a satellite TV system. Explains what's up there to see and how to find it.

**8.95** Item No. BOOSATWORLD  
Add 1.40 shipping & handling

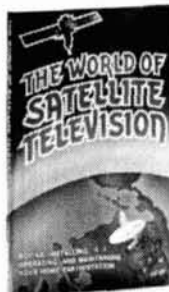

### "Build a Personal Earth Station for Worldwide Satellite TV Reception"

Shows how to select a site for your system, choose equipment, as well as how to build one from scratch. Also features programming information. Thorough and well illustrated.

**9.95** Item No. BOOTAB1409  
Add 1.40 shipping & handling



# Long's Electronics

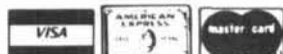

MAIL ORDERS: 2700 CRESTWOOD BLVD. BIRMINGHAM, AL. 35210 • SHOWROOM: 3131 4TH AVENUE SOUTH, BIRMINGHAM, AL. 35233



# Super buys from Long's!



**OVER  
1/2  
OFF!**



## Commodore 64 personal computer

This Commodore gives you more power and more capabilities than any other home computer. It has 64K memory, full size typewriter-style keyboard and built-in BASIC language. Use it for business applications, education, or entertain the whole family with exciting video games.

**249.00** List Price 595.00 Item No. COM64  
Add 3.74 shipping & handling

## Commodore VIC-1701 13 inch color monitor

Full color, 13 inch monitor designed for use with the Commodore 64, VIC-20 and most other personal computers. Offers 320 lines of resolution for sharp displays. Built-in amplifier and speaker. Direct video/audio inputs.

**299.00** Item No. COMVIC1701  
Add 8.03 shipping & handling



**NEW!**

## NEW! UNIDEN CR-2021 world band radio

In addition to standard AM/FM reception, the CR-2021 has longwave/shortwave capability. Enjoy broadcast from over 100 capitals worldwide. Tune in ships at sea, aircraft, police and ham operators. Also operates on SSB and CW. Features one touch memory tuning, LCD readout, automatic channel search and micro processor. Dual power AC or DC for both table top and portable use.

**249.95** List Price 299.95  
Item No. UNICR2021  
Add 2.37 shipping & handling

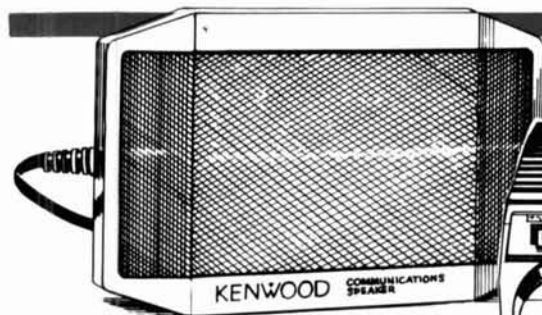

## KENWOOD TM-201A ultra-compact 2 meter FM mobile transceiver

Kenwood has broken the size barrier with this handsome new mobile unit! It measures only 5.6" x 1.6" x 7.2" yet features 25 watts of FM power, dual digital VFO's, 5 memories with memory scan and a highly visible yellow LED frequency display. It covers 142-149 MHz and may be programmed to scan only a portion of the 2 meter band. Also included is a 16-key autopatch mic with up/down control and a high quality external speaker. Power requirement: 13.8V DC.



**\$37 OFF!**

**332.95**

List Price 369.95 Item No. KENTM201  
Add 2.96 shipping & handling

Call Toll Free **1-800-633-3410**

IN ALABAMA CALL 1-800-292-8668 9 AM TIL 5:30 PM CST, MONDAY THRU FRIDAY

More Details? CHECK-OFF Page 110

161

September 1983 39

# COMPLETE READY-TO-USE SYSTEMS

## ATV TRANSMITTER/CONVERTER



TC-1

**\$399**

- ★ High resolution and color video
- ★ 10 watts output
- ★ Broadcast standard sound
- ★ Tunable downconverter and preamp

Connect to the antenna terminals of any TV set, add a good 450 MHz antenna, a camera and there you are . . . Show the shack, home movies, computer games, video tapes, etc.

## ATV DOWNCONVERTER



TVC-4

For those who want to see the ATV action before they commit to a complete station, the TVC-4 is for you. Great for public service setups, demonstrations, getting a buddy interested. Just hook an antenna and a TV set tuned to 2, 3, or 4 and plug in to 117 volts at **\$89.00**

TVC-4L extra low-noise version . . . ~~\$145~~ . . . \$99 delivered in USA

## MODULES



**TXA5-4 Exciter/Modulator** . . . ~~\$90~~ . . . **\$85.00 ppd.**  
Wired and tested module designed to drive PA5 10 watt linear amplifier. The 100 MHz crystal design keeps harmonics out of two meters for talk back. Video modulator is a full 8 MHz for computer graphics and color. Requires 13.8 VDC reg. @ 100 ma. 80 mw output power. Tuned with crystal or 25.434 or 426.25 MHz. Dual frequency model available . . . **\$110.00 ppd.**



**TVC-2 ATV Downconverter** . . . ~~\$95~~ . . . **\$45.00 ppd.**  
Stripline MRF, 40 dB amp and double balanced mixer digs out the video and resists intermod and overload between UHF antenna and TV set. Output channels 2 or 3. 100 pF tuner 420 to 450 MHz. Requires 12 to 18 VDC @ 100 ma.  
**Extrasensitive TVC 2G with bipolar preamp** (.9 dB NF) . . . ~~\$60~~ . . . **\$59.00 ppd.**  
**Supersensitive TVC 2G with GaAs Fet preamp** (.5 dB NF) ant. mount . . . **\$79.00 ppd.**



**FMA5 Audio Subcarrier Generator** . . . **\$29.00 ppd.**  
Puts audio on your camera video just as broadcast does at 4.5 MHz. Puts out 1 V p-p to drive TXA5. Requires low Z mike. 150 to 600 Ω and 12 to 18 VDC @ 25 ma. Works with any transmitter with 5 MHz video bandwidth.



**PA5 10 Watt ATV Power Amplifier** . . . **\$89.00 ppd.**  
The PA5 will put out 10 watts RMS power on sync tips when driven with 80 mw by the TXA5 exciter. 50 ohms in and out plus bandwidth for the whole band with good linearity for color and sound. Requires 13.8 VDC reg. @ 3 amps.

Call or write for our complete catalog of specifications, station setup diagrams, and optional accessories which include: antennas, modulators, test generators, cameras and much, much more. See Ch. 14 1983 ARRL Handbook.

TERMS: VISA or MASTERCARD by telephone or mail, or check or money order by mail. All prices are delivered in USA. Charge orders normally shipped within 24 hours. Personal checks must clear first.

(213) 447-4565

Let P.C. put you on the air and SAVE!

All four modules —

**Complete System price \$235.00**

SAVE \$27.00 over price if purchased individually

**P.C. ELECTRONICS** 2522 Paxson Lane  
Tom W6ORG Maryann WB6YSS Arcadia, California 91006

## PRINTED CIRCUIT KITS MAKE CARDS QUICKLY



ONLY Vector kits contain:

- Positive photo-resist coated AND uncoated copper laminate—no messy photo-reversal—no spraying, dipping, or baking.
  - 4 types of art aids: rub transfers, ink, tape, cut and peel—use 1 or all.
  - 1:1 circuit art rub transfers—IC sets, pads, lines, connectors, symbols, letters, and numbers.
  - Everything included—just add water and sunlamp or bright sunshine.
  - Liquid etchant and developer—no dry chemical mixing problems.
- AND
- Process choices—make circuit on copper and etch for 1 card.
  - Make circuit on film, expose, develop and etch for 1 or many cards.

ART AIDS + mylar film + sunlamp + developer & etchant = 1 or many PC's  
+ card + etchant = 1PC

32XA-1 kit makes 7 PC cards, \$46.41, 32X-1 starter kit makes 2 cards, \$18.24  
If not available locally factory order-include \$3.00 shipping, U.S. only  
Prices subject to change without notice

510177

Vector Electronic Co., 12460 Gladstone Av., Sylmar, CA 91342

## STUMPED FOR A GIFT IDEA?

### I.D. BADGES

No ham should be without an I.D. badge. It's just the thing for club meetings, conventions, and get-togethers, and you have a wide choice of colors. Have your name and call engraved in either standard or script type on one of these plastic laminated I.D. badges. Wear it with pride! Available in the following color combinations (badge/lettering): white/red, woodgrain/white, blue/white, white/black, yellow/blue, red/white, green/white, metallic gold/black, metallic silver/black.

UID Engraved I.D. Badge

**\$2.50**



### HERE'S A GIFT IDEA!

How about an attractive BASEBALL style cap that has name and call on it. It's the perfect way to keep eyes shaded during Field Day, it gives a jaunty air when worn at Hamfests and it is a great help for friends who have never met to spot names and calls for easy recognition. Great for birthdays, anniversaries, special days, whatever occasion you want it to be. Hats come in the following colors: GOLD, BLUE, RED, KELLY GREEN. Please send call and name (maximum 6 letters per line).

UFBC-81

**\$5.00**

REGULAR PRICE HAT AND BADGE \$7.50 + SHIPPING

**SPECIAL \$6.49**

**SAVE \$1.00**

Please enclose \$1 to cover shipping and handling.

**HAM RADIO'S BOOKSTORE**

GREENVILLE, NH 03048

(603) 878-1441

# ham radio TECHNIQUES

Bill W6SAI

Just about the time you are reading this column, the summer static level should be dropping off and the low frequency DX bands should be coming back to life. Low frequency DX conditions should improve during the next few years as the sunspot count continues to drop. This means that the 160 meter band will be a good performer for a number of years. Some Amateurs have stuck to 160 meters, year in and year out, but many of the newer Amateurs are not yet aware of the DX possibilities of this band.

A majority of the new transceivers have incorporated the 160 meter band and the 1983-84 winter season promises to be a good one for this venerable Amateur band, with a high level of activity.

## the 1983/84 DX season on 160 meters

The number one DX operator on 160 meters is Stew Perry, W1BB, who has been active in that portion of the spectrum since 1920! (See **figs. 1**

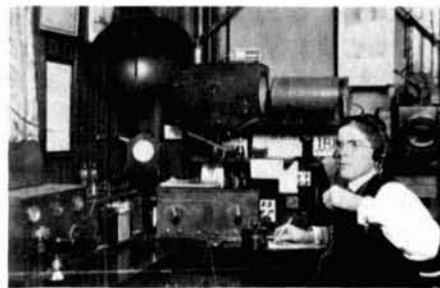

**fig. 1.** Stew Perry, W1BB, on the alert for 160 meter DX in 1920. Transmitter is a single tube oscillator, modulated for a-m phone. Running 35 watts, Stew quickly discovered the thrill of working DX.

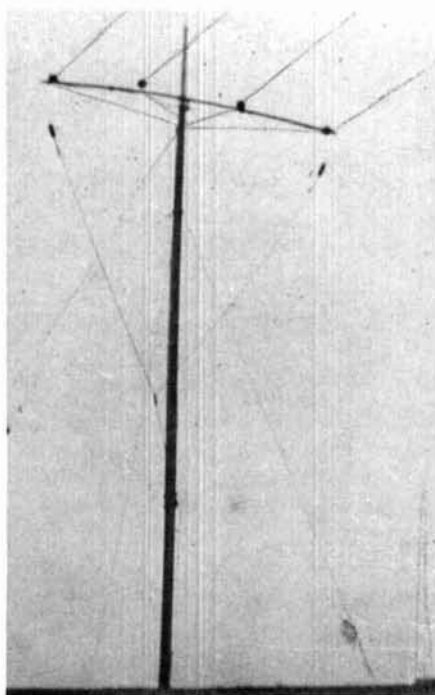

**fig. 2.** The 160-meter flat-top antenna of W1BB in 1920. This was a Marconi affair, working against a good ground. Even in the 1920's, Steve was an old-timer, since he'd been licensed since 1912. (He's now celebrating his 71st year on the air!)

and 2.) I asked Stew what he thought about the forthcoming season and this is what he said:

While I've not been very active recently, I've made a few good contacts this year (4X4NJ-Israel, PY1ARS-Brazil, and others). I think conditions seem quite sound and feel "right" for a good season. In spite of some changes, it still is the "gentleman's band", where folks are friendly and cooperative, without so much push and shove!

By its nature, you're forced to work DX the hard way, at all hours of the day and night for world cover-

age. Sunset and sunrise (local time) are excellent periods, full of good DX surprises.

As far as antennas for the "top band," the best receiving and transmitting antennas are required for top results, but you will be surprised what can be done with a simple inverted-L Marconi, or a Sloper with a good ground system.

Come on down to 160 and meet some fine guys.

## FCC rules and regulations

A collection of the FCC rules and regulations governing ham radio fills a thick notebook! Is it all worth the effort? Let's return again to the simple regulations of the Federal Radio Commission of 1927 (**fig. 3**). Think of how many problems these simple rules would solve. As a famous philosopher once said, "I have seen the past, and it works!"

## horizontal versus vertical antennas

I am still getting mail on my comments concerning horizontal versus vertical polarization for simple high frequency antennas (October, 1982, and April, 1983). A recent letter from my friend Win Wagener, W6VQD, says, in part:

Too many people discuss the pros and cons of polarization without a good understanding of what is involved. It is not a simple question of which is better, a vertical or a horizontal antenna; but a need to consider the full environment of the antenna system.

Too many articles on the effect of the surface of the earth in the vicinity of an antenna assume a perfectly conducting and flat surface for the

October 28, 1927.

**Supervisors of Radio and Others Concerned:**

For your information and guidance the Federal Radio Commission has established the following regulations governing the licensing and operation of amateur radio stations:

Amateur radio stations are authorized for communication only with similarly licensed stations and on wavelengths or frequencies within the following bands:

| Kilocycles         | Meters           | Kilocycles     | Meters         |
|--------------------|------------------|----------------|----------------|
| 401,000 to 400,000 | 0.7477 to 0.7496 | 8,000 to 7 000 | 37.5 to 42.8   |
| 64,000 to 56,000   | 4.69 to 5.35     | 4,000 to 3,500 | 75.0 to 85.7   |
| 16,000 to 14,000   | 18.7 to 21.4     | 2,000 to 1,500 | 150.0 to 200.0 |

and at all times unless interference is caused with other radio services, in which event a silent period must be observed between the hours of 8:00 p. m. and 10:30 p. m., local time and on Sundays during local church services.

Amateur radio telephone operation will be permitted only in the following bands:

| Kilocycles       | Meters        |
|------------------|---------------|
| 64,000 to 56,000 | 4.69 to 5.35  |
| 14,500 to 14,000 | 20.88 to 21.4 |
| 2,000 to 1,580   | 150 to 190    |

Spark transmitters will not be authorized for amateur use.

Amateur stations must use circuits loosely coupled to the radiating system or devices that will produce equivalent effects to minimize key impacts, harmonics and plate supply modulations. Conductive coupling, even though loose, will NOT be permitted, but this restriction shall not apply against the employment of transmission line feeder systems to Hertzian antennas.

Amateur stations are not permitted to communicate with commercial or government stations unless authorized by the licensing authority except in an emergency or for testing purposes. This restriction does not apply to communication with small pleasure craft such as yachts and motor boats holding limited commercial station licenses which may have difficulty in establishing communication with commercial or government stations.

Amateur stations are not authorized to broadcast news, music, lectures, sermons or any other form of entertainment.

No person shall operate an amateur station except under and in accordance with an operator's license issued to him by the Secretary of Commerce.

**W. D. TERRELL.**

rk

Chief, Radio Division.

fig. 3. Early FCC regulations were simple, straightforward.

mathematical calculations. Unless the antenna is located above salt water (bay, tidal land, or ocean), which gives a flat, low-loss surface, the real earth is usually quite different and does not meet this requirement.

Calculations for the radiation intensity at different vertical angles from an antenna are based on combining the direct radiation from the antenna at a particular wave angle with the wave reflected from the ground. Wave reflection takes place at a distance from the antenna which varies with the particular angle of elevation being studied. For a high angle the reflection area is near the antenna, but for low angles the area of reflection is more remote, and for near-zero takeoff, that area is many wavelengths from the antenna.

For vertical polarization at low

angles, the absorption of energy by the earth increases with ground loss for some distance from the antenna. There is considerably less ground loss upon reflection when antenna polarization is horizontal.

In addition to the need in real life to consider the effect of ground loss, the surface of the earth is often not flat, but hilly out to a thousand feet or so from an antenna. This must be taken into consideration. If, for instance, the radiation from an antenna system fifty feet above a flat surface is desired at an angle of five degrees elevation, the earth surface involved in the reflection area is five hundred to six hundred feet away from the antenna. If the ground slopes away from the antenna, the reflection area is closer and if the ground rises, the area is further away.

In my case, near the top of a ridge with thin topsoil and shale below, slopers and phased verticals seemed always below the performance of a halfwave horizontal antenna.

Win brings up a good point. Antenna reflection drawings in handbooks and articles are comforting, but they assume a perfectly conducting ground surface. In actuality, the "lay of the land" within five hundred feet, or more, of your antenna determines the actual reflection pattern.

Many Amateurs, surrounded by other people's houses, telephone and utility wires, and television antennas, can only guess at the angle of takeoff of their signal as the reflecting ground surface is obscured. So don't take

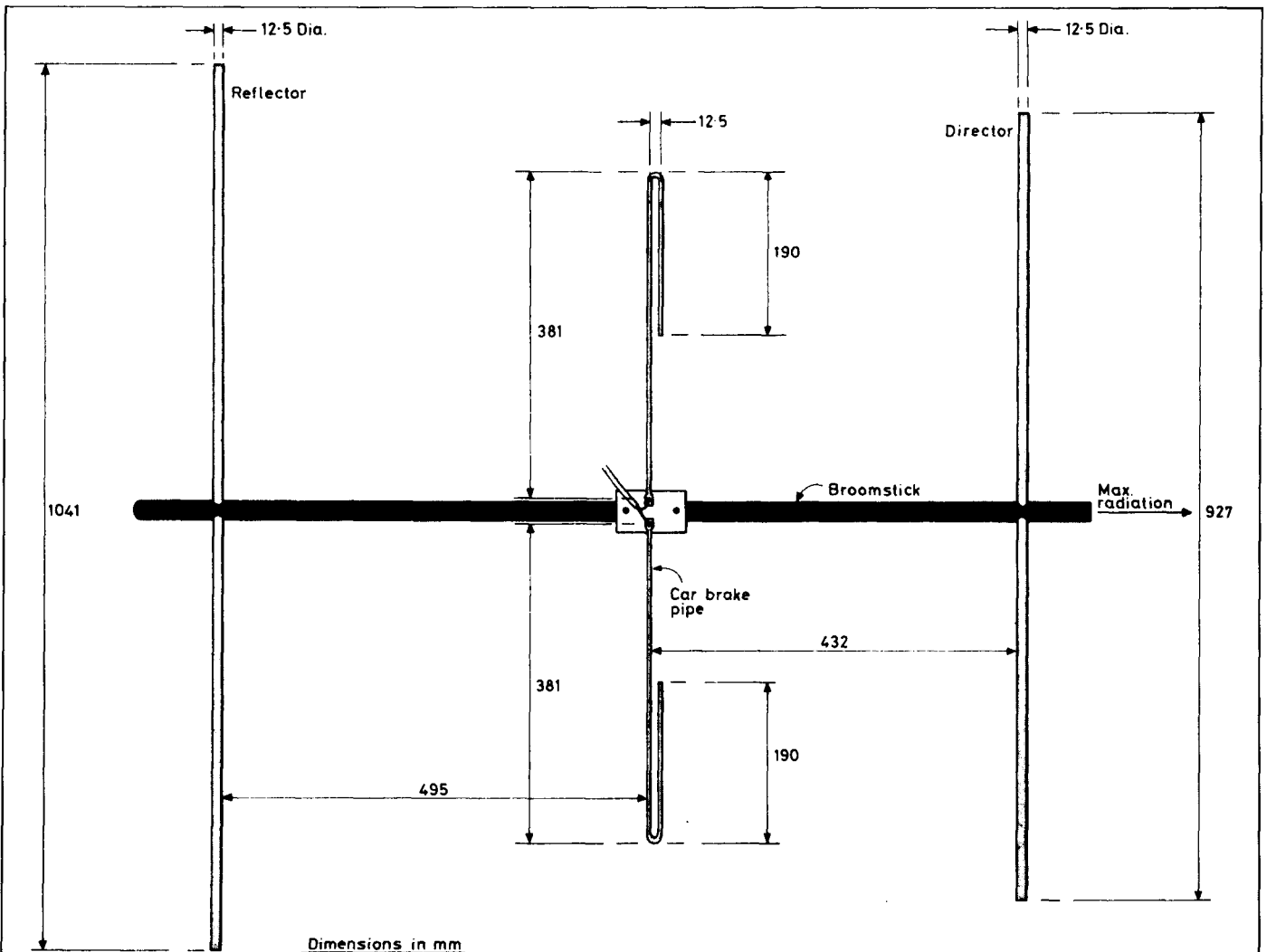

fig. 4. The unusual 2 meter Yagi beam designed by G6AFJ. Note that the driven element is folded back upon itself at the tips. Does this provide a good match for the 50 ohm transmission line? Try it and see! (Dimensions are in millimeters.) Illustration from *Practical Wireless*.



**Zenith Tuners**  
9-151-03C  
In Stock \$79.95



**FV3 Restorer**  
P.C. Board  
In Stock \$30.00



**Deluxe Aluminum**  
Cabinet  
\$24.95

Also available for restorer IC chips, power supply kit, coils, and edge connectors.

To order call 1-800-433-5169

Information 1-817-460-7071

**P.B. Radio Service**  
1950 E. Park Row  
Arlington, Tx. 76010

We accept Visa, Mastercard and COD.

✓ 173



**The HAM SHACK**

808 N. Main Street • Evansville, IN 47711



**NEW FROM ICOM**  
IC-751

Full featured, all solid state Competition Grade Transceiver. Transmitter covers all ham bands plus three new WARC bands. Receiver covers 100 kHz through 30 MHz too!

**Receiver:** Sensitivity .25µV for 10 dB S/N, J-FET DBM, 105 dB dynamic range; 70.4 MHz 1st IF eliminates spurs; 9 MHz 2nd IF features high gain and PBT, IF notch, adjustable AGC and noise blanker (for woodpecker too) are just a few of the features.

**Transmitter:** 200 watts PEP input SSB/CW, 2SC2097 transistors feature high reliability in low IMD; -32 dB @ 100W internal cooling fan standard, XIT and high performance speech processor and much more.

**And there's even more:** Dual VFO's, 32 memories with lithium battery for seven year memory retention, scanning, FM board, wide selection of filters.

This is a value packed unit. Call or write today for more information.

✓ 143

For Discount Prices on Icom radios or accessories call Dan or Rick Mon.-Fri. 9-6 PM, Sat. 9-3 PM at

(812) 422-0231

## CRYSTALS 2 meter

for these Radios

Drake TR-22  
Drake TR-33 rec. only  
Drake TR-72  
Genave  
Healthkit HW-2021 rec. only  
Hygain 3806  
Icom VHF Eng  
Wilson 1402.5, MK2, 4

Lafayette HA-146  
Midland 13-505  
Midland 13-500  
Regency HR T2  
Regency HR 2, A  
Regency HR-212  
Regency HR-2B  
Regency HR-312

Regency HR-2MS  
Healthkit HW-202  
Sears 3573  
Standard 146/826  
Tempo FMH  
Trio/Kenwood TR2200  
Trio/Kenwood TR7200  
Yaesu FT 202R

FREQUENCIES WE STOCK

|         |       |       |       |
|---------|-------|-------|-------|
| 146.01T | 6.22T | 6.52R | 7.75T |
| 6.61R   | 6.82R | 6.55T | 7.15R |
| 6.04T   | 6.25T | 6.55R | 7.78T |
| 6.64R   | 6.85R | 6.58T | 7.18R |
| 6.07T   | 6.28T | 6.58R | 7.81T |
| 6.67R   | 6.88R | 6.94T | 7.21R |
| 6.10T   | 6.31T | 7.60T | 7.84T |
| 6.70R   | 6.91R | 7.00R | 7.24R |
| 6.13T   | 6.34T | 7.63T | 7.87T |
| 6.73R   | 6.94R | 7.03R | 7.27R |
| 6.18T   | 6.37T | 7.65T | 7.90T |
| 6.76R   | 6.97R | 7.06R | 7.30R |
| 6.19T   | 6.40T | 7.69T | 7.93T |
| 6.78R   | 6.46T | 7.09R | 7.33R |
| 6.79R   | 6.46R | 7.72T | 7.96T |
|         | 6.52T | 7.12R | 7.36R |
|         |       |       | 7.99T |
|         |       |       | 7.39R |

IF YOUR RADIO IS A NEW MODEL — PLEASE INQUIRE FOR PRICING AND DELIVERY

ANY TWO METER FREQUENCY OR RADIO NOT LISTED CAN BE SPECIAL ORDERED FOR \$5.00

CRYSTALS ARE \$3.95 EA.

IF RADIO AND FREQUENCY IS LISTED IN AD

WE ALSO SUPPLY MICRO-PROCESSOR CRYSTALS

PHONE ORDERS ACCEPTED

**A TO Z CRYSTAL CO.**

✓ 102

(617) 294-1553

MON.-FRI. — 5:30 P.M.-9:00 P.M.

P.O. Box 454H  
PEMBROKE, MA. 02359



We can ship C.O.D. first class mail. Orders can be paid by check, money order, Master Charge, or Visa. Orders prepaid are shipped postage paid. Crystals are guaranteed for life.

## GOT SOMETHING TO SELL?

Try a classified ad in Amateur Radio's #1 magazine, *ham radio*.

Non-commercial ads \$.10 per word. Commercial ads \$.60 per word. No agency discounts allowed. 15% discount allowed for ads run 6 consecutive months without change. 33% discount allowed for ads run 12 months without change. Payable in advance. Deadline 15th of 2nd prior month.

From something simple to something exotic, *ham radio* readers are interested. And results prove that they BUY!

Send your ad in today. Send payment with order or give us your MasterCard or VISA and we'll charge your account for you.

Name \_\_\_\_\_

Address \_\_\_\_\_

City \_\_\_\_\_

State \_\_\_\_\_ Zip \_\_\_\_\_

Card Number \_\_\_\_\_

Expires \_\_\_\_\_ MasterCard VISA

**HAM RADIO MAGAZINE**  
Greenville, NH 03048

## 2-12 MHZ USB TRANSCEIVER

RT-671/PRC-47 TRANSCEIVER —

2-12 Mhz USB (voice/CW +800 Hz) in 100 KHz steps; 20 or 100 watts PEP. Partially transistorized Collins-designed set uses PL-177WA tube in P-A. Requires either 24 VDC 20 amps or 115 VAC 400 Hz power. 7x21 1/4x13 1/2". 45 lbs. sh. Used-repairable \$375.

With H-33 handset and AS-1320 long-wire antenna \$395. Manual, partial reproduction \$17 w/set purchase.

**PRC-47 ACCESSORY PACK**, transit case with 15' whip, speaker, headset, key, backpack harness, etc; 95 lbs. sh. wt. \$55 with RT-671 purchase.

Prices F.O.B. Lima, O. • VISA, MASTERCARD Accepted. Allow for Shipping • Send for New FREE CATALOG '83 Address Dept. HR • Phone: 419/227-6573



**FAIR RADIO SALES**

1016 E. EUREKA • Box 1105 • LIMA, OHIO • 45802

✓ 135

## TEN FM

JOIN THE FUN and EXCITEMENT!

Wired & Tested

\$139\*\*



\$68\*\*  
FM.10 KIT

FM 10 includes a two color, silk screened, aluminum chassis, the deluxe CYBERNET (Hy Gain) CB board, True FM discriminator kit, crystal, jacks, pots, hardware and a thorough instruction manual.

**HAMFEST SPECIAL** \$33.00

Same as above, less chassis, hardware

**DISCRIMINATOR/DEVIATION KIT** \$12.95

**TEN METER FM HANDBOOK** \$4.95



**HEIL SOUND, LTD.**

Marissa, IL 62257

The One-Stop Parts House for 10 FM!

✓ 147

the patterns seriously. In most cases, the higher the antenna, the better the DX results. And that's probably due less to the reflection angle of takeoff than to elevating the antenna above nearby conducting structures!

## the G6AFJ beam antenna for 2 meters

Is someone pulling my leg? Or does it really work? (See fig.4.) This is reproduced from the February issue of *Practical Wireless*, a well-known British publication. (Antenna dimensions are given in millimeters.) The noteworthy aspect of this three-element Yagi for 144 MHz is the unusual driven element, with its tips folded back upon themselves, presumably to provide a match to the 50-ohm line. G6AFJ says "the antenna can be tuned by altering the position of the bends in the folded elements to vary the gap."

The driven element is made of "car brake pipe," a substance that is unknown to me, but I would assume that it is thin-wall copper tubing. It appears to be about 3/16 of an inch (5 mm) in diameter.

In any event, the antenna is simple to make, and if any readers try out the idea, I'd like to hear about the results.

## inexpensive station clock

Would you like a small, accurate station clock that you can set to WWV and buy for less than \$15.00? I found one at my local hardware store. (I also found the same item for sale in several drug stores.) I am talking about the Timex model 5204-412 digital clock that sells for \$9 to \$14. This compact clock has a large red LED display of hours and minutes, plus an indicator of "a.m." and "p.m." It also has an alarm which is handy for keeping to schedules.

The instruction manual tells everything about the clock except how to set it to WWV, so the "minute" LED advances exactly on the proper WWV time-tick. Once you know how to do it (and I found out by experimentation), it is easy to lock the clock within a second of WWV. Here's the

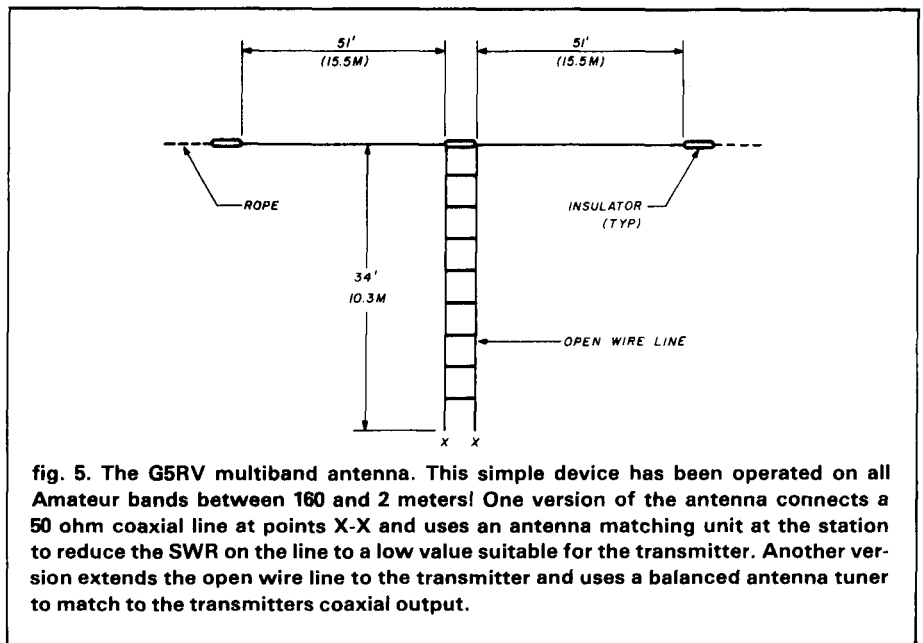

fig. 5. The G5RV multiband antenna. This simple device has been operated on all Amateur bands between 160 and 2 meters! One version of the antenna connects a 50 ohm coaxial line at points X-X and uses an antenna matching unit at the station to reduce the SWR on the line to a low value suitable for the transmitter. Another version extends the open wire line to the transmitter and uses a balanced antenna tuner to match to the transmitters coaxial output.

trick. Advancement of time as shown on the "minute" LED is performed when the clock is turned on. For some obscure reason (don't ask me why) there is a built-in 30 second time-shift in the clock. The trick is to plug the clock into your power receptacle exactly 30 seconds after a WWV minute tone. If you do this, then when you set the clock to WWV the LED will advance exactly on the minute tone of WWV. Once you accomplish this simple feat, the little clock runs right along with WWV UCT time.

## the G5RV "all band" antenna

Have you ever noticed the antenna description on an overseas QSL card was the "G5RV antenna?" Little-known in W-land, the G5RV is a popular multiband wire antenna used by many overseas operators. Popularized by Louis Varney, G5RV, the basic antenna is shown in fig. 5.

A 102 foot long flat-top is used, fed at the center with a length of open wire transmission line. The antenna operates as a shortened dipole on 80 meters, an extended dipole on 40 meters, nearly three 1/2 wavelengths on 20 meters, and as a center-fed long wire on 15 and 10 meters.

There are many methods of feeding the G5RV antenna. The original

design uses an open wire stub plus a length of coaxial line. An antenna tuning unit is used in the station, as the SWR on the coaxial line can be quite high at certain frequencies.

A second feed system is to extend the open wire line directly into the station, and use a balanced antenna tuner at this point.

The G5RV feeders can be connected in parallel at the bottom of the stub and the antenna operated against ground as a top-loaded vertical on 160 meters. Some hams have even used it on 6 and 2 meters by using a VHF antenna matching unit at the station!

My preference is to run open wire line from the antenna directly to an antenna tuner in the station. (Saxton makes heavy-duty open wire line, I believe.) For low power (a hundred watts or so), TV-type twin lead may be substituted for the open wire line.

## moonbounce revisited

The popular brochure "All You Want to Know About Moonbounce (EME) Transmission" has been reprinted and is once again available. If you wish a copy, send four 20¢ stamps, or four IRCs, to me at the following address: Eimac Division of Varian, 301 Industrial Way, San Carlos, California 94070.

ham radio

## NEW LOW-NOISE PREAMPS

New low-noise microwave transistors make preamps in the 0.9 to 1.0 dB noise figure range possible without the fragility and power supply problems of gas-fet's. Units furnished wired and tuned to ham band. Can be easily retuned to nearby freq.



Models LNA( ), P30, and P432 shown

| Model   | Tunable Freq Range | Noise Figure | Gain  | Price   |
|---------|--------------------|--------------|-------|---------|
| LNA 28  | 20-40              | 0.9 dB       | 20 dB | \$39.95 |
| LNA 50  | 40-70              | 0.9 dB       | 20 dB | \$39.95 |
| LNA 144 | 120-180            | 1.0 dB       | 18 dB | \$39.95 |
| LNA 220 | 180-250            | 1.0 dB       | 17 dB | \$39.95 |
| LNA 432 | 380-470            | 1.0 dB       | 18 dB | \$44.95 |

## ECONOMY PREAMPS

Our traditional preamps, proven in years of service. Over 20,000 in use throughout the world. Tuneable over narrow range. Specify exact freq. band needed. Gain 16-20 dB. NF = 2 dB or less. VHF units available 27 to 300 MHz. UHF units available 300 to 650 MHz.

- P30K, VHF Kit less case \$14.95
- P30C, VHF Kit with case \$20.95
- P30W, VHF Wired/Tested \$29.95
- P432K, UHF Kit less case \$18.95
- P432C, UHF Kit with case \$24.95
- P432W, UHF Wired/Tested \$33.95

P432 also available in broadband version to cover 20-650 MHz without tuning. Same price as P432; add "B" to model #.

## HELICAL RESONATOR PREAMPS

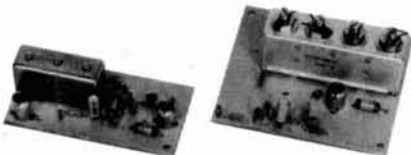

Our lab has developed a new line of low-noise receiver preamps with helical resonator filters built in. The combination of a low noise amplifier similar to the LNA series and the sharp selectivity of a 3 or 4 section helical resonator provides increased sensitivity while reducing intermod and cross-band interference in critical applications. See selectivity curves at right. Noise figure = 1 to 1.2 dB. Gain = 12 to 15 dB.

| Model   | Tuning Range | Price   |
|---------|--------------|---------|
| HRA-144 | 143-150 MHz  | \$49.95 |
| HRA-220 | 213-233 MHz  | \$49.95 |
| HRA-432 | 420-450 MHz  | \$59.95 |

## RECEIVING CONVERTERS



Models to cover every practical rf & if range to listen to SSB, FM, ATV, etc. NF = 2 dB or less.

|                   | Antenna Input Range | Receiver Output |
|-------------------|---------------------|-----------------|
| <b>VHF MODELS</b> | 28-32               | 144-148         |
|                   | 50-52               | 28-30           |
| Kit \$44.95       | 50-54               | 144-148         |
| Less Case \$39.95 | 144-146             | 28-30           |
| Wired \$59.95     | 145-147             | 28-30           |
|                   | 144-144.4           | 27-27.4         |
|                   | 146-148             | 28-30           |
|                   | 144-148             | 50-54           |
|                   | 220-222             | 28-30           |
|                   | 220-224             | 144-148         |
|                   | 222-226             | 144-148         |
|                   | 220-224             | 50-54           |
|                   | 222-224             | 28-30           |

|                   | Antenna Input Range | Receiver Output |
|-------------------|---------------------|-----------------|
| <b>UHF MODELS</b> | 432-434             | 28-30           |
|                   | 435-437             | 28-30           |
| Kit \$54.95       | 432-436             | 144-148         |
| Less Case \$49.95 | 432-436             | 50-54           |
| Wired \$74.95     | 439.25              | 61.25           |

**SCANNER CONVERTERS** Copy 72-76, 135-144, 240-270, 400-420, or 806-894 MHz bands on any scanner. Wired/tested Only \$79.95.

**SPECIAL FREQUENCY CONVERTERS** made to custom order \$119.95. Call for details.

## SAVE A BUNDLE ON VHF FM TRANSCEIVERS!

FM-5 PC Board Kit - **ONLY \$159.95** complete with controls, heatsink, etc. 10 Watts, 5 Channels, for 6M, 2M, or 220



Cabinet Kit, complete with speaker, knobs, connectors, hardware. Only \$59.95

**REPEAT OF A SELLOUT!**

While supply lasts, get \$59.95 cabinet kit free when you buy an FM-5 Transceiver kit. Where else can you get a complete transceiver for only \$159.95?

## TRANSMIT CONVERTERS

For SSB, CW, ATV, FM, etc. Why pay big bucks for a multi mode rig for each band? Can be linked with receive converters for transceive. 2 watts output.

|                                                                    | Exciter Input Range | Antenna Output |
|--------------------------------------------------------------------|---------------------|----------------|
| For VHF, Model XV2 Kit \$79.95<br>Wired \$119.95<br>(Specify band) | 28-30               | 144-146        |
|                                                                    | 28-29               | 145-146        |
|                                                                    | 28-30               | 50-52          |
|                                                                    | 27-27.4             | 144-144.4      |
|                                                                    | 28-30               | 220-222*       |
|                                                                    | 50-54               | 220-224        |
|                                                                    | 144-146             | 50-52          |
|                                                                    | 50-54               | 144-148        |
|                                                                    | 144-146             | 28-30          |

|                                                  | Exciter Input Range | Antenna Output |
|--------------------------------------------------|---------------------|----------------|
| For UHF, Model XV4 Kit \$99.95<br>Wired \$149.95 | 28-30               | 432-434        |
|                                                  | 28-30               | 435-437        |
|                                                  | 50-54               | 432-436        |
|                                                  | 61.25               | 439.25         |
|                                                  | 144-148             | 432-436*       |

\*Add \$20 for 2M input

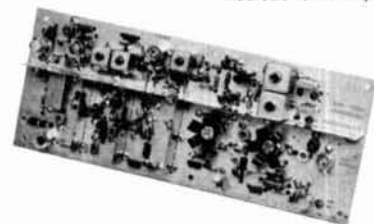

**VHF & UHF LINEAR AMPLIFIERS.** Use with above. Power levels from 10 to 45 Watts. Kits from \$69.95.

## LOOK AT THESE ATTRACTIVE CURVES!

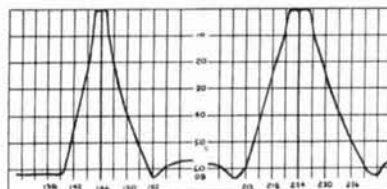

R144 & R220 Front Ends, HRA 144/220, & HRF-144/220

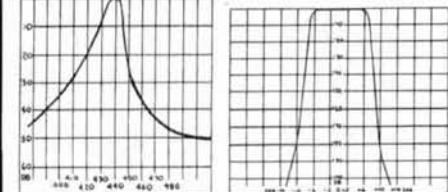

R451 Receiver Front End

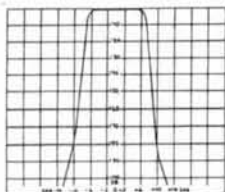

Rcvr I-F Selectivity

Typical Selectivity Curves of Receivers and Helical Resonators.

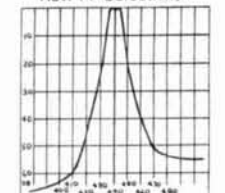

HRA-432, HRF-432

- Call or Write for **FREE CATALOG** (Send \$1.00 or 4 IRC's for overseas mailing)
- Order by phone or mail ● Add \$2 S & H per order (Electronic answering service evenings & weekends) Use VISA, MASTERCARD, Check, or UPS COD.

# hamtronics, inc.

65-Y MOUL RD. ● HILTON NY 14468  
Phone: 716-392-9430

Hamtronics is a registered trademark



**AT LAST —  
A REPEATER  
YOU CAN AFFORD!**

For years, Hamtronics® Modules have been used by individual hams and manufacturers to make repeaters. Now, in the Hamtronics tradition of top quality and superb value, we are proud to offer a complete repeater package.



**JUST LOOK AT THESE PRICES!**

| Band        | Kit   | Wired/Tested |
|-------------|-------|--------------|
| 6M, 2M, 220 | \$595 | \$745        |
| 440         | \$645 | \$795        |

Both kit and wired units are complete with all parts, modules, hardware, and crystals.

**CALL OR WRITE FOR COMPLETE DETAILS.**

Also available for remote site linking/crossband & 10M.

**FEATURES:**

- SENSITIVITY SECOND TO NONE; TYPICALLY 0.15 uV ON VHF, 0.3 uV ON UHF.
- SELECTIVITY THAT CAN'T BE BEAT! BOTH 8 POLE CRYSTAL FILTER & CERAMIC FILTER FOR GREATER THAN 100 dB AT ± 12KHZ. HELICAL RESONATOR FRONT ENDS. SEE R144, R220, AND R451 SPECS IN RECEIVER AD BELOW.
- OTHER GREAT RECEIVER FEATURES: FLUTTER-PROOF SQUELCH, AFC TO COMPENSATE FOR OFF-FREQ TRANSMITTERS, SEPARATE LOCAL SPEAKER AMPLIFIER & CONTROL.
- CLEAN, EASY-TUNE TRANSMITTER; UP TO 20 WATTS OUT.

**HIGH QUALITY MODULES FOR  
REPEATERS, LINKS, TELEMETRY, ETC.**

**INTRODUCING —  
NEW 1983 RECEIVERS**

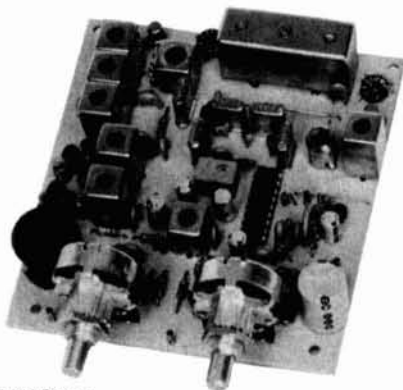

R144 Shown

- **R144/R220 FM RCVRs** for 2M or 220 MHz. 0.15uV sens.; 8 pole xtal filter & ceramic filter in i-f, helical resonator front end for exceptional selectivity (curves at left). AFC incl., xtal oven avail. Kit only \$119.95
- **R451 FM RCVR** Same but for uhf. Tuned line front end, 0.3 uV sens. Kit only \$119.95.
- **R76 FM RCVR** for 10M, 6M, 2M, 220, or commercial bands. As above, but w/o AFC or hel. res. Kits only \$109.95. Also avail w/4 pole filter, only \$94.95/ kit.
- **R110 VHF AM RECEIVER** kit for VHF aircraft band or ham bands. Only \$84.95
- **R110 UHF AM RECEIVER** for UHF uses, including special 259 MHz model to hear SPACE SHUTTLE. Kit \$94.95



- **HELICAL RESONATOR FILTERS** available separately on pcb w/connectors.

HRF-144 for 143-150 MHz \$34.95  
HRF-220 for 213-233 MHz \$34.95  
HRF-432 for 420-450 MHz \$44.95

(See selectivity curves at left.)



- **COR KITS** With audio mixer and speaker amplifier. Only \$29.95.
- **CWID KITS** 158 bits, field programmable, clean audio. Only \$59.95.
- **DTMF DECODER/CONTROLLER KITS.** Control 2 separate on/off functions with touchtones®, e.g., repeater and autopatch. Use with main or aux. receiver or with Autopatch. Only \$89.95.
- **AUTOPATCH KITS.** Provide repeater autopatch, reverse patch, phone line remote control of repeater, secondary control via repeater receiver. Many other features. Only \$89.95. Requires DTMF Module.
- **A16 RF TIGHT BOX** Deep drawn alum. case with tight cover and no seams. 7 x 8 x 2 inches. Only \$18.00.

**TRANSMITTERS AND  
ACCESSORIES**



- **T51 VHF FM EXCITER** for 10M, 6M, 2M, 220 MHz or adjacent bands. 2 Watts continuous. Kits only \$59.95



- **T451 UHF FM EXCITER** 2 to 3 Watts on 450 ham band or adjacent. Kits only \$69.95.
- **VHF & UHF LINEAR AMPLIFIERS.** Use on either FM or SSB. Power levels from 10 to 45 Watts to go with exciters & xmtg converters. Kits from \$69.95.

**hamtronics®**

# rf synthesizers for hf communications: part 2

## Understanding the phase-locked loop

**Part one** described the functional blocks of a PLL synthesizer and loop operation and presented a simple approach to PLL synthesizer design. This part details the loop components with an analysis that points out aspects critical to an understanding of the loop. The open loop performance is then examined in terms of its individual sections which leads to a comparison of open and closed loop operation. Finally, phase noise basics are discussed, showing the effects of a PLL on closed loop VCO phase noise.

### VCO operation

VCO gain defined by  $K_{VCO} = \Delta f_{VCO} / \Delta V_t$ , indicates the dependency of VCO frequency on a tune or control voltage. However, a VCO when used in a phase locked loop incorporates a **phase** not a frequency detector. Therefore the effect of  $\Delta V_t$  on VCO phase, relative to the reference oscillator phase ( $f_{REF}$ ), is seen as a system integration.

**Fig. 1A** shows a perfectly stable reference oscillator at a frequency of  $f_{REF}$ , and a VCO that has a  $K_{VCO} = 1 \text{ MHz/volt}$ . The phase detector is a perfect

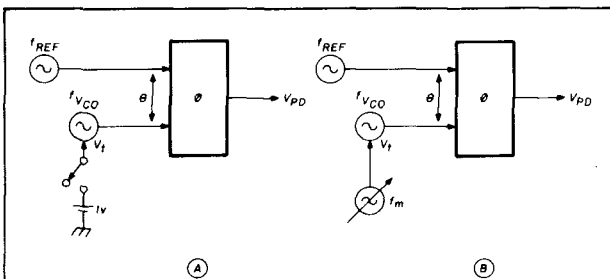

fig. 1. Circuit block arrangement to show combined VCO-phase detector response to a voltage step and swept frequency on  $V_t$ .

phase detector with an input range of zero degrees to infinity and a  $K_\phi = \frac{1 \text{ volt}}{10 \text{ degrees}}$ . If  $f_{REF}$  and  $f_{VCO}$

equal exactly 5 MHz, and are in phase, then the phase detector output will be 0 volts.

At  $t = 0$  a plus 1 volt applied to the VCO tune line causes an instantaneous 1 MHz jump in VCO frequency. 100 nanoseconds after voltage is applied the phase difference between  $f_{REF}$  and  $f_{VCO}$  is:

$$\theta = 360^\circ t(\Delta f)$$

$$\theta = 360^\circ (100 \text{ ns})(1 \text{ MHz}) = 36^\circ$$

At  $1 \mu\text{s}$ ,  $\theta = 360^\circ$ , at  $10 \mu\text{s}$  it becomes  $3600^\circ$ , or in other words, a linear accumulation in phase difference. The output of the phase detector is a ramp going from zero volts towards infinity, as shown in **fig. 2A**. The VCO can be considered a perfect integrator.

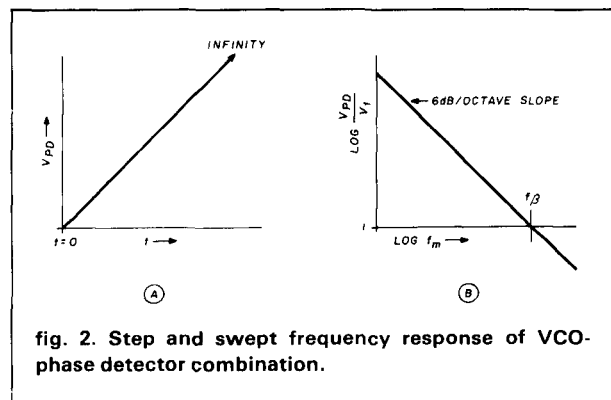

fig. 2. Step and swept frequency response of VCO-phase detector combination.

Since  $\theta$ , and therefore  $V_{PD}$ , are a function of time and  $V_t$ , they must also be a function of signal frequency and amplitude at  $V_t$ .

**Fig. 1B**, is similar to **fig. 1A** except that in **fig. 1B**, the tune line is connected to a swept frequency sine-wave source with fixed amplitude (in this case 1 volt P-P). Plotting the ratio  $V_t/V_{PD}$  versus  $f_M$  (**fig. 2B**)

By Craig Corsetto, WA6OAA, 4312 Marlowe Drive, San Jose, California 95124

shows a 6 dB/octave slope and crosses unity ( $V_t = V_{PD}$ ) at a frequency:

$$f_\beta = \frac{K_{VCO} K_\phi}{2\pi}$$

$$f_\beta = \frac{(1 \text{ MHz/volt}) \cdot (5.73 \text{ v/RAD})}{2\pi}$$

$$= 912 \text{ kHz}$$

Besides having a frequency response similar to a perfect integrator, it also has a constant 90 degree phase lag when comparing  $V_{PD}$  to  $V_t$ . This can be seen by using **fig. 1B** and **fig. 3**. At time A the voltage on  $V_t$  is zero volts ( $f_{VCO}$  in phase with  $f_{REF}$ ).

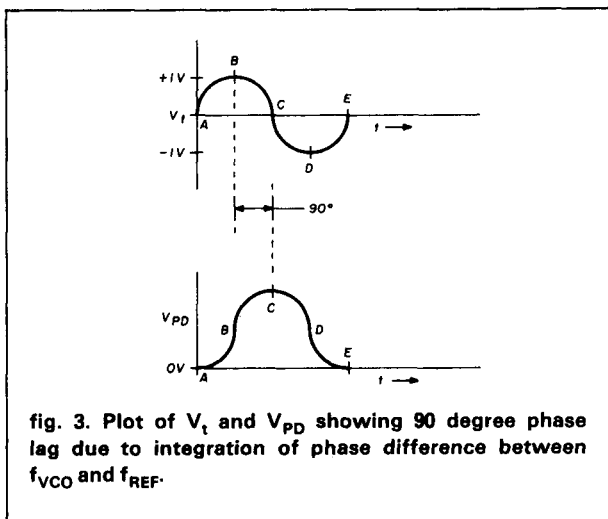

Therefore,  $V_{PD} = 0$  volts. As voltage  $V_t$  approaches +1 volt at time B,  $f_{VCO}$  becomes greater than  $f_{REF}$  so the phase difference at the phase detector accumulates causing  $V_{PD}$  to rise. Between time B and C the voltage on the VCO tune line decreases, but because  $f_{VCO}$  is still greater than  $f_{REF}$  the accumulated phase difference continues to increase, only at a decreasing rate. A plot of both  $V_{PD}$  and  $V_t$  over 360 degrees shows that  $V_{PD}$  lags  $V_t$  by 90 degrees.

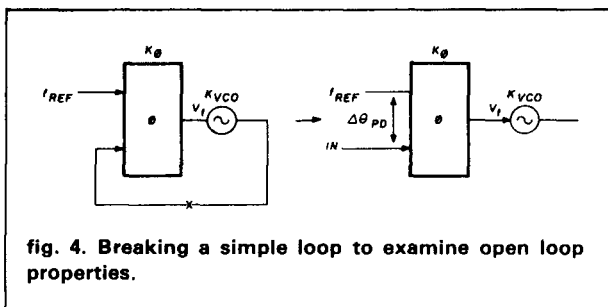

## open loop properties

Gain, frequency, and phase are open loop characteristics as shown in **fig. 4**. The total gain,  $K_t$ , is

$$K_t = K_\phi K_{VCO}$$

This means that with a phase difference at the input of the phase detector ( $\Delta\theta_{PD}$ ) there is a frequency change of the VCO frequency ( $\Delta f_{VCO}$ ), or:

$$K_t = K_\phi K_{VCO} = \left( \frac{\Delta V_t}{\Delta \theta_{PD}} \right) \cdot \left( \frac{\Delta f_{VCO}}{\Delta V_t} \right)$$

$$= \frac{\Delta f_{VCO}}{\Delta \theta_{PD}}$$

## frequency divider

Adding a frequency divider (**fig. 5**) with gain term,  $K_N$ , changes the open loop gain equation to:

$$K_t = K_\phi K_{VCO} K_N$$

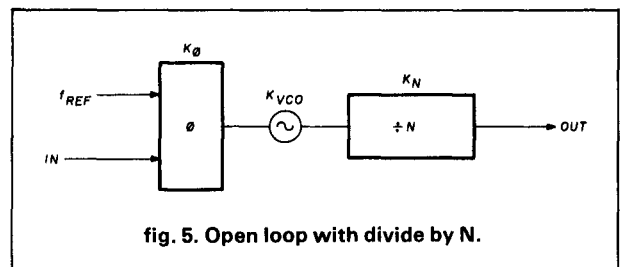

Plotting  $K_t$  as a function of  $f_M$  gives a plot similar to that of **fig. 2B** except unity open loop gain occurs when:

$$f_M = \frac{K_\phi K_{VCO} K_N}{2\pi}$$

## loop filter

Because of the more complex gain and phase versus frequency characteristics of the loop filter,  $K_F$ , it is examined separately, and then added to the loop.

Use of a simple loop filter (**fig. 6**) provides the gain and phase plots (**fig. 7**). Gain equals unity when:

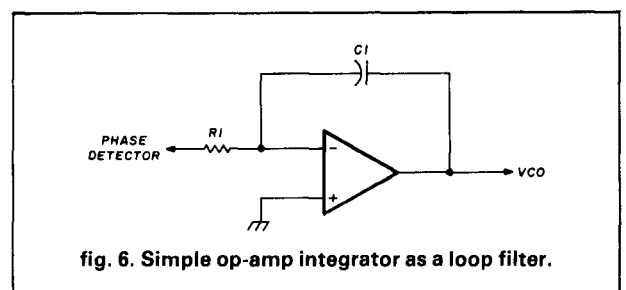

$$f = \frac{1}{2\pi R_1 C_1}$$

The phase will lag by 90 degrees from approximately  $f_1$  to  $f_2$ .

To have more control over gain and phase, another resistor,  $R_2$ , is added to the loop filter (fig. 8). The effects of  $R_2$  are seen in fig. 9.

### open loop phase

By adding  $K_F$  to  $K_\phi K_{VCO} K_N$ , (fig. 10) the final open loop characteristics are determined. This is accomplished by plotting  $K_F$  and  $K_\phi K_{VCO} K_N$  separately on log-log paper and then adding the gains in dB together (fig. 11).

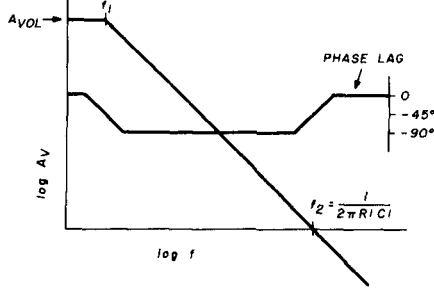

fig. 7. Amplitude and phase plot of simple loop filter in fig. 6.

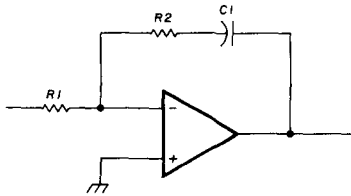

fig. 8. Adding resistor  $R_2$  to integrator for better control of gain and phase.

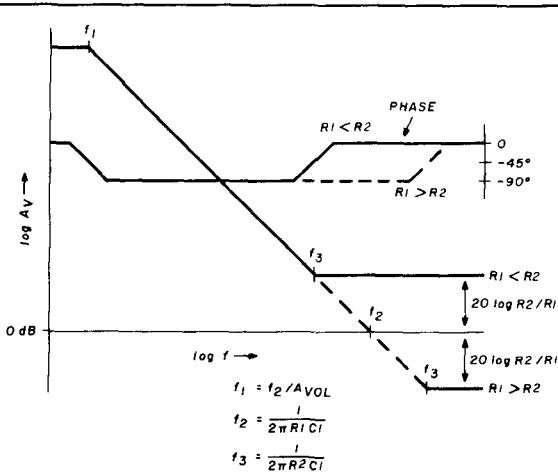

fig. 9. Amplitude and phase plot of loop filter in fig. 8.

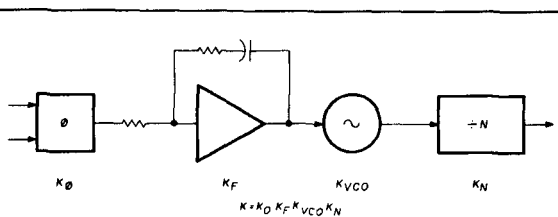

fig. 10. Open loop with loop filter.

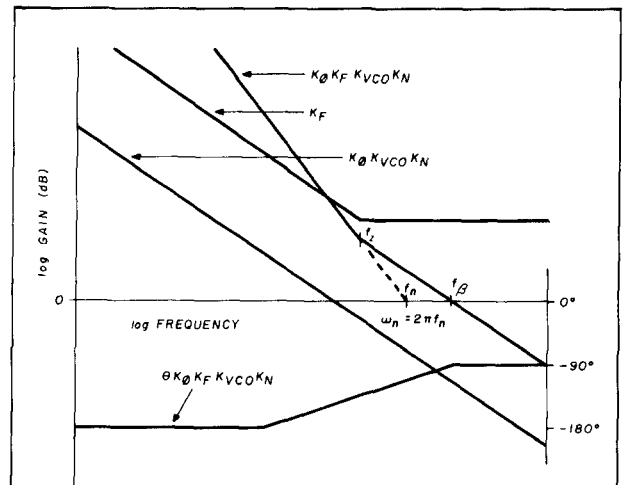

fig. 11. Plotting  $K_F$  separately from  $K_\phi K_{VCO} K_N$  and then adding them to show combined frequency and phase characteristics.

The plot of phase shows the additive phase lags of both the loop filter and the VCO. Though the phase lag from the VCO is constant, the loop filter will start to reduce its own phase lag at:

$$f_z = \frac{1}{2\pi R_2 C_1}$$

About one decade of frequency past  $f_z$  the loop filter phase lag will be close to zero.

### closing the loop

Finally, closing the loop gives an essentially flat response from dc to frequency  $f_\beta$ , which is the frequency where the open loop gain equals unity (fig. 12). From frequency  $f_\beta$  and higher the closed loop gain follows the open loop gain.  $f_\beta$  is defined as the closed loop 3 dB bandwidth.

Since the PLL uses negative feedback, 180 de-

# MICROWAVE TV ANTENNA SYSTEMS

Freq. 2.1 to 2.6 GHz • 34 db Gain +



**TWO YEAR WARRANTY  
PARTS & LABOR**

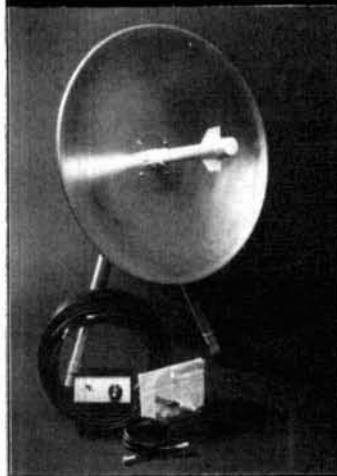

## COMPLETE SYSTEMS

(as Pictured)  
Commercial 40"

Rod Style \$ 89.95

Parabolic 20"

Dish Style \$ 79.95

## COMPONENTS

Down Converters  
(both types) \$ 34.95

Power Supplies

(12V to 16V) \$ 24.95

Data Info (Plans) \$ 9.95

**CALL OR WRITE FOR  
KITS, PARTS, INDIVIDUAL  
COMPONENTS**

*We Repair All Types Down  
Converters & Power Supplies*

**Phillips-Tech  
Electronics**

P.O. Box 34772  
Phoenix, AZ 85067  
(602) 265-8255

Special Quantity Pricing  
Dealers Wanted



# KCS

## ELECTRONICS CORPORATION

### SEMICONDUCTOR PARTS & PRODUCTS

#### FACTORY PRIME DEVICES INCLUDE:

- Capacitors  
*all types & styles*
- Chokes & Coils
- Connectors
- Digital & Linear IC's
- Hardware & Accessories
- IC Sockets
- Memory
- Microwave Semiconductors
- Resistors  
*fixed & variable*
- Transformers
- Transistors & MORE!

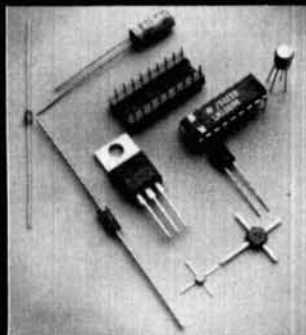

**MANUFACTURERS SUCH AS:** Motorola, National, NEC, J.W. Miller, Texas Instruments and more!

**WE STOCK & SUPPLY DEVICES FOR:** OEM's, Distributors, Hobbyists, Magazine Projects, Engineers, Schools, Technicians & You!

*Call or Write for Quantity Pricing  
and FREE Catalog.*

P.O. Box 33205  
Phoenix, AZ 85067 **(602) 274-2885**

174

## FREE! CABLE LOSS CHART IN SPRING CATALOG NEMAL ELECTRONICS COAXIAL CABLE SALE

### POLYETHYLENE DIELECTRIC

- \* RG-8/U 96% shield Mil Spec (\$27.95/100) or 31'/ft.
- RG11U 96% shield 75 ohm mil spec 25'/ft.
- RG-55B/U double shield (RG-58 size) 50 ohm 50'/ft.
- \* RG58U mil spec 96% shield (\$9.95/100) or 11'/ft.
- RG62A/U 96% shield mil spec 93 ohm 12'/ft.
- RG174/U min. 50 Ω mil spec 10'/ft.
- RG213 noncontaminating 96% shield mil spec 36'/ft.
- RG214/U double silver shield 50 ohm \$1.55'/ft.
- RG214 061 tinned copper 65'/ft.

### LOW LOSS FOAM DIELECTRIC

- RG-8X (Mini 8) 95% shield (\$14.95/100) or 17'/ft.
- \* RG8U 80% shield (\$15.95/100) or 19'/ft.
- RG-8/U 97% shield 11 gu. (eq. Belden 8214) 31'/ft.
- RG58U 80% shield 07'/ft.
- RG58U 95% shield 10'/ft.
- RG59/U 100% foil shield TV type (\$7.00/100) or 10'/ft.
- RG59/U 70% copper shield 09'/ft.
- HEAVY DUTY rotor cable 2-16 ga 6-18 ga 36'/ft.
- Rotor cable 2-18 ga 6-22 ga 19'/ft.

Complete line of multiconductor cables available

### CONNECTORS MADE IN USA

- Amphenol PL 259 79¢
- PL-259 push-on adapter shell 10/\$3.89
- PL-259 and/or SO-239 10/\$5.89
- Double Male Connector \$1.79
- PL-258 Double Female Connector 98¢
- PL-259 Silver-Teflon Kings \$1.59 ea
- Reducer UG-175 or 176 10/\$1.99
- UG-255 (PL-259 to BNC) \$3.50
- Elbow (M359) UHF Elbow \$1.79
- F59A (TV type) 10/\$1.99
- UG 21 D/U Type N Male for RG8, Amphenol \$3.00
- UG-88C/U BNC Male for RG-58, Amphenol \$1.25
- UG 273 BNC-PL259 Amphenol \$3.00
- 3/16 inch Mike Plug for Collins etc. (cutoff) \$1.25

shipping Call or write for Free Catalog

Cable — \$3.00 1st 100 ft., \$2.50 each add'l 100 ft.  
Connectors — add 10%, \$3.00 minimum.  
Orders under \$20 add \$2 additional plus shipping.  
COD add \$2.00. Florida Residents add 5%.

## NEMAL ELECTRONICS

Dept. H, 1327 N.E. 119 St., N. Miami, FL 33161  
Telephone: (305) 893-3924



171

More Details? CHECK — OFF Page 110

155

**OVER 70 BRANDS IN STOCK** BIRD LAND-MOBILE RADIO HYGAIN • ARRL  
DRAKE ICOM SHORTWAVE SCANNERS BEARCAT • MORGAIN • MANY MORE...

**AMATEUR RADIO**

**SHORTWAVE SCANNERS**

**HOURS**  
MON, TUES, WED.: 9:30-6:00 PM  
THURS, FRI.: 9:30-8:00 PM  
SAT.: 9:30-3:00 PM

**SPECIALISTS IN Amateur Radio,  
Short-Wave Listening  
And Contemporary  
Electronic Gear.**

**SPECTRONICS, INC.** (312) 848-6777  
1009 GARFIELD ST. OAK PARK, IL. 60304

## DIRECTION FINDING?

- ★ Doppler Direction Finding
- ★ No Receiver Mods
- ★ Mobile or Fixed
- ★ Kits or Assembled Units
- ★ 135-165 MHz Standard Range



- ★ Circular LED Display
- ★ Optional Digital Display
- ★ Optional Serial Interface
- ★ 12 VDC Operation
- ★ 90 Day Warranty

**New Technology** (patent pending) converts any VHF FM receiver into an advanced Doppler Direction Finder. Simply plug into receiver's antenna and external speaker jacks. Use any four omnidirectional antennas. Low noise, high sensitivity for weak signal detection. Kits from \$270. Assembled units and antennas also available. Call or write for full details and prices.

**DOPLER SYSTEMS,** 5540 E. Charter Oak, (602) 998-1151  
Scottsdale, AZ 85254

131

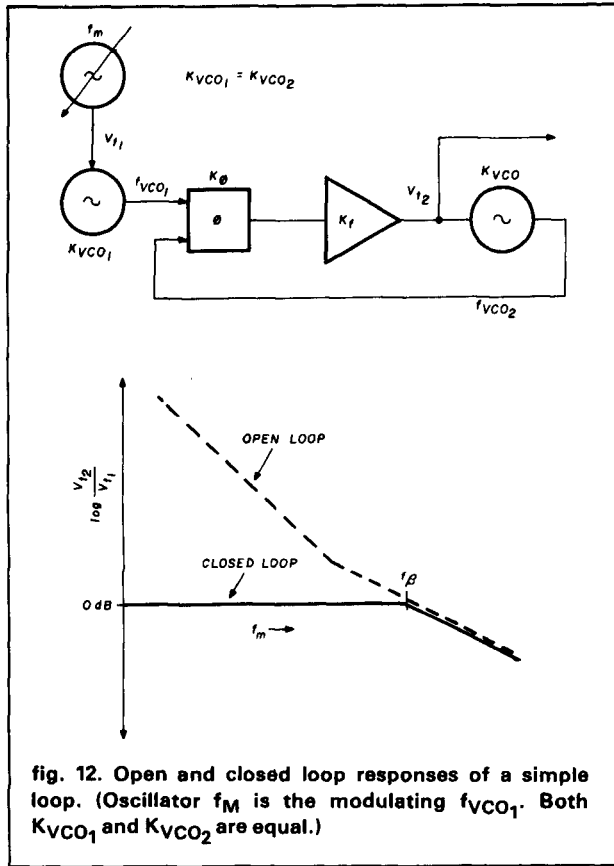

degrees of constant phase shift is required in the loop. This is usually obtained through proper selection of phase detector inputs. However, since both the loop filter and the VCO introduce phase lag, and if the accumulated lag becomes 360 degrees before the frequency where unity (open loop) gain occurs,  $f_\beta$ , the loop will oscillate. Since the phase detector introduces a constant 180 degrees, and the VCO a constant 90 degrees, the loop filter must introduce less than 90 degrees phase shift at  $f_\beta$ . The closer the loop filter comes to 90 degrees the more the loop will be inclined to ring to the point where it finally oscillates.

The distance the total loop phase lag is from 360 degrees at frequency  $f_\beta$  is called *phase margin* with zero being the smallest distance and 90 degrees the maximum. The damping factor,  $\xi$ , is related to phase margin by:

$$\text{phase margin} = 90^\circ - \tan^{-1} \sqrt{\frac{1 + \frac{1}{4\xi^2} - 1}{2}}$$

The loop natural frequency,  $\omega_n (= 2\pi f_n)$ , sometimes called the loop resonant frequency, is the frequency the loop would oscillate at if  $\xi = 0$  (no damping). While  $\omega_n$  has limited importance in basic PLL synthesizer design, it is very important in other PLL uses such as PLL demodulators. In this article,

however,  $\omega_n$  is used only as an intermediate answer in calculations.

### phase noise

Phase noise is random phase fluctuations of a signal. Typically hard to see on an oscilloscope except in severe cases, phase noise is more often examined on a high-resolution spectrum analyzer as shown in fig. 13. Since an identical noise component exists on either side of the carrier, usually only a one-sided spectrum, SSB, is shown on phase noise plots (fig. 14). Noise power is usually normalized to a 1 Hz bandwidth.

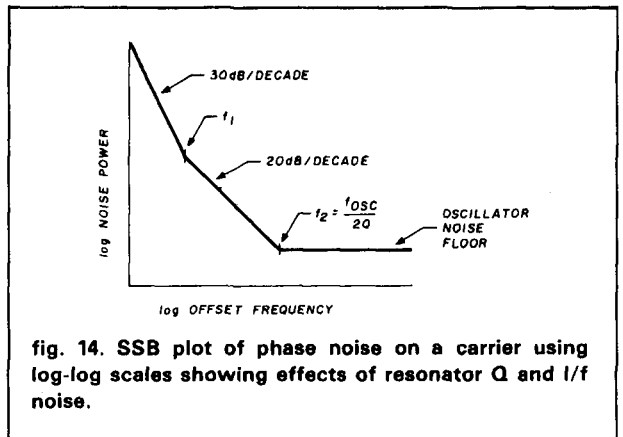
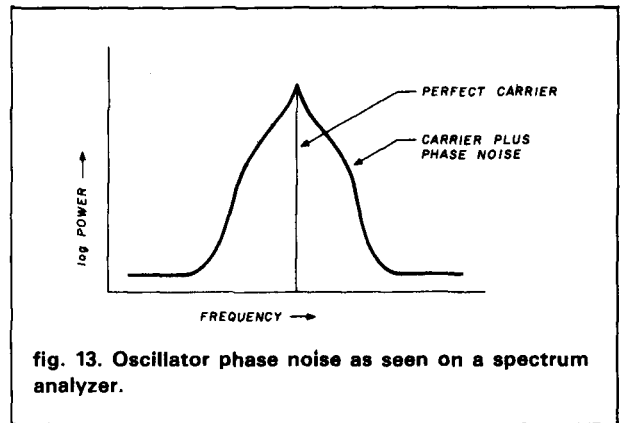

Fig. 14 shows a typical noise spectrum of an oscillator. The phase noise will start to rise from the oscillator noise floor at a 20 dB/decade slope at:

$$f_2 = \frac{f_{OSC}}{2Q}$$

where Q is the loaded resonator Q of the oscillator.

\*William F. Egan, *Frequency Synthesis by Phase Lock*, John Wiley & Sons, 1980, page 46.

**FREE!**  
**RADIO AMATEURS**  
**WORLD ATLAS**  
 with purchase of famous  
**CALLBOOK**  
**MAP LIBRARY!**

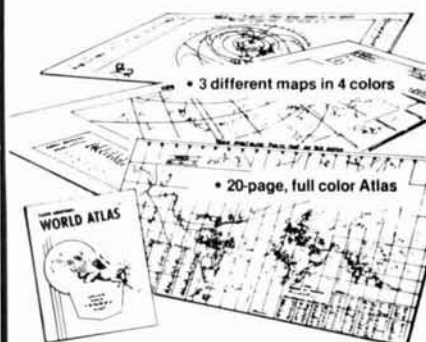

Here's an offer you can't refuse! You receive three, information-packed, Amateur Callbook maps, folded, plus the World Atlas for only \$4.50 plus \$1.50 shipping and handling. If purchased separately, total value of map/atlas offer would be \$7.50 plus shipping. You save \$3.00 and get these invaluable radio amateur aids!

- 1. Prefix Map of the World, folded.**  
World-wide prefixes. Shows 40-zone map on one side, 90-zone map on the other. Size 40" x 28"
- 2. Map of North America, folded.**  
Includes Central America and Caribbean to the Equator. Shows call areas, zone boundaries, prefixes, etc. Size 30" x 25"
- 3. Great Circle Chart of World, folded**  
Centered on 40°N, 100° W. Shows cities, latitude, longitude, great circle bearings and more! Size 30" x 25"

**Plus special FREE bonus!**  
 The Callbook's own **Radio Amateur World Atlas**, FREE with the purchase of the 3 maps. Contains eleven full color maps of the world, looking at things from the radio amateurs point of view.

Callbook Map Library \$4.50  
 Shipping 1.50  
 Total \$6.00



**Special Offer!**  
**Amateur Radio**  
**Emblem Patch**  
 only \$2.50 prepaid

Pegasus on blue field, red lettering. 3" wide x 3" high. Great on jackets and caps. Sorry, no call letters.

**ORDER TODAY!**

Order from your favorite electronics dealer or direct from the publisher. All direct orders add \$1.50 for shipping. Illinois residents add 5% Sales Tax.

✓ 177

**RADIO AMATEUR**  
**callbook** INC.  
 Dept. F  
 925 Sherwood Drive  
 Lake Bluff, IL 60044

# The Interface

## Software Available for Six Computers

The versatility of the personal computer gives you a whole new world with the Kantronics Interface™ and Hamsoft™ or Hamtext™. The Interface™ connects to any of six popular computers with Hamsoft™ or Hamtext™ giving you the ability to send and receive CW/RTTY/ASCII. An active filter and ten segment LED bargraph make tuning fast and easy. All programs, except Apple, are on program boards that plug directly into the computer.

Hamtext™, our new program, is available for the VIC-20 and Commodore 64, with all the features of Hamsoft™ plus the ability to save received information to disc or tape, variable buffer sizes, VIC printer compatibility, and much more. Our combination of hardware and software gives you the system you want, with computer versatility, at a reasonable price.

### Hamsoft™ Features

- Split Screen Display
- 1026 Character Type Ahead Buffer
- 10 Message Ports-255 Characters each
- Status Display
- CW-ID from Keyboard
- Centronics Type Printer Compatibility
- CW send/receive 5-99 WPM
- RTTY send/receive 60, 67, 75, 100 WPM
- ASCII send/receive 110, 300 Baud

### Hamsoft™ Prices

|                |         |
|----------------|---------|
| Apple Diskette | \$26.00 |
| Atari Board    | \$49.95 |
| VIC-20 Board   | \$49.95 |
| TRS-80C Board  | \$59.95 |
| TI-99 Board    | \$99.95 |

### Hamtext™ Prices

|                    |         |
|--------------------|---------|
| VIC-20 Board       | \$99.95 |
| Commodore 64 Board | \$99.95 |



**Suggested Retail \$169.95**

For more information contact your local Kantronics Dealer or:  
 Kantronics 1202 E. 23rd Street Lawrence, KS 66044

✓ 157

## UP YOUR ERP

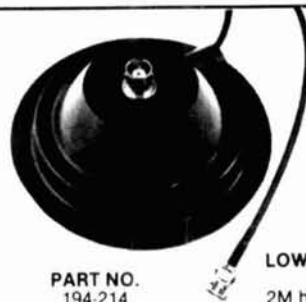

For HT owners operating inside a vehicle and wanting increased T/R range, RF PRODUCTS has the low cost solution.

Remove your BNC antenna from the HT and mount on the RF PRODUCTS BNC magnet mount, install the magnet mount on the roof top and connect the BNC co-ax connector.

The magnet mount (part no. 199-445) has 10 feet of small (5/32") co-ax with BNC connector attached and is priced at \$15.95 (including shipping by UPS to 48 states).

**TO ORDER - send \$15.95 money order or cashiers check only**

Fla. residents add 5% tax, for air UPS add \$1.50

| PART NO. |
|----------|
| 194-214  |
| 194-254  |
| 194-814  |
| 194-854  |
| 194-944  |
| 195-914  |
| 196-214  |
| 196-244  |

### LOW COST ACCESSORY ANTENNAS

| DESCRIPTION                              | PRICE  |
|------------------------------------------|--------|
| 2M helical full length BNC connector     | \$7.95 |
| 2M helical stubby type BNC connector     | 8.95   |
| 1 1/4M helical full length BNC connector | 7.95   |
| 1 1/4M helical stubby type BNC connector | 8.95   |
| 3/4M helical stubby type BNC connector   | 8.95   |
| 3/4M flexible 1/4 wave BNC connector     | 7.95   |
| 2M telescopic 1/4 wave BNC connector     | 6.95   |
| 2M-3/4M whip 1/4 wave BNC connector      | 7.95   |

✓ 176

### RF PRODUCTS

P.O. Box 33, Rockledge, FL 32955, U.S.A. (305) 631-0775

# RADIO WAREHOUSE

**NO FRILLS — JUST LOW PRICES**

• **KENWOOD**

TS 430 HF \$Call TR 2500 2m 285.00 TW 4000 UHF/VHF \$Call

• **YAESU**



FT 980 HF \$Call 2AT 2M \$219 IC-751 HF \$Call

• **ICOM**

*We also carry computer hardware/software*

EPSON RX-80 \$395.00 GEMINI-15 \$495.00  
EPSON FX-80 565.00 C. Itoh 8510 495.00

For information on our other lines . . .

CALL TOLL FREE

**1-800-433-3203**



**IN TEXAS CALL 817-496-9000**  
P.O. BOX 50155  
FT. WORTH, TEXAS 76105

## ISOTRON ANTENNAS

THE BEST THINGS  
come in little packages...

FOR 80-40-20-15 METERS



|                                      |                                      |                                      |                                      |
|--------------------------------------|--------------------------------------|--------------------------------------|--------------------------------------|
| ISOTRON 80<br>54 IN. HIGH<br>\$63.95 | ISOTRON 40<br>31 IN. HIGH<br>\$52.95 | ISOTRON 20<br>17 IN. HIGH<br>\$49.95 | ISOTRON 15<br>18 IN. HIGH<br>\$32.95 |
|--------------------------------------|--------------------------------------|--------------------------------------|--------------------------------------|

**BIG ON PERFORMANCE  
SMALL ON SPACE**

**\*BILAL COMPANY**  
(918) 253-4094

STAR ROUTE 2 EUCHA, OK 74342

## Iron Powder and Ferrite TOROIDAL CORES

Shielding Beads, Shielded Coil Forms  
Ferrite Rods, Pot Cores, Baluns, Etc.

Small Orders Welcome  
Free 'Tech-Data' Flyer

**AMIDON**  
*Associates* Since 1963



12033 Otsego Street, North Hollywood, Calif. 91607

In Germany: Elektronikiaden, Wilhelm — Mellies Str. 88, 4930 Detmold 18, West Germany  
In Japan: Toyomura Electronics Company, Ltd., 7-9, 2-Chome Sota-Kanda, Chiyoda-Ku, Tokyo, Japan

## TIDBITS

### MORSE CODE, BREAKING THE BARRIER

by Phil Anderson, WØXI

Learning the Morse Code does not have to be the painful experience many folks make it out to be. This little booklet is chockfull of helpful and highly recommended hints and tips on how to learn the Morse Code. Use the high/low method to eliminate the dreaded 10 wpm plateau. ©1982, 1st edition.

PA-MC Softbound \$1.50 each

Please add \$1.00 for shipping and handling.

**HAM RADIO'S BOOKSTORE**  
Greenville, NH 03048

## TIDBITS

### THE PRACTICAL HANDBOOK OF AMATEUR RADIO FM & REPEATERS

by Bill Pasternak, WA6ITF

Comprehensive handbook covers just about every facet of FM operation in a simple, easy to understand manner. 45 chapters put all kinds of FM and Repeater topics within easy reach. You get a solid background in FM theory, control devices for repeaters, how to build a repeater, ATV and RTTY application ideas and more. This huge, fact-filled repeater book is a must for anyone interested in FM communication. ©1980, 536 pages, 1st edition.

T-1212 Softbound \$12.95

Please add \$1.00 for shipping and handling.

**HAM RADIO'S BOOKSTORE**  
Greenville, NH 03048



### FREE CATALOG HARD-TO-FIND PRECISION TOOLS

Lists more than 2000 items: pliers, tweezers, wire strippers, vacuum systems, relay tools, optical equipment, tool kits and cases. Send for your free copy today!

**JENSEN TOOLS INC.**

7815 S 46TH STREET PHOENIX, AZ 85040

154

### Custom Mailing Lists on Labels! Amateur Radio Operator NAMES

Custom lists compiled to your specifications

- Geographic by ZIP and/or State
- By License Issue or Expiration Date
- On Labels of Your Choice

Total List: 415,000 Price: \$25/Thousand

Call 203: 438-3433 for more information

**Buckmaster Publishing**

70 Florida Hill Rd., Ridgefield, CT 06877

**SAY  
YOU SAW  
IT IN  
ham radio!**



At small frequency offsets from the carrier the noise rises with a 30 dB/decade slope due to additive  $1/f$  noise generated by the oscillator active device.

In high performance receivers not only are synthesizers required to assume crystal-like frequency stability but crystal-like phase noise performances as well. PLL frequency synthesizers have the unique ability to improve oscillator (LC, RC, etc.) phase noise performance approaching that of the reference oscillator (typically crystal).

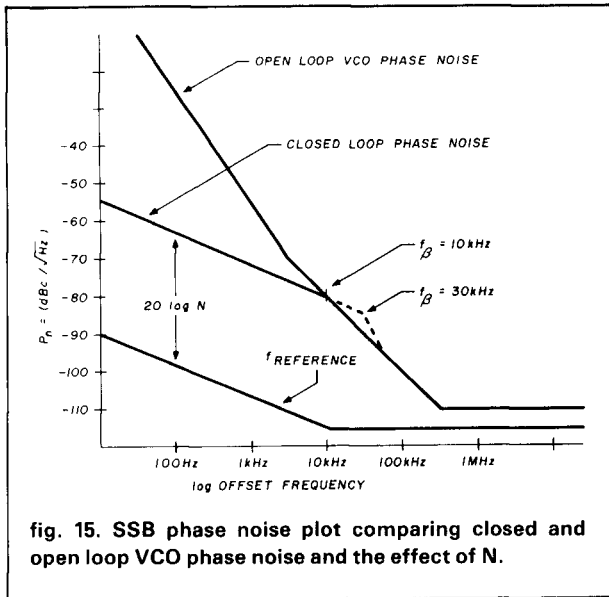

fig. 15. SSB phase noise plot comparing closed and open loop VCO phase noise and the effect of N.

Fig. 15 shows an open loop phase noise plot of a VCO. Also shown is what might be the phase noise of a crystal controlled reference oscillator. When the VCO is incorporated in a PLL and the loop is closed the VCO achieves improved phase noise performance within the bandwidth of the loop, and assumes its normal open loop phase noise response outside the loop bandwidth. However, the phase noise within the loop bandwidth is largely determined by the value of N and the phase noise of  $f_{REF}$ . This can be illustrated by a simple loop where the divider equals one, and the reference oscillator suddenly incurs a short term shift in frequency (phase noise). The phase detector senses this and generates a voltage to adjust the VCO frequency to the new reference oscillator frequency.

When the programable divider value, N, is greater than one, then in order for the phase detector to see zero phase difference at its inputs, after the same short term shift in  $f_{REF}$ , the VCO must change to a frequency N times the change in  $f_{REF}$ . Therefore the effect of N on VCO phase noise, within the loop bandwidth, is to multiply it by N, showing up on phase noise plot as a  $20 \log N$  more phase noise than the reference oscillator. This effect of N on phase

noise can be a determining factor when selecting the optimum loop bandwidth (see fig. 15).

Often in medium performance receivers it is acceptable just to have the local oscillators meet the phase noise performance of the VCO. It happens that this can simplify the synthesizer design, allowing N to be large and  $f_{\beta}$  small for optimum phase noise performance, instead of using a more complex design in order to keep N small and loop bandwidth wide for improved phase noise performance. Problems encountered in using the simpler loop is an increase in lock time (due to the narrower loop bandwidth) and increasing difficulty in reducing reference feed-through due to  $f_{\beta}$  approaching  $f_{REF}$ .

For increased synthesizer phase noise performance without too high a lock time and reference feed-through, a more complex loop structure is required. Figs. 17-19 show more complex loops, with the simple loop in fig. 16 as a reference, while fig. 20 plots their approximate relative phase noise performance.

The loop in fig. 17 requires closer attention. This loop used in-loop mixing to reduce the required size of N. With N reduced the phase noise within the loop bandwidth decreases and the optimum value of loop bandwidth increases, decreasing lock time. More importantly, the local oscillator used in the in-loop mix-

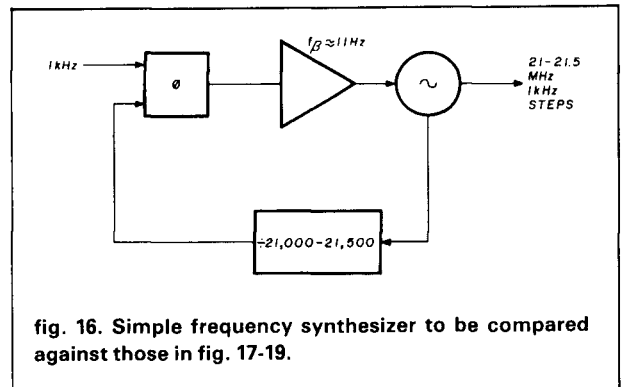

fig. 16. Simple frequency synthesizer to be compared against those in fig. 17-19.

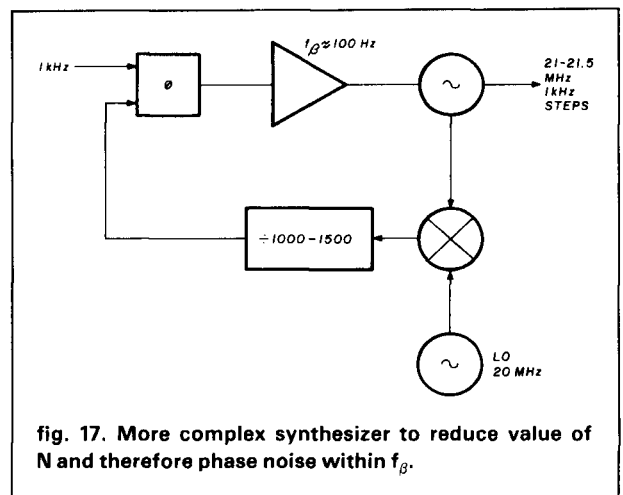
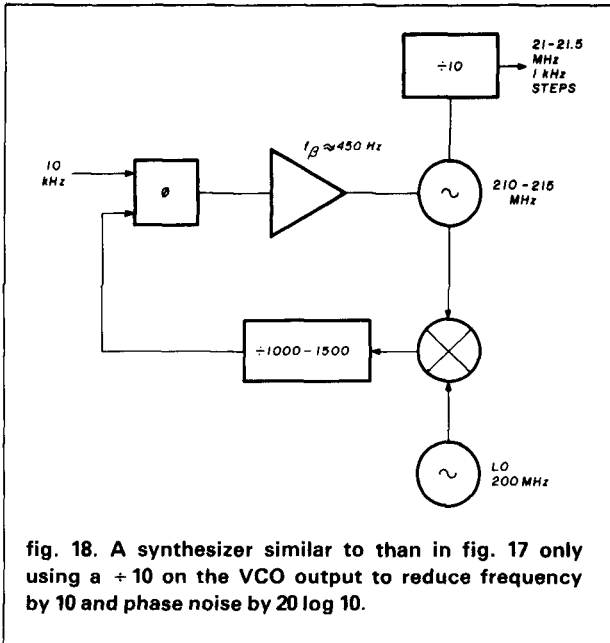

fig. 17. More complex synthesizer to reduce value of N and therefore phase noise within  $f_{\beta}$ .



ting the synthesizer step in 1 kHz increments by changing N and then step in 100 Hz increments by tuning the VCXO local oscillator using a DAC (Digital to Analog Converter).

### VCO phase noise and $K_{VCO}$

In real synthesizers the phase noise is more than expected due to additive noise generated by both ac-

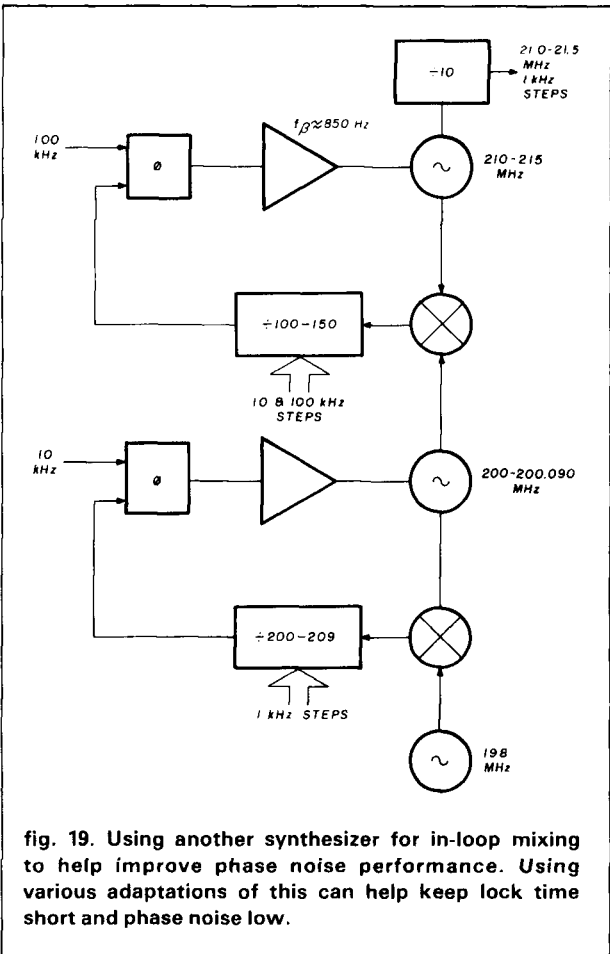
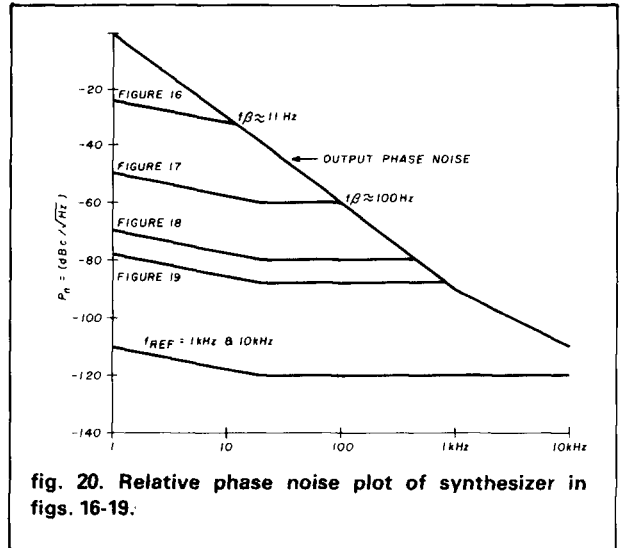

tive and passive devices modulating the VCO. Therefore, for best performance, choose the components used in the synthesizer wisely, especially those in and around the VCO and loop filter.

The effects of noise and spurious signals on the VCO tune line can be approximated if the modulation index caused by these is known to be small.

$$P_n \approx 20 \log \frac{2\sqrt{2} V_t K_{VCO}}{8\pi f_M}$$

where  $P_n$  = SSB noise power in a 1 Hz bandwidth, or spur power, in dBc

$V_t$  = RMS noise, or signal voltage on VCO tune line

$f_M$  = frequency of noise or signal on VCO tune line

For example a VCO with a  $K_{VCO} = 628.3 (10^3)$  has  $100 \mu v$  (RMS) of spurious signal at 1 kHz on its VCO tune line. This spurious signal appears as 1 kHz sidebands with a sideband spur power of:

$$P_n = 20 \log \frac{2\sqrt{2} (100 \mu v) 628 (10^3)}{8\pi (1 \text{ kHz})}$$

or  $-43 \text{ dBc}$ .

ing can be a VFO, VCO, VCXO, or even another synthesizer (fig. 19) for finer frequency steps. Some Amateur radio transceivers use this technique by let-

## frequency division and phase noise

External to the phase locked loop, synthesizer phase noise can be reduced through the use of frequency division by  $20 \log N$  if a reduction of frequency by  $N$  is acceptable. This is quite common in commercial synthesizers and is shown in **figs. 18 and 19**.

As is always the case, using this technique to reduce phase noise has its limits, in this case the noise floor of the digital divider.

For MOS, TTL, and ECL devices, the noise floors are typically  $-120$  to  $-140$  dBc  $\sqrt{\text{Hz}}$ , MOS devices having poorer noise performance than TTL and ECL.

In the third and final part of this series, two techniques for designing a 5.000-5.500 MHz synthesizer — as well as trade-offs common in PLL design circuits — will be discussed.

### bibliography

- Egan, William, *Frequency Synthesis by Phase Lock*, 1981, John Wiley & Sons.  
 Gardner, Floyd, *Phaselock Techniques*, Second Edition, 1979, John Wiley & Sons.  
 Rhode, Ulrich, DJ2LR, "Modern Design of Frequency Synthesizers," *ham radio*, July, 1976, pages 10-23.  
 Scherer, Dieter, "Design Principles and Test Methods for Low Phase Noise RF and Microwave Sources," *Hewlett Packard Application Note*.  
 "Noise-property Analysis Enhances PLL Designs," *EDN*, September, 1981, pages 91-98.  
 "The Phase Locked Loop IC as a Communication System Building Block," *National Semiconductor Application Note 46*, 1971.

### ham radio

## This Publication is available in Microform.



### University Microfilms International

Please send additional information

for \_\_\_\_\_ (name of publication)

Name \_\_\_\_\_

Institution \_\_\_\_\_

Street \_\_\_\_\_

City \_\_\_\_\_

State \_\_\_\_\_ Zip \_\_\_\_\_

300 North Zeeb Road, Dept. P.R., Ann Arbor, Mi. 48106

State of the art



by

K.V.G.

### 9 MHz CRYSTAL FILTERS

| MODEL    | Application | Bandwidth | Poles | Price   |
|----------|-------------|-----------|-------|---------|
| XF-9A    | SSB         | 2.4 kHz   | 5     | \$53.15 |
| XF-9B    | SSB         | 2.4 kHz   | 8     | 72.05   |
| XF-9B-01 | LSB         | 2.4 kHz   | 8     | 95.90   |
| XF-9B-02 | USB         | 2.4 kHz   | 8     | 95.90   |
| XF-9B-10 | SSB         | 2.4 kHz   | 10    | 125.65  |
| XF-9C    | AM          | 3.75 kHz  | 8     | 77.40   |
| XF-9D    | AM          | 5.0 kHz   | 8     | 77.40   |
| XF-9E    | FM          | 12.0 kHz  | 8     | 77.40   |
| XF-9M    | CW          | 500 Hz    | 4     | 54.10   |
| XF-9NB   | CW          | 500 Hz    | 8     | 95.90   |
| XF-9P    | CW          | 250 Hz    | 8     | 131.20  |
| XF910    | IF noise    | 15 kHz    | 2     | 17.15   |

### 10.7 MHz CRYSTAL FILTERS

|           |          |        |   |         |
|-----------|----------|--------|---|---------|
| XF107-A   | NBFM     | 12 kHz | 8 | \$67.30 |
| XF107-B   | NBFM     | 15 kHz | 8 | 67.30   |
| XF107-C   | WBFM     | 30 kHz | 8 | 67.30   |
| XF107-D   | WBFM     | 36 kHz | 8 | 67.30   |
| XF107-E   | Pix/Data | 40 kHz | 8 | 67.30   |
| XM107-SO4 | FM       | 14 kHz | 4 | 30.15   |

Export Inquiries Invited.

Shipping \$3.50

### MICROWAVE MODULES VHF & UHF EQUIPMENTS

Use your existing HF or 2M rig on other VHF or UHF bands.

### LOW NOISE RECEIVE CONVERTERS

|          |              |          |
|----------|--------------|----------|
| 1691 MHz | MMk1691-137  | \$224.95 |
| 1296 MHz | MMk1296-144  | 119.95   |
| 432/435  | MMc432-28(S) | 74.95    |
| 439-ATV  | MMc439-Ch x  | 84.95    |
| 220 MHz  | MMc220-28    | 69.95    |
| 144 MHz  | MMc144-28    | 54.95    |

Options: Low NF (2.0 dB max., 1.25 dB max.), other bands & IF's available

### LINEAR TRANSVERTERS

|          |                     |              |          |
|----------|---------------------|--------------|----------|
| 1296 MHz | 1.3 W output, 2M in | MM1296-144   | \$339.95 |
| 432/435  | 10 W output, 10M in | MM1432-28(S) | 269.95   |
| 144 MHz  | 10 W output, 10M in | MM144-28     | 179.95   |

Other bands & IFs available.

### LINEAR POWER AMPLIFIERS

|          |              |               |        |
|----------|--------------|---------------|--------|
| 1296 MHz | 10 W output  | MML1296-10-L  | \$ ask |
| 432/435  | 100 W output | MML432-100    | 399.95 |
|          | 50 W output  | MML432-50-S   | 214.95 |
|          | 30 W output  | MML432-30-LS  | 189.95 |
| 144 MHz  | 100 W output | MML144-100-LS | 254.95 |
|          | 50 W output  | MML144-50-S   | 214.95 |
|          | 30 W output  | MML144-30-LS  | 109.95 |
|          | 25 W output  | MML144-25     | 99.95  |

All models include VOX T/R switching.

"L" models 1 or 3W drive, others 10W drive.

Shipping: FOB Concord, Mass.

### ANTENNAS



#### 420-450 MHz MULTIBEAMS

|            |          |          |         |
|------------|----------|----------|---------|
| 48 Element | 70/MBM48 | 15.7 dBd | \$75.75 |
| 88 Element | 70/MBM88 | 18.5 dBd | 105.50  |

#### 144-148 MHz J-SLOTS

|                   |            |          |         |
|-------------------|------------|----------|---------|
| 8 over 8 Hor. pol | D8/2M      | 12.3 dBd | \$63.40 |
| 8 by 8 Vert. pol  | D8/2M-vert | 12.3 dBd | 76.95   |
| 8 + 8 Twist       | 8XY/2M     | 9.5 dBd  | ask     |

#### UHF LOOP YAGIS

|                        |         |        |         |
|------------------------|---------|--------|---------|
| 1250-1350 MHz 29 loops | 1296-LY | 20 dBi | \$44.95 |
| 1650-1750 MHz 29 loops | 1691-LY | 20 dBi | 55.95   |

Order Loop-Yagi connector extra:

Type N \$14.95, SMA \$5.95

Send 40¢ (2 stamps) for full details of all your VHF & UHF equipment and KVG crystal product requirements.



181

si

(617) 263-2145

SPECTRUM

INTERNATIONAL, INC.

Post Office Box 1084

Concord, MA 01742, U.S.A.

**STOP PRESS  
AMTOR NOW OFFICIALLY  
APPROVED IN U.S.A.**

# AMT-1 The Definitive AMTOR Terminal Unit



**\$499<sup>95</sup> Introductory Price**

AMTOR is the system of error correcting RTTY which has been rapidly overtaking conventional RTTY in Europe, just as its marine equivalent, SITOR, has been taking over in ship to shore communications.

It was originated by Peter Martinez, G3PLX (see June 1981 QST, p. 25). He first interpreted the international marine CCIR 476-1 specification for amateur use. Virtually all of the 400+ stations presently on AMTOR world wide are using software/hardware designs originated by Peter. The AMT-1 is a proven product which represents his latest and most highly refined design. It represents the culmination of over three years of development and on the air testing, and sets the standard against which all future AMTOR implementations will be judged.

Not only does it incorporate the latest AMTOR specification, but it gives superlative performance on normal RTTY, ASCII and CW (transmit only). As well as some fairly incredible real time microprocessor software, the AMT-1 boasts a four pole active receive filter, a discriminator type demodulator, a crystal controlled transmit tone generator, and a 16 LED frequency analyzer type tuning indicator, which is very easy to use.

Driven from a 12 volt supply, the AMT-1 connects to the speaker, microphone and PTT lines of an HF transceiver and to the RS-232 serial interface of a personal computer or ASCII terminal. All mode control is via ESCAPE and CONTROL codes from the keyboard (or computer program).

It used to be that C.W. was the ultimate mode for "getting through" when QRM and fading were at their worst. That's no longer true — AMTOR will get through with perfect error-free copy when all other conventional transmission modes become useless.



## Henry Radio

2050 S. Bundy Dr., Los Angeles, CA 90025 (213) 820-1234  
931 N. Euclid, Anaheim, CA 92801 (714) 772-9200  
Butler, Missouri 64730 (816) 679-3127

**TOLL FREE ORDER NUMBER: (800) 421-6631**

For all states except California

Calif. residents please call collect on our regular numbers.

## **AEA** Brings you the Breakthrough!

# CHAMPAGNE RTTY/CW on a Beer Budget

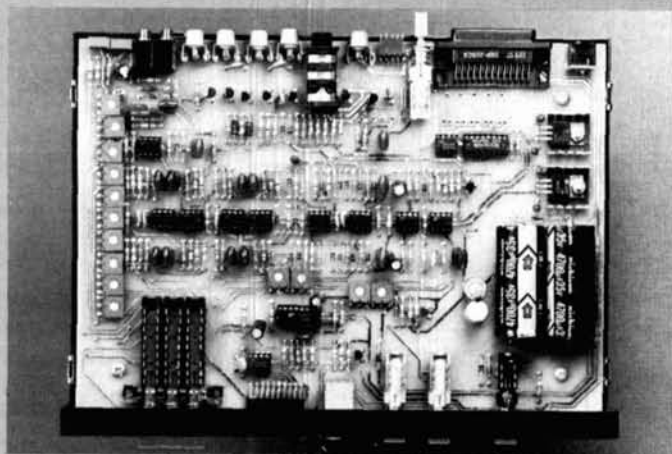

## CP-1 Computer Patch™ Interface

The AEA Model CP-1 Computer Patch™ interface will let you discover the fastest growing segment of Amateur Radio: computerized RTTY and CW operation.

When used with the appropriate software package (see your dealer), the CP-1 will patch most of the popular personal computers to your transceiver for a complete full-feature RTTY/CW station. No computer programming skills are necessary. The CP-1 was designed with the RTTY neophyte in mind, but its sophisticated circuitry and features will appeal to the most experienced RTTY operator.

The CP-1 offers variable shift capability in addition to fixed 170 Hz dual channel filtering. Auto threshold plus pre and post limiter filters allow for good copy under fading and weak signal conditions.

Transmitter AFSK tones are generated by a clean, stable function generator. Plus (+) and minus (-) output jacks are also provided for CW keying of your transmitter. An optional low cost RS-232 port is also available. The CP-1 is powered with 16 VAC which is supplied by a 117 VAC wall adaptor included with the CP-1.



**Henry Radio**

2050 S. Bundy Dr., Los Angeles, CA 90025 (213) 820-1234  
931 N. Euclid, Anaheim, CA 92801 (714) 772-9200  
Butler, Missouri 64730 (816) 679-3127

TOLL FREE ORDER NUMBER: (800) 421-6631

For all states except California

Calif. residents please call collect on our regular numbers.

**AEA** Brings you the  
Breakthrough!

## A new challenge in the amateur radio world...

Introducing 2m & 6m SSB/CW QRP Transceiver kit . . .



**MX 2 (144 MHz band) and MX-6Z (50 MHz band) SSB/CW QRP . . .** Transceiver offers the user unlimited challenges in QRP. It creates a new dimension in amateur radio operation and lots of fun to play with. The major circuits are factory assembled and tested to insure superior performance. Just solder a few wires to switches and connectors and you are in operation. No special tools are needed, only about one hour of your time assembling, and you are ready to challenge the amateur world . . .

### FEATURES

- 200mW for MX-2 and 250mW for MX-6Z
- MOS FET receiver front-end
- Noise blanker built in
- Single conversion receiver
- Built-in CW keyer
- VXO controlled (+50kHz per channel)
- External microphone and speaker jacks
- High quality crystal filter (7.8MHz)
- Provision for external DC operation
- 6 x AAA dry-cell or 9V transistor battery

### SPECIFICATIONS

- Model MX-2 144MHz band SSB/CW Transceiver
- Model MX-6Z 50MHz band SSB/CW Transceiver
- Operating Mode: A3J (USB), A1 (CW)
- Maximum Output Power: 200mW (MX-2), 250mW (MX-6Z)
- Spurious Output: Greater than 40dB down
- Sideband Suppression: Greater than 40dB
- Receiver Sensitivity: Less than 0.5uV for 15dB S/N
- Frequency Tuning Range: Maximum +50kHz per channel
- No. of Channels: 2

**\$129.95** semi-knock-down kit with channel crystal (one channel) and assembly instructions.

Order today direct or from **HENRY RADIO (800) 421-6631**. To order direct include \$3.00 shipping/handling. From California add sales tax. VISA/MC orders welcome. We will pay shipping/handling charge for all prepaid orders. **NO C.O.D. PLEASE.**

**ACE communications, inc.**

2832-D WALNUT AVENUE, TUSTIN, CALIFORNIA 92680 (714) 544-8281  
TELE. 655 306

130

### SYNTHESIZED SIGNAL GENERATOR

MADE IN USA



MODEL  
SG1000  
\$349.95  
plus shipping

- Covers 100 to 185 MHz in 1 kHz steps with thumb-wheel dial
- Accuracy 1 part per 10 million at all frequencies
- Internal FM adjustable from 0 to 100 kHz at a 1 kHz rate
- Spurs and noise at least 60 dB below carrier
- RF output adjustable from 5-500 mV at 50 ohms
- Operates on 12 Vdc @ 1/2 Amp
- Available for immediate delivery • \$349.95 plus shipping
- Add-on Accessories available to extend freq. range, add infinite resolution, voice and sub-audible tones, AM, precision 120 dB calibrated attenuator
- Call for details • Dealers wanted worldwide

**VANGUARD LABS**  
196-23 Jamaica Ave., Hollis, NY 11423  
Phone: (212) 468-2720

192

### ALL BAND TRAP VERTICAL ANTENNAS!

FULL 1/4th WAVE - All Bands! Automatic Selection with proven Hi-Q Traps. 3 Models-ALL self supporting - Ground or roof mount. HI STRENGTH FIBERGLASS TUBING OVER - ALL NO WOBBLY, LUMPY TRAPS - NO UNSIGHTLY CLAMPS needed - Size 1 1/4" all the way up - Traps hidden inside. You can use it in a 1 ft. sq. Backyard FOR APARTMENTS, MOBILE HOMES - CONDOS etc. where minimum space and neat appearance is MANDATORY! Instant "Drive In" ground mount (included). Use with or without radials (included) (All angle roof mount - Extra) COMPLETELY PRE-TUNED - NO ADJUSTMENTS NEEDED EVER! NO TUNER NEEDED FOR MOST TRANSCEIVERS! Use - RG8U feedline, any length! 2000 Watt PEP, input power. Shipped - PREPAID IN USA. Assemblies in 10 min. using only screwdriver. WEATHERPROOF!

No.-AVT80-10 — 5 Band — 25'6" — \$179.95  
No.-AVT40-10 — 4 Band — 16'9" — \$129.95  
No.-AVT20-10 — 3 Band — 11'4" — \$99.95

SEND FULL PRICE FOR PP DEL IN USA (Canada is \$10.00 extra for postage, clerical, Customs.) or order using VISA, MASTER CARD or AMER-EXP. Ph 1-308-236-5333 9AM-6PM weekdays. We ship in 2-3 days. All Antennas Guaranteed for 1 year - 10 day money back trial. Free Inf.



WESTERN ELECTRONICS 196  
Dept. AR. 9 Kearney Ne. 68847

### CATCH 10 METER FEVER with a MONGOOSE 2000



~~\$299.95~~  
NOW  
\$229.95

### 200 CHANNEL 10 METER ALL MODE TRANSCEIVER

The Mongoose incorporates the latest technology for today's high-tech standards. The Mongoose also features a manual off-set for working repeater stations.

### Specifications

|                                                                       |                                  |       |         |
|-----------------------------------------------------------------------|----------------------------------|-------|---------|
| <b>General</b>                                                        |                                  |       |         |
| Frequency composition:                                                | PLL synthesizer                  |       |         |
| Frequency range:                                                      | 28.000 MHz to 30.000 MHz         |       |         |
| Channels:                                                             | 200                              |       |         |
| Frequency space:                                                      | 10 kHz                           |       |         |
| Emission:                                                             | AM/FM/USB/LSB/CW                 |       |         |
| Power source:                                                         | 13.8 V DC                        |       |         |
| <b>Receiver</b>                                                       |                                  |       |         |
| Sensitivity:                                                          | AM — 1 micro-V @ 10 dB S/N       |       |         |
|                                                                       | FM — 1 micro-V @ 20 dB S/N       |       |         |
|                                                                       | SSB/CW — 0.5 micro-V @ 20 dB S/N |       |         |
| Selectivity:                                                          | 60 dB                            |       |         |
| Audio Output:                                                         | 2 W @ 8 Ohm                      |       |         |
| Fine Tune range:                                                      | ± 800 Hz                         |       |         |
| Course Tune range:                                                    | ± 5 kHz                          |       |         |
| Squelch range:                                                        | 0.5 to 300 micro-V               |       |         |
| Intermediate freq.:                                                   | AM/FM — 10.695 MHz/455 kHz       |       |         |
|                                                                       | SSB/CW — 10.695 MHz              |       |         |
| <b>Transmitter</b>                                                    |                                  |       |         |
| RF power output:                                                      | High                             | Mid   | Low     |
|                                                                       | SSB/CW                           | 12 W  | 8 W 2 W |
|                                                                       | AM                               | 7.5 W | 4 W 1 W |
|                                                                       | FM                               | 10 W  | 7 W 2 W |
| SSB generation: Double-balanced modulator with crystal lattice filter |                                  |       |         |
| Coarse Tune range: +5 kHz                                             |                                  |       |         |

Make Check or Money Order payable to:  
**COIN INT'L, INC.**

7861 S.W. 53RD AVE., MIAMI, FL 33143  
(305) 593-9300



Don't delay — order today!



\*\*10% off with purchase of 2 or more units.  
Prices and specifications subject to change without notice.  
Dealer inquiries invited.  
Florida Residents please add 5% sales tax.  
Allow 6-8 weeks for delivery. 123

TOLL FREE ORDERS • 1-800-826-5432  
(IN CALIFORNIA: 1-800-258-6666)

AK, HI OR INFORMATION • (213) 380-8000

#### 5 KEY ASSEMBLY

**\$1.00 EACH**  
CONTAINS 5 SINGLE-POLE NORMALLY OPEN SWITCHES MEASURES 3 3/4" LONG

#### 6 KEY ASSEMBLY

**\$1.25 EACH**  
CONTAINS 6 SINGLE-POLE NORMALLY OPEN SWITCHES MEASURES 4 1/4" LONG

#### 120V INDICATOR

**75¢ EACH**  
NEON INDICATOR RATED 120 V 1/3 W MOUNTS IN 5/16" HOLE RED LENS  
10 FOR \$7.00  
100 FOR \$65.00

#### MINIATURE 6 VDC RELAY

**\$1.00 EACH**  
SUPER SMALL SPDT RELAY GOLD COBALT CONTACTS

RATED 1 AMP AT 30 VDC. HIGHLY SENSITIVE, TTL DIRECT DRIVE POSSIBLE. OPERATES FROM 4.3 TO 6 V. COIL RES 220 OHM 1 3/16" x 13/32" x 7/16" AROMAT # RSD-6V  
**\$1.50 EACH**  
10 FOR \$13.50

#### 13 VDC RELAY

**\$1.00 EACH**  
CONTACT S.P.N.C. 10 AMP @ 120 VAC ENERGIZE COIL TO OPEN CONTACT COIL 13 VDC 650 OHMS SPECIAL PRICE

SEND FOR NEW LARGER 48 PAGE CATALOG

### MINIATURE TOGGLE SWITCHES

ALL ARE RATED 5 AMPS @ 125 VAC

|                                                                                             |                                                                                                          |                                                                                                        |
|---------------------------------------------------------------------------------------------|----------------------------------------------------------------------------------------------------------|--------------------------------------------------------------------------------------------------------|
| <b>S.P.D.T. (on-on)</b><br>P.C. STYLE NON-THREADED BUSHING<br>75¢ EACH<br>10 FOR \$7.00     | <b>S.P.D.T. (on-on)</b><br>SOLDER LUG TERMINALS<br>\$1.00 EACH<br>10 FOR \$9.00<br>100 FOR \$80.00       | <b>S.P.D.T. (on-off-on)</b><br>SOLDER LUG TERMINALS<br>\$1.00 EACH<br>10 FOR \$9.00<br>100 FOR \$80.00 |
| <b>S.P.D.T. (on-off-on)</b><br>NON-THREADED BUSHING P.C. STYLE<br>75¢ EACH<br>10 FOR \$7.00 | <b>S.P.D.T. (on-on)</b><br>P.C. LUGS THREADED BUSHING<br>\$1.00 EACH<br>10 FOR \$9.00<br>100 FOR \$80.00 | <b>D.P.D.T. (on-on)</b><br>SOLDER LUG TERMINALS<br>\$2.00 EACH<br>10 FOR \$19.00<br>100 FOR \$180.00   |

**ALL ELECTRONICS CORP.**  
**ALL ELECTRONICS CORP.**

905 S. VERMONT • P.O. BOX 20406 • LOS ANGELES, CA 90006

- QUANTITIES LIMITED
- MINIMUM ORDER \$10.00
- USA \$2.50 SHIPPING
- NO C.O.D.
- FOREIGN ORDERS INCLUDE SUFFICIENT SHIPPING
- CALIF. RES. ADD 6.12%

106

# 10-GHz weather radar

## A unique application for a Gunnplexer transceiver

**Commercial weather radar systems** have become quite popular in recent years and have proven their true life-saving ability. And over and above their use during dangerous storms, they have now become almost a part of our daily lives. The only drawbacks to these commercial radar systems are their inability to scan a small area (such as an individual's neighborhood), and the fact that commercial radar scans are generally made available only at fixed times.

To overcome these limitations, I have designed a mini weather radar system which is both inexpensive and easy to build. A short scanning range was my only criterion. Guidelines are provided for those interested in pursuing and refining this unique concept.

This mini weather radar is based on two simple facts: a radio signal travels one mile in 5.4 microseconds; and an electron beam can be timed to travel across a CRT's screen at a predetermined rate. If a radio wave leaves a transmitting antenna at the same time that a horizontal line begins on the left side of a

CRT display, that radio wave will travel approximately 12.1 miles in the 63 microseconds it typically takes for one scan of a horizontal line in conventional TV.

### operation

The first version of this unit is shown in **fig. 1**. An oscilloscope with horizontal trigger output is used with a 10-GHz Gunnplexer, an NE555 pulse modulating circuit, and a high gain amplifier to produce a distance-and-azimuth Amateur weather radar. The Gunnplexer's mixer uses the unit's constantly transmitted signal for a local oscillator, eliminating the need for a T/R device. A horizontal scan-initiating sync pulse from the oscilloscope's horizontal trigger output is used to key the NE555 oscillator, which becomes the modulating signal for the Gunnplexer's varactor input.

The Gunnplexer transmits its signal toward a distant object, such as heavy storm clouds, and its reflection is then received. The return signal heterodynes in the Gunnplexer's mixer, the output of which drives a high-gain amplifier. The amplified echoes are then fed to the oscilloscope's vertical input for display. Since the scan started during the pulse-transmission time, its round-trip delay time is indicated in **fig. 2** as displacement on the screen.

The Gunnplexer's modulating frequency should be between 200 kHz and 1 MHz. This frequency deter-

**By Dave Ingram, K4TWJ, Route 11, Box 499  
#1201 South, Birmingham, Alabama 35210**

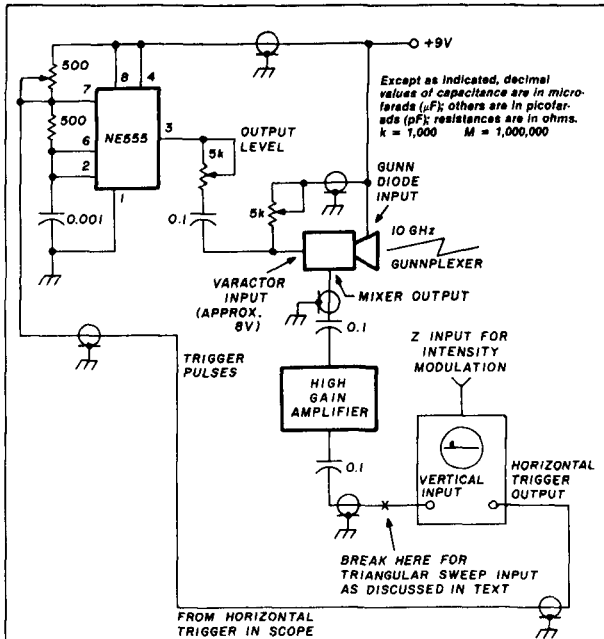

fig. 1. Arrangement of the first-generation Amateur weather radar, using an oscilloscope for generating timing pulses and displaying returned echoes.

mines the exact pulse width. Using the formula  $F = 1/T$ , a 200-kHz modulating frequency translates into approximately 5 microseconds: approximately one mile on the screen's display. A 1-MHz modulating signal encompasses approximately 1 microsecond (1/5 mile) on the screen. Although the Gunnplexer transmits a carrier continuously, only the brief modulating pulse causes indications on the CRT display. This unit will provide distance indications and information on the density of rain clouds, but it does not provide information on the direction of storm clouds. This shortcoming does not usually pose a problem.

### refinements

The second version of this weather radar uses an NE555 triangular wave generator and adds a modified oscillating house fan motor to make possible directional (azimuthal) readings. An outline of this arrangement is shown in fig. 3. The fan motor causes side-to-side movement of the remote Gunnplexer, while a microswitch at one end of the sweep provides synchronizing pulses for the NE555. The output from the triangular wave circuit is applied to the oscilloscope's vertical input; the high-gain amplifier's output is applied to the intensity (Z) input of the oscilloscope. The oscilloscope is adjusted for a dark screen until an intensity-modulating echo is received. Range markers can be added to this system with another NE555 circuit, or can simply be drawn on the screen with a washable-ink felt pen. I also suggest

that you replace the oscilloscope's P-1 phosphor cathode ray tube with a long-persistence-display P-7 equivalent tube.

During operation, horizontal sweep pulses from the oscilloscope trigger the NE555 modulation circuit, while vertical sweep is provided by the fan-motor-synchronized triangular wave generator. The Gunnplexer transmits a 200-kHz-modulated 10-GHz signal which is reflected according to cloud density and displayed on the screen. Horizontal displacement on the CRT indicates distance, and vertical height (with respect to the base line) indicates direction.

The received echoes are heterodyned with the Gunnplexer's carrier, amplified, and applied to either the oscilloscope's Z modulation port or vertical input (depending on the particular version of weather radar you build). Although a low-power 10-GHz Gunnplexer can transmit and receive over line-of-sight distances

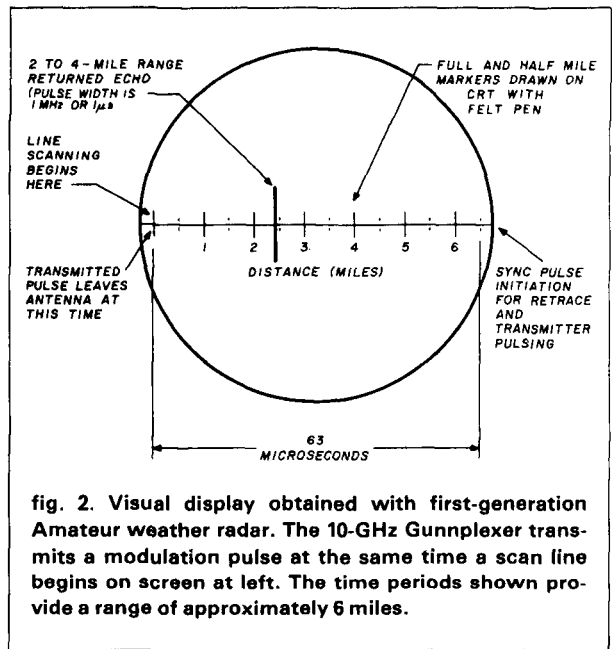

fig. 2. Visual display obtained with first-generation Amateur weather radar. The 10-GHz Gunnplexer transmits a modulation pulse at the same time a scan line begins on screen at left. The time periods shown provide a range of approximately 6 miles.

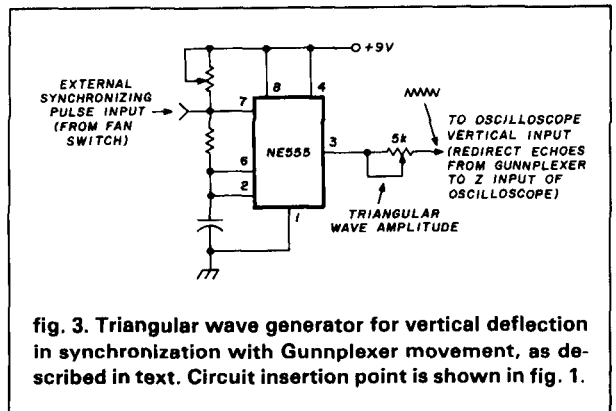

fig. 3. Triangular wave generator for vertical deflection in synchronization with Gunnplexer movement, as described in text. Circuit insertion point is shown in fig. 1.



in excess of 20 miles, I suggest that you limit its range in this application to less than 12 miles (a number chosen because of the oscilloscope's horizontal scan rate and the frequency of the Gunnplexer's modulator). This safety margin ensures reliable operation and permits accurate interpretation of the displayed information.

### a third mini radar

A third version of the mini weather radar is being developed now, and its capabilities look promising. This system employs a used black-and-white TV set rather than an oscilloscope, using the TV circuits to generate precisely timed transmitter pulses and to display the reflected signals. Since the set's tuner and i-f stages are bypassed, with the radar information applied directly to the video amplifier section, usable TVs could be picked up inexpensively at TV repair shops.

An outline of the system is illustrated in **fig. 4**. Narrow-width (and highly accurate) horizontal AFC pulses obtained from one of the low-voltage windings on the TV's horizontal output transformer trigger the Gunnplexer's NE555 modulator. This arrangement establishes radar timing while maintaining horizontal line sync in the television. A single-shot multivibrator or Schmitt trigger proves useful for buffering flyback pulses. Alternatively, a dropping resistor may be placed in the keyed AGC line for lowering that voltage to approximately 5 volts. A schematic diagram of the TV is needed for locating the keyed AGC line and determining its voltage level (don't "hunt around" in the horizontal output section: HIGH VOLTAGE!). The desired modulator-keying line is usually found connected to the AFC's discriminator diodes. You will also see a "second line" carrying sync pulses from the sync separator stage in the AFC's discriminator. That guidepost will help you locate the desired AGC keying takeoff point.

Output from the Gunnplexer's modulator is applied to that unit's varactor. The returned echoes are amplified to approximately 4 volts by a wideband amplifier similar to a single video stage in a television set, and applied to the TV's video amplifier section (a suitable injection point for this signal is quite often between the contrast control wiper and ground. If an ac/dc TV is used, be sure this point is not hot). The resultant echoes are displayed as intensity variations on the screen, with distance and timing calibrations provided by techniques similar to those in the second unit, described earlier. The next step in this system's development will include electronically sweeping the 10-GHz radar signal in sync with the TV's 60-Hz vertical scan rate. An illustration of the resultant display is seen in **fig. 5**.

A fourth generation Amateur weather radar is presently on the drawing board, and this version

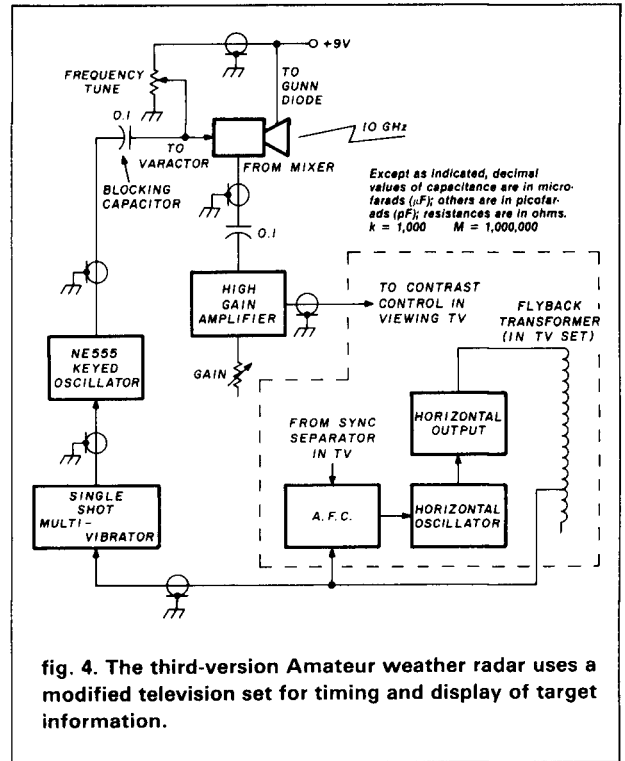

**fig. 4.** The third-version Amateur weather radar uses a modified television set for timing and display of target information.

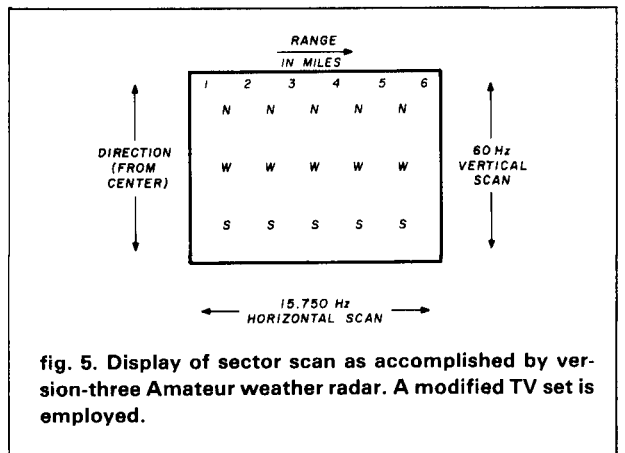

**fig. 5.** Display of sector scan as accomplished by version-three Amateur weather radar. A modified TV set is employed.

holds some truly exciting possibilities. Basically, this system employs an inexpensive home computer, such as the Apple II or TRS 80C, for generating all the required timing pulses and for creating a color-level display similar to that of commercial units. Since these microcomputers are easily programmed for various timing ranges and color presentations, they are quite useful for Amateur radar work. The integration of A-to-D and D-to-A converters in these units makes computer interfacing relatively simple.

Alden Electronics (Washington Street, Westborough, Massachusetts 01581) manufactures a weather chart recorder (Model 9321), available in assembled or kit form, that displays data generated by NOAA and other sources. — Editor

ham radio

# DoKay Computer Products, Inc.

VISIT OUR RETAIL STORE

2100 DE LA CRUZ BLVD.

SANTA CLARA, CA 95050

## 16K APPLE\* II RAM CARD

**BARE BOARD 14.00**

**ASSEMBLED 42.50**

\*Apple is a trademark of Apple Computer, Inc.

| INTERFACE |      |
|-----------|------|
| 8T26      | 1.65 |
| 8T28      | 1.95 |
| 8T95      | .95  |
| 8T96      | .95  |
| 8T97      | .95  |
| 8T98      | .95  |
| DM8131    | 2.90 |
| DP8304    | 2.25 |
| DS8835    | 1.89 |
| DS8836    | .99  |

| EPROMS       |       | STATIC RAMS |           |         |       |
|--------------|-------|-------------|-----------|---------|-------|
| 1702         | 1ns   | 2.95        | 450ns     | 1.80    |       |
| 2708         | 450ns | 2.98        | 5101      | 450ns   | 3.89  |
| 2758         | 450ns | 5.89        | 2102-1    | 450ns   | .78   |
| 2716         | 450ns | 3.90        | 2102L-2   | 250nsLP | 1.44  |
| 2716-1       | 350ns | 5.90        | 2111      | 450ns   | 2.48  |
| TMS2516      | 450ns | 5.49        | 2112      | 450ns   | 2.58  |
| TMS2716      | 450ns | 7.89        | 2114      | 450ns   | 1.74  |
| 2532         | 450ns | 5.35        | 2114L-4   | 450nsLP | 1.84  |
| 2732         | 450ns | 4.90        | 2114L-3   | 300nsLP | 1.84  |
| 2764         | 450ns | CALL        | 2114L-2   | 200nsLP | 1.94  |
| MC68764      | 450ns | 34.95       | 2147      | 55ns    | 4.89  |
| DYNAMIC RAMS |       | TMS4044-4   | 450ns     | 3.15    |       |
| TMS 4027     | 250ns | .79         | TMS4044-3 | 300ns   | 3.45  |
| UPD 411      | 300ns | 2.89        | TMS4044-2 | 200ns   | 3.89  |
| MM 5280      | 300ns | 2.89        | MK4118    | 250ns   | 9.69  |
| MK4108       | 200ns | 1.74        | TMM2016   | 200ns   | 4.15  |
| MM 5298      | 250ns | 1.74        | TMM2016   | 150ns   | 4.89  |
| 4027         | 250ns | 2.00        | HM6116-4  | 200ns   | 5.90  |
| 4116         | 200ns | CALL        | HM6116-3  | 150ns   | 6.90  |
| 4116         | 150ns | CALL        | HM6116-2  | 120ns   | 8.95  |
| 4164         | 200ns | CALL        | Z6132     | 300ns   | 32.95 |
| 4164         | 150ns | CALL        |           |         |       |

LP = LOW POWER

| RESISTORS                |       |
|--------------------------|-------|
| 1/4 WATT 5% CARBON FILM  |       |
| ALL STANDARD VALUES      |       |
| FROM 1 OHM TO 10 MGE OHM |       |
| 50 PCS. SAME VALUE       | .0200 |
| 100 PCS. SAME VALUE      | .0150 |
| 1000 PCS. SAME VALUE     | .0125 |

### 6500 1 MHz

|      |       |
|------|-------|
| 6502 | 5.25  |
| 6504 | 6.85  |
| 6505 | 7.60  |
| 6507 | 9.85  |
| 6520 | 3.95  |
| 6522 | 4.95  |
| 6532 | 5.95  |
| 6545 | 16.95 |
| 6551 | 10.95 |

### 2 MHz

|       |       |
|-------|-------|
| 6502A | 8.95  |
| 6522A | 9.95  |
| 6532A | 11.90 |
| 6545A | 27.90 |
| 6551A | 11.90 |

### 3 MHz

|       |       |
|-------|-------|
| 6502B | 11.90 |
|-------|-------|

▶ **APPLE ROM SET** ◀  
69.95  
▶ **AUTOSTART ROM** ◀  
34.95

|         |      |         |      |         |      |
|---------|------|---------|------|---------|------|
| 74LS00  | 23   | 74LS123 | .77  | 74LS253 | .57  |
| 74LS01  | 23   | 74LS124 | 2.88 | 74LS257 | .57  |
| 74LS02  | 23   | 74LS125 | .47  | 74LS258 | .57  |
| 74LS03  | 23   | 74LS126 | .47  | 74LS259 | 2.73 |
| 74LS04  | 23   | 74LS132 | .57  | 74LS260 | .57  |
| 74LS05  | 23   | 74LS136 | .37  | 74LS266 | .53  |
| 74LS08  | 23   | 74LS137 | .97  | 74LS273 | 1.47 |
| 74LS10  | 23   | 74LS138 | .53  | 74LS275 | 3.33 |
| 74LS11  | 25   | 74LS139 | .53  | 74LS279 | .47  |
| 74LS12  | 25   | 74LS145 | 1.18 | 74LS280 | 1.96 |
| 74LS13  | .39  | 74LS147 | 2.47 | 74LS283 | .67  |
| 74LS14  | .39  | 74LS148 | 1.33 | 74LS290 | .87  |
| 74LS15  | .29  | 74LS151 | .53  | 74LS293 | .87  |
| 74LS20  | 23   | 74LS153 | .53  | 74LS295 | .97  |
| 74LS21  | 23   | 74LS154 | 1.88 | 74LS298 | .87  |
| 74LS22  | 23   | 74LS155 | .67  | 74LS324 | 1.73 |
| 74LS26  | .29  | 74LS156 | .67  | 74LS352 | 1.27 |
| 74LS27  | 23   | 74LS157 | .63  | 74LS353 | 1.27 |
| 74LS28  | .29  | 74LS158 | .57  | 74LS363 | 1.33 |
| 74LS30  | 23   | 74LS160 | .67  | 74LS364 | 1.93 |
| 74LS32  | .25  | 74LS161 | .63  | 74LS365 | .47  |
| 74LS33  | .49  | 74LS162 | .67  | 74LS366 | .47  |
| 74LS37  | .29  | 74LS163 | .63  | 74LS367 | .43  |
| 74LS38  | .29  | 74LS164 | .67  | 74LS368 | .43  |
| 74LS40  | .23  | 74LS165 | .93  | 74LS373 | 1.37 |
| 74LS42  | .43  | 74LS166 | 1.93 | 74LS374 | 1.37 |
| 74LS47  | .49  | 74LS168 | 1.73 | 74LS377 | 1.37 |
| 74LS48  | .74  | 74LS169 | 1.73 | 74LS378 | 1.17 |
| 74LS49  | .74  | 74LS170 | 1.47 | 74LS379 | 1.33 |
| 74LS51  | .23  | 74LS173 | .67  | 74LS385 | 1.88 |
| 74LS54  | 23   | 74LS174 | .53  | 74LS386 | .43  |
| 74LS55  | .28  | 74LS175 | .53  | 74LS390 | 1.17 |
| 74LS63  | 1.23 | 74LS181 | 2.13 | 74LS393 | 1.17 |
| 74LS73  | .37  | 74LS189 | 8.93 | 74LS395 | 1.17 |
| 74LS74  | .33  | 74LS190 | .87  | 74LS399 | 1.47 |
| 74LS75  | .37  | 74LS191 | .87  | 74LS424 | 2.93 |
| 74LS76  | .37  | 74LS192 | .77  | 74LS447 | .35  |
| 74LS78  | .47  | 74LS193 | .77  | 74LS490 | 1.93 |
| 74LS83  | .58  | 74LS194 | .67  | 74LS668 | 1.67 |
| 74LS85  | .67  | 74LS195 | .67  | 74LS669 | 1.87 |
| 74LS86  | .37  | 74LS196 | .77  | 74LS670 | 1.47 |
| 74LS90  | .53  | 74LS197 | .77  | 74LS674 | 9.63 |
| 74LS91  | .87  | 74LS221 | .87  | 74LS682 | 3.18 |
| 74LS92  | .53  | 74LS240 | .93  | 74LS683 | 3.18 |
| 74LS93  | .53  | 74LS251 | .59  | 74LS684 | 3.18 |
| 74LS95  | .73  | 74LS242 | .97  | 74LS685 | 3.18 |
| 74LS96  | .87  | 74LS243 | .97  | 74LS688 | 2.38 |
| 74LS107 | .37  | 74LS244 | 1.27 | 74LS689 | 3.18 |
| 74LS109 | .37  | 74LS245 | 1.47 |         |      |
| 74LS112 | .37  | 74LS247 | .73  | 81LS95  | 1.47 |
| 74LS113 | .37  | 74LS248 | .97  | 81LS96  | 1.47 |
| 74LS114 | .37  | 74LS249 | .97  | 81LS97  | 1.47 |
| 74LS122 | .43  | 74LS251 | .57  | 81LS98  | 1.47 |

### UARTS

|          |       |
|----------|-------|
| AY3-1014 | 5.85  |
| AY5-1013 | 3.90  |
| AY5-1015 | 6.90  |
| TR1602   | 3.90  |
| IM6402   | 7.85  |
| IM6403   | 8.85  |
| INS8250  | 10.49 |

### LEDS

|              |         |
|--------------|---------|
| Jumbo Red    | 10/1.00 |
| Jumbo Green  | 6/1.00  |
| Jumbo Yellow | 6/1.00  |

### DIP SWITCHES

|            |     |
|------------|-----|
| 4 Position | .85 |
| 5 Position | .90 |
| 6 Position | .90 |
| 7 Position | .90 |
| 8 Position | .95 |

### EXAR

|        |      |
|--------|------|
| XR2206 | 3.75 |
| XR2207 | 3.75 |
| XR2208 | 3.90 |
| XR2211 | 5.25 |
| XR2240 | 3.25 |

### RCA

|         |      |
|---------|------|
| CA 3010 | .95  |
| CA 3013 | 1.99 |
| CA 3023 | 2.75 |
| CA 3035 | 2.49 |
| CA 3039 | 1.25 |
| CA 3046 | 1.25 |
| CA 3053 | 1.45 |
| CA 3059 | 2.90 |
| CA 3060 | 2.90 |
| CA 3065 | 1.75 |
| CA 3080 | 1.10 |
| CA 3081 | 1.65 |
| CA 3082 | 1.65 |
| CA 3083 | 1.65 |
| CA 3086 | .80  |
| CA 3089 | 2.10 |
| CA 3130 | 1.25 |
| CA 3140 | 1.15 |
| CA 3146 | 1.75 |
| CA 3160 | 1.15 |
| CA 3401 | .59  |
| CA 3600 | 3.45 |

**-VIEWMAX 80-**  
A Full Function  
80-Column  
card for Apple II  
**\$149<sup>95</sup>**

**APPLE JOYSTICKS**  
**29.95**

**APPLE SUPER COOLING FANS**  
**49.95**  
WITH SURG PROTECH  
**69.95**

**APPLE PADDLES**  
**9.95**

**APPLE UPGRADE TRS-80**  
**4116 - 200<sub>ns</sub>**  
**CALL**

### STORE HOURS:

MON-FRI 8:30 A.M. - 5:30 P.M.  
SAT 10:00 A.M. - 3:00 P.M.



**DoKay Computer Products, Inc.**

2100 De La Cruz Blvd.  
Santa Clara, CA 95050  
(800) 538-8800

Calif. Residents  
(800) 848-8008

Local Phone  
(408) 988-0697

TERMS For shipping include \$2.00 for UPS Ground \$3.00 for UPS Blue Label Air \$10.00 minimum order Bay Area residents add 6% Sales Tax California residents add 6% Sales Tax We reserve the right to limit quantities and substitute manufacturer. Prices subject to change without notice. Send SASE for complete list



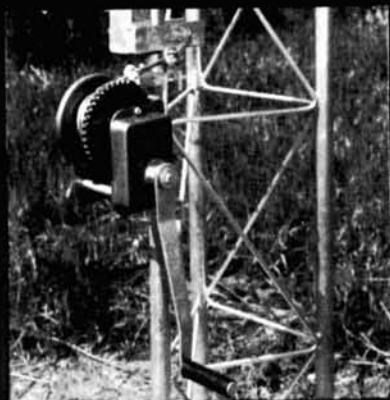

## ROHN "FOLD-OVER" TOWERS

**EASE OF INSTALLATION**  
ROHN "Fold-Over" Towers are quickly and easily installed. The "Fold-Over" is safe and easy to service.

**ADAPTABILITY**  
ROHN has several sizes to fit your applications or you can purchase the "Fold-Over" components to convert your ROHN tower into a "Fold-Over".

**HOT DIP GALVANIZED**  
All ROHN towers are hot dip galvanized after fabrication.

**REPUTATION**  
ROHN is one of the leading tower manufacturers, with over 25 years of experience.

Write today for complete details.

QUALITY STEEL PRODUCTS BY

# ROHN

Box 2000 · Peoria, Illinois 61656  
U.S.A.

✓ 191

## HAMPAK-64™ FOR

### Commodore 64

- Instant, accurate beam headings based on your QTH
- Instant call prefix identification
- "Electronics Math" assistant
- No printer required

The original HAM-PAK allowed owners of disk-based TRS-80 systems to obtain instant Great Circle bearings from their QTH to nearly 300 call areas. It allowed them to easily handle some of the trickier math formulas encountered in radio work.

NOW, this same power comes to all of you cassette-based commodore 64 owners! And the best part is the price:

**\$16<sup>95</sup>** introductory offer  
expires October 15, 1983

**\$19<sup>95</sup>** after October 15, 1983

... and we pay the postage!  
(Checks or money orders. No COD's please.)  
The original HAM-PAK is still only \$29.95



**SUNDERLAND SOFTWARE**  
39256 Sunderland Drive  
Mt. Clemens, MI 48044 ✓ 184

1983-1984

## AMATEUR RADIO

# CALL DIRECTORY

THE BARGAIN AT **\$14<sup>95</sup>**  
Plus Shipping

A no frills directory of over  
415,000 U.S. Radio Amateurs.  
8½x11, easy to read format.  
Completely updated.

*Also available for the  
first time ever—*  
(Alphabetically arranged—Sold separately)

**Geographical Index**  
by State, City and Street No. and Call  
**Name Index**  
by Name and Call

Ordering Information:

- Directory—\$14.95
- Geographical Index—\$25.00
- Name Index—\$25.00

Add \$3.00 Shipping to all orders.

Dealer / Club inquiries welcome

Send your order—enclosing check or  
money order in U.S. dollars to:

**Buckmaster Publishing**  
70 Florida Hill Road  
Ridgefield, CT 06877 U.S.A. ✓ 120



U.S.  
Listings

# WANTED

HIGHEST PRICES PAID FOR:

## HARRIS RF-301

### &

ASSOCIATED EQUIPMENT

CALL COLLECT:

**LIBERTY ELECTRONICS, INC.**

**(212) 925-6048** ✓ 160

**SURGE PROTECTION  
PLUS MASTER CONTROL  
for all your equipment**

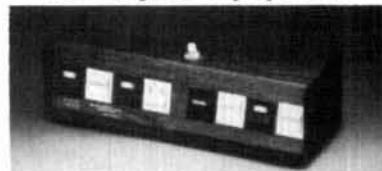

Modern solid state circuitry is vulnerable to transient currents that can come from distant lightning and surges from household appliances. Alpha Delta's Master AC Control clips off those harmful surges before they reach your valuable electronic equipment. MACC also gives you 8 grounded, 7 switchable and lighted, one continuous-on outlets: Master on/off switch too. Tested to IEEE pulse standards; rated 15 A, 125 VAC, 60 Hz; 1875 watts continuous.

GET MACC PROTECTION TODAY —  
TOMORROW COULD BRING DISASTER

See your local Alpha Delta dealer today or order  
direct \$79.95 + \$4 postage handling.

## ALPHA DELTA COMMUNICATIONS

P.O. Box 571, Centerville, Ohio 45459  
(513) 435-4772 ✓ 107

## MICROWAVE COMPONENTS

25 MW EXCITER \$49.95  
45 MHZ SUBCARRIER \$19.95  
AM VIDEO MODULATOR \$19.95  
50 MW UP CONVERTER \$149.95

## GIZMOELECTRONICS, INC.

P.O. BOX 1205  
PITTSBURG, KS 66762  
PH. 316-231-8171

Kansas residents 3% sales tax ✓ 140

# installing effective ground systems

A few hours' work improves signal, reduces RFI

Many Amateurs strive for maximum efficiency from their antennas yet fail to give the same consideration to their ground systems. All too often their ground consists of a metal rod or pipe driven into the soil at some convenient point. Any handy piece of wire is run between it and the rig. Many times, the transceiver or transmitter is the only piece of equipment connected to the ground. While this type of wiring practice may be satisfactory for ac or dc, it is totally ineffective at radio frequencies.

Poor grounding can worsen TVI and RFI, reduce the effectiveness of the shielding in your rig and allow rf feedback into various pieces of equipment. Good grounding can noticeably enhance the performance of antennas on 160, 80; and 40 meters.

There are two phases in the establishment of an effective ground system. The first involves properly bonding together all equipment in the shack. The second entails the construction of a low resistance earth ground.

## what should be bonded?

All pieces of equipment in the shack should be correctly bonded together. This includes transceivers, transmitters, receivers, power supplies, keyers, antenna tuners, etc. Unlike dc or ac, all current flow is at or near the surface of a conductor at radio frequencies. Thus, the ideal bonding material should have a large surface area to present the least impedance to the flow of rf currents. The best and most expensive conductors are braided copper strap and flashing copper, which both possess large surface areas. No. 6 gauge copper wire, normally used for grounding, has *less* surface area than the shield of RG-58 coaxial cable. In addition to being expensive, large gauge solid copper wire is very stiff, making it difficult to use.

A less expensive substitute for copper flashing or braided copper strap is the shield of RG-8 coaxial cable. It isn't necessary to use new cable. If you replace your coaxial cable every three to five years, as do most hams, the cable you replace will probably be adequate for grounding purposes.

A ground bus using the entire cable is shown in fig. 1. It is not necessary to pull the shield off the coaxial (a nearly impossible task). The center conductor is not used in order to avoid making the cable self-resonant. In the installation shown in fig. 1, short lengths of RG-58 cable were used to make connections to individual pieces of equipment. Again, only the shield was used. To facilitate connection, the center conductor and insulation were cut to allow 2 inches of free shield at each end. The RG-8 bus was stapled across the back of the desk to place it as close as possible to the equipment.

## cold water pipe

Amateurs are often advised to ground their equipment to the nearest cold water pipe. But this is impossible if the pipe is plastic or corroded metal. Even with copper pipe, these makeshift grounds may be difficult or impossible to reach — unless you operate from the kitchen, bathroom, or laundry room. The use of water pipe instead of a good earth ground is justified only if you live above the first floor of an apartment building.

## achieving good earth grounds

The construction of a good earth ground, while not difficult, involves more than driving a metal rod into the lawn. The soil into which the ground rod is driven should present minimum resistance to the flow of electric currents. When completely dry, most soils are non-conductors. Pure water is a very poor conductor. The basic electrical conductivity of a soil is the result of electron transfer through electrolytes dissolved in the water present in that soil. However, there are many factors that can affect this basic conductivity.

By Bradley Wells, KR7L, 5053 37th Avenue, S.W., Seattle, Washington 98126

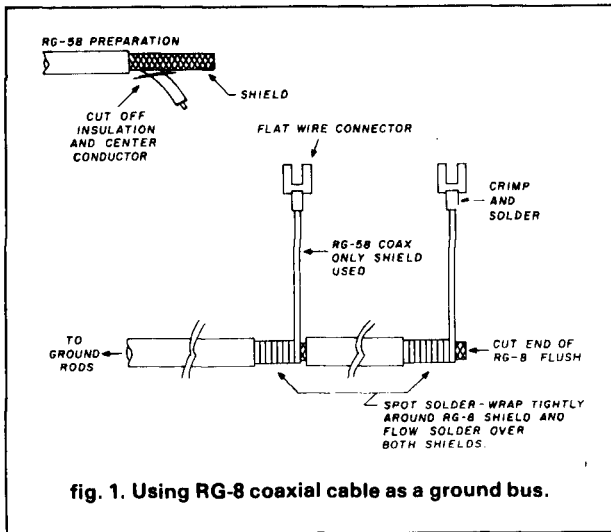

fig. 1. Using RG-8 coaxial cable as a ground bus.

| material       | conductivity<br>(millimhos/meter) |
|----------------|-----------------------------------|
| poor soil      | 1-5                               |
| average soil   | 10-15                             |
| very good soil | 100                               |
| water          | 10-15                             |
| salt water     | 5000                              |

fig. 2. Soil conductivity chart.

Soil type has an important effect on local ground resistance as shown in fig. 2 and 3. Commercial broadcast stations require excellent ground systems for their vertical antennas. This is why they show a marked preference for low swamps over rocky mountain tops. Soil particle size and density influence conductivity, which explains the differing resistances between clay and sandy gravel. A fact to consider in locating your own earth ground is that soil type can change over very short distances, both vertically and horizontally. The flowerbed may look like a good place for a ground rod, but it won't be if the topsoil is resting on gravel or rock.

The moisture content and concentration of dissolved salts markedly affect soil resistance (see figs. 4 and 5). There is a direct correlation between increased soil moisture and lowered resistance. The same effect is noted with respect to dissolved salts in the soil. Little information is available on the changes of soil conductivity with respect to different types of salts. The importance of soil moisture and salt concentration cannot be overemphasized. Salts disasso-

ciate into the ions involved in electron current flow; water provides the medium to facilitate easy flow of these ions through the soil.

Two other interrelated factors affect soil conductivity. As shown in figs. 6 and 7, soil resistance rises quickly as the temperature drops. Soil conductivity is lowest during the winter months and highest in summer. However, these temperature and climatic effects become less noticeable with increasing depth in the soil. Those of you living in cold climates will notice the large jump in soil resistance as the soil freezes. This is due to ions being trapped in the crystalline structure of the ice. Maintaining a low ground resistance during winter months means driving your ground rods well below the frost line.

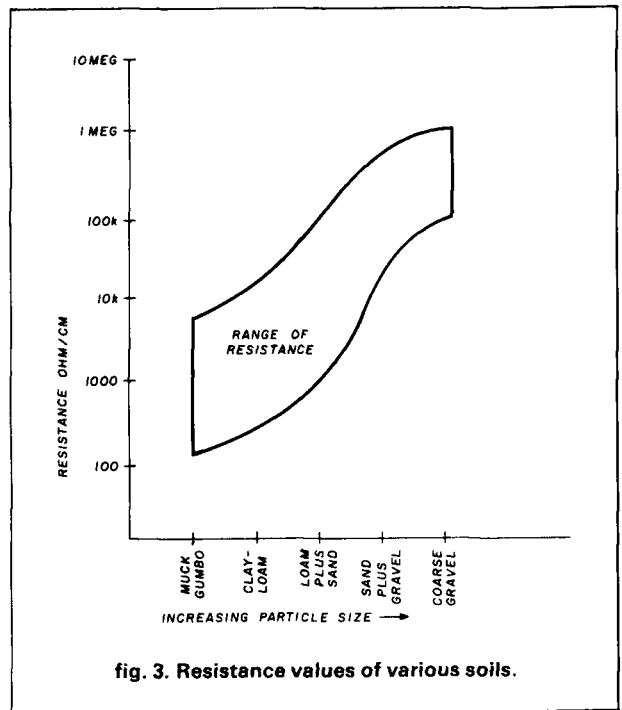

fig. 3. Resistance values of various soils.

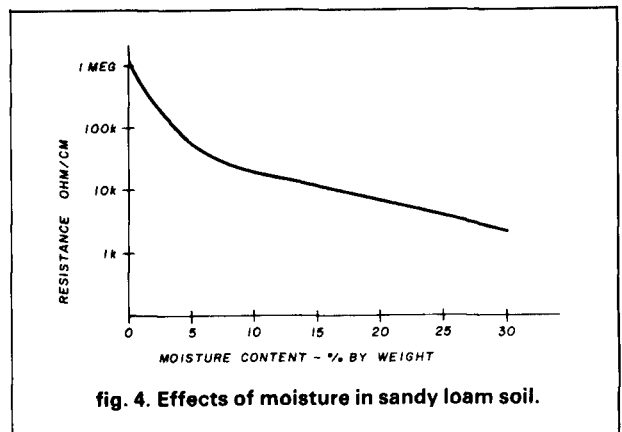

fig. 4. Effects of moisture in sandy loam soil.

# CUE DEE

**First**  
**North American Availability**  
 — Mid - July —  
 — PLACE YOUR ORDER NOW —

CUE DEE antennas are Quality Designed to ensure optimal performance and durability. Five (5) years written GUARANTEE against materials or manufacturing faults on all CUE DEE (Quality Designed) antennas.

Exclusive Distributors in North America Call —

**The VHF Shop**  
 Box 349 R.D. 4  
 Mountain Top, PA.  
 (717) 868-6565  
 K3MKZ  
 M-F after 6:00 p.m. EST  
 Weekends anytime

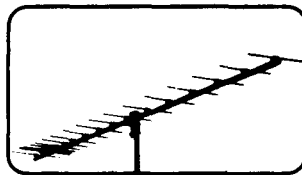

**Nampa Satellite Systems**  
 312 12th Ave. So.  
 Nampa, Idaho 83651  
 1-800-654-0795  
 K17D - WB6TOC  
 M-S 8:00 a.m. - 6:00 p.m. MST

## 2 METER ANTENNAS

- 4144A - 4 elem - 3.5' boom length ..... Call
- 10144A - 10 elem - 2.2 yagi ..... \$64.95
- 10X144A - 10 elem - 2.2 Twist yagi ..... \$79.95
- 15144A - Equal in gain to ANY commercial antenna in the 3.1 boom size - weighs 11 lbs. < 2 sq. ft. surface area ..... \$79.95
- 15X144A - Same gain in each plane as 15144A but a 3.1 Twist yagi weighs only 12 lbs. - surface area 2.5 feet ..... \$99.95

ALL ANTENNAS ARE SUPPLIED WITH "N" CONNECTORS

## 432 ANTENNAS

- 17432AN - 17 elem yagi, Boom length 8.12 feet ..... \$54.95

### Specifications VHF antennas:

| Antenna          | 4144A               | 10144A              | 10X144A             | 15144A              | 15X144A             |
|------------------|---------------------|---------------------|---------------------|---------------------|---------------------|
| No. Elements     | 4                   | 10                  | 2x10                | 15                  | 2x15                |
| Gain             | 8 dBd               | 11.4 dBd            | 11.4 dBd            | 14 dBd              | 14 dBd              |
| Front / Back     | 20 dB               |                     | 25 dB               |                     |                     |
| Front / Side     |                     |                     | > 40 dB             |                     |                     |
| SWR              |                     |                     | < 1.5 / 1           |                     |                     |
| Aperture Angle E | 2 x 29°             | 2 x 18°             | 2 x 18°             | 2 x 15°             | 2 x 15°             |
| Aperture Angle H | 2 x 46°             | 2 x 24°             | 2 x 24°             | 2 x 16°             | 2 x 16°             |
| Impedance        | 50 ohm              |                     |                     |                     |                     |
| Mast Diameter    | 50 mm               |                     |                     |                     |                     |
| Boom Length      | 1.1 m               | 4.5 m               | 4.55 m              | 6.45 m              | 6.5 m               |
| Surface Area     | 0.03 m <sup>2</sup> | 0.12 m <sup>2</sup> | 0.16 m <sup>2</sup> | 0.18 m <sup>2</sup> | 0.23 m <sup>2</sup> |
| Weight           | 1 Kg                | 3 Kg                | 3.4 Kg              | 5 Kg                | 5.5 Kg              |
| Boom             |                     | 3 sections          | 3 sections          | 4 sections          | 4 sections          |

N-type connector may be supplied upon request. SO 239-type connector is delivered as standard on all antennas.



Element to boom mounting of CUE DEE VHF/UHF yagi antennas.



Driver element for 144 MHz with pre-tuned gamma match.



SWR of CUE DEE 15144A and 15X144A



15144A, 15 el. long yagi 144MHz.

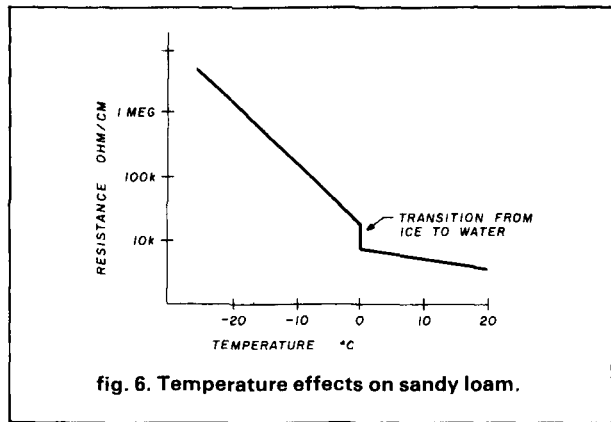
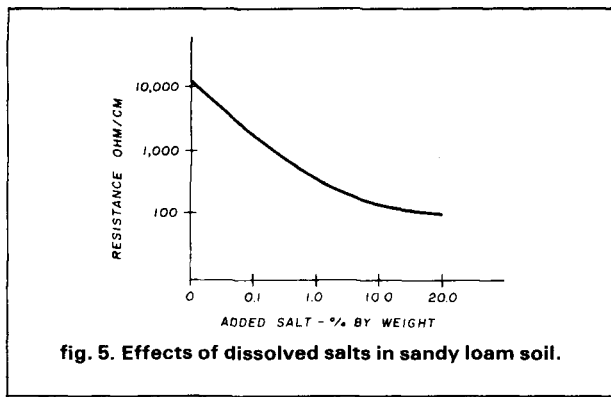

### chemical treatment

Chemical treatment of the soil around a ground rod will increase the effectiveness of your ground system.\* Rock salt, copper sulphate or magnesium sulphate (commonly known as Epsom salt) will inject large quantities of ions into the soil increasing its conductivity while reducing seasonal variation. However, these salts will gradually be washed away by rain and groundwater. They should be replaced every one to three years depending on climate and soil type. Rock salt is the most readily available and least expensive. Magnesium sulphate (Epsom salt) is available at any drugstore. Copper sulphate is the most effective but the most expensive.

### ground rods

Copper pipe makes the best ground rod, but unfortunately, it's expensive and too soft to be driven into the ground. The best practical rods are made of steel plated with copper to decrease resistance. These are available through most Amateur Radio outlets. Remember that the length of a ground rod is more important than its diameter. Doubling its length will

\*Use extreme caution in applying chemicals that may pollute ground water, wells, or soil. Editor.

cut resistance by 40 percent, while doubling the diameter will result in only a 10 percent reduction.

Spaced rods provide large reductions in the resistance of your earth ground system as shown in **fig. 8**. Ground rods should be separated from each other by a distance equal to their length. This reduction of resistance is not proportional to the number of rods in the system. Three rods spaced 15 to 25 feet apart will provide an optimal ground for all Amateur stations.

A typical ground rod set-up is shown in **fig. 9**. This is most effective since the chemical salts are distributed through a large volume of soil. Unfortunately, these salts are toxic to vegetation and can leave a ring of bare soil around each rod.

An alternate installation method for ground rods is shown in **fig. 10**. This was used for my station since I have a small city lot and all the good locations for driving ground rods seemed to be covered with petunias. All excavation was done with a post-hole digger to minimize damage to the flower beds. While not quite as effective as the method in **fig. 9**, it allows much greater latitude in the placement of your ground rods.

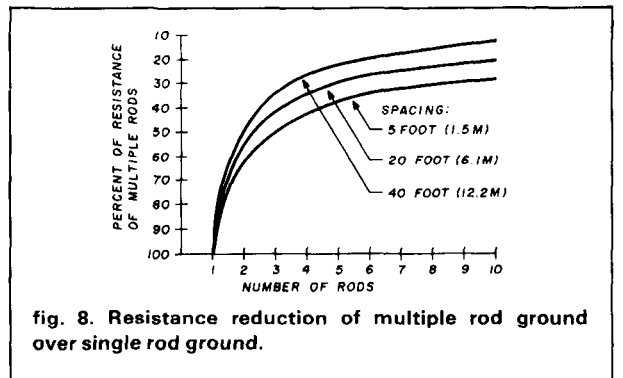
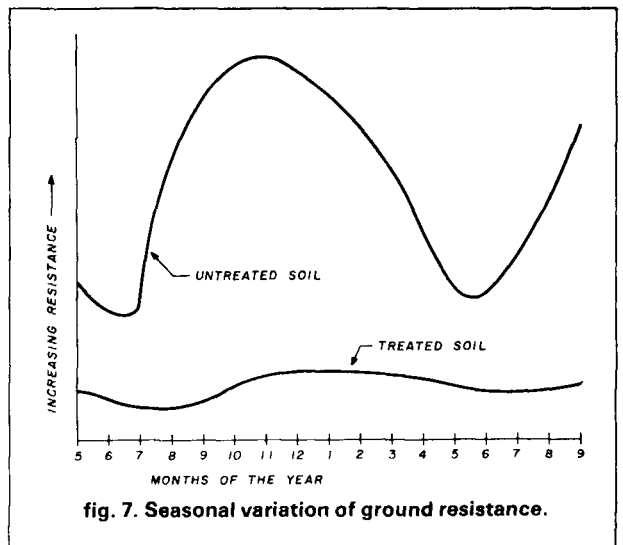



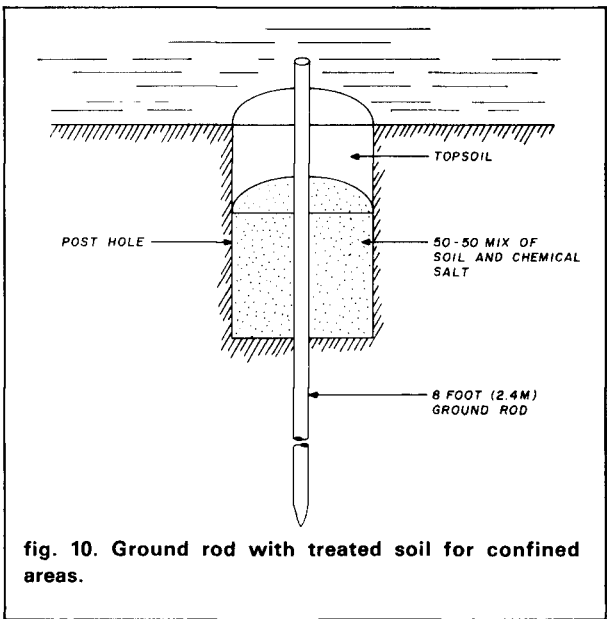
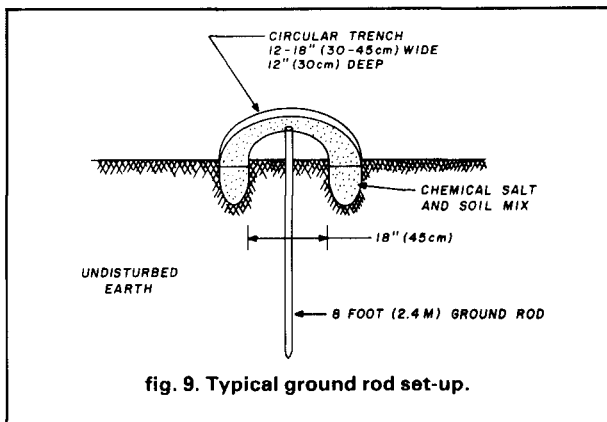

The proper construction of a low resistance earth ground system is a relatively simple task. It can eliminate the problem of "rf in the shack," reduce your TVI potential, and improve the performance of low band antennas — not a bad trade-off for several hours of work.

### bibliography

- Card, R.H., "Earth Resistivity and Geological Structure," *Electrical Engineering*, November, 1935, pages 1153-1161.
- DeMaw, Doug, W1FB, "That First Ham Station — How to Choose It and Set It Up," *QST*, November, 1981, pages 37-40.
- Hypnarowski, Joe, WA6VNR, "Effective Grounds," *CQ*, August, 1982, pages 34-37.
- Sevick, Jerry, W2FMI, "Measuring Soil Conductivity," *QST*, March, 1981, pages 38-39.
- "Practical Grounding Principles and Practices for Safe Dependable Grounds," Copperweld Steel Company, Glassport, Pennsylvania.
- Radio Amateur's Handbook*, 1981 Edition, American Radio Relay League, pages 15-5 to 15-6.
- Reference Data For Radio Engineers*, Fifth Edition, Howard S. Sams and Co., pages 26-3 to 26-5.

ham radio

More reasons to call Calvert first:

**Lowest prices  
in America.  
Service you can  
depend on.  
Net 30 credit terms.**

Now introducing the additional convenience of



or



### TRANSMITTING TUBES

|                |         |            |          |              |         |
|----------------|---------|------------|----------|--------------|---------|
| 0A2            | \$ 2.00 | 304TH      | \$355.00 | 6550A        | \$ 6.50 |
| 0B2            | 2.00    | 304TL      | 320.00   | 6883B/8032A  | 7.35    |
| 1AD4           | 9.50    | 572B/T160L | 56.00    | 6907         | 100.00  |
| 2C39WA         | 45.00   | 807        | 6.50     | 6939         | 28.00   |
| 2D21           | 2.45    | 811A       | 11.00    | 7054/8077    | 5.00    |
| 2E24           | 9.50    | 812A       | 35.00    | 7056         | 4.00    |
| 2E26           | 7.50    | 813        | 35.00    | 7058         | 5.75    |
| 3-400Z         | 88.00   | 816        | 15.00    | 7059         | 5.00    |
| 3-500Z         | 88.00   | 829B       | 15.00    | 7060         | 6.00    |
| 3-1000Z        | 367.00  | 832A       | 12.00    | 7061         | 6.75    |
| 3B28           | 12.50   | 833A       | 80.00    | 7167         | 3.67    |
| 3CX400U7       | 285.00  | 866A       | 7.50     | 7258         | 6.00    |
| 3CX800A7       | 250.00  | 1625       | 12.00    | 7360         | 12.00   |
| 3CX1500A7/8877 | 470.00  | 2050A      | 3.75     | 7551         | 8.50    |
| 3E29           | 20.00   | 4657       | 95.00    | 7591A        | 4.70    |
| 4-65A          | 59.00   | 5651       | 3.50     | 7701         | 8.00    |
| 4-125A         | 70.00   | 5654       | 2.25     | 7716         | 6.00    |
| 4-250A         | 80.00   | 5670       | 4.40     | 7854/YL1060  | 114.00  |
| 4-400A/C       | 89.00   | 5672       | 4.25     | 7905         | 16.00   |
| 4-400B/7527    | 99.00   | 5678       | 4.50     | 8072         | 92.00   |
| 4-1000A        | 452.00  | 5687       | 4.00     | 8102         | 3.75    |
| 4CS250R        | 180.00  | 5751       | 4.00     | 8121         | 115.00  |
| 4CX250B        | 65.00   | 5763       | 4.50     | 8122         | 110.00  |
| 4CX250BC       | 73.00   | 5814A      | 3.70     | 8156         | 11.00   |
| 4CX350A        | 110.00  | 5894A      | 48.00    | 8417         | 6.85    |
| 4CX1000A       | 395.00  | 5894B/8737 | 91.00    | 8458/YL1240  | 35.00   |
| 4CX1500B       | 500.00  | 5965       | 2.50     | 8505A/YL1250 | 95.00   |
| 4E27A          | 150.00  | 6005       | 5.25     | 8509         | 140.00  |
| 4X150A         | 58.00   | 6080       | 7.50     | 8560AS       | 78.00   |
| 4X150D         | 50.00   | 6146A      | 6.25     | 8595         | 39.00   |
| 4X150G         | 75.00   | 6155       | 75.00    | 8624         | 105.00  |
| 5R4WGB         | 5.00    | 6156       | 85.00    | 8643         | 117.00  |
| 5U4G           | 2.75    | 6201       | 5.35     | 8753         | 60.00   |
| 6DJ8           | 2.75    | 6252       | 70.00    | 8873         | 200.00  |
| 6L6GC          | 3.85    | 6360       | 5.50     | 8874         | 194.00  |
| 7N7            | 15.00   | 6397       | 8.50     | 8908         | 12.75   |
| 254W           | 215.00  | 6528A      | 75.00    | 8950         | 11.50   |

Minimum order \$25.00 • Shipping charges extra  
F.O.B. East Rutherford, NJ.

Prices and terms subject to change or withdrawal without prior notice.

### COAST TO COAST TOLL FREE NUMBERS:

To call NJ office: **800-526-6362** (except from NJ)

To call CA office: **800-421-7549** (except from CA)

✓ 121

**800-824-6232** (from CA only)

**CALVERT**   
**ELECTRONICS, INC.**

One Branca Rd. E. Rutherford, NJ 07073  
201 460 8800 • TWX 710 989 0116  
Telex 4990274

1355 Rendon Ave., Suite 6  
Long Beach, CA 90804  
213-498-3504

# locate orbiting satellites

The motion of satellites  
around the earth  
is explained to help you  
find and use  
Amateur satellites

**For the beginning satellite chaser**, probably the most perplexing question is, how do I find out when I can hear it? Although there are now numerous ways of finding the answer to that question, the newcomer — and possibly some old-timers — will find it very helpful to understand the spatial relationships that exist between satellites and the earth. With the aid of a simple globe of the earth and some basic information on satellite behavior, a clearer picture of how to find satellites emerges.

Look at a globe of the earth and visualize it divided exactly in half by a flat planar surface. Imagine this plane at a slight angle to the polar axis, so that it passes to one side of the north pole and to the other side of the south pole. Now consider this plane to be stationary, with the earth rotating freely through it. Note that twice during each rotation each point on the earth's surface passes through this plane — except for small regions near each pole. At each passage the plane will appear to approach the earthbound observer from the east and disappear to the west, just like the sun and moon.

## satellite paths

What does this have to do with satellites? Satellites travel around the earth in a path that stays on a flat plane of this kind, and the planes of the various satellites are completely independent of one another. Much of the apparent movement of the satellites is merely the movement of the earthbound observer

being carried toward and away from the orbital plane.

The problem of discovering when a given satellite comes within useful distance is then really the problem of finding out where the orbital plane is when the satellite is near your latitude. Since this information is different for every station, a convention is used that identifies the time and location of the satellite's equatorial crossing. From that information you can derive the specific data you need for your own location.

A satellite circling the earth in the orbit previously described crosses the equator twice during each revolution around the earth. The convention for reference data identifies only the northbound equator crossing. Information on the longitude and time of the first northbound equatorial crossing for the UCT (Greenwich) day is published and broadcast by ARRL, AMSAT, and others. In addition to this information, we must also know certain other facts about the satellite's orbit. The time it takes a satellite to revolve exactly once around the earth is called its *period*. The angular distance, measured at the equator, between successive northbound equator crossings is called the *increment*; measured in degrees of longitude, and mainly related to the earth's rotation. It is also important to know the *inclination angle*, the angle between the orbital plane and a plane through the earth's equator. All these orbital characteristics are unique to each satellite and are published in various Amateur magazines.

For the ham who really wants to get serious about tracking satellites, there is another item of information I can recommend. That is something that's not published but must be calculated by the individual for his own location. I have called it the *index point*, and I define it as the longitude of the intersection of the orbital plane with the equator that causes the satellite to pass directly overhead. These index points are different for each satellite, and, in fact, there will be two: one for northbound satellite movements (ascending orbits) and one for southbound move-

By John L. Hill, W0ZWW, 2838 Lake Boulevard, North St. Paul, Minnesota 55109

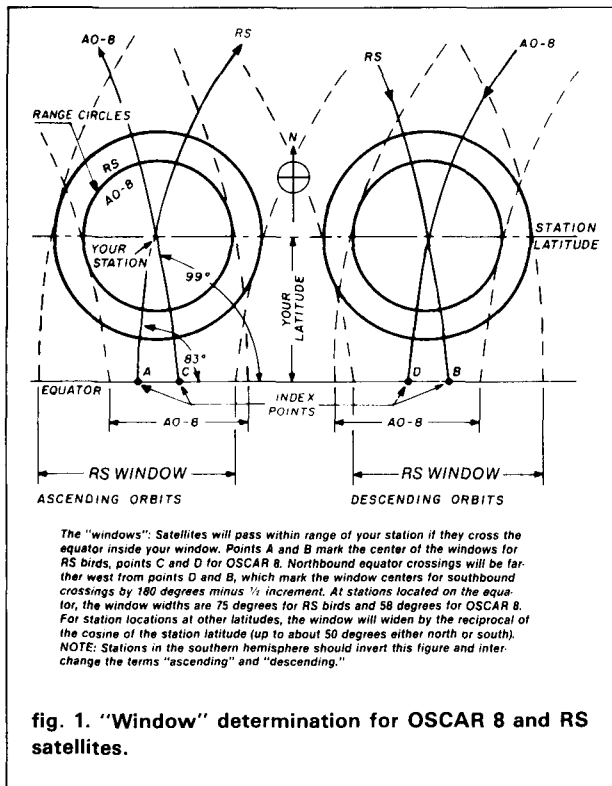

fig. 1. "Window" determination for OSCAR 8 and RS satellites.

ments (descending orbits). Let's take a closer look at these index points.

If the orbital plane had an inclination angle of 90 degrees (perpendicular to the equator), one might predict that the index point would have the same longitude as the ground station. That is not quite true, however, because it takes time for the satellite to move from the equator to the station and the rotation of the earth during this interval has moved the station eastward by one degree longitude for each four minutes. Thus the orbital plane must be positioned east of the station longitude to accommodate this fact.

Since the inclination angle of the orbital plane is not 90 degrees for any of the satellites now in orbit, there will be a difference between the longitude of the equator crossing point and the ground station because of this "leaning" of the plane. An effective way to visualize this is to stretch a rubber band around the globe, making a great circle. Position this great circle so that it passes through the ground station location, and make the northernmost and southernmost points tangent to latitude parallels equal to the inclination angle. For OSCAR 8 this angle is 99 degrees, so the great circle will come tangent to 81 degrees, passing to the left of the north pole (as you view your station's location) and to the right of the south pole. For the Russian satellites (RS-3 through RS-8) the inclination angle is 83 degrees, which makes the tangency points nearly the same, but on opposite sides of the earth's poles.

With the assistance of this great circle it's apparent that for inclination angles of less than 90 degrees, the plane crosses the equator slightly west of the ground station's longitude; for inclination angles greater than 90 degrees, it crosses slightly east. The contribution to the displacement due to the earth's movement is always toward the east; thus these two effects almost cancel one another for the RS birds. They add for OSCAR 8.

For ground stations with latitudes of not greater than about 60 percent of the inclined orbital plane's northernmost (or southernmost) latitude, it's possible to calculate the location of the index points without resorting to spherical geometry and still get accurate enough results for Amateur communications. For example, consider a ground station at 40 degrees north latitude and 80 degrees west longitude. And let us use the data for the RS-8 satellite, because it provides some easily understood calculations (see fig. 1). RS-8 has a period of just under two hours, an increment of almost exactly 30 degrees of longitude, and an inclination angle of 83 degrees. Its height above the earth's surface is 1680 kilometers, a value we will also need.

The first value we will need to derive is the displacement caused by the earth's rotation. Since the satellite travels at a velocity of 3 degrees per minute, it will take 13.3 minutes for it to travel north from the equator to the station's latitude. Meanwhile, the earth turned 3.33 degrees (13.3 divided by 4).

The *inclination factor* is the latitude multiplied by the cosine of the inclination angle. That is 4.9 degrees, but since it's west and the 3.33 degrees is east, they partially cancel, making the index point 81.47 degrees west longitude. The significance of this is that every orbit of RS-8 that ascends across the equator at 81.5 degrees will pass over the ground station 13.3 minutes later.

A similar index point can be found for satellite passes which ascend on the other side of the earth and descend over the station. The arithmetic for determining this index point has almost all been done, since the satellite now passes the station before it reaches the equator by 13.3 minutes. Both the previous displacements change direction, and the equator crossing on descent becomes 78.5 degrees west.

It's more useful to learn where the ascending equator crossing must be to produce the desired descending longitude. One might expect it to be exactly opposite (i.e. 180°), however, that is not correct since the earth has been turning during the intervening half-orbit. Therefore, the required longitude of ascension will be east of a point opposite by an amount proportional to the time required for this half-orbit transit. Since all satellite locations are expressed in longitude degrees west of zero, this point is most easily obtained by adding 180 degrees minus

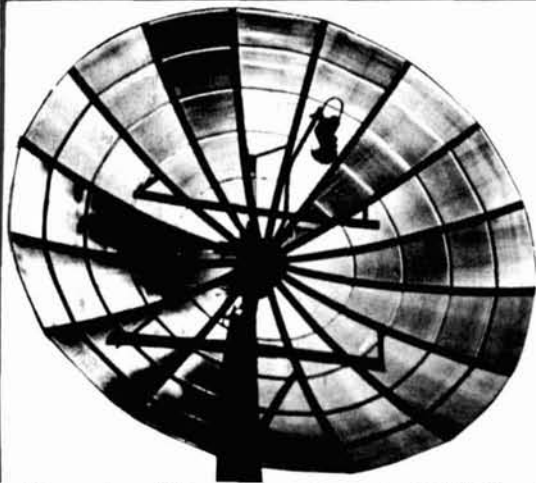

## CQ CQ HAMS

- SPECIAL OFFER TO LICENSED HAMS -

Do you think *Ham Radio* is the number 1 Amateur Publication?

Are you interested in Satellite Television?  
Then why not read *Satellite TV Magazine*?

Believe me - this is the number 1  
Satellite TV Publication!

Now ... as a special offer to licensed amateurs only - we will send you a sample copy of *Satellite TV Magazine* for only \$1.00\* (Reg. \$2.95) and offer you an annual subscription for only \$24.95\* (Reg. \$29.95).

If you're still not convinced - QSY the Satellite TV Net each Sunday at 2:00 pm Eastern Time on 14.310 MHz and hear what the other HAMS are saying about *Satellite TV Magazine*.

Chris J. Schultheiss VE-2FRJ  
Editor & Publisher

Just give us your name and QTH

Name \_\_\_\_\_ Call \_\_\_\_\_

Address \_\_\_\_\_

State \_\_\_\_\_ Zip \_\_\_\_\_

Please Enclose Check or Money Order or if you prefer we accept Visa® & Mastercard®.

Card Number \_\_\_\_\_ Exp. Date \_\_\_\_\_

\*All Prices in US Funds.



Satellite TV Magazine  
P.O. Box 2384



Call Toll Free

Shelby, North Carolina 28150

180 1-800-438-2020

NEW  
FROM  
LUNAR

### STRIPLINE POWER AMPLIFIER KITS 50, 144, 220 AND 432 MHz.



Perfect for EME, aurora, meteor and tropo scatter, and other specialized communications modes.

These high performance state-of-the-art amplifiers come in two basic models: 500 watts output using either the 4CX250 family or 8730 tetrode tubes. 1000 watts output using 8874 triode tubes. The amplifier is 12" x 8" x 6" and weighs just 14 lbs. excluding cooling blower.

Power supply kits for both triode and tetrode models available in kit form. Rated outputs are 2,000 VDC @ 500 ma; 7.6 VAC @ 6A for filament voltages; for tetrode models 300 VDC regulated at 40 mA screen and -120 VDC bias supply voltage. Power supply is 12" x 8" x 6" and weighs 37 lbs. Full line of accessories, rack or cabinet mounts, manufactured and kit options available. Contact factory for details.

Each kit comes with fully illustrated, easy-to-read instructions. Factory back-up assistance is available from trained technicians.

CALL FOR PRICING



2775 Kurtz St., Suite 11  
San Diego, CA 92110  
(619) 299-9740

162



## ORR BOOKS

### BEAM ANTENNA HANDBOOK

by Bill Orr, W6SAI

Recommended reading. Commonly asked questions like: What is the best element spacing? Can different yagi antennas be stacked without losing performance? Do monoband beams outperform tribanders? Lots of construction projects, diagrams, and photos. 198 pages. ©1977. 1st edition.

RP-BA Softbound \$7.95

### SIMPLE LOW-COST WIRE ANTENNAS

by Bill Orr, W6SAI

Learn how to build simple, economical wire antennas. Apartment dwellers take note! Fool your landlord and your neighbors with some of the "invisible" antennas found here. Well diagramed. 192 pages. ©1972.

RP-WA Softbound \$7.95

### THE RADIO AMATEUR ANTENNA HANDBOOK

by William I. Orr, W6SAI and Stuart Cowan, W2LX

Contains lots of well illustrated construction projects for vertical, long wire, and HF/VHF beam antennas. There is an honest judgment of antenna gain figures, information on the best and worst antenna locations and heights, a long look at the quad vs. the yagi antenna, information on baluns and how to use them, and new information on the popular Sloper and Delta Loop antennas. The text is based on proven data plus practical, on-the-air experience. The *Radio Amateur Antenna Handbook* will make a valuable and often consulted reference. 190 pages. ©1978.

RP-AH Softbound \$7.95

### ALL ABOUT CUBICAL QUAD ANTENNAS

by Bill Orr, W6SAI

The cubical quad antenna is considered by many to be the best DX antenna because of its simple, lightweight design and high performance. You'll find quad designs for everything from the single element to the multi-element monster quad, plus a new, higher gain expanded quad (X-Q) design. There's a wealth of supplementary data on construction, feeding, tuning, and mounting quad antennas. 112 pages. ©1977.

RP-CQ Softbound \$6.95

Please add \$1.00 to cover shipping and handling.

## HAM RADIO'S BOOKSTORE

GREENVILLE, NH 03048

one-half the increment. (Should the result be greater than 360 degrees, the correct value is obtained by subtracting 360.) For the example we've been using, this ascending crossing will be at 243.5 degrees west. It's useful to note that the 'bird' will arrive over the station 46.5 minutes after this crossing: one-half the period minus the time from the station to the equator.

So much for passes which are overhead. But what about the ones that come by without being that high in the sky? To find out when and where these occur, we must take up the question of range. When the satellite is just on our horizon (unless the horizon is obscured by a mountain or building) the ground station is at the 90-degree corner of a right triangle, the other two corners of which are the center of the earth and the satellite. The useful information to be drawn from this triangle is the angle between the lines joining the center of the earth with the other two corners. This angle defines the maximum range at which the satellite is visible on the horizon, and its value can be used to calculate the equator crossing longitudes of orbits that will carry the satellite inside a "range circle" that's centered on the ground station and has a radius of that dimension.

If the ground station were on the equator, we could merely add and subtract the range angle to the index points to derive the "window" through which every satellite would have to pass to come into ground station range. For ground stations off the equator — at latitudes greater than zero — the range window widens. Without getting into complicated spherical geometry, it's possible to estimate the width between eastern and western equator crossings at the range limits by dividing the range angle by the cosine of the station latitude, and adding and subtracting the resulting value to the previously calculated index points.

Using the RS-8 satellite and the ground station of the earlier example, the range angle is 37.7 degrees.\* Dividing this by the cosine of 40 degrees widens this angle to 49.2 degrees. Adding and subtracting this gives limits of 32.3 degrees and 130.7 degrees, and provides a fair approximation of where ascending equator crossings will bring the satellite within range of this ground station. The same operation on the other index point gives a set of limits for descending orbits in terms of the longitude of ascension. For this station they are 194.3 degrees and 292.7 degrees west longitude.

The true boundaries of equator crossings are slightly beyond these calculated values, but the

mathematics becomes too involved to make their determination worthwhile. Also, this simple scheme develops gross inaccuracies as the location of the ground station exceeds latitudes greater than about 60 percent of the maximum satellite latitude. Stations in higher latitudes need to use a different approach.

### which satellites are in range?

Having established the edges of our own personal index windows, we now need a list of all the satellite equator crossings to see which of them will be in range. Lists showing all equator crossing longitudes and times for ascending orbits are available, but they are predictions, made months into the future, and tend to require corrections when the actual date arrives. Here is a simple technique, using an ordinary pocket calculator, for getting the same information from more correct reference orbit data broadcasts by W1AW and the AMSAT nets. If your calculator has a memory capable of storing an eight-digit constant, it can handle this procedure.

The idea is to combine the two values — time and longitude — into a single multiple digit value that can be repeatedly added to the initial reference data to yield successive orbital data. Again using data for RS-8, the satellite has a period of 119.7 minutes and an increment of 30.07 degrees. Combine these two values into a single expression and enter it into the calculator's memory. Make this value 199.70301 (why it's not 119.70301 will be explained later — see **calculator values**). Note that the increment has been rounded off to stay within eight digits.

Assuming that the reference data for RS-8 this day is 00:42:36 (hours:minutes:seconds) at longitude 260.4 degrees west, enter these two items as a single value (42.62604) and add the constant to get 242.32905. This can be mentally separated to be 2 hours, 42.3 minutes at longitude 290.5. Add the constant again and get 442.03206, 4 hours, 42.0 minutes at 320.6 degrees longitude. Add the constant once more and get 6 hours, 41.7 minutes at 350.7 degrees west longitude. The next addition comes to 841.43808, but since the longitude portion exceeds 360 degrees, merely subtract 0.036 and you find that this orbit ascends the equator at 8 hours, 41.4 minutes at 20.8 degrees west. You can continue to develop data for each successive orbit. Should the minutes value of the time come out between 60 and 99, merely subtract 40.0 and you have a correct value and can continue. In fact, you can even subtract 2400.0 when the time exceeds 2359 and continue on into the next day if you don't have new reference data for that day. If you go on too far, of course, the inaccuracies of rounding will build up.

---

\*The angle is equal to arc cosine  $[R/(R + H)]$ , where  $R = 6371$  km and  $H = 1680$  km.

# HOBBY KITS®

EXPERIMENT — LEARN ELECTRONICS  
 BUILD AND DESIGN YOUR OWN AM, FM, CW,  
 OR SSB RECEIVERS, TRANSMITTERS AND ETC.  
 WITH OUR MINI-LINEAR CIRCUIT KITS

All kits Come Complete With Etched and Drilled Circuit Boards  
 and All Parts Needed To Function As Described

|                                                                            |         |
|----------------------------------------------------------------------------|---------|
| AFA-1 AUDIO AMP, LM-380 1-2 Watts 4-16 OHM Output .....                    | \$4.95  |
| AFP-1 AUDIO PREAMP, Dual Audio Preamp — For Mike Etc .....                 | \$3.95  |
| BMD-1 BAL. MIX, LM 1496 Mixer — S.B. Modulator Tuned Output .....          | \$9.95  |
| DET-1 AM DET, Am Envelope Detector With AGC Output .....                   | \$3.95  |
| DET-2 FM DET, LM 3065 FM Detector (455 KHZ or 4-11 MHZ) .....              | \$7.95  |
| DET-3 SSB DET, LM 1496 SSB Detector (Needs OSC-1 or OSC-4) .....           | \$9.95  |
| IFA-1 IF AMP, CA 3028 30 DB Gain, Optional AGC (455 KHZ or 9-11 MHZ) ..... | \$6.95  |
| FLS-9 SSB FILTER 9 MHZ/2.1 KHZ BW with USB XAL for OSC-1 .....             | \$49.95 |
| IFA-2 IF AMP, CA 3028 30 DB Gain 1-100 MHZ Optional AGC .....              | \$6.95  |
| MBA-1 FREQ. MULT, Tuned Output Buffer-Mult. Amplifier To 250 MHZ .....     | \$5.95  |
| OSC-1 CRYSTAL OSC, 100 KHZ — 20 MHZ Not Tuned (Less XAL) .....             | \$3.95  |
| OSC-2 CRYSTAL OSC, Ov. 18-200 MHZ Tuned Output (Less XAL) .....            | \$4.95  |
| OSC-3 VARIABLE FREQ OSC, Varactor Tuned 455KHZ + 10% Tuning .....          | \$5.95  |
| OSC-4 VARIABLE FRFY OSC, Varactor Tuned 4-11 MHZ .....                     | \$5.95  |
| PSV-1 POWER SUPPLY, LM 723 With Pass Transistor, 3 amps max .....          | \$7.95  |
| PLL-2 TONE DETECTOR, LM567 PLL Tone Detector (Two For Touch Tone) .....    | \$5.95  |
| RF/MIX-2 RF-AMP/MIXER, 3N204 Tuned RF AM/Mixer 1 — 250 MHZ .....           | \$7.95  |

## MANY OTHER MODULES AVAILABLE

SEND \$2.00 FOR FULL CATALOG  
 WITH CIRCUIT DIAGRAMS AND  
 TYPICAL RECEIVER AND  
 TRANSMITTER HOOK-UPS

COMPLETE SET OF MODULES TO BUILD A  
 1-WATT SSB/CW MONO-BAND TRANSCIEVER  
 LESS CASE, CONTROLS, PWR SUPPLY  
 (12 VDC), SPK AND MIKE

\$149.95 (Specify Band)

**MORNING DISTRIBUTING CO.**

P.O. BOX 717, HIALEAH, FLA. 33011

✓ 168

## Computer Program Books for Beginners

### Color Computer

**101 Color Computer Programming Tips & Tricks**, learn-by-doing instructions, hints, secrets, shortcuts, techniques, insights, for TRS-80 Color Computer. 128 pages. **\$7.95**

**55 Color Computer Programs for Home, School & Office**, practical ready-to-run software with colorful graphics for TRS-80 Color Computer. 128 pages. **\$9.95**

**55 MORE Color Computer Programs for Home, School & Office**, sourcebook of useful type-in-and-run software with exciting graphics, for TRS-80 Color Computer. 112 pages. **\$9.95**

### Pocket Computer

**Pocket Computer Programming Made Easy**, new fast 'n easy way to learn BASIC, make your computer work for you. For TRS-80, Sharp, Casio pocket computers. 128 pages. **\$8.95**

**101 Pocket Computer Programming Tips & Tricks**, secrets, hints, shortcuts, techniques from a master programmer. 128 pages. **\$7.95**

**50 Programs in BASIC for Home, School & Office**, sourcebook of tested ready-to-type-in-and-run software for TRS-80 and Sharp pocket computers. 96 pages. **\$9.95**

**50 MORE Programs in BASIC for Home, School & Office**, ideal source for lots more useful software for TRS-80 and Sharp pocket computers. 96 pages. **\$9.95**

Please add \$2.00 for shipping and handling.

Allow 2-4 weeks for delivery.



SEND TO: HAM RADIO'S BOOKSTORE  
 GREENVILLE, NH 03048  
 (603) 878-1441

By comparing the longitudes of equator crossings with the limits you have computed for your two index windows, you can select those which will pass within the range of your station and establish the time that each will pass your latitude. The elapsed time from equator crossing to arrival at your latitude will be the same whether the equator crossing is such that the bird passes overhead or only out near the limits of your range. When the pass is directly overhead, you can expect the duration of visibility to be twice the range (degrees) divided by the velocity (degrees per minute). For OSCAR 8 this is 16.7 minutes ( $2 \times 29.1 \div 3.49$ ). For the RS birds this duration is 25 minutes ( $2 \times 37.7 \div 3.0$ ). When the pass is halfway between the station and the range limit, the duration is 85 percent of the overhead value; at the range limit, it may be only a minute or less.

A helpful exercise in developing your understanding of how the satellite moves through any portion of your range circle is to place your great circle marker on your globe at various longitudes within the index window and note the path it defines as it comes into and leaves your range circle. For stations in the Northern Hemisphere this track causes the RS birds to depart off to the northeast on ascending orbits and to arrive from the northwest on descending orbits. For OSCAR 8 the opposite relationship results from the difference in inclination angle, its having an angle of inclination 9 degrees greater than 90, while the Russian orbits are 7 degrees less than 90 (see fig. 1). By attaching a length of string to your globe at the station location and tying a knot at a distance representing the range limit, you can obtain an excellent graphical representation of your range limit. Note that the length to the knot can be measured in either latitude degrees or in longitude degrees at the equator.

### calculator values

By making the constant for the period and increment that value given earlier, you are simultaneously adding two hours and subtracting a few minutes to the mixed hours and minutes expression. Occasionally, when the minutes value is small, the result comes out a few minutes less than 99 when it should be the same number of minutes less than 59. Subtracting 40 minutes fixes it up.

No doubt a home computer with satellite locating programs can provide more exact information, but satisfactory operation can be achieved using the simple methods described here. For almost ten years I have tracked the satellites — and had hundreds of QSOs — using only my globe, a rubber band, some string, and a hand calculator.

ham radio

**Our 4th Year**  
**BUY • SELL**  
**TRADE**  
**ELECTRONICS**

**NUTS & VOLTS**  
 HAM GEAR  
 COMPUTERS  
 SOFTWARE  
 SCANNERS • OPTICS  
 TEST EQUIPMENT  
 MICROWAVE  
 SATELLITE  
 AUDIO VISUAL  
 NEW PRODUCTS  
 COMPONENTS • KITS  
 ANTIQUE ELECT.  
 PUBLICATIONS  
 PLANS • SERVICES

IN  
**NUTS & VOLTS**  
**The Nation's #1 Electronic**  
**Shopper Magazine**

PO BOX 1111-H • PLACENTIA, CA 92670  
 (714) 632-7721

Join 1000's of Readers Nationwide  
 Each Month ✓ 172

**U.S.A. SUBSCRIPTIONS**  
 \$ 7.00 - 1 YEAR 3RD CLASS MAIL  
 \$12.50 - 1 YEAR 1ST CLASS MAIL  
 \$25.00 - LIFETIME - 3RD CLASS MAIL

With Free Classified Ad

**RADIO EXPO**

sponsored by

**Chicago FM Club**

**September 24 & 25**

**Lake County Fairgrounds**  
**Grayslake, Illinois**

Flea Market  
 Major Manufacturer Exhibits  
 Tech talks - Seminars - Ladies' Programs

Tickets good for both days  
 \$3.00 advance - \$4.00 at gate

SASE TO  
**RADIO EXPO '83**  
 Box 1532  
 Evanston, IL 60204  
 (312) 582-6923

**ATTENTION**  
**DEALERS!**

Interested in  
 making a PROFIT?

Sell our magazine in  
 your store with  
**100% Return Privileges**

Rose will tell  
 you how —

**CALL 1-603-878-1441**

**The Ham Radio**  
**Publishing Group**

Greenville, NH 03048

**BUTTERNUT**  
**ELECTRONICS**  
**COMPANY**



**THE**  
**WINNERS**

Model HF6V. Completely automatic bandswitching 80 through 10 plus 30 meters. Outperforms all 4- and 5-band "trap" verticals of comparable size. Thousands in use worldwide since December '81! 160 meter option available now; retrofit kits for remaining WARC bands coming soon. Height: 26 ft/7.8 meters; guying not required in most installations.

Model 2MCV "Trombone" — omnidirectional collinear gain vertical for 2 meters having the same gain as "double-A" types, but the patented "trombone" phasing section allows the radiator to remain unbroken by insulators for maximum strength in high winds. No coils "plumber's delight" construction and adjustable gamma match for complete D.C. grounding and lowest possible SWR. Height: 9.8 ft/2.98 meters.

Model 2MCV-5 "Super Trombone" — Same advanced features as the basic 2MCV but a full wavelength taller with additional "Trombone" phasing section for additional gain. Height: 15.75 ft/4.8 meters.

All BUTTERNUT ANTENNAS use stainless steel hardware and are guaranteed for a full year. For further information on these and other BUTTERNUT products write for our FREE CATALOG!

**BUTTERNUT**  
**ELECTRONICS**  
 405 E. MARKET STREET  
 LOCKHART, TX 78644

**NEW**

THE



**AMATEUR RADIO**  
**CALL**  
**DIRECTORY**

A new publication from the league which lists in callsign order the addresses of all FCC licensed radio amateurs in the United States and possessions. It also includes a separate listing of all club stations.

**ONLY \$15.75 POSTPAID**

(\$19.75 in Canada and Elsewhere including shipping by surface mail)

Enclosed is \$ \_\_\_\_\_ in U.S. funds or charge \_\_\_\_\_ MASTERCARD \_\_\_\_\_ VISA \_\_\_\_\_ American Express for \_\_\_\_\_ copies of the ARRL Amateur Radio Call Directory(s).

Name \_\_\_\_\_ Call \_\_\_\_\_

Address \_\_\_\_\_

City \_\_\_\_\_ State/Prov \_\_\_\_\_

Zip/Postal Code or Country \_\_\_\_\_

Charge Number \_\_\_\_\_

Good from \_\_\_\_\_ to \_\_\_\_\_

Signature \_\_\_\_\_

THE AMERICAN RADIO RELAY LEAGUE  
 225 MAIN ST.  
 NEWINGTON, CT 06111

**THE AFFORDABLE REPEATER**  
FROM THE MANUFACTURER OF COMMERCIAL &  
MILITARY EQUIPMENT MADE IN USA AT OUR  
MIAMI, FLORIDA PLANT



**\$699.\*** Basic Price

**FEATURES:**

- Several Frequency Ranges  
30-50 MHZ, 132-172 MHZ,  
200-240 MHZ, 380-480 MHZ.
- Sensitivity .3 Microvolt 12 DB S/N
- Power Output 30 Watts.
- Four Pole IF Filter.
- Complete separate transmitter  
and Receiver
- 13.6 VDC or 115/220 UAC  
Power Supply.
- 19" Rack Mounting.

**OPTIONS**

- Helical Filter Installed \$65.00.
- 8 Pole Filter Installed \$20.00.
- Cooling Fan Installed \$30.00.
- Duplexer
- Deluxe Cabinets
- Timer
- Tone Panel

**OTHER PRODUCTS**

- Simplex and Full Duplex
- VHF/UHF Mobiles and Bases
- Rural Radio Telephone
- Auto Patch
- HF SSB Transceiver
- Catalogues available upon request

**DEALER INQUIRIES INVITED**

ITS International Telecommunications Systems Florida Inc.

8416 N.W. 61 ST. / MIAMI, FLORIDA 33166  
TEL: (305) 593-0214 / TELEX: 525834

**Attn: Recruiters**

**Expose Your  
Recruitment Ads  
to the most  
Technical  
Audience of Radio  
Hams Available**

**Here's how**

Are you looking for a technically qualified person and find that few are available locally? Broaden your search by running an ad in HAM RADIO Magazine. HAM RADIO's readers are the most technically qualified. Over 60% are actively involved in one or more areas of the electronics industry. Their skills range from bench technician to design engineer. Here are some of the benefits from running an ad in HAM RADIO Magazine.

- National coverage at an affordable price
- Specially segmented audience
- Active Hams who do more than just read about electronics — they participate in it

Call today for more information about placing an ad in HAM RADIO. *Get the person you want!*

**CALL TODAY**  
**(603) 878-1441**  
Ham Radio  
Box 0  
Greenville, NH 03048

Tell 'em you saw it in HAM RADIO!

153



C-1000-DW  
\$337.59

**Organize your shack with a  
CLUTTERFREE MODULAR  
CONSOLES**

**Prices start at \$169.92**

- 9 Models to choose from
- Large, 42" H X 57" W X 30" D
- Strong groove - construction
- Mar-resistant wood grain finish
- Options, drawers & face plate
- For ham or home computer
- Visa and Master Charge

**CLUTTERFREE  
MODULAR  
CONSOLES**

P.O. Box 5103 Tacoma, WA. 98405  
(206) 272 0713

124

**MOVING?**  
**KEEP HAM RADIO COMING...**

If possible let us know four to six weeks before you move and we will make sure your HAM RADIO Magazine arrives on schedule. Just remove the mailing label from this magazine and affix below. Then complete your new address (or any other corrections) in the space provided and we'll take care of the rest.

**ham  
radio**  
Magazine

Greenville, NH 03048

Allow 4-6 weeks for correction.

Thanks for helping us to serve you better.

Here's my new address:

Call \_\_\_\_\_ Zip \_\_\_\_\_  
Name \_\_\_\_\_ State \_\_\_\_\_  
Address \_\_\_\_\_ City \_\_\_\_\_

**AFFIX  
LABEL  
HERE**



## RADIO DIRECTION FINDER The SuperDF

Inexpensive kit and assembled units for use with Hand-Held, Mobile, or Base Station. 100 to 260 MHz or 200 to 550 MHz with one antenna. Non-ambiguous. No overloading. Use with unmodified HT, scanner, or transceiver. No attenuator or "S" meter needed. Can DF signals below the noise. Averages out local reflections while mobile-in-motion. Used by FCC, US Army, State of California, Coast Guard Aux. Prices start at \$125. For details send SASE to; BMG Engineering, 9935 Garibaldi Ave, Temple City, Cal, 91780

✓ 116



### FCC LOWERS REQUIREMENTS — GET YOUR RADIO TELEPHONE LICENSE

FCC changes make obtaining a High-level Radio Telephone License much easier now. Eliminate unnecessary study with our short-cuts and easy to follow study material. Obtaining the General Radio Telephone License can be a snap! Sample exams, also section covering Radar Endorsement.

A small investment for a high-paying career in electronics.

**\$19.95 ppd.**

Satisfaction Guaranteed

**SPI-RO DISTRIBUTING**

P.O. Box 1538

Hendersonville, N. C. 28793

✓ 183

## Fiendishly ingenious devices!

Free catalog of "Hard-to-Find Tools"



Most of the tools you find in a hardware store are made with ordinary quality, for doing ordinary jobs. Brookstone's famous "Hard-to-Find Tools" are extraordinary in their craftsmanship and utility — made to do the job right. And everything we sell is **guaranteed for life**. Send for your free catalog today!

Send me Brookstone's FREE 68-page catalog.

Name \_\_\_\_\_  
Address \_\_\_\_\_  
City \_\_\_\_\_  
State \_\_\_\_\_ Zip \_\_\_\_\_

**Brookstone**

70 Vose Farm Road Dept 981A  
Peterborough, New Hampshire 03458

✓ 119

# RTTY



### TU-470

- Full featured RTTY to 300 baud plus CW terminal unit.
  - 3 Shifts, active filters, remote control, xtal AFSK, FSK, plus much more.
- Suggested retail price...\$499.95



### TU-170A

- Single shift RTTY terminal unit.
- Xtal AFSK, FSK, active-filters and more.

Kit **\$189.95**  
wired \$289.95



### TU-170

- Single shift RTTY terminal unit.
- Low cost, AFSK, active-filters.

**\$149.95**  
(Kit only)



### TRS-80\* RTTY/CW

ROM-116 Interface for model I, III, IV (16K MIN). All standard Baudot & ASCII rates to 1200 baud. Text editing, auto CW/ID, split screen, RTTY art, & much more. Proven reliable & available on tape or disk. Disk MAILBOX software available too. Call or write for more details & special prices.

\*Trademark of TANDY CORP.

SALES ONLY

**1-800-HAM-RTTY**



**Flesher Corporation**

P.O. BOX 976  
TOPEKA, KS. 66601

✓ 137

## 2 for 1 Performance from MIRAGE

Dual-purpose power  
amplifiers for  
HT and XCVR!



- 1-10 Watts Input
- All-mode operation
- 5 year warranty

model:

**B1016 (2 meters)**

1W In = 35W Out

2W In = 90W Out

10W In = 160W Out

with RX preamp!

\$279.95

**C106 (220 MHz)**

1W In = 15W Out

2W In = 30W Out

10W In = 60W Out

with RX preamp!

\$199.95

**D1010 (430-450 MHz)**

1W In = 20W Out

2W In = 45W Out

10W In = 100W Out

\$319.95

There's more, and  
WATT/SWR Meters, too!  
See your nearest Dealer

**MIRAGE  
MIRAGE  
MIRAGE**  
COMMUNICATIONS EQUIPMENT, INC.  
P.O. Box 1393  
Gilroy, CA 95020  
(408) 847-1857  
**made in U.S.A.**

✓ 167

**\$15 DTMF DECODER \$15**

The LJM2RK decoder kit converts your receiver into a special receiver or control. When a user-selected time-tone combination is received, the output provides a relay control for activating speakers or other devices.

INPUT: Audio from transceiver, scanner, etc.  
OUTPUT: SPST (N.O.) relay.

FEATURES: Single or dual tones adjustable over the 16 digit Touch Tone range • Adjustable response time • Relay output • Manual or auto reset • Single tone ON latching with different single tone reset OFF • Operates on 12VDC • Interfacing of multiple boards for multi-digit sequential activation and reset.

APPLICATIONS: Call-up system • Repeater or commercial controls • Etc. limited only to your imagination •

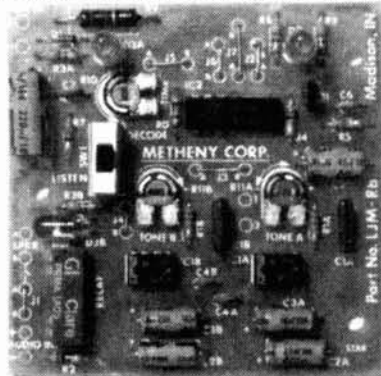

Actual Size 3"x3" - Shown Assembled

LJM2RK decoder kit includes all component, relay, and P.C. Board. . . \$15 plus \$1.50 shipping.

LJM2RC enclosure kit includes molded case, speaker, input cable. . . \$5 plus \$1.50 shipping.

For information and to order write:

**THE METHENY CORPORATION**  
204 Sunrise Drive, Madison, IN 47250

**Barry Electronics**  
**Your One-Stop Electronic Supermarket**

Barry is New York City's largest stocking Ham Dealer. From accessories to transceivers — Barry has it all. Barry also carries commercial and business band radio equipment and systems.

When in town, come on down. Barry is easy to get to by either subway or bus. Don't pay uptown prices!

Barry is also as close as your phone or telex machine. Contact us today for the *best buys* in Amateur Radio.

**BARRY ELECTRONICS CORP.**  
**512 BROADWAY**  
**NEW YORK CITY, NY 10012.**  
**212-925-7000 TELEX 12-7670**

OPEN 7 DAYS A WEEK.

Monday-Friday 9 to 6:30 PM  
Saturday & Sunday 10 to 5 PM

**CABLE CONVERTER SALE**

MAGNAVOX FV-25 - 26 CHANNEL WITH REMOTE CONTROL - VHF-MIDBAND-SUPERBAND - REG \$59.95 - NOW **\$49.95**

JERROLD JSX-30IC - 36 CHANNEL WITH IN BAND GATED SYNC DECODER - REG \$209.95 - NOW **\$149.95**

JERROLD SB-3 - IN BAND GATED GATED SYNC DECODER - USE WITH ANY CONVERTER WITH OUTPUT ON CHANNEL 3 - REG \$149.95 - NOW **\$99.95**

UHF BLOCK CONVERTER - CONVERTS MIDBAND AND SUPERBAND TO UHF - REG \$39.95 - NOW **\$26.95**

SEND **\$1.00** (REFUNDABLE) FOR CATALOG

ADD **\$4.25** SHIPPING/HANDLING FOR EACH UNIT ORDERED

NYS ADD SALES TAX - C.O.D.'S OK

24 HOUR ORDER LINE  
(607) 962-7313

ORDER DIRECT FROM -

**TAYCO COMMUNICATIONS**  
R3-146A NARROWS CREEK ROAD  
CORNING, NEW YORK 14830 **185**

**SOLID T.V.R.O. HARDWARE AT ROCK BOTTOM PRICES!**

**SYSTEM A**  
DEXCEL (GOULD) 1100 D2, 100° L.N.C. POLAROTOR I, CONTROL, 11' A.D.M. ANTENNA, TRI-POD POLAR MOUNT, 125' CABLE PACKAGE, JUMPER, BALUN **ONLY \$2195.00**

**SYSTEM B**  
SAT-TEC R-5000, DEXCEL 100° L.N.A. MODULATOR, POLAROTOR I, CONTROL, 8' SPUN ALUMINUM ANTENNA, POLAR MOUNT, 125' CABLE PACKAGE, JUMPERS, BALUN **ONLY \$1395.00**

OTHER SYSTEMS AND COMPONENTS AVAILABLE AT OUR VERY LOW PRICES! INSTALLATION, VIDEOTAPE RENTAL SERVICE IMMEDIATE SHIPMENT! ALL ORDERS FREIGHT/POSTAGE COLLECT. PRICES SUBJECT TO CHANGE WITHOUT NOTICE.

YES, I AM KNOWLEDGEABLE ABOUT SATELLITE T.V., I'VE COMPARED HARDWARE AND PRICES AND AM VERY IMPRESSED WITH YOUR OFFER! PLEASE SEND ME

SYSTEM A  SYSTEM B  FREE PRICE LIST

ENCLOSED IS MY  CHECK  M.O. FORS \_\_\_\_\_

MY NAME IS \_\_\_\_\_

MY ADDRESS IS \_\_\_\_\_

CITY \_\_\_\_\_ STATE \_\_\_\_\_ ZIP \_\_\_\_\_

TELEPHONE NUMBER \_\_\_\_\_ DATE \_\_\_\_\_



**1-602-445-0383**

MAILING ADDRESS: P.O. BOX 449  
PRESCOTT, ARIZONA 86302

**WARNING**  
**SAVE YOUR LIFE OR AN INJURY**

Base plates, flat roof mounts, hinged bases, hinged sections, etc., are not intended to support the weight of a single man. Accidents have occurred because individuals assume situations are safe when they are not.

Installation and dismantling of towers is dangerous and temporary guys of sufficient strength and size should be used at all times when individuals are climbing towers during all types of installations or dismantlings. Temporary guys should be used on the first 10' or tower during erection or dismantling. Dismantling can even be more dangerous since the condition of the tower, guys, anchors, and/or roof in many cases is unknown.

The dismantling of some towers should be done with the use of a crane in order to minimize the possibility of member, guy wire, anchor, or base failures. **Used towers in many cases are not as inexpensive as you may think if you are injured or killed.**

Get professional, experienced help and read your Rohn catalog or other tower manufacturers' catalogs before erecting or dismantling any tower. A consultation with your local, professional tower erector would be very inexpensive insurance.

**Paid for by the following:**

**UNR-Rohn**  
Division of UNR, Inc.  
6718 West Plank Road  
Peoria, Illinois 61601  
USA

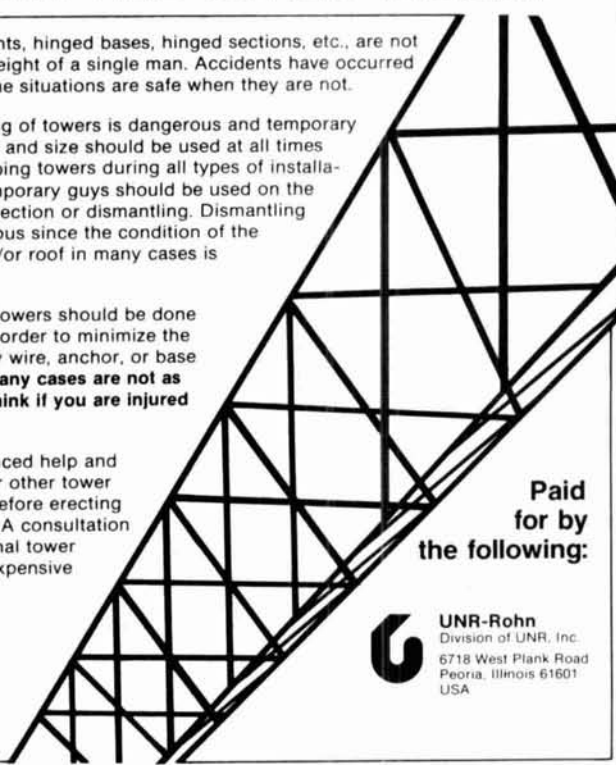

**BUY! SELL! TRADE!**

COMPUTER & HAM EQUIPMENT

**COMPUTER TRADER**

**ANNUAL SUBSCRIPTION \$15.00**

Low Ad Rates — Mailed Monthly  
Foreign Subscriptions - \$30.00 Year  
FREE 50 Word Classified Ad with Subscription Order

**COMPUTER TRADER**

Chet Lambert, W4WDR  
1704 Sam Drive • Birmingham, AL 35235  
(205) 854-0271

Sample Copy — \$1.00

# working W5LFL from space

All you'll need is ten watts and an antenna  
— and lots of luck.

**So you want to work an astronaut from space?** You'll have your chance when Dr. Owen Garriott, W5LFL, begins transmitting from the space shuttle *Columbia* on the third day of the nine-day mission scheduled for launch September 30.

Details of the flight plan, are still being worked out. As of this writing, transmission is expected to be within the range of 145.51 to 145.77 MHz, with 145.55 the primary channel (downlink). Using split operation, W5LFL will listen between 144.91 and 145.09 MHz, stepping in 20 kHz increments. (Stay tuned to AMSAT nets and W1AW for specifics. Newsletters will also provide details as the launch date approaches.)

NASA has mapped out a flight path that takes the *Columbia* over the most heavily populated areas of the earth. In ascending orbit, the ship will appear over the southwest horizon of the United States and follow a gentle curve towards the northeast, its path dividing the contiguous United States into four areas corresponding roughly to the time zones. Tracking data is being compiled for release by AMSAT.

Flying at 17,000 miles per hour at an altitude of approximately 200 statute miles, Garriott will have line-of-sight for about 1,000 miles. He'll be radio-visible for a *maximum* of eight minutes over any given point.

Based on experience with OSCAR, AMSAT tells us we can expect to receive full quieting signals while the ship is passing overhead — even on a hand-held radio with a rubber-duckie antenna. Transmission may not be as simple; you'll need ten watts and a gain antenna — and lots of luck — to stand a chance of being heard by W5LFL.

ing heard by W5LFL.

Garriott will operate from the aft flight deck of the

*Columbia*, using a specially-built transceiver operating at 5 watts. His split-ring antenna, housed in a window overlooking the European-built Space Lab, will give him line-of-sight perspective to earth during most of the flight.

Astronauts work a schedule of twelve hours on, twelve hours off. Garriott has NASA's OK to operate up to one hour per day during his free time, most likely on either end of his eight-hour sleep; he'll tell Mission Control when he's ready to operate. Club stations at each NASA site will pass the word to other Amateurs; those of us on earth can expect about 35 to 40 minutes' notice.

Once he begins operating, Garriott will transmit on the even minutes and listen on the odd minutes. During transmission, he'll state his location, then identify call areas for which he'll be standing by, and finally begin acknowledging calls he's been able to log.

NASA recommends that amateurs wishing to contact W5LFL transmit *only* their calls during the odd minutes. Just fifteen to twenty orbits at most are expected to be effective, and on each pass, no more than a few dozen earth stations can be worked. If you call but are not acknowledged, don't give up hope: Garriott will tape record all Amateur activity and the resulting tapes will be used as a log for QSLing after completion of the mission. (Attention DX'ers: W5LFL does *not* count as another country!)

September is a good time to clean up that 2-meter equipment. So clean it up, follow the news closely, and get ready to make history . . . as one of the lucky ones to make contact with "W5LFL from Columbia" this fall.

ham radio

by Roy Neal, K6DUE, Senior Correspondent,  
NBC Network News.

# Nampa Satellite SYSTEMS

IDAHO'S LARGEST DEALER

"HAMS SERVING HAMS"

Lowest prices in TVRO  
INTRODUCING  
The NSS 80A

.45 F/D Spun Aluminum Dish  
weighs only 60# - True polar-  
mount - Quadpod Feed.

— COMPLETE —

|                        |        |
|------------------------|--------|
| SAT-TEC R5000          | \$1350 |
| KLM Sky Eye IV         | 1495   |
| Universal Comm. DL2000 | 1495   |
| AUTO-TECH GLR 500      | 1595   |
| DRAKE ESR 224          | 1595   |
| DEXCEL DXP 1100-stereo | 1750   |
| DRAKE ESR 24           | 1795   |
| Luxor-Stereo           | 1850   |

All packages include: 8' Spun  
Aluminum Dish, Polar mount,  
Polarotor II Polarizer, 110° K LNA,  
modulator and 100' cables.

— PRODELIN —

10' Dish - .3 F/D - 8 panels - The  
Ultimate in TVRO Dishes.

— COMPLETE —  
SYSTEM PRICES

|                                           |      |
|-------------------------------------------|------|
| SAT-TEC                                   | 1475 |
| KLM Sky Eye IV                            | 1730 |
| Universal Comm. DL2000                    | 1730 |
| AUTO-TECH GLR 500                         | 1750 |
| DRAKE ESR 224                             | 1895 |
| AUTO-TECH GLR 520                         | 1950 |
| DRAKE ESR 24                              | 1995 |
| DEXCEL DXR 1100<br>with LNC - stereo      | 2095 |
| AUTO-TECH GLR 560                         | 2025 |
| LUXOR STEREO, Infra-Red<br>remote control | 2125 |

All packages include 110° K LNA (or  
LNC), 100' Cable, Modulator, Polar-  
mount, Polarotor II Polarizer.

DEALERSHIPS AVAILABLE

NATIONAL FINANCING  
AVAILABLE WITH AS LITTLE AS  
10% DOWN (O.A.C.)

CALL TOLL FREE  
1-800-654-0795

for info or ordering  
312 12th Avenue South  
Nampa, Idaho 83651

WB6TOC (208) 466-6727 K17D

## TOWERS by ALUMA

HIGHEST QUALITY  
ALUMINUM & STEEL

60 Ft. Alum. TELESCOPING (CRANK-UP)  
Crank-Up GUYED (STACK-UP)  
Model T-60-H TILT-OVER MODELS  
Easy to install. Low Prices.  
Crank-ups to 100 ft.

EXCELLENT FOR  
AMATEUR COMMUNICATIONS

Mobile Trailer Type



40' Steel  
Crank-Up  
Model SHO-40

Mobile Truck Type



Over 36 types aluminum  
and steel towers made—  
specials designed and  
made—write for details

Fixed Base



SPECIAL  
Four Section 50 Ft.  
Van Mounted Crank-Up  
Aluma Tower

ALUMA TOWER COMPANY

BOX 2806HR  
VERO BEACH, FLA. 32960-2806  
(305) 567-3423 TELEX 90-3405

108

## TS430S FILTER DEAL

For superior performance at lower cost, use  
top-rated 8-pole Fox Tango crystal filters to fill  
the optional spots in your rig. For example,  
our 1800 Hz FT2808 equivalent of the YK88SN  
has a 60/6dB shape factor of 1.7 compared  
with 2.0, a price of \$55 vs \$63, and squarer  
shoulders at the top with steeper skirts all the  
way down to more than -80dB.

For more pleasant audio use our 2100 Hz for  
SSB and/or our 6000 Hz for AM. For CW, our  
400 Hz unit is better than the YK88C, while our  
250 Hz is sharper than the YK88CN. The more  
you buy, the more you save!

**BIGGER IS BETTER!**

Fox Tango filters are better because of their  
*discrete crystal* (not monolithic) construction.  
This makes them slightly larger than YK filters  
so they are patched into the circuit with short  
lengths of coax. Installation is easy — no drill-  
ing or circuit changes. Order with confidence.

**INTRODUCTORY PRICES — Complete Kit**

Any ONE filter ..... \$55  
Any TWO filters ..... \$100 (Save \$10)  
Any THREE filters ..... \$145 (Save \$20)

Includes all needed cables, parts, detailed in-  
structions. Specify the type(s) desired.

AM — FT2811 (6000 Hz Bandwidth)

CW — FT2801 (250 Hz); FT2802 (400 Hz)

SSB — FT2808 (1800 Hz); FT2809 (2100 Hz)

Shipping \$3 per order. (\$5 air) FL Sales Tax 5%

**ONE YEAR WARRANTY**

**GO FOX-TANGO—TO BE SURE!**

Order by Mail or Telephone.  
AUTHORIZED EUROPEAN AGENTS

Scandinavia MICROTEC Makedien 26  
3200, Sandefjord, NORWAY  
Other INGOIMPEX, Postfach 24 49  
D-8070, Ingolstadt, W. GERMANY



138

**FOX TANGO CORPORATION**  
Box 15944 H, W. Palm Beach, FL 33416  
(305) 683-9587

# Radio Handbook

by Bill Orr

NEW 22nd EDITION

The Radio Handbook  
has been a best seller for  
over 45 years. This  
brand-new edition covers  
in complete detail all of  
the latest state-of-the-art  
advances in electronics.  
Hams and engineers alike  
will find this handy,  
single-source reference an  
invaluable aid. Chock-  
full of projects from sim-  
ple test equipment to  
complex receivers and  
amplifiers. Chapters in-  
clude an explanation of  
Amateur Radio commu-  
nications, electronic and  
electrical theory, tubes  
and semiconductor de-  
vices; a special chapter  
on RFI and more . . .  
This invaluable book is a  
must for every ham-  
shack. Order yours  
today and save. 1136  
pages. ©1982 □21874

~~\$34.95~~

**SPECIAL \$29.95**

Please add \$2.00 for shipping and handling.

ham radio's  
**BOOKSTORE**  
Greenville, NH 03048

# technical forum

*Have a technical question?* Ask your fellow Amateurs through Technical Forum. You'll reach knowledgeable readers ready to help you find the answer you're looking for. *Have an answer?* Send it in. Every month we'll award a specially selected book from Ham Radio's Bookstore to the writer of the best response to a question previously posed in this column. Address your questions and answers (typewritten, if possible) to Technical Forum, *ham radio magazine*, Greenville, New Hampshire 03048.

## efficient matching

Joe Czerniak, W8NWU, asked for "the most efficient way" of feeding a 432 MHz helical antenna with 70 ohm cable from a 50 ohm source (Technical Forum, March, 1983). I assume that by "most efficient way" he meant the way resulting in the least power loss, not the way representing the best possible ratio between personal effort extended and the result achieved.

It seems to me that with the system having a relatively narrow bandwidth, then if effort is not a consideration, a 1/4 wave section of air-spaced coaxial should be constructed to match the unbalanced 140 ohm antenna to the unbalanced line. This should be constructed in the form of a trough, using the jacket of the 70 ohm cable as the outer strips to avoid having a connector (fig. 1A). The impedance of the trough section should be 99 ohms (the square root of the product of 140 and 70).

At the equipment end, the matching is best done in the converter, by arranging it to match directly to a 70 ohm feedline.

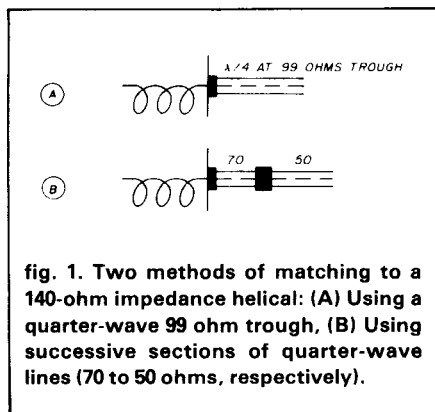

fig. 1. Two methods of matching to a 140-ohm impedance helical: (A) Using a quarter-wave 99 ohm trough, (B) Using successive sections of quarter-wave lines (70 to 50 ohms, respectively).

A more conventional way, using the connectors (while acknowledging their possible future problems), would be to match the antenna to the cable with two successive 1/4-wave sections (fig. 1B). It is a fortunate coincidence that a section of 70-ohm coaxial would transform from 140 to 35 (70 is the square root of the product of 140 and 35) and a section of 50 ohm coaxial would transform from 35 to 70 (50 is the square root of the product of 35 and 70). If the helical were a balanced antenna it would be interesting to note that a 140/balanced to 35/unbalanced balun could be built from the same cable used for the feedline.

If the idea of changing the converter input is not acceptable, a pair of nonsynchronous sections, one of 50 ohms and the other of 70 ohms, as described by K1XX in *ham radio* (September, 1978) would be nice. In the same issue, W7VK shows how to put a standard connector on the hardline cable. — **Bob Eldridge, VE7BS**

## rain static resolved

HB9FU's letter in July, 1983, Technical Forum recalls difficulty of reception of radio signals aboard aircraft flying through rainstorms. About 1948 an "anti-precipitation static" (APS) wire system began to appear on aircraft.

The wire for the antenna was single-strand copperweld covered with a tough insulation, much like the dielectric in RG-59/U. (In fact, take the outer cover and braid off RG-59/U and you have APS wire.)

While the system on aircraft uses

special nylon insulators to grip the wire or to tap off in a "Tee," the main idea is that no rain be allowed to get to the *wire conductor*. Simply stated, the conductor(s) are totally encapsulated.

The static is apparently caused by the charge a wire antenna picks up and the changing charges as the rain drips off.

If HB9FU can get to an airport and see a high-frequency antenna on an overseas aircraft, he'll get the picture — maybe he can also find out where he can obtain that kind of wire and insulators.

Anyway, as long as no part of the conductor is exposed, APS will almost totally disappear. — **Dave Walsh, W1FYX**

## LED puzzle

Can anyone tell me what's wrong with the first LED in my Kenwood TS590SE's digital display. It reads 1 on 80 to 40, 2 on 20 and WWV, and 3 on 15 or 10. Can you help? — **John E. Dunn, WB9JKV**.

## "hidden" antenna

I would like to correspond with anyone who has used, or is successfully using a "hidden antenna." — **Michael H. Landwehr, KE7T**, P.O. Box 4502 Huachuca City, Arizona 85616.

## Heath HX1681

I want to modulate my Heath HX1681 CW transmitter. Is a kit (or circuit) available? — **Robert Miller, W2UWO**

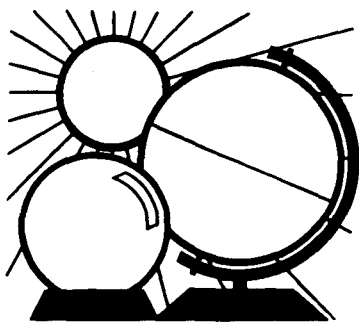

Garth Stonehocker, KØRYW

# DX FORECASTER

## last-minute forecast

The forecast for September emphasizes the end of summertime DX conditions with its longer daylight hours, increased short-skip openings during the sporadic-E season, and evening thunderstorm QRN. Fall DX conditions are quite different.

In the band-by-band summary below look for geomagnetic-ionospheric disturbances to increase (especially during 1983 and 1984); transequatorial openings to begin again; transpolar openings (gray-line DX) to occur near twilight; maximum usable frequencies to increase; and thunderstorm activity to change from airmass to frontal, with related QRN changes. Accompanying these changes, the lower hf bands (30, 40, 80, and 160 meters) are forecast to be best during the first two weeks of the month. Then the higher bands (30, 20, 15, and 10 meters) are expected to take over, providing excellent conditions considering this point in the 11-year sunspot cycle. Disturbed geomagnetics ionospheric conditions are probable on September 2-5th, 10-13th, 16-19th, and 23-25th.

The full moon will occur on September 22nd and its perigee on the 6th. The autumnal equinox will be on the 23rd at 1442 UT. No significant meteor showers are expected in September.

## solar cycle

It's time to check the decline of this solar cycle. April 1982's lower solar flux and sunspot number (SSN) values confirmed that the gradual downward trend of the cycle from the peak had begun (in February for SSN and April for solar flux). In September 1982 the SSN was recorded at 100.6. At present (June, 1983) a plateau has

been reached where it levels off before descending at a more leisurely rate to the minimum years of 1985 and 1986. The plateau is at approximately a SSN of 62 or flux value of 110. It is expected to remain constant through the winter months before decreasing again.

In July I mentioned that the critical frequency, foF2, the main variable of the maximum usable frequency (MUF), was nearly a linear function of SSN or radio flux and gave three representative values at mid-latitude. The foF2 (MUF equals approximately  $2.5 \times \text{foF2}$ ) variation is 0.0485 MHz per SSN value or 0.0557 MHz per flux value,  $\phi$ . The equations are:

$$\begin{aligned} \text{foF2} &= 0.0475 \text{ SSN} + 5.25 \\ \text{foF2} &= 0.0557 \phi + 1.8 \end{aligned}$$

where SSN is the 12 month smoothed sunspot number and  $\phi$  is the monthly mean solar flux. The 2.5 (in the parentheses) is the MUF factor, a geometric angular relationship formed by the distance between the transmitter and the receiver and the height of the ionosphere.

Daily foF2 show greater variation with daily solar flux values or five-day running mean SSN. These relationships will be provided in a future column.

## band-by-band summary

*Ten and fifteen meters* will be open to many areas of the world from morning until early evening hours many days. Geomagnetic disturbances will limit the number of signals heard, but listen carefully—they can be from very unusual places, particularly one-long-hop transequatorial DX. Fifteen meters should stay open later in the day than 10 meters. Operate 10 first and then move down to 15.

*Twenty meters* will be the main daytime DX band, as it is almost always open to some part of the world. It opens to the east as the sun rises and extends into the late evening hours to the west. Geomagnetic disturbances do not affect this band as much as 10 and 15 meters, but look for unusual transequatorial DX of 5,000 to 7,000 miles (8,000 to 11,200 km). These paths may be possible in the late evening hours during some of these unusual conditions.

*Thirty meters* is a day and night band. The day portion should be like 20 meters except that signal strengths may decrease during some middays. Days of decreasing strength are related to those having high solar flux values. This band can also be used well into the night, and often through the night; nights in which this doesn't hold true will most likely be those that follow very high solar flux days. The questionable periods are usually the hour or so before dawn. The workable distance may be expected to be greater than 80 meter DX at night and less than 20 during the day.

*Forty and eighty meters* will exhibit short skip conditions during daylight hours and lengthen after dark. The bands will open for DX to the east just before your sunset, swing more to the south toward Latin America about midnight, and end up in Pacific areas during the hour or so before dawn. On some nights these bands will have low QRN similar to the winter DX season conditions. Coastal regions usually have the edge for working rare DX on these bands. Look for transpolar openings on these bands. (See *ham radio*, September, 1982, p. 56.)

*One sixty meters* will probably have many nights that will remind you of last summer's noise. However, useful nighttime conditions aren't too far off. Propagation on 160 meters will approximate a shortened 80-meter condition.

ham radio

| GMT       | PDT   | WESTERN USA      |        |           |            |            |             |                      |       |
|-----------|-------|------------------|--------|-----------|------------|------------|-------------|----------------------|-------|
|           |       | N                | NE     | E         | SE         | S          | SW          | W                    | NW    |
| 0000      | 5:00  | 20               | 20     | 15        | 10         | 15         | 10          | 10                   | 15    |
| 0100      | 6:00  | 20               | 20     | 15        | 10         | 15         | 10          | 10                   | 15    |
| 0200      | 7:00  | 20               | 30     | 20        | 10         | 15         | 10          | 10                   | 15    |
| 0300      | 8:00  | 20*              | 30     | 20        | 15*        | 15         | 10          | 10                   | 15    |
| 0400      | 9:00  | 20               | 30     | 20        | 15         | 20         | 10          | 10                   | 15    |
| 0500      | 10:00 | -                | 20     | 20        | 20         | 20         | 10          | 15                   | 20    |
| 0600      | 11:00 | -                | -      | 20        | 20         | 20         | 15          | 15                   | 20    |
| 0700      | 12:00 | -                | -      | 20        | 20         | 20         | 15          | 15                   | 20    |
| 0800      | 1:00  | -                | -      | 20        | 20         | 20         | 15          | 20                   | 20    |
| 0900      | 2:00  | -                | -      | 20        | 20         | -          | 20          | 20                   | 30    |
| 1000      | 3:00  | -                | -      | -         | -          | -          | 20          | 20                   | 30    |
| 1100      | 4:00  | -                | -      | -         | -          | -          | 20          | 20                   | -     |
| 1200      | 5:00  | -                | -      | -         | -          | -          | 20          | 20                   | -     |
| 1300      | 6:00  | -                | -      | -         | -          | -          | 20          | -                    | -     |
| 1400      | 7:00  | -                | -      | 15        | -          | -          | -           | -                    | -     |
| 1500      | 8:00  | -                | -      | 15        | 20         | -          | -           | -                    | -     |
| 1600      | 9:00  | 30               | 20     | 15        | 20         | -          | -           | -                    | -     |
| 1700      | 10:00 | 30               | 15     | 10        | 20         | -          | 15          | 15                   | -     |
| 1800      | 11:00 | 30               | 15     | 10        | 15         | 15         | 15          | 15                   | 20    |
| 1900      | 12:00 | 30               | 15     | 10        | 15         | 15         | 15          | 15                   | 20    |
| 2000      | 1:00  | 20               | 20     | 10        | 10         | 15         | 10          | 15                   | 20    |
| 2100      | 2:00  | 20               | 20     | 10        | 10         | 15         | 10          | 10                   | 20    |
| 2200      | 3:00  | 20               | 20     | 15        | 10         | 15         | 10          | 10                   | 20    |
| 2300      | 4:00  | 20               | 20     | 15        | 10         | 15         | 10          | 10                   | 20    |
| SEPTEMBER |       | ASIA<br>FAR EAST | EUROPE | S. AFRICA | S. AMERICA | ANTARCTICA | NEW ZEALAND | OCEANIA<br>AUSTRALIA | JAPAN |

| MDT   | MID USA |                  |        |           |            |            |             |                      | CDT   |
|-------|---------|------------------|--------|-----------|------------|------------|-------------|----------------------|-------|
|       | N       | NE               | E      | SE        | S          | SW         | W           | NW                   |       |
| 6:00  | 30      | 20               | 15     | 10        | 15         | 10         | 10          | 15                   | 7:00  |
| 7:00  | 30      | 20               | 15     | 10        | 15         | 10         | 10          | 15                   | 8:00  |
| 8:00  | 30      | 30               | 20     | 10        | 15         | 10         | 10          | 15                   | 9:00  |
| 9:00  | 30      | 30               | 20     | 10        | 20         | 10         | 10          | 15                   | 10:00 |
| 10:00 | 30      | 30               | 20     | 15        | 20         | 10         | 15          | 20                   | 11:00 |
| 11:00 | 30      | 30               | 20     | 15        | 20         | 15         | 15          | 20                   | 12:00 |
| 12:00 | 30      | -                | 20     | 15        | 20         | 15         | 15          | 20                   | 1:00  |
| 1:00  | -       | -                | 20     | 20*       | 20         | 15         | 15          | 20                   | 2:00  |
| 2:00  | -       | -                | 20     | 20        | 20         | 20         | 20          | -                    | 3:00  |
| 3:00  | -       | -                | 20     | 20        | -          | 20         | 20          | -                    | 4:00  |
| 4:00  | -       | -                | 20     | 20        | -          | 20         | 20          | -                    | 5:00  |
| 5:00  | -       | -                | -      | 20        | -          | 20         | -           | -                    | 6:00  |
| 6:00  | -       | -                | -      | -         | -          | -          | -           | -                    | 7:00  |
| 7:00  | -       | -                | -      | -         | -          | -          | -           | -                    | 8:00  |
| 8:00  | -       | -                | 15     | -         | -          | -          | -           | -                    | 9:00  |
| 9:00  | 20*     | 20               | 15     | 15        | -          | -          | -           | -                    | 10:00 |
| 10:00 | 20      | 20*              | 10     | 15        | -          | -          | -           | -                    | 11:00 |
| 11:00 | 20      | 15               | 10     | 15        | -          | 15         | 15          | -                    | 12:00 |
| 12:00 | 20*     | 15               | 10     | 15        | 15         | 15         | 15          | -                    | 1:00  |
| 1:00  | -       | 15               | 10     | 10        | 15         | 15         | 15          | -                    | 2:00  |
| 2:00  | -       | 15               | 10     | 10        | 15         | 15*        | 15          | 20                   | 3:00  |
| 3:00  | -       | 20               | 10     | 10        | 15         | 10         | 10          | 20                   | 4:00  |
| 4:00  | -       | 20               | 15     | 10        | 15         | 10         | 10          | 20                   | 5:00  |
| 5:00  | -       | 20               | 15     | 10        | 15         | 10         | 10          | 20                   | 6:00  |
|       |         | ASIA<br>FAR EAST | EUROPE | S. AFRICA | S. AMERICA | ANTARCTICA | NEW ZEALAND | OCEANIA<br>AUSTRALIA | JAPAN |

| EDT   | EASTERN USA |                  |        |           |                         |            |             |                      |       |
|-------|-------------|------------------|--------|-----------|-------------------------|------------|-------------|----------------------|-------|
|       | N           | NE               | E      | SE        | S                       | SW         | W           | NW                   |       |
| 6:00  | 30          | 20               | 15     | 10        | 15                      | 10         | 10          | 15                   |       |
| 7:00  | 30          | 20               | 15     | 10        | 15                      | 10         | 10          | 15                   |       |
| 8:00  | 30          | 30               | 20     | 10        | 15                      | 10         | 10          | 15                   |       |
| 9:00  | 30          | 30               | 20     | 15*       | 20                      | 10         | 10          | 15                   |       |
| 10:00 | 30          | 30               | 20     | 15*       | 20                      | 15*        | 15          | 20                   |       |
| 11:00 | 30          | 30               | 20     | 15        | 20                      | 15         | 15          | 20                   |       |
| 12:00 | 30          | 30               | 20     | 15        | 20                      | 15         | 15          | 20                   |       |
| 1:00  | 30          | 30               | 20     | 15        | 20                      | 15         | 15          | 20                   |       |
| 2:00  | -           | 30*              | 20     | 15        | 20                      | 15         | 15          | 20                   |       |
| 3:00  | -           | -                | 20     | 20        | 20                      | 15         | 20          | -                    |       |
| 4:00  | -           | -                | 20     | 20        | -                       | 20         | -           | -                    |       |
| 5:00  | -           | -                | 20     | 20        | -                       | 20         | -           | -                    |       |
| 6:00  | -           | -                | -      | 20        | -                       | -          | -           | -                    |       |
| 7:00  | -           | -                | -      | -         | -                       | -          | -           | -                    |       |
| 8:00  | -           | -                | -      | -         | -                       | -          | -           | -                    |       |
| 9:00  | -           | -                | -      | -         | -                       | -          | -           | -                    |       |
| 10:00 | 20          | -                | 15     | 20        | -                       | -          | -           | -                    |       |
| 11:00 | 20          | 15               | 10     | 20*       | -                       | 20         | -           | -                    |       |
| 12:00 | 20          | 15               | 10     | 15        | -                       | 15         | -           | -                    |       |
| 1:00  | 20          | 15               | 10     | 15        | 20                      | 15         | 15          | -                    |       |
| 2:00  | -           | 15               | 10     | 15*       | 20*                     | 15         | 15          | -                    |       |
| 3:00  | -           | 15               | 10     | 10        | 15                      | 15         | 15          | -                    |       |
| 4:00  | -           | 15               | 10     | 10        | 15                      | 10         | 15          | 20                   |       |
| 5:00  | -           | 20               | 10     | 10        | 15                      | 10         | 10          | 20                   |       |
| 6:00  | 20          | 20               | 15     | 10        | 15                      | 10         | 10          | 20                   |       |
| 7:00  | 30          | 20               | 15     | 10        | 15                      | 10         | 10          | 20                   |       |
|       |             | ASIA<br>FAR EAST | EUROPE | S. AFRICA | CARIBBEAN<br>S. AMERICA | ANTARCTICA | NEW ZEALAND | OCEANIA<br>AUSTRALIA | JAPAN |

\*Look at next higher band for possible openings.

## Free Tool Catalog



Thousands of hard-to-find products for building, testing, and repairing electronics. Everything is easy to order by phone or mail, ready for immediate delivery.

Contact East—Dept. 0218  
7 Cypress Drive, Burlington, MA 01803  
In a hurry to receive your catalog?  
Call (617) 272-5051.

128

### QUALITY MICROWAVE TV SYSTEMS

Complete Systems From \$69<sup>95</sup>

1.9 to 2.5 GHz Antennas

**Galaxy Electronics**  
6007 N. 61st Ave.  
Glendale, Az.  
85301  
1-602-247-1151  
1-800-247-1151

COO's / Dealers Wanted



139

**1296 & PHASE III**  
MAKI UTV 1200 - \$499<sup>95</sup>  
2M or 6M I.F. / 3 WATTS

**MICROWAVE MODULES**  
432 / PHASE III UNITS  
\$269.95

**J-BEAM / LOOP YAGIS**  
AND ACCESSORIES

SEE US IN HOUSTON

**SPECTRUM WEST**  
5717 NE 56th, SEATTLE, WA  
206-382-2132 182 98105

## TUBES, SEMICONDUCTORS, IC'S DIODES AT SUPER LOW PRICES IN DEPTH INVENTORY EIMAC, SYLVANIA, GE, CETRON



**SYLVANIA**

**RCA**



**NATIONAL**



|                |        |
|----------------|--------|
| OA2            | \$2.75 |
| 3-400Z         | 115.00 |
| 3-500Z         | 99.00  |
| 4CX250B/7203   | 58.00  |
| 4CX1000A/8168  | 430.00 |
| 4PR60C/8252W   | 295.00 |
| 4X150A/7034    | 58.00  |
| 5AR4           | 4.73   |
| 5C22           | 165.00 |
| 5R4GB          | 3.85   |
| 6AK5           | 4.26   |
| 6AL5           | 2.93   |
| 6AQ5           | 2.85   |
| 6CA7           | 5.61   |
| 6DJ8           | 2.75   |
| 6JG6A          | 6.56   |
| 6JS6C          | 6.05   |
| 6KD6           | 6.90   |
| 6L6GC          | 5.25   |
| 6KV6A          | 6.02   |
| 6LF6           | 7.19   |
| 6LQ6           | 6.83   |
| 6MJ6           | 7.28   |
| 12AT7          | 2.93   |
| 12AU7          | 2.63   |
| 12AX7A         | 2.64   |
| 572B/T160L     | 46.00  |
| 705A           | 10.00  |
| 811A           | 13.50  |
| 813            | 40.00  |
| 829B           | 40.00  |
| 832A           | 38.00  |
| 833A           | 185.00 |
| 866A           | 9.50   |
| 872A           | 24.00  |
| M-2057         | 15.00  |
| 5670           | 4.40   |
| 5684           | 33.00  |
| 5687           | 4.00   |
| 5751           | 4.00   |
| 5814A          | 3.70   |
| 5879           | 5.75   |
| 5894           | 65.00  |
| 6005           | 5.25   |
| 6146B          | 7.50   |
| 6360           | 6.50   |
| 6528A          | 75.00  |
| 6550A          | 7.50   |
| 6883B          | 9.00   |
| 7360           | 12.25  |
| 7558           | 7.00   |
| 7591A          | 4.70   |
| 7868           | 3.75   |
| 8072           | 95.00  |
| 8417           | 6.87   |
| 8874           | 195.00 |
| 8875           | 210.00 |
| 8877/3CX1500A7 | 475.00 |
| 8908           | 12.95  |
| 8950           | 11.50  |
| MRF-453        | 18.50  |
| MRF-454/A      | 18.50  |
| MRF-455/A      | 18.50  |
| 2N6084         | 15.00  |



**NATIONAL**



**RCA**

**SYLVANIA**

187

Full line of Sylvania ECG Replacement Semiconductors Always in Stock. All Major Manufacturers Factory Boxed, Hard To Get Receiving Tubes At Discount Prices.

Minimum Order \$25.00. Allow \$3.00 For UPS Charges. Out of Town, Please Call Toll Free: 800-221-5802 and Ask For "ABE".



**TRANSLERONIC INC.**

1365 39th STREET, BROOKLYN, N. Y. 11218H  
Tel. 212-633-2800/Wats Line 800-221-5802  
TWX 710-584-2460 ALPHA NYK.

## UHF/VHF BOOK SPECIAL OFFER

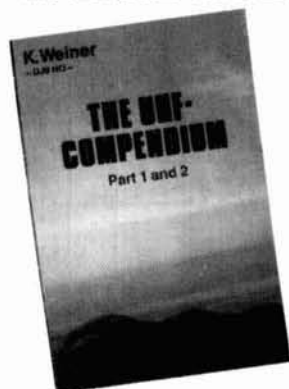

### THE UHF COMPENDIUM by K. Weiner, DJ9HO

This 413 page book is an absolute must for every VHF and UHF enthusiast. Special emphasis has been placed on state-of-the-art techniques. Author Weiner fully describes test equipment, alignment tools, power measuring equipment and other handy gadgets. All of the projects and designs have been tested and proven and are not engineer's pipe dreams. Antennas are also fully covered with a number of easy-to-build designs as well as large mega-element arrays. ©1980.

□KW-UHF Softbound \$23.75



### VHF HANDBOOK by W9EGQ and W6SAI

New 3rd Edition contains all the latest information for VHF operation. Antenna design and construction from 50-432 MHz is fully covered with proven practical design information. You also get a complete rundown on FM theory, design and plenty of helpful hints and tips. In the construction section, the authors detail how to build low noise, high performance converters, transceivers, amplifiers and plenty of other pieces of interesting equipment. This book is a must for both the beginner and expert in VHF communications. ©1974. 336 pages, 3rd edition.

□RP-VH Softbound \$11.95

**VHF/UHF BOOK SPECIAL OFFER**  
Buy 'em separately \$35.90  
SPECIAL PRICE \$29.95

SAVE \$5.95

Please add \$2.50 for shipping

**HAM RADIO'S BOOKSTORE**  
Greenville, NH 03048



## BASIC PROGRAM MANUAL FOR AMATEURS

Programs Design: Quads, beams, trap dipoles, antenna wind load, filters, pads, striplines, op amps, microwave, RF coils, calc. Ohms law, L, C, power, log QSO's, global distances and much more.

All for **\$9.95** (INCLUDES SHIPPING AND HANDLING)

### ATTENTION YAESU FT-207R OWNERS AUTOMATIC SCAN MODULE

15 minutes to install; scan re-starts when carrier drops off; busy switch controls automatic scan on-off; includes module and instructions.

Model AS-1 **\$25.00**

### BATTERY SAVER KIT

Model BS-1 **\$14.95**

- No more dead batteries due to memory backup
- 30% less power drain when squelched
- Simple to install, step-by-step instructions and parts included
- 4 mA memory backup reduced to 500  $\mu$ A
- 45 mA receiver drain reduced to 30 mA
- Improved audio fidelity and loudness

### ENGINEERING CONSULTING

P.O. BOX 216 DEPT. H  
BREA, CALIFORNIA 92621

## TUNE IN THE WORLD OF HAM-TV!

Amateur Radio operators in the 1980's are discovering the fascinating "World of Amateur Television". Be it Fast Scan TV (FSTV), Slow Scan TV (SSTV), Facsimile (FAX) or somewhere in between. Video communications modes are growing at an exciting pace!

New advancements are taking place in High-Resolution/Color SSTV and the use of personal computers for ATV graphics. SSTV-FAX-RTTY communications. Interest is even growing in MICROWAVE and TVRO applications.

A5 ATV MAGAZINE™ has supported these modes of Amateur Specialized Communications since 1967 — over 17 years! And now, under guidance of the UNITED STATES ATV SOCIETY, HAM-TV will continue to grow rapidly. Interested?

Send SASE for "free" information brochures today!

Special six month TRIAL  
subscription only **\$10.00**

One year subscription (12 issues)  
of the "USATV's Journal" **\$20.00**

Sample issue available for **\$2.50 ppd**

**A5 ATV MAGAZINE™**

P.O. BOX H  
LOWDEN, IOWA, 52255

A DIVISION OF QCD PUBLICATIONS, INC.

✓ 115



**SAY  
YOU SAW  
IT IN  
ham radio!**

This tower is ready for shipment to one of our customers, or is it? If we were an ordinary tower company, this tower would have already been sent.

We are not an ordinary tower company and that is why this tower did not go out.

We have the best quality control in the business and we are not afraid to say so. That is why when John Pasillas

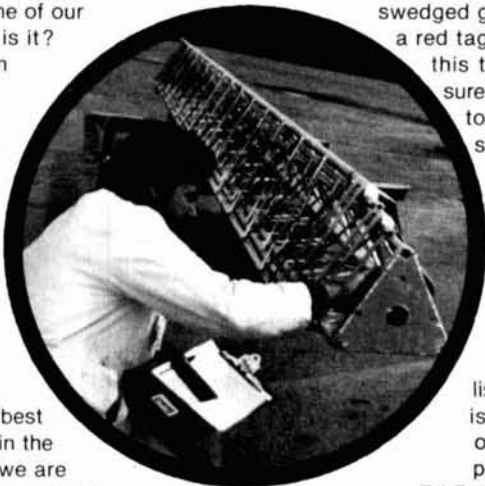

found a 1/8" clearance on the swedged guide, he placed a red tag of rejection on this tower and made sure it was corrected to 1/16" before he stamped his final approval for shipment.

Every employee at Tri-Ex knows that the reputation you establish in an industry is what will make or break his company. That is why Tri-Ex has been in business continually since 1955.

When you purchase your tower from Tri-Ex, you can be assured that all welds have been done by certified welders, all construction and galvanizing has met ASTM standards, all towers have been constructed in precision jigs, all steel has been tested for carbon content and tensile strength.

When it goes to shipping, John is ready.

When you decide on Tri-Ex you have many models to choose from.

### STACKED:

Light, medium, heavy duty  
10 feet and up.

### CRANK UPS:

Light, medium, heavy duty  
25 feet to 88 feet standard.

### SPECIAL TOWERS:

Sky needle, Clementower  
37 feet to 180 feet & higher

Introducing Tri-Ex's new DX-86 — 86 feet tall, 25 square feet in a 50 mph wind.

**Call your local dealer for details.**

FOR ADDITIONAL INFORMATION WRITE TO:



**TOWER  
CORPORATION**

7182 Rasmussen Ave.  
Visalia, Calif. 93291

P.O. Box 5009  
Visalia, California 93278  
(209) 651-2171

✓ 188



product

# REVIEW

## TH5MK-2 broadband thunderbird

Over the past three years I have been using the Hy-Gain TH5DX triband beam. The performance overall has been excellent with no problems experienced. I had no intention of replacing the antenna — that is until Alan Caplan, WØRIC, of Hy-Gain called and told me about a new version of the TH5 they were getting ready for release. The new antenna is called the TH5MK-2 and is based upon a dual-driven element design. This design facilitates operation from band edge to edge with low SWR and high performance.

For years, broadbanding antennas was not as important as it is now. But today's solid-state radios and amplifiers are much more sensitive to antenna mismatches. To achieve maximum equipment performance, it is imperative to keep VSWR levels below 2 to 1. Otherwise, protective circuits will start shutting the power amplifier down. Another limitation of older antenna designs is that the user usually had to make a choice of either CW or SSB subbands when assembling the antenna. Hy-Gain's solution for broadbanding was the TH5MK-2 — And, it's quite a solution.

### construction

My first feeling upon opening the two shipping boxes was that I was looking at a hardware store's inventory. I was overwhelmed by a lot of parts. Before you touch *anything*, grab the instruction manual and read it thoroughly. Hy-Gain has carefully researched instruction manuals and found that when owners read through the instructions several times, assembly problems are drastically reduced. This is a sound recommendation that should be adhered to — without exception. Hy-Gain went to quite a bit of time and expense to write an accurate and precise instruction manual. You'll save yourself time and hassle if you're familiar with the instructions before you start.

Parts are in poly bags so it will also be worth your time to segregate all the different clamps, bolts, nuts, screws, and tubing prior to putting the antenna together. This saved me time and eliminated frantic searching while putting the antenna together. One word of warning. Make sure you carefully measure tubing lengths as you assemble the elements. (I didn't. Well, so

much for my advice about reading the manual!)

One place where I did divert (again, not following my own recommendation . . .) from Hy-Gain's instructions was in the assembly of the elements. Hy-Gain suggests that you first build the boom and then assemble the elements on the boom. Not having the time on weekends to sit down and assemble the antenna from start to finish, I decided to assemble the elements first and then mate them to the boom. This allowed me to put the antenna together over several evenings. Other than investing a bit of extra diligence, I didn't have any additional problems using this method. I also didn't have to worry about losing element parts. It took less than two hours to mate all the elements to the boom assembly and assemble the beta match.

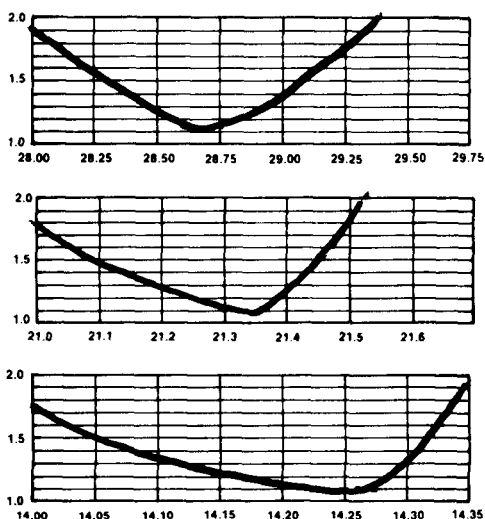

fig. 1. VSWR on 10, 15, and 20 meters (Hy-Gain TH5MK-2).

### performance

Initial results have been most favorable with the new TH5MK-2. Not being a "hot and heavy" high band DXer, I can't give a day-by-day summary of its performance. However, in casual DXing and in several contests, it has performed admirably well. In comparing the TH5MK-2 to my TH5DX, my gut feeling is that the TH5MK-2 has a slight edge. The big plus, however, is that the MK-2 operates efficiently from band edge to band edge.

### specifications

The TH5MK-2 is a five-element broadband antenna designed to operate on 20, 15, and 10

meters. A big plus for the MK-2 is that all hardware is stainless instead of plated steel. This eliminates (or reduces) the problem of hardware oxidization. Hy-Gain also supplies a BN86 balun with the antenna. The TH5MK-2 weighs 57 pounds and has a wind surface area of 7.4 square feet and is designed to survive a 100 mph maximum wind. Each band has one director and one reflector, as well as the two driven elements. The boom is 19 feet long (one foot longer than the TH5DX) and the longest element is 31 feet 6 inches. Hy-Gain rates the antenna at 7.8 dBi gain for 20 meters, 8 dBi for 15 meters, and 9 dBi for 10 meters. Since the antenna employs a Beta match and balun, the antenna is at dc ground for lightning protection. For more information contact Hy-Gain, 9100 Aldrich Avenue, Minneapolis, Minnesota 55420.

N1ACH

## Triplet model 3500

The Model 3500 is a compact, portable autorange manual digital multimeter designed to be easy to operate and read and also be able to withstand rough handling. The autorange feature eliminates the need for manual selection of range; you can select the ranges manually if you desire. All measurements except 10 amperes are made from two jacks, eliminating the need to switch test leads as different ranges are selected. The Model 3500 is fully overload-protected with a special 0.3A/250V and 2A/600V fuse arrangement.

The Model 3500 measures ac/dc volts, ac/dc current and high or low power ohms. Accuracy is guaranteed for one year. Protection from overload is up to 1000 Vdc and 750 Vac without fuseblow. The 3500 also features a tilt stand to facilitate greater visibility on the test bench. The case is ribbed to provide a stable, non-slip grip for the user. Battery life is approximately one year in occasional service but less in daily use. The low-battery indicator will alert the user when battery life remaining falls to approximately 50 hours.

We found the Triplet Model 3500 simple to use, handy to have, and rugged enough to stand up well in most ham shacks. Its large LCD display is readable under a variety of lighting conditions. Packaged in a high-impact plastic case, the Model 3500 measures 3-1/2 × 6 × 1-5/8 inches (88 × 155 × 34 mm). It weighs 12.5 ounces (0.35 kg) with battery installed. The suggested retail price (\$140) includes the unit itself, 36 inch test leads with alligator clips, and two 1-1/2 volt batteries. Contact your local distributor or Triplet Corp., One Triplet Drive, Bluffton, Ohio 45817 for further information. RS#301

N1ACH



## 1.2 GHz mobile transceiver and receiver

ICOM's new IC-120 is a 1.2 GHz fm mobile transceiver, covering 1260 to 1300 MHz. This unit is styled similarly and has features similar to the IC-15A/H series of 2-meter transceivers, and has many equivalent features. Duplex split is variable, but is initiated at 20 MHz when the unit is first turned on. Duplex up and down as well as scanning features are offered. Power output is 1 watt. ICOM is the first to offer a full-featured mobile transceiver for this mostly unused band.



To complement ICOM's entry into the 1.2 GHz Amateur band with its IC-120 mobile transceiver, ICOM has also announced the release of a 1.2 GHz repeater with a power output of 10 watts, CTCSS capability, IDER, and DTMF control. The RP1210 is synthesized to be complementary to the IC-120 transceiver, and has a duplex split of 20 MHz.

For further information, contact ICOM America, Inc., 2112-116th Ave., NE, Bellevue, Washington 98004. RS#302

## programmable linear amplifier

The ETO Alpha 85 features a microprocessor control circuit that eliminates manual tune-up and ensures maximum output and performance. Using the new Eimac 3CX800AF ceramic metal triodes, the Alpha 85 is designed to cover 1.8-2 and 3-22 MHz and is rated at 1500 watts PEP rf output SSB, 1500 watts CW and 1000 watts RTTY and SSTV. (Export and government models tune to 30 MHz. U.S. licensed Amateurs can modify their unit to tune to 29.7 MHz.)

# Project Engineer Antennas/RF Communications



**GOULD**

Electronics

Gould Defense Electronics Division has an outstanding reputation in the field of sonar, seismic systems, and marine instruments for military and commercial applications. We have a strong engineering department performing research, design, and development in communication systems. We are seeking a project engineer with a systems engineering background to assume a significant leadership role in a growing ocean-based communications program.

In order to qualify for consideration, you must have a BSEE degree and a minimum of 6 years' related experience, including design and evaluation of antenna and communication systems up to 1 GHz. Ability to define problems and contribute creative solution concepts is essential. Familiarity with DOD acquisition and system engineering procedures would be a plus. You will have the responsibility for providing technical input and guidance to the project team during analysis, implementation, and testing of the antenna system concepts. As project engineer you will also have the responsibility for the technical management of the project team from a schedule and manpower perspective.

If you meet the qualifications stated above and are ready to assume a highly visible leadership role in a program vital to our nation's defense, we want to hear from you. Gould offers an excellent work environment and very competitive benefits. For confidential consideration, please send resume and salary requirements to: Employment Manager, **GOULD DEFENSE ELECTRONICS DIVISION**, 6711 Baymeadow Drive, Department 13-153-83, Glen Burnie, Maryland 21061. An Equal Opportunity Employer M/F.

Office Hours: Mon-Thurs 8-5 MST.

## ANTECK, INC.

STAINLESS STEEL WHIP — FIBERGLASS LOADING COIL  
— PATENT APPLIED. NO COILS TO CHANGE  
— LESS THAN 1.5 VSWR (ENTIRE TUNING RANGE)  
TUNE 3.2 TO 30 MHz FROM THE OPERATORS POSITION  
— FAST AND SLOW SCAN RATES

The Model MT-1RT mobile antenna tunes 3.2 to 30 MHz inclusive. 750 watts CW, 1500 watts PEP for hams, military, MARS, CAP, and commercial service. Center loaded for high efficiency. Enables tuning to exact resonance to wanted frequency. Allows full output from solid state finals. No worry about reduced output from shut down circuits. Output is unaffected by moisture and the elements. Tuned by a control box at the operator's position. Mast section contains a double action hydraulic cylinder driven by two miniature hydraulic pumps and 12 volt DC motors for positive control. No creeping during operation or mobile motion. Can be removed up to 500 ft. from antenna.

MT-1RT (remote tuned) \$279.95  
MT-1RTR (retro kit for MT-1) \$129.95  
MT-1 (manual tuned) \$149.95  
MT-1A (marine manual tuned) \$199.95

11.00 UPS shipping  
6.00 UPS shipping  
9.00 UPS shipping  
9.00 UPS shipping

**ANTECK, INC.** Route 1, Box 415  
Hansen, Idaho 83334 208-423-4100

✓ 112

DEALER INQUIRIES INVITED



# new SIX BAND VERTICAL ANTENNA

**Model AV-25  
NO TRAP VERTICAL**  
for 80, 40, 30, 20, 15, 10 meters.

**\$99.50**

UPS SHIPPING & HANDLING  
ADD \$11



- Only 25 ft. high.
- Three parallel vertical elements.
- Rugged steel tubing.
- Direct feed with 52 ohm coax, low SWR.
- Broad band.
- Capacity loaded, top and sides.
- Only one coil, high in 80 M element.
- Also available for commercial frequencies.

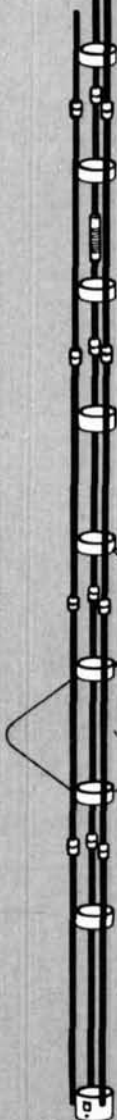

4 1/2" DIA. SPACERS

**AR-25 Radial System for AV-25 antenna. Four multiwire radials that are resonant on each of the six bands. \$49.50**

PATENT PENDING



ALL OUR PRODUCTS MADE IN USA

**BARKER & WILLIAMSON**

Quality Communication Products Since 1932

At your Distributors write or call

10 Canal Street, Bristol PA 19007

(215) 788-5584



The microprocessor is factory-programmed to tune each Amateur band except for 10 meters. Five band-segment pushbuttons can be field programmed to any frequency for rapid band changes and ease of use. The unit can also be manually tuned. To ensure maximum output on all high-frequency bands, a tuned input circuit has been incorporated.

The Alpha 85 measures 7-1/2 x 17-1/10 x 17 inches and weighs 60 pounds.

For more information, contact Ehrhorn Technological Operations, Inc., Canon City, Colorado 81212.

## handheld transceiver

The new 2-meter handheld transceiver, model 2591, from Ten-Tec was designed in collaboration with Motorola. Its advanced microprocessor provides features that include a key pad, ten memories, memory scan, and programmable band scan. Any section of band within user-selected upper and lower limits may be scanned in steps of 5, 10, 15, 25, or 30 kHz. Either step size, upper limit or lower limit can be changed independently without complete reprogramming. User selectable HOLD or SKIP is also included. Manual scan is possible — up or down in 5 kHz steps.

A new memory lockout feature allows the scanner to temporarily bypass channels while retaining memory and provides quick lockout of busy frequencies yet returns to normal operation on command.

Other features include selectable power level and extended frequency coverage from 143.500 to 148.995 MHz. A dual function LED shows battery status and indicates transmit mode. A quick-release Ni-Cad pack provides heavy duty 450 mAh rating at 8.4 volts. Standard accessories include rubber flex antenna with BNC connector and wall charger.

The price of Model 2591 is \$319.00.

For more information, contact Ten-Tec, Inc., Sevierville, Tennessee 37863.

## computer patch™ interface

Now you can convert your personal computer and transceiver into a full-function RTTY station with the new CP-1 Computer Patch™ interface by AEA and appropriate AEA software and cabling. Software packages include split screen operation and large type-ahead and message (brag) buffers at all the common RTTY and CW speeds. No computer programming knowledge is required to use the CP-1.

The CP-1 demodulator is said to provide improved performance compared to single channel RTTY detectors. An easy-to-use AEA

## Homebrew Headquarters

### COMPONENTS

- Amphenol connectors
- B&W coils, switches, antennas
- Hammond and LMB enclosures
- Jackson dials and drives
- J.W. Miller parts
- Knobs and shaft couplers
- Millen components
- Multronics roller inductors
- Padders and trimmer capacitors
- Resistors, capacitors, inductors
- Toroids, cores, beads, baluns
- Transmitting/Receiving Capacitors
- Air Variables: Cardwell — E.F. Johnson  
Hammarlund — Millen
- Doorknob: Centralab — Jennings
- Iambic paddles
- Wire and cable

### PROJECT PACKS

- Direct from England, Featured in Radio & Electronic World
- GaAs FET 2 Meter Mast Head Pre-Amplifier 123.50
  - 2 Meter Pre-Amplifier 6.50
  - 2 Meter Converter 37.50
  - UHF (70 cm) Pre-Amplifier 9.50
  - UHF (70 cm) Converter 38.50
  - UHF (70 cm) to VHF (TV) Converter 60.50
  - 23 cm Converter 43.50
  - Air Band Receiver 162.00
  - FET Dip Oscillator 52.50

### OTHER KITS

- CPP1 Code Practice Processor/Electronic Keyer 47.00
- General Coverage for Drake R4C, B, A Receivers
- Split Band Speech Processor 69.95
- Smart Squelch 49.95
- R-X Noise Bridge 33.45
- L Meter 25.50
- 40 Meter ORP Transceiver 101.95

\* Shipping & Handling \$2.50 \*

1983 Catalog 50 cents

**RADIOKIT**  
Box 411H, Greenville, NH 03048  
(603) 878-1033

**SALE**  
**BOUND VOLUMES**  
**ham radio magazine**

REGULAR  
\$24.95  
each

**SALE**  
**SPECIAL**  
**\$19.95 each**  
**3 for \$49.95**

Please add \$2.50 for shipping and handling

QUANTITIES LIMITED  
CALL TODAY

| Yrs. Avail. |      |      |
|-------------|------|------|
| 1977        | 1978 | 1979 |
| 1980        | 1981 | 1982 |

**HAM RADIO'S BOOKSTORE**  
GREENVILLE, NH 03048  
(603) 878-1441





## Stuck with a problem?

Our TE-12P Encoder might be just the solution to pull you out of a sticky situation. Need a different CTCSS tone for each channel in a multi-channel Public Safety System? How about customer access to multiple repeater sites on the same channel? Or use it to generate any of the twelve tones for EMS use. Also, it can be used to access Amateur repeaters or just as a piece of versatile test equipment. Any of the CTCSS tones may be accessed with the TE-12PA, any of the audible frequencies with the TE-12PB. Just set a dip switch, no test equipment is required. As usual, we're a stickler for 1day delivery with a full 1 year warranty.

- Output level flat to within 1.5db over entire range selected.
- Immune to RF.
- Powered by 6-30vdc, unregulated at 8 ma.
- Low impedance, low distortion, adjustable sinewave output, 5v peak-to-peak.
- Instant start-up.

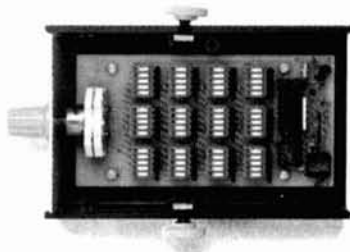

### TE-12PA

|         |          |          |          |          |          |
|---------|----------|----------|----------|----------|----------|
| 67.0 XZ | 85.4 YA  | 103.5 1A | 127.3 3A | 156.7 5A | 192.8 7A |
| 71.9 XA | 88.5 YB  | 107.2 1B | 131.8 3B | 162.2 5B | 203.5 M1 |
| 74.4 WA | 91.5 ZZ  | 110.9 2Z | 136.5 4Z | 167.9 6Z |          |
| 77.0 XB | 94.8 ZA  | 114.8 2A | 141.3 4A | 173.8 6A |          |
| 79.7 SP | 97.4 ZB  | 118.8 2B | 146.2 4B | 179.9 6B |          |
| 82.5 YZ | 100.0 1Z | 123.0 3Z | 151.4 5Z | 186.2 7Z |          |

- Frequency accuracy,  $\pm 1$  Hz maximum  $-40^{\circ}\text{C}$  to  $+85^{\circ}\text{C}$
- Frequencies to 250 Hz available on special order.
- Continuous tone

### TE-12PB

| TEST-TONES: | TOUCH-TONES: | BURST TONES:        |
|-------------|--------------|---------------------|
| 600         | 697 1209     | 1600 1850 2150 2400 |
| 1000        | 770 1336     | 1650 1900 2200 2450 |
| 1500        | 852 1477     | 1700 1950 2250 2500 |
| 2175        | 941 1633     | 1750 2000 2300 2550 |
| 2805        |              | 1800 2100 2350      |

- Frequency accuracy,  $\pm 1$  Hz maximum  $-40^{\circ}\text{C}$  to  $+85^{\circ}\text{C}$
- Tone length approximately 300 ms. May be lengthened, shortened or eliminated by changing value of resistor

**\$89.95**

**COMMUNICATIONS SPECIALISTS**

426 West Taft Avenue, Orange, California 92667  
(800) 854-0547/California: (714) 998-3021





## New DTMF Receiver Kit turns phones into control devices.

With Telnet's TRK-956 kit, you get all the parts necessary to breadboard a central office quality DTMF detection system for only \$22.75. That's the lowest installed cost for a DTMF system. All you provide is 5V dc. For decoding DTMF signals from telephone lines, radios, and tape players, use the TRK-956. To order call: (800) 227-3800 ext 1130. [In CA, (800) 792-0990 ext 1130.]

**TELNET**

✓ 186



High quality, natural sounding speech synthesis, including a portion of ACC's custom repeater vocabulary, is built in. Together with the control board's Touch-Tone activated message editor, ID and tail messages can be made informative, reminding users of nets, meetings,



and special events, or informing users of repeater status. An alarm logic input provides the repeater owner with a site alarm to enhance security of the installation. The RC-85 uses CMOS circuitry (no TTL) for low-power consumption from a single +12 volt supply. All ICs are socketed in high reliability machine contact sockets. The control board is a compact 6" x 9" for easy integration into any repeater. The price is \$849.

For more information, contact Ed Ingber, WA6AXX, at Advanced Computer Controls, Inc., 10816 Northridge Square, Cupertino, California 95014. RS#305

## dual band radio

Trio-Kenwood has recently announced a new model, the TS-780 All-Mode "Dual-Bander," a combination of 2-m/70-cm (144-148 MHz/430-440 MHz) radio designed to meet the needs of the Amateur Radio enthusiast active on both bands. Important features included in the TS-780 are USB, LSB, CW, and FM operation, dual digital VFO's, cross-frequency operating capability, 10 memories that store frequency and band data, internal battery memory back-up, band scan, memory scan, i-f shift, fluorescent tube digital display, 2-m offset switch, and 10 watts of rf output. VOX and



CW semi break-in are built in. An optional TU-4C two frequency tone encoder unit is available.

Additional information is available from Trio-Kenwood Communications, 1111 West Walnut Street, Compton, California 90220. RS#306

## GO MOBILE WITH YOUR H.T.!

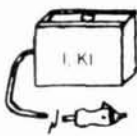

Model I—Icom IC-2A/T, Etc.  
Model K-1 for TR-2500  
—slides on bottom of radio

Guaranteed!



Model K—TR-2400;  
—powered thru battery plug  
Model N—FT-208R  
Model T—Simple mod for Tempo  
and all Santic

NOW FOR FT 208R & TR 2500



Model Y—FT-207R, Wilson  
—fits into battery compartment

"A unique battery eliminator"  
HANDI-TEK Regulator allows  
constant hand-held operation  
from auto DC or base supply  
with no nicad drain and  
WITHOUT RADIO MODIFICA-  
TION! \$24.95 PPD in USA  
Calif. add \$1.50 Sales Tax.

✓ 145

**HANDI-TEK**

P.O. BOX 2205, LA PUENTE, CA 91746

## CB TO TEN METER CONVERSION KITS

KITS for AM—SSB—FM 40 Channel PLL  
chassis conversions

**DETAILED INSTRUCTIONS** for easy installation with minimum time and equipment

**BAND COVERAGE** flexibility provides up to 1 MHz coverage for most PLL chassis.

**PRICES** Low cost prices range from \$8.00 to \$50.00

All kits are in stock including several different FM kits.

**FREE CATALOG** Write or call today.

**INDEPENDENT**

**CRYSTAL SUPPLY COMPANY**

P.O. Box 183  
Sandwich, Ma. 02563-0183  
(617) 888-4302

✓ 152

magic-eye bargraph tuning indicator gives the closest thing to scope tuning, but separate Mark/Space scope output jacks are also provided. A state-of-the-art multi-usage active filter is incorporated offering pre- and post-limited filtering. Floating comparator (automatic threshold) circuits give the best possible copy under fading and weak signal conditions.

Additionally, the CP-1 offers a variable receiver shift capability for any shift from 100 to 1000 with a NORMAL/REVERSE tone selector switch on the front panel.

A function generator chip is utilized for clean, stable sine wave AFSK tone output to the transmitter. Both plus (+) and minus (-) keyed output jacks are provided for CW keying of virtually any popular transceiver. Automatic transmit/receive switching is available under computer control or from a front panel manual transmit button. Output and computer control signals are available in the usual TTL levels (or RS-232 format with an optional low-cost RS-232 kit).

For complete information, contact Advanced Electronic Applications, Inc., P.O. Box C-2160, Lynnwood, Washington 98036. RS#304

## low-cost repeater control

The RC-85 low-cost repeater controller board from Advanced Computer Controls, Inc., is a scaled-down, simplified version of the RC-850 controller. The microcomputer-based control board offers built-in speech synthesis, Touch-Tone remote programming, and a full-featured autopatch at a cost comparable to a collection of "dumb" repeater control boards. It provides the complete interface between the repeater's receiver and transmitter.

The autopatch features autodial, long distance protection, optional phone number read-back, DTMF or dial pulse regeneration, and reverse patch.

Some operating parameters of the RC-85 control board may be changed remotely with Touch-Tone commands, including ID and tail messages (with its built-in Touch-Tone activated message editor), command codes, and autodial numbers. Storage is in write-protected RAM. An optional fully documented Personality EPROM allows the repeater owner to define a backup set of parameters independent of the firmware for use in case power is lost. Built-in diode switching allows easy battery backup.

**MORE FROM PRO-SEARCH™ ELECTRONICS**



## NOW THREE MODELS OF OUR DIGITAL ANTENNA CONTROL

Your Choice Of Center, North Or South



**GOOD**  
PSE-1A, 3A

The "CONTESTER" provides the least expensive DIGITAL CONTROL UNIT WITH COMPLETE COMPUTERIZED CONTROL, BUT WITH LESS FEATURES, than the "DX'ER" and "DELUX".

This unit gives you the current position of your antenna digitally in 5° steps. It has 2 memories and the command mode, plus single button operation. The PSE-1A, "CONTESTER" comes with a 7.0 amp continuous duty motor supply. PSE-3A has a 12 amp power pack.

It is not capable of being modified to talk or accept the computer interface or remote interface.

It is completely shielded and made of the same quality components as the other models.

The warranty on our unit is one year on materials and labor, and ninety days on parts.

This unit is a very inexpensive way to have the best of both worlds. A real time saver during contests. Hands off operation will save many hours of hanging on the rotor. Just a few dollars more than the manual control box, but worlds apart in state-of-the-art and operation. Price \$229.95\*

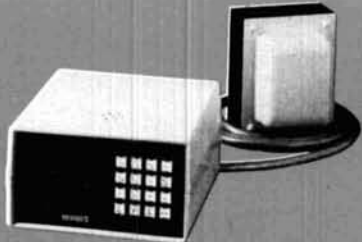

**BETTER**  
PSE-1, PSE-3

The "DX'ER" is the top of the line of the non-voice synthesized units, and is for the ham who is in need of more features on their controller. It has "2" digital readouts, one to show the antenna's current position, plus a storage readout which holds a heading or digitally displays your last position. This is valuable for switching between long path or short path, or checking front to back, or working between two different stations...a real time saver and just a nice convenience.

The "DX'ER" also has "5" scan functions: 0-90, 90-180, 180-270, 270-360, and 0-360. This is a real aid in looking for that dogleg opening or peaking a weak signal.

It can be expanded to talk, and does have the hardware necessary to use with the computer interface.

It can be remotely keyed, where verbal confirmation isn't required. Price \$362.95\*

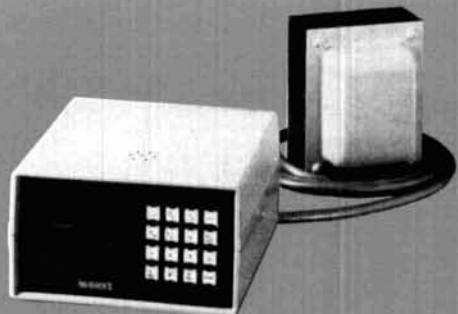

**BEST**  
PSE-2, PSE-4

This is the ultimate in rotor controls. Nothing tops this one.

It has all the features of the other models, plus it talks...Yes, it talks.

The "DELUX" has a voice synthesizer which confirms your entries, plus tells you your heading as you enter it and when your antenna arrives.

All commands are spoken, plus as your antenna turns you hear a 400Hz tone going in one direction and a 80Hz tone in the other. This gives you positive verification of movement.

This unit, as the others, will combine with the HAM IV, T2X, and HDR-300, giving you the best antenna rotor combination you could ever want at any Price \$469.00\*

## INTRODUCING THE ULTIMATE PACKAGE...FROM PRO-SEARCH™ NINE COMBINATIONS OF OUR CONTROL UNIT AND THE TELEX/HYGAIN\* ROTOR MOTORS... FOR JUST A FEW DOLLARS MORE YOU CAN HAVE THE CONTROLLER OF THE FUTURE TODAY!

1 The "Contester" Package...try one of these TELEX/HY-GAIN rotors with our PSE-1A/3A. A system which is low in cost, high in performance.

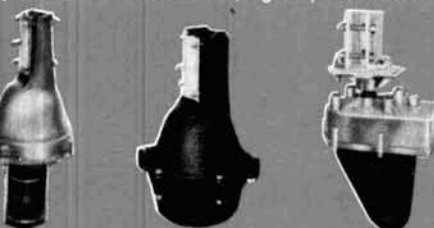

HAM IV\*

T2X\*

HDR-300\*

PSE-1A will save you lots of time in your favorite contests. No more hanging on the rotor control...Gives you positive control with DIGITAL readout plus 10 memories, command positioning, and single button manual movement.

The "DX'ER" Package...Couple this unit with a rotor and you have the best non talking control we make. Expandable, plus has 5 scan functions, 2 DIGITAL displays and REC/LAST to check long path or short path. Has all internal hardware to plug into our computer interface. Can be remotely controlled from accessory jack.

Try this with any of the TELEX/HY-GAIN\* Rotors! This will give you the broadest of functions with a mid-range price.

The "Delux" is the most sophisticated antenna control unit ever made. With the "Delux" you have all the functions of our other units, plus it talks...Yes it talks. Not only do you have your headings digitally displayed, but is also said as your antenna stops...All commands are spoken, plus as your antenna turns you hear a 400Hz tone in one direction and an 80Hz in the other, giving you positive verification of movement. This unit, when combined with the HAM IV, T2X or HDR-300 gives you the best buy anywhere at any price...

**Package Special**

PSE-1 + HAM IV \$508.95  
PSE-1 + T2X 548.95  
PSE-3 + HDR-300 677.95

**Package Special**

PSE-2 + HAM IV \$608.95  
PSE-2 + T2X 655.00  
PSE-4 + HDR-300 784.00

PSE-1A + HAM IV \$369.95  
PSE-1A + T2X 415.95  
PSE-3A + HDR-300 544.95

\* Printed with permission of TELEX/HYGAIN Telex Communications, Inc.



© Copyright 1983

Controllers also available for other rotors.  
Prices and specifications subject to change without notice or obligation.  
U.S. and Foreign Patents  
\* For PSE, 3A, 3, 4 add \$24.50 for 12 amp power pack

Write or Call for our Catalog • Pro-Search Electronics Co. Suite 305 10411 Clayton Rd. St. Louis, Mo. 63131 1-314-994-7872 (Missouri) 1-800-325-4016

# JPC/AZDEN®

## 4000 SERIES

### FM TRANSCEIVERS

10 METERS & DOWN



COMMERCIAL-GRADE  
QUALITY AT AMATEUR PRICES

**EXCLUSIVE 1 YEAR LIMITED WARRANTY! COMPARE!**

#### THE 4000 SERIES



PCS-4300 70-cm FM Transceiver



PCS-4500 6-m FM Transceiver



PCS-4800 10-m FM Transceiver

COMING SOON  
PCS-4200 1 1/4-m FM Transceiver



PCS-300  
2m Handheld  
FM Transceiver  
142-149.995 MHz

- **WIDE FREQUENCY COVERAGE:** PCS-4000 covers 142.000-149.995 MHz in selectable steps of 5 or 10 kHz. PCS-4200 covers 220.000-224.995 MHz in selectable steps of 5 or 20 kHz. PCS-4300 covers 440.000-449.995 MHz in selectable steps of 5 or 25 kHz. PCS-4500 covers 50.000-53.995 MHz in selectable steps of 5 or 10 kHz. PCS-4800 covers 28.000-29.990 MHz in selectable steps of 10 or 20 kHz.
- **CAP/MARS BUILT IN:** PCS-4000 includes coverage of CAP and MARS frequencies.
- **TINY SIZE:** Only 2"H x 5.5"W x 6.8"D. COMPARE!
- **MICROCOMPUTER CONTROL:** At the forefront of technology!
- **UP TO 8 NONSTANDARD SPLITS:** Ultimate versatility. COMPARE!
- **16-CHANNEL MEMORY IN TWO 8-CHANNEL BANKS:** Retains frequency and standard simplex or plus/minus offsets. Standard offsets are 600 kHz for PCS-4000, 1.6 MHz for PCS-4200, 5 MHz for PCS-4300, 1 MHz for PCS-4500, and 100 kHz for PCS-4800.
- **DUAL MEMORY SCAN:** Scan memory banks either separately or together. COMPARE!
- **TWO RANGES OF PROGRAMMABLE BAND SCANNING:** Limits are quickly reset. Scan the two segments either separately or together. COMPARE!
- **FREE AND VACANT SCAN MODES:** Free scanning stops 5 seconds on a busy channel; auto-resume can be overridden if desired. Vacant scanning stops on unoccupied frequencies.
- **DISCRIMINATOR SCAN CENTERING (AZDEN EXCLUSIVE PATENT):** Always stops on frequency.
- **TWO PRIORITY MEMORIES:** Either may be instantly recalled at any time. COMPARE!
- **NICAD MEMORY BACKUP:** Never lose the programmed channels!
- **FREQUENCY REVERSE:** The touch of a single button inverts the transmit and receive frequencies,

no matter what the offset.

- **ILLUMINATED KEYBOARD WITH ACQUISITION TONE:** Unparalleled ease of operation.
- **BRIGHT GREEN LED FREQUENCY DISPLAY:** Easily visible, even in direct sunlight.
- **DIGITAL S/R/F METER:** Shows incoming signal strength and relative power output.
- **BUSY-CHANNEL AND TRANSMIT INDICATORS:** Bright LEDs show when a channel is busy and when you are transmitting.
- **FULL 16-KEY TOUCHTONE® PAD:** Keyboard functions as autopatch when transmitting (except in PCS-4800).
- **PL TONE:** Optional PL tone unit allows access to private-line repeaters. Deviation and tone frequency are fully adjustable.
- **TRUE FM:** Not phase modulation. Unsurpassed intelligibility and audio fidelity.
- **HIGH/LOW POWER OUTPUT:** 25 or 5 watts selectable in PCS-4000; 10 or 1 watt selectable in PCS-4200, PCS-4300, PCS-4500, and PCS-4800. Transmitter power is fully adjustable.
- **SUPERIOR RECEIVER:** Sensitivity is 0.2 uV or better for 20-dB quieting. Circuits are designed and manufactured to rigorous specifications for exceptional performance, second to none. COMPARE!
- **REMOTE-CONTROL MICROPHONE:** Memory A-1 call, up/down manual scan, and memory address functions may be performed without touching the front panel! COMPARE!
- **OTHER FEATURES:** Dynamic microphone, rugged built-in speaker, mobile mounting bracket, remote speaker jack, and all cords, plugs, fuses, and hardware are included.
- **ACCESSORIES:** CS-7R 7-amp ac power supply, CS-4.5R 4.5-amp ac power supply, CS-AS remote speaker, and Communications Specialists SS-32 PL tone module.
- **ONE YEAR LIMITED WARRANTY!**

EXCLUSIVE DISTRIBUTOR

**AMATEUR-WHOLESALE ELECTRONICS**

8817 S.W. 129th Terrace, Miami, Florida 33176

DEALER INQUIRIES INVITED

**TOLL FREE... 800-327-3102**

Telephone (305) 233-3631

Telex: 80-3356

MANUFACTURER

**JPC/AZDEN**

**JAPAN PIEZO CO., LTD.**

1-12-17 Kamirenjaku, Mitaka, Tokyo, 181 Japan.

Telex: 781-2822452





# flea market



**RATES** Noncommercial ads 10¢ per word; commercial ads 60¢ per word **both payable in advance.** No cash discounts or agency commissions allowed.

**HAMFESTS** Sponsored by non-profit organizations receive one free Flea Market ad (subject to our editing) on a space available basis only. Repeat insertions of ham-fest ads pay the non-commercial rate.

**COPY** No special layout or arrangements available. Material should be typewritten or clearly printed (**not** all capitals) and must include full name and address. We reserve the right to reject unsuitable copy. **Ham Radio** cannot check each advertiser and thus cannot be held responsible for claims made. Liability for correctness of material limited to corrected ad in next available issue.

**DEADLINE** 15th of second preceding month.

**SEND MATERIAL TO:** Flea Market, Ham Radio, Greenville, N. H. 03048.

## QSL CARDS

**QSLs & RUBBER STAMPS** — Top Quality! Card Samples and Stamp Info — 50¢ — Ebbert Graphics 5R, Box 70, Westerville, Ohio 43081.

**TRAVEL-PAK QSL KIT** — Converts post cards, photos to QSLs. Stamp brings circular. Samco, Box 203-c, Wyanntskill, New York 12198.

**DISTINCTIVE QSL's** — Largest selection, lowest prices, top quality photo and completely customized cards. Make your QSL's truly unique at the same cost as a standard card, and get a better return rate! Free samples, catalogue. Stamps appreciated. Stu K2RPZ Print, P.O. Box 412, Rocky Point, NY 11778 (516) 744-6260.

**QSL CARDS:** \$17.50/500 ppd. Free catalog. Bowman Printing, 743 Harvard, St. Louis, MO 63130.

## Foreign Subscription Agents for Ham Radio Magazine

Ham Radio Austria  
Karin Ueber  
Postfach 2454  
D-7850 Loerrach  
West Germany

Ham Radio Belgium  
Sterehouse  
Brusselsesteenweg 416  
B-9218 Gent  
Belgium

Ham Radio Canada  
Box 400, Goderich  
Ontario, Canada N7A 4C7

Ham Radio Europe  
Box 2084  
S-194 02 Uplands Vasby  
Sweden

Ham Radio France  
SM Electronic  
20 bis, Ave des Clairons  
F-59000 Auxerre  
France

Ham Radio Germany  
Karin Ueber  
Postfach 2454  
D-7850 Loerrach  
West Germany

Ham Radio Holland  
Postbus 413  
NL-7800 Ar Emmen  
Holland

Ham Radio Italy  
Via Pordenone 17  
I-20132 Milano  
Italy

Ham Radio Switzerland  
Karin Ueber  
Postfach 2454  
D-7850 Loerrach  
West Germany

Ham Radio UK  
P.O. Box 63, Harrow  
Middlesex HA3 6HS  
England

Holland Radio  
143 Greenway  
Greenside, Johannesburg  
Republic of South Africa

**CABLE TV EQUIPMENT**, Channel 3 or 4 notch filter \$20.00. Information \$1.00. Goldcoast, P.O. Box 63/6025G, Margate, FL 33063. (305) 752-9202.

**SATELLITE**, Microwave, video, audio components and equipment. Send \$1 for 1983 catalog. DSCO, Department C, 3110 Evelyn Street, Roseville, MN 55113.

**KLM PA15-80BL** 2 meter amplifier. 10W-in/80W-out, multimode, mint condx. \$100. MO, bank check. Rich Tashner, N2EO, 163-34 21 Road, Whitestone, NY 11357.

**CHASSIS** and cabinet kits. **SASE** K31WK.

**TENNATEST** — Antenna noise bridge — out-performs others, accurate, costs less, satisfaction guaranteed. Send stamp for details. W8URR, 1025A Wildwood Road, Quincy, MI 49082.

**ELECTRON TUBES:** Receiving, transmitting, microwave . . . all types available. Large stock. Next day delivery most cases. Daily Electronics, 14126 Willow Lane, Westminster, CA 92683. (714) 894-1368.

**LINEAR GANTT** — A new scheduling tool for project engineers and the like. Written in BASIC and easy to use. Send \$9.95 to Howe Associates, 3223 Stimson Way, San Jose, CA 95135.

**BUY SELL TRADE** — Next 6 issues \$2.00. WA4OSR's Rigs & Stuff, Box 973-H, Mobile, AL 36601.

**VLF-LF** preamps, coupler, Loran-C boards. **SASE**. Burhans Electronics, 161 Grosvenor St., Athens, Ohio 45701.

**WANTED:** Kenwood TS-700SP transceiver and MARS-7600 adapter. C. T. Huth, 146 Schonhardt, Tiffin, OH 44883.

**ROHN TOWERS** — Wholesale direct to users. All products available. Write or call for price list. Also we are wholesale distributors for Antenna Specialists, Regeney, Hy-Gain and Wilson. Hill Radio, P.O. Box 1405, 2503 G.E. Road, Bloomington, IL 61701-0887. (309) 663-2141.

**PRE-1946 TELEVISION SETS** wanted for substantial cash. Finder's fee paid for leads. Also interested in spinning disc, mirror in-the-lid, early color sets, 9AP4 picture tubes. Arnold Chase, 9 Rushleigh Road, West Hartford, Conn. 06117 (203) 521-5280.

**FOR SALE:** Heathkit DX-100 (160/10 meters), \$75.00. Technical material GPR-90. General coverage receiver, \$150.00. National NCX-5 transceiver with remote VFO, power supply/speaker and Heath mobile power supply \$375.00. All with manuals. K3UWO, Route 1, Box 201-A, Bridgewater, VA 22812. (703) 828-3723.

**MUSEUM** now open for radio historians and collectors. Free admission. Old time Amateur (W2AN) and commercial station exhibits, 1925 replica store and telegraph displays. 15,000 items. Write A.W.A. for details: Bruce Kelley, W2ICE, Holcomb, NY 14469.

**LOW VOLTAGE POWER SUPPLIES:** 5/12V at 2A each. Ideal for IC's. \$45.00 — Hollan Electronics, P.O. Box 18632, Austin, TX 78760.

**MOBILE IGNITION SHIELDING.** Estes Engineering, 930 Marine Dr., Port Angeles, WA 98362.

**OLD TIMERS:** Collector looking for old bugs and Spark keys. Vibroplex, McElroy, Marconi, DeForest, etc. K5RW, Neal McEwen, 1128 Midway, Richardson, TX 75081.

**CABLE CONVERTERS, decoders.** Catalog \$1 refundable. APS, POB 263 HR, Newport, RI 02840.

**IBM-PC RTTY & ASCII.** **SASE** for full details. E. Alline, NE5S, 773 Rosa, Metairie, LA 70005.

**HAM HOLIDAY** Sri Lanka. Write to Spangles Travels, 84 Templers Road, Mount Lavinia, Sri Lanka. Enclose 5 IRCs.

**SELL COLLECTION** of 40 years receiving tubes only one dollar each. Drake R4C \$275, T4XC \$275 plus DC4 P.S. MS4 Speaker \$25. Drake 1A \$100. Wanted machinist tools from retired machinists. Reasonable. W5QJT, 314 N. Restler Drive, El Paso, TX 79912. (915) 581-2017.

**RTTY-EXCLUSIVELY** for the Amateur Teleprinter. One year \$7.00. Beginners RTTY Handbook \$8.00 includes journal index. PO Box RY, Cardiff, CA 92007.

**6 NEW CHAPARRAL** "Super" feed horns \$20 each, 9 new regular circular feed horns \$8 each, Force AMU-150T 2 ch. UHF mobile with factory CTCSS, adjustable

\$250. Heath IG-102 signal generator, new tubes/clean \$40. GE 4ER25C2 VHF Rx \$25. (2) GE 4EP3A1 rack mount power supplies \$30 each. RCA senior volt ohmyst \$35. Dave Fant, Rt. 2, Box 381, Ozark, Arkansas 72949. (501) 667-4743.

**APPLE COMPUTER OWNERS** — Announcing "The Logger" — A very sophisticated, full-featured disk-based log book for ham radio operators. "The Logger" manages over 1900 log entries per standard DOS 3.3 diskette with sixteen separate functions including personalized QSL cards for less than 2 cents each! Unlocked program diskette and User's Guide \$35. pd. U. S. Large **SASE** for more information. Bob Jackson, Dept. HR, Box 57304, Webster, TX 77598.

**RS303U AND FERRITE BEADS** for W2DU's balun (QST March '83) HF \$8, VHF \$6 ppd. Copperweld™ 30% . 18 ga 3¢, 14 ga 6¢. All Amateur wire and cable (Belden & generic); Larsen, Unadilla, Janel, custom QSL's, crystals. All from Certified Communications, "the CB to 10 meter people", 4138 S. Ferris, Fremont, MI 49412.

**HALLICRAFTERS \$\$\$** Serious collector needs Hallicrafter and other Ham equipment manufactured before 1940 for restoration and eventual museum exhibit. Need Hallicrafters, National, Hammarlund, Patterson, RCA, RME, Grebe, etc. Condition not important. Also need QST mags Vols. I & II and old tubes. All letters answered. Write Dave Medley, WA5YXA, 6621 Duffield Drive, Dallas, Texas 75248.

**DRAKE R-4C**, FL1500, FL500, 10.0-10.5 MHz xtal. Excellent, UPS prepaid. \$325. W7BDO.

**WANTED:** Schematics-Rider, Sams or other early publications. Scaramella, P.O. Box 1, Woonsocket, RI 02895-0001.

**WANTED, MILITARY SURPLUS RADIOS.** We need Collins 618T, ARC-94, ARC-102, 718F-1/2, MRC-95, MRC-108, RT-980/GRC-171, RT-712/ARC-105, RT-804A/APN-171, ARC-114, ARC-115, RT-823/ARC-131 or FM-622, RT-857/ARC-134 or Wilcox 807A, ARC-159, ARC-164, RT-859/APX-72, APN-153, Antenna Couplers 490T, CU-1658A, CU-1239/ARC-105, CU-1669A, ARC-105, Sperry Rand 3226A1, 3226B1, 490B-1, 690D1. Top dollar paid or trade for new amateur gear. Write or phone Bill Slep, 704-524-7519, Slep Electronics Company, Hwy. 441, Otto, NC 28763.

**WANTED:** Cash paid for used Speed Radar equipment. Write or call: Brian R. Esterman, PO Box 8141, Northfield, Illinois 60093. (312) 251-8901.

**COLOR COMPUTER OWNERS** — Free hardware and software catalog. Spectrum Projects, 93-15 86 Drive, Woodhaven, NY 11421.

**WANTED:** Early Hallicrafter "Skyriders" and "Super Skyriders" with silver panels, also "Skyrider Commercial", early transmitters such as HT-1, HT-2, HT-8, and other Hallicrafter gear, parts, accessories, manuals. Chuck Dachis, WD5EOG, The Hallicrafter Collector, 4500 Russell Drive, Austin, Texas 78745.

**RUBBER STAMPS:** 3 lines \$4.50 PPD. Send check or MO to G.L. Pierce, 5521 Birkdale Way, San Diego, CA 92117. **SASE** brings information.

**RADIO WEST!** High quality coverage communications receivers with Collins filters and other DX modifications! Catalog 50¢ (refundable). Radio West, 3417 Purer Rd., Dept HR, Escondido, CA 92025 (619) 741-2891.

**VERY in-ter-est-ing!** Next 4 issues \$2. Ham Trader "Yellow Sheets", POB356, Wheaton, IL 60189.

**SUPER CQWW CONTEST** programs. TRS-80 Model I, III, (IV in III mode) Completely machine language. Logs 3200+ contacts per band. Automatic identification of country and zone from call letters. Dupé Speed 12000+ contacts per second. Screen displays zones still needed, total points, zones, countries, etc. Automatic cw generator with 2 buffers. Log Print program prepares logs and dupe sheets. \$39.95 Log Preparation program for hand logs. Similar features to above. \$29.95 Free fact sheet and sample printouts. K4SB, 3496 Velma Dr., Powder Springs, Georgia, 30073.

**VARIABLE VOLTAGE SUPPLY**, 0-25V, 3A. Kit \$50, Assembled \$65. (+ \$3.00 shipping.) Hollan Electronics, P.O. Box 18632, Austin, TX 78760.

**CUSTOM P/C BOARDS.** Send schematic for quotes. 1-4 transistors and/or IC's, \$15 single board. Orders of 1-10 please enclose payment. Hollan Electronics, P.O. Box 18632, Austin, TX 78760.

# flea market

## Coming Events ACTIVITIES "Places to go..."

**CALIFORNIA:** Sonoma County Radio Amateurs giant indoor flea market, Saturday, September 17, 9 AM to 3 PM, Sebastopol Community Center, 390 Morris St., Sebastopol, 5 miles west of Santa Rosa. Free admission and parking. Indoor flea market space \$3 (\$6 with table) at the door. Advance \$2.50 and \$5. Vendor set up 8 AM. Radio clinic, refreshments, auction in afternoon. Talk in on 146.13/73. For tickets and information: SCRA, Box 116, Santa Rosa, CA 95404.

**CONNECTICUT:** The Natchaug ARA will hold a giant flea market, Sunday, September 25, 9 AM to 4 PM, Elks Home off Rt. 32, Willimantic. Indoor/outdoor, rain or shine. Dealers set up 8 AM. Refreshments, free parking. Tables \$5 advance, \$7 at door. Admission \$2.00. Under 16 free. For information: Edward C. Sadeski, KA1HR, 49 Circle Drive, Willimantic, CT 06226, (203) 423-7137; or Clifton Pease, KA1HYW, 268 Main Street, Willimantic, CT 06226, (203) 456-1432 after 4 PM.

**COLORADO:** The Boulder Amateur Radio Club's "Barcrest", September 25, National Guard Armory, 4750 N. Broadway, Boulder, 9 AM to 3 PM. Admission \$3.00 per person or \$3.00 per family. Free parking. Refreshments. Talk in on 146.10/70 and 146.52 simplex. For information: Tim Groat, KR0U, 1000 East 10th Avenue, Broomfield, CO 80020. (303) 466-3733.

**FLORIDA:** The Platinum Coast Amateur Radio Society's 18th annual Hamfest and indoor swap-and-shop, September 10-11, Melbourne Auditorium, Melbourne. Admission \$3.00 advance, \$4.00 door. Swap tables and tailgating space available. Free parking. Awards, forums and meetings. Talk in on .25/.85 and .52/.52. For reservations, tables and information: PCARS, P.O. Box 1004, Melbourne, FL 32901.

**GEORGIA:** The 10th annual Lanierland ARC Hamfest, September 25, 9 AM, Holiday Hall, Holiday Inn, Gainesville. Free tables and inside display for dealers. Large flea market, boat anchor auction. Free admission. Talk in on 146.07/67. For information: Phil Loveless, KC4UC, 3574 Thompson Bend, Gainesville, GA 30506. (404) 532-9160.

**IOWA:** The 9th annual Cedar Valley ARC Hamfest, Sunday, October 2, Doors open 7 AM, Hawkeye Downs Exhibition Building, Cedar Rapids. Tickets \$2.00 advance, \$3.00 door. First table \$5.00 others \$7.00. Overnight camping area, picnic facilities, airport nearby. Collins surplus store will be open 9 AM to 2 PM. Talk in on 146.16/-76, .52, 223.34-94. For tickets and information: CVARC Hamfest, P.O. Box 994, Cedar Rapids, IA 52406.

**ILLINOIS:** The Sangamon County Fair and Agricultural Association's 8th annual New Berlin Hamfest, Sunday, September 25, Sangamon County Fairgrounds, New Berlin, rain or shine. Camping available. A model railroad train meet will also be held that day. For details: K9QFR, Box 2, Pleasant Plains, IL 62677.

**ILLINOIS:** The Peoria Area ARC Superfest '83, September 17 and 18, Exposition Gardens, W. Northmoor Road, Peoria. Gate opens 8 AM. Commercial building 9 AM. Admission \$3.00 advance, \$4.00 gate. Amateur Radio and computer displays, huge free flea market, free transportation to Northwoods Mall on Sunday. Camping facilities on grounds. Talk in on 146.16/76, W9UVI. For information and reservations SASE to: Superfest '83, 5808 N. Andover Ct., Peoria, IL 61615.

**KANSAS:** The Sandhills ARC's annual Eye-Ball QSO Party, September 25, Finney County Fairgrounds, Garden City. Doors open 9 AM. For information SASE to S.H.A.R.C., P.O. Box 811, Garden City, KS 67846.

**INDIANA:** The 4th annual Grant County ARC Hamfest, Saturday, September 10, McCarthy Hall, St. Paul's Catholic Church, Marion. Doors open 8 AM. Donation \$2.00 advance, \$3.00 gate. Table reservations \$2.00 per 8 ft. table. Refreshments, free parking. Talk in on 146.19/79 or 146.52 simplex. For information/tickets SASE to: KA9DLJ, Jerry Richards, P.O. Box 1146, Marion, IN 46952.

**MARYLAND:** The Columbia Amateur Radio Association's 7th annual Hamfest, Sunday, October 23, 8 AM to 3:30 PM, Howard County Fairgrounds, 15 miles west of

Baltimore. Admission \$3.00. Indoor tailgating and tables \$6.00 additional. Outdoor tailgating \$3.00 additional. Talk in on 147.735/135, 146.52/52. For reservations and information: Ed Wallace, K3EF, 9905 Carillon Drive, Ellicott City, MD 21043.

**MASSACHUSETTS:** The 19-79 ARA's annual fall flea market, Sunday, October 16, 11 AM to 4 PM, Beachmont VFW Post, 150 Bennington St., Revere. Sellers 10 AM. Admission \$1.00. Sellers tables \$6.00 advance, \$8.00 at door if available. Talk in on 19-79 and 52 direct. For table reservations send check to 19-79 Amateur Radio Association, P.O. Box 171, Chelsea, MA 02150.

**MICHIGAN:** The Grand Rapids ARA's annual Swap and Shop, Saturday, September 17, Hudsonville Fairgrounds. Dealers. Refreshments. Indoor sales area and outdoor trunk swap area. Gates open 8 AM. Talk in on 146.16/76. For information: Grand Rapids ARA, P.O. Box 1248, Grand Rapids, MI 49501.

**MICHIGAN:** The L'Anse Creuse Amateur Radio Club's 11th annual Swap and Shop, Sunday, September 18, 9 AM to 3 PM, L'Anse Creuse High School on Reimold. Admission \$1.00 advance, \$2.00 at door. Good food, free parking. Talk in on 147.69/.09 and 146.52. For information and tables SASE to William Chesney, N8CVC, 215 Elizabeth @ Mt. Clemens, MI 48043. (313) 463-1412.

**NEW ENGLAND:** The Hosstraders will hold their annual autumn swapfest, Saturday, October 8, rain or shine, Deerfield, New Hampshire, Fairgrounds. Admission \$1.00, tailgating included. Friday night camping for self-contained rigs, after 4 PM. Profits benefit Shriners' Boston Burns Hospital. Last May's donation \$2,702.00. For information/map SASE to Norm, WA1IVB, RFD Box 57, West Baldwin, ME 04091; or Joe, K1RQG, Star Rt. Box 56, Bucksport, ME 04416; or Bob, W1GWU, 105 Walton Rd., Seabrook, NH 03874.

**NEW JERSEY:** The De Vry Technical Institute ARC's annual flea market, October 1, 9 AM to 4 PM, school parking lot at 479 Green Street, Woodbridge. Buyers free admission. Sellers \$3.00. No electricity. For information contact WB2JKU.

**NEW HAMPSHIRE:** The Connecticut Valley FM Association's 6th annual Hamfest and Flea Market, September 25, 9 AM to 5 PM, King Ridge Ski Area, Sutton, rain or shine. Admission \$2.00. Dealers and flea marketeers \$5.00. Refreshments available. Overnight camping for self-contained RV's. No hookups. Talk in on 146.16/76 or 146.52 simplex.

**NEW YORK:** The Yonkers electronics fair and giant flea market, Sunday, October 2, 9 AM to 4 PM, Yonkers Municipal Parking Garage, Corner of Nepperhan Avenue and New Main Street. Rain or shine. Live demonstrations, Amateur Radio, computers, electric car, satellite TV, SSTV, Hi-Fi/audio. Refreshments, free parking. Unlimited free coffee all day. Admission \$2.00, children under 12 free. Sellers \$6.00 per space, bring tables. Sponsored by the Yonkers ARC. For information (914) 969-1053.

**NEW YORK:** The Radio Amateurs of Greater Syracuse, RAGS, annual Hamfest and Computer Display, Saturday, October 1, 9 AM to 6 PM, Art and Home Center, New York State Fairgrounds, Syracuse. Commercial exhibitors, large indoor/outdoor flea market, tech talks, ARRL booth, contests and entertainment. Refreshments. Admission \$3.00. Talk in on 90/30, 31/91 and 52 simplex. For information: RAGS, Box 88, Liverpool, NY 13088.

**NEW YORK:** The Elmira International Hamfest, September 24, Chemung County Fairgrounds, gates open 8 AM. Free flea market, dealers, tech talks. Refreshments available. Talk in on 147.96/36, 146.10/70 and 146.52/52. Advance tickets \$2.00 from John Brees, 340 West Avenue, Horseheads, NY 14845. Tickets at gate \$3.00.

**NEW YORK:** Seaway Valley Hamfest, Saturday, September 10, 9 AM to 4 PM, Louisville Firemen's Arena, Louisville. ARRL forum, tech programs, demos, entertainment, flea market, snack bar. Tickets \$3.00 at door, \$2.50 advance. For information/tickets: SASE to Lois Jerlan, WA2RXO, 725 Proctor Avenue, Ogdensburg, NY 13669. (U.S. funds only please).

**NEW JERSEY:** The South Jersey Radio Association's 35th annual Hamfest, September 18, Pennsauken Sr. High School, Hylton Road, Pennsauken, 8 AM to 4 PM. Advance tickets \$2.50. \$3.50 at gate. Tailgaters \$5.00. Refreshments available. Talk in 22/82 and 52. For information: Fred Holler, W2EKB, 348 Bortons Mill Road, Cherry Hill, NJ 08002. (609) 795-0577.

**OHIO:** The Cleveland Hamfest and ARRL Great Lakes Division Convention, Saturday, September 24, banquet. Sunday, September 25, Hamfest, 8 AM to 5 PM. NEW LOCATION: Cleveland Aviation High School, North Marginal Road, Cleveland. Exhibits, refreshments, overnight parking available. Flea market open 6 AM, \$2.00 per space. General admission \$3.00. Talk in on 146.52, WBQV. For advance tickets send check or MO for \$2.50

before August 31 to: Cleveland Hamfest Association, P.O. Box 93077, Cleveland, OH 44101.

**WASHINGTON:** The Walla Walla Valley Radio Amateur Club's 37th annual Hamfest, September 24 and 25, Milton-Freewater, Oregon Community Building. Doors open 8:30 AM. Swap shop, crafts, Tesla coil and spark gap demo. Antique, homebrew contests. Bazaar Sunday. Potluck dinner Sunday noon. For information: W7DP, P.O. Box 321, Walla Walla, WA 99362.

**PENNSYLVANIA:** 1983 A-5 Magazine/USATVS 4th annual fall ATV Conference, September 23-25, to be held concurrent with York, PA Hamfest. Seminars Friday 6-10:30 PM. Saturday 9 AM to 10 PM with banquet. Sunday 7 AM to noon. FSTV and SSTV to be fully covered with excellent speakers. SASE to W3SST or ATV Magazine, P.O. Box H, Lowden, IA 52255.

**PENNSYLVANIA:** The Skyview Radio Society's annual Hamfest, Sunday, September 18, noon to 4 PM, club grounds on Turkey Ridge Road, New Kensington. Talk in on 04-64 and 52 simplex. Registration fee \$2.00. Vendors \$4.00.

**PENNSYLVANIA:** The Pack Rats (Mt. Airy VHF ARC) invites all Amateurs and friends to the 7th annual Mid-Atlantic VHF Conference, Saturday, October 1, Warrington Motor Lodge, Route 611, Warrington; and Sunday, October 2, Hamarama, Bucks County Drive-In Theater, Route 611, Warrington. Flea market admission \$3.00. Selling space \$5.00 each. Bring own tables. Gates open 7:30 AM. Rain or shine. Advance registration \$4.00 for conference and Hamarama. Send to Hamarama '83, P.O. Box 311, Southampton, PA 18966 or Lee A. Cohen, K3MXX, (215) 635-4942.

**SOUTH CAROLINA:** 32nd annual Rock Hill Hamfest, October 2, For information: YCARS, Box 4141CRS, Rock Hill, SC 29730.

**SOUTH DAKOTA:** The ARRL Dakota Division Convention, September 23-25, Howard Johnson Motor Lodge, Sioux Falls. Friday evening registration and entertainment. Saturday forums, exhibits, flea market, contests, luncheon. ARRL forum led by Vic Clark, President. Sunday 2 meter transmitter hunt. Convention pre-registration prior to September 1 is \$5.00. \$6.00 at door. Convention and banquet \$15, \$16 at door. Banquet only \$10. Talk in on 16/76 and 52/52. For information, Sioux Falls ARC, P.O. Box 91, Sioux Falls, SD 57101.

**RADIO EXPO:** Sponsored by the Chicago FM Club, Saturday and Sunday, September 24 and 25, Lake County Fairgrounds, Routes 120 and 45, Grayslake, Illinois. Flea market opens 6 AM. Exhibits open 9 AM. Indoor flea market tables available at \$5.00 per day. Tickets \$3.00 advance, \$4.00 at gate, good for both days. Seminars, tech talks, ladies' programs. Talk in on 146.16/76, 146.52 and 222.5/224.10. For information: SASE to Radio Expo 83, Box 1532, Evanston, IL 60204 or (312) 582-6923.

**TENNESSEE:** The Memphis Hamfest, Saturday and Sunday, October 8 and 9, Memphis Fairgrounds, Mid South Building. Radio and computer displays and forums. Hospitality party Saturday night. Dealer and flea market set-up Friday evening till 9 PM. Tables on site. Talk in on 28/88 and 34/94. For information/reservations: Clayton Elam, K4FZJ, 28 No. Cooper, Memphis, TN 38104. (901) 274-4418 days or (901) 743-6714 evenings.

**TEXAS:** The Wichita ARS's second annual Hamfest, September 24 and 25, National Guard Armory, Wichita Falls. Saturday 8 AM to 6 PM. Sunday 8 AM to 2 PM. Dealer displays, computers, large inside flea market, refreshments, free RV parking no hookups. Nearby shopping malls. Air Force MARS, QCWA meeting and more. Pre-registration by September 21, \$4.00. \$5.00 at door. Talk in on 146.34/94 and 147.75/15. For information/tickets: WARS HAMFEST, P.O. BOX 4363, Wichita Falls, TX 76308.

**VIRGINIA:** The 8th annual Tidewater Amateur Radio Hamfest, Computer Convention, Electronic Flea Market, Saturday and Sunday, October 8 and 9, Virginia Beach Pavilion, 9 AM to 5 PM. \$4.00 admission good for both days. Flea market tables \$5.00 one day, \$8.00 both days. Dealers, displays, forums, computers, satellite equipment. Beautiful Virginia Beach nearby. Visit Norfolk Waterfront Festival Marketplace. For information/tickets: Jim Harrison, N4NV, 1234 Little Bay, Norfolk, VA 23503. (804) 587-1695.

**WISCONSIN:** The St. Croix Valley Repeater Association's 7th annual Hamfest, Saturday, September 24, 9 AM to 2 PM, American Legion Hall, Baldwin. Admission \$2.00. Talk in on 147.93/33 and 146.52 simplex. For information: Bruce Olson, N9BLU, Box 91, St. Croix Falls, WI 54024.

**OHIO:** Lima Hamfest, Allen County Fairgrounds, October 9. Gates open 6 AM. Advance tickets \$3.00; at gate \$3.50. Tables \$6.00 each; half tables \$3.50. For information/reservations: N.O.A.R.C., Box 211, Lima, Ohio 45802.

## OPERATING EVENTS "Things to do..."

**SEPTEMBER 3 AND 4:** The Independence FM Radio Association will operate a special event station celebrating Santa Caligdon Days in Independence. Frequencies: 10-30 kHz from lower General and Novice band edges. Certificate for large SASE to KD0FW, Mike Bogard, 608 Concord Circle, Independence, MO 64056.

**SEPTEMBER 13-17:** The Southern Counties ARA will operate a special events station at the Miss America Pageant, Caesars Hotel Casino on the boardwalk in Atlantic City on a 24-hour basis. Frequencies: Phone - 25 kHz inside General band. CW 65 kHz from bottom of General band. 80-10 meters. Novice contacts 15 and 40 meters in the middle of Novice band. Local SCARA repeater K2BR at 146.745, output/input down 800. A special QSL available for SASE to: SCARA, K2BR, Box 121, Lynwood, NJ 08221.

**SEPTEMBER 17:** The Sweetwater ARC will operate special event station WA7USI from an historic site in southwestern Wyoming from 1800Z Sept. 17 to 1800Z Sept. 18. Frequencies: Up 40 kHz on General phone bands. Also Novice.

**SEPTEMBER 17-19:** Kansas State QSO Party sponsored by Boeing Employees' ARS of Wichita. Sept. 17 - 0100 UTC to 0700 UTC. Sept. 17 1300 UTC to 0700 UTC Sept. 18. Sept. 18 1300 UTC to 0100 UTC Sept. 19. All Amateurs are invited to participate. All bands and modes may be used. Kansas stations send QSO number, RS(T) and county. All others send QSO number, RS(T) and state, Province or foreign country. Logs must show dates, times in UTC, stations worked, exchanges, bands, modes and scores claimed. Log and summary sheets available for SASE. Must be postmarked NLT October 20, 1983 and sent to: Boeing Employees' ARS of Wichita, c/o Mike Thornton, WA0TAH, 1001 Munnell Avenue, Wichita, KS 67213.

**SEPTEMBER 18:** The Wisconsin Valley Radio Association will operate a special event station from Marathon County in north central Wisconsin at the intersection of 45 degrees North Parallel and 90 degrees West Meridian, near the city of Wausau, exactly halfway between the North Pole and the Equator and halfway between the Zero Meridian at Greenwich, England, and the International Dateline. Listen for club call W9SM. 7 AM to 7 PM CDT. Frequency (depending on band conditions) will be 25 kHz up from bottom of General phone portion of band(s) used. For a QSL card SASE with \$1.00 to Wisconsin Valley Radio Association, Box 363, Wausau, WI 54401.

**SEPTEMBER 23 AND 24:** The Smithfield (Ohio) Apple Festival is sponsoring a special event station. 2300 UTC to 0400 UTC. Frequencies: SSB, 3.900 ± 5 MHz. Novice 7.110 ± 5 MHz. Station call N8CUX. For a special certificate SASE to Robert Carson, N8CUX, 259 Hill Street, Smithfield, Ohio 43948.

**SEPTEMBER 22-24:** The Fisher Body Lordstown ARC will operate W8KKZ from 1200Z to 0300Z daily to commemorate the 75th anniversary of General Motors. Operations lower portion of 20 and 40 meter General phone band and lower portion of 15 and 40 meter Novice CW bands. QSL information will be given on the air.

**OCTOBER 1 AND 2:** Oregon QSO party sponsored by the Hermiston Amateur Radio Club. Oct. 1 1700Z to 0800Z Oct. 2. 1500Z Oct. 2 to 0000Z Oct. 3. Exchange: OR stations signal report and county. Others signal report and state/province/country. A station may be worked once per band and mode. Mixed mode or CW only. All entries must have log and summary sheet. Summary sheet available from KA7IXH for SASE. Logs must be received by November 4, 1983. Mail to Bob Franklin, KA7IXH, Rt. 3, Box 3783, Hermiston, OR 97838.

**OCTOBER 1-9:** Special events station KN5D will operate throughout the 12th annual International Hot Air Balloon Fiesta, Albuquerque, New Mexico. 1400 to 1800 UTC daily. Frequencies: 15-25 kHz above low end of General phone bands. For a special QSL card and Balloon Fiesta certificate SASE to KN5D, P.O. Box 997, Corrales, NM 87048.

**OCTOBER 1, 2 & 8, 9:** VK/ZL/Oceania Contest. The WIA and NZART invite worldwide participation in this year's VK/ZL DX contest. Phone: From 1000 GMT, Saturday, October 1 to 1000 GMT, Sunday, October 2. CW: From 1000 GMT, Saturday, October 8 to 1000 GMT, Sunday, October 9. Logs overseas stations: Show date, time in GMT, call sign of station contacted, band, serial number send, serial number received. Underline each new VK/ZL contact. Separate logs must be submitted for each band. Summary sheet to show call sign, name and address, equipment used, QSO points for each band, VK/ZL call areas worked on that band. WIA/VK/ZL Contest Manager, VK3BGW, 1 Noorabil Court, Greensborough, Victoria 3088, Australia by January 31, 1984.

## High Performance vhf/uhf preamps

EME  
Scatter  
Tropo  
Satellite  
ATV  
Repeater  
FM Equipment  
Radio Telescope

NEW GaAsFETs!

|         | Freq. Range (MHz) | N.F. (dB) | Gain (dB) | 1 dB Comp. (dBm) | Device Type | Price   |
|---------|-------------------|-----------|-----------|------------------|-------------|---------|
| P28VD   | 28-30             | <1.1      | 15        | 0                | DGFET       | \$29.95 |
| P50VD   | 50-54             | <1.3      | 15        | 0                | DGFET       | \$29.95 |
| P50VDG  | 50-54             | <0.5      | 24        | +12              | GaAsFET     | \$79.95 |
| P144VD  | 144-148           | <1.5      | 15        | 0                | DGFET       | \$29.95 |
| P144VDA | 144-148           | <1.0      | 15        | 0                | DGFET       | \$37.95 |
| P144VDG | 144-148           | <0.5      | 24        | +12              | GaAsFET     | \$79.95 |
| P220VD  | 220-225           | <1.8      | 15        | 0                | DGFET       | \$29.95 |
| P220VDG | 220-225           | <1.2      | 15        | 0                | DGFET       | \$37.95 |
| P220VDA | 220-225           | <0.5      | 20        | +12              | GaAsFET     | \$79.95 |
| P432VD  | 420-450           | <1.8      | 15        | -20              | Bipolar     | \$32.95 |
| P432VDA | 420-450           | <1.1      | 17        | -20              | Bipolar     | \$49.95 |
| P432VDG | 420-450           | <0.5      | 16        | +12              | GaAsFET     | \$79.95 |

Advanced Receiver Research

Box 1242 • Burlington CT 06013 • 203 582-9409

Preamps are available without case and connectors: subtract \$10. Other preamps available in the 1 - 800 MHz range. Prices shown are postpaid for U.S. and Canada. CT residents add 7-1/2% sales tax. C.O.D. orders add \$2. Air mail to foreign countries add 10%.



104

### SEMICONDUCTORS:

|                            |         |           |         |
|----------------------------|---------|-----------|---------|
| MRF-208                    | - 12.00 | MHW-252   | - 50.00 |
| MRF-240                    | - 15.50 | MHW-710-1 | - 61.00 |
| MRF-247                    | - 34.80 | MPSH-81   | - .50   |
| MRF-309                    | - 27.60 | MV2205    | - .58   |
| MRF-422                    | - 41.40 | 78L08CP   | - .50   |
| MRF-454                    | - 20.00 | 2N4401    | - .75   |
| MRF-901                    | - 1.75  | 2N5190    | - 1.50  |
| SBL-1 Double-Balance Mixer | - 6.50  |           |         |

### P.C. BOARDS FOR MOTOROLA BULLETINS

|        |         |        |         |
|--------|---------|--------|---------|
| EB-18A | - 12.00 | AN-762 | - 14.00 |
| EB-27A | - 14.00 | AN-791 | - 10.00 |
| EB-63  | - 14.00 | EB-67  | - 14.00 |

KEMET CHIP CAPACITORS: 56 pf, 82 pf, 100 pf, 390 pf, 470 pf; -.50 ea  
680 pf, 1000 pf; -.55 ea  
5600 pf, 6800 pf, .1 uf; -1.00 ea  
SBL-1 Double-Balance Mixer - .33 uf; -1.90 ea .68 uf; -3.90 ea

CAMBION RF CHOKES: .15 uh, .22 uh, .33 uh, 4.7 uh, 10 uh - 1.20 ea  
BROADBAND TRANSFORMERS PER MOTOROLA BULLETINS: AN-762, EB-27A, EB-63  
UNDERWOOD/SEMCO METAL-CLAD MICA CAPACITORS: 5pf, 10pf, 15pf, 25pf, 30pf, 40pf, 56pf, 60pf, 68pf, 80pf, 91pf, 100pf, 200pf, 250pf, 390pf, 470pf, 1000pf

We also carry a line of VHF, UHF amplifiers and ATV equipment.

Call or write for our free catalog.



Communication Concepts Inc.



2648 North Aragon Ave • Dayton, Ohio 45420 • (513) 296-1411

125

### INTERFERENCE HANDBOOK

by William R. Nelson, WA6FQG

RFI is a very sticky problem. It can ruin your operating fun and worse. This brand-new book covers every type of RF interference that you are likely to encounter. Emphasis is placed on Amateur Radio, CB and power line problems. Author Nelson solves the mystery of power line interference — how to locate it, cure it, safety precautions and more. He also gives you valuable steps on how to eliminate TV and stereo problems. To help you understand this perplexing problem even more, this new book gives you interesting RFI case histories, filters to buy or build, mobile, telephone, CATV and computer problems and ideas on how to solve them. Profusely illustrated and packed with practical, authoritative information. ©1981. 247 pages, first edition.

RP-1H Softbound \$9.95

Please add \$1.00 to cover shipping and handling.

HAM RADIO'S BOOKSTORE  
GREENVILLE, N. H. 03048

### TIDBITS

## 2ND OP

by Jim Rafferty, N6RJ

Completely revised and updated with all of the latest information, the latest 2nd Op is an indispensable operating aid for all Radio Amateurs. The 2nd Op gives you at the twist of a dial: prefixes in use, continent, zone, country, beam heading, time differential, postal rates, QSO and QSL record and the official ITU prefix list. Every ham needs a 2nd Op. Order yours today. ©1981, N6RJ's 1st Edition.

HR-OP \$6.95  
Please add \$1.00 for shipping and handling.

HAM RADIO'S BOOKSTORE  
GREENVILLE, NH 03048

# HAM MART

*Ham Radio's guide to help you find your local*

## California

### C & A ELECTRONIC ENTERPRISES

22010 S. WILMINGTON AVE.  
SUITE 105

CARSON, CA 90745

213-834-5868

Not The Biggest, But The Best —  
Since 1962.

### FONTANA ELECTRONICS

8628 SIERRA AVENUE

FONTANA, CA 92335

714-822-7710

714-822-7725

The Largest Electronics Dealer in San  
Bernardino County.

### JUN'S ELECTRONICS

3919 SEPULVEDA BLVD.

CULVER CITY, CA 90230

213-390-8003

619-463-1886 San Diego

800-882-1343 Trades

The Home of the One Year Warranty

— Parts at Cost — Full Service.

Habla Espanol

### SHAVER RADIO, INC.

1378 S. BASCOM AVENUE

SAN JOSE, CA 95128

408-998-1103

Azden, Icom, Kenwood, Tempo,

Ten-Tec, Yaesu and many more.

## Connecticut

### HATRY ELECTRONICS

500 LEDYARD ST. (SOUTH)

HARTFORD, CT 06114

203-527-1881

Call today. Friendly one-stop shop-  
ping at prices you can afford.

## Delaware

### DELAWARE AMATEUR SUPPLY

71 MEADOW ROAD

NEW CASTLE, DE 19720

302-328-7728

800-441-7008

Icom, Ten-Tec, DenTron, Yaesu,

Azden, Santec, KDK, and more.

One mile off I-95, no sales tax.

## Florida

### AMATEUR ELECTRONIC SUPPLY

1898 DREW STREET

CLEARWATER, FL 33515

813-461-HAMS

Clearwater Branch

West Coast's only full service

Amateur Radio Store.

### AMATEUR ELECTRONIC SUPPLY

621 COMMONWEALTH AVE.

ORLANDO, FL 32803

305-894-3238

Fla. Wats: 1 (800) 432-9424

Outside Fla: 1 (800) 327-1917

### AMATEUR RADIO CENTER, INC.

2805 N.E. 2ND AVENUE

MIAMI, FL 33137

305-573-8383

The place for great dependable  
names in Ham Radio.

### RAY'S AMATEUR RADIO

1590 US HIGHWAY 19 SO.

CLEARWATER, FL 33516

813-535-1416

Your complete Amateur Radio and

Computer Store.

## Illinois

### ERICKSON COMMUNICATIONS, INC.

5456 N. MILWAUKEE AVE.

CHICAGO, IL 60630

Chicago — 312-631-5181

Outside Illinois — 800-621-5802

Hours: 9:30-5:30 Mon, Tu, Wed & Fri;

9:30-8:00 Thurs; 9:00-3:00 Sat.

## Indiana

### THE HAM SHACK

808 NORTH MAIN STREET

EVANSVILLE, IN 47710

812-422-0231

Discount prices on Ten-Tec, Cubic,

Hy-Gain, MFJ, Azden, Kantronics,

Santec and others.

## Kansas

### ASSOCIATED RADIO

8012 CONSER, P. O. BOX 4327

OVERLAND PARK, KS 66204

913-381-5900

America's No. 1 Real Amateur Radio

Store. Trade — Sell — Buy.

## Kentucky

### L & S RADIO

307 McLEAN AVENUE

HOPKINSVILLE, KY 42240

502-885-8071

Ten-Tec, Azden, Ameritron Sales and

Service.

## Maryland

### THE COMM CENTER, INC.

LAUREL PLAZA, RT. 198

LAUREL, MD 20707

800-638-4486

Kenwood, Drake, Icom, Ten-Tec,

Tempo, Microlog, AEA, Ameritron.

## Massachusetts

### TEL-COM, INC.

675 GREAT ROAD, RTE. 119

LITTLETON, MA 01460

617-486-3040

617-486-3400 (this is new)

The Ham Store of New England

You Can Rely On.

## Minnesota

### MIDWEST AMATEUR RADIO SUPPLY

3452 FREMONT AVE. NO.

MINNEAPOLIS, MN 55412

612-521-4662

It's service after the sale that counts.

## Nevada

### AMATEUR ELECTRONIC SUPPLY

1072 N. RANCHO DRIVE

LAS VEGAS, NV 89106

702-647-3114

Dale Porray "Squeak," AD7K

Outside Nev: 1 (800) 634-6227

### JUN'S ELECTRONICS

460 E. PLUMB LANE — 107

RENO, NV 89502

702-827-5732

Outside Nev: 1 (800) 648-3962

Icom — Yaesu Dealer

## New Jersey

### ROUTE ELECTRONICS 46

225 ROUTE 46 WEST

TOTOWA, NJ 07512

201-256-8555

### ROUTE ELECTRONICS 17

777 ROUTE 17 SOUTH

PARAMUS, NJ 07625

201-444-8717

Drake, Cubic, DenTron, Hy-Gain,

Cushcraft, Hustler, Larsen, MFJ,

Butternut, Fluke & Beckman

Instruments, etc.

**Dealers:** *YOU SHOULD BE HERE TOO!*  
*Contact Ham Radio now for complete details.*

## Amateur Radio Dealer

### New York

**BARRY ELECTRONICS**  
512 BROADWAY  
NEW YORK, NY 10012  
212-925-7000  
New York City's Largest Full Service  
Ham and Commercial Radio Store.

**GRAND CENTRAL RADIO**  
124 EAST 44 STREET  
NEW YORK, NY 10017  
212-599-2630  
Drake, Kenwood, Yaesu,  
Ten-Tec, DenTron, Hy-Gain,  
Mosley in stock.

**HARRISON RADIO CORP.**  
20 SMITH STREET  
FARMINGDALE, NY 11735  
516-293-7990  
"Ham Headquarters USA" since  
1925. Call toll free 800-645-9187.

**RADIO WORLD**  
ONEIDA COUNTY AIRPORT  
TERMINAL BLDG.  
ORISKANY, NY 13424  
TOLL FREE 1 (800) 448-9338  
NY Res. 1 (315) 337-0203  
Authorized Dealer — ALL major  
Amateur Brands.  
We service *everything* we sell!  
Bob WA2MSH.

### Ohio

**AMATEUR ELECTRONIC SUPPLY**  
28940 EUCLID AVE.  
WICKLIFFE, OH (CLEVELAND AREA)  
44092  
216-585-7388  
Ohio Wats: 1 (800) 362-0290  
Outside Ohio: 1 (800) 321-3594

**UNIVERSAL AMATEUR RADIO, INC.**  
1280 AIDA DRIVE  
REYNOLDSBURG (COLUMBUS), OH  
43068  
614-866-4267  
Featuring Kenwood and all other  
Ham gear. Authorized sales and ser-  
vice. Shortwave headquarters. Near  
I-270 and airport.

### Oklahoma

**DERRICK ELECTRONICS, INC.**  
714 W. KENOSHA — P.O. BOX A  
BROKEN ARROW, OK 74012  
Your *Discount* Ham equipment dealer  
in Broken Arrow, Oklahoma  
1-800-331-3688 or  
1-918-251-9923

### Pennsylvania

**HAMTRONICS,**  
DIV. OF TREVOSE ELECTRONICS  
4033 BROWNSVILLE ROAD  
TREVOSE, PA 19047  
215-357-1400  
Same Location for 30 Years.

**LaRUE ELECTRONICS**  
1112 GRANDVIEW STREET  
SCRANTON, PENNSYLVANIA 18509  
717-343-2124  
Icom, Bird, Cushcraft, Beckman,  
Fluke, Larsen, Hustler, Astron,  
Antenna Specialists, W2AU/W2VS,  
AEA, B&W, CDE, Sony, Vibroplex.

**THE VHF SHOP**  
BOX 349 RD 4  
MOUNTAINTOP, PA 18707  
717-868-6565  
Lunar, Microwave Modules, ARCOS,  
Astron, KLM, Tama, Tonna-F9FT,  
UHF Units/Parabolic, Santec, Tokyo  
Hy-Power, Dentron, Mirage,  
Amphenol, Belden

### Texas

**MADISON ELECTRONICS SUPPLY**  
1508 MCKINNEY  
HOUSTON, TX 77010  
713-658-0268  
Christmas?? Now??

### Virginia

**ELECTRONIC EQUIPMENT BANK**  
516 MILL STREET, N.E.  
VIENNA, VA 22180  
703-938-3350  
Metropolitan D.C.'s One Stop  
Amateur Store. Largest Warehousing  
of Surplus Electronics.

### Wisconsin

**AMATEUR ELECTRONIC SUPPLY**  
4828 W. FOND DU LAC AVE.  
MILWAUKEE, WI 53216  
414-442-4200  
Wisc. Wats: 1 (800) 242-5195  
Outside Wisc: 1 (800) 558-0411

# NOW!



a  
**30 watt  
amplifier  
that also  
CHARGES!**

35 mA rate recharges  
your handheld when it's  
off, maintains charge in  
the receive mode.

And it adds 30 watts of  
mobile talk-out power;  
makes an incredible  
performer of your  
HT-based mobile radio  
system.

All at the price of an  
amplifier alone! An  
incredible value.

Only \$74.95! Order  
today. Call toll-free

1-800-USA-MADE

Charge VISA, MC or mail  
check, money order.  
Add \$3.00 for shipping;  
Illinois residents also  
add \$4.50 sales tax.

**VoCom**  
PRODUCTS CORPORATION  
65 East Palatine Road  
Prospect Heights, IL 60070  
(312) 459-3680



EIMAC 4CX10,000D/8171 with SK300 and SK1306 . \$1200.00  
 SK300 and SK1306 Only. \$ 350.00  
 (These are all new not used.) Limited Supply.

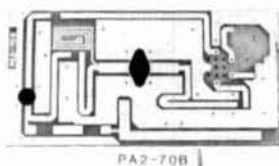
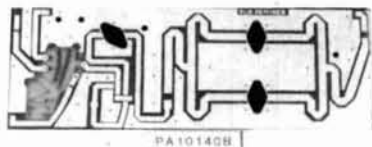

KLM ELECTRONICS, INC. VHF AMPLIFIER PC BOARDS AND RF TRANSISTOR KITS.  
 Model PA2-70B RF power input 2watts at 144 to 148MHz output 70watts 13.5vdc at 10amps.  
 \$49.99 with data PC Board Only \$14.99  
 MODEL PA10140B RF power input 10watts at 144 to 148MHz output 140watts 13.5vdc at 18amps.  
 \$89.99 with data PC Board Only \$19.99

#### GENEVA CALCULATOR WATCH

This attractive watch has the following modes:  
 Normal Time Setting,  
 Calendar Setting,  
 Daily Alarm Time Setting,  
 Weekly Alarm Time Setting,  
 Chronograph,  
 Calculator.



Featured in Black Plastic \$18.99 or Featured in Stainless Steel \$29.99

#### SILICON DIODES

|           |         |         |           |             |
|-----------|---------|---------|-----------|-------------|
| MR751     | 100vdc  | 6Amps   | 10/\$5.00 | 100/\$38.00 |
| MR510     | 1000vdc | 3Amps   | 10/\$3.75 | 100/\$24.00 |
| HEP170    | 1000vdc | 2Amps   | 20/\$2.00 | 100/\$15.00 |
| IN3209    | 100vdc  | 15Amps  | \$2.00    | 10/ \$15.00 |
| BYX21/200 | 200vdc  | 25Amps  | \$2.00    | 10/ \$15.00 |
| IN2138A   | 600vdc  | 60Amps  | \$5.00    | 10/ \$40.00 |
| DS85-04C  | 400vdc  | 80Amps  | \$10.00   | 10/ \$80.00 |
| IN3269    | 600vdc  | 160Amps | \$15.00   | 10/\$120.00 |
| 275241    | 300vdc  | 250Amps | \$20.00   | 10/\$175.00 |
| 7-5754    | 300vdc  | 400Amps | \$30.00   | 10/\$250.00 |
| RCD-15    | 15KVDC  | 20ma.   | \$3.00    | 10/ \$20.00 |
| SMFR20K   | 20KVDC  | 20ma.   | \$4.00    | 10/ \$30.00 |
| IN4148    | signal  |         | 30/\$1.00 | 100/ \$3.00 |

#### FAIRCHILD 4116 16K DYNAMIC RAMS 200ns. Part # 16K75

25 For \$25.00 or 100 For \$90.00 or 1000 For \$750.00

#### FEED THRU SOLDER RF CAPACTORS

|                                          |
|------------------------------------------|
| 470pf +-20%                              |
| 5/\$1.00 or 100/\$15.00 or 1000/\$100.00 |
| 1000pf/.001uf +-10%                      |
| 4/\$1.00 or 100/\$20.00 or 1000/\$150.00 |

#### E PROMS

|             |              |
|-------------|--------------|
| 2708 1024x1 | \$2.00 each  |
| 2716 2048x8 | \$4.00 each  |
| 27L32/25L32 | \$10.00 each |

#### HEWLETT PACKARD MICROWAVE DIODES

|           |              |                         |                                  |
|-----------|--------------|-------------------------|----------------------------------|
| IN5711    | (5082-2800)  | Schottky Barrier Diodes | \$1.00 or 10 for \$ 8.50         |
| IN5712    | (5082-2810)  | " " "                   | \$1.50 or 10 for \$10.00         |
| IN6263    | (HSCH-1001)  | " " "                   | \$ .75 or 10 for \$ 5.00         |
| 5082-2835 |              | " " "                   | \$1.50 or 10 for \$10.00         |
| 5082-2805 | Quad Matched | " " "                   | per set \$5.00 or 10 for \$40.00 |

For information: 602-242-8916

Toll Free Number  
 800-528-0180  
 (For orders only)

**MHz electronics**

"All parts may be new or surplus, and parts may be substituted with comparable parts if we are out of stock of an item."

PRICES SUBJECT TO CHANGE WITHOUT NOTICE

# "MIXERS"

## WATKINS JOHNSON WJ-M6 Double Balanced Mixer

|                         |                         |                 |
|-------------------------|-------------------------|-----------------|
| LO and RF 0.2 to 300MHz | IF DC to 300MHz         | \$21.00         |
| Conversion Loss (SSB)   | 6.5dB Max. 1 to 50MHz   |                 |
|                         | 8.5dB Max. .2 to 300MHz | WITH DATA SHEET |
| Noise Figure (SSB)      | same as above           |                 |
|                         | 8.5dB Max. 50 to 300MHz |                 |
| Conversion Compression  | .3dB Typ.               |                 |

## NEC (NIPPON ELECTRIC CO. LTD. NE57835/2SC2150 Microwave Transistor

|               |             |            |             |        |
|---------------|-------------|------------|-------------|--------|
| NF Min F=2GHz | dB 2.4 Typ. | MAG F=2GHz | dB 12 Typ.  | \$5.30 |
| F=3GHz        | dB 3.4 Typ. | F=3GHz     | dB 9 Typ.   |        |
| F=4GHz        | dB 4.3 Typ. | F=4GHz     | dB 6.5 Typ. |        |

Ft Gain Bandwidth Product at Vce=8v, Ic=10ma. GHz 4 Min. 6 Typ.  
Vcbo 25v Vceo 11v Vebo 3v Ic 50ma. Pt. 250mw

## UNELCO RF Power and Linear Amplifier Capacitors

These are the famous capacitors used by all the RF Power and Linear Amplifier manufacturers, and described in the RF Data Book.

|       |      |        |      |      |       |        |              |                |
|-------|------|--------|------|------|-------|--------|--------------|----------------|
| 5pf   | 10pf | 18pf   | 30pf | 43pf | 100pf | 200pf  | 1 to 10pcs.  | \$1.00 ea      |
| 5.1pf | 12pf | 22pf   | 32pf | 51pf | 110pf | 220pf  | 11 to 50pcs. | \$ .90 ea      |
| 6.8pf | 13pf | 25pf   | 33pf | 60pf | 120pf | 470pf  | 51 up        | pcs. \$ .80 ea |
| 7pf   | 14pf | 27pf   | 34pf | 80pf | 130pf | 500pf  |              |                |
| 8.2pf | 15pf | 27.5pf | 40pf | 82pf | 140pf | 1000pf |              |                |

## NIPPON ELECTRIC COMPANY TUNNEL DIODES

|                                |           |                         |                         |        |
|--------------------------------|-----------|-------------------------|-------------------------|--------|
|                                |           | MODEL 1S2199            | 1S2200                  | \$7.50 |
| Peak Pt. Current ma.           | Ip        | 9min. 10Typ. 11max.     | 9min. 10Typ. 11max.     |        |
| Valley Pt. Current ma.         | Iv        | 1.2Typ. 1.5max.         | 1.2Typ. 1.5max.         |        |
| Peak Pt. Voltage mv.           | Vp        | 95Typ. 120max.          | 75Typ. 90max.           |        |
| Projected Peak Pt. Voltage mv. | Vpp Vf=Ip | 480min. 550Typ. 630max. | 440min. 520Typ. 600max. |        |
| Series Res. Ohms               | rS        | 2.5Typ. 4max.           | 2Typ. 3max.             |        |
| Terminal Cap. pf.              | Ct        | 1.7Typ. 2max.           | 5Typ. 8max.             |        |
| Valley Pt. Voltage mv.         | VV        | 370Typ.                 | 350Typ.                 |        |

## FAIRCHILD / DUMONT Oscilloscope Probes Model 4290B

Input Impedance 10 meg., Input Capacity 6.5 to 12pf., Division Ratio (Volts/Div Factor) 10:1, Cable Length 4Ft. , Frequency Range Over 100MHz.  
These Probes will work on all Tektronix, Hewlett Packard, and other Oscilloscopes.

PRICE \$45.00

## MOTOROLA RF DATA BOOK

Lists all Motorola RF Transistors / RF Power Amplifiers, Varactor Diodes and much much more.

PRICE \$7.50

For information: 602-242-8916

**Toll Free Number**  
**800-528-0180**  
**(For orders only)**

# MHz electronics

"All parts may be new or surplus, and parts may be substituted with comparable parts if we are out of stock of an item."

**PRICES SUBJECT TO CHANGE WITHOUT NOTICE**

# RF TRANSISTORS, MICROWAVE DIODES

| PART      | PRICE   | PART               | PRICE    | PART                 | PRICE    |
|-----------|---------|--------------------|----------|----------------------|----------|
| 1S2199    | \$ 7.50 | 2N6083             | \$ 13.25 | CA2612 (TRW)         | \$ 25.00 |
| 1S2200    | 7.50    | 2N6084             | 15.00    | CA2674 (TRW)         | 25.00    |
| 2N1561    | 25.00   | 2N6094 /M9622      | 11.00    | CA2881-1 (TRW)       | 25.00    |
| 2N1562    | 25.00   | 2N6095 /M9623      | 12.00    | CA4101 (TRW)         | 25.00    |
| 2N2857    | 1.55    | 2N6096 /M9624      | 15.50    | CA4201 (TRW)         | 25.00    |
| 2N2857JAN | 2.55    | 2N6097             | 17.25    | CA4600 (TRW)         | 25.00    |
| 2N2876    | 11.00   | 2N6136             | 21.85    | CD1889               | 20.00    |
| 2N2947    | 18.35   | 2N6166             | 40.25    | CD2545               | 20.00    |
| 2N2948    | 15.50   | 2N6201             | 50.00    | CMD514AB             | 20.00    |
| 2N2949    | 3.90    | 2N6459             | 18.00    | D4959                | 10.00    |
| 2N2950    | 4.60    | 2N6603             | 12.00    | D4987M               | 20.00    |
| 2N3375    | 8.00    | 2N6680             | 80.00    | D5147D               | 10.00    |
| 2N3553    | 1.57    | 2SC756A            | 7.50     | D5506                | 10.00    |
| 2N3632    | 13.80   | 2SC781             | 2.80     | D5827AM              | 20.00    |
| 2N3818    | 5.00    | 2SC1018            | 1.00     | DMD6022              | 30.00    |
| 2N3866    | 1.30    | 2SC1042            | 12.00    | DMS-2A-250           | 40.00    |
| 2N3924    | 3.35    | 2SC1070            | 2.50     | HEP76                | 4.95     |
| 2N3927    | 17.75   | 2SC1239            | 2.50     | HEPS3002             | 11.30    |
| 2N3950    | 25.00   | 2SC1251            | 12.00    | HEPS3003             | 30.00    |
| 2N4072    | 1.80    | 2SC1306            | 2.90     | HEPS3005             | 10.00    |
| 2N4127    | 21.00   | 2SC1307            | 5.50     | HEPS3006             | 19.90    |
| 2N4427    | 1.30    | 2SC1760            | 1.50     | HEPS3007             | 25.00    |
| 2N4428    | 1.85    | 2SC1970            | 2.50     | HEPS3010             | 11.34    |
| 2N4957    | 3.45    | 2SC2166            | 5.50     | HTEF2204 H.P.        | 112.00   |
| 2N4958    | 2.90    | 8B1087 (M.A.)      | 25.00    | 5082-0112 H.P.       | 14.20    |
| 2N4959    | 2.30    | A50-12             | 20.00    | 5082-0253 H.P.       | 105.00   |
| 2N5090    | 13.90   | A283B              | 5.00     | 5082-0320 H.P.       | 58.00    |
| 2N5108    | 4.00    | ALD4200N (AVANTEK) | 395.00   | 5082-0386 H.P.       | POR      |
| 2N5109    | 1.70    | AM123              | 97.35    | 5082-0401 H.P.       | POR      |
| 2N5160    | 3.45    | AM688              | 100.00   | 5082-0438 H.P.       | POR      |
| 2N5177    | 21.62   | BB105B             | .52      | 5082-1028 H.P.       | POR      |
| 2N5179    | 1.00    | BD4/4JFBD4 (G.E.)  | 10.00    | 5082-2711 H.P.       | 23.15    |
| 2N5583    | 4.00    | BFQ85              | 1.50     | 5082-3080 H.P.       | 2.00     |
| 2N5589    | 8.65    | BFR90              | 1.30     | 5082-3188 H.P.       | 1.00     |
| 2N5590    | 10.35   | BFR91              | 1.65     | 5082-6459 H.P.       | POR      |
| 2N5591    | 13.80   | BFW92              | 1.50     | 5082-8323 H.P.       | POR      |
| 2N5635    | 10.95   | BFX89              | 1.00     | 35826E H.P.          | POR      |
| 2N5637    | 15.50   | BFY90              | 1.00     | 35831E H.P.          | 29.99    |
| 2N5641    | 9.20    | BGY54              | 25.00    | 35853E H.P.          | 71.50    |
| 2N5642    | 10.95   | BGY55              | 25.00    | 35854E H.P.          | 75.00    |
| 2N5643    | 15.50   | BGY74              | 25.00    | HPA0241 H.P.         | 75.60    |
| 2N5645    | 13.80   | BGY75              | 25.00    | HXTR3101 H.P.        | 7.00     |
| 2N5646    | 20.70   | BL161              | 10.00    | HXTR3102 H.P.        | 8.75     |
| 2N5691    | 18.00   | BLX67              | 11.00    | HXTR6101/2N6617 H.P. | 55.00    |
| 2N5764    | 27.00   | BLY568CF           | 25.00    | HXTR6104 H.P.        | 68.00    |
| 2N5836    | 5.45    | BLY87              | 13.00    | HXTR6105 H.P.        | 31.00    |
| 2N5842    | 8.00    | BLY88              | 14.00    | HXTR6106 H.P.        | 33.00    |
| 2N5849    | 20.00   | BLY89              | 15.00    | QSCH1995 H.P.        | POR      |
| 2N5913    | 3.25    | BLY90              | 20.00    | JO2000 TRW           | 10.00    |
| 2N5922    | 10.00   | BLY351             | 10.00    | JO2001 TRW           | 25.00    |
| 2N5923    | 25.00   | C4005              | 20.00    | JO4045 TRW           | 25.00    |
| 2N5941    | 23.00   | CA402 (TRW)        | 25.00    | K3A                  | 10.00    |
| 2N5942    | 40.00   | CA405 (TRW)        | 25.00    | MA450A               | 10.00    |
| 2N5944    | 9.20    | CA612B (TRW)       | 25.00    | MA41487              | POR      |
| 2N5945    | 11.50   | CA2100 (TRW)       | 25.00    | MA41765              | POR      |
| 2N5946    | 19.00   | CA2113 (TRW)       | 25.00    | MA43589              | POR      |
| 2N6080    | 9.20    | CA2200 (TRW)       | 25.00    | MA43636              | POR      |
| 2N6081    | 10.35   | CA2213 (TRW)       | 25.00    | MA47044              | POR      |
| 2N6082    | 11.50   | CA2418 (TRW)       | 25.00    | MA47651              | 25.50    |

**Toll Free Number**  
**800-528-0180**  
**(For orders only)**

**For information: 602-242-8916 PRICES SUBJECT TO CHANGE WITHOUT NOTICE**

"All parts may be new or surplus, and parts may be substituted with comparable parts if we are out of stock of an item."

**MHz electronics**



# GaAs, TUNNEL DIODES, ETC.

| <u>PART</u>     | <u>PRICE</u> | <u>PART</u>  | <u>PRICE</u> | <u>PART</u>    | <u>PRICE</u> |
|-----------------|--------------|--------------|--------------|----------------|--------------|
| MA47100         | \$ 3.05      | MRF503       | \$ 6.00      | PT4186B        | \$ POR       |
| MA47202         | 30.80        | MRF504       | 7.00         | PT4209         | POR          |
| MA47771         | POR          | MRF509       | 5.00         | PT4209C        | POR          |
| MA47852         | POR          | MRF511       | 8.65         | PT4566         | POR          |
| MA49558         | POR          | MRF605       | 20.00        | PT4570         | POR          |
| MB4021          | POR          | MRF629       | 3.47         | PT4571         | POR          |
| MBD101          | 1.00         | MRF644       | 23.00        | PT4571A        | POR          |
| MDO513          | POR          | MRF816       | 15.00        | PT4577         | POR          |
| MHW1171         | 42.50        | MRF823       | 20.00        | PT4590         | POR          |
| MHW1182         | 48.60        | MRF901       | 3.00         | PT4612         | POR          |
| MHW4171         | 49.35        | MRF8004      | 2.10         | PT4628         | POR          |
| MHW4172         | 51.90        | MS261F       | POR          | PT4640         | POR          |
| MHW4342         | 68.75        | MT4150 Fair. | POR          | PT4642         | POR          |
| MLP102          | 25.00        | MT5126 Fair. | POR          | PT5632         | POR          |
| MM1500          | 32.32        | MT5481 Fair. | POR          | PT5749         | POR          |
| MM1550          | POR          | MT5482 Fair. | POR          | PT6612         | POR          |
| MM1552          | 50.00        | MT5483 Fair. | POR          | PT6626         | POR          |
| MM1553          | 50.00        | MT5596 Fair. | POR          | PT6709         | POR          |
| MM1614          | 10.00        | MT5764 Fair. | POR          | PT6720         | POR          |
| MM2608          | 5.00         | MT8762 Fair. | POR          | PT8510         | POR          |
| MM3375A         | 11.50        | MV109        | .77          | PT8524         | POR          |
| MM4429          | 10.00        | MV1401       | 8.75         | PT8609         | POR          |
| MM8000          | 1.15         | MV1624       | 1.42         | PT8633         | POR          |
| MM8006          | 2.30         | MV1805       | 15.00        | PT8639         | POR          |
| MO277L          | POR          | MV1808       | 10.00        | PT8659         | POR          |
| MO283L          | POR          | MV1817B      | 10.00        | PT8679         | POR          |
| MO3757          | POR          | MV1863B      | 10.00        | PT8708         | POR          |
| MP102           | POR          | MV1864A      | 10.00        | PT8709         | POR          |
| MPN3202         | 10.00        | MV1864B      | 10.00        | PT8727         | POR          |
| MPN3401         | .52          | MV1864D      | 10.00        | PT8731         | POR          |
| MPN3412         | 1.00         | MV1868D      | 10.00        | PT8742         | POR          |
| MPSU31          | 1.01         | MV2101       | .90          | PT8787         | POR          |
| MRA2023-1.5 TRW | 42.50        | MV2111       | .90          | PT9790         | 41.70        |
| MRF212/208      | 16.10        | MV2115       | 1.55         | PT31962        | POR          |
| MRF223          | 13.25        | MV2201       | .53          | PT31963        | POR          |
| MRF224          | 15.50        | MV2203       | .53          | PT31983        | POR          |
| MRF237          | 3.15         | MV2209       | 2.00         | PTX6680        | POR          |
| MRF238          | 12.65        | MV2215       | 2.00         | RAY-3          | 24.99        |
| MRF243          | 25.00        | MWA110       | 7.45         | 40081          | POR          |
| MRF245          | 34.50        | MWA120       | 7.80         | 40281          | POR          |
| MRF247          | 34.50        | MWA130       | 8.25         | 40282          | POR          |
| MRF304          | 43.45        | MWA210       | 7.80         | 40290          | POR          |
| MRF315          | 23.00        | MWA220       | 8.25         | RF110          | 25.00        |
| MRF420          | 20.00        | MWA230       | 8.65         | SCA3522        | POR          |
| MRF421          | 36.80        | MWA310       | 8.25         | SCA3523        | POR          |
| MRF422          | 41.40        | MWA320       | 8.65         | SD1065         | POR          |
| MRF427          | 16.10        | MWA330       | 9.50         | SS43           | POR          |
| MRF428          | 46.00        | NEC57835     | 5.30         | TP1014         | POR          |
| MRF450/A        | 13.80        | ON382        | 5.00         | TP1028         | POR          |
| MRF453/A        | 17.25        | PPT515-20-3  | POR          | TRW-3          | POR          |
| MRF454/A        | 19.90        | PRT8637      | POR          | UTO504 Avantek | 70.00        |
| MRF455/A        | 16.00        | PSCQ2-160    | POR          | UTO511 Avantek | 75.00        |
| MRF458          | 19.90        | PT3190       | POR          | V15            | 4.00         |
| MRF463          | 25.00        | PT3194       | POR          | V33B           | 4.00         |
| MRF472          | 1.00         | PT3195       | POR          | V100B          | 4.00         |
| MRF475          | 2.90         | PT3537       | POR          | VAB801EC       | 25.00        |
| MRF477          | 11.50        | PT4166E      | POR          | VAB804EC       | 25.00        |
| MRF502          | 1.04         | PT4176D      | POR          | VAS21AN20      | 25.00        |

For information: 602-242-8916

**Toll Free Number**  
**800-528-0180**  
**(For orders only)**

"All parts may be new or surplus, and parts may be substituted with comparable parts if we are out of stock of an item."

## MHz electronics

PRICES SUBJECT TO CHANGE WITHOUT NOTICE

COAXIAL RELAY SWITCHES SPDT

Electronic Specialty Co./Raven Electronics FSN 5985-556-9683 \$49.00  
 Part # 25N28 Part # SU-01  
 26Vdc Type N Connector, DC to 1 GHz.



Amphenol  
 Part # 316-10102-8  
 115Vac Type BNC DC to 3 GHz.

\$29.99

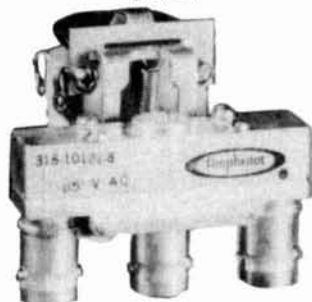

FXR  
 Part # 300-11182  
 120Vac Type BNC DC to 4 GHz.  
 FSN 5985-543-1225

\$39.99

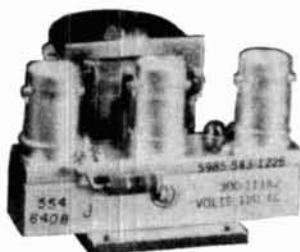

FXR  
 Part # 300-11173  
 120Vac Type BNC Same  
 FSN 5985-543-1850

\$39.99

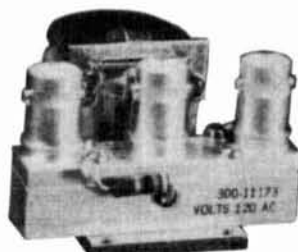

BNC To Banana Plug Coax Cable RG-58 36 inch or BNC to N Coax Cable RG-58 36 inch.

\$7.99 or 2 For \$13.99 or 10 For \$50.00

\$8.99 or 2 For \$15.99 or 10 For \$60.00



SOLID STATE RELAYS

P&B Model ECT1DB72 5vdc turn on  
 PRICE EACH \$5.00

Digisig, Inc. Model ECS-215 5vdc turn on  
 PRICE EACH \$7.50

Grigsby/Barton Model GB7400 5vdc turn on  
 PRICE EACH \$7.50

120vac contact at 7amps or 20amps on a 10"x 10"x .124 aluminum. Heatsink with silicon grease.

240vac contact 14amps or 40amps on a 10"x 10"x .124 aluminum. Heatsink with silicon grease.

240vac contact at 15amps or 40amps on a 10"x 10"x .124 aluminum. Heatsink with silicon grease.

NOTE: \*\*\* Items may be substituted with other brands or equivalent model numbers. \*\*\*

For information: 602-242-8916

**MHz** electronics

"All parts may be new or surplus, and parts may be substituted with comparable parts if we are out of stock of an item."

Toll Free Number  
 800-528-0180  
 (For orders only)

PRICES SUBJECT TO CHANGE WITHOUT NOTICE

RECALL PHONE MEMORY TELEPHONE WITH 24 NUMBER AUTO DIALER

The Recall Phone Telephone employs the latest state of art communications technology. It is a combination telephone and automatic dialer that uses premium-quality, solid-state circuitry to assure high-reliability performance in personal or business applications. \$49.99



ARON ALPHA RAPID BONDING GLUE

Super Glue #CE-486 high strength rapid bonding adhesive. Alpha Cyanoacrylate. Set-Time 20 to 40 sec., 0.7fl.oz. (20gm.) \$2.00



TOUCH TONE PAD

This pad contains all the electronics to produce standard touch-tone tones. New with data.



\$9.99 or 10/\$89.99

MITSUMI UHF/VHF VARACTOR TUNER MODEL UVE1A

Perfect for those unscrambler projects. New with data.



\$19.99 or 10/\$149.99

INTEGRATED CIRCUIT.

|           |                                                                     | 1 to 10 | 11up   |
|-----------|---------------------------------------------------------------------|---------|--------|
| MC1372P   | Color TV Video Modulator Circuit.                                   | \$ 4.42 | \$2.95 |
| MC1358P   | IF Amp., Limiter, FM Detector, Audio Driver, Electronic Attenuator. | 5.00    | 4.00   |
| MC1350P   | IF Amplifier                                                        | 1.50    | 1.25   |
| MC1330A1P | Low Level Video Detector                                            | 1.50    | 1.15   |
| MC1310P   | FM Stereo Demodulator                                               | 4.29    | 3.30   |
| MC1496P   | Balanced Modulator/Demodulator                                      | 1.50    | 1.25   |
| LM565N    | Phase Locked Loop                                                   | 2.50    | 2.00   |
| LM380N14  | 2Watt Audio Power Amplifier                                         | 1.56    | 1.25   |
| LM1889N   | TV Video Modulator                                                  | 5.00    | 4.00   |
| NE564N    | Phase Locked Loop                                                   | 10.00   | 8.00   |
| NE561N    | Phase Locked Loop                                                   | 10.00   | 8.00   |

FERRANTI ELECTRONICS AM RADIO RECEIVER MODEL ZN414 INTEGRATED CIRCUIT.

Features:

1.2 to 1.6 volt operating range., Less than 0.5ma current consumption. 150KHz to 3MHz Frequency range., Easy to assemble, no alignment necessary. Effective and variable AGC action., Will drive an earphone direct. Excellent audio quality., Typical power gain of 72dB., T0-18 package. With data. \$2.99 or 10 For \$24.99

NI CAD RECHARGEABLE BATTERIES

AA Battery Pack of 6 These are Factory New. \$5.00

SUB C Pack of 10 2.5Amp/Hr. \$10.00

Gates Rechargeable Battery Packs

12vdc at 2.5Amp/Hr. \$11.99

12vdc at 5Amp/Hr. \$15.99



MOTOROLA MRF559 RF TRANSISTOR

hfe 30min 90typ 200max.  
 ft 3000mhz  
 gain 8db min 9.5typ at 870mhz  
 13db typ at 512mhz  
 output power .5watts at 12.5vdc  
 at 870mhz.

\$2.05 or 10/\$15.00

For information: 602-242-8916

**MHz electronics**

"All parts may be new or surplus, and parts may be substituted with comparable parts if we are out of stock of an item."

**Toll Free Number  
800-528-0180  
(For orders only)**

**PRICES SUBJECT TO CHANGE WITHOUT NOTICE**

# "SOCKETS AND CHIMNEYS"

## EIMAC TUBE SOCKETS AND CHIMNEYS

|        |                                                             |          |
|--------|-------------------------------------------------------------|----------|
| SK110  | Socket                                                      | \$POR    |
| SK300A | Socket For 4CX5000A,R,J, 4CX10,000D, 4CX15,000A,J           | \$520.00 |
| SK400  | Socket For 4-125A,250A,400A,400C,4PR125A,400A,4-500A,5-500A | 260.00   |
| SK406  | Chimney For 4-250A,400A,400C,4PR400A                        | 74.00    |
| SK416  | Chimney For 3-400Z                                          | 36.00    |
| SK500  | Socket For 4-1000A/4PR1000A/B                               | 390.00   |
| SK600  | Socket For 4CX250B,BC,FG,R,4CX350A,F,FJ                     | 51.00    |
| SK602  | Socket For 4CX250B,BC,FG,R,4CX350A,F,FJ                     | 73.00    |
| SK606  | Chimney For 4CX250B,BC,FG,R,4CX350A,F,FJ                    | 11.00    |
| SK607  | Socket For 4CX600J,JA                                       | 60.00    |
| SK610  | Socket For 4CX600J,JA                                       | 60.00    |
| SK620  | Socket For 4CX600J,JA                                       | 66.00    |
| SK626  | Chimney For 4CX600J,JA                                      | 10.00    |
| SK630  | Socket For 4CX600J,JA                                       | 66.00    |
| SK636B | Chimney For 4CX600J,JA                                      | 34.00    |
| SK640  | Socket For 4CX600J,JA                                       | 36.00    |
| SK646  | Chimney For 4CX600J,JA                                      | 71.00    |
| SK700  | Socket For 4CX300A,Y,4CX125C,F                              | 225.00   |
| SK711A | Socket For 4CX300A,Y,4CX125C,F                              | 225.00   |
| SK740  | Socket For 4CX300A,Y,4CX125C,F                              | 86.00    |
| SK770  | Socket For 4CX300A,Y,4CX125C,F                              | 86.00    |
| SK800A | Socket For 4CX1000A,4CX1500B                                | 225.00   |
| SK806  | Chimney For 4CX1000A,4CX1500B                               | 40.00    |
| SK810  | Socket For 4CX1000A,4CX1500B                                | 225.00   |
| SK900  | Socket For 4X500A                                           | 300.00   |
| SK906  | Chimney For 4X500A                                          | 57.00    |
| SK1420 | Socket For 5CX3000A                                         | 650.00   |
| SK1490 | Socket For 4CV8000A                                         | 585.00   |

## JOHNSON TUBE SOCKETS AND CHIMNEYS

|                  |                                                       |             |
|------------------|-------------------------------------------------------|-------------|
| 124-111/SK606    | Chimney For 4CX250B,BC,FG,R, 4CX350A,F,FJ             | \$ 10.00    |
| 122-0275-001     | Socket For 3-500Z, 4-125A, 250A, 400A, 4-500A, 5-500A | (pair)15.00 |
| 124-0113-00      | Capacitor Ring                                        | 15.00       |
| 124-116/SK630A   | Socket For 4CX250B,BC,FG,R, /4CX350A,F,FJ             | 55.00       |
| 124-115-2/SK620A | Socket For 4CX250B,BC,FG,R, /4CX350A,F,FJ             | 55.00       |
|                  | 813 Tube Socket                                       | 20.00       |

## CHIP CAPACITORS

|       |      |        |                 |
|-------|------|--------|-----------------|
| .8pf  | 10pf | 100pf* | 430pf           |
| 1pf   | 12pf | 110pf  | 470pf           |
| 1.1pf | 15pf | 120pf  | 510pf           |
| 1.4pf | 18pf | 130pf  | 560pf           |
| 1.5pf | 20pf | 150pf  | 620pf           |
| 1.8pf | 22pf | 160pf  | 680pf           |
| 2.2pf | 24pf | 180pf  | 820pf           |
| 2.7pf | 27pf | 200pf  | 1000pf/.001uf*  |
| 3.3pf | 33pf | 220pf* | 1800pf/.0018uf  |
| 3.6pf | 39pf | 240pf  | 2700pf/.0027uf  |
| 3.9pf | 47pf | 270pf  | 10,000pf/.01uf  |
| 4.7pf | 51pf | 300pf  | 12,000pf/.012uf |
| 5.6pf | 56pf | 330pf  | 15,000pf/.015uf |
| 6.8pf | 68pf | 360pf  | 18,000pf/.018uf |
| 8.2pf | 82pf | 390pf  |                 |

PRICES: 1 to 10 - .99¢ 101 to 1000 .60¢ \* IS A SPECIAL PRICE: 10 for \$7.50  
 11 to 50 - .90¢ 1001 & UP .35¢ 100 for \$65.00  
 51 to 100 - .80¢ 1000 for \$350.00

## TUBE CAPS (Plate)

|              |         |
|--------------|---------|
| HR1, 4       | \$11.00 |
| HR2,3, 6 & 7 | 13.00   |
| HR5, 8       | 14.00   |
| HR9          | 17.00   |
| HR10         | 20.00   |

WATKINS JOHNSON WJ-V907: Voltage Controlled Microwave Oscillator \$110.00

Frequency range 3.6 to 4.2GHz, Power output, Min. 10dBm typical, 8dBm Guaranteed.  
 Spurious output suppression Harmonic (nf<sub>0</sub>), min. 20dB typical, In-Band Non-Harmonic, min. 60dB typical, Residual FM, pk to pk, Max. 5KHz, pushing factor, Max. 8KHz/V, Pulling figure (1.5:1 VSWR), Max. 60MHz, Tuning voltage range +1 to +15volts, Tuning current, Max. -0.1mA, modulation sensitivity range, Max. 120 to 30MHz/V, Input capacitance, Max. 100pf, Oscillator Bias +15 +-0.05 volts @ 55mA, Max.

For information: 602-242-8916  
 Toll Free Number  
 800-528-0180  
 (For orders only)

"All parts may be new or surplus, and parts may be substituted with comparable parts if we are out of stock of an item."

# MHz electronics

PRICES SUBJECT TO CHANGE WITHOUT NOTICE

# TUBES

| TYPE           | PRICE    | TYPE             | PRICE    | TYPE               | PRICE    |
|----------------|----------|------------------|----------|--------------------|----------|
| 2C39/7289      | \$ 34.00 | 1182/4600A       | \$500.00 | ML7815AL           | \$ 60.00 |
| 2E26           | 7.95     | 4600A            | 500.00   | 7843               | 107.00   |
| 2K28           | 200.00   | 4624             | 310.00   | 7854               | 130.00   |
| 3-500Z         | 102.00   | 4657             | 84.00    | ML7855KAL          | 125.00   |
| 3-1000Z/8164   | 400.00   | 4662             | 100.00   | 7984               | 14.95    |
| 3B28/866A      | 9.50     | 4665             | 500.00   | 8072               | 84.00    |
| 3CX400U7/8961  | 255.00   | 4687             | P.O.R.   | 8106               | 5.00     |
| 3CX1000A7/8283 | 526.00   | 5675             | 42.00    | 8117A              | 225.00   |
| 3CX3000F1/8239 | 567.00   | 5721             | 250.00   | 8121               | 110.00   |
| 3CW30000H7     | 1700.00  | 5768             | 125.00   | 8122               | 110.00   |
| 3X2500A3       | 473.00   | 5819             | 119.00   | 8134               | 470.00   |
| 3X3000F1       | 567.00   | 5836             | 232.50   | 8156               | 12.00    |
| 4-65A/8165     | 69.00    | 5837             | 232.50   | 8233               | 60.00    |
| 4-125A/4D21    | 79.00    | 5861             | 140.00   | 8236               | 35.00    |
| 4-250A/5D22    | 98.00    | 5867A            | 185.00   | 8295/PL172         | 500.00   |
| 4-400A/8438    | 98.00    | 5868/AX9902      | 270.00   | 8458               | 35.00    |
| 4-400B/7527    | 110.00   | 5876/A           | 42.00    | 8462               | 130.00   |
| 4-400C/6775    | 110.00   | 5881/6L6         | 8.00     | 8505A              | 95.00    |
| 4-1000A/8166   | 444.00   | 5893             | 60.00    | 8533W              | 136.00   |
| 4CX250B/7203   | 54.00    | 5894/A           | 54.00    | 8560/A             | 75.00    |
| 4CX250FG/8621  | 75.00    | 5894B/8737       | 54.00    | 8560AS             | 100.00   |
| 4CX250K/8245   | 125.00   | 5946             | 395.00   | 8608               | 38.00    |
| 4CX250R/7580W  | 90.00    | 6083/AZ9909      | 95.00    | 8624               | 100.00   |
| 4CX300A/8167   | 170.00   | 6146/6146A       | 8.50     | 8637               | 70.00    |
| 4CX350A/8321   | 110.00   | 6146B/8298       | 10.50    | 8643               | 83.00    |
| 4CX350F/8322   | 115.00   | 6146W/7212       | 17.95    | 8647               | 168.00   |
| 4CX350FJ/8904  | 140.00   | 6156             | 110.00   | 8683               | 95.00    |
| 4CX600J/8809   | 835.00   | 6159             | 13.85    | 8877               | 465.00   |
| 4CX1000A/8168  | 242.50*  | 6159B            | 23.50    | 8908               | 13.00    |
| 4CX1000A/8168  | 485.00   | 6161             | 325.00   | 8950               | 13.00    |
| 4CX1500B/8660  | 555.00   | 6280             | 42.50    | 8930               | 137.00   |
| 4CX5000A/8170  | 1100.00  | 6291             | 180.00   | 6L6 Metal          | 25.00    |
| 4CX10000D/8171 | 1255.00  | 6293             | 24.00    | 6L6GC              | 5.03     |
| 4CX15000A/8281 | 1500.00  | 6326             | P.O.R.   | 6CA7/EL34          | 5.38     |
| 4CW800F        | 710.00   | 6360/A           | 5.75     | 6CL6               | 3.50     |
| 4D32           | 240.00   | 6399             | 540.00   | 6DJ8               | 2.50     |
| 4E27A/5-125B   | 240.00   | 6550A            | 10.00    | 6DQ5               | 6.58     |
| 4PR60A         | 200.00   | 6883B/8032A/8552 | 10.00    | 6GF5               | 5.85     |
| 4PR60B         | 345.00   | 6897             | 160.00   | 6GJ5A              | 6.20     |
| 4PR65A/8187    | 175.00   | 6907             | 79.00    | 6GK6               | 6.00     |
| 4PR1000A/8189  | 590.00   | 6922/6DJ8        | 5.00     | 6HB5               | 6.00     |
| 4X150A/7034    | 60.00    | 6939             | 22.00    | 6HF5               | 8.73     |
| 4X150D/7609    | 95.00    | 7094             | 250.00   | 6JG6A              | 6.28     |
| 4X250B         | 45.00    | 7117             | 38.50    | 6JM6               | 6.00     |
| 4X250F         | 45.00    | 7203             | P.O.R.   | 6JN6               | 6.00     |
| 4X500A         | 412.00   | 7211             | 100.00   | 6JS6C              | 7.25     |
| 5CX1500A       | 660.00   | 7213             | 300.00*  | 6KN6               | 5.05     |
| KT88           | 27.50    | 7214             | 300.00*  | 6KD6               | 8.25     |
| 416B           | 45.00    | 7271             | 135.00   | 6LF6               | 7.00     |
| 416C           | 62.50    | 7289/2C39        | 34.00    | 6LQ6 G.E.          | 7.00     |
| 572B/T160L     | 49.95    | 7325             | P.O.R.   | 6LQ6/6MJ6 Sylvania | 9.00     |
| 592/3-200A3    | 211.00   | 7360             | 13.50    | 6ME6               | 8.90     |
| 807            | 8.50     | 7377             | 85.00    | 12AT7              | 3.50     |
| 811A           | 15.00    | 7408             | 2.50     | 12AX7              | 3.00     |
| 812A           | 29.00    | 7609             | 95.00    | 12BY7              | 5.00     |
| 813            | 50.00    | 7735             | 36.00    | 12JB6A             | 6.50     |

NOTE \* = USED TUBE

NOTE P.O.R. = PRICE ON REQUEST

"ALL PARTS MAY BE NEW, USED, OR SURPLUS. PARTS MAY BE SUBSTITUTED WITH COMPARABLE PARTS IF WE ARE OUT OF STOCK OF AN ITEM.

NOTICE: ALL PRICES ARE SUBJECT TO CHANGE WITHOUT NOTICE.

For information: 602-242-8916

**Toll Free Number**  
**800-528-0180**  
**(For orders only)**

"All parts may be new or surplus, and parts may be substituted with comparable parts if we are out of stock of an item."

**MHz electronics**

PRICES SUBJECT TO CHANGE WITHOUT NOTICE

# "FILTERS"

## COLLINS Mechanical Filter #526-9724-010 MODEL F455Z32F

455KHz at 3.2KHz wide. May be other models but equivalent. May be used or new, \$15.99

## ATLAS Crystal Filters

- 5.595-2.7/8/LSB, 5.595-2.7/USB  
8 pole 2.7KHz wide Upper sideband. Impedance 800ohms 15pf In/800ohms 0pf out. 19.99
- 5.595-2.7/8/U, 5.595-2.7/USB  
8 pole 2.7KHz wide Upper sideband. Impedance 800ohms 15pf In/800ohms 0pf out. 19.99
- 5.595-.500/4, 5.595-.500/4/CW  
4 pole 500 cycles wide CW. Impedance 800ohms 15pf In/800ohms 0pf out. 19.99
- 9.0USB/CW  
6 pole 2.7KHz wide at 6dB. Impedance 680ohms 7pf In/300ohms 8pf out. CW-1599Hz 19.99

## KOKUSAI ELECTRIC CO. Mechanical Filter #MF-455-ZL/ZU-21H

- 455KHz at Center Frequency of 453.5KC. Carrier Frequency of 455KHz 2.36KC Bandwidth.
- Upper sideband. (ZU) 19.99
- Lower sideband. (ZL) 19.99

\*\*\*\*\*

## CRYSTAL FILTERS

|          |            |                                                    |         |
|----------|------------|----------------------------------------------------|---------|
| NIKKO    | FX-07800C  | 7.8MHz                                             | \$10.00 |
| TEW      | FEC-103-2  | 10.6935MHz                                         | 10.00   |
| SDK      | SCH-113A   | 11.2735MHz                                         | 10.00   |
| TAMA     | TF-31H250  | CF 3179.3KHz                                       | 19.99   |
| TYCO/CD  | 001019880  | 10.7MHz 2pole 15KHz bandwidth                      | 5.00    |
| MOTOROLA | 4884863B01 | 11.7MHz 2pole 15KHz bandwidth                      | 5.00    |
| PTI      | 5350C      | 12MHz 2pole 15KHz bandwidth                        | 5.00    |
| PTI      | 5426C      | 21.4MHz 2pole 15KHz bandwidth                      | 5.00    |
| PTI      | 1479       | 10.7MHz 8pole bandwidth 7.5KHz at 3dB, 5KHz at 6dB | 20.00   |
| COMTECH  | AL0300     | 45MHz 2pole 15KHz bandwidth                        | 6.00    |
| FRC      | ERXF-15700 | 20.6MHz 36KHz wide                                 | 10.00   |
| FILTECH  | 2131       | CF 7.825MHz                                        | 10.00   |

\*\*\*\*\*

## CERAMIC FILTERS

|            |                |                                                               |       |
|------------|----------------|---------------------------------------------------------------|-------|
| AXEL       | 4F449          | 12.6KC Bandpass Filter 3dB bandwidth 1.6KHz from 11.8-13.4KHz | 10.00 |
| CLEVITE    | TO-01A         | 455KHz+2KHz bandwidth 4-7% at 3dB                             | 5.00  |
|            | TCF4-12D36A    | 455KHz+1KHz bandwidth 6dB min 12KHz, 60dB max 36KHz           | 10.00 |
| MURATA     | BFB455B        | 455KHz                                                        | 2.50  |
|            | BFB455L        | 455KHz                                                        | 3.50  |
|            | CFM455E        | 455KHz +5.5KHz at 3dB, +8KHz at 6dB, +16KHz at 50dB           | 6.65  |
|            | CFM455D        | 455KHz +7KHz at 3dB, +10KHz at 6dB, +20KHz at 50dB            | 6.65  |
|            | CFR455E        | 455KHz +5.5KHz at 3dB, +8KHz at 6dB, +16KHz at 60dB           | 8.00  |
|            | CFU455B        | 455KHz +2KHz bandwidth +15KHz at 6dB, +30KHz at 40dB          | 2.90  |
|            | CFU455C        | 455KHz +2KHz bandwidth +12.5KHz at 6dB, +24KHz at 40dB        | 2.90  |
|            | CFU455G        | 455KHz +1KHz bandwidth +4.5KHz at 6dB, +10KHz at 40dB         | 2.90  |
|            | CFU455H        | 455KHz +1KHz bandwidth +3KHz at 6dB, +9KHz at 40dB            | 2.90  |
|            | CFU455I        | 455KHz +1KHz bandwidth +2KHz at 6dB, +6KHz at 40dB            | 2.90  |
|            | CFW455D        | 455KHz +10KHz at 6dB, +20KHz at 40dB                          | 2.90  |
|            | CFW455H        | 455KHz +3KHz at 6dB, +9KHz at 40dB                            | 2.90  |
|            | SFB455D        | 455KHz                                                        | 2.50  |
|            | SFD455D        | 455KHz +2KHz, 3dB bandwidth 4.5KHz +1KHz                      | 5.00  |
|            | SFE10.7MA      | 10.7MHz 280KHz +50KHz at 3dB, 650KHz at 20dB                  | 2.50  |
|            | SFE10.7MS      | 10,7MHz 230KHz +50KHz at 3dB, 570KHz at 20dB                  | 2.50  |
|            | SFG10.7MA      | 10.7MHz                                                       | 10.00 |
| NIPPON     | LF-B4/CFU455I  | 455KHz +1KHz                                                  | 2.90  |
|            | LF-B6/CFU455H  | 455KHz +1KHz                                                  | 2.90  |
|            | LF-B8          | 455KHz                                                        | 2.90  |
|            | LF-C18         | 455KHz                                                        | 10.00 |
| TOKIN      | CF455A/BFU455K | 455KHz +2KHz                                                  | 5.00  |
| MATSUSHIRA | EFC-L455K      | 455KHz                                                        | 7.00  |

\*\*\*\*\*

## SPECTRA PHYSICS INC. Model 088 HeNe LASER TUBES

|                       |                 |                 |                         |
|-----------------------|-----------------|-----------------|-------------------------|
| POWER OUTPUT 1.6MW.   | BEAM DIA. .75MM | BEAM DIR. 2.7MR | 8KV STARTING VOLTAGE DC |
| 68K OHM IWATT BALLAST | 1000VDC +100VDC | At 3.7MA        | \$59.99                 |

## ROTRON MUFFIN FANS Model MARK4/MU2A1

|                 |               |          |                       |                |         |
|-----------------|---------------|----------|-----------------------|----------------|---------|
| 115 VAC         | 14WATTS       | 50/60CPS | IMPEDENCE PROTECTED-F | 88CFM at 50CPS | \$ 7.99 |
| 105CFM at 60CPS | THESE ARE NEW |          |                       |                |         |

For information: 602-242-8916

Toll Free Number

800-528-0180

(For orders only)

"All parts may be new or surplus, and parts may be substituted with comparable parts if we are out of stock of an item."

# MHz electronics

PRICES SUBJECT TO CHANGE WITHOUT NOTICE

# HEWLETT PACKARD SIGNAL GENERATORS

|            |                                                                                                                                                                                                                                                                                                                                                                                                                                                                                                                                                                                                                                                          |           |         |                                                                                                                                                                                                                                                                                                                                                                                                                                                                                                                              |                                                         |
|------------|----------------------------------------------------------------------------------------------------------------------------------------------------------------------------------------------------------------------------------------------------------------------------------------------------------------------------------------------------------------------------------------------------------------------------------------------------------------------------------------------------------------------------------------------------------------------------------------------------------------------------------------------------------|-----------|---------|------------------------------------------------------------------------------------------------------------------------------------------------------------------------------------------------------------------------------------------------------------------------------------------------------------------------------------------------------------------------------------------------------------------------------------------------------------------------------------------------------------------------------|---------------------------------------------------------|
| 606A       | 50kHz to 65MHz in 6 bands $\pm 1\%$ output level adjustable 0.1 $\mu$ V to 3V into 50 ohms. Built-in crystal calibrator. 400-1000Hz modulation.                                                                                                                                                                                                                                                                                                                                                                                                                                                                                                          | \$ 650.00 | 616B    | Same as above but later model.                                                                                                                                                                                                                                                                                                                                                                                                                                                                                               | \$ 600.00                                               |
| 606B       | Same as above but has frequency control feature to allow operation with HP 8708A Synchronizer.                                                                                                                                                                                                                                                                                                                                                                                                                                                                                                                                                           | \$1100.00 | 618B    | 3.8 to 7.6GHz range, with calibrated output and selection of pulse-FM or square wave modulation.                                                                                                                                                                                                                                                                                                                                                                                                                             | \$ 600.00                                               |
| 608C       | 10MHz to 480MHz, 0.1 $\mu$ V-1V into 50 ohms, AM, CW, or pulse modulation, calibrated attenuator.                                                                                                                                                                                                                                                                                                                                                                                                                                                                                                                                                        | \$ 500.00 | 618C    | Same as above but later model.                                                                                                                                                                                                                                                                                                                                                                                                                                                                                               | \$2200.00                                               |
| 608D/TS510 | 10MHz to 420MHz, 0.1 $\mu$ V-0.5V into 50 ohms, $\pm 0.5\%$ accuracy, built-in crystal calibrator, AM-CW or pulse output.                                                                                                                                                                                                                                                                                                                                                                                                                                                                                                                                | \$ 375.00 | 620A    | 7 to 116Hz range, with calibrated output and selection of pulse-FM or square wave modulation.                                                                                                                                                                                                                                                                                                                                                                                                                                | \$ 750.00                                               |
| 608E       | Improved version of popular 608C, up to 1V output, improved stability, low residual FM.                                                                                                                                                                                                                                                                                                                                                                                                                                                                                                                                                                  | \$1450.00 | 620B    | Same as above but later model.                                                                                                                                                                                                                                                                                                                                                                                                                                                                                               | \$2200.00                                               |
| 608F       | 10MHz to 455MHz in 5 bands $\pm 1\%$ frequency accuracy with built-in crystal calibrator. Can be used with HP 8708A Synchronizer. Output continuously adjustable from .1 $\mu$ V to .5V into 50 ohms.                                                                                                                                                                                                                                                                                                                                                                                                                                                    | \$1100.00 | 626A    | 10 to 156Hz, 10mW output power with calibrated output and pulse-square wave or FM modulation.                                                                                                                                                                                                                                                                                                                                                                                                                                | \$4200.00                                               |
| 612A       | 450-1230MHz, 0.1 $\mu$ V-0.5V into 50 ohms, calibrated output.                                                                                                                                                                                                                                                                                                                                                                                                                                                                                                                                                                                           | \$ 750.00 | 8708A   | Synchronizer used with 606B, 608F. The synchronizer is a phase-lock frequency stabilizer which provides crystal-oscillator frequency stability to 430MHz in the 608F signal generator. Phase locking eliminates microphonics and drift resulting in excellent frequency stability. The 8708A includes a vernier which can tune the reference oscillator over a range of $\pm 0.25\%$ permitting frequency settable to 2 parts in 10 to the seventh. Provides a very stable signal that satisfies many critical applications. | (With HP 606B or 608F) \$ 350.00<br>(Without) \$ 450.00 |
| 614A       | 900-2100MHz with many features including calibrated output and all modulation characteristics.                                                                                                                                                                                                                                                                                                                                                                                                                                                                                                                                                           | \$ 500.00 | EMC-10  | ELECTROMETRICS EMC-10 RFI/EMI RECEIVER Low frequency analyzer covering 20Hz to 50kHz frequency range. Extendable to 500 kHz in wideband mode.                                                                                                                                                                                                                                                                                                                                                                                | \$2500.00                                               |
| 616A/TS403 | Direct reading and direct control from 1.8 to 4.2GHz. The H.P. 616A features $\pm 1.5$ dB calibrated output accuracy from -31.7dBm to -0dBm. The output is directly calibrated in microvolts and dBm with continuous monitoring. Simple operation frequency dial accuracy is $\pm 1\%$ and stability exceeds 0.005% / C change in ambient temperature. Calibrated attenuator is within $\pm 1.5$ dB over entire output band. 50 ohm impedance unit has internal pulse modulation with rep rate variable from 40 Hz to 4kHz, variable pulse width (1 to 10usec) and variable pulse delay (3 to 300usec). External modulating inputs increase versatility. | \$ 375.00 | NF-105F | Empire Devices Field Intensity Meter. Has NF-105/TA, NF-105/TX, NF-105/TI, NF-105/T2, NF-105/T3. Covers 14kHz to 1000MHz.                                                                                                                                                                                                                                                                                                                                                                                                    | \$2100.00                                               |

ALL EQUIPMENT CARRY A 30 DAY GUARANTEE.  
EQUIPMENT IS NOT CALIBRATED.

## UNEX LABORATORIES THS-2 FLEXICOM HEADSET.

these headsets come with data to hook up to a 100M radios and many other equipment.  
Perfect for Airplanes, Helicopters, Mobile Radios, or Just the Telephone.  
These Are Factory New In Sealed Boxes. Limited Supply Only \$69.95



\$69.95

## ORDERING INSTRUCTIONS

**DEFECTIVE MATERIAL:** All claims for defective material must be made within sixty (60) days after receipt of parcel. All claims must include the defective material (for testing purposes), our invoice number, and the date of purchase. All returns must be packed properly or it will void all warranties.

**DELIVERY:** Orders are normally shipped within 48 hours after receipt of customer's order. If a part has to be backordered the customer is notified. Our normal shipping method is via First Class Mail or UPS depending on size and weight of the package. On test equipment it is by Air only. FOB shipping point.

**FOREIGN ORDERS:** All foreign orders must be prepaid with cashier's check or money order made out in U.S. Funds. We are sorry but C.O.D. is not available to foreign countries and Letters of Credit are not an acceptable form of payment either. Further information is available on request.

**HOURS:** Monday thru Saturday, 8:30 a.m. to 5:00 p.m.

**INSURANCE:** Please include 25¢ for each additional \$100.00 over \$100.00. United Parcel only.

**ORDER FORMS:** New order forms are included with each order for your convenience. Additional forms are available on request.

**POSTAGE:** Minimum shipping and handling in the US, Canada, and Mexico is \$2.50 all other countries is \$5.00. On foreign orders include 20% shipping and handling.

**PREPAID ORDERS:** Order must be accompanied by a check.

**PRICES:** Prices are subject to change without notice.

**RESTOCK CHARGE:** If parts are returned to MHZ Electronics due to customer error, customer will be held responsible for all extra fees, will be charged a 15% restocking fee, with the remainder in credit only. All returns must have approval.

**SALES TAX:** Arizona must add 5% sales tax, unless a signed Arizona resale tax card is currently on file with MHZ Electronics. All orders placed by persons outside of Arizona, but delivered to persons in Arizona are subject to the 5% sales tax.

**SHORTAGE OR DAMAGE:** All claims for shortages or damages must be made within 5 days after receipt of parcel. Claims must include our invoice number and the date of purchase. Customers which do not notify us within this time period will be held responsible for the entire order as we will consider the order complete.

OUR 800 NUMBER IS STRICTLY FOR ORDERS ONLY  
NO INFORMATION WILL BE GIVEN 1-800-528-0180

**TERMS DOMESTIC:** Prepaid, C.O.D. or Credit Card

**FOREIGN:** Prepaid only, U.S. Funds—money order or cashier's check only

**C.O.D.:** Acceptable by telephone or mail. Payment from customer will be by cash, money order or cashier's check. We are sorry but we cannot accept personal checks for C.O.D.'s

**CONFIRMING ORDERS:** We would prefer that confirming orders not be sent after a telephone order has been placed. If company policy necessitates a confirming order, please mark "CONFIRMING" boldly on the order. If problems or duplicate shipments occur due to an order which is not properly marked, customers will be held responsible for any charges incurred, plus a 15% restock charge on returned parts.

**CREDIT CARDS:** WE ACCEPT MASTERCARD VISA AND AMERICAN EXPRESS.

**DATA SHEETS:** When we have data sheets in stock on devices we do supply them with the order.

**MHZ** electronics



(802) 242-8916  
2111 W. CAMELBACK ROAD  
PHOENIX, ARIZONA 85015

Toll Free Number  
800-528-0180  
(For orders only)

"All parts may be new or surplus, and parts may be substituted with comparable parts if we are out of stock of an item."

For information: 602-242-8916

# Advertisers check-off

... for literature, in a hurry — we'll rush your name to the companies whose names you "check-off"

Place your check mark in the space between name and number. Ex: Ham Radio  234

|                     |          |                     |          |
|---------------------|----------|---------------------|----------|
| A to Z Crystal      | 102      | Hy-Gain *           |          |
| Ace Comm.           | 103      | Icom                | 151, 302 |
| ACC                 | 305      | Independent Crystal | 152      |
| AEA                 | 304      | I. T. S.            | 153      |
| Advanced Receiver   |          | Jensen Tools        | 154      |
| Research            | 104      | KCS Elec.           | 155      |
| Alden Elec.         | 105      | KLM Elec.           | 156      |
| All Elec.           | 106      | Kantronics          | 157      |
| Alpha Delta         | 107      | Kenpro              | 158      |
| Alumia Tower        | 108      | Kenwood *           | 306      |
| Amateur-Wholesale   | 109      | Larsen              | 159      |
| ARRL                | 110      | Liberty Elec.       | 160      |
| Amidon              | 111      | Long's              | 161      |
| Anteck              | 112      | Lunar Elec.         | 162      |
| Antenna Dev. & Man. | 113      | MFJ                 | 163      |
| Applied Inv.        | 114      | MHz Elec.           | 164      |
| ATV Magazine        | 115      | Madison Elec.       | 165      |
| BMG Eng.            | 116      | Metheny             | 166      |
| Barker & Williamson | 117      | Mirage Comm.        | 167      |
| Barry *             |          | Morning Dist.       | 168      |
| Bilal               | 118      | NCG                 | 169      |
| Brookstone          | 119      | Nampa Satellite     | 170      |
| Buckmaster          | 120      | Nemal               | 171      |
| Butternut *         |          | Nuts & Volts        | 172      |
| Calvert Elec.       | 121      | P. B. Radio         | 173      |
| Ceco                | 122      | P. C. Elec. *       |          |
| C. I. A. *          |          | Phillips-Tech       | 174      |
| Clutterfree Modules | 124      | Pro-Search          | 175      |
| Coin Inter.         | 123      | RF Products         | 176      |
| Comm. Concepts      | 125      | Callbook            | 177      |
| Comm. Spec.         | 126      | Radio Expo *        |          |
| Comp. Trader        | 127      | Radiokit            | 178      |
| Contact East        | 128      | Radio Warehouse *   |          |
| Direct Video        | 129      | Random Access       | 179      |
| Dokay               | 130      | Satellite TV Mag.   | 180      |
| Doppler             | 131      | Spectronics *       |          |
| E. T. O. *          |          | Spectrum Inter.     | 181      |
| Elec. Spec.         | 132      | Spectrum West       | 182      |
| Encomm              | 133      | Spi-Ro Dist.        | 183      |
| Eng. Consulting     | 134      | Sunderland          |          |
| Fair Radio          | 135      | Software            | 184      |
| Ferritronics        | 136      | Tayco               | 185      |
| Flesher             | 137      | Telex Comm. *       |          |
| Fox-Tango           | 138      | Teltone             | 186      |
| Galaxy Elec.        | 139      | Ten-Tec *           |          |
| Gizmo Elec.         | 140      | Transleteronic      | 187      |
| Gould Elec. *       |          | Tri-Ex Tower        | 188      |
| Ham MasterTapes     | 141      | Triplet             | 301      |
| H. R. B.            | 142      | Ungar               | 189      |
| Ham Shack           | 143      | UNR-Rohn            | 191      |
| Hamtronics          | 144      | Vanguard Labs       | 192      |
| Handi-Tek           | 145      | Vector Elec.        | 193      |
| Heath               | 146      | VHF Shop            | 190      |
| Heil Sound          | 147      | Videosat            | 194      |
| Henry Radio         | 148, 149 | Vocom               | 195      |
| Hustler             | 150      | Western             | 196      |
|                     |          | Yaesu               | 197      |

\*Please contact this advertiser directly.

Limit 15 inquiries per request.

**September 1983**

Please use before October 31, 1983

Tear off and mail to  
HAM RADIO MAGAZINE — "check off"  
Greenville, N. H. 03048-0498

NAME .....

CALL .....

STREET .....

CITY .....

STATE.....ZIP.....

# SCHOOL DAZE

## SIGNAL ONE

|              |           |
|--------------|-----------|
| Milspec 1030 | \$4995.00 |
| ROBOT 800    | 447.00    |
| AEA MM2      | 149.00    |
| CK2          | 129.00    |
| HAL ST6K     | 229.00    |
| ST5000       | 209.00    |

## TOKYO HYPOWER

|              |        |
|--------------|--------|
| HC200 Tuner  | 89.00  |
| HC2000 Tuner | 289.00 |
| HL10160V Amp | 289.00 |
| HL30160V Amp | 249.00 |

## BELDEN CABLE

|                           |        |
|---------------------------|--------|
| 9258 RG8x                 | 19¢/ft |
| 8214 RG8 foam             | 39¢/ft |
| 8237 RG8                  | 36¢/ft |
| 8235 300 Ohm kW twinlead  | 20¢/ft |
| 8000 14 Ga. stranded ant. | 10¢/ft |
| 8267 RG213                | 46¢/ft |
| 8448 rotorcable           | 27¢/ft |
| 9405 heavy rotor cable    | 45¢/ft |

KDK 2030 2M FM.....259.00

SANTEC 144µP.....279.00

400µP.....299.00

ST7T.....230.00

JANEL, SHERWOOD..... 10% off list

DRAKE TR7A/RV75..... 1700.00

TR7A..... 1389.00

ROCKWELL KWM380..... 3995.00

QSL Holder or Coax Seal..... 2.00 ea

TCG 2.5A/1000PIV..... 19¢

BENCHER ST2

Chrome singlelever..... 45.00

Call Don for Sony Prices

BIRD 43 & elements..... Stock

ROBOT 1200C SSTV..... 1139.00

450C..... 789.00

800C..... 789.00

400C Kit..... 469.00

800C Kit..... 155.00

JERSEY Specialty

RG213.....29¢/ft

RG8X.....14¢/ft

AMPHENOL PL259

Silverplate..... 1.25

SURPLUS SALES

Resistors 1/4, 1/2, 1,

2 Watt..... 10¢ ea.

Caps to 1mFd, 100 V..... 25¢ ea

Tubes, Schematics, Meters,

Switches, Coils, Connectors, and a

batch more in stock

Madison-Hal: Trade up your old VIC20,

AEA, software for new Hal CT2200,

KB2100 system, \$900.00 difference,

fob Houston.  165

# MADISON

## Electronics Supply

1508 McKinney

Houston, Texas 77010

713-658-0268

TOLL FREE - ORDERS ONLY

1-800-231-3057

# Advertisers iNdex

|                                          |                                |
|------------------------------------------|--------------------------------|
| A to Z Crystal Co.                       | 44                             |
| Ace Communications                       | 60                             |
| Advanced Receiver Research               | 97                             |
| Alden Electronics                        | 11                             |
| All Electronics Corp.                    | 60                             |
| Alpha Delta Communications               | 66                             |
| Aluma Tower Co.                          | 82                             |
| Amateur-Wholesale Electronics            | 94                             |
| American Radio Relay League              | 77                             |
| Amidon Associates                        | 54                             |
| Anteck, Inc.                             | 89                             |
| Antenna Development & Man.               | 31                             |
| Applied Invention                        | 37                             |
| ATV Magazine                             | 87                             |
| BMG Engineering                          | 79                             |
| Barker & Williamson                      | 90                             |
| Barry Electronics                        | 80                             |
| Bilal Co.                                | 54                             |
| Brookstone                               | 79                             |
| Buckmaster Publishing                    | 54, 66                         |
| Butternut Electronics                    | 77                             |
| Calvert Electronics, Inc.                | 71                             |
| Ceco Communications                      | 17                             |
| Central Intelligence Agency              | 9                              |
| Clutterfree Modules                      | 78                             |
| Coin International, Inc.                 | 60                             |
| Communications Concepts                  | 97                             |
| Communications Specialists               | 91                             |
| Computer Trader                          | 80                             |
| Contact East                             | 86                             |
| Direct Video Sales                       | 37                             |
| Dokay Computer Products, Inc.            | 64, 65                         |
| Doppler Systems                          | 51                             |
| Electronic Specialists                   | 37                             |
| Encomm, Inc.                             | 37                             |
| Engineering Consulting                   | 87                             |
| Fair Radio Sales                         | 44                             |
| Ferritronics, Ltd.                       | 17                             |
| Flesher Corp.                            | 79                             |
| Fox Tango Corp.                          | 82                             |
| Galaxy Electronics                       | 86                             |
| Gizmo Electronics                        | 66                             |
| Gould Electronics                        | 89                             |
| Ham MasterTapes                          | 19                             |
| Ham Radio's Bookstore                    | 54, 74, 76, 82, 86, 87, 90, 97 |
| The Ham Shack                            | 44                             |
| Hamtronics, N.Y.                         | 46, 47                         |
| Handi-Tek                                | 92                             |
| Heath Co.                                | 23                             |
| Heil Sound                               | 44                             |
| Henry Radio                              | 58, 59                         |
| Hustler, Inc.                            | 114                            |
| Icom America, Inc.                       | Cover II                       |
| Independent Crystal Supply Company       | 92                             |
| International Telecommunications Systems | 78                             |
| Jensen Tools                             | 54                             |
| KCS Electronics Corp.                    | 51                             |
| KLM Electronics, Inc.                    | 13                             |
| Kantronics, Inc.                         | 53                             |
| Kenpro                                   | 19                             |
| Trio-Kenwood Communications              | 2, Cover IV                    |
| Larsen Electronics                       | 6                              |
| Liberty Electronics                      | 66                             |
| Long's Electronics                       | 38, 39                         |
| Lunar Electronics                        | 74                             |
| MFJ Enterprises                          | 100-109                        |
| MHz Electronics                          | 110                            |
| Madison Electronics                      | 80                             |
| The Metheny Corp.                        | 79                             |
| Mirage Communications Equipment, Inc.    | 76                             |
| Morning Distributing, Inc.               | 17                             |
| NCG                                      | 82                             |
| Nampa Satellite Receiver Systems         | 51                             |
| Nemal Electronics                        | 77                             |
| Nuts & Volts Magazine                    | 44                             |
| P. B. Radio                              | 40                             |
| P. C. Electronics                        | 51                             |
| Phillips-Tech Electronics                | 93                             |
| Pro-Search Electronics                   | 53                             |
| RF Products                              | 53                             |
| Radio Amateur Callbook                   | 77                             |
| Radio Expo                               | 90                             |
| Radiokit                                 | 54                             |
| Radio Warehouse                          | 19                             |
| Random Access, Inc.                      | 74                             |
| Satellite TV Magazine                    | 51                             |
| Spectronics                              | 57                             |
| Spectrum International, Inc.             | 86                             |
| Spectrum West                            | 79                             |
| Spi-Ro Distributing                      | 66                             |
| Sunderland Software                      | 80                             |
| Tayco Communications                     | 25                             |
| Telex Communications                     | 92                             |
| Teltone Corp.                            | 113                            |
| Ten-Tec                                  | 86                             |
| Transleteronic, Inc.                     | 87                             |
| Tri-Ex Tower Corp.                       | 26                             |
| Ungar                                    | 66, 80                         |
| UNR-Rohn                                 | 60                             |
| Vanguard Labs                            | 40                             |
| Vector Electronic Co.                    | 69                             |
| The VHF Shop                             | 80                             |
| Videosat, Inc.                           | 99                             |
| Vocom Products                           | 60                             |
| Western Electronics                      | Cover III                      |
| Yaesu Electronics Corp.                  |                                |



# ham radio Reader Service

For literature or more information, circle the appropriate number on this card, affix postage and send to us. We'll hustle your name and address to the companies you're interested in.

101 113 125 137 149 161 173 185 197 209 221 233 245 257 269 281 293 305 317 329 341  
102 114 126 138 150 162 174 186 198 210 222 234 246 258 270 282 294 306 318 330 342  
103 115 127 139 151 163 175 187 199 211 223 235 247 259 271 283 295 307 319 331 343  
104 116 128 140 152 164 176 188 200 212 224 236 248 260 272 284 296 308 320 332 344  
105 117 129 141 153 165 177 189 201 213 225 237 249 261 273 285 297 309 321 333 345  
106 118 130 142 154 166 178 190 202 214 226 238 250 262 274 286 298 310 322 334 346  
107 119 131 143 155 167 179 191 203 215 227 239 251 263 275 287 299 311 323 335 347  
108 120 132 144 156 168 180 192 204 216 228 240 252 264 276 288 300 312 324 336 348  
109 121 133 145 157 169 181 193 205 217 229 241 253 265 277 289 301 313 325 337 349  
110 122 134 146 158 170 182 194 206 218 230 242 254 266 278 290 302 314 326 338 350  
111 123 135 147 159 171 183 195 207 219 231 243 255 267 279 291 303 315 327 339  
112 124 136 148 160 172 184 196 208 220 232 244 256 268 280 292 304 316 328 340

*Limit 15 inquiries per request.*

NAME \_\_\_\_\_ CALL \_\_\_\_\_

ADDRESS \_\_\_\_\_

CITY \_\_\_\_\_ STATE \_\_\_\_\_ ZIP \_\_\_\_\_

Please use before October 31, 1983

**September 1983**

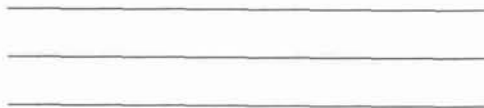

AFFIX POSTAGE  
OR  
POST OFFICE  
WILL NOT  
DELIVER

**ham**  
**radio**  
*magazine*

READER SERVICE CENTER  
P.O. BOX 358  
ARLINGTON, MA 02174

ATTN: Reader Service Dept.

# Grab a fistful of TEN-TEC's new 2 meter FM talkie

it has features never  
before available in  
one handheld, it's  
made in the USA  
and it's  
priced right!

## COMPARE TENNESSEE TECHNOLOGY WITH THE OTHERS...

### Do their handhelds have memory lockout?

Exclusive memory lockout on the TEN-TEC 2591 allows scanner to temporarily bypass channels for quick lockout of busy frequencies yet retain them in memory for normal operation on demand.

### Do theirs store transmit offset?

The 10 memories of the 2591 allow stored offset for easiest operation. And memory channel 0 accepts any non-standard offset.

### Do theirs offer selectable SKIP or HOLD?

When scanning with the 2591, choose HOLD to stop and stay on a busy frequency. Choose SKIP to stop for several seconds and continue.

### Do theirs offer modifiable Band Scan without complete reprogramming?

With the 2591 you can scan any section of the band with user defined upper and lower limits in steps of 5, 10, 15, 25, or 30 kHz. Change step size, upper and lower limits independently. Manual Scan also, up or down, in 5 kHz steps.

### Do theirs have Quick-Release NI-CAD Battery Pack?

The 2591 battery pack slides off easily, yet is secure in use, has a heavy duty 450 mAH rating at 8.4v, and the 2591 has capacitive memory retention to permit pack changing without reprogramming.

## THE TEN-TEC 2591 HAS ALL THE RIGHT FEATURES...

- **Memory Scanner scans only programmed channels** and has user selectable HOLD or SKIP
- **Selectable 2.5 Watts or 300 Milliwatts power**, top panel switched
- **Extended Frequency Coverage—143.5 to 148.995 MHz.** Covers full Amateur Band plus some CAP and MARS frequencies.
- **4-Digit LCD Readout with Switchable Back Light**—large, easy-to-read digits, selectable for frequency or memory channel number.
- **Key-Pad Frequency and Function Control**—16 key dual tone encoder
- **Dual Function LED**—shows battery status and transmit mode.
- **Electret Microphone** plus separate speaker for superior audio.
- **Compact, Lightweight, Complete**—easy to handle and rugged. Standard equipment includes flexible antenna with BNC connector, AC charger, belt clip, connectors for mike and speaker. Options include: adaptor pack for +12 VDC mobile operation, speaker/mike, 25 watt power amplifier, leather case, desk charger, subaudible tone module, and spare NI-CAD pack.

**DESIGNED AND MANUFACTURED IN TENNESSEE** and it carries the famous TEN-TEC 1 year warranty. See your dealer for the best in 2 meter FM—the TEN-TEC 2591. Or write for information to TEN-TEC, Inc., Sevierville, TN 37862.



TEN-TEC

# Hustler Tribander 3-TBA

**The Rugged, Reliable 10, 15, and 20-Meter Yagi You've Been Waiting for Is Now Available.**

This exciting new tribander sets the pace for dependable performance with its two in one trap design — and the solid construction you've come to expect from Hustler. In fact, its durable design is partially based on concepts used in the time-tested and world-renowned Hustler 4-Band Trap Vertical.

**The 3-TBA is the smallest full-featured tribander available today.** It offers excellent front to back ratio and SWR at resonance. Plus, it is engineered to provide the widest possible bandwidths with superior power handling capacity.

A special heavy-duty saddle prevents mechanical distortion. Although light enough to ship UPS, and enable use of smaller, less expensive rotors, the 3-TBA can manage windloads up to 100 MPH! Its turning radius is only 14 feet.

All in all, you can't surpass the Hustler 3-TBA for top triband quality: Hustler — still the standard of performance.

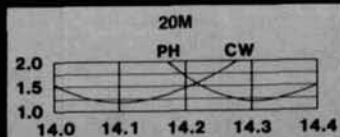
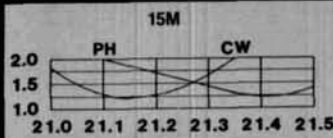
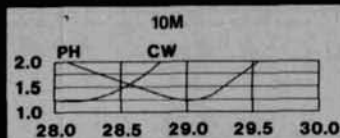

For more information on this and other fine Hustler amateur radio products, contact:

#### Specifications:

- Gain 8dB
- F/B Ratio 28dB - (20M)
- Power Rating 1KW at Antenna
- Boom Length 14'
- Longest Element 24'9"
- Turning Radius 14'2-1/2"
- Wind Surface 5.7 Sq. Feet
- Wind Survival 100 MPH
- Weight 40 lbs.

## HUSTLER®

3275 North "B" Avenue  
Kissimmee, Florida 32741

An AMATRON Company

# YAESU FT-726R TRIBANDER

NEW GALAXIES OF PERFORMANCE ON VHF AND UHF

FULL DUPLEX!!

SATELLITES!!

SCATTER!!

M!!

EME!!



The New Yaesu FT-726R Tribander is the world's first multiband, multimode Amateur transceiver capable of full duplex operation. Whether you're interested in OSCAR, moonbounce, or terrestrial repeaters, you owe yourself a look at this one-of-a-kind technological wonder!

#### Multiband Capability

Factory equipped for 2 meter operation, the FT-726R is a three-band unit capable of operation on 10 meters, 6 meters, and/or two segments of the 70 cm band (430-440 or 440-450 MHz), using optional modules. The appropriate repeater shift is automatically programmed for each module. Other bands pending.

#### Advanced Microprocessor Control

Powered by an 8-bit Central Processing Unit, the ten-channel memory of the FT-726R stores both frequency and mode, with pushbutton transfer capability to either of two VFO registers. The synthesized VFO tunes in 20 Hz steps on SSB/CW, with selectable steps on FM. Scanning of the band or memories is provided.

#### Full Duplex Option

The optional SU-726 module provides a second, parallel IF strip, thereby allowing full duplex crossband satellite work. Either the transmit or receive frequency may be varied during transmission, for quick zero-beat on another station or for tracking Doppler shift.

#### High Performance Features

Borrowing heavily from Yaesu's HF transceiver experience, the FT-726R comes equipped with a speech processor, variable receiver bandwidth, IF shift, all-mode squelch, receiver audio tone control, and an IF noise blanker. When the optional XF-455MC CW filter is installed, CW Wide/Narrow selection is provided. Convenient rear panel connections allow quick interface to your station audio, linear amplifier, and control lines.

Leading the way into the space age of Ham communications, Yaesu's FT-726R is the first VHF/UHF base station built around modern-day requirements. If you're tired of piecing together converters, transmitter strips, and relays, ask your Authorized Yaesu Dealer for a demonstration of the exciting new FT-726R, the rig that will expand your DX horizons!

Price And Specifications Subject To  
Change Without Notice Or Obligation

✓ 197

YAESU  
*The radio.*



483

YAESU ELECTRONICS CORPORATION 6851 Walthall Way, Paramount, CA 90723 • (213) 633-4007  
YAESU CINCINNATI SERVICE CENTER 9070 Gold Park Drive, Hamilton, OH 45011 • (513) 874-3100

# Digital DX-terity...



**General coverage, Superior dynamic range, 2 VFO's, 8 memories, Scan, Notch... COMPACT!**

## TS-430S

The TS-430S combines the ultimate in compact styling with advanced circuit design and performance. An all solid-state SSB, CW, and AM transceiver, with FM optional, covering the 160-10 meter Amateur bands, it also incorporates a 150 kHz-30 MHz general coverage receiver having a superior dynamic range, dual digital VFO's, 8 memories, memory scan, programmable band scan, IF shift, notch filter, all-mode squelch, and built-in speech processor.

### TS-430S FEATURES:

- **160-10 meter operation, with general coverage receiver**  
With 160-10 meter Amateur band coverage, including WARC 30, 17, and 12 meter bands, it also features a 150 kHz-30 MHz general coverage receiver. Innovative UP-conversion digital PLL circuit, for superior frequency stability and accuracy. UP/DOWN band switches for Amateur bands or 1-MHz steps across entire 150 kHz-30 MHz range. Two digital VFO's continuously tuneable from band to band. Band information output on rear panel.
- **USB, LSB, CW, AM, with optional FM**  
Operates on USB, LSB, CW, and AM, with optional FM, internally installed. AGC time constant automatically selected by mode.
- **Compact, lightweight design**  
Measures only 10-5/8 (270) W x 3-3/4 (96) H x 10-7/8 (275) D, inches (mm), weighs only 14.3 lbs. (6.5 kg.).
- **Superior receiver dynamic range**  
Use of 2SK125 junction-type FET's in the Dyna-Mix high sensitivity, balanced, direct mixer circuit provides superior dynamic range.
- **10-Hz step dual digital VFO's**  
10-Hz step dual digital VFO's operate independently, include band and mode information. Different band and mode cross operation possible. Dial torque adjustable. STEP switch for tuning in 10-Hz or 100-Hz steps. A=B switch quickly shifts "B" VFO

to the same frequency and mode as "A" VFO, or vice-versa. VFO LOCK switch provided. RIT control tunes VFO or memory. UP/DOWN manual scan possible using optional microphone.

- **Eight memories store frequency, mode, and band data**  
Memories store frequency, mode, and band data. Eighth memory stores receive and transmit frequencies independently. M.CH switch for operation of memory as independent VFO, or fixed frequency.
- **Lithium battery memory back-up**  
Estimated five-year life.
- **Memory scan**  
Scans memories in which data is stored.
- **Programmable automatic band scan**  
Scans programmed band width. Scan speed adjustable. HOLD switch interrupts band or memory scan.
- **IF shift circuit for minimum QRM.**  
IF passband may be moved to place interfering signals outside the passband, for best interference rejection.
- **Tuneable notch filter built-in**  
Deep, sharp, tuneable, audio notch filter.
- **Narrow-wide filter selection**  
NAR-WIDE switch for IF filter selection on SSB, CW, or AM, when optional filters are installed. (2.4 kHz IF filter built-in.)
- **Speech processor built-in**  
Improves intelligibility, increases average "talk-power".
- **Fluorescent tube digital display**  
Indicates frequency to 100 Hz (10 Hz modifiable).
- **All solid-state technology**  
Input rated 250 W PEP on SSB, 200 W DC on CW, 120 W on FM (optional), 60 W on AM. Built-in cooling fan, multi-circuit final protection. Operates on 12 VDC, or 120/220/240 VAC with optional PS-430 AC power supply.
- **All-mode squelch circuit, built-in**
- **Noise blanker, built-in**
- **RF attenuator (20 dB)**
- **Vox circuit, plus semi break-in with side-tone**



### Optional AT-250 Automatic Antenna Tuner

Designed to match the TS-430S in size, color, and appearance. Functionally compatible with any HF transceiver of 200 watts PEP or lower. (Requires manual bandswitching.)

- Covers 160-10 meter incl. WARC
- ABC Automatic Band Changing System (when used with TS-430S)
- SWR/Power meter
- 4 antenna terminals
- Built-in AC Power Supply.

### Other optional accessories:

- PS-430 compact AC power supply.
- PS-30 or KPS-21 AC power supplies.
- SP-430 external speaker.
- MB-430 mobile mounting bracket.
- AT-130 compact antenna tuner, 80-10 m incl. WARC.
- FM-430 FM unit.
- YK-88C (500 Hz) or YK-88CN (270 Hz) CW filters.
- YK-88SN (1.8 kHz) narrow SSB filter.
- YK-88A (6 kHz) AM filter.
- MC-42S UP/DOWN hand microphone.
- MC-60A deluxe desk microphone, UP/DOWN switch.
- MC-80 UP/DOWN desk microphone.

More information on the TS-430S is available from all authorized dealers of Trio-Kenwood Communications, 1111 West Walnut Street, Compton, California 90220.

# KENWOOD

...pacesetter in amateur radio

Specifications and prices are subject to change without notice or obligation.